



HAL
open science

Optimal design of manufacturing systems with ergonomics : application to assembly lines

Mohammed Amine Abdous

► **To cite this version:**

Mohammed Amine Abdous. Optimal design of manufacturing systems with ergonomics : application to assembly lines. Other. Université de Lyon; Universita degli Sudi di Padova, 2019. English. NNT : 2019LYSEM034 . tel-02953642

HAL Id: tel-02953642

<https://theses.hal.science/tel-02953642>

Submitted on 30 Sep 2020

HAL is a multi-disciplinary open access archive for the deposit and dissemination of scientific research documents, whether they are published or not. The documents may come from teaching and research institutions in France or abroad, or from public or private research centers.

L'archive ouverte pluridisciplinaire **HAL**, est destinée au dépôt et à la diffusion de documents scientifiques de niveau recherche, publiés ou non, émanant des établissements d'enseignement et de recherche français ou étrangers, des laboratoires publics ou privés.

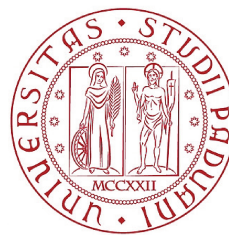

N° D'ORDRE NNT : 2019LYSEM034

THESE de DOCTORAT DE L'UNIVERSITE DE LYON
OPÉRÉE AU SEIN DE
L'Ecole des Mines de Saint-Etienne
délivrée en partenariat international avec l'Université de Padoue en Italie

Ecole Doctorale N° 488
Sciences, Ingénierie, Santé

Spécialité de doctorat : GÉNIE INDUSTRIEL

SOUTENUE PUBLIQUEMENT LE 16/12/2019, PAR :

Mohammed-Amine ABDOUS

**Optimal design of manufacturing systems with
ergonomics: application to assembly lines**

Devant le jury composé de :

<i>Daria Battini</i>	<i>Professeur, Université de Padoue, Italie</i>	<i>Co-directeurice de thèse</i>
<i>Lyes Benyoucef</i>	<i>Professeur, Aix-Marseille Université, France</i>	<i>Rapporteur</i>
<i>Sandrine Berger-Douce</i>	<i>Professeur, Mines Saint-Étienne, France</i>	<i>Co-directeurice de thèse</i>
<i>Xavier Delorme</i>	<i>Professeur, Mines Saint-Étienne, France</i>	<i>Directeur de thèse</i>
<i>Alexandre Dolgui</i>	<i>Professeur, IMT Atlantique, France</i>	<i>Rapporteur (Président)</i>
<i>Matteo Mario Savino</i>	<i>Université du Sannio, Italie</i>	<i>Examineur</i>

Spécialités doctorales	Responsables :	Spécialités doctorales	Responsables
SCIENCES ET GENIE DES MATERIAUX	K. Wolski Directeur de recherche	MATHEMATIQUES APPLIQUEES	O. Roustant, Maître-assistant
MECANIQUE ET INGENIERIE	S. Drapier, professeur	INFORMATIQUE	O. Boissier, Professeur
GENIE DES PROCEDES	F. Gruy, Maître de recherche	SCIENCES DES IMAGES ET DES FORMES	JC. Pinoli, Professeur
SCIENCES DE LA TERRE	B. Guy, Directeur de recherche	GENIE INDUSTRIEL	N. Absi, Maître de recherche
SCIENCES ET GENIE DE L'ENVIRONNEMENT	D. Graillot, Directeur de recherche	MICROELECTRONIQUE	Ph. Lalevée, Professeur

EMSE : Enseignants-chercheurs et chercheurs autorisés à diriger des thèses de doctorat (titulaires d'un doctorat d'Etat ou d'une HDR)

ABSI	Nabil	MR	Génie industriel	CMP
AUGUSTO	Vincent	CR	Image, Vision, Signal	CIS
AVRIL	Stéphane	PR2	Mécanique et ingénierie	CIS
BADEL	Pierre	MA(MDC)	Mécanique et ingénierie	CIS
BALBO	Flavien	PR2	Informatique	FAYOL
BASSEREAU	Jean-François	PR	Sciences et génie des matériaux	SMS
BATTON-HUBERT	Mireille	PR2	Sciences et génie de l'environnement	FAYOL
BEIGBEDER	Michel	MA(MDC)	Informatique	FAYOL
BLAYAC	Sylvain	MA(MDC)	Microélectronique	CMP
BOISSIER	Olivier	PR1	Informatique	FAYOL
BONNEFOY	Olivier	PR	Génie des Procédés	SPIN
BORBELY	Andras	MR(DR2)	Sciences et génie des matériaux	SMS
BOUCHER	Xavier	PR2	Génie Industriel	FAYOL
BRODHAG	Christian	DR	Sciences et génie de l'environnement	FAYOL
BRUCHON	Julien	MA(MDC)	Mécanique et ingénierie	SMS
CAMEIRAO	Ana	MA(MDC)	Génie des Procédés	SPIN
CHRISTIEN	Frédéric	PR	Science et génie des matériaux	SMS
DAUZERE-PERES	Stéphane	PR1	Génie Industriel	CMP
DEBAYLE	Johan	MR	Sciences des Images et des Formes	SPIN
DEGEORGE	Jean-Michel	MA(MDC)	Génie industriel	Fayol
DELAFOSSE	David	PR0	Sciences et génie des matériaux	SMS
DELORME	Xavier	MA(MDC)	Génie industriel	FAYOL
DESRAYAUD	Christophe	PR1	Mécanique et ingénierie	SMS
DJENIZIAN	Thierry	PR	Science et génie des matériaux	CMP
BERGER-DOUCE	Sandrine	PR1	Sciences de gestion	FAYOL
DRAPIER	Sylvain	PR1	Mécanique et ingénierie	SMS
DUTERTRE	Jean-Max	MA(MDC)		CMP
EL MRABET	Nadia	MA(MDC)		CMP
FAUCHEU	Jenny	MA(MDC)	Sciences et génie des matériaux	SMS
FAVERGEON	Loïc	CR	Génie des Procédés	SPIN
FEILLET	Dominique	PR1	Génie Industriel	CMP
FOREST	Valérie	MA(MDC)	Génie des Procédés	CIS
FRACZKIEWICZ	Anna	DR	Sciences et génie des matériaux	SMS
GARCIA	Daniel	MR(DR2)	Sciences de la Terre	SPIN
GAVET	Yann	MA(MDC)	Sciences des Images et des Formes	SPIN
GERINGER	Jean	MA(MDC)	Sciences et génie des matériaux	CIS
GOEURIOT	Dominique	DR	Sciences et génie des matériaux	SMS
GONDRAN	Natacha	MA(MDC)	Sciences et génie de l'environnement	FAYOL
GONZALEZ FELIU	Jesus	MA(MDC)	Sciences économiques	FAYOL
GRAILLOT	Didier	DR	Sciences et génie de l'environnement	SPIN
GROSSEAU	Philippe	DR	Génie des Procédés	SPIN
GRUY	Frédéric	PR1	Génie des Procédés	SPIN
HAN	Woo-Suck	MR	Mécanique et ingénierie	SMS
HERRI	Jean Michel	PR1	Génie des Procédés	SPIN
KERMOUCHE	Guillaume	PR2	Mécanique et Ingénierie	SMS
KLOCKER	Helmut	DR	Sciences et génie des matériaux	SMS
LAFOREST	Valérie	MR(DR2)	Sciences et génie de l'environnement	FAYOL
LERICHE	Rodolphe	CR	Mécanique et ingénierie	FAYOL
MALLIARAS	Georges	PR1	Microélectronique	CMP
MOLIMARD	Jérôme	PR2	Mécanique et ingénierie	CIS
MOUTTE	Jacques	CR	Génie des Procédés	SPIN
NAVARRO	Laurent	CR		CIS
NEUBERT	Gilles			FAYOL
NIKOLOVSKI	Jean-Pierre	Ingénieur de recherche	Mécanique et ingénierie	CMP
NORTIER	Patrice	PR1	Génie des Procédés	SPIN
O CONNOR	Rodney Philip	MA(MDC)	Microélectronique	CMP
PICARD	Gauthier	MA(MDC)	Informatique	FAYOL
PINOLI	Jean Charles	PR0	Sciences des Images et des Formes	SPIN
POURCHEZ	Jérémy	MR	Génie des Procédés	CIS
ROUSSY	Agnès	MA(MDC)	Microélectronique	CMP
ROUSTANT	Olivier	MA(MDC)	Mathématiques appliquées	FAYOL
SANAUR	Sébastien	MA(MDC)	Microélectronique	CMP
SERRIS	Eric	IRD		FAYOL
STOLARZ	Jacques	CR	Sciences et génie des matériaux	SMS
TRIA	Assia	Ingénieur de recherche	Microélectronique	CMP
VALDIVIESO	François	PR2	Sciences et génie des matériaux	SMS
VIRICELLE	Jean Paul	DR	Génie des Procédés	SPIN
WOLSKI	Krzysztof	DR	Sciences et génie des matériaux	SMS
XIE	Xiaolan	PR0	Génie industriel	CIS
YUGMA	Gallian	CR	Génie industriel	CMP

Optimal design of manufacturing systems with ergonomics: application to assembly lines

Author

Mohammed-Amine ABDOUS

Supervisor

Daria Battini, Full Professor, University of Padua, Italy

Sandrine Berger-Douce, Full Professor, Mines Saint-Étienne, France

Xavier Delorme, Full Professor, Mines Saint-Étienne, France

Contact information

École des Mines de Saint-Étienne,
158 cours Fauriel, F-42023 Saint-Étienne cedex 2, France

Email address: webmaster@emse.fr

URL: <https://www.mines-stetienne.fr/>

Telephone: +33 (0)4 77 42 01 23

Fax: +33 (0)4 77 42 00 00

This work is lovingly dedicated to my mother, nothing would have been possible without you.

To my father, my example, his encouragement and unconditional support have sustained me throughout my life.

My deepest gratitude to my caring and loving soulmate, to Layla, your love and daily support make my life happy in so many ways, thank you for being here for me each day and night.

To my special little sister Leila, for her moral support, love, and care.

Acknowledgements

Undertaking this Ph.D. has been an inspiring experience, and it would not have been possible without the support and guidance that I received from many persons, and without a stimulating environment to combine scientific and human values.

First of all, I am endlessly thankful to my supervisor, Prof. Xavier Delorme, for providing me the opportunity to expand my boundaries, for his ideas, his support, and the long discussions that have taken us far beyond manufacturing systems. I would like to thank Prof. Daria Battini for supporting me during these three years, and for providing guidance and feedback throughout this project. Also, I would like to thank Prof. Sandrine Berger-Douce, for her advice, encouragement, and the interdisciplinary vision that she was able to bring to this work.

I express my deep gratitude to the members of the jury, who agreed to evaluate this work: Prof. Alexandre Dolgui, Prof. Lyes Benyoucef, and Assoc. Prof. Matteo Mario Savino.

I convey my sincerest appreciation to the research group from Mines Saint-Etienne and the University of Padua, especially Audrey Cerqueus, Paolo Gianessi, and Fabio Sgarbossa. Also, I would like to say thank you to Mireille Batton-Hubert, Martina Calzavara, Frédéric Grimaud and Damien Lamy. A very special thanks to the administrative staff, Christine Exbrayat, Fatima Haimad, Joëlle Guelon, Amandine Hirondeau, and Jean-François Tchebanoff for their help.

I greatly appreciate the support received throughout the collaborative work undertaken with the University of Padua in Italy, I am very grateful to Serena Finco and Valentina Visentin for the fruitful collaborative work and valuable discussions. My great thanks go to my friends Mahdi El Alaoui El Abdellaoui, Oussama Masmoudi, and Muhammad Khakim Habibi who were always so helpful in numerous ways. I cannot forget to thank my colleagues that I met at different times and places during the preparation of this work: Ayoub, Francesco, Ilenia, Niloofar, Nour, Marco, Rachid, Riccardo, Sawssen, Silvia, Stéphanie, and Zineb.

Finally, I greatly appreciate and acknowledge the support received from the peoples who mean the world to me, my mother and my father, my beloved Layla, and my sister, I don't imagine a life without your love. I would like to express my gratitude to my grandparents,

and to my uncles and aunts. Last but by no means least, special thanks and gratitude to Kamal and Samira Hassani for their valuable help, and for my uncles Belkacem and M'Hammed Abdous for their support and for the proofreading of the manuscript. I consider myself the luckiest in the world to have such a supportive family.

Mohammed-Amine ABDOUS

Contents

List of Figures	xv
List of Tables	xvii
Introduction	2
1 Ergonomics in manufacturing systems	6
1.1 Introduction	6
1.2 Ergonomics	8
1.2.1 Ergonomics in Operation Management	8
1.2.2 Corporate Social Responsibility and financial performance	9
1.3 Importance of ergonomics in manufacturing systems	9
1.3.1 Ergonomics and performance of manufacturing systems	10
1.3.2 The level of automation	11
1.3.3 Ergonomics in the Industry 4.0	11
1.3.4 Contribution of operations research	13
1.4 Ergonomic assessment methods	14
1.4.1 Qualitative assessment methods	15
1.4.2 Semi-quantitative assessment methods	15
1.4.2.1 Rapid Upper Limb Assessment (RULA)	16
1.4.2.2 Rapid Entire Body Assessment (REBA)	16
1.4.2.3 Occupational Repetitive Action (OCRA)	16
1.4.2.4 Rating of perceived exertion and discomfort	17
1.4.2.5 Snook Tables	17
1.4.3 Quantitative assessment methods	17
1.4.3.1 NIOSH equation	17
1.4.3.2 Energy expenditure and metabolic rate	18
1.4.3.3 Rest allowance	19
1.4.3.4 Fatigue and recovery models	20
1.4.3.5 Virtual and digital human simulation	21
1.4.3.6 Vibration assessment	22

1.5	Conclusion	23
2	Line Design and Balancing Problems	26
2.1	Introduction	26
2.2	Assembly Line Balancing Problem	27
2.2.1	Simple Assembly Line Balancing Problem	28
2.2.1.1	Integer programming formulation of SALBP	29
2.2.1.2	Example of SALBP-1	30
2.3	Main characteristics of assembly lines	31
2.3.1	Number of products models	31
2.3.1.1	Single model	31
2.3.1.2	Multi-model	31
2.3.1.3	Mixed model	32
2.3.2	Line layout	32
2.3.3	Operations characteristics	33
2.3.3.1	Deterministic times	33
2.3.3.2	Stochastic times	33
2.3.3.3	Dynamic times	34
2.3.4	Equipment selection	34
2.3.4.1	Assembly line design with equipment costs	34
2.3.4.2	Transfer line	35
2.3.4.3	Robotic Assembly Line Balancing Problem	35
2.4	Solutions methods	36
2.4.1	Exact methods	36
2.4.2	Approximate methods	37
2.4.2.1	Heuristics	37
2.4.2.2	Metaheuristics	37
2.5	Multi-objective approaches for line balancing	39
2.5.1	Multi-objective solutions methods	39
2.5.1.1	Aggregative methods	39
	Weighted sum	40
	Lexicographic methods	40
	Goal programming approaches	40
2.5.1.2	Pareto-optimal methods	40
2.5.1.3	Interactive multiobjective optimization	42
2.6	Ergonomics in line balancing	42
2.6.1	Semi-quantitative methods	42
2.6.2	Quantitative methods	43
2.7	The importance of reducing physical fatigue	44
2.7.1	Physical fatigue in assembly lines	45

2.7.2	Fatigue and recovery evolution	46
2.8	Conclusion	46
3	Simple Assembly Line Balancing Problem with ergonomics	50
3.1	Introduction	50
3.2	Definition of the fatigue and recovery model	51
3.2.1	Fatigue and recovery data and assumptions	52
3.2.2	Objective function	52
3.3	Problem formulation	55
3.3.1	Mixed-Integer Nonlinear Programming	55
3.3.2	Linearization technique	56
3.3.2.1	Lower bound on the ergonomics level	56
3.4	Iterative Dichotomic Search	58
3.4.1	Example of exact resolution	59
3.5	Iterative Local Search	60
3.5.1	Pool generation	61
3.5.2	Local Search	63
3.6	Numerical experiments dataset	65
3.6.1	Experimental conditions	66
3.6.1.1	Comparison formulations	66
3.6.2	Data and characteristics of instances	67
3.6.2.1	Instances selection	67
3.6.2.2	Workers characteristics	68
3.6.2.3	Operation physical load	68
3.6.2.4	Transfer time	69
3.7	Numerical results	69
3.7.1	Exact resolution and bounds	69
3.7.2	Proportion of instances solved optimally	70
3.7.3	Results analysis and algorithms comparison	70
3.8	Conclusion	75
4	Multi-objective design of assembly line with ergonomics and cost	78
4.1	Introduction	78
4.2	Assembly Line Design Problem with ergonomics	79
4.2.1	Problem statement and hypothesis	79
4.3	Multi-objective formulation	80
4.3.1	Problem notations	80
4.3.2	Ergonomics level	81
4.3.3	Multi-objective Mixed-Integer Nonlinear Programming	81
4.3.4	Linearization of takt time constraint	82

4.3.5	Linearization of the objective function	83
4.3.6	Mixed-Integer Linear Programming	84
4.4	Multi-objective algorithm	85
4.4.1	ϵ -constraint framework	86
4.4.2	Iterative Dichotomic Search with cost constraint	87
4.4.3	Example of resolution	88
4.5	Numerical experiments	90
4.5.1	Experimental conditions	90
4.5.2	Instances characteristics	90
4.5.3	Optimal Pareto front	91
4.5.4	Instances with an approximation of the Pareto front	93
4.5.4.1	Gap in hyper-area	93
4.5.4.2	Approximation results	94
4.6	Conclusion	96
5	Methodology for line design with ergonomics: illustration on two industrial case studies	98
5.1	Introduction	98
5.2	Main steps for assembly line design with ergonomics	99
5.2.1	Product analysis and process planning	99
5.2.1.1	Operations processing time	99
5.2.1.2	Technological constraints and precedence graph	100
5.2.1.3	Takt time	100
5.2.1.4	Input data for operations physical load	100
5.2.2	Line configuration	101
5.2.3	Line re-configuration	102
5.2.4	Operational planning	103
5.3	Assembly line of agricultural mulchers	103
5.3.1	Product and process analysis	104
5.3.2	Line configuration	105
5.3.3	Solution analysis	106
5.3.4	Simulation of the optimal solution	107
5.4	Assembly line of condensing boiler	108
5.4.1	Product and process analysis	108
5.4.2	Line configuration	109
5.4.3	Solution analysis	110
5.4.4	Simulation of the optimal solution	110
5.5	Conclusion	113
	Conclusion	113

Contents	xiii
Annex A: Publication	139
Annex B	141

List of Figures

1.1	Physical ergonomics assessment methods	23
2.1	Precedence graph (Scholl and Becker, 2006)	27
2.2	Solution of SALBP-1	30
3.1	Working and recovery time for two successive takt time	53
3.2	Evolution of the muscular capacity for a worker in workstation k in the work and recovery time for two successive takt time	54
3.3	The evolution of the upper and lower bounds and the target in the execution of IDS with the solution of SALBP-1 as a starting solution; instance Hahn, with minimal adjusted takt time and transfer time of 5%	60
3.4	Percentage of instance for which the optimal solution was found according to the number of operations n	71
3.5	Box plot describing the Gap (%) of all algorithms with the best found upper bound; box limits indicate the Q1 and Q3; whiskers extend 1.5 times the interquartile range; center lines show the medians; diamonds represent the averages; circles represent outliers	72
3.6	Box plot describing the computational time in seconds of all algorithms; center lines show the medians; box limits indicate the Q1 and Q3; whiskers extend 1.5 times the interquartile range; diamonds represent the averages; circles represent outliers	74
4.1	Solution of ALDP	80
4.2	Search space in the first step	88
4.3	Search space in the second step	89
4.4	The Pareto front with all non-dominated points	89
4.5	Pareto front, Otto n=20.9 with 8 possible equipment	93
4.6	Hyperarea with normalized axis	94
5.1	Agricultural mulcher (BERTI MACCHINE AGRICOLE S.p.A., 2019) . . .	103
5.2	Combined precedence diagram of agricultural mulchers (Maccini, 2017) . .	104

5.3	The evolution of bounds in the execution of IDS with the solution of SALBP-1 as starting solution - agricultural mulcher assembly line	106
5.4	Condensing boiler (elm.leblanc, 2019)	109
5.5	The evolution of F(%) in several cycles of work for a workstation at risk in the industrial solution	111
5.6	The evolution of F(%) in several cycles of work for the most charged workstation in the ILS solution	112

List of Tables

2.1	The different versions of SALBP	28
2.2	An overview of the literature for ALBP with ergonomics consideration	48
3.1	Average Gap in % of all algorithms presented according to the category of instances, adjusted takt time and transfer time	71
3.2	Averages computational times in seconds (s) of all algorithms presented according to the category of instances, adjusted takt time and transfer time	75
4.1	Average statistics obtained with the ϵ -constraint algorithm for instances when we obtain the Pareto front	92
4.2	Average results of instances when we obtain the Pareto front according to the number of equipment	92
4.3	Average statistics obtained with the ϵ -constraint algorithm for instances with a percentage of non-dominated points	95
4.4	Averages statistics obtained with the ϵ -constraint algorithm for instances without any non-dominated points	95
5.1	Scale of rating for perceived effort (%MVC) (Bernard, 2012 ; Borg, 1982)	101
5.2	Processing time and operations load - agricultural mulcher assembly line (Maccini, 2017)	105
5.3	Percentage of workload and recovery times assigned to workstations - agricultural mulcher assembly line	107
5.4	F_k in (%) of the average model solution	108
5.5	Recovery time (s) of the average model solution	108
5.6	Ergonomics level and computational time - condensing boiler assembly line	109
5.7	Percentage (%) of workload and recovery time assigned to workstations - condensing boiler assembly line case study	110
B1	Average results of Scholl instances (Minimal adjusted takt time, $TT = 0\%$)	143
B2	Average results of Scholl instances (Minimal adjusted takt time, $TT = 5\%$)	144
B3	Average results of Scholl instances (Median adjusted takt time, $TT = 0\%$)	145
B4	Average results of Scholl instances (Median adjusted takt time, $TT = 5\%$)	146
B5	Average results of Otto instances ($TT = 0\%$)	147

B6 Average results of Otto instances ($IT = 5\%$) 148

List of Algorithms

1	Iterative Dichotomic Search	59
2	Iterative Local Search	61
3	GeneratePool()	62
4	LocalSearch(s_i)	64
5	ϵ -constraint algorithm	86
6	Iterative Dichotomic Search with cost constraint	87

Introduction

This Ph.D. was carried out within the framework of a cotutelle program between Mines Saint-Etienne in France and the University of Padua in Italy. The research is a part of the main themes of research in the *Laboratoire d'Informatique de Modélisation et d'Optimisation des Systèmes* (LIMOS) in France and the *Industrial plants and Logistics* in Italy. Linked to the central theme of research in LIMOS and the research department in Padua, our research focuses on the design and management of industrial systems and goods production. More specifically aim to develop realistic models and efficient optimization methods for manufacturing systems design.

Concerned with the design and control of the production process, operations management has generated a large number of tools and methods (e.g., operations research, lean manufacturing) for addressing manufacturing systems problems. These tools and methods often aim to optimize performance-related objectives, such as the maximization of performance and the minimization of production costs. Despite the advance observed in the last decades in safety and ergonomics of workplaces, workers are still exposed to work-related musculoskeletal disorders (MSDs) and injuries, particularly in fully-manual and semi-automatic manufacturing systems. Prevention of MSDs depends upon the identification and the control of risk factors in the workplace and on the application of good ergonomic practices. According to (Bevan, 2015), the cost of MSDs is consuming almost 2% of the European Union's (EU) gross domestic product (GDP). Likewise, the U.S. Bureau of Labor Statistics reported that in 2016 MSDs counted for 32% of private-sector days away from work in the USA. Furthermore, according to the 6th European Working Conditions Survey, the proportion of workers over 50 years grown from 24% to 31% between 2005 and 2015 (Parent-Thirion et al., 2016). By 2030, workers over 60 years old should represent almost a quarter of the total workforce of the European Union. A similar aging trend is also observed in the U.S. (Calzavara et al., 2020).

Usually, the primary objective in the design stage of manufacturing systems is the optimization of economic efficiency with the sole consideration of cost and profit. Ergonomics considerations are taken into account later on existing systems with adjustment of posture or investment on equipment to mitigate risks of injury. In production systems, the original approach of considering ergonomics from the design

phase through decision support tools and methods provides more leeway for decision-makers and helps to prevent costly interventions later on already existing systems.

The issue of ergonomics is related to the design of efficient, productive, profitable, and safe production systems for workers. Keeping in mind that both performance and human health are central to sustainable manufacturing systems design, this thesis proposes methods to build production systems designed around productivity and ergonomics criteria. The issue of criteria which reflect the ergonomics of workstations from the design stage will also be addressed.

More specifically, we focus on assembly lines, which are production lines used to manufacture products, ranging from mass-production products to mass-customization with low unit products, varying from big-size products such as aircraft to medium and small size products such as electronic goods. Also, these assembly lines not only consume the largest parts of investment funds but also involve the largest proportion of companies' labor force. Hence, the understanding and improvement of assembly systems would enhance the production firms' performance, with positive effects on the global economy and safety and health of the labor force.

The assignment of operations in assembly lines plays a significant role in ergonomics, even with a fixed cost. Furthermore, in some situations, the balancing of operations is not enough to obtain good ergonomics. Engineers and designers face the problem of equipment selection, to keep productivity and throughput as high as possible and lower the ergonomic risks. Proposing a trade-off between conflicting objectives such as productivity, cost, safety, and ergonomics is discussed in this thesis, with models and algorithms to consider the different alternatives of solutions. The general and specific objectives of the present thesis are:

General objective: Propose a design method for manufacturing systems, with the joint consideration of ergonomics, productivity, and cost.

Specific objective 1: Define relevant ergonomics criteria suitable for the design stage of manufacturing systems.

Specific objective 2: Propose operations research methods and algorithms for the consideration of ergonomics and productivity for manufacturing systems design.

Specific objective 3: Propose a methodology to help decision-makers to improve the ergonomics of production systems at the design stage.

This manuscript is organized as follows:

Chapter 1 highlights the importance of ergonomics, particularly in operations management and production systems. We discussed the importance of operations

research in improving the production conditions and ergonomics by presenting the main qualitative, quantitative, and semi-quantitative methods used to evaluate ergonomics in production systems.

Line design and balancing problems studied in this work are described in **chapter 2**. We present in this chapter a literature review of the essential elements relative to line design and balancing. Without seeking to be exhaustive, the presented elements are necessary for the understanding of production line and optimization problems dealt with in this thesis.

Chapter 3 develops the first contribution of the thesis. We present a new modeling approach for the assembly line balancing problem with the optimization of workers ergonomics. Using a quantitative criterion, we examine ergonomics applying a model of fatigue and recovery of workers. However, the quantitative criterion is non-linear; for that, we propose a technique of linearization using an Integer Linear Programming (ILP) and an Iterative Dichotomic Search (IDS) algorithm. We also present in this chapter, a constrained-based local search metaheuristic, designed to solve the problem quickly, and based on the ubiquitous Iterative Local Search (ILS) framework.

To validate the modeling approach and solving algorithms, we carry out in chapter 3 numerical experiments. Also, we report in this chapter all the results and analysis of the different algorithms. The objective is to evaluate the performance of algorithms and assess the quality of solutions and computational times.

In **chapter 4**, we present a generalization of the modeling approach proposed in chapter 3 to line design problem with the consideration of ergonomics. As the problem involves a trade-off between the investment cost and the level of ergonomics, we propose a multiple criteria decision-making approach with a Mixed-Integer Linear Programming (MILP) and an ϵ -constraint algorithm to provide decision-makers and line designers with a Pareto front. After that, we propose numerical experiments to assess the performance of the formulation and the solving algorithm.

Finally, in **chapter 5**, we present the overall methodology for line design with ergonomics, and we illustrate the use of different optimization methods on two industrial applications. Firstly, with an assembly line of agricultural mulchers from a company specialized in the production of agricultural equipment. Secondly, with an industrial case study concerning an assembly line of condensing boiler. We describe in this chapter concrete applications of our contribution to industrial cases, with conclusions and means of action to improve the ergonomics of workers.

In conclusion, we summarize the key ideas discussed in this thesis and highlight future perspectives and possibilities offered by this work.

Chapter 1

Ergonomics in manufacturing systems

Contents

1.1 Introduction	6
1.2 Ergonomics	8
1.2.1 Ergonomics in Operation Management	8
1.2.2 Corporate Social Responsibility and financial performance	9
1.3 Importance of ergonomics in manufacturing systems	9
1.3.1 Ergonomics and performance of manufacturing systems	10
1.3.2 The level of automation	11
1.3.3 Ergonomics in the Industry 4.0	11
1.3.4 Contribution of operations research	13
1.4 Ergonomic assessment methods	14
1.4.1 Qualitative assessment methods	15
1.4.2 Semi-quantitative assessment methods	15
1.4.3 Quantitative assessment methods	17
1.5 Conclusion	23

1.1 Introduction

Henry Ford is often credited with being the inventor of assembly lines, or the first complex and technically advanced assembly lines ([Christoph, 2016](#)). By implementing the assembly line to produce the Ford Model T around 1910, Ford Motor Company set the foundation of the mass-production or flow production method. This mass production is the manufacturing of large amounts of standardized products, and the keys of mass production are the interchangeability of parts, and the possibility to assemble them quickly ([Womack et al., 2007](#)).

At that time, the trend on management theory was scientific management ([Taylor, 1911](#)), when Frederick Taylor applied science and analytical methods for the production

process for the sake of efficiency. Scientific management recommends dissociating the manager's decision, who plans and organizes, and the workers performing the tasks.

Scientific management has lost traction after 1930. However, it still influences the design of assembly lines and production systems until now. A significant criticism of Taylorism and Fordism is the alienation of the workforce and the sole consideration of the performance in production systems (Womack et al., 2007). Indeed, the early mass production systems, not only interchanged parts of the product to assemble but also interchanged their workforce, with workers performing single and specialized operations. The division of operations assigns a specific and restricted part of the job to the workers. For example, cleaning operation was performed by specialized workers and quality issues fixed at the end of the production line. With this production configuration, workers did not require long-term training and were most of the time freshly hired, and inefficient workers were replaced. In this production configuration, management does not expect any voluntary information from the worker on the production systems or ways to solve malfunctions.

Later, lean management tried to provide an improved way of production. The lean manufacturing revolution, thought by Kiichiro Toyoda and Taiichi Ohno, comes more than 50 years after Ford Model T. Toyota Motor Company in Japan held the birthplace of the Toyota Production System, which paved the road to lean manufacturing or lean management. The lean focus on the product and on what customers value while systematically identify and eliminate all waste from the production process. In a nutshell, as described by Womack and Jones (1996), lean is doing more of what the customers want with less time, human effort, and cost (Arnheiter and Maleyeff, 2005; Salah et al., 2010).

The information and telecommunications began a third industrial revolution, and there has been an advent of computer science and automation in manufacturing systems, with more programmable logic controllers and robots processing operations which were performed by humans. There was also a trend in the production system to become more flexible. A Flexible Manufacturing System (FMS) is a flexible system that allows reaction in case of changes, whether the changes are predicted or unpredicted.

Many programs were initiated in several countries to attempt to make the work more human and reduce exposing workers to work-related risks. Besides, humans are a central component for flexibility of manufacturing systems (Krüger et al., 2009), and the efficiency of lean management (Cirjaliu and Draghici, 2016), when the workforce is supposed to communicate problems and is part of the process of problem-solving in a manufacturing environment. Many scientific fields have been transposed into management, for example, operations research and analytics, statistical quality control, and, more generally, management science. Much modern practices concerned the studies, and the optimization of complex production systems are grouped in the umbrella

inter-disciplinary industrial engineering field and Operations Management (OM).

In this chapter, first and foremost, we define *Ergonomics* in a broad sense and specifically in operation management. Then, in [Section 1.3](#), we discuss the importance of ergonomics and its relationship with the system performance in manufacturing systems, especially fully-manual and semi-automatic lines. After that, in [Section 1.4](#), we present ergonomics qualitative, quantitative, and semi-quantitative assessment methods present in the literature.

1.2 Ergonomics

Ergonomics is composed of the Greek words *ergon*, which means work and *nomos*, which means law. Ergonomics means the interaction between humans and their environment, to improve their well-being and effectiveness. As a field that studies the physical interaction between humans and systems, ergonomics aims to optimize the system performance by reducing human error, improving productivity and safety with a focus on the human-machine physical and cognitive interaction. Ergonomics came as an answer to workers' operational and strategic problems in manufacturing systems and aimed to mitigate the system inefficiency and to improve the safety of the workplace and fit the system to the needs of the workers, i.e., Fitting the Job to the Man (FJM) ([Bridger, 2008](#)). FJM takes into account worker capabilities and limitations and seeks to ensure that operations, workstations, and environment are accepted and suitable for them.

Humans are the most critical resource in production systems ([Boudreau et al., 2003](#)). Workers perform physical operations such as assembling parts in an assembly line, handling materials in the picking area, ensuring maintenance and follow-up operations, and so on. Besides physical operations, workers also ensure cognitive operations such as product quality monitoring, supervision, and data collection, and analysis. Most production systems cannot operate without human intervention and input.

1.2.1 Ergonomics in Operation Management

Operations Management or OM deals with the design and control of production systems of goods and services. More specifically, the contribution of ergonomics to OM is reflected in the design and assignment of operations that are compatible with workers' characteristics and needs, the selection of equipment that is useful and safe for workers in the workplace, and the overall policy of aligning the system characteristics to human needs.

In recent years, more publications and interests are observed concerning ergonomics in OM ([Kalkis and Roja, 2016](#); [Neumann and Dul, 2010](#); [Neumann et al., 2016](#)). Most ergonomics related issues such as fatigue, learning and forgetting, motivation, and many others should be included in quantitative optimization and simulation models. Several authors including [Boudreau et al. \(2003\)](#); [Kalkis and Roja \(2016\)](#); [Neumann and Dul](#)

(2010); Otto (2012); Otto and Battaïa (2017) recommend an integrated approach with the joint consideration of ergonomics and OM. However, these researchers pointed to the difficulty of defining suitable analytical ergonomics measures that integrates with existing OM analytical and decision models.

Current Lean Manufacturing practices are also more driven toward fitting the work to the workers with clear working standard, adjustable workstations, and precise value stream mapping along the production lines. Key Performance Indicator (KPI) and performance measure simplify the monitoring of the production activity and the work of workers in the production line.

1.2.2 Corporate Social Responsibility and financial performance

Corporate Social Responsibility or CSR is internal organizational self-regulation that aims to contribute to societal objectives. CSR is nowadays considered a strategic issue for all organizations, regardless of their size and activity sector (Berger-Douce, 2015). Besides, researchers have established the positive effect of Corporate Social Responsibility (CSR) on Corporate Financial Performance (CFP) (Berger-Douce, 2008; Callan and Thomas, 2009; Flammer, 2015; Orlitzky et al., 2003). Both social and financial performance is essential for the sustainability and the growth of companies, as stated in the article of Walsh et al. (2003): “*we must find a way to satisfy the economic and social objectives that provide the raison d’être for corporations*”.

Ergonomics have both implications on the social and the performance of the production system (Distelhorst et al., 2016; Flammer, 2015; Górný, 2012; Zink and Fischer, 2013). However, ergonomics and OM research streams and applications tend to be separated. Indeed, Dul and Neumann (2009) argue that if ergonomics is only seen from the social and ethical perspective, without financial and profit issues, then it will be isolated from OM researchers and limit the attention accorded to ergonomics in OM model and optimization methods. The joint consideration of ergonomics as a social and CSR issue with cost and profit optimization is a promising approach to integrate OM into CSR and ergonomics research and application stream (Abdous et al., 2018).

1.3 Importance of ergonomics in manufacturing systems

Humans are involved in most manufacturing systems at different levels. When human workers are more present in the system, this makes ergonomics more critical. Indeed, the more humans are actively present in the system, the more there is a need for better ergonomics. In this section, we discuss the contribution of ergonomics to systems’ performance. Then, we discuss the involvement of the workforce and the automation level. Later on, we shed light on the new trend of ergonomics in Industry 4.0.

1.3.1 Ergonomics and performance of manufacturing systems

Despite the advances observed in the last decades in the safety and ergonomics of workplaces. Workers are still exposed to work-related musculoskeletal disorders (MSDs). MSDs are injuries and pain in the musculoskeletal system (e.g., muscles, ligaments, joints, nerves, tendons). Prevention of MSDs depends upon the identification and control of risk factors in the workplace and on the application of good ergonomic practices.

The estimation of costs of ergonomic risks in manufacturing systems is hard, mainly because of the indirect and long-term effects related to workers' absenteeism, turn-over, permanent injuries, disabilities, and non-quality. An estimation of the cost of MSDs in the European Union (EU) is up to 2% of the gross domestic product (GDP) (Bevan, 2015). In the US, according to the U.S. Bureau of Labor Statistics, MSDs were still counted for 32% of private-sector days away from work in the USA in 2016 with median days away from work of 8 days annually in 2017. Besides, according to the U.S. Bureau of Labor Statistics, annual compensation cost for MSDs in 2009 was up to 20 billion \$.

An analysis of 250 case studies by Goggins et al. (2008) concluded that ergonomics intervention includes a reduction in the number of reported MSDs as well as related lost workdays and workers' compensation cost. Additional benefits reported were mostly positive on the systems productivity, turn-over, and absenteeism, with a typical payback period of less than one year.

In addition to the high level of MSDs and the cost associated directly with workers' injuries, bad ergonomics is also associated with a high rate of workers' errors (Thun et al., 2007). Errors in manufacturing systems are a deviation from the required standard and result in non-conformity and non-quality (Yung et al., 2020). Studies suggested a causal relationship between ergonomics and product quality, Falck and Rosenqvist (2014) showed that the cost of quality errors due to poor ergonomics is 12 times more than the cost of ergonomics investment. Lin et al. (2001) investigate quality in paced assembly lines. Time pressure and postural deficiencies directly predicted 50% of quality variances. A recent systematic review of more than 70 empirical studies by Kolus et al. (2018) linked poor ergonomics and low product quality in the manufacturing process.

Numerous studies showed a direct link between poor work environment and ergonomics with the under-performance of manufacturing systems (Rose et al., 2013; Yung et al., 2020). In the work of Thun et al. (2011), 55 companies in the automotive industry are analyzed, and companies with ergonomic practices show a better economic performance.

The workforce aging phenomenon is recently affecting most of the developed countries. According to the 6th European Working Conditions Survey, the proportion of workers over 50 years grown from 24% to 31% between 2005 and 2015 (Parent-Thirion et al., 2016). According to the European Commission, by 2030, workers over 60 years old should represent almost a quarter of the total workforce of the European Union. Therefore,

managers and production researchers, as well as policymakers, have to take into account the needs of changing and aging workforces (Calzavara et al., 2020).

1.3.2 The level of automation

The importance of ergonomics grows as the human presence grows. The involvement of humans depends on the Level of Automation (LoA), which is the percentage of automated operations. While many complex and challenging operations have been automated in production systems, there are still manual and semi-manual workers involved.

We distinguish mainly three Level of Automation in manufacturing systems:

- Fully-manual lines, with the only intervention of workers in operations;
- Fully-automatic lines without workers intervention in operations;
- Semi-automatic lines with cooperation between workers and automatic systems.

The current industrial context is characterized by more and more demand for mass-customized products through high agility and flexibility of manufacturing systems. Besides, product complexity has resulted in more complex manufacturing systems (Frohm et al., 2008). Flexibility and quick changes have become a critical factor in the design of complex manufacturing systems to adapt to the highly competitive global competition and changing markets.

Even if a fully manual system is highly flexible and offers a better ability for complex products, it requires a high level of ergonomics and safety. On the other hand, a fully-automated production line provides advantages such as work without break and systems without ergonomic risks. However, Gorlach and Wessel (2008) points out that the flexibility of fully-automated systems is low due to programming issues and the difficulty in handling complex and small parts; furthermore, a fully-automatic system cost evolves exponentially compared to manual labor cost.

Semi-automatic systems could benefit from the advantages and strengths of both manual and automated systems, and it has been shown that such Human-Machine cooperation has the most significant economic benefits compared to fully-automatic or fully-manual systems (Krüger et al., 2009). In other words, both highly skilled and trained workers, along with automatic equipment, are needed to achieve a high level of performance and flexibility in manufacturing systems. Semi-automatic systems are more present in today's manufacturing system than before, especially with the rise of the fourth industrial revolution or Industry 4.0 (Cohen et al., 2019; Kadir et al., 2019; Mattsson et al., 2018).

1.3.3 Ergonomics in the Industry 4.0

Industry 4.0 is the name given to the current trend of using modern hardware and software technologies in manufacturing systems. Industry 4.0 brings many changes to

the manufacturing systems, including the use of software technologies such as cyber-physical systems, Internet of Things (IoT), cloud computing, machine learning, and hardware technologies such as augmented reality, cobot, and additive manufacturing. These technologies are expected to transform the manufacturing systems in the next few years, and since humans are an essential part of the system, Industry 4.0 is presumed to improve the ergonomics positively and contribute to making the workplace safer for humans (Cohen et al., 2019). Related to this trend, the emerging concept of Operator 4.0 is anticipated to improve Human-Machine work systems for better ergonomics and sustainability in the industry environment (Romero et al., 2016).

Industry 4.0 is the name given to the current trend of using modern hardware and software technologies in manufacturing systems. Industry 4.0 brings many changes to the manufacturing systems, including the use of software technologies such as cyber-physical systems, Internet of Things (IoT), cloud computing, machine learning, and hardware technologies such as augmented reality, cobot, and additive manufacturing. It is expected to transform the manufacturing systems in the next few years, and since humans are an essential part of the system, Industry 4.0 is expected to improve the ergonomics positively and contribute to making the workplace safer for humans (Cohen et al., 2019). There is also an emerging concept of Operator 4.0 (Romero et al., 2016), Operator 4.0 concept in the context of Industry 4.0 push towards better Human-Machine work systems for better ergonomics and sustainability.

Industry 4.0 is linked with the emergence of new technological advances or the enhancement of existing equipment to improve ergonomics and assess workers in their work at the production systems. Information flows across the production between humans, machines, parts, and products. Connected workforce provides devices to ease internal communication and human resource management. The Digital Workplace enables sufficient working conditions and provides operational information, reducing processing time, and enhancing quality check. The digital workplace also helps workers to update on-line workstation information and KPI. Another advance in augmented reality enhances workers' perception by the use of virtual objects and represents relevant information in production lines.

Collaborative robot (cobot) is designed to interact with the worker in a shared workspace to enhance its capability and performance. The cobot adds flexibility in the workstation by serving the human in the workplace. They are safe to interact with and bring more options for the assignment of work to workstations. A cobot can enhance interaction with humans and reduce the ergonomic risks due to physical and cognitive loading while improving the safety of the workplace and the quality of the products. Furthermore, Automated Guided Vehicle (AGV) are used to transport parts and substitute the human in heavy material handling jobs. AGV reduces the ergonomic risks in the parts feeding in assembly lines and warehouse systems.

Exoskeletons are also used to enhance workplace safety and mitigate ergonomic risks. Exoskeletons are mechanical structures designed to enhance workers' ability and muscular capacity and are classified as active and passive (de Looze et al., 2016). Active exoskeletons contain actuators to provide power to the workers (powered, e.g., with electrical energy, pneumatic or hydraulic energy), while passive structure provides mechanical support for workers' motion and posture, without being powered externally.

The wide range of Industry 4.0 equipment and their different effects on the nature of the work and the ergonomics level challenge the ability of decision-makers to choose the adequate equipment for their production systems while designing cost-effective production systems. While there's a risk of being an early adopter of Industry 4.0, especially for medium and small companies, industries can mitigate these risks by making smart investment and equipment selection.

1.3.4 Contribution of operations research

Operations Research (OR) was born in England during the Second World War. It was used first in the military, then expanded into an increasingly wide range of civilian sectors, including industry and OM. This discipline develops advanced mathematics, analytical, and optimization methods for decision making and provides optimal or near-optimal solutions for a broad set of problems.

OR is well used in several fields of OM, such as network optimization (e.g., telecommunications, electrical network distribution system); Supply chain optimization; Facility location; Scheduling (e.g., allocate plant, allocate personnel, economic production quantity model); Assembly Line Balancing and Design and so on. So far, operations research models contribute to advanced analytical methods to help make better decisions in the industry to maximize sales, profits, and to minimize costs and risks. Further, in manufacturing sectors, OR brought quantitative decision support to improve decision-making in different areas.

Today, OR is a well-established discipline. However, a real gap in the literature is observed concerning the consideration of ergonomics in OM or industrial companies' strategic planning (Dul and Neumann, 2009; Neumann and Dul, 2010). Usually, ergonomics in manufacturing systems are considered at operational planning with adjustment of postures or equipment and workers assignment on existing systems. There are already some attempts to incorporate ergonomics in the design stage of manufacturing systems (Battini et al., 2017, 2016; Carnahan et al., 2001; Finco et al., 2019). However, there is much to be done to define relevant ergonomic criteria and to integrate them into OR models effectively, and to change the conventional of improving working conditions and ergonomics only on existing systems.

One of the critical issues for the consideration of ergonomics in OR analytical models

is the ability to provide a clear definition of ergonomics assessment methods in decision support tools and OR. Besides, the efficiency of optimization models relies on the use of criteria and assessment methods that include the ergonomics of manufacturing systems during the design stage.

1.4 Ergonomic assessment methods

Ergonomics studies the factors that affect the interaction between humans and their working environment. Its purpose is the improvement of the working conditions and the mitigation of risks. Ultimately, the ergonomics target an efficient and safe Human-Machine interaction in manufacturing systems.

Ergonomics can be improved by the consideration of each aspect in the Human-Machine interaction, i.e., the aspects that surround workers in their workplace and environment. Mainly, three aspects are essential in such interaction:

- Physical ergonomics: refers to the repetitiveness of workload, operations physical burden, the risk associated with the layout of the workplace and the working environment such as noise, temperature, lighting, and equipment vibration. Physical ergonomics is an answer to improve health in the workplace and reduce MSDs;
- Cognitive ergonomics: refers to the worker's cognitive abilities and limitations, and focuses on the cognitive and behavioral aspects of the work, such as the design of human-machine interface HMI, the user acceptance of technology, and their perception of how and when they are used. Furthermore, cognitive ergonomics investigate the compatibility between operations and worker cognitive capabilities. Another essential aspect is the learning and forgetting phenomenon and their incidence on the work;
- Organizational, environmental, and managerial ergonomics: refers to the managerial aspects, communication, team-work, and operational decisions and the place of ergonomics in environmental and organizational improvement.

While following an integrated approach that takes into account the physical, cognitive, and managerial dimensions of ergonomics, is likely to be more productive, the absence of quantitative criteria for these dimensions remains a challenge. Although these dimensions of strongly linked to each other: for example, improving the physical dimension improves the cognitive and managerial dimensions indirectly.

Given the importance of physical ergonomics for labor force health and the poor ergonomics of workstations in manufacturing systems, we decided to focus on physical ergonomics in this thesis. This dimension of ergonomics is more related to occupational health and safety legislation. The majority of works on ergonomics criteria and

development of assessment methods focus on the physical component of the ergonomics (Otto and Battaïa, 2017).

Several assessment tools and methods are developed to investigate the physical ergonomic risks and the identification of work-related MSDs. We use the classification of Chengalur (2004) that classify the physical ergonomic assessment methods into three categories: qualitative, semi-quantitative, and quantitative.

1.4.1 Qualitative assessment methods

Qualitative assessment methods consist of subjective evaluations of physical ergonomic risks. They are based on verbal estimation given by workers during the performance of industrial operations. The advantages of using such techniques are the absence of investment (i.e., most of the time, qualitative methods do not require equipment and tools to assess ergonomics' risks). Furthermore, the necessary time for the understanding and the effective use of these methods in manufacturing systems is often short, which makes them practical.

Qualitative methods gather necessary information and data about the operations. These methods, such as job safety and job hazard analysis and checklists, are quick to deploy by practitioners. For example, a job analysis is done on each elementary operation. For each elementary operation, possible hazards associated with its execution are listed, and for each hazard, a solution is proposed. Job analysis relies on the experience of practitioners and their subjective judgments.

Borg (1998) reported that subjective evaluation gives feedback regarding the stress of the muscles and joints and also for the central nervous system. However, qualitative assessment methods are influenced by subjectivity and the difficulty of assessing the accuracy and the variability of the measure between different workers. Qualitative methods with a predefined checklist for the job hazards and risk factors analysis are efficient in gathering data and collecting information and interview workers in manufacturing systems. However, it relies on the practitioners' judgment, and appreciation and the results could be inconsistent (Chengalur, 2004). Ultimately, qualitative assessment methods are easy to use and practical, but they over-simplify the assessment process. They are usually only suitable for quick estimation of the level of ergonomics in manufacturing systems.

1.4.2 Semi-quantitative assessment methods

Semi-quantitative assessment methods use both simple judgment information and quantitative information. These methods complement the qualitative collection of data with other quantitative elements, which require a minimum of processing to conclude and make decisions.

The use of semi-quantitative methods begins with a qualitative collection of data on operations and labor, before moving to a data processing to draw relevant information on the physical difficulty of a job and its level of risk. In the following subsection, we review some of the most common semi-quantitative ergonomics assessment methods.

1.4.2.1 Rapid Upper Limb Assessment (RULA)

The RULA (McAtamney and Corlett, 1993) is a physical ergonomics assessment method for the use of ergonomics investigation in workplaces. The method focuses on the risks in the upper part of the worker's body (neck, trunk, upper limbs, muscle function, external loads) and provides a screening tool for a working situation.

The method uses a diagram of body postures and scoring tables. The practitioner reports score related to each segment, working time, and the scale of the load of the body, and all the collected data are then processed with the scoring tables generating a final score that represents the level of risks. Engineering controls or work activity changes to improve the situation are extracted from the final score.

RULA was developed for a paper-pencil analysis and does not require any special equipment or work disruption.

1.4.2.2 Rapid Entire Body Assessment (REBA)

The basic idea of the method is similar to the RULA method. REBA (Hignett and McAtamney, 2000) is a postural analysis tool, classified as a semi-quantitative method. REBA has been developed to quantify the risk of working static and dynamic postures of the entire body found in health care and industries. The methods divide the body into segments and provide a scoring system to reflect the level of risk and to identify its gravity. The method provides an action level with an insight of the urgency, and like in the RULA method, REBA requires minimal tools (only pen and paper) to assess the final score.

1.4.2.3 Occupational Repetitive Action (OCRA)

OCRA (Occhipinti, 1998) is a widely used method for the evaluation of risks of exposure to repetitive operations of the upper limbs. OCRA assesses the upper limb load of body exposure to load, forces, and exposure time. OCRA process the ratio between the daily number of actions performed by the upper limb and the corresponding number of recommended actions. OCRA can be used to assess in an integrated method the various risk factors in a work environment.

A similar semi-quantitative method to OCRA is the Job Strain Index (JSI) (Steven Moore and Garg, 1995). JSI uses additional parameters such as the speed of work and duration of strain.

1.4.2.4 Rating of perceived exertion and discomfort

The rating of perceived exertion (RPE), proposed by Borg (1982) is a rating scale of perceived exertion (i.e., RPE scale). The Borg RPE is a widely and reliable method to assess effort intensity used as a semi-quantitative measure of perceived exertion.

The Borg RPE scale allows workers to note their level of effort on a numerical scale subjectively. We refer to the work of Borg (1982) and Borg (1998) that provides the scales and the instructions for use and interpretation.

1.4.2.5 Snook Tables

Materials handling, pushing, and pulling, and carrying jobs contain risk factors and expose workers to MSDs. Snook Tables in their revised version based on the work of Snook and Ciriello (1991), highlight the design goals (accepted level of exertion) for various lifting, lowering, pushing, pulling, and carrying operations.

Snook and Ciriello tables provide a maximum acceptable load for lifting and material handling and force for the design of push/pull operations for a specific percentile of the working population.

1.4.3 Quantitative assessment methods

Quantitative assessment methods require an effort to collect and process the input data. These input data are used to assess the level of ergonomics. Quantitative methods provide objective ergonomics evaluation of industrial operations and operations concerning physical fatigue and strain. They involve advanced analytical models such as biomechanics models, metabolic rate, and NIOSH equation. According to Chengalur (2004), quantitative methods are more objective and reliable to design jobs.

1.4.3.1 NIOSH equation

The National Institute for Occupational Safety and Health (NIOSH) developed the NIOSH equation that helps to determine acceptable weight limits for lifting operations (Waters et al., 1993). NIOSH equation assesses the manual material handling risks of lifting and lowering operations in the workplace. Since the input data of the NIOSH equation are objective measures, NIOSH is considered as quantitative assessment methods, as in (Chengalur, 2004).

The critical values are the *RWL* or Recommended Weight Limit, which defines the maximum acceptable weight over a shift time and the Lifting Index (*LI*) that determines the relative value of the level of physical stress and gravity.

The *RWL* is computed with information relative to horizontal, vertical, and traveling distances, as well as coupling, frequency, and other lifting data that the practitioner

could collect from the lifting situation. *RWL* determines if the weight is heavy and the *LI* assesses the level of risk. The *RWL* is expressed as:

$$RWL = LC.HM.VM.DM.AM.FM.CM \quad (1.1)$$

- *LC*: a constant equal to 23 kg;
- *HM*: horizontal multiplier, obtained from the horizontal location of the load relative to the body;
- *VM*: Vertical multiplier, obtained from the vertical location of the load relative to the floor;
- *DM*: Vertical travel distance multiplier, obtained from a distance the load is moved vertically;
- *AM*: Asymmetry angle multiplier, obtained from the angle of the body;
- *FM*: Frequency multiplier, obtained from the duration of the load-lifting;
- *CM*: Coupling multiplier, obtained from the grip quality of the load.

The *LI* is expressed as:

$$LI = W/RWL \quad (1.2)$$

With *W* the weight of the load. *RWL* and *LI* are used to guide the design of lifting activity. The higher the *LI* value, the higher the risk of developing MSDs while performing the lifting activities. Furthermore, multipliers values give insight into the engineering control methods and strategies to mitigate the risks.

By examining the value of each multiplier, the smallest values are associated with higher risk, thereby determining their relative importance in alternate the lifting redesign of the operation. NIOSH equation provides general design/redesign suggestions for the manual lifting depending on the lowest multiplier.

1.4.3.2 Energy expenditure and metabolic rate

The work-energy expenditure and metabolic rate may be used to determine the workload and physical ergonomics of industrial jobs. Several works have been developed to assess the physical ergonomics with energy expenditure and metabolic rate and oxygen consumption. The physical demands of operations could be measured or estimated using macro-studies using literature tables, observational methods, or predictive equations (Battini et al., 2016; Chengalur, 2004; Garg et al., 1978).

Garg et al. (1978) proposes a predictive equation for the metabolic rates for manual materials handling operations. The metabolic rate or energy expenditure index for manual

operations and body movements is composed of two terms. The first one represents the energy required to maintain a body posture, while the second one represents the energy required to perform a specific activity. High energy expenditure is associated with a high risk of MSDs. The model proposed in Garg et al. (1978) relies on the assumption that a job can be divided into simple elementary operations or activities. The model defines the energy expenditure of each elementary operation and time duration. The average metabolic energy expenditure is defined with the sum of each elementary energy demands of operations.

1.4.3.3 Rest allowance

As stated in Elahrache and Imbeau (2009), manufacturing processes and assembly work usually involve the use of static and intermittent muscular work. The static muscular exertion and the duration of shifts affect the fatigue and improve the risk of MSDs. A practical solution to reduce muscular fatigue is the allocation of adequate rest allowance and break time or the so-called work-rest schedule.

In industrial work, the assignment of adequate rest allowance after the completion of the work passes by the determination of the level of fatigue by adequate metrics or some scale. The most important method to measure fatigue is the reduction in the maximum working capacity or strength (Rohmert, 1973). The static exerting in the duration of operation with a high level of heaviness decrease the maximum strength. On the other hand, an adequate period of rest helps to reverse fatigue and recover muscle capacity.

Rohmert (1973) uses the relative intensity of exertion expressed relative to the percentage of the maximum voluntary contraction $\%MVC$ (MVC represents the maximum possible effort). The model by Rohmert (1973) is among the most cited model in the industrial ergonomics textbook (Elahrache and Imbeau, 2009).

The model is expressed as following with the notation of Elahrache and Imbeau (2009):

$$RA(\%) = 18.(t/T)^{1.4} . ((\%MVC/100) - 0.15)^{0.5} . 100 \quad (1.3)$$

With $RA(\%)$ the rest allowance expressed as a percentage of the working time t . In Equation (1.3), t is the duration of contraction or working time in minutes and T the maximum holding time, $\%MVC$ represents the percentage of the load or the level of exertion expressed relative to the MVC .

Other similar models exist to assess the rest allowance. We refer to the work of Byström and Fransson-Hall (1994); Milner (1986); Price (1990); Rose et al. (2014) and Elahrache and Imbeau (2009) for a comparison of different models.

To sum up, muscular recovery could be evaluated through the definition of rest allowances, which is a practical way to reduce the risk of work-related MSDs. The rest allowance in static work represents the time needed for adequate recovery following a

static exertion and is expressed as a percentage of holding time, i.e., the time during which a static exertion, static posture, or a combination of both is maintained without interruption (Rohmert, 1973).

1.4.3.4 Fatigue and recovery models

Physical fatigue resulting from industrial work in manufacturing systems is one of the risk factors for MSDs. There is also growing evidence that MSDs can result from fatigue in muscle tissues (Gallagher and Jr., 2017). In *Occupational Biomechanics*, Chaffin et al. (1999) stated that muscle fatigue reduces muscle power, results in discomfort, pain, and in the long run, contribute to cumulative trauma disorders. Chaffin et al. (1999) highlighted the importance of quantification of fatigue and acceptable loads. Overexertion of muscles in a frequent and high force level is the main reason for muscle fatigue. Furthermore, worker characteristics and anthropometry are essential in defining muscular fatigue. In rest and break periods, the workers could benefit from the idle time and in activities times to recover from fatigue.

For the objective evaluation of muscular fatigue, several works attempt to develop models and frameworks to quantify and represent the evolution of muscular fatigue. Wexler et al. (1997) proposes a mathematical model based on the physiological mechanism that predicts the force generated by muscles during effort and contraction and verifies the model with experiments. The applicability of the model remains inconvenient due to the number of model parameters. Liu et al. (2002) proposes a dynamic model for muscle fatigue and recovery phenomenon based on the motor unit pattern of muscle. The authors do not further investigate the model application and parameters, and there was no application of the model in ergonomics studies.

A method developed by Ma et al. (2009) proposes a model for the evaluation of the evolution of muscular capacity and fatigue with a dynamic model. The evolution of muscle capacity is expressed in the differential equation (see (Equation (1.4))) and is based on the motor mechanism pattern of muscles (Liu et al., 2002; Ma et al., 2009). According to these authors, there are three motor units, type I, type IIa, and type IIb. Each type has a force generation capability and fatigue and recovery properties. Type I has small force capacity but high fatigue resistance; type IIa has reduced capacity and fatigability; while type IIb has high force capacity but fast fatigability. The sequence recruitment of the different types of motor units explains the phenomena expressed in equation (1.4). The discussion of the exact mechanism of muscle fatigue is beyond the scope of this manuscript. The fatigue evolution may change according to individual factors (highly trained, aged) and to the type of activity. Nevertheless, the model of fatigue of Ma et al. (2009) is validated for the case of workers in industrial assembly lines.

$$\frac{\partial Fcem(t)}{\partial t} = -\frac{K}{MVC} Fcem(t) Fload(t) \quad (1.4)$$

$F_{cem}(t)$ presents the current capacity of muscle at time t ; $Fload(t)$ operations load and K is the fatigue rate or fatigability constant that represent the worker personal characteristics and MVC . The maximum voluntary contraction is defined as the maximum force generation with the maximum will, when the workers perform a maximal effort.

The solution of (1.4) is (1.5):

$$F_{cem}(t) = MVCe^{-\frac{K}{MVC} \int_0^t Fload(u)du} \quad (1.5)$$

This model considers the intensity of the dynamic external load of industrial operations $Fload(t)$ and repetitiveness along with the exertion. In addition to an external factor such as load, the individual factors (K, MVC) are considered to vary according to workers' characteristics.

Later, Ma et al. (2010) published a recovery model, based on the work of Wood et al. (1997) and described the recovery phase in inactivity and rest time. The recovery model is also based on the muscle motor mechanism. The recovery rate denoted R represents the speed of recovery of workers' muscle or group of muscles. The recovery depends on the starting state at the beginning of the recovery process and is expressed in (1.6) and the solution in (1.7).

$$\frac{\partial F_{cem}(t)}{\partial t} = -R(F_{max} - F_{cem}(t)) \quad (1.6)$$

$$F_{cem}(t) = MVC + (MVCe^{-\left(\frac{K}{MVC} \int_{t_{start}}^{t_{end}} Fload(u)du\right)} - 1)e^{-R(t-t_{end})} \quad (1.7)$$

With $MVCe^{-\left(\frac{K}{MVC} \int_{t_{start}}^{t_{end}} Fload(u)du\right)}$ represents the fatigue level from Equation (1.5) from the beginning of the exertion t_{start} until the end of the exerting period t_{end} , which is the starting point of the recovery process, with $t - t_{end}$ the length of recovery time. $F_{cem}(t)$ represents the level of muscular strength at the end of the recovery period, F_{max} the maximal level of muscular strength, or MVC .

The mathematical formulation of the fatigue and recovery model remains valid if we consider torque instead of force. This fatigue and recovery model was validated with the existing static and dynamic endurance time models and rest allowance models from the literature. Several articles investigate the model and give further details on parameters (K, MVC, R) and experimental validation (see, e.g., Liu et al. (2018); Ma et al. (2010, 2011c, 2015); Zhang et al. (2014)).

1.4.3.5 Virtual and digital human simulation

Digital human modeling and virtual human simulation have been developed to assess the physical ergonomics and perform ergonomics analysis. The primary purposes of digital human modeling tools are the postural analysis, work visualization, forces, and kinematics

data assessment. The visualization and simulation of the work allow determining the degree of risk a worker is exposed to in the working environment and to simulate a real working situation to prevent ergonomic risks. Motion Time Methods MTM and conventional time measurement methods are incorporated into digital simulation tools to simulate real working situations.

Among the virtual and digital human simulation software and tools to assess the work objectively, there are for example 3DSSPP, Santos, ErgoMAN, AnyBody, and Siemens Jack.

1.4.3.6 Vibration assessment

The high level of vibrations at which workers can be exposed when some manual operations are executed with automatic tools could lead to MSDs (Finco et al., 2019, 2020). In a working environment, tools and equipment could be light and handy, but they could produce a high level of vibrations with some negative aspects for the worker's health.

An excessive vibration level may cause work-related MSDs in the upper part of the body, such as white finger disorder, neurological disorders, and muscular weakness. Around 1.7% to 5.8 % of workers in Europe, the U.S., and Canada are exposed to hand-arm vibration (HAV) syndrome (Radwin et al., 1990).

The ISO 5349 norm (ISO, 2001a,b) defines the threshold of risk and vibration assessment method. The vibration exposure depends on its frequency spectrum, its magnitude, and its duration. As defined in the ISO 5349 (ISO, 2001a) norm, the daily vibration exposure duration requires an evaluation of the exposure duration associated with each work phase.

Equation (1.8) defines the vibration level of a tool or equipment expressed in m/s^2 and it integrates the vibration values in the three directions: x , y and z in a single value. The different components of the (1.8) are obtained with direct measure with an accelerometer or they are already provided by the equipment manufacturer.

$$a_{hv} = \sqrt{a_{hvx}^2 + a_{hvy}^2 + a_{hvx}^2} \quad (1.8)$$

The ISO 5349 norm defines the daily exposure through the total vibration value and its daily duration expressed as:

$$A(T_0) = a_{hv} \sqrt{\frac{T}{T_0}} \quad (1.9)$$

Where T represents the total daily exposure to a_{hv} while T_0 represents the working time (shift time, e.g., 8h). Considering a typical working day of 8h, the ISO 5349 norm defines two threshold values of daily vibration exposure which are respectively equal to 2.5 m/s^2 for moderate risk threshold and 5 m/s^2 for the maximum admissible threshold.

1.5 Conclusion

Ergonomics is an important issue in manufacturing systems (c.f. [Section 1.3](#)). Poor ergonomics result in MSDs that are responsible for work-related accidents, diseases, and potential disability, negative social effects, and poor quality of products. Additionally, a good ergonomics in manufacturing systems reflect in higher productivity. Over the years, several studies investigated the economic effectiveness of ergonomics in the workplace in reducing the worker's MSDs and injuries while reducing product defects in the production process.

The design of the manufacturing systems is made within the guidelines of the company strategy. Designers of intricate manufacturing production lines are likely to face a large number of conflicting criteria and constraints, including implementation cost and profit, legislation, and norms associated with production systems. Fully-manual and semi-automatic manufacturing systems are more concerned with ergonomic risks due to the presence of humans and Human-Machine interaction and cooperation. Strategic decisions in the design stage could be a source of ergonomic risks and MSDs. It is well-established that decision-makers have more flexibility in implementing ergonomics solutions in the design stage than retrofitting existing systems. Besides, ergonomics consideration at early stages could cost less than intervention on existing systems and production lines in subsequent stages.

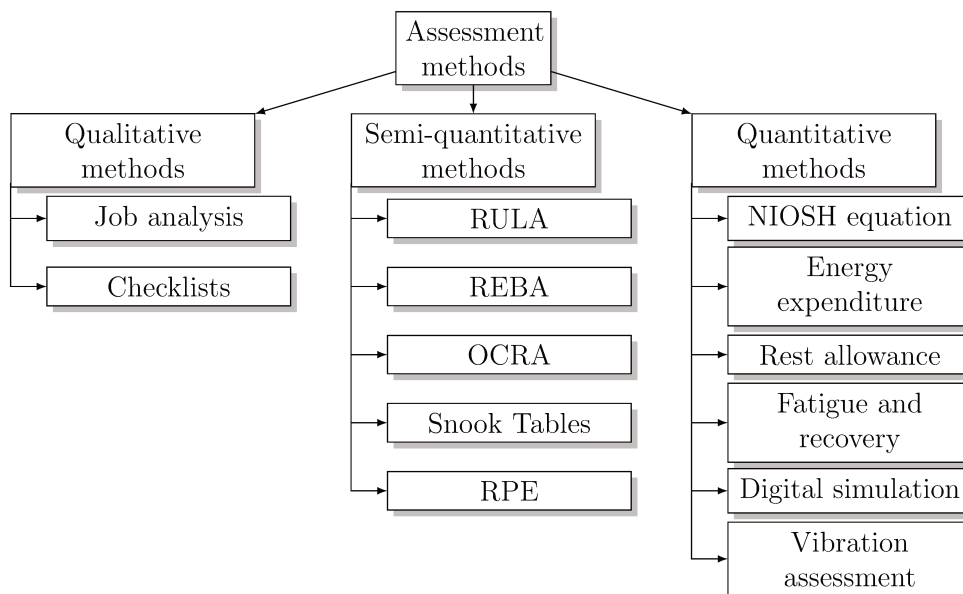

Figure 1.1: Physical ergonomics assessment methods

To consider ergonomics in manufacturing systems and provide decision-makers with OR models and decision support, a careful and well-chosen choice of ergonomic criteria and their ability to be used from the design stage is a critical element in building an accurate and reliable decision support models. Several assessment methods and criteria

are present in the literature, we have presented some physical ergonomics risks and assessment methods from the literature (c.f. [Section 1.4](#)) without being exhaustive, which we have structured with the classification proposed in [Chengalur \(2004\)](#). As summarized in [Figure 1.1](#), most criteria from the literature belong to one of the main three categories: qualitative, semi-quantitative, and quantitative.

Qualitative assessment methods gather observational data about the work and are generally used to screen the work. Semi-quantitative assessment methods use a mix of judgment data and/or quickly obtained quantitative data. The input data in semi-quantitative methods are processed with a simple set of decisions and ranking of work risks. Semi-quantitative methods may be used for more detailed information about the risk factors of the work and identify necessary future interventions. On the other hand, quantitative assessment methods primarily require objective data. Quantitative methods provide more precise and complete insight into the level of risks. As suggested in [Chengalur \(2004\)](#), it is inappropriate to design works based on qualitative and semi-quantitative analyses. Indeed, Qualitative assessment methods are more suitable for the design of work and the objective assessment of the ergonomics level.

In the next chapter, we review the essential elements relative to line design and balancing. We also examine the primary studies that consider ergonomics in the design phase of production systems and highlight the research gap in the consideration of ergonomics in line design.

Chapter 2

Line Design and Balancing Problems

Contents

2.1	Introduction	26
2.2	Assembly Line Balancing Problem	27
2.2.1	Simple Assembly Line Balancing Problem	28
2.3	Main characteristics of assembly lines	31
2.3.1	Number of products models	31
2.3.2	Line layout	32
2.3.3	Operations characteristics	33
2.3.4	Equipment selection	34
2.4	Solutions methods	36
2.4.1	Exact methods	36
2.4.2	Approximate methods	37
2.5	Multi-objective approaches for line balancing	39
2.5.1	Multi-objective solutions methods	39
2.6	Ergonomics in line balancing	42
2.6.1	Semi-quantitative methods	42
2.6.2	Quantitative methods	43
2.7	The importance of reducing physical fatigue	44
2.7.1	Physical fatigue in assembly lines	45
2.7.2	Fatigue and recovery evolution	46
2.8	Conclusion	46

2.1 Introduction

Assembly lines are among the most significant technological development of the 20th century. Without the development of assembly lines technologies, it would be impossible to produce most of the products in high quantity and quality and at a low price. Assembly lines are the driving force behind industrial nations where the raw materials are transformed into final products on a large scale to satisfy the customers' demands at a favorable price.

In this chapter, we review the Assembly Line Balancing and Design Problems. We start by classifying the different types of assembly lines, and the corresponding combinatorial

problems, while providing brief insights on how to resolve these problems. Subsequently, we highlight the use of multi-objective approaches in the design of assembly lines and end by surveying the use of ergonomics assessment methods in assembly lines with the specification of the research gap.

2.2 Assembly Line Balancing Problem

With the rise of operations research during the post-war years, line balancing was one of the first problems considered by OR (Salveson, 1955). The problem has since attracted the interest of the scientific and industrial community. A fundamental problem in assembly lines is the Assembly Line Balancing Problem (ALBP), which is the combinatorial problem of partitioning or balancing the workload among workstations and optimizing some objectives such as productivity, system utilization, cost, profit, and ergonomics. The production rate imposes the cadence of the line and the rate of production. In the case of paced assembly lines, without stock between workstation, a conveyor belt is used to transport parts between a workstation and the next one. Usually, the production follows the one-piece flow system.

A paced assembly line can be seen as a set of workstations $W = \{1, \dots, m\}$ arranged sequentially and connected with a conveyor, sub-assembly parts move between workstation in a fixed production rate. The value of takt time must thus be defined according to the required production rate. Parts are moved from a workstation to the next one at each takt time T . The total amount of work (tasks or operations) to assemble a product are defined with a set $V = \{1, \dots, n\}$, with an execution time of operation $j \in V$ denoted $t_j \in \mathbb{N}$. Due to the technological constraints, the order of operations is restricted by precedence constraints, usually represented in a precedence graph. Figure 2.1 presents an example of a precedence graph with 10 operations, each node represents an operation, arcs represent the precedence relation between operations, (e.g., operation 1 must be executed before operation 2) with its execution time above the node. The line balancing solution is a feasible solution that consists of assigning operations to different workstations. A solution is feasible when it respects the constraints of the problem and when the total time assigned to a workstation $k \in W$ does not exceed the takt time T .

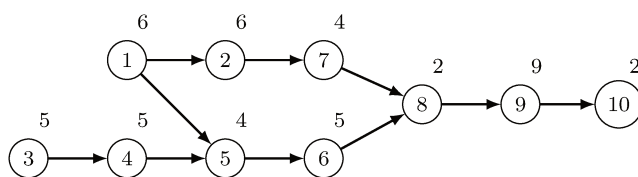

Figure 2.1: Precedence graph (Scholl and Becker, 2006)

2.2.1 Simple Assembly Line Balancing Problem

The majority of assembly lines researches focuses on the classical Simple Assembly Line Balancing problem (SALBP) (Scholl and Becker, 2006). The main characteristics of the problem were formulated for the first time by Baybars (1986); the assumptions behind the SALBP are:

1. All input data are known and deterministic;
2. An operation $j \in W$ cannot be split further;
3. Workstations are equivalent and can process all operations;
4. All operations must be processed;
5. Operations time is independent of the workstation at which they are assigned, and operations could be assigned to all workstations;
6. The assembly line is paced and serial with no buffer or stock between workstations.
7. The assembly line manufactures only one type of product;
8. Operations assignment must respect the precedence relation (i.e., technological constraints).

Depending on the objective function, 4 versions of the problems are defined in Table 2.1. Each version of the problem relies on the same hypothesis of the SALBP but optimizes a different objective.

Table 2.1: The different versions of SALBP

		Takt time	
		Fixed	Minimized
Number of workstation	Fixed	SALBP-F	SALBP-2
	Minimized	SALBP-1	SALBP-E

- SALBP-F: F means feasibility, with a fixed takt time and workstation, the decision problem defines whether or not an assignment of operations to workstations is feasible.
- SALBP-2: With a fixed workstations number, the objective is to minimize the takt time (i.e., maximize the production rate).
- SALBP-1: With a fixed takt time, the objective is to minimize the number of workstations.

- SALBP-E: E means efficiency; this is the most general problem when the objective is to minimize both the takt time and the number of workstations. The problem maximizes the effectiveness of the line by minimizing the product: (number of workstations multiplied by the takt time).

SALBP-F is NP-complete, and since SALBP-1, SALBP-2, and SALBP-E contain SALBP-F as their decision problem, they are NP-hard (Scholl, 1999). SALBP has been studied intensively, and several algorithms were proposed to solve the problem optimally or near the optimal. The industrial development of assembly systems has made the SALBP popular in the scientific community, several studies and bibliographies have been presented, for example, Battaia and Dolgui (2013); Becker and Scholl (2006); Boysen et al. (2007, 2008); Ghosh and Gagnon (1989); Scholl and Becker (2006). We note, however, that in the literature, more attention has been paid to the SALBP-1 version.

2.2.1.1 Integer programming formulation of SALBP

The SALBP consist of a set of operations $V = \{1, \dots, n\}$ that should be assigned to a set of workstations $W = \{1, \dots, m\}$. t_j represents the processing time of operation j . The technological constraints between operations are represented with the set of precedence P . When $(h, g) \in P$, operation h is a predecessor of g , the operation g is also called the successor of h . The takt time T represents the maximal amount of time sub-assembly products should be processed at a given workstation, often defined by customer demand. The assembly lines are paced without buffer, and the takt time or production rate ($\frac{1}{T}$) defines the pace of the line. The takt time is composed of two physical quantity $T = AT + TT$. With AT , the adjusted takt time, which is the strict time to respect when assigning operations to a workstation. The second component of the takt time is the transfer time TT , which represents the time required to transport a product from one station to another, the TT is often of low value or completely negligible. However, in many cases, non-negligible transfer time is observed to transport a product from a workstation to another.

Several formulations of the problem are present in the literature. We choose to illustrate the 0-1 Integer Linear Programming (0-1ILP) of SALBP-1 with the formulation from Baybars (1986). Using the notations introduced before, the SALBP-1 can be introduced as follows:

Decision variables:

$$x_{j,k} = \begin{cases} 1 & \text{if operation } j \text{ is assigned to workstation } k \\ 0 & \text{Otherwise} \end{cases}$$

$$y_k = \begin{cases} 1 & \text{if workstation } k \text{ is open} \\ 0 & \text{Otherwise} \end{cases}$$

Objective:

The objective in (2.1a) is the minimization of the total number of workstations.

$$\text{Minimize } \left\{ \sum_{k \in W} y_k \right\} \quad (2.1a)$$

Occurrence constraint:

(2.1b) defines the occurrence constraint and guarantees that a given operation j cannot be split among two workstations and that all operations must be processed.

$$\sum_{k \in W} x_{j,k} = 1 \quad \forall j \in V \quad (2.1b)$$

Takt time constraint:

The total processing time of a given workstation should not exceed the adjusted takt time.

$$\sum_{j \in V} t_j \cdot x_{j,k} \leq AT \cdot y_k \quad \forall k \in W \quad (2.1c)$$

Precedence constraint:

(2.1d) represents the technological precedence between operations.

$$\sum_{k \in W} k \cdot x_{h,k} \leq \sum_{k \in W} k \cdot x_{g,k} \quad \forall (h, g) \in P \quad (2.1d)$$

Variables type:

(2.1e) defines the type of decision variables.

$$x_{j,k}, y_k \in \{0, 1\} \quad \forall j \in V, k \in W \quad (2.1e)$$

2.2.1.2 Example of SALBP-1

We consider the example defined previously with the precedence diagram in Figure 2.1, the adjusted takt time is $AT = 15$, and the transfer time $TT = 1$. The optimal number of workstations obtained with SALBP-1 is $m = 4$.

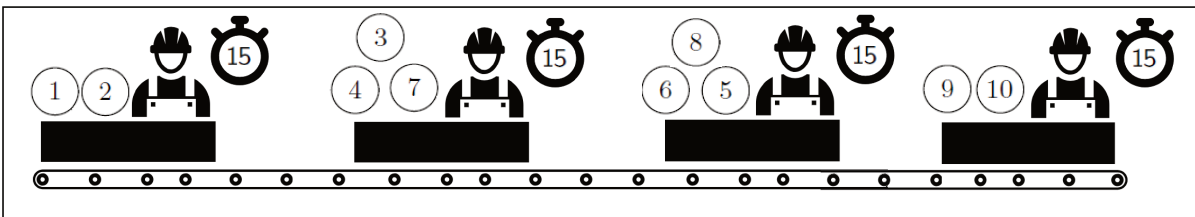

Figure 2.2: Solution of SALBP-1

Operations assigned to different workstations are specified in [Figure 2.2](#), the working time of a given workstation denoted $t(W_k) = \sum_{j \in W_k} t_j$ does not exceed the adjusted takt time. In this example, we obtain: $t(W_1) = 12$, $t(W_2) = 14$, $t(W_3) = 11$ and $t(W_4) = 11$.

The inactivity time or idle time is defined in a workstation k as $T - t(W_k)$, which represents the differences between the takt time T and the sum of the execution time of workstation k .

The SALBP does not represent all the complexity of assembly systems because of the restrictive assumptions. Several studies in the literature have tried to relax one or more hypotheses of SALBP. Any problem with at least one different assumption compared to the basic SALBP formulation has been named in the literature General Assembly Line Balancing Problem (GALBP) ([Baybars, 1986](#)). Here are some references for works and reviews on GALBP ([Battaia and Dolgui, 2013](#); [Becker and Scholl, 2006](#); [Boysen et al., 2007, 2008](#); [Delorme et al., 2014](#); [Rekiek et al., 2002](#)). In the next section, we try to cover some of the characteristics studied in the literature.

2.3 Main characteristics of assembly lines

Since various manufacturing features and characteristics have been studied for the ALBP, we survey some of the main characteristics in this section. Without being exhaustive, we select the relevant characteristics and especially those that are relevant for the rest of our manuscript.

2.3.1 Number of products models

From the literature, we identified three types of ALBP product models: single, multiple, and mixed models.

2.3.1.1 Single model

Single model assembly lines manufacture one product per line. Assembly lines are established for the high volume of mass-production products. The production of one kind of product enables a unique setup of the assembly lines without setup times. The SALBP considers single model production in which the product is known, and operations are identical in all production cycles.

2.3.1.2 Multi-model

In multi-model assembly lines, the same resources are used to manufacture different products in batch. Setup time, tools swap, and equipment reconfiguration is necessary to move from a product to another. Even in this production model, a certain degree of similarity between different products is inherent ([Boysen et al., 2008](#)), the relative

similarity between products reduces the costs associated with the loss of productive time in tools swap and equipment reconfiguration. In a short planning horizon, managers may consider the batch sequencing and lot-sizing problem to determine the size of products batch (Dobson and Yano, 1994).

As highlighted in Boysen et al. (2008), the nature of the work may change from one batch to another in manual assembly lines. Hence it may increase the training cost, the cognitive charge, and may influence the learning and forgetting and physical ergonomics of workers. All those factors are essential for establishing a multi-product assembly line.

2.3.1.3 Mixed model

The production of a single product without variations and options is not cost-effective for manufacturing companies. Nowadays, competitive companies offer a vast catalog of products to their customers. Mixed-model assembly lines eliminate setup-time between models, and different models can be assembled on the same production line. To keep mix-model assembly lines versatile, the base of the different products should be the same; models are assumed to be similar in the majority of operations and differ only in some options. For example, different models in the mix-models offered by a car manufacturer could differ between them in options such as sunroof, car headlight style, the color of the chassis and the cabin, presence or not of air conditioning.

As a result of this way of producing, the total time of a workstation $t(W_k)$ may vary according to the type of model to be produced. Decision-makers could determine the sequencing of models to avoid overloads. Merengo et al. (1999) introduced the notion of horizontal balancing that makes the workload of each workstation uniform along the assembly line. Horizontal balancing could reduce the sequencing-dependent problems in mixed-model production lines. A possible objective to achieve uniformity of working time among workstation is to minimize the smoothness index: $\sqrt{\sum_{k \in W} (T - t(W_k))^2}$.

The mixed-model can be transformed into a single model by considering the joint precedence graph, to this end, processing times of different models are weighted by their occurrence in a production period, based on the daily customers' demand. For more details on the mixed-model production assembly lines and related issues, see e.g., Battaia et al. (2015); Battini et al. (2009a,b); Boysen et al. (2009); Emde et al. (2010).

2.3.2 Line layout

The assembly line layout concern the physical implementation and the plant floor design. Workstations are arranged in ALBP following several standard configurations, and the following line layouts are often considered in the ALBP literature:

- Serial straight line or I-line: the assembly line is arranged in a linear form, workstations are linked with a conveyor to transport sub-assembly product from a

workstation to another, the SALPB respect this line layout;

- Multiple workstations: some workstations are duplicated to improve the flexibility and the reliability of the line;
- U-line: as its name says, the U-line has its extremity shaped in “U”, usually workers are allowed to work on several workstations;
- Multiple I-line: the serial I-line could be duplicated with or without crossover between them, workers could perform operations in a different line.

Different assembly line layout involve different constraints and economic considerations, such as the total cost, equipment cost, and plant space limitations. [Battini et al. \(2007\)](#) reviewed the most common line layout present in the literature.

2.3.3 Operations characteristics

An essential attribute of operations is their processing time, in the existing ALBP literature, the processing time is often represented in three different ways: deterministic, stochastic, and dynamic.

2.3.3.1 Deterministic times

An important parameter of assembly operations is the execution or processing time. In the deterministic assumption, operation times are constant and invariant. To obtain a deterministic operation time in an assembly line, workers must be trained and already at a high learning rate.

The predetermined motion time systems (e.g., PMTS, MOST, MTM) are usually used in industrial work to quantify the time required to perform the specific operation under the assembly line conditions. Despite a low level of automation of an assembly line, the assumption of a deterministic task time is often justified ([Boysen et al., 2008](#)). Indeed, the execution time of the operations in the assembly lines is often standard and fixed by the method office by the use of the predetermined motion time system. With accurate operations time measurement, the use of deterministic assumption in line balancing could result in an excellent final balancing solution.

2.3.3.2 Stochastic times

Processing times could be stochastic due to the uncertainty caused by human work or reliability. In paced assembly lines, stochastic times may cause workstation time to exceed the adjusted takt time. With stochastic times, processing times could follow a known statistical distribution. Another method used is the scenario based on the robust optimization of the assembly line ([Dolgui and Kovalev, 2012](#)). Furthermore, the stability

of the solution with stability analysis could also be used with uncertain processing times (Sotskov et al., 2006).

2.3.3.3 Dynamic times

In addition to the stochastic definition of processing time, dynamic variations of operations times could be defined in assembly lines. The learning effect or improvement of the process could change the processing time dynamically. We refer for more details to Cohen and Dar-El (1998); Toksarı et al. (2008, 2010).

2.3.4 Equipment selection

The cost plays a significant role in the design of the production lines. The installation of an assembly line requires a long-term and significant investment. Moreover, operating the production line induces costs, such as wages, raw materials, maintenance, energy, incompleteness, setup, and inventory (Öncü Hazır et al., 2015; Scholl, 1999). In this study, we are particularly interested in problems of the assembly line design with the consideration of cost, especially the cost related to the equipment. This interest is grounded in the influence of equipment on the operating times and the performance of the line, and of course, the levels of ergonomics.

In past studies, the equipment selection is not taken into account in the design stage of assembly lines. Mainly for two reasons, first, when the equipment selection is trivial (i.e., well-defined equipment is the only possibility in the line); second, when the operations assigned to a workstation requires knowledge of the equipment. However, when operations could be performed by various equipment, for example, when more than one equipment alternative is possible, the selection of equipment becomes an important issue, mainly when the equipment affects the investment costs and the level of ergonomics of the line.

Past studies that take into account the problem of equipment selection and line balancing consider a hard LoA with fully-automatic lines, robotic lines, or transfer lines. The presence of workers is omitted.

2.3.4.1 Assembly line design with equipment costs

Early, Graves and Whitney (1979) proposed a model to satisfy a production volume requirement with a minimum cost. Graves and Lamar (1983) proposes a 0-1ILP for the ALDP with the proposition of bounds for the linear relaxation. Later, Graves and Redfield (1988) considers the ALDP with multi-product and tool costs, change times, and the fixed capital costs for equipment, then propose an algorithm to enumerate all feasible solutions.

Likewise, in Gadidov and Wilhelm (2000); Pinnoi and Wilhelm (1997, 1998); Wilhelm and Gadidov (2004), the authors of these articles consider the total design cost

(equipment selection) and operation issues (operations assignment) with several methodological contributions and valid inequality for the ALDP.

Bukchin and Tzur (2000) addresses the equipment alternatives when the total equipment costs are minimized. Later, Bukchin and Rubinovitz (2003) considers the ALDP with parallel workstations and proposes a Branch and Bound as solving approach. These authors assume that operations times and equipment costs are correlated; the cheaper equipment never gives shorter operation times.

2.3.4.2 Transfer line

Another related problem that involves equipment selection is the machining line or Transfer Line Balancing Problem (TLBP), introduced by Dolgui et al. (1999). The problem considers a fully-automatic line with or without limited workers' intervention. TLBP consist of a sequential paced serial workstations composed of one or several CNC machines linked by a conveyor for automated material transfer. Each CNC machine is equipped with a multi-spindle head with machining tools that perform machining operations by block. The problem considers the optimization of workstations' number and investment costs with the assignment of the blocks of operations. The balancing decision consists in assigning sets of operations to parallel blocks and workstations to the assignment restrictions.

Dolgui et al. (2006) optimized a weighted sum of the number of workstations and blocks of operations, with the development of exact and heuristic solving methods. Borisovsky et al. (2012) proposed a model for TLBP in the case when operations of the same workstation are performed in parallel. Likewise, Borisovsky et al. (2014) solved the TLBP with the optimization of the design cost and the consideration of processing and sequence-dependent setup times of operations. Essafi et al. (2010) investigated TLBP with parallel machines and sequence-dependent setup times. Delorme et al. (2012) proposed two combinatorial solving approaches for TLBP. The first is based on the enumeration of feasible solutions, and the second reduces the problem to a maximum weight clique.

2.3.4.3 Robotic Assembly Line Balancing Problem

Rubinovitz et al. (1993) introduced the robotic assembly line balancing problem (RALBP), a generalization of the ALBP with the additional assignment of a robot as equipment. The purpose of the RALBP (Rubinovitz et al., 1993) is to balance the workload for the production rate and to allocate the most efficient robot that offers different specialization. RALBP was discussed in the literature as fully-automated lines without any references to workers' presence and Human-Machine cooperation.

2.4 Solutions methods

In ALBP, as in many combinatorial optimization problems, an exhaustive search to find the optimal or near-optimal solutions from all feasible solutions is not tractable, particularly for discrete optimization problems. Also, as the central problem of the assembly line design, namely the SALBP is NP-hard, an enumerative strategy will not be able to solve line balancing problems in a reasonable time. Solving assembly line design and balancing problems require the use of combinatorial optimization methods. These methods are divided into exact methods that guarantee the optimality of the solution and approximate methods that provide optimal or near-optimal solutions.

2.4.1 Exact methods

Balancing and line design problems are solved with exact methods in the literature in two ways, first with a solver, and second with a dedicated exact algorithm.

Solvers are software that implements exact methods to find optimal solutions for combinatorial optimization problems, including balancing and assembly line design problems. We can mention solvers such as Cplex, Xpress, Lindo, GAMS, and Gurobi. The problem should be defined and modeled in such a way that the library can solve it efficiently. These solvers can be used as *black-box* or nested in other algorithms coded in another language such as Python, C++, or Java with the use of Application Programming Interface (API).

As for the exact methods dedicated to solving design and balancing of assembly lines, we can mention the following:

- Branch & Bound (B&B) algorithms: the most known B&B algorithms for ALBP are, FABLE by [Johnson \(1988\)](#), OptPack by [Nourie and Venta \(1991\)](#), EUREKA by [Hoffmann \(1992\)](#) and SALOME by [Scholl and Klein \(1997\)](#). Recently, an efficient algorithm denoted Branch&Bound&Remember (B&B&R) was proposed by [Morrison et al. \(2014\)](#); [Sewell and Jacobson \(2012\)](#) with competitive results over a large dataset available in the literature;
- Dynamic programming (DP): for example with the work of [Jackson \(1956\)](#), [Held et al. \(1963\)](#), [Gutjahr and Nemhauser \(1964\)](#) and [Easton et al. \(1989\)](#). DP procedures are often based on the shortest path problem.

We refer to the survey by [Baybars \(1986\)](#), [Scholl and Becker \(2006\)](#), [Battaïa and Dolgui \(2013\)](#) for more details and description of the exact methods proposed in the literature.

The effectiveness of an exact method is often measured by the computation time to find the optimal solution. When a time limit is set for an exact method, it only provides an approximate solution. For challenging and time-consuming instances, several approximate methods are proposed to solve ALBP.

2.4.2 Approximate methods

The approximate methods do not guarantee the optimality of the solution but offer a good compromise between the quality of the solution and the computation time. These methods can be seen in two categories as well, heuristics and metaheuristics.

2.4.2.1 Heuristics

Heuristics are problem-dependent methods that find a solution in the solution space, without a guarantee of optimality. The main advantage of heuristics is finding a solution close to the optimal in a reasonable computational time. Because of their ability to find a solution to optimization problems in a short amount of time, heuristics are valuable. However, they could get trapped in a local optimum and fail to provide or approximate the global optimum. Heuristics for the design and balancing of assembly lines can be a single-pass or multiple pass heuristics (Arcus, 1965; Delorme et al., 2012; Halgeson and Birnie, 1961; Raouf and Tsui, 1982);

2.4.2.2 Metaheuristics

Metaheuristics are general algorithms designed to solve a wide range of optimization problems without having to adapt to each of them. They are problem-independent and can be extracted from local optimum.

For ALBP, the following metaheuristics are often used: Simulated Annealing (Cakir et al., 2011; Kara et al., 2007; Metropolis et al., 1953; Otto and Scholl, 2011; Özcan and Toklu, 2009); Tabu Search (Chiang, 1998; Lapierre et al., 2006; Özcan and Toklu, 2008; Scholl and Voß, 1997); GRASP (Dolgui et al., 2010; Essafi et al., 2012); Genetic Algorithm Borisovsky et al. (2013); Carnahan et al. (2001); Falkenauer and Delchambre (1992); Levitin et al. (2006); Rekiek et al. (1999); Swarm intelligence-based (Oesterle and Lionel, 2018; Tapkan et al., 2012).

The metaheuristic Iterative Local Search (ILS) has been successfully applied to a wide range of combinatorial optimization problems. ILS achieves highly competitive performance for some optimization problems compared to other metaheuristics, and in some cases, ILS is among the best state-of-art metaheuristics. Some examples of ILS applications are the traveling salesman problem, the quadratic assignment problem, and scheduling problems (Lourenço et al., 2003; Stützle and Ruiz, 2017). Furthermore, ILS has several positive points: simple, easy to implement, robust, and highly effective (Lourenço et al., 2003).

Since its introduction, many exact and approaching methods were developed in the literature to tackle the ALBP. However, to our knowledge, Iterative Local Search has been used once for line balancing problems, by Antoine et al. (2016) for the dynamic

line-re-balancing problem. A local search was also successfully used by [Otto and Scholl \(2011\)](#) with simulated annealing to improve the level of ergonomics for SALBP.

In this work, we developed an ILS algorithm that will be discussed later. The ILS we developed uses a multi-start schema to browse different regions of the search space and avoid local optima. ILS shares some similarities with other metaheuristics. These metaheuristics are more often used for ALBP. We distinguish as in [Lourenço et al. \(2003\)](#) two categories of metaheuristics similar to ILS; the first category is *neighborhood-based metaheuristics*, which are variants of local search metaheuristics and the second category are *multi-start based metaheuristics*.

Neighborhood-based metaheuristics are improvement algorithms with an extension to avoid locally optimal solutions by allowing degrading moves. Metaheuristics of this category mainly differ by their moves schemes. Among the metaheuristics of this category used for the resolution of ALBP, one finds Tabu Search (TS) proposed by [Glover \(1986\)](#). TS embed a local search to enhance its performance by allowing worsening moves and a prohibition list called tabu to avoid returning to previously-visited solutions. Several versions of TS are proposed for the ALBP. One refers particularly to [Chiang \(1998\)](#); [Lapierre et al. \(2006\)](#); [Özcan and Toklu \(2008\)](#); [Scholl and Voß \(1997\)](#). Other neighborhood-based metaheuristics are the Simulated Annealing (SA) algorithm proposed by [Metropolis et al. \(1953\)](#), whose name is inspired by annealing in metallurgy. The decision to move from the current solution to another depends on a probability, the objective function becomes the energy of the system, and the temperature determines the stopping criteria. Among the SA algorithm dedicated to ALBP, we refer to [Cakir et al. \(2011\)](#); [Kara et al. \(2007\)](#); [Otto and Scholl \(2011\)](#); [Özcan and Toklu \(2009\)](#).

Multi-start based metaheuristics, on the other hand, generate iteratively input solutions that are passed to a local search procedure. Among the well-known multi-start metaheuristics, one can find GRASP (Greedy Randomized Adaptive Procedure), which consists of constructing a feasible solution and then improving it. Ant Colony Optimization (ACO) creates selection functions that bias the search toward patterns found in quality solutions, whereas GRASP and ACO both use a probabilistic solution construction phase. For ALBP, GRASP is used in [Dolgui et al. \(2010\)](#); [Essafi et al. \(2012\)](#); [Guschinskaya \(2007\)](#) and ACO in [Bautista and Pereira \(2007\)](#). For its part, ILS uses perturbation to create a new solution while GRASP and ACO use a construction scheme. Variable Neighborhood Search (VNS) is another multi-start metaheuristic featuring an interesting pattern to avoid local optimum, VNS maintains a degree of diversification that specifies which neighborhood to use from a set of neighborhoods. VNS was used for ALBP in [Polat et al. \(2016\)](#) and [Lei and Guo \(2016\)](#).

2.5 Multi-objective approaches for line balancing

Multi-objective optimization (MOO) has intensively been implemented in engineering fields and particularly in the industrial engineering field. In assembly lines, we often find conflicting objectives. For example, the productivity of the line, the health of operators, and the cost. The presence of these conflicting objectives pushes decision-makers to consider multi-objective optimization techniques to find interesting trade-offs.

MOO is the simultaneous consideration of several objectives which are to be *minimized* or *maximized*. According to the duality principle (Deb, 2001), we can convert a maximization problem into a minimization problem (or vice versa) by multiplying the objective function by -1.

The MOO could be formulated as:

$$\text{Minimize } F(x) = \{f_1(x), f_2(x), \dots, f_k(x)\} \quad \text{s.t. } x \in \mathcal{X} \quad (2.2)$$

Where k is the number of objectives with $2 \leq k$ and the set \mathcal{X} is the feasible set of decision that solutions must satisfy or the decision variable space. The image of the feasible set is denoted as $\mathcal{Y} = F(\mathcal{X})$. We use the term solution to refer to a solution vector x . For each solution $x \in \mathcal{X}$, there is a feasible set in the objective space denoted $F(x) = \{z_1, z_2, \dots, z_k\}$. The image of a solution x in the objective space is called a point.

We refer to Chankong and Haimes (1983); Deb (2001); Ehrgott (2005) for a more formal definition and details on multi-objective problems, and different optimality conditions. We also refer to the comprehensive literature review by Marler and Arora (2004) on the use of MOO in engineering fields.

The growing interest in multi-objective optimization for line balancing problems often generates more complex optimization challenges. In the last 20 years, numerous publications have been proposed in the literature for MOO in assembly lines (Delorme et al., 2014). In the following, we describe multi-objective solutions methods, with a focus on studies dealing with MOO for ALBP.

2.5.1 Multi-objective solutions methods

Many solutions methods exist for multi-objective problems, and these methods can be classified into three categories (Miettinen, 2012), a priori methods or aggregative methods; a posteriori methods or Pareto-optimal approaches; interactive multi-objective methods.

2.5.1.1 Aggregative methods

The aggregative function or a priori methods assume that the preferences of decision-makers are known before the solution process or a priori. The most common

approaches are the weighted sum, the lexicographic order, and the goal programming approach.

Weighted sum All objectives are combined to form a global criterion. Weighted sum in ALBP as an aggregative MOO method was used, for example, in [Leu et al. \(1994\)](#), [Ponnambalam et al. \(2000\)](#), and [Hamta et al. \(2011\)](#). [Carnahan et al. \(2001\)](#) aggregate in a single combined composite measure the sum of the takt time and fatigue measures as an objective function for the SALBP type 2.

Lexicographic methods In lexicographic methods, objective functions are ranked by order of importance. The decision-maker arrange objectives according to their absolute importance. This approach consists of solving the sequence of single-objective problems, as in the work of [Gokcen and Erel \(1997\)](#) for ALBP. An interesting approach to solve ALBP with ergonomics would be the consideration of economics objective in the first step, then to solve the problem with the optimal level of economics function and to optimize an ergonomics criteria.

Goal programming approaches The idea of goal programming is that the decision-maker specifies goal levels for objectives, and any deviations from these aspiration goal levels are minimized. The target values of all objectives are known a priori by the decision-maker. We refer to [Çil et al. \(2016\)](#); [Charnes and Cooper \(1977\)](#); [Deckro and Rangachari \(1990\)](#) for works applying goal programming in ALBP. [Choi \(2009\)](#) adopts the goal programming approach for SALBP with the consideration of a goal on processing time and physical workload with various ergonomic measures.

2.5.1.2 Pareto-optimal methods

A posteriori methods or methods for generating the Pareto optimal solutions are used when the preferences of the decision-makers are not a priori defined. The decision aid tries to provide a set of interesting solutions and trade-offs between different conflicting objectives. In practice, the Pareto optimality (cf. [Definition 2.1](#)) is usually used to define the optimal set of solutions. The inconveniences of these methods are that the generation of the Pareto optimal solutions for combinatorial problems is usually computationally expensive and challenging.

Most of the multi-objective algorithms use the concept of Pareto efficiency or Pareto optimality in their resolution of MOO problems when solutions are compared based on their efficiency. We formally use the definition in [Ehrgott \(2005\)](#) for efficient solutions and non-dominated points.

Definition 2.1 ([Ehrgott, 2005](#))

A feasible solution $x^1 \in \mathcal{X}$ is called efficient or Pareto optimal, if there is no other $x^2 \in \mathcal{X}$

such that $F(x^2) \leq F(x^1)$. If x^1 is efficient, $F(x^1)$ is called a non-dominated point. We say that x^1 dominates x^2 and $F(x^1)$ dominates $F(x^2)$. The set of all efficient solutions is denoted \mathcal{X}_E and called the efficient set. The set of all non-dominated points is called the non-dominated set.

The efficient set of the entire space \mathcal{X}_E is denoted the Pareto-optimal set, or simply Pareto set. Concisely, the Pareto set is the set of solutions that cannot be further improved for any objectives without degrading at least another. Throughout the rest of this manuscript, we will use the terms Pareto set or front and efficient set interchangeably. The Pareto optimality definition is similar to the definition of efficiency, and a Pareto optimal point is considered the same as a non-dominated point (Marler and Arora, 2004).

The classification of efficient solutions is defined by Geoffrion (1968) and based on the weighted sum problem that considers an aggregating multiplier for the scalarization of the objective function. An efficient solution x is called *supported* if its image is located on the boundary of the convex hull of \mathcal{Y} . *Non-supported* solutions image does not belong to the convex hull. Generally, the Pareto set of non-dominated points contains non-supported points, which are more difficult to obtain since they are not optimal solutions to a weighted sum problem.

Exact methods for multi-objective ALBP in the literature are rare. Indeed, only a few studies investigate the optimum-seeking methods such as the work of Pekin and Azizoglu (2008) that consider the bi-criteria optimization problem with equipment cost and the total number of workstations to optimize. The authors generate a set of efficient solutions with a bi-objective B&B algorithm with reduction and bounding mechanisms. Bukchin and Masin (2004) propose a backtracking B&B algorithm for the team-oriented assembly systems that consider the design of assembly lines with a team-oriented approach to improve product quality, flexibility, and workers motivation and well-being. In Abdous et al. (2018b), the authors proposed an ϵ -constraint algorithm for the bi-objective SALPB. The objectives are the number of workstations and the ergonomics of workers. Cerqueus and Delorme (2019) proposed a generic Branch and Bound algorithm for the bi-objective SALPB. The objectives are the number of workstations and takt time. The algorithm uses the notion of bounds set to obtain a finer estimation of the Pareto efficient solutions. The algorithm developed by Cerqueus and Delorme (2019) is versatile and could be adopted for a wide range of objectives.

The majority of approaches used in MOO of ALBP seek to obtain an approximation of the Pareto front instead of optimum-seeking methods. Among the most widespread algorithms used for the approximation of the Pareto front are multi-objective evolutionary and genetic algorithms, as, e.g., in Chen and Ho (2005); Chutima and Chimklai (2012); Nearchou (2008); Oesterle and Lionel (2018); Rekiek et al. (2002).

2.5.1.3 Interactive multiobjective optimization

In interactive multi-objective optimization methods, the preferences of decision-makers are progressively specified during the solution process to guide the search towards the preferred regions. Decision-makers can learn from the solution process and adjust their preferences during the process. Some examples of the use of interactive multi-objective optimization for ALBP in the literature are the works by [Alavidoost et al. \(2016\)](#); [Chica et al. \(2015\)](#).

2.6 Ergonomics in line balancing

Ergonomics criteria are classified as qualitative, semi-quantitative, and quantitative (cf. [Section 1.4](#)). In the literature, there is a promising trend to include ergonomics and workers' health in OR models for OM optimization and particularly for the design phase of assembly lines with the optimization of ergonomics that is measured with various physical assessment methods.

Qualitative assessment methods are not analytically formulated and are challenging to consider in the design stage of assembly lines, almost all publications that consider ergonomics in ALBP formulate the problem with semi-quantitative or quantitative methods. We review some of the works that consider the ergonomics in the ALBP.

2.6.1 Semi-quantitative methods

Semi-quantitative methods are used to evaluate the ergonomics in ALBP due to their low cost of evaluation, usually simple formulation, and moderate to good validity and reliability ([Rosecrance et al., 2017](#)).

[Otto and Scholl \(2011\)](#) propose methods to incorporate risk assessment tools from the literature such as OCRA, Job Strain Index (JSI), and the European Assembly Worksheet (EAWS) into ALBP as constraints or objectives. The authors investigate several methods to improve ergonomics on assembly lines, such as minimization of the average ergonomic risks, minimization of workstations with the highest risk, and deviation from average acceptable risk value. OCRA for risk assessment of upper extremities in assembly lines was also used by [Akyol and Baykasoğlu \(2019\)](#) and [Tiacci and Mimmi \(2018\)](#).

Ergonomics criteria measured with self-defined experts rating on a scale as semi-quantitative methods are also used with ALBP. [Choi \(2009\)](#) proposes different risks element for three categories: environment criteria, postural criteria, and physical loads. Each criterion is measured on a five-point scale, and the aggregation of risks is calculated with a sum of physical loads of operations assigned to a given workstation. Likewise, [Özcan Mutlu and Özgörmüş \(2012\)](#) considers the physical load with an estimation of risks on a defined scale for the optimization of ergonomics in assembly lines.

Some other papers consider more than one criterion in an integrated manner. [Xu et al. \(2012\)](#) propose to measure ergonomics of the upper extremity in an integrated manner, based on the guideline from the American Conference of Governmental Industrial Hygienists (ACGIH) concerning physical exposures of workers. Ergonomics criteria are exertion frequency, duty cycle, normalized peak force, and vibration. [Kara et al. \(2014\)](#) consider in an integrated way, several industry-originated restrictions such as energy expenditure, workers skills, working conditions, and illumination levels. The objective function considers an aggregation of several costs to minimize, such as workers and equipment cost.

Ergonomic risks are also quantified in several papers by a semi-quantitative customized set of criteria instead of assessment methods available in the literature. [Bautista et al. \(2016\)](#) and [Bautista et al. \(2017\)](#) propose to optimize customized risks of injuries and the linear space given to workers to execute their jobs.

The level of ergonomics of a subset of operations assigned to a workstation is assessed with semi-quantitative methods most of the time with a non-linear aggregation function of the single risk evaluation of one operation, such as multiplication in OCRA and JSI, and a mixture of multiplication and addition in EAWS. Customized criteria (i.e., non-present in the literature) are aggregated for a set of operations by a mixture of addition and multiplication.

2.6.2 Quantitative methods

Only a few works in the literature used quantitative-based methods such as energy expenditure, fatigue and recovery, and vibration analysis.

[Gunther et al. \(1983\)](#) pioneer the consideration of ergonomics into ALBP with energy expenditure and metabolic rate, the authors measure the physical demands for each operation with the energy expenditure and propose the linear aggregation of the total energy assigned to a workstation. [Gunther et al. \(1983\)](#) formulated a goal programming model and proposed a B&B algorithm to solve the problem. [Battini et al. \(2015\)](#) proposed two approaches to incorporate the energy expenditure rate as operations ergonomics measure. The first approach applies a bi-objective optimization problem with time and energy expenditure rate. The second approach uses a single objective with rest allowances that transform the energy expended into rest time requirements. Likewise, [Battini et al. \(2016\)](#) proposed a method to estimate the energy expenditure called Predetermined Motion Energy System; this method helps to estimate the energy expenditure values. Later, [Battini et al. \(2017\)](#) formulated the integrated assembly line balancing and parts feeding planning problem with the use of operations energy expenditure measures to reduce the total system labor costs and to improve the ergonomics.

Worker's energy expenditures are considered as ergonomic aspects and integrated into the SALBP-2 through the rest allowance evaluation in the work of [Finco et al. \(2019\)](#).

The objective in [Finco et al. \(2019\)](#) is an economic objective with the production rate optimization, ergonomics is considered as a constraint, and the balancing solution must assign sufficiently rest period to allow complete recovery after the effort for workers.

Physical fatigue and reduction of the ability to execute assembly operations are studied in the work of [Carnahan et al. \(2001\)](#). In his paper, the fatigue and recovery model for the assessment of grip strength was used with SALBP-2. The objective considered is a weighted sum of takt time and fatigue after several cycles of work and recovery. Approximate solving approaches are used to solve the problem. The approach proposed by [Carnahan et al. \(2001\)](#) pioneer the consideration of fatigue and recovery into SALBP. Despite the importance of fatigue in assembly lines (cf. [Section 2.7](#)), scientific contribution in the field neglect models of fatigue and recovery during industrial work. The primary reason behind this is the complexity of the model and its non-linearity.

The level of ergonomics of a subset of operations assigned to a workstation is aggregated in quantitative methods with a linear sum with energy expenditure models ([Battini et al., 2015](#)) and rest allowance ([Finco et al., 2019](#)). Non-linear product of exponential function in the case of fatigue model ([Abdous et al., 2018b](#); [Carnahan et al., 2001](#)), and non-linear aggregation composite index for the NIOSH equation ([Otto and Scholl, 2011](#)).

2.7 The importance of reducing physical fatigue

Several operations in the production systems are still manual or semi-manual and carried out by humans ([Calzavara et al., 2018](#)). In particular, the major part of the active manufacturing operators work in assembly lines ([Claeys et al., 2015](#); [Pasquale et al., 2018](#)). Manufacturing assembly lines typically require workers to perform operations with varying physical demands at a high production rate to satisfy customers' demands ([Sonne and Potvin, 2015](#)).

The load and repetitiveness of operations in assembly lines can lead to muscle fatigue ([Ma et al., 2009](#)), which has been shown to reduce the performance and the product quality ([Elmaraghy et al., 2008](#); [Kolus et al., 2018](#)), and leads to MSDs ([Battini et al., 2016](#); [Otto and Scholl, 2011](#)). Ergonomists have developed assessment tools that can be used to evaluate different characteristics of the work, such as posture, discomfort, and pain. However, many of these tools assume that the efforts are of equal intensity or/and duration, and suppose that the operators benefit from a complete rest period ([Rohmert, 1973](#); [Sonne and Potvin, 2015](#)). Most of the time, in assembly lines, a high effort and intensity lead to the fatigue of operators. Besides, operators can initiate several cycles on several products without the benefit of sufficient rest time to recover and reduce fatigue.

2.7.1 Physical fatigue in assembly lines

Physical fatigue is the decrease in muscular performance associated with a sustained contraction. [Vøllestad \(1997\)](#) defined the physical fatigue as “*a loss of maximal force-generating capacity*”. Therefore, physical fatigue refers to a decline in physical muscular capacity and operators (or workers) performance that results from prolonged exertion and excessive operations load.

The fatigue accrues with a poorly designed work-rest pattern. The workload is related to fatigue. Operators are more easily fatigued if their work is at a high pace, with complex and physical-demanding operations. The workload is the part of ergonomics that is most related to decisions in assembly lines balancing. Indeed, the workload of workstations is related to the assignments of operations, which is the core decision in ALBP. Besides, decisions of ALBP also influences on the idle time and recovery period assigned to each workstation, and the assignment of idle time is closely linked with the evolution of the level of fatigue of workers ([Glock et al., 2019](#); [Jaber et al., 2013](#); [Ma et al., 2010](#); [Yung et al., 2020](#)).

Observing automobile assembly lines, [Rodgers \(2004\)](#) reported that operators were accumulating fatigue as their shift progress. Analyses of operations and postures could not always explain the perceived discomfort related to the fatigue. The fatigue was somewhat related to the temporal work-rest patterns. Operators reported that they sped-up their work in paced assembly lines to increase the amount of idle time and recovery length ([Rodgers, 2004](#)).

Due to the labor-intensive nature of operations in assembly lines, workers frequently suffer from MSDs and excessive fatigue. MSDs are one of the significant ergonomic problems for workers involved in assembly lines ([Battini et al., 2016](#); [Bautista et al., 2017](#); [Neumann et al., 2006](#); [Otto and Battaïa, 2017](#); [Otto and Scholl, 2011](#)), and physical fatigue is among the risk factors for MSDs ([Ma et al., 2010, 2009](#)). The fatigue can be correlated to the heart rate or the energy expenditure rate ([Abdous et al., 2018](#); [Battini et al., 2016, 2015](#); [Calzavara et al., 2018](#)). Besides, rest allowance or recovery times are also essential to reduce the level of fatigue and to assign sufficient recovery times to mitigate the risks and improve the ergonomics of workstations ([Calzavara et al., 2018](#); [Finco et al., 2019](#); [Jaber et al., 2013](#); [Ma et al., 2010](#)).

There is growing evidence to support the benefits of the use of fatigue assessment in the early stages of assembly lines, where costs are lower with the most significant flexibility ([Perez et al., 2014](#)). Moreover, as we discussed before, the consideration of ergonomics from the design stage requires that the models to quantify ergonomics can be integrated into models of ALBP.

The fatigue and recovery used in the design of work-rest patterns lead to a reduction of ergonomic problems ([Carnahan et al., 2001](#); [Perez et al., 2014](#); [Wood et al., 1997](#)),

especially in paced assembly lines, where the work rate is high, and operators have little to no control over their work-rest patterns. To design such work-rest patterns in assembly lines, we discuss in the next subsection, analytical models that study the fatigue and recovery evolution.

2.7.2 Fatigue and recovery evolution

When operations are assigned to workstations in production lines and assembly systems, there is a need for predictive tools to design the work-rest patterns. Models that describe the variation of muscular capacities are necessary for the design of safe work-rest patterns (Rose et al., 2018).

In the literature, the shape of fatigue functions over time are described both with linear and non-linear function. A part of the literature focus on developing models for Maximum Endurance Time (MET), which represents the point at which operators can no longer exert the required effort to execute an operation. Elahrache et al. (2006) review some of the most famous models for determining MET for static muscular work, MET model describes the endpoint at which maximum fatigue is reached without focusing on the evolution and the shape of the curve of fatigue. Some papers support the exponential development of fatigue over time, such as Konz (2000); Ma et al. (2010, 2009); Xia and Law (2008), while others assume a linear shape (Jaber and Neumann, 2010).

Most empirical, theoretical, and experimental studies support the non-linearity of the evolution of fatigue and recovery during exertion and rest (Jaber et al., 2013; Ma et al., 2009; Rose et al., 2018; Zhang et al., 2014). The assumption of linearity of the evolution of fatigue and recovery is often considered to simplify models and is not supported by experimental evidence. Moreover, even authors who use linear models (e.g., Jaber and Neumann (2010)), revise this hypothesis and confirm a non-linear evolution in their recent works (Givi et al., 2015; Jaber et al., 2013; Rose et al., 2014, 2018).

2.8 Conclusion

Assembly lines are an essential means of production in which human plays an important role. Workers' intervention in manual and semi-automatic assembly lines is essential to ensure productivity and flexibility. However, special attention must be paid to the question of ergonomics and work-related risks. The consideration of ergonomics at the design stage has the advantage of allowing more flexibility for changes at a low cost. At present, the reduction of work-related risks of assembly lines is carried out by the arrangement on existing workstations, which generates a significant cost related to the difficulty of intervention on already existing lines. Decision-makers and assembly lines designers must find an efficient assessment method of ergonomics and decision support models to predict the level of ergonomics in the production line from the design stage.

To assess the physical risks and quantify MSDs, several ergonomic assessment methods were developed and classified (cf. [Section 1.4](#)). While these methods are used to assess ergonomic risks in practice, there are still several limitations and issues. First, the precision and reliability of measures are medium to low, especially in qualitative and semi-quantitative assessment methods ([Chengalur, 2004](#)). Second, observational methods are mainly developed for the static and specific type of activity (posture, lifting, push/pull, and so on), and they are not general-purpose tools. Also, most methods are designed to carry out analysis on-site. Few methods are suitable for the design stage of manufacturing systems.

Apart from the recent interest in the introduction of ergonomics in the assembly lines, the literature on the question is not extensive. We present a non-exhaustive overview of the literature in [Table 2.2](#). Most publications used semi-quantitative criteria, and more specifically, criteria for assessing the risks associated with working conditions, such as postures, repetition frequency, and intensity of the effort. In their literature review, [Otto and Battaïa \(2017\)](#) stated that most ergonomic methods are designed for existing assembly lines, this has led to a simplification of estimation and lack of rigor, only a few ergonomics criteria are suitable for the design stage of assembly lines. Moreover, the majority of ergonomic criteria are non-linear and are difficult to formulate with the linear formulation of ALBP. The non-linearity of criteria and the large number of possible assignments of ALBP raise the question of the algorithm and their efficiency to find an optimal or near-optimal solution. In their survey, [Otto and Battaïa \(2017\)](#) stated that most articles recommend metaheuristics to solve problems but fail to provide a good quality gap to the optimal solution and information about the bounds. Furthermore, to compare different ergonomics criteria from the literature, an exact solution for the balancing problems is the more neutral base to assess the efficiency of a given approach.

Equipment and tools are essential in the production lines; the operating mode of many operations depends on the presence of adequate equipment. Besides, equipment influences the execution time of operations as well as physical load. In manual or semi-automatic lines, mitigating ergonomic risks depends on the equipment selection decision, the decision problem, in this case, is to find the right trade-off between investment cost and its benefits on ergonomics ([Otto, 2012](#)). As we discussed in [Subsection 2.3.4](#), several works show the interest of equipment selection with the decision of balancing workload, even though these works often consider completely automated lines without the consideration of ergonomics. The consideration of ergonomics in the equipment selection problems in the assembly lines could mitigate ergonomic risks, mainly when the equipment in question influences the productivity or the level of ergonomics of workstations. Besides, the investment costs for equipment selection are an expensive and long-term decision for companies. It would be of great interest to propose a multi-objective approach to provide decision-makers with interesting trade-offs between different criteria such as investment cost, productivity, and

Table 2.2: An overview of the literature for ALBP with ergonomics consideration

Reference(s)	Ergonomic measure(s)	Type of measure(s)	Objective(s)	Solution method(s)
(Akyol and Baykasoğlu, 2019)	OCRA	Semi-quantitative	Minimize the Cycle time; OCRA	Multiple-rule constructive randomized search
(Battini et al., 2016, 2015, 2017)	Energy expenditure	Quantitative	Minimize Energy expenditure; time	Enumeration
(Bautista et al., 2017)	Physical risk factors	Semi-quantitative	Minimize the average of maximum risk; the average absolute deviations of risk	GRASP
(Bautista et al., 2016)	Physical risk factors	Semi-quantitative	Optimize several physical risks formulation	ILP solver (Cplex)
(Carnahan et al., 2001)	Fatigue (Grip strength)	Quantitative	Minimize a weighted sum: cycle time and fatigue	Genetic algorithms; multiple ranking heuristics
(Choi, 2009)	Environmental parameters; postures; force loads	Semi-quantitative	Equalizing the processing time; minimize physical workload	ILP solver (Cplex)
(Finco et al., 2019)	Energy expenditure and rest allowance	Quantitative	Goal Programming with several objectives	ILP solver (Cplex) and a heuristic
(Gunther et al., 1983)	Energy expenditure	Quantitative	Smoothness index of idle time	Branch&Bound
(Kara et al., 2014)	Energy expenditure; tasks rigidity; illumination levels	Semi-quantitative	Minimize weighted sum of costs	ILP solver (Xpress)
(Özcan Mutlu and Özgörmüş, 2012)	Physical risk (self-designed parameters)	Semi-quantitative	Minimize the number of workstations	ILP solver (Cplex)
(Otto and Scholl, 2011)	OCRA; NIOSH-eq; JSI; EAWS	Semi-quantitative	A weighted sum of risks and the number of workstation	Two-stage heuristics: SALOME and simulated annealing
(Tiacci and Mimmi, 2018)	OCRA	Semi-quantitative	Minimize the normalized design cost corrected for OCRA	Genetic algorithm and simulation
(Xu et al., 2012)	Exertion frequency; duty cycle; peak force; vibration	Semi-quantitative	Minimize the number of workstations	ILP solver (Cplex)

ergonomics.

In [Chapters 1](#) and [2](#), we defined concepts for the understanding of the present manuscript with a focus on the essential works from the literature. We were interested in the place of ergonomics and its importance in production systems, especially assembly lines. The main ergonomics assessment methods have been classified, with a literature review of works that have addressed ergonomics in assembly lines. Besides, we have described the problem of equipment selection and design of assembly lines; the introduction of ergonomics into this problem has hardly been addressed.

In the rest of this manuscript, we first discuss how to consider fatigue and recovery of workers as ergonomics criterion in assembly lines, with optimal and approximate solving approaches. Second, we discuss the joint problem of line balancing and equipment selection with a multi-objective approach to propose trade-offs between investment cost and ergonomics. Third, we illustrate the overall methodology of optimal manufacturing systems design with ergonomics on industrial cases.

Chapter 3

Simple Assembly Line Balancing Problem with ergonomics

Contents

3.1	Introduction	50
3.2	Definition of the fatigue and recovery model	51
3.2.1	Fatigue and recovery data and assumptions	52
3.2.2	Objective function	52
3.3	Problem formulation	55
3.3.1	Mixed-Integer Nonlinear Programming	55
3.3.2	Linearization technique	56
3.4	Iterative Dichotomic Search	58
3.4.1	Example of exact resolution	59
3.5	Iterative Local Search	60
3.5.1	Pool generation	61
3.5.2	Local Search	63
3.6	Numerical experiments dataset	65
3.6.1	Experimental conditions	66
3.6.2	Data and characteristics of instances	67
3.7	Numerical results	69
3.7.1	Exact resolution and bounds	69
3.7.2	Proportion of instances solved optimally	70
3.7.3	Results analysis and algorithms comparison	70
3.8	Conclusion	75

3.1 Introduction

In this chapter, we resume the assumptions of the SALBP, and we extend the SALBP with the consideration of ergonomics. Most publications that include ergonomics into ALBP consider the SALBP assumptions (Battini et al., 2016; Carnahan et al., 2001; Finco et al., 2019; Otto and Battaia, 2017; Otto and Scholl, 2011). Although our findings can be generalized to GALBP.

As we stated before, there's a need to define a framework and a methodology for taking

ergonomics into account as early as in the design phase of assembly lines. For this reason, we propose a quantitative model of fatigue and recovery of operators in the assembly lines. As we discussed in [Chapter 1](#), ergonomics quantitative assessment methods provide advanced analytical models for the objective evaluation of ergonomics, with an accurate evaluation of the fatigue level and the assessment of the positive effect of rest allowance and recovery times.

Although previous approaches have included ergonomics in SALBP, they have some limitations. Most of the past studies take into account restrictive criteria applicable only for restrictive situations such as postural analysis criteria, repetition, and material handling work criteria. Moreover, most of these studies consider nonlinear quantitative models for the assessment of ergonomics without an efficient exact solving algorithm ([Otto and Battaia, 2017](#)).

In this chapter, we propose an approach to overcome these limitations. In [Section 3.2](#), we present the ergonomics criterion. Afterward, in [Section 3.3](#), we propose a problem formulation and a linearization of the ergonomics criterion with an Integer Linear Programming (ILP) and in [Section 3.4](#), an exact algorithm denoted Iterative Dichotomic Search. Subsequently, we develop in [Section 3.5](#) a metaheuristic based on a multi-start Iterative Local Search. Finally, we validate our approach by proposing numerical experiments and analysis on instances from the literature in [Section 3.6](#) and [3.7](#).

3.2 Definition of the fatigue and recovery model

To represent the evolution of fatigue level in assembly lines, we choose the fatigue and recovery model proposed by [Ma et al. \(2009, 2010\)](#). The model mathematical properties are suitable for the evaluation of workload in assembly lines. The evolution of the fatigue depends on the external load and duration of operations, the aggregation of a load of operations is possible with the additivity of integration on intervals, which allows to aggregate a subset of operations assigned to a workstation. Besides, workers' factors or characteristics are represented by the widely used MVC (Maximum Voluntary Contraction) measure defined as the maximum generation of force with a maximum will and without fatigue, and a measure of fatigability or fatigue rate. The recovery process in the model ([Ma et al., 2010](#); [Wood et al., 1997](#)) depends on the recovery rate and the length of the recovery time. In assembly lines, workers benefit from idle and transfer time to decrease fatigue. Furthermore, the fatigue and recovery model is general for a single or group of muscles and was validated experimentally and theoretically with a series of articles in the last decade ([Liu et al., 2018](#); [Ma, 2009](#); [Ma et al., 2009, 2011c, 2009, 2015](#); [Ma, 2012](#); [Zhang et al., 2014](#)).

However, the fatigue and recovery model is non-linear. In the following section, we propose a linearization technique to include fatigue and recovery of workers into the

classical linear model of SALBP.

3.2.1 Fatigue and recovery data and assumptions

Using the SALBP assumptions, we include fatigue and recovery model along with the decisions of assigning operations to workstations (See [Subsection 2.2.1](#) for the foremost data and assumptions of SALBP). In what follows, we define the data and assumptions to include the ergonomics criterion of fatigue and recovery in SALBP.

MVC: Maximum voluntary contraction. Unit [N] or [N.m]. This physical measure is significant to construct and define fatigue. It represents the maximal muscular power output generation. The majority of MET and fatigue and recovery models are defined with this measure. To simplify, in the rest of the manuscript, we assume that $MVC = 100\%$, which represents the maximum level of muscular strength expressed as a percentage. The percentage is used to simplify the comprehension of the measure and to make it unit-independent. All measures of muscular capacity or operations load would be expressed in percentage (% or %MVC, used interchangeably).

Fload_j: the magnitude of operation intensity. Unit [N] or [N.m]. This measure would be expressed relative to MVC with $MVC=100\%$. For example, if the magnitude or intensity of operation $j \in V$ is $Fload_j = 20\%$, it means that the operation load represents 20% of the maximum force capability.

K: Worker fatigability or fatigue rate; unit [s^{-1}]; positive constant that represents the fatigability and operator's characteristics.

R: Worker recovery rate [s^{-1}]; a positive constant that represents the recovery rate of operators.

An important assumption of our modeling is the constant average operator (worker) characteristics. We assume that operators belong to the 50% percentile of the population, and hence, we consider average physical characteristics. The average worker's characteristics are used since SALBP does not consider the assignment of workers. Besides, in the design stage of assembly lines, workers' characteristics could not always be available to designers, a consideration of a percentile of the working population is a reasonable assumption in this stage.

3.2.2 Objective function

The evolution of muscle capacity in [Ma et al. \(2010, 2015\)](#) model is based on the motor mechanism pattern of muscles, as described in [Section 1.4.3.4](#). The fatigue evolves exponentially, depending on operations load, duration, and magnitude. In addition to the operator's physical characteristics, such as *MVC*, *K*, and *R*. The discussion of the exact mechanism of muscle fatigue is beyond the scope of this thesis. However, the fatigue and recovery model considered is general and considers dynamic load and is

validated theoretically with the existing MET models and experimentally in several papers. Furthermore, regressions were performed to define different operators' characteristics (Liu et al., 2018; Ma et al., 2009, 2010, 2011c, 2009, 2015), the model is also validated with industrial workers (Zhang et al., 2014) and embedded in virtual human simulation tools to investigate the fatigue and recovery in an airplane assembly line (Ma, 2009).

The fatigue and recovery model is obtained from the resolution of a differential equation (see Section 1.4.3.4 for more details). The fatigue evolves exponentially starting from the initial state when we assume the operator is without fatigue, the recovery process then begins from the fatigue level at the end of the work and also evolve exponentially.

Figure 3.1 represents the working and recovery time in an assembly line of 3 workstations (WS1, WS2, WS3) in two successive takt times. Parts to assemble in paced lines are transported between workstations at the end of the adjusted takt time AT with conveyors. In the example of Figure 3.1, the working time colored in gray in each workstation represents the sum of operations times assigned to that workstation, and the recovery time is composed of the idle time and the transfer time TT .

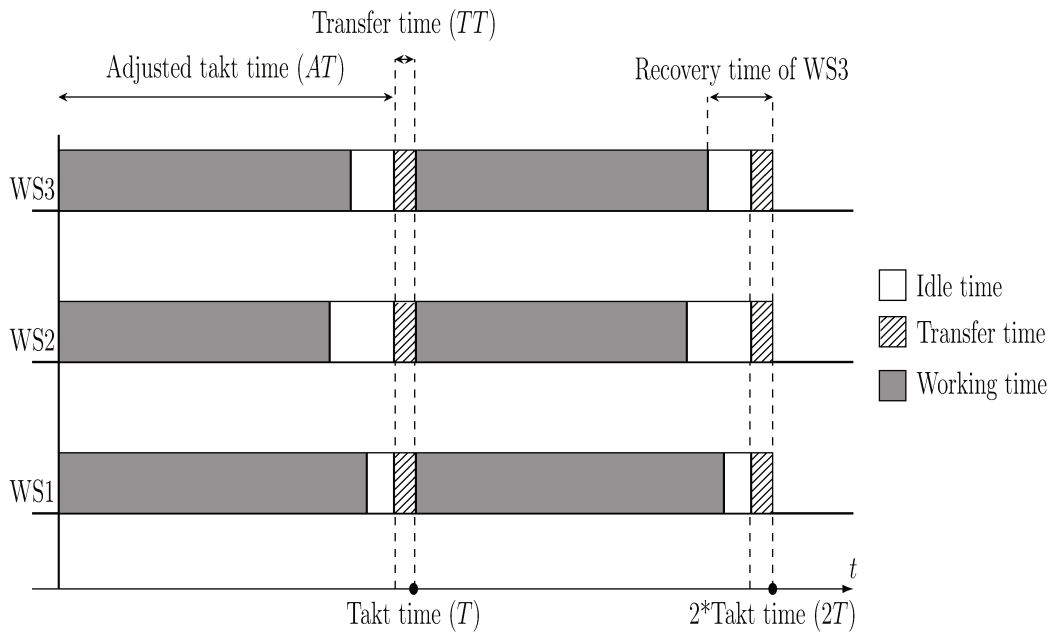

Figure 3.1: Working and recovery time for two successive takt time

We consider an average operator's characteristics (i.e., MVC, K, R are constant). We consider the evolution of the muscular capacity in each workstation F_k at the end of a takt time T , that we expressed in Equation (3.1).

$$F_k = 1 + \left(e^{-\left(\frac{K}{MVC} \int_0^{AT} Fload_j(u) \cdot x_{j,k} du\right)} - 1 \right) e^{-R(T - \sum_{j \in V} t_{j \cdot x_{j,k}})} \quad \forall k \in W \quad (3.1)$$

Let $F_k \in [0, 1]$ be a function representing the level of muscular capacity of the operator in the workstation k at the end of takt time. We introduce the following definition:

Definition 3.1 A workstation k is called critical if the muscular capacity of the operator in that workstation is the worst among other operators in the assembly line. i.e., $\text{Min}_{k \in W} \{F_k\}$. We define $F = \text{Min}_{k \in W} \{F_k\}$ that represents the ergonomics level of the critical workstation. Non-critical workstations are called slack workstations.

For the sake of clarity, in the rest of this manuscript, F would be referred to as the *ergonomics level*, which is used as defined in [Definition 3.1](#) to refer to the state of the muscular capacity in a critical workstation at the end of one takt time.

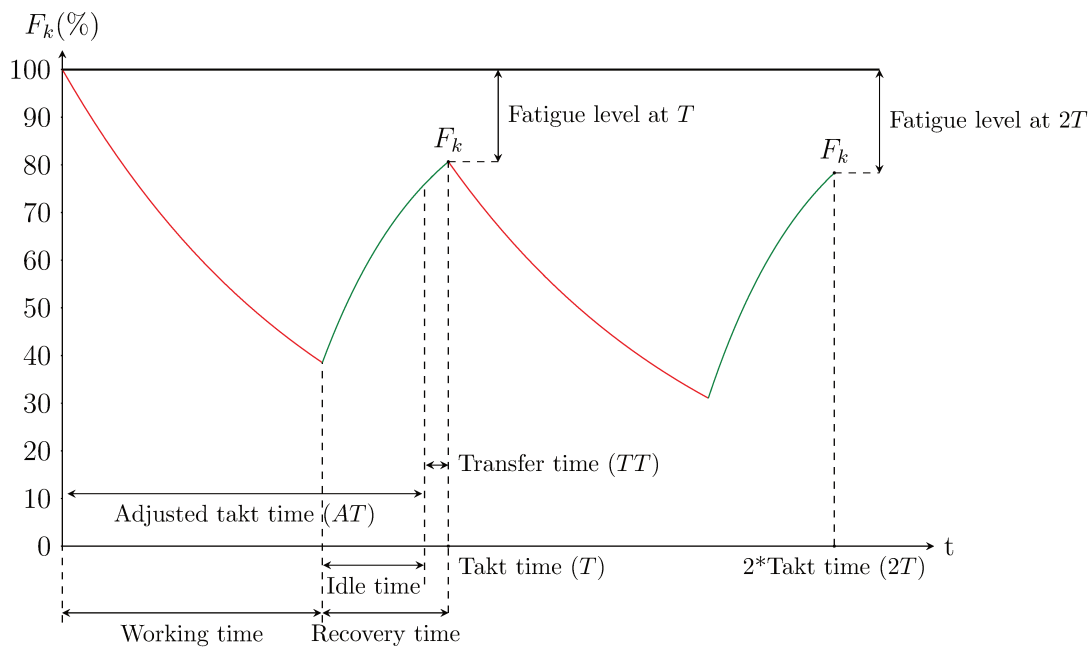

Figure 3.2: Evolution of the muscular capacity for a worker in workstation k in the work and recovery time for two successive takt time

[Figure 3.2](#) represents the evolution of the muscular capacity in working and recovery time in an assembly line after two successive takt time. The fatigue is accrued in working time when the operator executes the assembly operations. Afterward, in recovery time (idle time and transfer time), the operator recovers from fatigue. In recovery times (idle time, transfer time), the operator in a given workstation k benefits from the recovery process, the latter depends on the operator's recovery rate R , the length of recovery $T - \sum_{j \in V} t_j \cdot x_{j,k}$ and the fatigue level at the beginning of the recovery period.

At the end of takt time, the difference between the initial level without fatigue (100%) and the final $F_k(\%)$ represents the level of fatigue after the first takt time in a workstation k .

After several takt time, the fatigue and recovery function slope decrease quickly in first takt time and when the worker reaches a high fatigue level, relatively short recovery time is sufficient to reduce the fatigue as it will not increase sharply during the next cycles. We refer to [Glock et al. \(2019\)](#) for more details on the evolution of the fatigue and recovery after several cycles of work. However, the consideration of the fatigue level after one takt time, which is the unitary measure in assembly lines, is relevant criteria for the design stage. Besides, a critical workstation after one takt time is likely to remain so after several cycles.

3.3 Problem formulation

3.3.1 Mixed-Integer Nonlinear Programming

In this part, we consider the SALBP-1 when we have a fixed takt time, and we seek to optimize the number of workstations. Solving SALBP-1 without the ergonomics constraints define the optimal number of workstations m . The consideration of the optimal number of workstations makes it possible to design an assembly line in which the design cost is optimal because the cost of the line in the case of the SALBP-1 hypothesis is strongly correlated to the number of workstations.

To introduce the ergonomics in SALBP, we formulate a Mixed-Integer Nonlinear Programming (MINLP) model, which allows obtaining an assembly line balancing with a fixed takt time, and an optimal number of workstations m (obtained by solving SALBP-1), while optimizing the ergonomics. The main structure of this MINLP model, apart from the objective function, corresponds to a SALBP-F (cf. [Subsection 2.2.1](#)). The goal here is to maximize the *level of ergonomics* for an assembly line for one takt time with the optimal number of workstations (m).

$$\text{Maximize } \left\{ \text{Min}_{k \in W} \left(1 + \left(e^{-\left(\frac{K}{MVC} \int_0^{AT} \text{Fload}_j(u) \cdot x_{j,k} du \right)} - 1 \right) e^{-R(T - \sum_{j \in V} t_j \cdot x_{j,k})} \right) \right\} \quad (3.2a)$$

$$\sum_{k \in W} y_k = m \quad (3.2b)$$

s.t. [\(2.1b\)](#) to [\(2.1e\)](#)

All the elements can be gathered in a MINLP which is defined by the set of equations: $\{ \text{(3.2a)}, \text{(3.2b)}, \text{(2.1b)}, \text{(2.1c)}, \text{(2.1d)}, \text{(2.1e)} \}$. The objective function in [\(3.2a\)](#) represents the maximization of the *ergonomics level*, i.e, $\text{Min}_{k \in W} \{ F_k \}$. Constraint [\(3.2b\)](#) fix the optimal number of workstations m . The subset of constraints $\{ \text{(2.1b)}, \text{(2.1c)}, \text{(2.1d)}, \text{(2.1e)} \}$ define the classical constraints of SALBP-F as in [Section 2.2.1.1](#).

3.3.2 Linearization technique

The MINLP is an NP-hard combinatorial problem since it includes a Mixed-Integer Linear Programming (MILP) formulation (Kannan and Monma, 1978), and the SALBP is an NP-Hard problem (Scholl, 1999; Wee and Magazine, 1982). Hence, the resolution of the MINLP is challenging and requires searching in an extensive search tree (Tawarmalani et al., 2002). The nonlinearity of the objective function (3.2a) is a considerable limitation and puts a brake on the use of linear programming. The reason linear programming models are given more attention in comparison to nonlinear models is the ease of their resolution (Williams, 2013). In the following section, we propose a suitable linear programming formulation for the problem of assembly line balancing with the optimization of the ergonomics level.

First and foremost, we formulate an Integer linear programming (ILP), which allows after its resolution to obtain a level of ergonomics better than a given threshold. After that, we propose an algorithm that starts with an initial solution and improves it with an iterative process that converges to the optimal solution (Abdous et al., 2018a).

3.3.2.1 Lower bound on the ergonomics level

First, we define I_j expressed in Equation (3.3) that represents the integral of the operation's load, the integration by part allows us to aggregate a subset of operations $V' \subseteq V$ assigned to the operator in a given workstation $k \in W$, with K the fatigue rate constant.

$$I_j = \frac{K}{MVC} \int_t^{t+t_j} Fload_j(u) du \quad (3.3)$$

Let assume a dynamic loading of an operation $j \in V$, the operation time or processing time is t_j . The $Fload_j$ of the operation j is dynamic, which means it changes along with the exertion and it is expressed in percentage related to MVC.

We introduce $\underline{F} \in [0, 1[$ that represents a lower bound on the ergonomics level. Hence, (3.4) holds for all $k \in W$.

$$\underline{F} \leq 1 + (e^{-\sum_{j \in V} I_j \cdot x_{j,k}} - 1) e^{-R(T - \sum_{j \in V} t_j \cdot x_{j,k})} \quad \forall k \in W \quad (3.4)$$

(3.4) is equivalent to (3.5).

$$(\underline{F} - 1) e^{R(T - \sum_{j \in V} t_j \cdot x_{j,k})} + 1 \leq e^{-\sum_{j \in V} I_j \cdot x_{j,k}} \quad \forall k \in W \quad (3.5)$$

We developed (3.5) into (3.6), with respect to the definition domain of the natural logarithm function.

$$\sum_{j \in V} I_j \cdot x_{j,k} \leq \ln \left(\frac{1}{(\underline{F} - 1) e^{R(T - \sum_{j \in V} t_j \cdot x_{j,k})} + 1} \right) \quad \forall k \in W \mid \text{with } 0 < (\underline{F} - 1) e^{R(T - \sum_{j \in V} t_j \cdot x_{j,k})} + 1 \quad (3.6)$$

In (3.6), we obtain a constraint on the workload to obtain an ergonomics level that respect the bound \underline{F} , the domain of definition depends on the length of recovery time ($T - \sum_{j \in V} x_{j,k} \cdot t_j$). Since the t_j are integers, we introduce a decision variable $z_{l,k}$ for the recovery time with $U = \{0, 1, \dots, T\}$ the set of possible recovery time.

$$z_{l,k} = \begin{cases} 1 & \text{if recovery time of workstation } k \text{ is equal to } l, \text{ with } l \in U \\ 0 & \text{Otherwise} \end{cases}$$

(3.6) is developed in (3.7).

$$\sum_{j \in V} x_{j,k} \cdot I_j \leq \ln \left(\frac{1}{(\underline{F} - 1)e^{R \cdot l} + 1} \right) \quad \forall k \in W, \text{ if } z_{l,k} = 1 \mid \text{with } l < \frac{1}{R} \ln \left(\frac{1}{1 - \underline{F}} \right) \quad (3.7)$$

Finally, we developed (3.7) into (3.8), with the use of $z_{l,k}$.

$$\sum_{j \in V} x_{j,k} \cdot I_j \leq \sum_{l \in U \mid l < \mathcal{D}} \ln \left(\frac{1}{(\underline{F} - 1)e^{R \cdot l} + 1} \right) \cdot z_{l,k} + \sum_{j \in V} \sum_{l \in U \mid l \geq \mathcal{D}} I_j \cdot z_{l,k} \quad \forall k \in W \quad (3.8)$$

When the value of recovery time l is strictly inferior to the value $\mathcal{D} = \frac{1}{R} \ln \left(\frac{1}{1 - \underline{F}} \right)$, the natural logarithm function in (3.8) is defined and specifies a bound on the load in workstations to respect the lower bound \underline{F} on the ergonomics level. On the other hand, when the value of the recovery is equal or exceeds \mathcal{D} (i.e., $l \geq \mathcal{D}$), no matter which load value is assigned to the workstation, the ergonomics level will respect the bound \underline{F} , in this case, a maximum load $\sum_{j \in V} I_j$ can be used as a bound on the load.

Finally, we can write the complete ILP model $\{(3.9a) \text{ to } (3.9h)\}$, denoted *SALBP-FR*, for Simple Assembly Line Balancing Problem with workers Fatigue and Recovery.

$$\sum_{k \in W} y_k = m \quad (3.9a)$$

$$\sum_{k \in W} x_{j,k} = 1 \quad \forall j \in V \quad (3.9b)$$

$$\sum_{j \in V} t_j \cdot x_{j,k} \leq AT \cdot y_k \quad \forall k \in W \quad (3.9c)$$

$$\sum_{k \in W} k \cdot x_{h,k} \leq \sum_{k \in W} k \cdot x_{g,k} \quad \forall (h, g) \in P \quad (3.9d)$$

$$\sum_{j \in V} x_{j,k} \cdot I_j \leq \sum_{l \in U \mid l < \mathcal{D}} \ln \left(\frac{1}{(\underline{F} - 1)e^{R \cdot l} + 1} \right) \cdot z_{l,k} + \sum_{j \in V} \sum_{l \in U \mid l \geq \mathcal{D}} I_j \cdot z_{l,k} \quad \forall k \in W \quad (3.9e)$$

$$T - \sum_{j \in V} t_j \cdot x_{j,k} = \sum_{l \in U} l \cdot z_{l,k} \quad \forall k \in W \quad (3.9f)$$

$$\sum_{l \in U} z_{l,k} = 1 \quad \forall k \in W \quad (3.9g)$$

$$x_{j,k}, y_k, z_{l,k} \in \{0, 1\} \quad (3.9h)$$

To define the value of the recovery time, constraint (3.9f) makes sure that the recovery time l in workstation k is equal to the difference between the takt time and working time. Constraint (3.9g) ensures the uniqueness of the recovery time in each workstation k .

Solving the decision problem SALBP-FR does not guarantee to maximize the ergonomics level in the assembly line since we only get an ergonomics level better than a given threshold or lower bound. To obtain the optimal solution, we propose in the next subsection an algorithm, using this ILP model to solve the problem.

3.4 Iterative Dichotomic Search

To solve the MINLP, or even to obtain a lower bound when the exact resolution is not possible in a given computational time, we developed an exact algorithm, which is based on the ILP denoted SALBP-FR and a dichotomic search algorithm, denoted Iterative Dichotomic Search (IDS).

The decision problem SALBP-FR tries to find a solution that is better than a fixed target on the ergonomics level defined with the bound \underline{F} in Equation (3.9e). The iterative improvement of the target leads to the optimal solution and the improvement of the overall ergonomics condition. The algorithm fixes a target on the level of ergonomics iteratively and solves each time the SALB-FR to find a better solution. The dichotomy is used to reduce the search space quickly.

We propose an algorithm that operates on the difference between the ergonomics level of an initial solution (e.g., with an existing known solution, or with the solution of the SALBP-1), from that initial balancing solution, we determine the value of \underline{F} , which represents the ergonomics level of the initial solution.

We can also define an upper bound of the ergonomics level that can be obtained using Equation (3.10). \overline{F} represents the maximal ergonomics level, \overline{F} is important to shorten quickly the search space.

$$\overline{F} = \text{Min}_{j \in V} \{1 + (e^{-I_j} - 1)e^{-R(T-t_j)}\} \quad (3.10)$$

The search space is defined with the interval $[\underline{F}, \overline{F}]$, at each iteration, the algorithm divides the interval and sets a target F^{target} in constraint (3.9e) and looks for a feasible solution. If it exists, we obtain a better lower bound. We update the value of the target, and we iterate the same procedure. In the case where there is no feasible solution, we update \overline{F} to reduce the search space. We execute the same steps described before for the new interval. The algorithm converges to the optimal solution when the length of the interval of search $[\underline{F}, \overline{F}]$ is below a small fixed precision, denoted ϵ , i.e., $|\overline{F} - \underline{F}| \leq \epsilon$.

Algorithm 1 Iterative Dichotomic Search

```

1:  $S = \emptyset; i \leftarrow 0$ 
2: Solve SALBP-1; set  $m$ .
3: Compute  $F$  from the solution of SALBP-1
4: Set  $\underline{F}_i \leftarrow F$  ▷ Initial lower bound
5:  $S \leftarrow S \cup \{\underline{F}_i\}$ .
6: Compute  $\overline{F}_i$  with Equation (3.10) ▷ Initial upper bound
7: while ( $\epsilon \leq |\overline{F}_i - \underline{F}_i|$ ) do
8:   Compute  $F_i^{target} \leftarrow \underline{F}_i + \frac{\overline{F}_i - \underline{F}_i}{2}$ 
9:   Set  $\underline{F} \leftarrow F_i^{target}$  in Equation (3.9e)
10:  Solve SALBP-FR ▷ Solve return the status of the solver
11:   $i \leftarrow i + 1$ 
12:  if Time out then
13:    Compute the gap
14:    break
15:  else if Feasible then
16:    Compute the new  $F$  from the solution
17:    Set  $\underline{F}_i \leftarrow F$ 
18:     $S \leftarrow S \cup \{\underline{F}_i\}$ 
19:  else if Infeasible then
20:     $\overline{F}_i \leftarrow F_i^{target}$ 
21:  end if
22: end while
23: return  $Max_{i \in S} \{\underline{F}_i\}$  ▷ return the best found lower bound

```

We depict in [Algorithm 1](#) the pseudo-code for the IDS algorithm. The first step is to solve the SALBP-1 ([Line 2](#)) and set m with the optimal number of workstations. We determine the ergonomics level of the SALBP-1 solution, and we consider this level as a first lower bound, which we try to improve afterward. We compute the initial upper bound in ([Line 6](#)).

In the main while loop, we solve the SALBP-FR, and we update the search interval at each iteration, we keep a record of the values obtained at each step. To keep the computational time compatible with practical industrial applications, we fix a time limit for each iteration of the main loop. When we exceed the time limit (i.e., Time out), we exit the procedure, and we specify the gap between the lower and upper bound.

A commercial solver like Cplex can be used as a solver for SALBP-1 and SALBP-FR. We present in the following an example of the execution of IDS on an instance from the literature.

3.4.1 Example of exact resolution

In [Figure 3.3](#), we represent the evolution of the upper and lower bounds and the target in the execution of the IDS on the instance of Hahn ($n = 53$) from the dataset of Scholl, with

a beta distribution of physical load and with a transfer time of 5% of AT (cf. [Section 3.6](#) for details on the experimental conditions). [Figure 3.3](#) represents the execution of IDS with the initial solution obtained with SALBP-1 and denoted $\underline{F}_0^{SALBP-1}$ which represent the first lower bound, \overline{F}_0 represents the initial upper bound computed with [Equation \(3.10\)](#). The first target F_0^{target} which is the middle of the interval $[\underline{F}_0^{SALBP-1}, \overline{F}_0]$ set the target value used to solve SALBP-FR in the first initial step of IDS (cf. [Algorithm 1](#)). Here, the solution obtained with IDS is optimal. The difference between the initial solution of SALBP-1 and the final upper bound ($|\overline{F}_{10}^{IDS} - \underline{F}_0^{SALBP-1}|$) gives a relative gap of 25.25%.

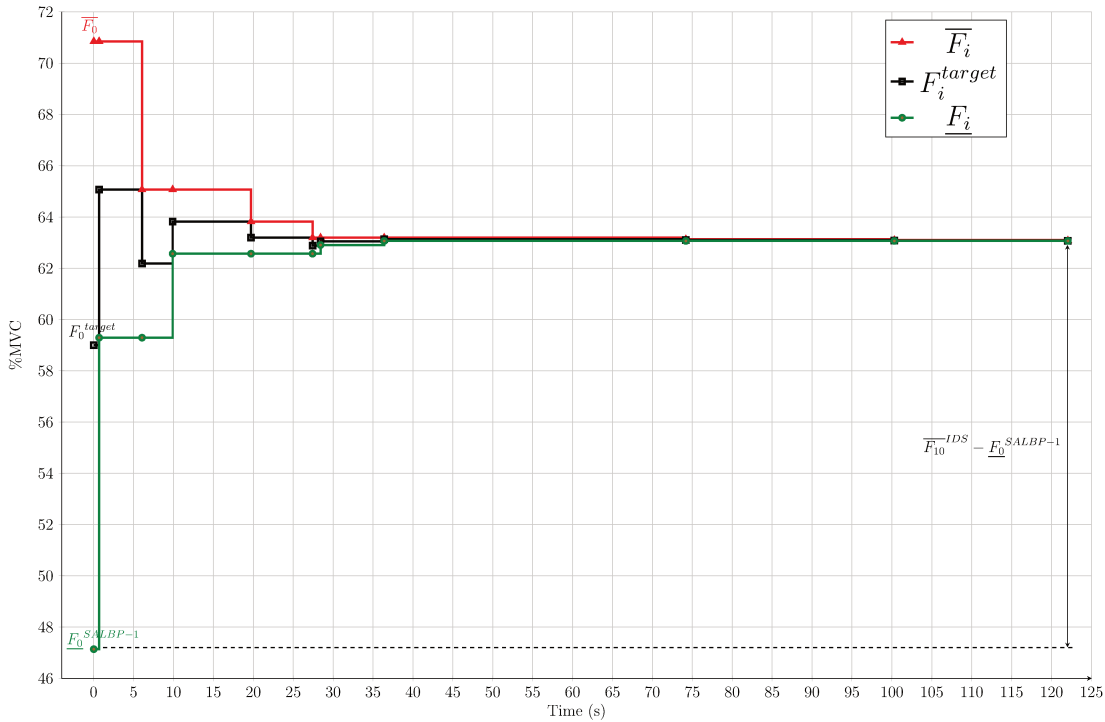

Figure 3.3: The evolution of the upper and lower bounds and the target in the execution of IDS with the solution of SALBP-1 as a starting solution; instance Hahn, with minimal adjusted takt time and transfer time of 5%

In the next subsection, we present an approximate algorithm to solve the MINLP.

3.5 Iterative Local Search

SALBP-FR is an NP-complete decision problem because it is a generalization of the NP-complete SALBP-F. We propose a framework for the approximate resolution and to tackle significant large scale problems in a suitable computational time. We aim to solve the MINLP defined in [Subsection 3.3.1](#) with a metaheuristic. The metaheuristic does not guarantee optimality, but it can achieve acceptable results in a reasonable computational time. An approximate method that gives results in a short

computational time is appealing for industrial applications. The performance of metaheuristics for tackling NP-hard problems is paramount. In many practical cases of challenging optimization problems, the most successful methods are metaheuristics.

We chose to use the improvement procedure Iterative Local Search (ILS). Iterative Local Search is a multi-start based metaheuristic that iterates a specific local search procedure from different starting solutions to sample various regions of the search space and avoid local optimum. Most of the time, the improvement procedure is a local search, hence the name ILS of the metaheuristic. Also, we chose ILS to take advantage of the Cplex one-tree algorithm (Danna et al., 2007), which allows us to generate quickly multiple feasible solutions to the decision problem SALBP-F (i.e., a feasible balancing solution), all multiples solutions are stored in a pool. Since the objective is to improve the level of ergonomics, we can make local perturbation to all solutions from the pool provided by Cplex to improve the objective function.

Algorithm 2 Iterative Local Search

```

1:  $P = \text{GeneratePool}()$ 
2:  $s^* \leftarrow s_0$  with  $s_0 \in P$ 
3: for each  $s_i$  in  $P$  do
4:    $s \leftarrow \text{LocalSearch}(s_i)$ 
5:   if  $f(s) > f(s^*)$  then
6:      $s^* \leftarrow s$ 
7:   end if
8: end for
9: return  $s^*$  ▷ return the best solution

```

The general framework of ILS is depicted in Algorithm 2. The algorithm generates a pool of initial solutions *GeneratePool* (cf. Algorithm 3), then performs several iterations (Line 3 to 8), In each iteration, the algorithm picks a solution from the pool s_i and executes a local search *LocalSearch*(s_i) (Line 4) and update s^* with the best solution. The function f represents the ergonomics level as in Definition 3.1, considered as objective function.

3.5.1 Pool generation

We propose to start the ILS from a pool of solutions. However, we need to be able to build a pool of feasible solutions for the SALBP-F. Danna et al. (2007) addresses the problem of generating multiple solutions for a MILP model. The main algorithm introduced in Danna et al. (2007) is a one-tree algorithm, which is a modification of the standard B&B algorithm. Concisely, the one-tree algorithm populates the solution pool works in two phases. In the first phase, it solves the MILP model to optimality or till a stopping criterion, and also retains nodes that have a feasible relaxation, but with an objective value worse than the cutoff value. In the second phase, the tree of the first stage is reused and explored to generate different solutions. The algorithm makes multiple solutions by

using the information stored in the first phase and by exploring the tree. The stopping criterion for both steps could be fixed as in the standard B&B with a time limit, node limit, or the number of solutions generated, and so forth.

A significant advantage of using the one-three algorithm to generate the solution pool is that it is implemented in the Cplex solver, and we can easily nest it in our ILS. Cplex offers the possibility with an intensity parameter to tune the algorithm to specify the amount of preparation of the first phase and the intensity of exploration in the second phase of the one-tree algorithm.

We use the Hamming distance (Hamming, 1950) as a metric to keep in the pool only solutions sufficiently different from each other (cf. Algorithm 3). The Hamming distance between two solutions $s_i \in P$ and $s_{i'} \in P$ with $i \neq i'$ is the number of assignment of operations to workstations at which the corresponding solutions are different. By way of explanation, it measures the minimum number of moves required to change one solution s_i into $s_{i'}$. The Hamming distance between the two solutions s_i and $s_{i'}$ from the pool is defined in Equation (3.11), with $x_{j,k}^i$ and $x_{j,k}^{i'}$ respectively the assignment decision variables of solution s_i and $s_{i'}$.

$$D(s_i; s_{i'}) = \sum_{j \in V} \sum_{k \in W} |x_{j,k}^i - x_{j,k}^{i'}| \quad (3.11)$$

We go through the pool of sorted solutions (Line 4 to Line 10), and we eliminate solutions that have a Hamming distance less than or equal to a fixed threshold that we set to 3. In other words, the minimum number of assignments required to transform a solution s_i from the pool into another solution $s_{i'}$ from the pool is at least 4 assignments.

Algorithm 3 GeneratePool()

```

1:  $P \leftarrow CplexPopulate()$ 
2: Compute  $f(s_i) \quad \forall s_i \in P$ 
3: DescendingSort(P)
4: for each  $s_i$  in P do
5:   for each  $s_{i'}$  in P with  $i \neq i'$  do
6:     if  $D(s_i; s_{i'}) \leq 3$  then
7:       Erase  $s_{i'}$  from  $P$ 
8:     end if
9:   end for
10: end for
11: return  $P$ 

```

Filtering the initial pool with Hamming distance ensures that the pool contains different starting solutions to sample various regions of the search space and avoid returning to a low quality local optimum or performing the local search on similar starting solutions.

We depict in Algorithm 3 the procedure to generate the pool of solutions. *CplexPopulate* is the Cplex one-tree algorithm that generates the initial pool of solution, we compute

the ergonomics level of each solution to sort the pool according to the ergonomics level with *DescendingSort*.

3.5.2 Local Search

Local search is a heuristic for solving computationally hard optimization problems. Local search explores the search space, moving from one solution to a neighboring solution, and seeking to improve the cost function. Defining a neighborhood and exploring it are two essential issues in the design of an efficient local search algorithm (Van Hentenryck and Michel, 2005). In this part, we describe the procedure we use for our local search for the problem considered in this chapter.

At this stage, we need the following definitions by Scholl (1999) to describe the local search procedure. The precedences are used to restrict the possible assignment of operations to workstations. Precedences are used to restrict the number of workstations to which an operation j could be assigned. Hence, for each operation $j \in V$, we define the earliest and latest workstation.

- EW_j : Earliest workstation to which a successor of operation j is currently assigned;
- LW_j : Latest workstation to which a predecessor of operation j is currently assigned.

We depict the following definitions related to the moves to transform a solution to neighbor solutions. Those moves are shifts and swaps (Scholl, 1999).

Definition 3.2 *A shift move describes the move of an operation j from the critical workstation k_1 to a different slack workstation k_2 . The shift is feasible if $k_2 \in [LW_j, EW_j]$ and if $t(k_2)$ respect the adjusted takt time AT . The shift is denoted $shift(j, k_1, k_2)$.*

Definition 3.3 *A swap move is an exchange between an operation j_1 from the critical workstation k_1 with another operation j_2 from a slack workstation k_2 . The swap is feasible if the two corresponding $shift(j_1, k_1, k_2)$ and $shift(j_2, k_2, k_1)$ are feasible and if there is no precedence between j_1 and j_2 . The swap is denoted $swap(j_1, k_1, j_2, k_2)$.*

The neighborhood of a SALBP consists of all transformed solutions which are obtained by a single feasible swap or shift move. A swap or shift select the operation to move from the critical workstation since it is likely what could maximize our objective function as we have defined it. To improve the ergonomics level, we choose the steepest descent or best-fit procedure that chooses a move leading to the maximum improvement of the current ergonomics level. When the evaluation of the entire neighborhood is possible within reasonable computational time, the steepest descent is expected to produce the best results (Scholl, 1999).

Algorithm 4 LocalSearch(s_i)

```

1:  $s^* \leftarrow s_i$ 
2: do ▷ Shift moves
3:   Define the critical workstation  $k^{cr}$  from  $s^*$ 
4:    $s^{break} \leftarrow s_i$ 
5:   for each  $j_1$  in  $k^{cr}$  do
6:     for each  $k \in [LW_{j_1}, EW_{j_1}] \setminus \{k^{cr}\}$  do
7:        $s^c \leftarrow s_i$ 
8:       Apply shift( $j_1, k^{cr}, k$ ) to  $s^c$ 
9:       if  $s^c$  is feasible and  $f(s^c) > f(s^*)$  then
10:         $s^* \leftarrow s^c$ 
11:       end if
12:     end for
13:   end for
14:    $s_i \leftarrow s^*$ 
15: while  $f(s^{break}) \neq f(s^*)$ 
16: do ▷ Swap moves
17:   Define the critical workstation  $k^{cr}$  from  $s^*$ 
18:    $s^{break} \leftarrow s_i$ 
19:   for each  $j_1$  in  $k^{cr}$  do
20:     for each  $k_2 \in [LW_{j_1}, EW_{j_1}] \setminus \{k^{cr}\}$  do
21:       for each  $j_2$  in  $k_2$  do
22:          $s^c \leftarrow s_i$ 
23:         Apply swap( $j_1, k^{cr}, j_2, k_2$ ) to  $s^c$ 
24:         if  $s^c$  is feasible and  $f(s^c) > f(s^*)$  then
25:           $s^* \leftarrow s^c$ 
26:         end if
27:       end for
28:     end for
29:   end for
30:    $s_i \leftarrow s^*$ 
31: while  $f(s^{break}) \neq f(s^*)$ 
32: return  $s^*$  ▷ return the best found solution

```

If more workstations than one are critical, the ergonomics level cannot be improved by a single move. However, this situation is scarce in practice, because there must be two workstations with the same working time, and the same physical load of operations. Furthermore, the two workstations should be critical. We do not consider this case in ILS.

We depict in [Algorithm 4](#) the local search procedure. The *LocalSearch*(s_i) algorithm starts from an input solution i from the pool P , denoted s_i and moves from the initial solution to neighborhood solutions to maximize f , recall that the function f represents the ergonomics level. We define the best-found solution s^* , which keeps track of the best

solution. In **Line 1**, s^* starts with the initial input solution to improve. Recall that a neighborhood of a SALBP solution is a transformed solution obtained with a single swap or shift move. We apply a set of shift moves (**Line 2 to 15**) sequentially, we update s^* with the best solution, then we apply the swap moves (**Line 16 to 31**) on s^* obtained from the shift moves. After the end of the two shift and swap moves, $LocalSearch(s_i)$ return the best-found solution.

When we transform a solution with moves, for example with shifts (**Line 2 to 15**), the algorithm goes through all the operations in the critical workstation and checks if a shift of operation from the critical workstation to another slack workstation is possible (i.e., legal concerning the takt time constraint since precedence are verified with the selection of the workstation in the interval $[LW_j, EW_j]$). If the shift is legal, we check if the value of the objective function f of the solution found with the shift improves the current solution s^c . If it is the case, we update the value of s^* . However, we do not change the current solution with the best-found solution s^* . We restart the sift moves from the same starting solution s_i . The search is exhaustive and verifies all the possible neighbors of the initial solution. After testing all the possible shift moves from the first critical workstation, we apply the shift moves on the new s^* as long as the solution stored at the beginning denoted s^{break} is different from s^* at the end of the main shift loop to ensure that no better solution with this first neighborhood is still possible.

Similarly, the second neighborhood is applied in the same way (**Line 16 to 31**). We are starting from the best solution obtained by the first neighborhood (i.e., shift moves). We apply swap moves to all the operations in the critical workstation and checks if a swap of an operation from the critical workstation with another operation from a slack workstation is legal. When the swap is legal, we check if the value of the objective function f improves the current solution s^c to update the value of s^* . Also, in this case, we do not change the initial solution s_i with the best-found solution. The search is exhaustive and verifies all the possible neighbors of the initial solution. Then, we apply the swap neighborhood as long as the solution stored at the beginning denoted s^{break} is different from s^* at the end of the main loop. The local search returns at the end (**Line 32**) the best solution obtained.

ILS is a modular metaheuristic, *GeneratePool*, and *LocalSearch* can follow the framework that we propose or another completely different one, which makes the ILS quite appealing and versatile.

3.6 Numerical experiments dataset

To apply models and solving approaches, we conducted numerical experiments. In this section, we present the experimental conditions and the instances used as a dataset.

3.6.1 Experimental conditions

The algorithms are developed in C++. We used Cplex V12.6 as a solver with default parameters. We integrated the solver and C++ with Concert Technology. All the experiments reported in this chapter were performed with a single node of a cluster with a CPU Intel(R) Xeon(R) CPU E5-2660, 2.60GHz, and 65GB of RAM.

To generate the initial pool of solutions for ILS, we set the parameter of Cplex to *Very aggressive* to enumerate almost all practical solutions (Danna et al., 2007).

We fix a time limit to keep the algorithm running time compatible with practical application. Line design problems are strategic or tactical optimization problems, and we can allow setting a relatively high time limit. A time limit of 3,600s is set for each iteration of the IDS algorithm. Similarly, 3,600s for each call of Cplex as a solver. For the IDS algorithm, we fix a precision of $\epsilon = 10^{-5}$.

Also, we propose two comparison formulations or algorithms which present an approximation of the criterion of fatigue or recovery.

3.6.1.1 Comparison formulations

To assess the performance of models and algorithms developed in this chapter, we compare them with three other formulations or heuristics, by abuse of language, we refer to the formulations described here as algorithms to simplify.

First, we compare with the SALBP-1 without consideration of any ergonomics criterion. Second, the formulation denoted SALBP-Fmax similar to the formulation proposed in Abdous et al. (2018b) when only the fatigue was considered, without consideration of the recovery process. Third, with the formulation denoted SALBP-idle. In SALBP-idle, we optimize the recovery time without consideration of fatigue. The formulation is similar to the work of Rachamadugu and Talbot (1991). To summarize, SALBP-Fmax seeks to optimize operator fatigue without considering recovery times while SALBP-idle only optimizes recovery times without considering fatigue.

We define the problem SALBP-Fmax with the use of notations already introduced in Chapter 3. This model has similarities with models that consider the optimization of criteria related to the energy expenditure of workers (Battini et al., 2016).

SALBP-Fmax is defined as follows: *Minimize* $\{F_{max}\}$; s.t. $\sum_{j \in V} I_j \cdot x_{j,k} \leq F_{max}, \forall k \in W$; (2.1b);(2.1c);(2.1d);(2.1e); $F_{max} \geq 0$.

To consider the fatigue, without recovery, we consider the evolution of fatigue which is expressed as $e^{-\sum_{j \in V} I_j x_{j,k}}$, the optimization of the fatigue after the exertion is equivalent to the minimization of the term inside the exponential function. The objective function optimizes F_{max} , which represents the fatigue function, and the constraint ensures that F_{max} represents the maximum physical load among all workstations. The set of constraints (2.1b) to (2.1e) are the classical constraints of SALBP (cf. Section 2.2.1.1).

Similarly, we present the SALBP-idle formulation that optimizes the recovery time in workstations and therefore considers a criterion taking into account only the positive aspect related to the recovery process and does not take into account the level of workload and the associated level of fatigue.

SALBP-idle is defined as follows: $Minimize \{R_{max}\};$ s.t.
 $T - \sum_{j \in V} t_j \cdot x_{j,k} \leq R_{max} \quad \forall k \in W;$ (2.1b);(2.1c);(2.1d);(2.1e); $R_{max} \in \mathbb{N}.$

The objective function optimize R_{max} , which represents the maximal value of recovery time, and the constraint to ensure that R_{max} represents the maximum recovery time among all workstations, with $T - \sum_{j \in V} t_j \cdot x_{j,k}$ the recovery time in a given workstation k . Recall that, $T = TT + AT$ is composed of adjusted takt time AT and transfer time TT .

3.6.2 Data and characteristics of instances

We use for our experiments a selection of instances for SALBP, namely those of Scholl and Otto (available on the website: <https://assembly-line-balancing.de>). Due to the lack of available instances in the literature (to the best of our knowledge) for the line balancing problems with the physical operations load ($Fload$), we randomly generate the physical loads of operations for our instances.

3.6.2.1 Instances selection

We solved instances of SALBP-1 from the Scholl dataset with Cplex and discarded instances that were not solved within the time limit. This phase of selection is used to eliminate the instances of SALBP-1 which are not solved within the time limit, as the problem with the consideration of the ergonomics is more complicated to solve than the SALBP-1, we kept in the dataset only instances of SALBP-1 that are solved in less than 3,600s with Cplex. Four instances from the dataset were eliminated in the first selection phase, and we obtain 21 instances. Scholl offers several adjusted takt time values, and we select two values, the minimum value and the median value. We end up with 42 starting instances from the Scholl dataset.

Otto has generated an extensive dataset of instances, with sizes of 20, 50, 100, and 1000. Several modality and distributions are used to generate this dataset. In our experiments, we selected instances of size 20, 50, and 100. Then, we took instances according to the trickiness measure (Tr), the trickiness is the proportion of non-optimal solutions found by 10000 runs of a random search method (Otto et al., 2013). For each size of the operation, we select the first 2 instances tagged as *extremely tricky*, *very tricky*, *tricky* and *less tricky*. For example, for instances with 20 operations, we select 8 instances, with 2 instances extremely tricky, 2 instances very tricky, 2 instances tricky, and finally 2 instances less tricky. A similar selection is made for instances with 50 and 100 operations. Only one adjusted takt time has been proposed in Otto dataset. We do not have to

consider several adjusted takt time values in this category of instances. Also, all these 24 instances of SALBP of Otto are solved by Cplex in less than 3,600s.

We find ourselves with a selection of 42 from the Scholl dataset and 24 instances from the Otto dataset, with several operations between 7 and 148.

3.6.2.2 Workers characteristics

A human worker is assigned to each workstation. For our model of fatigue and recovery, we take anthropometrics, and physical constants values for a worker belonging to the 50th percentile of the working population, i.e., a worker with average characteristics with $K = 0.017s^{-1}$ and $R = 0.017s^{-1}$, these values are obtained with experimental regression, see for more details [Liu et al. \(2018\)](#); [Ma et al. \(2015\)](#).

3.6.2.3 Operation physical load

Operation physical load or exertion intensity denoted $Fload$, and expressed with a percentage relative to the maximum voluntary contraction $\%MVC$ is a measure of strength. MVC represents the maximal capacity, expressed in here as $MVC = 100\%$. Data are available from the literature to present various postures and effort values and their distribution for different working populations ([Bernard, 2012](#); [Chengalur, 2004](#); [Norman et al., 1998](#)).

The percent of Maximum Voluntary contraction ($\%MVC$) is the percentage ratio of the force (in joint, muscle, or group of muscles) to the MVC . This measure is widely used to assess physical ergonomics load, to design static and dynamic operations, and to define work-rest patterns ([Glock et al., 2019](#)). We refer to [Chapter 5](#) for practical details on the measurement and collection of operations load in the context of assembly lines.

In our experiments, we generate a load distribution for operations, we assume that the effort is static for the duration of the effort (i.e., $I_j = \frac{K}{MVC} \int_t^{t+t_j} Fload_j(u) du = \frac{K}{MVC} \cdot Fload_j \cdot t_j$). The proposed modeling is not restrictive to static load and is suitable also for dynamic loading. The static assumption is only considered for the numerical experiments. The load follows a statistical beta distribution with $(\alpha < \beta)$ and distributed between $[2\%, 60\%]$ and with integer percentage values, with statistical parameters specified by making values between 2% and 25% more likely and values further from 25% less likely.

In an assembly line, a light effort is frequently present in assembly line operations and is usually presented with a range of $Fload$ associated with the posture of work and the effort between 2% to 25%. There are also somewhat heavy operations, between 25% and 55%. Severe operations from 55% to 75% are not usual in manual and semi-automatic assembly lines, while near maximal exertion is rare ([Chengalur, 2004](#)). The beta law seems to represent the distribution of load in a manual and semi-automatic line as it was observed in real data from industrial lines (cf. [Chapter 5](#)). With the beta distribution, most

operations are in a low and medium-range of difficulty, but there is also a proportion of operations with a high physical load. This assumption is also observed in the distribution of energy expenditure values in assembly line case studies (Battini et al., 2017; Finco et al., 2019).

For each instance, we generate four physical loads according to the beta law. We end up with 264 instances.

3.6.2.4 Transfer time

Transfer time, denoted TT is the time required for transport between workstations in paced assembly lines. In our experiments, we tested two values of transfer time, $TT = 0$ when the transfer time is negligible, and when $TT = 5\%AT$, which means that the transfer time represents 5% of the adjusted takt time.

All instances are tested with two values of transfer time (i.e., 0% and 5%). The 264 instances that we generated before are considered with the two values of transfer time. We performed experiments on 528 instances in this chapter.

3.7 Numerical results

We use the experimental conditions previously explained to solve all 528 instances. Full detailed results are available in [Annex B](#).

We present in this section the analysis of numerical experiments. First, in the next subsection, we focus on exact solutions and bounds, as well as the proportion of instances solved optimally. Subsequently, we compare the gap and computational time of the exact algorithm, or the best solution obtained with the exact algorithm (IDS) with the other methods.

3.7.1 Exact resolution and bounds

We focus here on the exact resolution of instances. To evaluate the quality of the exact solution obtained with the IDS algorithm (cf., [Algorithm 1](#)), we are interested in three elements:

- We test two starting solutions for the IDS algorithm, first with the solution of SALBP-1, then with the solution obtained with the metaheuristic ILS;
- The gap of the best solution (i.e., a lower bound, recall that we are dealing with a maximization problem) and the best upper bound. The best upper bound is the best value obtained after two IDS resolution using both starting solutions (i.e., SALBP-1 and ILS). The gap is obtained using the following equation:

$$Gap = \frac{|\overline{F}^{IDS} - \underline{F}^{IDS}|}{|\overline{F}^{IDS}|} \quad (3.12)$$

With \overline{F}^{IDS} the best upper bound and \underline{F}^{IDS} the lower bound at the end of the execution of the algorithm;

- The comparison of the exact resolution with approximate algorithms (SALBP-1, SALBP-Fmax, SALBP-idle, ILS).

3.7.2 Proportion of instances solved optimally

Figure 3.4 represents the percentage of instances solved optimally according to the number of operations n . $IDS(SALBP)$ means that the solution of SALBP-1 is used as a starting solution for IDS. Similarly, $IDS(ILS)$ means that the IDS uses the solution of ILS as a starting solution.

$IDS(SALBP)$ solves more than 98% of instances with less or equal than 50 operations from Scholl and Otto datasets and solves 60% of instances from Scholl dataset with more than 50 operations. $IDS(SALBP)$ does not solve optimally any instances with 50 or 100 operations from the Otto dataset.

$IDS(ILS)$ solves nearly all instances with less or equal than 50 operations from the Scholl dataset and all instances with 20 operations from the Otto dataset. $IDS(ILS)$ solves 65% of instances with more than 50 operations from the Scholl dataset. However, the algorithm solves only 4% of Otto instances with 50 operations and fail to solve optimally any instances with 100 operations. It seems complicated to solve Otto instances with a size of 50 and 100 operations.

3.7.3 Results analysis and algorithms comparison

In this section, we evaluate the performance of different solving approaches. We are interested in the gap obtained by each algorithm with respect to the best upper bound, we always calculate the gap with the best upper bound obtained by the two IDS resolution (i.e., with SALBP-1 and ILS as starting solution). For example, to calculate the gap of SALBP-1, we apply Equation (3.12), with the solution SALBP as lower bound and the best upper bound obtained with IDS: $Min\{\overline{F}^{IDS(SALBP)}; \overline{F}^{IDS(ILS)}\}$.

A display of gaps distribution is depicted in Figure 3.5 with box plots. There is also a difference in the spread of gaps. Note that, all algorithms gaps are approximately balanced around zero, with their respective first quartile Q1 equal to 0%. We could also notice that on average, SALBP-1, SALBP-Fmax, and SALBP-idle gaps are higher, their median and average are higher than ILS, $IDS(SALBP)$, and $IDS(ILS)$.

Given the much longer whiskers for SALBP-1 and SALBP-Fmax, we can interpret that the gaps vary more widely and can go up to 100%. SALBP-idle gives a better gap compared to SALBP-1 and SALBP-Fmax with an average of 15.17% and a median of 3%. However, the upper whisker is relatively tall, up to 52%, and outliers are numerous and up to 99.8%.

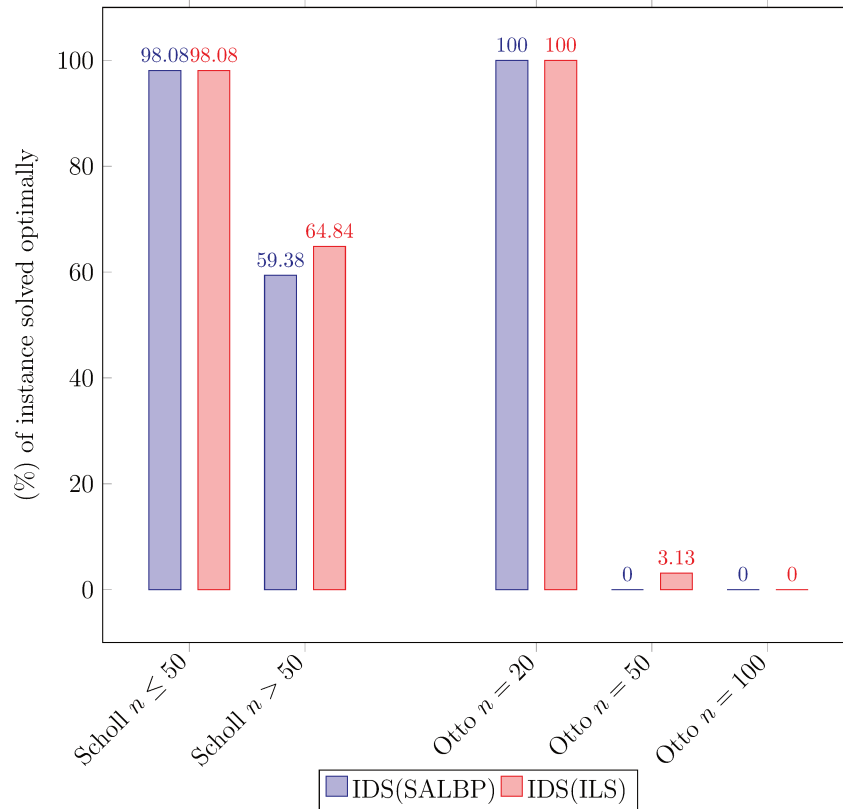

Figure 3.4: Percentage of instance for which the optimal solution was found according to the number of operations n

The gaps of ILS range approximately from 0% to 25.6%, whereas the gaps of IDS(SALBP) range approximately from 0% to 21.9% and from 0% to 17.2% in IDS(ILS). Although gaps span much the same range of values with approximately similar average and median (0% in the three cases), all three algorithms have outliers that can be more than 95%.

Table 3.1: Average Gap in % of all algorithms presented according to the category of instances, adjusted takt time and transfer time

	Adj takt time	Transfer time	Avg Gap (%)	Avg Gap (%)	Avg Gap (%)	Avg Gap (%)	Avg Gap (%)	Avg Gap (%)
			SALBP	Fmax	Idle	ILS	IDS(SALBP)	IDS(ILS)
Scholl	Min	0%	14.73	12.94	12.54	4.30	3.75	1.33
		5%	4.95	4.64	4.22	0.8	0.33	0.23
	Median	0%	19.83	14.59	15.17	6.47	5.95	4.8
		5%	7.61	5.03	5.74	2.78	3.62	2.45
Otto	-	0%	74.52	78.3	37.66	34.6	42.78	34.15
		5%	23.07	24.48	12.79	12.83	18.3	13

We present in [Table 3.1](#) the average gap in % of all algorithms, clustered in categories according to the adjusted takt time and transfer time for Scholl instances and transfer time for Otto instances, since, in the dataset of Otto, only one value of the adjusted takt time is available.

Overall, gaps are lower with a transfer time of 5% both in Otto and Scholl datasets with

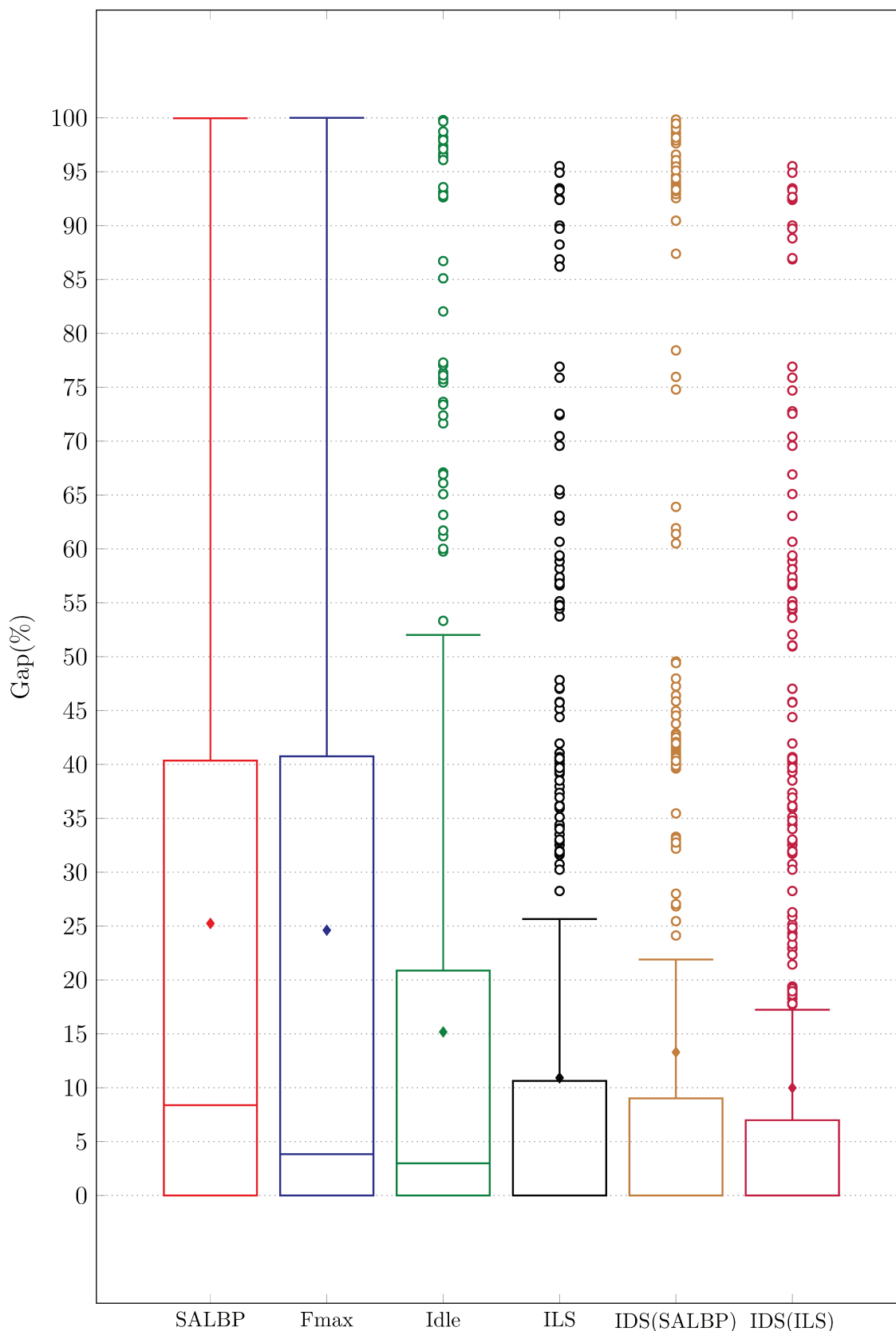

Figure 3.5: Box plot describing the Gap (%) of all algorithms with the best found upper bound; box limits indicate the Q1 and Q3; whiskers extend 1.5 times the interquartile range; center lines show the medians; diamonds represent the averages; circles represent outliers

IDS(ILS) presenting almost the best average gap by each category. In the Scholl dataset, the median adjusted takt time is more challenging than the minimal adjusted takt time. Overall, the most challenging subset of instances seems to be the dataset of Otto with a transfer time of 0%.

The average gap for IDS(SALBP) is 13.29%, and the average gap of IDS(ILS) is 9.98%. IDS is useful to provide overall good results and to improve the starting solution efficiently. IDS(ILS) with the starting solution of ILS seems to be more productive and provide overall better results. The differences between SALBP-1 and IDS(SALBP) is up to 11.96 percentage points. Even when IDS does not succeed in providing the optimal solution, it is practical to improve a starting solution.

ILS presents an overall average gap of 10.91%, with, on average, a difference of 2.37 percentage points better than IDS(SALBP). An average difference of 0.93 percentage points exists between IDS(ILS) and ILS, in favor of IDS(ILS). Generally, results of ILS are of good quality for all instances from the Scholl dataset, with an average gap of 3.6% and an average gap of 0.92% with optimal solutions (when they are known). For Otto dataset, the average gap is high, up to 23.72%. However, the average gap is only 1.33% with optimal solutions (when they are known).

In the following, we analyze computational times with a comparison similar to the one we just made for gaps. Likewise, we present in [Figure 3.6](#) box plots, with computational times for all algorithms (i.e, SALBP-1, SALBP-Fmax, SALBP-idle, ILS, IDS(SALBP), IDS(ILS)).

From the results, the SALBP-1 computational time distribution is low, with a flat box around zero, SALBP-1 resolution took only a few seconds. The distribution of computational time for SALBP-Fmax range between 0.01s and 167s with outliers that can be up to 3,600s. Recall that 3,600s is the fixed time limit, which means that we obtain only a feasible solution in some cases with SALBP-Fmax. Similarly, SALBP-idle presents similar computational times as SALBP-Fmax.

The computational times of the metaheuristic ILS are relatively low, 75% of instances are solved within 88s with a median of 16s and an average of 10.9s with 258s for the most significant outlier. On the other hand, the box plots are comparatively tall for IDS(SALBP) and IDS(ILS), which suggests that computational times are different. We note though that the median value is low, 47s for IDS(SALBP), and 77s for IDS(ILS). The average and third quartile Q3 are approximately the same in both cases, nearly 1,535s for the average and 3,600s for the Q3. Recall that 3,600s is the time limit fixed for one iteration of IDS, this justifies the fact that certain instances exceed 3,600s. The upper whisker of IDS(SALBP) is 8,905s, and that of IDS(ILS) is 7,884s. Outliers are even extreme, up to 9,976s for IDS(SALBP) and 10,183s for IDS(ILS).

In [Table 3.2](#), we present the average computational times in seconds (s) for different algorithms represented according to different categories of instances.

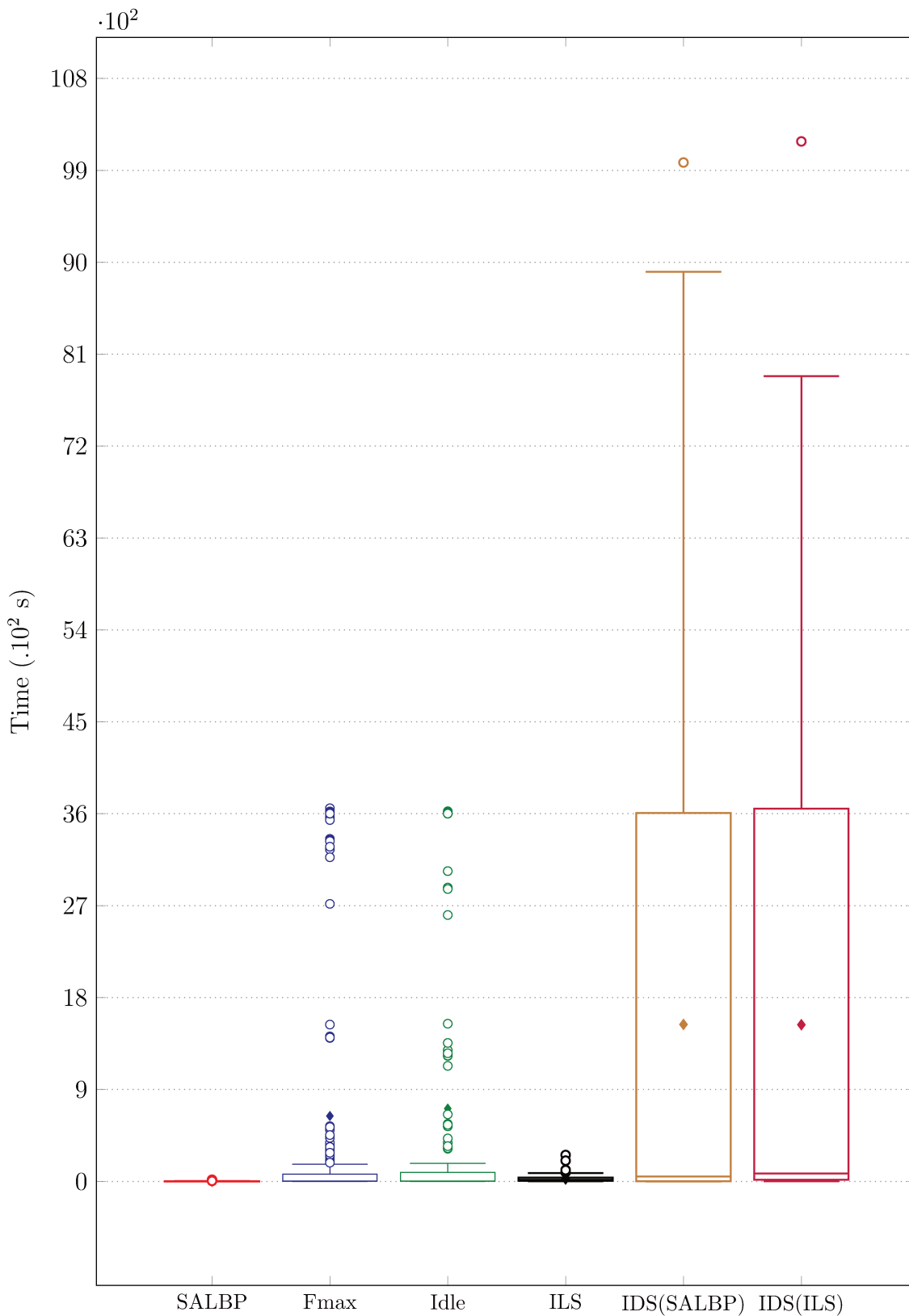

Figure 3.6: Box plot describing the computational time in seconds of all algorithms; center lines show the medians; box limits indicate the Q1 and Q3; whiskers extend 1.5 times the interquartile range; diamonds represent the averages; circles represent outliers

For IDS(SALBP) and IDS(ILS), instances of Scholl with a median adjusted takt time consume more computational times, especially those with a transfer time of 0%. Otto instances are the ones that consume the most computational time on average and seem to be more challenging. The starting solution, whether with SALBP-1 or ILS, does not change computational time.

With ILS, the average computational time for Scholl instances is less than 20s and less than 40s for instances from the Otto dataset. There is no dispersion of time according to the adjusted takt time and transfer time. This excellent computational time performance is partly due to the filtering stage of the algorithm (cf. [Subsection 3.5.1](#)). The filtering phase makes it possible to keep various solutions in the pool according to the Hamming distance. Indeed, the parameterization of the filtering phase makes it possible to keep solutions with at least 4 different assignments. This filtering phase makes it possible to avoid applying local search on several initial solutions that are very close to each other. On average, 18 starting solutions are present in the initial filtered pool, and the filtering phase makes it possible to reduce, on average, 54% of the computational times of ILS.

Table 3.2: Averages computational times in seconds (s) of all algorithms presented according to the category of instances, adjusted takt time and transfer time

	Adj takt time	Transfer time	Avg Time (s)	Avg Time (s)	Avg Time (s)	Avg Time (s)	Avg Time (s)	Avg Time (s)
			SALBP	Fmax	Idle	ILS	IDS(SALBP)	IDS(ILS)
Scholl	Min	0%	1.56	95.87	269.75	16.49	667.47	587.06
		5%	1.58	91.1	71.36	18.62	712.71	635.65
	Median	0%	0.89	352.33	481.91	17.17	1141.55	1126.22
		5%	1.01	352.96	361.07	19.58	777.15	696.57
Otto	-	0%	1.75	1363.4	1380.57	30.4	2805.23	2822.73
		5%	1.54	1375.81	1504.59	36.76	2760.33	2949.63

To conclude, IDS provides significantly better solutions, even for challenging instances, the version IDS(ILS), when ILS is used as a starting solution, is the best solving approach regarding the quality of the gap, and IDS computational time is not sensible to the quality of the starting solution. On the other hand, the metaheuristic ILS is efficient as an approximate algorithm and provides excellent results in a competitive computational time.

3.8 Conclusion

In this chapter, we proposed a model for the problem of balancing assembly lines with the consideration of ergonomics. The criterion for ergonomics is based on the muscular fatigue and recovery of operators. The non-linearity of the criterion requires a methodological approach to introduce it with the assembly line balancing problem. For this, we proposed a linearization and an exact algorithm of resolution denoted Iterative Dichotomic Search or IDS.

Subsequently, to deal with large-scale industrial and practical problems in reasonable computational time, we proposed a metaheuristic denoted Iterative Local Search or ILS that has the merit of being simple and effective for our problem.

After that, different approaches proposed in this chapter are validated throughout an experimental protocol on a set of instances of various characteristics and sizes. We relied for this on instances from the literature for the assembly line balancing problem, with physical load generated using a beta distribution.

These numerical experiments made it possible to highlight the interest of the IDS algorithm, in particular, to obtain an upper bound to evaluate the quality of a solution. Indeed, IDS proves its effectiveness to improve an initial solution and to obtain a better quality solution. We succeed in solving almost all instances with less than 50 operations, we also have good quality results for instances with several operations greater or equal than 50 operations, and we can solve some instances up to a size of 148 operations. Computational times are competitive and suitable for long-term optimization problems such as assembly line balancing.

The metaheuristic ILS also allows obtaining good quality results; the average gap of ILS with known optimal solutions is less than 1%. The execution time is also competitive and allows us to obtain solutions quickly; the average computational time for all instances is 24s. This excellent computational time performance is partly due to the efficient filtering stage of the algorithm.

In the following, we present a more general assembly line design problem, taking into account equipment selection decisions. Besides, we consider the problem with a multi-objective approach to propose to decision-makers a Pareto front with several solutions.

Chapter 4

Multi-objective design of assembly line with ergonomics and cost

Contents

4.1	Introduction	78
4.2	Assembly Line Design Problem with ergonomics	79
4.2.1	Problem statement and hypothesis	79
4.3	Multi-objective formulation	80
4.3.1	Problem notations	80
4.3.2	Ergonomics level	81
4.3.3	Multi-objective Mixed-Integer Nonlinear Programming	81
4.3.4	Linearization of takt time constraint	82
4.3.5	Linearization of the objective function	83
4.3.6	Mixed-Integer Linear Programming	84
4.4	Multi-objective algorithm	85
4.4.1	ϵ -constraint framework	86
4.4.2	Iterative Dichotomic Search with cost constraint	87
4.4.3	Example of resolution	88
4.5	Numerical experiments	90
4.5.1	Experimental conditions	90
4.5.2	Instances characteristics	90
4.5.3	Optimal Pareto front	91
4.5.4	Instances with an approximation of the Pareto front	93
4.6	Conclusion	96

4.1 Introduction

Sometimes, even the optimal solutions of the line balancing problem give unsatisfactory results concerning ergonomics. In paced assembly lines, the takt time is set and can rarely be relaxed in production companies, whose primary purpose is to produce enough products to satisfy customers' demand. Also, the number of workstations is often optimally set and linked to the physical layout and flow of materials constraints. When assembly systems are to be designed or redesigned, a significant leeway to improve the performance and

ergonomics, without changing the layout, the number of workstations, and the takt time is the adequate selection of equipment. Mitigating ergonomic risks is connected to the problem of equipment selection, the optimization problem, in this case, is to find the right trade-off between the cost of equipment and their benefits on improving the ergonomics level for workers.

There is a large type of equipment to improve the work efficiency and ergonomic loads, such as industrial lifts to position parts and materials; balancers to suspend equipment and tools and support their weights; cranes for workstations; mechanical manipulators for the horizontal load; and so on. Moreover, adjustable equipment and tools for workers to be easy to reach, avoid awkward posture and stretching. With the digital transition and Industry 4.0, a wide range of new technological equipment are used in manufacturing systems, among them, intelligent automation devices (IAD), intelligent gripping, power amplifying assist devices, touch-based admittance control of robot, collaborative robot (cobot) that interact with workers in a shared workspace, and assistive exoskeleton technology. Equipment could enhance the ergonomics but decrease the throughput of the line, or vice-versa. Expensive equipment comes with an improvement, either fastening the execution time, or reducing the physical load, or both.

In this chapter, we will examine a generalization of the approach proposed in [Chapter 3](#) to the Assembly Line Design Problem or ALDP (cf. [Subsection 2.3.4](#)), including the combinatorial optimization problem of assigning different operations to be performed for every workstation, and the equipment selection problem. Since ALDP involves conflict between the level of investment and the level of ergonomics, we propose to consider the problem with a multi-objective approach to offer to decision-makers a trade-off between these two objectives.

First of all, we explain the problem in [Section 4.2](#), and then we propose a multi-objective formulation of the problem in [Section 4.3](#). In [Section 4.4](#), we propose a multi-objective solving algorithm to find the Pareto front for the ALDP with ergonomics. Finally, in [Section 4.5](#), we perform numerical experiments to validate and evaluate the performance of the approach.

4.2 Assembly Line Design Problem with ergonomics

4.2.1 Problem statement and hypothesis

An assembly line is composed of a set of workstations arranged in a linear form, and connected by a material handling device such as conveyor that transport parts between workstations at the end of takt time. We consider the hypothesis of SALBP (cf. [Subsection 2.2.1](#)), except the hypothesis of equally equipped workstations. The decisions are the assignment of operations and the assignment of a unique set of equipment to each workstation.

We suppose that a set of equipment is composed of one or many components. All operations could be executed with all predefined set, and only one set could be assigned to each workstation. A given set of equipment could influence the load of operations and/or the processing time. Each set of equipment has an associated cost.

For example, in [Figure 4.1](#) which takes again the example already presented in [Section 2.2.1.2](#), we represent a solution of the ALDP. The first set of equipment in workstation 1 includes only basic manual tools, and the set of equipment in workstation 2 includes the same basic manual tools with an advanced exoskeleton. Another set is composed of a cobot as in workstation 3. Finally, the set in workstation 4 includes a basic tool and an industrial manipulator that assist with heavy workloads. Besides, operations assigned to workstations are also represented. In the rest of this manuscript, we refer to the predefined set of equipment only by *equipment*.

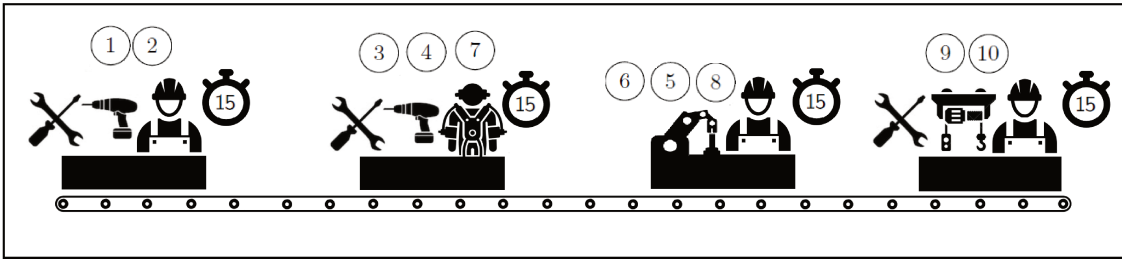

Figure 4.1: Solution of ALDP

4.3 Multi-objective formulation

4.3.1 Problem notations

Decision variable $x_{j,k}$ is used for the assignment of the operation $j \in V$ to a workstation $k \in W$, with $V = \{1, \dots, n\}$ the set of operations and $W = \{1, \dots, m\}$ the set of workstations. The decision variables $y_{i,k}$ is used for the assignment of an equipment $i \in E$ to workstation k , with E the set of equipment. C_i represents the cost of equipment $i \in E$ ⁽¹⁾.

An equipment i influences the deterministic processing time $t_{i,j}$ of operation j and/or the physical load, defined with $Fload_{i,j}$. Operation time or processing time $t_{i,j}$ set the standard time in which a worker should complete a given operation j when executed with equipment i . $Fload_{i,j}$ represents the physical load of operation j when executed with the equipment i . The assignment of operations to workstations must respect the takt time T . Recall that the takt time T is composed of the adjusted takt time AT and the transfer time TT , i.e., $T = AT + TT$, as already defined in [Chapter 3](#).

⁽¹⁾**Note:** We compared our proposed formulation to the classical formulation of ALDP from the literature (using three-index decision variables $x_{i,j,k}$ for the assignment of equipment and operations). This comparison shows that our proposed formulation is better in numerical experiments.

4.3.2 Ergonomics level

We take the same model of fatigue and recovery as a criterion for assessing the ergonomics level (cf. [Subsection 3.2.2](#)). The ergonomics level after a takt time in a workstation k is represented with the ALDP notations as:

$$F_k = 1 + \left(e^{-\left(\frac{K}{MVC} \sum_{i \in E} \sum_{j \in V} \int_0^{t_{i,j}} \text{Fload}_{i,j}(u) \cdot x_{j,k} \cdot y_{i,k} \cdot du\right)} - 1 \right) e^{-R \cdot (T - \sum_{i \in E} \sum_{j \in V} t_{i,j} \cdot x_{j,k} \cdot y_{i,k})} \quad \forall k \in W \quad (4.1)$$

4.3.3 Multi-objective Mixed-Integer Nonlinear Programming

In addition to the notation introduced in the previous chapters, we present the additional notations and data of the problem.

ALDP notations:

$t_{i,j} \in \mathbb{N}$: processing time of operation j when executed with the equipment i , expressed in seconds [s].

$C_i \in \mathbb{N}$: Cost of equipment i .

Ergonomics notations:

$\text{Fload}_{i,j}$: Operations load of operation j when performed with the equipment i , expressed in percentage relative to MVC (% or %MVC, with $MVC = 100\%$).

Decision variables:

$$x_{j,k} = \begin{cases} 1 & \text{if operation } j \text{ is assigned to workstation } k \\ 0 & \text{Otherwise} \end{cases}$$

$$y_{i,k} = \begin{cases} 1 & \text{if equipment } i \text{ is assigned to workstation } k \\ 0 & \text{Otherwise} \end{cases}$$

Objective functions:

- (4.2): Minimization of the total cost, which represents the total cost of equipment.
- (4.3): Maximization of the ergonomics level at the most charged workstation, with F_k defined with [Equation \(4.1\)](#).

$$\text{Minimize } \left\{ \sum_{i \in E} \sum_{k \in W} C_i \cdot y_{i,k} \right\} \quad (4.2)$$

$$\text{Maximize } \{ \text{Min}_{k \in W} \{ F_k \} \} \quad (4.3)$$

Occurrence constraints:

Occurrence constraint (4.4) ensures that each operation j is assigned to only one

workstation k . (4.5) guarantees that for each workstation k , we assign only one equipment i .

$$\sum_{k \in W} x_{j,k} = 1 \quad \forall j \in V \quad (4.4)$$

$$\sum_{i \in E} y_{i,k} = 1 \quad \forall k \in W \quad (4.5)$$

Takt time:

Constraint (4.6) guarantees that the working time of a given workstation k is at most equal to the adjusted takt time AT .

$$\sum_{i \in E} \sum_{j \in V} t_{i,j} \cdot x_{j,k} \cdot y_{i,k} \leq AT \quad \forall k \in W \quad (4.6)$$

Precedence:

Constraint (4.7) ensures the respect of the technological order of operations.

$$\sum_{k \in W} k \cdot x_{h,k} \leq \sum_{k \in W} k \cdot x_{g,k} \quad \forall (h, g) \in P \quad (4.7)$$

Finally, (4.8) defines the type of variables.

$$x_{j,k}, y_{i,k} \in \{0, 1\} \quad (4.8)$$

The Multi-Objective Mixed-Integer Nonlinear Programming (MO-MINLP), defined with (4.2) to (4.8) combines the challenges of handling nonlinearities, the multi-objective aspects and the combinatorial explosion of integer variables. We remind that the ALDP is an NP-hard combinatorial problem. To tackle this problem, we propose a linearization of the takt time constraint, after that in Subsection 4.3.5 a linearization of the objective function (4.3). Finally, in Subsection 4.3.6 we transform the MO-MINLP into a MILP.

4.3.4 Linearization of takt time constraint

We introduce an additional variable to linearize the product $x_{j,k} \cdot y_{i,k}$, with $\pi_{j,k} = \sum_{i \in E} t_{i,j} \cdot x_{j,k} \cdot y_{i,k}$. In addition to constraint (4.5), the variable $\pi_{j,k}$ will take the value $t_{i,j}$ when the equipment i and the operation j are assigned to workstation k .

Linear constraints for time:

The tandem of constraints (4.6a) and (4.6b) guarantee that the variable $\pi_{j,k}$ takes the time $t_{i,j}$ when we have a given set of equipment i and an operation j assigned to the workstation k .

For example, when a given equipment $i = 2$ is assigned to workstation $k = 1$ (i.e, $y_{2,1} = 1$) the value of the variable $\pi_{2,1}$ take the value $t_{2,1}$ and represents the processing time of operation $j = 1$ when executed with equipment $i = 2$ in workstation $k = 1$.

The sum $\sum_{i' \in E \mid t_{i,j} \leq t_{i',j}} y_{i',k}$, instead of only using $y_{i,k}$ in (4.6a), and the use of $Max_{q \in E} \{t_{q,j}\} - \sum_{i' \in E \mid t_{i,j} \leq t_{i',j}} (Max_{q \in E} \{t_{q,j}\} - t_{i',j}) \cdot y_{i',k}$, instead of only using $Max_{q \in E} \{t_{q,j}\} \cdot x_{j,k}$ in (4.6b) demonstrated to improve the linear relaxation in the numerical experiments and are more tight as constraints ⁽²⁾.

$$t_{i,j} \cdot \left(x_{j,k} + \sum_{i' \in E \mid t_{i,j} \leq t_{i',j}} y_{i',k} - 1 \right) \leq \pi_{j,k} \quad \forall i \in E, \forall j \in V, \forall k \in W \quad (4.6a)$$

$$\pi_{j,k} \leq Max_{q \in E} \{t_{q,j}\} - \sum_{i' \in E \mid t_{i,j} \leq t_{i',j}} (Max_{q \in E} \{t_{q,j}\} - t_{i',j}) \cdot y_{i',k} \quad \forall i \in E, \forall j \in V, \forall k \in W \quad (4.6b)$$

Takt time:

Constraint (4.6) is transformed into (4.6c).

$$\sum_{j \in V} \pi_{j,k} \leq AT \quad \forall k \in W \quad (4.6c)$$

4.3.5 Linearization of the objective function

We define, as in Section 3.3.2.1, $I_{i,j} = \frac{K}{MVC} \int_0^{t_{i,j}} Fload_{i,j}(u) du$, that represents the integral of load along the processing time $t_{i,j}$ of operation j when executed with equipment i .

We introduce the variable $\sigma_{j,k} = \sum_{i \in E} I_{i,j} \cdot x_{j,k} \cdot y_{i,k}$, with $\sigma_{j,k} \geq 0$, that will take the value $I_{i,j}$ when the equipment i and the operation j are assigned to workstation k . Then, the tandem of constraint (4.3a) and (4.3b) guarantee that the variable $\sigma_{j,k}$ takes the value $I_{i,j}$.

Linear constraints for operation load:

$$I_{i,j} \cdot \left(x_{j,k} + \sum_{i' \in E \mid I_{i,j} \leq I_{i',j}} y_{i',k} - 1 \right) \leq \sigma_{j,k} \quad \forall i \in E, \forall j \in V, \forall k \in W \quad (4.3a)$$

$$\sigma_{j,k} \leq Max_{q \in E} \{I_{q,j}\} - \sum_{i' \in E \mid I_{i,j} \leq I_{i',j}} (Max_{q \in E} \{I_{q,j}\} - I_{i',j}) \cdot y_{i',k} \quad \forall i \in E, \forall j \in V, \forall k \in W \quad (4.3b)$$

Then, we use the same linearization technique presented in Section 3.3.2.1, we define a lower bound $\underline{F} \in [0, 1]$ on the ergonomics level. Hence, Equation (4.3c) is valid for all $k \in W$.

$$\underline{F} \leq 1 + (e^{-\sum_{j \in V} \sigma_{j,k}} - 1) e^{-R \cdot (T - \sum_{j \in V} \pi_{j,k})} \quad \forall k \in W \quad (4.3c)$$

⁽²⁾**Note:** We tested several versions of constraints with numerical experiments, we present here the best version.

We also need to define a decision variable as in [Section 3.3.2.1](#), denoted $z_{l,k}$, with $l \in U$ and $U = \{0, 1, \dots, T\}$ the set of discrete recovery time. We develop [\(4.3c\)](#) to obtain the following constraint:

$$\sum_{j \in V} \sigma_{j,k} \leq \sum_{l \in U \mid l < \mathcal{D}} \ln \left(\frac{1}{(\underline{F} - 1)e^{R \cdot l} + 1} \right) \cdot z_{l,k} + \sum_{j \in V} \sum_{l \in U \mid l \geq \mathcal{D}} I_{i,j} \cdot z_{l,k} \quad \forall k \in W \quad (4.3d)$$

With $\mathcal{D} = \frac{1}{R} \ln \left(\frac{1}{1 - \underline{F}} \right)$ the domain of definition of the logarithm function.

To define the value of the recovery time, constraint [\(4.3e\)](#) makes sure that the recovery time l in workstation k is equal to the difference between the takt time T (including AT and TT) and working time. Constraint [\(4.3f\)](#) ensures the uniqueness of the recovery time in each workstation k . Finally, [\(4.3g\)](#) defines the type of variables.

$$T - \sum_{j \in V} \pi_{j,k} = \sum_{l \in U} l \cdot z_{l,k} \quad \forall k \in W \quad (4.3e)$$

$$\sum_{l \in U} z_{l,k} = 1 \quad \forall k \in W \quad (4.3f)$$

$$\pi_{j,k} \in \mathbb{N}; \sigma_{j,k} \geq 0, z_{l,k} \in \{0, 1\} \quad (4.3g)$$

4.3.6 Mixed-Integer Linear Programming

We transform the MO-MINLP defined in [Subsection 4.3.3](#) into a Mixed-Integer Linear Programming (MILP). We present the whole model denoted Assembly Line Design Problem with workers Fatigue and Recovery (ALDP-FR):

$$\text{Minimize } \left\{ \sum_{i \in E} \sum_{k \in W} C_i \cdot y_{i,k} \right\} \quad (4.9a)$$

$$\sum_{k \in W} x_{j,k} = 1 \quad \forall j \in V \quad (4.9b)$$

$$\sum_{i \in E} y_{i,k} = 1 \quad \forall k \in W \quad (4.9c)$$

$$\sum_{k \in W} k \cdot x_{h,k} \leq \sum_{k \in W} k \cdot x_{g,k} \quad \forall (h, g) \in P \quad (4.9d)$$

$$\sum_{j \in V} \pi_{j,k} \leq AT \quad \forall k \in W \quad (4.9e)$$

$$t_{i,j} \cdot \left(x_{j,k} + \sum_{i' \in E \mid t_{i,j} \leq t_{i',j}} y_{i',k} - 1 \right) \leq \pi_{j,k} \quad \forall i \in E, \forall j \in V, \forall k \in W \quad (4.9f)$$

$$\pi_{j,k} \leq \text{Max}_{q \in E} \{t_{q,j}\} - \sum_{i' \in E \mid t_{i,j} \leq t_{i',j}} (\text{Max}_{q \in E} \{t_{q,j}\} - t_{i',j}) \cdot y_{i',k} \quad \forall i \in E, \forall j \in V, \forall k \in W \quad (4.9g)$$

$$I_{i,j} \cdot \left(x_{j,k} + \sum_{i' \in E \mid I_{i,j} \leq I_{i',j}} y_{i',k} - 1 \right) \leq \sigma_{j,k} \quad \forall i \in E, \forall j \in V, \forall k \in W \quad (4.9h)$$

$$\sigma_{j,k} \leq \text{Max}_{q \in E} \{I_{q,j}\} - \sum_{i' \in E \mid I_{i,j} \leq I_{i',j}} (\text{Max}_{q \in E} \{I_{q,j}\} - I_{i',j}) \cdot y_{i',k} \quad \forall i \in E, \forall j \in V, \forall k \in W \quad (4.9i)$$

$$\sum_{j \in V} \sigma_{j,k} \leq \sum_{l \in U \mid l < \mathcal{D}} \ln \left(\frac{1}{(\underline{F} - 1)e^{R \cdot l} + 1} \right) \cdot z_{l,k} + \sum_{j \in V} \sum_{l \in U \mid l \geq \mathcal{D}} I_{i,j} \cdot z_{l,k} \quad \forall k \in W \quad (4.9j)$$

$$T - \sum_{j \in V} \pi_{j,k} = \sum_{l \in U} l \cdot z_{l,k} \quad \forall k \in W \quad (4.9k)$$

$$\sum_{l \in U} z_{l,k} = 1 \quad \forall k \in W \quad (4.9l)$$

$$\pi_{j,k} \in \mathbb{N}; \quad \sigma_{j,k} \geq 0; \quad x_{j,k}, y_{i,k}, z_{l,k} \in \{0, 1\} \quad (4.9m)$$

ALDP-FR optimizes the total design cost while respecting a lower bound on the ergonomics level, a solution of the problem will only gives a better level of ergonomics than the fixed lower bound \underline{F} with the minimization of the total design cost.

In order to obtain the Pareto set of the MO-MINLP (cf. [Subsection 4.3.3](#)) with the minimization of the design cost and the level of ergonomics, we propose in the following section a multi-objective exact algorithm.

4.4 Multi-objective algorithm

We propose an ϵ -constraint algorithm to obtain the Pareto front of the MO-MINLP developed in [Subsection 4.3.3](#). The ϵ -constraint algorithm is among the best-known technique to solve multi-objective optimization problems ([Ehrgott, 2005](#)). ϵ -constraint is a generic method, proposed by [Haimes et al. \(1971\)](#), the algorithm solves the multi-objective optimization problem by solving the single-objective version of the problem.

We design the ϵ -constraint algorithm in order to get efficient solutions with the two objectives: the total design cost and the ergonomics level. The ϵ -constraint algorithm could be described in two steps:

- **Step 1:** the algorithm fixes an upper bound \overline{C} on the budget, and call the IDS algorithm to solve iteratively the MILP decision problem denoted F-ALDP-FR, for Feasibility Assembly Line Design Problem with workers Fatigue and Recovery, defined with the set of constraints: $\sum_{i \in E} \sum_{k \in W} C_i \cdot y_{i,k} \leq \overline{C}$; [\(4.9b\)](#) to [\(4.9m\)](#). F-ALDP-FR determines a solution (if it exists) respecting the fixed bound on the budget \overline{C} and a fixed level of ergonomics fixed with \underline{F} in constraint [\(4.9j\)](#). IDS

is used, as defined in [Chapter 3](#), to obtain the optimal level of ergonomics for the constraint on the cost \bar{C} ;

- **Step 2:** The algorithm fixes the optimal ergonomics level from **Step 1** as bound and solves ALDP-FR to obtain a non-dominated point. The algorithm reduces the bound on the cost \bar{C} and goes back to **Step 1**. The stopping condition is reached when the bound on the cost cannot further be reduced.

In the following section, we depict the detailed framework of the ϵ -constraint.

4.4.1 ϵ -constraint framework

[Algorithm 5](#) presents the pseudo-code of the ϵ -constraint algorithm. First, we fix in [Line 2](#) the value of the initial parametric bound on the budget, which represents the maximum possible budget, corresponding to: $C^{max} = m.Max_{i \in E}\{C_i\}$ (i.e., the most expensive equipment is assigned to all m workstations).

The minimal bound on the budget C^{min} could be obtained with: $C^{min} = m.Min_{i \in E}\{C_i\}$. It corresponds to the situation when the less expensive equipment is assigned to all m workstations. C^{min} is used as a stopping condition in the algorithm. We continue to decrease the bound on the budget until it is inferior or equal to the value of C^{min} .

Algorithm 5 ϵ -constraint algorithm

- 1: $S = \emptyset; i \leftarrow 0$
 - 2: Set $\bar{C} \leftarrow C^{max}$
 - 3: **while** ($C^{min} \leq \bar{C}$) **do**
 - 4: $\underline{F}_i \leftarrow IDS(\bar{C})$ ▷ Call the IDS algorithm with \bar{C}
 - 5: Set $\underline{F} \leftarrow \underline{F}_i$ in constraint (4.9j)
 - 6: $C_i \leftarrow$ Solve ALDP-FR with \underline{F}
 - 7: $S \leftarrow S \cup \{(F_i, C_i)\}$
 - 8: Decrease the bound on the budget by 1 unit: $\bar{C} \leftarrow C_i - 1$
 - 9: $i \leftarrow i + 1$
 - 10: **end while**
 - 11: **return** S ▷ return the Pareto set S
-

Inside the while loop, we call IDS with a constraint \bar{C} on the budget. From IDS, we obtain the optimal level of ergonomics \underline{F}_i for the budget. A detailed description of the IDS algorithm is provided in the next subsection. We use the optimal level of ergonomics \underline{F}_i as bound in (4.9j), and we solve the ALDP-FR to obtain the optimal cost for the optimal level of ergonomics. Hence, we obtain the non-dominated point.

ϵ -constraint decrease the value of the cost C_i of the non-dominated point by one unit (recall that the cost is considered as an integer), and repeat the same procedure described above until the stopping condition, i.e., $\bar{C} \leq C^{min}$. In the end, the algorithm returns the Pareto set denoted S .

4.4.2 Iterative Dichotomic Search with cost constraint

We depict in [Algorithm 6](#) the Iterative Dichotomic Search algorithm or IDS, with a cost constraint \bar{C} as input. The general operating mode of the algorithm follows the IDS framework already presented in the previous chapter. However, some minor adaptations are necessary, especially for calculating initial bounds and the new decision problem.

We compute in [Line 1](#) the initial upper bound on the ergonomics level. \bar{F} represents the optimal level of ergonomics that we can obtain and it is defined as:

$$\bar{F} = \text{Min}_{j \in V} \{ \text{Max}_{i \in E} \{ 1 + (e^{-I_{i,j}} - 1)e^{-R(T-t_{i,j})} \} \} \quad (4.16)$$

The initial lower bound \underline{F} could be obtained with a solution known beforehand, or by solving the decision problem denoted F-ALDP-1 without consideration of the ergonomics level and defined with: $\{ \sum_{i \in E} \sum_{k \in W} C_i \cdot y_{i,k} \leq \bar{C}; (4.9b); (4.9c); (4.9d); (4.9e); (4.9f); (4.9g) \}$.

Recall that the IDS divide the initial search space, and set the target bound \underline{F}^{target} and look for a solution to improve the initial lower bound by solving the decision problem F-ALDP-FR. If a solution exists, the algorithm updates the lower bound and repeats the same procedure with the new search space. Otherwise, if no solution is found, we update the upper bound to reduce the search space.

The optimal solution is found when the distance between the \underline{F} and \bar{F} in a given iteration of the while loop is less than a small fixed precision ϵ .

Algorithm 6 Iterative Dichotomic Search with cost constraint

Input: \bar{C}

Output: \underline{F}

- 1: Compute \bar{F} with [\(4.16\)](#)
 - 2: Solve F-ALDP-1 and compute the initial \underline{F}
 - 3: **while** ($\epsilon \leq |\bar{F} - \underline{F}|$) **do** ▷ ϵ is the precision
 - 4: Set $\underline{F}^{target} \leftarrow \underline{F} + \frac{\bar{F} - \underline{F}}{2}$ ▷ Initial target
 - 5: Set $\underline{F} \leftarrow \underline{F}^{target}$ in constraint [\(4.9j\)](#)
 - 6: Solve F-ALDP-FR ▷ Solve return the status of the solver
 - 7: **if** Feasible **then**
 - 8: Update \underline{F}
 - 9: **else if** Infeasible **then**
 - 10: $\bar{F} \leftarrow \underline{F}^{target}$
 - 11: **end if**
 - 12: **end while**
 - 13: **return** $\{\underline{F}\}$
-

We present in the next subsection, an example of the resolution of the ϵ - constraint algorithm.

4.4.3 Example of resolution

In Figure 4.2, we present an example of different steps of the ϵ -constraint algorithm on an instance of the studied problem. The ergonomics level is represented in percentage (%) in the abscissa, and the cost is represented in the ordinate.

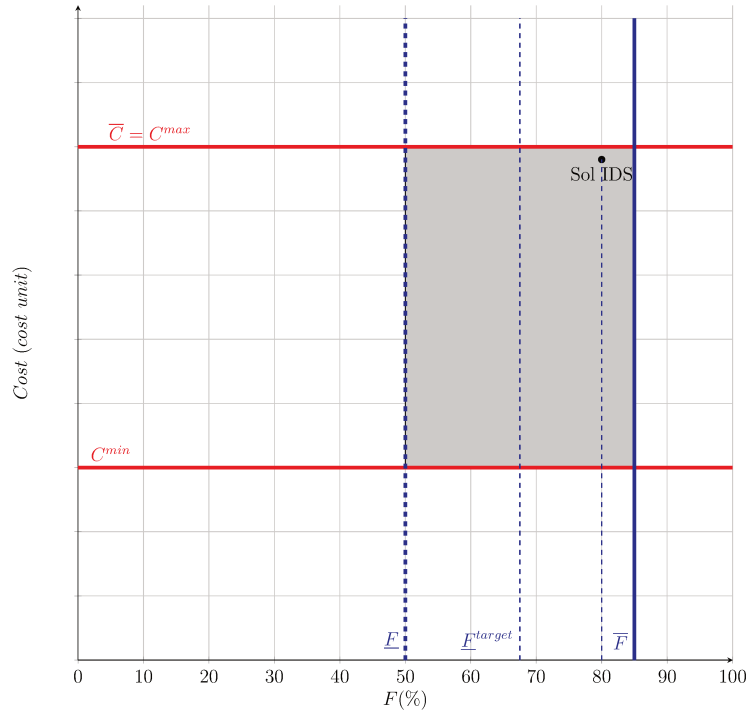

Figure 4.2: Search space in the first step

We represent the maximum and minimum possible budget, C^{max} and C^{min} . In the initial step, we fix the bound on the budget to the maximum possible budget, i.e., $\bar{C} = C^{max}$. The initial lower bound on the ergonomics \underline{F} is obtained with the resolution of F-ALDP-1 and the initial upper bound on the ergonomics \bar{F} is obtained with Equation (4.16). The resulting initial search space is represented with the gray area.

IDS divides the initial space and set the target bound \underline{F}^{target} and look for a solution in the right side of the search area. If a solution exists, the algorithm updates the search space $[\underline{F}, \bar{F}]$ and repeat the same procedure with the new search space. Otherwise, if no solution is found, we update the upper bound \bar{F} to reduce the search space. The output of the IDS in this example is 80%, which represents the optimal ergonomics level.

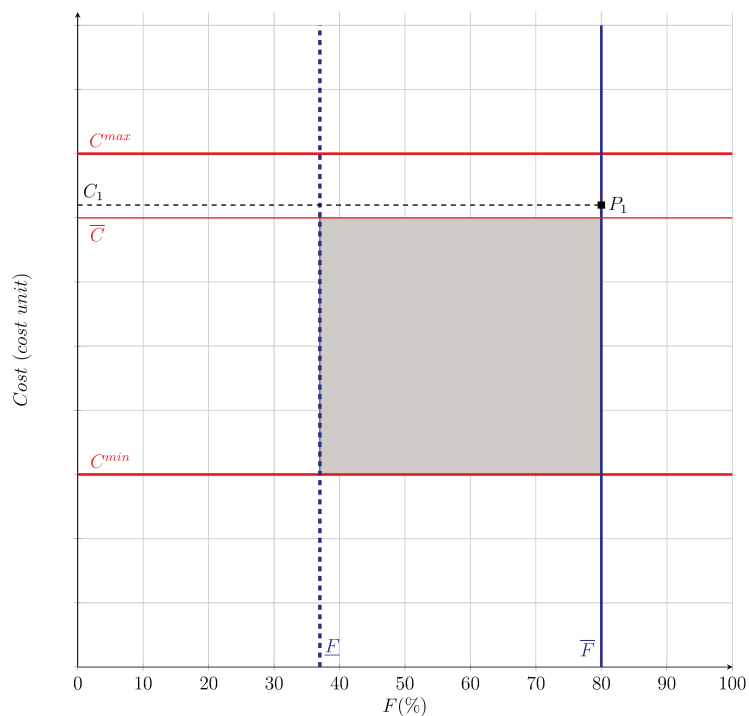

Figure 4.3: Search space in the second step

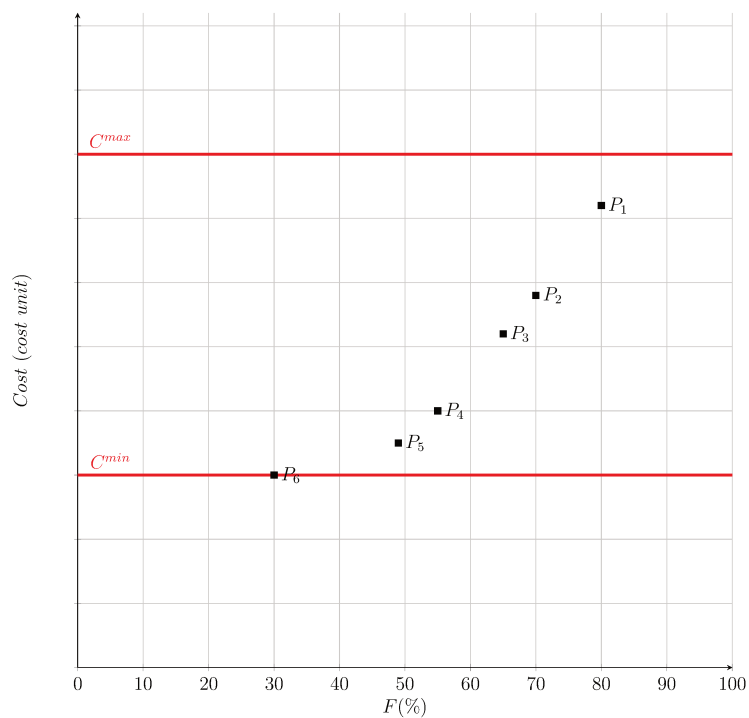

Figure 4.4: The Pareto front with all non-dominated points

We continue with the second step of the algorithm in [Figure 4.3](#), we use the output of IDS (i.e., the optimal ergonomics level) as bound in (4.9j) to solve the ALDP-FR and

obtain the optimal cost. Hence, the algorithm determines the first non-dominated point, denoted P_1 . We update the \overline{F} to exclude the corresponding dominated search space. Then, the ϵ -constraint update the bound on the cost, $\overline{C} = C_1 - 1$.

We solve the F-ALDP-1 to obtain the new \underline{F} and update the search space $(\underline{F}, \overline{F}, \overline{C}, C^{min})$ as represented in gray in [Figure 4.3](#).

The same procedure described above is repeated until the stopping condition defined with $\overline{C} \leq C^{min}$. [Figure 4.4](#) represents the Pareto front with 6 non-dominated points.

4.5 Numerical experiments

We present the experimental conditions and instances in the next subsection. In [Subsection 4.5.2](#), we present and analyze the results of instances with the optimal Pareto front. After that, in [Subsection 4.5.4](#), we present and analyze the results of instances with an approximation of the optimal front, with the use of a gap quality metric that allows the evaluation of the quality of the approximation.

4.5.1 Experimental conditions

We implemented the IDS algorithm and the ϵ -constraint in C++. We used Cplex with default parameters as a solver, and we integrated the solver in C++ with Concert Technology. We use in our experiments the same hardware as in [Subsection 3.6.1](#).

For the IDS algorithm, we fix a precision of 10^{-5} . We fix a time limit to keep the algorithm running time compatible with the practical application. The time limit is 3,600s for each call of the solver for F-ALDP-1, ALDP-FR, and F-ALDP-FR.

4.5.2 Instances characteristics

To the best of our knowledge, no dataset exists for the line balancing and equipment selection problem with the physical load of operations. We generate a dataset to test the approach proposed in this work experimentally. We start from the same set of instances described in [Subsection 3.6.2](#), except Otto instances with several operations of 100. Indeed, as we have not managed to solve instances of this category in our previous experiments, we chose to exclude them for this experimentation. We start with 37 SALBP instances, with 21 from the Scholl dataset and 16 instances from the Otto dataset. For each of the starting 37 SALBP instances, we generate 9 ALDP instances with 2 to 10 equipment. A total of 333 ALDP instances are tested in our experiment. For each ALDP instance, we generate the data according to the following procedure:

- We generate operations physical load corresponding to basic manual equipment with static operations load assumption following the same procedure explained in [Section 3.6.2.3](#).

- We generate a cost C_0 for the basic manual equipment.
- We generate more sophisticated equipment that impacts a subset of operations by reducing the processing time and/or the load of some operations. Equipment that does not improve either time or/and load is not considered. Sophisticated equipment could impact a subset of operations up to 60% of operations determined randomly from the set of operations V . For each operation of the subset impacted by the sophisticated equipment, the reduction of processing time is defined according to a uniform distribution law in the discrete range $[0\%, 30\%]$ (i.e., the reduction of the processing time could be up to 30% of the processing time of the basic equipment). Similarly, for each operation of the subset, the reduction of the load is defined according to a uniform distribution law in the discrete range $[0\%, 50\%]$. (i.e., the reduction of load could be up to 50% of the load of the basic equipment).
- Manual tools could be economically justifiable, but expose the workers to heavy load and low ergonomics work quality while more advanced equipment reduces the load and time execution and apparent inertia (Krüger et al., 2009). However, advanced equipment raises the cost over-proportionally and causes the cost to increase exponentially (Gorlach and Wessel, 2008). Therefore, we generate the cost of the sophisticated equipment i such that: $C_i = \lceil C_0 \cdot e^\lambda \rceil$, with $\lambda > 0$. The value of λ is correlated to the features of the equipment and could be up to $10 \cdot C_0$ (i.e., ten-time the cost of basic equipment). An equipment i is expensive depending on the proportion of operations that it influences and the magnitude of reduction of the physical load and/or the execution time, e.g., equipment that reduces by a large magnitude the load and processing time, and for a large proportion of operations is more expensive and could be up to 10 times the cost of the basic equipment.

4.5.3 Optimal Pareto front

We succeeded in obtaining the Pareto front of 56% of the dataset (out of 333 ALDP instances), with instances up to 94 operations. We present in Table 4.1 average statistics; each line corresponds to average results obtained by the number of ALDP instances (nb ALDP instances). The first column shows the instance name; n represents the number of operations. We present in the fifth column the average total time in second (Avg tot time [s]) to obtain the set of non-nominated points. In the sixth column, we represent the average number of non-dominated points (Avg nb non-dom pt) in the Pareto front. We compute in the last column, the average percentage of non-dominated points in the convex hull (Avg % non-dom pt in the convex hull) (cf. Section 2.5).

The average number of points in the set of Pareto front is approximately 5 points, with an average computation time to obtain the whole front of 2,781.68s. The average computation time to obtain each non-dominated point is 593.4s. Otto instances appear

Table 4.1: Average statistics obtained with the ϵ -constraint algorithm for instances when we obtain the Pareto front

Instance name	n	nb ALDP instances	nb equip	Avg tot time [s]	Avg nb non-dom pt	Avg % non-dom pt in conv hull
Mertens	7	9	2 to 10	16.92	3.56	75.05
Bowman	8	9	2 to 10	44.44	3.33	86.60
Jaeschke	9	9	2 to 10	2.70	1.89	100.00
Jackson	11	9	2 to 10	7.62	2.33	88.89
Mansoor	11	9	2 to 10	54.20	4.44	76.43
Otto_n=20.1	20	9	2 to 10	1102.74	6.89	67.53
Otto_n=20.2	20	9	2 to 10	1184.13	7.44	71.79
Otto_n=20.8	20	9	2 to 10	1255.34	7.67	62.96
Otto_n=20.9	20	9	2 to 10	1310.41	7.22	71.41
Otto_n=20.12	20	9	2 to 10	1067.79	7.89	58.14
Otto_n=20.14	20	9	2 to 10	1483.80	7.11	74.89
Otto_n=20.17	20	4	2,3,4,5	24702.48	5.25	79.19
Mitchell	21	9	2 to 10	76.12	6.78	67.89
Roszieg	25	9	2 to 10	325.59	7.44	64.68
Heskiaoff	28	9	2 to 10	19033.20	7.00	77.43
Buxey	29	9	2 to 10	609.87	3.56	82.05
Sawyer	30	9	2 to 10	1530.53	5.22	83.33
Lutz1	32	7	2 to 8	1272.63	2.00	88.89
Gunther	35	9	2 to 10	287.42	3.11	83.15
Kilbridge	45	9	2 to 10	66.05	1.67	96.30
Hahn	53	9	2 to 10	1085.14	1.89	100.00
Wee-Mag	58	1	2	87.56	1.00	96.30
Tonge	70	1	2	104.92	1.00	92.59
Lutz3	89	1	2	10255.20	10.00	94.44
Mukherje	94	2	2,4	2575.23	1.50	100.00

to have a higher average of non-dominated points in the Pareto front, with an average of 7 points. Scholl instances only have an average of approximately 4 points.

On average, 81.6% of non-dominated points are supported and are located in the convex hull. This high average value could be explained by the relatively low number of average non-dominated points in the Pareto front.

We represent in [Figure 4.5](#) an example of a Pareto front for the instance Otto n=20.9 with 20 operations and 8 equipment. The Pareto front present 9 non-dominated points and the computational time to obtain the front is 2,441.1s. Non-dominated points are represented by filled black circles, and the convex hull is shown with a black line.

Table 4.2: Average results of instances when we obtain the Pareto front according to the number of equipment

Nb of equipment	Nb of instances	Avg tot time [s]	Avg nb non-dom pt
2	25	546.86	2.65
3	21	260.1	3.16
4	22	808.23	4.5
5	21	1456.67	4.24
6	20	624.09	4.89
7	20	914.06	5.68
8	20	1025.81	5.42
9	19	1030.62	6.56
10	19	894.51	7.06

We present in [Table 4.2](#), depending on the number of equipment, the average total time to obtain the Pareto front (Avg tot time [s]), and the average number of non-dominated

points on the front (Avg nb non-dom pt). The number of equipment seems to have a limited effect on the complexity of the problem compared to the number of operations. Although the number of non-dominated points is higher, with the increase in the number of equipment, the average computational time seems to grow linearly.

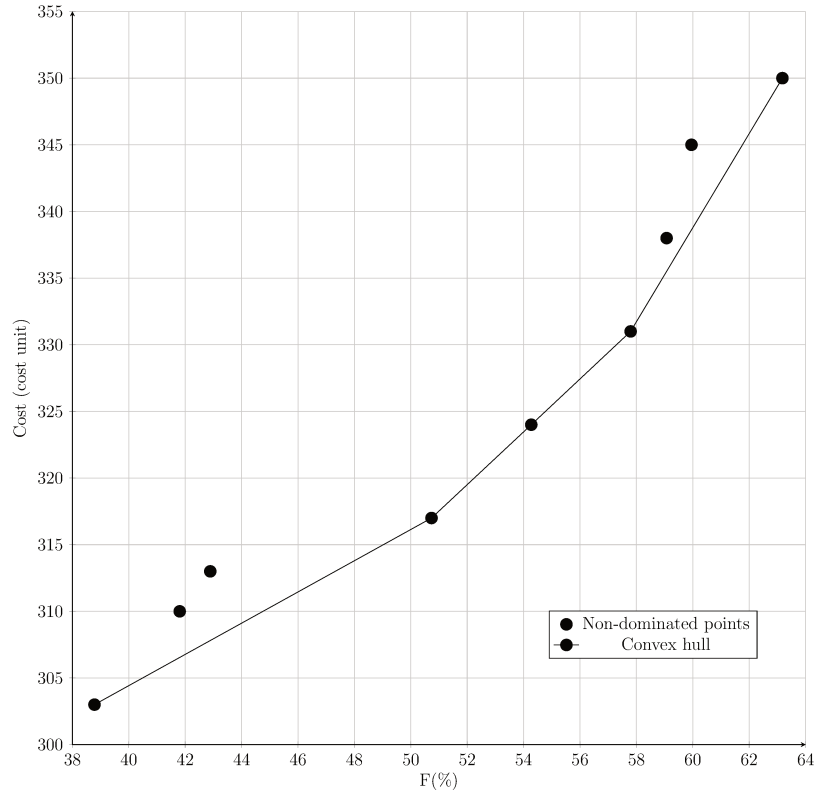

Figure 4.5: Pareto front, Otto n=20_9 with 8 possible equipment

4.5.4 Instances with an approximation of the Pareto front

4.5.4.1 Gap in hyper-area

Even if [Algorithm 5](#) and [6](#) are described in the case where we obtain all non-dominated points, this is not always guaranteed within a reasonable computational time, especially for NP-hard problems such as ALDP. We set a time limit of 3,600s for each call of the solver. When we exceed the time limit, the ϵ -constraint reduces by 1 unit, the value of \overline{C} and continue the procedure. When the time limit is exceeded in a given iteration of IDS, the algorithm exit and keep track of the best-found value of \underline{F} and \overline{F} .

In instances where we exceed the fixed time limit, we compute a gap with the hyper-area metric (S-metric, proposed by [Zitzler and Thiele \(1999\)](#)). The hyper-area represents the area enclosed between the axes and the set of bounds of the ergonomics level. We fix as reference the point representing the worst situation, with an ergonomics level of 0% and

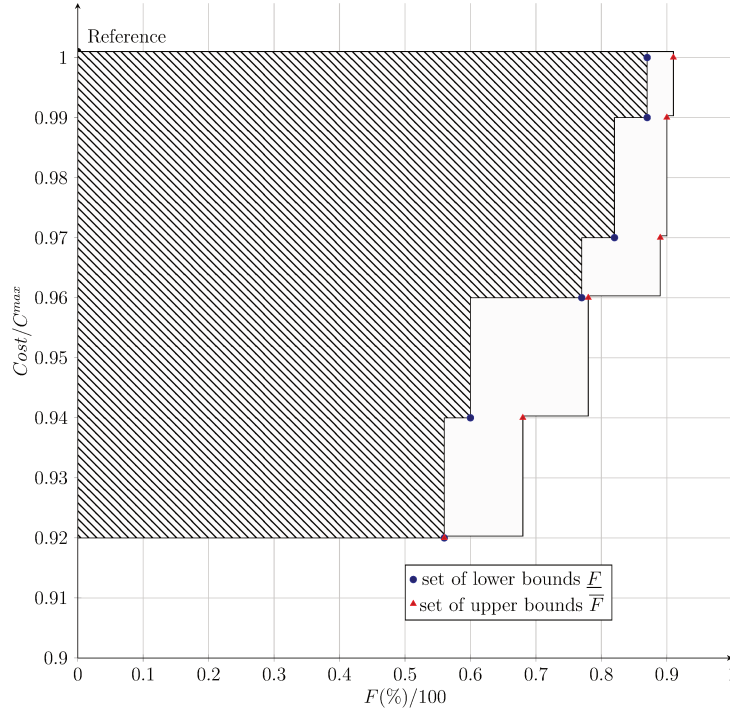

Figure 4.6: Hyperarea with normalized axis

a budget $C^{max} + 1$. We normalize the axis, before computing the *gap* to use a similar scale. Figure 4.6 shows the two areas, the hashed area represents the area related to the lower bound $A(\underline{F})$. The light gray area represents the area of the upper bound $A(\overline{F})$. The following formula gives the *gap*:

$$gap = \frac{|A(\overline{F}) - A(\underline{F})|}{|A(\overline{F})|} \quad (4.17)$$

4.5.4.2 Approximation results

In instances that are difficult to solve, we cannot expect to find any proven non-dominated points at all within the computational time limit. We present in this section an analysis on the so-called set of potentially non-dominated points (i.e., an archive containing points not dominated by any other points generated by ϵ -constraint so far) when the set does not solely consist of non-dominated points, we pay attention to ensure the quality of the approximation with the *gap* metric and we present the percentage of proved non-dominated points.

We present the results according to the percentage of non-dominated points. For instances where we do not succeed in obtaining all the non-dominated points of the Pareto front, we compute the percentage of proved non-dominated points in the approximation. We cluster the instances into two categories. The first category with instances where there is a percentage of non-dominated points, and the second category of instances without

any proven non-dominated points. A point is added to the potentially non-dominated points if it is non-dominated by any point in the archive, and all points dominated are removed.

We present in [Table 4.3](#) statistics of instances from the first category, the fifth column (Avg nb pot non-dom pt) represents the average number of potentially non-dominated points, the sixth column (Avg gap (%)) the average gap in percentage and column seven (Avg non-dom pt (%)) the average percentage of points which are proven to be non-dominated in the set of potentially non-dominated points. Instances of this category represent approximately 14% of the dataset. The average gap is less than 18%. The average computational time to obtain the set of potentially non-dominated points is 15,427.9s, with an average of 2.47 potentially non-dominated points, and on average, 41.43%, which are proven as non-dominated.

Table 4.3: Average statistics obtained with the ϵ -constraint algorithm for instances with a percentage of non-dominated points

Instance name	n	nb ALDP instances	Avg tot time [s]	Avg nb pot non-dom pt	Avg gap (%)	Avg non-dom pt (%)
Otto_n=20_17	20	5	24754.93	4.00	13.03	64.29
Otto_n=20_39	20	9	17512.17	2.67	48.55	4.17
Lutz1	32	2	4941.77	2.50	0.81	89.47
Wee-Mag	58	8	11045.45	1.75	3.33	13.33
Tonge	70	8	17785.96	2.25	4.36	36.84
Lutz3	89	8	17810.4	2.13	26.39	40.74
Mukherje	94	7	14144.63	2	30.49	41.18

We present in [Table 4.4](#) results of instances when the algorithm does not provide any non-dominated point. This category represents 30% of the dataset, and has the highest total computation time, with an average of 16,858.4s, and the highest average gap of 49.84%. Besides, only an average of 2.09, potentially non-dominated points, are obtained in this category without any proven non-dominated points.

Table 4.4: Averages statistics obtained with the ϵ -constraint algorithm for instances without any non-dominated points

Instance name	n	nb ALDP instances	Avg tot time [s]	Avg nb pot non-dom pt	Avg gap (%)	Avg non-dom pt (%)
Otto_n=50_1	50	9	11821.48	2.11	18.45	0
Otto_n=50_2	50	9	12627.99	2.11	23.67	0
Otto_n=50_7	50	9	14464.2	2.44	53.15	0
Otto_n=50_12	50	9	17912.37	2.56	58.53	0
Otto_n=50_22	50	9	15767.93	2.5	49.8	0
Otto_n=50_26	50	9	11966.32	1.56	73.04	0
Otto_n=50_27	50	9	10876.94	1.67	68.1	0
Otto_n=50_54	50	9	13353.75	2.22	50.86	0
Arcus1	83	9	15264.15	1.67	48.9	0
Arcus2	111	9	57400.89	3.11	38.58	0
Barthold	148	9	3986.42	1.00	65.18	0

Same as in instances solved optimally, the number of equipment seems to have less effect on the computation time compared to the number of operations. Only small differences could be observed in the results when the number of equipment increase. The operation number n seems to have more influence over the complexity of an instance.

In contrast, Otto instances, denoted as Otto_n=20_17 and Otto_n=20_39, although their number of operations is only 20 operations, we have not managed to solve these instances optimally. These two instances are labeled as *extremely tricky* by Otto et al. (2013). Recall that the trickiness is the proportion of non-optimal solutions found by 10000 runs of a random search method.

The results are promising for instances from the Scholl dataset. We managed to optimally solve Scholl instances up to an operation size of 94 and up to 4 equipment. We have a good approximation of the Pareto front up to several operations of 94 and up to 10 equipment.

We have only solved optimally Otto's instances with 20 operations that are *less tricky*, *tricky* and *very tricky*. We only have an approximation of the Pareto front of the *very tricky* instances with 20 operations (Otto_n=20_17 and Otto_n=20_39). Also, we only have an approximation of the Pareto front for Otto instances with 50 operations.

4.6 Conclusion

In this chapter, we present a new multi-objective approach for the early phase of assembly lines design. The objectives are the maximization of the ergonomics level and the minimization of the design cost. We propose a new MO-MINLP formulation, a linearization approach, and an ϵ -constraint algorithm that provides the Pareto set. We test our approach on different instances from the literature. The work we propose in this chapter is the first to study the ALDP with the consideration of ergonomics.

In Chapter 3, the problem of ergonomics is considered in SALBP, without equipment selection, and with a single objective. Even though we have seen that we can improve the ergonomics with a better assignment of operations and without additional cost, it is not always guaranteed to obtain a satisfactory ergonomics level. Often, to reduce the risks in workstations, without changing the constraint of takt time, the decision-maker may have recourse to the use of equipment. Indeed, a large number of industrial equipment are offered by Industry 4.0 to improve productivity and ergonomics.

The contribution of this chapter is to offer a decision support tool, which allows decision-makers to consider the problem of the assembly line design with the consideration of ergonomics. We succeed in solving almost all instances with less than 30 operations and up to 10 equipment. Depending on the instance, we sometimes obtain a good approximation of the Pareto front with medium-size instances between 30 and 70 operations and up to 10 equipment.

Chapter 5

Methodology for line design with ergonomics: illustration on two industrial case studies

Contents

5.1	Introduction	98
5.2	Main steps for assembly line design with ergonomics	99
5.2.1	Product analysis and process planning	99
5.2.2	Line configuration	101
5.2.3	Line re-configuration	102
5.2.4	Operational planning	103
5.3	Assembly line of agricultural mulchers	103
5.3.1	Product and process analysis	104
5.3.2	Line configuration	105
5.3.3	Solution analysis	106
5.3.4	Simulation of the optimal solution	107
5.4	Assembly line of condensing boiler	108
5.4.1	Product and process analysis	108
5.4.2	Line configuration	109
5.4.3	Solution analysis	110
5.4.4	Simulation of the optimal solution	110
5.5	Conclusion	113

5.1 Introduction

In previous chapters, we have seen that ergonomics can be considered from the design stage of manufacturing systems, particularly assembly lines. In this chapter, we present a brief insight into the overall methodology of designing assembly lines with respect to ergonomics, with a definition of the context in which the contribution of this thesis could be used and on different methodologies to measure necessary input data. We illustrate with two industrial studies the steps to apply our contributions in an industrial environment and the means of actions and conclusions that one can draw from the results.

In this chapter, we present the main steps of the assembly line design with ergonomics. Thereafter, in [Sections 5.3](#) and [5.4](#) the two following case studies:

- The first case study from Berti, an Italian agricultural machinery company that manufactures a broad range of specialized equipment and machines for the agricultural sector;
- The second case study from elm.leblanc, a French company which is part of the thermo-technology division of the Bosch Group, the German leader in heating and hot water systems.

Both industrial cases concern manual assembly lines with the strong presence of human operators. Hence, the interest in using our approach for decision support to design the assembly lines.

5.2 Main steps for assembly line design with ergonomics

The efficient design of assembly lines is of considerable importance. We refer to [Delorme et al. \(2014\)](#); [Rekiek and Delchambre \(2006\)](#) for more details on the main steps to design assembly lines and [Delorme \(2014\)](#) for the contribution of operations research and modeling approaches to the design of manufacturing systems and assembly lines. [Battini et al. \(2011\)](#) provides detailed insights on the possible intervention to improve the ergonomics in assembly lines at strategic, tactical, and operational stages. In the following section, we describe the contribution of this manuscript in integrating the different decision levels in the design of assembly lines with physical ergonomics.

5.2.1 Product analysis and process planning

The product analysis and process planning define complete descriptions of products, operations, processing times, and technological constraints. Moreover, the definition of the takt time based on customer demands. To introduce the different methodologies of this thesis, we need to assess the operations' physical load with different equipment.

5.2.1.1 Operations processing time

The Predetermined Motion Time System (PMTS) is the concept used to evaluate processing times. One of the most used methods in the industrial context is MTM (Methods-Time Measurement), we refer to [Laring et al. \(2002\)](#); [Zandin \(2002\)](#) for details on PMTS and MTM methods.

5.2.1.2 Technological constraints and precedence graph

The definition of the technological constraints could be achieved with a precedence graph (Scholl, 1999). The definition of a precedence graph requires a methodology for extracting assembly information from product data (Pintzos et al., 2016). We refer to Fouda et al. (2001); Miller and Stockman (1990) for more details.

5.2.1.3 Takt time

The takt time is the maximal amount of time a workstation can process a sub-assembly product. The takt time is set to meet customer demand. Takt time T can be determined with the formula: $T = \frac{\text{Available time}}{\text{Demand}}$, when the *Available time* is the net amount of time available for the production and the *Demand* specify the total customer demand to satisfy.

5.2.1.4 Input data for operations physical load

As we propose in this work, the ergonomics level in a workstation depends on the relative physical effort expressed as the percent of maximal strength.

To apply our approaches, we must define the physical load of operations or the Percent Maximum Voluntary Contraction (*Fload* expressed in %). *Fload* is the applied force or moment in a joint, e.g., at the shoulder level.

In practice, the calculation of *Fload* can be obtained by professional ergonomist with several methods. We present below in a non-exhaustive way, tools, and techniques that can be used for the practical data collection of operations load.

- *Fload* can be assessed with the objective measures of the forces exerted by a muscle or group of muscles with surface electromyography (EMG). EMG is a technique in which electrodes are placed on the skin to detect the electrical activity of the muscle or group of muscles. EMG has been suggested in the literature for its reliability to determine the force level when assessing the muscle activity level (González-Izal et al., 2012). we refer to Ashok et al. (2018); Balasubramanian et al. (2009); Choung et al. (2016); Graham et al. (2009) for applications of EMG in assembly lines;
- Computer-aided ergonomics and digital human models with virtual human simulation can be used for the assessment of *Fload* (Duffy et al., 2007; Ma et al., 2011a,b). Greig et al. (2018) recently developed a tool that could be considered as a digital human simulation tool to predict the operation's physical load or *Fload* for light assembly lines. The tool only uses as input the available design data of operations and workstations in light assembly lines. This tool could easily be used to collect the data needed to apply our approach for light assembly lines. Recently, Glock et al. (2019) estimated *Fload* for packaging process with computer-aided ergonomics software;

- The assessment of operations load is possible with a rating of perceived effort on a scale such as the Borg scale (cf. [Subsection 1.4.1](#) and [Table 5.1](#)). A high correlation was found between perceived effort estimation with the Borg scale and the objective evaluation with EMG for different force levels. This method is simple and could be applied easily in industrial configuration ([Hampton et al., 2014](#); [Hummel et al., 2005](#); [Troiano et al., 2008](#)). Although it is only a substitute to direct quantitative assessment, it may be useful in the evaluation of perceived effort and working postures, especially in the design stage of assembly lines. The rating of perceived effort can be collected by a qualified ergonomist from an existing assembly line, or by a mock-up simulation of the real conditions of the execution of operations.

Table 5.1: Scale of rating for perceived effort (%MVC) ([Bernard, 2012](#); [Borg, 1982](#))

Score	Verbal Anchor	%MVC
0	Nothing at all	0
0.5	very, very weak	5
1	very weak	10
2	Weak	20
3	Moderate	30
4	somewhat strong	40
5	Strong	50
6		60
7	Very strong	70
8		80
9		90
10	Extremely strong (maximal)	100

5.2.2 Line configuration

Line configuration defines the type of the line, the assignment of operations and equipment to a workstation, and the type of production models (i.e., single, multi-model, or mix model).

At this stage, the ergonomics could be improved by the consideration of the approach proposed in [Chapters 3](#) and [4](#). Firstly, the decision-maker could consider the assignment of basic equipment to minimize the investment on the assembly line, then use the methodology developed in [Chapter 3](#), taking into account average workers.

The selection of the appropriate optimization algorithm depends on the size of the problem and the available computational time. IDS could be used for problems up to a size of 50 operations. Otherwise, for larger sizes, the metaheuristic ILS is the most suitable. However, if the decision-maker has a relatively long computational time (e.g., a few hours), IDS could be used for sizes up to 150 operations.

After that, a simulation of the solution could be used to analyze the values obtained after a shift. It allows assessing the number of workstations at risk and the time in which a worker is at risk.

If a solution with basic equipment does not provide a satisfactory level of ergonomics, with one or several workstations at risk. A solution that could be offered to decision-makers to improve the ergonomics at this stage is the use of worker rotation with the job rotation that prevents a worker from spending the whole shift in the most charged workstation. We refer to [Carnahan et al. \(2000\)](#); [Otto \(2012\)](#); [Otto and Battaïa \(2017\)](#) for more details on the job rotation in assembly lines.

If the solution still does not provide a satisfactory level of ergonomics, investment in proper equipment may help to improve the situation. The decision-maker may use the approach proposed in [Chapter 4](#) to generate a set of trade-offs between the investment in equipment and the ergonomics level, then select the appropriate solution from the Pareto front.

5.2.3 Line re-configuration

When the demand is subject to fluctuation, or when the product definition or operating mode changes, the assembly line has to undergo a re-configuration. The problem of reconfiguration of the assembly line has some similarities with the line configuration as the initial configuration has to be taken into account.

In this stage, since the worker's physical characteristics could be available, the approach developed in [Chapter 4](#) could be used to assign workers with different characteristics. We define the decision problem W-ALBP-FR for the Worker assignment with the consideration of Fatigue and Recovery. We use notations already introduced in [Subsection 4.3.6](#), with the substitution of equipment with workers (i.e., the set E became the set of workers).

W-ALBP-FR is defined as follows:

$$\sum_{k \in W} y_{i,k} = 1 \quad \forall i \in E \tag{5.1}$$

$$\sum_{j \in V} \sigma_{j,k} \leq \sum_{l \in U \mid l < \mathcal{D}_i} \ln \left(\frac{1}{(F-1)e^{R_{i,l}} + 1} \right) \cdot z_{l,k} + \sum_{j \in V} I_{i,j} \cdot (1 - y_{i,k}) + \sum_{j \in V} \sum_{l \in U \mid l \geq \mathcal{D}_i} I_{i,j} \cdot z_{l,k} \quad \forall i, \forall k \tag{5.2}$$

s.t. [\(4.9b\)](#) to [\(4.9m\)](#)

The additional constraint [\(5.1\)](#) ensures that a worker is only assigned once to a given workstation $k \in W$. Constraint [\(5.2\)](#) is adapted in the case of workers with different characteristics (i.e., K_i and R_i , with $i \in E$). The set of constraints [{\(4.9b\) to \(4.9m\)}](#) is already defined in [Chapter 4](#).

The optimal solution could be obtained with the use of IDS (cf. [Section 3.4](#)) with the W-ALBP-FR as a decision problem.

5.2.4 Operational planning

In the operational planning horizon, when the assembly line manufacture several products, a sequencing problem has to be considered to determine the sequence of products. Besides, methodological interventions could be realized on existing assembly systems by professional ergonomists to improve the working postures and operating modes. For workforce scheduling and assignment with consideration of ergonomics in the operational planning stage, we refer to [Ferjani et al. \(2017\)](#); [Moussavi et al. \(2016\)](#); [Savino et al. \(2019\)](#). The framework developed by [Battini et al. \(2011\)](#) shows different methods to improve productivity and ergonomics in assembly systems at the operational level.

5.3 Assembly line of agricultural mulchers

The case study concerns an assembly line from the Italian company Berti. The company is among the leaders in the international market, with more than 60-years of presence in the sector of manufacturing of agricultural machinery. Berti is specialized in a wide range of products, such as mulchers, shredders, and rotary mowers, with more than 500 models.

The line that interests us concerns an assembly line of agricultural mulchers (cf. [Figure 5.1](#)). Agricultural mulchers are conceived for vast farms and farming contractors and are dedicated to intensive mulching, and intended for mulching grass, nurseries, and park maintenance.

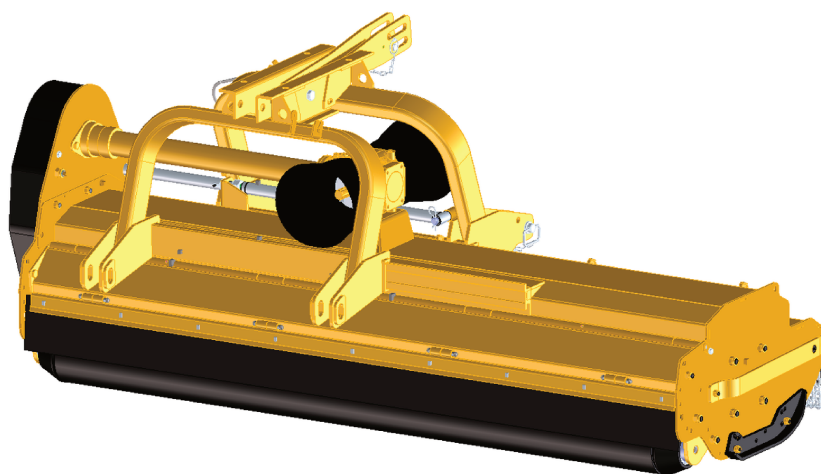

Figure 5.1: Agricultural mulcher (BERTI MACCHINE AGRICOLE S.p.A., 2019)

The assembly line we are interested in is manual, operators handle massive part and are exposed to ergonomic risks, the company often encounters problems related to ergonomics and MSDs.

We apply the methodology presented in Section 5.2 to the case study. First, we present the product analysis and process planning, then we present the line configuration.

5.3.1 Product and process analysis

The line assembles three types of mulchers (i.e., three models), and produce with a mix-model production policy. In this assembly line, the customer demands are ten machines each working day. To satisfy the demand, the company must manufacture six machines of model 1 denoted M1, three of model 2 (M2), and only one of model 3 (M3). The net available time of work is 7.35h, to satisfy the demand of 10 models, the takt time in seconds is $T = \frac{7.35 \times 3600}{10} = 2646s$; in this case, the transfer time is negligible.

We consider the mixed-model assembly line system with the average model defined by the combined precedence constraints, as shown in Figure 5.2 and the average operation time. Some operations are absent, depending on the model to assemble. For instance, model 1 (M1) excludes operations colored with red and gray, while model 2 leaves out operations colored with gray and blue, and model 3 omits operations colored with green. When we consider the equivalent average model, we find a balancing solution for the whole planning horizon since we consider the demand of each model of machines to manufacture the total mix (Scholl, 1999). As presented in Scholl (1999), the processing time of an operation j for the average model is obtained using the weighted sum, i.e., $t_j^{MIX} = [d_1 t_j^{M1} + d_2 t_j^{M2} + d_3 t_j^{M3}]$, $\forall j \in V$ with t_j^{M1} , t_j^{M2} and t_j^{M3} respectively operations time of model M1, M2 and M3. $d_1 = 0.6$, $d_2 = 0.3$, and $d_3 = 0.1$ are the demand ratio of M1, M2 and M3 respectively.

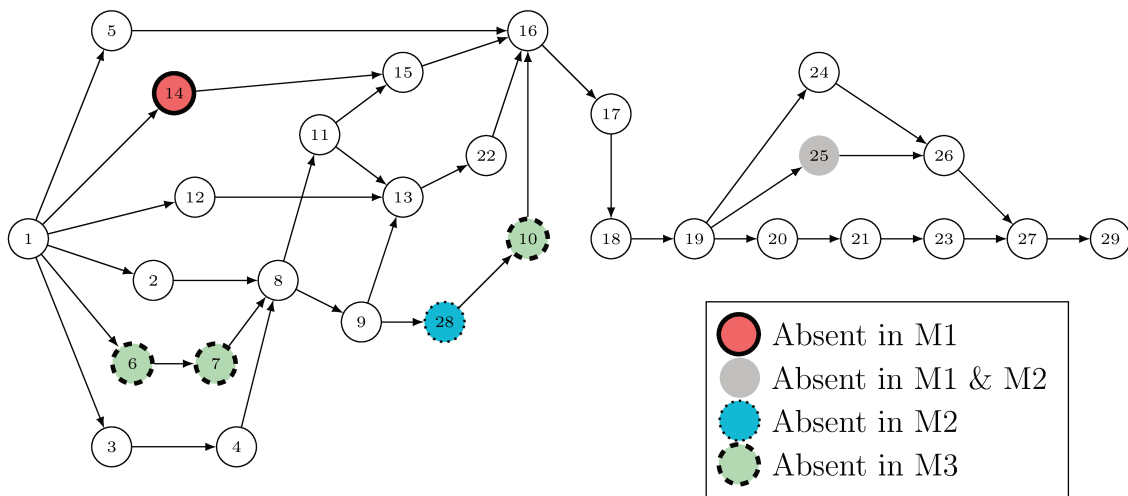

Figure 5.2: Combined precedence diagram of agricultural mulchers (Maccini, 2017)

We used the Borg scale to evaluate the physical effort of operations in the assembly line. The load of operations is considered static, a qualified ergonomist put a score from 0 to 10 to each operation based on the Borg scale with the aid of the verbal anchor, as in Table 5.1. It is crucial to rate operations as they are executed to take into account the posture of workers. From the Borg score, the %MVC is equal to 10 times the scored value, as explained in Bernard (2012). When the anchor is empty, for example, in scale 6 in the table, the effort is more than *strong* but less than *very strong*. The distribution of operations load (in percentage % or %MVC) seems to follow a beta distribution (cf. Table 5.2), with most of the operations between 10% and 40%, and only a few with more than 40%.

Table 5.2: Processing time and operations load - agricultural mulcher assembly line (Maccini, 2017)

Operations	Time M1 [s]	Time M2 [s]	Time M3 [s]	Time Mixed-model [s]	%MVC
1	172	171	175	172	20
2	210	465	205	286	40
3	200	196	207	200	40
4	261	268	264	264	60
5	62	61	62	62	40
6	92	109	0	88	40
7	199	236	0	191	60
8	69	64	73	68	20
9	227	218	229	225	50
10	148	182	0	144	60
11	495	457	487	483	60
12	269	261	266	267	40
13	602	611	602	605	40
14	0	591	556	233	30
15	292	277	293	288	30
16	185	189	183	186	30
17	256	256	256	256	30
18	1982	1889	1820	1938	30
19	322	319	318	321	30
20	218	183	215	208	40
21	126	126	127	127	30
22	102	106	104	104	30
23	213	213	214	214	30
24	342	483	484	399	40
25	0	0	263	27	40
26	279	275	273	278	30
27	523	518	516	521	10
28	245	0	244	172	30
29	73	74	72	74	20

5.3.2 Line configuration

Four is the optimal number of workstations to manufacture the three models of agricultural mulcher in a mix-model policy. The products are assembled with 29 operations. Hence, IDS is suitable for this case study.

The ergonomics level obtained with IDS is $F = 99.97\%$, we obtain this result in 15.35s. The computational time is suitable for practical industrial applications for this assembly

line. Figure 5.3 presents the evolution of the execution of IDS, we could notice the quick improvement of the initial lower bound obtained with SALBP, denoted \underline{F}_0^{SALBP} . We get a better solution at each iteration i of IDS until the stopping condition when we prove the optimality of the solution; there is a reduction of 0.03 percentage point after one takt time.

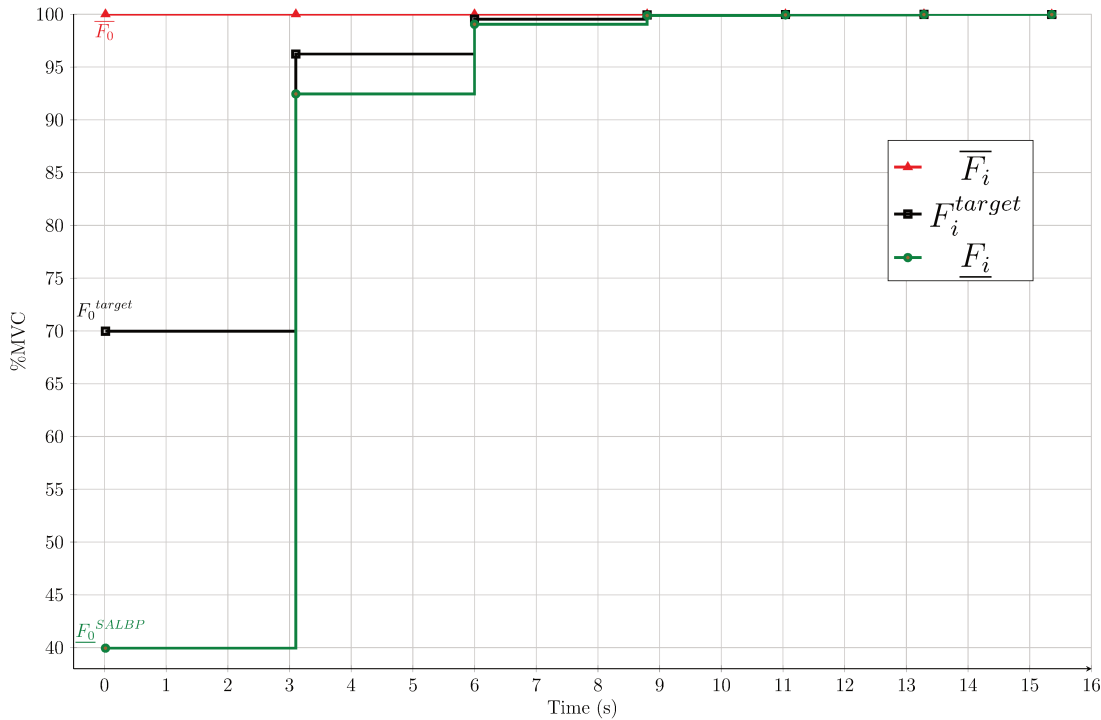

Figure 5.3: The evolution of bounds in the execution of IDS with the solution of SALBP-1 as starting solution - agricultural mulcher assembly line

5.3.3 Solution analysis

We compare the optimal solution obtained with IDS with a pool of SALBP-1 solutions. We compare with SALBP because it represents a configuration without taking ergonomics into account.

The average ergonomics level of SALBP is $F=67.2\%$, obtained with a pool of 66 SALBP solutions. SALBP gives a line configuration with the lowest ergonomics level, with an average gap of 32.78% with the optimal solution of IDS. Taking into account only performance without ergonomics can lead to a low ergo-quality level and exposes workers to labor-intensive workload and, eventually, potential MSDs.

To analyze the structure of the optimal solution and compare it with the starting solution of SALBP-1, we present in Table 5.3 the percentage of the workload and recovery time assigned to each workstation. The percentage of workload of a workstation k is

the ratio of the workload assigned to the workstation k and the total workload (i.e., $\frac{\sum_{j \in V | x_{j,k}=1} I_j}{\sum_{j \in V} I_j}$). Similarly, the percentage of recovery time is the ratio between the recovery time in a given workstation k and the takt time (i.e., $\frac{T - \sum_{j \in V | x_{j,k}=1} t_j}{T}$).

Since we have four workstations in the line, the ideal balance of workload is 25% for each workstation. To quantify the dispersion of the workload in workstations, we compute the standard deviation or SD. We observe that the SALBP solution displays the most significant standard deviation of 9.71, which means that this solution does not assign a balanced workload for workstations. The optimal solution presents a lower SD with only 5.85.

Table 5.3: Percentage of workload and recovery times assigned to workstations - agricultural mulcher assembly line

	Percentage of workload		Percentage of recovery time	
	SALBP	IDS(SALBP)	SALBP	IDS(SALBP)
Workstation 1	19	30.03	46.26	18.14
Workstation 2	38.53	30.09	1.13	19.58
Workstation 3	25.42	19.59	4.95	26.76
Workstation 4	17.05	20.3	30.16	18.03
SD	9.71	5.85	21.40	4.15

The ideal recovery time in this case study is approximately 20.6%, which means that workers could work 80% of the takt time. SALBP has the highest standard deviation of 21.4, and its solution does not balance recovery times for different workstations. The optimal solution provides a relatively low SD of 4.15.

By analyzing the percentage of workloads and the recovery times, we can observe that the best solution structures have the lowest standard deviations for both the load and the recovery periods, the optimization of both aspects is essential to improve the ergonomics level as we define it in this thesis.

5.3.4 Simulation of the optimal solution

The industrial company manufactures ten machines every working day with a mix-model production policy. The simulation of different sequences of models (M1, M2, M3) for the whole production period shows that different sequences do not influence on the ergonomics level in this case study. Indeed, all sequence of production leads to approximately similar ergonomics level after the production of 10 models.

We present in [Table 5.4](#) the value of F_k (%) obtained with the average model. We present different values for each workstation and different models. We observe that the M2 presents a low ergonomics level. However, the simulation shows that the different sequence allows balancing the workload in $W1$ at the end of the shift (i.e., after the production of 10 models).

Table 5.4: F_k in (%) of the average model solution

	W1	W2	W3	W4
M1	100	99.98	100	99.99
M2	67.99	99.98	100	99.96
M3	99.93	100	100	93.85
Mix Model	99.98	99.99	100	99.97

Similarly, we present in [Table 5.5](#) the value of recovery time obtained with the average model. The takt time is respected in all models.

Table 5.5: Recovery time (s) of the average model solution

	W1	W2	W3	W4
M1	702	504	664	550
M2	67	507	757	455
M3	427	659	826	164
Mix Model	480	518	708	477

With the methodology we proposed, we can reduce the fatigue for the workforce involved in the system without additional investment in equipment or technologies, and with the optimal number of workstations.

5.4 Assembly line of condensing boiler

Condensing boiler is a water heater, usually fueled by gas that achieves high efficiency by condensing water vapor in the exhaust gases and recover the latent heat of vaporization. Condensing boilers are compact and provide instant and abundant quality hot water.

The assembly line we are studying concerns a condensing boiler of the French company elm.leblanc that is today part of Bosch thermo-technology. elm.leblanc is specialized in the construction of boilers and individual gas water heaters. The product which interests us in this case study is a modern boiler with micro-accumulation condensing gas (cf. [Figure 5.4](#)).

5.4.1 Product and process analysis

The condensing boiler is assembled in a serial straight line or I-line, 300 operations are necessary to assemble the single product. All operations are manual and require only simple equipment. Input data for this case study are provided by the office methods, for confidentiality reasons, the product data (description of operations, processing times, precedence diagram, takt time, operations load), will not be disclosed.

The physical load of operations is obtained as in [Section 5.2.1.4](#), with the Borg scale. A qualified ergonomist from the company evaluates operations load with the active

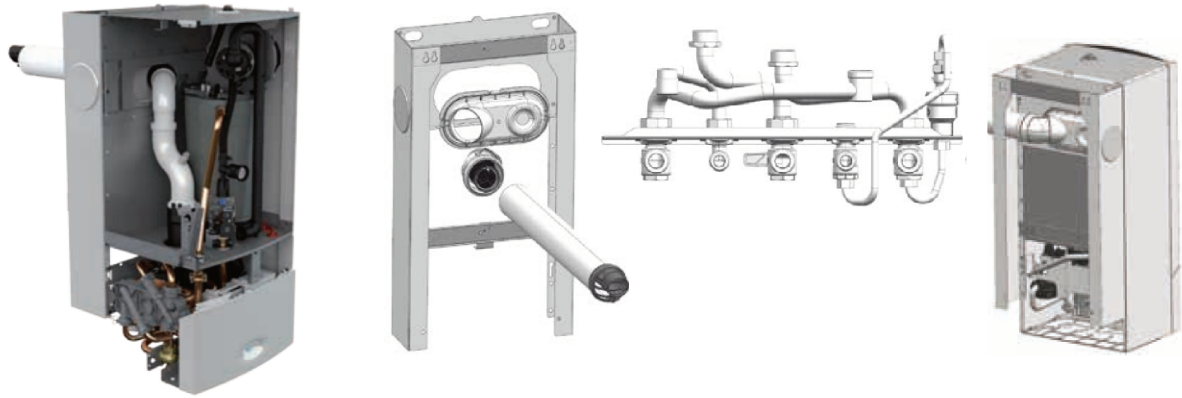

Figure 5.4: Condensing boiler (elm.leblanc, 2019)

involvement of the office methods. We could observe that the distribution of operations load follows a beta distribution.

5.4.2 Line configuration

The size of operations in this case study is 300 operations, which suggests that the suitable methodology to solve the problem in reasonable computational time is the metaheuristic ILS.

We present in [Table 5.6](#) the ergonomics level $F(\%)$, and the computational time in seconds. We have at our disposal the real industrial balancing solution put in place to produce the condensing boiler, and the real solution is presented in the second column (Industrial). The third column (Pool of SALBP) presents the average results of a pool of SALBP solutions.

Table 5.6: Ergonomics level and computational time - condensing boiler assembly line

	Industrial	Pool of SALBP	ILS
F%	42.63	41.4	75.17
Computational time [s]	-	1.79	861.38

The ergonomics level of the industrial solution is similar to the solution of SALBP, although the industrial solution is slightly better than the average result obtained by a pool of SALBP solutions. Note that, we fixed the number of workstations to 15 since the industrial solution uses 15 workstations. Therefore, SALBP, in this case, is a decision problem SALBP-F, recall that “F” means feasibility, with a fixed takt time and a fixed number of workstations, the decision problem defines whether or not an assignment of operations to workstations is feasible. ILS presents the best solution, with $F = 75.17\%$ in the computational time of 861s.

Table 5.7: Percentage (%) of workload and recovery time assigned to workstations - condensing boiler assembly line case study

	Percentage of workload			Percentage of recovery time		
	Industrial	SALBP	ILS	Industrial	SALBP	ILS
Workstation 1	7.97	7.22	5.94	20	1.2	17.45
Workstation 2	7.22	11.07	7.12	22.62	2.69	21.37
Workstation 3	4.19	7.07	7.41	51.28	15.46	22.32
Workstation 4	7.75	7.33	6.37	0.83	4.69	18.54
Workstation 5	5.89	2.91	6.16	13.3	41.94	17.87
Workstation 6	6.2	9.41	6.32	14.1	0.61	19.4
Workstation 7	6.17	9.64	7.41	29.58	1.49	22.29
Workstation 8	7.23	9.41	6.18	13.3	0.79	18.64
Workstation 9	6.71	2.9	8.37	31.41	63.86	25.18
Workstation 10	7.15	7.54	7.93	21.47	28.01	24.19
Workstation 11	10.07	1.69	6.98	1.35	12.33	21.07
Workstation 12	6.89	5.03	8.00	29.23	45.97	23.95
Workstation 13	8.16	9.22	1.69	19.36	4.3	12.33
Workstation 14	1.69	1.73	6.92	12.33	81.31	20.52
Workstation 15	6.7	7.82	7.19	26.5	2.01	21.52
SD	1.88	3.08	1.56	12.63	26.08	3.24

5.4.3 Solution analysis

We present in [Table 5.7](#) the percentage of the workload and recovery time assigned to each workstation for different solutions. With 15 workstations, the ideal workload balance is approximately 6.67% of the total workload in each workstation, to quantify the dispersion of the workload in workstations, we compute the SD. ILS has the smallest standard deviation. On the other hand, SALBP has the highest dispersion; the dispersion of the industrial solution is better than the solution of SALBP.

The ideal recovery time in this case study is approximately 20%, which means that workers could work only 80% of the takt time. However, the SD could be high, as in the SALBP and in the industrial solution, which means that the rest allowance is not balanced.

The ILS solution offers the best workload and recovery time distribution, and the solution assigns almost equivalent ratio of workload/recovery time for all workstations. The industrial solution, on the other hand, does not balance the workload and the recovery times. However, the company manages to find a better-balanced solution compared to SALBP.

5.4.4 Simulation of the optimal solution

Since the ergonomics level sharply decreases after one takt time, we simulate the evolution during a shift of production to assess the ergonomics risk. The shift of production is

composed of 77 takt times, which the workers perform without taking a break (usually 30 min of a break after 77 cycles of work), a break period of 30min is sufficient to fully-recover according to the fatigue-recovery model we used. A given worker in workstation k is at risk if the level of muscular capacity fall below the threshold of risk, i.e., $F_k \leq F_{risk}$, we consider the F_{risk} for a workstation k as the average load of operations assigned to that workstation k (Ma et al., 2010). A worker at risk would not be able to complete operations correctly and may develop MSDs. Besides, a worker at risk would increase the error rate and quality defects in the production. The time in which this situation happens is called in the literature the Maximum Endurance Time or MET (Elahrache et al., 2006).

The industrial solution has two workstations in risk, workstation 4 and 11. SALBP has five workstations at risk. In the industrial solution, workstation 2 and 11 have a significant deviation from the ideal workload and recovery time. On the other hand, no workstation is at risk with ILS.

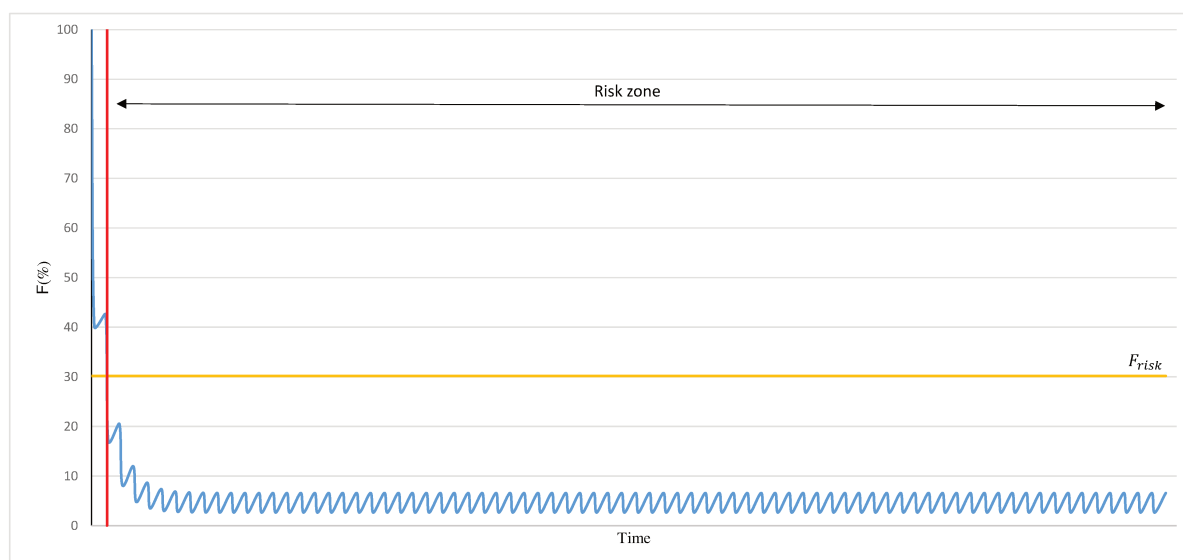

Figure 5.5: The evolution of $F(\%)$ in several cycles of work for a workstation at risk in the industrial solution

Figure 5.5 depicts the evolution of $F_k(\%)$ in workstation $k = 11$, which is the most charged workstation in the industrial solution (i.e., $F = F_{11}$). The level of risk F_{risk} is specified in the figure. We observe that the worker is at risk from the second takt time (second cycle of work) and remains at risk till the break. The shape of the curve is the result of the fatigue and recovery model assumed in this thesis. In the first cycles, the slope of the function decreases rapidly. The muscular capacity of a worker decreases faster than in later cycles when the fatigue and recovery evolution is in a quasi-steady state with a slighter decrease. Once the worker reaches a low muscular capacity level, relatively short recovery time is sufficient to reduce fatigue. These results are consistent

with the evolution of the fatigue in the work of [Glock et al. \(2019\)](#) for several cycles of the packaging process. We refer for more details on the evolution of the level of fatigue after several work cycles to the results and discussion provided in the recent work of [Glock et al. \(2019\)](#) that consider a fatigue and recovery model similar to the one we used in this thesis.

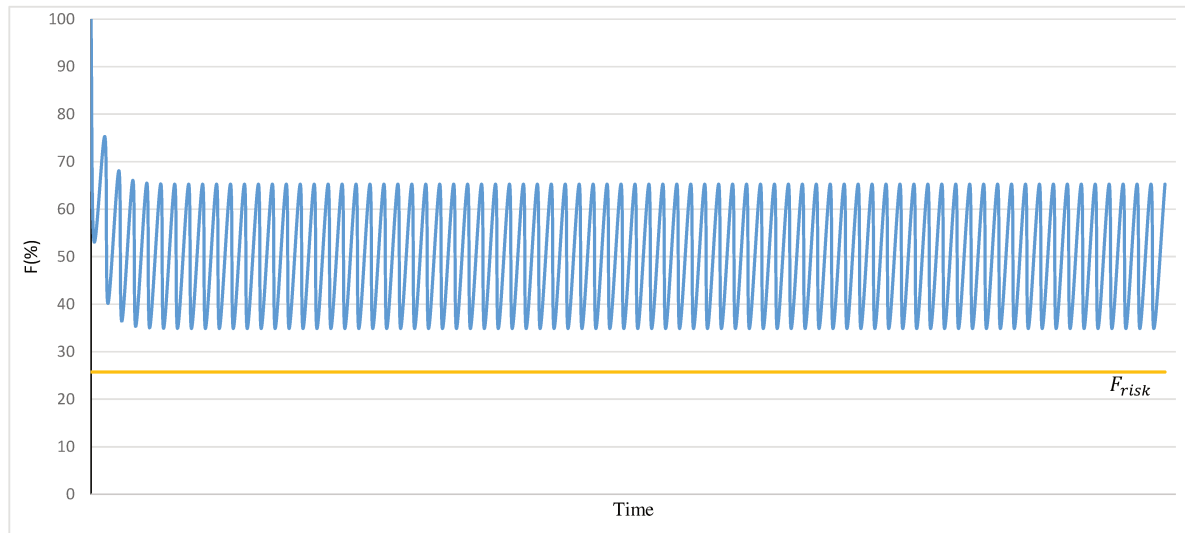

Figure 5.6: The evolution of $F(\%)$ in several cycles of work for the most charged workstation in the ILS solution

In [Figure 5.6](#), we present the evolution of the muscular capacity in the most charged workstation (i.e., $F(\%)$) obtained with ILS. We can observe that the level of F does not fall below the value F_{risk} in the first cycles of work, and therefore, during the rest of the work time before the break, the worker is not in a risky situation. Recall that the workstation represented in this figure is the most charged workstation, workers in other workstations of the assembly line are in better condition without any risk.

For this industrial case study, the approach we propose with the metaheuristic ILS makes it possible to solve the problem by taking into account ergonomics in a suitable computational time. Furthermore, the solution proves to be of better quality than the one already implemented by the company, which suggests that changes in the assignment of operations will eventually lead to a better quality of work in the assembly line.

At the time of writing, the company has invested in a cobot to improve productivity and ergonomics. An interesting perspective would be to apply the approach proposed in [Chapter 4](#) for future investment in equipment since the company seeks to improve its productivity to adapt to future demands and also to operate with a safer assembly line.

5.5 Conclusion

We proposed in this chapter a methodology for the ergonomics design of assembly line from the design stage, with an insight on the different relevant optimization problems to consider at each step and a definition of the context in which the contribution of this thesis could be used. We illustrated the developed methodology on two industrial case studies, the first concerns an Italian producer of agricultural machinery and the second a French producer of condensing boiler. In both cases, ergonomics in the assembly line could be improved without additional investment. This chapter enabled us to validate different aspects and methodologies proposed in this manuscript with an application to real problems.

We studied a mixed-model in the first case study. Indeed, with the increasing diversity of demand, production systems tend to change and adapt their products and produce them in a mixed-model production policy. These changes involve a growing need to dispose of design tools and techniques to allow the design of assembly lines. We considered the mix-model with an average model. We showed how the operation load could be obtained with the Borg scale, and then we discussed the output solutions. Similarly, we applied the same methodology to the condensing boiler case study, with a discussion of results and practical insight to improve the ergonomics.

Conclusion and perspectives

The work we presented in this thesis is part of a research stream of evaluation and optimization of ergonomics in the design phase of manufacturing systems. We proposed operation research models and solving methods to include ergonomics in manufacturing systems from the design stage. Poor physical ergonomics result in lower productivity, lower motivation, injuries, and MSDs, and increases costs for companies (e.g., absenteeism, non-quality cost, cost linked to a high rate of errors). The main objective of this thesis was to propose design methods for manufacturing systems, with the joint consideration of ergonomics, productivity, and cost. We applied our approach to strategic and tactical decisions in assembly lines. In the following, we report the main findings and the significant implications of this Ph.D., and then we highlight suggestions for future research directions.

We have shown the multitude of models and methods of evaluation and assessment of physical ergonomics, by reviewing three different methods: qualitative, semi-quantitative, and quantitative. Qualitative methods are mainly developed to assess ergonomics risks in existing workplaces quickly. While semi-quantitative methods are more often designed for the evaluation of work postures, they are ideal for improving the way of performing operations. Moreover, semi-quantitative methods are not generic and depend on the context of the application. We opted for quantitative, general, and precise fatigue and recovery model with interesting mathematical properties, which models almost all the factors involved in the execution of an assembly operation, such as the magnitude of the load, the processing time, the frequency, and worker characteristics. The quantitative fatigue and recovery model describes ergonomics for a broad set of situations. Furthermore, the model is validated, theoretically, and experimentally (Liu et al., 2018; Ma, 2009; Ma et al., 2010, 2011a,b,c, 2015; Zhang et al., 2014).

In manual and semi-automatic production lines such as assembly lines, muscular strengths are necessary to execute operations adequately and generate enough forces and torques to operate the equipment. Insufficient strength can lead to injuries and MSDs. Furthermore, short recovery periods result in bad work-rest patterns and inadequate rest allowance for workers after the execution of operations. The quantitative model used allowed us to evaluate the level of ergonomics (i.e., modeled with the evolution of the muscular capacity of workers) in a production line. Moreover,

it allowed optimizing the assignment of recovery times or rest allowance. However, the main counterpart of the choice of the fatigue and recovery model is its non-linearity, which complicated the optimization process. To deal with these methodological difficulties, we proposed operations research methods and solving approaches.

We proposed a Mixed-Integer Non-Linear Programming model for the Simple Assembly Line Balancing Problem with workers Fatigue and Recovery. The objective was to optimize the ergonomics level without additional investment (i.e., fixed cost). To use operations research linear programming techniques, we propose a linearization using a formulation of the problem in the form of a decision problem denoted SALBP-FR, where we define a target on the level of ergonomics. To solve the problem, we developed an exact algorithm, denoted Iterative Dichotomic Search or IDS, which iteratively updates the target on the level of ergonomics and solve the SALBP-FR with a Branch&Cut algorithm (Cplex), a dichotomy is used to browse the search space quickly.

SALBP is an NP-hard problem, which means that likely, there is no polynomial-time algorithm to solve the problem. To tackle large scale instances, we developed an Iterative Local Search or ILS metaheuristic that provides a sufficiently good quality solution in reasonable computational time. Besides, we have the IDS as an exact algorithm, able to find bounds of good quality, which allows us to prove the efficiency and the quality of the solutions obtained by the metaheuristic.

We proposed a generalization to the Assembly Line Design Problem or ALDP, including the combinatorial optimization problem of assigning different operations to be performed for each workstation, and the selection of equipment. We proposed a multi-objective model that optimized the design cost of the assembly line and the level of ergonomics. The objectives are conflicting, and the preferences of decision-makers are not known a priori, we developed a multi-objective algorithm, based on the ϵ -constraint and the IDS algorithm to obtain the Pareto-optimal solutions. The algorithm helps to provide either the Pareto front or a good approximation of the Pareto front.

We applied and validated models and solving approaches with numerical experiments. The primary purpose of the experimental analysis was to examine the performance of models and solving approaches. The first step of the numerical experiments was the definition of a set of instances that represents situations that are similar to the industrial realities (different takt time values, transfer times, precedence graph structure, number of operations, distribution of operation load, equipment cost). We generated a population of instances to compare different algorithms, and then we analyzed their solutions qualities and computational times.

The results of the experiments showed the possibility of improving the ergonomics of a line from the design phase without additional investment. Significant mitigation of ergonomic risks and a more uniform distribution of workload and rest time can be achieved with the approach we proposed in a suitable computational time. Furthermore, IDS

allowed to obtain good computational results on tested instances, and even for cases where the optimal solution was not obtained, most of the time, the initial solution is improved. We succeeded in solving almost all instances optimally with less than 50 operations, and we obtained promising results for instances between 50 and 148 operations. Indeed, we solved instances with up to 148 operations. Computational times are suitable for practical application, especially for assembly line design and balancing problems where the decision horizon is long. For cases where the computational time is high, or else a solution must be obtained quickly, the ILS metaheuristic allowed to find reasonable quality solutions in a short time. The average computational time of ILS was approximately 24s, with an average gap of less than 1% with known optimal solutions. Furthermore, the best quality results of IDS are obtained when ILS is used as a starting solution.

For the Assembly Line Design Problem or ALDP with the optimization of ergonomics and cost, we succeed with the ϵ -constraint algorithm to obtain the Pareto-optimal front or an approximation of the front. For small size instances up to 30 operations and 10 equipment, we succeed in obtaining the Pareto-optimal front. Furthermore, we obtained either the Pareto front or a good approximation of the front with instances up to 70 operations and up to 10 equipment.

We presented in the last chapter an insight of the overall methodology of designing assembly lines with the consideration of ergonomics, with a discussion of the context in which the contribution of this thesis could be used in practice. We illustrated with two industrial cases different steps to apply our contributions in an industrial environment with practical analysis and conclusions. Both cases involved manual assembly lines with the strong presence of human workers. The ergonomics is improved in both cases without additional investment, and our approach could bring a valuable contribution and managerial insight to assist engineers and decision-makers in designing sustainable assembly lines, with an evaluation of the level of ergonomics of solutions from the design stage.

Perspectives

We conclude this manuscript by discussing a few areas of research that are worth exploring further in the future:

First of all, several quantitative ergonomics criteria could be considered jointly. The relevance and the complementarity of the consideration of several criteria should be addressed in future work. We initiated works on the selection of equipment with a vibration criterion in [Finco et al. \(2019, 2020\)](#), the criteria considered in this work could be jointly integrated with the fatigue and recovery model to design new assembly lines with the joint mitigation of equipment vibration risks and the optimization of muscular capacity of workers. Moreover, since most ergonomic quantitative methods are non-linear, the capacity to integrate them with low computational cost in the

decision-making processes of manufacturing systems should be investigated in future research. The development of Industry 4.0 changes the demands and the role of humans in manufacturing systems. The modern industry grows toward a human-robot collaboration to benefit from the automation and the flexibility of workers. This fourth industrial revolution raises questions about worker technology acceptance and human-machine interactions. Future work should address those cognitive ergonomics issues and develop frameworks to design new manufacturing systems and to select equipment and technologies that workers come to accept and use.

Although we have proposed accurate and complete ergonomics modeling capable of handling a large number of situations in production systems, the manual aspects of industrial work raise the question of variability. Our current contribution could be completed by taking into account stochastic processing time. The uncertainty in the definition of operations times raises methodological difficulties. Indeed, this generates several changes in optimization models. The processing time of operations influences on the evolution of fatigue since it depends on the load of operations and on processing time. The uncertainty will also affect the recovery time that allows the worker to recover muscle strength. Besides, the uncertainty of processing time may cause the working time exceeding the takt time in paced assembly lines.

Another research opportunity that emerges from this work is the consideration of ergonomics in tactical and operational decisions of job rotation. Job rotation schedules change the assignments of workers to workstations in a given period, with the rotation of workers between high loaded and less loaded workstations, ergonomic risks could be smoothed and mitigated. The fatigue and recovery model could be defined within several periods, and then the job rotation schedules determine the period of swap between a worker in a critical workstation and slack workstations to avoid risks.

In the literature, only a few studies have developed efficient algorithms for the consideration of ergonomics in the design stage of assembly lines. The development of optimal algorithms for operations research models could provide insights into the effectiveness of certain methods in a particular situation. Moreover, many of the problems encountered are multi-objective, with a conflict between ergonomics and productivity. It would be interesting to develop multi-objective algorithms in future research.

References

- Abdous, M.-A., S. Berger-Douce, and X. Delorme (2018). Intégrer l’ergonomie dans la conception des systèmes de production: outil d’aide à la décision. *13ème Congrès du RIODD*. 15 pages. (In French).
- Abdous, M.-A., X. Delorme, D. Battini, F. Sgarbossa, and S. Berger-Douce (2018a). Assembly line balancing problem with consideration of workers fatigue and recovery. *20th International Working Seminar on Production Economics - IWSPE 51(11)*. 12 Pages.
- Abdous, M.-A., X. Delorme, D. Battini, F. Sgarbossa, and S. Berger-Douce (2018b). Multi-objective optimization of assembly lines with workers fatigue consideration. *IFAC-PapersOnLine 51(11)*, 698 – 703. 16th IFAC Symposium on Information Control Problems in Manufacturing INCOM.
- Abdous, M.-A., S. Finco, and V. Visentin (2018). Workload evaluation of industrial work: existing methods and practical applications. *XXIII Summer School “Francesco Turco” – Industrial Systems Engineering*. 7 pages.
- Akyol, S. D. and A. Baykasoğlu (2019). ErgoALWABP: a multiple-rule based constructive randomized search algorithm for solving assembly line worker assignment and balancing problem under ergonomic risk factors. *Journal of Intelligent Manufacturing 30(1)*, 291–302.
- Alavidooost, M., H. Babazadeh, and S. Sayyari (2016). An interactive fuzzy programming approach for bi-objective straight and U-shaped assembly line balancing problem. *Applied Soft Computing 40*, 221 – 235.
- Antoine, M., B. E.-H. Hind, R. C.-K. Wahiba, and B. M. Lounes (2016). Iterated local search for dynamic assembly line rebalancing problem. *IFAC-PapersOnLine 49(12)*, 515 – 519. 8th IFAC Conference on Manufacturing Modelling, Management and Control MIM 2016.
- Arcus, A. L. (1965). A computer method of sequencing operations for assembly lines. *International Journal of Production Research 4(4)*, 259–277.

- Arnheiter, E. D. and J. Maleyeff (2005). The integration of lean management and six sigma. *The TQM magazine* 17(1), 5–18.
- Ashok, P., G. Madhan Mohan, and K. Nitish (2018). Musculoskeletal disorders and workplace analysis of assembly section in a submersible pump industry: An EMG-based approach. In P. K. Ray and J. Maiti (Eds.), *Ergonomic Design of Products and Worksystems - 21st Century Perspectives of Asia*, pp. 131–138. Singapore: Springer Singapore.
- Balasubramanian, V., K. Adalarasu, and R. Regulapati (2009). Comparing dynamic and stationary standing postures in an assembly task. *International Journal of Industrial Ergonomics* 39(5), 649 – 654.
- Battaïa, O., X. Delorme, A. Dolgui, J. Hagemann, A. Horlemann, S. Kovalev, and S. Malyutin (2015). Workforce minimization for a mixed-model assembly line in the automotive industry. *International Journal of Production Economics* 170, 489 – 500.
- Battaïa, O. and A. Dolgui (2013). A taxonomy of line balancing problems and their solution approaches. *International Journal of Production Economics* 142(2), 259 – 277.
- Battini, D., M. Calzavara, A. Otto, and F. Sgarbossa (2017). Preventing ergonomic risks with integrated planning on assembly line balancing and parts feeding. *International Journal of Production Research* 55(24), 7452–7472.
- Battini, D., X. Delorme, A. Dolgui, A. Persona, and F. Sgarbossa (2016). Ergonomics in assembly line balancing based on energy expenditure: a multi-objective model. *International Journal of Production Research* 54(3), 824–845.
- Battini, D., X. Delorme, A. Dolgui, and F. Sgarbossa (2015). Assembly line balancing with ergonomics paradigms: two alternative methods. *IFAC-PapersOnLine* 48(3), 586 – 591. 15th IFAC Symposium on Information Control Problems in Manufacturing.
- Battini, D., M. Faccio, E. Ferrari, A. Persona, and F. Sgarbossa (2007). Design configuration for a mixed-model assembly system in case of low product demand. *The International Journal of Advanced Manufacturing Technology* 34(1-2), 188–200.
- Battini, D., M. Faccio, A. Persona, and F. Sgarbossa (2009a). Balancing–sequencing procedure for a mixed model assembly system in case of finite buffer capacity. *The International Journal of Advanced Manufacturing Technology* 44(3), 345–359.
- Battini, D., M. Faccio, A. Persona, and F. Sgarbossa (2009b). Evaluation of the mixed-model assembly line balancing problem with variable operation times and

- product mix. *International Journal of Services and Operations Management* 6(2), 126–148.
- Battini, D., M. Faccio, A. Persona, and F. Sgarbossa (2011). New methodological framework to improve productivity and ergonomics in assembly system design. *International Journal of industrial ergonomics* 41(1), 30–42.
- Battini, D., C. H. Glock, E. H. Grosse, A. Persona, and F. Sgarbossa (2017). Ergo-lot-sizing: An approach to integrate ergonomic and economic objectives in manual materials handling. *International Journal of Production Economics* 185, 230 – 239.
- Bautista, J., R. Alfaro-Pozo, and C. Batalla-García (2017). Maximizing comfort in assembly lines with temporal, spatial and ergonomic attributes. *International Journal of Computational Intelligence Systems* 9(4), 788–799.
- Bautista, J., C. Batalla-García, and R. Alfaro-Pozo (2016). Models for assembly line balancing by temporal, spatial and ergonomic risk attributes. *European Journal of Operational Research* 251(3), 814 – 829.
- Bautista, J. and J. Pereira (2007). Ant algorithms for a time and space constrained assembly line balancing problem. *European Journal of Operational Research* 177(3), 2016 – 2032.
- Baybars, Ä. (1986). A survey of exact algorithms for the simple assembly line balancing problem. *Management Science* 32(8), 909–932.
- Becker, C. and A. Scholl (2006). A survey on problems and methods in generalized assembly line balancing. *European Journal of Operational Research* 168(3), 694 – 715.
- Berger-Douce, S. (2008). Rentabilité et pratiques de RSE en milieu PME - premiers résultats d'une étude française. *Management & Avenir* 15, 9–29. (In French).
- Berger-Douce, S. (2015). La performance par l'innovation responsable. *Entreprendre & Innover* 24, 37–44. (In French).
- Bernard, T. E. (2012). Static work. University of South Florida, College of Public Health, Personal.health.usf.edu/tbernard.
- BERTI MACCHINE AGRICOLE S.p.A. (2019). BERTI machine agricole. <https://www.bertima.it/en/>, Last accessed on 2019-08-01.
- Bevan, S. (2015). Economic impact of musculoskeletal disorders (MSDs) on work in Europe. *Best Practice & Research Clinical Rheumatology* 29(3), 356 – 373.

- Borg, G. (1982). Psychophysical bases of perceived exertion. *Medicine and Science in Sports and Exercise* 14(5), 377–381.
- Borg, G. (1998). *Borg's perceived exertion and pain scales*. Human kinetics.
- Borisovsky, P. A., D. Alexandre, and K. Sergey (2012). Modelling transfer line design problem via a set partitioning problem. *Optimization Letters* 6(5), 915–926.
- Borisovsky, P. A., X. Delorme, and A. Dolgui (2013). Genetic algorithm for balancing reconfigurable machining lines. *Computers & Industrial Engineering* 66(3), 541 – 547.
- Borisovsky, P. A., X. Delorme, and A. Dolgui (2014). Balancing reconfigurable machining lines via a set partitioning model. *International Journal of Production Research* 52(13), 4026–4036.
- Boudreau, J., W. Hopp, J. O. McClain, and L. J. Thomas (2003). On the interface between operations and human resources management. *Manufacturing & Service Operations Management* 5(3), 179–202.
- Boysen, N., M. Fliedner, and A. Scholl (2007). A classification of assembly line balancing problems. *European Journal of Operational Research* 183(2), 674 – 693.
- Boysen, N., M. Fliedner, and A. Scholl (2008). Assembly line balancing: Which model to use when? *International Journal of Production Economics* 111(2), 509 – 528.
- Boysen, N., M. Fliedner, and A. Scholl (2009). Sequencing mixed-model assembly lines: Survey, classification and model critique. *European Journal of Operational Research* 192(2), 349 – 373.
- Bridger, R. (2008). *Introduction to ergonomics*. CRC Press.
- Bukchin, J. and M. Masin (2004). Multi-objective design of team oriented assembly systems. *European Journal of Operational Research* 156(2), 326 – 352.
- Bukchin, J. and J. Rubinovitz (2003). A weighted approach for assembly line design with station paralleling and equipment selection. *IIE transactions* 35(1), 73–85.
- Bukchin, J. and M. Tzur (2000). Design of flexible assembly line to minimize equipment cost. *IIE Transactions* 32(7), 585–598.
- Byström, S. and C. Fransson-Hall (1994). Acceptability of intermittent handgrip contractions based on physiological response. *Human Factors* 36(1), 158–171.

- Cakir, B., F. Altiparmak, and B. Dengiz (2011). Multi-objective optimization of a stochastic assembly line balancing: A hybrid simulated annealing algorithm. *Computers & Industrial Engineering* 60(3), 376 – 384.
- Callan, S. J. and J. M. Thomas (2009). Corporate financial performance and corporate social performance: an update and reinvestigation. *Corporate Social Responsibility and Environmental Management* 16(2), 61–78.
- Calzavara, M., D. Battini, D. Bogataj, F. Sgarbossa, and I. Zennaro (2020). Ageing workforce management in manufacturing systems: state of the art and future research agenda. *International Journal of Production Research* 58(3), 729–747.
- Calzavara, M., A. Persona, F. Sgarbossa, and V. Visentin (2018). A model for rest allowance estimation to improve tasks assignment to operators. *International Journal of Production Research* 57(3), 948–962.
- Carnahan, B. J., B. A. Norman, and M. S. Redfern (2001). Incorporating physical demand criteria into assembly line balancing. *IIE Transactions* 33(10), 875–887.
- Carnahan, B. J., M. S. Redfern, and B. Norman (2000). Designing safe job rotation schedules using optimization and heuristic search. *Ergonomics* 43(4), 543–560.
- Çil, Z. A., S. Mete, and K. Ağpak (2016). A goal programming approach for robotic assembly line balancing problem. *IFAC-PapersOnLine* 49(12), 938 – 942. 8th IFAC Conference on Manufacturing Modelling, Management and Control MIM 2016.
- Cerqueus, A. and X. Delorme (2019). A branch-and-bound method for the bi-objective simple line assembly balancing problem. *International Journal of Production Research* 57(18), 5640–5659.
- Chaffin, D., G. Andersson, and B. Martin (1999). *Occupational Biomechanics*. Wiley.
- Chankong, V. and Y. Haimes (1983). *Multiobjective decision making: theory and methodology*. North-Holland series in system science and engineering. North Holland.
- Charnes, A. and W. W. Cooper (1977). Goal programming and multiple objective optimizations: Part 1. *European journal of operational research* 1(1), 39–54.
- Chen, J.-H. and S.-Y. Ho (2005). A novel approach to production planning of flexible manufacturing systems using an efficient multi-objective genetic algorithm. *International Journal of Machine Tools and Manufacture* 45(7), 949 – 957.
- Chengalur, S. N. (2004). *Kodak's ergonomic design for people at work*. John Wiley & sons.

- Chiang, W.-C. (1998). The application of a tabu search metaheuristic to the assembly line balancing problem. *Annals of Operations Research* 77, 209–227.
- Chica, M., Ó. Cordon, S. Damas, and J. Bautista (2015). Interactive preferences in multiobjective ant colony optimisation for assembly line balancing. *Soft Computing* 19(10), 2891–2903.
- Choi, G. (2009). A goal programming mixed-model line balancing for processing time and physical workload. *Computers & Industrial Engineering* 57(1), 395 – 400.
- Choung, S.-D., K.-N. Park, S.-H. Kim, and O.-Y. Kwon (2016). Comparison of muscle activity of wrist extensors and kinematics of wrist joint during wrist extension in automobile assembly line workers with and without lateral epicondylitis. *Work* 55(1), 241–247.
- Christoph, R. (2016). *“Faster, Better, Cheaper” in the History of Manufacturing: From the Stone Age to Lean Manufacturing and Beyond*. Productivity Press.
- Chutima, P. and P. Chimklai (2012). Multi-objective two-sided mixed-model assembly line balancing using particle swarm optimisation with negative knowledge. *Computers & Industrial Engineering* 62(1), 39 – 55.
- Cirjaliu, B. and A. Draghici (2016). Ergonomic issues in lean manufacturing. *Procedia - Social and Behavioral Sciences* 221, 105 – 110. 13th International Symposium in Management: Management During and After the Economic Crisis.
- Claeys, A., S. Hoedt, N. Soete, H. V. Landeghem, and J. Cottyn (2015). Framework for evaluating cognitive support in mixed model assembly systems. *IFAC-PapersOnLine* 48(3), 924 – 929. 15th IFAC Symposium on Information Control Problems in Manufacturing.
- Cohen, Y. and M. E. Dar-El (1998). Optimizing the number of stations in assembly lines under learning for limited production. *Production Planning & Control* 9(3), 230–240.
- Cohen, Y., H. Naseraldin, A. Chaudhuri, and F. Pilati (2019). Assembly systems in industry 4.0 era: a road map to understand assembly 4.0. *The International Journal of Advanced Manufacturing Technology*, 18 pages. (In press).
- Danna, E., M. Fenelon, Z. Gu, and R. Wunderling (2007). Generating multiple solutions for mixed integer programming problems. In M. Fischetti and D. P. Williamson (Eds.), *Integer Programming and Combinatorial Optimization*, Berlin, Heidelberg, pp. 280–294. Springer Berlin Heidelberg.

- de Looze, M. P., T. Bosch, F. Krause, K. S. Stadler, and L. W. O'Sullivan (2016). Exoskeletons for industrial application and their potential effects on physical work load. *Ergonomics* 59(5), 671–681.
- Deb, K. (2001). *Multi-Objective Optimization Using Evolutionary Algorithms*. Wiley.
- Deckro, R. F. and S. Rangachari (1990). A goal approach to assembly line balancing. *Computers & Operations Research* 17(5), 509 – 521.
- Delorme, X. (2014). *Apports de modélisations mathématiques pour l'évaluation et l'optimisation de systèmes industriels complexes*. Habilitation à diriger des recherches, Université Jean Monnet de Saint-Etienne. (In French).
- Delorme, X., O. Battaïa, and A. Dolgui (2014). Multi-objective approaches for design of assembly lines. In L. Benyoucef, J.-C. Hennet, and M. K. Tiwari (Eds.), *Applications of Multi-Criteria and Game Theory Approaches: Manufacturing and Logistics*, pp. 31–56. London: Springer London.
- Delorme, X., A. Dolgui, and M. Y. Kovalyov (2012). Combinatorial design of a minimum cost transfer line. *Omega* 40(1), 31 – 41.
- Distelhorst, G., J. Hainmueller, and R. M. Locke (2016). Does lean improve labor standards? management and social performance in the nike supply chain. *Management Science* 63(3), 707–728.
- Dobson, G. and C. A. Yano (1994). Cyclic scheduling to minimize inventory in a batch flow line. *European Journal of Operational Research* 75(2), 441 – 461.
- Dolgui, A., A. Ereemeev, and O. Guschinskaya (2010). MIP-based GRASP and genetic algorithm for balancing transfer lines. In V. Maniezzo, T. Stützle, and S. Voß (Eds.), *Matheuristics: Hybridizing Metaheuristics and Mathematical Programming*, pp. 189–208. Boston, MA: Springer US.
- Dolgui, A., B. Finel, N. N. Guschinsky, G. M. Levin, and F. B. Vernadat (2006). Mip approach to balancing transfer lines with blocks of parallel operations. *IIE Transactions* 38(10), 869–882.
- Dolgui, A., N. Guschinsky, and G. Levin (1999). On problem of optimal design of transfer lines with parallel and sequential operations. In *7th IEEE International Conference on Emerging Technologies and Factory Automation*, Volume 1, pp. 329–334.
- Dolgui, A. and S. Kovalev (2012). Scenario based robust line balancing: Computational complexity. *Discrete Applied Mathematics* 160(13), 1955 – 1963.

- Duffy, V. G. et al. (2007). A methodology for assessing industrial workstations using optical motion capture integrated with digital human models. *Occupational Ergonomics* 7(1), 11–25.
- Dul, J. and W. P. Neumann (2009). Ergonomics contributions to company strategies. *Applied Ergonomics* 40(4), 745 – 752.
- Easton, F., B. Faaland, T. D. Klastorn, and T. Schmitt (1989). Improved network based algorithms for the assembly line balancing problem. *International Journal of Production Research* 27(11), 1901–1915.
- Ehrgott, M. (2005). *Multicriteria optimization*, Volume 491. Springer Science & Business Media.
- Elahrache, K. and D. Imbeau (2009). Comparison of rest allowance models for static muscular work. *International Journal of Industrial Ergonomics* 39(1), 73 – 80.
- Elahrache, K., D. Imbeau, and B. Farbos (2006). Percentile values for determining maximum endurance times for static muscular work. *International Journal of Industrial Ergonomics* 36(2), 99 – 108.
- Elmaraghy, W., O. Nada, and H. A. ElMaraghy (2008). Quality prediction for reconfigurable manufacturing systems via human error modelling. *International Journal of Computer Integrated Manufacturing* 21(5), 584–598.
- elm.leblanc (2019). A propos d’elm.leblanc. <https://www.elmleblanc.fr/fr/fr/a-propos-d-elm-leblanc/>, Last accessed on 2019-08-01.
- Emde, S., N. Boysen, and A. Scholl (2010). Balancing mixed-model assembly lines: a computational evaluation of objectives to smoothen workload. *International Journal of Production Research* 48(11), 3173–3191.
- Essafi, M., X. Delorme, and A. Dolgui (2010). Balancing lines with cnc machines: A multi-start ant based heuristic. *CIRP Journal of Manufacturing Science and Technology* 2(3), 176 – 182.
- Essafi, M., X. Delorme, and A. Dolgui (2012). A reactive GRASP and Path Relinking for balancing reconfigurable transfer lines. *International Journal of Production Research* 50(18), 5213–5238.
- Falck, A.-C. and M. Rosenqvist (2014). A model for calculation of the costs of poor assembly ergonomics (part 1). *International Journal of Industrial Ergonomics* 44(1), 140 – 147.

- Falkenauer, E. and A. Delchambre (1992). A genetic algorithm for bin packing and line balancing. In *Proceedings of the 1992 IEEE international conference on robotics and automation*, pp. 1186–1192.
- Ferjani, A., A. Ammar, H. Pierreval, and S. Elkosantini (2017). A simulation-optimization based heuristic for the online assignment of multi-skilled workers subjected to fatigue in manufacturing systems. *Computers & Industrial Engineering* 112, 663 – 674.
- Finco, S., M.-A. Abdous, D. Battini, M. Calzavara, and X. Delorme (2019). Assembly line design with tools vibration. *IFAC-PapersOnLine* 52(13), 247 – 252. 9th IFAC Conference on Manufacturing Modelling, Management and Control MIM 2019.
- Finco, S., M.-A. Abdous, M. Calzavara, D. Battini, and X. Delorme (2020). A bi-objective model to include workers' vibration exposure in assembly line design. *International Journal of Production Research*. 16 pages. (In press).
- Finco, S., D. Battini, X. Delorme, A. Persona, and F. Sgarbossa (2019). Workers' rest allowance and smoothing of the workload in assembly lines. *International Journal of Production Research*. 16 pages. (In press).
- Flammer, C. (2015). Does corporate social responsibility lead to superior financial performance? a regression discontinuity approach. *Management Science* 61(11), 2549–2568.
- Fouda, P., P. De Lit, B. Rekiek, and A. Delchambre (2001). Generation of precedence graphs for a product family using a disassembly approach. In *IEEE International Symposium on Assembly and Task Planning. Assembly and Disassembly in the Twenty-first Century*, pp. 226–231.
- Frohm, J., V. Lindström, M. Winroth, and J. Stahre (2008). Levels of automation in manufacturing. *Ergonomia - International Journal of Ergonomics and Human Factors* 30, 181–207.
- Gadidov, R. and W. Wilhelm (2000). A cutting plane approach for the single-product assembly system design problem. *International Journal of Production Research* 38(8), 1731–1754.
- Gallagher, S. and M. C. S. Jr. (2017). Musculoskeletal disorders as a fatigue failure process: evidence, implications and research needs. *Ergonomics* 60(2), 255–269.
- Garg, A., D. B. Chaffin, and G. D. Herrin (1978). Prediction of metabolic rates for manual materials handling jobs. *American Industrial Hygiene Association Journal* 39(8), 661–674.

- Geoffrion, A. M. (1968). Proper efficiency and the theory of vector maximization. *Journal of mathematical analysis and applications* 22(3), 618–630.
- Ghosh, S. and R. J. Gagnon (1989). A comprehensive literature review and analysis of the design, balancing and scheduling of assembly systems. *The International Journal of Production Research* 27(4), 637–670.
- Givi, Z., M. Jaber, and W. P. Neumann (2015). Modelling worker reliability with learning and fatigue. *Applied Mathematical Modelling* 39(17), 5186 – 5199.
- Glock, C., E. Grosse, T. Kim, W. P. Neumann, and A. Sobhani (2019). An integrated cost and worker fatigue evaluation model of a packaging process. *International Journal of Production Economics* 207, 107 – 124.
- Glover, F. (1986). Future paths for integer programming and links to artificial intelligence. *Computers & Operations Research* 13(5), 533 – 549.
- Goggins, R. W., P. Spielholz, and G. L. Nothstein (2008). Estimating the effectiveness of ergonomics interventions through case studies: Implications for predictive cost-benefit analysis. *Journal of Safety Research* 39(3), 339 – 344.
- Gokcen, H. and E. Erel (1997). A goal programming approach to mixed-model assembly line balancing problem. *International Journal of Production Economics* 48(2), 177 – 185.
- González-Izal, M., A. Malanda, E. Gorostiaga, and M. Izquierdo (2012). Electromyographic models to assess muscle fatigue. *Journal of Electromyography and Kinesiology* 22(4), 501 – 512.
- Gorlach, I. and O. Wessel (2008). Optimal level of automation in the automotive industry. *Engineering Letters* 16(1). 9 pages.
- Górny, A. (2012). Ergonomics in the formation of work condition quality. *Work* 41(1), 1708–1711.
- Graham, R. B., M. J. Agnew, and J. M. Stevenson (2009). Effectiveness of an on-body lifting aid at reducing low back physical demands during an automotive assembly task: Assessment of EMG response and user acceptability. *Applied Ergonomics* 40(5), 936 – 942.
- Graves, S. C. and B. W. Lamar (1983). An integer programming procedure for assembly system design problems. *Operations Research* 31(3), 522–545.
- Graves, S. C. and C. H. Redfield (1988). Equipment selection and task assignment for multiproduct assembly system design. *International Journal of Flexible Manufacturing Systems* 1(1), 31–50.

- Graves, S. C. and D. E. Whitney (1979). A mathematical programming procedure for equipment selection and system evaluation in programmable assembly. In *18th IEEE Conference on Decision and Control including the Symposium on Adaptive Processes*, Volume 2, pp. 531–536.
- Greig, M. A., J. Village, F. A. Salustri, S. Zolfaghari, and W. P. Neumann (2018). A tool to predict physical workload and task times from workstation layout design data. *International Journal of Production Research* 56(16), 5306–5323.
- Gunther, R. E., G. D. Johnson, and R. S. Peterson (1983). Currently practiced formulations for the assembly line balance problem. *Journal of Operations Management* 3(4), 209 – 221.
- Guschinskaya, O. (2007). *Outils d'aide à la décision pour la conception en avant-projet des systèmes d'usinage à boîtiers multibroches*. Ph. D. thesis, Ecole Nationale Supérieure des Mines de Saint-Etienne, France. (In French).
- Gutjahr, A. L. and G. L. Nemhauser (1964). An algorithm for the line balancing problem. *Management Science* 11(2), 308–315.
- Haimes, Y. Y., L. S. Lasdon, and D. A. Wismer (1971). On a bicriterion formulation of the problems of integrated system identification and system optimization. *IEEE Transactions on Systems, Man, and Cybernetics* 1(3), 296–297.
- Halgeson, W. and D. Birnie (1961). Assembly line balancing using the ranked positional weighting technique. *Journal of Industrial Engineering* 12(6), 394–398.
- Hamming, R. W. (1950). Error detecting and error correcting codes. *The Bell system technical journal* 29(2), 147–160.
- Hampton, S., G. Armstrong, M. S. Ayyar, and S. Li (2014). Quantification of perceived exertion during isometric force production with the borg scale in healthy individuals and patients with chronic stroke. *Topics in Stroke Rehabilitation* 21(1), 33–39.
- Hamta, N., S. F. Ghomi, F. Jolai, and U. Bahalke (2011). Bi-criteria assembly line balancing by considering flexible operation times. *Applied Mathematical Modelling* 35(12), 5592 – 5608.
- Held, M., R. M. Karp, and R. Shreshian (1963). Assembly-line balancing - dynamic programming with precedence constraints. *Operations research* 11(3), 442–459.
- Hignett, S. and L. McAtamney (2000). Rapid entire body assessment (REBA). *Applied Ergonomics* 31(2), 201 – 205.

- Hoffmann, T. R. (1992). EUREKA: A hybrid system for assembly line balancing. *Management Science* 38(1), 39–47.
- Hummel, A., T. Läubli, M. Pozzo, P. Schenk, S. Spillmann, and A. Klipstein (2005). Relationship between perceived exertion and mean power frequency of the EMG signal from the upper trapezius muscle during isometric shoulder elevation. *European Journal of Applied Physiology* 95(4), 321–326.
- ISO (2001a). Mechanical vibration - measurement and evaluation of human exposure to hand-transmitted vibration - part 1: General requirements. URL: <https://www.iso.org/standard/32355.html>.
- ISO (2001b). Mechanical vibration - measurement and evaluation of human exposure to hand-transmitted vibration - part 2: Practical guidance for measurement at the workplace. URL: <https://www.iso.org/standard/27511.html>.
- Jaber, M., Z. Givi, and W. P. Neumann (2013). Incorporating human fatigue and recovery into the learning-forgetting process. *Applied Mathematical Modelling* 37(12), 7287 – 7299.
- Jaber, M. and W. P. Neumann (2010). Modelling worker fatigue and recovery in dual-resource constrained systems. *Computers & Industrial Engineering* 59(1), 75 – 84.
- Jackson, J. R. (1956). A computing procedure for a line balancing problem. *Management Science* 2(3), 261–271.
- Johnson, R. V. (1988). Optimally balancing large assembly lines with “FABLE”. *Management Science* 34(2), 240–253.
- Kadir, B. A., O. Broberg, and C. S. da Conceição (2019). Current research and future perspectives on human factors and ergonomics in industry 4.0. *Computers & Industrial Engineering* 137.
- Kalkis, H. and Z. Roja (2016). Strategic model for ergonomics implementation in operations management. *Journal of Ergonomics* 6(4), 173.
- Kannan, R. and C. L. Monma (1978). On the computational complexity of integer programming problems. In *Optimization and Operations Research*, pp. 161–172. Springer.
- Kara, Y., Y. Atasagun, H. Gökçen, S. Hezer, and N. Demirel (2014). An integrated model to incorporate ergonomics and resource restrictions into assembly line balancing. *International Journal of Computer Integrated Manufacturing* 27(11), 997–1007.

- Kara, Y., U. Ozcan, and A. Peker (2007). An approach for balancing and sequencing mixed-model JIT U-lines. *The International Journal of Advanced Manufacturing Technology* 32(11), 1218–1231.
- Kolus, A., R. Wells, and W. P. Neumann (2018). Production quality and human factors engineering: A systematic review and theoretical framework. *Applied Ergonomics* 73, 55 – 89.
- Konz, S. (2000). Work/rest part II: The scientific basis (knowledge base) for the guide. In A. Mital, A. Kilbom, and S. Kumar (Eds.), *Ergonomics Guidelines and Problem Solving*, Volume 1, pp. 401 – 427. Elsevier.
- Krüger, J., T. Lien, and A. Verl (2009). Cooperation of human and machines in assembly lines. *CIRP Annals* 58(2), 628 – 646.
- Lapierre, S. D., A. Ruiz, and P. Soriano (2006). Balancing assembly lines with tabu search. *European Journal of Operational Research* 168(3), 826 – 837.
- Laring, J., M. Forsman, R. Kadefors, and R. Örtengren (2002). Mtm-based ergonomic workload analysis. *International Journal of Industrial Ergonomics* 30(3), 135 – 148.
- Lei, D. and X. Guo (2016). Variable neighborhood search for the second type of two-sided assembly line balancing problem. *Computers & Operations Research* 72, 183 – 188.
- Leu, Y.-Y., L. A. Matheson, and L. P. Rees (1994). Assembly line balancing using genetic algorithms with heuristic-generated initial populations and multiple evaluation criteria. *Decision Sciences* 25(4), 581–605.
- Levitin, G., J. Rubinovitz, and B. Shnits (2006). A genetic algorithm for robotic assembly line balancing. *European Journal of Operational Research* 168(3), 811 – 825.
- Lin, L., C. Drury, and S.-W. Kim (2001). Ergonomics and quality in paced assembly lines. *Human Factors and Ergonomics in Manufacturing & Service Industries* 11(4), 377–382.
- Liu, B., L. Ma, C. Chen, and Z. Zhang (2018). Experimental validation of a subject-specific maximum endurance time model. *Ergonomics* 61(6), 806–817.
- Liu, J. Z., R. W. Brown, and G. H. Yue (2002). A dynamical model of muscle activation, fatigue, and recovery. *Biophysical journal* 82(5), 2344–2359.
- Lourenço, H. R., O. C. Martin, and T. Stützle (2003). Iterated local search. In F. Glover and G. A. Kochenberger (Eds.), *Handbook of Metaheuristics*, pp. 320–353. Boston, MA: Springer US.

- Ma, L. (2009). *Contribution for the ergonomic analysis using virtual human*. Ph. D. thesis, Ecole Centrale de Nantes, France.
- Ma, L., D. Chablat, F. Bennis, and W. Zhang (2009). A new simple dynamic muscle fatigue model and its validation. *International Journal of Industrial Ergonomics* 39(1), 211 – 220.
- Ma, L., D. Chablat, F. Bennis, W. Zhang, and F. Guillaume (2010). A new muscle fatigue and recovery model and its ergonomics application in human simulation. *Virtual and Physical Prototyping* 5(3), 123–137.
- Ma, L., D. Chablat, F. Bennis, W. Zhang, B. Hu, and F. Guillaume (2011a). Fatigue evaluation in maintenance and assembly operations by digital human simulation in virtual environment. *Virtual Reality* 15(1), 55–68.
- Ma, L., D. Chablat, F. Bennis, W. Zhang, B. Hu, and F. Guillaume (2011b). Fatigue evaluation in maintenance and assembly operations by digital human simulation in virtual environment. *Virtual Reality* 15(1), 55–68.
- Ma, L., D. Chablat, F. Bennis, W. Zhang, B. Hu, and F. Guillaume (2011c). A novel approach for determining fatigue resistances of different muscle groups in static cases. *International Journal of Industrial Ergonomics* 41(1), 10 – 18.
- Ma, L., W. Zhang, D. Chablat, F. Bennis, and F. Guillaume (2009). Multi-objective optimisation method for posture prediction and analysis with consideration of fatigue effect and its application case. *Computers & Industrial Engineering* 57(4), 1235–1246.
- Ma, L., W. Zhang, S. Wu, and Z. Zhang (2015). A new simple local muscle recovery model and its theoretical and experimental validation. *International Journal of Occupational Safety and Ergonomics* 21(1), 86–93.
- Ma, R. (2012). *Modélisation de la fatigue musculaire dynamique et son application pour l'analyse ergonomique*. Ph. D. thesis, Ecole Centrale de Nantes, France. (In French).
- Maccini, M. (2017). Bilanciamento e re-layout di una linea di assemblaggio manuale: il caso berti macchine agricole s.p.a. Master's thesis, Università Degli Studi Di Padova, Italy. (In Italian).
- Marler, R. and J. Arora (2004). Survey of multi-objective optimization methods for engineering. *Structural and Multidisciplinary Optimization* 26(6), 369–395.
- Mattsson, S., Åsa Fast-Berglund, D. Li, and P. Thorvald (2018). Forming a cognitive automation strategy for operator 4.0 in complex assembly. *Computers & Industrial Engineering*, 105360. (In press).

- McAtamney, L. and E. N. Corlett (1993). Rula: a survey method for the investigation of work-related upper limb disorders. *Applied ergonomics* 24(2), 91–99.
- Merengo, C., F. Nava, and A. Pozzetti (1999). Balancing and sequencing manual mixed-model assembly lines. *International Journal of Production Research* 37(12), 2835–2860.
- Metropolis, N., A. W. Rosenbluth, M. N. Rosenbluth, A. H. Teller, and E. Teller (1953). Equation of state calculations by fast computing machines. *The Journal of Chemical Physics* 21(6), 1087–1092.
- Miettinen, K. (2012). *Nonlinear multiobjective optimization*, Volume 12. Springer Science & Business Media.
- Miller, J. M. and G. Stockman (1990). Precedence constraints and tasks: how many task orderings? In *IEEE International Conference on Systems Engineering*, pp. 408–411. IEEE.
- Milner, N. (1986). Modelling fatigue and recovery in static postural exercise. *Clinical Biomechanics* 1(1), 29.
- Morrison, D. R., E. C. Sewell, and S. H. Jacobson (2014). An application of the branch, bound, and remember algorithm to a new simple assembly line balancing dataset. *European Journal of Operational Research* 236(2), 403 – 409.
- Moussavi, S., M. Mahdjoub, and O. Grunder (2016). Reducing production cycle time by ergonomic workforce scheduling. *IFAC-PapersOnLine* 49(12), 419–424. 8th IFAC Conference on Manufacturing Modelling, Management and Control MIM 2016.
- Nearchou, A. C. (2008). Multi-objective balancing of assembly lines by population heuristics. *International Journal of Production Research* 46(8), 2275–2297.
- Neumann, W. P. and J. Dul (2010). Human factors: spanning the gap between OM and HRM. *International Journal of Operations & Production Management* 30(9), 923–950.
- Neumann, W. P., A. Kolus, and R. W. Wells (2016). Human factors in production system design and quality performance – a systematic review. *IFAC-PapersOnLine* 49(12), 1721 – 1724. 8th IFAC Conference on Manufacturing Modelling, Management and Control MIM 2016.
- Neumann, W. P., J. Winkel, L. Medbo, R. Magneberg, and S. E. Mathiassen (2006). Production system design elements influencing productivity and ergonomics: A case study of parallel and serial flow strategies. *International journal of operations & production management* 26(8), 904–923.

- Norman, R., R. Wells, W. P. Neumann, J. Frank, H. Shannon, and M. Kerr (1998). A comparison of peak vs cumulative physical work exposure risk factors for the reporting of low back pain in the automotive industry. *Clinical Biomechanics* 13(8), 561 – 573.
- Nourie, F. J. and E. R. Venta (1991). Finding optimal line balances with OptPack. *Operations Research Letters* 10(3), 165 – 171.
- Occhipinti, E. (1998). OCRA: a concise index for the assessment of exposure to repetitive movements of the upper limbs. *Ergonomics* 41(9), 1290–1311.
- Oesterle, J. and A. Lionel (2018). Evaluation of the influence of dominance rules for the assembly line design problem under consideration of product design alternatives. *Engineering Optimization* 50(6), 982–995.
- Öncü Hazir, X. Delorme, and A. Dolgui (2015). A review of cost and profit oriented line design and balancing problems and solution approaches. *Annual Reviews in Control* 40, 14 – 24.
- Orlitzky, M., F. L. Schmidt, and S. L. Rynes (2003). Corporate social and financial performance: A meta-analysis. *Organization Studies* 24(3), 403–441.
- Otto, A. (2012). *Application of operational research methods for ergonomic design of working places at assembly lines*. Pro Business.
- Otto, A. and O. Battaïa (2017). Reducing physical ergonomic risks at assembly lines by line balancing and job rotation: A survey. *Computers & Industrial Engineering* 111, 467 – 480.
- Otto, A., C. Otto, and A. Scholl (2013). Systematic data generation and test design for solution algorithms on the example of SALBPGen for assembly line balancing. *European Journal of Operational Research* 228(1), 33 – 45.
- Otto, A. and A. Scholl (2011). Incorporating ergonomic risks into assembly line balancing. *European Journal of Operational Research* 212(2), 277 – 286.
- Özcan, U. and B. Toklu (2008). A tabu search algorithm for two-sided assembly line balancing. *The International Journal of Advanced Manufacturing Technology* 43(7), 822.
- Özcan, U. and B. Toklu (2009). Balancing of mixed-model two-sided assembly lines. *Computers & Industrial Engineering* 57(1), 217 – 227.
- Özcan Mutlu and E. Özgörmüş (2012). A fuzzy assembly line balancing problem with physical workload constraints. *International Journal of Production Research* 50(18), 5281–5291.

- Parent-Thirion, A., I. Biletta, J. Cabrita, O. Vargas, G. Vermeylen, A. Wilczynska, and M. Wilkens (2016). *Sixth European Working Conditions Survey- Overview Report*. Eurofound (European Foundation for the Improvement of Living and Working).
- Pasquale, V. D., S. Miranda, W. P. Neumann, and A. Setayesh (2018). Human reliability in manual assembly systems: a systematic literature review. *IFAC-PapersOnLine* 51(11), 675 – 680. 16th IFAC Symposium on Information Control Problems in Manufacturing INCOM 2018.
- Pekin, N. and M. Azizoglu (2008). Bi criteria flexible assembly line design problem with equipment decisions. *International Journal of Production Research* 46(22), 6323–6343.
- Perez, J., M. de Looze, T. Bosch, and W. P. Neumann (2014). Discrete event simulation as an ergonomic tool to predict workload exposures during systems design. *International Journal of Industrial Ergonomics* 44(2), 298 – 306.
- Pinnoi, A. and W. Wilhelm (1997). A family of hierarchical models for the design of deterministic assembly systems. *International Journal of Production Research* 35(1), 253–280.
- Pinnoi, A. and W. E. Wilhelm (1998). Assembly system design: A branch and cut approach. *Management Science* 44(1), 103–118.
- Pintzos, G., C. Triantafyllou, N. Papakostas, D. Mourtzis, and G. Chryssolouris (2016). Assembly precedence diagram generation through assembly tiers determination. *International Journal of Computer Integrated Manufacturing* 29(10), 1045–1057.
- Polat, O., C. B. Kalayci, Özcan Mutlu, and S. M. Gupta (2016). A two-phase variable neighbourhood search algorithm for assembly line worker assignment and balancing problem type-II: an industrial case study. *International Journal of Production Research* 54(3), 722–741.
- Ponnambalam, S., P. Aravindan, and G. M. Naidu (2000). A multi-objective genetic algorithm for solving assembly line balancing problem. *The International Journal of Advanced Manufacturing Technology* 16(5), 341–352.
- Price, A. (1990). Calculating relaxation allowances for construction operatives part 2: Local muscle fatigue. *Applied Ergonomics* 21(4), 318 – 324.
- Rachamadugu, R. and B. Talbot (1991). Improving the equality of workload assignments in assembly lines. *International Journal of Production Research* 29(3), 619–633.

- Radwin, R. G., T. J. Armstrong, and E. Vanbergeijk (1990). Vibration exposure for selected power hand tools used in automobile assembly. *American Industrial Hygiene Association journal* 51(9), 510–518.
- Raouf, A. and C. Tsui (1982). A new method for assembly line balancing having stochastic work elements. *Computers & Industrial Engineering* 6(2), 131 – 148.
- Rekiek, B. and A. Delchambre (2006). *Assembly line design: the balancing of mixed-model hybrid assembly lines with genetic algorithms*. Springer Science & Business Media.
- Rekiek, B., A. Delchambre, A. Dolgui, and A. Bratcu (2002). Assembly line design: a survey. *IFAC Proceedings Volumes* 35(1), 155 – 166. 15th IFAC World Congress.
- Rekiek, B., P. D. Lit, and A. Delchambre (2002). Hybrid assembly line design and user's preferences. *International Journal of Production Research* 40(5), 1095–1111.
- Rekiek, B., P. D. Lit, F. Pellichero, E. Falkenauer, and A. Delchambre (1999). Applying the equal piles problem to balance assembly lines. In *IEEE International Symposium on Assembly and Task Planning*, pp. 399–404.
- Rodgers, S. H. (2004). Muscle fatigue assessment: functional job analysis technique. In *Handbook of human factors and ergonomics methods*, pp. 130–141. CRC Press.
- Rohmert, W. (1973). Problems in determining rest allowances: part 1: use of modern methods to evaluate stress and strain in static muscular work. *Applied ergonomics* 4(2), 91–95.
- Romero, D., P. Bernus, O. Noran, J. Stahre, and Å. Fast-Berglund (2016). The operator 4.0: Human cyber-physical systems & adaptive automation towards human-automation symbiosis work systems. In I. Nääs, O. Vendrametto, J. Mendes Reis, R. F. Gonçalves, M. T. Silva, G. von Cieminski, and D. Kiritsis (Eds.), *Advances in Production Management Systems. Initiatives for a Sustainable World*, pp. 677–686. Springer International Publishing.
- Rose, L., W. P. Neumann, G. Hägg, and G. Kenttä (2014). Fatigue and recovery during and after static loading. *Ergonomics* 57, 1–15.
- Rose, L. M., C. A. Beauchemin, and W. P. Neumann (2018). Modelling endurance and resumption times for repetitive one-hand pushing. *Ergonomics* 61(7), 891–901.
- Rose, L. M., U. E. Orrenius, and W. P. Neumann (2013). Work environment and the bottom line: Survey of tools relating work environment to business results. *Human Factors and Ergonomics in Manufacturing & Service Industries* 23(5), 368–381.

- Rosecrance, J., R. Paulsen, and L. Murgia (2017). Risk assessment of cheese processing tasks using the strain index and OCRA checklist. *International Journal of Industrial Ergonomics* 61, 142 – 148.
- Rubinovitz, J., J. Bukchin, and E. Lenz (1993). RALB - a heuristic algorithm for design and balancing of robotic assembly lines. *CIRP annals* 42(1), 497–500.
- Salah, S., A. Rahim, and J. A. Carretero (2010). The integration of six sigma and lean management. *International Journal of Lean Six Sigma* 1(3), 249–274.
- Salveson, M. E. (1955). The assembly line balancing problem. *The Journal of Industrial Engineering* 6, 18–25.
- Savino, M. M., C. Riccio, and M. Menanno (2019). Empirical study to explore the impact of ergonomics on workforce scheduling. *International Journal of Production Research*. 19 pages. (In press).
- Scholl, A. (1999). *Balancing and Sequencing of Assembly Lines*. Contributions to Management Science. Physica-Verlag HD.
- Scholl, A. and C. Becker (2006). State-of-the-art exact and heuristic solution procedures for simple assembly line balancing. *European Journal of Operational Research* 168(3), 666 – 693.
- Scholl, A. and R. Klein (1997). SALOME: A bidirectional branch-and-bound procedure for assembly line balancing. *INFORMS Journal on Computing* 9(4), 319–334.
- Scholl, A. and S. Voß (1997). Simple assembly line balancing - heuristic approaches. *Journal of Heuristics* 2(3), 217–244.
- Sewell, E. C. and S. H. Jacobson (2012). A Branch, Bound, and Remember Algorithm for the Simple Assembly Line Balancing Problem. *INFORMS Journal on Computing* 24(3), 433–442.
- Snook, S. H. and V. M. Ciriello (1991). The design of manual handling tasks: revised tables of maximum acceptable weights and forces. *Ergonomics* 34(9), 1197–1213.
- Sonne, M. W. and J. R. Potvin (2015). Fatigue accumulation and twitch potentiation during complex mvic-relative profiles. *Journal of Electromyography and Kinesiology* 25(4), 658 – 666.
- Sotskov, Y. N., A. Dolgui, and M.-C. Portmann (2006). Stability analysis of an optimal balance for an assembly line with fixed cycle time. *European Journal of Operational Research* 168(3), 783 – 797.

- Steven Moore, J. and A. Garg (1995). The strain index: a proposed method to analyze jobs for risk of distal upper extremity disorders. *American Industrial Hygiene Association Journal* 56(5), 443–458.
- Stützle, T. and R. Ruiz (2017). Iterated local search. In R. Martí, P. Panos, and M. G. C. Resende (Eds.), *Handbook of Heuristics*, pp. 1–27. Springer International Publishing.
- Tapkan, P., L. Özbakır, and A. Baykasoğlu (2012). Bees algorithm for constrained fuzzy multi-objective two-sided assembly line balancing problem. *Optimization Letters* 6(6), 1039–1049.
- Tawarmalani, M., N. V. Sahinidis, and N. Sahinidis (2002). *Convexification and global optimization in continuous and mixed-integer nonlinear programming: theory, algorithms, software, and applications*, Volume 65. Springer Science & Business Media.
- Taylor, F. W. (1911). *The Principles of Scientific Management*. Harper & Brothers.
- Thun, J., A. Großler, and S. Miczka (2007). The impact of the demographic transition on manufacturing: Effects of an ageing workforce in german industrial firms. *Journal of Manufacturing Technology Management* 18(8), 985–999.
- Thun, J.-H., C. B. Lehr, and M. Bierwirth (2011). Feel free to feel comfortable – An empirical analysis of ergonomics in the german automotive industry. *International Journal of Production Economics* 133(2), 551 – 561.
- Tiacci, L. and M. Mimmi (2018). Integrating ergonomic risks evaluation through OCRA index and balancing/sequencing decisions for mixed model stochastic asynchronous assembly lines. *Omega* 78, 112 – 138.
- Toksarı, M. D., S. K. İşleyen, E. Güner, Baykoç, and Ö. Faruk (2008). Simple and U-type assembly line balancing problems with a learning effect. *Applied Mathematical Modelling* 32(12), 2954 – 2961.
- Toksarı, M. D., S. K. İşleyen, E. Güner, Baykoç, and Ö. Faruk (2010). Assembly line balancing problem with deterioration tasks and learning effect. *Expert Systems with Applications* 37(2), 1223 – 1228.
- Troiano, A., F. Naddeo, E. Sosso, G. Camarota, R. Merletti, and L. Mesin (2008). Assessment of force and fatigue in isometric contractions of the upper trapezius muscle by surface EMG signal and perceived exertion scale. *Gait & posture* 28(2), 179–186.
- Van Hentenryck, P. and L. Michel (2005). *Constraint-Based Local Search*. MIT Press.

- Vøllestad, N. K. (1997). Measurement of human muscle fatigue. *Journal of Neuroscience Methods* 74(2), 219 – 227.
- Walsh, J., K. Weber, and J. Margolis (2003). Social issues and management: Our lost cause found. *Journal of Management* 29(6), 859–881.
- Waters, T. R., V. Putz-Anderson, A. Garg, and L. J. Fine (1993). Revised NIOSH equation for the design and evaluation of manual lifting tasks. *Ergonomics* 36(7), 749–776.
- Wee, T. and M. Magazine (1982). Assembly line balancing as generalized bin packing. *Operations Research Letters* 1(2), 56 – 58.
- Wexler, A. S., J. Ding, and S. A. Binder-Macleod (1997). A mathematical model that predicts skeletal muscle force. *IEEE transactions on biomedical engineering* 44(5), 337–348.
- Wilhelm, W. E. and R. Gadidov (2004). A branch-and-cut approach for a generic multiple-product, assembly-system design problem. *INFORMS Journal on Computing* 16(1), 39–55.
- Williams, H. P. (2013). *Model building in mathematical programming*. John Wiley & Sons.
- Womack, J. and D. Jones (1996). *Lean thinking: banish waste and create wealth in your corporation*. Lean Enterprise Institute. Simon & Schuster.
- Womack, J., D. Jones, and D. Roos (2007). *The Machine That Changed the World: The Story of Lean Production– Toyota’s Secret Weapon in the Global Car Wars That Is Now Revolutionizing World Industry*. Free Press.
- Wood, D. D., D. L. Fisher, and R. O. Andres (1997). Minimizing fatigue during repetitive jobs: Optimal work-rest schedules. *Human Factors* 39(1), 83–101.
- Xia, T. and L. A. F. Law (2008). A theoretical approach for modeling peripheral muscle fatigue and recovery. *Journal of biomechanics* 41(14), 3046–3052.
- Xu, Z., J. Ko, D. J. Cochran, and M.-C. Jung (2012). Design of assembly lines with the concurrent consideration of productivity and upper extremity musculoskeletal disorders using linear models. *Computers & Industrial Engineering* 62(2), 431 – 441.
- Yung, M., A. Kolus, R. Wells, and W. P. Neumann (2020). Examining the fatigue-quality relationship in manufacturing. *Applied ergonomics* 82, 102919.
- Zandin, K. B. (2002). *MOST work measurement systems*. CRC press.

-
- Zhang, Z., K. W. Li, W. Zhang, L. Ma, and Z. Chen (2014). Muscular fatigue and maximum endurance time assessment for male and female industrial workers. *International Journal of Industrial Ergonomics* 44(2), 292 – 297.
- Zink, K. J. and K. Fischer (2013). Do we need sustainability as a new approach in human factors and ergonomics? *Ergonomics* 56(3), 348–356.
- Zitzler, E. and L. Thiele (1999). Multiobjective evolutionary algorithms: a comparative case study and the strength pareto approach. *IEEE transactions on Evolutionary Computation* 3(4), 257–271.

Annex A: Publication

- Finco, S., M.-A., Abdous, M., Calzavara, D. Battini, X. Delorme (2020). A bi-objective model to include workers' vibration exposure in assembly line design. International Journal of Production Research. 16 pages, In Press.
- Abdous, M.-A., X. Delorme, D. Battini, F. Sgarbossa, and S. Berger-Douce. Assembly line balancing problem with consideration of workers fatigue and recovery. **Under preparation to submit to Computers & Industrial Engineering.**
- Abdous, M.-A., X. Delorme, D. Battini, and S. Berger-Douce. Multi-objective design of assembly lines with ergonomics and cost. **Under preparation to submit to International Journal of Production Research.**
- Finco, S., M.-A. Abdous, D. Battini, M. Calzavara, and X. Delorme (2019). Assembly line design with tools vibration. To appear in IFAC-PapersOnLine. 6 pages, 9th IFAC Conference on Manufacturing Modelling, Management and Control, MIM 2019. Berlin, Germany. **Awarded with the IFAC “Young Author Award”, and selected for the Special Issue “MIM conference” of International Journal of Production Research.**
- Abdous M.-A., X. Delorme, D. Battini, S. Berger-Douce (2019). Ergonomics in the assembly line design problem. 20ème Congrès annuel de la société française de Recherche Opérationnelle et d'Aide à la Décision - ROADEF. Le Havre, France.
- Cerqueus A., X. Delorme, M.-A. Abdous (2019). Branch-and-bound bi-objectif pour l'équilibrage de ligne d'assemblage intégrant la fatigue des opérateurs. 20ème Congrès annuel de la société française de Recherche Opérationnelle et d'Aide à la Décision - ROADEF. Le Havre, France.
- Abdous, M.-A., S. Berger-Douce, X. Delorme (2018). Intégrer l'ergonomie dans la conception des systèmes de production: outil d'aide à la décision. 13ème Congrès du RIODD, 15 pages. Grenoble, France.
- Abdous, M.-A., Finco S., and Visentin V. (2018). Workload evaluation of industrial work: existing methods and practical applications. In XXIII Summer

School Francesco Turco – Industrial Systems Engineering. 7 pages. Palermo, Italy.

- Abdous, M.-A., X. Delorme, D. Battini, F. Sgarbossa, and S. Berger-Douce (2018). Multi-objective optimization of assembly lines with workers fatigue consideration. *IFAC-PapersOnLine* 51(11), 698–703. 16th IFAC Symposium on Information Control Problems in Manufacturing INCOM 2018. Bergamo, Italy.
- Abdous, M.-A., X. Delorme, D. Battini, F. Sgarbossa, and S. Berger-Douce (2018). Assembly line balancing problem with consideration of workers fatigue and recovery. 20th International Working Seminar on Production Economics - IWSPE 51 (11). 12 pages. Innsbruck, Autriche.

Annex B

This appendix presents the detailed results of numerical experiments in [Chapter 3](#). In tables, the name of instances is accompanied by the number of operations n . For each line, we present averages of 4 instances with four different operations load. We represent the average percentage of Gap (%) values for the different algorithms – similarly, the average computation times values in seconds [s]. The caption resumes the parameters like the value of the adjusted takt time and the percentage of the transfer time TT .

Table B1: Average results of Scholl instances (Minimal adjusted takt time, $TT = 0\%$)

Instance	n	Gap (%)					Time [s]					IDS(ILS)	IDS(SALBP)	IDS(ILS)
		SALBP	Fmax	Idle	ILS	IDS(SALBP)	IDS(ILS)	SALBP	Fmax	Idle	ILS			
Arcus1	83	93.79	86.83	67.09	17.23	69.21	15.00	4.72	1804.45	15.40	26.41	4026.59	4071.92	
Arcus2	111	95.12	94.78	92.75	54.49	6.99	9.14	4.05	3.44	1.34	16.42	5116.80	3409.78	
Barthold	148	6.09	7.94	6.81	0.00	0.00	0.00	0.90	3.74	581.06	25.39	4.30	25.39	
Bowman	8	0.00	0.00	0.00	0.00	0.00	0.00	0.02	0.02	0.03	0.92	0.05	0.93	
Buxey	29	2.13	0.00	2.50	0.00	0.00	0.00	0.04	2.66	2.65	3.55	11.16	9.79	
Gunther	35	12.75	2.72	5.95	0.00	0.00	0.00	0.04	3.26	3.16	16.62	9.93	16.62	
Hahn	53	0.00	0.00	0.00	0.00	0.00	0.00	0.03	0.31	1.07	14.05	0.03	14.05	
Heskiaoff	28	26.53	17.45	19.40	3.83	0.00	0.00	0.02	1.53	2.00	14.95	123.10	255.31	
Jackson	11	0.01	0.86	0.04	0.00	0.00	0.00	0.00	0.00	0.00	6.80	0.00	6.80	
Jaeschke	9	0.00	0.00	0.38	0.00	0.00	0.00	0.00	0.00	0.00	1.07	0.00	1.07	
Kilbridge	45	10.71	3.71	9.63	1.72	0.96	2.08	0.13	25.09	1.15	10.45	1846.55	1961.53	
Lutz1	32	0.00	0.00	0.00	0.00	0.00	0.00	0.25	0.58	0.76	17.41	0.25	17.41	
Lutz3	89	14.41	22.78	14.22	2.96	0.00	0.00	6.63	12.47	11.71	30.25	282.66	427.78	
Mansoor	11	0.49	0.00	0.51	0.00	0.00	0.00	0.00	0.00	0.00	7.24	0.10	7.65	
Mertens	7	0.09	0.00	0.00	0.00	0.00	0.00	0.00	0.00	0.00	8.66	0.01	8.66	
Mitchell	21	0.62	0.00	0.01	0.00	0.00	0.00	0.01	0.02	0.01	3.64	0.06	3.82	
Mukherje	94	14.56	14.56	12.30	1.39	0.02	0.00	1.42	127.41	81.42	32.57	1477.76	764.39	
Roszieg	25	0.69	0.03	0.63	0.00	0.00	0.00	3.27	3.54	3.25	10.21	22.38	36.87	
Sawyer	30	5.74	0.13	4.19	0.22	0.00	0.00	4.36	8.66	9.80	12.19	100.13	79.97	
Tonge	70	25.39	20.10	26.60	8.62	1.68	1.79	4.90	10.02	3614.89	51.70	980.28	1172.86	
Wee-Mag	58	0.39	0.00	0.40	0.00	0.00	0.00	2.02	6.13	1335.18	35.83	14.83	35.83	

Table B2: Average results of Scholl instances (Minimal adjusted takt time, $TT = 5\%$)

Instance	n	Gap (%)					Time [s]					IDS(ILS)	
		SALBP	Fmax	Idle	ILS	IDS(SALBP)	IDS(ILS)	SALBP	Fmax	Idle	ILS		IDS(SALBP)
Arcus1	83	3.05	2.39	2.50	1.55	1.40	0.87	9.16	1808.24	17.71	23.73	5399.18	5108.26
Arcus2	111	0.52	0.50	0.51	0.32	0.13	0.20	10.42	7.25	1.68	18.80	4747.67	3411.72
Barthold	148	1.92	8.48	3.00	0.00	0.00	0.00	0.40	2.88	17.22	36.62	4.08	36.62
Bowman	8	0.00	0.00	0.00	0.00	0.00	0.00	0.01	0.02	0.02	3.59	0.03	3.63
Buxey	29	2.09	0.00	0.73	0.00	0.00	0.00	0.02	1.57	1.38	5.78	8.35	11.61
Gunther	35	12.22	2.61	9.04	0.00	0.00	0.00	0.04	1.81	2.53	14.23	6.28	14.23
Hahn	53	0.00	0.00	0.00	0.00	0.00	0.00	0.02	1.01	2.12	13.81	0.02	13.81
Heskiaoff	28	22.61	14.88	17.86	3.27	0.00	0.00	0.02	1.77	3.42	11.06	105.04	229.52
Jackson	11	0.01	0.86	0.04	0.00	0.00	0.00	0.00	0.00	0.00	0.68	0.01	0.68
Jaeschke	9	0.00	0.00	0.38	0.00	0.00	0.00	0.00	0.01	0.00	7.34	0.00	7.34
Kilbridge	45	10.20	20.43	11.79	1.88	0.44	2.12	0.02	13.70	1.60	128.71	2540.73	2097.18
Lutz1	32	0.00	0.00	0.00	0.00	0.00	0.00	0.34	0.70	1.07	6.35	0.34	6.35
Lutz3	89	13.30	21.11	10.89	2.00	0.00	0.00	6.05	10.74	5.43	25.54	250.33	287.55
Mansoor	11	0.47	0.00	0.49	0.00	0.00	0.00	0.01	0.01	0.01	2.76	0.15	3.03
Mertens	7	0.09	0.00	0.00	0.00	0.00	0.00	0.00	0.00	0.00	2.37	0.00	2.37
Mitchell	21	0.62	0.00	0.01	0.00	0.00	0.00	0.02	0.02	0.01	2.58	0.09	2.67
Mukherje	94	11.00	11.00	6.78	0.04	3.68	0.04	0.63	53.17	87.94	29.47	901.82	1082.44
Roszieg	25	0.69	0.03	0.63	0.03	0.00	0.00	1.18	1.57	1.26	2.08	9.19	7.91
Sawyer	30	5.63	0.13	4.61	0.21	0.00	0.00	0.62	1.70	1.94	8.83	23.21	51.15
Tonge	70	19.24	15.23	18.79	7.62	1.48	1.73	3.70	5.42	1243.24	24.00	967.64	947.84
Wee-Mag	58	0.3825	0.00	0.61	0.00	0.00	0.00	0.68	1.55	110.16	22.87	2.94	22.87

Table B3: Average results of Scholl instances (Median adjusted takt time, $TT = 0\%$)

Instance	n	Gap						Time [s]					
		SALBP	Fmax	Idle	ILS	IDS(SALBP)	IDS(ILS)	SALBP	Fmax	Idle	ILS	IDS(SALBP)	IDS(ILS)
Arcus1	83	48.10	61.16	0.06	4.03	0.16	0.04	0.45	296.61	3600.17	37.90	4236.46	4629.77
Arcus2	111	73.64	85.56	79.40	5.56	14.38	2.71	0.77	817.15	3601.48	46.17	3964.98	4043.89
Barthold	148	80.91	44.37	71.71	38.56	32.13	19.89	5.21	3605.76	7.32	58.59	6301.68	5469.19
Bowman	8	1.27	0.00	1.27	0.00	0.00	0.00	0.03	0.03	0.03	2.89	0.38	3.02
Buxey	29	4.95	0.20	5.77	0.00	0.00	0.00	0.03	1.81	2.23	8.83	21.90	33.68
Gunther	35	7.04	8.85	5.19	0.85	0.00	0.00	0.02	0.72	0.92	13.13	13.31	70.00
Hahn	53	0.00	0.00	0.00	0.00	0.00	0.00	0.13	0.10	0.24	4.09	39.60	71.71
Heskiaoff	28	55.10	25.96	24.64	4.51	0.00	0.00	0.01	1.26	1.31	5.81	55.15	89.98
Jackson	11	0.73	0.19	0.19	0.00	0.00	0.00	0.00	0.01	0.00	4.13	0.07	4.39
Jaeschke	9	0.74	0.68	0.35	0.00	0.00	0.00	0.02	0.02	0.02	2.53	0.06	2.53
Kilbridge	45	8.49	0.05	11.93	0.61	0.00	0.00	1.29	4.68	1.44	8.17	29.24	50.10
Lutz1	32	0.00	0.00	0.00	0.00	0.00	0.00	1.78	2.18	2.37	4.32	154.42	181.39
Lutz3	89	16.03	2.46	15.53	2.33	0.00	0.00	1.57	3.80	2.75	14.57	107.59	207.95
Mansoor	11	0.00	0.00	0.00	0.00	0.00	0.00	0.00	0.00	0.00	1.07	0.11	1.24
Mertens	7	0.00	0.03	0.56	0.00	0.00	0.00	0.00	0.68	0.01	2.58	2.71	7.74
Mitchell	21	1.88	0.00	0.31	0.00	0.00	0.00	0.00	0.02	0.00	3.20	0.09	3.52
Mukherje	94	44.68	18.33	40.47	24.10	5.71	22.92	4.70	2650.32	15.62	77.03	5386.18	4735.99
Roszieg	25	1.15	0.85	0.79	0.00	0.00	0.00	0.00	2.02	0.01	6.26	6.58	19.05
Sawyer	30	1.48	0.00	1.48	0.00	0.00	0.00	0.75	2.27	0.68	7.00	48.91	79.63
Tonge	70	70.30	57.78	55.70	55.45	72.77	55.45	1.25	7.19	2846.69	25.09	3602.36	3918.61
Wee-Mag	58	0.00	0.08	3.41	0.00	0.00	0.00	0.87	2.40	37.05	27.36	0.87	27.36

Table B4: Average results of Scholl instances (Median adjusted takt time, $TT = 5\%$)

Instance	n	Gap (%)			Time [s]			IDS(ILS)	IDS(SALBP)	IDS(ILS)			
		SALBP	Fmax	Idle	ILS	Fmax	Idle				ILS		
Arcus1	83	0.32	0.42	0.00	0.03	0.00	0.00	0.27	231.88	3600.22	39.48	219.10	109.46
Arcus2	111	0.11	0.13	0.00	0.00	0.02	0.00	0.49	905.12	3606.14	61.63	2745.67	97.29
Barthold	148	6.26	4.95	5.86	2.84	7.31	2.48	5.56	3602.71	3.67	66.39	4483.44	5384.33
Bowman	8	1.25	0.00	1.25	0.00	0.00	0.00	0.00	0.00	0.00	5.96	0.04	6.21
Buxey	29	4.85	0.20	5.69	0.00	0.00	0.00	0.02	1.15	2.40	15.92	16.50	75.64
Gunther	35	6.73	8.47	6.35	0.81	0.00	0.00	0.10	2.23	1.86	15.55	20.07	74.43
Hahn	53	0.00	0.00	0.00	0.00	0.00	0.00	0.09	0.04	0.06	1.04	46.94	48.94
Heskiaoff	28	40.25	18.95	15.70	3.57	0.00	0.00	0.01	3.16	5.75	4.82	102.38	118.23
Jackson	11	0.73	0.19	0.19	0.00	0.00	0.00	0.00	0.00	0.00	2.45	0.05	2.61
Jaeschke	9	0.74	0.68	0.35	0.00	0.00	0.00	0.00	0.00	0.00	7.28	0.01	7.33
Kilbridge	45	7.86	0.05	9.48	0.05	0.00	0.00	1.61	5.11	0.97	17.91	53.11	114.60
Lutz1	32	0.00	0.00	0.00	0.00	0.00	0.00	4.90	7.93	5.72	3.59	321.38	140.98
Lutz3	89	13.20	2.03	11.13	1.76	0.00	0.00	2.50	3.41	2.61	17.41	126.18	204.97
Mansoor	11	0.00	0.00	0.00	0.00	0.00	0.00	0.00	0.00	0.00	7.17	0.07	7.54
Mertens	7	0.00	0.03	0.56	0.00	0.00	0.00	0.00	0.15	0.00	6.93	2.76	24.18
Mitchell	21	1.84	0.00	0.31	0.00	0.00	0.00	0.01	0.08	0.04	8.50	0.18	8.83
Mukherje	94	20.63	16.06	20.51	9.41	9.99	9.19	3.75	2641.36	12.97	55.15	4531.76	4242.00
Roszieg	25	1.12	0.83	0.77	0.00	0.00	0.00	0.00	0.37	0.00	13.95	3.86	45.10
Sawyer	30	1.45	0.00	0.85	0.00	0.00	0.00	0.40	1.63	0.73	9.13	44.21	98.20
Tonge	70	52.53	52.77	38.17	39.92	58.84	39.92	1.41	5.21	336.93	24.88	3602.30	3791.12
Wee-Mag	58	0.00	0.08	3.47	0.00	0.00	0.00	0.27	0.74	2.47	26.16	0.27	26.16

Table B5: Average results of Otto instances ($TT = 0\%$)

Instance	n	SALBP			Gap (%)			IDS(ILS)			Time [s]			IDS(SALBP)			IDS(ILS)
		Fmax	Idle	ILS	Fmax	Idle	ILS	Fmax	Idle	ILS	Fmax	Idle	ILS	Fmax	Idle	ILS	
Otto_n=20_1	20	36.84	46.98	0.00	0.00	0.00	0.00	0.00	0.00	0.00	0.86	1.37	0.55	24.40	15.19		
Otto_n=20_2	20	26.79	73.90	0.47	0.47	0.00	0.00	0.00	0.00	0.00	0.99	0.53	6.93	22.60	37.91		
Otto_n=20_8	20	73.33	63.77	18.23	7.17	0.00	0.00	0.00	0.00	0.00	0.60	0.94	0.50	17.93	14.43		
Otto_n=20_9	20	71.09	76.01	2.69	2.69	0.00	0.00	0.00	0.00	0.00	1.48	1.98	4.45	28.25	37.28		
Otto_n=20_12	20	34.10	54.70	0.50	0.12	0.00	0.00	0.00	0.00	0.00	1.61	2.30	4.26	26.34	37.05		
Otto_n=20_14	20	74.51	77.14	23.45	9.36	0.00	0.00	0.00	0.00	0.00	1.59	1.72	5.01	32.36	39.24		
Otto_n=20_17	20	42.30	48.33	0.00	0.00	0.00	0.00	0.00	0.00	0.00	3.82	1.63	4.11	895.85	1035.24		
Otto_n=20_39	20	3.86	18.25	24.08	0.00	0.00	0.00	0.00	0.00	0.00	1.96	1.97	1.21	3031.07	1205.33		
Otto_n=50_1	50	57.30	61.25	6.27	6.61	8.89	8.89	6.61	6.61	6.61	2945.07	464.65	33.87	3719.34	3764.72		
Otto_n=50_2	50	89.51	56.17	6.35	6.29	11.43	11.43	6.48	6.48	6.48	815.75	3.58	17.83	4733.09	4687.91		
Otto_n=50_7	50	93.19	93.82	27.75	29.74	40.73	40.73	33.01	33.01	33.01	175.50	7.30	28.05	3631.11	3893.81		
Otto_n=50_12	50	49.97	90.93	26.61	29.96	15.40	15.40	25.62	25.62	25.62	255.08	13.86	19.78	6928.29	7481.45		
Otto_n=50_22	50	92.96	85.62	22.57	22.03	35.19	35.19	22.15	22.15	22.15	132.90	162.51	19.74	3878.08	3937.26		
Otto_n=50_26	50	96.19	94.21	97.84	92.85	96.19	96.19	92.85	92.85	92.85	5.57	1736.47	30.80	3607.19	3633.49		
Otto_n=50_27	50	96.21	98.01	98.57	90.59	96.21	96.21	90.59	90.59	90.59	914.73	6.95	19.22	3602.89	3620.12		
Otto_n=50_54	50	87.06	84.42	33.97	42.91	54.59	54.59	48.70	48.70	48.70	3604.20	3600.35	35.49	3694.38	3654.32		
Otto_n=100_1	100	98.48	98.75	90.26	90.44	98.48	98.48	90.84	90.84	90.84	1.75	3609.51	3600.41	3629.19	3721.44		
Otto_n=100_2	100	97.77	97.63	45.50	62.19	98.36	98.36	62.19	62.19	62.19	1.40	2715.61	3602.13	3605.62	3694.73		
Otto_n=100_3	100	90.74	98.09	70.90	69.01	80.44	80.44	70.65	70.65	70.65	2.83	993.25	3604.28	3674.53	3709.95		
Otto_n=100_4	100	96.10	98.32	89.79	69.51	96.31	96.31	71.33	71.33	71.33	2.84	3023.11	3606.43	3620.84	4334.46		
Otto_n=100_5	100	98.30	98.73	60.82	51.22	73.75	73.75	57.15	57.15	57.15	3.60	3607.65	3604.02	3855.82	3682.70		
Otto_n=100_7	100	91.50	95.76	76.48	56.77	94.57	94.57	56.77	56.77	56.77	1.80	1834.52	3604.93	3612.89	3785.49		
Otto_n=100_20	100	91.37	95.52	57.60	48.81	93.59	93.59	48.81	48.81	48.81	2.30	2743.53	3607.95	3609.85	3928.74		
Otto_n=100_30	100	99.08	72.93	23.28	41.90	32.83	32.83	35.96	35.96	35.96	1.54	3601.88	3601.14	3843.83	3793.39		

Table B6: Average results of Otto instances ($TT = 5\%$)

Instance	n	Gap (%)				IDS(%)				Time [s]			
		SALBP	Fmax	Idle	ILS	SALBP	Fmax	Idle	ILS	SALBP	Fmax	Idle	ILS
Otto.n=20.1	20	9.75	14.82	0.00	0.00	0.00	0.01	2.00	2.36	0.53	28.00	13.44	
Otto.n=20.2	20	7.77	21.46	0.14	0.14	0.00	0.01	2.24	2.08	5.69	23.43	29.69	
Otto.n=20.8	20	4.89	4.20	1.13	0.45	0.00	0.00	0.85	0.64	5.57	19.26	33.20	
Otto.n=20.9	20	14.79	15.88	0.57	0.57	0.00	0.03	2.11	2.37	4.42	27.28	31.11	
Otto.n=20.12	20	6.70	12.35	0.10	0.03	0.00	0.00	0.82	0.87	4.57	22.54	30.35	
Otto.n=20.14	20	6.31	6.40	0.97	0.51	0.00	0.00	0.62	1.90	24.49	27.80	108.21	
Otto.n=20.17	20	10.87	12.33	0.00	0.00	0.00	0.00	2.50	2.26	20.12	784.24	1732.67	
Otto.n=20.39	20	0.47	2.03	2.31	0.00	0.00	0.04	2.26	2.15	15.94	2476.87	3200.20	
Otto.n=50.1	50	21.97	25.93	2.28	2.51	3.57	0.09	3055.49	21.71	48.73	4110.08	4375.51	
Otto.n=50.2	50	32.96	21.61	4.63	3.95	8.07	0.02	975.25	4.62	44.22	4437.27	5779.65	
Otto.n=50.7	50	23.82	24.05	9.01	9.74	15.52	0.09	220.03	15.12	41.53	4170.16	3912.54	
Otto.n=50.12	50	5.35	9.53	3.26	3.30	3.23	0.28	230.90	3.80	25.46	5181.82	5853.44	
Otto.n=50.22	50	24.06	22.31	6.92	7.94	16.40	0.13	130.40	11.74	53.76	4385.80	4371.28	
Otto.n=50.26	50	40.93	39.59	37.49	40.02	40.93	5.10	1739.42	3610.94	51.56	3607.83	3654.82	
Otto.n=50.27	50	40.74	41.50	41.74	36.40	40.74	2.73	916.21	7.56	32.12	3604.83	3635.35	
Otto.n=50.54	50	26.31	29.33	11.34	13.08	25.57	1.49	3594.75	3600.22	40.10	3746.24	3669.73	
Otto.n=100.1	100	30.66	30.72	30.74	28.35	30.66	10.26	3586.33	3601.08	104.81	3648.72	3719.03	
Otto.n=100.2	100	36.62	40.10	19.67	25.49	42.03	0.89	2709.20	3602.45	46.93	3604.30	3653.93	
Otto.n=100.3	100	33.75	35.98	23.65	25.20	36.41	3.22	990.25	3602.98	45.16	3640.15	3752.80	
Otto.n=100.4	100	35.84	34.74	31.01	29.31	41.81	3.28	3057.47	3602.48	38.32	3607.82	3955.00	
Otto.n=100.5	100	31.65	31.84	26.87	18.48	42.31	3.92	3623.42	3602.61	67.96	3606.65	3811.93	
Otto.n=100.7	100	32.41	43.61	20.07	21.58	40.37	1.33	1818.14	3601.85	53.41	3604.35	3820.25	
Otto.n=100.20	100	39.99	41.05	22.17	26.84	39.99	2.15	2757.05	3604.30	62.07	3606.75	3672.88	
Otto.n=100.30	100	35.12	26.41	10.95	14.21	11.78	2.11	3601.81	3602.14	44.90	4275.87	3974.15	

École Nationale Supérieure des Mines
de Saint-Étienne

NNT :

Mohammed-Amine ABDOUS

PROGETTAZIONE OTTIMALE DEI SISTEMI DI FABBRICAZIONE CON
ERGONOMIA: APPLICAZIONE ALLE LINEE DI MONTAGGIO

Specialità : Ingegneria industriale

Parole chiave : Ottimizzazione, progettazione e bilanciamento di linee di assemblaggio manuale, ergonomia, fatica e recupero, ottimizzazione multi-obiettivo, algoritmi di ottimizzazione, metaeuristica

Sommario :

Questa tesi contribuisce a valutare e integrare approcci ergonomici in fasi di progettazione di sistemi produttivi, in particolare linee di assemblaggio manuali. La scarsa ergonomia fisica nei sistemi di produzione comporta una produttività inferiore, una motivazione inferiore, infortuni e un aumento dei costi per le aziende. L'obiettivo principale di questo lavoro è la proposta di metodi di ottimizzazione per la progettazione di sistemi di produzione, con la considerazione congiunta di ergonomia, produttività e costi.

Questo lavoro si concentra sulla progettazione preliminare delle linee di assemblaggio. La sfida consiste nel fornire ai decisori metodi di ottimizzazione che tengano conto dell'ergonomia, soddisfacendo al contempo tutti i vincoli tecnologici ed economici. I problemi combinatori considerati sono i problemi di bilanciamento delle linee di assemblaggio e la selezione delle attrezzature. Abbiamo preso in considerazione un modello quantitativo di ergonomia basato sull'equazione della fatica e del recupero tratti dalla letteratura. Oltre alla natura combinatoria dei problemi affrontati, la principale difficoltà scientifica deriva dalla natura non lineare del modello ergonomico.

Metodi di linearizzazione sono stati proposti e si sono sviluppati approcci risolutivi ottimali ma anche euristici. Abbiamo anche proposto una generalizzazione dell'approccio, con un modello multi-obiettivo che ottimizza i costi e l'ergonomia. Abbiamo sviluppato un algoritmo multi-obiettivo per la sua risoluzione.

Sulla base dei modelli proposti e degli algoritmi di ottimizzazione, abbiamo definito una metodologia per la progettazione di linee di assemblaggio integrando l'ergonomia. Questa metodologia è stata applicata con successo su casi industriali.

École Nationale Supérieure des Mines
de Saint-Étienne

NNT :

Mohammed-Amine ABDOUS

OPTIMAL DESIGN OF MANUFACTURING SYSTEMS WITH ERGONOMICS:
APPLICATION TO ASSEMBLY LINES

Specialty : Industrial Engineering

Keywords : Optimization, Manufacturing Systems Design, Assembly Line Balancing Problem, Assembly Line Design Problem, Ergonomics, Multi-objective optimization, Optimal algorithms, Metaheuristics

Abstract :

This thesis contributes to the research stream of evaluation and optimization of ergonomics in the design phase of manufacturing systems. Poor physical ergonomics in manufacturing systems results in lower productivity, lower motivation, injuries, and increases costs for companies. The main objective of this work is the proposition of optimization methods for manufacturing systems design, with the joint consideration of ergonomics, productivity, and cost.

This work focuses on the preliminary design of assembly lines. The challenge is to provide decision-makers with optimization methods to take ergonomics into account while satisfying all technological and economic constraints. The combinatorial problems considered are the assembly line balancing problem and the selection of equipment. We considered a quantitative model of ergonomics based on fatigue and recovery equations taken from the literature. In addition to the combinatorial nature of problems dealt with, the main scientific challenge stems from the non-linear nature of the ergonomics model.

We proposed a linearization allowing defining an integer linear program, we developed optimal and approximate resolution approaches. Besides, we proposed a generalization of the approach, with a multi-objective model optimizing cost and ergonomics. We developed a multi-objective algorithm for its resolution.

Based on the proposed models and optimization algorithms, we have defined a methodology for the design of assembly lines with the optimization of ergonomics from the design phase. This methodology has been successfully applied to industrial cases.

École Nationale Supérieure des Mines
de Saint-Étienne

NNT :

Mohammed-Amine ABDOUS

CONCEPTION OPTIMALE DES SYSTÈMES DE PRODUCTION AVEC
ERGONOMIE: APPLICATION AUX LIGNES D'ASSEMBLAGE

Spécialité : Génie Industriel

Mots clefs : Optimisation, Conception des systèmes de production, Problème d'équilibrage de ligne d'assemblage, Choix d'équipements et équilibrage de lignes, Ergonomie, Optimisation multi-objectif, Méthodes exactes, Métaheuristiques

Résumé :

Cette thèse contribue à l'évaluation et l'optimisation de l'ergonomie dans la phase de conception des systèmes de production. Une mauvaise ergonomie physique dans les systèmes de production se traduit par une productivité plus faible des opérateurs, une motivation réduite, des blessures, et augmente les coûts pour les entreprises. L'objectif principal de ce travail est de proposer des méthodes d'optimisation pour la conception de systèmes de production, tenant compte à la fois de l'ergonomie, de la productivité et des coûts.

Ce travail se concentre sur la conception préliminaire des lignes d'assemblage. L'enjeu est de fournir aux décideurs des méthodes d'optimisation pour la prise en compte de l'ergonomie, tout en satisfaisant toutes les contraintes technologiques et économiques. Les problèmes combinatoires considérés sont les problèmes d'équilibrage de lignes d'assemblage et de sélection des équipements. Nous avons considéré un modèle quantitatif d'ergonomie basé sur des équations de fatigue et de récupération tirées de la littérature. Outre le caractère combinatoire des problèmes traités, le principal verrou scientifique provient du caractère non linéaire du modèle d'ergonomie.

Nous avons ainsi proposé une linéarisation permettant de définir un programme linéaire en variables entières pour ce problème et des méthodes de résolution optimale et approchée. Nous avons également proposé une généralisation de l'approche, avec un modèle multi-objectif optimisant le coût et l'ergonomie. Nous avons développé un algorithme multi-objectif pour sa résolution.

Sur la base des modèles et des algorithmes d'optimisation proposés, nous avons défini une méthodologie pour la conception de lignes d'assemblage avec l'optimisation de l'ergonomie dès la phase de conception. Cette méthodologie a été appliquée avec succès dans deux cas industriels.