



HAL
open science

Fractal analysis and planning of future power grids

Yousra Sidqi

► **To cite this version:**

Yousra Sidqi. Fractal analysis and planning of future power grids. Electric power. Université Grenoble Alpes, 2019. English. NNT : 2019GREAT089 . tel-02954349

HAL Id: tel-02954349

<https://theses.hal.science/tel-02954349v1>

Submitted on 1 Oct 2020

HAL is a multi-disciplinary open access archive for the deposit and dissemination of scientific research documents, whether they are published or not. The documents may come from teaching and research institutions in France or abroad, or from public or private research centers.

L'archive ouverte pluridisciplinaire **HAL**, est destinée au dépôt et à la diffusion de documents scientifiques de niveau recherche, publiés ou non, émanant des établissements d'enseignement et de recherche français ou étrangers, des laboratoires publics ou privés.

THÈSE

Pour obtenir le grade de

DOCTEUR DE LA COMMUNAUTE UNIVERSITE GRENOBLE ALPES

Spécialité : **Génie électrique**

Arrêté ministériel : 25 mai 2016

Présentée par

Yousra SIDQI

Thèse dirigée par **Nicolas Retière, Professeur, Université Grenoble-Alpes**, et
codirigée par **Pierre Frankhauser, Professeur émérite, Université de Franche-Comté**

préparée au sein du **Laboratoire de Génie électrique**
dans **l'École Doctorale Electronique, Electrotechnique, Automatique, Traitement du Signal (EEATS)**

Analyse et Planification Fractales des Réseaux Electriques du Futur

Thèse soutenue publiquement le « **22 Octobre 2019** »,
devant le jury composé de :

M. Cyrille BERTELLE

Professeur, Université le Havre Normandie, Président

M. Olivier BONIN

Chargé de recherche, IFSTTAR, université Marne-la-Vallée, Rapporteur

M. Alberto BORGHETTI

Professeur, Université de Bologne-Italie, Rapporteur

M. Andreas SUMPER

Professeur, Université Polytechnique de Catalogne-Espagne, Rapporteur

M. Nicolas RETIERE

Professeur, Université Grenoble-Alpes, Membre

M. Pierre FRANKHAUSER

Professeur émérite, Université de Franche-Comté, Membre



To the memory of my Grandmother...

Declaration

I hereby declare that except where specific reference is made to the work of others, the contents of this dissertation are original and have not been submitted in whole or in part for consideration for any other degree or qualification in this, or any other University. This dissertation is the result of my own work and includes nothing which is the outcome of work done in collaboration, except where specifically indicated in the text.

Yousra SIDQI

2019

Acknowledgements

First and foremost, I wish to express my sincere appreciation to my supervisors: Professor Nicolas Retière, who convincingly guided and encouraged me throughout the whole process of conducting this research and writing my dissertation, and Professor Pierre Frankhauser, whose comments and advices were very valuable for my work. It was an absolute honor to work with you both.

I am very grateful to all the members of the jury, whose comments on my dissertation and during my defense were very constructive. I am very grateful to have had such a multi-specialized committee judging my work and giving me a positive feedback.

I would like to pay my special regards to all the staff of the Laboratory of Electrical engineering of Grenoble. To my colleagues, it was a pleasure sharing the same workspace with you and getting to know you at work and outside of the lab.

Over the years that I spent in Grenoble, I had the extreme honor to meet at school and at work, many inspiring women whom I shared scientific and personal experiences with. To Oana, working with you on the Fractal Grid project was an absolute delight, I could not have dreamed of a better partner to carry on this research. I wish you the best for your career. To Ronak, you are a great friend and an inspiring accomplished scientific. I am looking forward to having many more encounters in the future. To Aurélie, you have been incredibly supportive over the last year and I will always be grateful for all the positivity you gave me when I needed it the most. I was very lucky to have you as a friend. To Baoling, I feel very lucky to have shared my office with you throughout my whole time in the lab. You were a constant support and an amazing friend to have while working. I was very happy to share time with you outside of office where you were always very generous and giving. I am looking forward to spending more time with you sharing the same scientific passion and enjoying life in the Swiss Alps.

To Chhay, I have known you for many years living in Grenoble and I am very honored to have you as a friend. I am very grateful for all the moments we spent either discussing about science or life, eating international food or even marching for women's rights. I wish you all the best for your career in research.

Finally, I want to dedicate this work to my family. There is no words to describe my gratitude to all of you for pushing me and supporting me. To my parents, I will never be able to thank you enough for all you have given me ever since I decided to pursue a career in Research. To my beloved sisters and brother, you guys are the best. I could have never achieved anything if it wasn't for you being my inspiration in life and the most incredible support system. I love you all.

Contents

Contents	vii
List of Figures	ix
List of Tables	xiii
Introduction.....	xv
Chapter 1 Planning of urban territory.....	17
1.1 Urban planning.....	17
1.1.1 Why plan cities?.....	17
1.1.2 How do we define urban planning?	18
1.1.3 Theoretical approaches: From a traditional approach towards a more collaborative one.....	19
1.1.4 Urban planning in France.....	24
1.1.5 Sustainable urban planning.....	26
1.2 Planning of French distribution power networks	32
1.2.1 Brief description of the network	33
1.3 New challenges for planning future power networks.....	38
1.3.1 Paradigm changes	38
1.3.2 Planning with variability and flexibility	39
1.3.3 Planning with complexity	42
1.4 Conclusion.....	44
Chapter 2 Fractality as a tool to understand the complexity of the urban energy system ..	47
2.1 Understanding the complexity of urban networks	47
2.1.1 Complex systems and their study	47
2.1.2 Complex systems theories.....	48
2.1.3 Approaches to analyze the complexity of power networks	50
2.1.4 Introducing fractals as a new tool to analyze power networks	52
2.2 Fractal analysis of urban territory	53
2.2.1 Why using fractality to analyze urban networks?.....	53
2.2.2 Basic introduction to fractality.....	54
2.2.3 Fractal dimension.....	57
2.2.4 The box counting method	57
2.2.5 The cluster growing method	58
2.3 Multi-fractal analysis.....	59

2.3.1	The generalized dimension	60
2.3.2	Multi-fractal spectrum	61
2.3.3	Cluster growing method to analyse multifractality.....	63
2.4	Conclusion.....	63
Chapter 3	Concordance analysis of the distribution power grid of the city of Grenoble ...	65
3.1	Scaling behaviour and concordance analysis	66
3.2	Tools to analyse the fractality of urban networks	67
3.2.1	The software FracGis.....	67
3.2.2	Data processing.....	69
3.3	Results of the fractal analysis for the city of Grenoble.....	73
3.3.1	Buildings.....	73
3.3.2	Power grid.....	74
3.3.3	Road network.....	76
3.4	Results of the concordance analysis for the city of Grenoble.....	76
3.4.1	Global concordance analysis.....	76
3.4.2	District fractal and concordance analysis	80
3.4.3	Fractal dimensions	83
3.4.4	Local scaling behavior	86
3.4.5	Local concordance analysis	89
3.5	Results of fractal analysis for the Franche-Comté area.....	91
3.5.1	Fractal analysis of the power grid.....	92
3.5.2	Concordance analysis between the power grid and the built-up areas and comparison with Grenoble.....	93
3.6	Conclusion.....	95
Chapter 4	Multifractal analysis of distribution power systems	97
4.1	Formalizing power networks as a load flow problem.....	97
4.1.1	Problem formulation	97
4.1.2	Power balance equations.....	99
4.2	Tools for multifractal analysis for distribution power systems.....	101
4.3	Results of fractal analysis of distribution power grids.....	103
4.3.1	Analysis on a 15-node simple case	103
4.3.2	Analysis of Caracas (IEEE 141) vs Grenoble distribution grid.....	105
4.4	Conclusion.....	115
	Towards a fractal planning of power grids	117
	References.....	122

List of Figures

Figure 1-1: Annual fuel consumption (GJoules/person) compared to urban density (/ha) [54]	31
Figure 1-2: Conventional grid architecture [71]	39
Figure 1-3: The energy landscape emerging through smart grid and urban energy system concepts [71]	42
Figure 1-4: Energy flow in cities: thermodynamic model, metabolic model, systemic model [76, 82, 83]	45
Figure 2-1: Complex systems theories [87]	50
Figure 2-2: First iterations for the construction of a Sierpinski carpet	56
Figure 2-3 : Sierpinski carpet using a different initiator and generator	56
Figure 2-4: Fournier dust	56
Figure 2-5: Illustration of a random object	57
Figure 2-6: Illustration of the box counting method	58
Figure 2-7: Illustration of the box counting method (left: random coverage / right: minimum coverage)	58
Figure 2-8: Iterative generation of a multifractal Sierpinski carpet [135]	60
Figure 3-1: User interface of FracGis	68
Figure 3-2: Iteration example of the box counting method	69
Figure 3-3: Determining the fractal dimension and scaling behavior using FracGis	69
Figure 3-4: Grenoble's building view: (left) Grenoble city (right) Grands boulevards district	70
Figure 3-5: Grenoble's medium voltage power grid: (left) Grenoble city (right) Grands boulevards district	71
Figure 3-6: Grenoble's medium voltage power grid after processing: (left) Grenoble city (right) Grands boulevards district	72
Figure 3-7: Grenoble's road network: (left) Grenoble city (right) Grands boulevards district	72
Figure 3-8: Grenoble's road network after processing: (left) Grenoble city (right) Grands boulevards district	73
Figure 3-9: Scaling behavior of the built-up areas	74
Figure 3-10: Overview of the scaling behavior of the power grids using unprocessed data versus processed data	75

Figure 3-11: Example of network coverage with boxes of size 1024 m	75
Figure 3-12: Overview of the scaling behavior of the road network using unprocessed data versus processed roads data set.....	76
Figure 3-13: Concordance analysis between the power grid and buildings	78
Figure 3-14: Concordance analysis between the road network and buildings.....	79
Figure 3-15: Concordance analysis between the power grid and road network	80
Figure 3-16: Zoning for the built-up areas of the city of Grenoble	82
Figure 3-17: Zoning for the power network of the city of Grenoble	82
Figure 3-18: Zoning for the road network of the city of Grenoble	83
Figure 3-19: Fractal dimensions for the built-up areas of Grenoble.....	84
Figure 3-20: Fractal dimensions for the power grid Grenoble	85
Figure 3-21: Fractal dimensions for the road network Grenoble.....	85
Figure 3-22: Scaling behavior for the buildings	87
Figure 3-23: Scaling behavior for the power grid.....	88
Figure 3-24: Scaling behavior for the road network.....	88
Figure 3-25: Concordance of the scaling behavior between buildings and the power grid.....	89
Figure 3-26: Concordance of the scaling behavior between buildings and roads	90
Figure 3-27: Concordance of the scaling behavior between the roads and the power grid.....	90
Figure 3-28: Distribution power grid for Jura and Haute-Saône departments.....	91
Figure 3-29: Scaling behavior of the entire power grid of the Jura and Haute-Saône Departments	92
Figure 3-30: Scaling behavior of the medium voltage power grid of the Jura and Haute-Saône Departments	93
Figure 3-31 :Scaling behavior of the low voltage power grid of the Jura and Haute-Saône Department.....	93
Figure 3-32: Classification for different zones in Grenoble and Franche-Comté	95
Figure 4-1: A typical one-line diagram.....	98
Figure 4-2: Cluster growing method for power networks : the cluster size is increased according to the shortest path distance	102
Figure 4-3 : Multifractal analysis algorithm	102
Figure 4-4: 15 node case with singularity (Conf 1: same impedance for all lines, Conf 2: introducing an impedance singularity, Conf 3: introducing a bifurcation, Conf 4: introducing both bifurcation and singularities)	104
Figure 4-5: 15 node case voltage drops analysis : qth moments of normalized measures in a double logarithmic representation.....	105
Figure 4-6: Graph representation of IEEE141 case with power distribution and its proportion in MW	106
Figure 4-7: Medium voltage network of the city of Grenoble (Red line).....	107
Figure 4-8: Histogram of active power distribution (left : IEEE141, right: Grenoble)	107

Figure 4-9: Active power measures (up: IEEE141, down : Grenoble).....	109
Figure 4-10: Generalized dimension for active power	109
Figure 4-11:Reactive power measures (up: IEEE141, down : Grenoble)	110
Figure 4-12:Generalized dimension for reactive power	110
Figure 4-13: Histogram of reactive power distribution (left : IEEE141, right: Grenoble	111
Figure 4-14:Impedance measures (up: IEEE141, down : Grenoble).....	112
Figure 4-15 : Impedance generalized dimensions	113
Figure 4-16:Voltage drop measures (up: IEEE141, down : Grenoble)	114
Figure 4-17: Generalized dimension for voltage drops	114
Figure 1: Comparison of a randomly generated fractal (left) and the built-up area of Paris	119
Figure 2: Iterations 1 and 2 of the fractal process to plan the power grid (upper left panel – generator : upper right panel – initiator ; bottom panel – 2 nd iteration).....	120
Figure 3: Theoretical fractal planed power grid	121
Figure 4: Fractal grid adapted to the road network.....	121

List of Tables

Table 3-1 : Concordance analysis for Franche-Comté94

Introduction

Using fractal theory to model the complexity of systems was introduced by Mandelbrot in the mid-eighties [1]. Ever since, in-depth theory has emerged to apply fractals to measures and multiple methods were developed [2, 3]. Historically, small distribution networks from the early 20th century have been connected as years gone by to become larger distribution grids. From passive and unidirectional networks, they embed more and more active devices and renewable energy sources. Thus, the distribution power grid gained more interest in recent years as a research study case in terms of modeling, analysis and design. Intuitively, the utility of such studies starts at showing the links between the geometry of the grid (line impedance or length) and its use and response (power distribution, voltage drops) .

The structure of the distribution power grid is strongly linked to the built-up areas within the city. Many studies showed that built-up fabrics are structured according to an internal logic and multiple results confirmed this statement [4-11]. Metropolitan areas are usually structured according to certain organization laws despite their irregular appearance [4, 9-13]. In the same fashion as numerous socio-technical systems, distribution networks are related to a manifest hierarchy and fractal geometry could be used to offer a geometric interpretation of such an organization. [1, 10]

Distribution System Operators (DSOs) should guarantee the quality of the electricity they provide to their users. For instance, one of the DSO's major legal commitments is to maintain the voltage at a predefined level. Since the early 2000s, there was a massive growth of renewable and intermittent production facilities connected to the distribution network, which is expected to expand even more with the current development of smart grids and the urgent need of a greener energy transition [14-16]. This dramatic change in distribution networks affects the ways DSOs plan their future grids. This research aims at providing a potential future assistance to power researchers and engineers looking into understating the geometrical features across scales within the distribution power grid in order to unravel its complexity and

its relationships with the urban fabric.

The first chapter of this dissertation introduces its background and motivations. It presents the urban territory planning with a focus on sustainable planning and future challenges of planning cities and their power systems within the French context. The second chapter details fractal theory as a tool to understand the complexity of distribution power systems. We focus on the application of classical methods to analyze and understand the fractality of urban fabrics and then we introduce the multifractal theory which is applied to analyze the complexity of the electrical properties of the distribution power grid. The third chapter summarizes the results of spatial fractal analysis and concordance analysis of the power grid of both the city of Grenoble and the Franche-Comté region. A detailed district analysis is conducted for the city of Grenoble to understand if the function of an area within such city has any influence on the spatial characteristics of its urban networks and spatial evolution. The last chapter details the results of the multi-fractal analysis of the distribution power grid of the city of Grenoble. We confront here the results of this French distribution power network to the IEEE141 case which represents part of the distribution network of the city of Caracas. Finally, we discuss the possibility of planning fractal power networks in the future using the example of the city of Grenoble.

Note: This work comes in the crossing of multiple research fields but particularly electrical engineering and urban planning. Some mentioned notions may seem basic for specialists of either field but are presented here for those of the opposite specialty for better clarity and understanding.

Chapter 1 Planning of urban territory

The growth of cities raises issues in terms of urban planning and city dynamics [17]. Through their planning, neighborhoods integration in the city shall ensure the accessibility of all urban services, decent housing, spatial, economic and social equality [18]. Urban planning started back in the medieval period after the disintegration and fall of the West-Roman empire in the 5th century and came a long way up to the liberalism period in the early 20th century (City of Benevolo [19]) and later on the emergence of modern planning strategies in recent years (transit-oriented development [20], fractal planning [21]) In this chapter, planning of urban territories is introduced via a historical description of the emergence of theoretical approaches, which integrate more and more actors and dynamics as well as complex urban objects. The French frame is explained while describing the challenges of sustainable planning and more specifically for urban networks first and the power grid later as these two networks represent the focus of this study. The chapter is concluded by the main motivations of the work developed in the following chapters.

1.1 Urban planning

1.1.1 Why plan cities?

There is a variety of plans in urbanism: land use, transportation, economic development, housing needs assessments, emergency response, park and recreation plans, neighborhood plans and transit. Urban planning has been responding to multiple needs over the years, most prominently to provide housing and transportation choice, make efficient use of the infrastructure, preserve open space, protect critical environmental areas and sensitive land, reduce urban runoff and vehicle miles travelled [22-24]. As land use planning serves an

evolving market, it catalyzes economic and fiscal health. Urban planning has been facing some major challenges in terms of sustainability (energy, transportation, social equity), livability (housing, health, food), climate change (energy, transportation, food) and resilience (energy distribution, communication networks, building infrastructure) . As for electrical planning in particular, the main current drivers are greenhouse gas reduction by integrating more renewables and use of more resilient and more compact technologies to face space contain.[25]

1.1.2 How do we define urban planning?

Urban planning used to be defined as a physical design, enforced through land-use control and centered in the state. New approaches have introduced the institutional shift from government to governance, the necessarily wider scope of planning beyond land use (sustainability, energy efficiency...), and the need to consider how plans are implemented.

Planning is "the process of making plans for something" (Oxford dictionary). In a societal context defined by complexity and uncertainty, it is a formalized activity that enables a society to provoke and / or manage changes in the economic and urban context or the evolution of social demands.[26]

In France, urban planning is traditionally seen as a process of defining and implementing territorial strategies. For urban actors, this corresponds to the response to the challenges of social cohesion, economic competitiveness or sustainable development by formalizing a space project. It refers to a collective effort to imagine (or re-imagine) an urban space, and to transpose this new spatial vision in terms of coordination of public policies and the achievements of private actors [27].

The size of the project can be bigger than a city and may concern the institutional perimeters of a region, an agglomeration or a natural park. In addition, the project may correspond to the reference territory of a major project such as a business center, an airport, a high-speed train line, a technology park or a tourist zone. The diversity of the scales also refers to a multitude of actors included in the planning process, especially since 1983 with the

decentralization of powers to the benefit of local authorities (loi du 2 mars 1982 relative aux droits et libertés des communes, des départements et des régions [28]).

1.1.3 Theoretical approaches: From a traditional approach towards a more collaborative one

In this section, we are going to understand how planning evolved throughout the last century to fulfill the need to better understand territorial dynamics by integrating more complexity and moving towards a less centralized and more collaborative approach.

1.1.3.1 Traditional approach

The traditional spatial planning approach refers to the model that emerged at the end of the 19th century in the context of the industrial revolution, particularly with the doctrine of "Comprehensive planning" that emerged at the turn of the 20th century. The structuring of this theoretical approach was mostly based on the work developed during the years 1940 and 1950 in the frame of the "Chicago School" [29], which is also best known for applying the principles of ecology to develop the social disorganization theory which studies the consequences of the failure of social institutions or social organizations including the family, schools, church, political institutions, policing, business.[30]

This research was influenced by the crisis of the 1930s and the response of planners who propose the "new deal". In a multidisciplinary perspective, the Chicago School proposes to develop rational for all public policies including planning. It is the subject of the book by Mr. M. Meyerson and E. C. Banfield: *Politics, Planning and the Public Interest* (1955) [31]. Then, from the 50's, there was the emergence of modernism. In terms of planning, this translates into the advent of the rational-global planning that will set in as the dominant paradigm in theories of planning, but also for professional practices [18].

Traditional spatial planning has its founding values in the knowledge and scientific expertise of statistical or cartographic information. The purpose of this rational model is to serve the public interest: "A decision is said to (...) be in the public interest if it serves the ends of the those of some sector of the public "[31].

Practically, this model is dominated by a spatial approach whose objective is the regulation of land use. It should be noted that this model was developed in the context of the strong growth of the "trente glorieuses". It is then then focused on regulating growth by defining zoning, building densities, building collective facilities ... To achieve these ambitions, the traditional model focuses on the production of plans. The reference space of this planning model corresponds to the political-administrative territory. It is about planning the future of a city, an agglomeration or even from a region, with a global approach.

This model involves only the traditional actors of the planning, ie policy makers and planners who act as experts. Even if the ideal of this theoretical model is to serve "the public interest ", the practice of this spatial planning reflects the image of a very bureaucratic style: the elaboration is a technical question which is settled between experts and elected officials, without really opening the negotiating arena to private actors or civil society [26, 32]. The planners have a central role, they are considered as experts, which is ensured by their scientific and technical knowledge. The information they hold puts them at the heart of the rational-global model.

The methods on which the traditional spatial planning model is based refer to science and rationality. The ambition to take a global look and objective places qualitative, but above all quantitative, information at the heart of the planning process. The development of a plan always begins with an important portrait of the situation of the territory. Then the planner highlights all the possible options, notably through the scenario method.

The final choice is carried out using a rational approach that identifies the most appropriate, "the one best way" to achieve the goals set by the leaders' policies:

"By a rational decision, we have made the following: 1. the decision-maker considers all of the alternatives (races of action) open to him; i.e., he considers what courses of action are possible within the conditions of the situation and the light of the ends he seeks to attain; 2. he identifies and evaluates all of the consequences which would follow from the adoption of each alternative; i.e. he predicts how the total situation would be changed each race of action he might adopt; and 3. he selects that alternative the probable consequences of which would not be preferable in terms of its most valued ends." [31]

However, this vision is nuanced by the authors who recognize limits to the rational model:

"Obviously no decision can be perfectly rational since no one can know all of the alternatives open to him would follow from any action. Nevertheless, decisions can be made with more or less knowledge of alternatives, consequences, and rising ends, and so we may describe some decisions and some decision-making processes as more nearly rational than others. "[31]

1.1.3.2 Strategic approach

The strategic planning model differs from the traditional model spatial planning by focusing public action on searching for results through the implementation of specific actions. Defining a planning perimeter appears much less formal than in the traditional planning model. It is no longer a matter of referring only to the political-administrative territory, but also to reflect on strengths and weaknesses structuring the territory itself and finally ensure that the territory planning will implement the adopted strategy, through appropriate projects.

The strategic planning model challenges the centrality of planners. They are no longer the expert who assumes their power over the detention of information and expertise They adopt a more pragmatic attitude, which pushes them to ensure interaction between policy makers and the business world, while ensuring that planning approaches remain action-oriented and seeking results.

The methods of strategic planning refer to a proactive, selective, contextualized and finally iterative attitude. To illustrate this ongoing process, we can identify the 7 major steps generally identified to achieve this model of planning:[33]

1. To draw a global portrait of the environment;
2. Identify the key issues;
3. Identify potential major strategic directions;
4. Analyze the strengths and weaknesses of the territory;

5. Select and prioritize orientations according to objectives;
6. Define the measures to ensure application;
7. Monitor and evaluate to revise priorities.

The decision-making process is more open than the rational-global model, but remains relatively conservative on the key actors who hold power: the planner who holds the power of information, the policy that holds the power of the decision and finally the businessman who can hold some of the resources to implement the strategy adopted or some of the methods, for example with the territorial marketing development.

This model has the advantage of being flexible and can quickly adapt to the economic and political context, with a vision that is both global and focused. However, this planning approach does not allow having a global vision of the territory and its issues. It often focuses on the realization of particular objects (transport infrastructure, special territories for development economic, social or environmental protection, structuring equipment, ...) by insisting on the notion of network [34].

Implementing the strategic planning model refers to a continuous, but mostly iterative process. It is about constantly updating the priorities in order to achieve better results, rather than producing a plan for a distant and uncertain horizon.

The starting point for this type of approach is always a contextualization of the planning exercise (assessment of strengths and weaknesses in a context of opportunities and constraints - SWOT model), which helps guide action towards implementation to achieve concrete results[35].

1.1.3.3 Collaborative approach

The collaborative approach is another denunciation of the traditional planning model with its global rational approach [36, 37]. Nevertheless, the origins are different: they emerge in line with the theories of social movements and are formalized in the field of territorial planning from the 1990s by registering in the pluralism that opens up to new actors. The

collaborative approach proposes to renew planning through communication. From a more theoretical point of view, it should be noted that there is a strong influence of the work of J. HABERMAS [38, 39] on communicative action. This author defines himself as an interactive activity directed towards the agreement, and whose function is the coordination of the actions and plans of action between partners. The goal of collaborative planning is to reach consensus through a good interaction within a large gathering of actors: "In the ideal of collaborative planning, stakeholders representing the differing interests meet for face-to-face dialogue and collectively work out a strategy to address a shared problem. Participants work through joint fact finding and agree on a problem, mission, and actions. The players learn and co-evolve. Under the right conditions, this dialogue can produce results that are more than the sum of the parts "[40].

The collaborative approach stems from the communicational turn [36] and therefore stresses the communication strategies to be implemented to establish a good interaction between actors [26]. In a context of uncertainty and indeterminacy, J. INNES [41] insists on the negotiation of agreements between the participants who represent the various interests, leading to the formulation of regional plans or legislative texts:

"When there are multiple goals, (...) planning requires bargaining or mediation (...) When the means for accomplishing goals are also uncertain, adaptive approaches are needed to facilitate learning by doing. When both goals and means are uncertain, (...) charismatic leadership or a social learning strategy is needed. Only when society knows how to do a task and agrees on a single objective is top-down regulation appropriate." .

The methods of the collaborative approach are based on two elements which are linked: communication and interaction. This planning model makes the starting point that planners spend most of their time talking and interacting: "This talk is a form of practical, communicative action" [42].

In this perspective, the dialogue and other forms of communication can change the actors like the situations: "Planners are engaged in a web of communicative and interactive activities that influence public and private actions direct and indirect ways " [42]. In this interactive process, J. INNES insists on the mobilization by the actors of different forms of information.

Scientific and technical information, which can be qualified as formal, is not the most important in determining the nature of the problems or to decide on actions to be taken. And finally, it identifies another type of information that would be constituted by the "stories" reported by the various participants in the process. At the end, these different types of information constitute as many resources as the actors can share[42]: "The term of information becomes stretched perhaps beyond its limit, as we begin to pay attention to the many forms of knowing that participants can use in learning through collaborative processes. ".

The instruments in this planning model are based on information and communication between the actors. They refer to the idea of interaction which can then take the form of forums, debates, even agreements. As for the strategic planning, they do not necessarily refer to a legal formal dimension. These instruments are then based on a legitimacy that seeks explicit decisions and the accountability of the actors [43].

The public sphere then intends to give the floor to the various actors, especially those traditionally excluded from bargaining forums. The obtained consensus on the basis of sharing common values and mutual trust engage the collaborative spirit of the participants. On one hand, they internalize these values and integrate them into their actions; on the other hand, they tend to respect their commitments, knowing that otherwise the other partners may also not respect their own. Collaborative planning « is about why urban regions are important to social, economic and environmental policy and how political communities may organize to improve the quality of their places ». [27]

It is now clear that planning approaches moved from a centralized approach towards integrating more complexity via a more collaborative approach. There is therefore a need to better understand complex territorial dynamics in order to study the use of urban networks via a mathematical method which allows it: fractality.

1.1.4 Urban planning in France

It was during the 1960s and 1970s that large-scale urban planning policies were initiated. They gave rise, for example, to the Concerted Development Zones (Zones d'aménagement concerté ZAC, 1967), the Master Plans of Planning and Urban Development (Schémas

directeurs d'aménagement et d'urbanisme SDAU, 1969), and the Land Use Plans (Plans d'occupation des sols POS, 1970). In 1965, a policy of loosening large urban concentrations around nine new cities was launched (including five in Ile-de-France), based on the master plan of planning and urban planning of the Paris region (Schéma directeur d'aménagement et d'urbanisme de la région Parisienne SDAURP).

From 1983, decentralization laws had consequences on urban planning, municipalities being now free and responsible for their policies. But the adoption of Master Plans (which replace the SDAU) has become scarce and, in order to guarantee minimum harmonization between planning policies, the Territorial Development Directives (Directives territoriales d'aménagement DTA, 1995 Pasqua's Act) have been imposed such as Land Use Plans POS. Decentralization has its virtues: better proximity with elected officials and citizens and better reactivity. But it also has its perverse effects, encouraging a misguided practice of Land Use Plans. When the City Council initially defines a weak Land Use Plans, it is then easy to make it evolve over the desired operations, according to the solicitations of promoters, electoral appointments, without stability, without lasting rules or global urban vision and over the duration.

Also, the law " Urban Solidarity and Renewals" (Solidarité et renouvellement urbains, SRU, 2000) provides for the replacement of the Master Plan by a Scheme of Territorial Coherence (Schéma de cohérence territoriale , SCOT) and that of the Land Use Plans POS by a Local Plan of Urbanism (Plan local d'urbanisme, PLU) of wider scope.

The Territorial Coherence Scheme (Schéma de cohérence territorial, SCOT) is an urban planning document with broader objectives than the Master Plan with the consideration of housing, transport and commercial equipment policies. Other urban plans (PLUs, Urban Travel Plans) must be brought into line with the SCOTs. The SCOT is elaborated by a public Institution of intercommunal cooperation (Établissement public de coopération intercommunal, EPCI) or by a mixed union. State services are involved in its development. It is approved after public inquiry.

The Local Urban Plan (PLU) is a document to replace the Land Use Plan (POS). It is a development project whose purpose is wider than POS. It must be a coherent framework for

the various spatial planning actions: urban development, preservation of natural spaces and landscapes, urban and social mix, control and management of travel, noise pollution, environmental control (air quality), water, etc.).

The PLU must be compatible, where applicable, with: SCOT; the Regional Natural Park Charter; the Urban Travel Plan (Plan de déplacements urbains PDU); the Local Habitat Program (Programme local de l'habitat PLH); the Territorial Development Guidelines (DTA); the laws "mountain" or "littoral"; the Scheme of enhancement of the sea. [44]

The processes of globalization of the economy and the metropolisation of territories change the nature of urban development and therefore the planning models. The challenge of the planning approaches is to go beyond the fragmentation logic by affirming a project that takes into account the context of globalization of the economy and the metropolisation of territories, consolidating the attractiveness of the metropolis while strengthening its social cohesion and protecting its natural environment. This is reinforcing the previous conclusion that planning is shifting towards an ever more integrated vision, taking into account the different new uses of territory.

1.1.5 Sustainable urban planning

1.1.5.1 Why do we need to revisit urban planning?

The 2005 World Summit on Social Development [45] defines sustainability as the ability to ensure economic development, social welfare and environmental protection.

The sustainable city must be based on strategic objectives that reflect urban development, which does not compromise other populations or future generations. One can identify strategic objectives to make a city sustainable: [46]

- Preserving and sustainably managing of the planet's resources (energy, air, water, soil, climate, materials, biodiversity).
- Improving the quality of the local environment (sanitary quality, reduction of nuisances and risks).

-
- Improving social equity by enhancing accessibility for all to employment, housing, education, health, community services and facilities and fighting social and ecological inequalities.
 - Improving equity and cohesion between territories: at the sub-municipal level (neighbourhoods), but also at the intercommunal level and within the framework of decentralized cooperation.
 - Improving the efficiency and attractiveness of the economic fabric.

A sustainable neighbourhood or eco-neighbourhood project is characterized by the implementation of an approach/ project aiming at responding, at its own scale, to the global challenges of the planet, to the local issues in order to improve the quality of life of its inhabitants and users and to contribute to the sustainability of the city.

It started with the "Grenelle Environnement", launched in 2007 and which combined the state and civil society in order to define new actions for sustainable development in France. Then came the debate in 2013 and vote in the National Assembly of the Energy Transition for Green Growth Act in October 2014 and adoption of a new energy-climate package by the European Union the same month.

The objectives of the law on the energy transition for green growth adopted at first reading (loi no 2015-992 du 17 août 2015 relative à la transition énergétique pour la croissance verte) are numerous:

- Reduce greenhouse gas emissions by 40% between 1990 and 2030 and half greenhouse gas emissions between 1990 and 2050.
- Reduce the final energy consumption by 50% in 2050 compared to the reference in 2012, aiming at an intermediate target of 20% by 2030. This dynamic supports the development of an energy efficient economy, particularly in the construction and transport sectors, and preserves the competitiveness and development of the industrial sector.
- Reduce the energy consumption of fossil fuels by 30% in 2030 compared to 2012.
- Increase the share of renewable energies to 23% of gross final energy consumption in 2020 and 32% of this consumption in 2030; at this date, to

achieve this goal, renewable energies must count for 40% of electricity production, 38% of final heat consumption, 15% of final fuel consumption and 10% of gas consumption.

- Reduce the share of nuclear power in electricity production to 50% by 2025.
- Contribute to the achievement of the air pollution reduction objectives provided by the national plan for the reduction of air pollutant emissions defined in Article L. 222-9 of the Environment Code.
- Have all buildings renovated according to the standards of "low consumption building" or similar, by 2050, by pursuing a policy of thermal renovation of housing mainly for low-income households
- Achieving energy self-sufficiency in the overseas departments by 2030, with an intermediate target of 50% renewable energies by 2020.

On the other hand, more than half of us, on a global scale, now live in urban areas. This figure is expected to reach 70% by 2050 [47]. It is still too early to judge how energy transition and urban growth will shape the major trends in urban development, but they certainly will.

The creation of resilient cities was one of the key themes that emerged from recent discussions [48]. Such a concept can have many connotations: from disaster risk reduction to responding to future environmental challenges such as climate change and peak oil or social issues. Resilient cities shall ensure that policies, urban planning and design support the aspirations of the poorest and marginalized citizens at the local level, instead of simply proposing a set of goals or strategies that promote resilience and sustainability across the board. In this perspective, it does not matter what our vision is for the cities of the future - be it a global city, a resilient city, a smart city, a sustainable city or a city for all.

1.1.5.2 Modern urbanization paradigm

How to approach the necessary evolution of the city? The paradigmatic approach seems much better adapted. A paradigm is not based on intentions or practices: it can be defined as a coherent set of recognized reasoning principles and used as a tacit reference, by the members

of a given group, to solve problems [49]. It is therefore used to deal with everyday concrete problems using standard methods and adapted solutions to different contexts.

All engineering develops around the paradigm, leading to the professionalization of its promoters and the institutionalization of procedures. After a while, however, a paradigm always ends up being unable to solve a growing part of the problems it faces, until its legitimacy is threatened. But the many professionals who have patiently built their skills and tools as part of the initial paradigm have no interest in thoroughly reviewing their practices and only amend them at the margins.

It is therefore, in general, people or rather marginal structures, enjoying a relative autonomy of reflection and action, who dare to explore new paradigms and engage in radical alternatives, breaking with traditional solutions. Therefore, during an "extraordinary period", as Thomas Kuhn [50] says, two paradigms coexist and clash, with a stiffening of positions on both sides. Some decisions may then appear contradictory because of different paradigms. It takes years - at least a generation - to hope that the new paradigm will supplant the previous one.

The dominant paradigm since the 1950s is modern urban planning and its declination in the field of transportation that is the "automobile city"[51]. The approach is still sectoral: urban functions are dissociated (zoning), segregated modes of transport and so on. Determinism is the rule: omniscient experts are supposed to master all the causes and consequences of the problems and decide what is the best solution to retain, in the name of the general interest. Speed is favoured to improve accessibility in the short term, favouring the automobile [52].

All this allows solving a good part of the difficulties of the post-war period, then years of growth: to quickly open new territories to urbanization, to reduce the industrial nuisances by creating zones of activities, to improve the consumers' access to cheap goods in large shopping centres, facilitating business access to larger customers and better-trained employees, etc.

Other modes of travel are tied with cars: public transport is considered useful only in city centres saturated with cars or for the public who do not have access to a car; the walk is reserved for local trips; the bicycle, considered degrading, has no place [53].

With the rise of road insecurity in a few decades, then automobile nuisance and energy difficulties, and climate risk and the excessive consumption of non-renewable resources, this paradigm is now increasingly contested. To go far beyond the marginal improvements it merely offers, a paradigm shift has become inevitable.

This paradigm shift came into light after Newman and Kenworthy's work which had a great impact: a simple link between agglomeration density and energy consumption of inhabitants [54]. The researchers compared the situations of 37 cities in North America, Australia, Europe and Asia. To study the link between urban form and energy, they carried out an energy assessment of metropolitan mobility from: the number of kilometres travelled by car; the average occupancy rate of cars (throughout the week); an estimation of the energy consumption of cars, the number of passengers for each mode of collective transport; average distances travelled per trip, by public transit; an estimate of the energy consumption of the various modes of public transport.

The results of this survey in Figure 1-1 show a relationship between density and the energy consumed for personal transportation. Three groups of cities stand out: The North American and Australian cities are characterized by low urban densities and a very high energy consumption. A second group of cities, whose density and energy consumption for private transport are average, this was noticed mainly for European cities. Finally, the densest cities and the least "energy-consuming" turn out to be the Asian cities.

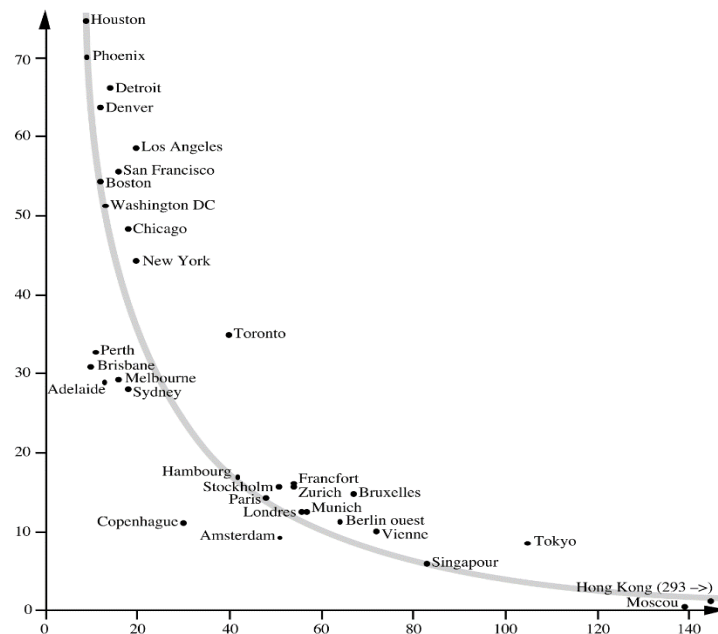

Figure 1-1: Annual fuel consumption (GJoules/person) compared to urban density (/ha) [54]

1.1.5.3 Sustainable city paradigm

It is based on quite different principles. The approach is primarily systemic and no longer sectoral: we seek to understand better the interactions between different phenomena, urban functions are mixed, modes of travel cohabit at low speed, nuisances are treated globally. Pragmatism replaces determinism: the expert sees their role diminished to the benefit of wide consultation at all stages of the projects. Long-term accessibility is preferred, relying on density and fluidity rather than speed.

The city is therefore based on an "ecological transport system" combining walking, cycling, public transport and shared use of the car, with an effort to moderate car traffic, that is to say reduced speeds and traffic. The efficiency of the automobile system is reduced in favour of alternative modes to the solo car. This solution favours a slightly more dense, mixed and multipolar urbanism that can be supported by a limitation of urban sprawl.

The story of the emergence of this paradigm remains to be done. The first experiments began in the Netherlands in the 1970s. Then the concept was refined in Germany during the 1980s. It spread afterwards to the Nordic countries, and eventually spread to all developed

countries, including France. Even if the results are still far from being satisfying, it opens up new perspectives and will, in the long term, make it much easier to adapt to environmental constraints.

Because of the existing buildings, infrastructures and the inertia of behaviours, such a paradigm shift cannot be quick or clear. Currently, there is a juxtaposition of solutions which still fall under the old paradigm, such as the promotion of the electric car or motorway ring road projects, solutions which combine the two, such eco-district that offers HQE buildings (high environmental quality), but which does not include the transport, and solutions clearly focused on the new paradigm, such as a program to moderate speeds throughout the agglomeration (Nantes), a bold pedestrian plan to develop pathways from a neighbourhood to another (Strasbourg), a strongly meshed network of tramways (Montpellier) ...

In short, the transition is difficult, because the proponents of both paradigms "live in different worlds". For example, while some people find it unimaginable to turn a highway into an urban avenue, the others show that the overall record of such an initiative can be largely positive[55]. Both public authorities and people are reluctant to take the plunge and commit themselves resolutely to the new path. It takes often special circumstances for resistances to break down and for shifts to take place. The change is not linear.

Sustainability is therefore a key motivation behind this work. It is crucial to propose approaches that accelerate the paradigm shift, allowing. For environmental sustainability, it is necessary to better understand the interactions between the development of buildings, urban use and the power grid and to consider new development schemes: greater use of renewable energies, transition to a less automotive city, with cleaner transportation means (electrical vehicles), facilitation of the creation of local energy communities to ensure local energy exchanges between citizens.

1.2 Planning of French distribution power networks

Utility networks eg water, waste, electricity, gas, and telecommunication systems are in the heart of economic, social, and environmental performance of modern life. They form the

most fundamental conduits through which modern cities operate. Sustainable urban planning aims at making the city more accessible. Electrical distribution grid comes then in the front line of our study as the main motivation behind this work is environmental and energetic sustainability. The following section is going to introduce the classical approach of planning power networks.

1.2.1 Brief description of the network

The electricity transmission network is meshed at the European level. The transmission of electricity is done by alternating current to a frequency of 50 Hertz in at an equilibrium supply / demand. Depending on whether production is above or below consumption, the frequency increases or decreases. For the smooth operation of all devices connected to the network, it is essential that the frequency is extremely stable (less 1% variation), which requires a near perfect balance to every moment between production and consumption. In case of imbalance between injection and withdrawal, the transmission system operator should be able to react as quickly as possible to restore the balance of the electric system .

At the current stage of knowledge, the electrical system cannot be totally constructed out of rotating machines, which are especially needed to create the shape of the wave electric. The first challenge of developing electricity networks is to connect the energy sources to the rest of the electric system, and in particular to consumers. Now these energy sources are not evenly distributed on the territory. In some cases, energy sources can be particularly concentrated and away from places of consumption (e.g. wind turbines, but also large photovoltaic park and large onshore wind sites ...). This is a challenge since the power connections require in some cases large technological development. Carrying the electricity under the sea or over great distances require for example to use direct current to reduce network losses.

While seeking to link renewable production sites the electrical system, the development of networks must aim to limit congestion episodes during renewable production peaks , which may have effects on the network stability at the local, national and European level. For this, the networks must make it possible to pool the variable productions in order to benefit from

the dynamics of geographically different wind or sunshine, as well as consumption shifts. [56-64]

This challenge goes through a reinforcement of existing networks and a denser network of the European electrical system. When the profusion of production is not enough, the networks must also be able to pool the flexibility resources of the electrical system (storage, demand management, erasures, programmable production ...). Finally, the electrical equipment of the networks must be adapted to be able to absorb large variations of renewable production and continue to guarantee the safety and quality of the supply of the electrical system

The electricity distribution networks allow carrying electricity locally. These networks are often defined by their upstream and downstream boundaries [65]: they are limited upstream by the transport network, dedicated to the transmission of electricity over long distances (interregional, national or even international scale), and downstream by the private facilities of the users of the network.

A distribution network can be seen as two parts : the medium voltage network said HTA in France, and the low voltage network said BT. In France, these two networks are distributed in three-phase, the electrical connections consisting of three phases in HTA and three phases and a neutral in BT. On the contrary to meshed transmission networks, these networks are radial and were not planned to embed electrical generation.

The interfaces between the different voltage levels are provided by transformer stations: more than 2200 source stations between the HTB (High voltage) and HTA networks and around 800 000 distribution stations between the HTA and BT networks in France [66] . These transformer stations have their functions which consist in the transformation of the voltage, the regulation of the voltage, the distribution of the energy flows and network protection. Source stations also contribute in the measurement of energy flows by counting equipment [67]. HTA network transports energy between the transmission grid and users connected to the HTA network. The BT network carries power between the HTA network and users connected in BT at 400 V three-phase or single-phase 230 V, over 692000 kilometers of electrical connections [66] . In France, the BT network is tree-shaped and not terminated, with departures generally built to be as short as possible. If there is an incident on the BT network, the supply of users

must be done manually by pulling a temporary cable from another BT start or by installing a generator. If an incident occurs at a higher level, it might mean power outage for a huge number of people and it should be identified and solved as quickly as possible. How to plan the distribution power grid?

Network planning can be defined as the anticipation of future requirements for lines, cables and substations of electrical system, in order to adapt networks to the evolutions of the system (consumption, energy mix, exchanges at borders). It concerns both the strengthening of existing infrastructure and the creation of new ones. Network planning must be optimal from a technical and economic point of view.

1.2.1.1 Economic and political criteria

Electricity is an essential component of the modern economy. The social and economic impacts of the choices made in the development of distribution network can be very important. A network delivering insufficient electrical energy may cause serious harm to users. This can, of course, influence the energy choices of the customer.

The cost of the distribution network is also an important element since it plays a large part in the cost price of the kilowatt hour. It can therefore have an impact on tariffs, which, again, may condition the choices of the customers. In addition, the performance of the distribution networks in terms of electrical losses weigh on the economy of a country, since their losses can represent a few percent of the transited energy.

The electricity sector, and distribution in particular, is an area of economic activity where capital expenditures are particularly important. This is obvious for countries in the process of electrification, but this is also true for developed nations. In France, the share of electricity distribution accounts is around 5% of the total industrial investments.

The objectives to be achieved are often difficult without making compromises and the choices that must be made are not simple, if we look at the specificities of the distribution system.

The investments are very heavy, and the savings generated by the implementation of the solutions are crucial in decision making. The lifetime of the distribution networks is very long, often over 40 years, and therefore the choices made engage largely the future. The long term is therefore to be taken consideration, but also the weight resulting from past choices.

The operation of electricity networks is complex and takes into account the interdependence of the networks and the randomness of the origin of the deteriorations. The deadlines of realization of the networks are not negligible. The weight and complexity of some networks require longer construction time. Moreover, these durations are lengthened by environment constraints (negotiation with the competent authorities, authorizations ...), therefore, deadlines for completion can be of several years, making it difficult to adapt to loads.

The investment choices of the networks are confronted with an uncertain future environment. An essential component of this environment is the demand for future consumption in a geographical location. It is obvious that the forecast of this demand can only be obtained with uncertainty. It is therefore necessary to have a strategic vision.

The purpose of planning is to look for compromises and, depending on these, to decide which means should be implemented, on what dates and in what places. One understands that the complexity of the problem needs to rely on an adapted methodological approach. Distribution network planning is well adapted to economic and technical calculation. But we can see that a lot of things are difficult to understand in a quantifiable manner: public service obligations, environmental constraints, operating constraints, etc.

In summary, it can be said that network planning's main objective is to seek the economic optimum under constraints, as part of the defined policies. The planner will therefore choose from a set of technical solutions to answer the problem, the best according to a well-defined economic criterion. This solution will have to satisfy the load constraints and the quality requirements. [68]

1.2.1.2 Economic and technical criteria

There are different criteria to make a choice between several strategies: [68]

- Return time: it is the duration T (in years) to recover the initial investment $I(0)$. It is determined by:

$$\sum_{n=1}^{n=T} B(n) = I(0) \quad (1-1)$$

where $B(n)$ is the annual benefits. It is computed to choose the investment with the shortest recovery. This criterion, which is a simple one, does not take into account investment lives and subsequent profits, and discourages long-term investments. Nevertheless, it can be interesting as an indication for an absolute estimation of the interest of a project to perform a choice between strategies.

- Return rate of a project: It is the value r which satisfies for N years:

$$-\sum_{n=1}^{n=N} \frac{I(n)}{(1+r)^n} + \sum_{n=1}^{n=N} \frac{B(n)}{(1+r)^n} + \frac{V(n)}{(1+r)^n} = 0 \quad (1-2)$$

where $V(n)$ is the residual value of installations at the end of their lifetime. This shows that the profits allow to recover the increased investments of an income at rate r . The criterion that arises is to choose the project which has the highest rate of return. To realize this project, one also requires that this rate is higher than a value set by the company. This criterion is very used.

- The discounted benefit is defined at the rate a :

$$B_a = -\sum_{n=1}^{n=N} \frac{I(n)}{(1+a)^n} + \sum_{n=1}^{n=N} \frac{B(n)}{(1+a)^n} + \frac{V(N)}{(1+a)^N} \quad (1-3)$$

The selection criterion associated with this calculation is to retain the projects having a positive discounted profit. Between two competing projects, the one with the largest discounted benefit is preferred. It can be noted that projects with a positive rate a is positive is equivalent to a profitability higher than a .

Nevertheless, the two criteria (return rate and discounted benefit) do not necessarily always lead to the same choice.

Of these three criteria, discounted benefits are generally considered the most relevant. However, this criterion involves the expected income from investments. In the case of a distribution system operator which is a public service, such as ENEDIS, the choice of a project investment is generally aiming to provide an answer in the context of a request for a fixed consumption.

1.3 New challenges for planning future power networks

1.3.1 Paradigm changes

In the years to come, the planning of distribution networks will be affected by their evolutions. Indeed, the architecture history of downstream networks, which connect centralized means of production towards consumers (Figure 1-2), gradually sets a way to a network architecture combining centralized and decentralized means of production and storage [69, 70].

Let us not forget the rapid emergence of electric vehicles which stands out as a strategic solution to face one of the greatest challenges of our future energy: the impact of transport on the environment. However, effective solutions of energy management will have to be found for the electric vehicle become a good alternative to traditional vehicles.

Electric vehicles also offer some significant opportunities to electricity suppliers, such as the increase of flexibility to prevent problems on the network. For example, the integration of electric vehicles and plug-in hybrid vehicles could prompt to build a network which would adapt to changes, with a restitution of energy from vehicle to network and management of pricing according to demand.

Following the adoption of the law on the energy transition for green growth, the present and increasing introduction of renewable decentralized energy sources and new uses (e.g. electric vehicles) has already had an impact on the operation (modification of the voltage plan and power transits, among others) and planning of distribution networks. These impacts, which

are not always beneficial, are currently under control, particularly in France, thanks to reinforcement of the network or the creation of dedicated departures. But if the insertion rate of decentralized production becomes too important, the traditional methods of planning may be insufficient. It becomes therefore necessary to change the way of planning [69] (Figure 1-3).

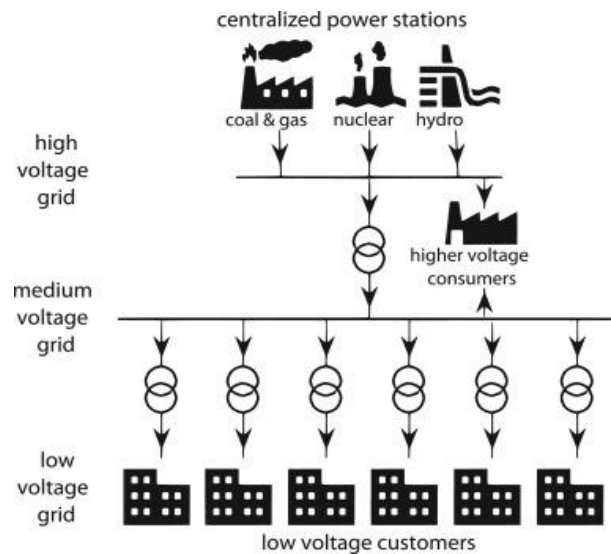

Figure 1-2: Conventional grid architecture [71]

1.3.2 Planning with variability and flexibility

The power consumption is a key element in sizing the necessary network to meet the needs of consumers. The load curve of an end consumer is the resulting from the consumed powers from the set of its electrical equipment. The sum of all load curves of all consumers in France constitutes the curve of national charge.

The balance between electricity supply and variable consumption must be strictly maintained, under penalty of collapse of the electrical system. Also, the demand varies during the day, week and year, the electrical system must respond to these variations. These adjustments can be made by modulating the production plants as well as by managing demand.

The development of variable renewable energies makes this balancing more complex. Indeed, these energies depend directly on weather conditions (sun, wind ...) that vary in time. The electrical system must now also respond to these variations of production, uncorrelated

with changes in consumption. These variations are partly predictable. But, if for example forecast errors in French wind generation for the next day are, on average, low, some errors prediction can be important in extreme situations that the electrical system might not be able to cope with. Thus, the more variable renewables production capacities are installed, the more electrical system must be able to cope with wide variations and different situations (overproduction of renewable energy compared to demand, or on the contrary very low renewable production to be compensated by the flexibility of the programmable power plants back-ups).

Experience showed that exceeding some variable energy penetration thresholds in the production mix requires adapted technological responses. These thresholds depend on the size of the electrical system. At the scale of the European continental plate, the identified thresholds are, in the state of available technologies, the following: from 30 to 40% on average of variable energies in the system: the current electrical system is experiencing instability, especially during periods of low demand and / or high variable production of renewables. From 60 to 100% on average of variable energies in the system: the operation paradigm of the electrical system changes. [72] The stability of the electrical system can no longer rely on the inertia of the rotating machines. These thresholds have been identified in many electrical systems (particularly in island systems, such as Ireland) and need to reconsider the planning of electrical networks to facilitate a massive integration of renewable energy sources.

Storage is an elegant option for planners. It can provide flexibility and fulfill different functions:

- Smooth the peaks of production and consumption at a daily and weekly pace
- Optimize energy flows both locally and globally
- Improve network stability with system services
- Compensate for inter-seasonal fluctuations in production and variable renewables and participate in decarbonizing others energies.

These functions are provided by different technologies of storage both in competition (batteries, hydrogen production by electrolysis, pumped hydroelectric energy storage ...) and complementary since their time constants and storage capabilities can meet different needs.

Experiments in progress can confirm the unavoidable place of storage in the system, at the economic level but also at the ecological and societal one. [70, 73-75]

Demand-side management (DSM) is also a way to provide flexibility to the electrical system. It consists in inviting the consumer to use less energy during peak hours, or to change the time of their use of energy to off-peak times such as nighttime and weekends. In any case, flexibility management relies strongly on information technologies.

The penetration of information technologies and connected objects (the Internet of Things or IoT) in the daily lives of consumers represents important opportunities for the operation of the system. As previously depicted, the growing share of variable renewable energies in the electrical system reinforces the need to know the state of the real-time electrical system and the need to react in very short time.

The challenge of digital technology is to push the limits of electrical systems and evolve it to fit the penetration of renewable energies and decentralized power sources. These technologies aim to optimize the dynamic management of the electrical system, which reduces the need for network reinforcement and means of production.

They improve management forecast, automatic resorption of some incidents, centralized regulation of voltage, dynamic adjustment of the reactive power of the producers ... Typically, these different smart grid solutions rely on a set of technical components:

- Sensors to know better the state of the network's quantities for time control as well as to have the production/ consumption forecasts
- Collected data processing and transmission equipment for decision support
- Communicating meters
- New software functions for real time supervision and control
- Network simulation tools, ...

The implementation of these technical components in electrical infrastructures makes it possible to control the flexible energy resources and flows on the network with a more precise time step and a spatial resolution. Digitalization should allow more flexibility of the operation of the distribution power grid at local scales (by regulating nodal voltages for instance or

reducing the power through a line) and at global scale by facilitating the balance between production and loads.

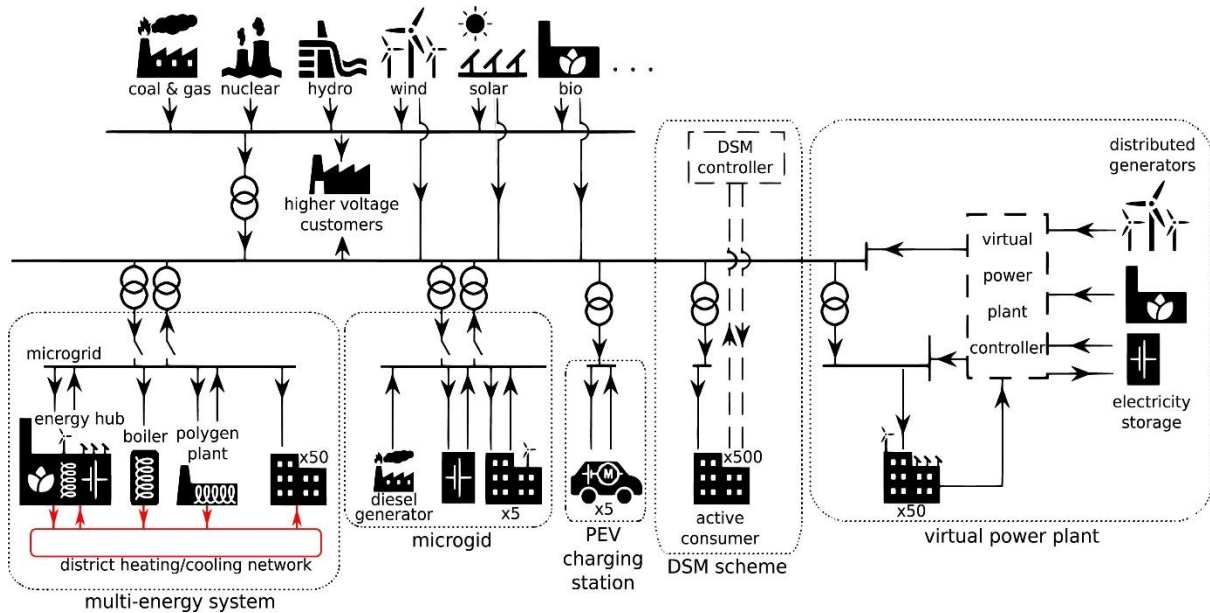

Figure 1-3: The energy landscape emerging through smart grid and urban energy system concepts [71]

1.3.3 Planning with complexity

Distribution power network is one element of the whole city's energy system, together with gas and heat facilities. It is also strongly connected to other infrastructures such as water and ICT systems. According to [76] there are three types of physical representation of the complexity of urban energy systems as shown in Figure 1-4: Figure 1-4.

The first is the thermodynamic model. This one considers the energy flows and materials entering the city to be transformed within it to produce work and inevitably garbage. These processes of energy transformation are regulated by the first two principles of thermodynamics. The first principle states that during a transformation of a closed system, the energy is conserved, the internal energy of the system being exchanged with the external environment under form of heat and work. According to the second principle, the entropy (the disorder) increases during the transformation of a thermodynamic system.

The second model is based on an analogy of the functioning of the city with the metabolic activity of living organisms. According to this vision, the city ingests resources that circulate throughout its territory according to distribution networks to use them before disposing of them. Analyzing urban metabolism comes therefore down to identify the incoming and outgoing material flows of the city, those stored there and all transformations undergone by these flows within the urban system [77].

The third mode of representation is a systemic view of the city energy system. It is made of a large number of interconnected components in multiple ways.

Each of these visions allows to highlight important characteristics of urban energy systems:

"First, the structure of urban energy systems emerges from the bottom-up. The activities of individual citizens create demands for energy services infrastructures in order to supply them. This sets up the dynamic of urban metabolism, the city importing energy resources and expelling wastes in order to maintain order and function. The laws of thermodynamics can be seen to govern these processes, for example, highlighting the open nature of the urban boundary and the inexorable loss of energy the steps of the energy systems. " [76]

Keirstead [76] proposes to define an urban energy system as "the combined processes of acquiring and using energy to satisfy the energy service demands of a given urban area ", i.e. as the whole process of the acquisition and use of the energy needed to meet energy needs of a given urban area.

Besides the energy functioning of the city, the interactions between its physical reality (location, urban forms, materiality, etc.) and energy flows, we must take into account the wide variety of actors participating in energy behavior of the urban environment: consumers, decision makers, industrial users, network managers, etc. Grenier [78] shares the idea that the diversity of actors concerned with the issue of energy in cities reinforces the complexity.

Given the complexity of urban systems, Maizia [79] believes that "it is currently impossible to propose a model of an integrated urban system that would reconstitute all the

articulations existing between all the phenomenologies concerning the environment and between all the physical and socioeconomic characteristics of the urban system ".

The complexity of the urban environment and its influence on the nature and form of the systems are still too much neglected by the actors in charge of these systems [80]. While energy research is starting to take into account the specificities of urban environment, the opposite is not common. Rutherford & Coutard [80] noticed from a keyword search in the Urban Studies and Energy policy journals, that a large number of publications in energy policy focus on the urban environment and its specificities and that few publications on the city in urban studies refer to the question of energy.

According to Magnin [81], energy policies must consider the urban energy system in all its complexity if they want to be effective: "a low-energy urban system, it is not a collection of powerful posed (buildings) or rolling (vehicles) objects on a territory. It is a complex set of relationships between multiple objects ". Planners shall take into account this complexity to reach the best solution for every one.

1.4 Conclusion

Urban planning is moving more and more towards an integrated design with the purpose of considering the whole interactions in the city between all urban objects.

Following this movement, the present thesis is motivated by:

- Integrating more complexity in the understanding of the interactions between land use and urban networks.
- Studying the multiscale characteristics of urban territory and their interactions.
- Hence, facilitating energy sustainability by a better comprehension of the scaling relationships inside the electrical energy system.

We begin with a first step on delimited simplified objects: the city is seen as a 2D urban footprint and the consumption is aggregated by zone (it will be specified later in Chapter 3), in order to understand the relations between roads, buildings and the power grid. This will lead to

explore the relations between the structure of the network and its electrical performances using tools based on fractality.

It became crucial to reconsider the structure of the power grid in order to optimize their operations by making them more flexible and resilient. To be able to propose new architectures, which meet optimality criteria, e.g better service, lower costs and minimized power losses, it is important to understand the behaviour of the existing power grid across scales. Another objective of the following study is to verify the existence of hierarchical scaling laws in spatial distributions and physical properties of the distribution power grid. Here, the core case study is the medium voltage distribution grid at city level.

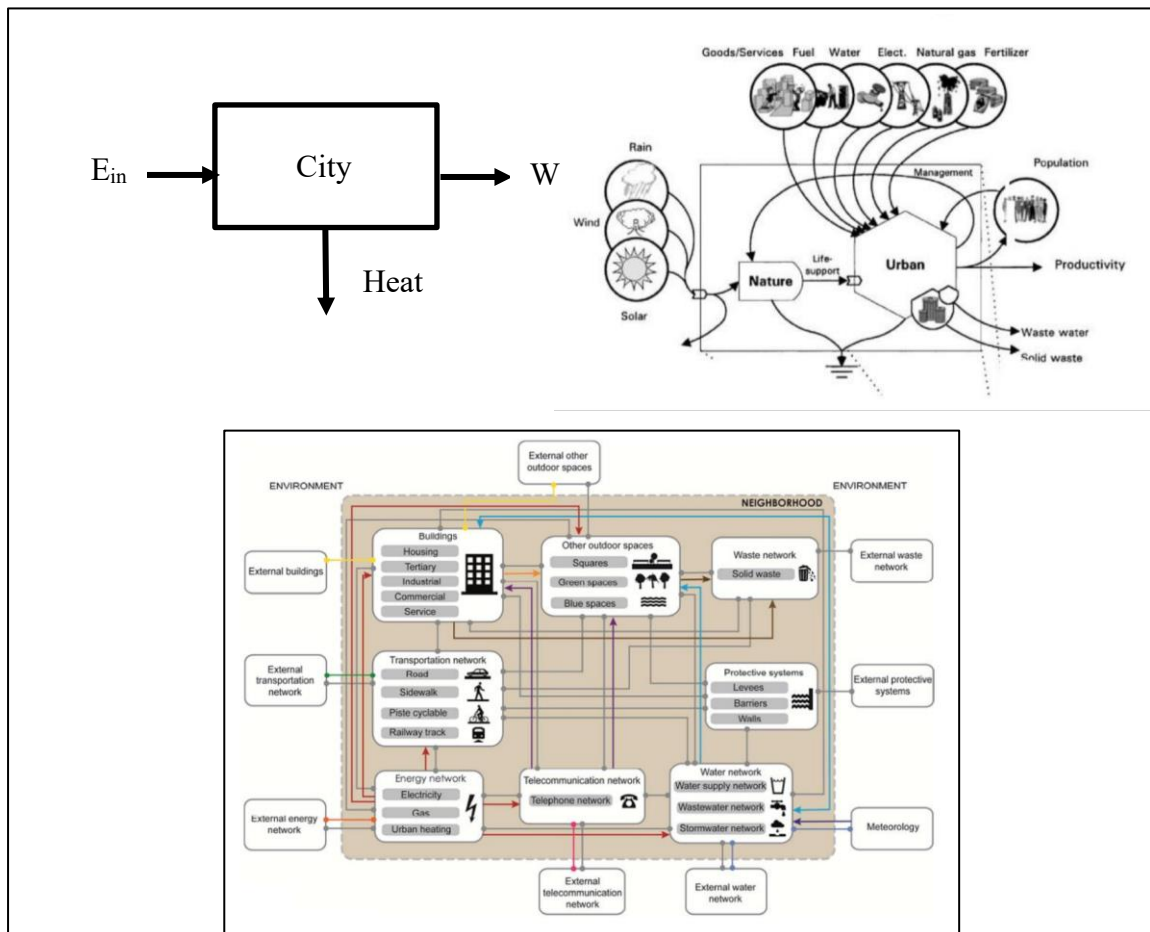

Figure 1-4: Energy flow in cities: thermodynamic model, metabolic model, systemic model [76, 82, 83]

Chapter 2 Fractality as a tool to understand the complexity of the urban energy system

A power grid has many interacting entities, sometimes with different objectives and specific constraints related to their location or their nature [70]. Power grids are complex networks and their planning over an urban territory must verify a variety of economic and technical criteria with the main objective of providing sustainable energy to end users. In this chapter, we define complex systems and the theories related to their study and analysis. We focus afterwards on the complexity of the power grids and the classical approaches as seen in the literature, their limitations as we move towards introducing the fractality as a new way to study and analyze power networks.

The chapter aims to shed light on fractal theory as introduced historically in physics but also more specifically as a way to study cities and urban networks [82]. We have a general look at the methods, either mono or multifractal, as introduced in the literature. They will be later adapted to analyzing Grenoble's power networks in chapter 3 and 4.

2.1 Understanding the complexity of urban networks

2.1.1 Complex systems and their study

Before being able to study the functioning and space dynamics of the power grid, which will help us explore the relations between the urban territory, its structure and electrical performances, we need to define and understand complex systems. According to the New England Complex Systems Institute, complex systems are a field of science studying how parts of a system give place to a collective behavior (emergence); and how the system interacts with its environment (self-organization), without a central controller.

A complex system adapts to external or internal pressures to maintain its functionality and stability. It is important to distinguish emergence and self-organization. Emergence is defined as the evolution (addition, deletion, modification) of a new internal property under the effect of internal and external constraints. Self-organization refers to the dynamics of the system in order to maintain its functionality. [83]

Examples of complex systems are the gene networks that drive development processes, immune networks or neural networks. Social networks, transportation, public or economic services are also considered as complex systems.

2.1.2 Complex systems theories

The study of complex systems is related to many theories as shown in Figure 2-1. The following description is not exhaustive but aims at showing the extent of the usual theories in the modeling of a complex system. [84]

- Nonlinear dynamics or dynamics of groups: A group is composed of at least two individuals linked by a relationship. Because of this interaction and its induced influence, a group develops dynamic processes differentiating them from a random configuration. Group dynamics study behavioral cycles, their evolution and stable and unstable states.
- Game theory: it is a field of mathematics which aims to establish and study the principles and mathematical rules that may interfere during a strategic interaction between multiple decision-makers. In a large number of decision-making problems, at least the first two of the following aspects are present: there are at least two decision makers; there is an interaction between decisions where the final outcome for one of the decision-makers depends not only on the chosen action but also the actions chosen by other decision-makers; there is one or more elements of uncertainty. One of the goals of game theory is to first provide mathematical models. These models try to synthesize all the elements which describe the interactions and then introduce solutions to describe the possible outcomes of a

game, and apply these tools to better understand the phenomena but also to predict the consequences of a strategic interaction.[85]

- Collective behavior: it refers to an action, a process or an event which that emerges spontaneously in a group. For example, a colony of birds move in unison, but there is no undisputed leader or global controller. Therefore, how do bird interactions follow each other to produce the overall movement? Similar questions arise when looking at ant or bee colonies, cellular interactions, and human economy. We can also refer to Haken Synergetics which explain the self-organization of patterns .
- Theory of networks: In different technical fields (computer science, telecommunications, energy, roads, water transport, etc.), a network is an ensemble of linked nodes to exchange information, share resources, to transport matter or energy. Nodes can have complex functions of distribution, concentration, enrichment... The theory of networks classifies these according to their geometrical configuration (small-world, random, scale invariant ...), but also the necessary properties for the good functioning of the network (resilience, communication).
- Evolution and adaptation: In biology, adaptation is defined as the modification of an anatomical character, a physiological process or a behavioral trait in a population of individuals under the effect of natural selection. In general, adaptation is the transformation of an entity leading to greater adequacy with external, environmental variables. A system must therefore have sensors to analyze, understand and make a decision. The evolution refers to the notions of learning, which means that the system can modify its internal mechanisms to better respond to constraints. Evolution and adaptation are universal phenomena since any system seeks to minimize its losses, be it energy, money, or whatever. Many optimization algorithms are based on these notions, such as the genetic algorithm that replicates the mutation and gene selection giving the best results.[86]
- Formation of schemes: Any organized element depends on mathematical schemes. Whether in computer science or physics, almost all the systems have structural schemes. Schemes depend on spatial properties. These are usually defined by statistics and the topology. The analysis of the evolution of mathematical schemes is essential in the prediction of the evolution of the system.

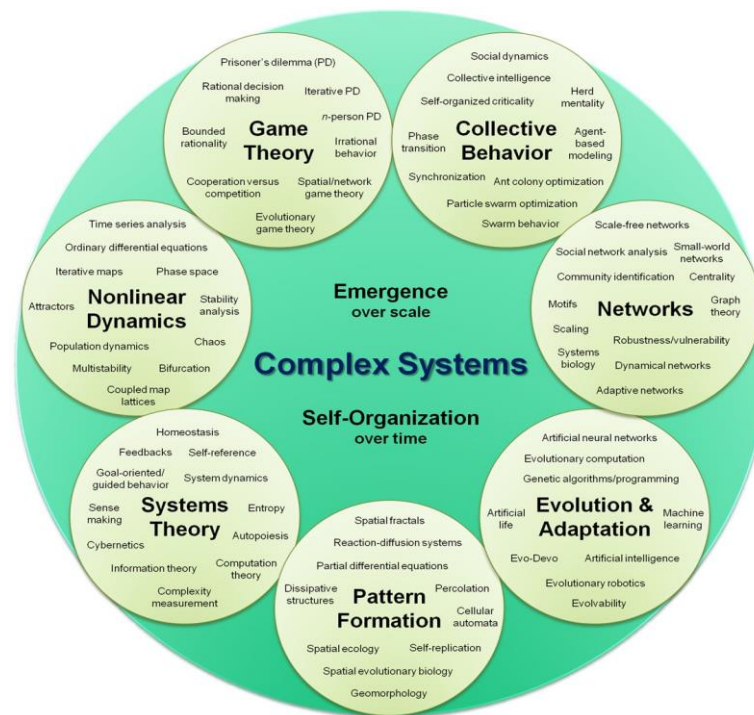

Figure 2-1: Complex systems theories [87]

2.1.3 Approaches to analyze the complexity of power networks

Let us now break down the previous complex system theories and their application to power systems.

- **Nonlinear dynamics or dynamics of groups:** Power grids allow the control of electrical flows between upstream production and downstream consumption. In order to keep a normal state of operation within the power system, there is different controls that assist in maintaining it: generator controls (automatic voltage regulator, power system stabilizer, speed governor, energy supply system controls), transmission system controls (voltage regulating transformers, synchronous condensers, static var compensators, reactor and capacitor switching), system generation control (load-frequency control with economic dispatch). [88-91]
- **Game theory:** Power systems include various stakeholders such as generation companies, grid operators, distribution utilities, and auxiliary service providers. This leads to different optimization targets (including production cost, emission reduction,

security enhancement), and uncertainties (resulting from renewable power generation and contingencies). Implementing a reliable and optimal solution depends on having solid mathematical tools to make scientific decisions at different levels from planning, operation, and control. Game theory is used to reach the said optimization targets in different areas of power systems studies: power market, power system dispatch, micro-grid and power system security. [92-95]

- **Collective behavior :** Power grids are complex and large-scale systems with nonlinear dynamics. Local instabilities might trigger failures and sometimes at a much important level wide-spread blackout. Detecting and managing these instabilities are among the biggest challenges of power systems. With higher integration of renewables, which are highly stochastic power sources, there is an increasing number of transient disturbances. An important form of power network stability is the so-called transient stability, which is “the ability of a power system to remain in synchronism when subjected to large transient disturbances such as faults or loss of system components or severe fluctuations in generation or load” [96, 97] . Transient stability problem is considered as a specific case of the more general synchronization problem, which is defined over a possibly longer time horizon, for non-stationary generator rotor angles, and for generators subject to local excitation controllers aiming to restore synchronism. The second-order Kuramoto oscillators has been widely used to describe the dynamics of coupled rotating machines, generators, and motors and therefore study synchronization problems within power systems. [98-100]
- **Theory of networks:** Ever since G. Kirchoff published his work where he uses graph theory to model and characterize electrical networks, graph theory has been used in electrical network theory and analysis. One of the main applications of graph theory is analysing the vulnerability of power networks: reliability of the grid under attack, cascading failures [89, 101-103]. More recently, spectral graph analysis gained attention as a powerful method to asses line outages and define vulnerability indexes. [103-107]
- **Evolution and adaptation:** We can note the classical optimization problem of power networks: the optimal power flow, which objective is to minimize the cost of generation

under equality constraints i.e. load generation balance and inequality constraints i.e. network operating limits (line flows, voltages).

- Formation of schemes: Percolation based analysis is a prominent tool to study blackouts as there is more and more recent work on large scale failures of power systems using this method [102, 108-110].

Within this approach of analyzing complex networks, fractality gained importance in recent years as a way to understand the multi-scale behavior of power grids. [15, 111-115]

2.1.4 Introducing fractals as a new tool to analyze power networks

Power systems are supposed to become in the future more and more scaling because they are made of recursive assembly of active devices, smart buildings, micro-grids, district grids (Figure 1-2, Figure 1-3). Studying the relationships of the power grid with other networks (ICT, gas, water...) within the urban structure is also getting more attention as part of planning more sustainable, energy efficient future cities [14, 116, 117].

Classical approaches used to investigate power systems are mono scale; hence they fail to comprehend complex systems with structural elements often belonging to different scales. Understanding this complexity helps design flexible and resilient architectures for the optimization of smart grids operations. This is a major challenge to increase efficiency and to avoid or better manage random breakdowns.

Moreover, at an urban level, power networks provide energy access to buildings. Their spatial development should thus be correlated to built-up patterns. We may as well expect that power networks go through existing corridors, which means here the street networks. Therefore, it seems interesting to explore to what extent the current power grid fits the existing built-up spaces and road network. This will lead to a better perception of how the current power grid spatial coverage is with regard to the road network. These results would ultimately be used to propose a reconfiguration of the existing urban structures but and also a new architecture for future planning of urban districts.

Traditional approaches such as complex networks theory [118] fail to consider geometrical, functional and dynamical aspects of a city and its associated networks at the

same time [119]. Hence, we carry out a fractal-based approach to analyze the properties of power systems and understand their organization across scales.

The following section introduces the fractal theory as seen in the literature and its application to understand the complexity of urban networks and later on of power grids.

2.2 Fractal analysis of urban territory

2.2.1 Why using fractality to analyze urban networks?

Fractal geometry has been widely and rather successfully used for over twenty years in disciplines like meteorology, biology, physics, thermodynamics, art, history, philosophy of seismology but also in geography [120]. While considering urban fabrics, fractal analysis turned out to be a powerful instrument for exploring their spatial organization [9, 13, 82, 121-124]. Public transportation networks were considered as well [125, 126] and showed a connection between both built-up spaces and street networks [11].

Urban fabrics and related networks are usually not issued from any coherent planning process and show no obvious organization. However, they are deeply multiscale, reaching the metropolitan scale of buildings. Hence, using fractals seems to be an interesting way to characterize these forms and unravel the complexity of underlying layers, which is a step further than classical approaches.

The fractal approach is geometrical, which makes it possible to study spatial phenomena either by using reference models or morphometric fractal measurements. By using fractal measurements, we can verify the existence of hierarchical scaling laws in spatial distributions. Being able to study a phenomenon throughout different scales provides the possibility of discovering thresholds or breaks within spatial organization. A morphological classification of networks becomes possible as this approach highlights the internal organization which does not appear using other approaches.

Beyond analysis, fractality may be used for planning. Indeed, the main function of networks is to connect the urban fabrics to a service as optimally as possible. Their topology must therefore ensure to get the service to as much of the urban fabric as possible, which could mean lengthening of paths. In the meantime, to minimize the overall length of the

network, they are spatially organized according to a hierarchical system of ramifications. This reminds the basic properties of fractals [127].

Beyond current methods used in fractal analysis, we use a specific method introduced in [11]: the concordance analysis that allows exploring how spatial organization of various interconnected systems follows the same logic across scales.

2.2.2 Basic introduction to fractality

Fractals describe a set which can't be described using the traditional geometry either locally or globally and shows some form of approximate or statistical self-similarity. [128]

Fractal geometry is based on the repetition of a principle over interlocking scales [1].

If this repetition is strict (e.g. in the case of a deterministic fractal), two elements are enough to characterize a fractal:

- The shape of the basic structure, called initiator or initial figure. It is usually a Euclidean geometric object: a square, a circle, but also any figure. The initiator plays a minor role in the fractal theory. It represents the Euclidean part in a fractal object, because it shows whether an object resembles rather a square, a circle and so on.
- The repetition rule that generates the hierarchical spatial system is referred to as the generator of the fractal. Its characteristics are crucial for fractal morphological descriptors, and most particularly fractal dimensions. The generator defines how the self-repetition occurs across scales.

The fractal is obtained by applying the generator iteratively. We therefore distinguish different stages of iteration. At each stage, the generated structure consists of replicas of the initial figure that we designate as the elements or occupied elements of the structure. We denote all these occupied elements as the occupied mass of a fractal at a given iteration stage.[9, 10, 12, 129]

Figure 2-2 shows the first iterations of the construction of a Sierpinski carpet. The logic of this fractal as introduced in literature [1, 10, 12] is the following: the initial figure is a square

of a given length L . This is reduced by a factor $r = 1/3$ and $N = 5$ squares of length of $l_1 = rL = 1/3 L$ are placed according to a chosen disposition. This is the generator. In the next step, each square of length l_1 is replaced by N squares of length $l_2 = r l_1 = 1/9 L$. For the following steps, the same procedure is repeated and for a step n the length of the squares is equal to $l_n = r^n L$. This rule of construction confines the Sierpinski carpet within the initial square of length L .

The surface of this object is then:

$$A_n = N_n \cdot (l_n)^2 = \left(\frac{5}{9}\right)^n \cdot L \quad (2-1)$$

As $5/9 < 1$, the surface tends to zero as we continue the iterations.

Figure 2-3 shows another iterative construction of the Sierpinski carpet which follows more the logic of urban growth [9, 130]. We start from a square of length L , but we add other squares around this initial figure. In this example, four squares of length L were placed on the four sides of the initial square. The generator is composed of $N = 5$ squares arranged in a cross. In the next iteration, the same aggregate is added on each side of the cross, the fractal spreads consequently progressively in space. If we consider that the sequence of iterations represents different stages in the gradual spreading of an agglomeration, we can give this model an urbanistic interpretation.[9]

The underlying logic of Fournier's dust as shown in Figure 2-4: Fournier dust is close to Sierpinski carpets although the elements of this fractal are not connected. The number of aggregates M_i increases over the iterations according to a geometric law: $M_i = N^i$ unlike the Sierpinski carpet which consists of a single aggregate. [10]

This type of model can serve as a reference to study two types of space systems: at the scale of the urban district, the islets are separated by roads and organized in a hierarchical fashion as shown in the left of Figure 2-4. This structure resembles the plan of a neighborhood. Then, in the right of Figure 2-4, the elements appear to be placed in a way to keep a large empty space in the heart of a city, a sort of central park or other recreational area. [9, 12, 130]

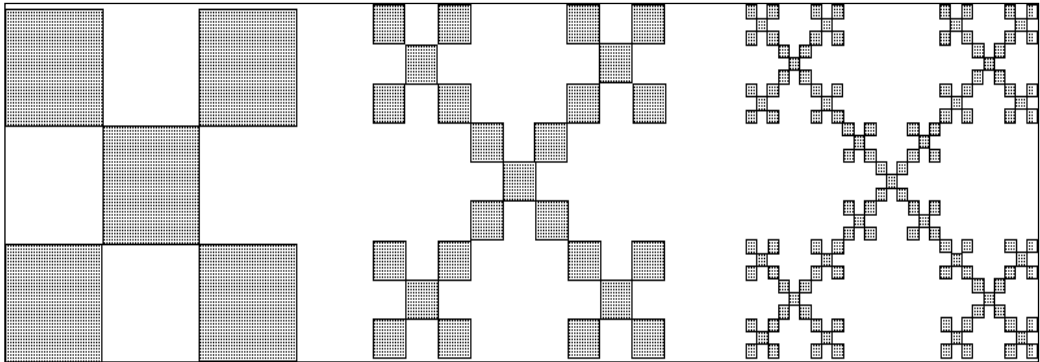

Figure 2-2: First iterations for the construction of a Sierpinski carpet

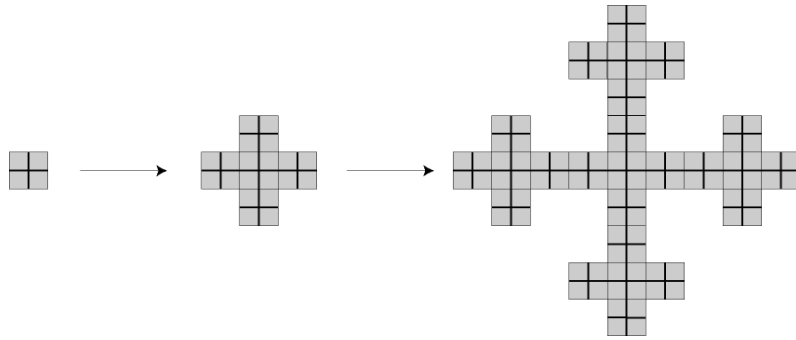

Figure 2-3 : Sierpinski carpet using a different initiator and generator

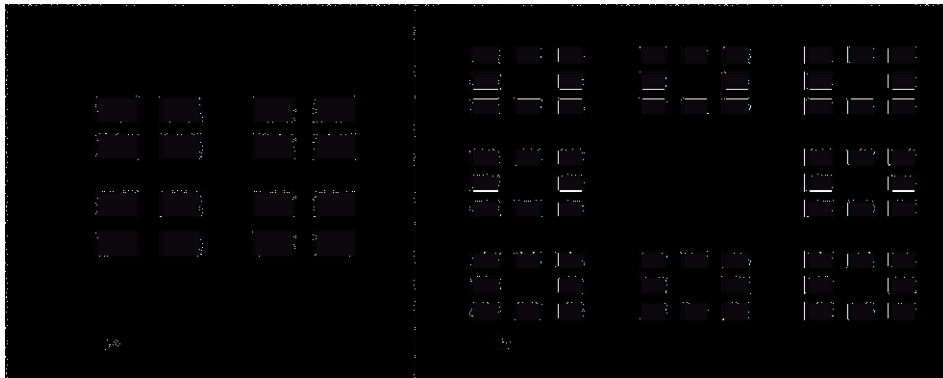

Figure 2-4: Fournier dust

2.2.3 Fractal dimension

Fractals show a form of self-similarity. By zooming in or out from the structure, we find the same shape. This means, that while considering an arbitrarily chosen zone of size L of the object, the number M of its elements (e.g. points or network length lying within this zone) scales according to a power law :

$$M(L) = L^{D_0} = M_0 \quad (2-2)$$

D_0 is also called the self-similarity dimension, meaning that, at different scales (as one zooms in or zooms out from the fractal), part of the fractal object is similar to the whole object.

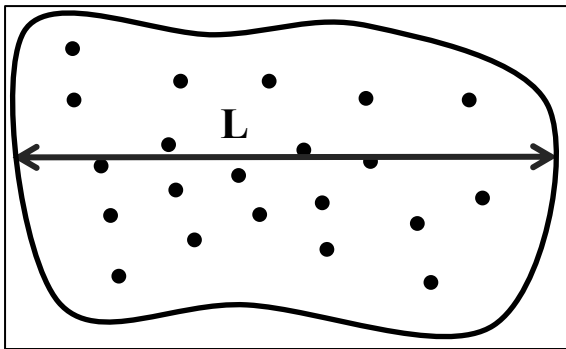

Figure 2-5: Illustration of a random object

2.2.4 The box counting method

The box counting method is one of the most commonly used methods to measure the dimension of fractal objects. In order to explore the distribution of the constitutive elements of the structure across scales, boxes of size ε are used to cover the objects as shown in Figure 2-6. For each value ε we count the number $N(\varepsilon)$ of non-empty boxes of side ε needed to cover the object of length L . For fractal structures the relation holds: $N(\varepsilon) = a \varepsilon^{-D_0}$ where $\varepsilon \rightarrow 0$. Taking the logarithm of the relation yields $\text{Log } N(\varepsilon) = \log a - D_0 \log \varepsilon$, a being the fractal measure of the object, which is often called the ‘shape prefactor’ [124, 127]. Hence, by logarithmic transformation, we obtain a linear relationship where the slope value is the fractal dimension D_0 [2, 129]. When assuming a discrete series of values ε_i , we obtain:

$$D_0 = - \frac{\log N(\varepsilon_{i+1}) - \log N(\varepsilon_i)}{\log \varepsilon_{i+1} - \log \varepsilon_i} \quad (2-3)$$

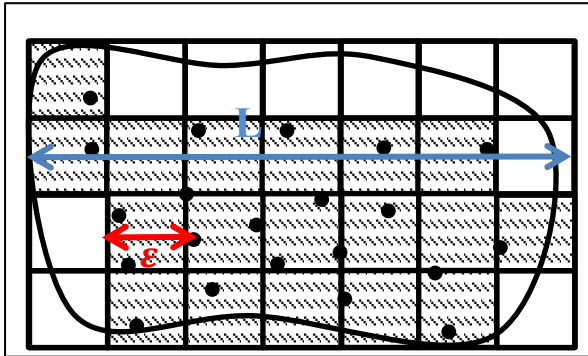

Figure 2-6: Illustration of the box counting method

This method allows the minimum coverage of a structure by covering each occupied point of a square of variable size ε . However, if two points are located at a distance less than ε , only one box is kept. Theoretically, this method corresponds exactly to the claim of the minimum coverage and which defines the Hausdorff dimension [1, 10, 131, 132]. This is the main reason why it was preferred in this study. However, this logic of counting is hard to reproduce in a software and the reliability of the programmed method could be questioned as shown in Figure 2-7. The coverage in the figure at the left shows 7/9 filled boxes while the minimum coverage is 2/9 filled boxes. This issue is considered in the software FracGis, which is used for this work and will be introduced later on in the next chapter, as we can use a gliding coefficient to adjust the grid to measured object.



Figure 2-7: Illustration of the box counting method (left: random coverage / right: minimum coverage)

2.2.5 The cluster growing method

A rather more adapted fractal measuring method to networks is the clustering method. This method is used to determine the dimension of a fractal distribution by computing the mass M of the structure which is inside a cluster of size r , centred around one point of the object.

This mass scales such as $M \propto r^D$. Its logic reminds the situation of an observer who is placed in a given place and who progressively widens their field of vision. It has therefore analogies with our perception of space [133]. If we choose a bi-logarithmic representation of the results, this aspect is reinforced since it brings out more the phenomena close to the counting centre, while globalizing the information on more distant zones. It is well adapted to the study of centred structures.

For a homogeneous fractal distribution, the mass surrounding each point of the distribution is arranged in the same way, which means that within a sphere of radius r centered on x_i , the mass $M_{x_i}(r)$ fluctuates very little around its mean value $\langle M_{x_i}(r) \rangle$. This method will be used in chapter 4 to determine the multifractality of networks.

2.3 Multi-fractal analysis

One could not only measure the number of non-empty boxes but physical quantities such as the mass, the conductivity, voltage drops, etc. Hölder's theory allows to study the singularity of these measurements in different points of the fractal object.

As it is usually complicated to find the uniformity in every single point, we define the singularity spectrum, which gives for every singularity value, the dimension of Hausdorff of the set of points with the same singularity (Hölder exponent) .

Let M_i be the measure inside boxes i . For clarity purpose, in this section, it is related to the mass, i.e. the number of elements of the object inside the boxes. The probability $\mu_i = \frac{M_i}{M_0}$ (M_0 is the total mass), varies as a power law of ε^{α_i} , ε is the box size and α_i the Lipschitz-Holder exponent (also known as singularity exponent), which characterizes the singularity inside the box i . The number of boxes $N(\alpha)$, in which the singularity is between α and $\alpha + d\alpha$, follows the equation: [134]

$$N(\varepsilon, \alpha) \propto \varepsilon^{-f(\alpha)} \quad (2-4)$$

$f(\alpha)$ is the fractal dimension related to the α singularity- sets of points of the structure. Its plot with respect to α is called the multifractal spectrum.

For urban planning, Figure 2-8 shows an example of a multifractal Sierpinski carpet. A square which covers the entire urban is the initiator of the multifractal urban system. The generator then transforms the initial square into a central square and 4 surrounding smaller squares and a hierarchical level of urban centers appears at each iteration step. The generator contains two hierarchical levels. [135]

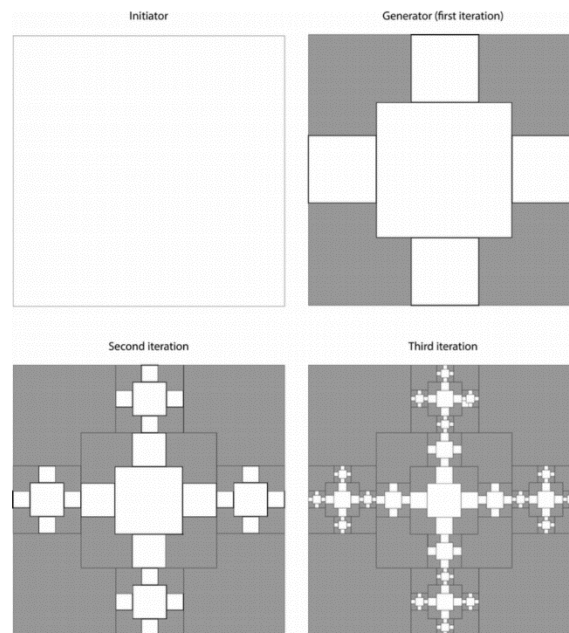

Figure 2-8: Iterative generation of a multifractal Sierpinski carpet [135]

2.3.1 The generalized dimension

Multi-fractal objects can also be characterized using the generalized dimensions, defined as:

$$D_q = \frac{1}{q-1} \frac{\log \mu(q, \varepsilon)}{\log(\varepsilon)} \quad (2-5)$$

$\mu(q, \varepsilon)$ is the q th moment defined as [134] :

$$\mu(q, \varepsilon) = \sum_{i=1}^{Nb} \mu_i^q \quad (2-6)$$

i is the index related to the boxes of size ε used to cover the fractal object.

For $q = 0$, $D_0 = \frac{-\sum_{non\ empty\ boxes} 1}{\log(\varepsilon)}$, which is the box counting dimension.

For $q = 1$, D_1 is computed as follows :

$$D_1 = \lim_{q \rightarrow 1} \frac{1}{q-1} \lim_{\varepsilon \rightarrow 0} \frac{\log \mu(q, \varepsilon)}{\log(\varepsilon)} \quad (2-7)$$

One could write : $\left(\frac{M_i}{M_0}\right)^q = \left(\frac{M_i}{M_0}\right) * \left(\frac{M_i}{M_0}\right)^{q-1} \cong \frac{M_i}{M_0} \left(1 + (q-1) \log\left(\frac{M_i}{M_0}\right)\right)$, then:

$$\begin{aligned} \log \mu(q, \varepsilon) &= \log \left(1 + \sum_{i=1}^{Nb} \frac{M_i}{M_0} (q-1) \log\left(\frac{M_i}{M_0}\right) \right) \\ &\cong (q-1) \sum_{i=1}^{Nb} \frac{M_i}{M_0} \log\left(\frac{M_i}{M_0}\right) \end{aligned} \quad (2-8)$$

Therefore:

$$D_1 = \lim_{\varepsilon \rightarrow 0} \frac{1}{\log(\varepsilon)} \sum_{i=1}^{Nb} \frac{M_i}{M_0} \log\left(\frac{M_i}{M_0}\right) \quad (2-9)$$

D_1 is called the information dimension as $\sum_{i=1}^{Nb} \frac{M_i}{M_0} \log\left(\frac{M_i}{M_0}\right)$ represents the information entropy of the distribution for which D_1 describes the scaling law.

2.3.2 Multi-fractal spectrum

To calculate the q th moment of the measures $\mu_i \propto \varepsilon^{\alpha_i}$, the sum is done over α instead of i .

$$\mu(q, \varepsilon) = \int N(\varepsilon, \alpha) \varepsilon^{q\alpha} d\alpha \quad (2-10)$$

According to (2-4):

$$\mu(q, \varepsilon) \sim \int \varepsilon^{-f(\alpha)} \varepsilon^{q\alpha} d\alpha \quad (2-11)$$

For small ε (fundamental assumption for fractal studies), the integral is dominated by the smallest exponent of ε . It is:

$$\tau(q) = \min_{\alpha} (-f(\alpha) + q\alpha) \quad (2-12)$$

Then:

$$\mu(q, \varepsilon) = \varepsilon^{\tau(q)} \quad (2-13)$$

We note with $\alpha(q)$ the value α for which the minimum is obtained.

As such, when $\alpha = \alpha(q)$, it verifies:

$$\frac{d}{d\alpha} [q\alpha - f(\alpha)] = 0 \quad (2-14)$$

and:

$$\frac{d^2}{d\alpha^2} [q\alpha - f(\alpha)] > 0 \quad (2-15)$$

Thus:

$$\tau(q) = -f(\alpha(q)) + q\alpha(q) \quad (2-16)$$

From equation (2-16) we have:

$$q = \frac{df(\alpha(q))}{d\alpha(q)} \quad (2-17)$$

And from equation (2-17):

$$\alpha(q) = \frac{d\tau(q)}{dq} \quad (2-18)$$

2.3.3 Cluster growing method to analyse multifractality

For a finite object of size L , the mass in a cluster of radius r at point x_i is [131, 134]:

$$M_{x_i}(r) = \frac{1}{L-1} \sum_{\substack{j=1 \\ j \neq i}}^L \theta(r - \|x_j - x_i\|) \text{ with } \theta(x) = \begin{cases} 0 & \text{if } x < 0 \\ 1 & \text{if } x \geq 0 \end{cases} \quad (2-19)$$

The q th moment is defined by:

$$\langle M(r)^{q-1} \rangle = \frac{1}{L} \sum_{i=1}^L M_{x_i}(r)^{q-1} \quad (2-20)$$

Therefore, the generalized dimensions are defined as:

$$D_q = \frac{1}{q-1} \frac{\log(\langle M(r)^{q-1} \rangle)}{\log r} \quad (2-21)$$

This approach will be applied in Chapter 4 for multi-fractal analysis of power networks.

2.4 Conclusion

In this chapter, fractality analysis was introduced. This theory stands for the study of the self-similarities within the behavior of any complex system. The following chapters are going to present the application of this theory to the city. Both analysis methods, i.e. box counting and cluster growing, are going to be used, the first in Chapter 3 within the frame of the FracGis software to complete the spatial analysis of Grenoble's urban area and the second in Chapter 4 as part of exploring the multi-fractal properties of distribution power grids.

Chapter 3 Concordance analysis of the distribution power grid of the city of Grenoble

Self-similarity does not strictly exist in empirical fractals. The forms we observe are not identical when scaling as for theoretical fractal such as the Sierpinski triangle. Generally, they are only statistically similar. On the other hand, many fractals observed especially in geography are scale invariant, but simply observing these objects rarely allows to claim that they are self-similar. [136-138]

The coherence between the distribution grid and urban territory is still to be investigated and has been raising more interest due to the needs for optimal solutions to deliver power to urban areas [15]. The coverage of the urban space by the power grid results from the objective of delivering power at any point of the city while lowering the cost and maximizing the quality of service. The power grids are also installed in sections that follow the city roads. A high coherence is therefore expected between the power grid and the roads.

The indices of the concordance between the power grids and urban systems will give us a metric to assess how coherent the system is with the urban territory it is covering. They are obtained by a fractal analysis of the MV distribution power system, roads network and built-up patterns in the city of Grenoble. We present the necessary tools to analyze the fractality of the power grid. We show the importance of using carefully data sets from different sources and how it could sometimes make major differences ahead of further use. We compare the fractal indices of the power grid to those computed on the spatial organization of the buildings and the road infrastructure. We assess the fractal dimensions and the curves of scaling behavior and conduct a concordance analysis. We investigate different districts within the city of Grenoble and supplementary results are given for another region of East France at the end of the chapter.

3.1 Scaling behaviour and concordance analysis

For a theoretical fractal, the fractal dimension D_0 is strictly the same all over the scales. However, real world objects do not follow strictly a fractal law. To explore efficiently if deviations from the fractal law exist, we use the curve of scaling behavior, [2, 13]. For this purpose, we compute for each value of the measuring step ε_i the slope values in the double logarithmic representation, according (3-3), and obtain then a local scaling exponent $\alpha(\varepsilon_i)$. Obviously, it is constant and equal to D_0 for theoretical fractals, what does not necessarily hold for empirical structures. Hence, by representing the sequence of these slopes as a function of ε_i , we obtain the scaling behavior $\alpha(\varepsilon_i)$, which variations informs us about changes in the fractal behavior of the analyzed structure across scales.

For large values of ε , the scaling behavior will provide a look at the scale behavior of the structure at global scale. Let's take the example of the scaling behavior for built-up areas, for global analyzes [9], the curves of scaling behavior decrease at the beginning then they often reach a plateau, so the values $\alpha(\varepsilon)$ remain fairly constant as soon as one exceeds a distance ε . High values appear at the beginning if the studied zone contains large buildings, for example factories. On the other hand, lower values will generally refer to the dimension of elements (points, lines, surfaces...) that constitute the investigated structure.

In order to assess the coherence between the analyzed objects, we compute the ratio of their scaling behavior, e.g. linking built-up space (*build*) to a network (*net*) yields:

$$\beta_{build/net}(\alpha_i) = \frac{\alpha_{build}(\varepsilon_i)}{\alpha_{net}(\varepsilon_i)} = \frac{\log N_{build}(\varepsilon_{i+1}) - \log N_{build}(\varepsilon_i)}{\log N_{net}(\varepsilon_{i+1}) - \log N_{net}(\varepsilon_i)} \quad (3-1)$$

We call this type of representation the concordance analysis [11]. It shows to what extent both the objects follow the same logic of covering space at each scale. The ε values becomes equal to one if the logics are the same.

3.2 Tools to analyse the fractality of urban networks

3.2.1 The software FracGis

FracGis was developed by Gilles Vuidel, Cécile Tannier and Pierre Frankhauser at ThéMA laboratory (University of Franche-Comté – CNRS). It is a software application for analyzing 2D texture by fractal theory. It runs on any computer supporting Java Virtual Machine[139]. FracGis, as shown in Figure 3-1, uses a variety of methods (box counting, correlation...) to measure the fractal dimension which corresponds to either Hausdorff, box counting, correlation... [10, 11, 130] depending on the method one choses to use. The measure process is carried out in two part: the counting method and the estimation module.

In this chapter, the fractal measures were conducted using the box counting method. Our tests have shown that this measurement methods shows some reliability issues, which is directly related to the measurement concept itself. The problem is that there is a grid with a defined mesh which is used to cover the analyzed structure (Figure 3-2), which is not related to the distribution of the structure's mass inside the boxes. Therefore, there is no guarantee that the coverage minimizes the number of elements necessary to cover the structure according to the mathematical theory.

However, this problem is relatively tackled in FracGis as the user can change some parameters for the grid choice, such as the iteration logic (arithmetic or geometric) as well as a “gliding coefficient” which allows to shift the coverage by predefined distance. For better reliability, the user can conduct a statistical analysis with different coverages if needed.

The counting method follows an iteration principle. At each iteration, the number of non-empty boxes inside the window (box, cluster) are counted (Figure 3-2). From one step to the next, the size of the counting window becomes bigger following either an arithmetic or geometric logic. By doing that, the level of analysis of the image is artificially changed.

Therefore, for each method we have two elements varying according to the counting step: the number of counted elements (N) and the size of the counting window (ϵ). Then, the result

of the measure can be represented on a Cartesian graph. The Y-axis represents the number of counted elements while the X-axis represents the size of the counting window.

Mathematically, the series of points is an empirical curve. It is then fitted to an estimated curve. If the empirical curve follows a fractal law, the estimated curve has the form of a power law (parabolic or hyperbolic), and the power exponent D represents the fractal dimension. $N = \varepsilon^{-D}$. In most cases, the empirical curve is represented in a log-log plot. The estimation of the fractal dimension becomes then a linear regression as shown in Figure 3-3.

For the following analysis, a geometrical progression fashion is used for the box counting analysis as the fractal law is described by Mandelbrot as the geometrical transcription of the Pareto-Zipf law [1].



Figure 3-1: User interface of FracGis

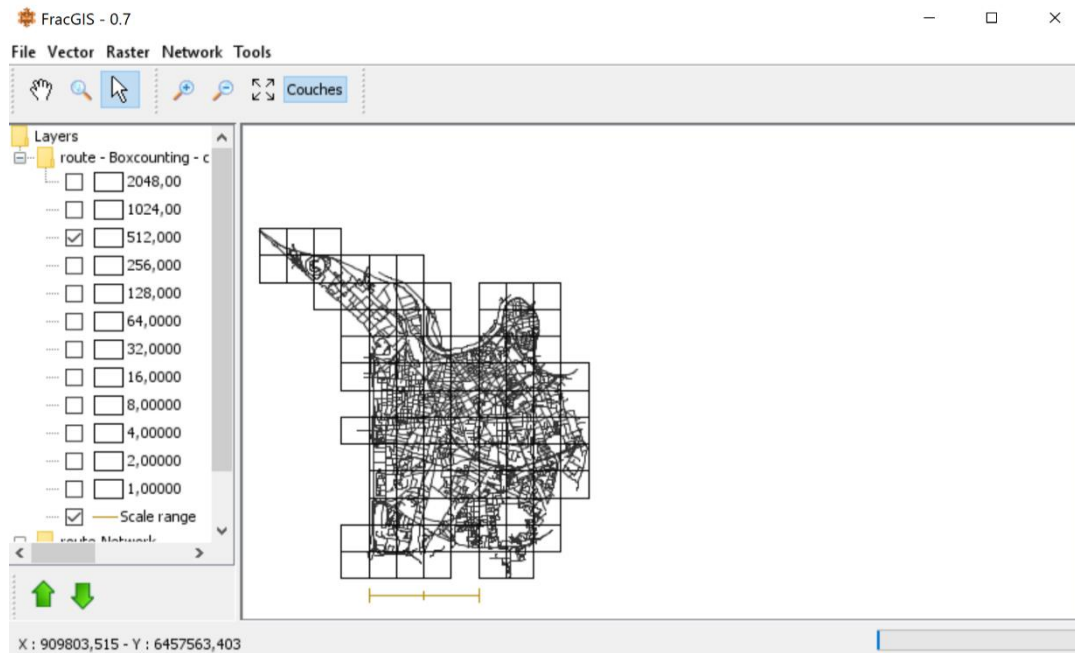

Figure 3-2: Iteration example of the box counting method

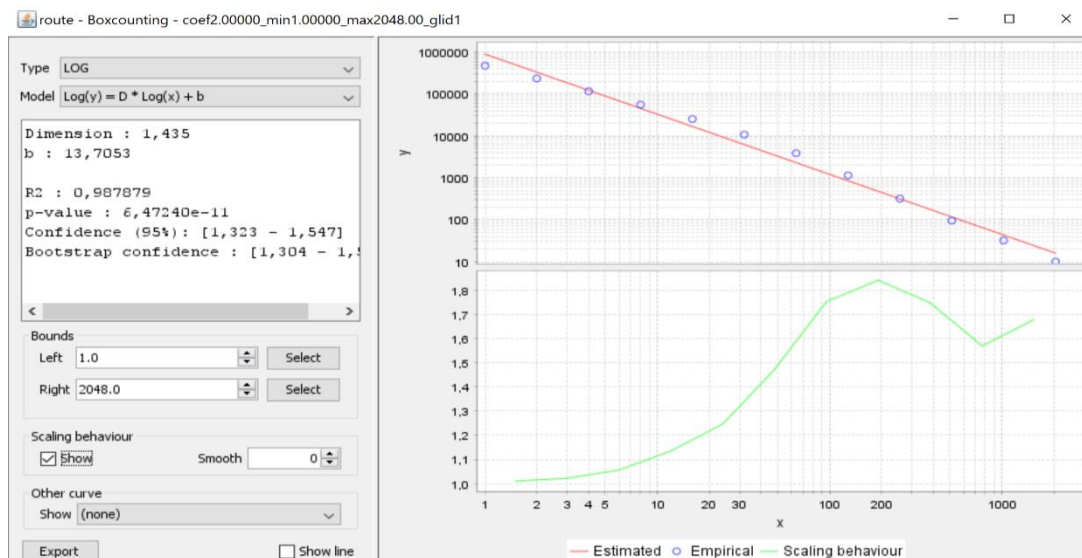

Figure 3-3: Determining the fractal dimension and scaling behavior using FracGis

3.2.2 Data processing

For this work, we study different networks which data comes from different sources. In order to make sure that the analysis will not be biased by the misinterpretation of data basis (incomplete data, poorly adapted to this analysis), we looked closer into each data set and

correct it before conducting the analysis. Here, we take the example of the case of the City of Grenoble where we show the effects of data processing on 3 different data sets. The results of the analysis are going to be detailed later in this chapter.

3.2.2.1 Buildings

The buildings map of Grenoble is available in the Institut géographique national (IGN) open data. It includes all the buildings of the city (residential, industrial, educational...). This data set seems to be coherent with reality and no abhorrent elements were identified. No processing was involved while using the building data.

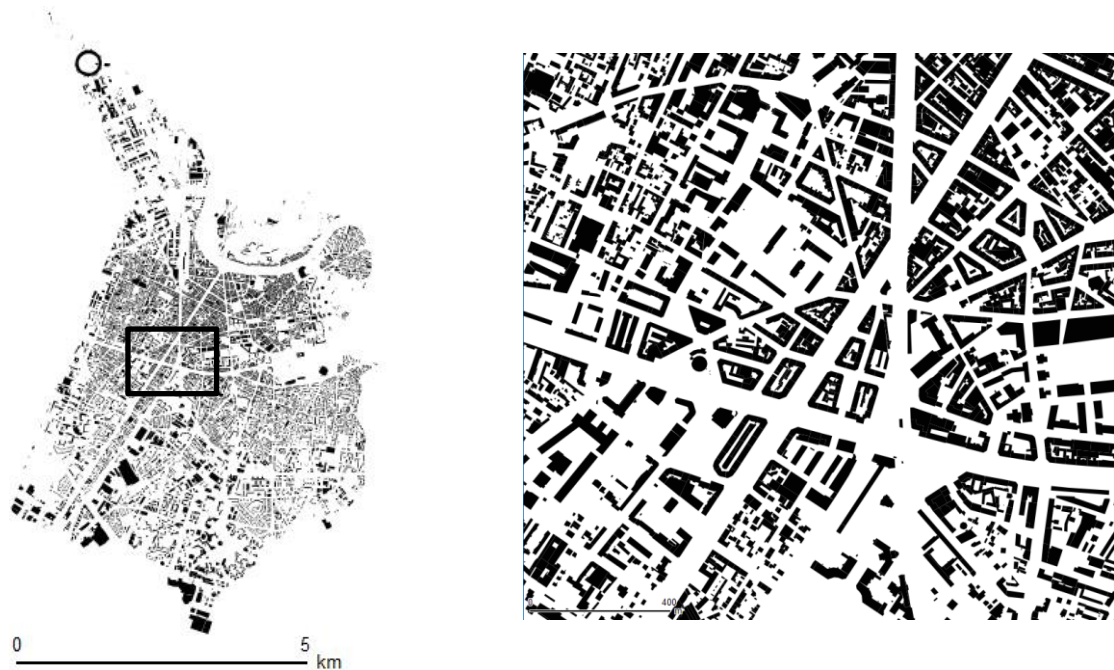

Figure 3-4: Grenoble's building view: (left) Grenoble city (right) Grands boulevards district

3.2.2.2 Power grid

The Distribution System Operator (DSO) of the city of Grenoble (France) provided us with the data we need for the fractal analysis of the power network and concordance analysis with roads and built-up areas. The data set at hands describes the medium voltage distribution system, i.e. the shape of the grid and the consumption data of the MV transformers distributed along the streets to feed the LV terminal networks. It is important to note that we do analyze

the MV network only and not the LV grid. The MV network function is to deliver power throughout the city but it will not deliver power to the majority of end users. Only some “big” users such as industry factories or research large facilities such as administration buildings, the other end-users (up to 250 kVA) are all connected to the LV grid. This is important because the logic of the spatial covering results to be totally different between MV and LV networks. The description of the MV network of Grenoble is detailed later in 4.3.2.1.

As shown in Figure 3-5, some power lines are roughly drawn. In some cases, a bundle of parallel cables is taking more space than it does in reality. As we are focusing on studying the shape of the network through its scaling behavior, parallel cables become irrelevant and are better represented using one single line.

The process to correct the “measurement errors” introduced by parallel cables consisted in merging all the parallel power lines into one single line. As the data set of the city is rather small, the process was executed manually to be able to appreciate the more appropriate way to reshape the drawing. The effects of data correction will be shown in the following section 3.3.2.

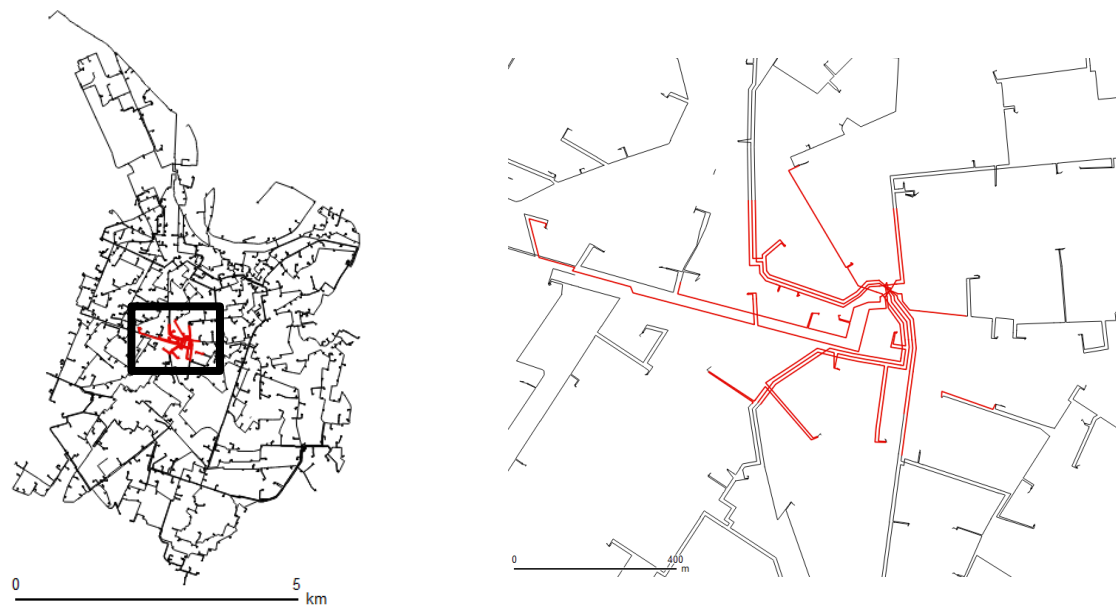

Figure 3-5: Grenoble's medium voltage power grid: (left) Grenoble city (right) Grands boulevards district

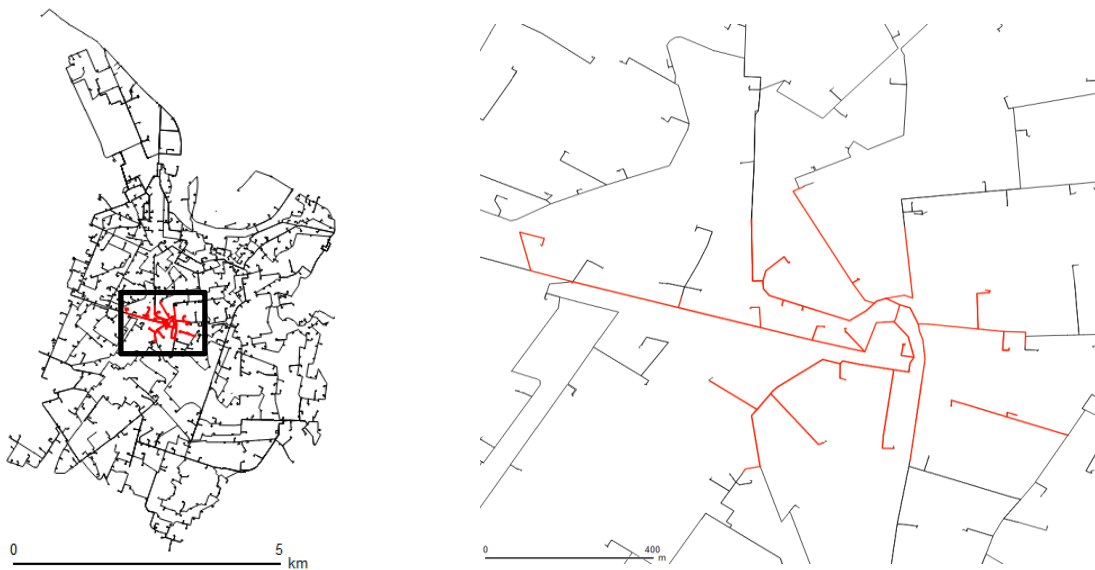

Figure 3-6: Grenoble's medium voltage power grid after processing: (left) Grenoble city (right) Grands boulevards district

3.2.2.3 Road network

The road network of Grenoble is also available in the IGN open data. The data consists of all the paths within the city including parking lots, railways, and pedestrian paths in parcs ...



Figure 3-7: Grenoble's road network: (left) Grenoble city (right) Grands boulevards district

The road data set was processed manually as well. As we are studying the medium voltage network, part of this data such as pedestrian paths and parking lots unlikely to be used for

power lines, was unnecessary and was removed (Figure 3-7.). The processed data set describes both single or multiple driving directions roads as a single line as shown in Figure 3-8.

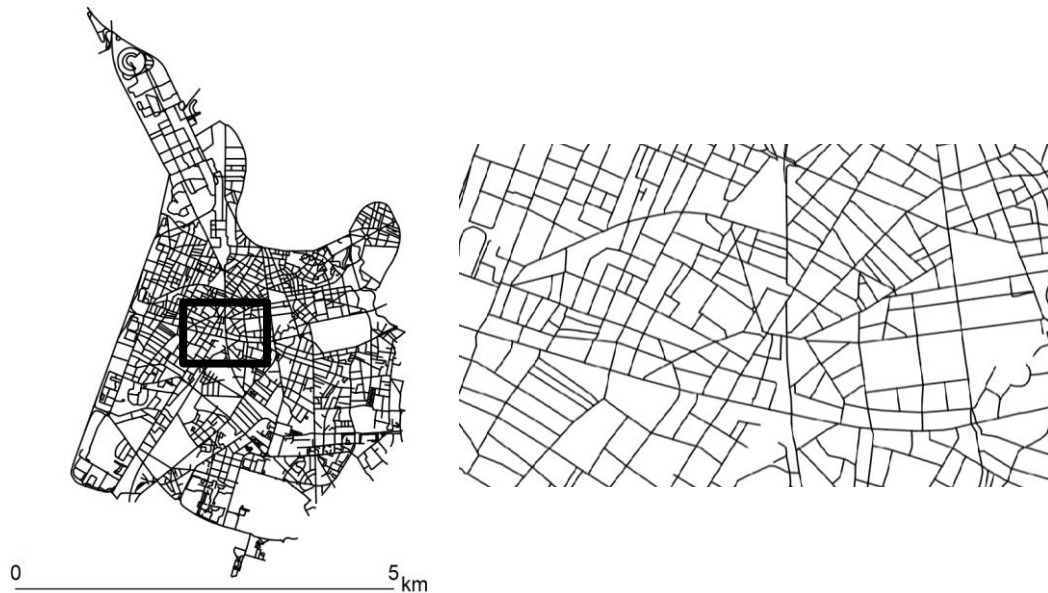

Figure 3-8: Grenoble's road network after processing: (left) Grenoble city (right) Grands boulevards district

3.3 Results of the fractal analysis for the city of Grenoble

3.3.1 Buildings

The fractal behaviour is observed in Figure 3-9 : the decrease for small distances is due to the modelling of the buildings. Every building is represented by a surface element whose size is proportional to its footprint. Therefore, at very local scales, the box-counting method provides a dimension closed to 2. These scales refer to distances inferior to that of the size of buildings and the number of occupied sites is thus dominated by built-up footprints.

When the size of boxes increases slightly, the dimension decreases abruptly due to the appearance of the empty spaces around the building footprints, but other buildings do not yet come into play. For higher sizes of the boxes, the relative position of one building to the others is taken into account and the dimension increases. The method is exploring the urban pattern

configuration. Between 100 m and 400 m, the fractal dimension settles around 1.7, which seems to indicate a scale invariant coverage of space by the buildings.

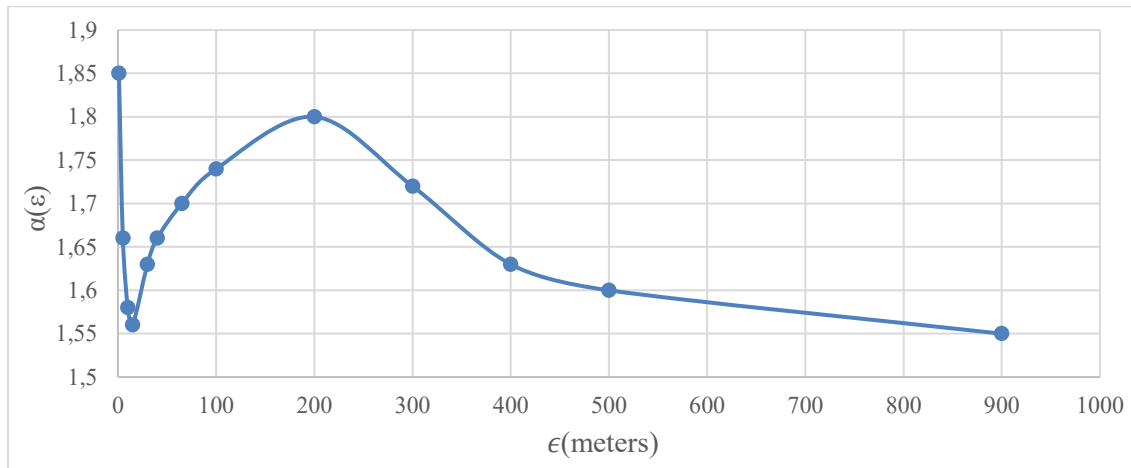

Figure 3-9: Scaling behavior of the built-up areas

3.3.2 Power grid

In Figure 3-10, we observe the scaling behavior over a wide range of scales, from 0 to 900m, the radius of Grenoble being about 5 km. Over 100m, the correction has a small impact on the results. But we notice that the cleaning process changes dramatically the results at small scales. For box sizes between 5 and 40m, the behavior is different as the original data deals mostly with parallel cables whose distance between cables are situated at this scale. The corrected data show a smoother transition when the parallel cables were merged into a single one.

For the processed data, at very small boxes sizes, there is no bifurcation and the power network can be seen as nearly linear (scaling value is close to one). For higher values of ϵ , the curve increases in a linear fashion. This is due to the appearance of bifurcations ensuring the necessary coverage of the distributed territory.

Then, it reaches a stable scaling behavior around 1.7 for ϵ larger than 400m. For these sizes, the box counting method is still relevant, the network being more uniform than the built-up areas as shown in Figure 3-11.

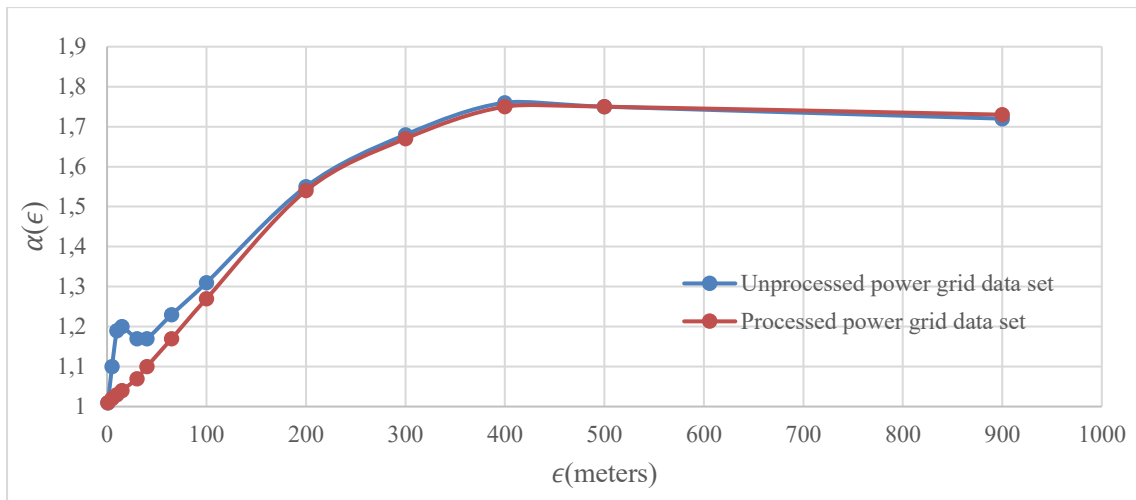

Figure 3-10: Overview of the scaling behavior of the power grids using unprocessed data versus processed data

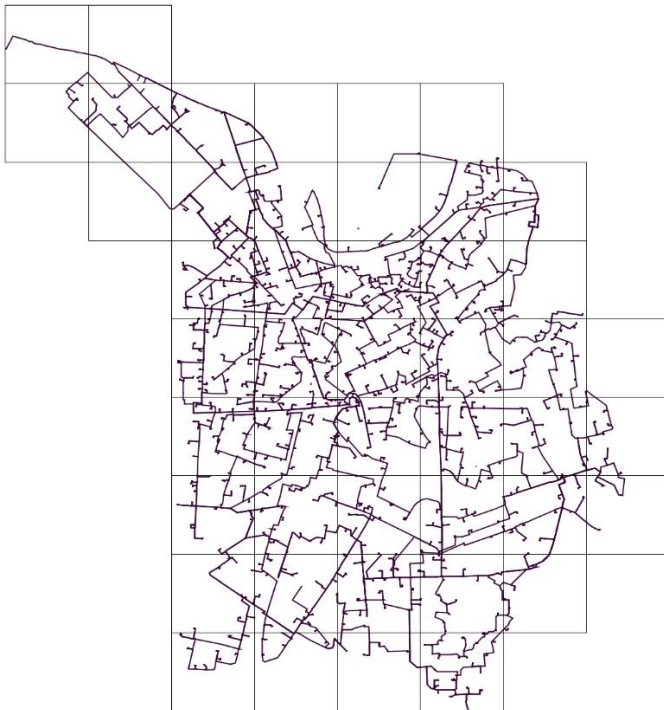

Figure 3-11: Example of network coverage with boxes of size 1024 m

3.3.3 Road network

In this case, the cleaning process did not lead to any noticeable changes in the fractal behavior (Figure 3-12). Here, in the case of the city of Grenoble, deleting pedestrian paths and parking lots from the data set does not seem to change the scaling behavior. It means that even at small values of ϵ , the road network is dominated by the main routes and not by paths or parking lots. The results would be different in the case of rural areas where rural tracks and paths are more prominent. Moreover, we notice that the scaling behavior becomes stable between 1.6 and 1.7 (Figure 3-12), which is, for high ϵ , very similar to the fractal behavior of the power grid (Figure 3-10).

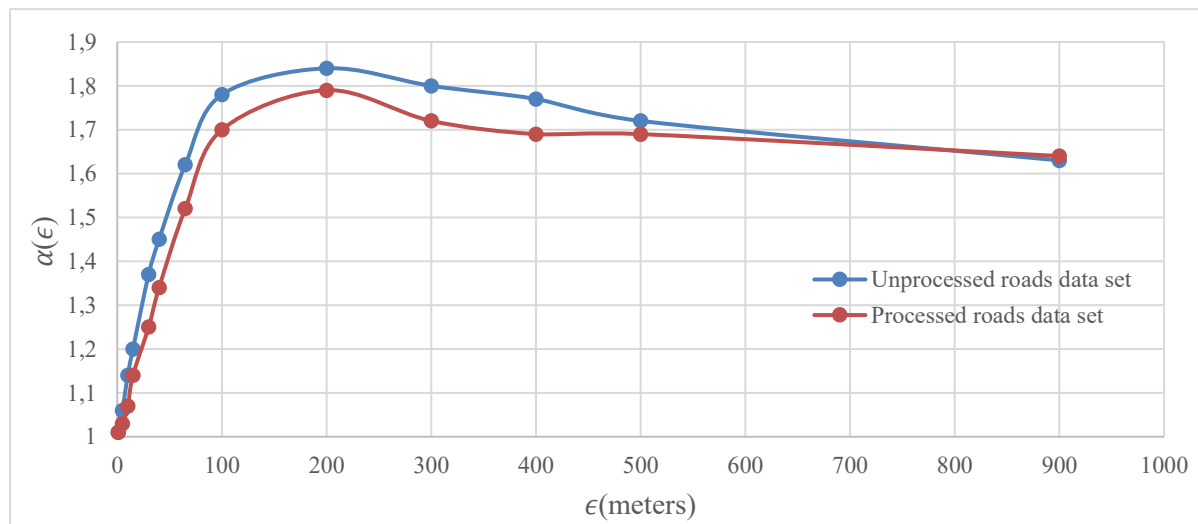

Figure 3-12: Overview of the scaling behavior of the road network using unprocessed data versus processed roads data set

3.4 Results of the concordance analysis for the city of Grenoble

This section is dedicated to concordance analysis of the city of Grenoble. Both a global and a local (via district separation) concordance analysis are conducted.

3.4.1 Global concordance analysis

In this section, we will compare the fractal behaviour of both urban networks at hands to the built-up areas within the whole city.

3.4.1.1 Power grid versus buildings

The concordance indicator between buildings and the power grid is defined by:

$$\beta_{build/powergrid}(\alpha_i) = \frac{\alpha_{build}(\varepsilon_i)}{\alpha_{powergrid}(\varepsilon_i)} \quad (3-2)$$

In Figure 3-13, at small measuring steps (lower than 20m), the ratio between the dimension of the buildings and the power grid decreases quickly from 1.9 to 1.5. At these scales, the built-up area dimension is close to 2 (ε much lower than building size), whereas the power grid is almost linear, ε being smaller than ramification distances. At larger values of ε , the concordance indicator decreases a lot until reaching a value close to 1. It is due to the increase of the grid's dimension resulting from its ramification to deliver electricity all over the covered area while minimizing its length.

It is worth noting that low values of the concordance parameter may mean that the network is overdeveloped compared to the built-up distribution. Historically, the power grid developed in Grenoble was mainly a 5.5 kV network but has expanded very quickly with the construction of new buildings in the 1960s to host the winter Olympics. This expansion added a 20 kV layer, making the network hypertrophied. The local DSO is in the process of switching from a mixed 20 kV and 5.5 kV network to an only 20 kV network by 2020, which is expected to fit more the expectations of planners from a concordance point of view. One of the planner's objectives is indeed to ensure a coverage of the urban territory at the minimal cost, meaning the maximization of the concordance indicator. This maximal value should however be limited to not decrease the quality of energy provided by the network. Covering the whole city by one line only (meaning a scaling behavior close to 1) would mean that there will be large variations of the voltage along this line due to the series impedance and that a single failure would cause a power outage for a large number of customers. .

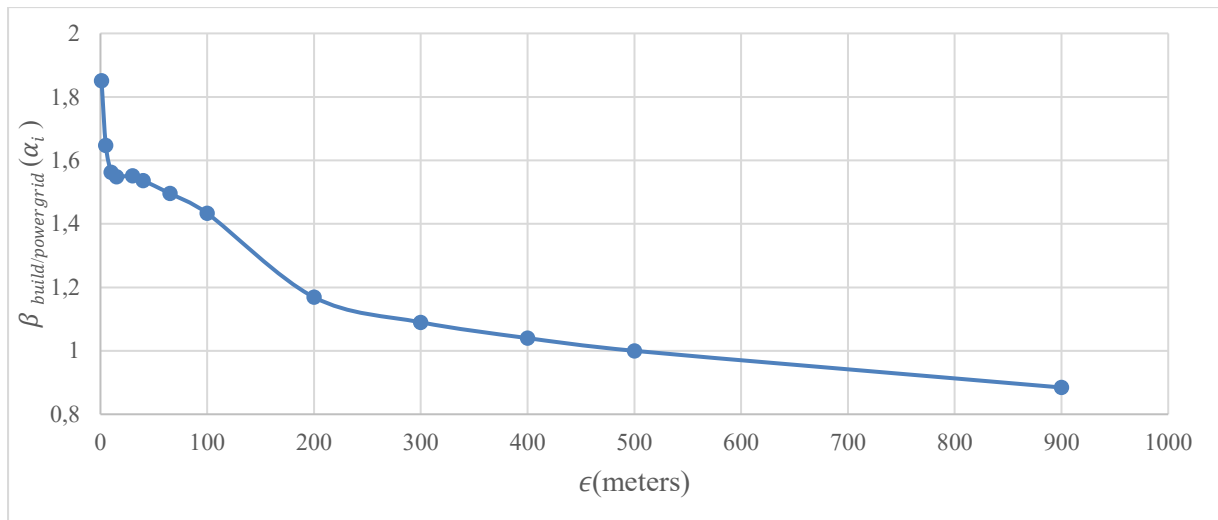

Figure 3-13: Concordance analysis between the power grid and buildings

3.4.1.2 Roads versus buildings

The concordance indicator is defined as follows:

$$\beta_{build/road}(\alpha_i) = \frac{\alpha_{build}(\epsilon_i)}{\alpha_{road}(\epsilon_i)} \quad (3-3)$$

We notice that the concordance between roads and buildings (Figure 3-14) has a similar variation to the concordance between the power grid and buildings (Figure 3-13). However, the indicator decreases faster until reaching 1. From an urbanistic point of view, it means that for distances higher than 100 m, the road network and built-up spaces follow the same type of spatial distribution while the same logic becomes only true starting from 300 m for the power grid. The role of the MV distribution grid is indeed to deliver electricity to the city in a global way whereas the local coverage and the end-user distribution is ensured by the LV grid.

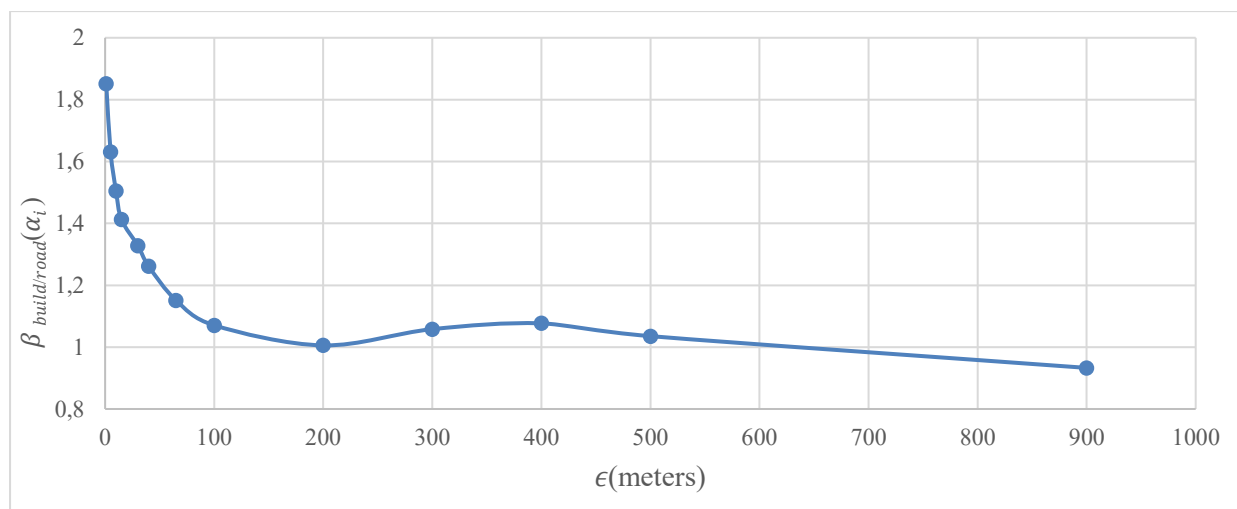

Figure 3-14: Concordance analysis between the road network and buildings

3.4.1.3 Power grid versus road network

According to (3-1) we use the ratio defined by:

$$\beta_{\text{road/power grid}}(\alpha_i) = \frac{\alpha_{\text{road}}(\epsilon_i)}{\alpha_{\text{power grid}}(\epsilon_i)} \quad (3-4)$$

At very local scales, this ratio is close to 1 (Figure 3-15) because both behaviors are linear. For ϵ between 0 and 100m, we notice a high rate of increase of β because the scaling behavior of the power grid remains almost linear (ϵ is smaller than its ramification distance) whereas the road network is already developed for enabling house accesses. For higher values of ϵ , both networks become more and more concordant. These results come as a surprise as we are comparing the scaling behavior of the road network with all its local development and the MV grid without all the LV bifurcations. This is first a consequence of the hypertrophy of the power grid as mentioned in the previous section. But, both networks are also rather concordant because at global scales we analyze essentially the macro structure of flow distribution in the city.

We should note that the concordance indicator plateaus at a value close but lower than 1, even though the power grid is a subset of the road network. This is certainly due to measurement uncertainties.

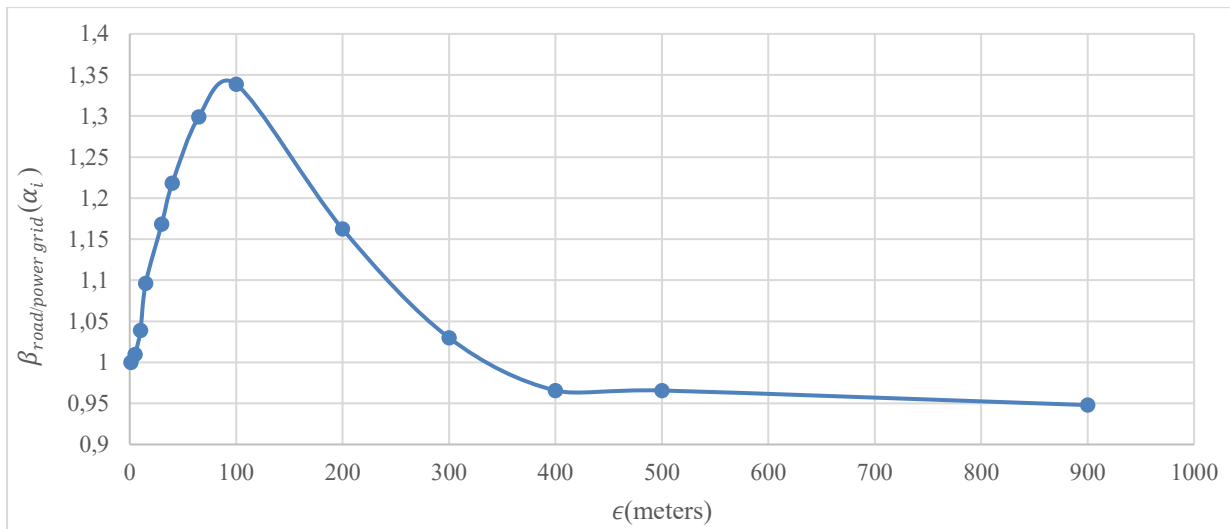

Figure 3-15: Concordance analysis between the power grid and road network

3.4.2 District fractal and concordance analysis

Instead of analysing the whole city, an assessment of local concordances is performed to determine whether the spatial configuration of some city areas impact a lot the results. Figure 3-16, Figure 3-17 and Figure 3-18 show the chosen zoning for this study for the built-up areas and both the power grid and the road network. Nine zones were chosen according to the district separation within the city.

The “presqu’île” district, also known as the scientific polygon, includes a significant number of research centers between the rivers Isère and Drac. It hosts the European Synchrotron Radiation Facility and the French Atomic Energy Commission.

Downtown Grenoble represents the city’s old town, which is a pedestrian zone, associated with the squares Victor Hugo and Grenette. It hosts the main shopping area of the city, as well fast-food chains, bars, restaurants. It is also the biggest hub for public transportation in the city.

“Saint Bruno” is considered to be the second downtown of Grenoble, meaning that it is a very dense district with housing buildings but also small shops, pedestrian streets and a main square with the same name.

The “Eaux Claires” area is a diverse district with a majority of housing. It hosts a big health facility and one of the most prominent (in size) high schools of the city.

“Ile verte” is mostly residential and relatively independent from downtown. The district is one of the most heavily populated in town, due primarily to the “Three Towers of Grenoble”. The Police Headquarters (Hotel de Police), the cemetery and the Bastille hills with its famous “bubble” cable car are also located there.

“Mistral Bachelard” is a peripheral district of Grenoble. It was deployed within the frame of a rent-controlled housing project. Lesdiguières Stadium and the parc Champs Elysées are located there.

“Villeneuve” was constructed in the early 1960s. The western side of the district is known as the Olympic district and was built in order to host the athletes competing in the 1968 Grenoble’s winter Olympics and the journalists covering the event. It is characterized by its park covering 14 hectares (10% of the district’s area). After the Olympics, the village was converted to rent-controlled housing. This district remains independent from the city with its own cultural and daily attractions (Shopping Center Grand Place).

“Capuche” is formed of disparate houses and villas, high buildings of recent period (mid-twentieth century) with some social housing. It is a suburban neighborhood without monuments or historical buildings. It includes the city’s biggest parc (parc Paul Mistral) and the parc Pompidou. It host the MC2, a 22 000 m² venue for public events and the wholesale market.

“Teissere” was constructed in the late 1950s in the east of Grenoble and is mostly formed of rent-controlled housing with over 50% of T3 apartments (1 living room + 1 bathroom+ 2 bedrooms). It is also independent from downtown as it hosts social, cultural and sports attractions.

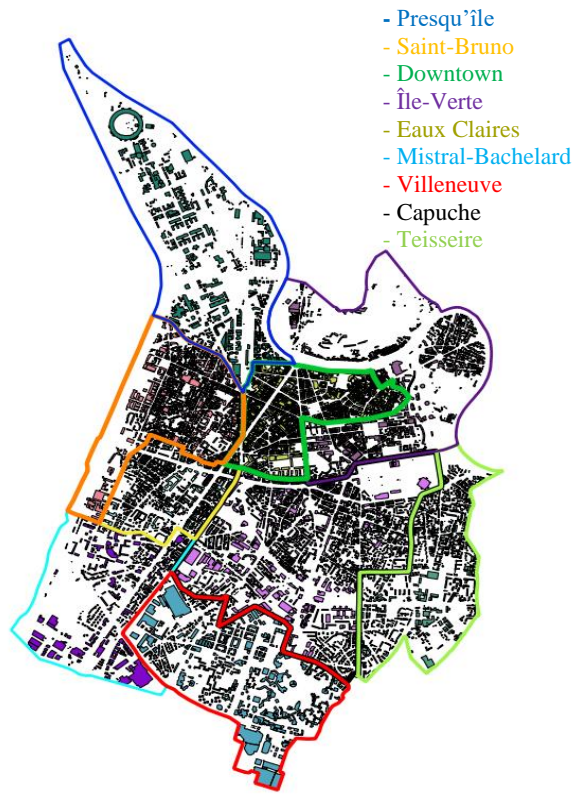

Figure 3-16: Zoning for the built-up areas of the city of Grenoble

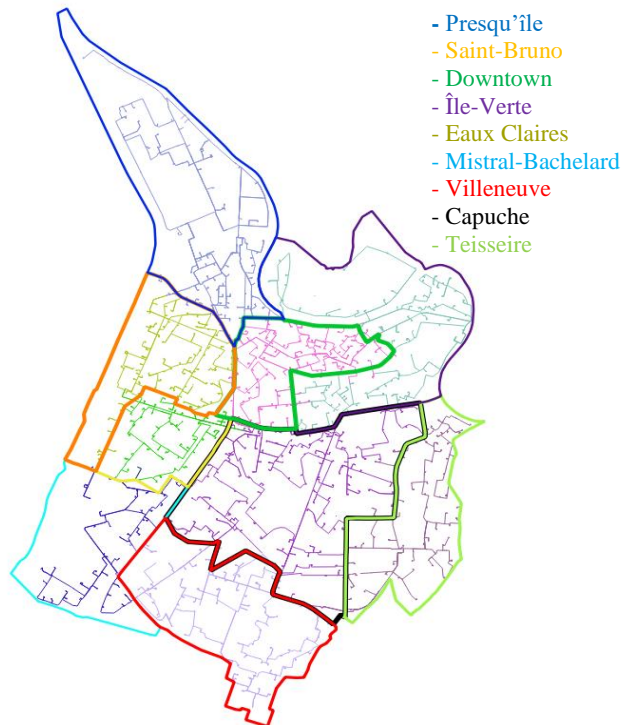

Figure 3-17: Zoning for the power network of the city of Grenoble

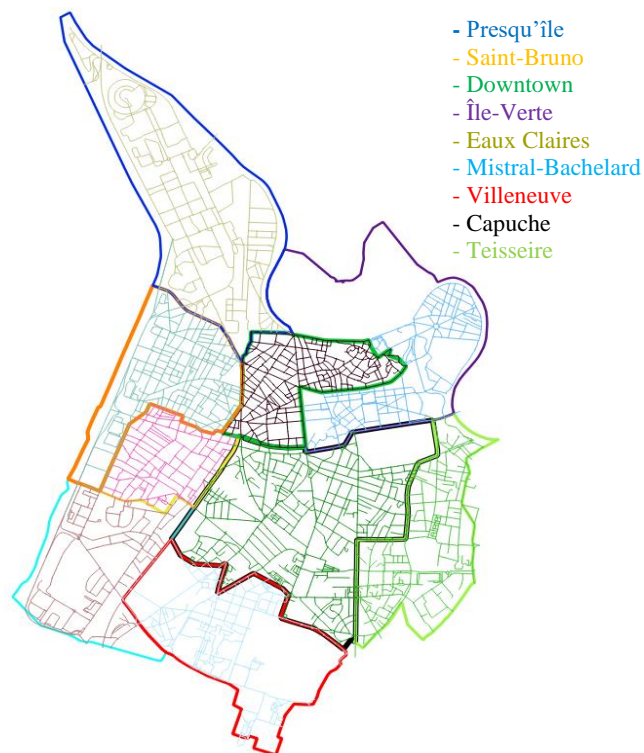

Figure 3-18: Zoning for the road network of the city of Grenoble

3.4.3 Fractal dimensions

Here we show the fractal dimensions for each district for the 3 data sets as presented in the previous section.

Figure 3-19 shows the fractal dimensions for the city as a whole and for each of the identified nine different zones. The error bars show the measurement accuracy (95% confidence interval) and are computed using FracGis. The overall dimension is 1.7 which, considering the large parcs and voids in between building ensembles, characterizes a highly dense urban area. [11].

Three districts show higher density than overall: Downtown, “Eaux claires” and “Saint Bruno”. This result reflects the type of the zones as these three neighborhoods are residential with very dense building distribution. The lowest dimension is registered for “Presqu’île” which is expected as the zone is mostly industrial with disparate buildings. “Teissere” and “Mistral Bachelard” and “Ile-verte” show low dimension values which could be explained by

the presence of parcs in these areas and voids. It is interesting to note that even though Ile verte is one of the most populated areas of the city, the fractal dimension does not reflect it because of the presence of “the Three Towers of Grenoble” which are 98 meters high and the cemetery. We identify two intermediary districts: Villeneuve which is characterized by large buildings and big voids, Capuche, which is a mix of the above and which resembles Grenoble at a smaller scale.

Figure 3-20 shows the fractal dimensions of the power grid. For all nine zones, the overall dimension is close to one as the medium voltage grid shows very few ramifications.

The road network shows a similar fractal behavior to the MV power grid’s as shown in Figure 3-21. However, the values are higher with an overall value of 1.4 as the road network shows in general shows more ramifications than medium voltage networks, especially in urban areas such as Grenoble where there are smaller streets than one could find in rural zones. It is important to note that Downtown registers the highest dimension with the presence of a relatively bifurcated network of shopping streets.

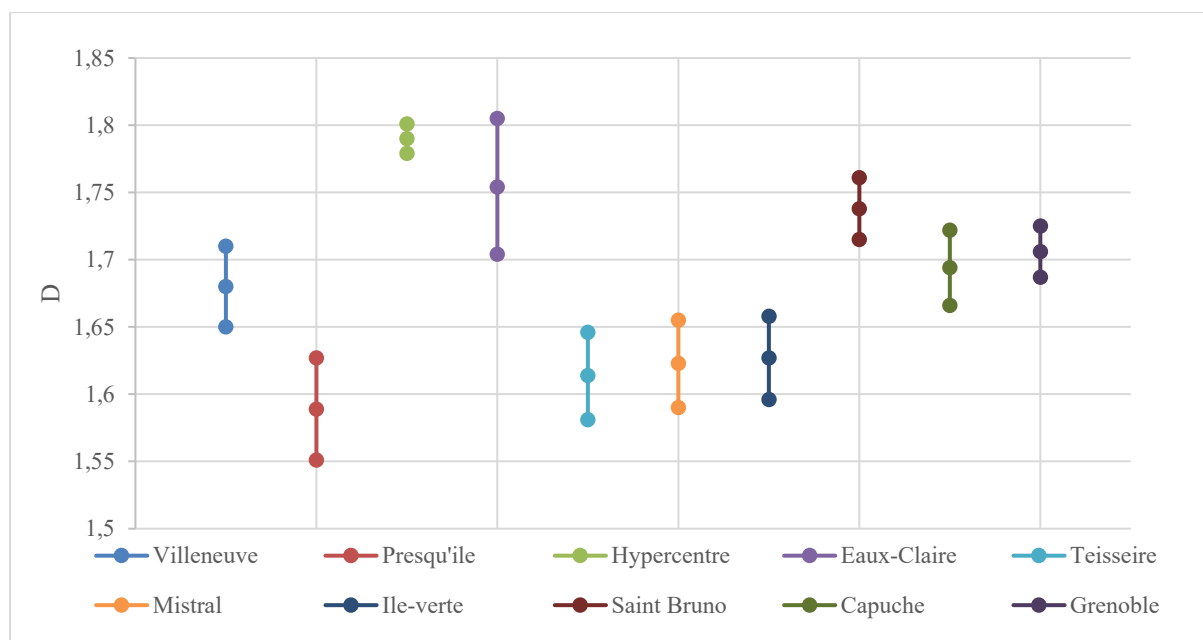

Figure 3-19: Fractal dimensions for the built-up areas of Grenoble

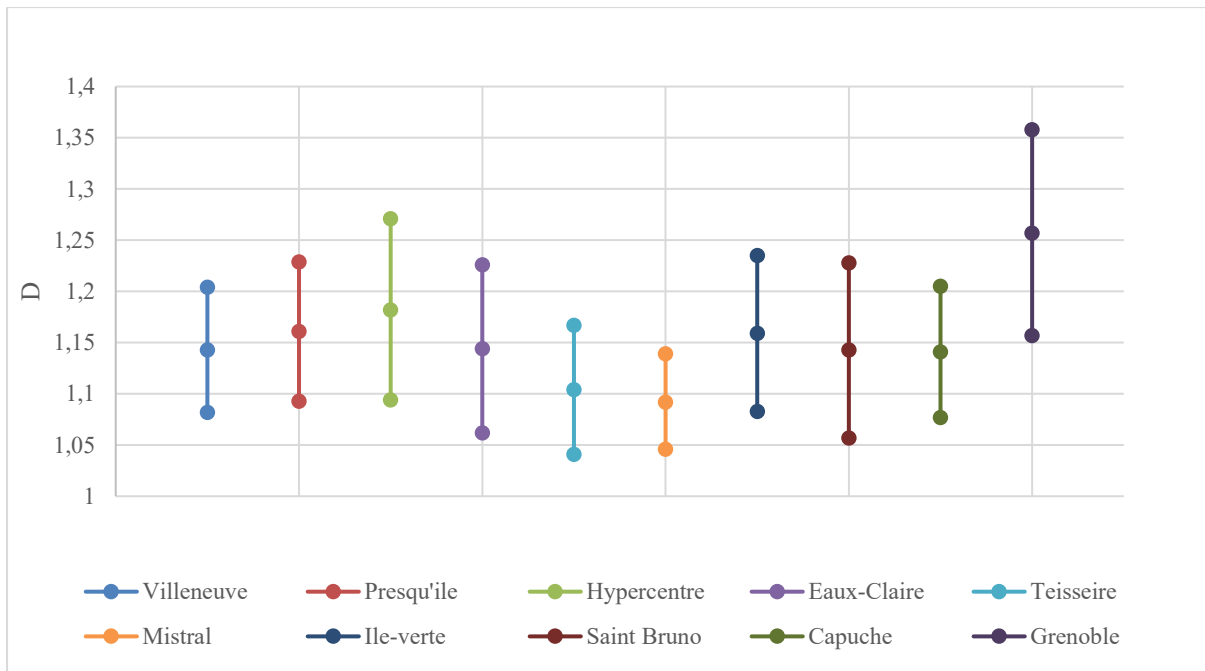

Figure 3-20: Fractal dimensions for the power grid Grenoble

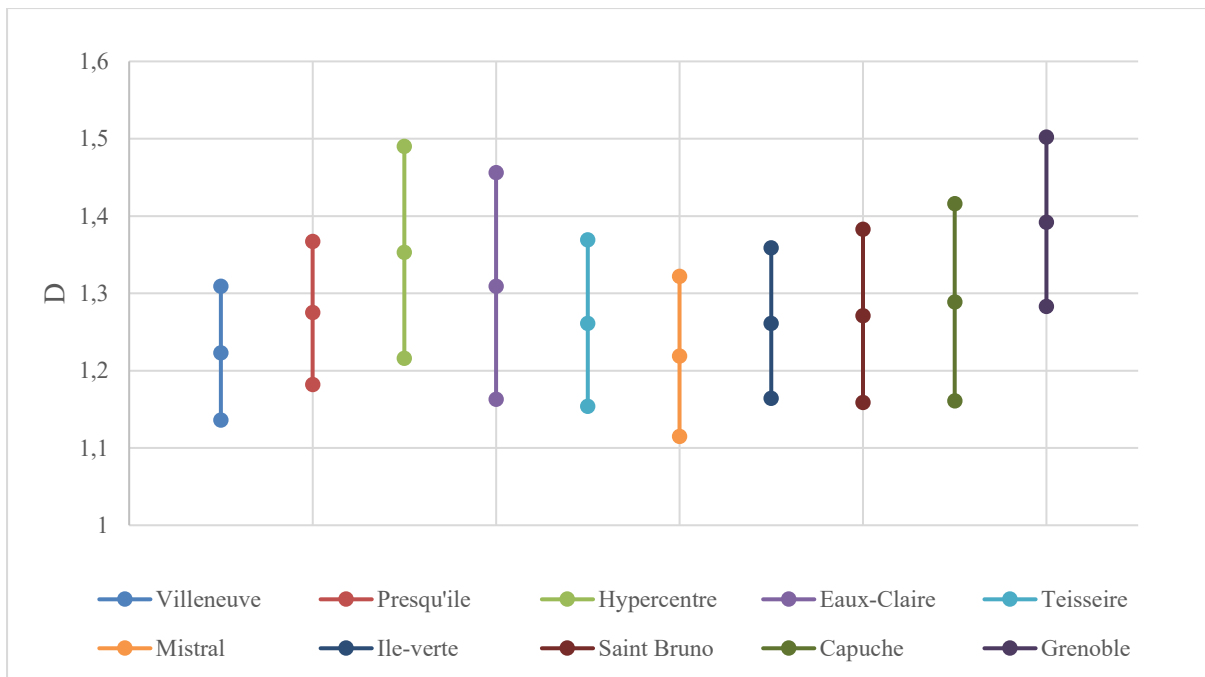

Figure 3-21: Fractal dimensions for the road network Grenoble

3.4.4 Local scaling behavior

In this section, we study the scaling behavior for each data set for the nine chosen zones. Considering the size of the zones, the maximum box size for this analysis will not go further than 70 m in order to have a reasonable number of boxes for the analysis to be accurate enough.

3.4.4.1 Buildings

Figure 3-22 confronts the scaling behavior of all nine zones. For very small box sizes, the fractal dimension is close to 2 as the boxes are smaller or equal to the mean footprint of the buildings. As the box sizes become higher than the footprints, there is a rapid decrease of the dimensions explained by the appearance of intra-building voids, followed by a small increase once the boxes start including other buildings.

One important result here is that independently from the overall building distribution, the scaling behavior reaches a plateau value for each district, meaning that for each zone, there is some sort of fractal behavior. This value is obviously different from one zone to another as it reaches 1.8 for a very dense district such as les Eaux Claires while it barely reaches 1.5 for Ile verte which hosts La Bastille and the cemetery. For this case in particular, one could notice an unexpected drop in the scaling behavior after 30 meters. This is an illustration of the artefact caused by the box counting method as explained in Chapter 2 (Figure 2-7), as the area is quite large with bigger intra-building voids that one could find downtown for instance. Hence, the scaling behavior computation is less accurate with the presence of poorly filled boxes.

3.4.4.2 Power Grid

Figure 3-23 shows the scaling behavior of the power grid. Following the same logic as for the buildings, for small boxes, the dimension is equal to 1 as the network is linear. As box sizes become bigger, bifurcations start to appear, and the dimension becomes higher. There is no tendency here to confirm the possibility of district independent fractal behavior of the grid as there is no stabilization. It is interesting to note that the scaling behavior for “Mistral Bachelard” remains around 1.1, meaning that it is mostly linear and shows very few bifurcations and it is the zone to show the closest form of a fractal distribution. Finally, the

downtown area shows the highest dimension, which is 1.4, meaning that the medium voltage grid shows more bifurcations than other districts as the streets are relatively small and highly bifurcated.

3.4.4.3 Road network

The same reasoning as described previously apply to the analysis of Figure 3-24. However, as the road network has, in general, more bifurcations than the MV power network for accessibility issues, It is interesting to note that unlike the power grid, we notice a beginning of stabilization of the values of the scaling behavior, meaning that the presence of more ramifications within networks could be a factor for the emergence of fractality.

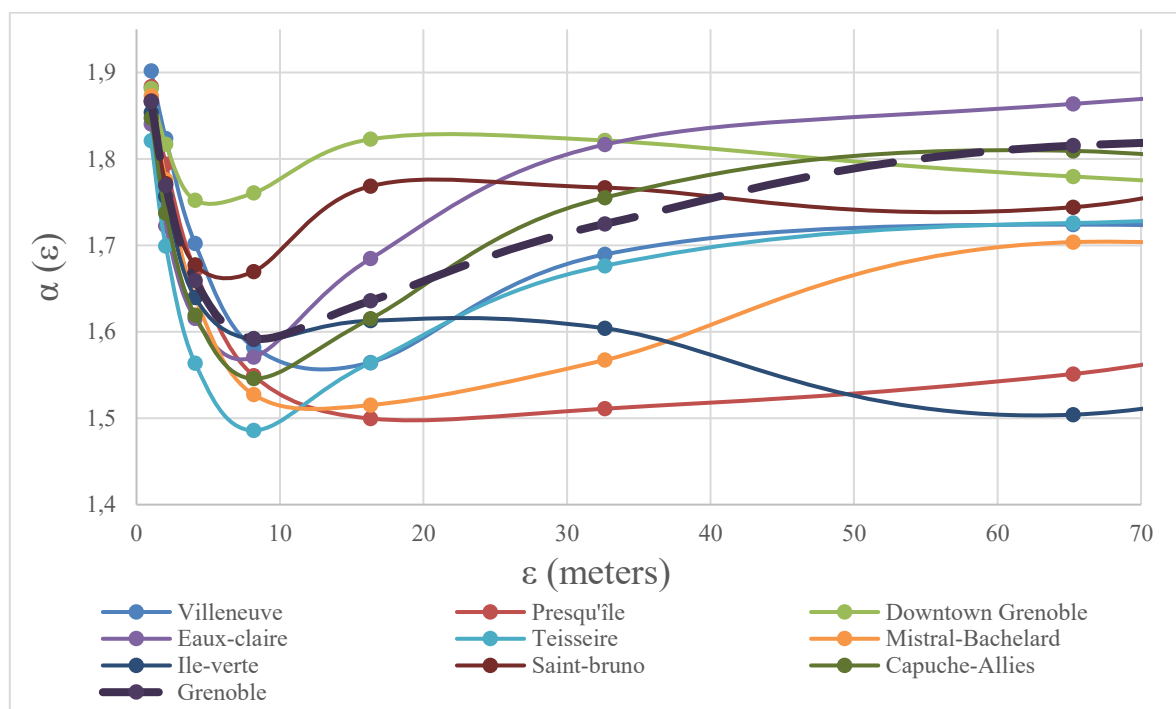

Figure 3-22: Scaling behavior for the buildings

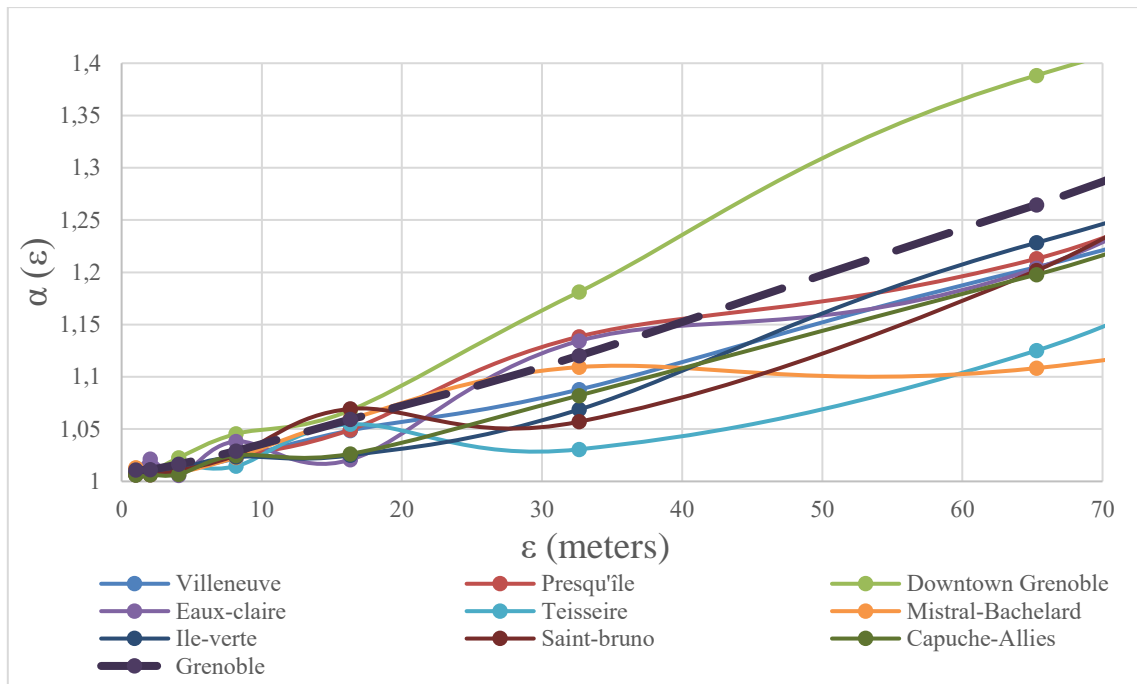

Figure 3-23: Scaling behavior for the power grid

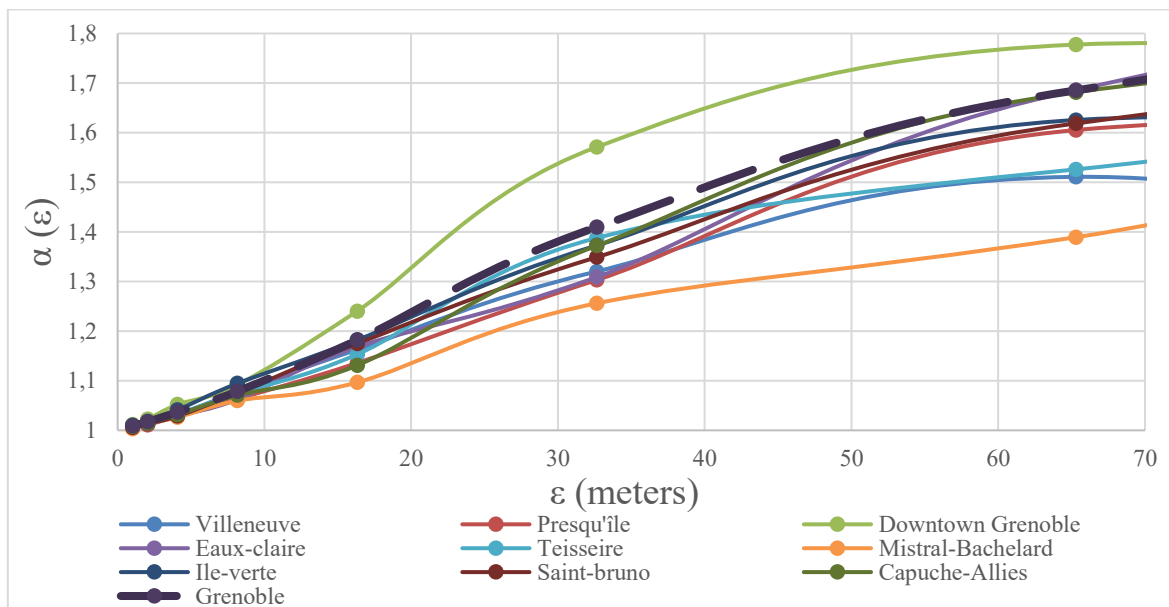

Figure 3-24: Scaling behavior for the road network

3.4.5 Local concordance analysis

In Figure 3-26, we notice that the road network's concordance to the built-up areas exhibits overall a similar behaviour in all districts. It is interesting to notice, that the district's main activity seems not to be correlated with the function of the road network.

For the MV distribution network, the main conclusions are:

- In Figure 3-25, for small sizes, the buildings distribution in all cases takes over the power grid but the power network tends to become more and more coherent when the measuring size increases.
- In Figure 3-27, we notice that for very local scales, both power and road networks are concordant. However, their scaling behaviour starts to move away from one another after 20. There is no obvious classification of the districts according to the concordance analysis of the power network.

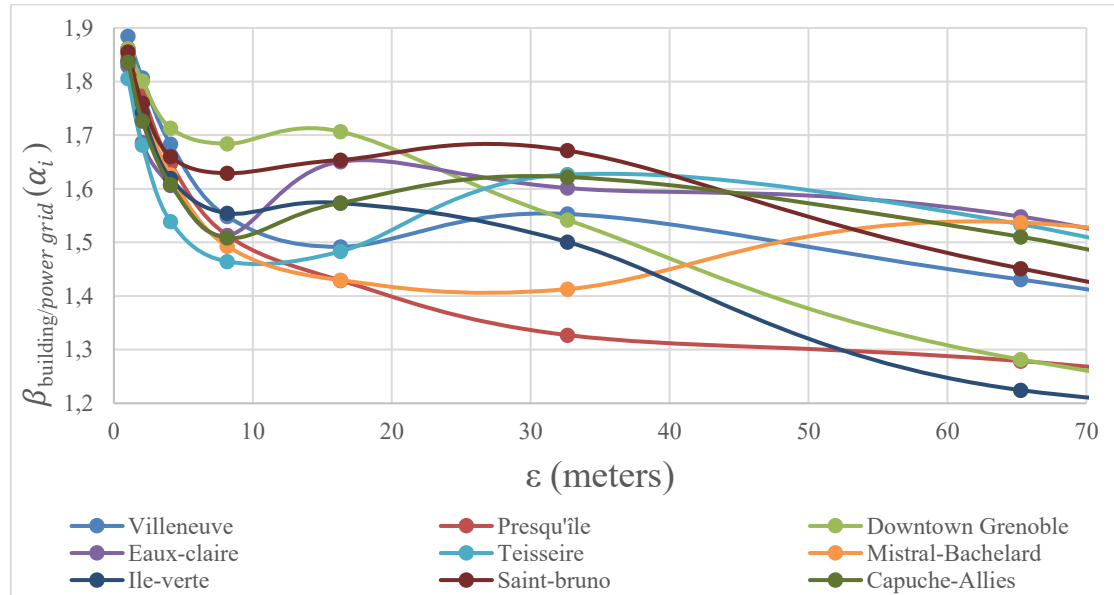

Figure 3-25: Concordance of the scaling behavior between buildings and the power grid

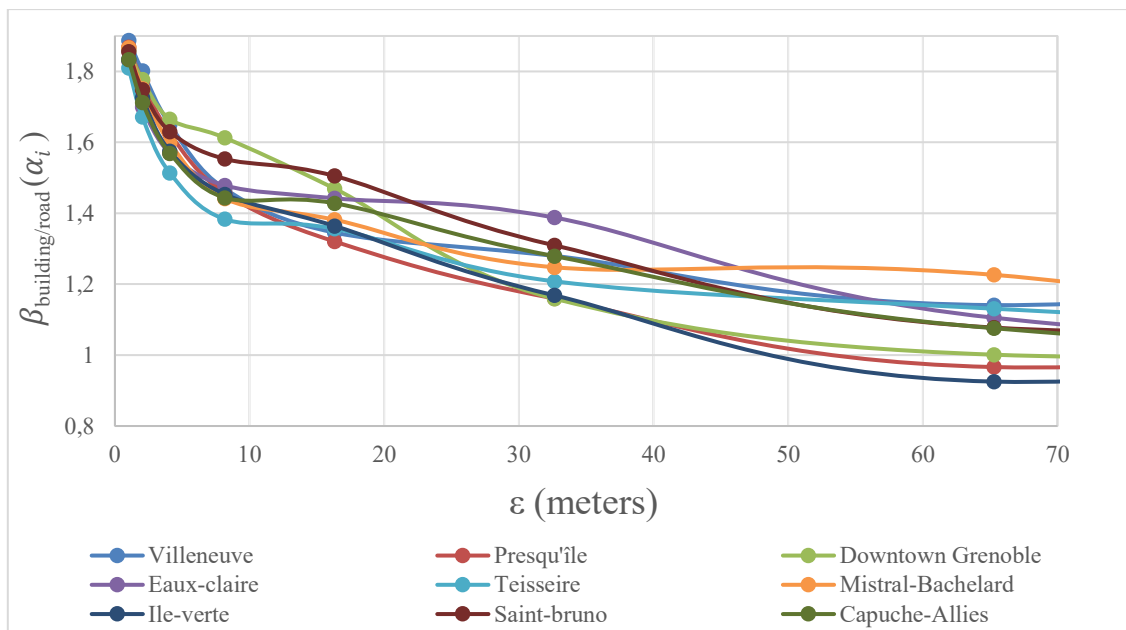

Figure 3-26: Concordance of the scaling behavior between buildings and roads

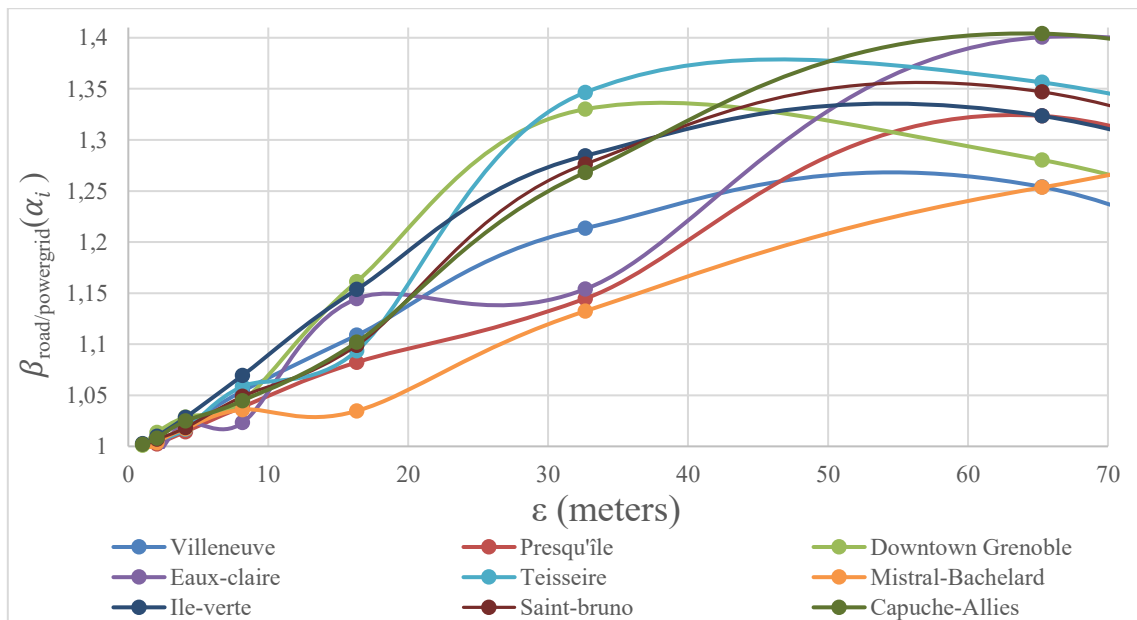

Figure 3-27: Concordance of the scaling behavior between the roads and the power grid

3.5 Results of fractal analysis for the Franche-Comté area

In order to further illustrate what the analysis of power distribution networks confronted to the territory shows, we conduct a fractal analysis of the power grid of two departments within the Franche-Comté region: Jura and Haute Saône. The data for the power grid refers to that of the main French distribution system operator Enedis within the framework of a research internship conducted by Allan Poirson and Xavier Lehmann. The data represents both medium and low voltage grids. All municipalities in Jura except for two: Salins-les-Bains and Bracon, which are managed by the “Régie de Salins-les-Bains”, are operated by Enedis. For Haute-Saone , some municipalities are managed by the distribution system operator SICAE Ray-Cendrecourt as shown in Figure 3-28. The building data was extracted from the opensource GIS data.

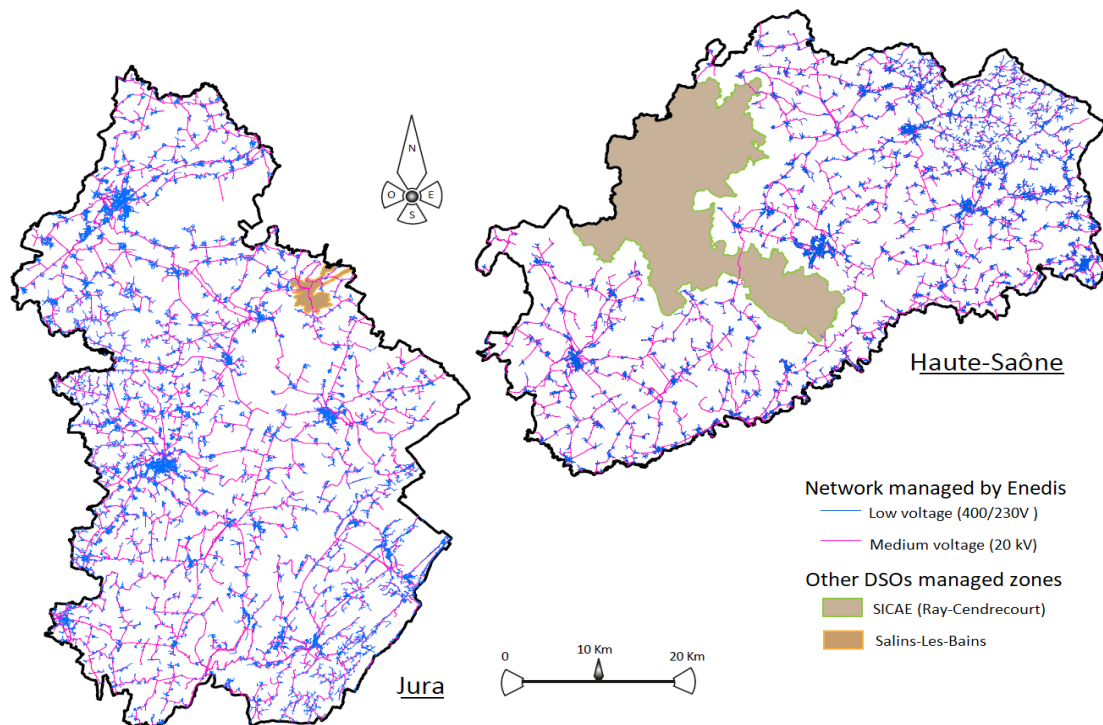

Figure 3-28: Distribution power grid for Jura and Haute-Saône departments

3.5.1 Fractal analysis of the power grid

For the analysis of the network of Franche-Comté (both Jura and Haute Saône), we start by analyzing the combination of both medium and low voltage (Figure 3-29), then we move on to the analysis of medium voltage (Figure 3-30) and finally the low voltage (Figure 3-31).

For the entire network, the fractal dimension is very similar for both departments (1,36 Jura vs 1,34 Haute Saône). As for the scaling behavior, we notice for both networks a high increase till reaching 1,8 for distances up to 4000 m, after which the dimension reaches a plateau. This leads to think that the power grid shows for both departments a sort of scale invariant behavior. For very small sizes the dimension is close to 1 as the network is purely linear. However, as bifurcations start to show for bigger sizes, the dimension becomes higher. The plateau value is 1.9 for Jura and 1.75 for Haute-Saône.

The following step of this analysis consists in separating both medium voltage and low voltage. Both separated networks show the same behavior as the entire network with slightly higher values for Jura.

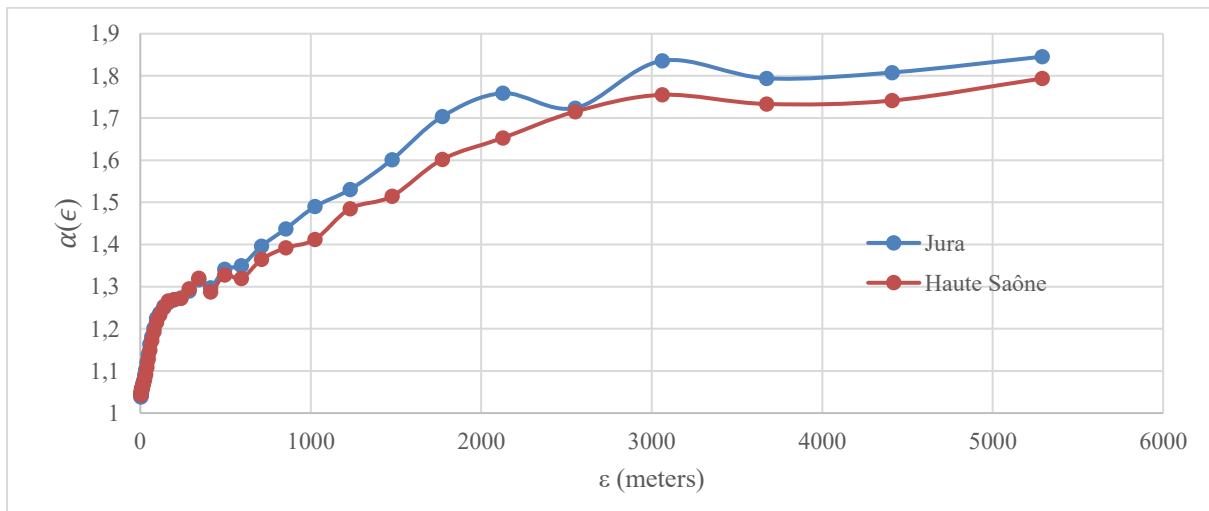

Figure 3-29: Scaling behavior of the entire power grid of the Jura and Haute-Saône Departments

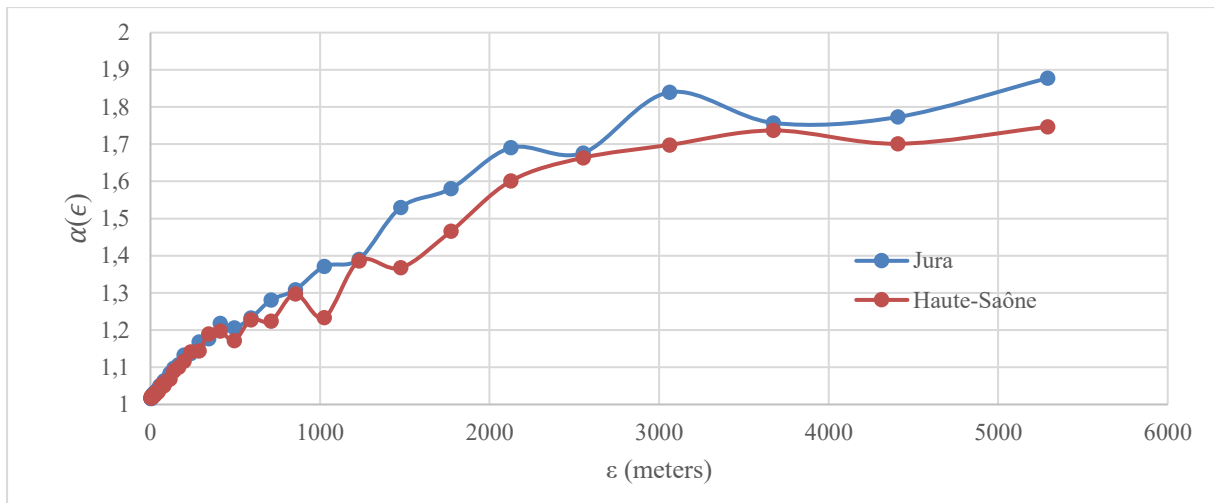

Figure 3-30: Scaling behavior of the medium voltage power grid of the Jura and Haute-Saône Departments

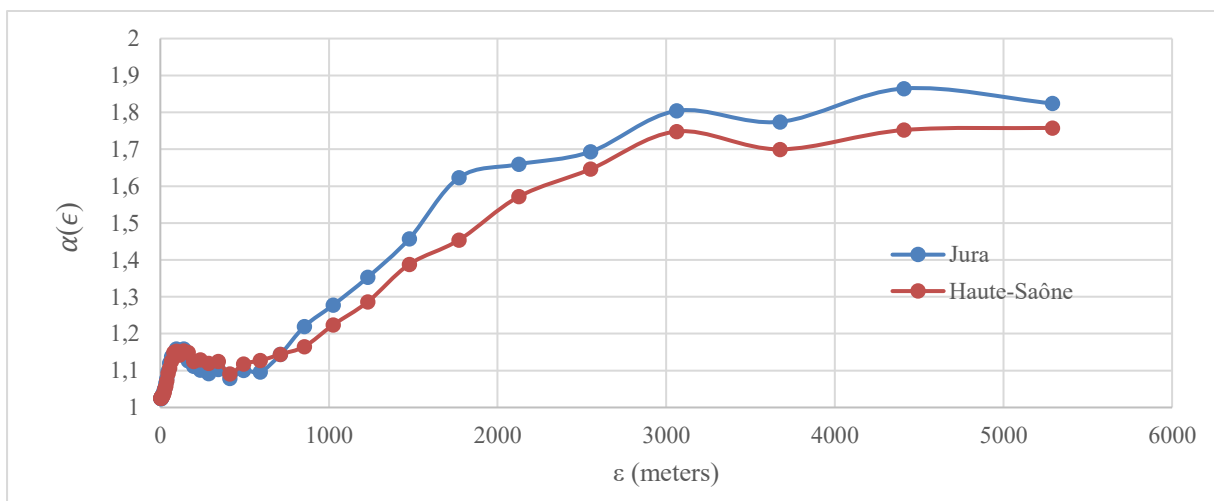

Figure 3-31 :Scaling behavior of the low voltage power grid of the Jura and Haute-Saône Department

3.5.2 Concordance analysis between the power grid and the built-up areas and comparison with Grenoble

In this section, we conducted a concordance analysis between the power grid and the built-up patterns for nine different zones. We compute the concordance indicator to understand the spatial distribution of the grid according to the buildings. The results are shown in Table 3-1.

	$D_{\text{power grid}}$	$D_{\text{built-up}}$	$D_{\text{built-up}}/D_{\text{power grid}}$
St Claude	1,37	1,47	1,07
Luxeuil	1,37	1,54	1,12
Gray	1,38	1,52	1,1
Champagnole	1,41	1,51	1,08
Héricourt	1,41	1,59	1,126
Lure	1,41	1,58	1,121
Vesoul	1,43	1,61	1,127
Dole	1,45	1,6	1,102
Lons	1,46	1,62	1,103

Table 3-1 : Concordance analysis for Franche-Comté

We can identify 3 different types of urban areas according to the concordance indicator (Figure 3-32):

- Type 1: St Claude, Champagnole : The ratio between the built-up areas and the power grid dimension is very low. One could say that the network is hypertrophied as there is more network than in other types to serve the buildings.
- Type 2 : Dole, Lons, Gray : The relationship between the network and built-up areas is in between two types. The fractal dimension of both the power grid and the built-up areas are high for Dole and Lons. For Gray , both dimensions are low.
- Type 3 : Lure, Luxeuil, Héricourt, Vesoul. The ratio between the dimension of the network and the building is high. Regardless of the fractal dimension of the building, the network's dimension is much lower. This is the type which seems closer to DSOs optimal spatial coverage .

Figure 3-32 show the classification for different cities within the Franche-Comté regions as well as the city of Grenoble. We notice that Grenoble show higher fractal dimensions in terms of built-up areas. It is expected as Grenoble city has a higher index in terms of inhabitant density compared to the cities in Franche-Comté (8 900/km² for Grenoble vs 640/km² for Dole, 1 800/km² for Vesoul, 410/km² for Champagnole to cite a few). On the other hand, the fractal dimension for the power grid is higher for Franche-Comté as we are studying both medium and low voltage networks.

Let's apply the same classification to Grenoble, type 1 includes Ile verte and Presqu'île while Type 2 includes Mistral, Capuche, Villeneuve and Teissère and Type 3 includes Eaux Claires, Saint-bruno and downtown. This comforts the results of the detailed analysis conducted earlier in this Chapter.

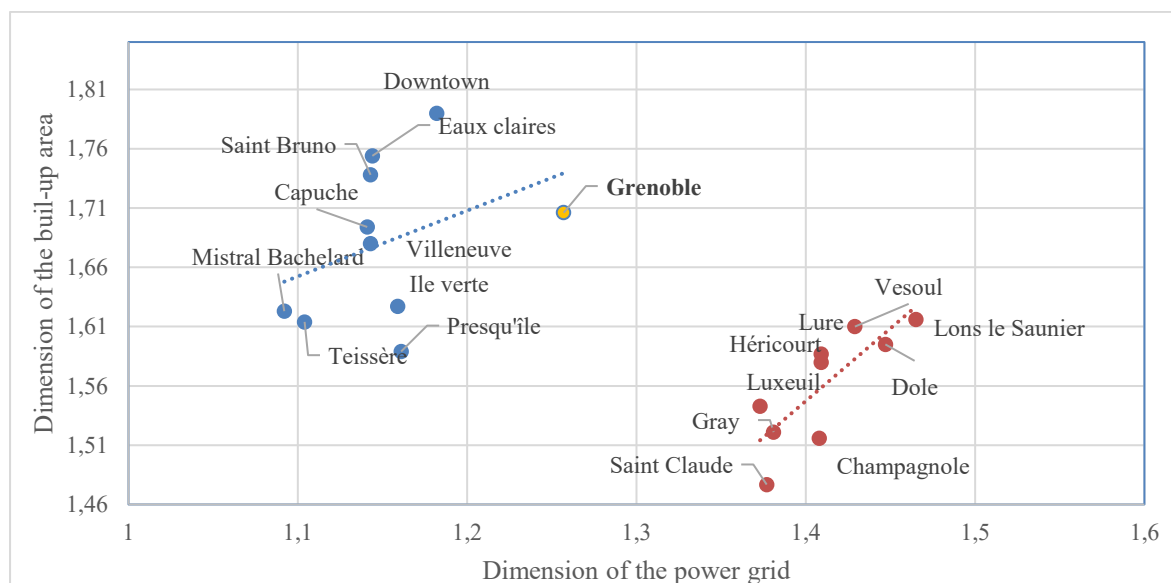

Figure 3-32: Classification for different zones in Grenoble and Franche-Comté

3.6 Conclusion

We demonstrated that the power grid for both Grenoble and the Franche-Comté region might show a scale invariant behavior. We were able to classify different areas for both cases after confronting the results of the fractal analysis of the power grid to roads and building via a detailed concordance analysis. Some similarities and divergences between the fractal

behavior of the urban fabric came into light via this analysis, which remains purely spatial. We showed that in the case of a dense city such as Grenoble, the function of districts does not seem to dramatically affect the spatial distribution of networks and buildings compared to the overall values. The next chapter adds another layer to this analysis via the introduction of a third dimension to the previous 2D analysis, i.e. taking into account the electrical power flows through the grid.

Chapter 4 Multifractal analysis of distribution power systems

In this chapter, we quantify the “electrical singularities” [2, 3] of power grids. Here, we aim particularly to identify the distribution of the main electrical variables of the grid, having in mind the main objective which is to understand the complexity of power distribution and the interactions across scales to facilitate the planning of a more sustainable power grid. A variety of measures such as active and reactive power consumed by every bus in the grid, voltage drops within the grid are considered to give us a better insight into the system’s behaviour and help us understand to what extent scaling phenomena occur in the grid. This work remains preliminary and is conducted in the electrical space only, no confrontation with the geographical data being done.

Two distribution networks are analysed in this study: Grenoble’s MV distribution grids and IEEE141 (part of the metropolitan area of Caracas served by AES-Venezuela [140]) to further illustrate and prove the relevancy of the multifractal analysis of distribution networks.

The first section of this chapter introduces the load flow formulation for power networks analysis as used later for the multi-fractal analysis. The second section details the application of the theory described in 0 to power systems. The third section is dedicated to results interpretations.

4.1 Formalizing power networks as a load flow problem

4.1.1 Problem formulation

Power flow study also known as load flow analysis is used for distribution power systems to compute the voltage magnitude and phase angle for each system generation or load node (called bus) , the power flow in each system cable (called branch) , the power injected by each

generation source, and the system losses. The computation is done in steady-state. The system is constituted by:

- Generators: They can provide active power but also provide or absorb a reactive power within certain limits.
- Loads : The consumption of electrical energy comes in very different forms: synchronous and asynchronous motors, heaters, ... Unlike generators, one cannot individualize each consumption. It is the aggregate of a sum of consumers at a node of the network which constitutes the 'load' characterizing this node.

The network consists of various connected elements (lines, cables, transformers) and associated devices (measuring and protection devices, etc.). Under the hypothesis of stationarity and three-phase symmetry , the network can be represented by a single-line diagram (Figure 4-1)

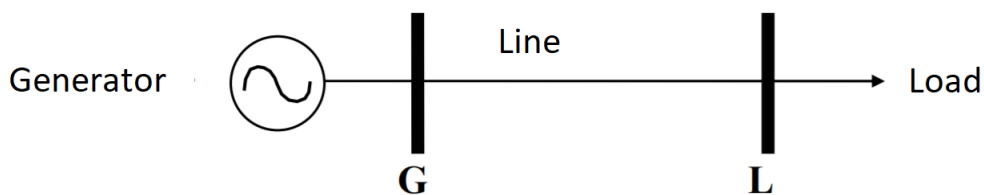

Figure 4-1: A typical one-line diagram

The problem of load distribution of a given network is correctly posed if we consider, at each node of the network, one of the following types of constraints:

- Active power P and reactive power Q imposed: this corresponds to node where a load is connected (about 80% of the nodes of the network).
- Imposed P and voltage V : this is a node where a generator is connected to support the voltage.
- V and voltage angle δ imposed: This is the node where a generator which plays the role of a balancer is connected. There is only one and it is called the slack node. It is used as the reference for all the other nodal voltage angles.

4.1.2 Power balance equations

The active power balance equation, where P_G and P_L are respectfully the generated and load active power, is written as :

$$\sum P_G = \sum P_L + \text{active losses} \quad (4-1)$$

The sum of the injected active powers by the generators is equal to the sum of the active powers absorbed by the loads, added to active losses from the network (resistance of lines, cables, etc.). In Europe, these losses represent up to 5% of the active power. [141]

The reactive power balance is written as:

$$\sum Q_G = \sum Q_L + \text{network reactive production/consumption} \quad (4-2)$$

The sum of the reactive powers injected or absorbed by the generators is equal to the sum of the reactive powers consumed/produced by loads and the reactive consumptions/productions of the network (reactance of the lines, cables, transformers, capacitor banks etc.).

The reactive consumption/production of the network is very variable and can be relatively high. The problem which arises at this point is that it is not possible to predict directly the power terms of the network in a direct way. These depend on the levels of voltage and the distribution of power transit in lines and transformers. The load flow resolution seeks to solve this issue.

For the resolution of a load flow problem, it is more convenient to work with admittances rather than impedances. We will start with a brief reminder of formulas related to the application of the so-called "admittance matrix method" for the calculation of any electrical network.

Let's suppose that the network consists of linear elements. The circuit equation is then:

$$\bar{I} = \bar{Y} \cdot \bar{U} \quad (4-3)$$

Where \bar{U} is the phase voltage and \bar{I} the injected current into a node. The matrix \bar{Y} is called "admittance matrix".

The value of the components of the admittance matrix is established as follows:

- The proper admittance Y_{ii} , associated with the node 'i', is equal to the sum of the admittances of branches incident to this node
- The transfer admittance Y_{ki} , associated with the nodes 'k' and 'i', is equal to the admittance of the branch that joins these two nodes, sign inversed.

The power injected into the node 'i' is:

$$\bar{S}_i = \bar{U}_i \cdot \bar{I}_i^* \quad (4-4)$$

From relation (4-3), we can express \bar{I}_i as follows:

$$\bar{I}_i = \sum_{k=1}^n \bar{Y}_{ik} \cdot \bar{U}_k \quad (4-5)$$

Where "n" represents the number of nodes. Then:

$$\bar{S}_i = \bar{U}_i \cdot \left(\sum_{k=1}^n \bar{Y}_{ik}^* \cdot \bar{U}_k^* \right) = P_i + j \cdot Q_i \quad (4-6)$$

Therefore, we can express the real and imaginary components of the power injected at each node as follows:

$$P_i = U_i \cdot \left(\sum_{k=1}^n Y_{ik} \cdot U_k \cdot \cos(\delta_i - \delta_k - \gamma_{ik}) \right) \quad (4-7)$$

And:

$$Q_i = U_i \cdot \left(\sum_{k=1}^n Y_{ik} \cdot U_k \cdot \sin(\delta_i - \delta_k - \gamma_{ik}) \right) \quad (4-8)$$

At this point, there are several ways to solve the system. By expressing the known P_i and Q_i equations, we get an equation system whose resolution is generally gets more complex as the number of nodes is higher.

The manual resolution of such a problem is not possible unless it is for a very small number of nodes. More complex systems will require digital support for the resolution.

The simplest solution is to solve the nonlinear system of equations (4-7) and (4-8) using an adapted computer software. For this work, the load flow of distribution grids was conducted using Matpower using Newton-Raphson method [142].

4.2 Tools for multifractal analysis for distribution power systems

In order to analyze the fractal behavior within the system's response, we use the cluster growing method [2, 3, 143] to compute the generalized dimensions and singularities as refer to in Chapter 2.

After conducting an AC load flow computation, we proceed into assessing the normalized measure (0) for different cluster sizes, until reaching the border of the network. The measure could describe voltage drops across the branches inside the clusters, active or reactive power of the nodes belonging to the cluster as referred to later in this chapter.

The cluster sizes are determined using the line impedances and a shortest path logic to get from one node to its closest neighbour from one iteration to another. Figure 4-2 shows the cluster growing method as applied to electrical networks for one specific node as the edges and their impedances are counted. Figure 4-3 shows the algorithm to compute the generalized dimension as defined in 2.3.1. This algorithm has been coded in Python to perform the multifractal studies.

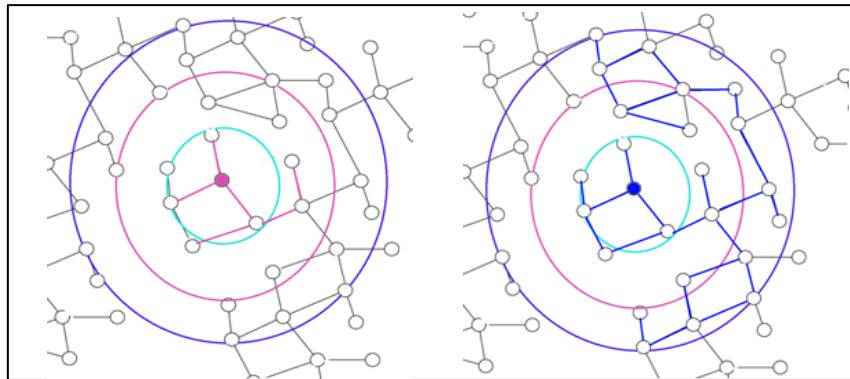

Figure 4-2: Cluster growing method for power networks : the cluster size is increased according to the shortest path distance

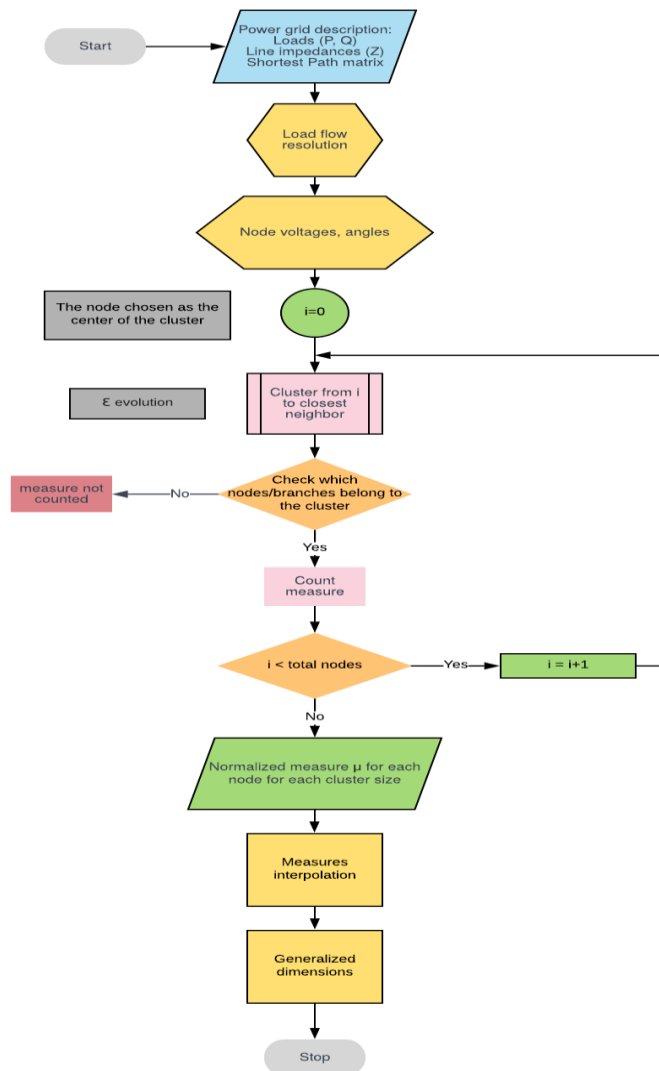

Figure 4-3 : Multifractal analysis algorithm

The different measures used to assess the fractality of the grid are as follows:

- Active power: The normalized measure is defined as $\mu_i(\varepsilon) = \frac{\sum_{j \in E_i} P_j}{\sum_{k \in E} P_k}$ where E_i is the set of nodes in a cluster around node i , P_j is the active power of every load j inside the cluster while E includes nodes of the whole power grid. The distribution of this measure gives an insight into how the loads are either centralized or rather dispersed within the grid.
- Reactive power: The normalized measure is defined as $\mu_i(\varepsilon) = \frac{\sum_{j \in E_i} Q_j}{\sum_{k \in E} Q_k}$ where Q_j is the reactive power of every load j inside the cluster. In addition to assessing the distribution of the reactive loads, this measure shows if and how the load type (highly active or reactive) affects the distribution of other measures.
- Impedance: The normalized measure is defined as $\mu_i(\varepsilon) = \frac{\sum_{j \in E_i} Z_j}{\sum_{k \in E} Z_k}$ where Z_j is the impedance of every edge j inside the cluster. This measure gives an outlook of the topology of the grid. [144]
- Voltage drop: The normalized measure is defined as $\mu_i(\varepsilon) = \frac{\sum_{j \in E_i} V_j}{\sum_{k \in E} V_k}$ where V_j is the voltage drop in every edge j inside the cluster. This is used as one of the parameters to assess the quality of the electrical power delivered to the customers. The system operator tries to minimize the absolute value of the voltage drop to keep the voltage at each node within an acceptable range (typically +/-5% of the nominal value). Otherwise, the currents are too high (too low voltages) or high voltage protections trip off.

4.3 Results of fractal analysis of distribution power grids

4.3.1 Analysis on a 15-node simple case

Before analyzing more realistic networks, let's apply the analysis to a simpler case. Figure 4-4 shows a resistive grid in four different configurations to explore how line impedances and bifurcations affect the quality of the network by measuring the distribution of voltage drops and its generalized dimensions.

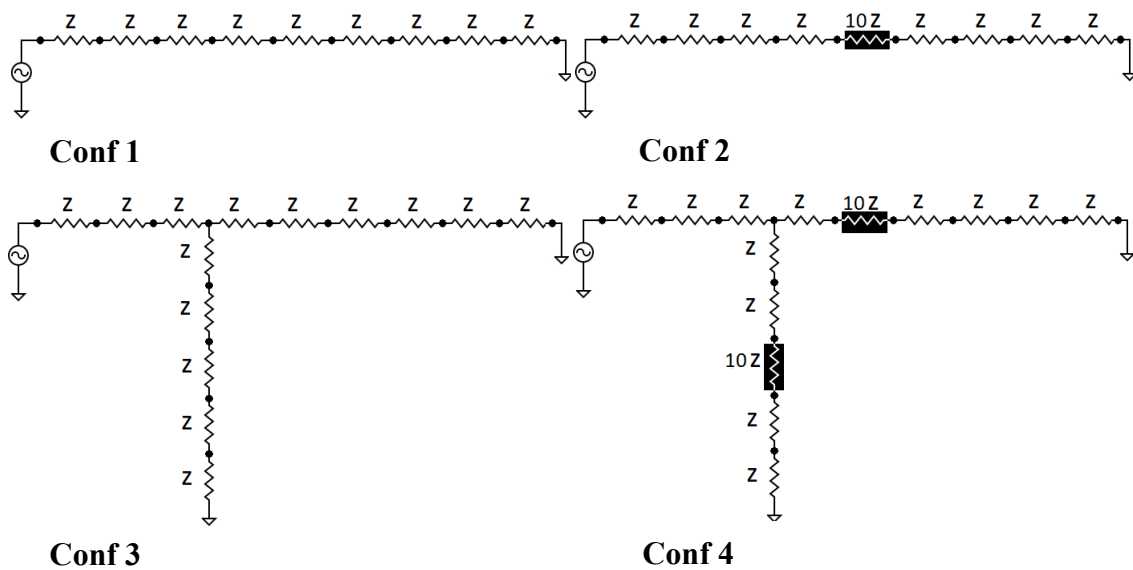

Figure 4-4: 15 node case with singularity (Conf 1: same impedance for all lines, Conf 2: introducing an impedance singularity, Conf 3: introducing a bifurcation, Conf 4: introducing both bifurcation and singularities)

In Figure 4-5, we measure the voltage drops for each configuration and represent it in a double logarithmic way to identify the power laws which might occur in the distribution of voltage drops.

In Conf 1, the network consists of 10 nodes connected via lines with the same value of impedance. We can identify a central zone for which there is a smooth evolution in the logarithmic scale.

Let's compare now the first and third configurations. We notice that adding a bifurcation does not seem to affect the width of the central zone. However, the slopes of the q th moments are less steep which could indicate that the voltage drops are not distributed evenly following the size of the cluster, even though the line impedances remain the same.

When observing the effect of adding a singularity, which was done by introducing a line with a higher impedance, we notice a modification of shape of the plot around -0.5 . Configuration 4 shows the result of adding singularities and bifurcations. The identification of a distinct zone with a power law evolution of the q th moments is possible here but could not be confirmed as we are dealing here with a very small system with few measurement points. This means that this kind of network might exhibit scale invariance in their properties, but this

is obviously yet to prove as we are investigating here the possibilities of the appearance of a law invariant distribution of some of the properties of the power grid.

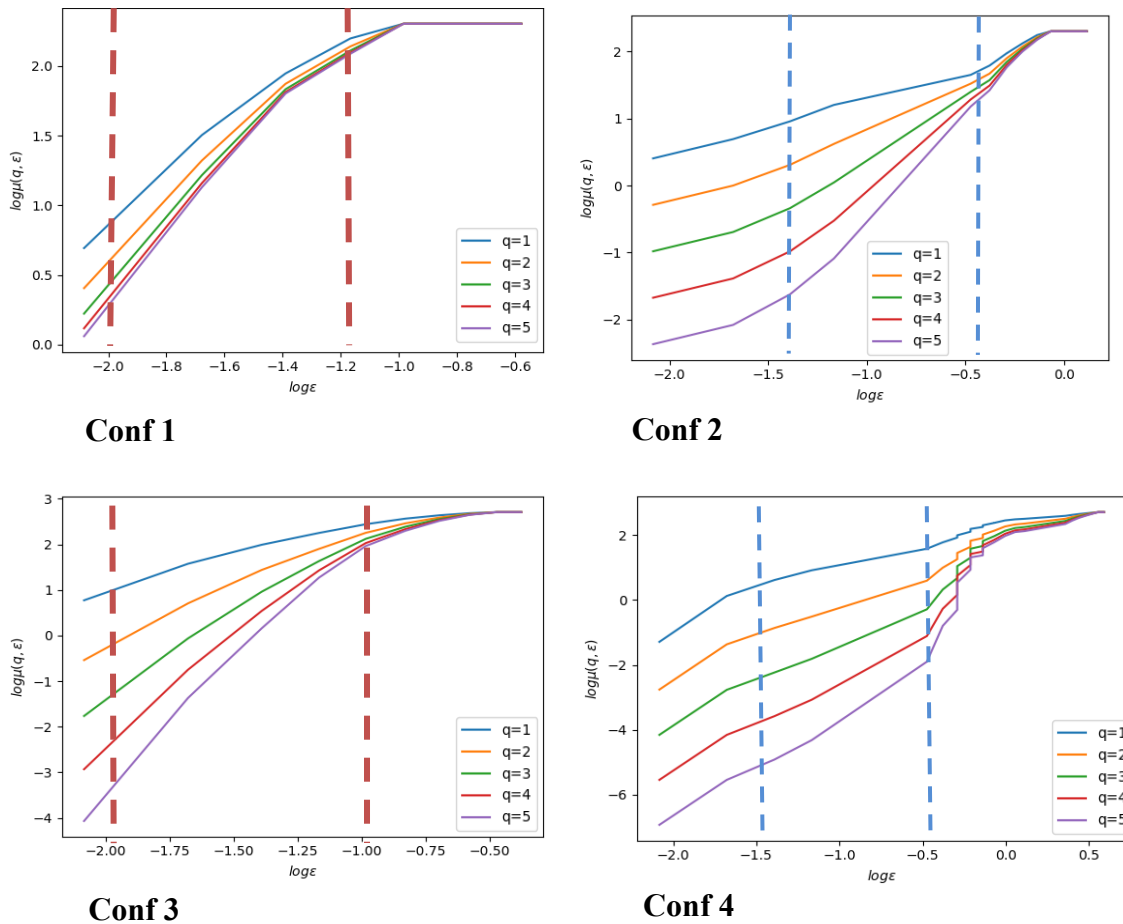

Figure 4-5: 15 node case voltage drops analysis : q th moments of normalized measures in a double logarithmic representation

4.3.2 Analysis of Caracas (IEEE 141) vs Grenoble distribution grid

4.3.2.1 Networks description

Part of the medium voltage distribution grid of the metropolitan area of Caracas served by AES-Venezuela [140] is described by the IEEE141 case as shown in Figure 4-6 with the distribution of active loads. Let's note that the loads are evenly distributed with very few bigger

loads. The reactive power of this network is proportional to its active power (ratio of 0.4 between the reactive and active power).

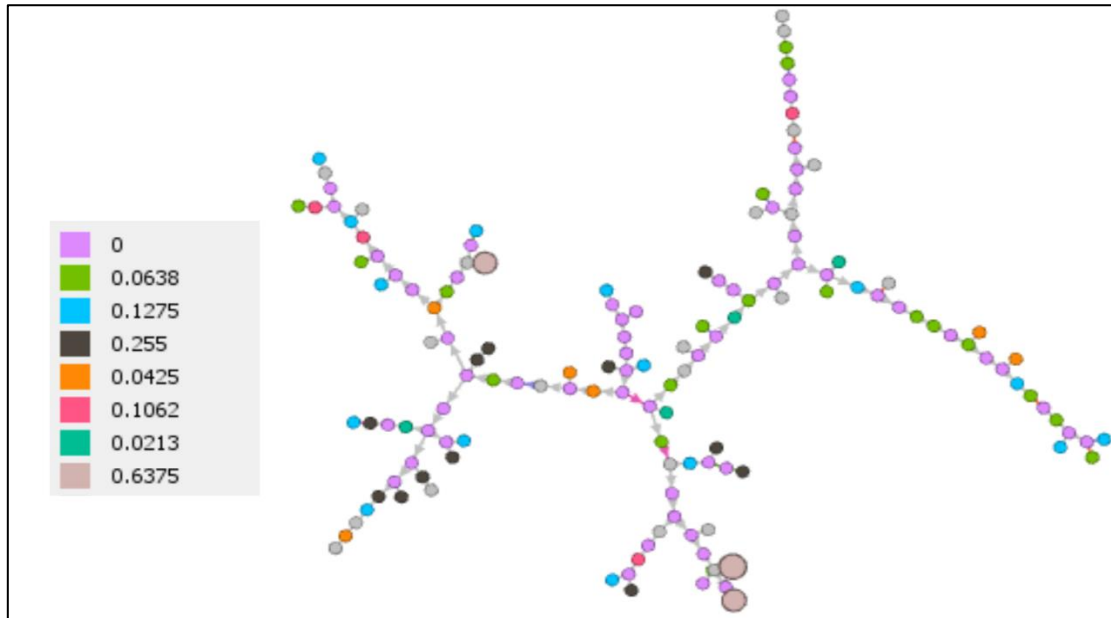

Figure 4-6: Graph representation of IEEE141 case with power distribution and its proportion in MW

The distribution grid of Grenoble is operated by the local DSO, Gaz Electricité de Grenoble (GEG). It is connected to the French transmission grid operated by the French TSO Rte (Réseau de transport d'électricité) via three 225/63 kV substations : Confluent, Pariset, Eybens. The network is constituted by eleven 63 kV feeders, thirty 20 kV feeders which distribute the power to around 1000 LV substations . GEG operates housing as well as big industrial clients: 150 loads over 250 kVA connected to the MV network, 1000 loads between 36 and 250 kVA and more than 100.000 loads lower than 36 kVA, these loads are connected to the LV feeders and are represented aggregated at the LV substations. The studied network is shown in Figure 4-7. It represents part of the network as operated in one of its multiple configurations to run a power flow calculation.

We notice in Figure 4-8 which shows the histogram of the active power within both distribution grids that the distribution of the values of loads is similar between both networks as we are confronted to two cases with a high density of small loads and very few high loads, which reminds the characteristic of a city distribution grid.

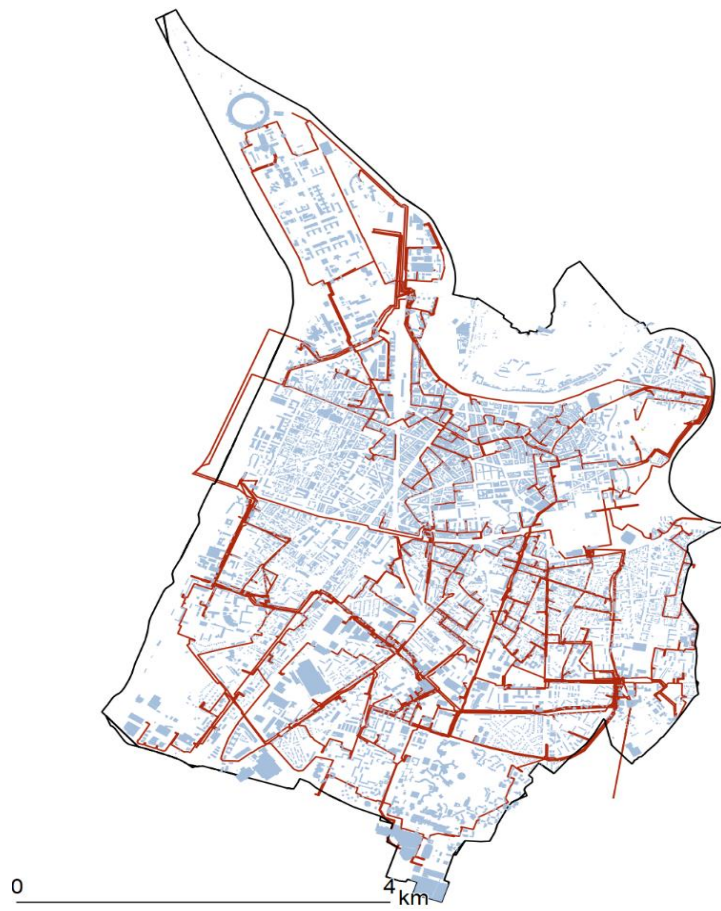

Figure 4-7: Medium voltage network of the city of Grenoble (Red line)

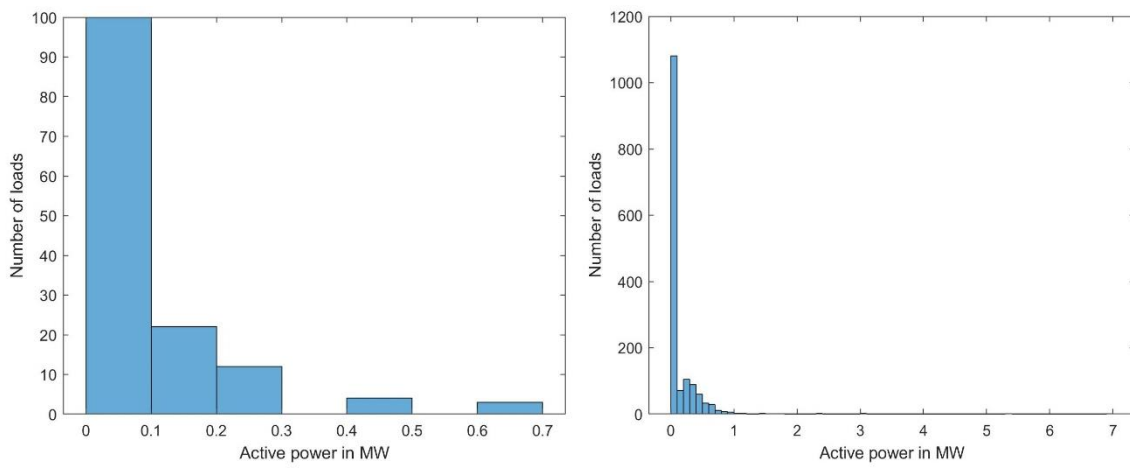

Figure 4-8: Histogram of active power distribution (left : IEEE141, right: Grenoble)

4.3.2.2 Active power

We first analyse the distribution of the nodal active power to further identify the links between the distribution of the loads and the resulting voltage drops. In Figure 4-9 – left panel, for the IEEE network, we notice a rather uniform evolution of the normalized measure while for Grenoble we see a rapid growth of the measure at closer distance to the nodes, which means that the loads are located close to each other. We note that for Grenoble, the moments reach 80 % of their maximum value for impedances values smaller than 2 p.u.

The active power of loads does not seem, in general, for both networks to be following a multifractal logic for small impedances as the logarithmic value is constant. However, we can identify a zone where the generalized measures evolve in a linear fashion according to impedances in a double logarithmic scale. This zone appears for impedance values higher than the mean value of line impedances, meaning that power laws seems to appear once we analyse the system as a whole.

The distribution of the loads might be considered to be showing a sort of multifractal behaviour. In other words, despite not being able to conclude here on the multifractality of the distribution of the loads which are close to each other, once we look at the system as whole, some multifractal features seems to arise within the distribution of the loads. We note in Figure 4-10 that the generalized dimension is rather constant in these identified zones.

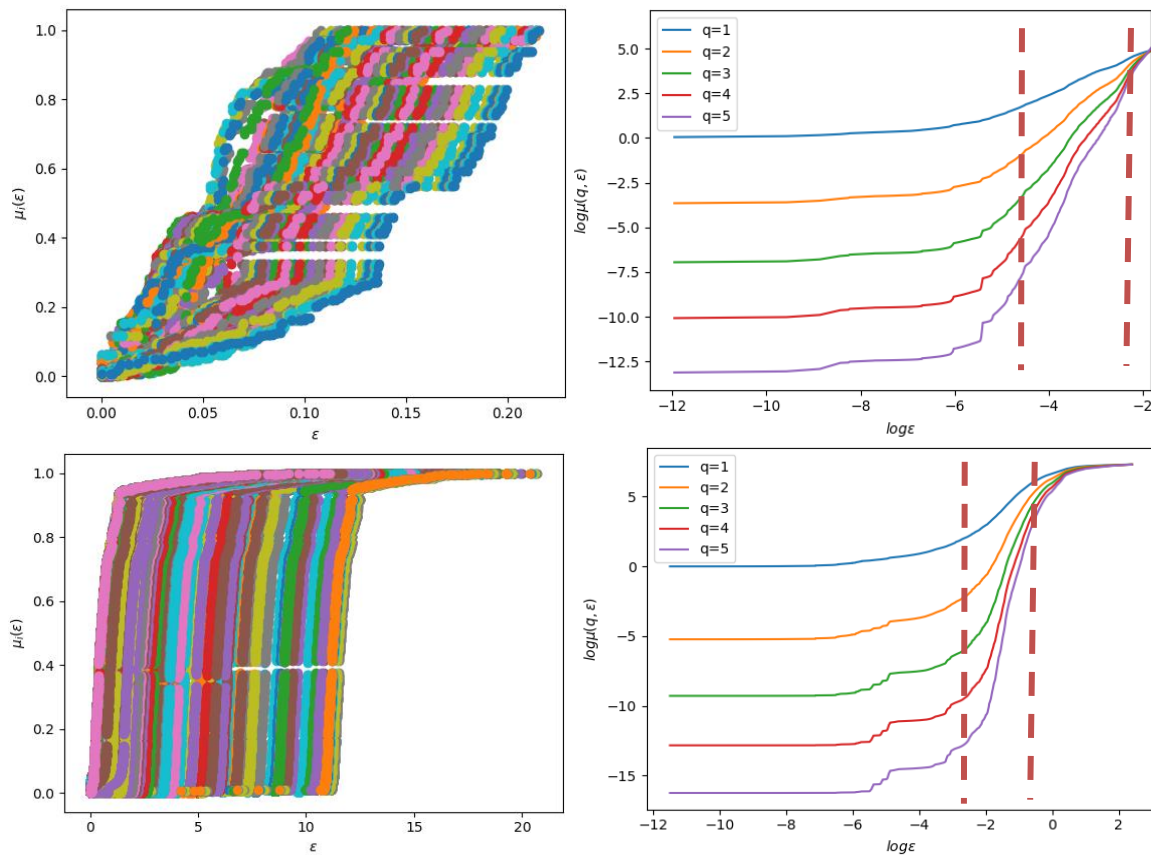

Figure 4-9: Active power measures (up: IEEE141, down : Grenoble)

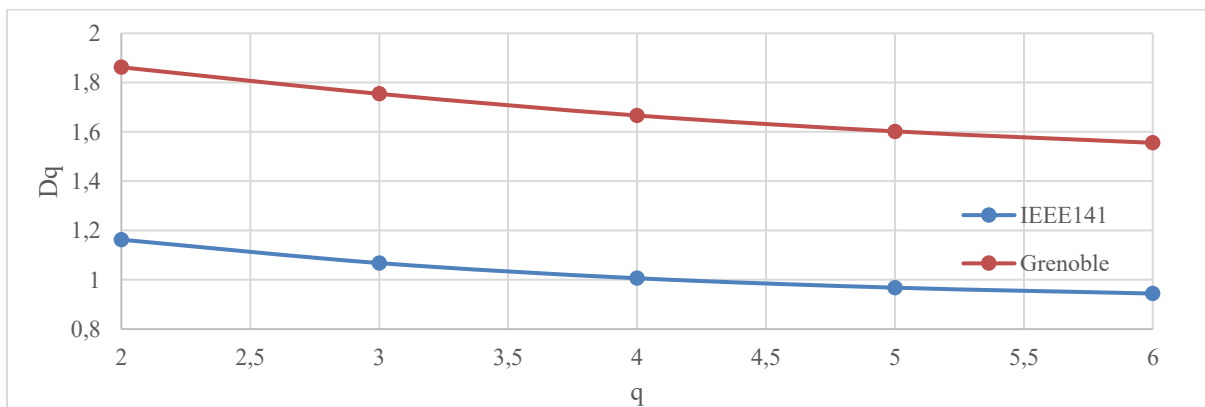

Figure 4-10: Generalized dimension for active power

4.3.2.3 Reactive Power

The analysis of reactive power show similar results to those of the previous section. The reactive power is proportional to active power for both networks which lead to similar results

for normalized measures and generalized dimensions (Figure 4-11, Figure 4-12, Figure 4-13). Consequently, the same interpretations apply here.

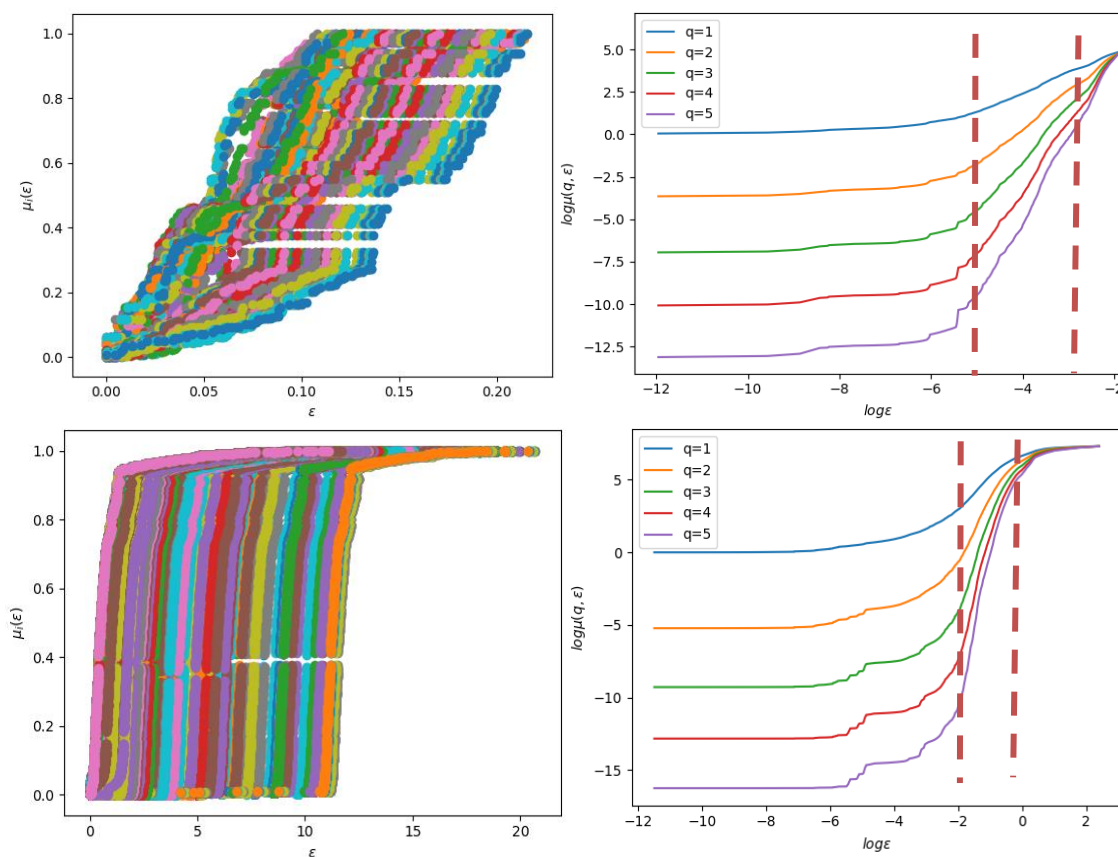

Figure 4-11: Reactive power measures (up: IEEE141, down : Grenoble)

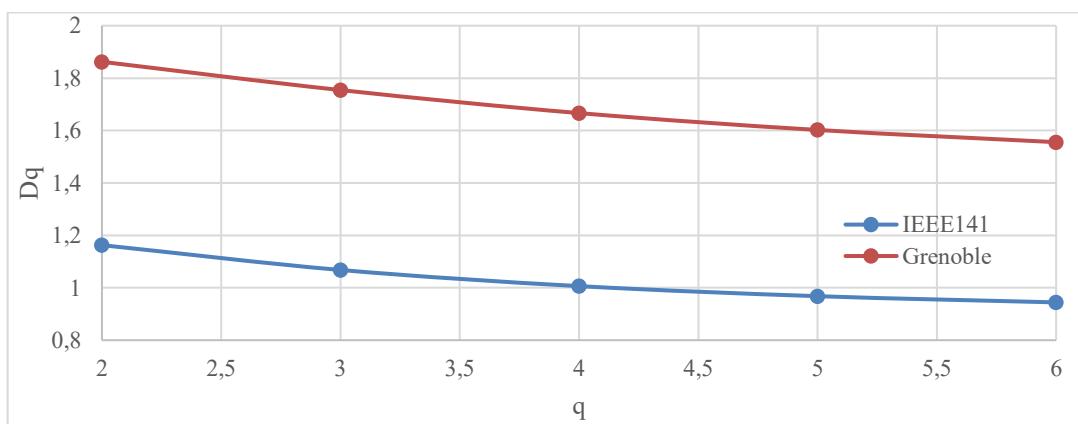

Figure 4-12: Generalized dimension for reactive power

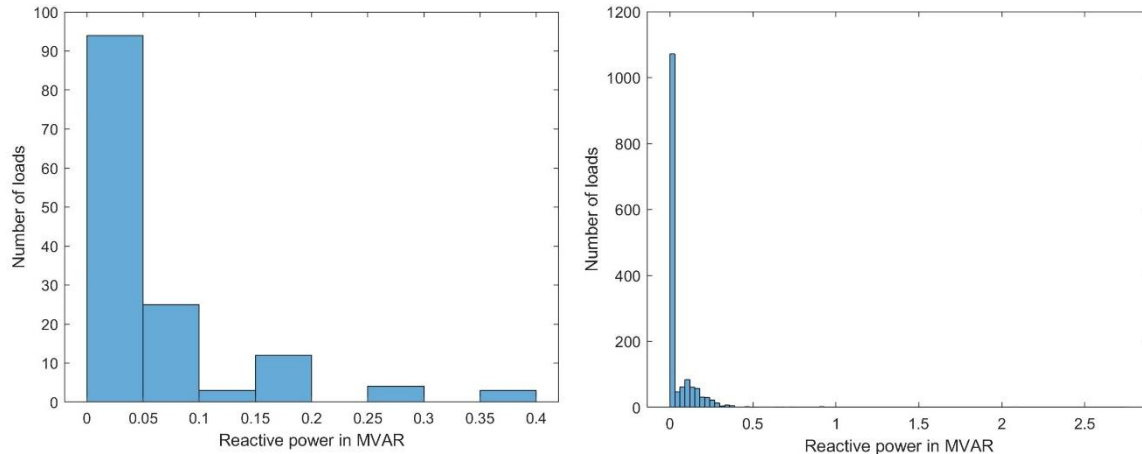

Figure 4-13: Histogram of reactive power distribution (left : IEEE141, right: Grenoble)

4.3.2.4 Impedance

The measure for both networks evolves in an exponential fashion as shown in Figure 4-14 even though the distribution of line impedances seems to be more uniform for Caracas distribution grid. For both networks, we observe that the generalized dimensions are quite similar, meaning that the variation of their connectivity over scales is similar. Here, we can conclude that both systems show a form of multifractal behaviour in terms of the distribution of impedances. One of the reasons which could explain it is that the impedance is proportional to the length of the lines of the network (even though the difference of the material as well as the size of the cable affect this value as well). As we have already shown that in the case of Grenoble, the power network shows self-similarities in terms of the length of the network, this result seems to confirm this tendency.

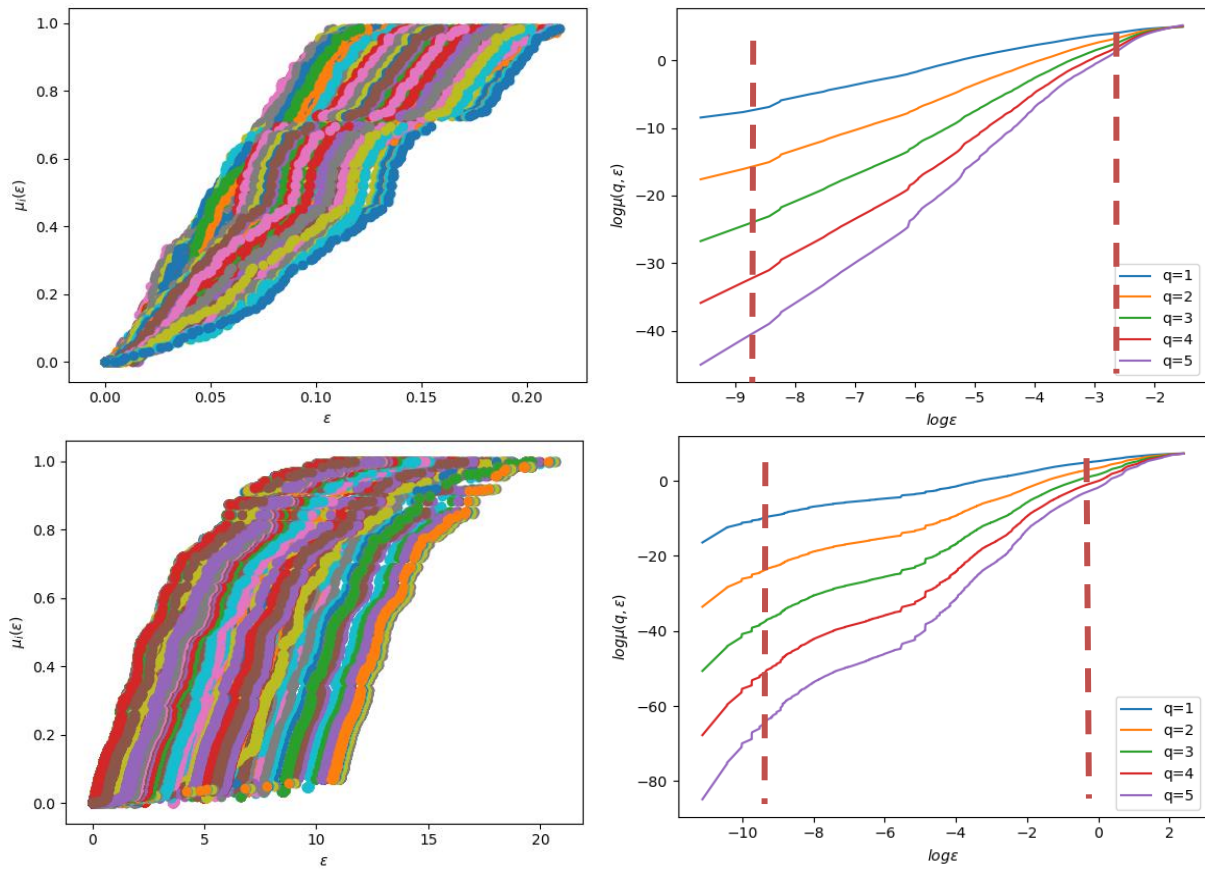

Figure 4-14: Impedance measures (up: IEEE141, down : Grenoble)

In the particular case of Grenoble's distribution system, we might notice that impedances values vary mostly up to 10 p.u while the max value to cover the whole network graph for very few nodes goes up to 20 p.u.

It is interesting to see, that despite studying two distribution grids deployed in two different cities with very different size and organization, there is a notable similarity between both topologies which we can describe as a sort of "universality" of the design of distribution grids.

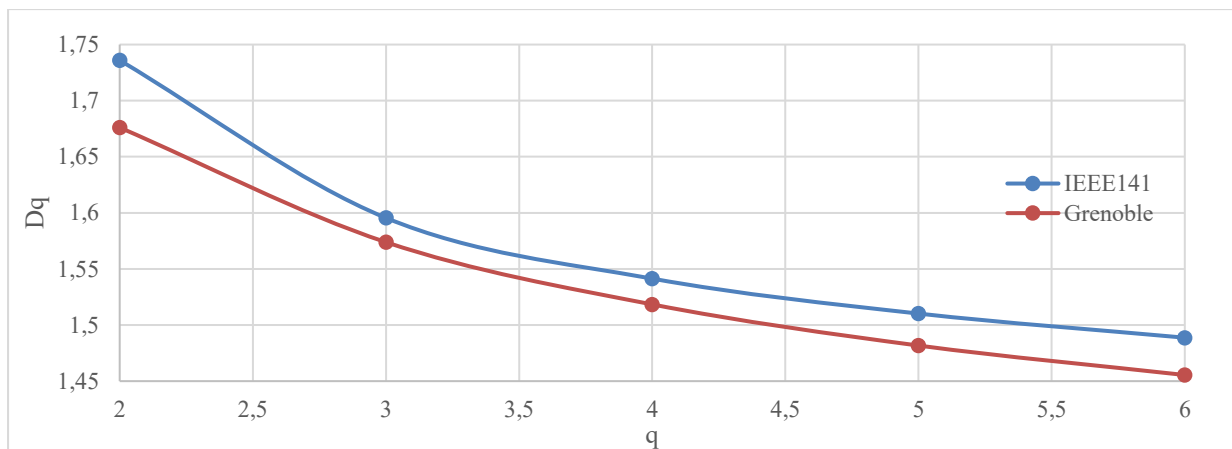

Figure 4-15 : Impedance generalized dimensions

4.3.2.5 Voltage drops

In Figure 4-16, we observe the evolution of voltage drops throughout the systems. For the Caracas distribution grid, we notice some ruptures in the measures which are translated by two different zones where we can observe two power laws. For $-10 < \log \varepsilon < -8$, the distribution of the logarithmic value of voltage drops is linear in regard to the size of the cluster. For $-8 < \log \varepsilon < -7$, we could notice a “transition phase” for which the voltage drop evolution remains constant leading to a second linear evolution for $-7 < \log \varepsilon < -4$, after which we reach the borders of the network and the measure remains constant.

It is of high interest to note that the transition phase would mean that the distribution network at hands could be seen as a two level network. The inner level goes up to an impedance of -8 in logarithmic value. The outer level starts from -7. Both exhibit the same behaviour and the transition level may be explained as a perturbation in the logic of progression of bifurcations and impedance values. The generalized dimension D_q for both zone as shown in Figure 4-17 are very similar which comforts the previous conclusion.

For Grenoble, we must note that the voltage drops show a form of multifractality with very small local deviation compared to the dominant law. It may be the result of the combination of the scale invariance of both impedances and load distribution as revealed below.

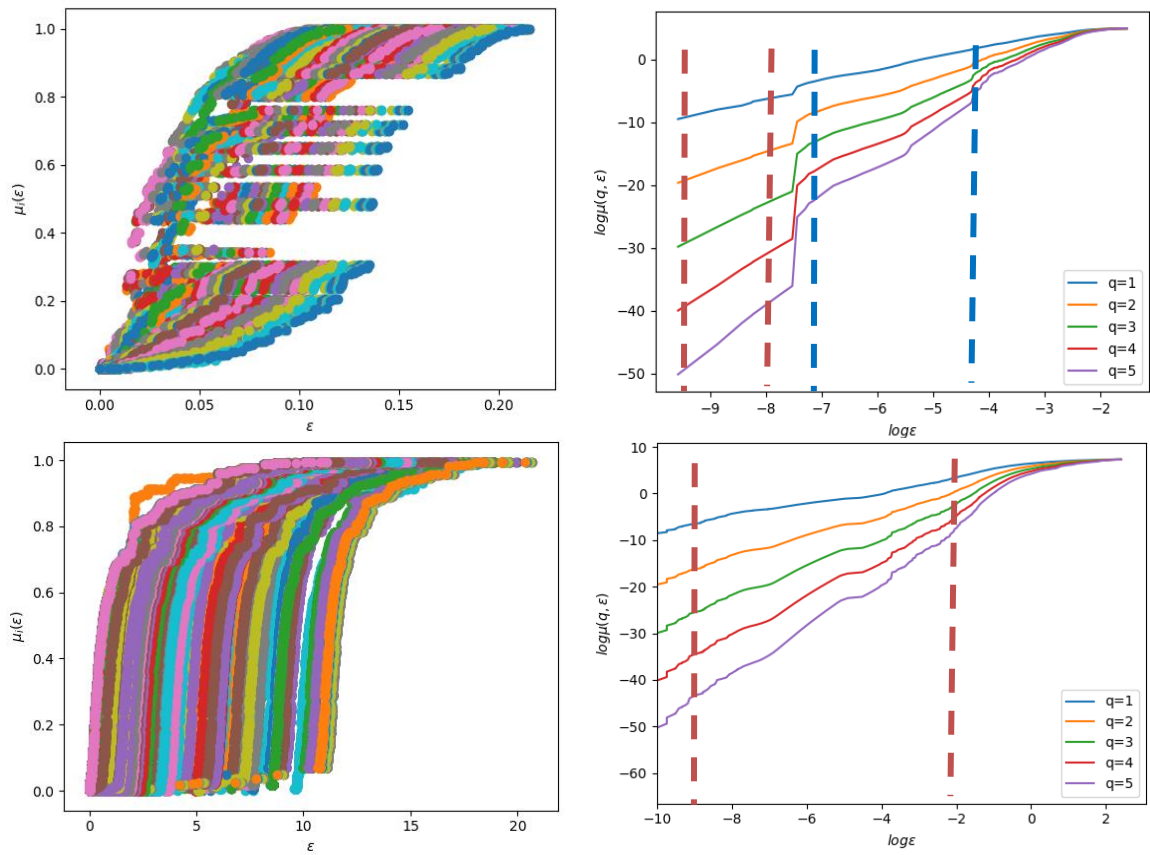

Figure 4-16: Voltage drop measures (up: IEEE141, down : Grenoble)

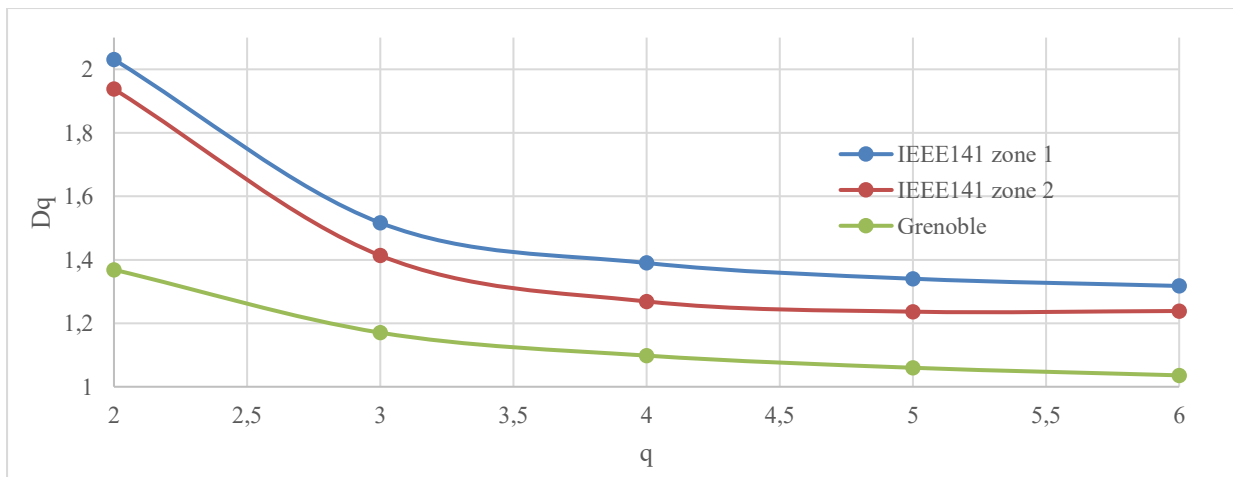

Figure 4-17: Generalized dimension for voltage drops

4.4 Conclusion

In this chapter, a multifractal tool is applied for the first time, to the best of our literature knowledge, to analyze the complexity of power networks. It allows us to have a multi-scale vision of the electrical properties and network singularities and to consequently classify networks and compare them. The results of such analysis could serve as indicators for network planners while designing new networks.

We investigated the multifractality among the electrical properties of two different medium voltage distribution grids. We came to the conclusion that in different cases, some electrical variables of the grids appear to follow a form of “a multifractal law”. We noted that the IEEE 141 shows more singularities when it comes to voltage drops than Grenoble’s case. This is certainly due to the combination of the grid’s topology, impedances and the power generators and loads location. But this is still to be more thoroughly determined as this empirical result is preliminary and needs to be confirmed using theoretical networks to understand the emergence of scaling laws within the electrical properties of networks.

Towards a fractal planning of power grids

In this study, we have shown that a fractal modelling of the power grid, through the theoretical properties of fractal objects and multifractal analysis is meaningful for the analysis across scales of urban distribution networks. In chapter 3, the box counting method was chosen to identify the fractal behavior, but we showed that it should be carefully used as one can identify a maximum value of box size that should not be exceeded to have a suitable coverage depending on the type of system at hands. It is undeniable that an important limitation of fractal analysis is that getting an empirically determined fractal dimension does not necessarily prove that a pattern is fractal. In chapter 4, the multifractal analysis carried out on two different distribution power grids showed that fractal patterns could be also identified in the electrical properties which might be a result of the combination of both the suspected fractality of the geometry of the network and the spatial distributions of the impedances, power sources and loads. These results will need to be confronted in the future to a multifractal analysis of the buildings using a 3rd dimension (building height, energy consumed per m²) and therefore conduct a multifractal concordance analysis between the grid and its urban use. We showed that carrying out a fractal analysis is valuable in understanding the complexity of the structure of the power grid and its relations with urban fabrics. Fractality could therefore be also an interesting way towards planning optimal power grids in the future.

Literature over the past three decades [5, 6, 9-11, 82, 124, 129, 130], and more specifically the work of P.Frankhauser have shown the existence of fractal forms and characteristics in urban planning. He compared in 1994 [9] the built-up area of Paris to a randomly generated fractal as shown in Figure 1 and demonstrated the appearance of this jagged form, which is a characteristic of fractals, due to the growth process of the Parisian urban area. He pointed out the presence of an internal hierarchy within the structure. This comes as a result of the repetition of the same elements during the construction of the city, which directly reflects the theoretical definition of a fractal. Paris is therefore an example or

even a possible model of a fractal inspired city which guarantees fundamental equilibria: density, accessibility, social acceptability and long and short distance connectivity. Other cities such as Mexico city, Nouakchott or Barcelona are known to also follow a predefined fractal geometry [145].

Our work showed as well the presence of fractal properties for the city of Grenoble, not only in the organization of urban tissues, but also in urban networks such as the road and power networks. The presence of this fractal morphology could either be a choice of planners to knowingly take advantage of the fractal structure or a random result of the evolution of the territory. The logical outcome would be to consider (reconsider) the planning of cities using fractal geometry.

Reconsidering the planning of an existing city, meaning making changes within an already established developed structure is a difficult task as it is not reasonable for urban planners, architects or politicians to destroy existing structures within the cities and therefore modify its morphology and historical evolution. If that were the case, the process would take a long period within which the changes will be made gradually not to shake the lifestyles of the individuals living in the city. However, the cities could evolve using a “fractal spirit” as this sort of planning will allow, via the destruction of buildings, creating empty spaces, which will be used as green spaces, which presence is necessary with the growth of the population and the densification of urban tissues.

Let us have a look at the specific case of the city of Grenoble, which is a compact city, with no possibility to expand territorially, but whose territorial evolution will be driven by the need to have more green facilities which are more asked for and highly appreciated by citizens. The following analysis is to make a proposition of a fractal planned power grid for Grenoble based on the existing data of the city. The results are conducted using the Software Fractalopolis and are inspired from the previous work of its creators. [21, 146]

The first step of the process is to identify the generator and the initiator of the fractal that could be used to generate the fractal planning of Grenoble. The generator is a square and the initiator is made by a distribution of squares that match the most to reality as shown in Figure 2. It means that the squares are put where the building density is higher. For planners, these

squares would be the areas to densify even more. Then comes the proposition of a theoretical fractal network which is consistent with the geometrical fractal used to cover the city. The links are made between the centroids of the squares following the same hierarchization as shown in Figure 3. Obviously, this proposed structure has to be adapted to the existent urban fabric as shown in Figure 4 while keeping the same fractal properties of the theoretical proposition. This was done by deforming the initial fractal network for the network cables to follow the streets. The fractal, multifractal and electrical properties of such a network, its concordance with the urban fabric are still to be investigated. This is the main research outlook of this work.

The planning of cities and more particularly power grids can therefore be thought using fractals, but, if proven, the advantages of such structures would make more sense and be plainly taken of in the construction of new cities. The creation of such new urban territories is a response to the need of empty spaces for the growing population but also to respond to the new challenges of urban planning. We can mention the recent opening in 2017 of an American town in Florida. In developing countries, in north Africa and south America, such projects are getting more and more support from local governments aiming at creating more sustainable cities for their citizens. Fractal planning is one option which could be considered and consolidated to build these new cities while responding to sustainability criteria.



Figure 1: Comparison of a randomly generated fractal (left) and the built-up area of Paris



Figure 2: Iterations 1 and 2 of the fractal process to plan the power grid (upper left panel – generator ; upper right panel – initiator ; bottom panel – 2nd iteration)

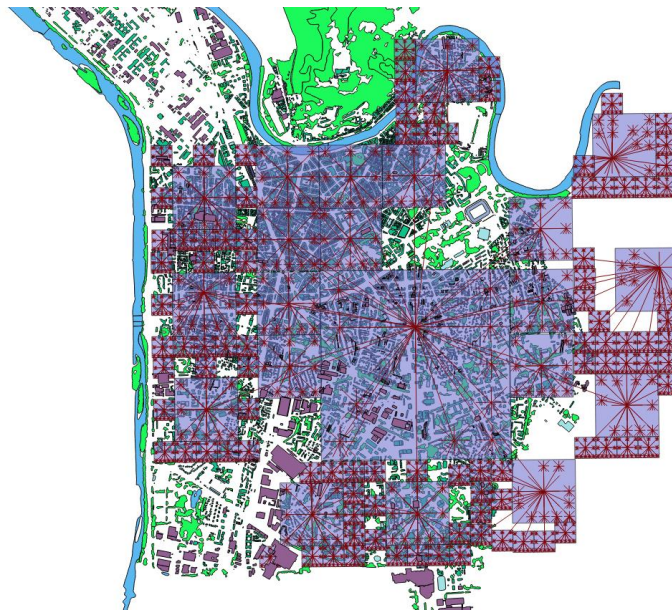

Figure 3: Theoretical fractal planed power grid

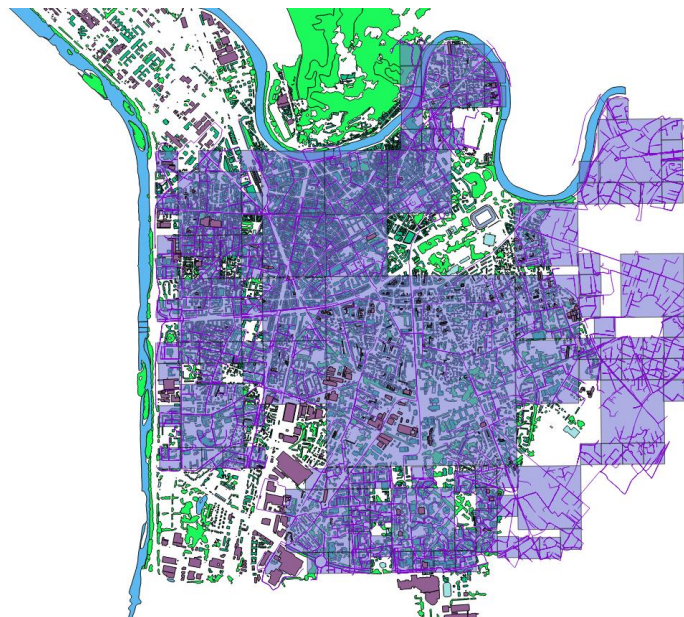

Figure 4: Fractal grid adapted to the road network

References

1. Mandelbrot, B.B., *The fractal geometry of nature*. 1982.
2. Tél, T., Á. Fülöp, and T. Vicsek, *Determination of fractal dimensions for geometrical multifractals*. *Physica A: Statistical Mechanics and its Applications*, 1989.
3. Theiler, J., *Estimating fractal dimension*. *Journal of the Optical Society of America A*, 1990. **7**(6): p. 1055-1073.
4. Anas, A., R. Arnott, and K. Small, *Urban Spatial Structure*. *Journal of Economic Literature*, 1998. **36**(3): p. 1426-1464.
5. Batty, M. and P.A. Longley, *The Fractal Simulation of Urban Structure*. *Environment and Planning A: Economy and Space*, 1986. **18**(9): p. 1143-1179.
6. Batty, M. and P.A. Longley, *Fractal-Based Description of Urban Form*. *Environment and Planning B: Planning and Design*, 1987. **14**(2): p. 123-134.
7. Batty, M. and P.A. Longley, *The Morphology of Urban Land Use*. *Environment and Planning B: Planning and Design*, 1988. **15**(4): p. 461-488.
8. Benguigui, L., E. Blumenfeld-Lieberthal, and D. Czamanski, *The Dynamics of the Tel Aviv Morphology*. *Environment and Planning B: Planning and Design*, 2006. **33**(2): p. 269-284.
9. Frankhauser, P., *La fractalité des structures urbaines*. 1994: Anthropos. 291.
10. Frankhauser, P., *Aspects fractals des structures urbaines*. *L'Espace géographique*, 1990: p. 45-69.
11. Thomas, I. and P. Frankhauser, *Fractal Dimensions of the Built-up Footprint: Buildings versus Roads. Fractal Evidence from Antwerp (Belgium)*. *Environment and Planning B: Planning and Design*, 2013. **40**(2): p. 310-329.
12. Frankhauser, P., *L'approche fractale. Un nouvel outil de réflexion dans l'analyse spatiale des agglomérations urbaines*. *Population*, 1997: p. 1005-1040.
13. Thomas, I., et al., *Clustering Patterns of Urban Built-up Areas with Curves of Fractal Scaling Behaviour*. *Environment and Planning B: Planning and Design*, 2010. **37**(5): p. 942-954.
14. Byun, J., et al., *A smart energy distribution and management system for renewable energy distribution and context-aware services based on user patterns and load forecasting*. *IEEE Transactions on Consumer Electronics*, 2011. **57**(2): p. 436-444.
15. Retiere, N., et al., *Fractal Grid – towards the future smart grid*. *CIREN - Open Access Proceedings Journal*, 2017. **2017**(1): p. 2296-2299.
16. Telukunta, V., et al., *Protection challenges under bulk penetration of renewable energy resources in power systems: A review*. *CSEE Journal of Power and Energy Systems*, 2017. **3**(4): p. 365-379.

-
17. Batty, M. and Y. Xie, *From Cells to Cities*. Environment and Planning B: Planning and Design, 1994. **21**(7): p. S31-S48.
 18. Domínguez, J.I., *Urbanization, Planning and National Development*. By John Friedmann. (Beverly Hills, Calif.: Sage Publications, Inc., 1973. Pp. 351. \$12.50.). American Political Science Review, 1974. **68**(3): p. 1354-1355.
 19. Tarn, J.N., *Benevolo, Leonardo, "The History of the City"*(Book Review). The Town Planning Review, 1981. **52**(3): p. 346.
 20. Bonin, O. and L. Tomasoni, *Evaluation of a transit-oriented development scenario in a medium-sized French city by simulation models*. 2015.
 21. Frankhauser, P., *The Fractalopolis model-a sustainable approach for a central place system*. 2012.
 22. Jourdan, G., *Transports, planification et gouvernance urbaine*. 2003: L'Harmattan. 319.
 23. Pinson, G., *Gouverner la ville par projet : urbanisme et gouvernance des villes européennes*. 2009: Presses de Sciences Po. 420.
 24. Hernandez, F., *Le processus de planification des déplacements urbains entre projets techniques et modèles de ville*. 2003. p. 2 vol. (351-156 p.).
 25. Singh, B., et al., *Sustainable integrated urban & energy planning, the evolving electrical grid and urban energy transition*. The Centre for Urban Energy. Ryerson University, 2015.
 26. Douay, N., *La planification urbaine française : théories, normes juridiques et défis pour la pratique*. L'Information géographique, 2013. **77**(3): p. 45-70.
 27. Healey, P., *Collaborative Planning in Perspective*. Planning Theory, 2003. **2**(2): p. 101-123.
 28. <https://www.vie-publique.fr>.
 29. Allmendinger, P., *Towards a Post-Positivist Typology of Planning Theory*. Planning Theory, 2002. **1**(1): p. 77-99.
 30. [https://en.wikipedia.org/wiki/Chicago_school_\(sociology\)](https://en.wikipedia.org/wiki/Chicago_school_(sociology)).
 31. Meyerson, M. and E.C. Banfield, *Politics, planning, and the public interest : The case of public housing in Chicago*. 1969: New York, The Free Press.
 32. Douay, N., *Shanghai : l'évolution des styles de la planification urbaine. L'émergence d'une « urbanisation harmonieuse » ?* Vol. 105. 2008. 16-26.
 33. Padioleau, J.-G. and R. Demesteere, *Les démarches stratégiques de planification des villes. Origines, exemples et questions*. Les Annales de la Recherche Urbaine, 1991: p. 29-40.
 34. Sutcliffe, A., (Gabriel Dupuy) *L'Urbanisme des réseaux : théories et méthodes*. FLUX Cahiers scientifiques internationaux Réseaux et Territoires, 1992: p. 60-61.
 35. Bryson, J.M. and W.D. Roering, *Applying Private-Sector Strategic Planning in the Public Sector*. Journal of the American Planning Association, 1987. **53**(1): p. 9-22.

-
36. Hamel, P., *La critique postmoderne et le courant communicationnel au sein des théories de la planification : une rencontre difficile*. Cahiers de géographie du Québec, 1997. **41**(114): p. 311-321.
37. Mbengue, A. and M. Ouakouak, *Planification stratégique rationnelle et performance de l'entreprise : une étude internationale*. Management international / International Management / Gestión Internacional, 2012. **16**(4): p. 117-127.
38. Habermas, J., *The theory of communicative action*. 1984, Boston: Beacon Press.
39. Habermas, J., *The Theory of Communicative Action, Volume 2: Lifeworld and System: A Critique of Functionalist Reason* 1987: Beacon Press.
40. Innes, J.E. and J. Gruber, *Planning Styles in Conflict: The Metropolitan Transportation Commission*. Journal of the American Planning Association, 2005. **71**(2): p. 177-188.
41. Innes, J.E., *Group Processes and the Social Construction of Growth Management: Florida, Vermont, and New Jersey*. Journal of the American Planning Association, 1992. **58**(4): p. 440-453.
42. Innes, J.E., *Information in Communicative Planning*. Journal of the American Planning Association, 1998. **64**(1): p. 52-63.
43. Lascoumes, P. and P. Le Galès, *Gouverner par les instruments*. 2005, Paris: Presses de Sciences Po. 370.
44. <http://geoconfluences.ens-lyon.fr/glossaire/urbanisme-et-planification-urbaine>.
45. https://en.wikipedia.org/wiki/2005_World_Summit.
46. UN-HABITAT, *Planning Sustainable Cities*. 2009(Global Report on Human Settlements).
47. <https://www.usnews.com/news/world/articles/2018-05-17/report-two-thirds-of-worlds-population-will-live-in-cities-by-2050>.
48. <https://www.diplomatie.gouv.fr/fr/dossiers-pays/malaisie/evenements/article/9eme-forum-urbain-mondial-villes-2030-villes-pour-tous-mettre-en-oeuvre-le>.
49. <https://www.metropolitiques.eu/L-amenageur-roi-du-copier-coller.html>.
50. https://en.wikipedia.org/wiki/Paradigm_shift.
51. BOESIGER, W.L.C., *Le Corbusier - Oeuvre complète 1938 - 1946 (Quatrième tome) . deuxième édition*. . Editions Girsberger, 1950 ed. 1950.
52. HÉRAN, F., *La ville morcelée*
Effets de coupure en milieu urbain. Méthodes et Approches ed. 2011.
53. Poulit, J., *La circulation urbaine* Revue générale des routes et des aérodromes, 1971. (462): p. 59-78.
54. Newman, P., L. Kosonen, and J. Kenworthy, *Theory of urban fabrics: Planning the walking, transit/public transport and automobile/motor car cities for reduced car dependency*. Vol. 87. 2016. 429-458.

-
55. Collectif, *Les métamorphoses de l'autoroute urbaine*. Points Fnau - Alternatives (n° 1), Gallimard. 2014. 144.
 56. Abdelouadoud, S.Y., *Integration of renewable energies in the electricity distribution system*. 2014, Ecole Nationale Supérieure des Mines de Paris.
 57. Amicarelli, E., *Control and management strategies of smart grids with high penetration of renewable energy*. 2017, Université Grenoble Alpes.
 58. Briceño Vicente, W.C., Briceno Vicente, *Stochastic modeling of distribution networks under uncertainty*. 2012, Université de Grenoble.
 59. Dutrieux, H.l.s., *Methods for the multi-year planning of distribution networks. Application to the techno-economic analysis of the solutions for integrating intermittent renewable energy sources*. 2015, Ecole Centrale de Lille.
 60. Gholizadeh Tayyar, S., *An optimization-based framework for concurrent planning of multiple projects and supply chain : application on building thermal renovation projects*. 2017, Ecole des Mines d'Albi-Carmaux.
 61. Grover silva, E., *Optimization of the planning and operations of electric distribution grids in the context of high renewable energy penetration*. 2017, PSL Research University.
 62. Hadj said, A., *Storage Integration in the planning methods of low voltage grid*. 2018, Université Grenoble Alpes.
 63. Luu, N.A., *Control and management strategies for a microgrid*. 2014, Université de Grenoble.
 64. Mendil, M., *Joint radio and power resource optimal management for wireless cellular networks interconnected through smart grids*. 2018, Université Grenoble Alpes.
 65. Alain, D., *Réseaux de distribution d'électricité Présentation*. Techniques de l'ingénieur Réseaux électriques de distribution publique, 2010. **base documentaire : TIB264DUO**(ref. article : d4200).
 66. <https://www.enedis.fr/fonctionnement-du-reseau>.
 67. ERDF, *Description physique du réseau public*. 2008. p. 17.
 68. CARRIVE, P., *Réseaux de distribution - Structure et planification*. 1991: Techniques de l'ingénieur.
 69. Alvarez-Hérault, M.-C., *ARCHITECTURES DES RÉSEAUX DE DISTRIBUTION DU FUTUR EN PRÉSENCE DE PRODUCTION DÉCENTRALISÉE*. 2009, Institut National Polytechnique de Grenoble - INPG.
 70. Gouin, V., *Evaluation of the impact of Smart Grid on planning practices with distributed generation and flexible loads*. 2015, Université Grenoble Alpes.
 71. Howell, S., et al., *Towards the next generation of smart grids: Semantic and holonic multi-agent management of distributed energy resources*. Renewable and Sustainable Energy Reviews, 2017. **77**: p. 193-214.

-
72. Burtin, A. and V. Silva, *TECHNICAL AND ECONOMIC ANALYSIS OF THE EUROPEAN ELECTRICITY SYSTEM WITH 60% RES.* 2015.
 73. Naggar, R., C. Langheit, and J. Dallaire. *ÉVALUATION ET PLANIFICATION DE FIABILITÉ DES RÉSEAUX DE DISTRIBUTION – NOUVELLE APPROCHE GLOBALE.* in *Distributech 2005 - San Diego.* 2005.
 74. Porkar Koumleh, S., *Distribution system planning implementing distributed generation.* 2011, Université Henri Poincaré - Nancy 1.
 75. Uppoor, S., *Understanding and exploiting mobility in wireless networks.* 2013, INSA de Lyon.
 76. Pantaleo, A., j. keirstead, and N. Shah, *Urban Energy Systems An Integrated Approach.* 2013.
 77. Barles, S., *Mesurer la performance écologique des villes et des territoires : le métabolisme de Paris et de l'Ile-de-France.* 2007.
 78. Grenier, A., *Ville et énergie. Spécificité et complexité de la question en France.* Les Annales de la Recherche Urbaine, 2007: p. 128-136.
 79. Maïzia, M. *Modélisation et systèmes urbains : une construction difficile.* 2002. Pontificia Universidade Catolica da Parana.
 80. Rutherford, J. and O. Coutard, *Urban Energy Transitions: Places, Processes and Politics of Socio-technical Change.* Urban Studies, 2014. **51**(7): p. 1353-1377.
 81. Magnin, G., *Vers des villes à basse consommation d'énergie et haute qualité de vie pour tous.* , in *La Revue Durable.* 2010.
 82. Batty, M. and M. and Longley, *Fractal Cities - A Geometry of Form and Function.* 1994.
 83. Rouquier, J.-B., *Robustness and emergence in complex systems : the model of cellular automata.* 2008, Ecole normale supérieure de lyon - ENS LYON.
 84. Vamvoudakis, K.G. and S. Jagannathan, *Chapter One - Introduction to Complex Systems and Feedback Control,* in *Control of Complex Systems,* K.G. Vamvoudakis and S. Jagannathan, Editors. 2016, Butterworth-Heinemann. p. 3-30.
 85. Ichiishi, T., *0 - Preliminary Discussion,* in *Game Theory for Economic Analysis,* T. Ichiishi, Editor. 1983, Academic Press: San Diego. p. 1-6.
 86. Sanderson, D.J., et al., *Graph theory and the analysis of fracture networks.* Journal of Structural Geology, 2019. **125**: p. 155-165.
 87. https://en.wikipedia.org/wiki/Complex_system.
 88. Anderson, P.M. and A.A. Fouad, *Power system control and stability.* 2008: John Wiley & Sons.
 89. Wang, Z., A. Scaglione, and R.J. Thomas. *Electrical centrality measures for electric power grid vulnerability analysis.* in *49th IEEE Conference on Decision and Control (CDC).* 2010.
 90. Machowski, J., J. Bialek, and J. Bumby, *Power system dynamics: stability and control.* 2011: John Wiley & Sons.

-
91. Kundur, P., N.J. Balu, and M.G. Lauby, *Power system stability and control*. Vol. 7. 1994: McGraw-hill New York.
 92. Ferrero, R., S. Shahidehpour, and V. Ramesh, *Transaction analysis in deregulated power systems using game theory*. IEEE transactions on power systems, 1997. **12**(3): p. 1340-1347.
 93. Singh, H., *Introduction to game theory and its application in electric power markets*. IEEE Computer Applications in Power, 1999. **12**(4): p. 18-20.
 94. MacKenzie, A.B. and S.B. Wicker. *Game theory in communications: Motivation, explanation, and application to power control*. in *GLOBECOM'01. IEEE Global Telecommunications Conference (Cat. No. 01CH37270)*. 2001. IEEE.
 95. Mei, S., W. Wei, and F. Liu, *On engineering game theory with its application in power systems*. Control Theory and Technology, 2017. **15**(1): p. 1-12.
 96. Dorfler, F. and F. Bullo, *Synchronization and transient stability in power networks and nonuniform Kuramoto oscillators*. SIAM Journal on Control and Optimization, 2012. **50**(3): p. 1616-1642.
 97. Dörfler, F., M. Chertkov, and F. Bullo, *Synchronization in complex oscillator networks and smart grids*. Proceedings of the National Academy of Sciences, 2013. **110**(6): p. 2005-2010.
 98. *Synchronization and Transient stability in Power Networks and Non-Uniform Kuramoto Oscillators*.
 99. Acebrón, J.A., et al., *The Kuramoto model: A simple paradigm for synchronization phenomena*. Reviews of modern physics, 2005. **77**(1): p. 137.
 100. Filatrella, G., A.H. Nielsen, and N.F. Pedersen, *Analysis of a power grid using a Kuramoto-like model*. The European Physical Journal B, 2008. **61**(4): p. 485-491.
 101. Ernster, T.A. and A.K. Srivastava. *Power system vulnerability analysis - towards validation of centrality measures*. in *PES T&D 2012*. 2012.
 102. Korkali, M., et al., *Reducing Cascading Failure Risk by Increasing Infrastructure Network Interdependence*. Scientific Reports, 2017. **7**: p. 44499.
 103. Ha, D.T., *Line outage vulnerabilities of power systems : models and indicators*. 2018, Université Grenoble Alpes.
 104. Retière, N., D.T. Ha, and J.-G. Caputo, *Spectral graph analysis of the geometry of power flows in transmission networks*. IEEE SYSTEMS JOURNAL: p. 12.
 105. Meakin, P. and H.E. Stanley, *Spectral Dimension for the Diffusion-Limited Aggregation Model of Colloid Growth*. Physical Review Letters, 1983. **51**(16): p. 1457-1460.
 106. Atay, F.M., T. Bıyıkoğlu, and J. Jost, *Network synchronization: Spectral versus statistical properties*. Physica D: Nonlinear Phenomena, 2006. **224**(1): p. 35-41.
 107. Rubido, N., *Energy Transmission and Synchronization in Complex Networks: Mathematical Principles*. 2015.

108. Meyers, R.A., *Fractal and multifractal scaling of electrical conduction in random resistor networks*.
109. Son, S.-W., et al., *Percolation theory on interdependent networks based on epidemic spreading*. EPL (Europhysics Letters), 2012. **97**(1): p. 16006.
110. Huang, Z., et al. *Modeling cascading failures in smart power grid using interdependent complex networks and percolation theory*. 2013. IEEE.
111. Ishida, M. and R.M. Hill, *The electrical impedance of a continuously scaled fractal transmission line*. Journal of Physics D: Applied Physics, 1997. **30**(7): p. 1157-1163.
112. Ortjohann, E., et al. *Cluster fractal model — A flexible network model for future power systems*. in *2013 International Conference on Clean Electrical Power (ICCEP)*. 2013.
113. Le, T.-T.-M., *Modelling of power systems dynamic, taking into account the properties of scale invariance*. 2014, Université de Grenoble.
114. Sidqi, Y., et al., *Comparing fractal indices of electric networks to roads and buildings: The case of Grenoble (France)*. Physica A: Statistical Mechanics and its Applications, 2019: p. 121774.
115. Sidqi, Y., N. Retière, and G. Vuidel, *ANALYZING THE FRACTAL BEHAVIOUR OF THE DISTRIBUTION POWER GRID IN THE CITY OF GRENOBLE-FRANCE*, in *CIREN- THE 25TH INTERNATIONAL CONFERENCE AND EXHIBITION ON ELECTRICITY DISTRIBUTION*. 2019: Madrid, Spain. p. 4.
116. Adil, A.M. and Y. Ko, *Socio-technical evolution of Decentralized Energy Systems: A critical review and implications for urban planning and policy*. Renewable and Sustainable Energy Reviews, 2016. **57**: p. 1025-1037.
117. Artmann, M., et al., *How smart growth and green infrastructure can mutually support each other — A conceptual framework for compact and green cities*. 2017.
118. Lagesse, C., et al., *Méthodologie de modélisation et de caractérisation des réseaux spatiaux. Application au réseau viaire de Paris*. Flux, 2016. **105**(3): p. 33-49.
119. Courtat, T., C. Gloaguen, and S. Douady, *Mathematics and morphogenesis of cities: A geometrical approach*. Vol. 83. 2011. 036106.
120. Lam, N. and L. De Cola, *Fractals in Geography*. 1993.
121. Batty, M. and Y. Xie, *Preliminary Evidence for a Theory of the Fractal City*. Environment and Planning A: Economy and Space, 1996. **28**(10): p. 1745-1762.
122. Feng, J. and Y. Chen, *Spatiotemporal Evolution of Urban Form and Land-Use Structure in Hangzhou, China: Evidence from Fractals*. Environment and Planning B: Planning and Design, 2010. **37**(5): p. 838-856.
123. Shen, G., *A fractal dimension analysis of urban transportation networks*. Vol. 1. 1997. 221-236.
124. Frankhauser, P., I. Thomas, and D. Badariotti, *Comparing the fractality of European urban districts: do national processes matter?* 2007.

-
125. Crews, J. and S. Thibault, *The morphology and growth of urban technical networks: a fractal approach*. FLUX Cahiers scientifiques internationaux Réseaux et Territoires, 1995: p. 17-30.
 126. Benguigui, L. and M. Daoud, *Is the Suburban Railway System a Fractal?* Geographical Analysis, 1991. **23**(4): p. 362-368.
 127. Gouyet J F, "Physique et Structures Fractales (Masson, Paris) ”.
 128. Falconer, K., *Fractal geometry: mathematical foundations and applications*. 2004: John Wiley & Sons.
 129. Frankhauser, P., *The fractal approach. A new tool for the spatial analysis of urban agglomerations*. Population, 1998. **53**(HS1): p. 205-240.
 130. Frankhauser, P., et al. *Approche fractale de l'urbanisation - Méthodes d'analyse d'accessibilité et simulations multi-échelles*. in *11th World Conference on Transportation Research - Septièmes rencontres francophones Est-Ouest de socio-économie des transports*. 2007. Berkeley, Californie, United States.
 131. Halsey, T.C., et al., *Fractal measures and their singularities: The characterization of strange sets*. Physical Review A, 1986. **33**(2): p. 1141-1151.
 132. Tél, T., Á. Fülöp, and T. Vicsek, *Determination of fractal dimensions for geometrical multifractals*. Physica A: Statistical Mechanics and its Applications, 1989. **159**(2): p. 155-166.
 133. François, N., P. Frankhauser, and D. Pumain. *Villes, densité et fractalité. Nouvelles représentations de la répartition de la population*. in *Les Annales de la recherche urbaine*. 1995. Centre de Recherche d'Urbanisme.
 134. Chhabra, A. and R.V. Jensen, *Direct determination of the $f(\alpha)$ singularity spectrum*. Physical Review Letters, 1989. **62**(12): p. 1327-1330.
 135. Frankhauser, P., et al., *An integrated multifractal modelling to urban and regional planning*. Computers, Environment and Urban Systems, 2018. **67**: p. 132-146.
 136. Dauphiné, A., *Les théories de la complexité chez les géographes*. 2003: Anthropos.
 137. Bak, P., *How nature works: the science of self-organized criticality*. 2013: Springer Science & Business Media.
 138. Song, C., S. Havlin, and H.A. Makse, *Self-similarity of complex networks*. Nature, 2005. **433**(7024): p. 392-395.
 139. Vuidel, G., C. Tannier, and P. Frankhauser.
<https://sourcesup.renater.fr/fractalyse/maven/>.
 140. Khodr, H.M., et al., *Maximum savings approach for location and sizing of capacitors in distribution systems*. Electric Power Systems Research, 2008. **78**(7): p. 1192-1203.
 141. <https://data.worldbank.org/indicator/EG.ELC.LOSS.ZS>.
 142. <https://matpower.org/docs/MATPOWER-manual-6.0b1.pdf>.
 143. Vicsek, T., *FRONT MATTER*, in *Fractal Growth Phenomena*. 1992, WORLD SCIENTIFIC. p. i-xix.

144. Park, S., D. Deka, and M. Chertkov. *Exact Topology and Parameter Estimation in Distribution Grids with Minimal Observability*. in *2018 Power Systems Computation Conference (PSCC)*. 2018.
145. IRAQI, M., *Theoretical approaches for geometric optimization of urban forms : towards a fractal development of the city*. 2017, Université Bourgogne Franche-Comté.
146. Yamu, C. and P. Frankhauser, *Spatial accessibility to amenities, natural areas and urban green spaces: using a multiscale, multifractal simulation model for managing urban sprawl*. *Environment and Planning B: Planning and Design*, 2015. **42**(6): p. 1054-1078.

