



HAL
open science

Towards efficient and fair resources management in wireless mesh networks

Ali El Masri

► **To cite this version:**

Ali El Masri. Towards efficient and fair resources management in wireless mesh networks. Networking and Internet Architecture [cs.NI]. Université de Technologie de Troyes, 2013. English. NNT : 2013TROY0011 . tel-02965703

HAL Id: tel-02965703

<https://theses.hal.science/tel-02965703>

Submitted on 13 Oct 2020

HAL is a multi-disciplinary open access archive for the deposit and dissemination of scientific research documents, whether they are published or not. The documents may come from teaching and research institutions in France or abroad, or from public or private research centers.

L'archive ouverte pluridisciplinaire **HAL**, est destinée au dépôt et à la diffusion de documents scientifiques de niveau recherche, publiés ou non, émanant des établissements d'enseignement et de recherche français ou étrangers, des laboratoires publics ou privés.

Thèse
de doctorat
de l'UTT

Ali EL MASRI

Towards Efficient and Fair Resources Management in Wireless Mesh Networks

Spécialité :
Réseaux, Connaissances, Organisations

2013TROY0011

Année 2013

THESE

pour l'obtention du grade de

DOCTEUR de l'UNIVERSITE DE TECHNOLOGIE DE TROYES Spécialité : RESEAUX, CONNAISSANCES, ORGANISATIONS

présentée et soutenue par

Ali EL MASRI

le 20 juin 2013

Towards Efficient and Fair Resources Management in Wireless Mesh Networks

JURY

M. B. JABBARI	PROFESSOR	Président
M. M. DIAS DE AMORIM	DIRECTEUR DE RECHERCHE CNRS	Rapporteur
Mlle D. GAÏTI	PROFESSEUR DES UNIVERSITES	Directrice de thèse
M. Y. GOURHANT	DOCTEUR	Examineur
M. L. KHOUKHI	ENSEIGNANT CHECHEUR	Directeur de thèse
M. P. MUHLET-HALER	DIRECTEUR DE RECHERCHE INRIA	Examineur
M. G. PUJOLLE	PROFESSEUR DES UNIVERSITES	Rapporteur

Personnalité invitée

Mme A. MUNARETTO PROFESSOR ADJUNTO

Résumé

Le but principal des réseaux mesh sans fil (Wireless Mesh Networks-WMNs) est de fournir une dorsale de communication pour un grand nombre d'utilisateurs, car les WMNs doivent supporter un trafic énorme. Dans cette thèse, nous visons la maximisation d'utilisation et la répartition équitable de la bande passante dans les WMNs. Nous considérons deux environnements : WMN utilisant la norme IEEE 802.11 MAC, qui est caractérisée par son déploiement répandu et peu cher, et WMN utilisant les antennes directionnelles, qui représentent une technologie clé pour la réutilisation spatiale dans les réseaux sans fil. Pour les WMMs basés sur IEEE 802.11, nous concevons NICC, un protocole de contrôle de congestion qui reconnaît la congestion comme un problème lié au voisinage, et non pas au lien. NICC gère la congestion par une collaboration entre les nœuds d'un voisinage sans fil. En faisant usage de certains champs sous-exploités dans l'en-tête IEEE 802.11, NICC fournit un retour de congestion implicite et multi-bit. Ceci assure un contrôle précis du trafic sans affecter la bande passante. Pour les WMNs utilisant les antennes directionnelles, nous concevons FreeDMAC, un protocole MAC basé sur la technologie TDMA. FreeDMAC garantit que chaque nœud est conscient de toutes les transmissions dans son voisinage, ce qui évite les problèmes MAC causés par les antennes directionnelles, et ainsi, améliore l'utilisation de la bande passante. En outre, FreeDMAC est capable de fournir deux niveaux d'équité : équité entre les liens et équité entre les flux.

Mots-clés : IEEE 802.11 (norme), Accès multiple par répartition dans le temps, Antennes adaptatives, Systèmes de communication sans fil, équité.

Abstract

The main purpose of Wireless Mesh Networks (WMNs) is to provide a communication backbone for a high number of end-users, thus WMNs have to support heavy traffic load. In this thesis, we intend to maximize utilization and achieve fair allocation of the bandwidth resources in WMNs. We consider two WMN environments: WMN using the IEEE 802.11 MAC standard, which is characterized by its cheap devices and widespread deployment, and WMN using directional antennas, which are emerged as an attractive technology to enhance the spatial reusability in wireless networks. For WMM based on IEEE 802.11, we design NICC, a congestion control scheme that recognizes congestion as neighborhood-related problem, and not a link-based one. Indeed, complex interference among neighboring nodes is the main starvation cause in WMNs. Therefore, NICC handles congestion using mutual cooperation within a wireless neighborhood. NICC makes use of some underexploited fields in the IEEE 802.11 frame header in order to provide an implicit multi-bit congestion feedback, and thus ensure accurate rate control without generating overhead, making efficient use of bandwidth. For WMN with directional antennas, we design FreeDMAC, a TDMA-based MAC scheme with contention-free scheduling. FreeDMAC guarantees that each node is aware of all ongoing transmissions in its neighborhood, and thus avoids directional-related problems such as deafness, making efficient use of bandwidth. Moreover, FreeDMAC presents a link-slot assignment that provides two levels of fairness: Per-link and per-flow fairness.

keywords: IEEE 802.11 (Standard), Time division multiple access, Adaptive antennas, Wireless communication systems, Equity.

Remerciements

Mes remerciements vont d'abord à mes deux directeurs de thèse, Dominique GAÏTI et Lyes KHOUKHI, pour la manière avec laquelle ils ont dirigé ma thèse, leur patience et leur grande disponibilité. Je remercie Dominique pour la confiance qu'elle a placée en moi et en mes choix de recherche. Je remercie particulièrement Lyes pour son dynamisme sans faille, sa disponibilité, son indulgence, ainsi que ses discussions sur les sujets scientifiques autant qu'humains.

Je tiens à exprimer mes remerciements à Ahmad SARDOUK, qui était en poste ATER pendant ma deuxième année de thèse, pour tout le travail que nous avons réalisé ensemble et les riches discussions que nous avons eues.

Je tiens ensuite à remercier tous les membres de l'équipe ERA pour leur accueil, leurs conseils et leur soutien.

Je remercie très fortement ma famille, ma mère, mon père, mes sœurs, et mes frères qui ce sont intéressés et ont vécu pleinement ce travail avec moi.

Pour la fin, mes remerciements les plus chers et les plus tendres s'adressent à ma femme Salam ALI, qui, a su m'épauler, m'aiguiller, me réconforter et supporter mon stress durant toute le période de la thèse.

Contents

Résumé	3
Abstract	5
Remerciements	7
List of Publications	13
List of Figures	15
List of Tables	19
List of Algorithms	21
List of Acronyms	23
1 Introduction	25
1.1 Wireless Mesh Networks	25
1.2 Motivation and Contributions	27
1.2.1 802.11-based Wireless Mesh Networks	27
1.2.2 Wireless Mesh Networks using beamforming antennas	29
1.3 Thesis Organization	31
2 Background	33
2.1 Introduction to Wireless Mesh Networks	33
2.1.1 Architecture Overview	34
2.1.2 Desired Properties	34
2.2 IEEE 802.11 MAC Standard	36
2.3 Beamforming Antennas	38
2.3.1 Basic Description	39
2.3.2 Antennas Types	39

2.3.3	Benefits	41
2.3.4	Exploitation	42
I	IEEE 802.11-based Wireless Mesh Networks	45
	Part I Introduction	47
3	NICC: A Neighborhood-based and Overhead-free Congestion Control for IEEE 802.11 WMNs	49
3.1	Introduction	50
3.2	Problem Statement	52
3.2.1	Starvation Scenarios	52
3.2.2	Fairness	55
3.3	Related Work	56
3.4	Definitions and Concepts	59
3.4.1	Link Neighborhood	60
3.4.2	Congested Link and Congested Neighborhood	60
3.4.3	Intra-Flow Dependency	60
3.5	NICC Design	60
3.5.1	NICC Frames	61
3.5.2	NICC Tables	62
3.6	NICC Process	63
3.6.1	Congestion Detection	64
3.6.2	Congestion Signaling	64
3.6.3	Congestion Notification	65
3.6.4	Rate Control	66
3.7	NICC Evaluation	68
3.7.1	Specific Topologies	69
3.7.2	Large Scale Topologies	73
3.8	Conclusion	75
4	FCD: A Fuzzy-based Congestion Detection Mechanism for IEEE 802.11-based WMNs	77
4.1	Introduction	77
4.2	FCD Model	80
4.2.1	Fuzzification	80
4.2.2	Rules Evaluation	82

<i>Contents</i>	11
4.2.3 Defuzzification	84
4.3 Performance Evaluation	85
4.3.1 Results Analysis	86
4.4 Conclusion	89
Part I Conclusion	91
II Wireless Mesh Networks using Beamforming Antennas	93
Part II Introduction	95
5 FreeDMAC: A TDMA-based MAC scheme for WMNs using Beamforming Antennas	97
5.1 Introduction	98
5.2 Beamforming-related MAC problems	100
5.2.1 Problems	100
5.2.2 Conclusion	103
5.3 Related Work	104
5.3.1 Contention-based Schemes	105
5.3.2 Synchronized Schemes	108
5.3.3 Discussion	110
5.4 FreeDMAC: An Overview	111
5.4.1 Network Characteristics	111
5.4.2 Overview	112
5.5 FreeDMAC Details	114
5.5.1 Link-Slot Assignment	114
5.5.2 Transmission Scheduling	116
5.5.3 Per-Link Fairness	119
5.5.4 Per-Flow Fairness	119
5.5.5 Discussion	121
5.6 FreeDMAC Evaluation	122
5.6.1 Small-size scenarios	123
5.6.2 Large Scale Topologies	129
5.7 Conclusion	130
Part II Conclusion	137
6 Conclusion and Future Works	139

6.1	Conclusion	139
6.1.1	802.11-based Wireless Mesh Networks	140
6.1.2	Wireless Mesh Networks using Beamforming Antennas	141
6.2	Possible Extensions	142
6.2.1	Interference range	142
6.2.2	Flows with different throughput demands	143
6.2.3	Analytical modeling	143
6.3	Future Directions	143
6.3.1	Quality-of-Service support	143
6.3.2	Directional routing	144
	Résumé en français	145
A	Introduction	146
B	Motivation et contributions	146
B.1	Les WMNs utilisant la norme IEEE 802.11	147
B.2	Les WMNs utilisant les antennes directionnelles	148
C	NICC : un protocole de contrôle de congestion pour les WMNs utilisant la norme IEEE 802.11	149
C.1	Introduction et état de l'art	149
C.2	Définition et concepts	152
C.3	Le design de NICC	153
C.4	Le processus de NICC	156
C.5	Évaluation de NICC	160
D	FCD : un mécanisme de détection de congestion pour les WMNs utilisant la norme IEEE 802.11	161
D.1	Principe de FCD	161
D.2	Système de logique floue proposé	164
D.3	Évaluation de FCD	166
E	FreeDMAC : un protocole MAC pour les WMNs utilisant les antennes directionnelles	167
E.1	Introduction	167
E.2	État de l'art	170
E.3	Le protocole FreeDMAC	173
E.4	Évaluation de FreeDMAC	179
F	Conclusion	181
	Bibliography	185

List of Publications

International Journals

1. L. KHOUKHI, **A. EL MASRI**, A. SARDOUK, A. HAFID, D. GAITI. Toward Fuzzy Traffic Adaptation Solution in Wireless Mesh Networks. In *IEEE Transactions on Computers* (Accepté en 2012).

International Conferences

1. **A. EL MASRI**, A. SARDOUK, L. KHOUKHI, and D. GAITI. An Efficient and Fair Congestion Control Protocol for IEEE 802.11-based Wireless Mesh Networks. In *the IEEE International Symposium on Personal, Indoor and Mobile Radio Communications - IEEE PIMRC*, Sydney, Australia, September 2012.
2. **A. EL MASRI**, L. KHOUKHI, A. SARDOUK, and D. GAITI. QoS Support in WMNs using Temporal Resource Reservation and Traffic Regulation Schemes. In *Proceedings of the IEEE Consumer Communications and Networking Conference - IEEE CCNC*, pages 132–137, Las Vegas-Nevada, USA, January 2012.
3. **A. EL MASRI**, L. KHOUKHI, A. SARDOUK, M. MANSOURI, and D. GAITI. WiRS: Resource Reservation and Traffic Regulation for QoS Support in Wireless Mesh Networks. In *Proceedings of the IEEE Global Communications Conference - IEEE GLOBECOM*, pages 1–5, Houston-Texas, USA, December 2011.
4. **A. EL MASRI**, A. SARDOUK, L. KHOUKHI, L. MERGHEM-BOULAHIA, D. GAITI, and R. RAHIM-AMOUD. A Hybrid Mesh, Ad Hoc, and Sensor Network for Forest Fire Management. In *Proceedings of the IEEE Vehicular Technology Conference - IEEE VTC-Fall*, pages 1–5, San Francisco-California, USA, September 2011.
5. **A. EL MASRI**, A. SARDOUK, L. KHOUKHI, and D. GAITI. Traffic Adaptation Model for Wireless Mesh Networks using Fuzzy Logic. In *the IEEE International Con-*

- ference on Networking, Architecture, and Storage - IEEE NAS*, pages 73–81, Dalian, China, July 2011.
6. L. KHOUKHI, **A. EL MASRI**, A. SARDOUK, A. HAFID, and D. GAITI. Traffic Adaptation in Wireless Mesh Networks: Fuzzy-based Model. In *Proceedings of the International Wireless Communications and Mobile Computing Conference - IEEE IWCMC*, pages 41–46, Istanbul, Turkey, July 2011.
 7. **A. EL MASRI**, L. KHOUKHI, and D. GAITI. A TDMA-based MAC Protocol for Wireless Mesh Networks using Directional Antennas. In *Proceedings of the International Conference on Communication Theory, Reliability, and Quality of Service - CTRQ*, pages 95–98, Budapest, Hungary, April 2011.
 8. **A. EL MASRI**, L. KHOUKHI, and D. GAITI. FTAM: A Fuzzy Traffic Adaptation Model for Wireless Mesh Networks. In *Proceedings of the International Conference on Communication Theory, Reliability, and Quality of Service - CTRQ*, pages 84–88, Budapest, Hungary, April 2011.
 9. L. KHOUKHI, **A. EL MASRI**, and D. GAITI. A Hybrid Stateless QoS Approach for Wireless Mobile Ad hoc Networks. In *Proceedings of the IFIP International Conference on New Technologies, Mobility and Security - IEEE/IFIP NTMS*, pages 1–5, Paris, France, February 2011.

List of Figures

2.1	Wireless Mesh Network	35
2.2	Transmission scheduling in IEEE 802.11 MAC	37
2.3	The radiation pattern of (a) omni-directional and (b) directional antennas.	40
2.4	Spatial reuse	42
3.1	The flow in the middle scenario	53
3.2	The hidden node scenario	53
3.3	A single-hop flow vs. a two-hop flow	54
3.4	Neighboring links with different numbers of flows	55
3.5	Links in the neighborhood of L_{S-R}	60
3.6	The <i>packet control</i> field	61
3.7	Acknowledgement frames	61
3.8	Data frames	62
3.9	SendData algorithm	65
3.10	ReceivingStandardDATA algorithm	65
3.11	ReceivingCL_Data algorithm	65
3.12	ReceivingCS_DATA algorithm	66
3.13	SendAcknowledgement algorithm	66
3.14	ReceivingAcknowledgement algorithm	66
3.15	Specific topologies	70
3.16	Scenario of Figure 3.15a: Per-flow throughput	70
3.17	Scenario of Figure 3.15a: Channel utilization	71
3.18	Scenario of Figure 3.15b: Per-flow throughput	71
3.19	Scenario of Figure 3.15b: Channel utilization	72
3.20	Scenario of Figure 3.15c: Per-flow throughput	72
3.21	Scenario of Figure 3.15d: Per-flow throughput	73
3.22	First scenario: Fairness index and throughput	74
3.23	First scenario: Throughput per flow	74

3.24	Second scenario: Fairness index and throughput	75
4.1	FCD Model	80
4.2	Fuzzy decision making process	84
4.3	Structured topologies: Chain, cross, star, and grid	85
4.4	Internet traffic	86
4.5	Internal traffic	87
4.6	Performance in random topology vs. number of nodes	87
4.7	Queue length and overflows	87
4.8	Traffic variation impact on the performance	88
4.9	Impact of the radio occupancy and related parameters	88
5.1	The deafness problem	101
5.2	The hidden node due to unheard RTS/CTS	101
5.3	The hidden node due to asymmetry in gain	102
5.4	The head-of-line blocking problem	103
5.5	The MAC-layer capture	103
5.6	Classification of directional MAC schemes	104
5.7	Time Structure	112
5.8	Link contention set	115
5.9	Link-slot assignment	115
5.10	Transmission scheduling	118
5.11	Per-link fairness	119
5.12	Per-flow fairness	120
5.13	Deafness scenarios	124
5.14	Flow throughput vs. flow sending rate (intra-flow deafness scenario)	124
5.15	Per-link throughput vs. flow sending rate (deadlock scenario)	132
5.16	Aggregate throughput and average delay vs. flow sending rate (deafness at the receiver scenario)	133
5.17	Small-size topologies that illustrate fairness	133
5.18	First random scenario: Aggregate throughput, average end-to-end delay, and Fairness Index vs. flow sending rate	134
5.19	Second random scenario: Aggregate throughput, average end-to-end delay, and Fairness Index vs. flow sending rate	135
1	Un réseau mesh sans fil	147
2	Antennes omnidirectionnelles vs antennes directionnelles	150

3	Le problème du flux au milieu	152
4	Le voisinage du lien L_{S-R}	152
5	Le champ <i>packet control</i> de la trame IEEE 802.11	154
6	Les trames de contrôle	154
7	Les trames de données	155
8	Le scénario illustrant l'utilité de la période t_{NICC}	159
9	Évaluation de NICC : indice d'équité et débit de bout-en-bout	160
10	Évaluation de NICC : débit de bout-en-bout par flux	161
11	Le modèle de FCD	164
12	Évaluation de FCD	167
13	Problème de deafness	169
14	La structure de temps	173
15	Attribution des liens aux intervalles	176
16	Processus de planification de transmissions	177
17	Per-link fairness	177
18	Équité par flux	178
19	Évaluation de FreeDMAC : débit, délai, et indice d'équité	180

List of Tables

- 3.1 Simulation parameters 69
- 4.1 Notation list 81
- 4.2 FCD Rules 83
- 4.3 Decision Algorithm 84

- 5.1 Simulation parameters 123
- 5.2 Per-flow sending rates of Figures 5.17a and 5.17b 128

- 1 Base de règles de FCD 166

List of Algorithms

1	The source reaction upon receiving a CN_ACK frame	69
2	Link-slot assignment	116

List of Acronyms

ACK	Acknowledgement
AIFSN	Arbitration Inter-Frame Space-Number
AIMD	Additive Increase Multiplicative Decrease
AP	Access Point
BFN	Beam Forming Network
CRC	Cyclic Redundancy Check
CS	Carrier Sensing
CSMA	Carrier Sense Multiple Access
CTS	Clear To Send
CW	Contention Window
DATA	Data
DCF	Distributed Coordinated Function
DCTS	Directional Clear To Send
DIFS	Distributed Coordinated Function Interframe Spacing
DMAC	Directional Medium Access Control
DNAV	Directional Network Allocation Vector
DPCS	Directional Physical Carrier Sensing
DVCS	Directional Virtual Carrier Sensing
DSSS	Direct-Sequence Spread Spectrum
DSL	Digital Subscriber Line
DSP	Digital Signal Processor
FreeDMAC	(beamforming-related problem)-Free Directional MAC
IEEE	Institute of Electrical and Electronics Engineers
LAN	Local Area Network
MAC	Medium Access Control

MANET	Mobile Ad hoc NETwork
MIMO	Multiple Input Multiple Output
NAV	Network Allocation Vector
NICC	NeIghborhood-based and overhead-free Congestion Control
OCTS	Omni-directional Clear To Send
OFDM	Orthogonal Frequency Division Multiplexing
ORTS	Omni-directional Ready To Send
PCF	Point Coordination Function
PCS	Physical Carrier Sensing
RTS	Request To Send
SIFS	Short Inter-Frame Spacing
TCP	Transport Layer Protocol
TDMA	Time division Multiple Access
VCS	Virtual Carrier Sensing
WLAN	Wireless Local Area Network
WMN	Wireless Mesh Network

Chapter 1

Introduction

Contents

1.1	Wireless Mesh Networks	25
1.2	Motivation and Contributions	27
1.2.1	802.11-based Wireless Mesh Networks	27
1.2.2	Wireless Mesh Networks using beamforming antennas	29
1.3	Thesis Organization	31

1.1 Wireless Mesh Networks

Wireless Mesh Networks (WMNs) have emerged as a key technology to provide cost-effective broadband Internet access as well as to offer connectivity where traditional networks are not available, damaged, or costly to install [15][17]. The key features of WMNs lie in their low-cost implementation, easy maintenance, self-organization, quick deployment, extended coverage, and incremental nature.

WMNs present a cost-effective alternative to replace current broadband Internet access networks (e.g., DSL (Digital Subscriber Line), cable modems, cellular networks), and thus remove the need for an expensive infrastructure in the last-mile of the network. Indeed, deploying DSL and cable modems is too costly in terms of both money and time. For instance, installing new wires for DSL requires several months, whereas adding a new router to an existing WMN takes few hours [7]. Furthermore, DSL and cable modems require expensive up-front set-up investments, which lead to hinder their widespread extension. Cellular networks require licensed spectrum and antennas mounted on top of high towers, both of them are prohibitively expensive. The WLAN (Wireless Local Area Network) requires a wire

deployment as a backbone for each wireless access point (AP), thereby making the network extension hard and expensive, especially when the extension is required for a temporary event exclusively (e.g., conference, festival).

WMN consists of mesh routers with no or minimal mobility, each router serves as an access point for wired and wireless mesh clients (e.g., end-users). Mesh routers communicate among them by relying on multi-hop wireless links; thus, when a single mesh router is connected to the Internet, all other routers can obtain connectivity (a line of sight to a given AP is not necessary to reach the Internet). This multi-hop connectivity makes the deployment/extension of WMNs easy, quick, and cheap.

The capacity of WMNs to deliver large-scale broadband connectivity to metropolitan areas is proven through several projects in which commercial WMNs have been successfully deployed in large cities (e.g., Moscow [2], San Francisco [3], Houston [12][30]). Nevertheless, due to the widely available wired broadband connectivity in developed countries, the mesh networking is shown to be more attractive for countries in which a widespread or significant infrastructure is not available anytime anywhere [11][70]. The most well known example is the One Laptop Per Child (OLPC) project [10][113], which intends to provide a laptop for each student in the world's poor countries, and allow each student accessing the Internet, sharing files, and collaboratively learning with the other students. Since OLPC is likely to be applied in regions with no or little communication infrastructure, the wireless mesh networking was chosen to enable the project connectivity. Note that community learning access using WMN has been also deployed in some developed countries, including Taipei [9], Dublin [134], and the Tegola Project in rural Scotland [31].

In addition to broadband Internet access, WMNs present a helpful solution to maintain communications in case of crisis and emergency situations [34][101][104]. In case of natural crisis (e.g., Haiti's earthquake of 2010, Japan's tsunami of 2011), the communication infrastructure is susceptible to be physically damaged, thereby hindering the rescue operations in critical moments in which every minute can save human lives. WMNs present an effective solution to immediately reestablish communications in such situations without the need of traditional infrastructure. In addition to natural disaster, recent events in the middle-east countries have shown that connectivity can be lost even in the presence of a robust and operational infrastructure [1]. For instance, during the Egyptian and Syrian revolutions of 2011, the government has switched off the Internet and cellular communications in order to disconnect the whole country from the outside world. On the one hand, this disconnection has shown the vulnerability of centralized communication infrastructure, and on the other hand, it has been considered as a violation of freedom and human rights. The New

York Times has reported that implementing the WMN technology in smartphones may be a solution to avoid such situations in the Future [6].

1.2 Motivation and Contributions

Maximizing utilization and achieving fair allocation of network resources are the major challenges facing the success and the scalability of WMNs. Indeed, on the one hand, the limited available frequency spectrum (*bandwidth scarcity*) and the heavy traffic of WMNs (i.e., traffic aggregated from many end-users) necessitate an efficient utilization of the bandwidth resources (*bandwidth efficiency*). On the other hand, the shared nature of wireless medium and the complex interference relations among neighboring mesh routers might create serious unfairness and even complete *starvation* among the network data flows. In this thesis, we seek to achieve fair and efficient utilization of the bandwidth resources in two different WMN environments: IEEE 802.11-based WMNs, and WMNs using beamforming antennas.

1.2.1 802.11-based Wireless Mesh Networks

In the first part of the thesis, we consider the WMN in which the mesh routers rely on the IEEE 802.11 standard to make the transmission decisions (*scheduling*) at the Medium Access Control (MAC) layer. The main advantage of IEEE 802.11-based WMNs lies in their cheap devices and widespread usage. Indeed, economies of scale have made IEEE 802.11 the commonly used MAC protocol in most of the current WMN deployments. Nevertheless, it has been shown that the IEEE 802.11 introduces serious unfairness in bandwidth allocation among neighboring routers (*nodes*) in WMNs [23][82][146]. Indeed, IEEE 802.11 was basically proposed to perform scheduling in one-hop wireless networks (e.g., WLAN) in which all nodes are within the same contention domain; this means that (1) at most one node can transmit at a given time, and (2) each node can sense whether the channel is idle or a transmission is going on. In contrast to WLAN, WMN is a multi-hop wireless network composed of multiple overlapped contention domains, which result in complex and asymmetric interference relations that are likely to introduce severe unfairness among neighboring nodes/links¹ [69][81]. From this discussion, we conclude that, despite the unfair nature of IEEE 802.11 in WMNs, addressing fairness, for instance using congestion control [89][128], seems to be more appropriate than replacing the IEEE 802.11 standard. We choose congestion control because prior research has shown that fairness becomes an issue only when the network is congested and the user demands are unsatisfied [68][102]. Consequently, the

¹In this thesis, we use the term link to refer a one-hop sender-receiver pair.

first contribution of this thesis is to design a congestion control scheme that intends to (1) efficiently utilize the bandwidth resources, and (2) fairly allocate the bandwidth resources among competing data flows.

Conventional congestion control schemes such as TCP [119] (Transport Layer Protocol) treat congestion as a link-based problem. This means that when a link is congested, to implement fairness, only flows traversing the congested link are regulated (i.e., their sending rates are reduced); flows traversing neighboring links are not affected. This regulation scheme is adapted to Internet and wired networks in which each link has its own bandwidth that cannot be used by any other link, i.e., transmissions on different links use different bandwidth resources. However, in WMNs, the bandwidth is a spatially shared resource that can be used by a set of links located in the same neighborhood, i.e., transmissions on neighboring links use the same bandwidth resources. Therefore, when a link is congested, all flows traversing any of its neighboring links should be regulated. Consequently, to implement fairness in WMNs, congestion should be handled using mutual cooperation within the neighborhood of the congested link. We define the neighborhood of a link L as the set of links sharing the same bandwidth resources with L , i.e., the link and L cannot be used for transmission at the same time because of interferences. When a link is congested, the congestion must be signaled to each neighboring link, i.e., the sender-receiver pair of each neighboring link should be informed of the congestion. Thereafter, the source of each flow traversing one or more of these neighboring links must be notified in order to regulate its sending rate. However, signaling congestion within the congested neighborhood and notifying the corresponding sources may generate a considerable overhead which will likely degrade the network performance in terms of the overall end-to-end throughput of WMNs (i.e., bandwidth utilization).

Consequently, the other challenge facing the congestion control is to make a trade-off between the overhead generated by the congestion notifications and the amount of information reported by these notifications. Indeed, using an explicit multi-bit congestion feedback yields source nodes a fine-grained indication of the congestion degree, thereby ensuring accurate rate control [125]; however, such feedback generates a heavy overhead. On the other hand, using an implicit single-bit congestion feedback could considerably reduce the overhead; however, such a feedback does not contain enough information about the congestion and may lead to inaccurate rate regulation by the source nodes. This may cause large oscillations in the network load leading to an inefficient use of the network bandwidth.

The first part of this thesis consists of two contributions that aim at achieving fair and efficient bandwidth utilization in IEEE 802.11-based WMNs. The main contribution is NICC, which is a NeIghborhood-based and overhead-free Congestion Control scheme that

intends to solve the starvation problem without impacting the scarce bandwidth of WMNs. The key idea behind NICC is to provide an implicit multibit congestion feedback taking into account neighborhood information, without additional overhead, in order to ensure fair and accurate rate control by the source nodes. For this purpose, NICC makes use of some underexploited fields in the IEEE 802.11 frames header, without modifying the standard frame size; using the newly formatted IEEE 802.11 data frames, NICC is able to transfer data frames, and at the same time, signal congestion within a neighborhood. Moreover, using the newly formatted IEEE 802.11 control frames, NICC is able to acknowledge the successful reception of data frames, and at the same time, notify upstream nodes about congestions. In this way, precise and neighborhood-aware congestion information circulates in the network without generating overhead (i.e., no control messages or piggybacked headers).

The NICC focus is to handle congestion upon being detected, without considering the congestion detection process. This allows NICC to be used with a variety of congestion detection mechanisms. Nevertheless, we believe that an adequate congestion detection mechanism can make NICC more effective. Therefore, the second contribution of this thesis is FCD, a Fuzzy-based Congestion Detection mechanism that we judge more adequate for the NICC needs in a WMN environment. FCD detects congestion by predicting the evolution of the queue length (i.e., buffer occupancy) at the intermediate nodes along a flow path. On the one hand, the evolution of the queue length is one of the best congestion indicators in WMNs; indeed, it presents a clear sign of the capacity of a link to relay the incoming data packets, and on the other hand, detecting congestion at intermediate nodes is necessary to perform the congestion signaling within a congested neighborhood; indeed, end-to-end congestion indicators cannot support neighborhood-based congestion management. Another feature of FCD is its ability to compute several congestion degrees; this is necessary to exploit the NICC's multi-bit congestion feedback, which intends to yield source nodes a fine-grained indication of the congestion degree, and thus help them performing accurate rate control.

1.2.2 Wireless Mesh Networks using beamforming antennas

In the second part of this thesis, we consider the WMN in which the mesh routers are equipped with beamforming/directional antennas [22][88]. These smart antennas are able to concentrate their transmissions/receptions to/from specific directions, thereby reducing interference and enabling multiple transmissions to occur simultaneously within the same neighborhood (i.e., spatial reuse). Hence, using beamforming antennas is a key to improve the bandwidth utilization in WMNs [145][144]; it presents a solution to the limited frequency spectrum as well as to the heavy mesh traffic. However, traditional wireless multi-hop net-

work protocols fails to exploit the benefits of beamforming antennas since they are basically designed assuming that nodes are equipped with omni-directional antennas.

Over the last few years, several MAC schemes using beamforming antennas have been proposed [29][63]; most of them focus on adapting the IEEE 802.11 standard to the context of beamforming antennas. However, several unprecedented MAC problems have been encountered, e.g., deafness [60], head-of-line (HoL) blocking [76], MAC-layer capture [38], and new hidden node problems [41]. Starvation and bandwidth waste are the common results of these problems (henceforth referred as beamforming-related problems). For instance, in the case of deafness, a sender wastes its time/bandwidth transmitting Request To Send (RTS) frames to an unreachable receiver (e.g., receiver beamformed in a different direction); this leads to unnecessarily increase the sender's backoff contention window, and subsequently, to cause unfairness, in terms of bandwidth utilization, between the sender and its neighbors.

The beamforming-related problems are mainly caused by the fact that, when using directional transmissions in contention-based MAC schemes (e.g., IEEE 802.11), a node is usually unaware of all ongoing transmissions within its neighborhood, and thus it may initiate inappropriate transmissions (e.g., transmissions that contend/interfere with the ongoing ones). Indeed, contention-based MAC schemes employ on-demand/random scheduling that results in asynchronous transmissions. However, while a node is engaged in a transmission on a link L , it cannot overhear a newly initiated transmission on a neighboring link L_1 ; thus, when the node becomes idle, it may initiate a transmission that contends with the transmission on L_1 , resulting in unfair use and waste of bandwidth (e.g., RTS failures, collision, delayed packets, unnecessary increase in the backoff contention window). For WMNs using beamforming antennas, we use the term *contending links* (instead of *neighboring links*) to denote two links that cannot be used for transmission at the same time.

In the second part of this thesis, we propose FreeDMAC, a TDMA-based directional MAC scheme that aims at avoiding beamforming-related problems, and at the same time, providing efficient and fair bandwidth utilization in WMNs. By exploiting the stationary nature of WMNs, synchronized directional transmissions are scheduled using a deterministic contention-free algorithm without the need of the RTS/CTS handshaking prior to each packet transmission. More specifically, FreeDMAC divides the scheduling frame into time slots acting as scheduling priorities; it assigns contending links to different slots. When scheduling a transmission on link L during the L 's assigned slot, any sender on any L 's contending link will be notified of the transmission on L ; this makes nodes aware of all ongoing neighboring transmissions and thus allows avoiding transmissions, at the same time, on contending links. Being link-based (i.e., transmission rights are assigned to links instead of nodes), the

proposed scheduling increases the number of simultaneous transmissions within the same neighborhood, and subsequently, improves bandwidth utilization, and being contention-free, it significantly reduces the control overhead compared to the case of the RTS/CTS-based contention. To provide (1) per-link fairness: FreeDMAC rotates the link-slot assignment (i.e., scheduling priorities) at the beginning of each time-frame; and (2) per-flow fairness: FreeDMAC computes an access weight, for each link, that increases with its traffic load (i.e., more loaded links are allocated more bandwidth).

1.3 Thesis Organization

This thesis is divided in two parts and structured in six chapters. In chapter 2, we present a concise overview of the WMN, the IEEE 802.11 MAC standard, and the beamforming antennas. In chapter 3, we illustrate the unfair nature of both IEEE 802.11 and TCP, and give an overview of research covering congestion control in WMNs; thereafter, we present our proposed congestion control (NICC), and prove, via extensive simulation, its ability to avoid starvation and achieve efficient bandwidth utilization. In chapter 4, we present and evaluate our proposed congestion detection mechanism (FCD), which is based on a Fuzzy Logic controller. In chapter 5, we illustrate the beamforming-related MAC problems and give a taxonomy of research covering directional MAC schemes in WMNs; thereafter, we present our proposed directional MAC scheme (FreeDMAC), and prove, via extensive simulation, its ability to avoid beamforming related problems, and at the same time, provide efficient and fair utilization of the bandwidth resources. Finally, in chapter 8, we conclude the thesis and give possible directions for future research.

Chapter 2

Background

Contents

2.1	Introduction to Wireless Mesh Networks	33
2.1.1	Architecture Overview	34
2.1.2	Desired Properties	34
2.2	IEEE 802.11 MAC Standard	36
2.3	Beamforming Antennas	38
2.3.1	Basic Description	39
2.3.2	Antennas Types	39
2.3.3	Benefits	41
2.3.4	Exploitation	42

In this chapter, we give a concise overview of wireless mesh networks, IEEE 802.11 MAC standard, and beamforming antennas. We do not cover all their aspects but aim at providing the reader with enough knowledge to understand the remainder of the thesis.

2.1 Introduction to Wireless Mesh Networks

In this section, we give an overview of the WMN architecture and state the system properties that are required for the large-scale adoption of WMNs.

2.1.1 Architecture Overview

Wireless mesh networks have emerged as a promising technology for several commercially interesting applications such as last-mile broadband Internet access, community and neighborhood networking, intelligent transportation systems, and public safety applications.

A typical WMN [17][56] (Figure 2.1) consists of mesh gateways, mesh routers, and mesh clients, organized in a three-tier architecture. The third tier is the access networks, through which the mesh clients (i.e., wireless or wireline end-users) access the Internet. The access networks may include WLANs, Mobile Ad hoc NETWORKs (MANETs), and cellular networks; a mobile client can seamlessly roam among the access networks. The second tier is the wireless mesh backbone, which consists of a set of wireless mesh routers placed at stationary locations. Each mesh router (1) serves as an access point for mesh clients, and (2) relays the traffic from/to neighboring routers. The first tier is the mesh gateways, which connect the mesh backbone to the wireline backbone (i.e., Internet). Typically, a WMN covers a large geographical area; thus, multi-hop communications are usually required to relay a source to its destination (i.e., a data flow is relayed through multiple intermediate routers).

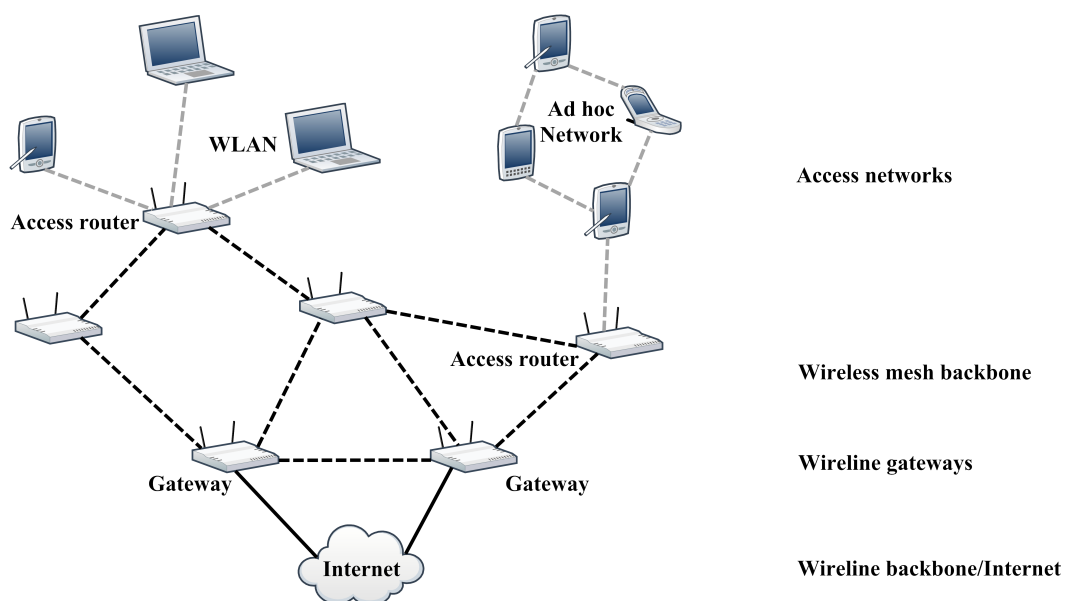

Figure 2.1: Wireless Mesh Network

The mesh routers are equipped with two wireless interfaces operating in two separate channels; thus, the connectivity problem in the mesh backbone is independent of that in the access networks. The focus of this thesis is on the wireless mesh backbone; indeed, the access networks are usually single-hop WLANs, which have been heavily studied in the literature. In what follows, the terms wireless mesh backbone and WMN are used interchangeably.

Even though WMNs are similar in concept to MANETs, there are some important differences between them. First, the mesh routers are typically placed at stationary locations with wired power supply; the topology changes infrequently (e.g., occasional router failure, adding a new router). Thus, there are neither mobility nor power consumption constraints such as in MANETs [98][120]. Second, the traffic load, being aggregated from a large number of end-users, is heavy and persistent (i.e., it does not change on a second-by-second basis). In summary, the main focus of the communication protocols in WMNs should be on improving the overall network capacity (i.e., bandwidth utilization) and the performance of individual flows (i.e., fairness) instead of coping with mobility and minimizing power usage.

2.1.2 Desired Properties

In this section, we briefly state the system properties that are required for the large-scale adoption of WMNs.

High Throughput

To serve as a communication backbone for a high number of end-users, WMNs have to support heavy traffic load, and thus deliver a high end-to-end throughput. To this end, the scarce bandwidth of WMNs should be efficiently utilized [80], i.e., the WMN has to avoid the typical sources of throughput degradation such as packet collisions, buffer overflows, and excessive control overhead.

Low Delays

The end-to-end communication delay is critical for most of nowadays applications; it should be minimized as much as possible. To this end, the mesh routers have to maintain lightly loaded queues.

Fairness

Throughput and delay consider the performance within a single flow. Typically, there are multiple flows concurrently present in a real WMN, and therefore, the WMN has to provide a certain level of fairness in order to avoid the starvation of some flows.

2.2 IEEE 802.11 MAC Standard

802.11 is a set of IEEE standards that govern the transmission methods in wireless local area networks. The IEEE 802.11 [14][92] standards include different modulation techniques operating in the 2.4 GHz and 5 GHz frequency bands and using the same basic protocol

[4]. The mostly used standards are IEEE 802.11a, IEEE 802.11b, IEEE 802.11g, and IEEE 802.11n; they are commonly deployed in homes, offices, and enterprises. For instance, the IEEE 802.11b (released in 1999) standard operates in the 2.4 GHz band using the Direct-Sequence Spread Spectrum (DSSS) technique; it provides data rates up to 11 Mbps. The IEEE 802.11a standard (released in 1999) operates in the 5 GHz band using the Orthogonal Frequency Division Multiplexing (OFDM) technique; it provides data rates up to 54 Mbps. The IEEE 802.11g standard (released in 2003) operates in the 2.4 GHz band using OFDM; it provides data rates up to 54 Mbps. The IEEE 802.11n standard (released in 2009) operates in the 2.4GHz and 5 GHz bands using the Multiple Input Multiple Output (MIMO) techniques; it provides highly increased data rates (up to 600 Mbps).

The common point among the IEEE 802.11 standards is that all of them rely on the Carrier Sense Multiple Access (CSMA) protocol to perform scheduling (i.e., transmission decisions) at the MAC layer¹. CSMA implements a backoff mechanism to resolve medium contention². Before initiating a transmission, a node performs a Physical Carrier Sensing (PCS) in order to detect whether the medium is idle or a transmission is going on. If the medium is idle, the node defers for a DCF Interframe Spacing (DIFS) period before transmitting the data frame. Otherwise (i.e., the medium is busy), the node selects a random backoff interval from $[0, CW]$, where CW is the backoff contention window. The CW is initially set to the minimal value CW_{min} ($CW_{min} = 25$ for 802.11b and 24 for 802.11a/g). Upon each time slot (20s for 802.11b and 9s for 802.11a/g), if the medium is idle, the backoff interval is decremented by one; otherwise, it remains frozen (the countdown resumes when the medium becomes idle for a DIFS period). Eventually, when the backoff interval reaches zero, the node transmits its data frame over the wireless medium, and then, it waits for an acknowledgement (ACK) from the corresponding receiver in order to verify the successful transmission of the data frame. If the ACK is received, the node resets its contention window to the minimal value CW_{min} and repeats the same process for the next data frame. Otherwise (i.e., ACK is not received), the node assumes the data frame is lost due to collision, and thus it doubles its contention window, selects a new backoff value, and starts counting down. An unsuccessful transmission is repeated at most seven times, and at each time, CW is doubled as long as it has not reached the maximal value CW_{max} ($CW_{max} = 2^{10}$). Upon seven unsuccessful attempts, the node drops the data frame and resets its contention window

¹The 802.11 MAC defines two modes to coordinate the use of the wireless medium: The Distributed Coordination Function (DCF) and the Point Coordination Function (PCF). In this thesis, we consider the DCF mode; indeed, on the one hand, it is most commonly used in 802.11 implementations [97], and on the other hand, it supports decentralized networks such as WMNs.

²The term medium contention denotes how to avoid collision, while the term congestion control denotes how to avoid buffer overflow.

to the minimal value CW_{min} .

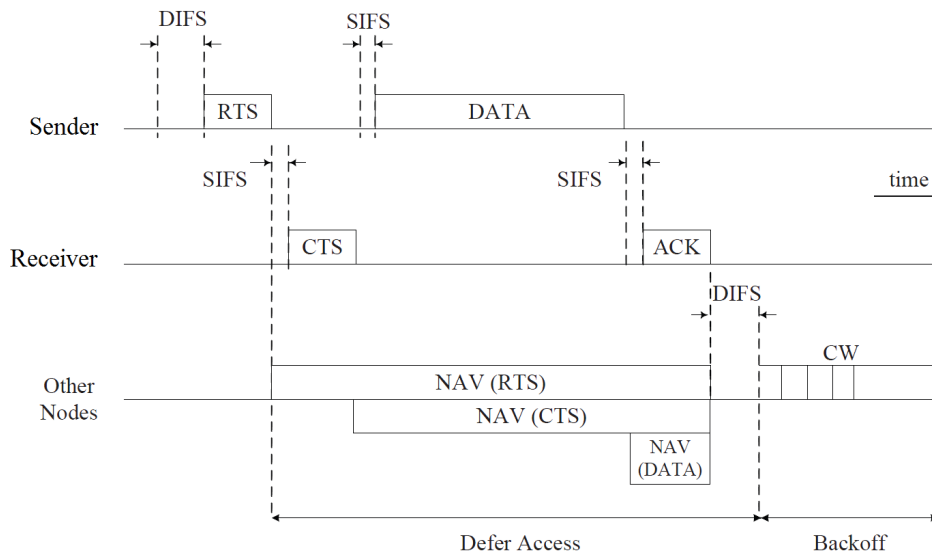

Figure 2.2: Transmission scheduling in IEEE 802.11 MAC

The main assumption behind CSMA is that all nodes are able to detect whether the medium is idle or a transmission is going on, and thus collisions occur only when two senders select the same backoff interval. However, this assumption is violated when two senders, which are outside the carrier sensing range of each other, attempt to communicate with a common receiver, thereby creating collision at the receiver. This problem is called hidden node and has shown causing serious performance degradation in WMNs. To overcome this problem, CSMA implements a collision avoidance scheme by using a handshaking mechanism before the data transmission [32]. Before starting the data transmission, the sender transmits, upon the backoff expiration, a short Request-To-Send (RTS) frame to its intended receiver, which in turn, responds, upon detecting the medium idle for a Short Inter-Frame Spacing (SIFS) period, with a short Clear-To-Send (CTS) frame. Both the RTS and CTS include the duration of the data transmission; neighboring nodes that overhear either RTS or CTS update their Network Allocation Vector (NAV) with the specified duration. This is called Virtual Carrier Sensing (VCS); it ensures that the neighboring nodes remain idle for the entire duration of the transmission, thereby reducing the probability of collision. Nevertheless, the RTS/CTS handshaking is rarely used in practice (i.e., it is turned off by default [1]). Indeed, the RTS/CTS handshaking is proven to be ineffective to handle the hidden node problem [136] and to increase the capacity of wireless multi-hop networks [33]. Figure 2.2 illustrates the CSMA scheduling process when the RTS/CTS handshaking is turned on.

Despite its simplicity and cheapness, the IEEE 802.11 has been shown performing poor in wireless mesh networks [138][82]. Indeed, to perform a data transmission (RTS/CTS/DATA/ACK handshaking), CSMA requires an idle channel at both the sender

and the receiver of the wireless link. However, in WMNs, interference and carrier sensing (CS) exhibit strong location-dependency, i.e., nodes located in different positions within the same neighborhood experience different degrees of contention [81][69]; this results in serious unfairness, and even complete starvation, in which some nodes/links have access to significant bandwidth while others are extremely starved (Chapter 2 illustrates the basic starvation scenarios of IEEE 802.11). On the other hand, when the traffic load is heavy, IEEE 802.11 experiences serious collision due to severe contention to access the same medium; these collisions cause a considerable number of retransmissions resulting in a dramatic increase of control overhead and thus of bandwidth waste, eventually limiting the scalability of WMNs.

2.3 Beamforming Antennas

In this section, we give an overview of beamforming antennas³ in order to provide the reader with enough knowledge to understand the MAC protocol proposed in Chapter 5. Additional details are provided in [22][88].

2.3.1 Basic Description

The main purpose of an antenna is to couple Radio Frequency (RF) energy from the transmitter to the outside world, in case of transmission purposes, and in reverse, from the outside world to the receiver, in case of reception purposes [118]. Traditional omni-directional antennas transmit/receive RF energy equally to/from all directions; they are also called *non-directional* antennas as they do not favor any particular direction. Figure 2.3a illustrates the radiation pattern of an omni-directional antenna: (1) for transmitters, the radiated signal has the same strength in all directions, and (2) for receivers, signals from all directions are received equally well. On the other hand, directional antennas can transmit/receive RF energy to/from one direction more than the others. Directional antennas are mainly characterized by their gain, directionality, and beamwidth [5]. Figure 2.3b illustrates the radiation pattern of a directional antenna; it consists of a peak main lobe (i.e., beam) and small side and back lobes: (1) for transmitters, the radiated signal has larger strength in the direction of the main lobe, and smaller strength in the direction of the side and back lobes, and (2) for receivers, signals received from the direction of the main lobe are maximized, while signals received from the directions of the side and back lobes are suppressed. It is worth noting that the side and back lobes represent lost energy, so research attempts focus on minimizing them. The term ideal directional antenna is used to refer an ideal antenna pattern in

³In what follows, the terms *beamforming antennas* and *directional antennas* are used interchangeably.

which the gain is constant in the main lobe and zero outside. The antenna beamwidth is the width, in degrees, of the main lobe. It is typically measured between the -3 dB points, i.e., the points on the main lobe where the signal strength is -3dB from the maximal signal strength points that lie on the axis of the main lobe (also known as the boresight [29]). It is worth noting that the antenna gain is inversely proportional to the beamwidth; the narrower the beamwidth the higher the gain.

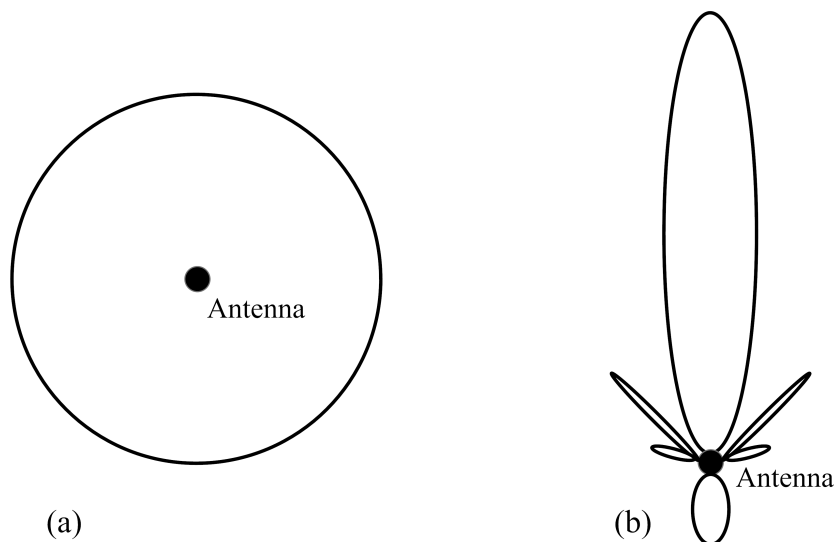

Figure 2.3: The radiation pattern of (a) omni-directional and (b) directional antennas.

Smart directional antennas are typically composed of an array of radiating elements, a combining/dividing network, and a control unit; the latter is generally realized using a Digital Signal Processor (DSP) [71]. The antenna radiation pattern is specified by the number of radiating elements, the element spacing, the geometrical configuration of the array, and the amplitude and phase of the signal on each element [29].

2.3.2 Antennas Types

Beamforming antennas are generally classified into two categories: *Switched beam antennas* and *Steered beam antennas*.

2.3.2.1 Switched beam antennas

In switched beam antennas, M radiating elements are combined with a fixed Beam Forming Network (BFN) to form up to M predetermined directional beams. The antenna adaptively switches to one of the predetermined beams, i.e., at a given moment, the antenna radiates/receives on/from one of the predetermined beams. Switched beam antennas provide

most of the benefits of smart antennas (e.g., spatial reuse, range extension and power saving) with little complexity and cheap cost; however, there are some limitations: (1) when the desired transmitter/receiver is not well located in one of the predetermined beams (e.g., located close to the edge of the beam), the transmission will suffer from gain reduction, and (2) switched beam antennas cannot completely eliminate the interference outside the main lobe, resulting in further reduction in the gain [118].

2.3.2.2 Steered beam antennas

Steered beam antennas (also known as adaptive array antennas) provide a high degree of flexibility in configuring the radiation patterns; the boresight of the main lobe could be adaptively directed towards the target, and thus the gain to/from the desired transmitter/receiver could be maximized. Furthermore, using advanced processing algorithms, the antenna can place nulls in the direction of interferences, and thus offer more comprehensive interference rejection. Steered beam antennas outperform switched beam antennas; they provide better transmission/reception quality, especially in multipath environments, resulting in better bandwidth utilization. However, steered beam antennas suffer from limitations in terms of complexity, cost, and power consumption [29].

We can conclude that the benefits of directional antennas increase with the cost and complexity; the higher the cost and complexity, the better the network performance. Thus, based on the network requirements, a proper antenna type can be used to balance the performance and cost constraints [29].

2.3.3 Benefits

Spatial Reuse

Spatial reuse is the main benefit of directional antennas. By using directional transmission/reception, the interference to/from the undesired directions can be avoided, and thus multiple transmissions can simultaneously occur within the same neighborhood, leading to improved bandwidth utilization. Figure 2.4 illustrates an example. In case of omnidirectional antennas, to perform the DATA/ACK handshaking of the transmission on link L_{S-R} , all the other nodes, which are neighbors of nodes S and/or R, should remain idle; thus, only one transmission can take place at the same time. On the other hand, in case of directional antennas, up to five transmissions can take place at the same time, leading to improved bandwidth utilization, and thus the network capacity. This improvement has been proven using theoretical analysis [139], simulations [107], and experimentations [108].

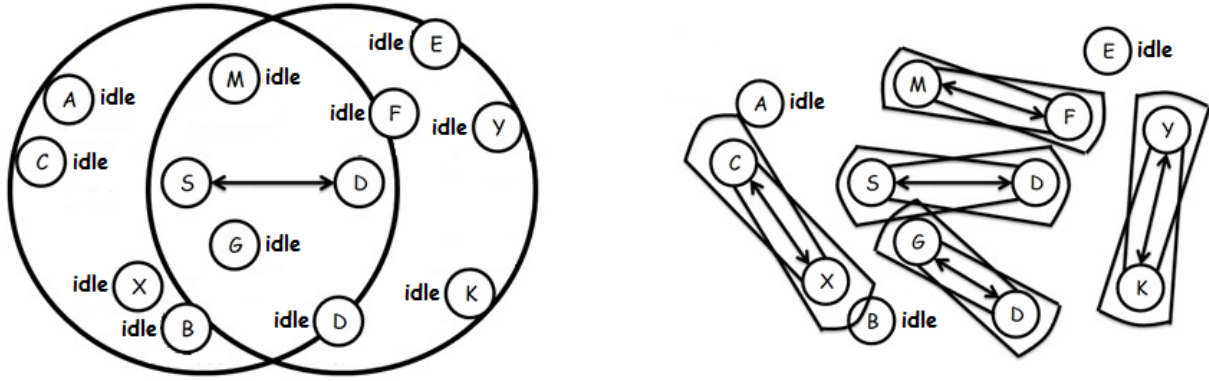

Figure 2.4: Spatial reuse

Connectivity Extension

Using the same transmit power, directional antennas can achieve much higher gain than omni-directional antennas, leading to extend the communication range, and thus the network connectivity [86]. Furthermore, this extension can minimize the number of hops in a flow path, and thus reduce the end-to-end delay [42].

Reduction of Power Consumption

Since directional antennas can achieve higher gain with the same transmit power, they can, in reverse, maintain the same link quality with less power consumption [117]; thus, directional antenna can reduce the power consumption without affecting the network performance. For instance, between two specific sender-receiver pair, directional antennas can maintain the same link quality (e.g., Signal-to-Noise-Ratio (SNR), transmission rate), achieved by omni-directional antennas, with less power consumption. It is worth noting that the reduction of power consumption hinders the connectivity extension; thus, based on the network requirements, a proper tradeoff should be used to balance the connectivity and energy constraints.

2.3.4 Exploitation

Traditional wireless multi-hop network protocols fails to exploit the benefits of directional antennas as they are basically designed assuming that nodes are equipped with omni-directional antennas. Therefore, novel upper layer protocols should be designed in order to appropriately control the use of directional antennas. Since the MAC layer lies just above the physical layer, it is the most important layer to be addressed in order to fully exploit the benefits of directional antennas.

Part I

IEEE 802.11-based Wireless Mesh Networks

Part I Introduction

The first part of this thesis considers the wireless mesh networks that rely on the IEEE 802.11 standard to perform scheduling at the MAC layer. Despite its cheap deployment and widespread usage, it has been reported that IEEE 802.11 is highly problematic in terms of starvation in WMNs (i.e., some links, and thus flows traversing them, suffer from too low bandwidth). This thesis part aims at achieving efficient and fair bandwidth utilization in 802.11-based WMNs. To this end, we propose a congestion control scheme called NICC; the key idea behind NICC is to recognize congestion as a neighborhood-related problem, instead of a link-based one. Therefore, in NICC, congestion is handled using mutual cooperation among nodes within the same wireless neighborhood. To solve starvation without affecting the scarce bandwidth of WMNs, NICC makes use of some underexploited fields in the IEEE 802.11 frame header, without modifying the standard frame size, in order to provide a multi-bit congestion feedback. On the one hand, being implicit, this feedback allows performing neighborhood cooperation without generating additional overhead, and on the other hand, being multi-bit, it yields the flow source a fine-grained indication of the congestion degree; this indication helps the source performing accurate rate control.

The NICC focus is to handle congestion without considering the congestion detection process. Therefore, the second contribution of this thesis part is FCD, a Fuzzy-based Congestion Detection mechanism designed adequately to the NICC needs. On the one hand, FCD allows detecting congestion at intermediate nodes; this is necessary to perform the congestion signaling within a congested neighborhood, and on the other hand, FCD is able to compute several congestion degrees; this is necessary to exploit the NICC's multi-bit congestion feedback, and thus help them performing accurate rate control, making efficient use of bandwidth.

The performance of the proposed schemes (NICC and FCD) in terms of starvation avoidance and bandwidth efficiency is proven through extensive simulations.

Chapter 3

NICC: A Neighborhood-based and Overhead-free Congestion Control for IEEE 802.11 WMNs

Contents

3.1	Introduction	50
3.2	Problem Statement	52
3.2.1	Starvation Scenarios	52
3.2.2	Fairness	55
3.3	Related Work	56
3.4	Definitions and Concepts	59
3.4.1	Link Neighborhood	60
3.4.2	Congested Link and Congested Neighborhood	60
3.4.3	Intra-Flow Dependency	60
3.5	NICC Design	60
3.5.1	NICC Frames	61
3.5.2	NICC Tables	62
3.6	NICC Process	63
3.6.1	Congestion Detection	64
3.6.2	Congestion Signaling	64
3.6.3	Congestion Notification	65
3.6.4	Rate Control	66

3.7	NICC Evaluation	68
3.7.1	Specific Topologies	69
3.7.2	Large Scale Topologies	73
3.8	Conclusion	75

3.1 Introduction

Starvation and bandwidth scarcity are the major obstacles limiting the scalability of WMNs. To overcome these obstacles, an optimal congestion control has to (1) efficiently use the bandwidth resources; and (2) fairly allocate the bandwidth resources among competing flows, even though the underlying MAC protocol, e.g., IEEE 802.11, is inherently unfair.

Economies of scale have made IEEE 802.11 the commonly used MAC protocol in WMNs [112]. However, it has been shown that IEEE 802.11 introduces serious unfairness in bandwidth allocation (i.e., throughput) among neighboring links in WMNs [23][82][138]. For its part, TCP-like congestion control adversely impacts the situation causing complete starvation among neighboring competing flows. Indeed, in TCP, when a link is congested, only flows traversing the congested link are regulated, i.e., their sending rates are reduced. However, since bandwidth is a spatially shared resource in WMNs, congestion is not solely related to flows traversing the congested link, but also to flows traversing the link's neighborhood.

To handle starvation, congestion should be handled using mutual cooperation within the neighborhood of the congested link. The neighborhood of a link L includes every link sharing the same bandwidth resources with L , i.e., the link and L cannot be used for transmission at the same time because of interferences (a link neighborhood is formally defined in Section 3.4). When a link is congested, the congestion must be signaled to each neighboring link, i.e., the sender-receiver pair of each neighboring link should be informed about the congestion. Thereafter, the source of each flow traversing one or more of these neighboring links must be notified in order to regulate its sending rate. However, signaling congestion within the congested neighborhood and notifying the corresponding sources may generate a considerable overhead which will likely degrade the network performance in terms of the overall end-to-end throughput of WMNs.

A trade-off is to be made between the overhead generated by the notifications and the amount of information reported by these notifications. An explicit multi-bit congestion feedback yields source nodes a fine-grained indication of the congestion degree, thereby

ensuring accurate rate control [125]; however, such feedback generates a heavy overhead. An implicit single-bit congestion feedback could considerably reduce the overhead; however, such a feedback does not contain enough information about the congestion and may lead to inaccurate rate regulation by the source nodes. This may cause large oscillations in the network load leading to an inefficient use of the network bandwidth.

Congestion control in WMNs is extensively studied in the literature [89]. However, most of existing schemes [19][106] do not explicitly consider congestion as a neighborhood phenomenon; indeed, competing flows are treated separately, eventually leading to starvation of some flows. Other schemes (e.g., [51][83][132]) propose congestion metrics that implicitly consider neighborhood information, such as MAC layer contention density [83], interference from neighboring nodes [132], and bandwidth availability estimation [51]. However, in WMNs, congestion is strongly location-dependent, i.e., neighboring links usually perceive different congestion degrees [109][137], thereby causing unfairness among flows traversing these links. Recently, a number of schemes [109][125], that recognizes congestion as a neighborhood issue, has been proposed. However, none of them efficiently resolves the tradeoff between congestion feedback accuracy and overhead generated in the network.

In this chapter, we propose a Neighborhood-based and overhead-free Congestion Control scheme (NICC) that aims at realizing efficient and fair bandwidth allocation in WMNs. The key idea behind NICC is to provide an implicit multibit congestion feedback taking into account neighborhood information, without additional overhead, in order to ensure fair and accurate rate control by the source nodes. For this purpose, NICC makes use of some underexploited fields in the IEEE 802.11 frames header, without modifying the standard frame size; using the newly formatted IEEE 802.11 data frames, NICC is able to transfer data frames, and at the same time, signal congestion within a neighborhood. Moreover, using the newly formatted IEEE 802.11 control frames, NICC is able to acknowledge the successful reception of data frames, and at the same time, notify upstream nodes about congestions. In this way, precise and neighborhood-aware congestion information circulates in the network without generating overhead (i.e., no control messages or piggybacked headers). The performance evaluation, via simulations, shows that NICC is able to fairly and efficiently allocate bandwidth in WMNs.

The remainder of this chapter is structured as follows. In Section 3.2, we analyze the behavior of IEEE 802.11 and TCP by illustrating some basic starvation scenarios in WMNs. In Section 5.3, we present related work review. In Section 3.4, we present definitions and concepts related to congestion control. In Section 3.5 and Section 3.6, we present the details of NICC. Section 3.7 presents the performance evaluation of NICC. Finally, Section 4.4 concludes the chapter.

3.2 Problem Statement

In this section, we illustrate the basic scenarios causing starvation in WMNs, and we analyze the behavior of IEEE 802.11 and TCP in each of these scenarios.

3.2.1 Starvation Scenarios

We classify starvation scenarios into three categories based on the reason causing starvation: (1) contention among links with asymmetric interference and carrier sensing relations; (2) contention among flows with different path lengths (number of hops); and (3) contention among links with different numbers of flows.

3.2.1.1 Contention among links with asymmetric interference and carrier sensing relations

In IEEE 802.11, to perform the DATA/ACK handshaking, an idle channel is required at both the sender and the receiver of a wireless link. However, in WMNs, interference and carrier sensing (CS) exhibit strong location-dependency, i.e., nodes located in different positions within the same neighborhood experience different degrees of contention [82][90]. Thus, the bandwidth allocation/utilization on a link depends on the location of its sender-receiver pair. Consequently, when using IEEE 802.11, within the same neighborhood, some links (called inhibitor links) will be allocated more bandwidth than others (called inhibited links); this means that flows traversing these links will achieve very different throughputs.

For its part, TCP worsens more the situation. Indeed, TCP interprets the higher throughput of flows traversing inhibitor links as an increase in the available bandwidth, and thus it increments their sending rates. In contrast, TCP considers the lower throughput of flows traversing inhibited links as congestion, and thus it reduces their sending rates. As a result, some flows get significant throughput, while other ones are drastically starved.

Example: The flow in the middle

In this scenario (Figure 3.1), each of links L_{S2-R2} and L_{S3-R3} interferes only with link L_{S1-R1} , while L_{S1-R1} interferes with both L_{S2-R2} and L_{S3-R3} . Thus, source S1 will access the wireless channel much less to send flow F1 compared with S2 and S3 to send F2 and F3, respectively. Further degrading the throughput achieved by F1 is the fact that TCP may force S1 to reduce further its rate assuming the start of congestion between S1 and R1 (e.g., TCP retransmission timer expires); in this case, S2 and S3 may increase their rate, and thus increase interferences with link L_{S1-R1} causing the starvation of F1.

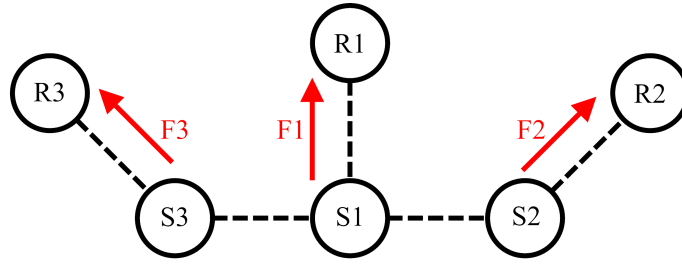

Figure 3.1: The flow in the middle scenario

Example: The hidden node

In this scenario (Figure 3.2), S1 and S2 are hidden to each other. Thus, S1 and S2 can transmit at the same time to R1 and R2, respectively; in this case, S2 will receive acknowledgement, from R2, after each transmission; in contrast, S1 will just try to retransmit packets due to collisions (R1 is in the transmission ranges of both S1 and S2). This situation will not be handled even when the RTS/CTS handshaking is used [112]; in this case, S1 will not be able to transmit more DATA packets (due to the absence of CTS from R1) but will be able to continue sending RTS packets causing long backoff delays. It is worth noting [82] that the RTS/CTS handshaking has been proven to be ineffective to handle the hidden node problem [136] and to increase the capacity of wireless multi-hop networks [33]. Further aggravating the situation, TCP will force S1 to reduce its sending rate, and thus S2 will increase its rate if needed. This may cause the starvation of the traffic flow from S1.

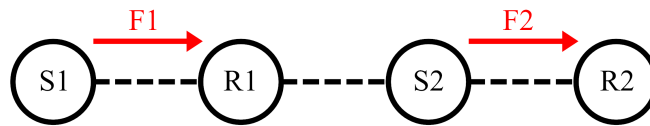

Figure 3.2: The hidden node scenario

3.2.1.2 Contention among flows with different path lengths

In WMNs, when competing flows have different path lengths, longer flows are usually starved. Indeed, in WMNs, when a sender S succeeds in sending a data packet and receiving the link-layer acknowledgement, it starts an access period in which it will be able to send a series of packets. In fact, upon receiving the link-layer acknowledgement, node S resets its backoff contention window while its neighboring nodes are still suffering large backoff windows; thus, compared to its neighbors, S will have a higher chance to send a new data packet. On the other hand, the congestion window of TCP limits the series of packets that could be sent by a TCP source before receiving an end-to-end acknowledgment (TCP ACK). Thus, if during the access period, S transmits on a link that represents a part of a multi-hop flow, then the length of the access period will be limited by the congestion window of the multi-hop flow.

In contrast, if S transmits on a single-hop flow, the access period is then self-maintained as the destination is directly connected to the source. As a result, when competing flows have different path lengths, longer flows are starved. A detailed description of this starvation scenario is presented in [62]. For better understanding let us consider the example shown in Figure 3.3.

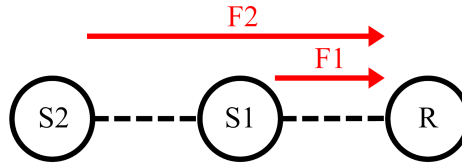

Figure 3.3: A single-hop flow vs. a two-hop flow

We assume that nodes S2 and R contend for transmitting TCP DATA (flow F2) and TCP ACK (flow F1), respectively, to node S1, while both of them have small backoff contention windows. According to [62], a series of collisions occurs until the backoff windows of both nodes (S2 and R) become sufficiently large, and then one of them succeeds in transmitting a packet. The winner node resets its backoff window while the loser one keeps incrementing its window size. Thereafter, the winner node starts an access period during which it sends a series of packets. Note that since S1 is in the transmission range of both S2 and R, it contends fairly with the node starting the access period, i.e., it will be also able to send a series of packets. The access period ends due to one of the followings: (1) the winner node and S1 have transmitted all their queued packets; (2) upon reaching the maximum window size (CW_{max}), the loser node resets its backoff window and then succeeds in sending a packet given its small backoff window; or (3) the loser node succeeds in sending a packet despite its large backoff window since the access probability is low but not zero.

Let us consider that S2 is the winner node; the series of packets that could be sent by S2 is limited by the congestion window of F2. Before retransmitting new packets, S2 should wait for a TCP ACK from R. This may take a long time until packets being relayed at S1. As a result, the access period of S2 is bounded. On the other side, when R is the winner node, a transmission loop between S1 and R will be created and self-maintained since S1 is able to receive TCP ACK of F1 from R, and then it will be able to send more data packets. Thus, F1 gets most of the available bandwidth, while F2 is starved.

3.2.1.3 Contention among links with different numbers of flows

In WMNs, when two neighboring links are traversed by different numbers of flows, flows traversing the link with the larger number of flows are relatively starved. It is worth noting that this starvation is not as important as in the cases (1) and (2). Indeed, the bandwidth

allocation of a link is fairly divided among flows passing through it. Thus, a flow traversing a link with a smaller number of flows gets more throughput than a flow traversing a link with a larger number of flows.

For clarity, let us consider the example shown in Figure 4. Since nodes S1 and S2 are located in the transmission range of each other and have symmetric interference and CS relations, IEEE 802.11 allows them to get a fair channel access. In this case, the throughput of F2 will be equal, in average, to the throughput of F1, F3 and F4; thus, F1, F3 and F4 will be relatively starved compared to F2.

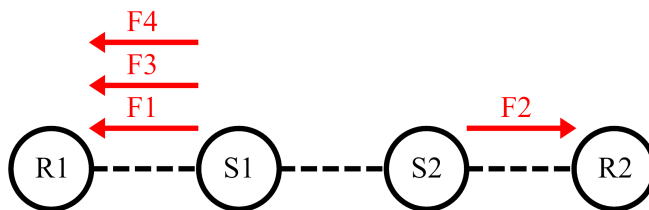

Figure 3.4: Neighboring links with different numbers of flows

3.2.2 Fairness

To implement fairness, all flows sharing the same bandwidth resources should get the same bandwidth allocation. In wired networks, each link has its own bandwidth that cannot be used by any other link, i.e., transmissions on different links use different bandwidth resources. Therefore, when a link is congested, to implement fairness, only flows traversing the congested link are regulated, i.e., their sending rates are reduced. Flows traversing neighboring links are not affected. This regulation scheme is employed by TCP; however, it causes starvation in WMNs. Indeed, in WMNs, the bandwidth is a spatially shared resource that can be used by a set of links located in the same neighborhood, i.e., transmissions on neighboring links use the same bandwidth resources. Therefore, when a link is congested, all flows traversing any of its neighboring links should be regulated.

For instance, in Figure 2, L_{S1-R1} and L_{S2-R2} share the same bandwidth resources, i.e., transmissions on these links cannot occur simultaneously due to interferences at node R1. When L_{S1-R1} is congested, TCP regulates F1 (i.e., reduces its rate) but not F2. To implement fairness between F1 and F2, when L_{S1-R1} is congested, both S1 and S2 should be notified about the congestion, and then both F1 and F2 will be regulated. Similarly, in Figure 3, links L_{S2-S1} and L_{S1-R} share the same bandwidth resources. Hence, when link L_{S2-S1} is congested, both F1 and F2 should be regulated despite the fact that F1 is not traversing the congested link L_{S2-S1} .

Based on the above discussion, to implement fairness, we need to (1) compute the link neighborhood: The neighborhood of a link L includes every link sharing the same bandwidth resources with L , i.e., the link and L cannot be used for transmission at the same time because of interferences; (2) signal congestion: When a link is congested, the congestion has to be signaled to the neighborhood of L , i.e., the sender-receiver pair of each neighboring link should be informed about the congestion; and (3) notify congestion: The source of any flow traversing the congested link L or its neighborhood is notified in order to regulate its sending rate.

To make efficient use of bandwidth, while implementing fairness, congestion notification/signaling should not generate considerable overhead. Furthermore, the congestion feedback should include enough information/details about the congestion to help the sources performing efficient/accurate rate regulations; finally, congestion has to be reported in timely fashion; any delay will degrade the network performance.

3.3 Related Work

In the last decade, several congestion control schemes, in wireless multi-hop networks, have been proposed [89].

A number of TCP-based approaches to improve the performance of TCP in WMNs are presented in [19][99][106]. The idea is to adjust some TCP variants, such as the Congestion Window ($cwnd$) and the Slow Start Threshold ($ssthresh$), in a less aggressive way upon transmission timeouts or duplicate acknowledgments. This adjustment aims to determine whether a packet loss is due to wireless corruption or to congestion, and then avoid unnecessary rate regulations. The authors in [19] propose iTCP in which $cwnd$ is adapted using a Neural-based model [65]. In iTCP, isolated failures are interpreted as wireless errors (propagation loss, multipath effect, etc.), while consecutive ones are considered as congestion; the $cwnd$ is shrunk only in case of congestion. In TCP SAC [106], upon receiving a duplicate acknowledgement, the TCP source is forced to spend more time in the Fast Retransmit and Recovery phase before reducing $cwnd$ to one and entering the Slow Start phase. In CLM-TCP [99], upon a transmission timeout, the TCP source checks the medium quality using the Expected Transmission Count (ETX) [46] and the Minimum Delay (MD) [43] metrics; then, it accordingly adjusts $cwnd$ and $ssthresh$. Actually, these protocols are too close to the standard TCP; thus, they do not recognize congestion as a neighborhood problem. Moreover, they are not able to support UDP-like traffic which represents a significant part of wireless communications.

Conventional schemes working independently of TCP mechanisms and able to support both TCP- and UDP-like traffic are proposed in [96][141]. These schemes allow any intermediate node along the flow path to detect congestion, and subsequently to notify the source node(s). The latter is then able to process congestion more quickly than a typical TCP source that waits for a transmission timeout or an end-to-end duplicate acknowledgment. In [96], a link is congested if the increase rate of its queue length is bigger than a predefined threshold. In CORE [141], the increase rate is combined with the queue length itself, using a mathematical model, in order to compute the accurate time of congestion occurrence, and thus to precisely select the time of rate regulation. These schemes [96][141] do not handle congestion as a neighborhood problem; furthermore, the congestion notifications to sources are achieved using explicit control messages which may generate considerable overhead.

In FuzzyWMN [74], a flow source periodically receives end-to-end feedbacks that include the average packets delay, and then it accordingly regulates the flow sending rate (a delay increase is interpreted as congestion). Actually, as in TCP, flows traversing a same neighborhood are regulated independently, thereby causing starvation. Moreover, the frequency of end-to-end feedbacks needs to be cautiously selected in order not to generate a considerable overhead.

In PICCO [143], a node experiencing a queue build-up calls the service of a mobile relay with sufficient available queues in order to avoid queue overflows. When the load of the node is reduced, it stops using the mobile relay service that can be used by other nodes. Actually, PICCO might avoid, or at least reduce, packet losses and thus improve network throughput; however, it can cause higher queuing delays. This is unacceptable for most of nowadays application [133].

A set of hop-by-hop congestion control protocols are proposed in [61][83][114][115][132][133][142]. The idea is to allow intermediate nodes to locally estimate the congestion degree and to individually regulate their sending rates. It is worth noting that the feasibility of hop-by-hop congestion control in wireless multi-hop networks has been originally explored in [140]; however, the proposed solution [140] is not realistic since it ignores interferences among links that do not share at least one end (i.e., node).

In SECC [114], a node experiencing a queue build-up sends a notification to its upstream neighbor including a target rate and an expiration time. Subsequently, the upstream neighbor regulates its sending rate such that it remains below the target rate. The rate regulation is performed by modifying the AIFSN (Arbitration Inter-Frame Space-Number) parameters of IEEE 802.11e. In AR-TP [61]; each node maintains a dedicated queue per neighbor; it uses two adaptable thresholds called the congestion threshold and the high uti-

lization threshold. When a node is in a congestion condition (i.e., queue length \geq congestion threshold), it asks its upstream neighbor for a rate adaptation, and it requests its downstream neighbor to increase the high utilization threshold in order to be able to support more traffic load. In SECC and AR-TP, only flows traversing congested links are regulated; thus, the starvation issue is not resolved.

In HRC [83], to select an appropriate sending rate, a node estimates the contention density at the MAC layer by computing the fraction of time during which the channel is busy. In CHCC [132], to avoid unnecessary route discovery operations, a node estimates the level of interferences caused by nearby transmitters, and then it determines whether a packet drop is due to congestion or to a broken link. Actually, such estimations implicitly take into account neighboring interfering links; however, congestion in wireless networks exhibits strong location dependency; this means that neighboring links usually experience different congestion degrees [137][110]. Thus, flows traversing a same neighborhood will be unfairly regulated.

In [115], CXCC imposes each node to maintain at most one packet per flow. This aims at preventing a flow sending rate from exceeding the available bandwidth at any link in the flow path. Indeed, maintaining a single packet per flow leads to avoid packets burst at inhibitor links; thus, offering more bandwidth allocation to inhibited links, and then alleviating starvation. However, as aforementioned, congestion in WMNs exhibits strong location dependency; thus, it needs explicit neighborhood-based management.

In [142], a dedicated queue is maintained for each next-hop neighbor. Bandwidth allocation inside a node is carried out by suppressing the deviation of length among local queues. Similarly, bandwidth allocation among nodes is performed by suppressing the deviation of length among queues of intermediates nodes along a flow path. Actually, like CXCC, this proposal might indirectly alleviate starvation, whereas it lacks explicit neighborhood-based management.

In DiffQ [133], a node maintains a dedicated queue for each destination. For each queue, a differential backlog is calculated equal to the difference of the queue length at two consecutive nodes in the flow path. When sending a packet, a node adapts the AIFS and the minimum backoff contention window (CW_{min}) of IEEE 802.11 according to the differential backlog of the queue in which the packet has been buffered; the bigger is the differential backlog, the higher is the channel access priority. In fact, DiffQ efficiently reacts to congestion as a neighborhood phenomenon. However, it is very complex since a node is required to maintain a separate queue for each possible destination [110].

Neighborhood-based congestion control has been originally explored in NRED [137];

however, in NRED, link neighborhood is not correctly identified.

EWCCP [125] and WCP [109] are two typical neighborhood-based congestion control schemes. EWCCP proposes a multi-bit congestion feedback able to yield source nodes a precise indication of the congestion degree. However, in EWCCP, congestion signaling within a neighborhood is performed using periodic dedicated control messages. Moreover, an additional feedback header is piggybacked on every data packet at each traversed link, and subsequently the aggregated feedback is sent back to the source node. The control messages and the additional feedback headers make use of considerable bandwidth resources (i.e., considerable overhead); this may degrade unacceptably the performance of WMNs using EWCCP. WCP does not make use of explicit signaling messages and limits the number of additional headers; thus, it reduces considerably the control overhead. Furthermore, WCP improves fairness by performing a synchronized rate control among flows traversing a same neighborhood. However, single-bit feedbacks (used by WCP) do not allow source nodes to have an accurate view of the congestion; thus, they may compute regulation rates causing inefficient bandwidth utilization.

In [111], C3L proposes a centralized traffic engineering model in which a central controller periodically receives per-link reports (passing-by flows, queue length, delivery ratio, etc); it uses these reports to calculate bandwidth allocations for the network links. C3L succeeds in providing a global fair bandwidth allocation; however, it generates a considerable overhead (e.g., control messages between the controller and the nodes, end-to-end feedbacks, and periodic hello messages).

The authors in [62] refer to the scenario in which a two-hop flow shares the same gateway with a single-hop flow (scenario shown in Figure 3.3) as the basic starvation scenario in WMNs. This scenario frequently occurs in WMNs due to the gateways' central role. The authors propose a counter-starvation solution in which nodes directly connected to gateways increase their minimum backoff contention window (CW_{min}) to a value significantly larger than that of the other nodes. Actually, in this proposal [62], only the second starvation category is handled (see Section 3.2); other starvation categories are not addressed. Furthermore, increasing the minimum contention window of some nodes might cause an underutilization of the wireless resources.

We can conclude that none of the existing contributions (see above) succeeds in being fair and efficient at the same time; indeed, fairness-aware protocols generate considerable overhead that may degrade significantly the network performance. We believe that NICC is the first congestion control protocol that provides fairness with the least overhead (no additional messages/headers). Indeed, by making use of the underexploited fields in the

IEEE 802.11 frames header, NICC provides an implicit multi-bit congestion feedback. Being implicit, NICC generates no extra overhead, while being multi-bit, it provides source nodes with a detailed information about the congestion, enabling efficient/accurate rate regulation (i.e., fine-grained congestion information).

3.4 Definitions and Concepts

This section presents some definitions regarding the congestion control process in WMNs. We define (1) the neighborhood of a link, (2) the difference between congested link and congested neighborhood, and (3) the intra-flow dependency concept. In what follows, the sender/receiver terms are used to refer link's transmitting-ends, while the source/destination terms are used to refer flow's end-points.

3.4.1 Link Neighborhood

The neighborhood of link L_{S-R} (Figure 3.5) includes every link sharing the same bandwidth resources with L_{S-R} , i.e., the link and L_{S-R} cannot be used for transmission at the same time because of interferences. IEEE 802.11 requires a link-layer acknowledgement for every data frame; thus, it necessitates an idle channel at both the sender and the receiver sides. Hence, a link interferes with L_{S-R} , i.e., is in the neighborhood of L_{S-R} , if one of its transmitting-ends is within the transmission range of either S or R (transmitting-ends of L_{S-R}), i.e., is a neighbor of either S or R. Consequently, the neighborhood of L_{S-R} includes all the incoming and the outgoing links of: S, R, neighbors of S, and neighbors of R. This definition is similar to that used in [109][125]. It is worth noting that if link L1 is in the neighborhood of link L2, then L2 is also in the neighborhood of L1.

3.4.2 Congested Link and Congested Neighborhood

The congested link is the link suffering congestion, i.e., link suffering a queue build-up. The congested neighborhood is the neighborhood of the congested link, i.e., if link L1 is congested, then each link L2 in the neighborhood of L1 is located in a congested neighborhood.

3.4.3 Intra-Flow Dependency

The intra-flow dependency requires a flow source to regulate its sending rate according to the most congested link (bottleneck link) along the path to the destination. Indeed, when the sending rate at the flow source is bigger than the available bandwidth at the bottleneck link,

the sender of the bottleneck link would not be able to forward the incoming data packets. Subsequently, the queue length at the bottleneck link will significantly increase, thereby dropping packets. As a result, the bandwidth resources used to transfer the dropped packets, from the source node to the dropping point, are practically wasted.

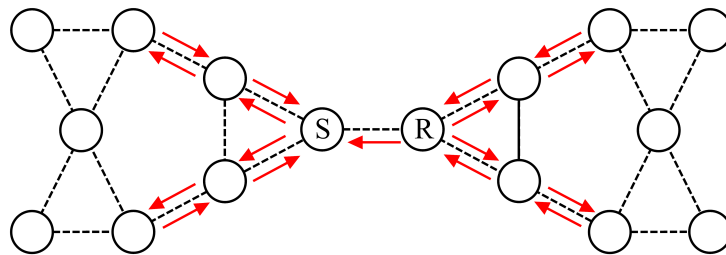

Figure 3.5: Links in the neighborhood of L_{S-R}

3.5 NICC Design

In this section, we define new IEEE 802.11 frames, to be used by NICC; these frames will help implicitly transport congestion information without modifying the structure of the IEEE 802.11 standard frames. We also define three congestion tables that will be maintained by every node in the network. In the next section, we will show how NICC uses these tables to provide fair and efficient bandwidth utilization in WMNs.

3.5.1 NICC Frames

The IEEE 802.11 frame header includes a 2 bytes field called *packet control* (Figure 3.6). This field contains 2 bits to identify the frame type and 4 bits to identify the frame subtype. In the type field, only three bits-combinations are used: 00 for management frames, 01 for control frames, and 10 for data frames. The last bits-combination (11) is not used. Thus, if we make use of the last bits-combination (11) of the *type* field and the 4 bits of the *subtype* field (16 bits-combinations), we would be able to obtain up to 16 new IEEE 802.11 frames. In addition, if we use the bits-combination (11) for data frames, we will be able to obtain up to 16 new data frames with the same size of the standard frames. In the case of control frames (i.e., field *type* is set to 01), only 8 bits-combinations of the subtype field are currently used/defined; thus, we can define 8 new control frames.

In summary, by using the unused bits-combinations in the *type* and the *subtype* fields of IEEE 802.11 frames, we can define up to 8 new control frames and up to 16 new data frames, without modifying the standard IEEE 802.11 structure. Using these new frames, NICC defines three novel IEEE 802.11 frame types: (1) The Congestion-Notification Acknowledge-

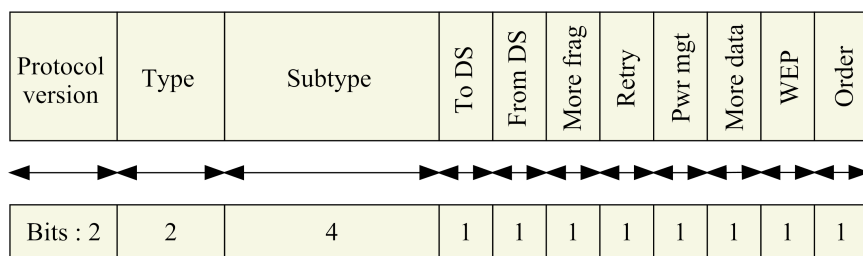

Figure 3.6: The packet control field

ment (CN_ACK) type: It includes the new control frames; (2) the Congested-Link Data (CL_DATA) type: It includes half of the new data frames; and (3) the Congestion-Signaling Data (CS_DATA) type: It includes the other half of the new data frames.

3.5.1.1 Acknowledgement Frames

Further link-layer acknowledgement, CN_ACK frames (Figure 3.7) are used to notify the upstream node that the corresponding flow is traversing a congested neighborhood (at least one congested neighborhood along the flow path). If the flow is not traversing any congested neighborhood, a standard ACK frame is used for link-layer acknowledgement.

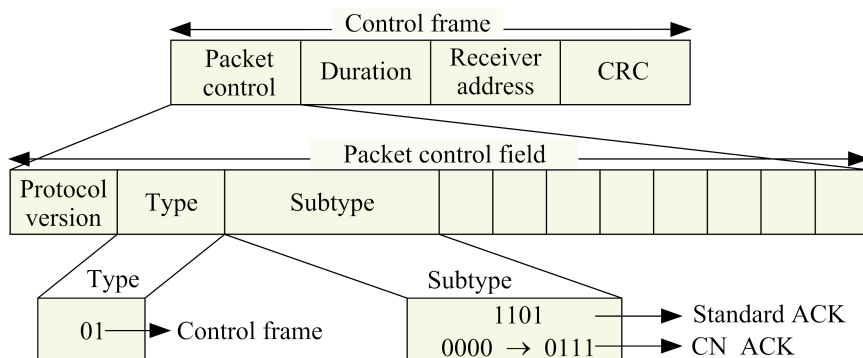

Figure 3.7: Acknowledgement frames

Each of the 8 new control frames (i.e., CN_ACK frames) represents a specific congestion level (e.g., degree); a CN_ACK frame includes the degree of the most congested neighborhood traversed by the flow from the source to the destination. Details of neighborhood congestion level computation can be found in Section 3.5.

3.5.1.2 Data Frames

To transmit data, node S uses standard DATA, CL_DATA, or CS_DATA frames; CL_DATA and CS_DATA frames (Figure 3.8) are also used to signal congestion within a congested neighborhood. More specifically, if S has no incoming/outgoing congested link, it generates a

standard DATA frame; otherwise, if S is to use a congested link to send the data, it generates a CL_DATA frame to notify nodes (in its transmission range) that it is using a congested link to transmit data. Finally, if S is to use a non-congested link to send data, it generates a CS_DATA frame to notify nodes (in its transmission range) that one or more of its links are congested.

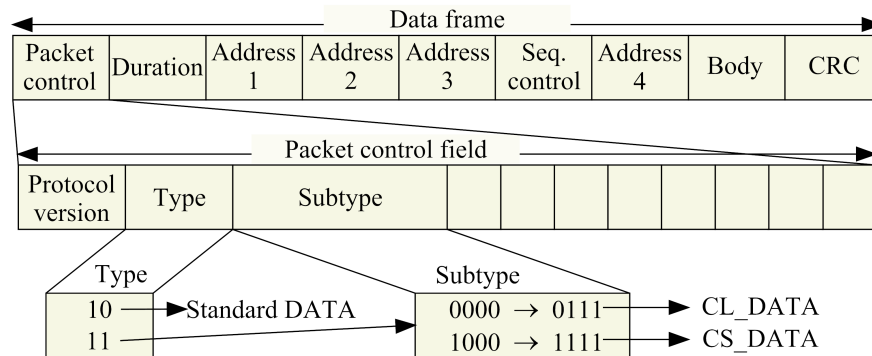

Figure 3.8: Data frames

There are 8 different CL_DATA and CS_DATA frames. A CL_DATA frame reports the congestion level of the outgoing congested link used to transmit data, while a CS_DATA frame reports the highest congestion level of the congested (incoming/outgoing) links.

We conclude that NICC provides fine-grained information about congestion (e.g., in opposition to the single-bit feedback of existing approaches) enabling source nodes to perform better/efficient rate regulations leading to better network performance.

3.5.2 NICC Tables

NICC requires each node to maintain three congestion tables: The *Links Table*, the *Nodes Table*, and the *Flows Table*. Each table is composed of two columns. The first column specifies the ID of the corresponding element (link, node, or flow), while the second column determines the congestion level (CongLevel) of this element. A Congestion Detection Mechanism (CDM) is used to compute the CongLevel (see Section 3.6.1 for more details).

3.5.2.1 Links Table

This table is used to maintain the list of congested incoming/outgoing links of node N ; if no congested link exists, the table is empty.

An outgoing link OL will be listed in *Links Table* if N detects, using CDM, congestion at this link. OL is removed, from the table, when it is no longer congested. An incoming link IL will be listed in *Links Table* if N receives a CL_DATA frame through IL ; the

corresponding CongLevel is included in the incoming CL_DATA frame. IL is removed, from the table, when N receives a standard DATA frame (either destined to N or not) or a CS_DATA frame (destined to N) from the *IL*'s sender.

3.5.2.2 Nodes Table

This table is used to maintain the list of neighboring nodes of node N. If a neighboring node has one or more congested incoming/outgoing links (excluding links to/from N), it will be listed in the table.

More specifically, a neighbor X of N is listed in *Nodes Table* if N receives a CS_DATA frame (or a CL_DATA frame not destined to N) from X; CongLevel is included in the CS_DATA/CL_DATA data frame received by N. When N receives a standard DATA frame (either destined to N or not) from X, it removes X from the table. It is worth noting that if *Nodes Table* is not empty, then all the incoming/outgoing links of N are located in a congested neighborhood.

3.5.2.3 Flows Table

This table is used to maintain the list of flows traversing node N. If flow F is traversing at least one congested neighborhood from the source to the destination, then, it will be listed in *Flows Table*; CongLevel of F corresponds to the congestion level of the most congested neighborhood traversed by F.

More specifically, F is listed in *Flows Table* when a DATA frame of F is acknowledged using a CN_ACK frame; the corresponding CongLevel is included in the CN_ACK frame. F is removed, from the table, when a data frame of F is acknowledged using a standard ACK frame.

It is worth noting that if node N has a non-empty *Links* or *Nodes Table*, then all flows passing by N are traversing a congested neighborhood. However, in NICC, *Flows Table* is updated using acknowledgement frames exclusively.

3.6 NICC Process

The congestion control process consists of four phases (1) Congestion detection phase: A node detects that one of its outgoing links is congested; (2) Congestion signaling phase: The congestion is signaled to each link in the neighborhood of the congested link, i.e., either the sender or the receiver of each neighboring link is informed about the congestion; (3)

Congestion notification phase: The sources of the flows traversing congested neighborhood(s) are notified about the congestion; and (4) Rate control phase: The sources adjust the sending rates of their flows according to the reported congestion levels.

3.6.1 Congestion Detection

The NICC focus is to handle congestion upon being detected, without considering the congestion detection itself. This allows NICC to be used with a variety of congestion detection mechanisms. Nevertheless, we believe that an adequate congestion detection mechanism can make NICC more effective. Therefore, in this thesis, we propose FCD, a Fuzzy-based Congestion Detection mechanism that we judge more adequate for the NICC needs and the WMN environment. For simplicity, we present the FCD mechanism in the next chapter (Chapter 4). Briefly, the basic idea of FCD is to predict the future queue length by analyzing its evolution during the previous control intervals using a fuzzy-based controller. Indeed, the queue length at intermediate nodes has a major impact on the packets' end-to-end delay. More specifically, a packet joining an empty queue will be immediately relayed to the next-hop in the flow path; however, before being relayed, a packet joining a heavy loaded queue should wait for all the queued packets to be served. FCD assumes that maintaining lightly loaded queues is appropriate for WMNs. Indeed, while a heavy loaded queue means that a link is not able to relay the incoming packets, a single-packet queue (i.e., queue size limited to one packet) usually causes unnecessary queuing delays as it cannot support packets burst, which frequently occurs in IEEE 802.11-based WMNs. In addition, maintaining lightly loaded queues can avoid buffer overflows, and thus improve the packet delivery ratio. Another feature of FCD is its ability to compute different congestion levels (based on the evolution of queue length); this is necessary to exploit the ability of the newly formatted IEEE 802.11 frames to report different congestion levels.

3.6.2 Congestion Signaling

NICC performs congestion signaling implicitly using standard DATA, CL_DATA and CS_DATA frames. When node S detects congestion at outgoing link L_{S-R} , it notifies its neighbors (i.e., nodes in its transmission range) including node R (i.e., the receiver of the congested link). Thereafter, node R notifies its neighbors about the congestion. S and R use CL_DATA and CS_DATA frames exclusively to keep neighbors aware of the congestion; neighbors of S and R (that are not transmitting-ends of one or more congested links), use standard DATA frames. Once congestion is removed, S and R start using standard DATA frames implicitly informing their neighbors of the congestion clearance.

The algorithm `SendData`, shown in Figure 3.9, presents the details of the use of the different DATA frame types to signal congestion (or the congestion clearance) in a congested neighborhood. The algorithm `ReceivingStandardDATA` (resp. `ReceivingCL_DATA` and `ReceivingCS_DATA`) shown in Figure 3.10 (resp. Figures 3.11 and 3.12) presents the details of update process of *Links* and *Nodes Tables* upon receipt of Standard DATA frame (resp. CL_DATA frame and CS_DATA frame).

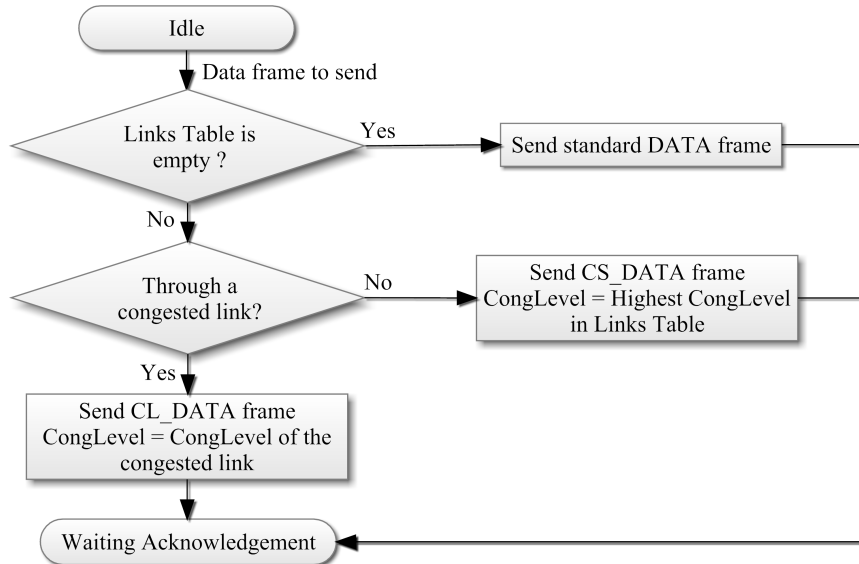

Figure 3.9: *SendData* algorithm

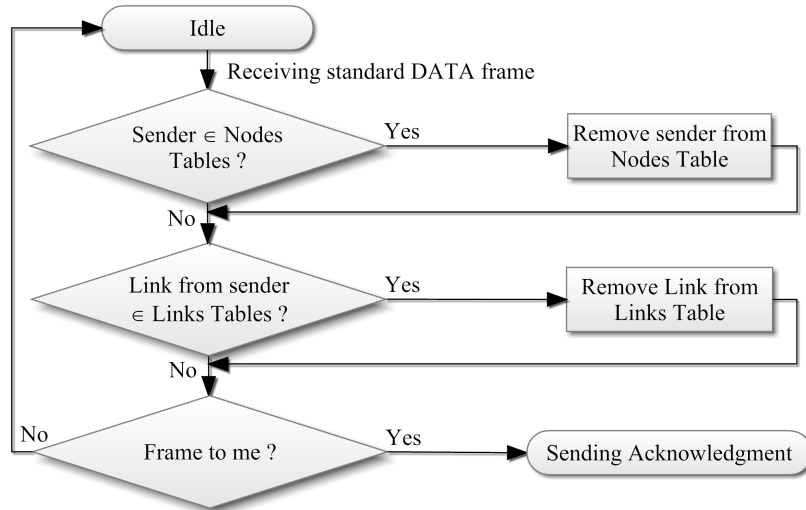

Figure 3.10: *ReceivingStandardDATA* algorithm

3.6.3 Congestion Notification

NICC performs congestion notification implicitly using the standard ACK and the new CN_ACK frames. When *Links* and *Nodes Tables* are empty, a node uses standard ACK

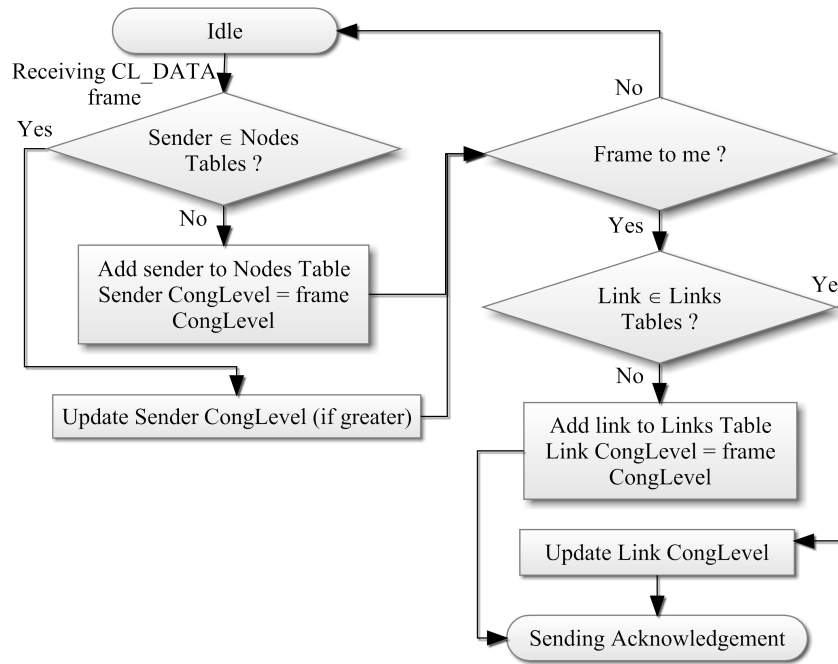

Figure 3.11: ReceivingCL_Data algorithm

frames for link-layer acknowledgements; otherwise, it uses the new CN_ACK frames to report congestion. Upon receipt of a CN_ACK frame, a source node regulates/adjusts the sending rate of the corresponding flow. Indeed, a CN_ACK frame, further the acknowledgement functionality, notifies the upstream node that the flow is traversing a congested neighborhood. A node that receives a CN_ACK frame, it uses this type of frame to acknowledge and notify its upstream node about the congestion; this process is repeated until the flow source receives a CN_ACK frame. Note that even when both *Links* and *Nodes Tables* are empty, if the flow is listed in the *Flows Tables*, the node should use a CN_ACK frame for the acknowledgement.

The algorithm SendAcknowledgment, shown in Figure 3.13, presents the details of the operation of a node when it receives a DATA frame, while the algorithm ReceivingAcknowledgement, shown in Figure 3.14, presents the details of the operation of a node when it receives a link-layer acknowledgment (i.e., standard ACK or CN_ACK frame).

3.6.4 Rate Control

In NICC, the rate control is performed at source nodes using an enhanced AIMD algorithm (Additive-Increase Multiplicative-Decrease). Two innovations differentiate our rate control algorithm from the basic AIMD. First, in the case of congestion, the sending rate is not always reduced by half; the degree of rate reduction is proportional to the CongLevel reported by the congestion notification (i.e., CN_ACK frame) received at the flow source. The higher

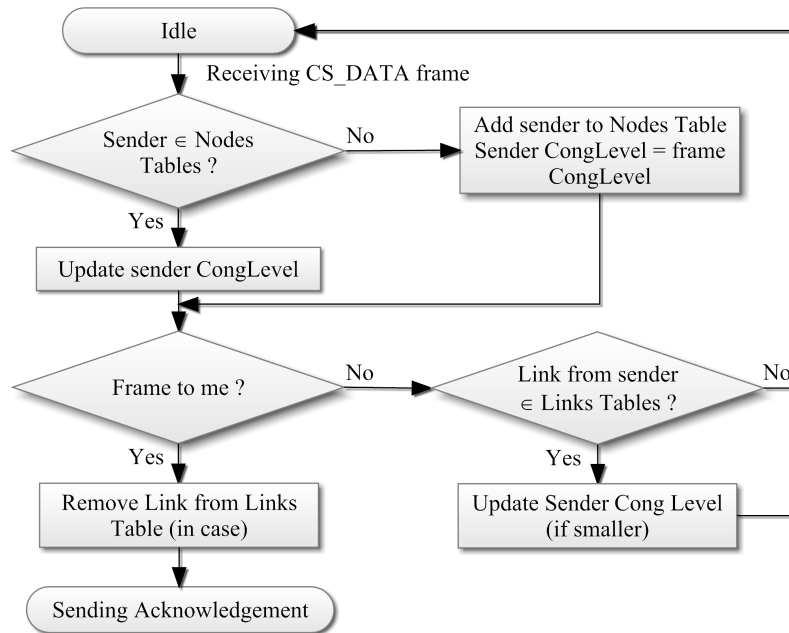

Figure 3.12: ReceivingCS_DATA algorithm

is the CongLevel, the larger is the rate reduction. Second, the sending rate is not reduced every time the flow source receives a congestion notification; the rate control operations are constrained by a newly proposed time period (t_{NICC}) that aims at avoiding unnecessary regulations of flows traversing multiple congested neighborhoods.

Rate increase

Upon each control interval (t_c), if no data frame, transmitted by the flow source, is acknowledged using a CN_ACK frame, then the sending rate will be linearly increased as follows:

$$sr_F = sr_F + \alpha \quad (3.1)$$

where sr_F is the sending rate of flow F and α is the increase degree (α is a constant value shared among all the source nodes).

The main advantage of using the control interval t_c is to provide synchronized rate control; this synchronization is indispensable to achieve fairness. Indeed, when the Round Trip Time (RTT) is used instead of t_c , flows with lower RTTs increase their sending rates much faster than flows with higher RTTs [109]; thus, even if a neighborhood-based congestion control is employed, fairness will not be achieved. For instance, in Figure 3.1, the average RTT of flow F1 is longer than that of flows F2 and F3 because of higher interferences at link L_{S1-R1} ; thus, the sending rate of F1 will be increased much slower than that of F2 and F3. It is worth noting that synchronized rate control is performed by most of fairness-aware

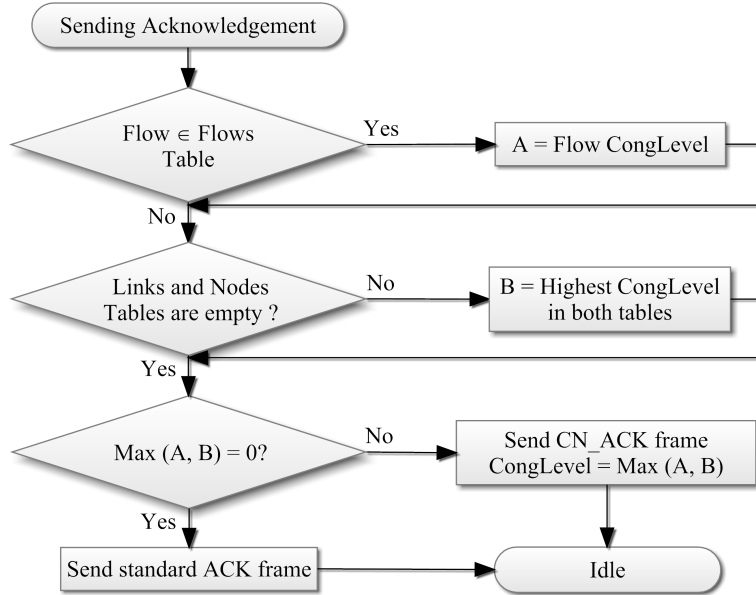

Figure 3.13: *SendAcknowledgement algorithm*

congestion control schemes [109][111][125].

Rate decrease

When a data frame, transmitted by the flow source, is acknowledged using a CN_ACK frame, then the sending rate will be multiplicatively decreased as follows:

$$sr_F = \frac{sr_F}{\beta_k} \quad (3.2)$$

where β_k is the decrease coefficient associated to the CongLevel k reported by the CN_ACK frame. As aforementioned, a CN_ACK frame is able to report up to 8 different congestion levels; thus, k could take one of the following values $\{1, 2, 3, 4, 5, 6, 7, 8\}$ and a decrease coefficient (β_k) is associated for each of these values. The β_k is proportional to the CongLevel; the higher is the CongLevel (more intense congestion), the higher is the β_k (larger reduction of the sending rate). It is worth noting that the CongLevel is proportional to the flows/nodes density in the congested neighborhood; the higher is the number of flows/nodes passing/located through/in the neighborhood, the higher is the CongLevel.

During the interval $[t_l, t_l + t_d]$ (t_l is the time of the rate decrease), if a data frame, transmitted by the flow source, is acknowledged using a CN_ACK frame, then the sending rate will not be regulated (i.e., the flow source will not react to CN_ACK). This aims at (1) verifying the impact of the last regulation before proceeding with a new one; indeed, the results of a decision should be observed before making another one, and (2) avoiding multiple regulations because of a single congestion; indeed, the data frames are acknowledged with

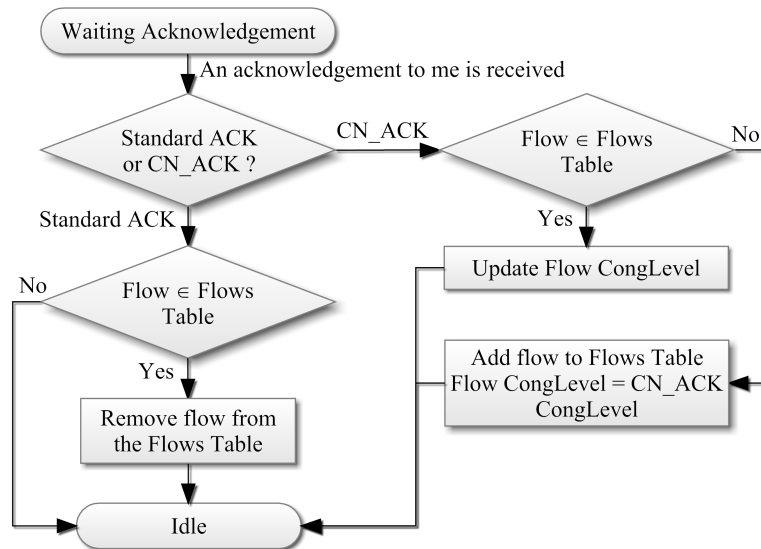

Figure 3.14: Receiving Acknowledgement algorithm

CN_ACK frames as long as the congestion is not resolved, and thus a flow source is likely to receive multiple notifications originating from the same congested neighborhood.

The time period t_{NICC}

Without using the time period t_{NICC} , the proposed AIMD-based rate control cannot achieve fair bandwidth utilization, even in the presence of a neighborhood-based congestion management; indeed, flows traversing multiple congested neighborhoods usually suffer from unnecessary rate reductions. For clarity, let us consider the example in Figure 3.15c, while flow F_{1-5} is traversing two congested neighborhoods, each other flow is traversing only one (see Section 3.2.1). Initially, F_{1-5} suffers congestion at link L_{1-2} ; thus, the sending rate of flows F_{1-5} , F_{6-7} , and F_{10-12} will be reduced to handle the congestion at L_{1-2} . Thereafter, F_{1-5} will suffer congestion at link L_{3-4} ; indeed, the sending rates of flows F_{8-9} and F_{12-13} are not regulated during the previous congestion (i.e., at L_{1-2}), hence, link L_{3-4} is still suffering higher interferences, which result in congestion. Thus, the sending rates of flows F_{1-5} , F_{8-9} and F_{12-13} will be reduced to handle the congestion at L_{3-4} . As a result, flow F_{1-5} is regulated twice as much as each other flow, thereby breaking fairness. Indeed, despite F_{1-5} is traversing two congested neighborhoods, only one regulation is needed; according to the intra-flow dependency (see Section 3.4.3), the flow sending rate should be regulated based on the most congested neighborhood traversed by the flow (i.e., congested neighborhood with highest CongLevel). In Figure 3.15c, both congested neighborhoods are suffering the same CongLevel; thus, only one regulation of F_{1-5} is sufficient for both of them. However, without using t_{NICC} , F_{1-5} is regulated twice; this means that the sending rate is inversely proportional to the number of congested neighborhoods traversed by the flow.

NICC proposes a new time period, called t_{NICC} ($t_{NICC} \geq t_c$), that aims at avoiding unnecessary regulations of flows traversing multiple congested neighborhoods. During the interval $[t_l + t_c, t_l + t_{NICC}]$, if a data frame, transmitted by the flow source, is acknowledged using a CN_ACK frame, then the sending rate will be regulated only if the CongLevel reported by CN_ACK is greater than that of the regulation performed at t_l . t_{NICC} should be long enough so that the flow source receives a congestion notification from each congested neighborhood traversed by the flow. Using t_{NICC} , the flow rate will be regulated according to the most congested neighborhood traversed by the flow, independently of the number of traversed congested neighborhoods. For instance, in Figure 3.15c, the source of F_{1-5} receives twice the congestion notifications received by each other source; however, using t_{NICC} , it reacts to only half of these notifications, and then, F_{1-5} will get roughly the same throughput achieved by each other flow. Algorithm 1 presents the reaction of a flow source upon being acknowledged using a CN_ACK frame.

Algorithm 1 The source reaction upon receiving a CN_ACK frame

```

1:  $t_r =$  The time of the CN_ACK reception
2:  $t_l =$  The time of the last regulation
3:  $k_r =$  The CongLevel reported by CN_ACK
4:  $k_l =$  The CongLevel of the last regulation (at  $t_l$ )
5: if  $t_r - t_l \leq t_c$  then
6:   return /*Nothing to do*/
7: else
8:   if  $t_r - t_l \leq t_{NICC}$  then
9:     if  $k_r \leq k_l$  then
10:    return /*Nothing to do*/
11:   end if
12: end if
13:  $sr_F \leftarrow sr_F / \beta_{k_r}$  /*Regulate the flow sending rate*/
14:  $t_l \leftarrow t_r$  /*Update the value of  $t_l$ */
15:  $k_l \leftarrow k_r$  /*Update the value of  $k_l$ */
16: end if

```

3.7 NICC Evaluation

In this Section, we evaluate, via simulations, the performance of NICC and compare it to the performance of WCP [110], APCC [96], and WiRS [51]. APCC and WiRS do not

explicitly recognize congestion as a neighborhood phenomenon; thus, competing flows are regulated independently. In contrast, in WCP, neighboring nodes mutually cooperate to handle congestion in a clearly defined wireless neighborhood. We used GloMoSim [126] to perform the simulations; Table 5.1 shows the simulation parameters.

Table 3.1: Simulation parameters

Parameter	Value
Channel rate	11 Mbps
Packet size	1500 bytes
Simulation length	150 s
CW_{min}	16
CW_{max}	128
Node transmission range	250 m
RTS/CTS handshaking	enabled

To show the effectiveness of NICC, we run simulations using small-size specific topologies that enable basic starvation scenarios. To study the scalability of NICC, we run simulations using large-size WMNs with large number of flows. The focus of the simulations is to evaluate the capacity of NICC in providing fairness among competing flows and achieving efficient bandwidth utilization. Note that some simulation parameters and scenarios are inspired from [109][111].

3.7.1 Specific Topologies

We run simulations using topologies shown in Figure 3.15. We did consider 2 performance parameters: (1) per flow end-to-end throughput to evaluate fairness and (2) channel utilization to evaluate bandwidth utilization efficiency. We define channel utilization as follows:

$$CU = \sum_{i=1}^n T_i * H_i \quad (3.3)$$

where T_i is the end-to-end throughput achieved by flow i , H_i is the number of hops traversed by flow i , and n is the number of flows in a neighborhood. Equation (3.3) shows that a flow that traverses m hops consumes m times the amount of resources consumed by a single-hop flow.

3.7.1.1 Basic starvation scenarios

Fisrt scenario

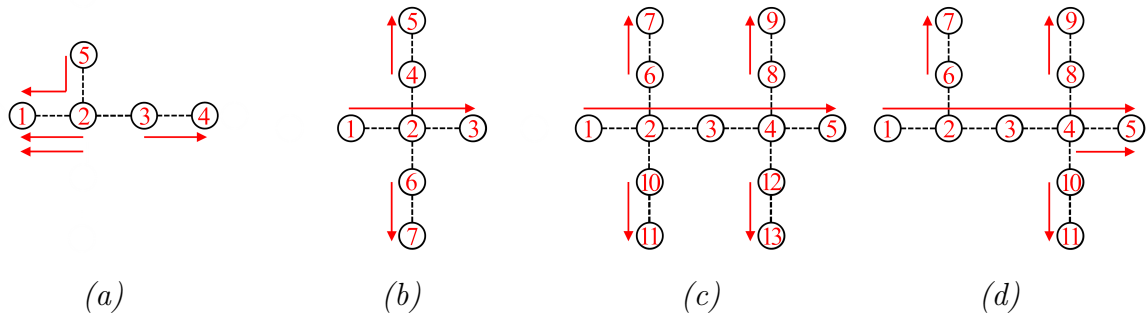

Figure 3.15: Specific topologies

This scenario (Figure 3.15a) covers (1) the second starvation category (Section 3.2.1): F_{5-1} is a multi-hop flow competing with two single-hop flows, F_{2-1}^1 and F_{2-1}^2 ; and (2) the third starvation category (Section 3.2.1): L_{2-1} and L_{3-4} are two neighboring links traversed by different numbers of flows. Figure 3.16 shows the per-flow throughput achieved by NICC, WiRS, WCP, and APCC.

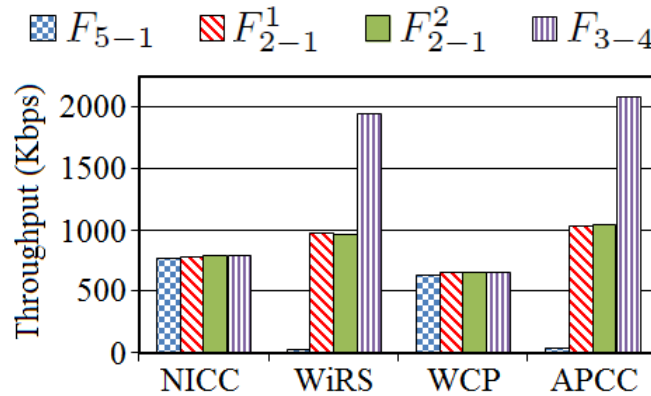

Figure 3.16: Scenario of Figure 3.15a: Per-flow throughput

In the case of APCC and WiRS, we observe that (1) F_{3-4} achieves a throughput roughly equal to the sum of the throughputs achieved by flows F_{2-1}^1 , F_{2-1}^2 , and F_{5-1} ; (2) F_{2-1}^1 and F_{2-1}^2 are relatively starved; indeed, each of them achieves a throughput which is half of the throughput achieved by F_{3-4} ; and (3) F_{5-1} is fully starved; indeed, its throughput is almost zero. These results are expected since, when using APCC and WiRS, there is no cooperation among neighboring nodes; indeed, F_{3-4} uses the whole bandwidth share of link L_{3-4} , while F_{2-1}^1 and F_{2-1}^2 use the bandwidth share of L_{2-1} regardless the state of F_{5-1} , and thus the rate of F_{5-1} is reduced to almost zero due to the queue build-up at L_{5-2} .

With respect to NICC and WCP, we observe the followings: (1) the four flows achieve almost the same throughput; this is due to the cooperation among neighboring nodes; (2) the overall throughput of NICC and WCP is smaller compared to the throughput achieved by APCC and WiRS. Indeed, F_{5-1} (2-hop flow) requires twice the resources required by F_{2-1}^1 or F_{2-1}^2 (1-hop flows); thus, to achieve similar throughput, NICC and WCP requires more

resources than APCC and WiRS; (3) NICC outperforms WCP. This can be explained by the fact that NICC (a) provides fine-grained congestion information to sources (NICC uses multi-bit feedbacks while WCP uses single-bit feedbacks) for more efficient rate regulations, and (b) is overhead free (NICC uses underexploited fields in IEEE 802.11 frames while WCP requires new headers to be piggybacked in data frames).

Figure 3.17 shows that all schemes achieve comparable channel utilization; this confirms that NICC makes efficient use of resources. Indeed, its slight underperformance in terms of throughput, compared to APCC and WiRS, is due to the fact that it needs more resources to support flows that are starved by APCC and WiRS (and not because of non-efficient channel utilization); starved flows allow a reduction of contention density at the MAC layer enabling high throughput. We observe also that NICC provides better channel utilization than WCP; this is expected due the overhead-free multi-bit feedbacks used by NICC.

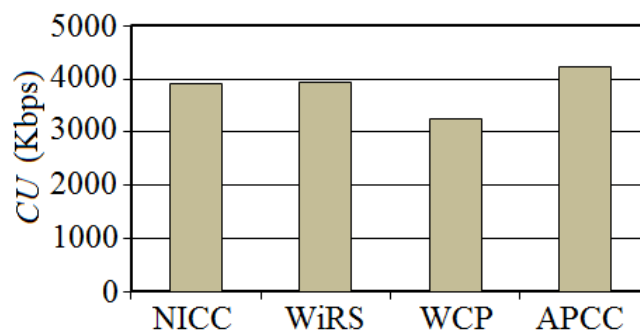

Figure 3.17: Scenario of Figure 3.15a: Channel utilization

Second scenario

The first starvation category is presented in Figure 3.15b. F_{1-3} is a middle multi-hop flow competing with two outer single-hop flows (F_{4-5} and F_{6-7}). There is one congested link L_{1-2} (See section 3.2.1). The per-flow end-to-end throughput is presented in Figure 3.18. As we could observe, in APCC and WiRS, the middle flow is extremely starved. Actually, without cooperation among neighboring nodes, the congested link L_{1-2} is hidden to F_{4-5} and F_{6-7} . Hence, their sending rates are increased as much as possible regardless the congestion at L_{1-2} . On the other hand, NICC and WCP provide a fair bandwidth allocation among the three flows. Indeed, in NICC and WCP, due to neighborhood cooperation, when L_{1-2} is congested: In addition to F_{1-3} , both F_{4-5} and F_{6-7} are regulated.

The CU results are presented in Figure 3.19. Only flows F_{1-3} and F_{4-5} are considered. Indeed, each of links L_{4-5} and L_{6-7} is not in the neighborhood of the other; thus, F_{4-5} and F_{6-7} do not compete. The CU results are too similar to the previous scenario.

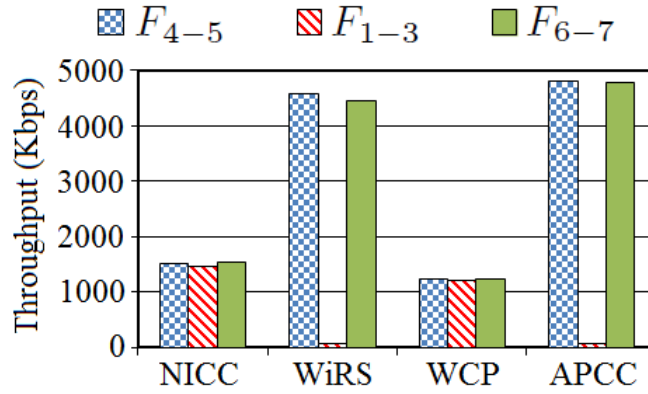

Figure 3.18: Scenario of Figure 3.15b: Per-flow throughput

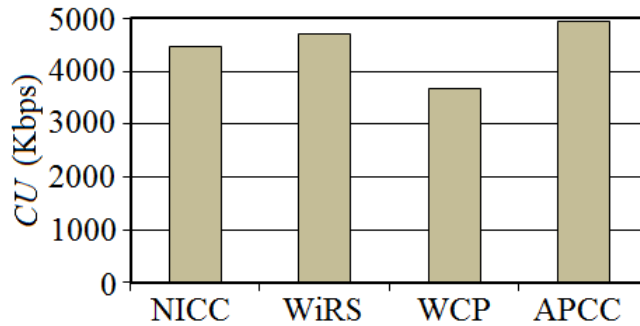

Figure 3.19: Scenario of Figure 3.15b: Channel utilization

3.7.1.2 More complex situations

First scenario

This scenario (Figure 3.15c) is composed of one middle multi-hop flow (F_{1-5}), and four outer single-hop flows (F_{6-7} , F_{8-9} , F_{10-11} , and F_{12-13}). There are two congested links (L_{1-2} and L_{3-4}) creating two congested neighborhoods suffering the same congestion level. Each outer flow is traversing only one congested neighborhood, while the middle flow is traversing both of them. Since the middle flow is extremely starved in APCC and WiRS, we only present the per-flow throughput in NICC and WCP (Figure 3.20).

Figure 3.20 shows that F_{1-5} is relatively starved in WCP. It gets nearly half the throughput of each outer flow. Indeed, since F_{1-5} is traversing two congested neighborhoods, it receives twice the notifications received by an outer flow (flow traversing only one congested neighborhood); thus, it gets half the throughput achieved by an outer flow. As a result, in WCP, the throughput of a flow is inversely proportional to the number of the congested neighborhoods traversed by the flow (on contrary to the intra-flow dependency). This

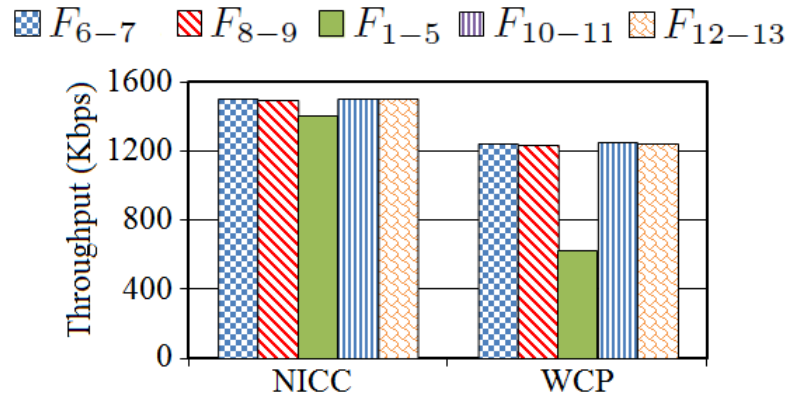

Figure 3.20: Scenario of Figure 3.15c: Per-flow throughput

problem does not exist in NICC. As shown in Figure 3.20, NICC maintains a near-optimal bandwidth allocation among all the flows. This is due to the use of the proposed time period t_{NICC} . Using t_{NICC} , flow F_{1-5} reacts to roughly the half of its congestion notifications; thus, it avoids unnecessary rate reductions and gets a throughput comparable to that of an outer flow.

Second scenario

This scenario (3.15d) is composed of a middle single-hop flow (F_{4-5}), a middle multi-hop flow (F_{1-5}), and three outer single-hop flows (F_{6-7} , F_{8-9} , and F_{10-11}). There are two congested neighborhoods: The first is traversed by flows F_{1-5} and F_{6-7} , while the second one is traversed by flows F_{1-5} , F_{4-5} , F_{8-9} , and F_{10-11} . The second congested neighborhood is more congested (higher congestion level) than the first one. In order to highlight a specific feature, we only present the simulation results of NICC (Figure 3.21).

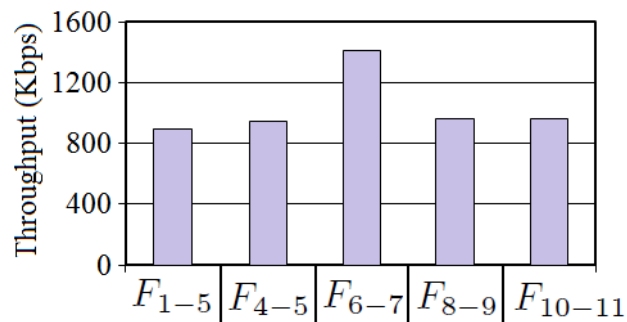

Figure 3.21: Scenario of Figure 3.15d: Per-flow throughput

A near-optimal bandwidth allocation is maintained among all the flows excluding F_{6-7} , which achieves more throughput than the others. The performance of NICC in terms of fairness and efficiency is proved again; flow (F_{6-7}) traversing the less congested neighborhood is regulated less aggressively than flows (F_{4-5} , F_{8-9} , and F_{10-11}) traversing the most congested one. Furthermore, flow (F_{1-5}) traversing both of the congested neighborhoods is regulated

according to the most congested one (second one). These results reflect the impact of the congestion tables proposed by NICC. These tables correctly separate between the congestion signaling that takes place within a local congested neighborhood (*Links* and *Nodes Tables*), and the congestion notification that takes place between the congested neighborhood and the source nodes (*Flows Table*). This separation guarantees that a flow is regulated according to the most congested neighborhood along its own path, even if it competes with other flows traversing other congested neighborhoods.

3.7.2 Large Scale Topologies

To investigate the fairness ability in large topologies, we choose the commonly used Jain's Fairness index [66] defined as follows:

$$FI = \frac{(\sum_{i=1}^n T_i)^2}{n * \sum_{i=1}^n T_i^2} \quad (3.4)$$

where FI is the fairness index, T_i is the end-to-end throughput achieved by a flow i , and n is the number of flows in the network. The fairness index could vary between 0 and 1; the closer the fairness index to 1, the fairer the bandwidth allocation. In addition to the Jain's index, we plot the average and the minimum end-to-end throughput. The efficiency of bandwidth utilization is evaluated by observing the ability to achieve a higher average throughput with a relatively high value of achieved minimum throughput.

We used a WMN configuration that consists of 70 randomly distributed nodes and 21 randomly generated flows. Figure 3.22a shows that NICC and WCP achieve near perfect fairness (Jain's index approaches 1). This is expected since NICC and WCP, in opposition to APCC and WiRS, control congestion as a neighborhood phenomenon, and thus perform cooperation among neighboring nodes.

Figures 3.22b and 3.22c show that the difference between average throughput and minimum throughput, achieved by APCC and WiRS, is significant; this means that a subset of flows were starved. This is in opposition to the case of NICC and WCP where the difference is relatively small. We also observe that NICC outperforms WCP in terms of average throughput and minimum throughput; this can be explained by the fact that NICC uses (1) overhead-free fine-grained (i.e., multi-bit) congestion feedbacks (in opposition to single-bit feedbacks with extra overhead); and (2) the proposed period t_{NICC} , which avoids unnecessary rate reductions in situations where a flow (or more) are traversing two or more congested neighborhoods.

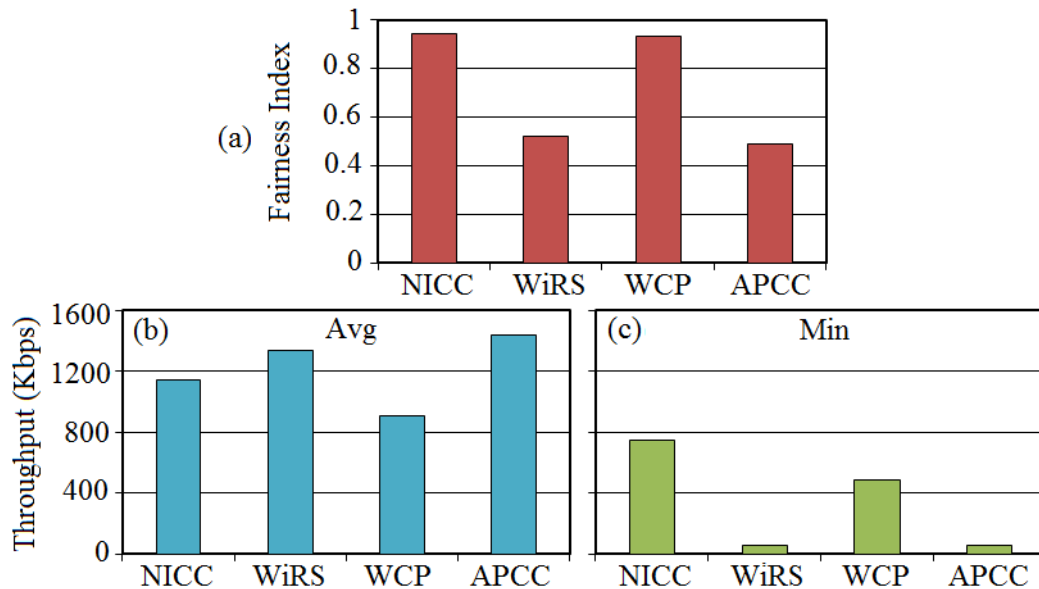

Figure 3.22: First scenario: Fairness index and throughput

Figure 3.22b shows that APCC and WiRS outperform NICC (and WCP) in terms of average and thus overall throughput. This can be explained by the fact that a number of flows facing starvation uses multi-hop paths and thus consumes more resources. When these flows starve, in the case of APCC and WiRS, more resources are available (starved flows use no or a small amount of resources), and thus a better throughput is achieved. Figure 3.23 shows that when using APCC and WiRS, non-starved flows achieve far bigger throughput since more resources are free because of the starved flows. In contrast, when using NICC (and WCP) each flow achieves a smaller throughput; it is a small price to pay for not starving a subset of flows, and thus achieving a certain degree of fairness.

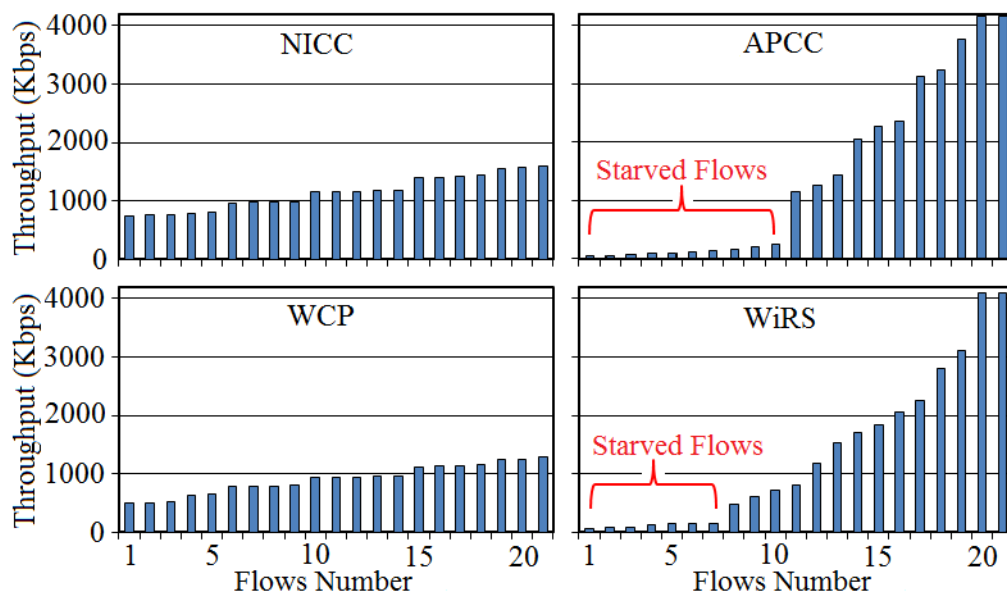

Figure 3.23: First scenario: Throughput per flow

To confirm our findings we run simulations using a WMN configuration that consists of 70 randomly distributed nodes, 4 gateways and 31 flows each destined to the closest gateway. Figure 3.24 shows again that NICC and WCP outperforms handily APCC and WiRS in terms of fairness (no fairness is supported by APCC and WiRS) and slightly underperforms them in terms of overall throughput; it also shows that NICC outperforms WCP in terms of fairness and throughput (NICC provides higher throughput than WCP).

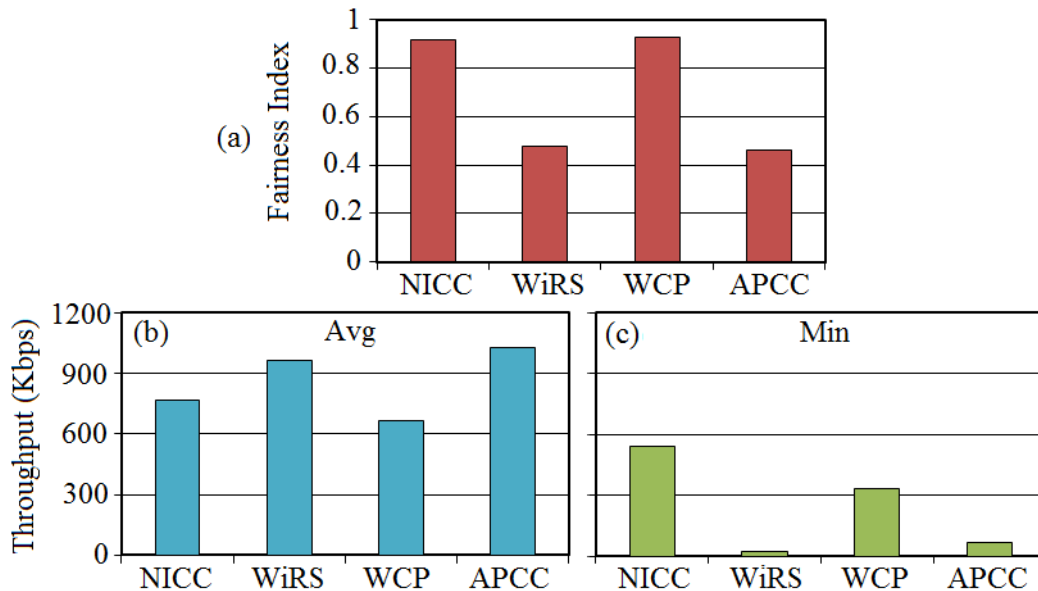

Figure 3.24: Second scenario: Fairness index and throughput

3.8 Conclusion

In this chapter, we proposed a fairness-aware and overhead-free congestion control scheme, called NICC. To realize fairness, and thus avoid starvation of flows, NICC controls congestion via mutual cooperations among nodes located in a congested neighborhood. NICC makes use of underexploited fields in the IEEE 802.11 frames for congestion signaling and notifications; thus, it does not introduce any overhead in controlling congestion. More specifically, NICC signals congestion levels and notifies source nodes using newly formatted IEEE 802.11 data and control frames; the new frames have the same size of standard IEEE 802.11 frames. NICC allows source nodes to regulate flows sending rates using an enhanced AIMD-based algorithm that processes different congestion levels. Furthermore, the rate regulations are constrained by a newly proposed time period (t_{NICC}) that aims at avoiding unnecessary rate reductions of flows traversing several congested neighborhoods. The simulation results show that NICC outperforms existing schemes (APCC, WiRS, and WCP) in terms of fairness; it also outperforms schemes that provide fairness (WCP) in terms of overall throughput.

Chapter 4

FCD: A Fuzzy-based Congestion Detection Mechanism for IEEE 802.11-based WMNs

Contents

4.1	Introduction	77
4.2	FCD Model	80
4.2.1	Fuzzification	80
4.2.2	Rules Evaluation	82
4.2.3	Defuzzification	84
4.3	Performance Evaluation	85
4.3.1	Results Analysis	86
4.4	Conclusion	89

4.1 Introduction

The NICC objective is to handle congestion upon being detected, without considering the congestion detection process. This allows NICC to be used with a variety of congestion detection mechanisms. Nevertheless, we believe that an adequate congestion detection mechanism can make NICC more effective. Therefore, the second contribution of this thesis is FCD, a Fuzzy-based Congestion Detection mechanism that we judge more adequate for achieving the NICC objectives in a WMN environment. FCD detects congestion by predicting the

evolution of queue length (i.e., buffer occupancy) at the intermediate nodes along a flow path. The evolution of the queue length is predicted by combining, using a fuzzy logic controller, the queue length with its variation rate during previous control intervals. We believe that the evolution of the queue length is one of the best congestion indicators in WMNs; it presents a clear sign of the capacity of a link to relay the incoming data packets. One of the FCD features is its ability to compute several congestion degrees; this is necessary to exploit the NICC's multi-bit congestion feedback, which intends to yield source nodes a fine-grained indication of the congestion degree, and thus helps them performing accurate rate control, making efficient use of bandwidth.

Another feature of FCD is that it allows each intermediate node along the flow path to detect if one of its outgoing links is congested. Indeed, the intermediate node, which detects that one of its outgoing links is congested, should signal the congestion within the neighborhood of the congested link, and thereafter, the source of each flow traversing this neighborhood should be notified in order to regulate its sending rate. It is worth noting that several congestion control schemes (e.g., [55][57]) rely on an end-to-end congestion feedback to make the source node aware of congestion, and thus perform sending rate regulation. Obviously, such congestion feedback employs an end-to-end congestion indicator such as the end-to-end delay, the inter-arrival time of two successive packets, out-of order packet arrivals, the packet loss ratio, and the RTT variation. The main shortcoming of such congestion feedback is that it cannot specify which link, in the flow path, is congested, and thus the congestion cannot be signaled within the neighborhood of the congested link (such congestion feedback is suitable to wired networks in which the congestion should not be handled using neighborhood-based management). Furthermore, such congestion feedback (1) generates a considerable overhead (it should traverse the whole reverse path, i.e., from the destination to the source); and (2) experiences a relatively long delay before reaching the source node, and thus the latter cannot react in time, i.e., the congestion situation may be aggravated before regulating the sending rate.

On the other hand, the queue length can be measured more accurately compared to the congestion indicators that use neighborhood monitoring (e.g., MAC layer contention density [83], interference from neighboring nodes [132], and bandwidth availability estimation [51]); indeed, accurately monitoring channel utilization is difficult to perform in practical systems. Furthermore, even though such congestion indicators aim at considering neighborhood information; however, in WMNs, neighboring nodes usually perceive different congestion degrees, resulting in unfair regulation among flows traversing the same wireless neighborhood. In contrast, by using FCD with NICC, on the one hand, the queue length (i.e., congestion indicator) can be accurately measured by each intermediate node, and on the other hand, the

neighborhood-based congestion management will be provided by the different mechanisms of NICC.

The queue length at intermediate nodes has a major impact on the packets' end-to-end delay. More specifically, a packet joining an empty queue will be immediately relayed to the next-hop in the flow path; however, before being relayed, a packet joining a heavy loaded queue should wait for all the queued packets to be served. FCD assumes that maintaining lightly loaded queues is appropriate for WMNs. Indeed, while a heavy loaded queue means that a link is not able to relay the incoming packets, a single-packet queue (i.e., queue size limited to one packet) usually causes unnecessary queuing delays as it cannot support packet burst, which frequently occurs in IEEE 802.11-based WMNs. In addition, maintaining lightly loaded queues can avoid queue overflows, and thus improve the packet delivery ratio.

In addition to the queue length itself, FCD takes into consideration its variation rate. Indeed, the queue length yields an idea of the current congestion state (congestion state at instant t); however, by monitoring the queue length evolution (i.e., by combining the queue length with its variation rate), a node will be able to predict the future congestion state (congestion state at instant $t + x$). This prediction helps making efficient rate control decisions. Indeed, by considering the queue length solely, the sending rate will be regulated whenever the queue length is greater than a certain threshold; however, by combining the queue length with its variation rate, even if the queue length is greater than the corresponding threshold, the sending rate will not be regulated if the variation rate is negative; indeed, such a variation means that the congestion is going to be removed, and thus the sending rate regulation is no longer required. Moreover, monitoring the queue length evolution can detect, and thus manage, congestion early enough before its occurrence.

FCD proposes a fuzzy logic controller that aims at computing the *congestion state*¹, which is a fuzzy output that reflects the congestion level (i.e., CongLevel) that should be reported by the congestion notifications (i.e., CN_ACK frames) of NICC. Indeed, given the dynamic and complex nature of the traffic in WMNs, we believe that using an intelligent learning tool, such as the fuzzy logic controller, is appropriate to combine the input parameters of FCD (queue length and its variation rate). The fuzzy logic controller, which consists of fuzzifier, inference engine, and defuzzifier, has shown [47][121], compared to traditional deterministic decision-maker, performing well in complex and dynamic environments such as WMNs.

¹We use the term *congestion state* to specify the CongLevel using a linguistic variable; the CongLevel is typically specified using a number.

4.2 FCD Model

The proposed FCD aims at computing the congestion state based on the queue length and its variation rate. The FCD model (Figure 4.1) is performed in three steps: fuzzification, rules evaluation and defuzzification. In the fuzzification step, real numbers representing the values of the inputs (i.e., queue length and variation rate) are converted into linguistic values, each of which is characterized by its own membership function. In the inference step (i.e., rules evaluation), a set of rules, called the rule-base, which emulates the decision-making process, is applied to the linguistic values of the inputs so as to infer the linguistic value of the output (i.e., congestion state). This output is then defuzzified to the actual congestion level that should be reported by the CN_ACK frames of NICC. To help the reader, Table 4.1 provides a list of notations used throughout the chapter.

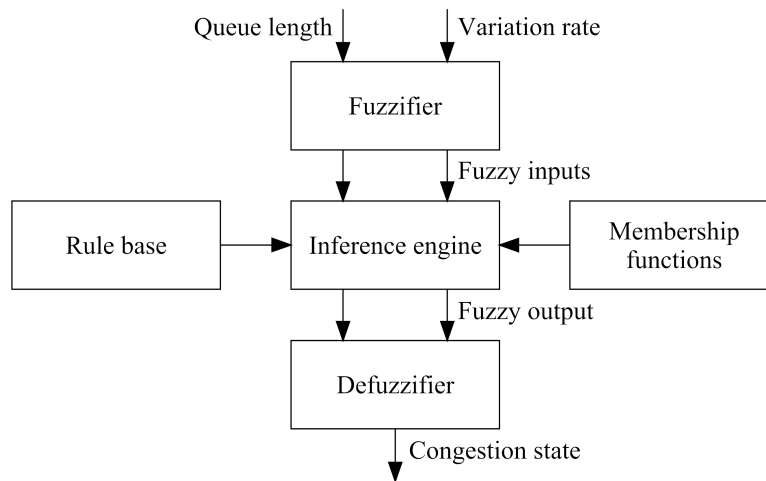

Figure 4.1: FCD Model

4.2.1 Fuzzification

The fuzzy inputs in our system are the queue length and its variation rate; the congestion state represents the fuzzy output. These parameters have to be converted into fuzzy sets; in fuzzy logic, a fuzzy set may contain elements that have different degrees of membership in a set. A variety of membership functions may be applied, such as triangular, Gaussian, and trapezoidal functions. In FCD, we have chosen triangular functions because of their computation simplicity.

Note that a fuzzy set is an extension of a classical crisp set. A fuzzy set in the universe of discourse U , $U = \{u_1, u_2, \dots, u_n\}$, can be described by a membership function μ_A , $\mu_A : U \rightarrow [0,1]$, represented by:

Table 4.1: Notation list

U	Universe of discourse which is the range of all possible values for an input or output in a fuzzy system
u_A	A Fuzzy set that allows its members to have different grades of membership in the interval $[0, 1]$
$u_A(u_i)$	indicates the grade of membership (i.e., member of the universe) in the fuzzy set A
A, B	Triangular fuzzy sets parameterized by the triplets (a_1, a_2, a_3) and (b_1, b_2, b_3) respectively
\oplus	Addition operation between two triangular fuzzy sets
\otimes	Multiplication operation between two triangular fuzzy sets
\odot	Maximum operation between two triangular fuzzy sets
ν	Provides the maximum value of two fuzzy sets
R^k	The k th fuzzy rule; each rule includes a set of conditional statements
X_1^k, \dots, X_n^k	Input linguistic variables of rule k
Y_1^k, \dots, Y_n^k	Output linguistic variables of rule k
$A_i^{(k)}, B_i^{(k)}$	Linguistic values of the variables X_i^k and Y_i^k in the universe of discourse U , respectively
QL	Queue length
VR	Variation rate
CS	Congestion state

$$u_A = u_A(u_1)/u_1 + u_A(u_2)/u_2 + \dots + u_A(u_n)/u_n \quad (4.1)$$

where $u_A(u_i)$ indicates the grade of membership of u_i in the fuzzy set A (e.g., the queue length in the sets *small*, *medium*, etc).

A triangular fuzzy set can be parameterized by a triplet (a_1, a_2, a_3) , where the membership function of the triangular fuzzy set is defined as follows:

$$u_A(u) = \begin{cases} 0 & u < a_1 \\ (u - a_1)/(a_2 - a_1), & a_1 \leq u \leq a_2 \\ (a_3 - u)/(a_3 - a_2), & a_2 \leq u \leq a_3 \\ 0 & u \geq a_3 \end{cases} \quad (4.2)$$

In what follows, some arithmetic operations between generalized triangular fuzzy sets are presented: let A and B be two triangular fuzzy sets parameterized by the triplets

(a_1, a_2, a_3) and (b_1, b_2, b_3) , respectively. The addition and multiplication operations of the triangular fuzzy sets A and B are defined, respectively, as follows:

$$\begin{aligned} A \oplus B &= (a_1, a_2, a_3) \oplus (b_1, b_2, b_3) \\ &= (a_1 + b_1, a_2 + b_2, a_3 + b_3) \end{aligned} \quad (4.3)$$

$$\begin{aligned} A \otimes B &= (a_1, a_2, a_3) \otimes (b_1, b_2, b_3) \\ &= (a_1 \times b_1, a_2 \times b_2, a_3 \times b_3) \end{aligned} \quad (4.4)$$

As we observe in the equation 4.3, both the addition and multiplication of two triangular fuzzy sets A and B are achieved by summing and multiplying respectively the values of each triplet.

The maximum operation \odot between A and B is defined as follows:

$$A \odot B = [a_1 \nu b_1, a_2 \nu b_2, a_3 \nu b_3] \quad (4.5)$$

The maximum operation is used to obtain the maximum effect of two or more outputs fuzzy sets.

The membership functions of the FCD parameters (i.e., queue length, variation rate, and congestion state) are drawn according to their influence on the congestion control process. For instance, the queue length parameter is fuzzified into *very small* set with the triplet $(0, 5, 10)$, *small* set with the triplet $(5, 10, 15)$, *medium* set with the triplet $(10, 15, 20)$, *big* set with the triplet $(15, 25, 40)$, and *very big* set with the triplet $(25, 40, 100)$. The choice of these triplets is achieved according to the FCD objective that aims at maintaining lightly loaded buffers in order to reduce the packets' end-to-end delay as well as improve the packet delivery ratio. The unit of the queue length is the degree of fullness (occupancy) of the queue (i.e., the current size of the queue). When the queue is completely full, then it is at 100% of fullness, and when the queue is empty, it is at 0%. On the other hand, the variation rate parameter is fuzzified into *negative*, *insignificant*, and *positive* sets, which are defined by the triplets $(-2, -11, -20)$, $(-2, 0, 2)$, and $(2, 11, 20)$, respectively; the rationale behind our choice is to reflect the variation of the queue length parameter among its above defined sets, and thus to predict congestion early enough before its occurrence.

4.2.2 Rules Evaluation

In this step, a set of rules, called the rule-base, is applied to the input parameters using an inference engine. The rule-base holds the knowledge, in the form of a set of rules $R^{(1)}$ to

$R^{(m)}$, of how best to control the system; it includes a set of conditional statements defined as follows:

$R^{(1)}$: If X_1^1 is $A_1^{(1)}$... X_n^1 is $A_n^{(1)}$ then Y_1 is $B^{(1)}$

.

$R^{(k)}$: If X_1^k is $A_1^{(k)}$... X_n^k is $A_n^{(k)}$ then Y_k is $B^{(k)}$

.

$R^{(m)}$: If X_1^m is $A_1^{(m)}$... X_n^m is $A_n^{(m)}$ then Y_m is $B^{(m)}$

Where, for a given rule $R^{(k)}$ ($k = 1, \dots, m$), $X_1^k, X_2^k, \dots, X_n^k$ are the input linguistic variables representing the input parameters; and Y_k is the output linguistic variable representing the output parameter. $A_1^{(k)}, \dots, A_n^{(k)}$ and $B^{(k)}$ are linguistic values of the variables X_1, \dots, X_n and Y_k in the universe of discourse U . The following rules (Table 4.3 and Figure 4.2) are used by the decision algorithm to compute the congestion state. For simplicity, Figure 4.2 shows only two rules.

The rules R_1, R_2, \dots , and R_{15} become active when they receive the input parameters; these parameters consist of QL (queue length) which can be either *very small, small, medium, big, or very big*, and VR (variation rate) which can be either *negative, insignificant, or positive*; the output parameter is CS (congestion state) which can be either *clear, acceptable, sensitive, critical, or urgent*. The parameters QL and VR are manipulated in the fuzzification process, while CS is generated by the defuzzification process.

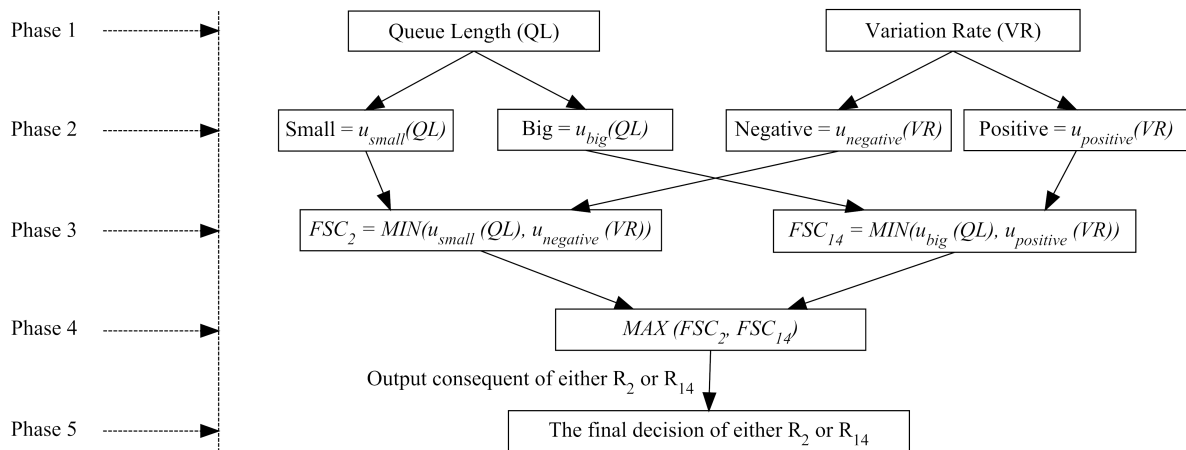

Figure 4.2: Fuzzy decision making process

4.2.3 Defuzzification

In the defuzzification step, the decision sets (i.e., *clear, acceptable, sensitive, critical, and urgent*) concerning the congestion state are converted into precise values. The defuzzification chooses a representative value for the resulting fuzzy set as the final output. There are several

Table 4.2: FCD Rules

n	IF		THEN
	Variation rate	Queue length	Congestion state
R_1	<i>Negative</i>	<i>Very small</i>	<i>Clear</i>
R_2	<i>Negative</i>	<i>Small</i>	<i>Clear</i>
R_3	<i>Negative</i>	<i>Medium</i>	<i>Acceptable</i>
R_4	<i>Negative</i>	<i>Big</i>	<i>Sensitive</i>
R_5	<i>Negative</i>	<i>Very big</i>	<i>Critical</i>
R_6	<i>Insignificant</i>	<i>Very small</i>	<i>Clear</i>
R_7	<i>Insignificant</i>	<i>Small</i>	<i>Acceptable</i>
R_8	<i>Insignificant</i>	<i>Medium</i>	<i>Sensitive</i>
R_9	<i>Insignificant</i>	<i>Big</i>	<i>Critical</i>
R_{10}	<i>Insignificant</i>	<i>Very big</i>	<i>Urgent</i>
R_{11}	<i>Positive</i>	<i>Very small</i>	<i>Acceptable</i>
R_{12}	<i>Positive</i>	<i>Small</i>	<i>Sensitive</i>
R_{13}	<i>Positive</i>	<i>Medium</i>	<i>Critical</i>
R_{14}	<i>Positive</i>	<i>Big</i>	<i>Urgent</i>
R_{15}	<i>Positive</i>	<i>Very big</i>	<i>Urgent</i>

heuristics [35][84] that allow performing defuzzification. Center of Area (CoA) [35] (referred to as the Center of Gravity) computes and returns the center of gravity of the resulting fuzzy set (the center is the centroid of the composite area representing the output fuzzy set). Center of Maximum (CoM) [84] determines the numerical value of each scaled membership function; only the peaks of the membership functions are used, which are determined by finding the place where the weights are balanced. The output value is computed as a weighted mean of the term membership maxima, weighted by the inference results. Mean of maximum (MoM) [84] computes the most plausible result which is obtained as the average of the elements that reach the maximum grade in a fuzzy set [8]. In FCD, we use MoM as a defuzzifier because of its light computational complexity.

The final output value presents the congestion level (i.e., CongLevel) that should be reported by the congestion notifications (i.e., CN_ACK frames) of NICC. For instance, if the output value is defuzzified from the sets *sensitive*, *critical*, or *urgent*, then the corresponding link is considered as congested, and accordingly, it should be added to the *Links Table* of NICC; the CongLevel is high in case of the *urgent* set, and low in case of the *sensitive* set. Otherwise, if the output value is defuzzified from the *acceptable* set, then the current state

Table 4.3: Decision Algorithm

Phase 1:	Enter the input parameters of the rules R_1, R_2, \dots , and R_{15}
Phase 2:	Calculate the degree of truth of the antecedent conditions
Phase 3:	Apply the operation of minimum composition (MIN) with the fuzzy operator AND/OR in order to generate the firing strength value for each rule R_1, R_2, \dots , and R_{15}
Phase 4:	Apply the operation of maximum composition to select the winning rule among the rules R_1, R_2, \dots , and R_{15}
Phase 5:	Generate the output consequent of the selected winning rule

(i.e., listed or not in the *Links Table*) of the corresponding link should not be modified. Finally, if the output value is defuzzified from the *clear* set, then the corresponding link should be removed from the *Links Table*.

4.3 Performance Evaluation

In this section, we use GloMoSim to evaluate/compare the proposed FCD against SWAN-AIMD [16] and IEEE 802.11 (with no explicit rate control). SWAN-AIMD performs a hop-by-hop AIMD-based rate control; instead of relying on an end-to-end acknowledgement, as in TCP, to detect congestion and perform rate control, in SWAN-AIMD, each intermediate node individually regulates its transmission rate by relying on the link-layer acknowledgement of the IEEE 802.11 data frames (SWAN-AIMD is called simply AIMD in the rest of this Section). The simulation scenarios are mainly based on three criteria: topology type, network density and traffic model. We used two types of topologies: structured and random. The structured topologies are presented in Figure 4.3 (inspired from [131]) where we have generated 4 architectures: chain, cross, grid, and star.

It is worth noting that FCD has been enabled with NICC in the evaluation presented in Chapter 3; however, the main focus of that evaluation was to prove the ability of the NICC's neighborhood-based congestion control to achieve fair bandwidth allocation among competing data flows. In contrast, the focus of the current simulation is to evaluate the ability of the FCD's congestion detection to improve the network performance in terms of throughput, delay, and packet delivery ratio. Therefore, in the current simulation, we disable the NICC's neighborhood-based congestion control, i.e., we consider that when a link is congested, only flows traversing the congested link will be regulated; a dedicated notification packet is used to notify the corresponding source nodes about the congested

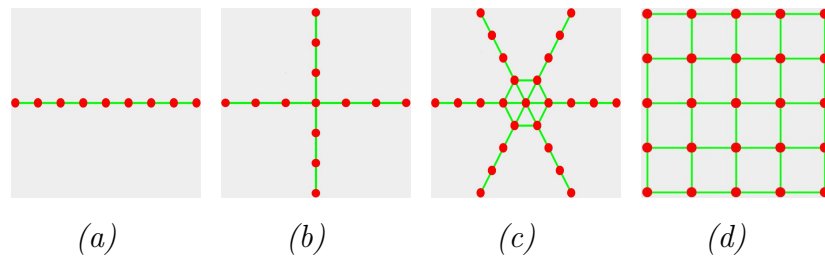

Figure 4.3: Structured topologies: Chain, cross, star, and grid

link.

The network density (number of nodes per square meter) impacts directly the number of generated events (neighbors' interferences, reception of messages) and channel occupancy. Thus, to evaluate the performance of FCD in different conditions, we run our approach in 10, 30, 50, 70 and 90 nodes topologies. These nodes are deployed within a fixed area of 1,000 m x 1,000 m square with equal radio range per node (250m).

The traffic model is also a main key in the evaluation of any approach. We suppose video session of 200 Kbps and audio session of 80 Kbps; the rationale behind this choice is to evaluate the ability of FCD to support real-time traffic, which presents a significant part of today's wireless communications. We have also mixed both traffic model and network density in the random topologies, where we simulate the same quantity of exchanged information, separately from the number of nodes. Hence, in a 10 nodes network, a node has to send/receive more packets than a node in 90 nodes network, while the latter will be more influenced by its neighborhood. We consider two scenarios in our simulations: (1) Internet scenario where all traffic, generated by the nodes in the network, is sent to the Internet via a single gateway; and (2) internal traffic scenario where all traffic is exchanged among the nodes in the network.

4.3.1 Results Analysis

We did consider end-to-end delay, packet delivery ratio, and throughput for performance evaluation.

Structured Topology

Figures 4.4 and 4.5 show the simulation results in the context of Internet scenario and internal scenario, respectively. We observe that FCD significantly outperforms IEEE 802.11 in terms of end-to-end delay (for IEEE 802.11, we show only the end-to-end delay graphs, Figures 4.4a and 4.5a); this is expected since IEEE 802.11 does not support any rate control mechanism. Figures 4.4b and 4.5b show that FCD outperforms AIMD; we also observe that the delay, provided by AIMD increases with the network size/density (the number of

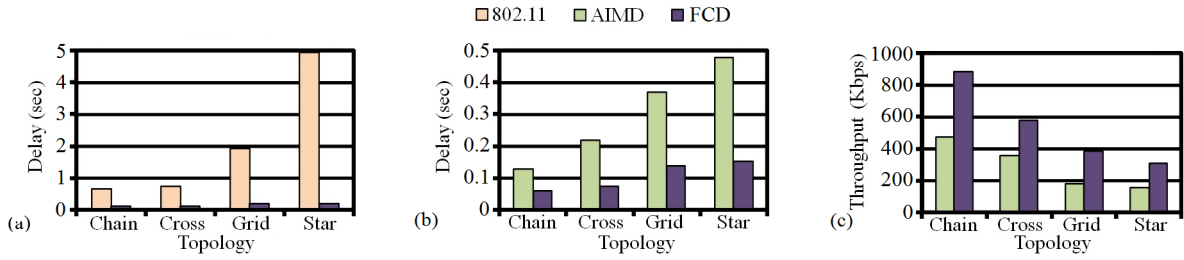

Figure 4.4: Internet traffic

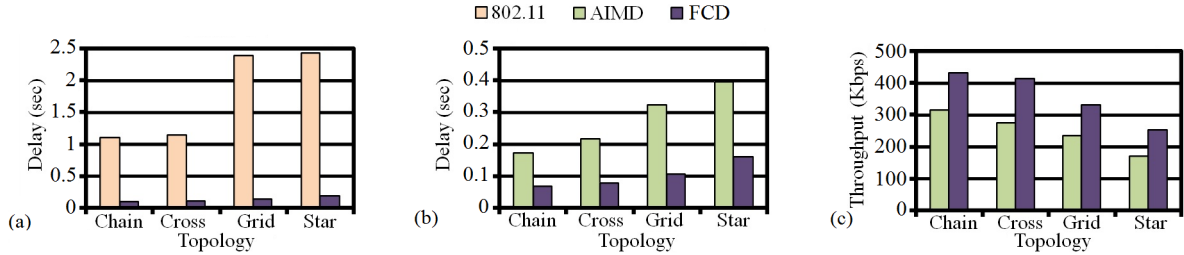

Figure 4.5: Internal traffic

nodes increases from Chain topology to Cross topology to Grid topology to Star topology; see Figure 4.3). In contrast, the delay, provided by FCD, is not significantly impacted by the network size; this is desirable for real-time traffic. Figures 4.4c and 4.5c show that the throughput decreases with the network size; this is expected since more nodes, in a fixed area, means more interferences. More importantly, FCD outperforms handily AIMD; indeed, it provides almost two times the throughput provided by AIMD.

Random Topology

Figure 4.6 shows that FCD outperforms AIMD in terms of delay, throughput and packet delivery ratio; particularly, Figure 4.6a shows that the delay, provided by AIMD, increases significantly, compared to the delay provided by FCD, when the network size increases. We conclude that FCD provides far better performance than AIMD independently of the type of topology and the network size/density.

Queue Analysis

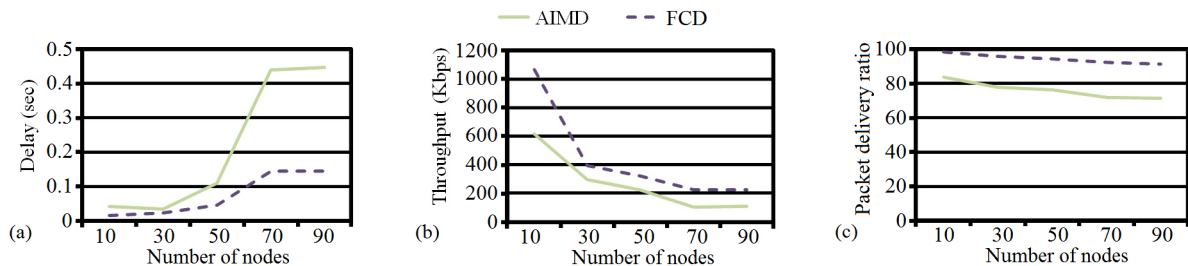

Figure 4.6: Performance in random topology vs. number of nodes

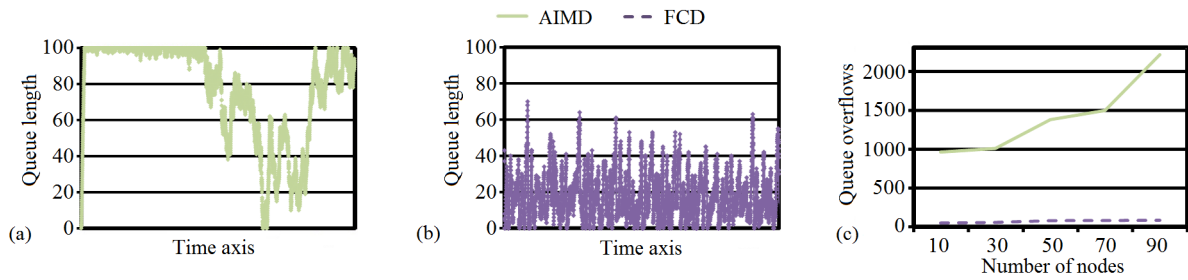

Figure 4.7: Queue length and overflows

Figures 4.7a and 4.7b show captures of the queue length variation in AIMD and FCD, respectively. We observe that, using the proposed fuzzy logic controller, FCD succeeds in maintaining lightly loaded queues (Figure 4.7b), i.e., the oscillations of the queue length are maintained within small ranges; this leads to reduce the queuing delays as well as to avoid the queue overflows (i.e., high packet delivery ratio).

On the other hand, we observe that AIMD experiences severe oscillations in the queue length (Figure 4.7a), i.e., the queue remains overflowed in some periods, and thereafter, it remains lightly loaded in other periods; this leads to unguaranteed end-to-end delay as well as to numerous queue overflows.

The above results are summarized in Figure 4.7c, which shows the number of dropped packets due to queue overflow. By maintaining lightly loaded queues, FCD guarantees a low amount of dropped packets independently of the network size; in contrast, AIMD experiences significant amount of dropped packets as it does not explicitly control the queue length.

Traffic Impact on the Network Performance

In this subsection, we vary the amount of traffic (number of sessions) to study the impact on delay, throughput, and packet delivery ratio; we run the simulations using a 25-nodes structured topology (star).

Figure 4.8a shows that there is slight impact on the delay, when increasing the number of sessions, for both approaches. However, as shown above, FCD maintains a significantly low delay compared to AIMD.

Figure 4.8b shows that the throughput, with AIMD, decreases significantly when the number of sessions increases; in contrast, we observe that FCD maintains stable high throughput even in the presence of a large number of sessions.

Figure 4.8c shows that FCD keeps stable packet delivery ratio even when the network size increases; in contrast, with AIMD, packet delivery ratio decreases when the network size increases. This expected since FCD maintains lightly loaded queues, thereby reducing the number of dropped packets due to queue overflow.

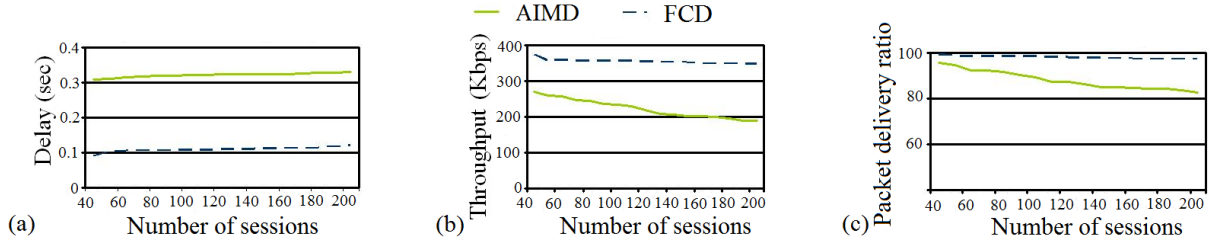

Figure 4.8: Traffic variation impact on the performance

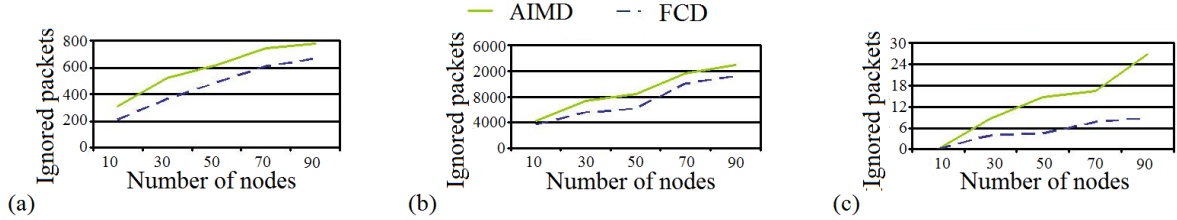

Figure 4.9: Impact of the radio occupancy and related parameters

Network Density Impact on the Network Performance

Figure 4.9 shows the impact of the network size on ignored packets due to busy channel, collisions, and dropped packets due to retransmission. Let us remind that when a collision is detected, a packet retransmission is performed (using the backoff mechanism); however, the packet will be considered lost if after a maximum number of retransmission, the packet is not successfully delivered. This is what we call here dropped packet due to retransmission.

Figure 4.9a shows that ignored packets due to busy channel increases with the network size for both approaches; however, their number is smaller with FCD compared to AIMD. Figure 4.9b shows similar trend for the number of collisions when the network size increases.

Figure 4.9c shows a significant increase in dropped packets, with AIMD, in large networks; with FCD, there is only a slight increase of dropped packets. We observe also that in a small size network (e.g., 10 nodes) both approaches perform well with no dropped packets. We can conclude that AIMD performs badly in large size networks while FCD succeeds in keeping these dropped packets in check.

4.4 Conclusion

In this chapter, we have proposed FCD, a fuzzy-based congestion detection mechanism that is designed to be used with NICC, the congestion control scheme proposed in Chapter 2. FCD detects congestion, at intermediate nodes, by combining the queue length with its variation rate during the previous control intervals; the combination is made using fuzzy logic theory. FCD maintains lightly loaded queues in order to reduce the queuing delay as

well as to avoid queue overflows. FCD can compute different congestion degrees in order to exploit the NICC's multi-bit congestion feedback, and thus ensure accurate rate control, making efficient use of bandwidth. Simulation results have shown that FCD is able to achieve high throughput, low delay, and near optimal packet delivery ratio.

Part I Conclusion

In this thesis part, we have considered IEEE 802.11-based wireless mesh networks. First, we have proven, using different WMN scenarios, the unfair nature of both the IEEE 802.11 MAC and the TCP-like congestion control. Second, we have defined the congestion as a neighborhood-related problem, instead of a link-based one. Third, we have presented an overview of research covering congestion control in WMNs. Fourth, we have proposed NICC, a congestion control scheme that relies on a neighborhood-based congestion management and an implicit multi-bit congestion feedback in order to solve starvation without affecting the scarce bandwidth of WMNs. Fifth, we have proposed FCD, a fuzzy-based congestion detection mechanism designed adequately to make NICC more effective. Finally, we have proven, via extensive simulations, the ability of NICC and FCD to achieve efficient and fair bandwidth utilization in 802.11-based WMNs. In Chapter 6, we investigate several opportunities for future works in 802.11-based WMNs.

Part II

Wireless Mesh Networks using Beamforming Antennas

Part II Introduction

This thesis part considers the wireless mesh networks in which the mesh routers are equipped with beamforming/directional antennas. The use of beamforming antennas is a key to improve the bandwidth utilization in WMNs; however, it introduces unprecedented MAC problems such as deafness and Head-of-Line blocking. Indeed, when using directional transmissions in contention-based MAC schemes (e.g., IEEE 802.11), a node is usually unaware of all ongoing transmissions within its neighborhood, and thus it may initiate inappropriate transmissions (e.g., transmissions that contend with the ongoing ones) resulting in unfair use and waste of bandwidth (e.g., RTS failures and collisions). To the best of our knowledge, most of the proposed beamforming MAC schemes are contention-based without an explicit consideration of fairness. This thesis part aims at avoiding beamforming-related problems, and at the same time, achieving efficient and fair bandwidth utilization in WMNs. To this end, we propose a TDMA-based MAC scheme called FreeDMAC; the key idea behind FreeDMAC is to (1) guarantee that each node is aware of all ongoing transmissions within its neighborhood, and thus avoid beamforming-related problems making efficient use of bandwidth; and (2) provide two levels of fairness: Per-link and per-flow fairness. By exploiting the stationary nature of WMNs, FreeDMAC provides a link-based contention-free scheduling; being link-based, the proposed scheduling increases the number of simultaneous transmissions within the same neighborhood, and thus improves bandwidth utilization, and being contention-free, it significantly reduces the control overhead compared to the RTS/CTS-based contention. The effectiveness of FreeDMAC in terms of fairness and bandwidth efficiency is proven through extensive simulation.

Chapter 5

FreeDMAC: A TDMA-based MAC scheme for WMNs using Beamforming Antennas

Contents

5.1	Introduction	98
5.2	Beamforming-related MAC problems	100
5.2.1	Problems	100
5.2.2	Conclusion	103
5.3	Related Work	104
5.3.1	Contention-based Schemes	105
5.3.2	Synchronized Schemes	108
5.3.3	Discussion	110
5.4	FreeDMAC: An Overview	111
5.4.1	Network Characteristics	111
5.4.2	Overview	112
5.5	FreeDMAC Details	114
5.5.1	Link-Slot Assignment	114
5.5.2	Transmission Scheduling	116
5.5.3	Per-Link Fairness	119
5.5.4	Per-Flow Fairness	119
5.5.5	Discussion	121

5.6 FreeDMAC Evaluation	122
5.6.1 Small-size scenarios	123
5.6.2 Large Scale Topologies	129
5.7 Conclusion	130

5.1 Introduction

Starvation and bandwidth scarcity are the major obstacles limiting the scalability of wireless mesh networks. One way to overcome these obstacles is to design a MAC protocol able to (1) make efficient use of bandwidth; and (2) fairly allocate bandwidth among contending links¹ (i.e., links that share the same bandwidth resources and thus cannot be used for transmission at the same time).

Using beamforming/directional antennas is a key to improve bandwidth utilization in WMNs. These antennas are able to concentrate their transmissions/receptions to/from specific directions, thereby reducing interferences and enabling multiple transmissions to occur simultaneously in the same neighborhood (i.e., spatial reuse). However, exploiting the beamforming capabilities offered in the physical layer requires the development of upper layer protocols, especially MAC protocols. Recently, several MAC schemes using beamforming antennas have been proposed [29]; most of them are contention-based with on-demand/random channel access. However, several unprecedented MAC problems have been encountered, e.g., deafness [60], head-of-line (HoL) blocking [76], MAC-layer capture [38], and new hidden node problems [41]; starvation and bandwidth waste are the common results of these problems (henceforth referred as beamforming-related problems). For instance, in the case of deafness, a sender wastes its time/bandwidth transmitting RTS frames to an unreachable receiver (e.g., receiver beamformed in a different direction); this leads to unnecessarily increase the sender's backoff contention window, and thus to cause unfairness, in terms of bandwidth utilization, between the sender and its neighbors.

When using contention-based directional MAC schemes, a network node is usually unaware of all ongoing transmissions in its neighborhood; this may cause problems (e.g., node S has packets to transmit on link L but S is unaware that a transmission on an L's contending link is already in progress), resulting in unfair use and waste of bandwidth. This lack of awareness was originally caused by the use of single-directional RTS/CTS handshaking, e.g., Basic DMAC [40], to enable a transmission between a sender-receiver pair (i.e., RTS (resp.

¹In this thesis part (WMNs using beamforming antennas), we use the term *contending links* (instead of *neighboring links*) to denote two links that share the same bandwidth resources.

CTS) is transmitted only in the direction of the receiver (resp. sender)), resulting in a partial neighborhood awareness (i.e., neighboring nodes that are located in the other directions are unaware of the transmission). Therefore, most of the proposed directional MAC schemes have attempted to improve neighborhood awareness of the network nodes by using additional control frames; for example, the authors in [78][85] proposed the use of multi-directional circular RTS/CTS handshaking (i.e., RTS (resp. CTS) is transmitted sequentially in multiple directions around the sender (resp. receiver)). However, due to the asynchronous nature of on-demand/random channel access, complete neighborhood awareness cannot be achieved by these schemes; indeed, while a transmission on link L is in progress, the corresponding sender/receiver (i.e., ends of L) will not hear any RTS/CTS handshaking that aims at enabling a transmission on neighboring link $L1$. Thus, inappropriate transmissions (e.g., transmission on $L1$'s contending link while transmission on $L1$ is already in progress) can be initiated by the sender/receiver.

In addition to beamforming-related problems, contention-based directional MAC schemes experience, when applied in WMNs, limitations in terms of (1) scalability: In the case of heavy traffic load, collisions occur because of severe contention to access the same channel; these collisions cause a considerable number of retransmissions resulting in a dramatic increase of control overhead and thus of bandwidth waste, eventually limiting the scalability of WMNs; and (2) fairness: In WMNs, interferences and carrier sensing exhibit strong location-dependency, i.e., nodes located in different positions within the same neighborhood experience different degrees of contention [69][81]; this results in unfairness, and even complete starvation, in which some nodes/links have access to significant bandwidth while others are extremely starved. Indeed, as reported in [29], fairness is not explicitly considered by most of the directional MAC schemes.

In this chapter, we propose a (beamforming-related problems)-Free TDMA-based Directional MAC scheme, called FreeDMAC, that aims at providing efficient and fair bandwidth utilization in WMNs. By exploiting the stationary nature of WMNs, synchronized directional transmissions are scheduled using a deterministic contention-free algorithm without the need of the RTS/CTS handshaking prior to each packet transmission. More specifically, FreeDMAC divides the scheduling frame into time slots acting as scheduling priorities; it assigns contending links to different slots. When scheduling a transmission on link L during L 's assigned slot, any sender on any L 's contending link is notified of the transmission on L ; this makes nodes aware of all ongoing neighboring transmissions and thus allows avoiding transmissions, at the same time, on contending links. Since FreeDMAC is link-based (i.e., transmission rights are assigned to links instead of nodes), it increases the number of simultaneous transmissions within the same neighborhood, and thus improves bandwidth

utilization. To provide (1) per link fairness: FreeDMAC rotates the link-slot assignment at the beginning of each time-frame; and (2) per flow fairness: FreeDMAC computes, for each link, an access weight that increases with its traffic load; the bigger the weight, the more bandwidth allocated to the link (i.e., more loaded links are allocated more bandwidth).

The remainder of the chapter is organized as follows. In Section 5.2, we briefly describe the beamforming-related MAC problems. Section 5.3 presents related work review. The assumed network characteristics and an overview of FreeDMAC are presented in Section 5.4. The FreeDMAC mechanisms are detailed in 5.5. Section 5.6 evaluates, via simulations, FreeDMAC. Finally, Section 5.7 concludes the chapter.

5.2 Beamforming-related MAC problems

In this section, we discuss the problems caused by using directional antennas in WMNs; a good understanding of these problems is a key to develop a MAC scheme that overcomes the limitations of contention-based directional MAC schemes. We make no assumption about the specifics of the RTS/CTS handshaking; the objective is to show that beamforming-related problems are mainly caused by the asynchronous nature of contention-based schemes and not the type of RTS/CTS handshaking (e.g., single directional RTS/CTS, multi-directional circular RTS/CTS).

5.2.1 Problems

5.2.1.1 Deafness

This problem [60] occurs when a sender fails to transmit to its intended receiver because the receiver is beamformed in a direction away from the sender. To better understand the deafness problem, let us consider the example shown in Figure 5.1. Suppose that node A starts a transmission with node B while node C is already engaged in a transmission with node D; thus, independently of its nature (e.g., single-directional, multi-directional), the RTS/CTS handshaking of the transmission $A \leftrightarrow B$ is not heard by C, and thus C is unaware of this transmission. Since the DATA/ACK handshaking of the transmission $A \leftrightarrow B$ is performed using the directional mode², when C becomes idle (at the end of the transmission $C \leftrightarrow D$), it senses an idle channel; if C has a packet destined for A, it transmits RTS in order to enable the transmission with A (either single RTS in the direction of A or multiple RTS in multiple directions). However, A does not hear RTS because it is beamformed in the

²All directional MAC schemes assume that the DATA/ACK handshaking is performed using the directional mode; indeed, this is necessary to enable the spatial reuse, which is the main benefit of beamforming antennas.

direction of B, and thus it does not respond with CTS (i.e., A is *deaf* to C's transmission). In the absence of the CTS response, node C assumes that the RTS failure is caused by a collision, and thus it enters the backoff mode, i.e., it (1) doubles its contention window; (2) selects a backoff interval based on the newly computed window; (3) starts counting down; and (4) at the end of the countdown, retransmits RTS; several retransmission attempts may take place until the transmission $A \leftrightarrow B$ is successful or the number of retransmissions exceeds the maximal retry threshold.

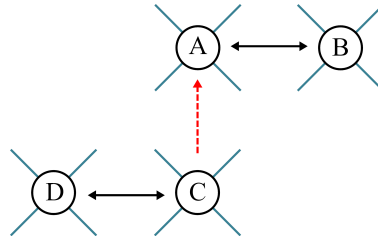

Figure 5.1: The deafness problem

At the end of the transmission $A \leftrightarrow B$, nodes A and B reset their contention windows to the minimum value; meanwhile, it is likely that node C is engaged with a large contention window. Hence, if A has a packet to transmit, it is probable that A starts a new transmission before RTS being retransmitted by C; this will worsen the transmission situation of C (e.g., C may start dropping packets when the number of retransmissions exceeds the maximal retry threshold).

We conclude that deafness causes unfair use and waste of bandwidth. This can be even worse when a node tries to transmit to a deaf node, while the deaf node itself tries to transmit to another deaf node (deadlock scenario [39]).

5.2.1.2 Hidden node

In the context of beamforming antennas, there are two types of the hidden node problem: (1) The unheard RTS/CTS; and (2) the asymmetry in gain.

Hidden Node due to Unheard RTS/CTS

This problem occurs when a sender C tries to transmit to a receiver A while A is already engaged in another transmission using the direction of C; thus, collision occurs at A. For clarity, let us consider the example shown in Figure 5.2; we assume the same scenario considered in the deafness case (Figure 5.1) except that the nodes' positions are modified. Node C is unaware of the transmission $A \leftrightarrow B$ because, at the beginning of this transmission, it was already engaged in a transmission with node D; thus, when C becomes idle, if node A is receiving from node B (either DATA or ACK frame), C will not overhear this reception,

and thus it will transmit RTS that will cause a collision at A. Indeed, the RTS transmission prevents A from correctly receiving from B causing retransmissions.

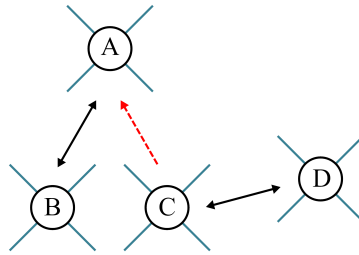

Figure 5.2: The hidden node due to unheard RTS/CTS

Hidden Node due to Asymmetry in Gain

Given that a node using the directional mode has a greater antenna gain (i.e., larger transmission/reception range) than a node using the omni-directional mode, we define 3 types of 1-hop neighboring relationships: (1) the OO-neighbors (omni-omni): Any two nodes able to communicate (i.e., engaged in a one-hop transmission) when both of them are using the omni-directional mode; (2) The DO-neighbors (directional-omni): Any two nodes able to communicate when only one of them is using the directional mode; and (3) The DD-neighbors (directional-directional): Any two nodes able to communicate when both of them are using the directional mode.

The hidden node problem due to asymmetry in gain occurs when a sender C transmits using the direction of its DD-neighbor A while A is already engaged in a transmission using the direction of C; thus, collision occurs at A. To better understand this problem, we refer to the scenario in Figure 5.3; (1) nodes A and C are DD-neighbors, while nodes A and B (and nodes C and B) are DO-neighbors, and (2) nodes A and B start their transmission while node C is idle³. Suppose that a single-directional RTS/CTS handshaking is used; in this case, node C cannot overhear the RTS (or CTS) transmitted by node B because it is transmitted only in the direction of A. Moreover, C cannot overhear the RTS (or CTS) transmitted by node A because C is idle using the omni-directional mode (DD-neighbors cannot communicate when one of them is using the omni-directional mode). Now, if C has a packet destined for B, it will sense an idle channel, and thus it transmits RTS towards B using the directional mode; this transmission will cause collision at node A since A is beamformed in the direction of C receiving from B (either DATA or ACK). One way to overcome this problem is to use multi-directional RTS/CTS handshaking; in this case, in addition to RTS transmitted towards node A, node B transmits RTS in the direction of node

³We suppose that when a node is idle, it uses the omni-directional mode, and thereafter, when RTS is received, it beamforms in the direction of the signal with the biggest strength.

C to make C aware of the transmission $A \leftrightarrow B$; however, as explained in the above scenarios, C may not overhear the RTS from B because it may be beamformed in another direction (e.g., engaged in a transmission).

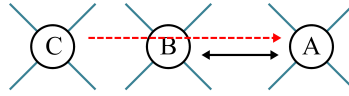

Figure 5.3: The hidden node due to asymmetry in gain

5.2.1.3 Head-of-Line Blocking

This problem is caused by the use of the First-In-First-Out (FIFO) queuing policy [76]; indeed, when using FIFO, if the packet at the top of the queue is destined for a busy node, all the subsequent packets are blocked including those destined for idle nodes. Let us consider the example shown in Figure 5.4. Suppose that node C has at the top of its queue a packet destined for busy node A (A is engaged in a transmission with node B) and the subsequent packet is destined for idle node D; if FIFO is used, the packet destined for D will be unnecessarily delayed, resulting in bandwidth waste. Using a beamforming-aware queuing policy (instead of FIFO) will not resolve the HoL blocking problem; indeed, as explained in the deafness and hidden node problems, it is possible that node C is unaware of the transmission $A \leftrightarrow B$; thus, the corresponding queuing decisions will use incorrect information.

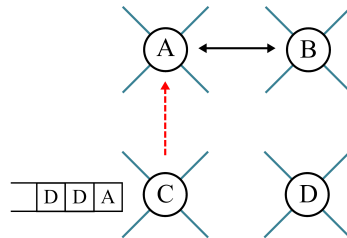

Figure 5.4: The head-of-line blocking problem

5.2.1.4 MAC-Layer Capture

This problem occurs when an idle node misses the reception of a productive packet (i.e., packet destined for it) because it has just beamformed in another direction to receive an unproductive packet (i.e., packet not destined for it). For better understanding, let us consider the example shown in Figure 5.5. Suppose that node A has a packet destined for B while node D has a packet destined for C; if A starts the RTS transmission just before D, both B and C will beamform in the direction of A, and thus C will not hear RTS from D before detecting that RTS from A is not destined for it. This results in unfair use and waste of bandwidth; indeed, in the absence of the CTS response, D has to enter the backoff mode

before retransmitting RTS. It was reported [87] that the MAC-layer capture problem leads to the same consequences of the deafness problem.

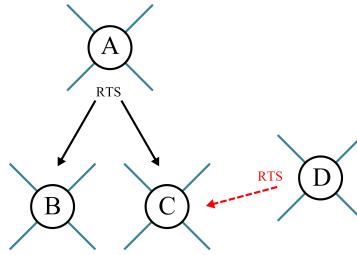

Figure 5.5: The MAC-layer capture

5.2.2 Conclusion

We conclude that the beamforming-related problems, in contention-based directional MAC schemes, are mainly caused by the fact that (1) a node may be unaware of all ongoing transmissions in its neighborhood; indeed, while a node is engaged in a transmission on link L, it does not hear newly started transmission on neighboring link L1, and thus when the node becomes idle, it can start a transmission on an L1's contending link while the transmission on L1 is in progress; and (2) a node may miss the reception of a productive packet (e.g., RTS destined for it) because of the reception of an unproductive one (e.g., RTS not destined for it). These problems will necessarily lead to unfair use and waste of bandwidth (e.g., RTS failures, collision, delayed packets).

To avoid these problems that are mainly due to the asynchronous nature of directional contention-based schemes, we propose a contention-free MAC scheme, called FreeDMAC. The proposed scheme divides the scheduling phase/frame into time slots acting as scheduling priorities; it assigns contending links to different slots. When scheduling a transmission on link L using L's assigned slot, any sender on any L's contending link is notified of the transmission on L; this makes nodes aware of all ongoing neighboring transmissions and thus allows avoiding transmissions, at the same time, on contending links.

5.3 Related Work

In the last decade, several MAC schemes, in wireless multi-hop networks using beamforming antennas, have been proposed [29]. These schemes could be broadly classified into two categories: (1) Contention-based schemes; and (2) synchronized schemes. The classification of directional MAC schemes is shown in Figure 5.6.

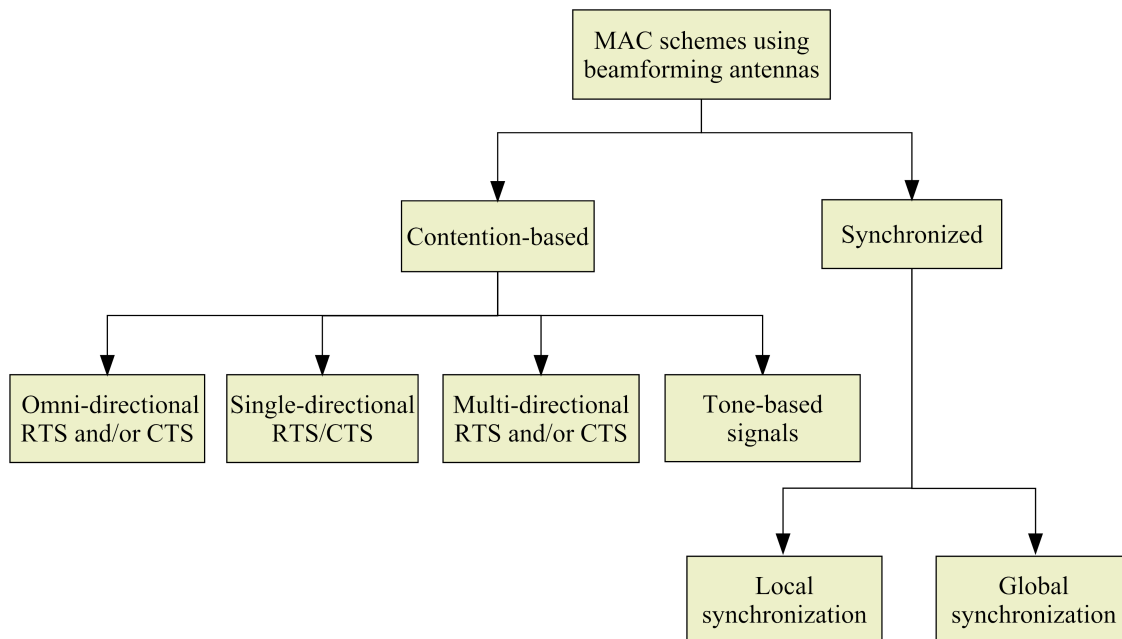

Figure 5.6: Classification of directional MAC schemes

5.3.1 Contention-based Schemes

These schemes are mainly based on the IEEE 802.11 DCF; they could be classified into four categories: (1) schemes using omni-directional RTS and/or CTS; (2) schemes using single-directional RTS/CTS; (3) schemes using multi-directional RTS and/or CTS; and (4) schemes using tone-based signals.

5.3.1.1 Omni-Directional RTS and/or CTS

In this category of schemes, at least one control frame is transmitted using the omni-directional mode, while the DATA/ACK frames are transmitted using the directional mode. In [100], both RTS and CTS are transmitted omni-directionally; neighboring nodes that overhear either RTS or CTS defer their transmissions and start a Virtual Carrier Sensing (VCS) using the IEEE 802.11 Network Allocation Vector (NAV) mechanism. In [75], RTS is transmitted directionally towards the receiver; thus, the sender can avoid unnecessary delay if one of its beams is blocked. In contrast, CTS is transmitted omni-directionally; thus, it cannot be transmitted if one of the receiver's beams is blocked. In [94], RTS, CTS and a newly proposed Data-Send (DS) control packet are all transmitted omni-directionally on a dedicated control channel. Indeed, using omni-directional RTS/CTS is helpful when neighboring nodes' directions are not permanently available, i.e., the receiver's direction is not known at the sender. In addition, omni-directional RTS/CTS can avoid the deafness and hidden node problems. However, the spatial reuse, which is the main benefit of beamforming antennas, is substantially reduced, i.e., inefficient bandwidth utilization; furthermore, since

at least one frame is transmitted omni-directionally, only OO-neighbors can communicate resulting in limited WMN connectivity (i.e., the higher gain offered by the directional mode is not exploited).

5.3.1.2 Single-Directional RTS/CTS

In this category of schemes, RTS/CTS/DATA/ACK are all transmitted in the directional mode. DVCS [122] and Basic DMAC [40] are two typical examples of this category; they introduce the concept of directional NAV (DNAV) in which the VCS is performed directionally, i.e., each direction has its own DNAV with its own expiration time. Using DNAV, when some directions are blocked, transmission/reception in the other directions remains possible. Indeed, by using the directional RTS/CTS, DVCS and Basic DMAC (1) enable communication among DO-neighbors and thus extend the WMN connectivity, and (2) improve the spatial reuse; however, DVCS and Basic DMAC do not address any of the beamforming-related problems, thereby resulting in unfair use and waste of bandwidth.

Kolar et al. [76] identify the HoL blocking problem in the context of Basic DMAC [40] using FIFO queuing policy. The authors propose a new queuing policy in which the packet for the next transmission is selected based on the least wait time, i.e., the packet for the next transmission is the one destined for the direction that has the DNAV with the smallest expiration time. However, they do not consider the deafness problem; this makes the DNAV information, based on which the packet for the next transmission is selected, incorrect/incomplete [24].

Ramanathan et al. [108] propose a new backoff algorithm in which the contention window (CW) is adjusted based on the event causing the backoff. For instance, (1) when the channel is busy, CW is maintained constant; (2) when a CTS is missed, CW is linearly increased; and (3) when an ACK is missed, CW is exponentially increased. In OPDMAC [28], upon a transmission failure, instead of entering the backoff mode and remaining idle, a node tries to transmit other outstanding packets destined for other directions; this allows avoiding the HoL blocking problem and reducing the impact of deafness. In RI-DMAC [123], when the next packet in the sender's queue is destined for the same receiver, the sender notifies the receiver using a dedicated header in the ongoing packet, and accordingly, the receiver adds the sender to a polling table. At the end of each transmission, if the polling table is not empty, then a node (which has been sender or receiver) will transmit a Ready-To-Receive (RTR) packet to invite the oldest sender in the polling table to start its transmission; actually, such a sender is suffering a deafness situation. These schemes [28][108][123] reduce the impact of deafness with no or light overhead; however, by using single-directional RTS/CTS, the deafness situation itself is not prevented from occurring,

and thus a node is always susceptible to transmit RTS to an unreachable receiver, resulting in bandwidth waste.

Choudhury and Vaidya [38] present a solution to the MAC-layer capture problem. They propose a scheme, called CADMAC, in which the time is divided into alternative ON and OFF durations. During the ON duration, a node (1) records each received packet and the beam used to receive it; and (2) classifies the received packets into productive packets (packets destined for the node itself), and unproductive packets (packets destined for other nodes). During the OFF duration, the node turns off the beams that are used, during the ON duration, to receive only unproductive packets. CADMAC effectively deals with the MAC-layer capture problem; however, it requires additional mechanisms to handle the other beamforming-related problems (e.g., deafness).

5.3.1.3 Multi-Directional RTS and/or CTS

In order to maintain the higher connectivity of single-directional RTS/CTS schemes, and at the same time, alleviate the deafness and hidden node problems, several schemes propose the use of multi-directional RTS and/or CTS. In CRM [77], RTS is transmitted directionally, in a circular way, to notify all the DO-neighbors around the sender while CTS is transmitted only in the direction of the sender. In CRCM [67], both RTS and CTS are transmitted directionally in a circular way in order to notify all the DO-neighbors around both the sender and the receiver; the CTS transmission is avoided in those directions that are already covered by the circular RTS. In MDA [59] and DMAC/DA [124], in order to reduce the control overhead, (1) the circular directional RTS/CTS are transmitted only after a successful exchange of a single-directional RTS/CTS between the sender-receiver pair; and (2) the circular RTS/CTS are transmitted only in those directions where neighboring nodes exist. MDA proposes an enhanced DNAV mechanism that differentiates between collision avoidance (updated when receiving the single RTS/CTS) and deafness avoidance (updated when receiving the circular RTS/CTS).

In [37], to avoid the hidden node problem in linear topologies, SpotMAC proposes an inverse RTS/CTS handshaking. A sender wishing to transmit has to exchange a directional RTS-Req/CTS-ACK handshaking with its upstream neighbor; the latter is then blocked from transmitting until receiving an ACK message from the sender. Meanwhile, the sender exchanges a directional RTS/CTS/DATA/ACK handshaking with its receiver (i.e., downstream neighbor).

In these schemes [37][59][67][77][124], especially in those using circular RTS/CTS, the deafness and hidden node problems are significantly alleviated; however, they are not com-

pletely avoided. Actually, given the asynchronous nature of contention-based schemes, a node that is already engaged in a transmission cannot overhear any RTS/CTS handshaking, and thus it cannot maintain a complete awareness of all ongoing neighboring transmissions. Furthermore, the control overhead required to exchange the circular RTS/CTS is too heavy, resulting in inefficient bandwidth utilization.

5.3.1.4 Tone-based Signals

In order to handle the deafness and hidden node problems, some schemes propose the use of tone-based signals. In DBTMA/DA [64], the channel is split into a data channel and a control channel; the data channel is reserved for the RTS/CTS/DATA/ACK handshaking while the control channel is reserved for two tones, namely transmit busy tone (BTt) and receive busy tone (BTr) (BTt and BTr are assigned two separate single frequencies in the control channel). To transmit RTS, the sender should not be sensing BTr tone; similarly, to respond with CTS, the receiver should not be sensing BTt tone. When the receiver (resp. sender) transmits CTS (resp. DATA), it turns on BTr (resp. BTt) until the end of the communication; BTt and BTr are tuned directionally. A similar approach with DNAV support, named BT-DMAC, is proposed in [44]. In opposition to DBTMA/DA, in BT-DMAC, (1) BTt and BTr are tuned omni-directionally, and (2) BTt/BTr is pulse-modulated so that it could carry the ID of its transmitter and the beam used to transmit it; thus, a node overhearing BTt/BTr can identify the transmitter, and thus accordingly updates DNAV.

In ToneDMAC [39], at the end of each transmission, the sender and the receiver transmit a tone omni-directionally on a dedicated control channel. When a neighboring node that is suffering a deafness situation detects the tone, it compares its intended receiver with the tone-transmitter; the latter is identified based on the frequency and the duration of the tone. If the tone-transmitter is the intended receiver, the neighboring node infers that deafness is the cause of its RTS failures; thus, it resets its backoff contention window and retransmits RTS.

Tone-based schemes effectively alleviate the deafness and hidden node problems; however, they suffer two main shortcomings [29]: (1) they offset the bandwidth: the available bandwidth should be split into two separate channels; and (2) they require additional hardware: A node should be able to transmit/receive on two separate channels and on multiple narrow frequency bands in the same channel.

5.3.2 Synchronized Schemes

To avoid the shortcomings of the asynchronous nature of contention-based schemes, recently, several MAC schemes using synchronized access control have been proposed. These schemes

could be classified into two categories [29]: (1) local synchronization schemes: Synchronization is locally maintained among neighboring nodes; and (2) global synchronization schemes: Synchronization is maintained among all the network nodes.

5.3.2.1 Local Synchronization

CW-DMAC [130], CD-MAC [105], and RDMAC [36] are three representative examples of local synchronization schemes. Generally, in these schemes, neighboring nodes realize a local timing structure that consists of a scheduling and a transmission period. In the scheduling period, transmissions are scheduled using an omni-directional RTS/CTS-based handshaking; the first node-pair (winner node-pair) that successfully completes the RTS/CTS handshaking specifies the duration of the scheduling and transmission periods. During the scheduling period, nodes in the neighborhood of the winner node-pair could schedule their transmissions as long as the new transmissions do not interfere with the previously scheduled ones. At the end of the scheduling period, contention-free directional DATA/ACK handshakes are simultaneously exchanged in the transmission period.

These schemes may alleviate the shortcomings of the asynchronous nature of contention-based schemes; however, they suffer from two main limitations: (1) since omni-directional RTS/CTS-based handshaking is used, only OO-neighbors can communicate resulting in limited WMN connectivity; and (2) transmissions between nodes located in different synchronized neighborhoods may be inappropriately scheduled (such nodes belong to different neighborhoods with different durations of the scheduling and transmission periods).

5.3.2.2 Global Synchronization

Few schemes have been proposed in this area. The authors in [116] propose DOA-MAC as a slotted ALOHA-based MAC protocol in which each slot is divided into three mini-slots. In the first mini-slot, each sender transmits a simple tone directionally towards its intended receiver; thereafter, each receiver beamforms towards the direction of the tone with the maximum received power. In the second slot, each sender transmits its DATA packet directionally towards its intended receiver; a receiver rejects the DATA packet if it is not destined for it. In the third mini-slot, each receiver, which has received a DATA packet destined for it, transmits ACK directionally towards its sender. We observe that location-dependency (i.e., a receiver beamforms towards the closest sender, which is the transmitter of the tone with the maximum received power) is the main shortcoming of DOA-MAC; indeed, if traffic from the closest sender is heavy, farther senders will be starved.

In SYN-DMAC [129], the time is divided into cycles, and each cycle is divided into three phases. In the first phase, multiple transmissions could be scheduled using a di-

rectional RTS/CTS/confirmed-RTS handshaking; later scheduled transmissions should not interfere with previously scheduled ones. When a node receives RTS for a transmission that interferes with a previously scheduled one, it responds with a negative-CTS frame; this avoids unnecessary bandwidth waste due to several RTS failures. The second and the third phases are reserved for contention-free DATA and contention-free ACK transmissions, respectively. Indeed, by using the proposed time structure, SYN-DMAC effectively deals with the asynchronous nature of contention-based schemes; however, the scheduling phase still uses RTS/CTS-based handshaking, which leads, as explained in Section 5.1, to limitations in terms of scalability and fairness.

RTDMA-DA [45] is a TDMA-based MAC protocol similar to our proposed FreeDMAC. In RTDMA-DA, the time is divided into alternative reservation and information frames. A contention-free scheduling is performed in the reservation frame followed by contention-free data transmissions in the information frame; this allows overcoming the limitations of RTS/CTS-based handshaking, and thus improving fairness, scalability, and bandwidth efficiency. However, in RTDMA-DA, only uniform grid topologies are considered; this makes RTDMA-DA inappropriate in real-life WMNs. In addition, in RTDMA-DA, a node is assumed to be able to transmit/receive multiple packets on different beams simultaneously⁴; this assumption extremely simplifies the design of the contention-free scheduling in the context of uniform grid topologies.

5.3.3 Discussion

After our overview of existing schemes (see above), we conclude that none of them resolves all beamforming-related problems while providing a fair and efficient use of bandwidth.

- Some schemes resolve only a subset of beamforming-related problems (e.g., MAC layer capture in [38] and HoL blocking in [76]);
- Most schemes generate extra overhead when resolving these problems; for instance, the deafness and hidden node problems are alleviated in multi-directional RTS/CTS and tone-based schemes, however, with considerable extra-overhead. In the case of multi-directional RTS/CTS, numerous control frames are required prior to each data transmission, while in tone-based schemes, a dedicated control channel is reserved to exchange the tone signals;
- Most schemes, even those supporting synchronized data transmissions, employ RTS/CTS-based contention; this impacts negatively their (1) scalability: in case of heavy traffic

⁴In FreeDMAC, as in most of directional MAC schemes, we assume that a node can transmit/receive at most one packet at the same; such assumption reduces the expense and complexity of the antennas.

load, a considerable amount of collisions occur, due to severe contention, causing re-transmissions; and (2) fairness: location-dependency in terms of interferences and carrier sensing cause unfair access to the channel and even starvation among neighboring nodes/links; indeed, as reported in [29], existing MAC schemes focus on enhancing the spatial reuse by optimizing other performance metrics, such as throughput and delay, causing unfair medium access;

- Most schemes consider the directional RTS/CTS/DATA/ACK handshaking as the cause of the deafness and hidden node problems; thus, they propose to use additional control frames (e.g., multi-directional RTS/CTS) in order to improve the awareness of nodes about ongoing neighboring transmissions. However, given the asynchronous nature of contention-based schemes, a node that is already engaged in a transmission is not able to overhear any control frame; thus, it has no information on newly started transmission within its neighborhood, resulting in incomplete neighborhood awareness.

We believe that the proposed FreeDMAC is the first MAC scheme that avoids all the beamforming-related problems, and at the same time, provides fair and efficient bandwidth utilization. FreeDMAC proposes a deterministic contention-free link-based scheduling algorithm without the use of the RTS/CTS handshaking; this allows (1) reducing the control overhead; (2) providing scalability; and (3) maximizing the spatial reuse. In FreeDMAC, when scheduling a transmission on link L using the L 's assigned slot, the sender of each L 's contending link is notified of the transmission on L . Thus, nodes are aware of all ongoing neighboring transmissions; this allows avoiding all beamforming-related problems. Moreover, FreeDMAC (1) rotates the link-slot assignment at the beginning of each time-frame to provide per link fairness; and (2) computes, for each link, an access weight that increases with its traffic load (the bigger the weight, the more bandwidth allocated to the link) to provide per flow fairness.

5.4 FreeDMAC: An Overview

In this section, we present the network characteristics required for the proposed scheme FreeDMAC; we also present a brief overview of FreeDMAC.

5.4.1 Network Characteristics

Synchronization: We assume that a Global (network-wide) time synchronization is maintained across the mesh backbone, i.e., the start and the end time of each slot/frame are the same at all mesh nodes. This synchronization could be provided using Global Positioning System (GPS) or other distributed synchronization techniques [103][127].

Nodes and Antennas: Each mesh node is equipped with an antenna system of M non-overlapping beams. A node could transmit/receive (1) omni-directionally or (2) directionally using only one of the M beams. When a node is idle using the omni-directional mode, the antenna system allows it to detect the beam-of-arrival of the received signals. At most one packet could be transmitted/received at a given time. The antenna model, assumed in this chapter, belongs to the category of *Switched Beam Antennas* in which the set of beams (i.e., directions) that could be used for transmission/reception are predetermined; the limitation of these antennas arises when the desired sender/receiver is not well located in one of the predetermined directions, thereby resulting in gain reduction. FreeDMAC is not restricted to these antennas; it could effectively work when using *Steered Beam Antennas* in which the direction of transmission/reception could be appropriately adapted in order to maximize the gain to/from the desired receiver/sender. We use *Switched Beam Antenna* to simplify the discussions and figures presented throughout the chapter.

To be able to communicate with its neighbors, each node maintains a table, called neighbor table, that includes the direction (i.e., the corresponding beam) of each node in its transmission range (i.e., neighboring node). Maintaining such a table is practically realistic given the stationary nature of the mesh backbone; this table is used to select the appropriate beam that should be used when transmitting a packet. Packets destined for different neighboring nodes are queued in different buffers; indeed, each mesh node maintains a dedicated buffer for each of its outgoing links.

5.4.2 Overview

This section presents a brief overview of FreeDMAC; the corresponding details are presented in Section 5.5. More specifically, we (1) define the concept of frames and subframes used in the operation of FreeDMAC; (2) briefly present the two main components of FreeDMAC, namely link-slot assignment and transmission scheduling; Indeed, the operation of FreeDMAC consists of assigning time slots to links and scheduling transmissions according to the resulting assignment; (3) describe how FreeDMAC provides fairness; and (4) discuss the performance of FreeDMAC in large scale WMNs.

5.4.2.1 Frames and Subframes

The time is divided into frames of constant length, and each frame is divided into a scheduling and a transmission subframe (the scheduling subframe is much smaller than the transmission one); the scheduling subframe is divided into N slots indexed $1, 2, \dots, N$, respectively, and each slot is divided into two sub-slots. The time structure is presented in Figure 5.7.

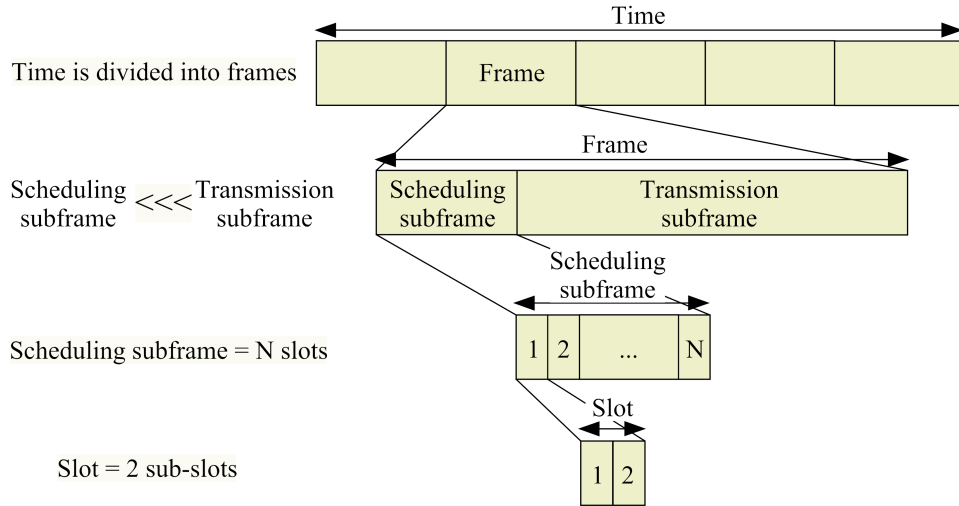

Figure 5.7: Time Structure

A deterministic contention-free link-based scheduling is performed in the scheduling subframe; the aim is to schedule the maximum number of directional contention-free transmissions to simultaneously occur in the transmission subframe.

5.4.2.2 Link-Slot Assignment

To provide contention-free scheduling, (1) the scheduling subframe is divided into N slots acting as scheduling priorities (a slot is assigned to a set of links, whereas a link is assigned to only one slot); and (2) contending links, which cannot be used for transmission at the same time, are assigned to different slots (two non-contending links could be assigned to the same slot). The details of link-slot assignment are presented in Section 5.5.1.

5.4.2.3 Transmission Scheduling

In FreeDMAC, the transmission rights are assigned to links instead of nodes, i.e., during the transmission subframe, a sender could transmit on a specific link (i.e., to a specific receiver) exclusively. In the context of beamforming antennas, link-based scheduling significantly improves the spatial reuse (i.e., bandwidth utilization) compared to node-based scheduling [91]. Indeed, in node-based scheduling, to avoid contention, neighboring nodes can never transmit at the same time. In contrast, in link-based scheduling, to avoid contention, neighboring nodes cannot transmit at the same time only towards specific directions; transmission towards other directions remains possible. Actually, when using beamforming antennas in WMNs, the shared medium is directionally divided, such that the medium could be available in one direction and busy in another one.

Now, let us consider (1) a scheduling subframe that is divided into N slots, and (2) a node S that has packets to transmit on its outgoing link L_{S-R} (i.e., to node R) that is

assigned to slot i . S monitors the channel during slot 1, slot 2, \dots , and slot $(i - 1)$. If S is notified, during any of these slots, that a transmission on an L_{S-R} 's contending link is scheduled to occur during the transmission subframe, it remains idle during slot i (i.e., it postpones the transmission on L_{S-R} to the subsequent frame); otherwise (i.e., there is no packet to transmit on any of the L_{S-R} 's contending links that are assigned to slot 1, slot 2, \dots , or slot $(i - 1)$), it notifies, during slot i , the sender of each L_{S-R} 's contending link that a transmission on L_{S-R} is scheduled to occur during the transmission subframe; thus, the notified senders remain idle during the slots assigned to the L_{S-R} 's contending links (slot $(i + 1)$, slot $(i + 2)$, \dots , or slot N), i.e., transmissions on these links are postponed to the subsequent frame. At the end of the scheduling subframe, (1) S transmits its data packets on L_{S-R} during the transmission subframe; and (2) no transmission occurs on any of the L_{S-R} 's contending links. Note that if a sender of an L_{S-R} 's non-contending link (L1) succeeds in scheduling a transmission on L1 during the L1's assigned slot, it will be allowed, like S, to transmit its data packets on L1 during the transmission subframe. The details of the scheduling process are presented in Section 5.5.5.

5.4.2.4 Fairness Support

To schedule a transmission on link L_{S-R} (assigned to slot i), no transmission should be scheduled on any of the L_{S-R} 's contending links that are assigned to slot 1, 2, \dots , or $(i - 1)$; thus, links assigned to slots with lower indexes have higher priorities, when scheduling transmissions, than links assigned to slots with higher indexes. Therefore, to provide fairness, in FreeDMAC, the scheduling priorities (i.e., link-slot assignment) are rotated at the beginning of each frame; this rotation results in an ideal per-link fairness (details are provided in Section 5.5.3). However, to provide per-flow fairness, heavily loaded links (i.e., links traversed by numerous flows) should get more bandwidth allocation than lightly loaded links (i.e., links traversed by few flows)⁵. To this end, when lightly loaded links are assigned to slots with lower indexes, sometimes the channel should be given up to heavily loaded links, i.e., the senders of lightly loaded links should remain idle during the corresponding assigned slots. In contrast, when heavily loaded links are assigned to slots with lower indexes, the channel should not be given up to lightly loaded links, i.e., the senders of heavily loaded links should always use the corresponding assigned slots to schedule transmissions. In FreeDMAC, an access weight is computed for each link based on its traffic load; this access weight specifies whether a link sender should use the link's assigned slot to schedule transmissions or should give up the channel to other links (details are provided in Section 5.5.4).

⁵We consider that all the network data flows have the same throughput demands.

5.4.2.5 Performance in Large Networks

FreeDMAC performance does not degrade in large networks (networks with larger number of nodes); indeed, the control overhead of FreeDMAC increases with the length of the scheduling subframe, which in turn, increases with the network neighborhood density. The length of the scheduling subframe corresponds to the densest neighborhood in the network (i.e., neighborhood with the highest number of contending links) and is not related to the size of the network.

5.5 FreeDMAC Details

In this Section, we present the details of link-slot assignment, transmission scheduling, and the support of per-link/per-flow fairness.

5.5.1 Link-Slot Assignment

To provide efficient bandwidth utilization, the number of slots in the scheduling subframe should be minimized; this can be realized by maximizing the number of simultaneous transmissions in the transmission subframe. Indeed, the objective of the proposed link slot assignment (LSA) is to maximize the number of non-contending links assigned to a given slot. Let us first define the concept of contention set (i.e., the set of contending links) and then detail the operation of LSA.

5.5.1.1 Contention set

Two links contend if they cannot be used for transmission at the same time because of either (1) interferences: Contention occurs when the transmission on one link creates significant interferences at the receiver of the other link, e.g., in Figure 5.8a, link L_{S1-R1} contends with L_{S-R} because the transmission on L_{S1-R1} creates significant interferences at node R when R is beamformed in the direction of node S. It is worth noting that the sender of an L_{S-R} -like link is a neighbor of S while its receiver is in the direction of R; or (2) antennas: Contention occurs due to the inability of the antenna system (see Section 5.4.1) to transmit/receive different packets on multiple beams simultaneously; thus, all incoming and outgoing links of nodes S and R contend with L_{S-R} , i.e., in Figure 5.8b, links L_{R-S} , L_{R-X} , and L_{X-R} contend with L_{S-R} .

Definition: The contention set of link L_{S-R} is a set that includes (1) all incoming and outgoing links of S; and (2) all incoming and outgoing links of R; and (3) any other link that its sender is a neighbor of S and its receiver is in the direction of R.

It is worth noting that we did not consider interferences at the links' senders, in defining the contention set, since only receivers require an idle channel; indeed, in contrast to IEEE 802.11, FreeDMAC provides contention-free transmissions, and thus it does not require a link-layer acknowledgement upon each data transmission.

5.5.1.2 Link-slot assignment

The objective of LSA is to assign all the network links to slots in the scheduling subframe. For link L_{S-R} (not already assigned), LSA checks whether no L_{S-R} 's contending link is assigned to the first slot. If the response is yes, LSA assigns L_{S-R} to this slot. Otherwise, (i.e., an L_{S-R} 's contending link is already assigned to the first slot), LSA considers the remaining slots, in increasing order (2nd slot, 3rd slot, etc.) and repeats the same operation until it succeeds assigning L_{S-R} or all slots are considered. If LSA fails to assign L_{S-R} to any of the existing slots (initially, there is only one slot in the scheduling subframe), it creates a new slot (in the scheduling subframe) and assigns L_{S-R} to the new slot. LSA terminates when all links are assigned to slots. The pseudo-code of LSA is shown in Algorithm 2.

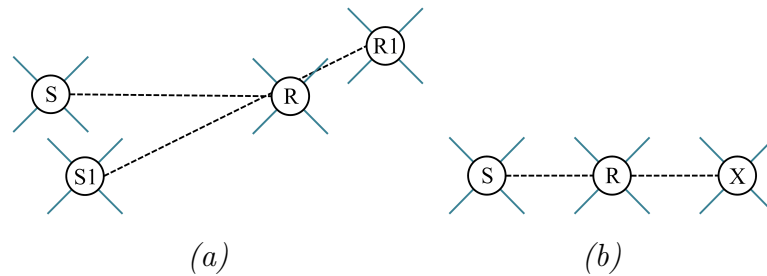

Figure 5.8: Link contention set

To better understand the operation of LSA, let us consider the example shown in Figure 3. Each of links L_{A-B} , L_{B-A} , L_{B-C} , and L_{C-B} is in the contention set of each other; thus, these links are assigned to different slots. In contrast, each of links L_{A-B} , L_{C-D} , and L_{E-F} is not in the contention set of each other; thus, these links are assigned to the same slot.

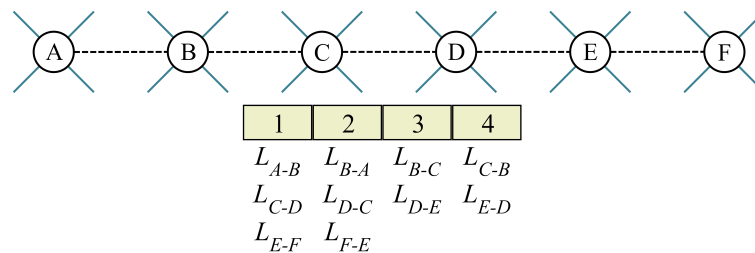

Figure 5.9: Link-slot assignment

Given the stationary nature of WMNs, LSA is executed only one time (at the network initialization), and thereafter, it will be valid throughout the network life; however, each time the network topology is modified (e.g., failure or addition of new mesh routers), LSA should be re-executed.

Algorithm 2 Link-slot assignment

```

1:  $N_l =$  Number of links in the network
2:  $N_s \leftarrow 1$ ; Number of slots (initialized to 1)
3:  $C_i =$  The contention set of link  $i$ 
4:  $S_j =$  The set of links assigned to slot  $j$ 
5:  $flag =$  Boolean variable
6: for  $i = 1$  to  $N_l$  do (For each link in the network)
7:    $flag \leftarrow$  false;
8:   for  $j = 1$  to  $N_s$  do (For each slot)
9:     if  $C_i \cap S_j == \emptyset$  then (If none of  $i$ 's contending links is assigned to slot  $j$ )
10:    add  $i$  to  $S_j$ ; (Assign  $i$  to slot  $j$ )
11:     $flag \leftarrow$  true;
12:    break;
13:   end if
14:   end for
15:   if  $flag == false$  then (If  $i$  is not assigned to any slot)
16:     $N_s \leftarrow N_s + 1$ ; (Add a new slot)
17:    add  $i$  to  $S_N$ ; (Assign  $i$  to the newly added slot)
18:   end if
19: end for

```

5.5.2 Transmission Scheduling

Let us assume that L_{S-R} is assigned to slot i and no transmission has been scheduled, during slot 1, slot 2, \dots , and slot $i - 1$, on a link that belongs to the contention set of L_{S-R} . To schedule a transmission on link L_{S-R} , S has to notify, during slot i , the sender of each L_{S-R} 's contending link (i.e., link in the contention set of L_{S-R}) that a transmission on L_{S-R} is scheduled to occur during the transmission subframe.

First sub-slot

As mentioned in Section 5.4.2.2, the time slot (slot i in this case) is divided into 2 sub-slots. During the first sub-slot, node S transmits a jamming signal using the omni-directional mode. The jamming signal is a busy-tone signal that does not carry any information; thus, it needs to be only sensed, i.e., it does not need to be decoded; it will be detected by all DO-neighbors around S, even when it is transmitted omni-directionally [135]. By detecting the direction-of-arrival and the power of the received signal, S's neighbors, including node R, recognize that S is the jamming-transmitter, and thus S will be a sender during the transmission subframe; furthermore, by checking the LSA, S's neighbors recognize that the

transmission of S will be on link L_{S-R} , and thus they postpone their transmissions on L_{S-R} 's contending links to the subsequent frame, i.e., they do not schedule transmissions during the corresponding assigned slots in the current frame.

Second sub-slot

During the second sub-slot, node R transmits a jamming signal using the omni-directional mode. Similarly to the first sub-slot, by detecting the direction-of-arrival and the power of the received signal, R's neighbors recognize that R is the jamming-transmitter, and thus R will be a receiver during the transmission subframe; furthermore, by checking the LSA, R's neighbors recognize that the reception of R will be on link L_{S-R} , and thus they postpone their transmissions on L_{S-R} 's contending links to the subsequent frame, i.e., they do not schedule transmissions during the corresponding assigned slots in the current frame. Consequently, at the end of L_{S-R} 's assigned slot, all DO-neighbors around nodes S and R are aware of the transmission scheduled on L_{S-R} ; thus, they postpone their transmissions on the L_{S-R} 's contending links to the subsequent frame (i.e., contending links will not be used for transmission at the same time). At the end of the scheduling sub-frame, S transmits its data packets to R using the directional mode. Simultaneously, all senders that succeeded (in the same way as S) scheduling transmissions during the scheduling subframe, transmit their packets using the directional mode.

Unlike MAC schemes that use tone-based signals [39][44], in FreeDMAC, the jamming signal and the data packets are transmitted on the same channel; thus, the available bandwidth is not split into two separate channels (i.e., the bandwidth is not offset). In addition, in FreeDMAC, the jamming-transmitter is identified based on the direction-of-arrival and the received power (this assumption is realistic given the stationary nature of WMNs); thus, a node is not required to be able to transmit/receive on multiple narrow frequency bands, and thus the hardware complexity is reduced (e.g., in ToneDMAC [39], the tone-transmitter is identified based on the frequency and the duration of the tone). Furthermore, unlike MAC schemes that use multi-directional RTS/CTS [67][77], in FreeDMAC, only two jamming signals are transmitted to notify all the DO-neighbors around the sender-receiver pair; thus, the heavy overhead of the circular RTS/CTS is avoided.

Example

For better understanding of the scheduling process, let us consider the example shown in Figure 5.10. Suppose that nodes C, D, E, and F have packets to transmit to nodes D, C, D, and E, respectively, while node B has packets to transmit to nodes A and C. The execution of LSA results in 4 time slots where (1) link L_{C-D} is assigned to the first slot; (2) Links L_{B-A} , L_{D-C} , and L_{F-E} are assigned to the second slot; (3) Link L_{B-C} is assigned to the

third slot; and (4) Link L_{E-D} is assigned to the fourth slot.

During the first sub-slot of the first slot, nodes A, B, D, E, and F remain idle, while node C transmits a jamming signal using the omni-directional mode; by detecting the direction-of-arrival and the received power of the jamming signal, and by checking the LSA, both nodes B and D recognize that C will be a sender on link L_{C-D} during the transmission subframe. Thereafter, during the second sub-slot of the same slot, node D transmits a jamming signal using the omni-directional mode; thus, similarly, node E recognizes that D will be receiver on link L_{C-D} during the transmission subframe.

Since link L_{D-C} is in the contention set of L_{C-D} , D postpones its transmission on L_{D-C} to the subsequent frame and remains idle during the second slot. On the other hand, since links L_{B-A} and L_{F-E} are not in the contention set of L_{C-D} , nodes B and F transmit a jamming signal omni-directionally during the first sub-slot of the second slot, and thereafter, nodes A and E transmit a jamming signal omni-directionally during the second sub-slot of the second slot

By now Node B is aware of the transmissions scheduled on link L_{B-A} (notified in second slot) and link L_{C-D} (notified in first slot). Since link L_{B-C} is in the contention set of both L_{B-A} and L_{C-D} , B postpones its transmission on L_{B-C} to the subsequent frame and remains idle during the third slot. At the end of the third slot, Node E has been notified (in previous slots) of the transmission scheduled on links L_{C-D} and L_{F-E} , and (2) link L_{E-D} is in the contention set of both L_{C-D} and L_{F-E} ; thus, E postpones its transmission on L_{E-D} to the subsequent frame and remains idle during the fourth slot.

After the end of the fourth slot, directional transmissions occur simultaneously (during the transmission subframe) on links L_{A-B} , L_{D-C} , and L_{F-E} . The operation of transmission scheduling is executed again during subsequent frames to complete the remaining transmissions.

5.5.3 Per-Link Fairness

As aforementioned, the priority of a link, when scheduling transmission, is inversely proportional to the index of its assigned slot; therefore, to provide fairness, in FreeDMAC, the scheduling priorities (i.e., link-slot assignment) are rotated at the beginning of each slot, i.e., if a link is assigned to slot i in the current frame, it will be assigned to slot $(i - 1)$ in the subsequent frame. For clarity, we consider the scenario shown in Figure 5.11; links (e.g., L_{B-A}) assigned to the second slot in the current frame are assigned to the first slot in the subsequent frame; similarly, links (e.g., L_{A-B}) assigned to the first slot in the current frame are assigned to the latest slot in the subsequent frame. However, the proposed rotation is

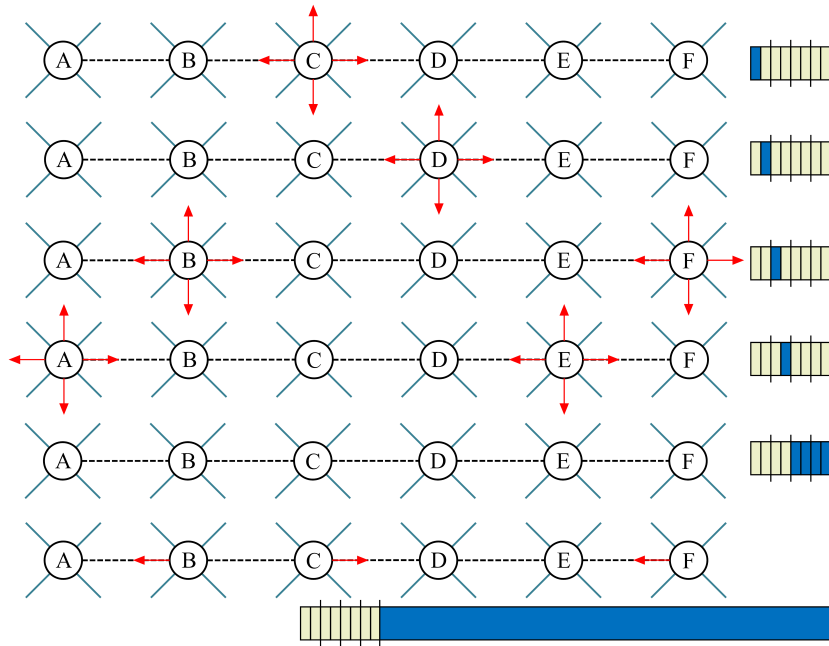

Figure 5.10: Transmission scheduling

not sufficient to provide per-link fairness; for instance, when using this rotation, link L_{E-F} has higher priority (i.e., is assigned to slot with lower index) than its contending link L_{F-E} in three of each four slots. To handle this issue, in FreeDMAC, the slots' indexes are rotated (i.e., slot i will be slot $(i - 1)$ and so on) periodically, where the period is equal to a predetermined number of frames, and thereafter, the link-slot assignment will be rotated according to the new slots' indexes.

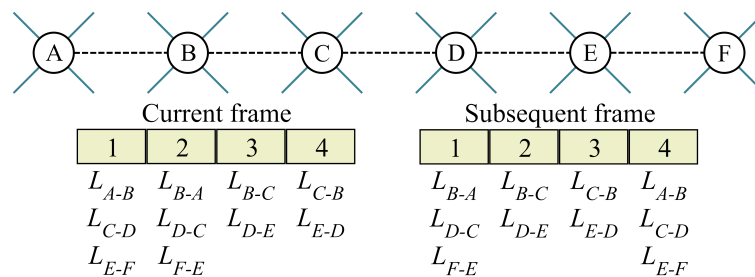

Figure 5.11: Per-link fairness

5.5.4 Per-Flow Fairness

In per-link fairness, a flow traversing a link with few flows gets more bandwidth allocation than a flow traversing a link with several flows; therefore, to provide per-flow fairness, heavily loaded links should get more bandwidth allocation than lightly loaded links⁶. To this end, FreeDMAC proposes to compute, for each link, an access weight that increases with its traffic load; node S uses this weight, when L_{S-R} is assigned to the first slot in the scheduling

⁶As aforementioned, we consider that all the network data flows have the same throughput demands.

subframe, to decide if it should (1) schedule a transmission on link L_{S-R} , or (2) give up the channel to be used by other links.

We define a contention domain as a maximal set of links, each of them contends with each other. In general, a link belongs to multiple overlapped contention domains; the contention set of a link is the union of the contention domains to which the link belongs. In per-flow fairness, the fraction of time in which the channel should be allocated to link L_{S-R} belonging to the contention domain D is proportional to the ratio of the number of flows traversing L_{S-R} to the total number of flows traversing L_{S-R} or any of the links belonging to D ; the fraction of time that should be allocated to L_{S-R} is then equal to $\frac{n_{L_{S-R}}}{n_{L_{S-R}} + \sum_{i=1}^N n_i}$, where $n_{L_{S-R}}$ is the number of flows traversing L_{S-R} , N is the number of links in D , and n_i ($1 \leq i \leq N$) is the number of flows traversing link i belonging to D . With multiple overlapped contention domains, a fraction of time should be computed from each contention domain, and then the smallest one should be considered.

On the other hand, in per-link fairness, the fraction of time during which the channel should be allocated to link L_{S-R} is $\frac{1}{N}$, where N is the number of slots in the scheduling subframe (i.e., link L_{S-R} will be assigned to the first slot in the scheduling subframe once every N frames). Then, the access weight ($x_{L_{S-R}}$) of link L_{S-R} is defined as follows:

$$x_{L_{S-R}} = N * \frac{n_{L_{S-R}}}{n_{L_{S-R}} + \sum_{i=1}^N n_i} \quad (5.1)$$

If $x_{L_{S-R}}$ is equal to 1, node S has to schedule a transmission on L_{S-R} during all the time-frames in which L_{S-R} is assigned to the first slot in the scheduling subframe; if L_{S-R} is assigned to slot i ($i \neq 1$), S is not allowed to schedule a transmission on L_{S-R} even if no transmission has been scheduled, during slot 1, slot 2, ..., or slot $(i - 1)$, on L_{S-R} 's contending links. If $x_{L_{S-R}}$ is smaller than 1, S will schedule a transmission on L_{S-R} during only a subset of the time-frames in which L_{S-R} is assigned to the first slot in the scheduling subframe. If $x_{L_{S-R}}$ is greater than 1, S has to schedule a transmission on L_{S-R} during all the time-frames in which L_{S-R} is assigned to the first slot in the scheduling subframe; if L_{S-R} is assigned to slot i ($i \neq 1$), S can schedule a transmission on L_{S-R} if no transmission is scheduled, during slot 1, slot 2, ..., or slot $(i - 1)$, on L_{S-R} 's contending links.

For clarity, let us consider the scenario shown in Figure 5.12, each of links L_{A-B} , L_{B-A} , L_{B-C} , and L_{C-B} is in the contention set of each other (they belong to the same contention domain); each of L_{B-A} and L_{B-C} is traversed by only one flow, L_{C-B} is traversed by two flows, and L_{A-B} is traversed by four flows. According to Equation (5.1), the access weight are $x_{L_{A-B}} = 2$, $x_{L_{B-A}} = 0.5$, $x_{L_{B-C}} = 0.5$, and $x_{L_{C-B}} = 1$; thus, each two time-frames in

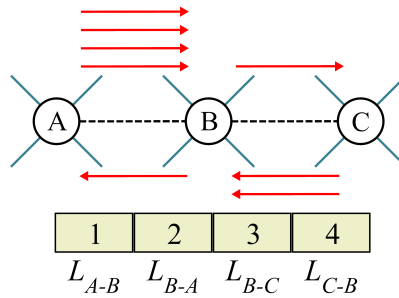

Figure 5.12: Per-flow fairness

which L_{B-A} (or L_{B-C}) is assigned to the first slot in the scheduling subframe, node B should schedule a transmission on L_{B-A} (or L_{B-C}) during one time-frame, and gives up the channel during the other time-frame. On the other hand, node A should schedule a transmission on L_{A-B} during (1) all the time-frames in which L_{A-B} is assigned to the first slot in the scheduling subframe, and (2) all the time-frames given up by node B. Finally, node C should schedule a transmission on L_{C-B} during all the time-frames in which L_{C-B} is assigned to the first slot; however, it does not schedule a transmission during any of the time-frames given up by node B.

It is worth noting that the proposed access weight provides fairness among single-hop flows (as in Figure 5.12). For multi-hop flows, the access weight should be computed for each link traversed by the flow, then the flow sending rate should be regulated according to the most constrained one (i.e., link with the minimum access weight). Furthermore, the proposed access weight requires an information exchange among the senders of links belonging to same contention domain (i.e., node S should be aware of the number of flows traversing each link in the contention set of L_{S-R}).

5.5.5 Discussion

In this Section, we discuss the ability of FreeDMAC to achieve the objectives stated earlier in the chapter. More specifically, we discuss how FreeDMAC resolves beamforming-related problems and provides fairness and scalability.

Deafness and hidden node problems: In FreeDMAC, synchronized transmissions are scheduled using a deterministic contention-free algorithm in which contending links are assigned to different slots; when scheduling a transmission on link L_{S-R} during the L_{S-R} 's assigned slot, the sender of each L_{S-R} 's contending link is notified of the transmission on L_{S-R} . These notifications allow each node to be aware of all ongoing neighboring transmissions (i.e., transmissions that may contend with one of its outgoing links); thus, no transmission will be scheduled, on any of the L_{S-R} 's contending links, and thus the deafness and hidden node problems, caused by unheard RTS/CTS problems, are avoided.

HoL blocking problem: FreeDMAC proposes a link-based scheduling in which the transmission rights are assigned to links instead of nodes; thus, when the transmission on an outgoing link is blocked (i.e., cannot be scheduled), the transmission on the other outgoing links will not be impacted, and thus, given the complete neighborhood awareness provided at each node, the HoL blocking problem is eliminated.

MAC-layer capture problem: In FreeDMAC, when a node receives multiple jamming signals from different directions, it will be able to (1) recognize that there are multiple senders/receivers among its neighbors; and (2) identify these senders/receivers based on the direction-of-arrival and the power of the received jamming signals; thus, a node is able to recognize multiple neighboring transmissions, even when they are concurrently scheduled, and thus the MAC-layer capture problem will no longer exist. Indeed, the MAC-layer capture problem occurs when a node misses the reception of a productive packet (e.g., RTS frame destined for it) because it has just beamformed in another direction to receive an unproductive one (e.g., RTS frame not destined for it).

Hidden node problem due to asymmetry in gain: In FreeDMAC, when scheduling a transmission on link L_{S-R} , all the DO neighbors around nodes S and R are notified, and thus the hidden node problem, caused by gain asymmetry, is largely alleviated; however, it will not be completely avoided. Indeed, it is possible that an S's (resp. R's) DD-neighbor, which is located in the direction of R (resp. S), is not a DO-neighbor of R (S); this being said, we believe that, given the stationary nature of WMNs, such a situation can be avoided in the phase of the WMN deployment.

Scalability: Being contention-free, the proposed scheduling completely eliminates the case of collisions due to failed transmission attempts; thus, (1) when the traffic load is heavy, the access performance will not be affected, and thus the bandwidth will not be wasted, and (2) the control overhead is reduced, and thus the bandwidth utilization will be improved.

Fairness: FreeDMAC (1) rotates the link-slot assignment at the beginning of each time-frame resulting in per-link fairness; and (2) computes, for each link, an access weight that increases with its traffic load (the bigger the weight, the more bandwidth allocated to the link), resulting in per-flow fairness.

To conclude, we can state that FreeDMAC provides a complete solution to all the beamforming-related problems, and at the same time, realizes efficient and fair bandwidth utilization; it also scales with the traffic load. However, FreeDMAC suffers a limitation that arises when a node is not be able to identify the jamming-transmitter because it has multiple neighbors located in the same direction; we argue that such a situation is infrequent in WMNs. Indeed, in WMNs, (1) nodes are placed in fixed locations and mobility infrequently occurs; and (2)

a node acts as an access point for many end-users; thus, typically, the nodes are not closely located, and thus the situation of unidentified jamming-transmitters can be avoided.

5.6 FreeDMAC Evaluation

In this section, we evaluate, via simulations, the performance of FreeDMAC and compare it to the performance of IEEE 802.11 (with omni-directional antennas), Basic DMAC [40] with directional physical carrier sensing (DMAC-DPCS), Basic DMAC with omni-directional physical carrier sensing (DMAC-OPCS), and CDR-MAC [78]; the Basic DMAC and CDR-MAC are commonly considered as typical representatives of the contention-based MAC schemes that use single-directional and multi-directional RTS/CTS, respectively. We used our developed event driven simulator. Table 5.1 shows the simulation parameters. Other parameters, not shown in Table 5.1 (e.g., interframe space, backoff contention window), are set according to the IEEE 802.11 DSSS specifications [13].

Table 5.1: Simulation parameters

Parameter	Value
Channel rate	11 Mbps
Packet size	1024 bytes
Sub-slot time (FreeDMAC)	20 μs
Slot time (other schemes)	20 μs
RTS retry limit (other schemes)	7
Propagation model	Free propagation loss
Omni-directional communication range	250 m
Directional communication range	500 m
Directional beam width	60-degree
Number of beams per node	6
Antenna model	Switched beam
Traffic model	CBR

To show the effectiveness of FreeDMAC, we run simulations using small-size scenarios that enable beamforming-related problems (we focus on the deafness problem⁷). To study the scalability of FreeDMAC, we run simulations using large-size WMNs. The focus of the simulations is to evaluate the capacity of FreeDMAC in providing fairness and achieving

⁷Deafness is by far most critical challenge when using beamforming antennas in WMNs [29]. In addition, by focusing on deafness, we test the ability of FreeDMAC to solve the incomplete neighborhood awareness, at network nodes, that is the main cause of all beamforming-related problems.

efficient bandwidth utilization. Note that some simulation parameters and scenarios are inspired from [123][124].

5.6.1 Small-size scenarios

We simulate three scenarios that illustrate the impact of deafness in different ways, and two scenarios that illustrate the difference between per-link fairness and per-flow fairness.

Intra-flow Deafness

This scenario (Figure 5.13a) is composed of a single two-hop flow (F_{A-C}) that originates from node A to node C via node B. The deafness problem arises when A fails to transmit to B because B is beamformed in the direction of C to forward data packets received from A. The spatial reuse is not possible (links L_{A-B} and L_{B-C} cannot be active for transmission at the same time); the aim is to measure the impact of deafness on each MAC scheme. Note that the impact of deafness is not too critical in this scenario because no flow originates from B; the deafness duration is limited by the size of the packets burst received from A. Figure 5.14 shows the throughput of flow F_{A-C} versus the sending rate. We observe that (1) FreeDMAC outperforms all other schemes; this can be explained by the fact that FreeDMAC uses contention-free scheduling that reduces control overhead and avoids deafness by maintaining, at each node, a complete awareness of all ongoing neighboring transmissions; (2) IEEE 802.11 outperforms DMAC and CDR-MAC; this is due to the use of omni-directional transmission/reception, by IEEE 802.11, which inherently eliminates deafness; (3) DMAC-OPCS outperforms DMAC-DPCS; the reason of this outperforming is clarified in the second scenario; and (4) CDR-MAC achieves the smallest throughput; indeed, even though CDR-MAC mitigates deafness, the heavy overhead generated by the transmission of circular RTS frames offsets the gains of this deafness mitigation.

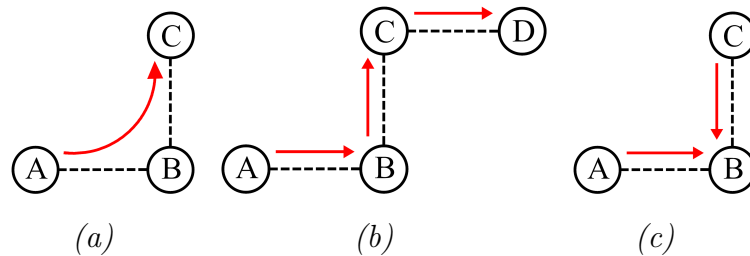

Figure 5.13: Deafness scenarios

Deadlock

This scenario (Figure 5.13b) is composed of three single-hop flows: F_{A-B} , F_{B-C} , and F_{C-D} . It differs from the previous scenario in three points: (1) there are two consecutive deaf nodes; node B is deaf to node A because it is beamformed in the direction of node C to transmit

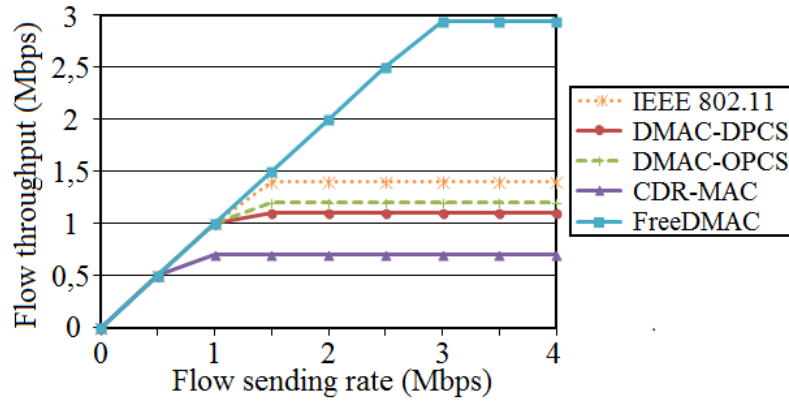

Figure 5.14: Flow throughput vs. flow sending rate (intra-flow deafness scenario)

data packets of flow F_{B-C} , and C is deaf to B because it is beamformed in the direction of node D to transmit data packets of flow F_{C-D} (deadlock scenario); (2) the impact of deafness is more critical because the deaf nodes are sources of flows; thus, the deafness duration is not limited by the size of a packets burst; (3) spatial reuse is possible; links L_{A-B} and L_{C-D} can be active for transmission at the same time. The aim of this scenario is to measure the fairness capacity of the 5 MAC schemes. Figure 5.15 shows the per-link throughput versus the per-flow sending rate. Note that, in this scenario, there is no difference between per-link fairness and per-flow fairness.

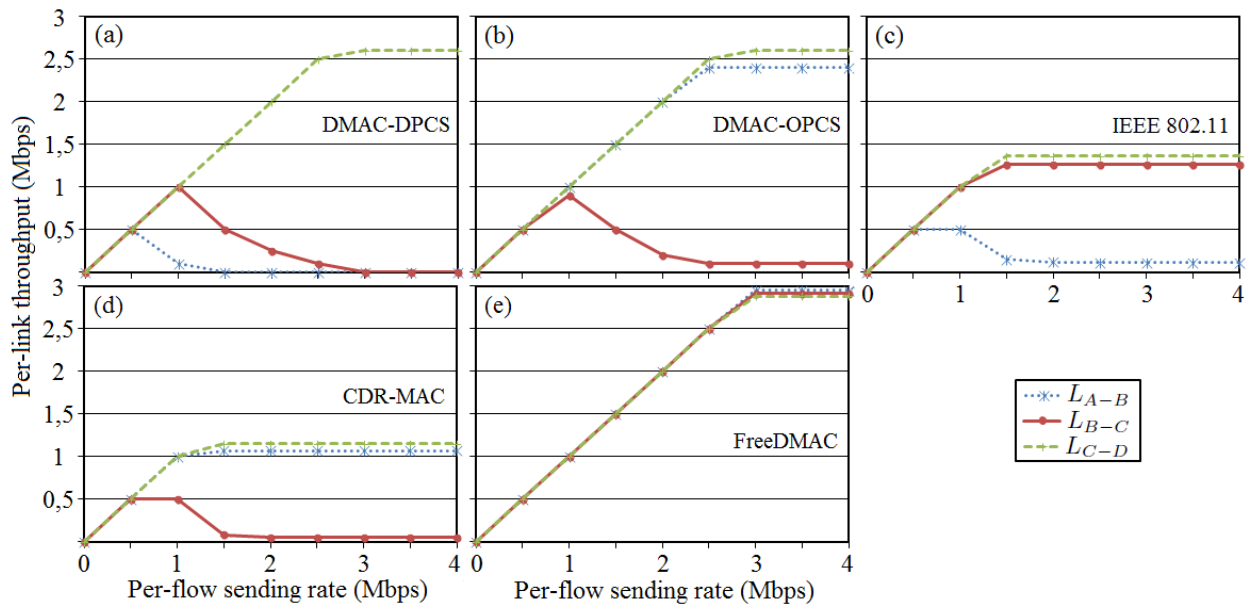

Figure 5.15: Per-link throughput vs. flow sending rate (deadlock scenario)

In the case of DMAC-DPCS (Figure 5.15a), we observe that when the traffic load increases, links L_{A-B} and L_{B-C} fully starve (i.e., throughput is almost zero) while the throughput on link L_{C-D} increases. Indeed, in DMAC-DPCS, the RTS/CTS/DATA/ACK handshaking, the PCS, and the backoff mode are all performed directionally. Therefore,

when the traffic load increases, C will be permanently beamformed in the direction of D to transmit data packets of flow F_{C-D} , and thus B fails to transmit data packets of flow F_{B-C} . In this case, B enters the backoff mode in the direction of C and disables the beams to the other directions; thus, A fails to transmit data packets of flow F_{A-B} . As a result, in case of heavy traffic load, link L_{C-D} will be active for transmission all the time while links L_{A-B} and L_{B-C} will not be able to carry any traffic (i.e., starve).

In the case of DMAC-OPCS (Figure 5.15b), we observe that when the traffic load increases, link L_{B-C} starves, while the throughput of links L_{A-B} and L_{C-D} increases. Indeed, in DNAV-OPCS, the RTS/CTS/DATA/ACK handshaking is performed directionally, while the PCS and the backoff mode are performed omni-directionally. Therefore, when B fails to transmit to C because C is transmitting to node D, it enters the backoff mode omni-directionally; thus, it will be able to receive the RTS frame from A (to establish the transmission on L_{A-B}). Thereafter, due to the asynchronous nature of DMAC-OPCS (contention-based scheme), at the end of the transmission on L_{A-B} , B fails again to transmit to C because C is transmitting another packet to D. As a result, in case of heavy traffic load, L_{A-B} and L_{C-D} will be active for transmission all the time, while L_{B-C} will starve.

Figure 5.15c shows that CDR-MAC and DMAC-OPCS follow the same pattern but with lower throughput achieved by CDR-MAC. Indeed, in CDR-MAC, by the use of circular RTS, B will be informed of the transmission on link L_{C-D} , and thus it will defer its transmission on link L_{B-C} ; thereafter, B receives an RTS from A and the transmission on link L_{A-B} takes place. Similarly to the case of DNAV-OPCS, because of the asynchronous nature of CDR-MAC, in case of heavy traffic load, L_{A-B} and L_{C-D} will be active for transmission all the time, while L_{B-C} will starve. With respect to the underperformance of CDR-MAC, in terms of throughput, compared to DNAV-OPCS, it is caused by the heavy overhead generated by circular RTS frames.

In the case of IEEE 802.11, links L_{B-C} and L_{C-D} achieve nearly the same throughput, while the throughput of link L_{A-B} is very low (Figure 5.15d). Indeed, because of the use of omni-directional transmission/reception of IEEE 802.11, only one link can be active for transmission at a given time. Furthermore, given their locations, nodes B and C are able to overhear the RTS/CTS handshaking of any transmission; thus, they will be able to appropriately set their NAVs, and then, keep their chances high to acquire the channel (i.e., transmit on links L_{B-C} and L_{C-D}). On the other hand, node A cannot overhear transmissions on L_{C-D} making it experiencing RTS failures (B cannot respond with CTS); thus, it will increase its backoff window; this explains the low throughput achieved by L_{A-B} .

Finally, in the case of FreeDMAC, an ideal per-link fairness is maintained, and the

throughput of each link is considerably high. Indeed, FreeDMAC assigns links L_{A-B} and L_{C-D} to the same slot, while link L_{B-C} to another slot; this enables spatial reuse and provides a contention-free scheduling (i.e., reduce the control overhead). Furthermore, FreeDMAC rotates the link-slot assignment at the beginning of each time-frame; thus, when L_{A-B} and L_{C-D} are active for transmission in one time-frame, L_{B-C} will be active in the subsequent time-frame, and vice versa (i.e., per-link fairness). As a result, FreeDMAC achieves an efficient bandwidth utilization, and at the same time, provides an ideal per-link fairness.

Deafness at the Receiver

This scenario (Figure 5.13c) is composed of two single-hop flows: F_{A-B} , and F_{C-B} . Figure 5.16a shows the aggregate throughput (i.e., sum of throughputs) versus the per-flow sending rate. The results are similar to these of the first scenario except that DMAC-DPCS and DMAC-OPCS achieve the same throughput in this scenario; this can be explained by the fact that the deaf node (node B) is a receiver (not a sender), and thus the impact of the PCS and the backoff mode is eliminated. It is worth noting that, due to the symmetry of the topology, the throughput is fairly allocated between the two flows (links) in all schemes (not shown in Figure 5.16a). Figure 5.16b shows the average delay versus the per-flow sending rate; we observe that FreeDMAC significantly outperforms all other schemes. Indeed, in the other schemes, when nodes A and C contend for transmitting to node B and one of them succeeds in exchanging the RTS/CTS/DATA/ACK handshake, the winner node resets its backoff contention window while the other one keeps increasing its window size, and thus the winner node will have a higher probability to transmit a new packet. As a result, node A and C alternately acquire the channel, each for multiple transmissions, resulting in high average delay. On the other hand, in FreeDMAC, link-slot assignments (i.e., scheduling priorities) are rotated at the beginning of each time-frame; thus, nodes A and C alternately acquire the channel, each for only a single transmission, resulting in low average delay.

In summary, even when DMAC-DPCS, DMAC-OPCS, and CDR-MAC achieve fairness, they achieve a long-term fairness that results in high average delay; in contrast, FreeDMAC maintains a short-term fairness that results in low average delay. Note that the delay is critical for most of nowadays applications.

Per-link fairness and per-flow fairness

To illustrate the difference between per-link fairness and per-flow fairness, we propose the scenarios shown in Figure 5.17. Table 5.6.1 presents the throughput of each flow versus the per-flow sending rate in the cases where per-link and per-flow fairness are enabled (in FreeDMAC), respectively.

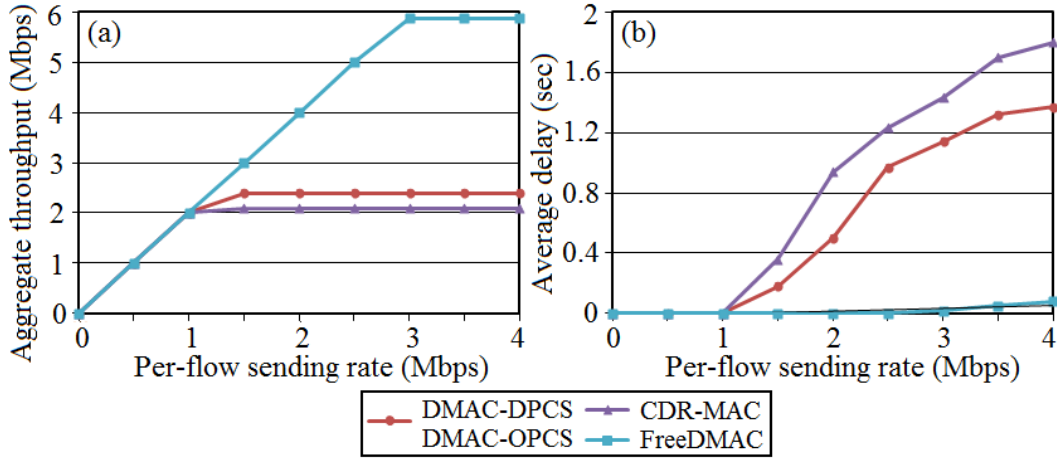

Figure 5.16: Aggregate throughput and average delay vs. flow sending rate (deafness at the receiver scenario)

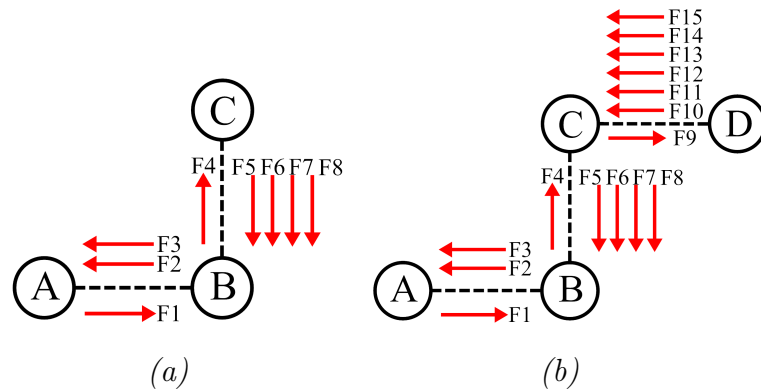

Figure 5.17: Small-size topologies that illustrate fairness

In the first scenario 5.17a, all links contend with each other; thus, there is only a single contention domain. We observe (Table 5.6.1) that when traffic load increases, in the case of per-link fairness, the throughput of a flow is inversely proportional to the number of flows sharing the same link with this flow; for instance, because links L_{A-B} , L_{B-A} , and L_{C-B} are traversed by 1, 2, and 4 flows, respectively, the throughput of flow F_1 is equal to the half of the throughput of flow F_2 , and at the same time, to the quarter of the throughput of flow F_5 . On the contrary, in the case of per-flow fairness, all flows achieve the same throughput (Table 5.6.1). It is worth noting that the aggregate throughput is the same in both per-link and per-flow fairness cases.

In the second scenario, we observe that (1) even in the case of per-flow fairness, the throughput of flows F_1 , F_2 , and F_3 is higher than the throughput of the other flows; and (2) the aggregate throughput in the case of per-flow fairness is lower than the aggregate throughput in the case of per-link fairness. Let us now explain these findings: Links L_{A-B} , L_{B-A} , L_{B-C} , and L_{C-B} contend with each other, and links L_{B-C} , L_{C-B} , L_{C-D} , and L_{D-C} contend with each other. Thus, there are two contention domains: One domain is traversed

Table 5.2: Per-flow sending rates of Figures 5.17a and 5.17b
Scenario of Figure 5.17a

Per-flow sending rate		0.1	0.3	0.5	0.7	0.9
Per-link fairness	Flow 1	0.099	0.299	0.499	0.699	0.768
	Flow 2-3	0.098	0.297	0.496	0.418	0.389
	Flow 4	0.099	0.298	0.498	0.696	0.769
	Flow 5-8	0.097	0.296	0.269	0.210	0.193
	Aggregate	0.782	2.375	3.065	3.071	3.087
Per-flow fairness	Flow 1	0.099	0.299	0.385	0.385	0.385
	Flow 2-3	0.098	0.297	0.383	0.383	0.383
	Flow 4	0.099	0.298	0.385	0.384	0.385
	Flow 5-8	0.097	0.296	0.381	0.382	0.383
	Aggregate	0.782	2.375	3.060	3.063	3.068

Scenario of Figure 5.17b

Per-flow sending rate		0.1	0.2	0.3	0.6	0.8
Per-link fairness	Flow 1	0.099	0.199	0.299	0.599	0.769
	Flow 2-3	0.099	0.198	0.297	0.386	0.386
	Flow 4	0.099	0.199	0.298	0.598	0.769
	Flow 5-8	0.098	0.197	0.296	0.235	0.192
	Flow 9	0.099	0.199	0.299	0.597	0.767
	Flow 10-15	0.097	0.196	0.213	0.157	0.128
	Aggregate	1.463	2.957	3.952	4.448	4.613
Per-flow fairness	Flow 1	0.099	0.199	0.299	0.382	0.382
	Flow 2-3	0.099	0.198	0.299	0.381	0.381
	Flow 4	0.098	0.199	0.257	0.256	0.256
	Flow 5-8	0.098	0.197	0.256	0.253	0.253
	Flow 9	0.099	0.199	0.256	0.255	0.255
	Flow 10-15	0.097	0.196	0.255	0.252	0.252
	Aggregate	1.462	2.957	3.964	4.179	4.179

by 8 flows and the other domain is traversed by 12 flows. As explained in Section 5.5.4, the access weight of a link is computed based on the number of flows traversing the contention domain to which the link belongs; thus, the access weights of links L_{A-B} and L_{B-A} are higher than those of the other links, and accordingly, the throughputs of flows F_1 , F_2 , and F_3 are higher compared to the other flows. On the other hand, links L_{B-C} and L_{C-B} belong to both of the contention domains; thus, (1) they have two access weights (one from

each domain), and (2) they should consider the smaller one (that of the second contention domain). Consequently, they cannot fully exploit the bandwidth reserved to which from the first contention domain (that with the highest access weight), resulting in an underutilization of the bandwidth resources.

We conclude that the bandwidth resources are efficiently used in the case of per-link fairness and are fairly allocated in the case of per-flow fairness.

5.6.2 Large Scale Topologies

In this set of simulations, we used a WMN configuration that consists of 30 nodes placed randomly in an area of 1,000 m x 1,000 m. Five flows were set up simultaneously between randomly selected source-destination pairs⁸. The results are averaged over 20 simulation runs.

To study the efficiency of bandwidth utilization, we plot the aggregate end-to-end throughput and the average end-to-end delay. To study the fairness capacity, of the 5 schemes, in large-scale WMNs, we choose the commonly used Jain's Fairness Index [66] defined as follows:

$$FI = \frac{(\sum_{i=1}^n T_i)^2}{n * \sum_{i=1}^n T_i^2} \quad (5.2)$$

where FI is the Fairness Index, T_i is the end-to-end throughput achieved by flow i , and n is the number of flows in the network. The fairness index can vary between 0 and 1; the closer the Fairness Index to 1, the fairer the bandwidth allocation.

Figure 5.18a shows the aggregate end-to-end throughput versus the per-flow sending rate. We observe that FreeDMAC significantly outperforms the other MAC schemes; this shows the ability of FreeDMAC to (1) reduce the control overhead by performing a contention-free scheduling; (2) avoid the beamforming-related problems by maintaining a complete awareness, at each node, about all ongoing neighboring transmissions; and (3) improve considerably the spatial reuse by fully exploiting the beamforming antennas (link-based instead of node-based scheduling). We also observe that (1) even though they suffer deafness, DMAC-DPCS and DMAC-OPCS outperform IEEE 802.11 because of their ability to benefit from the spatial reuse; and (2) CDR-MAC performs the worst; indeed, although CDR-MAC mitigates deafness, the heavy overhead generated by circular RTS frames almost cancels the benefit of spatial reuse.

⁸This simulation setup is commonly used in directional MAC schemes (e.g., [123][124]).

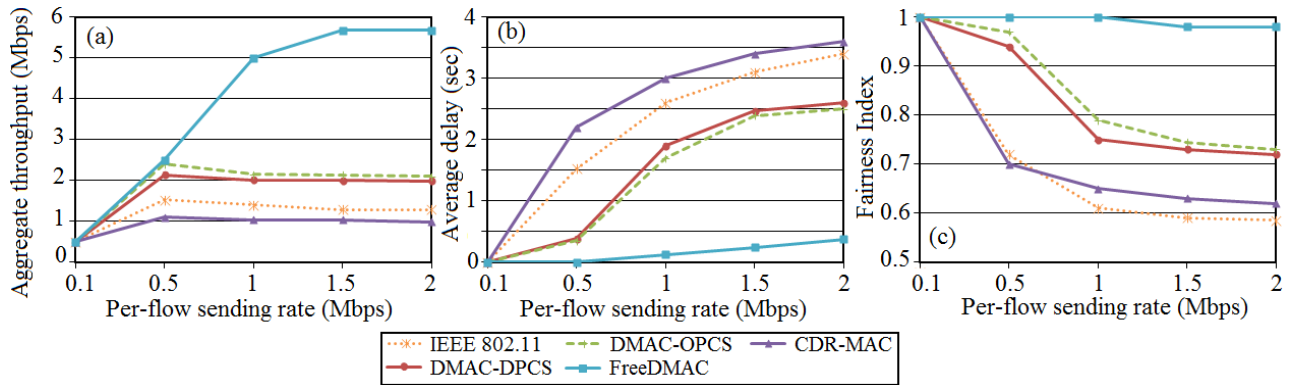

Figure 5.18: First random scenario: Aggregate throughput, average end-to-end delay, and Fairness Index vs. flow sending rate

Figure 5.18b shows that FreeDMAC outperforms the other MAC schemes; this can be explained as follows: (1) FreeDMAC maintains, at each node, a complete neighborhood awareness; thus, no additional delay is caused by deafness or other beamforming-related problems; (2) FreeDMAC provides a contention-free scheduling that completely eliminates collisions; thus, no additional delay is caused by packet retransmissions; and (3) FreeDMAC provides a short-term fairness (thanks to the rotation of link slot assignments); thus, no additional delay is caused by the transmission of packets bursts at neighboring links. The underperformance of the other schemes can be explained generally by the fact that (1) due to contention-based nature of these schemes, when traffic load increases, a considerable amount of collisions occurs because of severe contention, resulting in numerous retransmissions (and thus extra delay); and (2), when a node acquires a channel, it can transmit several packets causing neighboring nodes to increase their backoff contention windows resulting in high end-to-end delay. In particular, they can be explained by the fact that (1) DMAC-DPCS suffers from severe deafness; (2) CDR-MAC suffers from heavy overhead; (3) IEEE 802.11 suffers from omni-directional communications (i.e., no spatial reuse); and (4) DMAC-OPCS suffers from a limited spatial reuse because a node has to sense an idle channel omni-directionally before accessing it.

Figure 5.18c shows the Jain's Fairness Index versus the per-flow sending rate. We observe that FreeDMAC achieves near perfect fairness (Jain's index approaches 1); this is expected given the proposed mechanisms (the rotation of link-slot assignments and the link's access weight) that are able to provide both per-link and per-flow fairness. Note that, in case of heavy traffic load, the Fairness Index is slightly lower than 1; indeed, some flows experience more contention than others because belong to contention domains traversed by larger numbers of flows, and thus achieve less throughput. We also observe that the other MAC schemes experience low Fairness Index; indeed, without an explicit consideration of fairness, when

traffic load increases, the impact of beamforming-related problems and location-dependent carrier sensing will be aggravated, resulting in severe unfairness situations.

To confirm our findings, we run simulations using a WMN configuration that consists of 30 randomly distributed nodes, 2 gateways and 6 flows each destined to the closest gateway. Figure 5.19 shows again that FreeDMAC outperforms handily the other MAC schemes in terms of fairness, aggregate throughput, and average delay.

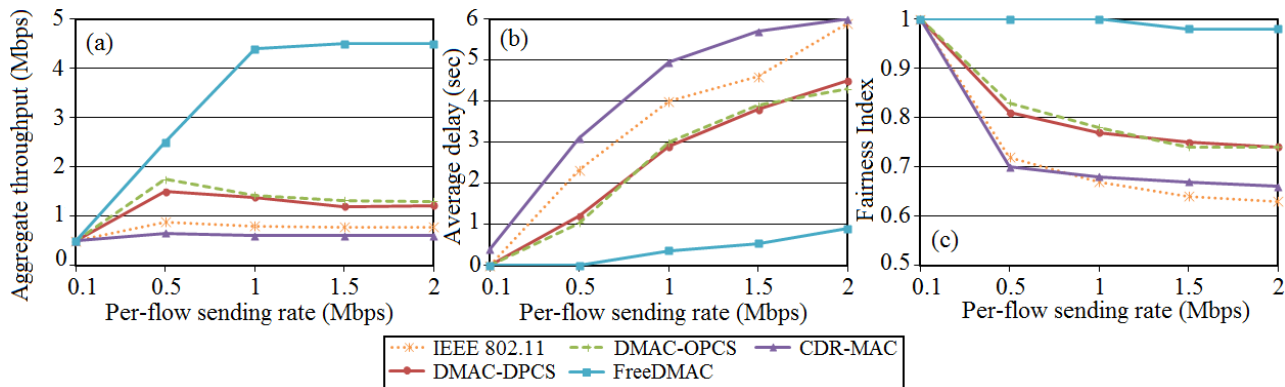

Figure 5.19: Second random scenario: Aggregate throughput, average end-to-end delay, and Fairness Index vs. flow sending rate

5.7 Conclusion

In this chapter, we proposed a TDMA-based Directional MAC scheme, called FreeDMAC, that aims at avoiding beamforming-related problems, and at the same time, providing efficient and fair bandwidth utilization. To provide efficient bandwidth utilization, FreeDMAC proposes a contention-free link-based scheduling; being contention-free, FreeDMAC reduces control overhead compared to RTS/CTS-based contention schemes, while being link-based, FreeDMAC significantly improves spatial reuse. To avoid beamforming-related problems, FreeDMAC allows each network node to be aware of all ongoing neighboring transmissions; indeed, in FreeDMAC, when scheduling a transmission on link L during L 's assigned slot, the sender of each L 's contending link is notified, and thus no transmission is scheduled on these links. To provide fairness, FreeDMAC rotates link-slot assignments at the beginning of each time-frame, resulting in per-link fairness; it computes, for each link, an access weight that increases with its traffic load, resulting in per-flow fairness. The simulation results show that FreeDMAC outperforms existing MAC schemes in terms of throughput, delay, and fairness.

Part II Conclusion

In this thesis part, we have considered the WMNs that use beamforming antennas. First, we have illustrated the beamforming-related challenges facing the MAC layer in WMNs. Second, we have presented an overview of research covering directional MAC schemes in WMNs. Third, we have proposed, FreeDMAC, a TDMA-based directional MAC scheme that (1) guarantees that each node is aware of all ongoing transmissions within its neighborhood, and thus avoid beamforming-related problems making efficient use of bandwidth; and (2) provide two levels of fairness: Per-link and per-flow fairness. Finally, we have proven, via in-depth simulations, the ability of FreeDMAC to achieve efficient and fair bandwidth utilization in WMNs using beamforming antennas. In the next chapter, we investigate several opportunities for future works in WMNs using beamforming antennas.

Chapter 6

Conclusion and Future Works

Contents

6.1 Conclusion	139
6.1.1 802.11-based Wireless Mesh Networks	140
6.1.2 Wireless Mesh Networks using Beamforming Antennas	141
6.2 Possible Extensions	142
6.2.1 Interference range	142
6.2.2 Flows with different throughput demands	143
6.2.3 Analytical modeling	143
6.3 Future Directions	143
6.3.1 Quality-of-Service support	143
6.3.2 Directional routing	144

In this chapter, we conclude the thesis, discuss possible extensions of the proposed schemes, and highlight future directions.

6.1 Conclusion

Showing quick progress and inspiring numerous applications, wireless mesh networks are becoming an essential part of next-generation wireless networks, and thus attracting an increasing research interest. Throughout this thesis we have focused on maximizing utilization and achieving fair allocation of the bandwidth resources in WMNs. We have considered two WMN environments: WMN based on the IEEE 802.11 MAC standard and WMN using beamforming antennas.

6.1.1 802.11-based Wireless Mesh Networks

The major incentives for considering IEEE 802.11-based WMNs come from their envisioned advantages: cheap devices and widespread deployment. Nevertheless, IEEE 802.11 has been shown performing poor in multi-hop environments such as WMNs; it creates, especially when used with TCP-like congestion control, serious unfairness and even complete starvation among competing data flows. Therefore, in the first part of this thesis, we have proposed NICC, a congestion control scheme that aims at achieving efficient and fair bandwidth utilization in IEEE 802.11-based WMNs. We have considered congestion control because prior research has shown that fairness becomes a critical issue only when the network is congested. We have proven, using different WMN scenarios, that congestion is a neighborhood-related problem, and not a link-based one. Therefore, to implement fairness, the proposed NICC handles congestion using mutual cooperation among nodes within a wireless neighborhood. On the other hand, in order not to affect the scarce bandwidth of WMNs, NICC makes use of some underexploited fields in the IEEE 802.11 frame header leading to provide an implicit multi-bit congestion feedback. Being multi-bit, this feedback yields source node a fine-grained indication of the congestion degree, and thus, ensures accurate rate control, and being implicit, it generates no overhead, making efficient use of bandwidth. As a result, NICC solves starvation without affecting the scarce bandwidth of WMNs.

Furthermore, we have shown that asynchronous rate control allows/forces some flows to increase/decrease their sending rates more quickly than the other ones. Therefore, to implement fairness, in addition to neighborhood-based congestion management, NICC guarantees that competing flows are regulated at the same timescales. On the other hand, we have shown that, in conventional congestion control schemes, flows traversing several congested neighborhoods undergo unnecessary rate regulations, thereby affecting both fairness and bandwidth efficiency. Therefore, to implement fairness, NICC allows source nodes to negatively react to some congestion feedbacks, and thus guarantees that a flow is regulated according to the most congested neighborhood traversed by it, independently of the number of traversed congested neighborhoods.

We have evaluated NICC in both small- and large-size topologies. First, compared to conventional congestion control schemes that do not recognize congestion as a neighborhood-related problem, the simulation results have shown that NICC handily outperforms in terms of fairness and slightly underperforms in terms of overall throughput; the slight underperformance in terms of throughput is due to the fact that, in the other schemes, the starved flows are usually multi-hop ones, and thus the whole bandwidth is allocated to single-hop flows, resulting in high throughput. However, when achieving fairness, NICC allocates more

bandwidth to multi-hop flows, resulting in low throughput. Second, compared to fairness-aware congestion control schemes, the simulation results have shown that NICC outperforms in terms of both fairness and throughput; this outperformance is mainly due to the NICC's implicit multi-bit congestion feedback that ensures accurate rate control without generating overhead.

To improve the NICC performance, we have proposed FCD, a Fuzzy-based congestion detection mechanism that is able to compute different congestion degrees, and thus support the NICC's multi-bit congestion feedback, enabling accurate rate control. FCD determines the congestion degree based on the evolution of the queue length at intermediate nodes using a fuzzy logic controller. Simulation results have shown that FCD maintains lightly loaded queues that result in minimizing the packets end-to-end delay as well as avoiding queue overflows (i.e., improving the packet delivery ratio).

6.1.2 Wireless Mesh Networks using Beamforming Antennas

The major incentives for considering beamforming antennas come from their envisioned advantages: spatial reusability, interference reduction, and connectivity extension. However, exploiting the benefits of beamforming antennas requires the design of novel MAC schemes. Currently proposed MAC schemes, which are mostly contention-based, have encountered unprecedented MAC problems such as deafness and head-of-line blocking; starvation and bandwidth waste are the common results of these problems. Therefore, in the second part of this thesis, we have proposed FreeDMAC, a TDMA-based MAC protocol that aim at avoiding beamforming-related problems, and at the same time, providing efficient and fair bandwidth utilization in WMNs. We have shown that because of the asynchronous nature of contention-based directional MAC schemes, a node is usually unaware of all ongoing transmissions in its neighborhood; thus, it may initiate inappropriate transmissions that result in unfair use and waste of bandwidth. Therefore, to outperform these challenges, the main purpose of FreeDMAC is to guarantee that each node is aware, at each time, of all ongoing neighboring transmissions, and thus avoid beamforming-related problems, making efficient use of bandwidth.

By exploiting the stationary nature of WMNs, FreeDMAC schedules synchronized transmissions using a contention-free link-based algorithm without the need of an RTS/CTS-based handshaking prior to each packet transmission. Being contention-free, the proposed scheduling significantly reduces the control overhead, and being link-based, it considerably increases the number of simultaneous transmissions within a neighborhood, resulting in further improve of the bandwidth utilization.

Furthermore, FreeDMAC provides two levels of fairness: Per-link and per-flow fairness. Per-link fairness is provided by rotating the link-slot assignment upon each time frame, and per-flow fairness is provided by computing, for each link, an access weight that increases with the number of flows traversing the link.

We have evaluated FreeDMAC in both small- and large-size topologies. The simulation results have shown that FreeDMAC handily outperforms existing directional MAC schemes in terms of fairness, overall throughput, and end-to-end delay. Moreover, the results have proven that FreeDMAC can achieve both short- and long-term fairness. Finally, the results have shown that the bandwidth resources are efficiently used in case of per-link fairness, and are fairly allocated in case of per-flow fairness.

The schemes proposed in this thesis have resulted in several publications [48] [49] [50] [51] [52] [53] [54] [72] [73] [74]. In the next section, we highlight possible extensions that aim at improving and enhancing the proposed schemes.

6.2 Possible Extensions

We believe that the proposed schemes NICC, FCD, and FreeDMAC take a significant step towards achieving efficient and fair bandwidth utilization in WMNs. However, to improve the performance of these schemes, several important issues still need to be addressed.

6.2.1 Interference range

The key idea behind NICC is to recognize congestion as a neighborhood-related problem, and thus to handle congestion using mutual cooperation within a congested neighborhood. To enable such neighborhood-based congestion management, the first step is to define the network links that share the same bandwidth resources and to allow the transmitting-ends of these links exchanging congestion information. There is a limitation in our definition (called link neighborhood) presented in Chapter 2. Indeed, the definition does not consider interference among non-neighboring nodes; it is made based on the assumption that the interference range of a node is close to its transmission range, whereas, in real cases, the interference range is larger. This may prevent some nodes, which are transmitting-ends of links sharing the same bandwidth resources, from exchanging congestion information, resulting in unfair throughput among the network flows. A possible solution to overcome this problem is to exchange congestion information among two-hop neighbors or to transmit congestion feedbacks at the basic rate (i.e., rate with larger transmission range); however,

this solution affects the overhead-free nature of NICC. Another solution is to use advanced radio technologies that are able to increase the co-channel interference tolerance, and thus allow a receiver to successfully decode the stronger signal from two transmitting nodes (i.e., the receiver is not affected by the transmissions of nodes that are outside its transmission range). Consequently, exchanging congestion information among non-neighboring nodes will not be required, and the definition of Chapter 2 will be valid. Finding the best solution to mitigate the problem of larger interference range is an open issue for our future works.

6.2.2 Flows with different throughput demands

To provide per-flow fairness, FreeDMAC computes, for each link, an access weight that increases with its traffic load, and thus more loaded links will be allocated more bandwidth. However, the access weight is computed based on the assumption that competing flows have the same throughput demands. In our future works, we plan to extend the access weight computation such that the bandwidth allocation can be dynamically adapted in order to support flows with different demands.

6.2.3 Analytical modeling

The performance evaluation of the proposed schemes (NICC, FCD, and FreeDMAC) is carried out using computer-based simulation. The main drawback of this tool is the huge simulation time that limits the scalability of the simulated scenarios. Evaluating the proposed schemes using analytical modeling is a key to prove their effectiveness. Indeed, there are several analytical models for the IEEE 802.11 MAC in multi-hop wireless networks using omni-directional antennas; however, few works have addressed analytical modeling of MAC schemes with beamforming antennas [20][26].

6.3 Future Directions

In this section, we highlight the directions of our future works.

6.3.1 Quality-of-Service support

Real-time services and multimedia applications are more and more offered and requested; thus, WMNs have to support heterogeneous traffic types (e.g., voice, video, and data traffic)

with various quality-of-service requirements [18][93]. Using beamforming antennas in WMNs has been shown providing significant improve in network performance, especially in terms of throughput and delay; however, few works have intended to exploit the beamforming antennas to provide QoS requirements [21][27][95]. Supporting QoS requirements of real-times services is one of the main considerations of our future works.

6.3.2 Directional routing

Recent works have shown that the routing has a major impact on exploiting the benefits of beamforming antennas [25][58]. Indeed, transmitting on a wireless link creates interference on other links, and thus affects their bandwidth allocation. Considering interference when routing a new flow is a key to guarantee higher bandwidth utilization, and thus improve the capacity of WMNs [79]. The route of a new arriving flow has to minimize the interference that will be created at existing flows. Designing an interference-aware routing protocol is another consideration of our future works.

Résumé en français

Contents

A	Introduction	146
B	Motivation et contributions	146
B.1	Les WMNs utilisant la norme IEEE 802.11	147
B.2	Les WMNs utilisant les antennes directionnelles	148
C	NICC : un protocole de contrôle de congestion pour les WMNs utilisant la norme IEEE 802.11	149
C.1	Introduction et état de l'art	149
C.2	Définition et concepts	152
C.3	Le design de NICC	153
C.4	Le processus de NICC	156
C.5	Évaluation de NICC	160
D	FCD : un mécanisme de détection de congestion pour les WMNs utilisant la norme IEEE 802.11	161
D.1	Principe de FCD	161
D.2	Système de logique floue proposé	164
D.3	Évaluation de FCD	166
E	FreeDMAC : un protocole MAC pour les WMNs utilisant les antennes directionnelles	167
E.1	Introduction	167
E.2	État de l'art	170
E.3	Le protocole FreeDMAC	173
E.4	Évaluation de FreeDMAC	179
F	Conclusion	181

A Introduction

Les réseaux mesh sans fil (*Wireless Mesh Networks-(WMNs)*) ont émergé comme une technologie clé pour fournir un accès rentable à l'Internet haut débit ainsi que pour offrir une connectivité dans les endroits où les réseaux traditionnels ne sont pas disponibles, endommagés, ou coûteux à installer [17][15]. En effet, les WMNs ont l'avantage du déploiement rapide et moins cher, l'entretien facile, et l'auto-configuration. En outre, les WMNs couvrent actuellement des domaines d'application multiples et hétérogènes tels que la connectivité Internet pour les zones urbaines et rurales, les systèmes de vidéosurveillance, la gestion des crises et la sécurité publique.

Un WMN typique (figure 1) se compose de passerelles mesh, routeurs mesh, et clients mesh, organisés dans une architecture à trois niveaux. Le troisième niveau est celui des réseaux d'accès, grâce à lesquelles les clients mesh (utilisateurs finaux sans fil ou filaires) accèdent à l'Internet. Les réseaux d'accès peuvent inclure des réseaux locaux sans fil (WLANs), des réseaux mobiles ad hoc (MANETs), et des réseaux cellulaires. Le deuxième niveau est la dorsale mesh sans fil (*mesh backbone*), qui se compose d'un ensemble de routeurs mesh sans fil placés à des endroits fixes. Chaque routeur mesh (1) sert de point d'accès pour des clients mesh, et (2) relaie le trafic de/vers les routeurs voisins. Le premier niveau est celui des passerelles mesh, qui relaient le *mesh backbone* au réseau filaire (Internet). Typiquement, un WMN couvre une grande zone géographique, ainsi les communications multi-sauts sont souvent nécessaires pour relayer une source à sa destination (un flux de données est souvent relayé à travers plusieurs routeurs intermédiaires).

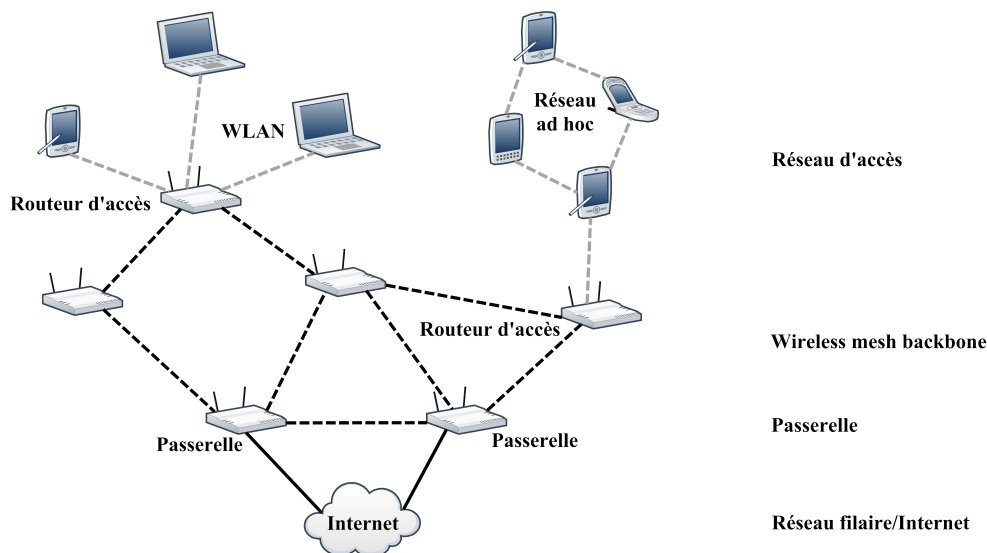

Figure 1: Un réseau mesh sans fil

Les routeurs mesh sont équipés de deux interfaces sans fil opérant sur deux canaux

distincts, ainsi le problème de connectivité dans le *mesh backbone* est indépendant de celui des réseaux d'accès. Cette thèse se focalise sur le *mesh backbone*. En effet, les réseaux d'accès sont généralement des WLANs, ceux-ci ont été largement étudiés dans la littérature. Dans la suite, les termes *mesh backbone* et WMN sont utilisés d'une façon interchangeable.

B Motivation et contributions

La maximisation d'utilisation et la répartition équitable des ressources de bande passante sont les principaux défis confrontant le succès et la mise à l'échelle des WMNs. En effet, d'une part, le spectre limité de fréquences disponibles et le trafic important des WMNs nécessitent une utilisation efficace des ressources de bande passante. D'autre part, la nature partagée du support sans fil et les relations d'interférences complexes entre les routeurs mesh situés dans un même voisinage pourraient créer une iniquité grave, et même un *starvation* complet, entre les flux de données d'un WMN. Dans cette thèse, nous visons à proposer de nouvelles solutions permettant une utilisation équitable et efficace des ressources de bande passante dans deux environnements WMN différents: WMNs utilisant la norme IEEE 802.11, et WMNs utilisant les antennes directionnelles.

B.1 Les WMNs utilisant la norme IEEE 802.11

La motivation principale de l'utilisation des WMNs avec la norme IEEE 802.11 provient de leurs avantages envisagés : déploiement répandu et coût réduit. En effet, l'économie d'échelle a rendu IEEE 802.11 le protocole MAC communément utilisé dans la plupart des déploiements WMNs actuels. Néanmoins, de nombreuses recherches ont montré que cette norme n'est pas performante dans les environnements multi-sauts tels que les WMNs. Ce standard introduit, en particulier lorsqu'il est utilisé avec un protocole de contrôle de congestion classique comme TCP, une iniquité grave, et même un *starvation*, entre les flux de données. Par conséquent, dans la première partie de cette thèse, nous proposons NICC, un protocole de contrôle de congestion qui sert à assurer une utilisation efficace et équitable de la bande passante dans les WMNs basés sur la norme IEEE 802.11. Nous considérons le contrôle de congestion parce que les recherches antérieures ont montré que l'équité ne devient un problème critique que lorsque le réseau est congestionné. Nous prouvons, en utilisant différents scénarios de WMNs, que la congestion est un problème lié au voisinage, et non pas au lien. Par conséquent, pour mettre en œuvre l'équité, le protocole NICC gère la congestion en utilisant une coopération mutuelle entre les nœuds dans un voisinage sans fil. D'autre part, afin de ne pas affecter la bande passante des WMNs, NICC fait usage de certains champs sous-exploités dans l'en-tête de trame IEEE 802.11 conduisant à fournir un

retour d'information de congestion implicite et multi-bits. D'une part, étant multi-bits, ce retour de congestion fournit aux nœuds sources une indication fine du degré de congestion, et donc, assure un contrôle précis du débit de transmission, et d'autre part, étant implicite, il ne génère pas de coût de communication (*overhead*), et donc, assure une utilisation efficace de la bande passante. De cette façon, NICC résout le problème de *starvation* sans affecter la bande passante limitée des WMNs.

Pour améliorer les performances de NICC, nous proposons FCD, un mécanisme de détection de congestion qui vise à améliorer les performances de NICC. FCD est capable de calculer plusieurs degrés de congestion, ce qui est nécessaire pour exploiter le retour de congestion multi-bit de NICC, conduisant ainsi à un contrôle précis des débits de transmission, et par la suite, une utilisation efficace de la bande passante. FCD détecte la congestion en surveillant l'évolution de la taille de la file d'attente en utilisant un contrôleur de logique floue. FCD a pour but de maintenir des courtes files d'attente, ce qui réduit le délai de bout-en-bout des paquets, et en même temps, améliore leur taux de livraison en évitant le rejet à cause des files d'attente pleines.

B.2 Les WMNs utilisant les antennes directionnelles

Dans la deuxième partie de cette thèse, nous considérons les WMNs dans lesquels les routeurs mesh sont équipés des antennes directionnelles. Ces antennes sont capables de concentrer leurs émissions/réceptions vers/à partir des directions spécifiques, réduisant ainsi les interférences et permettant à plusieurs transmissions de se dérouler simultanément dans le même voisinage (réutilisation spatiale (figure 2)). Par conséquent, l'utilisation des antennes directionnelles est l'un des éléments clés pour améliorer l'utilisation de la bande passante dans les WMNs. Cependant, les protocoles couramment utilisés dans les réseaux sans fil multi-sauts ne peuvent pas exploiter les avantages des antennes directionnelles, car ils sont conçus en supposant que les nœuds sont équipés des antennes omnidirectionnelles. Au cours des dernières années, plusieurs protocoles MAC ont été proposées [29] [63], la plupart d'entre eux se concentre sur l'adaptation de la norme IEEE 802.11 au contexte des antennes directionnelles. Cependant, de nouveaux problèmes MAC ont été rencontrés (ex. le *deafness* [60], le blocage (*head-of-line blocking*) [76], et nouveaux types du problème de nœud caché [41]. Le *starvation* et le gaspillage de la bande passante sont les résultats communs de ces problèmes.

Les problèmes liés à l'utilisation des antennes directionnelles sont principalement causés par le fait que, lors de l'utilisation des transmissions directionnelles dans un protocole MAC basé sur la contention (ex. IEEE 802.11), un nœud n'est souvent pas conscient de toutes les

transmissions en cours dans son voisinage, ainsi il est susceptible de lancer des transmissions inappropriées (ex. des transmissions qui s'interfèrent avec celles qui sont déjà en cours). Par conséquent, dans la deuxième partie de cette thèse, nous proposons FreeDMAC, un protocole MAC qui vise à éviter les problèmes liés à l'utilisation des antennes directionnelles, et en même temps, assure une utilisation efficace et équitable de la bande passante dans les WMNs. FreeDMAC est basé sur la technologie TDMA (Accès multiple par répartition dans de temps). Le but de FreeDMAC est de garantir que chaque nœud reste conscient, à tout instant, de toutes les transmissions en cours dans son voisinage, conduisant à éviter les problèmes liés à l'utilisation des antennes directionnelles, et par la suite, assurent une utilisation efficace de la bande passante. En exploitant le caractère stationnaire des WMNs, FreeDMAC propose un système de planification de transmission dans lequel les liens qui s'interfèrent sont répartis à différents intervalles de temps (*contention-free*), ceci considérablement réduit le coût de communications (*overhead*). D'autre part, vu que la répartition des intervalles de temps est faite en fonction des liens au lieu des nœuds, le nombre de transmissions possibles dans un même voisinage est significativement élevé, conduisant à une utilisation efficace de la bande passante. En outre, FreeDMAC est capable de fournir deux niveaux d'équité : équité par lien et équité par flux. L'équité par lien est assurée à travers la rotation de la répartition des liens aux intervalles de temps. L'équité par flux est assurée en calculant, pour chaque lien, un poids d'accès qui augmente avec le nombre de flux traversant le lien.

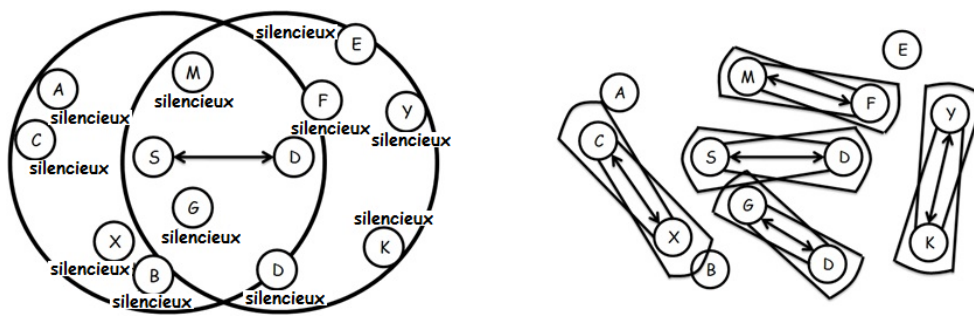

Figure 2: Antennes omnidirectionnelles vs antennes directionnelles

C NICC : un protocole de contrôle de congestion pour les WMNs utilisant la norme IEEE 802.11

C.1 Introduction et état de l'art

Les protocoles de contrôle de congestion classiques tels que TCP (Transport Layer Protocol) traitent la congestion comme un problème lié au lien. Cela signifie que quand un lien est congestionné, pour mettre en œuvre l'équité, seulement les flux traversant ce lien congestionné seront régulés (leur débit de transmission sera réduit). Les flux traversant les liens

voisins ne seront pas affectés. Ce système de régulation est adapté à l'Internet et aux réseaux filaires dans lesquelles chaque lien a sa propre bande passante qui ne peut pas être utilisée par n'importe quel autre lien, c.-à-d., les transmissions sur les liens différentes utilisent des ressources de bande passante différentes. Cependant, dans les WMNs, la bande passante est une ressource spatialement partagée. Elle peut être utilisée par un ensemble de liens situés dans le même voisinage, c.-à-d., les transmissions sur les liens voisins utilisent les mêmes ressources de bande passante. Par conséquent, quand un lien est congestionné, pour mettre en œuvre l'équité, tous les flux traversant au moins un de ses liens voisins devraient être régulés. Ainsi, la congestion doit être manipulée à travers une coopération mutuelle dans le voisinage du lien congestionné. Nous définissons le voisinage d'un lien L comme étant l'ensemble des liens partageant les mêmes ressources de bande passante avec L , c.-à-d., les liens qui ne peuvent pas être activés pour transmission en même temps que L à cause d'interférence. Lorsqu'un lien est congestionné, la congestion doit être signalée à chaque lien voisin, c.-à-d., l'émetteur ou le récepteur de chaque lien voisin doit être informé de la congestion. Par la suite, la source de chaque flux traversant un ou plusieurs de ces liens voisins doit être notifiées afin qu'elle régulerait son débit de transmission. Toutefois, la signalisation de la congestion dans un voisinage congestionné¹ et la notification des sources correspondantes peuvent générer un *overhead* considérable qui risque d'affecter les performances du réseau en termes du débit total de bout-en-bout d'un WMN, conduisant à une utilisation inefficace de la bande passante.

Par conséquent, l'autre défi en face du contrôle de congestion est d'effectuer un compromis entre l'*overhead* généré par les notifications de congestion et la quantité des informations rapportées par ces notifications. En effet, un retour d'information de congestion explicite et multi-bits donne aux nœuds sources une indication fine du degré de congestion, ainsi il assure un contrôle précis du débit de transmission [125]. Cependant, un tel retour génère un énorme *overhead* dans le réseau. D'autre part, un retour d'information de congestion implicite et à un seul bit pourrait considérablement réduire l'*overhead* généré. Cependant, un tel retour ne contient pas suffisamment d'informations sur la congestion, ainsi il peut conduire à une régulation inexacte du débit de transmission par les nœuds sources. Cela peut provoquer de fortes oscillations de la charge du trafic du réseau conduisant à une utilisation inefficace de la bande passante.

Le contrôle de congestion dans les WMNs est largement étudié dans la littérature [89]. Cependant, la plupart des protocoles proposés [19] [106] ne reconnaît pas explicitement la congestion comme un problème lié au voisinage. Cela signifie que les flux concurrents sont

¹Un voisinage congestionné est le voisinage d'un lien congestionné.

traités indépendamment, ce qui conduit à une iniquité entre les flux d'un WMN. D'autres protocoles (ex. [83][132][51]) proposent des métriques de congestion qui considèrent implicitement des informations de voisinage, telles que la densité de contention au niveau de la couche MAC [83], le degré d'interférence provenant des nœuds voisins [132], et l'estimation de la bande passante disponible [51]. Cependant, dans les WMNs, la congestion est fortement dépendante de la position, c.-à-d., les liens voisins perçoivent souvent des degrés de congestion différents [109][137], ce qui conduit à une iniquité entre les flux traversant ces liens. Récemment, un certain nombre de protocoles de contrôle de congestion [125][109], qui reconnaît explicitement la congestion comme un problème lié au voisinage, ont été proposés. Cependant, aucun d'entre eux ne résout efficacement le compromis entre la précision du retour de congestion et l'*overhead* généré par ce retour dans le réseau.

C.2 Définition et concepts

C.2.1 Démonstration que la congestion est problème lié au voisinage

Dans ce paragraphe nous présentons un scénario qui montre que la congestion est un problème lié au voisinage, et non pas au lien. Le scénario de la Figure 3 se compose de trois flux à un saut: F1 (lien L_{S1-R1}), F2 (lien L_{S2-R2}), et F3 (lien L_{S3-R3}). Chacun des liens L_{S2-R2} et L_{S3-R3} interfère seulement avec le lien L_{S1-R1} , alors que L_{S1-R1} interfère avec tous les deux L_{S2-R2} et L_{S3-R3} ². Ainsi, la source S1 accède au canal, pour envoyer les données du flux F1, beaucoup moins que les sources S2 et S3, pour envoyer les données des flux F2 et F3, respectivement. Pour sa part, le protocole TCP aggrave la situation. En effet, le protocole TCP interprète le faible débit du flux F1 comme étant une congestion, ainsi il force la source S1 à réduire son débit de transmission. En revanche, TCP considère le haut débit des flux F2 et F3 comme étant une disponibilité de bande passante, ainsi il permet aux sources S2 et S3 d'augmenter leur débit de transmission. En conséquence, en utilisant IEEE 802.11 avec TCP dans les WMNs, certains flux obtiennent un débit important, tandis que les autres sont complètement affamés (*starved*).

C.2.2 Voisinage d'un lien

Le voisinage d'un lien L_{S-R} (figure 4) se compose de tous les liens qui partagent les mêmes ressources de bande passante avec L_{S-R} , c.-à-d. les liens qui s'interfèrent avec L_{S-R} . Le standard IEEE 802.11 nécessite un acquittement de niveau MAC pour chaque trame de donnée transmise, ainsi il nécessite un canal libre à la fois au niveau de l'émetteur et au niveau du récepteur du lien en compte. Par conséquent, un lien s'interfère avec L_{S-R} (c.-à-d. situé dans le voisinage de L_{S-R}) si l'une de ses extrémités (émetteur ou récepteur) est

²Deux liens s'interfèrent entre eux s'ils ne peuvent pas être utilisés pour la transmission en même temps.

située dans la portée de transmission de S ou R (les extrémités du lien L_{S-R}). Autrement dit, un lien s'interfère avec L_{S-R} si l'une de ses extrémités est voisine de S ou R. Par conséquent, le voisinage du lien L_{S-R} se compose de tous les liens entrants et sortants des nœuds : S, R, les voisins de S, et les voisins de R. Cette définition est similaire à celles utilisées dans [125][109]. Notez bien que cette définition est transitive, c.-à-d. si le lien L1 est dans le voisinage du lien L2, alors L2 est également dans le voisinage de L1.

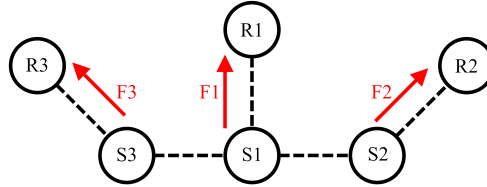

Figure 3: Le problème du flux au milieu

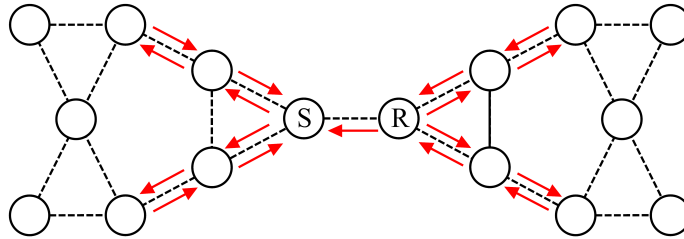

Figure 4: Le voisinage du lien L_{S-R}

C.2.3 Dépendance intra-flux

La dépendance intra-flux exige de la source d'un flux la régulation de son débit de transmission en fonction du lien le plus congestionné (goulot d'étranglement) le long du chemin du flux vers la destination. En effet, lorsque le débit de transmission à la source du flux est plus grand que la bande passante disponible au goulot d'étranglement, l'émetteur du goulot d'étranglement ne sera pas capable de relayer les paquets de données reçus. Par la suite, la taille de la file d'attente au goulot d'étranglement augmentera d'une manière significative, ce qui conduit à rejeter les paquets. Par conséquent, les ressources de bande passante utilisées pour transférer les paquets rejetés, à partir du nœud source vers le point de rejet, sont pratiquement perdues.

C.3 Le design de NICC

L'idée principale de NICC est de fournir un retour d'information de congestion implicite et multi-bits qui tient compte des informations de voisinage sans générer d'*overhead*, et en même temps, assure un contrôle précis du débit de transmission par les nœuds sources. Plus explicitement, NICC fait usage de certains champs sous-exploités dans l'en-tête de la trame

IEEE 802.11, sans modifier la taille standard de la trame. En utilisant les nouvelles trames de données IEEE 802.11, NICC est capable de transférer les trames de données, et en même temps, de signaler la congestion dans son voisinage. En outre, en utilisant les nouvelles trames de contrôle IEEE 802.11, NICC est capable d'acquitter la réception des trames de données, et en même temps, d'informer les nœuds émetteurs à propos de la congestion. Dans cette section, nous définissons les nouvelles trames IEEE 802.11 proposées par NICC.

C.3.1 Les trames de NICC

L'en-tête de la trame IEEE 802.11 contient un champ de 2 octets appelé *packet control* (Figure 5). Ce champ contient 2 bits pour identifier le type de la trame (champ *type*) et 4 bits pour identifier son sous-type (champ *subtype*). Dans le champ *type*, seuls trois combinaisons de bits sont utilisées: 00 pour les trames de gestion, 01 pour les trames de contrôle, et 10 pour les trames de données. La dernière combinaison de bits (11) n'est pas utilisée. Ainsi, si nous faisons usage de la dernière combinaison de bits (11) du champ *type* avec les 4 bits du champ *subtype* (16 combinaisons de bits), nous pouvons obtenir jusqu'à 16 nouvelles trame IEEE 802.11. En outre, si nous utilisons cette combinaison de bits (11) pour les trames de données, nous obtenons jusqu'à 16 nouvelles trames de données ayant la même taille de la trame standard. D'autre part, dans le cas des trames de contrôle (le champ *type* est 01), seulement 8 combinaisons de bits du champ *subtype* sont utilisées/définis, nous pouvons donc définir 8 nouvelles trames de contrôle.

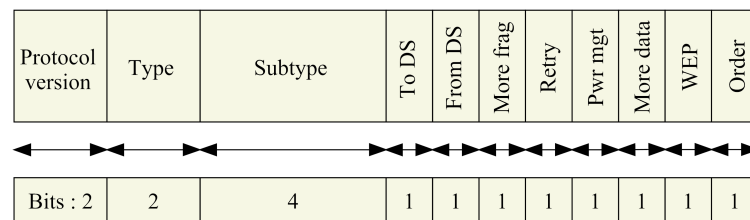

Figure 5: Le champ packet control de la trame IEEE 802.11

En résumé, en exploitant les combinaisons de bits qui sont actuellement inutilisées dans les champs *type* et *subtype* de la trame IEEE 802.11, nous pouvons définir jusqu'à 8 nouvelles trames de contrôle et jusqu'à 16 nouvelles trames de données, sans modifier la structure de la trame IEEE 802.11 standard. En utilisant ces nouvelles trames, NICC définit trois nouveaux types de trames IEEE 802.11: (1) le type nommé *Congestion-Notification Acknowledgement* (CN_ACK) ; ce type inclut les nouvelles trames de contrôle; (2) le type nommé *Congested-Link Data* (CL_DATA) ; ce type inclut la moitié des nouvelles trames de données, et (3) le type nommé *Congestion-Signaling Data* (CS_DATA) ; ce type inclut l'autre moitié des nouvelles trames de données.

Les trames de contrôle

En plus de l'acquittement, la trame CN_ACK (figure 6) est utilisée pour informer le nœud émetteur d'une trame de donnée que le flux correspondant traverse un voisinage congestionné (au moins un voisinage congestionné le long du chemin du flux). Si le flux ne traverse aucun voisinage congestionné, une trame ACK standard est utilisée pour acquitter la réception de la trame de donnée.

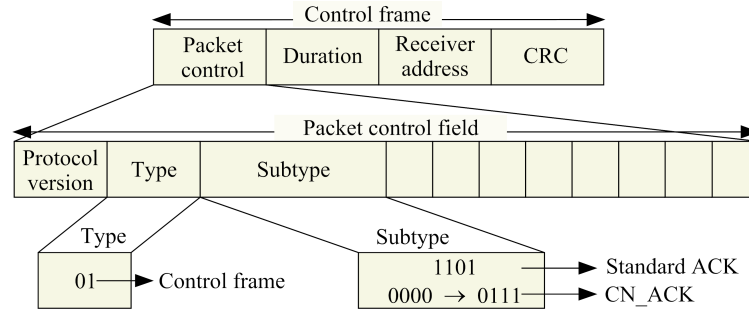

Figure 6: Les trames de contrôle

Chacune des 8 nouvelles trames de contrôle (trames CN_ACK) représente un niveau de congestion spécifique (c.-à-d., un degré de congestion déterminé), une trame CN_ACK rapporte le degré du voisinage le plus congestionné le long du chemin du flux.

Les trames de données

Pour transmettre les données, un nœud S utilise la trame DATA standard, la trame CL_DATA, ou la trame CS_DATA. Les trames CL_DATA et CS_DATA (figure 7) sont également utilisées pour signaler la congestion dans un voisinage congestionné. Plus précisément, si S n'a aucun lien entrant/sortant qui est congestionné, il transmet une trame DATA standard. Autrement (S a au moins un lien congestionné), si S utilise un lien congestionné pour transmettre les données, il transmet une trame CL_DATA pour notifier les nœuds situés dans sa portée de transmission que le lien en cours est congestionné. Enfin, si S n'utilise pas un lien congestionné pour transmettre les données, il transmet une trame CS_DATA pour notifier les nœuds situés dans sa portée de transmission que l'un ou plusieurs de ses liens (entrants ou sortants) sont congestionnés.

Il existe 8 différentes trames CL_DATA et CS_DATA. Une trame CL_DATA rapporte le niveau de congestion du lien en cours (le lien sortant qui est utilisé pour transmettre la trame CL_DATA), tandis qu'une trame CS_DATA rapporte le niveau de congestion le plus haut entre les liens entrants et sortants du nœud émetteur.

Nous concluons que NICC fournit une indication précise sur le niveau de la congestion permettant aux nœuds sources de régler leurs débits de transmission d'une façon efficace, ainsi assurant de meilleures performances du réseau.

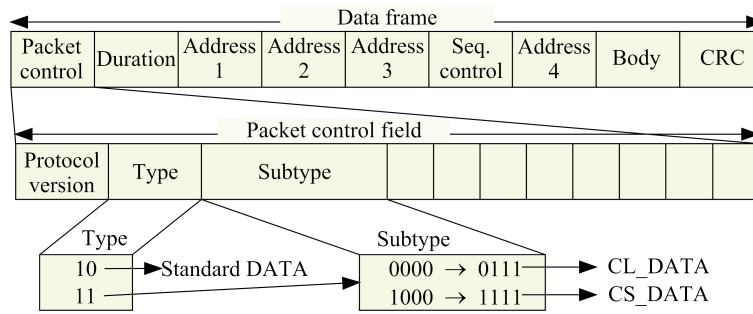

Figure 7: Les trames de données

C.3.2 Les tables de NICC

Dans NICC, chaque nœud maintient trois tables de congestion : une table des liens, une table des nœuds, et une table des flux. Chaque table est composée de deux colonnes. La première colonne indique l'identité de l'élément correspondant (lien, nœud, ou flux), tandis que la seconde colonne détermine le niveau de congestion (CongLevel) de cet élément. NICC suppose que la congestion est détectée en utilisant un mécanisme dédié (section D contient plus de détails).

Table des liens

Cette table est utilisée pour maintenir la liste des liens qui sont congestionnés parmi les liens entrants et sortants d'un nœud N. Si aucun lien de N n'est congestionné, la table est vide.

Un lien sortant *OL* sera listé dans la table des liens si N détecte, à l'aide d'un mécanisme de détection de congestion, que *OL* est congestionné. *OL* sera supprimé de la table dès que la congestion sera résolue. Un lien entrant *IL* sera listé dans la table des liens si N reçoit une trame CL_DATA à travers *IL*. Le CongLevel correspondant sera inclut dans la trame CL_DATA. *IL* sera supprimé de la table des liens lorsque N reçoit une trame DATA standard (soit destinée à N ou non) ou une trame CS_DATA (destinée à N) provenant de l'émetteur du lien *IL*.

Table des nœuds

Cette table est utilisée pour maintenir la liste des nœuds voisins du nœud N. Si un nœud voisin a un ou plusieurs liens congestionnés, entrants ou sortants (à l'exception des liens vers/à partir de N), il sera listé dans la table.

Plus précisément, un voisin X de N est listé dans la table des nœuds si N reçoit une trame CS_DATA (ou une trame CL_DATA non destinée à N) provenant de X. Le CongLevel sera inclut dans la trame CS_DATA/CL_DATA reçue par N. X sera supprimé de la tables des nœuds lorsque N reçoit une trame DATA standard (soit destinée à N ou non) provenant de X. Notez bien que lorsque la table des nœuds n'est pas vide, alors les

liens entrants/sortants de N sont situés dans un voisinage congestionné.

Table des flux

Cette table est utilisée pour maintenir la liste des flux qui traversent le nœud N. Si le flux F traverse au moins un voisinage congestionné entre sa source et sa destination, il sera listé dans la table des flux. Le CongLevel de F correspond au voisinage le plus congestionné le long du chemin du flux.

Plus précisément, F est listé dans la table des flux lorsqu'une trame de données de F sera acquittée en utilisant une trame CN_ACK. Le CongLevel correspondant sera inclut dans la trame CN_ACK. F sera supprimé de la table des flux lorsqu'une trame de données de F sera acquittée en utilisant une trame ACK standard.

Notez bien que lorsque les tables des liens et des nœuds de N ne sont pas vides, tous les flux passant par N sont alors des flux traversant un voisinage congestionné. Cependant, dans NICC, la table des flux est mise à jour en utilisant les trames d'acquiescement exclusivement.

C.4 Le processus de NICC

Le processus du contrôle de congestion se compose de quatre phases : (1) la phase de détection de congestion : un nœud détecte que l'un de ses liens sortants est congestionné ; (2) la phase de signalisation de congestion : la congestion est signalée à chaque lien dans le voisinage du lien congestionné, c.-à-d. l'émetteur ou le récepteur de chaque lien voisin sera informé à propos de la congestion, (3) la phase de notification de congestion : les sources des flux qui traversent le voisinage congestionné sont informés à propos de la congestion, et (4) la phase du contrôle du débit de transmission : les sources notifiées régulent leurs débits de transmission selon le niveau de congestion signalé.

Détection de congestion

L'objectif de NICC est de résoudre une congestion lorsqu'elle est détectée, sans tenir compte du processus de détection de congestion lui-même. Ceci permet à NICC d'être utilisé avec une variété de mécanismes de détection de congestion. Dans la section D, nous proposons un mécanisme de détection de congestion, nommé FCD, qu'on le juge capable de rendre NICC plus effectif. Les détails seront présentés dans la section D.

Signalisation de congestion

NICC effectue la signalisation de congestion implicitement à l'aide des trames DATA standard, CL_DATA, et CS_DATA. Lorsqu'un nœud S détecte que son lien sortant L_{S-R} est congestionné, il informe ses voisins (les nœuds dans sa portée de transmission), y compris le nœud R (le récepteur du lien congestionné). Par la suite, le nœud R notifie ses voisins à

propos de la congestion. S et R utilisent les trames CL_DATA et CS_DATA exclusivement afin de maintenir leurs voisins au courant de la congestion. Les voisins de S et R (qui ne sont pas des extrémités d'un ou plusieurs liens congestionnés) utilisent la trame DATA standard. Une fois que la congestion est enlevée, S et R réutilisent la trame DATA standard pour informer implicitement leurs voisins que la congestion est résolue.

Notification de congestion

NICC effectue la notification de congestion implicitement en utilisant la trame ACK standard et la nouvelle trame CN_ACK. Lorsque les tables des liens et des nœuds sont vides, un nœud utilise la trame ACK standard pour acquitter la réception d'une trame de donnée. Autrement (l'une des table n'est pas vide), le nœud utilise la nouvelle trame CN_ACK. Lors de la réception d'une trame CN_ACK, la source du flux correspondant régule son débit de transmission. En effet, en plus de l'acquiescement, la trame CN_ACK notifie l'émetteur d'une trame de donnée que le flux correspondant traverse un voisinage congestionné. Un nœud qui reçoit une trame CN_ACK utilise ce type de trames pour acquitter les nouvelles trames de données du même flux, ainsi la notification se propage jusqu'à ce que la source du flux reçoive la trame CN_ACK. Notez bien que même lorsque les tables des liens et des nœuds sont vides, si le flux est listé dans la table des flux, un nœud doit utiliser une trame CN_ACK pour l'acquiescement.

Contrôle du débit de transmission

Dans NICC, le contrôle du débit de transmission est réalisé aux nœuds sources en utilisant un algorithme AIMD amélioré (*Additive-Increase Multiplicative-Decrease*). Deux innovations distinguent notre AIMD amélioré de l'AIMD traditionnel. D'une part, lors d'une congestion, le débit de transmission n'est pas toujours réduit de sa moitié. Le degré de réduction du débit est proportionnel à la valeur du CongLevel rapporté par la notification de congestion (la trame CN_ACK) reçue à la source du flux. Plus le CongLevel est élevé, plus la réduction du débit de transmission est grande. D'autre part, le débit de transmission ne se réduit pas à chaque fois que la source du flux reçoit une notification de congestion. Les opérations de contrôle du débit de transmission sont contraintes par une période de temps, nommée t_{NICC} , qui vise à éviter les régulations inutiles qui sont généralement appliqués sur les flux qui traversent plusieurs voisinages congestionnés.

Augmentation du débit : à chaque intervalle de contrôle (t_c), si aucune trame de donnée, transmise par la source du flux, est acquittée en utilisant une trame CN_ACK, le débit de transmission sera augmenté d'une façon linéaire comme l'indique l'équation suivante:

$$sr_F = sr_F + \alpha \quad (1)$$

où sr_F est le débit de transmission du flux F et α est le degré d'augmentation (α est une valeur constante partagée entre tous les nœuds sources).

Réduction du débit : le principal avantage de l'utilisation de l'intervalle de contrôle t_c est de fournir un contrôle de débit de transmission synchronisé. Cette synchronisation est indispensable pour atteindre l'équité. En effet, lorsque le *Round Trip Time* (RTT) est utilisé à la place de l'intervalle de contrôle t_c , les flux possédants des petits RTTs augmentent leurs débit de transmission plus rapidement que les flux possédants des grands RTTs [109], ainsi même si le contrôle de congestion prend en considération le voisinage, l'équité ne sera pas atteinte. Par exemple, dans la figure 3, le RTT moyen du flux F1 est plus grand que celui des flux F2 et F3 en raison de la hausse d'interférence soufferte par le lien L_{S1-R1} , ainsi le débit de transmission du flux F1 sera augmenté plus lentement que celui des flux F2 et F3. Notez bien que le contrôle de débit de transmission synchronisé est assuré par la plupart des protocoles de contrôle de congestion qui prennent en considération l'équité [125][109][111].

Lorsqu'une trame de donnée, transmise par la source du flux, est acquittée en utilisant une trame CN_ACK, le débit de transmission sera réduit multiplicativement comme l'indique l'équation suivante:

$$sr_F = \frac{sr_F}{\beta_k} \quad (2)$$

où β_k est le coefficient de réduction associé au CongLevel k rapporté par la trame CN_ACK. Comme mentionné précédemment, une trame CN_ACK peut rapporter jusqu'à 8 différents niveaux de congestion, ainsi k pourrait prendre l'une des valeurs suivantes $\{1, 2, 3, 4, 5, 6, 7, 8\}$ et un coefficient de réduction (β_k) est associé à chacune de ces valeurs. La valeur du β_k est proportionnelle au CongLevel. Plus le CongLevel est élevé (congestion plus intense), plus la valeur de β_k est grande (réduction plus importante du débit de transmission). Notez bien que la valeur du CongLevel est proportionnelle à la densité des flux/nœuds dans le voisinage congestionné. Plus le nombre de flux/nœuds traversant/situés par/dans le voisinage est élevé, plus la valeur du CongLevel est grande.

Au cours de l'intervalle $[t_i, t_i + t_d]$ (t_i est l'instant du réduction du débit de transmission), si une trame de donnée, transmise par la source du flux, est acquittée en utilisant une trame CN_ACK, le débit de transmission ne sera pas réduit (c.-à-d. la source du flux ne réagit pas à la trame CN_ACK). Cette action vise à (1) vérifier l'impact de la dernière réduction avant de procéder à une nouvelle ; en effet, les résultats d'une décision doit être observés

avant de prendre une autre décision, et (2) éviter plusieurs réductions à cause de la même congestion ; en effet, les trames de donnée sont acquittées avec des trames CN_ACK tant que la congestion n'est pas résolue, ainsi la source d'un flux est susceptible de recevoir plusieurs notifications provenant du même voisinage congestionné.

La période t_{NICC} : le contrôle du débit de transmission basé sur AIMD n'est pas suffisant pour assurer une utilisation équitable de la bande passante, même si le voisinage est pris en considération. En effet, les flux traversant plusieurs voisinages congestionnés souffrent des réductions inutiles lors de l'utilisation de l'AIMD traditionnel. Plus précisément, prenons l'exemple de la figure 8, tandis que le flux F_{1-5} traverse deux voisinages congestionnés, chaque autre flux traverse un seul voisinage. Au départ, le flux F_{1-5} souffre d'une congestion au lien L_{1-2} , ainsi le débit de transmission des flux F_{1-5} , F_{6-7} et F_{10-11} sera réduit afin de résoudre la congestion au lien L_{1-2} . Par la suite, le flux F_{1-5} souffre d'une congestion au lien L_{3-4} ; en effet, le débit de transmission des flux F_{8-9} et F_{12-13} ne sont pas régulés lors de la congestion précédente (congestion au lien L_{1-2}). Par conséquent, le lien L_{3-4} souffre plus d'interférence, ce qui conduit à la congestion. Ainsi, le débit de transmission des flux F_{1-5} , F_{8-9} et F_{12-13} sera réduit afin de résoudre la congestion au lien L_{3-4} . En conséquence, le débit de transmission du flux F_{1-5} est réduit deux fois plus que chaque autre flux, conduisant à détruire l'iniquité. En effet, malgré que le flux F_{1-5} traverse deux voisinages congestionnés, une seule régulation est suffisante ; selon la dépendance intra-flux (section C.2.3), le débit de transmission doit être régulé en fonction du voisinage le plus congestionné le long du chemin du flux (voisinage avec le plus grand CongLevel). Dans la figure 8, les deux voisinages congestionnés souffrent de la même CongLevel, ainsi une seule régulation de F_{1-5} est suffisante pour tous les deux. Cependant, en utilisant l'AIMD traditionnel, le flux F_{1-5} est régulé deux fois, ce qui signifie que le débit de transmission est inversement proportionnelle au nombre de voisinages congestionnés traversé par le flux (au contraire du concept de la dépendance intra-flux (section C.2.3)).

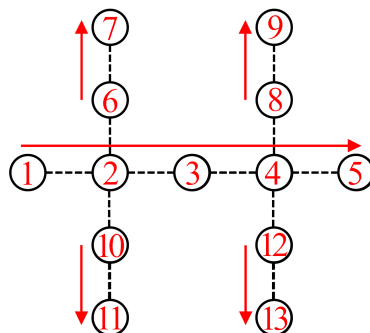

Figure 8: Le scénario illustrant l'utilité de la période t_{NICC}

NICC propose une nouvelle période de temps, nommée t_{NICC} ($t_{NICC} \geq t_c$), qui vise à

éviter les régulations inutiles subies par les flux qui traversent plusieurs voisinages congestionnés. Au cours de l'intervalle $[t_l + t_c, t_l + t_{NICC}]$, si une trame de donnée, transmise par la source du flux, est acquittée en utilisant une trame CN_ACK, le débit de transmission ne sera réglé que lorsque le CongLevel rapporté par la trame CN_ACK est supérieure à celui de la régulation effectuée à t_l . La période t_{NICC} doit être suffisamment longue pour que la source du flux reçoit une notification de congestion du chaque voisinage congestionné traversé par le flux. De cette façon, le débit de transmission sera réglé selon le voisinage le plus congestionné le long du chemin du flux indépendamment du nombre de voisinages congestionnés. Par exemple, dans la figure 8, la source du flux F_{1-5} reçoit deux fois les notifications de congestion reçues par chaque autre source, mais en utilisant la période t_{NICC} , la source réagit seulement à la moitié de ces notifications, ainsi le flux F_{1-5} reçoit à peu près le même débit obtenu par chaque autre flux.

C.5 Évaluation de NICC

Pour évaluer les performances de NICC, nous l'avons comparé avec WCP [109], APCC [96], et WiRS [51]. Les simulations ont été réalisées en utilisant GloMoSim [126]. Nous avons choisi l'équité et le débit de bout-en-bout comme indicateurs de performance. En effet, le débit de bout-en-bout est capable de refléter l'efficacité de l'utilisation de la bande passante.

Pour mesurer l'équité de l'allocation de la bande passante entre les flux du réseau, nous choisissons l'indice d'équité communément utilisé *Jain's index*. Cet indice est donné par l'équation suivante:

$$Fairnessindex = \frac{(\sum_{i=1}^n T_i)^2}{n * \sum_{i=1}^n T_i^2} \quad (3)$$

Où T_i est le débit de bout-en-bout obtenu par le flux i , et n est le nombre de flux dans le réseau. L'indice de l'équité peut varier entre 0 et 1. Plus l'indice d'équité est proche de 1, plus l'allocation de bande passante est équitable.

La figure 9 affiche les résultats d'un scénario de simulation avec 70 nœuds aléatoirement répartis et 16 flux aléatoires. L'indice d'équité est présenté dans la figure 9a, où NICC et WCP semblent être les meilleurs avec un indice d'équité quasi-optimale, alors que WiRS et APCC souffrent d'une sévère iniquité dans la répartition de la bande passante. Ces résultats expliquent l'impact de la gestion de congestion en considérant le voisinage. En effet, tandis que NICC et WCP reconnaissent la congestion comme un problème lié au voisinage, APCC et WiRS traitent les flux concurrents d'une façon indépendante.

Les figures 9b et 9c affichent la moyenne et le minimum du débit de bout-en-bout, re-

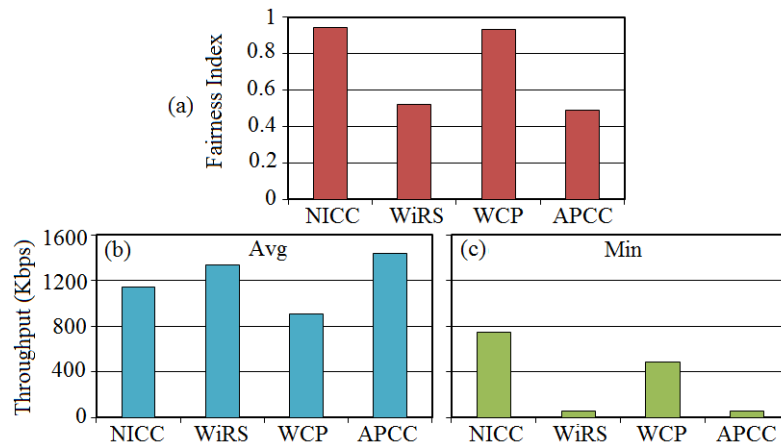

Figure 9: Évaluation de NICC : indice d'équité et débit de bout-en-bout

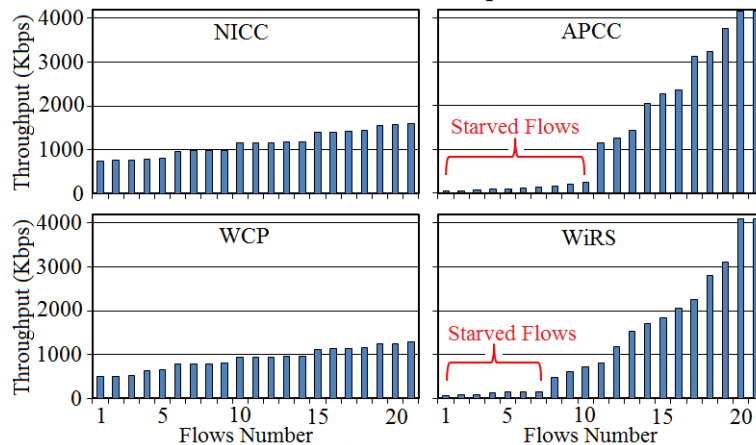

Figure 10: Évaluation de NICC : débit de bout-en-bout par flux

spectivement. Ces figures mettent en évidence deux points. Le premier est la différence entre le débit moyen et le débit minimum. Encore une fois, l'impact de la gestion de congestion en considérant le voisinage est observé. En APCC et WiRS, la différence est significative, ce qui reflète des situations sévères de *starvation*. Autrement, NICC et WCP atteignent une différence limitée, ce qui reflète leur capacité à éviter le *starvation*. Le second point est le débit de bout-en-bout lui-même, où NICC est plus performant que WCP dans le débit moyen et le débit minimum. Ces résultats expliquent l'impact de l'exactitude des retours de congestion. En effet, NICC fournit un retour d'information de congestion multi-bits qui est capable de bien stabiliser les débits de transmission des flux. Par contre, WCP utilise un retour de congestion constitué d'un seul bit, ce qui conduit à des sévères régulations des débits de transmission. D'autre part, APCC et WiRS sont plus performants que NICC dans le débit. Cela est dû au fait que les flux affamés (*starved*) sont généralement des flux multi-sauts. Par conséquent, pour éliminer le *starvation*, le débit global devrait être réduit. En effet, pour obtenir le même débit, un flux de n -sauts requiert n fois les ressources consommées par un flux d'un seul saut. Cela pourrait être clairement vu dans la répartition de l'allocation des flux

présenté dans la figure 10. Comme nous pourrions observer, comme coût de l'évitement de *starvation*, le débit des flux dominants est considérablement réduit.

D FCD : un mécanisme de détection de congestion pour les WMNs utilisant la norme IEEE 802.11

D.1 Principe de FCD

L'objectif de NICC est de gérer la congestion lorsqu'elle est détectée, sans tenir compte du processus de détection de congestion lui-même. Ceci permet à NICC d'être utilisé avec une variété de mécanismes de détection de congestion. Néanmoins, nous croyons qu'un mécanisme de détection de congestion adéquat est capable de rendre NICC plus efficace. Par conséquent, la deuxième contribution de cette thèse est FCD : un mécanisme de détection de congestion que nous jugeons plus approprié aux besoins de NICC et de l'environnement de WMN. FCD détecte la congestion en prédisant l'évolution de la taille de file d'attente (occupation du tampon) aux niveaux des nœuds intermédiaires le long du chemin d'un flux. L'évolution de la taille de la file d'attente est prédite en combinant la taille de la file d'attente avec son taux de variation pendant les intervalles de contrôle précédents ; la combinaison est effectuée en utilisant le concept de la logique floue. Nous croyons que l'évolution de la taille de la file d'attente est l'un des meilleurs indicateurs de congestion dans les WMNs ; elle présente un signe clair de la capacité d'un lien à relayer les paquets de données arrivants. Une autre caractéristique de FCD est sa capacité à calculer plusieurs degrés de congestion, ce qui est indispensable pour exploiter le retour de congestion multi-bits proposé par NICC, qui a pour but de transmettre aux nœuds sources une indication fine du degré de congestion, et donc les aider à effectuer un contrôle précis du débit de transmission, conduisant à une utilisation efficace de la bande passante.

L'une des caractéristiques de FCD est qu'il permet à chaque nœud intermédiaire, le long du chemin d'un flux, de détecter si l'un de ses liens sortants est congestionné. En effet, le nœud qui détecte que l'un de ses liens sortants est congestionné doit signaler la congestion au voisinage de ce lien, et par la suite, le nœud source de chaque flux qui traverse ce voisinage doit être informé afin qu'il régule son débit de transmission. Notez bien que plusieurs protocoles de contrôle de congestion (ex. [55][57]) se basent sur un retour de bout-en-bout pour permettre à un nœud source de détecter si son flux traverse un lien congestionné, et ainsi, réguler le débit de transmission. Evidemment, un tel retour se base sur un indicateur de congestion de bout-en-bout tel que le délai moyen de bout-en-bout, l'intervalle de temps entre la réception de deux paquets au niveau du nœud destinataire, le taux de perte des

paquets, et la variation de RTT. L'inconvénient majeur d'un tel indicateur de congestion est qu'il ne permet pas de spécifier lequel est le lien congestionné dans le chemin du flux, ainsi la congestion ne peut pas être signalée au voisinage de ce lien (ce type de retour est approprié aux réseaux filaires dans lesquels la congestion ne doit pas être gérée en considérant l'aspect du voisinage). En outre, un tel retour (1) génère un *overhead* considérable (il doit traverser tout le chemin inverse, c.-à-d., du nœud destinataire au nœud source) et (2) souffre d'un délai relativement long avant d'atteindre le nœud source, et donc celui-ci ne peut pas réagir à temps, c.-à-d., la situation de congestion peut être aggravée avant la régulation du débit de transmission.

D'autre part, la taille de la file d'attente peut être mesurée d'une façon précise en comparant avec les indicateurs de congestion qui utilisent la surveillance de voisinage (ex. la densité de contention au niveau de la couche MAC, le degré d'interférence provenant des nœuds voisins, et l'estimation de la bande passante disponible). En effet, surveiller avec précision l'utilisation du support sans fil est difficile à réaliser dans les systèmes pratiques. En outre, même si ces indicateurs de congestion visent à considérer l'aspect du voisinage ; cependant, dans les WMNs, les nœuds voisins souffrent souvent des degrés d'interférence différents, ce qui conduit à une régulation inéquitable entre les flux qui traversent le même voisinage sans fil. En revanche, en utilisant FCD avec NICC, d'une part, la file d'attente (l'indicateur de congestion) peut être mesurée d'une façon précise par chaque nœud intermédiaire, et d'autre part, la considération de l'aspect du voisinage lors de la gestion d'une congestion sera assurée par les différents mécanismes de NICC.

La taille de la file d'attente aux niveaux des nœuds intermédiaires a un impact majeur sur le délai de bout-en-bout des paquets de données. Plus précisément, un paquet rejoignant une file d'attente vide sera immédiatement relayé au nœud suivant dans le chemin du flux. Cependant, avant d'être relayé, un paquet rejoignant une longue file d'attente devra attendre que tous les paquets de la file d'attente soient servis. FCD suppose que le maintien d'une file d'attente courte est adéquat aux WMNs. En effet, d'une part, une longue file d'attente signifie que le lien n'est pas capable de relayer les paquets arrivants, et d'autre part, une file d'attente dont la taille est limitée à un seul paquet provoque souvent des délais d'attente inutiles parce qu'elle ne peut pas soutenir les rafales de paquets (ces rafales se produisent fréquemment dans les WMNs qui utilisent la norme IEEE 802.11). En outre, le maintien d'une file d'attente courte peut éviter le rejet des paquets qui se produise lorsque les files d'attente seront pleines, ceci conduit à améliorer le taux de livraison de paquets.

En plus de la taille de la file d'attente elle-même, FCD prend en compte son taux de variation pour détecter la congestion. En effet, la taille de la file d'attente donne une idée

de l'état courant de congestion (état de congestion à l'instant t). Cependant, en surveillant l'évolution de cette taille (c.-à-d., en combinant la taille de la file avec son taux variation), un nœud sera capable de prédire l'état futur de congestion (état de congestion à l'instant $t + x$). Ceci permet de réagir aux congestions d'une façon plus efficace. En effet, en considérant la taille de la file d'attente uniquement, le débit de transmission sera régulé à chaque fois que la taille est plus grande qu'un certain seuil. En revanche, en combinant la taille avec son taux de variation, même si la taille est plus grande que le seuil en compte, le débit de transmission ne sera pas régulé si le taux de variation est négatif (en effet, une telle variation signifie que la congestion est en cours de résolution, et donc la régulation du débit de transmission n'est plus nécessaire). D'autre part, la surveillance de l'évolution de la taille de la file d'attente permet de détecter, et donc gérer, la congestion suffisamment tôt avant son apparition réelle.

FCD propose un contrôleur de logique floue qui calcule l'état de congestion³, qui, en effet, reflète le niveau de congestion (CongLevel) qui doit être rapporté par les notifications de congestion (les trames CN_ACK) du protocole de contrôle de congestion NICC. En effet, vu la nature dynamique et complexe du trafic dans les WMNs, nous croyons que l'utilisation d'une théorie d'apprentissage intelligent, telle que la logique floue, est adéquate pour combiner les paramètres d'entrée de FCD (la taille de la file d'attente avec son taux de variation). De nombreuses recherches ont montrés que le contrôleur de logique floue, qui se compose d'un *fuzzifier*, un moteur d'inférence, et un *defuzzifier*, est plus adéquat, en comparaison avec les systèmes déterministes traditionnels, aux environnements complexes et dynamiques tels que les WMNs.

D.2 Système de logique floue proposé

FCD a pour but de calculer l'état de congestion en se basant sur la taille de la file d'attente et son taux de variation. Le modèle FCD (figure 11) est réalisé en trois étapes : la *fuzzification*, l'évaluation des règles par le moteur d'inférence, et la *defuzzification*. Dans l'étape de *fuzzification*, des nombres réels représentant les deux paramètres d'entrée (taille de la file d'attente et taux de variation) seront convertis en valeurs linguistiques, dont chacune est caractérisée par sa propre fonction d'appartenance (*membership function*). Dans l'étape d'inférence, une base de règles (*rule-base*), qui émule le processus de prise de décision d'un réseau, est appliquée aux valeurs linguistiques des entrées de manière à inférer le paramètre de sortie (état de congestion). Dans l'étape de *defuzzification*, la sortie du moteur d'inférence sera convertie dans un nombre réel représentant le niveau de congestion qui sera rapporté par les trames CN_ACK du protocole de contrôle de congestion NICC.

³Nous utilisons le terme état de congestion pour spécifier le niveau de congestion (CongLevel) en utilisant une variable linguistique ; le CongLevel est typiquement spécifié en utilisant un nombre.

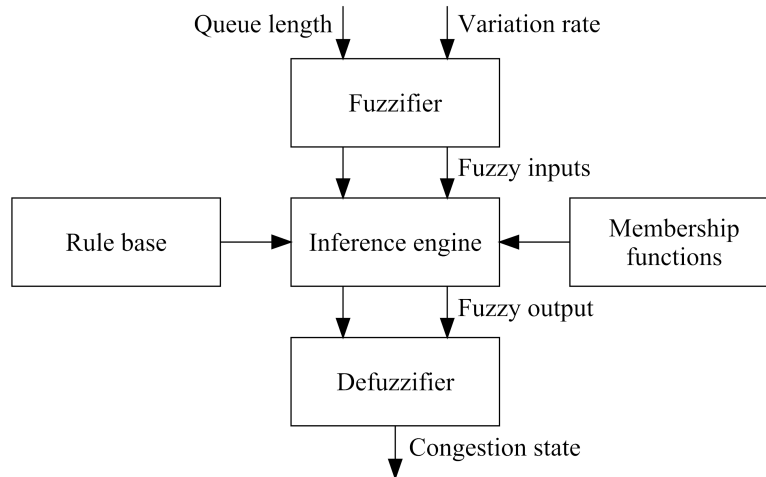

Figure 11: Le modèle de FCD

D.2.1 Fuzzification

Les entrées du modèle FCD sont la taille de la file d'attente et le taux de variation; l'état de congestion est la sortie. Ces paramètres doivent être convertis (*fuzzifié*) en ensembles flous (ces ensembles représentent les valeurs linguistiques). L'appartenance d'un élément à un ensemble flou est présentée par un nombre réel dans l'intervalle $[0, 1]$ (Notez bien que dans la logique traditionnel l'appartenance d'un élément à un ensemble est présentée par 0 ou 1). Une variété de fonctions d'appartenance peut être appliquée, par exemple la fonction triangulaire, gaussienne, et trapézoïdale. En FCD, nous choisissons les fonctions triangulaires en raison de leur simplicité de calcul. Une fonction d'appartenance triangulaire est paramétrée par le triplet (a_1, a_2, a_3) , où le degré d'appartenance (u_A) à l'ensemble flou est défini comme suit :

$$u_A(u) = \begin{cases} 0 & u < a_1 \\ (u - a_1)/(a_2 - a_1), & a_1 \leq u \leq a_2 \\ (a_3 - u)/(a_3 - a_2), & a_2 \leq u \leq a_3 \\ 0 & u \geq a_3 \end{cases} \quad (4)$$

Les fonctions d'appartenance des paramètres de FCD (la taille de la file d'attente, le taux de variation et l'état de congestion) sont établies en fonction de leur influence sur le processus de contrôle de congestion. Par exemple, le paramètre taille de la file d'attente est *fuzzifié* dans les ensembles *très courte*, *courte*, *moyenne*, *longue*, et *très longue*, qui sont paramétrés par les triplets $(0, 5, 10)$, $(5, 10, 15)$, $(10, 15, 20)$, $(15, 25, 40)$, et $(25, 40, 100)$, respectivement. Le choix de ces triplets est fait selon l'objectif du FCD qui vise à maintenir des courtes files d'attente afin de réduire le délai de bout-en-bout des paquets ainsi qu'améliorer leur taux de livraison. L'unité de la taille de la file d'attente est le degré de sa plénitude. Par exemple, lorsque la file d'attente est pleine, le degré est à 100 %, et

lorsque la file d'attente est vide, il est à 0 %. D'autre part, le paramètre taux de variation est *fuzzifié* dans les ensembles *néгатif*, *insignifiant* et *positif*, qui sont paramétrés par les triplets (-2, -11, -20), (-2, 0, 2), et (2, 11, 20), respectivement. La raison de ce choix est de refléter la variation du paramètre taille de la file entre ses ensembles définis ci-dessus, et donc de prédire la congestion suffisamment tôt avant son apparition.

D.2.2 Évaluation des règles par le moteur d'inférence

Dans cette étape, une base de règles est appliquée, en utilisant un moteur d'inférence, sur les ensembles flous des paramètres d'entrée (taille de la file d'attente et taux de variation) afin de les transformer en ensembles flous du paramètre de sortie (état de congestion). Les règles sont définies sous la forme SI-ALORS. La base de règles de FCD est présentée dans la table 1. FCD définit cinq ensembles flous pour le paramètre état de congestion (*nette*, *acceptable*, *sensible*, *critique*, et *urgent*).

Table 1: Base de règles de FCD

<i>n</i>	SI		ALORS
	Taux de variation	Taille de la file d'attente	État de congestion
<i>R</i> ₁	<i>Négatif</i>	<i>Très courte</i>	<i>Nette</i>
<i>R</i> ₂	<i>Négatif</i>	<i>Courte</i>	<i>Nette</i>
<i>R</i> ₃	<i>Négatif</i>	<i>Moyenne</i>	<i>Acceptable</i>
<i>R</i> ₄	<i>Négatif</i>	<i>Longue</i>	<i>Sensible</i>
<i>R</i> ₅	<i>Négatif</i>	<i>Très longue</i>	<i>Critique</i>
<i>R</i> ₆	<i>Insignifiant</i>	<i>Très courte</i>	<i>Nette</i>
<i>R</i> ₇	<i>Insignifiant</i>	<i>Courte</i>	<i>Acceptable</i>
<i>R</i> ₈	<i>Insignifiant</i>	<i>Moyenne</i>	<i>Sensible</i>
<i>R</i> ₉	<i>Insignifiant</i>	<i>Longue</i>	<i>Critique</i>
<i>R</i> ₁₀	<i>Insignifiant</i>	<i>Très longue</i>	<i>Urgent</i>
<i>R</i> ₁₁	<i>Positif</i>	<i>Très courte</i>	<i>Acceptable</i>
<i>R</i> ₁₂	<i>Positif</i>	<i>Courte</i>	<i>Sensible</i>
<i>R</i> ₁₃	<i>Positif</i>	<i>Moyenne</i>	<i>Critique</i>
<i>R</i> ₁₄	<i>Positif</i>	<i>Longue</i>	<i>Urgent</i>
<i>R</i> ₁₅	<i>Positif</i>	<i>Très longue</i>	<i>Urgent</i>

D.2.3 Defuzzification

Dans l'étape de *défuzzification*, les ensembles flous du paramètre de sortie (*nette*, *acceptable*, *sensible*, *critique*, et *urgent*) sont convertis en valeurs numériques. Il existe plusieurs méth-

odes heuristiques [35] [84] qui permettent d'effectuer la *defuzzification* telles que le *Center of Area* (CoA) [35], le *Center of Maximum* (CoM) [84], et le *Mean of maximum* (MoM) [84]. FCD utilise la méthode MoM en raison de sa simplicité de calcul. Cette méthode calcule le résultat le plus plausible, ceci est obtenu à travers la moyenne des éléments qui atteignent le degré maximal d'appartenance à un ensemble flou.

La valeur numérique *defuzzifié* présente le CongLevel qui sera rapporté par les trames CN_ACK du protocole de contrôle de congestion NICC. Par exemple, si la valeur numérique de *defuzzifié* est dans l'ensemble *sensible*, *critique* ou *urgent*, le lien correspondant est considéré comme congestionné, et donc il sera ajouté à la table des liens de NICC. Le CongLevel aura une grande valeur dans le cas de l'ensemble *urgent*, et une petite valeur dans le cas de l'ensemble *sensible*. D'autre part, si la valeur numérique de *defuzzifié* est dans *acceptable*, l'état actuel (existant ou non dans la table des liens) du lien correspondant ne sera pas changé. Enfin, si la valeur numérique de *defuzzifié* est dans l'ensemble *nette* (c.-à-d. congestion résolue), le lien correspondant sera enlevé de la table des liens.

D.3 Évaluation de FCD

Pour évaluer les performances de FCD, nous l'avons comparé avec SWAN-AIMD [16]. Les simulations ont été réalisées en utilisant GloMoSim [126]. SWAN-AIMD effectue une régulation de type saut-par-saut. En effet, au lieu de s'appuyer sur un acquittement de bout-en-bout, comme dans TCP, pour détecter la congestion et effectuer la régulation du débit de transmission à la source, chaque nœud intermédiaire régule individuellement son débit de transmission en s'appuyant sur l'acquittement des trames de données IEEE 802.11.

Notez bien que FCD était activé dans l'évaluation de NICC présentée dans la section C, mais l'objectif était de prouver la capacité du contrôle de congestion de NICC à assurer une allocation équitable de la bande passante entre les flux du réseau. En revanche, l'objectif de la simulation en cours est d'évaluer la capacité du mécanisme de détection de congestion de FCD à améliorer les performances du réseau en termes du débit, délai, et taux de livraison de paquets. Par conséquent, dans la simulation en cours, nous désactivons le contrôle de congestion de NICC qui est basé sur le voisinage, c.-à-d. nous considérons que lorsqu'un lien est congestionné, seulement les flux qui traversent le lien congestionné seront régulés, un paquet dédié est utilisé pour informer les nœuds sources sur la congestion.

Pour évaluer les performances de FCD dans des conditions différentes, nous avons simulé des topologies de 10, 30, 50, 70 et 90 nœuds, respectivement. Ces nœuds sont déployés dans une zone carré de 1,000 m x 1,000 m. La portée de transmission des nœuds est de 250 m. Les résultats de simulation sont présentés dans la figure 12. Globalement, nous remarquons

que FCD est en quelque sorte résistant à la taille du réseau tandis que les résultats de SWAN-AIMD dégradent quand la taille du réseau augmente, FCD est plus performant que SWAN-AIMD en termes de débit, délai, et taux de livraison de paquets (figures 12a, 12b, et 12c). Pour comprendre ces résultats, les figures 12d et 12e montrent des captures de la variation de la taille de la file d'attente dans AIMD et FCD, respectivement. Nous observons que FCD réussit à maintenir des files d'attente courtes, c.-à-d. les oscillations de la taille de la file d'attente sont maintenues dans des petits intervalles, ce qui conduit à réduire le délai des paquets ainsi qu'améliorer leur taux de livraison. D'autre part, nous observons que AIMD souffre de fortes oscillations, c.-à-d. la file d'attente reste pleine dans certaines périodes, et par la suite, elle reste légèrement chargée dans d'autres périodes, ce qui conduit à un délai de paquets non garanti ainsi qu'à de nombreux rejets à cause des files d'attente pleines. Ces résultats sont résumés dans la figure 12f qui montre le taux de rejet de paquets à cause des files d'attente pleines. En FCD, le taux de rejet est maintenu dans des petits intervalles tandis que, en SWAN-AIMD, le taux de rejet augmente avec la taille du réseau.

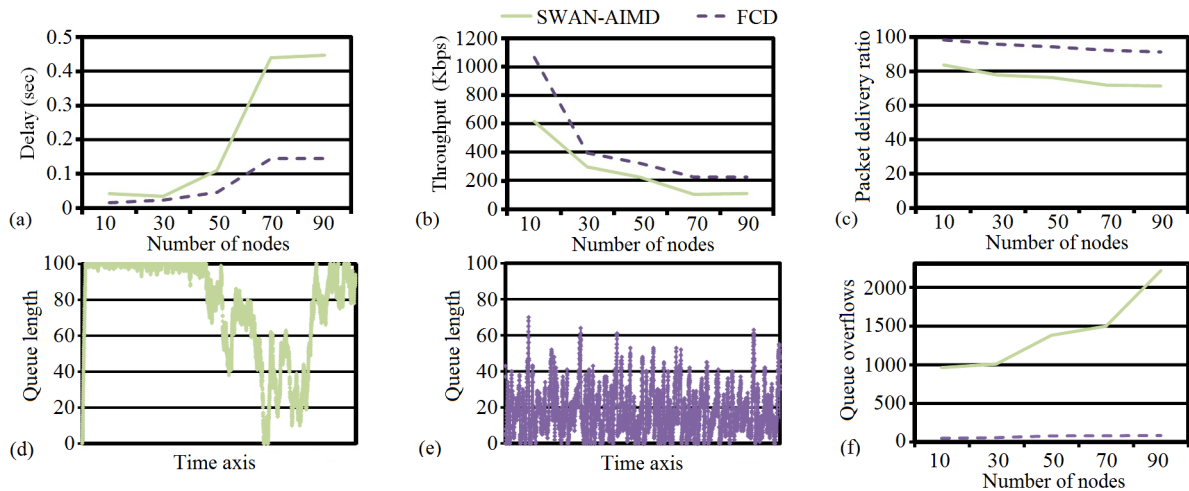

Figure 12: Évaluation de FCD

E FreeDMAC : un protocole MAC pour les WMNs utilisant les antennes directionnelles

E.1 Introduction

Dans la deuxième partie de cette thèse, nous considérons les WMNs dans lesquels les routeurs mesh sont équipés des antennes directionnelles [144][145]. Ces antennes intelligentes sont capables de concentrer leurs émissions/réceptions vers/à partir des directions spécifiques, réduisant ainsi les interférences et permettant à plusieurs transmissions de se dérouler simultanément dans le même voisinage (réutilisation spatiale). Par conséquent, l'utilisation des

antennes directionnelles est l'un des éléments clés pour améliorer l'utilisation de la bande passante dans les WMNs. Cependant, les protocoles couramment utilisés dans les réseaux sans fil multi-sauts ne peuvent pas exploiter les avantages des antennes directionnelles, car ils sont conçus en supposant que les nœuds sont équipés des antennes omnidirectionnelles. Au cours des dernières années, plusieurs protocoles MAC ont été proposées [29][63], la plupart d'entre eux se concentrent sur l'adaptation de la norme IEEE 802.11 au contexte des antennes directionnelles. Cependant, de nouveaux problèmes MAC ont été rencontrés (ex. *deafness* [60], blocage (*head-of-line blocking*) [76], et nouveaux types du problème de nœud caché [41]). Le *starvation* et le gaspillage de la bande passante sont les résultats communs de ces problèmes.

Les problèmes liés à l'utilisation des antennes directionnelles sont principalement causés par le fait que, lors de l'utilisation des transmissions directionnelles dans un protocole MAC basé sur la contention (ex. IEEE 802.11), un nœud n'est souvent pas conscient de toutes les transmissions en cours dans son voisinage, ainsi il est susceptible de lancer des transmissions inappropriées (ex. des transmissions qui s'interfèrent avec celles qui sont déjà en cours). En effet, les protocoles MAC basés sur la contention utilisent un accès à la demande, ce qui conduit à des transmissions asynchrones. Par conséquent, lorsqu'un nœud S est en cours de transmission sur un lien L, il ne peut pas détecter une transmission qui vient d'être initiée sur un lien voisin L1, ainsi à la fin de la transmission sur le lien L, le nœud S peut initier une transmission qui s'interfère avec la transmission sur le lien L1, ce qui conduit à une utilisation inéquitable et un gaspillage de la bande passante (ex. des trames RTS infructueuses, collisions, paquets retardés, augmentation inutile dans la fenêtre de contention *backoff*). Dans cette section, nous utilisons le terme liens concurrents (au lieu de liens voisins) pour désigner deux liens qui ne peuvent pas être utilisés pour la transmission en même temps (c.-à-d. deux liens qui partagent les mêmes ressources de bande passante).

Par conséquent, nous proposons FreeDMAC, un protocole MAC qui vise à éviter les problèmes liés à l'utilisation des antennes directionnelles, et en même temps, assure une utilisation efficace et équitable de la bande passante dans les WMNs. FreeDMAC est basé sur la technologie TDMA. Le but de FreeDMAC est de garantir que chaque nœud reste conscient, à tout instant, de toutes les transmissions en cours dans son voisinage, conduisant à éviter les problèmes liés à l'utilisation des antennes directionnelles, et par la suite, assurent une utilisation efficace de la bande passante. En exploitant le caractère stationnaire des WMNs, FreeDMAC propose un système de planification de transmission dans lequel les liens qui s'interfèrent sont répartis à différents intervalles de temps (*contention-free*), ceci considérablement réduit le coût de communications (*overhead*). D'autre part, vu que la répartition des intervalles de temps est faite en fonction des liens au lieu des nœuds, le nombre

de transmissions possibles dans un même voisinage est significativement élevé, conduisant à une utilisation efficace de la bande passante. En outre, FreeDMAC est capable de fournir deux niveaux d'équité : équité par lien et équité par flux. L'équité par lien est assurée à travers la rotation de la répartition des liens aux intervalles de temps. L'équité par flux est assurée en calculant, pour chaque lien, un poids d'accès qui augmente avec le nombre de flux traversant le lien.

Problème de *deafness*

Dans cette section nous présentons *deafness*, le problème le plus critique parmi les problèmes MAC liés à l'utilisation des antennes directionnelles. Ce problème aura lieu quand un émetteur tente de transmettre à un récepteur tandis que ce dernier est dirigé dans une direction autre que celle de l'émetteur⁴, ainsi le récepteur ne peut pas entendre l'émetteur et la transmission échoue. La figure 13 illustre un exemple. Supposons que le nœud A commence une transmission avec le nœud B, tandis que le nœud C est déjà engagé dans une transmission avec le nœud D. Ainsi, indépendamment de sa nature (ex. unidirectionnel, multidirectionnel), l'échange des trames RTS/CTS de la transmission A↔B ne sera pas entendu par C, et donc C ne sera pas conscient de cette transmission. Comme dans tous les protocoles MAC utilisant les antennes directionnelles, l'échange des trames DATA/ACK aura lieu en utilisant le mode directionnel, ainsi lorsque C devient libre (à la fin de la transmission C↔D), il détecte un canal libre, et donc s'il a un paquet destiné à A, il transmet une trame RTS afin d'établir la transmission vers A. Cependant, vu que A est dirigé dans la direction de B, il n'entend pas la trame RTS provenant de C, et donc il ne répond pas avec une trame CTS. En l'absence de cette réponse, le nœud C suppose que la trame RTS est perdue à cause d'une collision, et par conséquent, il entre dans le mode *backoff*, c.-à-d. il (1) double la fenêtre de contention *backoff*, (2) sélectionne un intervalle de la nouvelle fenêtre; (3) commence à décompter, et (4) à la fin du décompte, retransmet la trame RTS. En effet, plusieurs tentatives de transmission peuvent avoir lieu tant que la transmission A↔B n'est pas terminée ou les tentatives n'ont pas dépassé leur seuil maximal.

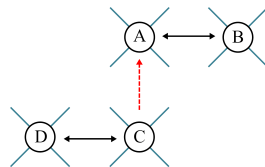

Figure 13: Problème de *deafness*

A la fin de la transmission A↔B, les nœuds A et B réinitialisent leurs fenêtres de

⁴Un nœud peut transmettre/recevoir en utilisant le mode directionnel ou le mode omnidirectionnel. Nous disons qu'un nœud est dirigé dans une direction pour désigner qu'il est en train de transmettre/recevoir vers/d'une direction spécifique (c.-à-d. en utilisant le mode directionnel).

contention *backoff* à la valeur minimale. En même temps, il est probable que le nœud C sera engagé avec une grande fenêtre de contention *backoff*, ainsi si A a un paquet à transmettre, il est probable que A commence une nouvelle transmission avant que C retransmette la trame RTS, ce qui conduit à aggraver la situation de C (C peut commencer à rejeter les paquets après avoir atteint le seuil maximal de tentatives de transmission).

En conséquence, le problème de *deafness* (1) aura lieu lorsqu'un nœud n'est pas conscient de toutes les transmissions en cours dans son voisinage et (2) conduit à une utilisation inéquitable et un gaspillage de la bande passante. Notez bien que presque tous les problèmes MAC liés à l'utilisation des antennes directionnelles partagent la même cause (manque de conscience sur les transmissions en cours dans le voisinage) et les mêmes conséquences (utilisation inéquitable et gaspillage de la bande passante).

E.2 État de l'art

Récemment, plusieurs protocoles MAC utilisant les antennes directionnelles ont été proposés [29]. Ces protocoles peuvent être classés en deux catégories: (1) les protocoles basés sur la contention (accès asynchrone), et (2) les protocoles synchronisés (accès synchrone).

Les protocoles basés sur la contention

Ces protocoles sont principalement basés sur la norme IEEE 802.11, ils peuvent être classés en quatre catégories : (1) les protocoles utilisant des trames RTS et/ou CTS omnidirectionnelles, (2) les protocoles utilisant des trames RTS/CTS unidirectionnelles, (3) les protocoles utilisant des trames RTS et/ou CTS multidirectionnelles, et (4) les protocoles utilisant des signaux de tonalité.

RTS/CTS omnidirectionnelles : Dans cette catégorie de protocoles [100][75], au moins une des deux trames RTS et CTS est transmise en utilisant le mode omnidirectionnel tandis que les trames DATA et ACK sont transmises en utilisant le mode directionnel. En effet, l'utilisation des trames RTS/CTS omnidirectionnelles évite le problème de *deafness*. Cependant, la réutilisation spatiale, qui est le principal avantage des antennes directionnelles, est considérablement réduite, conduisant à une utilisation inefficace de la bande passante. En outre, vu qu'au moins une trame est transmise omni-directionnellement, seuls les voisins OO⁵ peuvent se communiquer, ce qui réduit la connectivité des WMNs.

⁵Un nœud utilisant le mode directionnel a un gain d'émission/réception plus élevé que celui d'un nœud utilisant le mode omnidirectionnel (c.-à-d. sa portée de transmission/réception est plus grande). Par conséquent, il y a trois types de voisins à 1-saut : (1) les voisins omni-omni (OO) : deux nœuds qui sont capables de se communiquer (c.-à-d. engagé dans une transmission à 1-saut) lorsque tous les deux utilisent le mode omnidirectionnel, (2) les voisins directionnel-omni (DO) : deux nœuds qui sont capables de se communiquer lorsqu'un seul d'entre eux utilise le mode directionnel, et (3) les voisins directionnel-directionnel (DD) : deux

RTS/CTS unidirectionnelles : Dans cette catégorie de protocoles [122][40], toutes les trames IEEE 802.11 (RTS/CTS/DATA/ACK) sont transmises en utilisant le mode directionnel. Ceci (1) permet les communications entre les voisins DO, et donc étend la connectivité des WMNs, et (2) améliorent la réutilisation spatiale. DVCS [122] et Basic DMAC [40] sont deux exemples typiques de cette catégorie de protocoles. Cependant, DVCS [122] et Basic DMAC [40] ne traitent aucun des problèmes liés à l'utilisation des antennes directionnelles, ce qui conduit à une utilisation inéquitable et un gaspillage de la bande passante.

D'autres protocoles [28][123] qui visent à éviter les problèmes MAC liés aux antennes directionnelles ont été proposés. En OPDMAC [28], lors d'une transmission RTS infructueuses, au lieu d'entrer dans le mode *backoff* et rester inactif, un nœud tente de transmettre autres paquets qui sont destinés à d'autres directions, ce qui permet d'éviter le problème de blocage HoL⁶ et réduire l'impact de *deafness*. En RI-DMAC [123], à la fin de chaque transmission, un nœud transmet, en se basant sur une *polling table*, un paquet dédié pour inviter un émetteur potentiel à commencer sa transmission. La *polling table* est construite en utilisant des entêtes dédiés dans les trames de données. En effet, ces protocoles [28][123] réduisent l'impact du problème *deafness* avec peu ou sans *overhead*. Cependant, la situation de *deafness* n'est pas complètement évitée, et donc un nœud est toujours susceptible de transmettre une trame RTS infructueuse, conduisant au gaspillage de la bande passante.

RTS/CTS multidirectionnelles : Afin de maintenir la connectivité des protocoles utilisant les trames RTS/CTS unidirectionnelles, et en même temps, réduire les problèmes MAC liés aux antennes directionnelles, plusieurs protocoles utilisant les trames RTS/CTS multidirectionnelles ont été proposés⁷. Dans ces protocoles, au lieu de transmettre la trame RTS (ou CTS) uniquement dans la direction du nœud récepteur (ou émetteur), elle est transmise séquentiellement dans plusieurs directions autour de l'émetteur (ou récepteur). En CRM [77], la trame RTS est transmise dans toutes les directions autour de l'émetteur. En CRCM [67], les trames RTS et CTS sont transmises dans toutes les directions autour de l'émetteur et du récepteur, respectivement. En MDA [59] et DMAC/DA [124], RTS et CTS sont transmises uniquement dans les directions où des voisins existent.

Dans ces protocoles [77][67][59][124], les problèmes MAC liés aux antennes direction-

nœuds qui sont capables de se communiquer lorsque tous les deux utilisent le mode directionnel.

⁶Le problème de blocage HoL (*Head of Line blocking*) aura lieu quand le paquet dans la tête de la file d'attente est destiné à une direction bloquée (c.-à-d., le nœud récepteur est inaccessible) tandis qu'un ou plusieurs autres paquets dans la file d'attente sont destinés à des directions non bloquées.

⁷Notez bien que la définition initiale des protocoles MAC liés aux antennes directionnelles était dans le contexte du protocole Basic DMAC [40]. L'utilisation des trames directionnelles était considérée comme la cause principale de ces problèmes. L'impact de l'accès asynchrone n'était pas considéré.

nelles sont considérablement réduits. Cependant, ils ne sont pas complètement évités. En effet, vu la nature asynchrone des protocoles basés sur la contention, un nœud qui est déjà engagé dans une transmission ne peut pas entendre les échanges RTS/CTS, et par la suite, il ne peut pas maintenir une conscience complète des transmissions voisines en cours. En outre, l'*overhead* généré par la transmission des trames RTS/CTS dans plusieurs directions est trop lourd, ce qui conduit à une utilisation inefficace de la bande passante.

Signaux de tonalité : Pour éviter les problèmes liés aux antennes directionnelles, quelques protocoles [64][44][39] proposent l'utilisation des signaux de tonalité. Par exemple, dans ToneDMAC [39], à la fin de chaque transmission, l'émetteur et le récepteur transmettent une tonalité omnidirectionnelle sur un canal de contrôle dédié. Lorsqu'un nœud voisin qui souffre d'une situation de *deafness* détecte la tonalité, il compare son nœud destinataire avec l'émetteur de tonalité, ce dernier est identifié sur la base de la fréquence et la durée de la tonalité. Si l'émetteur de tonalité est le nœud destinataire, le nœud voisin déduit que le *deafness* est la cause des RTS infructueuses, ainsi il réinitialise sa fenêtre de contention *backoff* à sa valeur minimale et retransmet la trame RTS. Dans cette catégorie de protocoles, les problèmes liés aux antennes directionnelles sont considérablement réduits, cependant d'autres inconvénients sont rencontrés : (1) le débit est réduit (la bande passante disponible doit être divisée en deux canaux distincts), et (2) de nouveaux matériels sont demandés (un nœud doit être capable de transmettre/recevoir sur des canaux/fréquences distincts).

Les protocoles synchronisés

Afin d'éviter les limitations des protocoles basés sur la contention, récemment, quelques protocoles utilisant l'accès asynchrone ont été proposés. Ces protocoles peuvent être classés en deux catégories : (1) les protocoles avec synchronisation locale, et (2) les protocoles avec synchronisation globale.

Synchronisation locale : Dans cette catégorie de protocoles [130][105][36], les nœuds voisins réalisent une synchronisation locale dans laquelle le temps est divisé en une période de planification et une période de transmission. Dans la période de planification, les trames RTS/CTS sont transmises dans le mode omnidirectionnel. Les premiers émetteur et récepteur (nommés nœuds vainqueurs) qui réussissent à effectuer un échange RTS/CTS spécifient les durées des périodes de planification et de transmission. Durant la période de planification, les nœuds dans le voisinage des nœuds vainqueurs pourront planifier leurs transmissions tant que les nouvelles transmissions n'interfèrent pas avec celles déjà planifiées. A la fin de la période de planification, les échanges des trames DATA/ACK seront simultanément effectués dans la période de transmission. Cette catégorie de protocoles peut réduire les limitations des protocoles basés sur la contention, cependant d'autres inconvénients sont rencontrés :

(1) à cause de l'utilisations des trames RTS/CTS omnidirectionnelles, seuls les voisins OO peuvent se communiquer, ainsi la connectivité des WMNs est limitée, et (2) les transmissions entre les nœuds situés dans différents voisinages synchronisés peuvent être planifiées d'une façon inappropriée (c.-à-d., les nœuds qui appartiennent à deux voisinages avec différentes durées des périodes de planification et de transmission).

Synchronisation globale : Peu de protocoles [116][129][45], qui supposent qu'une synchronisation est maintenue entre tous les nœuds du réseau⁸, ont été proposés. Cependant, malgré la capacité d'une telle synchronisation à éviter les problèmes liés aux antennes directionnelles, les protocoles couramment proposés ne peuvent pas maintenir une utilisation efficace et équitable de la bande passante. Par exemple, dans SYN-DMAC [129], la planification des transmissions est réalisée en utilisant les trames RTS/CTS de la norme IEEE 802.11, ce qui conduit à des problèmes d'équité entre les nœuds situés dans le même voisinage (voir l'exemple de la section C.2). De même, en [116], lorsqu'un nœud reçoit deux signaux de tonalité provenant de différentes directions, il répond à l'émetteur le plus proche (c.-à-d., le signal avec la puissance la plus grande), conduisant à des problèmes d'équité. Le protocole RTDMA-DA proposé dans [45] est le plus proche à notre protocole FreeDMAC, cependant RTDMA-DA est conçu en supposant des topologies grilles, ce qu'il le rend non adéquat aux déploiements WMN réels.

E.3 Le protocole FreeDMAC

E.3.1 Vue d'ensemble

La structure de temps

Le temps est divisé en trames de longueur constante. Chaque trame est divisée en une sous-trame de planification et une sous-trame de transmission (la sous-trame de planification est plus petite que celle de transmission). La sous-trame de planification est divisée en N intervalles indexés 1, 2, ..., et N , respectivement. Chaque intervalle est divisé en deux sous-intervalles. La structure du temps est présentée dans la figure 14.

Une planification de type *contention-free* sera réalisée durant la sous-trame de planification, l'objectif est de planifier le nombre maximal possible de transmissions directionnelles pour se produire simultanément durant la sous-trame de transmission.

Planification des transmissions

Dans FreeDMAC, les droits de transmission sont attribués aux liens au lieu des nœuds, c.-à-

⁸Une telle synchronisation peut être effectuée en utilisant le *Global Positioning System* (GPS) ou d'autres techniques de synchronisation distribuée [127][103].

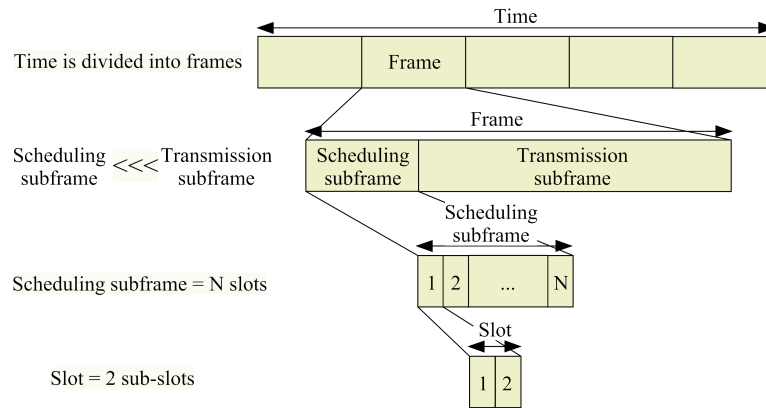

Figure 14: La structure de temps

d., dans la sous-trame de transmission, un émetteur peut transmettre sur un lien spécifique (à un récepteur spécifique) exclusivement. Dans le contexte des antennes directionnelles, la planification basée sur les liens améliore significativement la réutilisation spatiale en comparaison avec la planification basée sur les nœuds [91]. En effet, dans la planification basée sur les nœuds, pour éviter les collisions, les nœuds voisins ne peuvent jamais transmettre en même temps. En revanche, dans la planification basée sur les liens, pour éviter les collisions, les nœuds voisins ne peuvent pas transmettre en même temps seulement dans des directions spécifiques, les transmissions dans les autres directions restent possibles. En effet, lors de l'utilisation des antennes directionnelles dans les WMNs, le support sans fil est directionnellement partagé, de telle sorte que le support peut être disponible dans une direction et occupé dans une autre.

Maintenant, considérons (1) une sous-trame de planification qui est divisée en N intervalles, et (2) un nœud S qui a des paquets à transmettre sur son lien sortant L_{S-R} (c.-à-d., au nœud R) qui est attribué à l'intervalle i . S surveille le support durant l'intervalle 1, l'intervalle 2, \dots , et l'intervalle $(i - 1)$. Si S est notifié, au cours de l'un de ces intervalles, qu'une transmission est planifiée pour se produire, durant la sous-trame de transmission, sur un lien concurrent avec le lien L_{S-R} , alors le nœud S reste inactif durant l'intervalle i (c.-à-d., il reporte la transmission sur le lien L_{S-R} à la trame suivante). Autrement, (c.-à-d., aucune transmission n'est planifiée pour se produire sur aucun des liens qui sont (1) concurrents avec L_{S-R} et (2) attribués aux intervalles de 1 à $(i - 1)$), le nœud S notifié, durant l'intervalle i , les émetteurs des liens concurrents avec L_{S-R} qu'une transmission est planifiée pour se produire sur L_{S-R} durant la sous-trame de transmission. Par conséquent, les émetteurs notifiés resteront inactifs dans les intervalles attribués aux liens concurrents avec L_{S-R} (de l'intervalle $(i + 1)$ à l'intervalle N), c.-à-d., les transmissions sur ces liens sont reportées à la trame suivante. À la fin de la sous-trame de planification, (1) le nœud S transmet ses paquets de données sur le lien L_{S-R} durant la sous-trame de transmission, et (2) aucune

transmission ne sera produite sur aucun des liens concurrents avec L_{S-R} . Notez bien que si l'émetteur d'un lien (L1) non concurrent avec L_{S-R} réussit à planifier une transmission sur L1 en utilisant l'intervalle attribué à L1, il sera autorisé, comme S, à transmettre ses paquets de données sur L1 durant la sous-trame de transmission.

Équité

Pour planifier une transmission sur le lien L_{S-R} (attribué à l'intervalle i), aucune transmission ne doit être planifiée sur aucun des liens qui sont concurrents avec L_{S-R} et attribués aux intervalles de 1 à $(i - 1)$. Par conséquent, les liens attribués aux intervalles avec des indices inférieurs sont plus prioritaires, lors de la planification des transmissions, que les liens attribués aux intervalles avec des indices supérieurs. Ainsi, pour assurer l'équité, dans FreeDMAC, les priorités de planification (c.-à-d., l'attribution des liens aux intervalles) sont tournées au début de chaque trame, conduisant à une équité idéale entre les liens du réseau. Cependant, pour assurer l'équité entre les flux, les liens lourdement chargés (c.-à-d., les liens traversés par un grand nombre de flux) doivent obtenir une allocation de bande passante plus grande que celle obtenue par les liens légèrement chargés (c.-à-d., les liens traversés par un petit nombre de flux). Par conséquent, lorsque les liens légèrement chargés sont attribués aux intervalles avec des indices inférieurs, parfois le support doit être céder aux liens lourdement chargés (c.-à-d., les émetteurs des liens légèrement chargés doivent rester inactifs dans les intervalles correspondants). En revanche, lorsque les liens lourdement chargés sont attribués aux intervalles avec des indices inférieurs, le support ne doit jamais être céder aux liens faiblement chargés (c.-à-d., les émetteurs des liens lourdement chargés devraient toujours exploiter les intervalles correspondants pour planifier des transmissions). Dans FreeDMAC, un poids d'accès est calculé pour chaque lien en fonction de sa charge de trafic (le nombre de flux qui traversent le lien), ce poids d'accès détermine si l'émetteur du lien doit exploiter l'intervalle attribué pour planifier une transmission ou doit céder le support à d'autres liens.

E.3.2 Détails et exemples

Attribution des liens aux intervalles

Pour améliorer l'utilisation de la bande passante, le nombre de liens attribués à chaque intervalle doit être maximisé autant que possible. Cette maximisation conduit à (1) réduire le nombre d'intervalles dans la sous-trame de planification (c.-à-d., réduire l'*overhead*), et (2) maximiser le nombre de transmissions simultanées dans la sous-trame de transmission (c.-à-d., augmenter la capacité du réseau) car les liens attribués à un même intervalle peuvent être utilisés pour la transmission en même temps. D'autre part, pour assurer une planification de type *contention-free*, les liens concurrents ne doivent pas être attribués à un même inter-

valle car il ne peuvent pas être utilisés pour la transmission en même temps. En résumé, l'attribution des liens doit (1) maximiser le nombre de liens attribués à chaque intervalle, et (2) éviter l'attribution des liens concurrents à un même intervalle.

Pour attribuer un lien L_{S-R} , nous commençons par le premier intervalle, si aucun des liens concurrents avec L_{S-R} n'est attribué à cet intervalle, L_{S-R} sera attribué. Sinon (c.-à-d., un des liens concurrents avec L_{S-R} est attribué au premier intervalle), nous passons à l'intervalle suivant et ainsi de suite. Si L_{S-R} ne sera pas attribué à aucun intervalle, (1) un nouveau intervalle sera ajouté à la sous-trame de planification, et (2) L_{S-R} sera attribué au nouveau intervalle. Un exemple est illustré dans la figure 15. Par exemple, chacun des liens L_{A-B} , L_{B-A} , L_{B-C} , et L_{C-B} est concurrent avec les autres⁹, ainsi ils sont attribués à des intervalles différents. D'autre part, chacun des liens L_{A-B} , L_{C-D} , and L_{E-F} n'est pas concurrent avec les autres, ainsi ils sont attribués à un même intervalle.

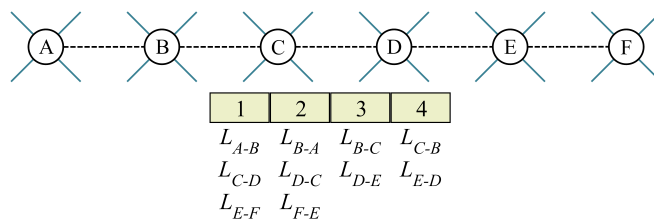

Figure 15: Attribution des liens aux intervalles

Processus de planification de transmissions

Nous expliquons le processus de planification de transmissions en utilisant l'exemple illustré dans la figure 16. Supposons que les nœuds C, D, E et F ont des paquets à transmettre aux nœuds D, C, D, et E, respectivement, tandis que le nœud B a des paquets à transmettre aux nœuds A et C. Autrement dit, les files d'attente des liens L_{B-A} , L_{B-C} , L_{C-D} , L_{D-C} , L_{E-D} , and L_{F-E} ne sont pas vides.

Parmi ces liens, uniquement L_{C-D} est attribué au premier intervalle de la sous-trame de planification, ainsi durant le premier sous-intervalle de cet intervalle, les nœuds A, B, D, E et F restent inactifs, tandis que le nœud C transmet un signal de tonalité en utilisant le mode omnidirectionnel. En détectant la direction de réception et la puissance du signal reçu, et en vérifiant l'attribution des liens aux intervalles, les nœuds B et D seront conscients que C sera un émetteur sur le lien L_{C-D} dans la sous trame de transmission. Par conséquent, durant le deuxième sous-intervalle du premier intervalle, le nœud D transmet un signal de tonalité en utilisant le mode omnidirectionnel, ainsi, de même, le nœud E sera conscient que

⁹Nous considérons qu'un nœud ne peut pas transmettre/recevoir dans différentes directions en même temps. Cette considération est tenu compte par la plupart des protocoles MAC utilisant les antennes directionnelles dans les réseaux sans fil multi-sauts.

D sera un récepteur sur le lien L_{C-D} dans la sous-trame de transmission¹⁰.

Les liens L_{B-A} , L_{D-C} , et L_{F-E} sont attribués au second intervalle. (1) le nœud D est notifié, durant le premier intervalle, qu'une transmission est planifiée sur le lien L_{C-D} , et (2) le lien L_{D-C} est concurrent avec le lien L_{C-D} , ainsi D reporte sa transmission sur le lien L_{D-C} à la trame suivante et reste inactif dans cet intervalle. D'autre part, les liens L_{B-A} et L_{F-E} ne sont pas concurrents avec le lien L_{C-D} , ainsi les nœuds B et F transmettent un signal de tonalité omnidirectionnel durant le premier sous-intervalle du second intervalle, et par la suite, les nœuds A et E transmettent un signal de tonalité omnidirectionnel durant le second sous-intervalle.

Le lien L_{B-C} est attribué au troisième intervalle. (1) Evidemment, le nœud B est conscient de la transmission planifiée sur le lien L_{B-A} , et en outre, il est notifié, durant le premier intervalle, de la transmission planifiée sur le lien L_{C-D} , et (2) le lien L_{B-C} est concurrent avec L_{B-A} et L_{C-D} , ainsi le nœud B reporte la transmission sur le lien L_{B-C} à la trame suivante et reste inactif durant cet intervalle.

Le lien L_{E-D} est attribué au quatrième intervalle. (1) le nœud E est notifié, durant les intervalles précédents, des transmissions planifiées sur les liens L_{C-D} et L_{F-E} , et (2) le lien L_{E-D} est concurrent avec L_{C-D} et L_{F-E} , ainsi le nœud E reporte la transmission sur le lien L_{E-D} à la trame suivante et reste inactif durant cet intervalle.

Enfin, durant la sous-trame de transmission, des transmissions directionnelles se produisent simultanément sur les liens L_{A-B} , L_{D-C} , and L_{F-E} .

Nous remarquons que vu (1) l'attribution des liens concurrents aux différents intervalles de temps, et (2) la notification des émetteurs de tous les liens concurrents lors de la planification d'une transmission sur un lien L_{S-R} , chaque nœud sera conscient à chaque moment de toutes les transmissions planifiées dans son voisinage, et par la suite, les problèmes liés aux antennes directionnelles seront complètement évités (les liens concurrents ne seront pas utilisés pour la transmission en même temps).

Équité par lien

Comme mentionné précédemment, pour assurer l'équité entre les liens, les priorités de planification (c.-à-d., l'attribution des liens aux intervalles) sont tournées au début de chaque

¹⁰Notez bien que, malgré l'utilisation du signal de tonalité, FreeDMAC ne souffre pas de la complexité des protocoles MAC utilisant ce type de signaux. En effet, dans FreeDMAC, le signal de tonalité est transmis sur le même canal utilisé pour les transmissions de donnée, ainsi la bande passant ne sera pas réduite. D'autre part, vu la nature stationnaire des WMNs, l'identification du nœud émetteur du signal de tonalité est faite en se basant sur la direction et la puissance du signal reçu, ainsi la complexité du matériel est réduite (il n'est pas besoin de transmettre sur différentes fréquences avec des durées différentes).

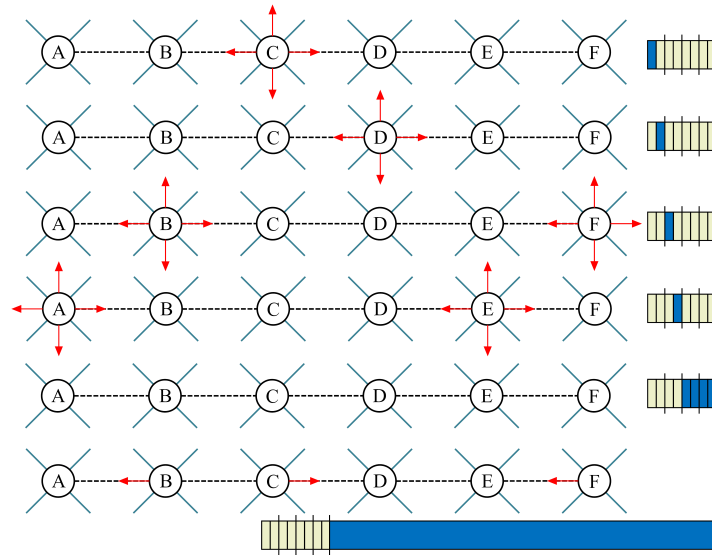

Figure 16: Processus de planification de transmissions

trame. Par exemple, si un lien est attribué à l'intervalle i dans la trame en cours, il sera attribué à l'intervalle $(i - 1)$ dans la trame suivante. De même, si un lien est attribué au premier intervalle dans la trame en cours, il sera attribué au dernier intervalle dans la trame suivante. Figure 17 illustre un exemple.

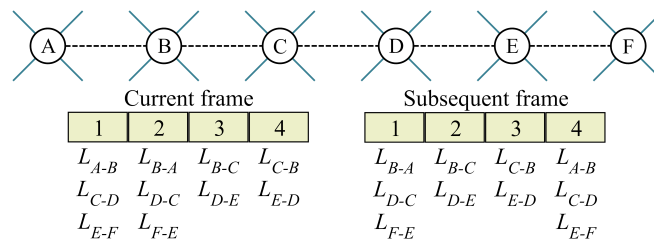

Figure 17: Per-link fairness

Équité par flux

Comme mentionné précédemment, pour assurer l'équité entre les flux, les liens qui sont traversés par un grand nombre de flux doivent obtenir une allocation de bande passante plus grande que celle obtenue par les liens qui sont traversés par un petit nombre de flux. Pour cette raison, FreeDMAC propose un poids d'accès, calculé pour chaque lien, qui augmente avec le nombre des flux qui traversent le lien. Ce poids indique si le nœud S , doit (1) planifier une transmission sur le lien L_{S-R} , ou (2) céder le support aux autres liens, lorsque L_{S-R} est attribué au premier intervalle dans la sous-trame de planification. Autrement dit, le poids d'accès indique la fraction de temps durant laquelle le support sera alloué au lien L_{S-R} .

Nous définissons un domaine de collision comme étant un ensemble maximal de liens, chacun d'entre eux est concurrent avec les autres. Dans les WMNs, un lien appartient souvent à plusieurs domaines de collision. Pour assurer l'équité entre les flux, la fraction de

temps dans laquelle le support doit être alloué au lien L_{S-R} , qui appartient au domaine de collision D , est égale au rapport du nombre des liens qui traversent L_{S-R} au nombre des liens qui traversent L_{S-R} ou aucun des liens qui appartiennent à D . Par conséquent, le poids d'accès ($x_{L_{S-R}}$) du lien L_{S-R} est égal à:

$$x_{L_{S-R}} = N * \frac{n_{L_{S-R}}}{n_{L_{S-R}} + \sum_{i=1}^N n_i} \quad (5)$$

Où $n_{L_{S-R}}$ est le nombre de flux qui traversent le lien L_{S-R} , N est le nombre de liens dans le domaine D , et n_1, n_2, \dots , et n_N sont le nombre de flux qui traversent chacun des liens qui appartiennent au domaine D , respectivement. Dans le cas où le lien L_{S-R} appartient à plusieurs domaines de collisions, un poids doit être calculé pour chaque domaine, et par la suite, le plus petit poids d'accès sera considéré. Pour expliquer l'utilisation du poids d'accès, la figure 18 illustre un exemple.

Chacun des liens L_{A-B} , L_{B-A} , L_{B-C} , et L_{C-B} est concurrent avec les autres (c.-à-d., ils appartiennent au même domaine de collision). Chacun des liens L_{B-A} et L_{B-C} est traversé par un seul flux, le lien L_{C-B} est traversé par deux flux, tandis que le lien L_{A-B} est traversé par quatre flux. Selon l'équation (5), les poids d'accès sont $x_{L_{A-B}} = 2$, $x_{L_{B-A}} = 0.5$, $x_{L_{B-C}} = 0.5$, and $x_{L_{C-B}} = 1$. Par conséquent, chaque deux opportunités où L_{B-A} (ou L_{B-C}) est attribué au premier intervalle dans la sous-trame de planification, le nœud B planifie une transmission sur L_{B-A} (ou L_{B-C}) uniquement durant une seule opportunité et reste inactif durant l'autre. D'autre part, le nœud A planifie une transmission sur le lien L_{A-B} , durant (1) toutes les opportunités où L_{A-B} est attribué au premier intervalle dans la sous-trame de planification, et (2) toutes les opportunités de L_{B-A} et L_{B-C} qui sont non-exploitées. Enfin, le nœud C planifie une transmission sur le lien L_{C-B} durant toutes les opportunités où L_{C-B} est attribué au premier intervalle dans la sous-trame de planification, cependant il ne planifie aucune transmission durant les opportunités de L_{B-A} et L_{B-C} qui sont non-exploitées.

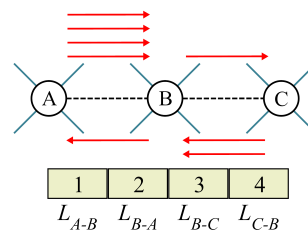

Figure 18: Équité par flux

E.4 Évaluation de FreeDMAC

Pour évaluer les performances de FreeDMAC, nous l'avons comparé avec Basic DMAC [40] avec *directional physical carrier sensing* (DMAC-DPCS), Basic DMAC avec *omni-*

directional physical carrier sensing (DMAC-OPCS), CDR-MAC [78] et IEEE 802.11 utilisant les antennes omnidirectionnelles [51]. Basic DMAC et CDR-MAC sont communément considérés comme représentants typiques des protocoles basés sur la contention avec des trames RTS/CTS unidirectionnelles et multidirectionnelles, respectivement. Nous avons choisi l'équité, le débit de bout-en-bout, et le délai de bout-en-bout comme indicateurs de performance. En effet, le débit de bout-en-bout est capable de refléter l'efficacité de l'utilisation de la bande passante tandis que le délai de bout-en-bout est capable de refléter la capacité de FreeDMAC à supporter du trafic avec contraintes de temps. Pour mesurer l'équité de l'allocation de la bande passante entre les flux du réseau, nous choisissons l'indice d'équité *Jain's index* présenté dans la section C.5.

La figure 19a affiche la somme du débit de bout-en-bout en fonction du débit de transmission de chaque flux. Nous observons que FreeDMAC est plus performant que les autres protocoles MAC, ce qui montre la capacité de FreeDMAC à (1) réduire l'*overhead* en réalisant une planification de transmission de type *contention-free*, (2) éviter les problèmes liés aux antennes directionnelles en assurant que chaque nœud maintient une connaissance complète des transmissions en cours dans son voisinage, et (3) maximiser la réutilisation spatiale en fournissant une planification de transmission basée sur les liens au lieu des nœuds. D'autre part, même s'ils souffrent du problème de *deafness*, DMAC-DPCS et DMAC-OPCS sont plus performant que IEEE 802.11 à cause de l'utilisation des transmissions directionnelles. Enfin, CDR-MAC est le moins performant. En effet, bien que CDR-MAC allège le problème du *deafness*, il génère un *overhead* significatif à cause de la transmission des trames RTS multidirectionnelles, ce qui annule l'avantage de la réutilisation spatiale.

La figure 19b affiche le délai moyen de bout-en-bout en fonction du débit de transmission de chaque flux. Nous observons que FreeDMAC est plus performant que les autres protocoles MAC, ce qui est dû à trois points. (1) FreeDMAC assure que chaque nœud maintient une connaissance complète des transmissions en cours dans son voisinage, ce qui évite les délais causés par les problèmes liés aux antennes directionnelles. (2) FreeDMAC fournit une planification de transmission de type *contention-free*, ce qui élimine les collisions, et par la suite, les délais causés par les retransmissions. (3) FreeDMAC assure une équité *court-terme*. En effet, FreeDMAC tourne les priorités de planification au début de chaque trame, ce qui évite les rafales de paquets. Des telles rafales se produisent souvent dans les protocoles basés sur la contention en raison du mécanisme *backoff*.

La figure 19c affiche l'indice d'équité en fonction du débit de transmission de chaque flux. Nous observons que FreeDMAC atteint un indice quasi-parfait (proche de 1), ceci est prévu compte tenu des mécanismes proposés (la rotation des priorités de planification et

le poids d'accès des liens) qui sont capable d'assurer l'équité par lien et l'équité par flux. Notez bien que, lorsque le trafic devient lourd, l'indice d'équité est légèrement inférieur à 1. En effet, certains flux souffrent plus de contention que les autres (c.-à-d. appartiennent à des domaines de collision traversés par un grand nombre de flux), ainsi ils auront moins de débit. D'autre part, les autres protocoles MAC souffrent d'une sévère iniquité dans la répartition de la bande passante. En effet, sans considérer l'équité explicitement, lorsque le trafic devient lourd, l'impact des problèmes liés aux antennes directionnelles sera aggravé, conduisant à une utilisation inéquitable de la bande passante.

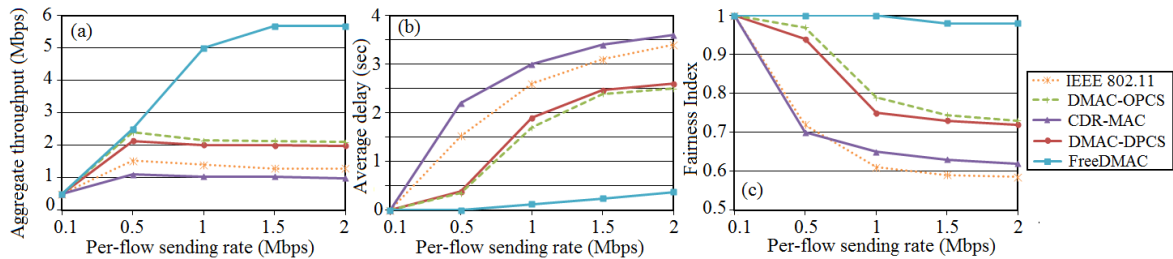

Figure 19: Évaluation de FreeDMAC : débit, délai, et indice d'équité

F Conclusion

Conclusion

En éprouvant un progrès rapide et en inspirant de nombreuses applications, les réseaux mesh sans fil sont de plus en plus une composante essentielle de la prochaine génération des réseaux sans fil, ainsi ils attirent un grand intérêt dans la communauté de la recherche. Tout au long de cette thèse, nous avons concentré notre travail sur la maximisation de l'utilisation et la répartition équitable des ressources de bande passante dans les WMNs. Nous avons considéré deux environnements WMN : les WMNs basés sur la norme IEEE 802.11 et les WMNs utilisant les antennes directionnelles.

Les WMNs basés sur la norme IEEE 802.11 : la motivation principale de la considération des WMNs basés sur la norme IEEE 802.11 provient de leur déploiement répandu et coût réduit. Cependant, la norme IEEE 802.11 introduit, en particulier lorsqu'elle est utilisée avec un protocole de contrôle de congestion classique comme TCP, une iniquité grave entre les flux du réseau. Dans la première partie de cette thèse, nous avons proposé NICC, un protocole de contrôle de congestion qui sert à assurer une utilisation efficace et équitable de la bande passante dans les WMNs basés sur la norme IEEE 802.11. Nous avons considéré le contrôle de congestion parce que l'iniquité se produit lorsque le réseau devient congestionné. Nous avons prouvé que la congestion est un problème lié au voisinage, et non pas au lien. Pour cette raison, le protocole NICC gère la congestion en utilisant une coopération mutuelle

entre les nœuds dans un voisinage sans fil. D'autre part, afin de ne pas affecter la bande passante des WMNs, NICC fait usage de certains champs sous-exploités dans l'en-tête de trame IEEE 802.11 conduisant à fournir un retour d'information de congestion implicite et multi-bits. D'une part, étant multi-bits, ce retour fournit aux nœuds sources une indication fine du degré de congestion, et donc assure un contrôle précis du débit de transmission, et d'autre part, étant implicite, il ne génère pas d'*overhead*, et donc assure une utilisation efficace de la bande passante. En conséquence, NICC assure l'équité sans affecter la bande passante limitée des WMNs.

En comparaison avec les protocoles de contrôle de congestion qui ne gèrent pas la congestion comme un problème lié au voisinage, les résultats de simulation ont montré que NICC est plus performant en termes d'équité et un peu moins performant en termes de débit. La sous-performance en termes de débit est due au fait que, dans les autres protocoles, les flux affamés (*starved*) sont des flux multi-sauts, ce qui signifie que toute la bande passante est allouée aux flux à un saut, conduisant à augmenter le débit global du réseau. En comparaison avec les protocoles qui considèrent la congestion comme un problème lié au voisinage, NICC est plus performant en termes d'équité et de débit. Cette surperformance est due au retour de congestion implicite et multi-bits de NICC, qui est capable d'assurer un contrôle précis du débit de transmission sans générer d'*overhead*.

Pour améliorer les performances de NICC, nous avons proposé FCD, un mécanisme de détection de congestion capable de calculer, grâce à un contrôleur de logique floue, plusieurs degrés de congestion, et donc exploiter le retour de congestion multi-bit de NICC, conduisant à un contrôle précis des débits de transmission, et par la suite, une utilisation efficace de la bande passante. Les résultats de simulation ont montré que FCD donne de bonnes performances en termes de délai de bout-en-bout des paquets, et leur taux de livraison.

Les WMNs utilisant les antennes directionnelles : Dans la deuxième partie de cette thèse, nous avons considéré les WMNs utilisant les antennes directionnelles. Ces antennes sont capables d'améliorer l'utilisation de la bande passante, cependant elles introduisent de nouveaux problèmes MAC tels que le *deafness*, le blocage, et de nouveaux types du problème de nœud caché. Ces problèmes conduisent au *starvation* et au gaspillage de la bande passante. Ils sont principalement causés par le fait que, lors de l'utilisation des transmissions directionnelles dans un protocole MAC basé sur la contention (ex. IEEE 802.11), un nœud n'est souvent pas conscient de toutes les transmissions en cours dans son voisinage, ainsi il est susceptible de lancer des transmissions qui s'interfèrent avec celles qui sont déjà en cours. Par conséquent, nous avons proposés FreeDMAC, un protocole MAC basé sur la technologie TDMA qui vise à éviter les problèmes liés à l'utilisation des

antennes directionnelles, et en même temps, assure une utilisation efficace et équitable de la bande passante dans les WMNs. FreeDMAC garantit que chaque nœud reste conscient, à tout instant, de toutes les transmissions en cours dans son voisinage, conduisant à éviter les problèmes liés à l'utilisation des antennes directionnelles, et par la suite, assurant une utilisation efficace de la bande passante. En exploitant le caractère stationnaire des WMNs, FreeDMAC propose un système de planification de transmission de type *contention-free*, ce qui conduit à une réduction considérable de l'*overhead*. La planification proposée est basée sur les liens au lieu des nœuds, ce qui améliore l'utilisation de la bande passante. En outre, FreeDMAC est capable de fournir deux niveaux d'équité : équité par lien et équité par flux.

En comparaison avec les protocoles MAC existants, les résultats de simulation ont montré que FreeDMAC est plus performant en termes d'équité, de débit, et de délai de bout-en-bout. En outre, les résultats ont prouvé que FreeDMAC peut assurer à la fois une équité à court et à long terme. Enfin, les résultats ont montré que les ressources de bande passante sont utilisées plus efficacement dans le cas de l'équité entre les liens, et plus équitablement dans le cas de l'équité entre les flux.

Extensions possibles

Portée d'interférence : pour assurer un contrôle de congestion qui gère la congestion comme étant un problème lié au voisinage au lieu du lien, il faut définir les liens du réseau qui partagent les mêmes ressources de bande passante, et par la suite, permettre aux extrémités de ces liens d'échanger les informations de congestion. Notre définition nommée voisinage d'un lien et présentée dans la section C contient une limite. En effet, la définition ne considère pas les interférences entre les nœuds qui ne sont pas voisins à un saut. Elle est conçue en supposant que la portée d'interférence d'un nœud est égale à sa portée de transmission, alors que, dans le cas réel, elle est plus grande. Ceci peut empêcher quelques nœuds, qui sont des extrémités des liens qui partagent les mêmes ressources de bande passante, d'échanger les informations de congestion, ce qui conduit à une iniquité entre les flux du réseau. Une solution possible est d'échanger les informations de congestion entre les nœuds qui sont voisins à deux sauts, mais ceci génère un overhead considérable, ce qui réduit l'utilisation de la bande passante. Une autre solution est d'utiliser des techniques radios avancées qui peuvent éviter les interférences provenant des nœuds qui sont à l'extérieur de la portée de transmission, ce qui rend la définition de la section C valide. La recherche de la meilleure solution du problème de la portée d'interférence est un axe de nos travaux futurs.

Flux avec différentes demandes de débit : pour assurer l'équité entre les flux, FreeDMAC calcule, pour chaque lien, un poids d'accès qui augmente avec le nombre de flux qui le traversent, et donc les liens qui sont traversés par un grand nombre de flux seront alloués

une bande passante plus grande que celle des liens qui sont traversés par un petit nombre de flux. Cependant, le poids d'accès est calculé sur la base que tous les flux ont la même demande de débit. L'extension du calcul du poids d'accès afin qu'il supporte les flux avec différentes demandes de débit est un axe de nos travaux futurs.

Modélisation analytique : l'évaluation des performances des protocoles proposés (NICC, FCD, et FreeDMAC) est réalisée en utilisant les simulations informatiques. L'inconvénient principal de cet outil est le temps de simulation énorme, ce qui limite la mise à l'échelle des scénarios simulés. L'évaluation des protocoles proposés à travers les modélisations analytiques est un élément efficace pour prouver leur performance. En effet, il existe plusieurs modèles analytiques pour la norme IEEE 802.11 dans les réseaux sans fil multi-sauts utilisant les antennes omnidirectionnelles, cependant peu de travaux ont considéré la modélisation analytique des protocoles MAC lors de l'utilisation des antennes directionnelles [20][26].

Directions futures

Qualité de service : Les services temps réel et les applications multimédia sont de plus en plus offerts et demandés, ainsi les WMNs doivent supporter un trafic hétérogène (vidéo, voix, et donnée) avec différentes demandes de QoS. La plupart des protocoles proposés dans le contexte des antennes directionnelles visent à améliorer les performances du réseau en termes de débit et de délai. Cependant, peu de travaux [21][27][95] ont considéré l'exploitation des antennes directionnelles pour améliorer la QoS des applications temps réel. Cette exploitation est une considération principale de nos travaux futurs.

Routage : récemment, plusieurs travaux [25][58] ont montré que le routage a un impact majeur sur l'exploitation des avantages des antennes directionnelles. En effet, la transmission sur un lien sans fil crée des interférences sur une partie des liens dans son voisinage, ainsi elle affecte leurs allocations de bande passante. La considération des interférences lors du routage d'un nouveau flux est l'un des éléments clés pour améliorer l'utilisation de la bande passante, et donc la capacité du réseau. Le routage d'un nouveau flux doit minimiser les interférences qui seront créées sur les flux existants. La conception d'un protocole de routage qui prend en compte ces interférences est une autre considération de nos futurs travaux.

Bibliography

- [1] A. Aziz. Bringing Stability to Wireless Mesh Networks. Ph.D. Thesis. Ecole Polytechnique Fédéral de Lausanne: Switzerland. 2011.
- [2] A. Barton. Nortel/Golden Telecom Pioneer Moscow Wireless Mesh Networks. Nortel, May 2006.
- [3] G. Fleishman. Francisco Gets Free Wi-Fi, Courtesy of Meraki. Wi-Fi Net News, January 2008.
- [4] IEEE 802.11, Part 11: Wireless LAN Medium Access Control (MAC) and Physical Layer (PHY) Specifications, August 1999.
- [5] J. Carr. Directional or Omnidirectional Antenna? Joe Carr's Radio Tech-Notes, Tech-Note No. 1, Universal Radio Inc , Reynoldsburg, Ohio USA.
- [6] K.C. Tofel. Egypt as example: A case for mesh networks on phones. The New York Times, February 2011.
- [7] M. L. Sichitiu. Wireless Mesh Networks Opportunities and Challenges. Raleigh, NC, USA: NC State University, USA, 2006.
- [8] National instruments corporationl, Labview 2011 PID and Fuzzy Logic Toolkit Help, 2011.
- [9] Nortel. Taipei's Mobile City Project Selects Nortel Wireless Mesh Network Solution. 2004. http://www.nortel.com/corporate/news/newsreleases/2004d/11_17_04_taipei_city.html.
- [10] *OLPC: Official Web Site*. <http://laptop.org/en/>.
- [11] S. Corbett. Can the Cellphone Help End Global Poverty? The New York Times, May 2008.
- [12] *Technology For All (TFA): Official Web Site*. <http://www.techforall.org/>.
- [13] ANSI/IEEE Std 802.11, Wireless LAN Medium Access Control (MAC) and Physical Layer (PHY) specifications, 1999.

- [14] Ieee standard for information technology–telecommunications and information exchange between systems local and metropolitan area networks–specific requirements part 11: Wireless lan medium access control (mac) and physical layer (phy) specifications. *IEEE Std 802.11-2012 (Revision of IEEE Std 802.11-2007)*, pages 1–2793, 2012.
- [15] G. Aggelou. *Wireless Mesh Networking*. McGraw Hill Professional, 2008.
- [16] G.-S. Ahn, A.T. Campbell, A. Veres, and L.-H. Sun. Supporting service differentiation for real-time and best-effort traffic in stateless wireless ad hoc networks (swan). *IEEE Trans. on Mob. Comp.*, 1:192–207, 2002.
- [17] I.F. Akyildiz and X. Wang. *Wireless Mesh Networks*. John Wiley & Sons, Ltd, 2009.
- [18] I.F. Akyildiz and Xudong Wang. A Survey on Wireless Mesh Networks. *IEEE Communications Magazine*, 43(9):S23–S30, 2005.
- [19] A.B.M.A. Al Islam and V. Raghunathan. End-to-end congestion control in wireless mesh networks using a neural network. In *IEEE Wireless Communications and Networking Conference (WCNC)*, pages 677–682, March 2011.
- [20] B. Alawieh, C. Assi, and H. Mouftah. Power-aware ad hoc networks with directional antennas: Models and analysis. *Ad Hoc Networks*, 7(3):486–499, 2009.
- [21] S. Atmaca, C. Ceken, and I. Erturk. A new qos-aware tdma/fdd mac protocol with multi-beam directional antennas. *Computer Standards & Interfaces*, 31(4):816–829, 2009.
- [22] C. A. Balanis and P. Ioannindes. *Introduction to Smart Antennas*. Morgan and Claypool Publishers, 2007.
- [23] S. Banaouas and P. Mühlethaler. Modeling and improving csma unfairness in mobile ad hoc networks. In *IFIP Annual Mediterranean Ad Hoc Networking Workshop (Med-Hoc-Net)*, pages 1–8, 2010.
- [24] O. Bazan and M. Jaseemuddin. An opportunistic directional mac protocol for multihop wireless networks with switched beam directional antennas. In *IEEE International Conference on Communications (ICC)*, pages 2775–2779, May 2008.
- [25] O. Bazan and M. Jaseemuddin. Routing and admission control for wireless mesh networks with directional antennas. In *IEEE Wireless Communications and Networking Conference (WCNC)*, pages 1974–1979, 2009.
- [26] O. Bazan and M. Jaseemuddin. Performance analysis of directional csma/ca in the presence of deafness. *IET Communications*, 4(18):2252–2261, Dec. 2010.

- [27] O. Bazan and M. Jaseemuddin. A conflict analysis framework for qos-aware routing in contention-based wireless mesh networks with beamforming antennas. *IEEE Transactions on Wireless Communications*, 10(10), 2011.
- [28] O. Bazan and M. Jaseemuddin. On the design of opportunistic mac protocols for multi-hop wireless ; networks with beamforming antennas. *IEEE Transactions on Mobile Computing*, 10(3):305–319, March 2011.
- [29] O. Bazan and M. Jaseemuddin. A survey on mac protocols for wireless adhoc networks with beamforming antennas. *IEEE Communications Surveys Tutorials*, 14(2):216–239, 2012.
- [30] O. Bejarano, S. Miskovic, E. Aryafar, and E.W. Knightly. Tfa: a large scale urban mesh network for social and network research. In *2010 ACM workshop on Wireless of the students, by the students, for the students (S3)*, pages 49–52, 2010.
- [31] G. Bernardi, P. Buneman, and M.K. Marina. Tegola tiered mesh network testbed in rural scotland. In *ACM workshop on Wireless networks and systems for developing regions (WiNS-DR)*, pages 9–16, 2008.
- [32] S. S. V. Bharghavan, A. Demers, and L. Zhang. Macaw: A media access protocol for wireless lans. In *ACM International Conference of the Special Interest Group on Data Communication (SIGCOMM)*, pages 212–225, 1994.
- [33] J. Bicket, D. Aguayo, S. Biswas, and R. Morris. Architecture and evaluation of an unplanned 802.11b mesh network. In *ACM international conference on Mobile computing and networking (MOBICOM)*, pages 31–42, 2005.
- [34] B. Braunstein, T. Trimble, R. Mishra, B.S. Manoj, R. Rao, and L. Lenert. Feasibility of using distributed wireless mesh networks for medical emergency response. In *AMIA Annual Symposium Proceedings Archive*, 2002.
- [35] E. V. Broekhoven and B.D. Baets. Fast and Accurate Center of Gravity Defuzzification of Fuzzy System Outputs Defined on Trapezoidal Fuzzy Partitions. *Fuzzy Sets and Systems*, 157(7):904–918, 2006.
- [36] J.-J. Chang, W. Liao, and T.-C. Hou. Reservation-based directional medium access control (rdmac) protocol for multi-hop wireless networks with directional antennas. In *IEEE International Conference on Communications (ICC)*, pages 1–5, June 2009.
- [37] K.-W. Chin. Spotmac: A pencil-beam mac for wireless mesh networks. In *International Conference on Computer Communications and Networks (ICCCN)*, pages 81–88, August 2007.

- [38] R.R. Choudhury and N. Vaidya. Mac-layer capture: A problem in wireless mesh networks using beamforming antennas. In *IEEE Communications Society Conference on Sensor, Mesh and Ad Hoc Communications and Networks (SECON)*, pages 401–410, June 2007.
- [39] R.R. Choudhury and N.H. Vaidya. Deafness: a mac problem in ad hoc networks when using directional antennas. In *IEEE International Conference on Network Protocols (ICNP)*, pages 283–292, October 2004.
- [40] R.R. Choudhury, X. Yang, R. Ramanathan, and N.H. Vaidya. Using directional antennas for medium access control in ad hoc networks. In *ACM International conference on Mobile computing and networking (MOBICOM)*, pages 59–70, 2002.
- [41] R.R. Choudhury, Xue Yang, R. Ramanathan, and N.H. Vaidya. On designing mac protocols for wireless networks using directional antennas. *IEEE Transactions on Mobile Computing*, 5(5):477–491, May 2006.
- [42] R. R. Choudhury and N. H. Vaidya. Performance of ad hoc routing using directional antennas. *Ad Hoc Networks*, 3(2):157–173, 2005.
- [43] W. Cordeiro, E. Aguiar, W. Moreira, A. Abelem, and M. Stanton. Providing quality of service for mesh networks using link delay measurements. In *International Conference on Computer Communications and Networks (ICCCN)*, pages 991–996, August 2007.
- [44] H.-N. Dai, K.-W. Ng, and M.-Y. Wu. A busy-tone based mac scheme for wireless ad hoc networks using directional antennas. In *IEEE Global Telecommunications Conference (GLOBECOM)*, pages 4969–4973, November 2007.
- [45] A. Das and T. Zhu. A reservation-based tdma mac protocol using directional antennas (rtdma-da) for wireless mesh networks. In *IEEE Global Telecommunications Conference (GLOBECOM)*, pages 5102–5106, November 2007.
- [46] D.S.J. De Couto, D. Aguayo, J. Bicket, and R. Morris. A high-throughput path metric for multi-hop wireless routing. In *ACM International conference on Mobile computing and networking (MOBICOM)*, pages 134–146, 2003.
- [47] P. Dely, A. Kessler, N. Bayer, H.-J. Emsiedler, and D. Sivchenko. Fuzpag: A fuzzy-controlled packet aggregation scheme for wireless mesh networks. In *International Conference on Fuzzy Systems and Knowledge Discovery (FSKD)*, volume 2, pages 778–782, August 2010.
- [48] A. El Masri, L. Khoukhi, and D. Gaiti. Ftam: A fuzzy traffic adaptation model

- for wireless mesh networks. In *International Conference on Communication Theory, Reliability, and Quality of Service (CTRQ)*, pages 84–88, 2011.
- [49] A. El Masri, L. Khoukhi, and D. Gaiti. A tdma-based mac protocol for wireless mesh networks using directional antennas. In *International Conference on Communication Theory, Reliability, and Quality of Service (CTRQ)*, pages 95–98, 2011.
- [50] A. El Masri, L. Khoukhi, A. Sardouk, and D. Gaiti. Qos support in wmns using temporal resource reservation and traffic regulation schemes. In *IEEE Consumer Communications and Networking Conference (CCNC)*, pages 132–137, 2012.
- [51] A. El Masri, L. Khoukhi, A. Sardouk, M. Mansouri, and D. Gaiti. Wirs: Resource reservation and traffic regulation for qos support in wireless mesh networks. In *IEEE Global Communications Conference (GLOBECOM)*, pages 1–5, December 2011.
- [52] A. El Masri, A. Sardouk, L. Khoukhi, and D. Gaiti. A preventive traffic adaptation model for wireless mesh networks using fuzzy logic. In *IEEE International Conference on Networking, Architecture and Storage (NAS)*, pages 73 –81, July 2011.
- [53] A. El Masri, A. Sardouk, L. Khoukhi, and D. Gaiti. An efficient and fair congestion control protocol for ieee 802.11-based wireless mesh networks. In *IEEE International Symposium on Personal, Indoor and Mobile Radio Communications (PIMRC)*, September 2012.
- [54] A. El Masri, A. Sardouk, L. Khoukhi, L. Merghem-Boulaiah, D. Gaiti, and R. Rahim-Amoud. A hybrid mesh, ad hoc, and sensor network for forest fire management. In *IEEE Vehicular Technology Conference (VTC Fall)*, pages 1–5, September 2011.
- [55] S.M. ElRakabawy, A. Klemm, and C. Lindemann. TCP with Adaptive Pacing for Multihop Wireless Networks. In *ACM international symposium on Mobile ad hoc networking & computing (MOBIHOC)*, pages 288–299, 2005.
- [56] L.S. Ferreira, M. Dias de Amorim, L. Iannone, L. Berlemann, and L.M. Correia. Opportunistic management of spontaneous and heterogeneous wireless mesh networks. *IEEE Wireless Communications*, 17(2):41–46, 2010.
- [57] Z. Fu, B. Greenstein, X. Meng, and S. Lu. Design and Implementation of a TCP-Friendly Transport Protocol for Ad Hoc Wireless Networks. In *IEEE International Conference on Network Protocols (ICNP)*, pages 216–225, 2002.
- [58] H. Gharavi. Directional antenna for multipath ad hoc routing. In *IEEE Consumer Communications and Networking Conference (CCNC)*, pages 1–5, 2009.
- [59] H. Gossain, C. Cordeiro, and D.P. Agrawal. Mda: an efficient directional mac

- scheme for wireless ad hoc networks. In *IEEE Global Telecommunications Conference (GLOBECOM)*, volume 6, pages 5 pp.–3637, December 2005.
- [60] H. Gossain, C. Cordeiro, D. Cavalcanti, and D.P. Agrawal. The deafness problems and solutions in wireless ad hoc networks using directional antennas. In *IEEE Global Communications Conference (GLOBECOM)*, pages 108–113, December 2004.
- [61] V.C. Gungor, P. Pace, and E. Natalizio. AR-TP: An adaptive and responsive transport protocol for wireless mesh networks. In *IEEE International Conference on Communications (ICC)*, pages 3740–3745, June 2007.
- [62] O. Gurewitz, V. Mancuso, J. Shi, and E.W. Knightly. Measurement and modeling of the origins of starvation of congestion-controlled flows in wireless mesh networks. *IEEE/ACM Transactions on Networking*, 17(6):1832–1845, December 2009.
- [63] D. Hong-Ning. An overview of mac protocols with directional antennas in wireless ad hoc networks. In *International Conference on Wireless and Mobile Communications (ICWMC)*, July 2006.
- [64] Z. Huang, C.-C. Shen, C. Srisathapornphat, and C. Jaikaeo. A busy-tone based directional mac protocol for ad hoc networks. In *Military Communications Conference (MILCOM)*, pages 1233–1238, October 2002.
- [65] A.K. Jain, J. Mao, and K.M. Mohiuddin. Artificial neural networks: a tutorial. *Computer*, 29(3):31–44, March 1996.
- [66] R. Jain, A. Duresi, and G. Babic. Throughput fairness index: an explanation, 1999.
- [67] G. Jakllari, I. Broustis, T. Korakis, S.V. Krishnamurthy, and L. Tassiulas. Handling asymmetry in gain in directional antenna equipped ad hoc networks. In *IEEE International Symposium on Personal, Indoor and Mobile Radio Communications (PIMRC)*, volume 2, pages 1284–1288, September 2005.
- [68] J. Jangeun. The nominal capacity of wireless mesh networks. *IEEE Wireless Communications*, 10(5):8–14, October 2003.
- [69] A. Jindal and K. Psounis. The achievable rate region of 802.11-scheduled multihop networks. *IEEE/ACM Transactions on Networking*, 17(4):1118–1131, August 2009.
- [70] D.L. Johnson and K. Roux. Building rural wireless networks: lessons learnt and future directions. In *ACM workshop on Wireless networks and systems for developing regions (WiNS-DR)*, pages 17–22, 2008.
- [71] R. Kawitkar. Issues in deploying smart antennas in mobile radio networks, 2009.

- [72] L. Khoukhi, A. El Masri, and D. Gaiti. A hybrid stateless qos approach for wireless mobile ad hoc networks. In *IFIP International Conference on New Technologies, Mobility and Security (NTMS)*, pages 1–5, 2011.
- [73] L. Khoukhi, A. El Masri, A. Sardouk, A. Hafid, and D. Gaiti. Traffic adaptation in wireless mesh networks: Fuzzy-based model. In *International Wireless Communications and Mobile Computing Conference (IWCMC)*, pages 41–46, July 2011.
- [74] L. Khoukhi, A. El Masri, A. Sardouk, A. Hafid, and D. Gaiti. Toward fuzzy traffic adaptation solution in wireless mesh networks. *IEEE Transactions on Computers*. To appear (accepted in 2012).
- [75] Y.-B. Ko, V. Shankarkumar, and N.H. Vaidya. Medium access control protocols using directional antennas in ad hoc networks. In *IEEE International Conference on Computer Communications (INFOCOM)*, volume 1, pages 13–21, 2000.
- [76] V. Kolar, S. Tilak, and N.B. Abu-Ghazaleh. Avoiding head of line blocking in directional antenna [mac protocol]. In *IEEE International Conference on Local Computer Networks (LCN)*, pages 385– 92, November 2004.
- [77] T. Korakis, G. Jakllari, and L. Tassiulas. A mac protocol for full exploitation of directional antennas in ad-hoc wireless networks. In *ACM international symposium on Mobile ad hoc networking & computing (MOBIHOC)*, pages 98–107, 2003.
- [78] T. Korakis, G. Jakllari, and L. Tassiulas. Cdr-mac: A protocol for full exploitation of directional antennas in ad hoc wireless networks. *IEEE Transactions on Mobile Computing*, 7(2):145 –155, 2008.
- [79] R. Langar, N. Bouabdallah, R. Boutaba, and G. Pujolle. Interferer link-aware routing in wireless mesh networks. In *IEEE International Conference on Communications (ICC)*, pages 1–6, 2010.
- [80] R. Langar, S. Njima, N. Bouabdallah, R. Boutaba, and G. Pujolle. Towards efficient use of radio resources in single channel wireless mesh networks. In *IEEE Global Telecommunications Conference (GLOBECOM)*, pages 1–6, 2010.
- [81] J. Lee, S.-J. Lee, W. Kim, D. Jo, T. Kwon, and Y. Choi. Understanding interference and carrier sensing in wireless mesh networks. *IEEE Communications Magazine*, 47(7):102–109, July 2009.
- [82] J. Lee, H. Yoon, and I. Yeom. Distributed fair scheduling for wireless mesh networks using ieee 802.11. *IEEE Transactions on Vehicular Technology*, 59(9):4467–4475, November 2010.

- [83] K.Y. Lee, K.-S. Cho, and B.-S. Lee. Cross-layered hop-by-hop congestion control for multihop wireless networks. In *IEEE International Conference on Mobile Adhoc and Sensor Systems (MASS)*, pages 485–488, October 2006.
- [84] W.V. Leekwijck and E.E. Kerre. Defuzzification: Criteria and Classification. *Fuzzy Sets and Systems*, 108(2):159–178, 1999.
- [85] P. Li, H. Zhai, and Y. Fang. Sdmac: Selectively directional mac protocol for wireless mobile ad hoc networks. *Wireless Networks*, 15:805–820, August 2009.
- [86] P. Li, C. Zhang, and Y. Fang. Asymptotic connectivity in wireless ad hoc networks using directional antennas. *IEEE/ACM Transactions on Networking*, 17(4):1106–1117, 2009.
- [87] Y. Li and A.M. Safwat. Dmac-daca: enabling efficient medium access for wireless ad hoc networks with directional antennas. In *International Symposium on Wireless Pervasive Computing (ISWPC)*, page 5 pp., January 2006.
- [88] J. C. Liberti and T. S. Rappaport. *Smart Antennas for Wireless Communications*. Prentice Hall, NJ, 1999.
- [89] C. Lochert, B. Scheuermann, and M. Mauve. A survey on congestion control for mobile ad hoc networks: Research articles. *Wireless Communications and Mobile Computing*, 7:655–676, June 2007.
- [90] A. Margolis, R. Vijayakumar, and S. Roy. Modelling throughput and starvation in 802.11 wireless networks with multiple flows. In *IEEE Global Communications Conference (GLOBECOM)*, pages 5123–5127, November 2007.
- [91] I. Martinez and J. Altuna. Influence of directional antennas in stdma ad hoc network schedule creation. In *International Workshop on Wireless Ad-hoc Networks (IWWAN)*, May 2005.
- [92] P. Mühlethaler. *802.11 et les Réseaux sans fil*. Eyrolles, 2002.
- [93] A. Munaretto and M. Fonseca. Routing and quality of service support for mobile ad hoc networks. *Computer Networks*, 51(11):3142–3156, August 2007.
- [94] J.C. Mundarath, P. Ramanathan, and B.D. Van Veen. Nullhoc : a mac protocol for adaptive antenna array based wireless ad hoc networks in multipath environments. In *IEEE Global Telecommunications Conference (GLOBECOM)*, volume 5, pages 2765–2769, Nov.-Dec. 2004.
- [95] J.C. Mundarath, P. Ramanathan, and B.D. Van Veen. A quality of service aware cross-

- layer approach for wireless ad hoc networks with smart antennas. *Ad Hoc Networks*, 7(5):891–903, 2009.
- [96] K. Nakajima, K. Mase, and H. Okada. A congestion control scheme for layer 3 wireless mesh networks. In *Asia-Pacific Conference on Communications (APCC)*, pages 722–725, October 2009.
- [97] N.S. Nandiraju, H. Gossain, D. Cavalcanti, K.R. Chowdhury, and D.P. Agrawal. Achieving fairness in wireless lans by enhanced 802.11 dcf. Technical report, University of Cincinnati, 2005.
- [98] S.H.R. Naqvi and L.M. Patnaik. A distributed channel access protocol for ad hoc networks with feedback power control. *IEEE Transactions on Mobile Computing*, 5(10):1448–1459, 2006.
- [99] V. Nascimento, C. Gomes, W. Moreira, and A. Abelem. Clm-tcp: Tcp congestion control mechanism using cross layer for wireless mesh networks. In *IEEE International Conference on Parallel and Distributed Systems (ICPADS)*, pages 885–890, December 2008.
- [100] A. Nasipuri, S. Ye, J. You, and R.E. Hiromoto. A mac protocol for mobile ad hoc networks using directional antennas. In *IEEE Wireless Communications and Networking Conference (WCNC)*, volume 3, pages 1214–1219, 2000.
- [101] C. Q. Nguyen, B.-C. Min, E.T. Matson, A.H. Smith, J. E. Dietz, and D. Kim. Using mobile robots to establish mobile wireless mesh networks and increase network throughput. *International Journal of Distributed Sensor Networks (Hindawi Publishing Corporation)*, 2012.
- [102] G. Panos. Congestion control mechanisms and the best effort service model. *IEEE Network*, 15(3):16–26, May 2001.
- [103] A.C. Pinho, D.R. Figueiredo, and F.M.G. Franca. A robust gradient clock synchronization algorithm for wireless sensor networks. In *International Conference on Communication Systems and Networks (COMSNETS)*, pages 1–10, January 2012.
- [104] M. Portmann. Wireless mesh networks for public safety and crisis management applications. *IEEE Internet Computing*, 12(1):18–25, January-February 2008.
- [105] A. Prabhu and S.R. Das. Addressing deafness and hidden terminal problem in directional antenna based wireless multi-hop networks. In *International Conference on Communication Systems Software and Middleware (COMSWARE)*, pages 1–6, January 2007.

- [106] S. Prasanthi and S.-H. Chung. An efficient algorithm for the performance of tcp over multi-hop wireless mesh networks. In *International Conference on Information Technology: New Generations (ITNG)*, pages 816–821, April 2010.
- [107] R. Ramanathan. On the performance of ad hoc networks with beamforming antennas. In *Proceedings of the 2nd ACM international symposium on Mobile ad hoc networking & computing (MOBIHOC)*, pages 95–105, 2001.
- [108] R. Ramanathan, J. Redi, C. Santivanez, D. Wiggins, and S. Polit. Ad hoc networking with directional antennas: a complete system solution. *IEEE Journal on Selected Areas in Communications*, 23(3):496–506, march 2005.
- [109] S. Rangwala, A. Jindal, K.-Y. Jang, K. Psounis, and R. Govindan. Understanding congestion control in multi-hop wireless mesh networks. In *ACM international conference on Mobile computing and networking (MOBICOM)*, pages 291–302, 2008.
- [110] S. Rangwala, A. Jindal, K.-Y. Jang, K. Psounis, and R. Govindan. Neighborhood-centric congestion control for multihop wireless mesh networks. *IEEE/ACM Transactions on Networking*, 19(6):1797–1810, December 2011.
- [111] A. Raniwala, P. De, S. Sharma, R. Krishnan, and T.-C. Chiueh. Globally fair radio resource allocation for wireless mesh networks. In *IEEE International Symposium on Modeling, Analysis Simulation of Computer and Telecommunication Systems (MAS-COTS)*, 2009.
- [112] A. Raniwala, D. Pradipta, and S. Sharma. End-to-end flow fairness over ieee 802.11-based wireless mesh networks. In *IEEE International Conference on Computer Communications (INFOCOM)*, pages 2361–2365, May 2007.
- [113] V. Rastogi, V.J. Ribeiro, and A.D. Nayar. Measurements in olpc mesh networks. In *International conference on Modeling and Optimization in Mobile, Ad Hoc, and Wireless Networks (WiOPT)*, pages 577–582, 2009.
- [114] B. Sadeghi, A. Yamada, A. Fujiwara, and L. Yang. A simple and efficient hop-by-hop congestion control protocol for wireless mesh networks. In *International workshop on Wireless internet (WICON)*, 2006.
- [115] B. Scheuermann, C. Lochert, and M. Mauve. Implicit hop-by-hop congestion control in wireless multihop networks. *Ad Hoc Networks*, 6(2):260–286, 2008.
- [116] H. Singh and S. Singh. A mac protocol based on adaptive beamforming for ad hoc networks. In *IEEE Personal, Indoor and Mobile Radio Communications (PIMRC)*, volume 2, pages 1346–1350, September 2003.

- [117] A. Spyropoulos and C.S. Raghavendra. Energy efficient communications in ad hoc networks using directional antennas. In *IEEE International Conference on Computer Communications (INFOCOM)*, volume 1, pages 220–228 vol.1, 2002.
- [118] I. Stevanovic, A. Skrivervik, and J.R. Mosig. Smart antenna systems for mobile communications. Technical report, Ecole Polytechnique Fédéral de Lausanne, 2003.
- [119] W. R. Stevens. *TCP/IP Illustrated*. vol. 1. Reading, MA: Addison-Wesley, 1994.
- [120] C.A. St.Jean, A.N. Zadeh, and B. Jabbari. Combined routing, channel scheduling, and power control in packet radio ad hoc networks with cellular overlay. In *IEEE Vehicular Technology Conference (VTC-Spring)*, volume 4, pages 1960–1964 vol.4, 2002.
- [121] I.K. Tabash, N. Ahmad, and S. Beg. A congestion window control mechanism based on fuzzy logic to improve tcp performance in manets. In *International Conference on Computational Intelligence and Communication Networks (CICN)*, pages 21–26, 2011.
- [122] M. Takai, J. Martin, R. Bagrodia, and A. Ren. Directional virtual carrier sensing for directional antennas in mobile ad hoc networks. In *ACM international symposium on Mobile ad hoc networking & computing (MOBIHOC)*, pages 183–193, 2002.
- [123] M. Takata, M. Bandai, and T. Watanabe. A receiver-initiated directional mac protocol for handling deafness in ad hoc networks. In *IEEE International Conference on Communications (ICC)*, volume 9, pages 4089–4095, June 2006.
- [124] M. Takata, M. Bandai, and T. Watanabe. A mac protocol with directional antennas for deafness avoidance in ad hoc networks. In *IEEE Global Telecommunications Conference (GLOBECOM)*, pages 620–625, November 2007.
- [125] K. Tan, F. Jiang, Q. Zhang, and X. Shen. Congestion control in multihop wireless networks. *IEEE Transactions on Vehicular Technology*, 56(2):863–873, March 2007.
- [126] U.P.C. and W. A. M. Lab. Glomosim: A scalable simulation environment for wireless and wired network systems. In *International Working Conference on Performance Modeling and Evaluation of Heterogeneous Networks (HET-NETs)*, 2005.
- [127] S. Venkateswaran, S. Singh, U. Madhow, and R. Mudumbai. Distributed synchronization and medium access in wireless mesh networks. In *Information Theory and Applications Workshop (ITA)*, pages 1–8, Februar 2011.
- [128] D.P. Venmani, D. Zeghlache, and Y. Gourhant. Demystifying link congestion in 4g-lte backhaul using openflow. In *IFIP International Conference on New Technologies, Mobility and Security (NTMS)*, pages 1–8, 2012.
- [129] J. Wang, Y. Fang, and D. Wu. Syn-dmac: a directional mac protocol for ad hoc

- networks with synchronization. In *IEEE Military Communications Conference (MILCOM)*, pages 2258–2263, October 2005.
- [130] J. Wang, H. Zhai, P. Li, Y. Fang, and D. Wu. Directional medium access control for ad hoc networks. *Wireless Networks*, 15(8):1059–1073, 2009.
- [131] P. Wang and W. Zhuang. A collision-free mac scheme for multimedia wireless mesh backbone. *IEEE Trans. on Wirel. Commun.*, 8(7):3577–3589, 2009.
- [132] X. Wang and D. Perkins. Cross-layer hop-by-hop congestion control in mobile ad hoc networks. In *IEEE Wireless Communications and Networking Conference (WCNC)*, pages 2456–2461, April 2008.
- [133] A. Warriier, S. Janakiraman, S. Ha, and I. Rhee. Diffq: Practical differential backlog congestion control for wireless networks. In *IEEE Conference on Computer Communications (INFOCOM)*, pages 262–270, April 2009.
- [134] S. Weberi, V. Cahill, S. Clarke, and M. Haahr. Wireless ad hoc network for dublin: A large-scale ad hoc network test-bed. *ERCIM News*, 54, July 2003.
- [135] J.H. Winters. Smart antenna techniques and their application to wireless ad hoc networks. *IEEE Wireless Communications*, 13(4):77–83, August 2006.
- [136] K. Xu, M. Gerla, and S. Bae. Effectiveness of rts/cts handshake in ieee 802.11 based ad hoc networks. *Ad Hoc Networks*, 1(1):107–123, 2003.
- [137] K. Xu, M. Gerla, L. Qi, and Y. Shu. Enhancing tcp fairness in ad hoc wireless networks using neighborhood red. In *ACM international conference on Mobile computing and networking (MOBICOM)*, pages 16–28, 2003.
- [138] S. Xu and T. Saadawi. Does the ieee 802.11 mac protocol work well in multihop wireless ad hoc networks? *IEEE Communications Magazine*, 39(6):130–137, June 2001.
- [139] S. Yi, Y. Pei, and S. Kalyanaraman. On the capacity improvement of ad hoc wireless networks using directional antennas. In *ACM international symposium on Mobile ad hoc networking & computing (MOBIHOC)*, pages 108–116, 2003.
- [140] Y. Yi and S. Shakkottai. Hop-by-hop congestion control over a wireless multi-hop network. In *IEEE Conference on Computer Communications (INFOCOM)*, volume 4, pages 2548–2558, March 2004.
- [141] J.-Y. Yoo and J. Kim. Core: An accurate congestion detection method in ieee 802.11 wireless mesh networks. In *International Conference on Advanced Communication Technology (ICACT)*, pages 1249–1252, February 2011.

- [142] A. Yoshida, T. Yamaguchi, N. Wakamiya, and M. Murata. Proposal of a reaction-diffusion based congestion control method for wireless mesh networks. In *International Conference on Advanced Communication Technology (ICACT)*, volume 1, pages 455–460, February 2008.
- [143] B.N. Yuvaraju and N.N. Chiplunkar. Picco: Protocol independent congestion control method using mobile relays for ad-hoc networks. In *International Conference on Computer and Network Technology (ICCNT)*, pages 93–97, April 2010.
- [144] J. Zhang and X.-H. Jia. Capacity analysis of wireless mesh networks with omni or directional antennas. In *IEEE International Conference on Computer Communications (INFOCOM)*, pages 2881–2885, April 2009.
- [145] J. Zhang and S.-C. Liew. Capacity improvement of wireless ad hoc networks with directional antennae. In *IEEE Vehicular Technology Conference (VTC)*, pages 911–915, May 2006.
- [146] D. Zhao. Throughput fairness in infrastructure-based ieee 802.11 mesh networks. *IEEE Transactions on Vehicular Technology*, 56(5):3210–3219, September 2007.

Ali EL MASRI

Doctorat : Réseaux, Connaissances, Organisations

Année 2013

Vers une gestion efficace et équitable des ressources dans les réseaux mesh sans fil

Le but principal des réseaux mesh sans fil (Wireless Mesh Networks-WMNs) est de fournir une dorsale de communication pour un grand nombre d'utilisateurs, car les WMNs doivent supporter un trafic énorme. Dans cette thèse, nous visons la maximisation d'utilisation et la répartition équitable de la bande passante dans les WMNs. Nous considérons deux environnements : WMN utilisant la norme IEEE 802.11 MAC, qui est caractérisée par son déploiement répandu et peu cher, et WMN utilisant les antennes directionnelles, qui représentent une technologie clé pour la réutilisation spatiale dans les réseaux sans fil. Pour les WMNs basés sur IEEE 802.11, nous concevons NICC, un protocole de contrôle de congestion qui reconnaît la congestion comme un problème lié au voisinage, et non pas au lien. NICC gère la congestion par une collaboration entre les nœuds d'un voisinage sans fil. En faisant usage de certains champs sous-exploités dans l'entête IEEE 802.11, NICC fournit un retour de congestion implicite et multi-bit. Ceci assure un contrôle précis du trafic sans affecter la bande passante. Pour les WMNs utilisant les antennes directionnelles, nous concevons FreeDMAC, un protocole MAC basé sur la technologie TDMA. FreeDMAC garantit que chaque nœud est conscient de toutes les transmissions dans son voisinage, ce qui évite les problèmes MAC causés par les antennes directionnelles, et ainsi, améliore l'utilisation de la bande passante. En outre, FreeDMAC est capable de fournir deux niveaux d'équité: équité entre les liens et équité entre les flux.

Mots clés : IEEE 802.11 (norme) - antennes adaptatives - équité - accès multiple par répartition dans le temps – systèmes de communication sans fil.

Towards Efficient and Fair Resources Management in Wireless Mesh Networks

The main purpose of Wireless Mesh Networks (WMNs) is to provide a communication backbone for a high number of end-users, thus WMNs have to support heavy traffic load. In this thesis, we intend to maximize utilization and achieve fair allocation of the bandwidth resources in WMNs. We consider two WMN environments: WMN using the IEEE 802.11 MAC standard, which is characterized by its cheap devices and widespread deployment, and WMN using directional antennas, which are emerged as an attractive technology to enhance the spatial reusability in wireless networks. For WMM based on IEEE 802.11, we design NICC, a congestion control scheme that recognizes congestion as neighborhood-related problem, and not a link-based one. Indeed, complex interference among neighboring nodes is the main starvation cause in WMNs. Therefore, NICC handles congestion using mutual cooperation within a wireless neighborhood. NICC makes use of some underexploited fields in the IEEE 802.11 frame header in order to provide an implicit multi-bit congestion feedback, and thus ensure accurate rate control without generating overhead, making efficient use of bandwidth. For WMN with directional antennas, we design FreeDMAC, a TDMA-based MAC scheme with contention-free scheduling. FreeDMAC guarantees that each node is aware of all ongoing transmissions in its neighborhood, and thus avoids directional-related problems such as deafness, making efficient use of bandwidth. Moreover, FreeDMAC presents a link-slot assignment that provides two levels of fairness: Per-link and per-flow fairness.

Keywords: IEEE 802.11 (standard) - adaptive antennas – equity - time division multiple access - wireless communication systems.

Thèse réalisée en partenariat entre :

