



**HAL**  
open science

# Les Enjeux de la circulation dans les sociétés durables : logistique et économie de fonctionnalité

Sébastien Dente

► **To cite this version:**

Sébastien Dente. Les Enjeux de la circulation dans les sociétés durables : logistique et économie de fonctionnalité. Environnement et Société. Université de Technologie de Troyes, 2013. Français. NNT : 2013TROY0017 . tel-02965764

**HAL Id: tel-02965764**

**<https://theses.hal.science/tel-02965764>**

Submitted on 13 Oct 2020

**HAL** is a multi-disciplinary open access archive for the deposit and dissemination of scientific research documents, whether they are published or not. The documents may come from teaching and research institutions in France or abroad, or from public or private research centers.

L'archive ouverte pluridisciplinaire **HAL**, est destinée au dépôt et à la diffusion de documents scientifiques de niveau recherche, publiés ou non, émanant des établissements d'enseignement et de recherche français ou étrangers, des laboratoires publics ou privés.

Thèse  
de doctorat  
de l'UTT

**Sébastien DENTE**

**The Stakes of Circulation  
in Sustainable Societies -  
Logistics and Functional Economy**

**Spécialité :  
Développement Durable**

2013TROY0017

Année 2013

---

---

# THESE

*pour l'obtention du grade de*

## DOCTEUR de l'UNIVERSITE DE TECHNOLOGIE DE TROYES Spécialité : **DEVELOPPEMENT DURABLE**

*présentée et soutenue par*

**Sébastien DENTE**

*le 11 septembre 2013*

---

---

### **The Stakes of Circulation in Sustainable Societies - Logistics and Functional Economy**

---

---

## JURY

Mme N. TROUSSIER	PROFESSEUR DES UNIVERSITES	Président
Mme C. BLANQUART	DIRECTRICE DE RECHERCHE	Rapporteur
M. N. BUCLET	PROFESSEUR DES UNIVERSITES	Directeur de thèse
Mme A. BURMEISTER	CHARGEE DE RECHERCHE	Examineur
M. B. PECQUEUR	PROFESSEUR DES UNIVERSITES	Rapporteur
M. C. RIZET	DIRECTEUR DE RECHERCHE	Examineur
M. L. TAVASSZY	PROFESSOR	Directeur de thèse

## French summary

### 1. Contexte et problématique de la recherche

#### 1.1 Une dégradation générale de l'environnement

Selon (Rotillon, 2010), deux périodes sont à distinguer en ce qui concerne les problèmes créés par l'utilisation des ressources naturelles par les sociétés humaines. L'une est liée à la question de l'épuisement des ressources naturelles et les conséquences sur la croissance économique. L'autre se préoccupe des dégradations environnementales liées à nos modes de production et de consommation actuels. Ces deux périodes soulèvent des questions différentes en ce qui concerne la gestion des ressources naturelles, la première portant sur la notion de rareté tandis que la seconde traite des limites posées par l'environnement sur les actions humaines.

La notion de rareté a été définie principalement dans le domaine économique étant donné que l'objet de la science économique est l'étude de la répartition optimale des ressources limitées. Par conséquent, les ressources naturelles sont également définies sur le plan économique comme quelque chose d'existant dans l'environnement naturel, utile pour les hommes, et pouvant être extrait et utilisé avec les technologies existantes et au niveau de prix actuel (Rotillon, 2010). D'une notion de ressources naturelles intuitivement liée aux sciences physiques et naturelles, les ressources naturelles sont transformées en un problème de gestion de prix avec la maximisation du profit comme objectif principal. Cependant, la dégradation des ressources naturelles et l'environnement se caractérisent bien en tout premier lieu par une réalité physique. Les 1,1 milliards tonnes de matière consommées par l'économie française en 2007 sont physiquement réelles (Commissariat général au développement durable, 2010). De même, la production 2011 d'acier brut de la Chine, environ cinq fois supérieure à celle de l'année 2000 atteignant de ce fait 683 millions de tonnes (Hashimoto, et al., 2012), constitue une preuve physique de l'augmentation de la pression des sociétés humaines sur l'environnement. Il y a donc une distinction importante à faire entre le stock physique et le stock économique, ce dernier représentant toujours une part plus ou moins grande du premier. Cette hiérarchie est souvent utilisée pour faire valoir qu'il est insensé de considérer possible l'épuisement total du stock physique dans la mesure où l'exploitation économiquement rentable d'un stock physique diminue à l'approche de l'épuisement de ce stock, favorisant de fait la recherche de ressources alternatives (Rotillon, 2010). De ce point de vue, les aspects physiques servent donc uniquement d'un point de vue méthodologique à établir une distinction entre les ressources renouvelables et non renouvelables, fondée sur la comparaison entre la durée des processus physiques et biologiques à l'origine du renouvellement des ressources et la durée de leur extraction et utilisation (Rotillon, 2010). Cependant, beaucoup d'indicateurs en ce qui concerne l'utilisation des ressources naturelles sont « au rouge ». Le pic de pétrole marquant la production maximale de pétrole brut a déjà été probablement atteint et la production est légèrement en baisse<sup>1</sup>. De même, le fait qu'en dépit de l'augmentation de la production de poissons de 98 10<sup>6</sup> tonnes en 1990 à 140 10<sup>6</sup> tonnes en 2007, les captures de poissons d'eau douce et de mer restent constantes, soit environ 90 10<sup>6</sup> tonnes, tend à démontrer qu'un pic de production a été atteint (World Trade Organization, 2010).

---

<sup>1</sup> [http://www.manicore.com/documentation/petrole/pic\\_futur\\_petrole.html](http://www.manicore.com/documentation/petrole/pic_futur_petrole.html)

Considérons à présent le deuxième aspect du lien reliant l'environnement et les activités humaines. Il s'agit des rejets physiques (déchets, émissions) provenant des activités de transformation des ressources, de leur phase d'usage et de leur fin de vie. En 2007, 73 % des émissions françaises ont été rejetées dans l'air et 25 % des rejets dans l'environnement correspondaient à une mise en décharge. Les émissions de dioxyde de carbone (CO<sub>2</sub>) s'élèvent à 397 millions tonnes (Mt), 88 % desquelles correspondent à la combustion de combustibles fossiles (Commissariat général au développement durable, 2010) comme le montre la **Figure 2**. Le secteur des transports apparaît quant à lui responsable en 2004 de 23 % des émissions mondiales de gaz à effet de serre liées à l'énergie (International Energy Agency, 2006). Ce niveau élevé d'émissions est également associé à une forte consommation matérielle des produits énergétiques puisque les activités de transport couvrent 70 % de la consommation française finale de produits pétroliers. Au niveau local, le transport est également responsable d'une partie importante de la pollution de l'air. Un rapport français récent montre ainsi que le transport représente 60 % des émissions françaises 2009 de dioxyde d'azote (NOx), un gaz important dans les phénomènes d'acidification, eutrophisation et pollution photochimique (CITEPA, 2011). Basé sur le même rapport, la **Figure 1** fournit un ensemble de polluants pour lesquels les contributions du secteur des transports sont importantes (> 10 %).

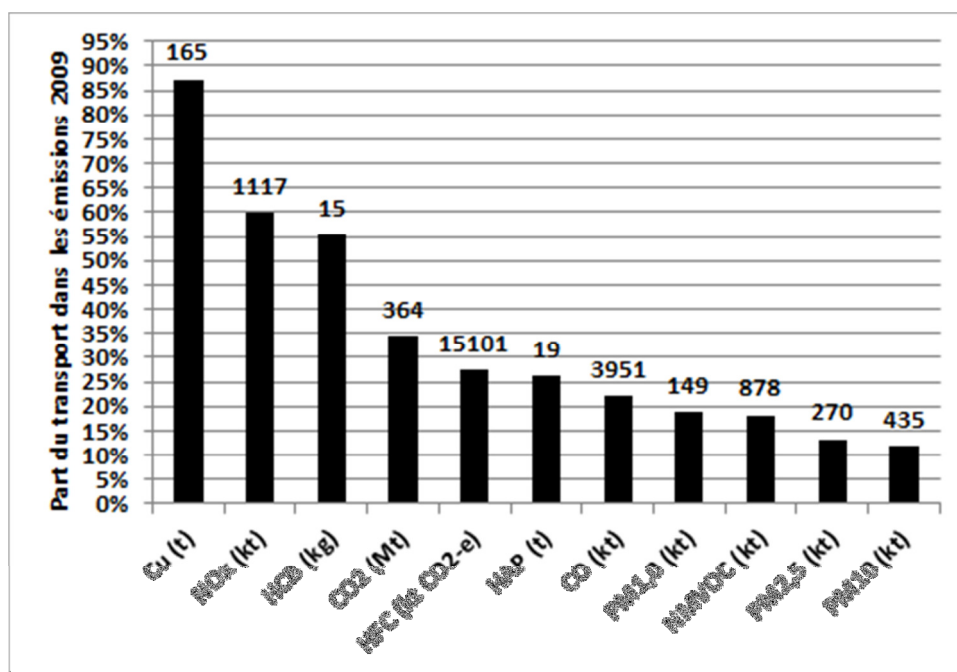

**Lecture:** En 2009, 165 tonnes de Cuivre (Cu) ont été émises dans l'atmosphère sous forme de particule principalement du fait de l'usure des caténaires et des plaquettes de frein. 87% provenaient du secteur des transports.

**Figure 1 : Part du transport dans les émissions 2009 de polluants atmosphériques (CITEPA, 2011)**

L'économie française a donc consommé environ 1,1 milliards de tonnes de matières en 2007. Néanmoins, ce chiffre ne couvre que les ressources entrant directement dans l'économie (DMI) et se révèle donc insuffisant pour obtenir une vue d'ensemble de la charge que représente une économie sur les écosystèmes de la Terre (Commissariat général au développement durable, 2010). Il paraît préférable de considérer les extractions totales de matières (TMR), ce qui permet d'ajouter au bilan national les flux cachés liés aux importations et aux extractions. De ce fait, alors que le DMI français pour l'année 2007 vaut 1101 Mt, le TMR s'élève à 2936 Mt, soit 2,7 fois la valeur du DMI. Cette différence se retrouve notamment dans la consommation de matière par habitant, 17 t/hab. (DMI)

contre 47 t/hab. (TMR), et dans la productivité matérielle qui diminue de 1490 €/t (DMI) à 550 €/t (TMR) (Commissariat général au développement durable, 2010). Etant donné que les flux indirects ne reçoivent pas de valeur (prix) sur le marché, ils ne sont pas considérés dans les indicateurs économiques actuels et par voie de conséquence, le prix ou densité de valeur apparaît comme un indicateur insuffisant pour obtenir une bonne approximation de la consommation de matières de l'économie. Cela pose aussi d'une manière plus générale la problématique de la durabilité telle que nous allons le voir dans le prochain paragraphe.

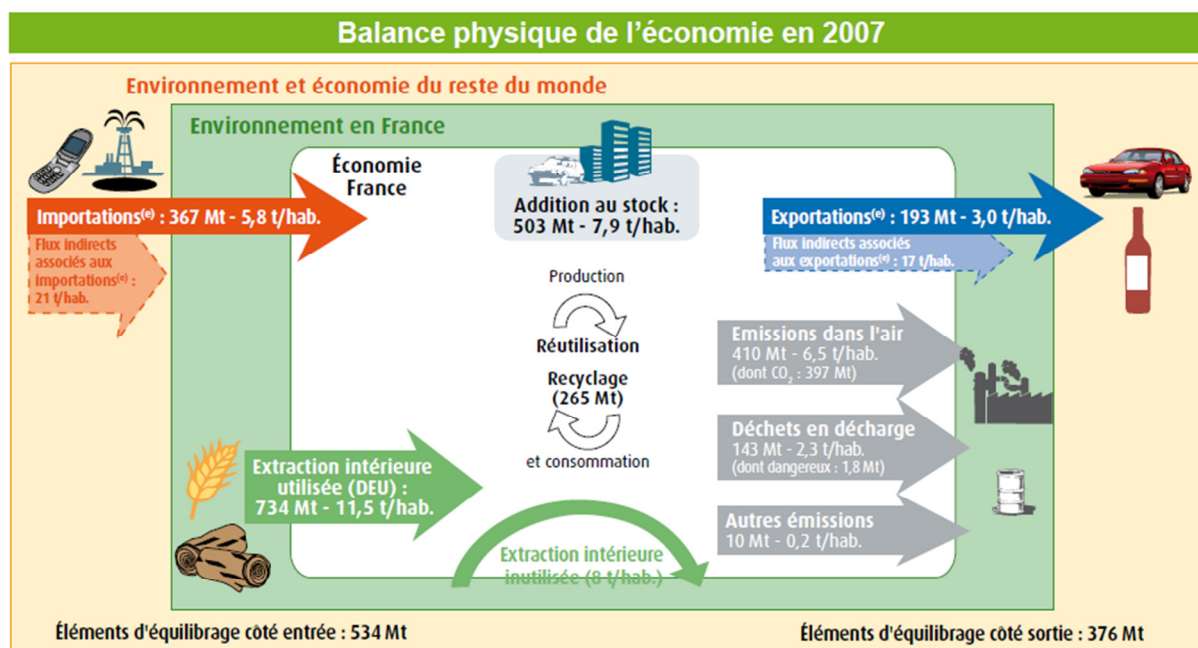

Figure 2 : La balance physique de l'économie Française en 2007 (Commissariat général au développement durable, 2010)

## 1.2 Une notion de durabilité toujours en mouvement

Face à la dégradation des conditions environnementales de la société décrite précédemment, la notion de durabilité, i.e. le moteur conceptuel de l'action visant à remédier à cette dégradation, a évolué à travers différentes étapes. En effet, la Conférence scientifique des Nations Unies (ONU) de 1949 sur la conservation et l'utilisation des ressources a été le premier organe de l'ONU mis en place pour répondre aux problèmes posés par l'épuisement des ressources naturelles. Toutefois, les ressources n'étaient considérées que du point de vue du développement économique et ce n'est qu'en 1968 que les questions environnementales ont reçu une attention sérieuse par les organes des Nations Unies. La pression environnementale liée à l'épuisement des ressources et aux impacts environnementaux augmentant, la première grande conférence scientifique de l'ONU sur l'environnement fut organisée à Stockholm en 1972 sous le nom de premier sommet de la Terre. Au cours de cette conférence, dans une section sur l'identification et le contrôle des polluants de large portée internationale, fut soulevée pour la première fois la question du changement climatique. Mais ce ne fut que bien plus tard, en 1992, que ce problème reçut une attention particulière par le biais de la Convention-cadre des Nations Unies sur les changements climatiques (CCNUCC) ainsi qu'un soutien scientifique fourni par le groupe d'experts intergouvernemental sur le changement climatique (GIEC). L'objectif ultime de la présente convention est de parvenir à la stabilisation des

concentrations de gaz à effet de serre dans l'atmosphère à un niveau qui empêche toute perturbation anthropique dangereuse du système climatique. De plus, cette stabilisation devra être atteinte dans un délai suffisant pour que les écosystèmes puissent s'adapter naturellement aux changements climatiques, que la production alimentaire ne soit pas menacée et que le développement économique puisse se poursuivre d'une manière durable (United Nations, 1992). Dans le cadre de la CCNUCC, il semble donc que le développement économique, c'est-à-dire le développement de l'activité économique humaine, et la circulation associée des marchandises doivent être organisés dans un cadre respectueux du fonctionnement des écosystèmes. Cependant, les autres organisations comme l'Organisation mondiale du commerce considèrent le problème sur les questions environnementales comme étant un débat intellectuel oscillant entre des vues pessimistes et optimistes du problème de la rareté des ressources naturelles. En fait, alors que l'économie libérale et néoclassique s'affiche optimiste dans la capacité d'innovation humaine à toujours s'affranchir davantage des limites physiques, Malthusiens et néo-malthusiens mettent l'accent sur le caractère absolu des limites physiques des ressources de la Terre (World Trade Organization, 2010).

Enfin, la notion de développement durable telle qu'elle s'exprime actuellement fut introduite en 1987 par le rapport Brundtland. Ce rapport définit le développement durable comme un développement qui répond aux besoins du présent sans compromettre la capacité des générations futures à satisfaire leurs propres besoins (World Commission on Environment and Development, 1987). En un sens, cette définition recherche un compromis entre les vues optimistes et pessimistes. En effet, les limites physiques deviennent alors définies comme une équité entre les générations en matière d'accès aux ressources naturelles, tandis que la partie « développement » accorde une place importante à l'économie et à son rôle face aux enjeux d'amélioration du bien-être individuel et collectif. Vingt-cinq ans plus tard, cette définition constitue toujours le principal cadre des politiques dites « durables ». Néanmoins, non seulement les dégradations environnementales ont continué d'augmenter dans le monde entier, mais le cadre socio-économique actuel est de plus en plus mis en doute quant à sa capacité à assurer le bien-être des individus. À cet égard, la Commission Stiglitz 2009 a formulé cinq recommandations afin de concilier système économique et création de bien-être. La première de ces recommandations concerne un revirement théorique de ce qui constitue le moteur de l'économie. En effet, plutôt que de focaliser l'analyse sur la production, il conviendrait au système économique de davantage s'intéresser aux revenus et à la consommation. De la même manière, les actifs devraient davantage être pris en compte et l'économie devrait s'axer sur la perspective des ménages, i.e. la demande finale. L'idée est donc notamment de mettre en évidence les activités économiques intermédiaires non nécessaires pour la satisfaction de la demande finale, qui bien que venant grossir artificiellement la croissance économique mesurée en termes de PIB, ne s'en traduisent pas moins par une véritable augmentation de la consommation des ressources naturelles et des émissions de polluants associés. Enfin, d'un point de vue social, le système économique devrait donner plus d'importance à la répartition des revenus, de la consommation et des richesses de sorte que les indicateurs de revenu devraient être étendus à des activités non marchandes.

Cependant, le cadre principal des politiques durables cherchent toujours à atteindre la durabilité au sein du cadre socio-économique actuel. Les objectifs sont généralement ambitieux puisque par exemple l'Union européenne (UE) vise une réduction de 80 à 95 % des émissions de gaz à effet de serre (GES) par rapport au niveau d'émissions de 1990, avec une étape intermédiaire de réduction de

20 % en 2020 (European Commission, 2011). De même, à l'horizon 2020 la part des ressources renouvelables est censée atteindre 20 %, alors que l'efficacité énergétique est censée avoir augmenté de 20 % (European Commission, 2011). Néanmoins, ces objectifs paraissent difficilement atteignables dans la mesure où les moyens proposés par l'U.E. pour atteindre ces objectifs de dématérialisation sont flous ou inexistant. De plus, plusieurs concepts demeurent flous dans la définition du développement durable telle que proposée par le rapport Brundtland puisque le progrès économique (croissance) est posé de façon systématique comme entraînant un progrès social (bien être). De ce fait, les questions générales de la durabilité relatives aux déterminants du bien-être et aux contraintes environnementales ne sont que peu traités. La représentation du développement durable actuellement dominante est donc celle de la **Figure 3**. La durabilité y apparaît définie comme un IDH supérieur à 0,8 et une empreinte écologique inférieure à 2 hectares par personne. De ce fait, les pays se trouvent divisés en deux principaux groupes, les pays en voie de développement devant s'améliorer économiquement pour atteindre un IDH supérieur à 0,8 et les pays développés devant s'améliorer du point de vue environnemental sans diminuer leurs performances économiques.

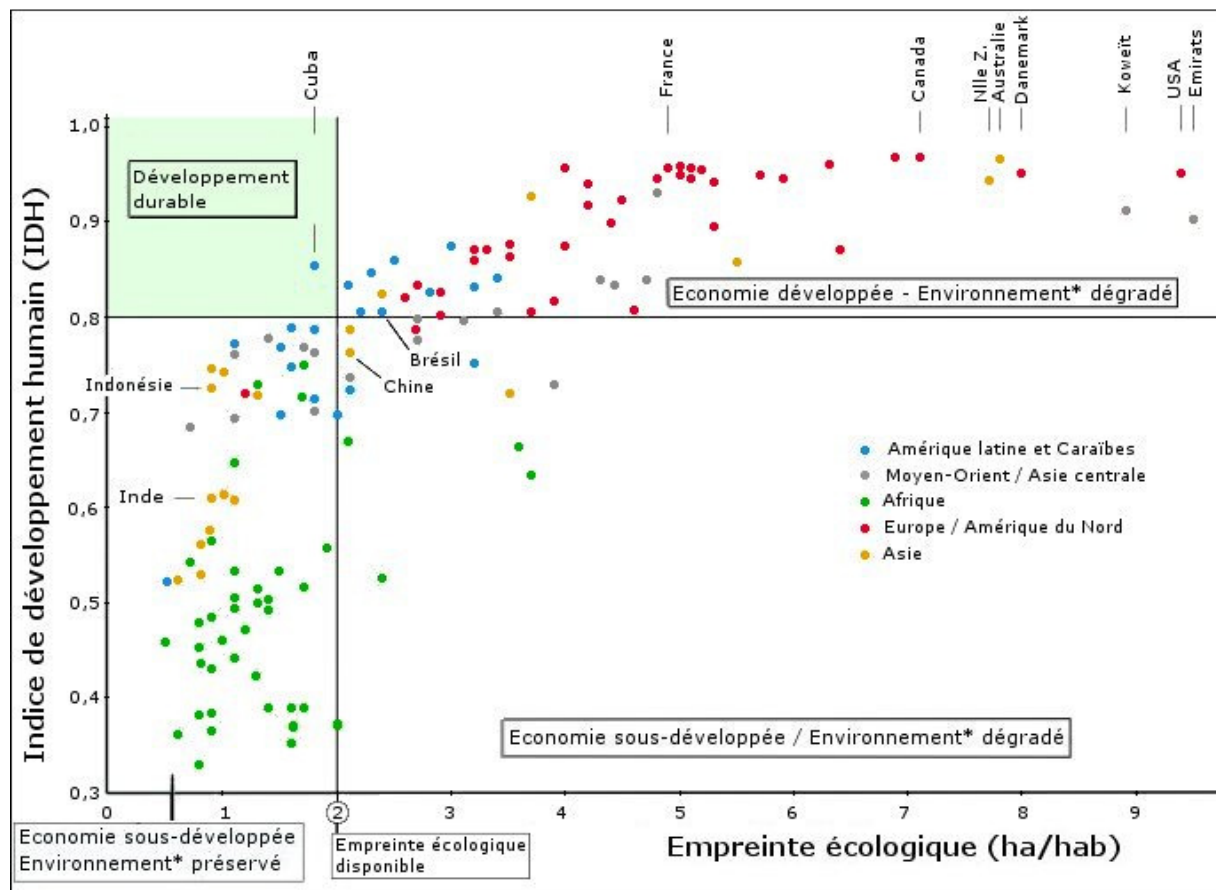

**Figure 3 : la voie du développement durable entre l'indice de développement humain et l'empreinte écologique.**

L'indice de développement humain concerne la santé, l'éducation et le niveau de vie. Ce cadre est donc conforme à la réalisation des Objectifs Millénaires du Développement (OMD) traitant la satisfaction des besoins essentiels liés à la nutrition, la santé et l'éducation de base (écriture et lecture). Néanmoins, le niveau de vie est défini à travers la notion de revenu qui est un indicateur monétaire établi selon un cadre comptable stricte. La représentation de l'activité humaine faite par



le cadre comptable fournit donc une part importante de la durabilité sociale décrite par l'indice de développement humain. La question de la durabilité est donc liée de manière générale à la représentation des activités humaines dans le cadre économique actuel, lesquelles influencent l'organisation spatio-temporelle de la société et notamment la circulation des marchandises.

### **1.3 Le problème croissant de la circulation**

Vingt-cinq ans après le rapport Brundtland, le monde a connu plusieurs phases successives de mondialisation faisant de la notion d'économie mondialisée une réalité. Cette mondialisation se caractérise par le nombre croissant de pays qui participent au commerce international et le nombre croissant de biens et services échangés tant en variété, quantité et valeur. Par exemple, la production mondiale et la mondialisation associée exprimée en fraction de PIB monde associée aux exportations ont été respectivement multipliés par 45 et 2,5 au cours des cinquante dernières années. Un autre point clé dans le processus de mondialisation est la sophistication croissante des chaînes d'approvisionnement (supply chain) modernes. En effet, l'application des principes de gestion moderne tout au long de la chaîne d'approvisionnement tels que le « juste à temps » ont conduit à des chaînes d'approvisionnement plus réactives et plus souples qui permettent aux entreprises de se livrer concurrence dans un marché mondial. En outre, l'efficacité des systèmes de transport modernes permet d'étendre le nombre possible de partenaires commerciaux et encourage les entreprises à découvrir des stratégies mondiales d'approvisionnement et de distribution plus large pour leurs produits finis (Cetinkaya, et al., 2011). Tous ces nouveaux aspects du commerce ont donc tendance à augmenter le besoin en transport de marchandises et notamment ceux des transports internationaux de marchandises dont les émissions ne sont pas traitées par le protocole de Kyoto, le principal cadre international des politiques climatiques.

Il est à noter que l'Organisation mondiale du commerce favorise la mondialisation à travers ses actions en faveur de l'abaissement des barrières commerciales telles que les droits de douane, douane, interdictions d'importation ou contingents (World Trade Organization, 2011). L'approvisionnement des entreprises donc peut être étendu dans l'espace menant à la réorganisation des chaînes d'approvisionnement adaptées aux nouvelles possibilités offertes par les processus de mondialisation. Par exemple, Panasonic France, filiale de la société japonaise Matsushita spécialisée dans l'électronique a connu quatre phases d'évolution depuis 1980 correspondant à une évolution de l'espace du marché mondial. En effet, dans les années quatre-vingt, les produits étaient principalement importés du Japon en France avant que ne soient créés des unités de production en Europe occidentale au début des années 90. Entre ces deux phases, la longueur de la chaîne d'approvisionnement se trouvait ainsi diminuée. Mais l'effondrement de l'URSS en 1991 et en conséquence l'ouverture du marché de l'Europe de l'Est au reste du monde a conduit à une relocalisation des unités de production en Europe de l'Est. De même, depuis le début des années 2000, l'ouverture du marché chinois a conduit à une relocalisation des unités de production de Panasonic en Chine (Dornier, et al., 2009). Ce processus lié à la recherche de capital humain à bas prix a donc conduit à l'extension de la longueur de la chaîne d'approvisionnement.

La mondialisation des marchés semble donc insensible aux questions spatiales réduisant ou augmentant la longueur des chaînes d'approvisionnement dans une réorganisation permanente fondée sur les possibilités de maximisation des affaires et des profits. Toutefois, ce modèle a une conséquence sur la consommation des ressources naturelles. La consommation d'énergie liée au

transport international devrait progresser régulièrement pour tenir compte de la disparité croissante entre l'emplacement de la demande et celui de la production (International Energy Agency, 2006). En outre, les problèmes environnementaux liés au transport, notamment en termes d'émissions de gaz à effet de serre et de polluants locaux, et les problèmes liés à l'épuisement des ressources énergétiques telles que le pétrole questionnent fortement la viabilité de l'organisation actuelle du triptyque constitué des activités de production, des activités de consommation et de l'organisation logistique associée.

La recherche développée dans ce mémoire s'est donc intéressée à la compréhension de ce triptyque et à la manière dont pourraient être modifiés les interfaces Nature-société et production-consommation afin d'améliorer la durabilité de nos sociétés. De ce fait, deux stratégies dites « durables » ont été particulièrement étudiées dans ce mémoire correspondant aux deux interfaces citées ci-dessus. La première de ces stratégies est désignée sous le terme « écologie industrielle » ou « économie circulaire ». Se concentrant sur l'interface Nature-société, l'économie circulaire considère que la société devrait gérer les ressources naturelles et les déchets/émissions en cycle fermé, chaque déchet/émission devenant une ressource pour une autre industrie. Dans cette perspective, la dématérialisation est obtenue par le biais des activités de remanufacturation et de recyclage qui préviennent l'épuisement des ressources naturelles vierges. La deuxième stratégie est connue en tant qu'économie de fonctionnalité et traite de la modification du lien entre producteurs et consommateurs. En effet, ce lien est actuellement établi par l'acte d'achat réalisant un transfert de propriété à travers des échanges monétaires. À l'opposé, l'économie de fonctionnalité s'intéresse tout d'abord à la satisfaction de la fonction résultant de l'utilisation d'un système de production particulier. De ce fait, l'acte d'achat concerne la fonction et on observe donc une vente liée à l'usage du produit plutôt que du produit lui-même. Le produit restant la propriété du producteur, il reçoit une incitation financière à le concevoir afin que sa durée de vie soit longue, diminuant de fait la consommation de matière associée. En quelque sorte, un parallèle peut être construit entre cette stratégie fonctionnelle et la recommandation du rapport Stiglitz de se concentrer davantage sur la consommation que la production. Toutefois, ces deux stratégies en sont toujours à un stade précoce, tant sur le plan des applications concrètes dans l'économie ou au niveau politique, que sur le plan de la compréhension des conditions théoriques pour rendre l'économie de fonctionnalité en phase avec les enjeux du développement durable.

La problématique de ma recherche s'articule donc autour du triptyque développement durable / supply chain management / économies circulaire et de fonctionnalité. L'idée principale est notamment de déterminer les conditions d'une circulation que l'on pourrait qualifier de durable et la manière dont l'application des principes de l'« économie de fonctionnalité » et de l'« économie circulaire » peut contribuer à cette durabilité.

## 2 Méthodologie et résultats de la recherche

### 2.1 Méthodologie de la recherche

Comme dit précédemment, la présente thèse se concentre sur l'analyse du triptyque développement durable / supply chain management / économies circulaire et de fonctionnalité. Cependant, comme les processus de la circulation des marchandises sont au centre des échanges économiques, cette analyse se rapporte aussi aux représentations des échanges dans notre système économique. Enfin, il convient de préciser que les stratégies de l'économie circulaire et de l'économie de fonctionnalité sont de nouvelles approches visant à favoriser la durabilité, de sorte que relativement peu de recherches ont encore permis d'en comprendre le potentiel vis-à-vis des enjeux du développement durable, ou encore sur la façon dont les échanges économiques devraient s'opérer. De ce fait, le présent travail se trouve divisé en six étapes méthodologiques permettant de préciser la place des stratégies de l'économie de fonctionnalité et de l'économie circulaire dans le champ de la logistique et du développement durable. Le présent mémoire est donc exploratoire, visant à inclure tout d'abord théoriquement et d'autre part autant que possible pratiquement les stratégies de l'économie circulaire et de l'économie de fonctionnalité dans le cadre général des théories économiques et des théories de gestion de la chaîne d'approvisionnement. C'est ce qui explique pourquoi une grande partie de la présente thèse met l'accent sur les liens entre la chaîne d'approvisionnement et de la durabilité avant de traiter de la place des stratégies des économies circulaires/de fonctionnalité. La structure logique de la méthodologie générale de la thèse est donc la suivante et couvre six aspects fondamentaux.

1. Le premier aspect concerne la façon dont les échanges sont représentés dans les théories économiques et les conventions comptables qui forment la base du fonctionnement des sociétés actuelles. L'objectif de ce premier aspect est de comprendre comment est caractérisée la nature de ce qui est échangé au cours d'une transaction économique et les raisons invoquées pour justifier cette compréhension de la transaction économique.
2. Le second aspect s'interroge sur la place du temps et de l'espace au sein des transactions économiques. En d'autres termes, comment s'inscrivent les chaînes d'approvisionnement dans les théories économiques ? L'enjeu est donc de déterminer l'évolution de la place accordée à la logistique et au transport dans les théories économiques.
3. Cela nous conduit au troisième aspect qui s'occupe plus précisément de la notion de durabilité. En effet, devant la montée des impacts environnementaux, des démarches analytiques de la relation nature-société (Analyse de Cycle de Vie, Analyse des Flux de Matières, etc.) ont été développées ainsi que des stratégies environnementales telles que l'affichage environnemental des produits et l'internalisation des coûts externes. Le but de cette troisième étape est de montrer les limites des stratégies environnementales actuelles et leur insuffisance, du fait de leur trop grande dépendance aux conventions dominantes de l'économie, à assurer à la fois les objectifs de réduction des impacts environnementaux et les objectifs sociétaux du développement durable. Les trois premiers aspects de la méthodologie sont donc consacrés à décrire la situation actuelle des relations entre développement durable et la chaîne d'approvisionnement ainsi que les limitations associées. Cela a conduit notamment à considérer comme un échec relatif les tentatives actuelles de favoriser un développement durable et la nécessité de développer de nouvelles stratégies intégrant

davantage les liens entre nature et société (économie circulaire) et les liens entre production et consommation (économie de fonctionnalité).

4. Le quatrième aspect de la méthodologie de recherche concerne donc la description des stratégies de l'économie circulaire et de l'économie de fonctionnalité ainsi que les avantages environnementaux et sociétaux attendus de leurs applications.
5. La cinquième étape consiste à compléter cette description par une critique des stratégies de l'économie circulaire et de l'économie de fonctionnalité du point de vue des processus de la circulation. En effet, de la même manière que la théorie économique dominante porte peu d'intérêt sur les aspects circulatoires, l'économie de fonctionnalité et l'économie circulaire dans leur description habituellement faite dans la littérature scientifique et économique ne considèrent que de manière partielle les aspects de la logistique et du transport.
6. Cela nous conduit à la sixième étape de la méthodologie qui, regroupant les cinq premières étapes, s'intéresse aux conditions permettant une application des stratégies de l'économie circulaire et de l'économie de fonctionnalité respectant les principes de la durabilité. Nous verrons que ces conditions impliquent notamment une nouvelle évolution de la durabilité. La **Figure 4** représente ces six étapes sous une forme schématique résumant ainsi la démarche méthodologique de la recherche.

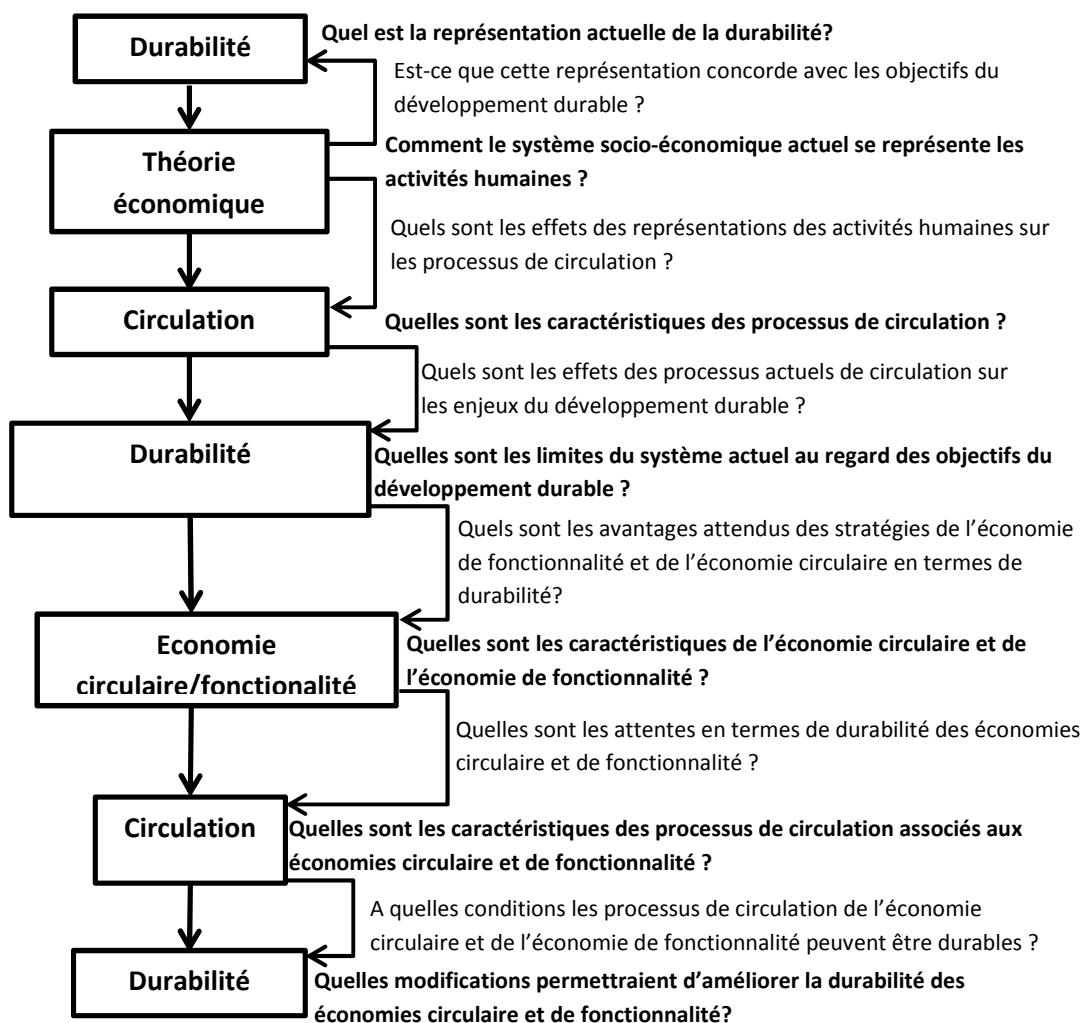

Figure 4: Structure méthodologique de la recherche

## 2.2 Résultats de la recherche

### 2.2.1 Des modifications théoriques importantes

Ainsi qu'expliqué dans la partie méthodologique, plusieurs questions doivent d'abord être résolues avant de pouvoir comprendre la manière dont les stratégies de l'économie de fonctionnalité et l'économie circulaire pourraient faire évoluer les processus de circulation de marchandise vers davantage de durabilité. La première de ces questions concerne la définition de la durabilité elle-même. Dans sa version actuelle, le développement durable, par le biais des politiques durables, se trouve divisé en trois parties ou piliers : l'économique, le social et l'environnemental. Ces trois piliers sont représentés dans la **Figure 5** et montrent la place respective des ressources, déchets et du bien-être dans la compréhension actuelle de la durabilité. En effet, la présente recherche pose en problèmes clés de la durabilité la compréhension de la représentation des ressources, déchets et du bien-être car ces représentations influencent fortement le triptyque « production – consommation – circulation » des marchandises.



**Figure 5 : Les liens entre l'économie, l'environnement et le social dans la compréhension actuelle de la durabilité.**

En d'autres termes, la société dans son organisation se trouve dépendante des conventions gérant la représentation dominante du bien-être, des ressources et des rejets. Or, revenant à la définition du développement durable du rapport Brundtland, la croissance économique apparaît comme la faiseuse de bien-être tandis que les problèmes environnementaux se posent en termes de limitations des ressources disponibles et des capacités de l'environnement à s'accommoder des rejets toujours plus importants. Le développement durable dans sa version actuelle se trouve donc dans une position instable dans la mesure où l'amélioration du bien-être implique une croissance économique qui à son tour implique une croissance des impacts environnementaux. Il convient donc de s'interroger sur la supposée capacité de la croissance économique d'améliorer le bien-être de la société puisqu'il s'agit là du seul fait supposé en faveur du schéma économique actuel. Pour cela, il s'est avéré nécessaire d'étudier dans un premier temps les conventions existantes quant à la façon de se représenter les activités humaines et les échanges économiques.

Le système économique actuel repose notamment sur deux systèmes de compte, les comptes macro-économiques nationaux et les comptes micro-économiques des entreprises. Ces deux systèmes représentent tous les deux les activités humaines sous la forme de flux monétaires. De ce fait, les caractéristiques de la consommation et des échanges entre les personnes s'opèrent dans ces systèmes de compte principalement par la voie marchande et de nombreux aspects de la vie en société (autoproduction, tâches domestiques, etc.) ne sont pas pris en compte ou considérés comme improductifs. De la même manière, ces systèmes de compte privilégient une approche de la production fondée sur la propriété, négligeant de ce fait les nombreuses ressources communes utilisées lors des processus de production. Ainsi, les processus naturels ne sont pris en compte que dans la mesure où un droit de propriété peut leur être appliqué. La pluie, élément fondamental des

cultures, n'est ainsi pas considérée comme un processus de production. Que ce soit le système des comptes nationaux ou le système des comptes d'entreprise, seuls les flux monétaires sont donc enregistrés. L'idée principale est donc de subordonner toute réalité économique à celle des flux monétaires. Pour parvenir à cette subordination, l'analyse de la théorie économique dominante a montré que cette dernière développe une vision objective de la valeur qui permet de concentrer toute réalité économique dans l'existence d'un prix dit « naturel », dont l'échange monétaire n'est que la réalisation commode. Pour cela, les acteurs économiques se doivent notamment de partager une nomenclature des objets et des activités commune, exhaustive (complète) et éternellement valide (futur totalement prévisible). Chaque acteur économique est donc supposé posséder une connaissance encyclopédique des marchandises (Marx, 1994) (p.563). D'un point de vue épistémologique, les fortes hypothèses donnant lieu aux nomenclatures s'inspirent donc fortement des sciences mécaniques et de leur capacité à prévoir de manière certaine les futures trajectoires d'un objet à partir d'une situation présente connue. Cette dépendance vis-à-vis d'une mauvaise compréhension des théories scientifiques fonde la théorie de la valeur qui gouverne la représentation des échanges économiques dans nos sociétés actuelles. Cette théorie de la valeur, empruntant au caractère inaltérable et fondamental des atomes et à la théorie atomique, suppose qu'il existe une définition objective de la valeur préexistante à l'échange et inaltérable. L'échange économique ne devient donc que la réalisation d'une valeur préexistante. Les salaires, les différentes marchandises, les moyens de production ont donc une origine secrète leur permettant une connexion parfaite au réseau monétaire. Dans cette perspective, le débat économique se réduit à des désaccords sur la nature de cette valeur. Ainsi, pour les économistes classiques (1700-1850), la nature de la valeur est liée au travail alors que pour les économistes néoclassiques (1850-aujourd'hui), cette nature est liée au concept d'utilité.

Cette objectivité de la valeur a d'importantes conséquences sur le fonctionnement des processus de circulation. En effet, puisque l'échange ne peut modifier la valeur associée à une marchandise et ne représente que la réalisation d'une transaction « naturelle », il n'est pas besoin d'attribuer de propriétés particulières à l'échange économique et au fait que, dans l'économie réelle, ces échanges ont lieu de manière délocalisée, i.e. dans des lieux situés spatialement et temporellement. Les processus de circulation sont donc entièrement vus comme des procédés abstraits, les lieux de production comme des centres de profit et les lieux de consommation comme l'expression d'une stricte individualité. Cette individualité qui nie toute interaction sociale est mise en place par l'établissement d'un prix unique pour chaque bien et résulte de la résolution du système d'équations de l'équilibre général dit Walrasien. L'individu ne s'exprimant que par le prix, ce représentant de l'utilité, le bien-être de l'individu et de la société elle-même, en vient à ne s'exprimer que par le prix. Dans cet état de fait, le lien positif entre croissance économique et bien-être n'est rien d'autre qu'une tautologie. De plus, dans ce schéma, le temps et l'espace se retrouvent réduits à une dimension nulle puisque le fait que les productions et consommations de biens sont localisées et que leurs circulations ne sont pas instantanés est complètement ignoré. Le transport et la logistique sont donc généralement sous-considérés dans la mesure où leur rôle se borne à celui de la réalisation des échanges et qu'une forte pression s'applique à ces activités puisqu'elles sont rendus responsables de la gestion des coûts de transaction, i.e. de l'écart entre la physique réelle de l'économie et la physique fantasmée d'une économie à coût de transaction nulle. Le transport et la logistique se trouvent donc dépendants de deux modèles idéaux de circulation tels que présentés dans la **Figure 6**.

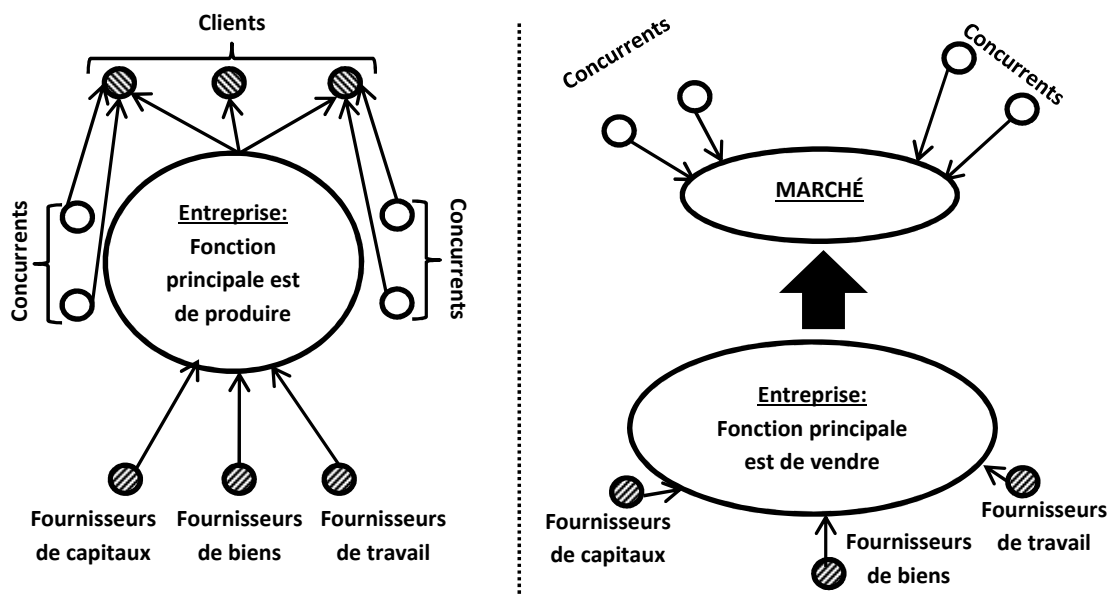

**Figure 6 : La fonction et structure d'une entreprise dans une économie industrielle (gauche) et de marché (droite) (Lendrevie, et al., 2003)(p.4-5)**

Ces deux modèles de circulations suivent l'évolution historique de l'économie classique à l'économie néoclassique. Ainsi, la période caractérisant le XIX<sup>ème</sup> siècle et le début du XX<sup>ème</sup> siècle jusqu'à la fin de la première guerre mondiale concerne le développement d'une production de masse avec de manière indissociable une concentration du capital. Dans cette première période, l'objectif principal est la production notamment par le biais du contrôle des moyens de production avec le développement des machines. Dans ce contexte, la géographie des flux est fortement modifiée par rapport à la situation préindustrielle, puisque la production locale pour une consommation locale est remplacée par une production concentrée pour une consommation se diffusant dans le monde entier. Tandis que l'artisan établit des liens non-marchand avec ses clients, connaissant leurs habitudes d'achat, l'industriel vend ses produits standardisés à des clients indifférenciés. Dans ce contexte d'extension et de découvertes propres aux révolutions scientifique du XIX<sup>ème</sup> siècle, le problème des débouchés n'est que peu abordé et les industriels étant assurés de l'écoulement de leur marchandise ne font que peu de cas des consommateurs et de leurs choix. Le problème se pose pour eux en termes de développement d'économie d'échelle et de système de production efficace, l'efficacité se comprenant comme la maximisation de l'utilisation des machines et l'établissement de processus temporellement efficace permettant des ratios journaliers de production de plus en plus importants. Tout ceci explique notamment pourquoi Ford ne vendait que des voitures noires dans les années 20 parce que les peintures noires séchaient plus vite que les autres peintures (Marty, 1997)(p.13). Dans une seconde période, soit la période 1920-1940 et l'après seconde guerre mondiale, le problème des débouchés devient plus prégnant, obligeant les entreprises à davantage s'intéresser aux consommateurs. C'est la naissance de l'économie de marché avec le développement de méthodologies notamment en marketing, permettant de comprendre, analyser et influencer le comportement des consommateurs. De nombreux livres en transport et logistique font état de ce passage d'une économie industrielle à une économie de marché ( Dornier, et al., 2009); (Marty, 1997); (Pimor, et al., 2008); (Pons, et al., 1996)). Cela est notamment dû au fait que la demande devenant différenciée, le transport doit faire face à une pression temporelle toujours plus forte

changeant l'activité basique du transport d'un transfert de marchandise à une activité au cœur des politiques commerciales, devant garantir flexibilité, fiabilité et rapidité à l'échange des marchandises. L'importance des économies d'échelles caractéristiques du transport massifié (transport ferroviaire, transport fluvial) diminue donc fortement et la part du transport routier augmente fortement. Tout cela a de fortes conséquences environnementales puisque les ratios d'émissions à la tonne-kilomètre du transport routier sont généralement bien supérieurs à ceux des transports massifiés. De plus, la représentation physique du transport en termes de quantité de mouvement montre bien que l'augmentation des vitesses et des masses transportées se traduit par une augmentation de l'énergie consommée. En effet, tel que le montre l'analyse de l'histoire des infrastructures, le transport a d'abord utilisé les premières maîtrises de l'énergie (voie fluviale, vapeur) pour massifier le transport et sortir les régions de leur relatif isolement géographique qui pouvait notamment aggraver l'intensité des famines. Par la suite, une fois l'accessibilité géographique suffisamment assise pour de nombreuses régions du globe, l'amélioration de la disponibilité des sources d'énergie s'est traduite principalement par l'augmentation des vitesses. De ce fait, le monde socio-économique actuel est fortement dépendant d'une accessibilité au domaine des fortes quantités de mouvement, i.e. à la disponibilité de l'énergie en grande quantité.

D'autre part, le problème principal vis-à-vis des enjeux de la durabilité se situe au niveau du monopole théorique du réseau monétaire et de l'objectivisation de la valeur. Tout cela a pour conséquence de nier l'appartenance des individus à de multiples réseaux interconnectés ainsi que le fait que les ressources sont généralement spécifiques, en dissonance avec les usages de l'économie industrielle et de l'économie de marché. Les flux de marchandises au sein de l'économie doivent donc apparaître au service des nœuds (territoires et individus) et doivent respecter les contraintes externes telles que les propriétés des écosystèmes et les autres limites établies localement, lesquelles constituent ce que j'ai appelé « propriétés territoriales ». Du point de vue des théories économiques, cela implique notamment de mieux examiner le rôle du temps et l'espace dans les échanges et par conséquent d'apporter une attention plus grande sur les décisions logistiques, puisque la logistique peut s'assimiler à un outil de gestion du temps et de l'espace. Dans la présente recherche, l'accent a notamment été mis sur le rôle de la monnaie, des débouchés et de proximité dans la caractérisation des limites induites par l'objectivisation de l'échange associée à la théorie de la valeur. En particulier, le rôle de la monnaie dans les échanges économiques n'est pas neutre comme supposé par la théorie de la valeur mais apparaît comme un réseau complexe lié à la question du pouvoir, de la confiance et de légitimité, loin donc de l'attribut de coordination non violente et parfaite idéalement présenté dans les théories économiques. De même, la proximité révèle qu'un échange économique est une construction complexe traitant de l'identification des ressources et de l'organisation de ces ressources, afin que les processus de production puissent avoir lieu et trouver des débouchés dans la consommation. Donc, l'espace, le temps et l'organisation associée sont d'inévitables caractéristiques de tout système « production – consommation », que ce soit l'actuel système socio-économique non durable ou des futurs systèmes durables qui restent encore à définir.

Par conséquent, la place actuelle des systèmes logistiques apparaît beaucoup plus claire. En traitant des aspects spatiaux et temporels de l'échange, les systèmes logistiques sont tributaires de la place accordée au temps et à l'espace dans la représentation des échanges. De ce fait, au sein de l'actuel système socio-économique dans lequel le temps et l'espace sont niés, les systèmes logistiques reçoivent peu d'intérêt. Il n'y a en effet pas besoin de la chaîne d'approvisionnement puisque les



mécanismes des prix assurent les processus de coordination. Néanmoins, les systèmes logistiques saisissent une part importante de la réalité des processus de coordination, apparaissant de ce fait comme une clé pour révéler l'absence de durabilité des modes actuels de coordination du système socio – économique. Il n'en demeure pas moins que l'absence de place donnée aux problèmes de la circulation dans la théorie économique standard a pour conséquence de rejeter la logistique à une place marginale. Il devient donc important de développer de nouveaux modèles théoriques dans lesquels les systèmes logistiques et les enjeux de la circulation recevront plus d'intérêt et se révéleront comme des éléments clé de la durabilité. C'est donc à ce titre qu'apparaissent la nécessité d'étudier l'économie circulaire et l'économie de fonctionnalité en tant que stratégie durable. En effet, bien que les problèmes environnementaux aient conduit à développer certaines approches environnementales de la chaîne d'approvisionnement, telles que l'affichage environnemental des produits, ces analyses ne traitent généralement que la partie production – mise à disposition auprès du consommateur des biens. Les parties correspondantes à la phase d'usage et au déchet (de la porte à la tombe) et à la phase de transformation des déchets en ressources par les voies naturelles ou anthropiques (de la tombe au berceau) sont absentes. De ce fait, l'attention portée sur le système de production est trop importante provoquant une absence de durabilité dans la mesure où les problématiques de la consommation et des contraintes environnementales ne sont que peu considérées. A l'opposé de ce schéma, l'économie circulaire rééquilibre l'attention à travers une approche holistique des interfaces nature-société. De la même manière, l'économie de fonctionnalité rééquilibre l'attention en développant la compréhension des aspects sociétaux de la consommation par l'intermédiaire de la notion de fonction. Ainsi, l'économie circulaire et l'économie de fonctionnalité apparaissent comme des stratégies de rupture pouvant enfin permettre l'accès de nos sociétés à une durabilité.

Les principales innovations prometteuses associées à ces nouveaux modèles économiques concernent la réintroduction des déchets au sein de l'économie et l'extension de vie du produit. En effet, l'analyse environnementale actuelle des chaînes d'approvisionnement a tendance à s'arrêter à la porte de la phase d'utilisation par le client (du berceau au domicile du consommateur) quand un transfert de propriété du produit a lieu entre le producteur et le consommateur. Par conséquent, une déconnexion se produit entre le fait de fournir des produits et le moment où ces produits deviennent des déchets. La première stratégie « de réintroduction des déchets au sein de l'économie » consiste à considérer que les déchets peuvent se transformer en ressources. Par conséquent, les déchets deviennent partie intégrante des stratégies d'approvisionnement des industries. Cela est notamment le cas des éco-parcs industriels tels que celui de Kalundborg où sont mis en pratique les principes de l'écologie industrielle. Dans la symbiose industrielle de Kalundborg, la circularité des échanges introduite par la réutilisation des déchets a par exemple conduit à l'économie de 45 000 tonnes de pétrole et à la réduction de 175 000 tonnes CO<sub>2</sub> par an. Néanmoins, la circularité des échanges peut aussi induire un statu quo dans les niveaux de consommation et de production des acteurs prenant part à l'éco-parc, dans la mesure où disponibilité des ressources et satisfaction des demandes deviennent fortement dépendantes l'une de l'autre. De plus, les déchets correspondent à des structures complexes qui ont été développés pour répondre à des fonctionnalités spécifiques de sorte qu'une fois ces fonctionnalités mortes, les déchets n'en demeurent pas moins des ressources spécifiques. Il est donc difficile de trouver une réutilisation directe des déchets et un processus de transformation des déchets en ressources générique devient nécessaire. Selon le degré de transformation, ces processus de transformation donnent lieu à des objets remanufacturés ou

recyclés. L'idée principale est que comme ces déchets sont réintroduits au sein de l'économie, les ressources génériques provenant de l'environnement naturel sont moins épuisées que dans le schéma linéaire habituel de l'économie. L'économie circulaire consiste donc en une gestion artificielle de la transformation de ressources spécifiques (déchets) en ressources génériques (nouveaux matériaux entrants dans l'économie). Cette nouvelle organisation suppose donc des connaissances particulières sur les différents matériaux disponibles dans les différents produits entrant dans la phase des déchets et sur les processus de transformations différents permettant la récupération des matériaux. Cette connaissance constitue une caractéristique des différentes industries du recyclage et de biens remanufacturés. Toutefois, les processus de transformation dépendent de la conception initiale des produits qui peuvent empêcher ou faciliter le démantèlement des produits. De même, les processus de recyclage et de remanufacturation ne sont pas libres d'un point de vue environnemental, car ils consomment de l'énergie et des matériaux. L'extension de l'analyse du cycle de vie à la phase des déchets est donc un préalable fondamental à l'évaluation de la durabilité de l'économie circulaire. De plus, l'économie circulaire dépend également d'une organisation spatio-temporelle, i.e. logistique, comme la disponibilité des déchets à un instant donné peut très bien ne pas correspondre aux besoins de la production. Il n'y a en effet aucune raison pour qu'un produit entrant dans la phase de déchets dans une zone géographique particulière trouve immédiatement une possibilité de réutilisation dans la même zone géographique. La gestion de la phase des déchets est donc principalement liée à la formation d'une nouvelle chaîne d'approvisionnement. Comme le montre la **Figure 7**, cette nouvelle chaîne d'approvisionnement agit comme un achèvement de la chaîne d'approvisionnement de produit.

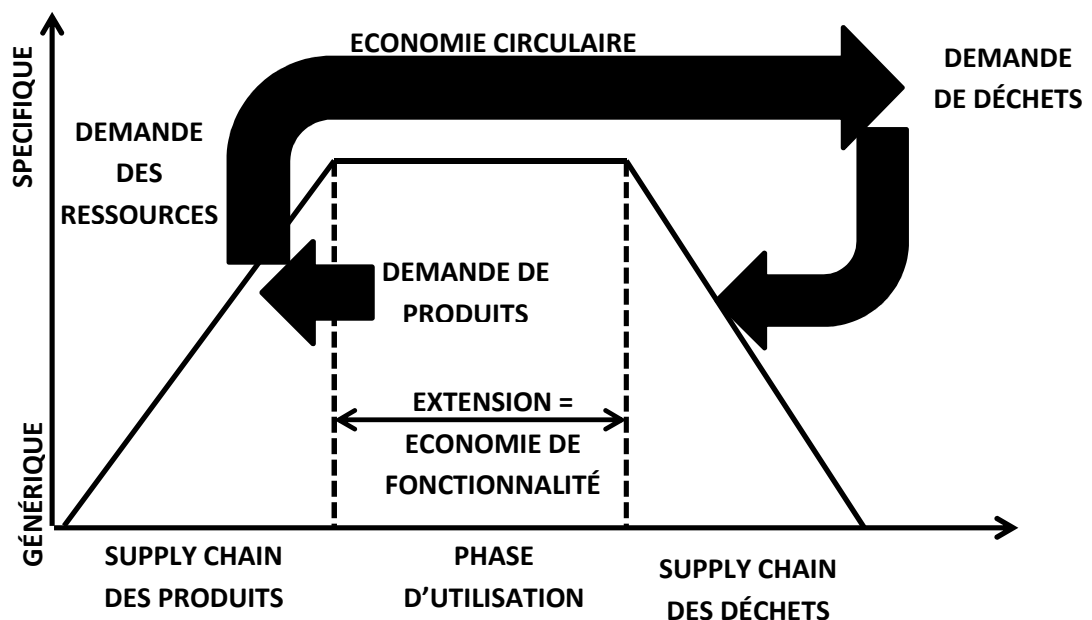

**Figure 7 : Les trois phases des produits et leur relation avec l'économie de fonctionnalité, l'économie circulaire et la dichotomie ressource générique/ressource spécifique.**

L'économie circulaire a donc plusieurs inconvénients caractéristiques du processus circulatoire. En effet, la disponibilité des déchets en tant que ressources est dépendante de la quantité de produits fabriqués par le biais de la chaîne d'approvisionnement de produit et du temps que ces produits sont

restés dans la phase d'utilisation. Le premier risque de l'économie circulaire est donc lié à la dégénérescence dans un statu quo qui rend légitime un certain niveau de consommation. Or rien ne prouve que ce niveau de consommation réponde aux enjeux de la durabilité, même s'il constitue une diminution des impacts environnementaux par rapport à une situation initiale plus critique. Ce point est encore plus important si l'on considère le problème de la dégradation de l'environnement associée aux émissions, dans la mesure où leur diminution n'est pas directement concernée par l'économie circulaire. Le deuxième risque de l'économie circulaire est lié à la possibilité d'augmenter la disponibilité des déchets en réduisant la durée de la phase d'utilisation. La demande de produits devient alors plus fréquente et le lien général entre la chaîne d'approvisionnement des produits et celle des déchets est accéléré. Une application durable de l'économie circulaire est donc tributaire d'une perspective durable du moteur de l'économie qu'est la phase d'utilisation des produits.

C'est justement le rôle de l'économie de fonctionnalité de cibler la phase d'utilisation des produits. L'idée de base est de considérer les produits comme des actifs particuliers mis au point pour l'accomplissement des fonctions de consommation. Si nous considérons la **Figure 7**, l'économie de fonctionnalité se traduit tout d'abord par une modification de la chaîne d'approvisionnement des produits à travers une approche plus spécifique de la consommation. Les produits sont ainsi transformés en systèmes produit-service qui sont à considérer comme des ressources spécifiques pour la consommation. Ces ressources considérées en tant qu'actifs sont ensuite maximisées à travers des modèles d'exploitation commerciales s'intéressant à la fourniture de services plutôt que de produits. Ainsi, les acteurs économiques, en restant propriétaires des produits supportant la fonction, reçoivent un intérêt financier à prolonger la durée de vie des produits. L'économie de fonctionnalité apparaît donc comme une stratégie de la durabilité dans la mesure où l'extension de la durée de vie du produit permet de diminuer le flux de matières de l'économie (durabilité environnementale) et de mettre l'utilisateur au centre de la relation entre production et consommation (durabilité sociale). Les systèmes produit-service sont de plusieurs types s'intéressant principalement soit à la maximisation de l'utilisation d'un bien, soit à la maximisation de la durée pendant laquelle un système productif permet d'accomplir la fonction souhaitée. Dans les systèmes produit-service orientés utilisation tels que le vélib', les problèmes de gestion logistique liés à la mise à disposition du bien assurant le service (vélo dans le cas du vélib') prennent toute leur importance. En effet, la conception du bien assurant le service doit évoluer pour prendre en compte l'usage plus intensif qui peut en être fait. Dans le cas du système vélib' par exemple, le guidon des vélos a été renforcé pour résister à une utilisation intensive des vélos et le panier avant de grande capacité renforcé pour résister aux usages du temps et à une utilisation détournée. De la même manière, les systèmes produit-service orientés fonction doivent développer des systèmes logistique plus performants de la maintenance, ainsi que de nouvelles approches de la conception des produits. L'économie de fonctionnalité développe donc une approche spécifique de la consommation qui suppose de revoir complètement la manière dont les produits sont conçus et leur mise à disposition organisée.

Ainsi, en dépit du fait que l'économie circulaire et l'économie de fonctionnalité sont des stratégies prometteuses pour la durabilité de nos systèmes socio-économiques, les processus circulatoires peuvent en diminuer considérablement l'efficacité. Par exemple, la gestion des déchets soutenue par l'économie circulaire dépend de la capacité à prédire les flux de déchets et à organiser la logistique associée. De même, la gestion des actifs (ex : voiture, vélo, etc.) associée à l'utilisation des systèmes produit-service orientés utilisation induit une dépendance plus forte à la logistique du « temps réel »

et à l'assurance d'un niveau de service 24 h/24. Les mêmes conclusions peuvent être faites sur l'aspect de la gestion de la fonction associée aux systèmes produit-service orientés fonction pour lequel l'entretien nécessite le suivi de l'état des composants afin d'assurer le service en continu. L'économie circulaire et l'économie de fonctionnalité conduisent donc à une importance croissante des flux d'information afin de gérer les deux réseaux de l'économie (monétaire et matériel). Il s'en déduit une augmentation de l'utilisation des technologies de l'information et des communications (TIC). Mais comme ces technologies se caractérisent par des procédés de production à forte consommation d'énergie avec l'extraction de matières rares et l'émission de métaux toxiques, la réduction de la consommation de matières dans la plupart des secteurs de l'économie se fait donc au détriment d'une augmentation de la consommation de matières associée aux TIC. En outre, l'instantanéité relative du transfert d'informations renforce le mythe de la théorie économique des coûts de transactions nulles. Les acteurs logistiques doivent donc opérer un choix important sur l'utilisation des TIC. Ils peuvent ainsi mettre tous leurs efforts à utiliser les possibilités offertes par les TIC afin d'étendre les chaînes d'approvisionnement existantes et les chaînes de transport, renforçant de ce fait le processus de mondialisation. Ils peuvent aussi utiliser les TIC pour améliorer les liens entre consommateurs et producteurs, les rendant plus dynamiques et plus aptes à la coproduction, permettant ainsi une reterritorialisation de la chaîne d'approvisionnement.

Les dangers d'une application non durable des stratégies de l'économie circulaire et de l'économie de fonctionnalité restent donc liés à l'influence de la théorie économique dominante sur la compréhension des processus de circulation des biens et des personnes. Ainsi, le schéma de dématérialisation se traduisant par une augmentation de la densité de valeur ( $\text{€}/T$ ) demeure insuffisant car il ne fait que combiner une vision objective de la valeur, le prix ( $\text{€}$ ), et une vision objective de la matérialité, la masse ( $T$ ). Le problème de fond des stratégies de dématérialisation est en réalité la mauvaise compréhension de la différence entre les ressources génériques et spécifiques. En effet, une vision abstraite de l'espace et du temps est une façon de normaliser la vie économique en considérant toutes les ressources comme principalement génériques et de négliger de nombreux aspects qui en font des ressources spécifiques. En un sens, le passage de l'économie industrielle à l'économie de marché s'est caractérisé par un changement de la perception de la demande, d'une vision générique à une vision spécifique. La durabilité apparaît liée à un changement du même ordre mais concernant les ressources. La dichotomie spécifique/générique se révèle donc être au cœur des enjeux de la durabilité.

Afin de caractériser davantage l'importance de la dichotomie spécifique/générique pour les enjeux de la durabilité, je me suis notamment intéressé à l'étude des écosystèmes et à la façon dont leur vulnérabilité s'exprimait. Ainsi, il est apparu que les écosystèmes étaient toujours localisés spatialement et temporellement, bien que liés par des processus naturels émanant des cycles géologiques mondiaux. Le réseau constitué des flux de matières circulant dans l'économie doit donc être élargi aux réseaux écosystémiques. De la même manière, la caractéristique massique (tonne) des flux de matière n'est pas suffisante pour rendre compte de la complexité des échanges écosystémiques de sorte que ces échanges sont bien mieux décrits par des indicateurs locaux multiformes prenant en compte par exemple les conditions d'existence des organismes et l'impact de la quantité, de la qualité, du lieu et du moment d'extraction des ressources naturelles alimentant l'économie. De la même manière, les émissions polluantes devraient être appréhendées par leurs conséquences sur les échanges écosystémiques.

La dichotomie spécifique/générique ne s'applique pas seulement aux aspects environnementaux des écosystèmes mais couvrent aussi l'organisation des systèmes sociaux. Ainsi la façon dont la connaissance est créée et s'organise prend toute son importance car elle régit fortement la relation aux produits des consommateurs. Ainsi, telle qu'exprimée par Anthony Giddens, la modernité se manifeste notamment par une distanciation spatio-temporelle qui engendre des systèmes experts caractérisés par l'absence de relations face-à-face. Les systèmes experts sont typiquement des systèmes techniques (voiture, machines) ou d'ordre professionnel (médecin, avocat, architecte) qui permettent, par la confiance qu'ils imposent, des usages réguliers indépendamment de la présence d'experts. Il s'agit donc de systèmes abstraits pour lesquels la confiance est construite et déconstruite dans des lieux bien particuliers nommés points d'accès. En dehors de ces points d'accès, le prix, i.e. la valeur d'échange telle que définie par la théorie dominante, prend le relais. La durabilité nécessite donc une meilleure appréhension et intégration par les utilisateurs des systèmes experts, ce qui suppose notamment le développement de la notion de co-production entre le fournisseur de service et l'utilisateur du service.

L'approche servicielle est donc fondamentalement un enrichissement de la « capabilité » des acteurs qui suppose notamment de développer une meilleure compréhension de l'échelle territoriale. En effet, le territoire est fondamentalement un système complexe qui regroupe différents niveaux de proximité. De fait, l'économie de proximité qui a été établie comme une réponse à l'absence de la prise en compte des particularités spatio-temporelles de l'échange dans la théorie économique standard prend toute son importance. En effet, alors que le marché Walrasien recherche l'amélioration de la « capabilité » individuelle par un détachement total de l'évolution sociétale aux aspects locaux, l'économie de proximité démontre la porosité du marché aux spécificités locales. La coordination territoriale s'opère donc aussi par des processus non-marchands tels que les relations de face-à-face et l'existence de réseaux interpersonnels ou professionnels, ainsi que des processus cognitifs collectifs faisant notamment appel à l'histoire, la vie culturelle et quotidienne du territoire. Il est à noter l'importance de la réciprocité qui permet aux transactions commerciales de s'étendre dans le temps.

Du point de vue de la durabilité, le caractère spécifique de la demande passe par exemple par des regroupements d'acteurs caractérisés par une forte volonté d'autolimitation. Ainsi, dans le cas italien de *La città dell' altra economia*, le mouvement consiste à rejeter les objectifs de croissance à tout prix, l'exploitation des individus, la violation des droits de l'Homme et le non-respect des limites posés par les écosystèmes naturels (Buclet, 2011). Ces regroupements d'acteurs, notamment aidés par les technologies de l'information et de la communication peuvent aboutir à des systèmes de production innovants tels que celui présenté dans le **Tableau 1**.

Dans ce schéma de production, la réalisation de l'objet final et donc la consommation de matière associée à la phase de production est localisée au niveau du territoire. Ainsi, les acteurs mobilisés et les ressources matérielles sont ceux présents sur le territoire. Cependant, la communauté des acteurs impliqués peut être étendue au reste du monde du fait de la circulation des connaissances. En effet, certaines connaissances d'ordre général peuvent librement circuler sur le réseau communautaire mondial avant d'être transformés à l'échelle locale pour répondre au problème spécifique posé par la production de l'objet. De façon symétrique, l'expérience gagnée localement permet l'amélioration des connaissances disponibles à l'échelle globale.

Tableau 1 : un modèle de production territorial basé sur une approche générique/spécifique de la connaissance (adapté de (Buclet, 2013))

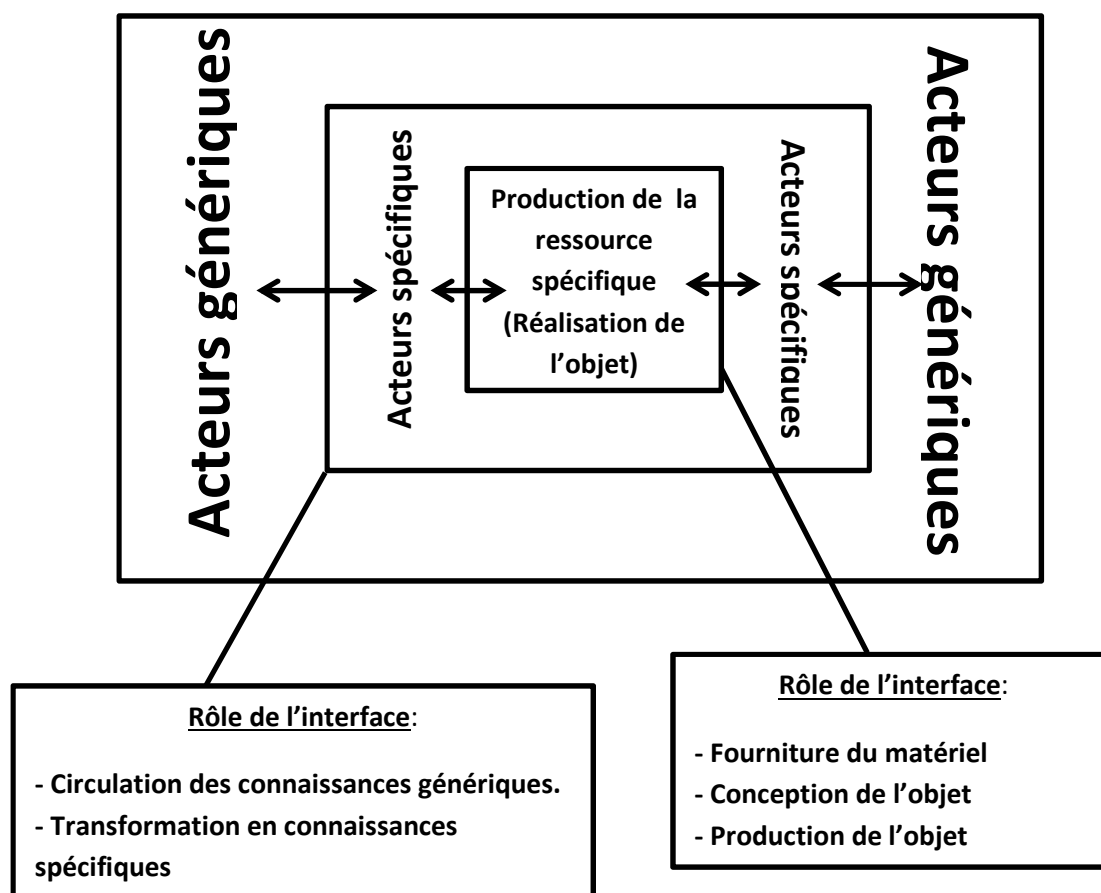

Les nouveaux systèmes de production devraient donc suivre une logique différente de celle de l'économie industrielle en ne faisant pas de l'économie d'échelle le but fondamental du système de production. En effet, de nombreuses contraintes propres à l'économie d'échelle telles que la nécessaire extension des sphères de marchés, la gestion de stock, la concentration des moyens de production compliquent la gestion de la production et favorisent une rentabilité basée sur une approche générique des ressources et de la demande.

La durabilité se pose ainsi en termes de compréhension de ce qui rend ressources et demandes spécifiques, favorisant une approche locale et territoriale des systèmes de production ainsi que des relations Nature-société. Comme nous allons le voir à présent, cela signifie notamment la nécessité d'opérer de nouveaux choix méthodologiques.

### 2.2.2 De nouveaux choix méthodologiques à opérer

Ces nouveaux choix méthodologiques concernent notamment les méthodologies environnementales. Afin de mieux caractériser le caractère unique des ressources, une approche basée sur les propriétés paraît mieux appropriée que les nomenclatures actuelles qui ne mettent l'accent que sur le caractère absolu des objets physiques.

En effet, le système harmonisé des marchandises (HS), donnant lieu à la nomenclature harmonisée des marchandises (NHM), couvre 98% des marchandises échangées internationalement, et sert de

base à près de 200 pays pour la détermination des tarifs de douane et la collecte de données statistiques sur le commerce. La nomenclature des marchandises illustre donc la force d'une convention et d'un procédé de standardisation qui permet d'accélérer les transactions en leur fournissant une base commune. Cependant, les points non abordés dans une nomenclature utilisée pour faciliter une transaction sont généralement omis de la transaction elle-même. Ceci est notamment le cas des nomenclatures actuelles qui ont beaucoup de mal à prendre en compte les aspects organisationnels de la production, ainsi que les aspects sociaux et environnementaux des échanges économiques. Par exemple, utiliser la nomenclature des secteurs pour rendre compte de l'organisation du transport sous-entend qu'est faite l'hypothèse que des entreprises appartenant au même secteur partagent une même vision stratégique du transport. De la même manière, l'utilisation de la nomenclature statistique des transports (NST) rend implicite l'hypothèse que les volumes de transports sont principalement déterminés par les propriétés physiques des marchandises. La réalité est généralement beaucoup plus complexe de sorte qu'une typologie unique apparaît comme insuffisante pour la saisir. Le danger se trouve donc dans une standardisation à outrance dans laquelle une typologie serait déclarée comme couvrant tous les aspects de la réalité d'un objet. A l'inverse, une approche évolutive faite de processus d'évaluation et de correction des typologies standardisées apparaît bien plus appropriée. En réalité, si nous observons la chaîne d'approvisionnement, nous pouvons considérer les trois étapes que sont l'extraction des ressources (1), leur « mise en valeur » par les transformations opérées par le système de production (2) et enfin de la demande finale (3). Alors que la typologie usuelle ne concerne qu'une vision générique de ces trois parties de la chaîne d'approvisionnement, l'évolution actuelle marquée par l'économie des variétés concerne tout d'abord un mouvement vers une vision spécifique du système de production. Le problème principal demeure néanmoins puisque ni les ressources ni la demande finale et la phase d'utilisation ne sont abordées d'un point de vue spécifique. Cela traduit bien l'absence de durabilité du système actuel qui ne s'intéresse ni aux buts sociaux (demande finale) ni aux limites des moyens (ressource) mais met toute son attention sur les activités de transformation, même si celles-ci peuvent s'avérer non nécessaires d'un point de vue social et dangereuses d'un point de vue environnemental.

Ainsi, il paraît nécessaire d'établir une nouvelle nomenclature des biens et des produits. Et il convient donc de caractériser les marchandises par les propriétés qui leur sont attachées. Dans cet esprit, la marchandise est définie par rapport aux connaissances existantes sur ses interactions avec son environnement. Par exemple, un cristal de sel peut aussi bien être décrit par l'aspect blanc de ses cristaux, que par sa constante de solubilité dans l'eau. La description de la marchandise se fait donc dans ce cas à travers une définition correspondant à des propriétés particulières artificiellement considérées comme stable, et à travers des propriétés qui peuvent apparaître et disparaître (donc variables) dans la zone de définition préalablement établie. Cette nomenclature des marchandises basée sur leurs propriétés est donc évolutive puisque les évolutions des connaissances et des expériences personnelles ou collectives peuvent en modifier la nature. Dans ce cadre, le cycle de vie des produits se traduit donc par une succession des modifications de leurs propriétés avec l'idée finale de créer des propriétés particulières dites fonctionnelles et devant s'exprimer le plus longtemps possible. La longévité et la fiabilité des propriétés sont donc des aspects importants à déterminer.

Une nomenclature basée sur les propriétés forme donc par l'analyse du couple marchandise – environnement une nouvelle manière d'appréhender et d'organiser l'espace de circulation des écosystèmes, ainsi que l'espace de circulation des matériaux et de l'énergie associé aux activités humaines. La nomenclature des marchandises utilisée dans le système des comptes nationaux et la théorie de la valeur doivent donc être remplacées par une nomenclature basée sur les propriétés. Cette compréhension par les propriétés est en effet en opposition totale avec l'hypothèse de nomenclature parfaite et inaltérable de la théorie économique standard et se doit de couvrir les trois points suivants:

1. Détermination des propriétés fonctionnelles pour la satisfaction de la consommation finale.
2. Détermination des propriétés des chaînes de production, en examinant les différentes propriétés des matériaux dans la Nature (matière première), la capacité offerte par les techniques de production pour modifier les propriétés du matériau tel qu'il existait dans la nature en produits avec les propriétés fonctionnelles requises (processus de transformation) et la transformation induite par les différents environnements rencontrés au cours de la phase de transport sur les propriétés fonctionnelles.
3. Détermination des modifications des propriétés des écosystèmes résultant du retrait des matières premières de la Nature où ils jouent un rôle et de la concentration des rejets des systèmes de production induits par la création d'environnements physiques particuliers, capables de transformer les propriétés initiales du matériau en propriétés fonctionnelles (processus de production), ou par le passage et l'entretien des propriétés fonctionnelles au sein des systèmes de transport et de logistique.

La durabilité repose donc sur l'équilibre entre les résultats des trois étapes précédentes. En d'autres termes, pour un ensemble particulier de propriétés fonctionnelles, désiré, les chemins de propriété doivent être choisis à l'étape 2, afin de minimiser les impacts sur les propriétés de l'étape 3. Sur cet aspect, le passage des biens naturels aux propriétés fonctionnelles doit se faire de la manière la plus directe possible, afin de minimiser les impacts environnementaux. Enfin, les propriétés fonctionnelles désirées par un groupe d'acteurs peuvent entrer en conflit avec le maintien des propriétés des écosystèmes directement ou indirectement par le biais de systèmes de production et de transport. Un choix devra dans ce cas être fait entre le maintien des écosystèmes et les satisfactions obtenues par le biais des propriétés fonctionnelles. Ce choix est un choix de société en ce qui concerne l'avenir des écosystèmes dans le monde, lesquelles maintiennent la vie sur Terre. La durabilité environnementale concerne donc la détermination de chaînes d'approvisionnement en mesure de maintenir les propriétés de l'écosystème, en d'autres termes capables de respecter les limites environnementales des actions humaines. Cette durabilité ne fournit cependant pas d'indications sur comment la société doit se comporter à l'intérieur de cette limite. Ce n'est que dans un second temps que la durabilité sociale se préoccupe du comportement de la société à l'intérieur des limites fixées par la durabilité environnementale. La durabilité sociale s'occupe alors des problèmes liés au bien-être, à l'amélioration de la « capacité » des individus ce qui, telle que nous l'avons déjà discuté, suppose une reterritorialisation des interactions et des processus de coordination liés aux activités humaines.



Afin de présenter quelles pourraient être les effets d'une approche spécifique de l'économie de fonctionnalité, la présente thèse s'est attachée à développer un modèle logistique concernant la France. Ce modèle est un modèle méso-économique concernant les 22 régions françaises et incluant six scénarios. Ces six scénarios se divisent en deux parties. Trois d'entre eux correspondent respectivement au scénario de référence (REF), à un scénario où l'application de l'économie est considéré comme non durable car ne faisant pas appel à un changement vers la spécification des ressources (NO\_FE), et à un scénario correspondant à une application durable de l'économie de fonctionnalité car se traduisant par une spécification des ressources (FE). La différence entre ces trois scénarios se trouve ainsi clairement représentée dans la **Figure 8** et se base notamment sur une typologie logistique développée par (Burmeister, 2000) (Burmeister, et al., 2006) and (Burmeister, et al., 2006). Les trois autres scénarios reprennent cette différenciation mais internalisent les coûts externes dans les coûts du transport.

Cette typologie logistique se constitue de quatre types d'organisation logistique, chacune avec une position particulière au regard de la dichotomie générique/spécifique appliquée aux ressources et à la demande :

1) Le monde industriel:

Ce monde se caractérise par la production de masse pour une demande standardisée. Aussi bien la ressource que la demande est donc considérée d'un point de vue générique. La logique servicielle du transport est principalement matérielle et l'usage des technologies de l'information et de communication est peu fréquent. La coordination s'opère donc principalement par la sphère marchande avec peu de relation en face-à-face. Du point de vue du transport, la logique d'économie d'échelle permet l'utilisation des modes de transport massifs et lents tels que le ferroviaire et le fluvial.

2) Le monde flexible:

Caractérisé par une production de masse pour une demande dédiée, ce monde partage avec le monde industriel une vision générique des ressources. Néanmoins, la diversité des produits associés à une demande dédiée impliquent une forte association des flux de matières et d'information. La logique servicielle du transport associé combine donc une logique matérielle et une logique d'information. Cependant, ces flux d'information sont codifiés de sorte qu'ils peuvent s'opérer à longue distance. Les interactions en face-à-face sont donc aussi absentes du monde flexible et la proximité géographique n'est donc pas une nécessité. Du point de vue de l'organisation logistique, ce monde se caractérise par un besoin en transport rapide capable de flexibilité et de fiabilité. L'économie d'échelle devient de seconde importance par rapport à l'économie de variété. Néanmoins, l'efficacité pour la maîtrise des coûts associée aux économies d'échelle fait que des cas d'organisation logistique hybride se rencontrent dans les secteurs tels que l'agro-industrie où l'aval (flexible) et l'amont (industriel) des chaînes d'approvisionnement s'insèrent bien dans ces logiques respectives.

3) Le monde professionnel:

Dans le monde professionnel, la demande est dédiée comme dans le monde flexible mais la ressource aussi. Cela a pour conséquence un abandon des économies d'échelle liées à la production

de masse avec une approche servicielle plus importante. Le juste à temps reste important mais c'est surtout l'importance des relations de proximité, non marchandes, en face à face qui caractérise le monde professionnel. Les outils des TIC sont fortement utilisés mais pas les Échanges de Données Informatisés (E.D.I.) dont la nature codifiée ne convient pas à l'échange spécifique d'informations du monde professionnel. D'un point de vue du transport, la relation de co-production entre le client et l'utilisateur d'un produit entraîne des rencontres fréquentes afin de réajuster en permanence la relation servicielle. Le transport de personnes et le transport de marchandises se trouvent donc particulièrement liés dans ce monde. De plus, l'importance de la gestion temporelle, et l'absence de recherche d'économie d'échelle font que les modes de transports caractérisant ce monde professionnel sont des modes rapides tels que la route.

4) Le monde immatériel:

Ce monde correspond au domaine de la création et de la recherche. Le transport y joue un rôle mineur en comparaison de la circulation de la connaissance. Alors que dans la phase de création, les contacts directs sont importants et que la proximité s'exprime sous ses trois formes (géographique, organisationnelle et institutionnelle), dans la phase de diffusion, l'usage des TIC devient relativement important assurant une mise à disposition électronique pouvant faire l'objet d'économie d'échelle.

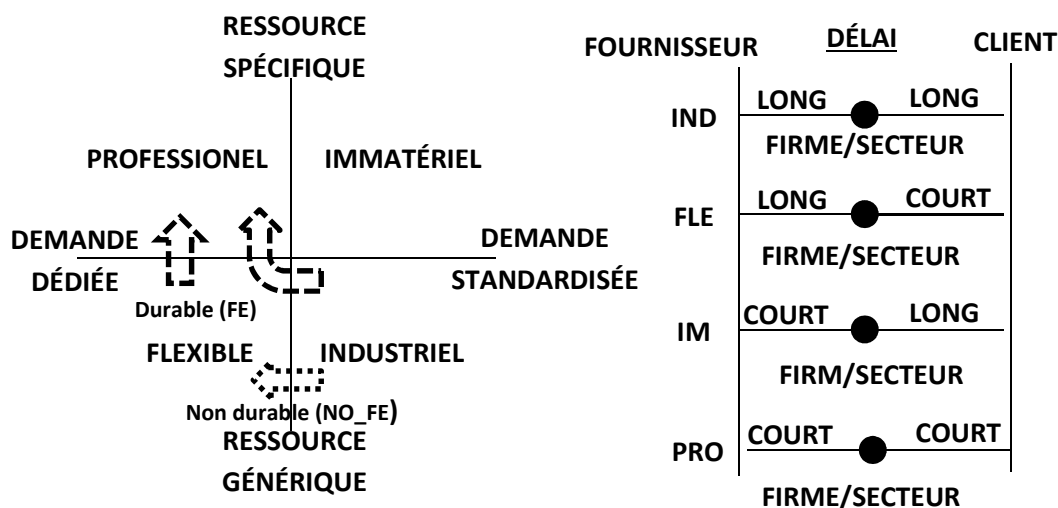
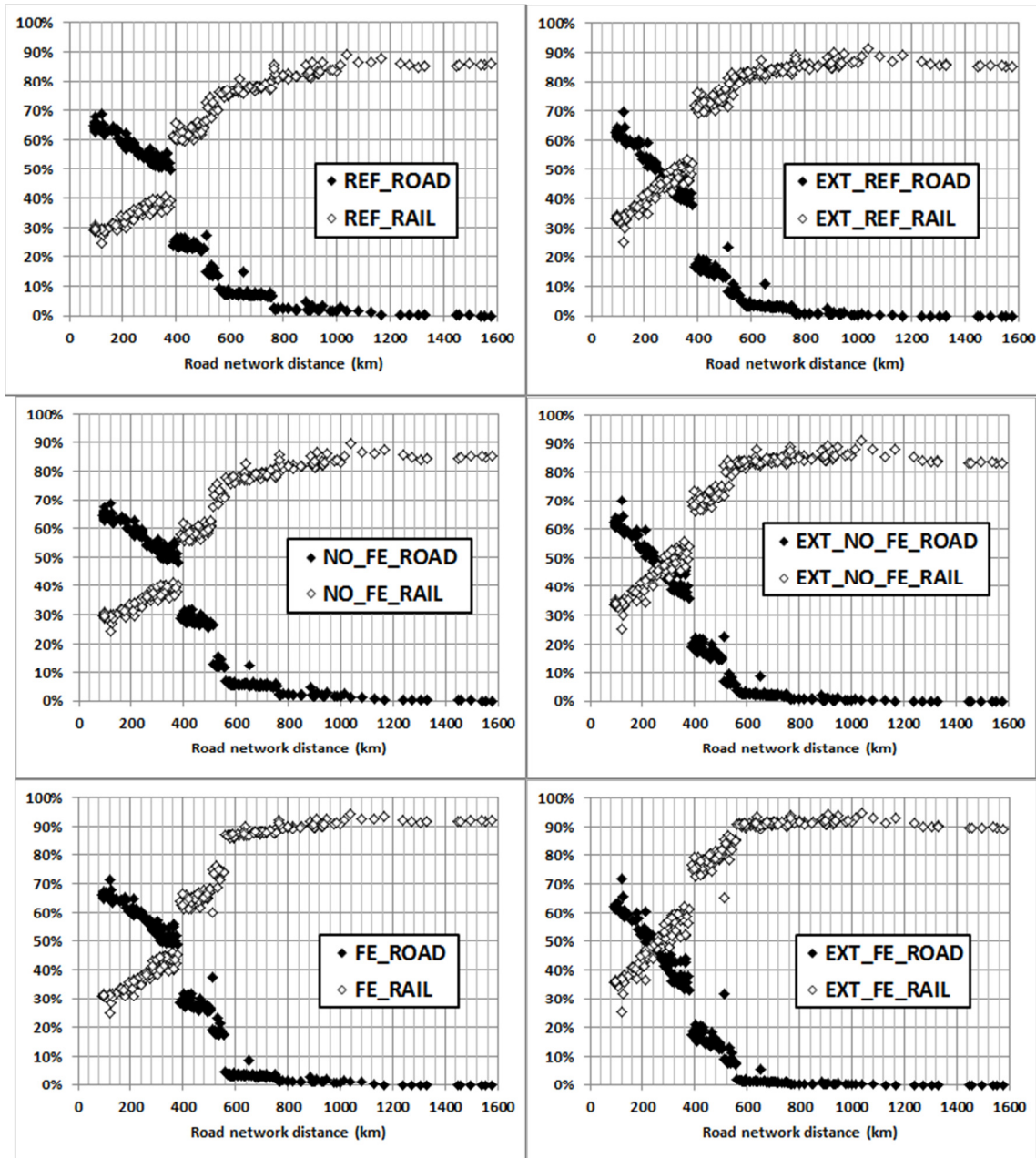

**Figure 8 : Une typologie logistique fondée sur la dichotomie spécifique/générique**

Les conséquences de l'économie de fonctionnalité s'expriment tout d'abord par une diminution de la consommation de matières puisqu'une baisse de 5,8%, de  $1,48 \cdot 10^{12}$  tonnes à  $1,40 \cdot 10^{12}$  tonnes, a été mise en évidence par le modèle. En termes de distribution, certaines régions consomment principalement les produits provenant de leurs régions. Cela est notamment le cas de l'Alsace (12%), de l'Aquitaine (14%), de l'Île de France (16%), du Midi-Pyrénées (13%), du Pays de La Loire (13%), de la Provence-Alpes Côte d'Azur (16%) et de la région Rhône-Alpes (21%).

Cependant, les résultats les plus intéressants ont été obtenus en ce qui concerne la répartition modale et la sensibilité à la distance parcourue. Ainsi, tel que présenté dans la **Figure 9**, trois zones de distance peuvent être distinguées. En dessous de 400 km, les scénarios liés à l'économie de fonctionnalité (NO\_FE and FE) n'ont que peu d'effets et la route demeure le mode prédominant. Seule la prise en compte des externalités par une internalisation des coûts permet une augmentation

de la part du transport ferroviaire pour des distances inférieures à 400 km. La deuxième zone correspond à une distance comprise entre 400 et 1000 km est celle subissant la plus grande transformation. Ainsi, la zone de prédominance du transport ferroviaire (>85%) est déplacée de 1000 km vers 600 km. Enfin, pour les longues distances (>1000km), la prédominance du ferroviaire demeurent.



**Figure 9 : Part modale transport routier (ROAD) et du transport ferroviaire (RAIL) en fonction des scénarios et de la distance sur le réseau routier.**

Cette différence entre les effets associés à l'économie de fonctionnalité et à l'internalisation des coûts externes peut facilement se comprendre dans la mesure où les scénarios liés à l'économie de fonctionnalité se traduisent soit par un mouvement vers le monde flexible (NO\_FE), soit par un mouvement vers le monde professionnel (FE). Or pour ces deux mondes, la demande est dédiée et la fréquence, la fiabilité et la flexibilité des modes de transport sont importantes. Ces mondes ne sont

donc pas régis par une logique d'économie d'échelle. Or le transport ferroviaire est par essence un mode de transport lié aux économies d'échelle du fait de ses coûts fixes importants. Ce n'est donc que pour des distances parcourues assez grandes que le coût à la tonne transportée diminue assez fortement pour faire du transport ferroviaire un mode compétitif. De ce fait, il n'est pas surprenant que les scénarios d'économie de fonctionnalité (NO\_FE et FE) ne modifient que marginalement la part du transport ferroviaire pour des distances parcourues inférieures à 400 km. À l'inverse, les coûts externes, de 4 à 20 fois plus élevés pour le transport routier que pour le transport ferroviaire, s'appliquent dès le premier kilomètre parcouru modifiant les rapports de compétitivité entre les modes aussi bien pour les longues que les courtes distances. Les meilleurs résultats sont néanmoins obtenus pour la combinaison des deux stratégies (EXT\_FE).

Du point de vue des émissions et de la consommation d'énergie, la combinaison des deux stratégies se confirme être la plus efficace. Ainsi, comme le montre le **Tableau 2**, la consommation d'énergie et donc les émissions de dioxyde carbone (CO<sub>2</sub>) peuvent se trouver diminuées de 18%. Les niveaux de réduction calculés peuvent même atteindre 24-26% dans le cas des émissions de particules (PM10), des composés organique volatils non méthylés (COVNM) et du monoxyde de carbone (CO). Cependant, les principales réductions ne sont réalisées que par le biais de l'internalisation des coûts externes. En effet, la réduction de la consommation d'énergie associée à une application durable de l'économie de fonctionnalité (FE) n'est que de 3% tandis que son application non durable (NO\_FE) conduit à une augmentation des émissions et de la consommation de l'énergie de 5%. Ces résultats illustrent bien le problème actuel posé par l'évolution du monde industriel vers le monde flexible qui se traduit par une augmentation des émissions liées au transport de marchandise.

**Tableau 2 : Emissions associées avec le transport interrégional des produits de l'industrie pharmaceutique.**

	NRJ (TJ)	CO <sub>2</sub> (kT)	SO <sub>2</sub> (T)	NO <sub>x</sub> (T)	PM10 (T)	COVNM (T)	CO (T)
REF	3 340 (100%)	244 (100%)	90 (100%)	2 837 (100%)	81 (100%)	226 (100%)	474 (100%)
NO_FE	3 499 (105%)	256 (105%)	94 (105%)	2 977 (105%)	85 (105%)	237 (105%)	498 (105%)
FE	3 236 (97%)	236 (97%)	88 (99%)	2 760 (97%)	77 (95%)	217 (96%)	451 (95%)
EXT_REF	2 917 (87%)	213 (87%)	81 (91%)	2 397 (85%)	67 (82%)	186 (82%)	385 (81%)
EXT_NO_FE	3 018 (90%)	220 (90%)	84 (94%)	2 482 (87%)	69 (85%)	192 (85%)	399 (84%)
EXT_FE	2 729 (82%)	199 (82%)	78 (86%)	2 240 (79%)	61 (75%)	171 (76%)	351 (74%)

Néanmoins, le modèle n'a été développé qu'à titre exploratoire et de nombreuses recherches restent encore à effectuer pour caractériser plus précisément, à différentes échelles d'action (individuel, territorial, régional, national, mondial), ce qui rend la ressource et la demande socialement et environnementalement spécifiques. De la même manière, les politiques commerciales et de libre d'échange devraient faciliter le respect des spécificités environnementales, territoriales et culturelles, plutôt que de forcer à l'uniformisation en favorisant les dumpings sociaux et environnementaux qui n'ont aucune conséquence néfaste sur la durabilité de nos sociétés que dans les mythes monétaires et d'ubiquité de la théorie économique dominante dont l'irréalisme a été clairement démontrée dans le présent travail.

1

2

### 3 **Acknowledgment**

4

5 An interdisciplinary research such as the one presented in this thesis is like a long journey with lots of  
6 exciting discoveries. It also demands lots of efforts and resilience.

7 Therefore, I would like first to thank my two PhD directors, Nicolas BUCLET, and Lóránt TAVASSZY, for  
8 their support and interesting exchanges which came along through the thesis work. I am forever  
9 indebted to them for the knowledge they provided me and their help for better grasping the  
10 tremendous complexity embodied in the notion of sustainability.

11 I would also like to thank all the members of the Jury for their interest in my research work and their  
12 comments which allowed this work to be much improved.

13 I would also like to thank all my colleagues of ITNOVEM for the different environmental projects I  
14 could join in.

15 Most of all, I would like to thank my family and close friends for the kind support and love they  
16 provided me all along my long research. Their presences near me have always been comforting and  
17 there is no doubt that their daily support has played a vital role in the success and achievement of  
18 my research.

19

20

1

2

### 3 **Abstract**

4

5 Functional economy and circular economy are often presented as promising sustainable strategies  
6 able to address the environmental issues associated with our modern production and consumption  
7 patterns. Nevertheless, the place of transportation, logistics and circulation processes are usually  
8 poorly addressed in spite of the increasing energy consumption and emissions associated with the  
9 current trends of globalization. The present thesis has aimed at filling this gap by analyzing the  
10 effects of the representation of human activities and circulation processes on the issue of  
11 sustainability. Dealing with the triptych sustainability/supply chain management/ circular and  
12 functional economies, the present thesis has shown the importance of changing the representation  
13 of space and time induced by the current dominant economic convention from a generic viewpoint  
14 to a specific viewpoint. The present work notably advocates the necessity to develop specific  
15 approaches of resources and demand because environmental sustainability (respect of Earth carrying  
16 capacity) and social sustainability (increase of welfare) are dependent on this development.  
17 Therefore, the closing loop approach of circular economy and the co-production serviciel approach of  
18 functional economy should benefit from more researches on what makes goods unique to be  
19 considered as real sustainable strategies. Developing an exploratory transport and logistics modeling  
20 framework, the present thesis also showed the potential of dematerialization and emission reduction  
21 of the functional economy strategy. It was notably found that around 6% of French interregional  
22 traded tons could be cut off. Similarly, by combining an internalization of external costs in transport  
23 costs and the strategy of functional economy, a reduction of 18% in energy consumption and CO<sub>2</sub>  
24 emission could be achieved.

25 **Key words:** Logistics, functional economy, product-service system, transportation, spatial  
26 economy

27

# Table of Contents

1		
2	<b>French summary</b> .....	<b>2</b>
3	<b>1. Contexte et problématique de la recherche</b> .....	<b>2</b>
4	1.1 Une dégradation générale de l'environnement .....	2
5	1.2 Une notion de durabilité toujours en mouvement .....	4
6	1.3 Le problème croissant de la circulation .....	7
7	<b>2 Méthodologie et résultats de la recherche</b> .....	<b>9</b>
8	2.1 Méthodologie de la recherche .....	9
9	2.2 Résultats de la recherche .....	11
10	2.2.1 Des modifications théoriques importantes .....	11
11	2.2.2 De nouveaux choix méthodologiques à opérer .....	20
12	<b>Acknowledgment</b> .....	<b>27</b>
13	<b>Abstract</b> .....	<b>28</b>
14	<b>Key words</b> .....	<b>28</b>
15	<b>General Introduction</b> .....	<b>38</b>
16	<b>1 Context</b> .....	<b>39</b>
17	1.1 A degraded environment for society .....	39
18	1.2 An evolution of the notion of sustainability .....	41
19	1.3 The growing issue of circulation.....	43
20	<b>2. Research questions</b> .....	<b>45</b>
21	<b>Part I: The limits of current socio-economic system</b> .....	<b>49</b>
22	<b>Chapter I: The representation of human activities in the current socio economic framework</b>	
23	<b>and its link with sustainable issues</b> .....	<b>50</b>
24	<b>1 Introduction</b> .....	<b>50</b>
25	1.1 The current representation of sustainability.....	50
26	1.2 From sustainability to the representation of human activities.....	52
27	<b>2 The description of human activities in the convention of current socio-economic accounting</b>	
28	<b>systems</b> .....	<b>54</b>
29	2.1 Boundaries associated with current accounting systems .....	55
30	2.1.1 The boundaries of national accounts.....	55
31	2.1.2 The boundaries of firm accounts .....	58
32	2.2 The circulation within accounting systems .....	61
33	2.2.1 The monetary circulation within the system of national accounts.....	61
34	2.2.1.1 The product approach.....	63
35	2.2.1.2 The income approach.....	66
36	2.2.2 The monetary circulation within the system of firm accounts .....	69
37	<b>3 The justification and associated criticism of the representation of human activities in the</b>	
38	<b>current socio-economic system</b> .....	<b>74</b>
39	3.1 The theories of value.....	74
40	3.2 Social criticism of the theories of value .....	77

1	3.3	Environmental criticism of the theories of value .....	80
2	3.4	Epistemological criticism of the theories of value .....	81
3	3.5	Circulation criticism of the theories of value .....	83
4	<b>4</b>	<b>Conclusion .....</b>	<b>86</b>
5	<b>Chapter II: Coordination in the current socio-economic framework.....</b>		<b>88</b>
6	<b>1</b>	<b>Introduction.....</b>	<b>88</b>
7	1.1	The role of money .....	88
8	1.2	The role of outlets .....	91
9	1.3	The role of proximity.....	93
10	<b>2</b>	<b>Transportation and logistics.....</b>	<b>97</b>
11	2.1	Transportation or the conditions of geographical proximity .....	97
12	2.1.1	The physics of transportation .....	97
13	2.1.2	The role of infrastructure.....	100
14	2.1.3	Transportation and geographic proximity .....	106
15	2.2	Logistics or the conditions of organizational and institutional proximities .....	109
16	2.2.1	The system of firms.....	109
17	2.2.2	Two “ideal” models of circulation.....	112
18	<b>3</b>	<b>Criticism of the coordination processes.....</b>	<b>116</b>
19	3.1	Money and economic power .....	116
20	3.2	The materiality of exchange.....	120
21	3.3	A diversity of circulation processes.....	122
22	<b>4</b>	<b>Conclusion .....</b>	<b>125</b>
23	<b>Chapter III: The attempts to solve environmental unsustainability of the current socio-</b>		
24	<b>economic system .....</b>		<b>127</b>
25	<b>1</b>	<b>Introduction.....</b>	<b>127</b>
26	<b>2</b>	<b>The environmental issue of activities .....</b>	<b>127</b>
27	2.1	Environmental labeling of products .....	127
28	2.2	Methodologies of environmental impact assessment.....	130
29	2.2.1	The extended input-output accounts .....	130
30	2.2.2	Applying EE-IO analysis to Climate Change and its implication on trade analysis.....	133
31	2.2.3	A general review of environmental analysis.....	138
32	<b>3</b>	<b>The environmental issue of the circulation process .....</b>	<b>140</b>
33	3.1	Learning from environmental analysis.....	140
34	3.2	Cost externalities.....	142
35	3.3	Eco-calculators .....	144
36	3.4	Allocation issues.....	147
37	3.5	Critical review of reduction strategies .....	150
38	<b>4</b>	<b>Conclusion .....</b>	<b>153</b>
39	<b>5</b>	<b>General conclusion of part I.....</b>	<b>154</b>
40	<b>PART II: Towards sustainable logistics .....</b>		<b>158</b>
41	<b>Chapter IV: Circular economy and functional economy strategies .....</b>		<b>159</b>



1	<b>1</b>	<b>Introduction .....</b>	<b>159</b>
2	1.1	Circular economy .....	159
3	1.1.1	Industrial ecosystems and bio-economy .....	159
4	1.1.2	Loop and lake economy .....	162
5	1.2	Functional economy .....	165
6	1.2.1	Principles and typology of functional economy.....	165
7	1.2.2	Circulation principles in functional economy.....	168
8	<b>2</b>	<b>Consequences of circular and functional economy on circulation process .....</b>	<b>171</b>
9	2.1	A material and information network.....	171
10	2.2	Logistics, transportation and information network .....	174
11	2.3	Logistics services, territories and environmental issues .....	177
12	2.4	Co – production and resource specification.....	181
13	2.5	The risk of the resurgence of the theories of value .....	182
14	<b>3</b>	<b>Conclusion .....</b>	<b>184</b>
15	<b>Chapter V: The conditions for sustainable applications of circular and functional economies</b>		
16	<b>.....187</b>		
17	<b>1</b>	<b>Introduction .....</b>	<b>187</b>
18	<b>2</b>	<b>Specificity as framing sustainability .....</b>	<b>187</b>
19	2.1	Specificity as a key characteristic of ecosystems .....	187
20	2.1.1	Ecosystem characterization as specific areas .....	187
21	2.1.2	Relationships between discharges/resources and ecosystem viability .....	189
22	2.2	Specificity as a key characteristic of social system.....	193
23	2.2.1	Time as a specific resource .....	193
24	2.2.2	Knowledge as a specific resource .....	196
25	<b>3</b>	<b>Constructing a sustainable framework for circular and functional economies strategies...202</b>	
26	3.1	A territorial approach.....	202
27	3.1.1	Territory as a place to address the issues of specificity.....	202
28	3.1.2	Territory as a multi-resource dynamic network .....	206
29	3.2	A property based nomenclature for sustainability .....	209
30	3.2.1	Discussion around the concept of properties.....	209
31	3.2.2	The effects on circulation spaces .....	212
32	<b>4</b>	<b>Conclusion .....</b>	<b>214</b>
33	<b>Chapter VI: Sustainability in quantitative transportation modeling.....215</b>		
34	<b>1</b>	<b>Introduction .....</b>	<b>215</b>
35	<b>2</b>	<b>Sustainable review of quantitative transport modeling .....</b>	<b>216</b>
36	2.1	The problem of generic nomenclature.....	216
37	2.2	The issue of the representation of spatial interactions .....	220
38	<b>3</b>	<b>A dematerialization meso - economic model.....</b>	<b>226</b>
39	3.1	Methodology .....	226
40	3.1.1	Principles.....	226
41	3.1.2	Top-down approach: from national Input-Output table to gravity model .....	227
42	3.1.2.1	From national input-output table to production/consumption monetary vectors .....	227
43	3.1.2.2	From monetary to physical vectors.....	230

1	3.1.3	Bottom-up approach: from transportation costs to gravity model .....	231
2	3.1.3.1	A logistic typology .....	231
3	3.1.3.2	A transportation cost framework with internalization of environmental cost .....	234
4	3.1.3.3	Inventory model and modal choice .....	238
5	3.1.4	The gravity model .....	241
6	3.2	Results .....	242
7	3.2.1	General results of functional economy and external cost framework .....	242
8	3.2.2	Particular study of “Manufacture of pharmaceuticals, medicinal chemicals and botanical	
9		products” .....	244
10	<b>4</b>	<b>Conclusion .....</b>	<b>251</b>
11		<b>General Conclusion .....</b>	<b>252</b>
12	<b>1</b>	<b>Research questions and methodology.....</b>	<b>253</b>
13	<b>2</b>	<b>Findings and results.....</b>	<b>254</b>
14	<b>3</b>	<b>Future researches and implications for sustainability .....</b>	<b>259</b>
15	3.1	Transportation and logistics agenda .....	259
16	3.2	Policy agenda .....	260
17	3.3	Research agenda .....	262
18		<b>References .....</b>	<b>264</b>
19		<b>ANNEX:.....</b>	<b>283</b>
20	<b>1</b>	<b>National IO-Table structure .....</b>	<b>283</b>
21	<b>2</b>	<b>Formation of €/T ratio based on import data analysis.....</b>	<b>293</b>
22	<b>3</b>	<b>Matlab script for top-down approach .....</b>	<b>298</b>
23	<b>4</b>	<b>Volume density classification.....</b>	<b>300</b>
24	<b>5</b>	<b>Distance tables.....</b>	<b>301</b>
25	<b>6</b>	<b>Cost Data characterization.....</b>	<b>302</b>
26	<b>7</b>	<b>Matlab script for bottom-up approach .....</b>	<b>304</b>
27			
28			

# 1 List of Figures

2	Figure 1 : Part du transport dans les émissions 2009 de polluants atmosphériques (CITEPA, 2011).....	3
3	Figure 2 : La balance physique de l'économie Française en 2007 (Commissariat général au	
4	développement durable, 2010).....	4
5	Figure 3 : la voie du développement durable entre l'indice de développement humain et l'empreinte	
6	écologique. ....	6
7	Figure 4: Structure méthodologique de la recherche .....	10
8	Figure 5 : Les liens entre l'économie, l'environnement et le social dans la compréhension actuelle de	
9	la durabilité. ....	11
10	Figure 6 : La fonction et structure d'une entreprise dans une économie industrielle (gauche) et de	
11	marché (droite) (Lendrevie, et al., 2003)(p.4-5).....	13
12	Figure 7 : Les trois phases des produits et leur relation avec l'économie de fonctionnalité, l'économie	
13	circulaire et la dichotomie ressource générique/ressource spécifique. ....	16
14	Figure 8 : Une typologie logistique fondée sur la dichotomie spécifique/générique .....	24
15	Figure 9 : Part modale transport routier (ROAD) et du transport ferroviaire (RAIL) en fonction des	
16	scenarios et de la distance sur le réseau routier.....	25
17	Figure 10 : 2009 transport shares in atmospheric pollutants emission (CITEPA, 2011) .....	40
18	Figure 11 : The evolution of world, Northern America, East Asia and Western Europe GDP together	
19	with the corresponding fraction of world GDP in the 1960 – 2008 period. (Dente, et al., 2012).....	44
20	Figure 12: Question structure of the dissertation.....	46
21	Figure 13 : the links between economy, social, and the environment in the current sustainability	
22	framework .....	50
23	Figure 14 : the sustainable development path between Human Development Index and Ecological	
24	footprint (WWF, 2006) .....	51
25	Figure 15 : Indicators forming the Human Development Index.....	52
26	Figure 16 : The material balance of the French economy in 2007 (Commission générale du	
27	développement durable, 2010).....	53
28	Figure 17: the place of accounting systems in regards to the three economic systems .....	61
29	Figure 18 : Relationships between nomenclatures.....	63
30	Figure 19 : The product approach of the SNA.....	65
31	Figure 20: The decomposition of resources through current and financial accounts with main results.	
32	.....	68
33	Figure 21 : The cash-flow engine.....	71
34	Figure 22 : Link between monetary and physical network through the nomenclature system .....	73
35	Figure 23 : The extension of circulation spaces and money legitimacy. ....	90
36	<b>Figure 24 : The role of the transportation system in the definition of the space of circulation.....</b>	<b>95</b>
37	Figure 25 : core concepts of logistics theory for analyzing networks (Nikkanen).....	96
38	Figure 26 : General framework of transportation issues .....	98
39	Figure 27 : A) Energy as a trade-off between quantity transported and speed of transportation. B)	
40	Relationship between speed and energy from a friction view. ....	99
41	Figure 28 : Transportation process as a superposition of networks .....	100
42	Figure 29 : Transport speed trends, in km/hr. (Source: adapted from (Samaras, 1962)).....	103

1	Figure 30: A) Range covered (average km travelled daily) per capita in France by mode and total since	
2	1800. B) Passenger (intra-and intercity) modal split in France, fractional shares of passenger-km	
3	performed and model estimates. Growth trend for TGV is speculative C) Goods transport output by	
4	different mode and total in France since 1800, in 10 <sup>9</sup> ton-km performed. D) Modal split in goods	
5	transport in France, in fractional shares of ton-km transported .....	105
6	Figure 31 : The accessibility from the “Le Havre” harbor to different part of the French territory	
7	(Sétra, 2008).....	108
8	Figure 32 : the system of proximities between firms.....	110
9	Figure 33 : The space of the circulation of the classical economy .....	112
10	Figure 34 : The functions and structure of the firm in an industrial (left) and a market world (right)	
11	(Lendrevie, et al., 2003)(p.4-5).....	115
12	Figure 35 : The structure of supply chains and the generalized simplified evolution of its indicators	123
13	Figure 36 : Relationships between money, outlets and proximity in the formation of economic	
14	exchange.....	126
15	Figure 37 : results of the two first session bids (Llerena, et al., 2007).....	128
16	Figure 38 : The analytical framework driven from the input-output tables .....	131
17	Figure 39 : Has the reduction targets been reached for Annex I countries? A direct ratio and	
18	cumulated ratio perspective .....	134
19	Figure 40: A historical perspective of the evolution of GHG emissions compared to 2008 emission	
20	level. ....	135
21	Figure 41 : LCA as a management of interface between local and global environment of firms (Grisel,	
22	et al., 2008) (p.319) .....	140
23	Figure 42 : Comparison of logistic chains for an apple sold in a supermarket for Belgium, France and	
24	United Kingdom (Rizet, et al., Décembre 2008).....	141
25	Figure 43 : the three stages of environmental impact reduction and its dependency to system	
26	boundaries and logistics typologies. ....	152
27	Figure 44 : A) network in classical economy, B) network in neoclassical network.....	155
28	Figure 45 : From linear to circular society.....	160
29	Figure 46 : Consequence of the linear economy on natural stocks (a=20%, b=20%, T=10 years).....	163
30	Figure 47 : The loop economy (Ellen MacArthur Foundation, 2013).....	164
31	Figure 48 : Environmental reduction strategies within an equation framework (Kanda, et al., 2006)	
32	.....	167
33	Figure 49 : The rigidity of industrial eco – parks. ....	171
34	Figure 50 : Spaces of circulation of the different dematerialization strategies.....	173
35	Figure 51 : Transportation characteristics and use of ICT in supply chain and dematerialization	
36	strategies.....	176
37	Figure 52 : A) Substitution of letters by telephone calls in the total number of messages	
38	communicated, France 1900 to 1985. B) Growth of passenger transport and communication in	
39	France, measured in passenger-km and total number of messages transmitted in form of an index	
40	1985=100. (Grübler, 1990)(p.255-256) .....	178
41	Figure 53 : ICTs development effects on proximity framework.....	180
42	Figure 54 : The three phases of products in relation with circular and functional economies and	
43	generic/specific characteristics of products.....	185
44	Figure 55 : the hierarchy in the structure of the physical environment, from global to local.....	189
45	Figure 56 : Relationships between the circulation spaces of human activities and ecosystems.....	190

1	Figure 57 : Relationships between performance (P) (growth, fecundity, survival) and concentrations	
2	of an essential (Ce) or nonessential (Cne) element of the diet of animals. Possible deficiency effects at	
3	ultra-trace levels (d) of an apparently nonessential element may be discovered as the sensitivities of	
4	analytical techniques are improved. (Walker, et al., 2006)(p.6).....	192
5	Figure 58 : the division of individual time between money budget creation and other times .....	193
6	Figure 59 : Difference between local and global speed represented as a timely distribution. ....	195
7	Figure 60 : the scientific methodology (McQuarrie, et al., 1992) .....	199
8	Figure 61 : Territories and ecosystems, from local to global. ....	205
9	Figure 62 : A model of territorial production based on generic-specific approach of knowledge	
10	(adapted from (Buclet, 2013)).....	207
11	Figure 63 : From concentration and generic production to distributed and specific production. ....	208
12	Figure 64 : Properties have their own time framework.....	210
13	Figure 65 : The life cycle of a product, an environment and property perspective.....	211
14	Figure 66 : The imbrications of networks in sustainability.....	214
15	Figure 67 : Inverting the projection framework between concrete and abstract network.....	220
16	Figure 68 : The four step models, associated decision structure and network modeling (adapted from	
17	(Tavasszy, 2006)) .....	221
18	Figure 69 : A similar pattern of questions for different scales.....	222
19	Figure 70 : Model structure.....	227
20	Figure 71 : A national to regional disaggregation based on value added decomposition.....	228
21	Figure 72 : Logistic typology and associated lead time framework .....	232
22	Figure 73 : Distinction between direct and indirect transportation .....	238
23	Figure 74 : Sectorial evolution of tons per shipment for a 24-40T truck (reference scenario).....	240
24	Figure 75 : Principles of gravity model .....	241
25	Figure 76 : A) Tons produced per capita. B) Tons consumed per capita. C) Ton regional balance per	
26	capita.....	244
27	Figure 77 : Evolution Cost per ton according to distance and scenarios .....	245
28	Figure 78: Sensitivity of direct shipment choice to distances for different scenarios .....	247
29	Figure 79 : Tons going through warehouses for pharmaceuticals, medicinal chemicals and botanical	
30	products.....	248
31	Figure 80 : Modal splits for direct shipments as a function of scenarios and distance driven on the	
32	road network.....	249
33	Figure 81 : External cost per ton.km comparison with bulk electric train as a reference (=1) .....	250
34	Figure 82 : the links between economy, social, and the environment in the current sustainability	
35	framework .....	254
36		
37		

# List of Tables

1		
2		
3	Table 1: Description of the dissertation structure .....	48
4	Table 2 : Usual analytical factors of material flow analysis.....	53
5	Table 3 : the six boundary issues of the system of national accounts .....	56
6	Table 4: Evolution of firm cycles (margin: 60 %, 93.75 %, and 100 %).....	70
7	Table 5 : Financial analysis through 12 ratios (Gérard Boileau, Comprendre les comptes d'une	
8	entreprise, p.137-172).....	71
9	Table 6 : Criteria of differentiation of the productive and logistics organization (Burmeister, 2000)	109
10	Table 7 : Cluster of pervasive technologies (Source: Adapted from (Pry, 1988)) .....	120
11	Table 8 : A typology of the logics of circulation (Burmeister, 2000) .....	124
12	Table 9: Differences between process Life Cycle Assessment and Input-Output Analysis.....	139
13	<b>Table 10 : the different environmental methodologies for sustainable consumption</b> (Hertwich, 2005)	
14	.....	139
15	Table 11: External costs and methodologies, an overview (Mc Kinnon, et al., 2010)(p.76).....	143
16	Table 12: Comparison of Eco – Calculators (Wolff, et al., 2010).....	146
17	Table 13 : Axes and means for reducing GHG emissions through shippers' logistic reorganization ..	151
18	Table 14 : A typology of product – service systems .....	166
19	Table 15 : Articulation between logics of production and transportation service trajectory (adapted	
20	from (Burmeister, et al., 2008)(Burmeister and al) and (Burmeister, et al., 2006)) .....	179
21	Table 16 : The objective value of the performance indicator (Stahel, 2010)(p.9) .....	182
22	Table 17 : Proximity for territorial analysis (adapted from (Bouba-Olga, et al., 2006)) .....	203
23	Table 18 : The dichotomy specific/generic and associated four worlds .....	215
24	Table 19 : The six scenarios studied in the economic modeling .....	215
25	Table 20 : NST nomenclature composition .....	216
26	Table 21 : Surveys of typologies (adapted from (Burmeister, 2000)) .....	218
27	Table 22: classification of typologies in regards of generic/specific dichotomy.....	219
28	Table 23 : Complexity evolution from generic resources to specific resources ( (Colletis-Wahl, et al.,	
29	2003) (Colletis-Wahl, et al., 2004) and (Burmeister, 2000)) .....	224
30	Table 24 : The effects of the different worlds on indicators framework ( (Gadrey, 1991), (Djellal, et al.,	
31	2006) and (Burmeister, et al., 2008)) .....	224
32	<b>Table 25: The different types of control process</b> .....	224
33	Table 26 : Structure of regions and sectors.....	229
34	Table 27 : Decomposition framework for consumption .....	229
35	Table 28 : Sensitivity of sectors to functional strategy adapted from (Combe , et al., 2008).....	230
36	Table 29 : Distribution of NST nomenclature in our logistic typology (adapted from (Burmeister,	
37	2000)) .....	233
38	Table 30: Repartition of sectors within logistics typology according to scenarios .....	234
39	Table 31 : Vehicle and load factor types in EcoTransIT world tool .....	235
40	Table 32 : Establishment of vehicle load factor trends for logistics typology.....	235
41	Table 33 : Establishment of vehicle load factors through combination of volume density.....	236
42	Table 34 : Vehicle types decomposition for each scenarios and sectors.....	236
43	Table 35 : cost and emission characteristics of vehicles .....	237

1	Table 36 : Warehouse costs per ton (reference and non-sustainable functional economy scenarios)	
2	.....	239
3	Table 37 : Warehouse costs per ton (sustainable functional economy scenarios).....	239
4	Table 38: Distribution of tons consumed by regions in reference scenario .....	242
5	Table 39 : Distribution of tons produced by regions in reference scenario.....	243
6	Table 40 : Emissions associated with interregional transportation of pharmaceuticals, medicinal	
7	chemicals and botanical products.....	250
8	Table 41 : Transportation and logistic scenarios.....	259
9	Table 42 : Nomenclature headings of the National French IO Table .....	283
10	Table 43: 2006 national IO table (left-upper part of the table) .....	287
11	<b>Table 44: 2006 national IO table (left-lower part of the table)</b> .....	288
12	<b>Table 45: 2006 national IO table (right-upper part of the table)</b> .....	289
13	<b>Table 46: 2006 national IO table (right-lower part of the table)</b> .....	290
14	<b>Table 47: 2006 Final Demand table</b> .....	291
15	Table 48 : National Imports in value and tons for “00” and “01” NST codes.....	293
16	Table 49 : countries available in Sitram custom database .....	294
17	Table 50 : Transport mode available in Sitram custom database .....	294
18	Table 51 : Goods available in Sitram database (NST-R code).....	295
19	Table 52: Correction process to establishing final bridge between NES and NST nomenclatures .....	296
20	Table 53 : Difference between IO table import reference and calculated imports (NES nomenclature)	
21	.....	297
22	Table 54 : Volume density classification of NST products.....	300
23	Table 55 : Volume density classification of NES sectors .....	300
24	Table 56 : Distance between regions through the road network (calculated through (EcoTransIT,	
25	2011)) .....	301
26	Table 57 : Distance between regions through the rail network (calculated through (EcoTransIT, 2011))	
27	.....	301
28	Table 58: Cost data referential.....	302
29	Table 59 : Tax framework for air emission environmental costs .....	303
30		
31		

1

2

3

4

5

# 6 *General Introduction*

7

8

9

10

11



# 1 Context

## 2 1.1 A degraded environment for society

3

4 According to (Rotillon, 2010), two periods can be distinguished in regards to the issues created by the  
5 use of natural resources by mankind. The first one is related to the question of the depletion of  
6 natural resources and associated consequences on economic growth. The second one is concerned  
7 by the environmental degradations linked to our current production and consumption patterns.  
8 These two periods lead to different questions in regards to the management of natural resources,  
9 the former dealing with the notion of scarcity while the latter deals with the notion of limits set by  
10 the environment on human actions.

11 The notion of scarcity has been mainly defined through the economic field since the object of the  
12 economy is the study of optimal allocations of scarce resources. Therefore, natural resources are also  
13 defined economically as something existing in natural environment, useful for men, and which can be  
14 extracted and used with existing technologies and at the current price (Rotillon, 2010). From a notion  
15 of natural resources intuitively linked to physics and natural sciences, natural resources are  
16 transformed into an issue of price management with maximization of profit as a main objective.  
17 However, the degradation of natural resources and the environment are characterized by a physical  
18 reality. The 1.1 billion tonnes of material consumed by the French economy in 2007 are physically  
19 real. Similarly, the crude steel production of China in 2011, about five times greater than in 2000 and  
20 consequently reaching 683 million tonnes (Hashimoto, et al., 2012), constitutes a physical proof of  
21 the increase of the pressure of human societies on the environment. There is thus an important  
22 distinction to make between the physical stock and the economic stock, the latter always  
23 representing a share of the former. This hierarchy is often used to argue that it makes no sense to  
24 consider possible the total depletion of a physical stock as reaching the depletion of economic stock  
25 implies the findings and exploitation of alternative resources (Rotillon, 2010). The physical aspects  
26 are thus only used from a methodological viewpoint to make a distinction between renewable and  
27 non-renewable resources based on the comparison between the duration of physical and biological  
28 processes at the origin of the renewal of resources and the duration of their extraction and use  
29 (Rotillon, 2010). However, many indicators in regards to the use of natural resources are red. The oil  
30 peak marking the maximum production of crude petroleum has already been reached and the  
31 production is going slightly down. Similarly, the fact that in spite of the increase of production of  
32 fishes from  $98 \cdot 10^6$  tons in 1990 to  $140 \cdot 10^6$  tons in 2007, the catches of sea and freshwater fishes have  
33 remain constant, around  $90 \cdot 10^6$  tons, tends to demonstrate that a production peak has been reached  
34 (World Trade Organization, 2010).

35 Regarding emissions and discharges made to the environment, 73% of the French emissions were  
36 found in 2007 made to air while landfill represented 25% of the discharges made to the environment.  
37 The carbon dioxide (CO<sub>2</sub>) emissions amounted to 397 million tonnes (Mt), 88% of which  
38 corresponding to fossil fuel combustion (Commission générale du développement durable, 2010).  
39 These figures can be compared with a recent study for the year 2004 which has shown that 627  
40 MtCO<sub>2</sub>e were emitted in 2004 to meet French households' consumption (Hawkins, et al.,  
41 2010). Several factors can be used to explain the huge difference between these two figures. First,

1 the 2004 study accounts for CO<sub>2</sub> equivalent emissions meaning that the emissions of the six GHG<sup>2</sup>  
 2 accounted in the Kyoto Protocol are summed according to their global warming potential (GWP) as  
 3 defined by the International Panel on Climate Change (IPCC). Secondly, the boundary analysis are  
 4 also very different since the 2004 study is a consumption analysis meaning that the emissions  
 5 associated with imports are also taken into account while the 2007 study is a territorial analysis of  
 6 French emissions. Concretely, on the 627 MtCO<sub>2</sub> found to be emitted to meet French households'  
 7 consumption, 35% are found to be extra-territorial emissions. Thirdly, the 2004 study also developed  
 8 a particular focus on transportation emission induced on the French territory and on foreign  
 9 territories by French household consumption. In regards of transportation issue, 13% of the total  
 10 2004 French households' consumption was found associated with freight transport and 11% with  
 11 passenger transport. Besides, freight transport accounted for as much as 28% of the extra-territorial  
 12 emissions described above compared to only 4 % of territorial emissions (Hawkins, et al., 2010). The  
 13 importance of transportation emissions when it comes to CO<sub>2</sub> emissions appears thus quite clear. It is  
 14 further confirmed at the international level as transportation was found responsible for 23% of world  
 15 energy-related greenhouse gas emissions in 2004 (International Energy Agency, 2006). These high  
 16 shares of emissions are also related to a high material consumption of energy products as  
 17 transportation activities cover 70% of the French final consumption of petroleum products<sup>3</sup>. At the  
 18 local level, transportation is also responsible for a huge share of the air pollution. For example, a  
 19 recent report shows that transportation amounts to as much as 60% of 2009 French national  
 20 nitrogen oxides (NOx) emission, an important gas in the phenomena of acidification, eutrophication  
 21 and photochemical pollutions (CITEPA, 2011). Based on the same report, **Figure 10** provides a set of  
 22 pollutants for which the transportation contributions are the most significant (>10%).

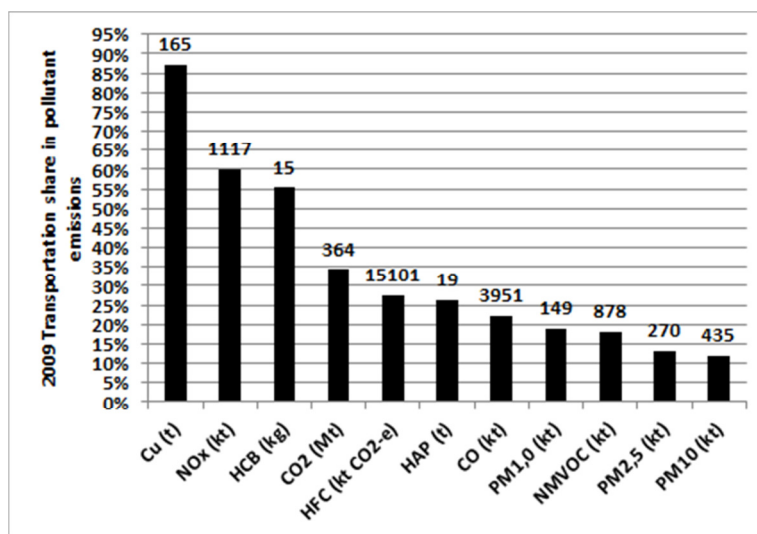

23  
 24 **Reading:** In 2009, 165 tons of Copper (Cu) has been released to air. 87% were coming from the transportation sector.<sup>4</sup>

25 **Figure 10 : 2009 transport shares in atmospheric pollutants emission (CITEPA, 2011)**

<sup>2</sup> CO<sub>2</sub> (GWP=1), CH<sub>4</sub> (GWP=23), N<sub>2</sub>O (GWP=296), SF<sub>6</sub> (GWP=22200), HFC (GWP=12-12000), PFC (GWP=5000-1200) *Source spécifiée non valide.*

<sup>3</sup> [http://www.insee.fr/fr/themes/tableau.asp?reg\\_id=0&ref\\_id=NATnon11350](http://www.insee.fr/fr/themes/tableau.asp?reg_id=0&ref_id=NATnon11350)

<sup>4</sup> The high share of copper emissions linked to transportation is due for road transportation (52% of total emissions) to the wear of brake pads and for other transportation (35% of total emissions) mainly to the railway sector and the wear of catenaries.

## 1.2 An evolution of the notion of sustainability

In respect of the degradation of the environmental conditions of society described previously, the notion of sustainability has evolved through different steps. Indeed, the 1949 United Nations (UN) Scientific Conference on the conservation and utilization of resources was the first UN body to address the depletion of those resources and their use. However, the management of resources for economic and social development was the main focus and it was not until 1968 that environmental issues received serious attention by any major UN organs<sup>5</sup>. Therefore, at that time, the perception of the role of natural resources was close to the problem of their economic exploitation. This first step was also characterized by the absence of awareness of the physical limitations of these resources. Finally, the rising pressure driven by the depletion of resources and the threats of environmental impacts led to the Stockholm 1972 UN scientific conference, also known as the First Earth Summit. During this conference, a declaration that set out principles for the preservation and enhancement of the human environment, and an action plan containing recommendations for international environmental action were adopted. Furthermore, in a section on the identification and control of pollutants of broad international significance, the Declaration raised the issue of climate change for the first time, warning Governments to be mindful of activities that could lead to climate change and evaluate the likelihood and magnitude of climatic effects<sup>5</sup>. This is rather important since climate change driven by the emissions of Greenhouse gases has become one of today's most dangerous environmental threats to human societies. Indeed, later in 1992, this problem was given a particular policy area through the United Nations Framework Convention on Climate Change (UNFCCC) together with a scientific support provided by the Intergovernmental Panel on Climate Change<sup>6</sup> (IPCC). The ultimate objective of this convention is to achieve stabilization of greenhouse gas concentrations in the atmosphere at a level that would prevent dangerous anthropogenic interference with the climate system. Such a level should be achieved within a time frame sufficient to allow ecosystems to adapt naturally to climate change, to ensure that food production is not threatened and to enable economic development to proceed in a sustainable manner (United Nations, 1992). In the UNFCCC framework, it thus appears that the economic development, i.e. the development of economic human activities and the associated circulation of goods, should be organized in a framework respectful of ecosystems functioning. However, other organizations such as the world trade organization considers the problem on environmental issues as being an intellectual debate oscillating between pessimistic and optimistic views of the problem of scarcity of natural resources. Actually, while liberal and neoclassical economy appears optimistic in the capacity of human innovation to always deal further with physical limits, Malthusians and neo-Malthusians focus on the absolute character of the physical limits of Earth resources (World Trade Organization, 2010).

Finally, in 1987, the Brundtland report defined sustainable development as a progress that meets the needs of the present without compromising the ability of future generations to meet their own needs (World Commission on Environment and Development, 1987). This definition tends to find a compromise between optimistic and pessimistic views. Indeed, the physical limits are set as an

---

<sup>5</sup>

<http://www.un.org/wcm/content/site/chronicle/lang/en/home/archive/issues2007/greenourworld/pid/21620>

<sup>6</sup> This UN body created in November 1988 regularly provides scientific reports on the world situation regarding climate change. So far, four assessment reports have been provided (1990, 1995, 2001 and 2007).

1 intergenerational equity in terms of access to natural resources while the “development” part gives  
2 an important place to economy and its supposed capacity to increase society welfare. Twenty-five  
3 years later, this definition still constitutes the main framework of sustainable policies. Nevertheless,  
4 not only the environmental degradations have kept increasing worldwide but the current socio-  
5 economic framework is more and more questioned in its ability to provide welfare for individuals in  
6 society. In this respect, the 2009 Stiglitz Commission made five recommendations to reconcile the  
7 economic system with the creation of welfare<sup>7</sup>. Firstly, the economic system should refer to income  
8 and consumption rather than production. Secondly, assets should receive more interest similarly  
9 income and consumption. Thirdly, the economy must focus more on households’ perspectives.  
10 Fourthly, the economic system should give more importance to the repartition of income,  
11 consumption and wealth. Finally, income indicators should be extended to non-market activities.  
12 However, the main framework of sustainable policies is still dealing with the perspective of obtaining  
13 sustainability with the current socio-economic framework. These attempts take notably the form of  
14 an analysis of material consumption and associated emissions based on decomposition in several  
15 explicative factors. Such example of decomposition is given by the famous I=PAT equation which  
16 decomposes an impact (I) into population (P), affluence (A) and technology (T)<sup>8</sup>. This equation in the  
17 case of CO<sub>2</sub> emissions associated with transportation could be expressed as CO<sub>2</sub> (t) = Population  
18 (cap.) \* Affluence (tkm/cap.) \* Technology\_1 (fuel liter/tkm)\* Technology\_2 (tCO<sub>2</sub>/fuel liter). Other  
19 applications of the I=PAT can be found for example in (Raupach, et al., 2007) and (Waggoner, et al.,  
20 2002). And we should admit with (Nansai, et al., 2009) that using decomposition technique like  
21 these, the principal drivers behind complex phenomena can be isolated and their roles in the overall  
22 system can be better understood.

23 In regards to the 1.1 billion tonnes of material consumed in 2007 by the French economy, these  
24 decomposition technics are translated for example by an internal consumption of 14.3 tonnes per  
25 inhabitant and an average material productivity of 1490 euro/tonne (Commission générale du  
26 développement durable, 2010). Sustainability in this framework is thus translated as a diminution of  
27 these ratios. In this respect, a material decoupling of the French economy is already happening as  
28 since 1990, the material consumption has increased by 11% while the GDP of French economy has  
29 increased by about 38% thus leading to an increase of around 24% in the French material  
30 productivity (Commission générale du développement durable, 2010). Nevertheless, this  
31 dematerialization is only relative as the quantity of tonnes consumed continues to increase. To fight  
32 against this trend, the European Union (E.U.) has developed a strategy with a focus on the  
33 decarbonization of the economy and energy efficiency first for 2020 and secondly for 2050. Indeed,  
34 the objectives of the E.U. for 2050 are 80-95% reduction of greenhouse gas emissions (GHG)  
35 compared to 1990 emissions level with an intermediate reduction step of 20% in 2020 (European  
36 Commission, 2011). Similarly, for 2020 the share of renewable resources is supposed to reach 20%  
37 while the energy efficiency is supposed to increase by 20% (European Commission, 2011).  
38 Nevertheless, the indications of the E.U. in terms of decoupling objectives remain unclear with no  
39 targets expressed quantitatively such as the change in the euro/ton ratio of goods. Indeed, the  
40 research program associated with the development of a decoupling economy is still in an early stage  
41 so that projects existing today mainly consist in the development of accounting and reporting

---

<sup>7</sup> [http://www.insee.fr/fr/publications-et-services/default.asp?page=dossiers\\_web/stiglitz/performance\\_eco.htm](http://www.insee.fr/fr/publications-et-services/default.asp?page=dossiers_web/stiglitz/performance_eco.htm)

<sup>8</sup> <http://www.ipcc.ch/ipccreports/sres/emission/index.php?idp=50>

1 obligations of principal material flows to the European statistic office, Eurostat (Commission générale  
2 du développement durable, 2010). However, some rupture strategies are also studied and concerned  
3 either a modification of the interface Nature – society or of the interface of production –  
4 consumption. The first of these strategies is circular economy sometimes also referred under the  
5 term industrial ecology. Concentrating on the interface Nature – society, circular economy considers  
6 that society should manage natural resources and wastes or discharges under the principles of closed  
7 ecosystem, each waste becoming a resource for another industry. In this perspective, the  
8 dematerialization is obtained through recycling and remanufacturing activities which prevent the  
9 depletion of virgin resources. The second strategy is known as functional economy and deals with the  
10 modification of the link between producers and consumers. Actually, this link is currently made  
11 through the act of purchase translated as a transfer of ownership through money exchanges. On the  
12 opposite, functional economy deals with the satisfaction of the function aimed by the use of  
13 particular production system. It is believed that the business model associated with the selling of  
14 product's use instead of the product itself will give incentive to the producer to conceive and provide  
15 environmentally friendly goods with extended lifetime. In a way, a parallel can be built between  
16 functional strategy and the recommendation of the Stiglitz report to focus more on consumption  
17 than production. However, both these strategies are still on an early stage both in terms of concrete  
18 applications in the economy or at the policy level and in terms of understanding of the theoretical  
19 conditions to make functional economy beneficial for the stakes of sustainability.

### 20 **1.3 The growing issue of circulation**

21  
22 Twenty five years after the Brundtland report defining sustainable development, the world is known  
23 to have experienced an unprecedented wave of globalization. Such globalization is characterized by  
24 the increasing number of countries taking part in international trade and the growing number of  
25 traded items both in variety, quantity, and value. For example, **Figure 11** shows the world production  
26 and the associated globalization expressed in terms of world GDP fraction associated with exports  
27 have been respectively multiplied by 45 and 2.5 over the last fifty years. Nevertheless, over the 1960  
28 – 2008 periods, it should be noted the same three regions<sup>9</sup> cover over half of the world GDP. It thus  
29 seems the globalization process has so far mainly consisted in a redistribution of GDP strength  
30 between these regions. Another key point in the globalization process is the increasing sophistication  
31 of modern supply chains. Indeed, the application of modern management principles throughout the  
32 supply chain such as Just-In-Time, lean production and Efficient Consumer Response have led to  
33 more responsive, more flexible supply chains that enable firms to compete in a global market.  
34 Furthermore, the potential extension of trade partners encourages companies to experience global  
35 sourcing strategies and wider distribution of finished products (Cetinkaya, et al., 2011). All these new  
36 aspects of trade tend to increase the need for freight transportation and particularly for international  
37 freight transportation whose associated emissions are not addressed by the Kyoto Protocol, the main  
38 international framework of Climate policies.

39

---

<sup>9</sup> **Western Europe**: Austria, Belgium, France, Germany, Luxembourg, Netherlands, Switzerland. **East Asia**: China, Hong Kong, Macao, North Korea, Japan, Mongolia, South Korea. **Northern America**: Bermuda, Canada, Greenland, Saint Pierre and Miquelon, USA.

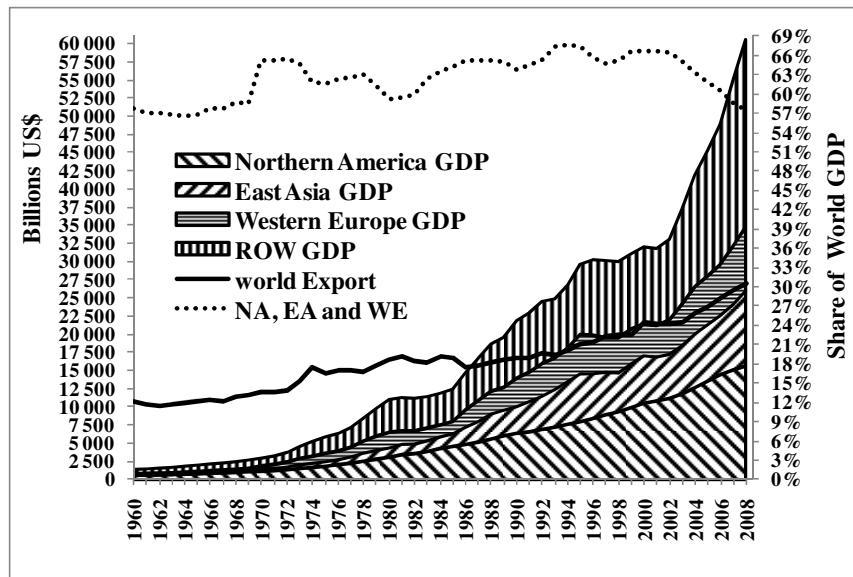

1  
2  
3 **Figure 11 : The evolution of world, Northern America, East Asia and Western Europe GDP together**  
4 **with the corresponding fraction of world GDP in the 1960 – 2008 period. (Dente, et al., 2012)**

5 The stakes of globalization in terms of trade is indeed important. For example, if we consider France  
6 as made of 22 regions, 22x22 possibilities of production/consumption relationships can be  
7 established for the internal market. For example, products produced in Ile de France can be  
8 consumed in Ile de France but also in Bretagne or any other regions leading to 22 possibilities of  
9 trade. The pattern becomes more complex with the increase of the number of trade partners, made  
10 possible by the suppression of trade barriers. On this aspect, it should be noted that the World Trade  
11 Organization favors globalization through its actions in favor of the lowering of trade barriers such as  
12 custom duties, custom tariffs, import bans or quotas (World Trade Organization, 2011). The sourcing  
13 of firms can thus be extended in space leading to reorganization of supply chains adapted to the new  
14 possibilities offered by the globalization processes. For example, Panasonic France, a subsidiary of  
15 the Japanese company Matsushita specialized in electronics has experienced four phases of  
16 evolution since 1980 corresponding to an evolution of the global market space. Indeed, in the  
17 eighties, products were mainly imported from Japan to France before the creation of production  
18 units in Western Europe in the beginning of the nineties. Between phase 1 and phase 2, the supply  
19 chain length was thus found diminishing. But the collapse of Soviet Union in 1991 and the  
20 consequently opening of Eastern Europe market to the rest of the world have led to a relocalization  
21 of production units in Eastern Europe. Similarly, since the beginning of the years 2000, the opening of  
22 the Chinese market has led to a relocalization of Panasonic production units in China (Dornier, et al.,  
23 2009). This process linked to the search for low-cost human capital has thus led to the extension of  
24 the supply chain length.

25 The globalization of markets thus seems insensitive to the issue of space extending or reducing  
26 supply chain length in a permanent reorganization based on business and profit maximization  
27 opportunities. However, this pattern has a consequence on the consumption of natural resources  
28 and notably international energy trade is expected to grow steadily to accommodate the increasing  
29 mismatch between the location of demand and that of production (International Energy Agency,  
30 2006). Besides, we already stated in 1.1 the environmental issues associated with transportation  
31 notably in terms of emissions of local pollutants and greenhouse gases and in terms of energy

1 resources depletion such as petroleum. Today's world is thus at the same time experiencing a  
2 shortage of natural resources and a degradation of the natural environment together with an  
3 increase of the need for circulation of goods driven by the process of globalization. These  
4 discrepancies constitute the context of this dissertation which logically addresses the issue of  
5 sustainability through the analysis of the circulation processes.

## 6 **2. Research questions**

7  
8 The main research question consists in determining the conditions for a sustainable application of  
9 the promising strategies of functional and circular economy. However, these conditions are  
10 examined through the issue of circulation. Therefore, the research question is made of two parts:

- 11 **1) How strategies of functional and circular economy can influence the conception of**  
12 **sustainable socio-economic system?**
- 13 **2) How strategies of functional and circular economy can influence the conception of**  
14 **sustainable circulation processes of goods?**

15 Our two research questions are intrinsically linked through the triptych sustainability/supply chain  
16 management/circular and functional economy. As shown in **Figure 12**, our first issue is to understand  
17 the current representation of sustainability and how human activities are perceived in the current  
18 socio-economic framework. Indeed, there cannot be any circulation as long as production and  
19 consumption activities are not made explicit. Therefore, through the analysis of accounting systems  
20 and economic theories, I will demonstrate that the boundaries and the beliefs of the current socio-  
21 economic system severely constrain the representation of sustainability. I will also demonstrate that  
22 the place made to the circulation process in the economic theories is unclear. Actually, I will  
23 demonstrate that economic theories happen to favor a non-spatial and non-temporal representation  
24 of the economic exchanges characterized by the absence of transaction costs. Therefore, transaction  
25 costs introduced notably by Williamson (Ghertman, 2003) and Coase (Bertrand, et al., 2002) are the  
26 main line of attack I will use to criticize the unsustainable patterns of the current socio – economic  
27 system.

28 The hypothesis of an absence of transaction costs is directly linked to the issue of circulation. Indeed,  
29 if there is no transaction costs, the exchange of goods become a trivial process as no management of  
30 physical and information flows is needed. However, the French association for logistics<sup>10</sup> (ASLOG)  
31 defines the vital stakes of companies as the design, the making and the delivery of the good product  
32 at the right time and the right place. Therefore, according to logistics and transportation activities,  
33 the success of economic exchanges is dependent on an efficient management of the circulation of  
34 goods within the economy. The place of logistics and transportation activities is thus of core  
35 importance in our framework though at first sight the supply chain management appears neglected  
36 by economic theories which through a normative reference to a without transaction cost economy  
37 consider transportation and associated management as a dysfunction of the current economic  
38 system. In this perspective, the purpose set by economic theories to logistic activities is to minimize  
39 transaction costs. On the other hand, the search for the absence of transaction costs makes the

---

<sup>10</sup> <http://www.aslog.org/mission>

- 1 analysis of logistics and transportation activities the perfect framework to understand the problem of
- 2 resource and coordination management characterizing our current socio – economic framework.

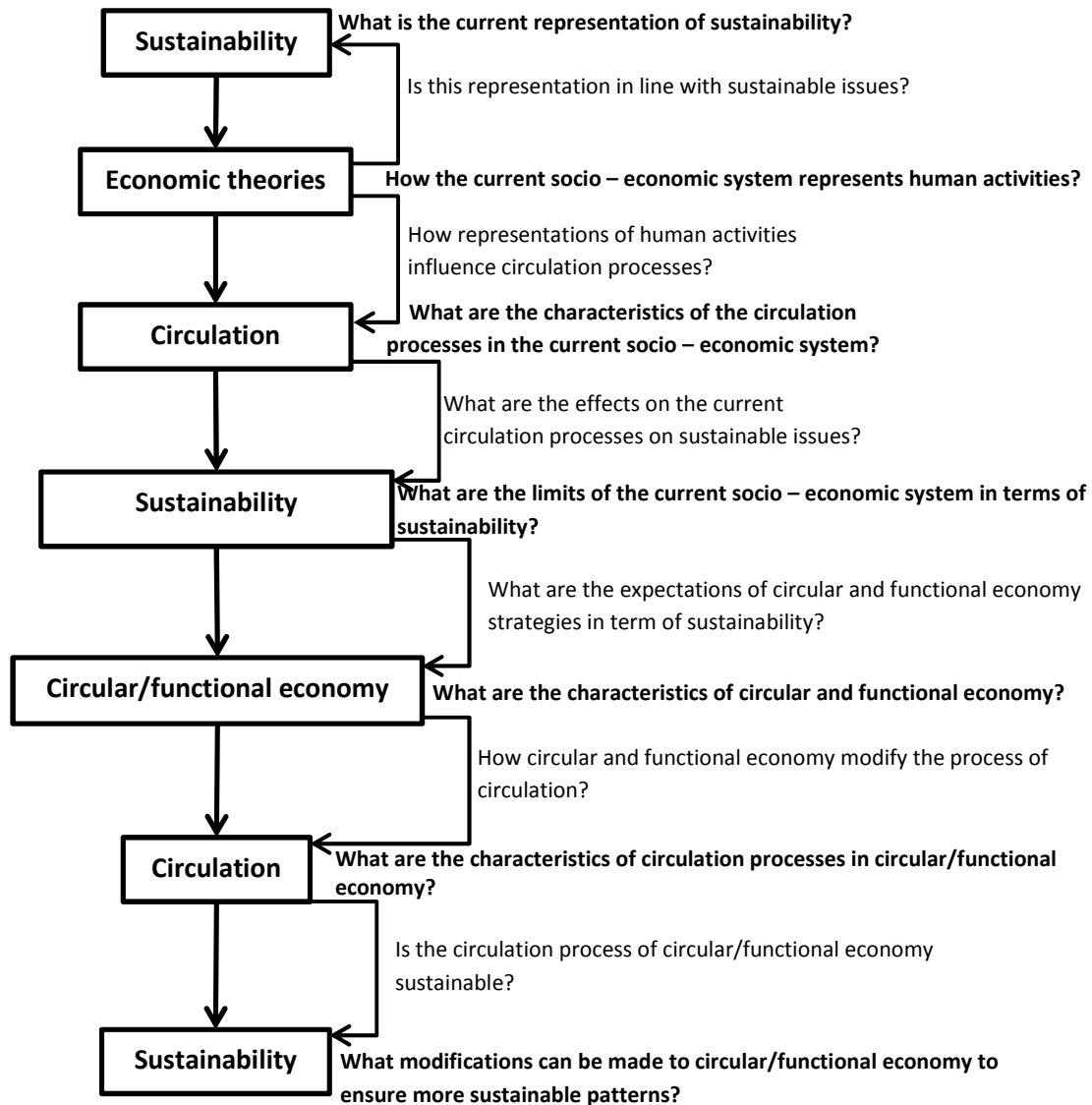

3

4 **Figure 12: Question structure of the dissertation**

5 Logistics and transportation activities constitute the framework through which sustainability and  
 6 circulation processes are interconnected. Indeed, I argue that sustainability is linked to a complete  
 7 revision of the circulation processes and the associated articulation between local and global  
 8 activities. On this aspect, I will first demonstrate the necessity to abandon the utopia of a world  
 9 without transaction costs as this framework do not cover and will never cover any aspect of reality.  
 10 Secondly, logistics once freed from the yoke of economic theories can welcome new description and  
 11 understanding of human activities such as circular and functional economy. In this framework,  
 12 logistics, also called supply chain management (SCM), appears as an intellectual capacity of the  
 13 *transport and storage sector* dealing with the management of the circulation of goods within the  
 14 economy. *Transport and storage* sector thus belongs to the tertiary sector of the economy and is part  
 15 of what French National Institute of Statistics and Economic Studies (INSEE) names services.



1 According to this institute, a service activity is essentially characterized by the act of making a  
2 technical or intellectual capacity available. In contrast to industrial activity, it cannot be described  
3 solely by the characteristics of a tangible asset acquired by the client<sup>11</sup>. Following this definition, the  
4 *transport and storage* sector is indeed a service as it provides the technical capacity for the moving of  
5 goods and the intellectual capacity for the organization of the circulation of these goods within the  
6 economy.

7 Supply chain management is thus dependent on choices made on definition of goods, the purpose of  
8 exchanges and their organization. The aim of logistic organization is thus subordinated to choices  
9 made by the socio – economic system, notably its representation of sustainability. Considering that  
10 the environmental impacts have recently reached warning levels, firstly in term of depletion of non-  
11 renewable resources such as minerals and petroleum which have direct consequences in the current  
12 economic framework on the company activities, and secondly in term of discharges to the  
13 environment which currently fall in the pit of externalities, it clearly appears that the choices made  
14 so far in regards to sustainability issues have been insufficient. Therefore, the present dissertation  
15 will also aim through the review of the circulation processes in different environments (economic  
16 theories, supply chain management theories, circular and functional economies) at establishing a  
17 clearer understanding of what constitutes sustainability. Indeed, sustainability appears as a complex  
18 and undefined notion the stakes of which seem to go further than a dematerialization or  
19 decarbonization of the economy to embrace a new conception of the relationships between the  
20 social, economic and environmental aspects of the life of individuals.

21 However, dealing with the usual technical aspects of decomposition analysis, the material aspect of  
22 the economy can be described as the following equation,  $M=M_A*A$  in which (M) is the material  
23 consumption of the economy, ( $M_A$ ) the material consumption per “activity unit” and (A) the number  
24 of “activity units” understood as the system “production – circulation – consumption”. Therefore, in  
25 this approach, the dissertation appears as a three steps approach consisting in studying the two  
26 factors of the equation, (A) and ( $M_A$ ), in 1) the current socio-economic framework to 2) understand if  
27 this pattern corresponds to sustainable goals and 3) develop a sustainable understanding of these  
28 two factors, i.e. the change in description of these two factors that a sustainable pattern induces.  
29 This framework notably explains the structure of the dissertation described in **Table 1** in two parts,  
30 the first one concentrating on the study of the “production – circulation – consumption” patterns  
31 within the current socio – economic system and the second one dealing with the changes induced  
32 primarily by the currently most promising sustainable strategies, circular and functional economies,  
33 and secondly by the general learning made on the role of circulation processes in the field of  
34 sustainability. This decomposition technique will thus play a role in framing the quantitative aspects  
35 of our analysis of sustainability, notably in chapter VI in which quantitative modeling of circulation  
36 processes will be studied notably in regards to their potential for sustainability. Nevertheless, I will  
37 also demonstrate the insufficiency of this decomposition framework showing that sustainability  
38 cannot be reduced to a simple decomposition of quantitative aspects.

39

40

---

<sup>11</sup> <http://www.insee.fr/en/methodes/default.asp?page=definitions/services.htm>

1 **Table 1: Description of the dissertation structure**

Dissertation description		Related questions	Part of the equation studied
<b>Part I</b>	<b>Chapter I</b>	<ul style="list-style-type: none"> <li>▪ What is the current representation of sustainability?</li> <li>▪ How the current socio – economic system represents human activities?</li> <li>▪ Is this representation in line with sustainable issue?</li> <li>▪ How representation of human activities influence circulation processes?</li> </ul>	<b>A</b>
	<b>Chapter II</b>	<ul style="list-style-type: none"> <li>▪ How representation of human activities influence circulation processes?</li> <li>▪ What are the characteristics of the circulation processes in the current socio – economic system?</li> </ul>	<b>A</b>
	<b>Chapter III</b>	<ul style="list-style-type: none"> <li>▪ What are the effects on the current circulation processes on sustainable issues?</li> </ul>	<b>M<sub>A</sub></b>
	<b>Part I conclusion</b>	<ul style="list-style-type: none"> <li>▪ What are the limits of the current socio – economic system in terms of sustainability?</li> </ul>	<b>M<sub>A</sub> and A</b>
<b>Part II</b>	<b>Chapter IV</b>	<ul style="list-style-type: none"> <li>▪ What are the expectations of circular and functional economy strategies in term of sustainability?</li> <li>▪ What are the characteristics of circular and functional economy?</li> <li>▪ How circular and functional economies modify the process of circulation?</li> <li>▪ What are the characteristics of circulation processes in circular/functional economy?</li> </ul>	<b>M<sub>A'</sub> and A'</b>
	<b>Chapter V</b>	<ul style="list-style-type: none"> <li>▪ What are the characteristics of circulation processes in circular/functional economy?</li> <li>▪ Is the circulation process of circular/functional economy sustainable?</li> <li>▪ What modifications can be made to circular/functional economy to ensure more sustainable patterns?</li> </ul>	<b>M<sub>A'</sub> and A'</b>
	<b>Chapter VI</b>	<ul style="list-style-type: none"> <li>▪ What are the characteristics of circulation processes in circular/functional economy?</li> <li>▪ What are the characteristics of the circulation processes in the current socio – economic system?</li> <li>▪ What modifications can be made to circular/functional economy to ensure more sustainable patterns?</li> </ul>	<b>(M<sub>A</sub> and A) and (M<sub>A'</sub> and A')</b>
	<b>Part II conclusion</b>	<ul style="list-style-type: none"> <li>▪ Is the circulation process of circular/functional economy sustainable?</li> <li>▪ What modifications can be made to circular/functional economy to ensure more sustainable patterns?</li> </ul>	<b>M<sub>A'</sub> and A'</b>
<b>General conclusion</b>		<ul style="list-style-type: none"> <li>▪ What are the limits of the current socio – economic system in terms of sustainability?</li> <li>▪ Is the circulation process of circular/functional economy sustainable?</li> <li>▪ What modifications can be made to circular/functional economy to ensure more sustainable patterns?</li> </ul>	<b>(M<sub>A</sub> and A) and (M<sub>A'</sub> and A')</b>

2  
3  
4  
5

1

2

3

4

*Part I: The limits of*

5

*current socio-*

6

*economic system*

7

8

9

10

11

# Chapter I: The representation of human activities in the current socio economic framework and its link with sustainable issues

## 1 Introduction

### 1.1 The current representation of sustainability

Going back to the notion of sustainability introduced by the Brundtland report, sustainable development is defined as a progress that meets the needs of the present without compromising the ability of future generations to meet their own needs (World Commission on Environment and Development, 1987). However, several concepts remain unclear in this definition. Firstly, the objective of sustainability supposes the capacity to define now both the needs of the present and future generations. Secondly, the means to reach sustainability are imposed under the form of a progress. There is no precision about the characteristics of this progress, if it is an economic progress or a social progress for example. Nevertheless, the notion of progress translates the idea of an evolution from a given situation towards a better situation. In this perspective, the sustainable appears mainly as a policy agenda based on the statement of the failure of the current socio – economic system to:

- 1) Not being able to meet the needs of the present (or)
- 2) Being able to meet the needs of the present but compromising the ability of future generations to meet their own needs.

Looking into the area of practical policy, the question of sustainable development is found divided in three main fields: economic, environmental, and social. **Figure 13** provides a description of the relationships between the environmental, social and economic aspects of sustainable development. At the center is found the economy defined as the “production – consumption – circulation” system of goods. The economy is supposed to enable the welfare for society under the environmental constrains of resources and discharges. In this perspective, sustainability can be understood as an economic system maximizing social welfare under environmental constrains.

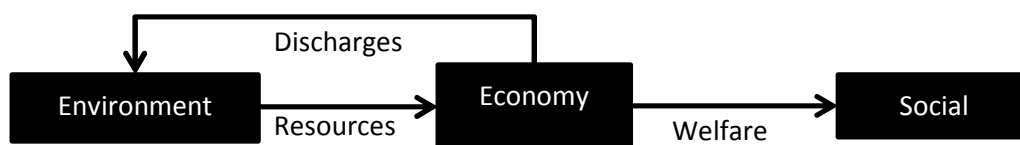

**Figure 13 : the links between economy, social, and the environment in the current sustainability framework**

With this idea, the general questions related to sustainability become:

- 1) How to define welfare?
- 2) How economy is dependent on environmental constrains?
- 3) Is the current socio – economic system enabling social welfare?
- 4) Is the current socio – economic system respectful of environmental constrains?

1 5) If the current socio – economic system does not enable social welfare or is not respectful of  
 2 environmental constrains, how to change the economic system to make it both respectful of  
 3 environmental constrains and an enabler of the social welfare?

4 Sustainability is thus primarily dependent on the representation by societies of welfare and  
 5 environmental constrains. Actually, if welfare and environmental constrains do not hold an objective  
 6 definition, i.e. independent of societies’ particularities, there is no one but a diversity of sustainable  
 7 frameworks. The current representation of sustainability seems nevertheless to favor an objective  
 8 representation of sustainability through the establishment of development paths based on the  
 9 relationships between the Human Development Index framing social sustainability and the ecological  
 10 footprint framing environmental sustainability. As shown in **Figure 14**, sustainability appears defined  
 11 as an HDI superior to 0.8 and an ecological footprint inferior to 1.8 hectares per person. **Figure 14**  
 12 also shows the formation of two kinds of countries, those with a high HDI and a high ecological  
 13 footprint, and those with a low HDI and a low ecological footprint. In this perspective, the notion of  
 14 sustainable development becomes much clearer. Indeed, the development part corresponds to the  
 15 development of the HDI index for countries inferior to 0.8 while the sustainable part corresponds to  
 16 the reduction or the maintenance of the ecological footprints below the 1.8 hectares per person.  
 17 Sustainability thus covered two different aspects depending on whether a developed or developing  
 18 country is studied. Developed countries such as France must reduce their ecological footprints  
 19 without diminishing their HDI. Developing countries must increase their HDI without increasing their  
 20 ecological footprint.

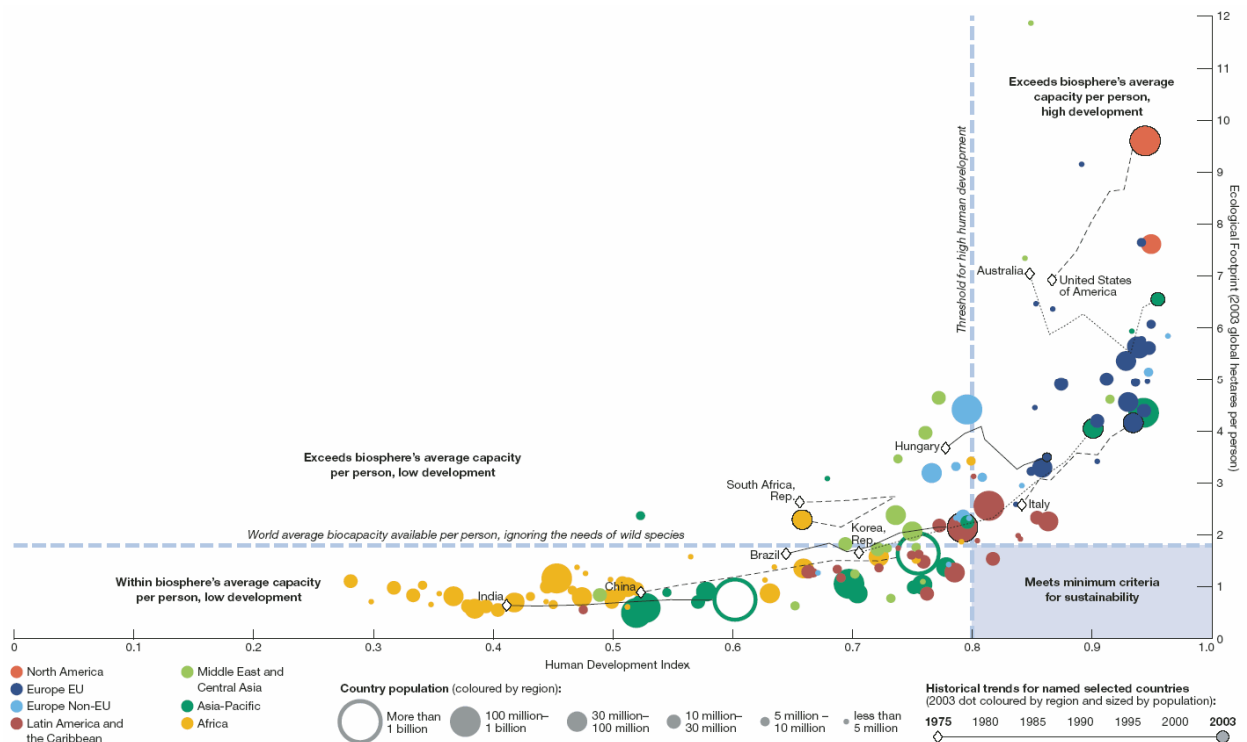

21  
 22 **Figure 14 : the sustainable development path between Human Development Index and Ecological**  
 23 **footprint (WWF, 2006)**

## 1.2 From sustainability to the representation of human activities

In respect to the representation of sustainability previously described, the purpose of the present dissertation is not to focus on the issue of sustainable development from the viewpoint of developing countries but rather to test the legitimacy of the definition of welfare associated with developed countries' socio – economic system to be used as a norm or objective for social sustainability. Actually, as shown in **Figure 15**, the human development index concerns health, education and the living standards. This framework is thus in line with the Millennium Development Goals<sup>12</sup> dealing with the fulfillment of essential needs related to nutrition, health and basic education (writing and reading skills). Nevertheless, the living standards are defined through the notion of income which is a monetary indicator depending on an accounting framework. The representation of human activities made by the accounting framework thus provides an important share of the social sustainability described by the human development index.

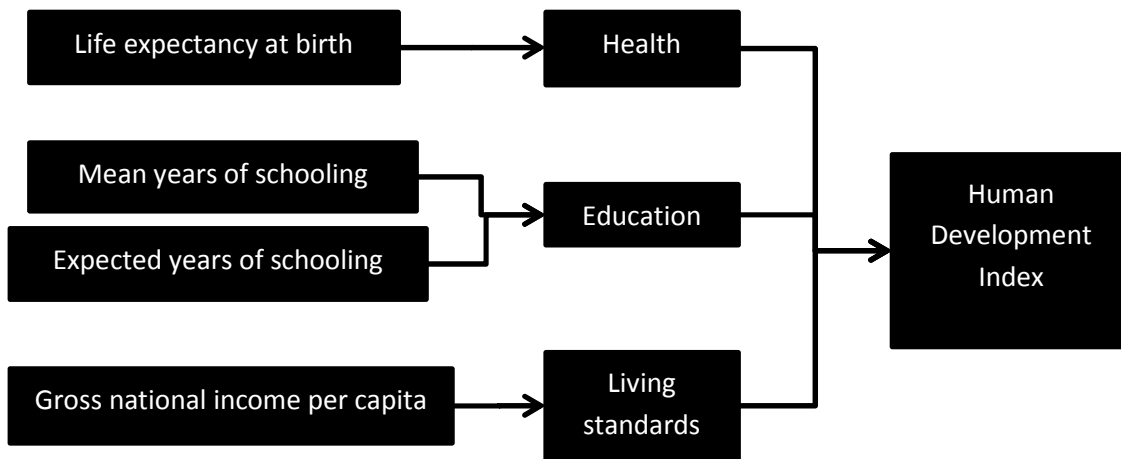

**Figure 15 : Indicators forming the Human Development Index<sup>13</sup>**

Going back to **Figure 13**, the sustainability also deals with the representation of human activities from an environmental viewpoint. In this perspective, the aim is to understand the link between the economic system and the depletion of resources. Indeed, if the depletion of resources keeps going on, the economy will eventually collapse so that the welfare supported by the economy will become not viable on the long term. On this aspect, one can notably note that discharges made to the environment are only taken into account through the effects they have on resource availability (viability criterion) or the direct effect they have on health (bearable criterion). Let us now examine closer the kind of indicators used to address resource consumption. As stated in the general introduction, the French economy consumed around 1.1 billion tons of materials in 2007. Nevertheless, this figure only covers the Direct Material Input (DMI) made to the economy. Indeed, the field of material flow analysis presented in **Table 2** indicates that DMI is not the only indicator used to obtain a general picture of the burden put by an economy on Earth ecosystems (Commission générale du développement durable, 2010).

<sup>12</sup> <http://mdgs.un.org/unsd/mdg/Host.aspx?Content=Indicators%2fOfficialList.htm>

<sup>13</sup> <http://hdr.undp.org/en/statistics/hdi/>

1 **Table 2 : Usual analytical factors of material flow analysis**

Name	Equation
DMI (Direct Material Input)	DMI = Visible internal extraction + Imports
TMR (Total Material Requirement)	TMR = DMI + hidden internal extraction+ indirect flows associated with imports
DMC (Domestic Material Consumption)	DMC = DMI – Exports
TMC (Total Material Consumption)	TMC = TMR – Exports – indirect flows associated with exports

2  
 3 The difference between DMI and TMR lies on the hidden flows which are not valued in the current  
 4 accounting system of the economy. Therefore, a high difference means that the current valuation  
 5 would not be enough to obtain a good proxy of the material consumption made by the economy.  
 6 Such is the case of France in which shifting from DMI to TMR multiplies by three the per capita  
 7 material consumption from 17 t/capita to 47 t/capita. Similarly, the material productivity diminishes  
 8 from 1490 €/t to 550 €/t (Commission générale du développement durable, 2010). Finally, the  
 9 general material framework of the French economy for the year 2007 is presented in **Figure 16**.

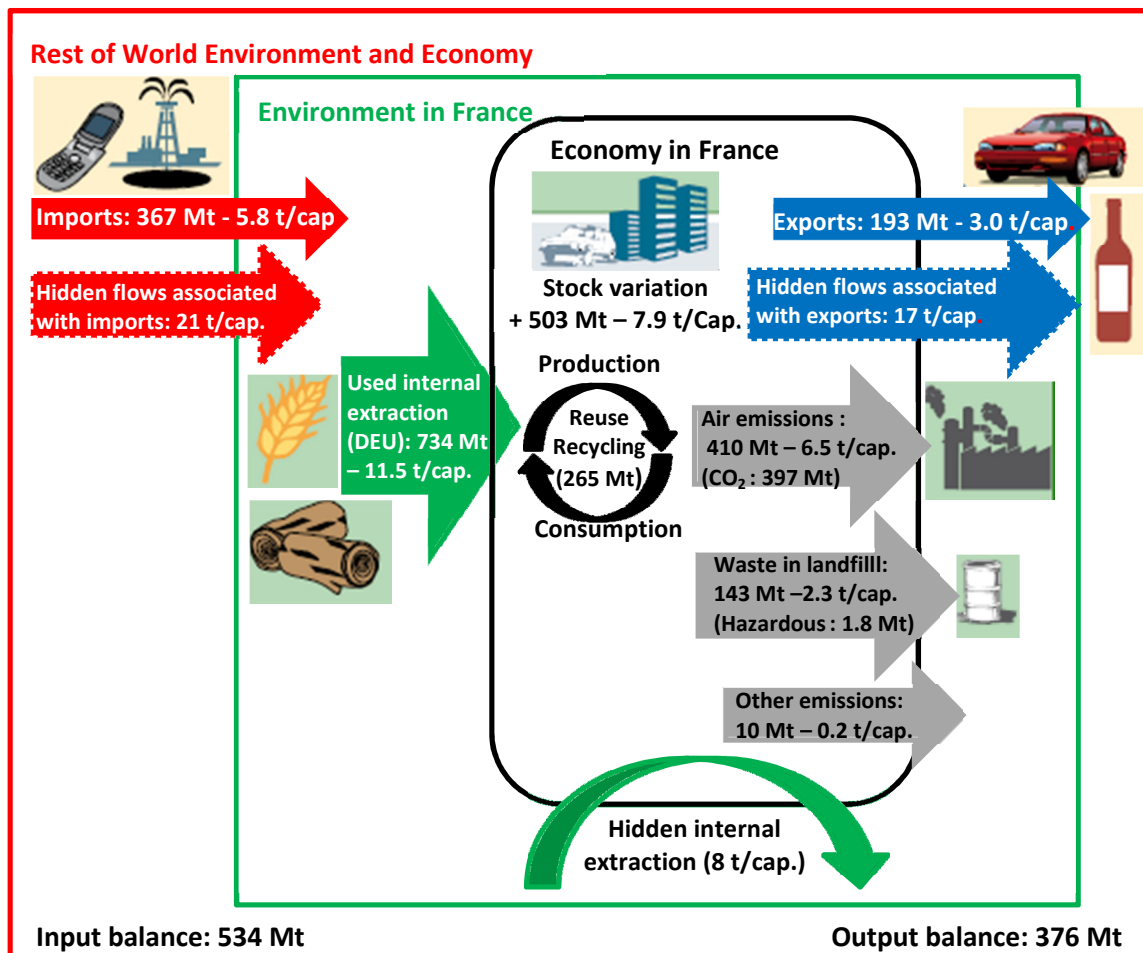

10  
 11 **N.B.:** Air and water as resources are not taken into account in the balance.

12 **Figure 16 : The material balance of the French economy in 2007 (Commission générale du**  
 13 **développement durable, 2010)**

14 It was found that the DMI is equal to 1101 Mt while the DMC is equal to 909 Mt. Similarly, the TMR is  
 15 found to be equal to 2936 Mt i.e. 2.7 times the DMI value while TMC is equal to 1 667 Mt, i.e. 1.8





1 is negative, then reaching sustainability may lead to a revision of the boundaries, underpinnings and  
2 goals of the current framework. The present section task is thus to make clear the boundaries and  
3 the underpinnings of the current framework, a necessary step to undertake a criticism of the current  
4 socio – economic framework from a sustainable viewpoint.

## 5 **2.1 Boundaries associated with current accounting systems**

6  
7 The current accounting system is usually divided into two categories: the system of national accounts  
8 (SNA) and the accounting framework of firms. This division is characteristic of a binary division of  
9 space between national and local, a policy driven area and a market driven area. This sub-section will  
10 thus study the boundaries of the two systems and state their differences as well as their similarities.

### 11 **2.1.1 The boundaries of national accounts**

12  
13 In the SNA, the actors of an Economy are labeled as “institutional units”. The defining characteristic  
14 of an institutional unit is that it is capable of owning goods and assets, incurring liabilities and  
15 engaging in economic activities and transactions with other units in its own right (European  
16 Commission, et al., 2009)(p.2). The national economy is made of all institutional units that have a  
17 center of interest in the economic territory<sup>15</sup>. For France, this economic territory consists of the  
18 metropolitan geographic territory, the national air space, territorial waters, deposits situated in  
19 international waters but exploited by resident units, the French overseas departments (French  
20 Guiana, Guadeloupe, Martinique, Réunion and Mayotte) but not the overseas territories (French  
21 Polynesia, Saint Pierre and Miquelon, Wallis and Futuna, St. Martin, St. Barthélemy, New Caledonia,  
22 French Southern and Antarctic lands, and Clipperton Island). Going further, an institutional unit is  
23 considered to have a center of interest in the territory when it realizes economic operation on this  
24 territory for at least a year. This means that nationality does not have any influence on the Economy.  
25 Indeed, a migrant worker in France belongs to the French national economy which is not the case of  
26 French people working abroad (European Commission, et al., 2009)(p.6). In this perspective, the  
27 number of French people who are living abroad amounts to 1.1 million<sup>16</sup> in 2002 against 3.7 million  
28 foreigners or 5.3 million migrants in 2008<sup>17</sup>, the difference between migrants and foreigners being  
29 linked to the French concept of nationality<sup>18</sup>.

30 Within the SNA, two main kinds of institutional units are distinguished: households and legal entities.  
31 Legal entities are either entities created for purposes of production, mainly corporations and non-  
32 profit institutions (NPIs), or are entities created by political institutions, specifically government  
33 units. Therefore, the institutional units are grouped into five mutually exclusive sectors: Non-financial  
34 corporations, financial corporations, government units including social security fund, NPIs serving  
35 households, and households (European Commission, et al., 2009)(p.2). The boundaries of the SNA is  
36 thus to be related to the space (French economic territory) and time (one year) framework chosen. It  
37 also has to be related to the way production, consumption and transactions are dealt within the SNA

---

<sup>15</sup> The national accounts use the term of “territory” but in social sciences this term covers another meaning as we will show later in this dissertation. The term of “geographical space” should thus be preferred.

<sup>16</sup> [http://www.insee.fr/fr/ffc/docs\\_ffc/ip919.pdf](http://www.insee.fr/fr/ffc/docs_ffc/ip919.pdf)

<sup>17</sup> [http://www.insee.fr/fr/themes/tableau.asp?reg\\_id=0&ref\\_id=NATTEF02162](http://www.insee.fr/fr/themes/tableau.asp?reg_id=0&ref_id=NATTEF02162)

<sup>18</sup> <http://www.insee.fr/fr/publics/communication/recensement/particuliers/doc/fiche-nationalites-immigration.pdf>

1 framework. Actually, according to SNA statisticians (European Commission, et al., 2009)(p.6-9), the  
 2 boundaries of the SNA concern six categories as described in **Table 3**. These boundary issues all deal  
 3 with the fact that monetary values and the functioning of market is at the center of the concern of  
 4 the SNA. This results in the tremendous shortcoming of reducing the human activities (A) into a  
 5 single dimension, the market one. Going further, the SNA bases the account of this single dimension  
 6 on the notion of transaction, i.e. the transfer of ownership between two different institutional units.  
 7 In this context, the formula behind human activities appears to be:

8 
$$A (\text{€}) = \text{Number of transactions per year (N)} * \text{Monetary value of the transaction (€)}^{19}$$

9 **Table 3 : the six boundary issues of the system of national accounts**

Boundary issue	Main description
Non – monetary transactions	<ul style="list-style-type: none"> <li>• Goods and services produced within the economy and sold in monetary transactions are valued at market price.</li> <li>• Goods bartered for other goods or service or provided free as transfers in kind needs to undertake a monetary estimate to enter the SNA framework.</li> <li>• The SNA statisticians suppose that it is possible to provide a value to non-monetary goods and services without any corruption of their nature.</li> </ul>
Production	<ul style="list-style-type: none"> <li>• Production is a physical process, carried out under the responsibility, control and management of an institutional unit, in which labour and assets are used to transform inputs of goods and services into outputs of other goods and services.</li> <li>• The production of other goods for own final use by households (construction of dwelling, production of foodstuffs and clothing, etc.), the production of housing services for own final consumption by owner occupiers, and the production of domestic and personal services for consumption within the same household (preparation of meals, care and training of children, cleaning, repairs, etc.) are not taken into account for two reasons. Firstly, there is a practical difficulty because estimating monetary values for the output of these activities also imply to assign values to the incomes generated by their production and to the consumption of the output. Secondly, SNA statisticians conclude that the inclusion of large non-monetary flows of this kind in the accounts together with monetary flows can obscure what is happening on markets and reduce the analytic usefulness of the data.</li> <li>• Natural processes may or may not be counted as production based on the notion that a productive activity must be carried out under the instigation, control and responsibility of some institutional units that exercises ownership rights over whatever is produced. For example, the natural growth of stocks of fish in the high seas not subject to international quotas is not counted as production because the process is not managed by any institutional unit and the fish do not belong to any institutional unit.</li> </ul>
Consumption	<ul style="list-style-type: none"> <li>• The consumption boundary, the one concerning goods and services included in household final consumption, is similarly governed by the production boundary. For example, these expenditures include the estimated values of the agricultural products consumed by households that they have produced themselves and also the values of the housing services consumed by owner occupiers, but not the values of “do-it-yourself” repairs and maintenance to vehicles or household durables, the cleaning of dwellings, the care and training of children, or similar domestic or personal services produced for own final consumption.</li> </ul>
Asset	<ul style="list-style-type: none"> <li>• Assets are entities that must be owned by some unit, or units, and from which economic benefits are derived by their owner(s) by holding or using them over a period of time.</li> <li>• Natural resources such as land, mineral deposit, fuel reserves, uncultivated forests or</li> </ul>

<sup>19</sup>  $A = \sum_{i=1}^N Tr_i$  in which  $Tr_i$  is the monetary value of transaction  $i$  and  $N$  the number of transactions made per year.

	other vegetation and wild animals are included in the balance sheet provided that institutional units are exercising effective ownership rights over them, that is, are actually in position to be able to benefit from them.
National boundaries	<ul style="list-style-type: none"> <li>The national accounts is interesting in the income or activities related to the resident activities rather than the geographical activities, such as those limited to French metropolitan territory for example.</li> </ul>
Final consumption, intermediate consumption and gross fixed capital formation	<ul style="list-style-type: none"> <li>Intermediate consumption consists of goods and services used up in the course of production within the accounting period, i.e. one year.</li> <li>Final consumption consists of goods and services used by individual households or the community to satisfy their own mean.</li> <li>The distinction between intermediate and gross capital formation is conceptually clear as it depends on whether the goods and services involved are completely used up in the accounting period of 1 year. Nevertheless, the borderline between consumption and gross fixed capital formation is not always easy to determine in practice especially in the case of non-tangible assets such as human capital (knowledge, skills, etc.).</li> </ul>

1  
2 The choices made by the statisticians of the SNA have important consequences. Firstly, applying the  
3 same rules to the non-monetary flows than those concerning monetary flows leads to a negation of  
4 the different social systems at stake especially if non –monetary flows are characterized by other  
5 dimensions than monetary units. Besides, if as asserted by statisticians, the SNA is designed to meet  
6 a wide range of analytical and policy needs, it is indeed troublesome that a huge part of human  
7 activities lying in non-monetary transactions and production for own use, taking place into the  
8 proximity of the household or other human relationships, are not taken into account in the SNA.  
9 Does it mean that for SNA statisticians these activities do not concern policy? Given the importance  
10 of these activities in the daily life of citizens, it seems quite doubtful. Secondly, quite ironically, the  
11 SNA statisticians state that though rainfall may be vital to the agricultural production of a country, it  
12 is not a process of production whose output can be included in the SNA. The boundaries of the SNA is  
13 thus in line with the idea that the Environment can be cut into pieces. If we agree with SNA  
14 statisticians that the location of the production boundary in the SNA is a compromise, but a  
15 deliberate one based on the belief that the present structure of the SNA takes into account the needs  
16 of most users, this gives a clear idea of the low understanding the users of SNA have of complex  
17 natural and social systems. One of these low understandings lies in the beliefs in almost total  
18 comprehensiveness of the SNA though we have already demonstrated the partial view of the SNA.  
19 Thirdly, the SNA through its definition of activity leads to a social stratification<sup>20</sup>. Indeed, labour force  
20 statistics define economically active persons as those engaged in productive activities as defined in  
21 the SNA. Therefore, this definition separates the population of a country into two distinct categories,  
22 the productive and the unproductive persons. This social stratification is totally assumed by the SNA  
23 statisticians. Indeed for them, if the production boundary were extended to include the production  
24 of personal and domestic services by members of households for their own final consumption, all  
25 persons engaged in such activities would become self-employed, making unemployment virtually  
26 impossible by definition. The idea that the notion of unemployment is something artificial does not  
27 come to their mind. On the contrary, this illustrates for them the need to confine the production

---

<sup>20</sup> Even if the SNA statisticians do not pretend that a productive person is superior to an unproductive person, from the moment the SNA defines wealth as only based on productive activities, it creates a discrepancy between these two categories. Indeed, as the two categories benefit from wealth, there is a sort of redistribution from productive person towards unproductive ones. A social stratification is created that subject unproductive persons towards productive ones. Charities towards unproductive ones or stigmatizations of those unproductive persons are examples of the consequences driven by the artificial bond created by the SNA.

1 boundary and other related statistical systems to market activities or fairly close substitutes for  
2 market activities. This justification is somewhat outrageous. Indeed, it is because SNA statisticians  
3 separate activities for own consumption from those based on market that unemployment is created  
4 since his definition is characterized by the absence of activities related to the market. The SNA thus  
5 deals with activities for own consumption and those based on market as if there were no links at all  
6 between them. However, very basically, one can note that the same person is leading productive and  
7 unproductive activities. Therefore, the allocation of time of the individual to the different activities  
8 already constitutes a basic link between these two types of activities. Any individual is thus struggling  
9 between the time dedicated to its unproductive but necessary activities and the time dedicated to its  
10 productive activities. Is not there some kind of schizophrenia? It would have been fairer for the SNA  
11 statisticians to only state that they took a bias on concentrating themselves in their accounting  
12 studies on the market activities or fairly close substitutes for market activities instead of trying to  
13 justify this choice by such a simple tautology as the one related to unemployment.

14 Indeed, it looks righter to say this is the balance between the desire for the accounts to be as  
15 comprehensive as possible and the need to prevent flows used for the analysis of market behaviour  
16 and disequilibria from being swamped by non-monetary values that is in question. In conclusion, the  
17 SNA is an accounting tool for the market and for policies related to it. Therefore, the key question is  
18 to know if the market has some political usefulness notably in regards to sustainability issues if cut  
19 from the rest of human activities

### 20 **2.1.2 The boundaries of firm accounts**

21

22 The aim of firm is to make profits, i.e. to drive money from the socio – economic environment of the  
23 firm to the bank accounts of the firm. Therefore, not surprisingly, the firm accountant has an  
24 important role in firms and acts as the recorder of the firm’s life with an only interest in money.  
25 Therefore, the accountant has a double obsession concerning money flows which is to record where  
26 the money comes from and where it goes (Boileau, 2003)(p.12). The first thing we can thus notice  
27 about firm accounts is their self – centered interest, together with the fact they cover the same time  
28 framework (1 year) than national accounts. Therefore, the boundaries of firm accounts are  
29 insensitive to any kind of geographical framework though the establishments of the firms are more  
30 or less always localized in space. Indeed, a firm can change its geographical space of activities  
31 without changing anything for the accountant such as in the case of delocalization or cross-countries  
32 supply chains, a characteristic of our globalized economy. This demonstrates the abstract pattern of  
33 the firm accounting system in regards to geographical aspects.

34 The main object of the firm accounting system is money. Therefore objects and persons do not get  
35 any interest except if they are related to money flows. But even in this case, the interest they receive  
36 is driven by money all other considerations (well-being of workers, quality of products) being  
37 ignored. Therefore, the firm accounting system and the system of national accounts put monetary  
38 transactions at the center of everything. In fact, there is a strong link between the firm accounting  
39 and the system of national accounts as the national accounts are based on an aggregation process of  
40 the firm accounts. Nevertheless, macroeconomic accounts can seldom be built up by simply  
41 aggregating the relevant microdata. Such is notably the case for gross capital formation since in  
42 microeconomic accounts depreciation is calculated based on tax policy leading to some adjustments

1 in the process of aggregation of microeconomic accounts. The inevitable consequence is to make the  
 2 resulting macrodata no longer equivalent to simple aggregations of microdata from which they are  
 3 derived<sup>21</sup>. Actually, considering macro-economic aspects of the economy which should establish the  
 4 political usefulness of such tax policies, it would constitute a tautology to base gross capital  
 5 formation on tax policies in national accounts. Therefore, national accounts' gross capital formation  
 6 is rather based on a convention with a fixed time framework for durable goods. The picture is of  
 7 course different for the firms which are dependent on the tax policies to make profits.

8 Considering the making of profits as the firm's goal and the given time framework of one year, we  
 9 can describe the activities of the firm quite basically with the following equation:

10 
$$\text{Profits (P) (€)} = \text{Number of transactions per year (N)} * \text{profits made per transaction (€)}$$

11 However, to make profits, the firm puts together production factors (matter, goods, work,  
 12 equipment, energy, information, and money) to make goods and services to sale. The aim is thus to  
 13 sell goods at a higher price than their costs to create an opportunity for the firm to survive, develop  
 14 and make wealthier its associates. This modifies our equation into two parts:

15 
$$\text{Profit (P) (€)} =$$
  
 16 
$$[\text{Number of input transactions per year (N)} * \text{price per input transaction (€}_i)] -$$
  
 17 
$$[\text{Number of output transactions per year (M)} * \text{cost per output transaction (€}_o)]^{22}$$

18 The boundaries of the firm accounting system are thus linked to the concept of monetary resources  
 19 and monetary uses made by the firms resulting from the exchanges made with other firms.  
 20 Consequently, at the level of the national accounting system, the firm accounting system is  
 21 characterized by its linearity with monetary inputs transformed into monetary outputs. In this  
 22 context, the accountant is very strict on the accounting of money flows going into the bank account  
 23 of the firm and the one leaving it. Consequently, any money going out the firm that cannot be  
 24 recovered is an expense while a stock corresponds to money that can be recovered. Therefore, this  
 25 distinction made by the accountant relies on the beliefs and intentions of the firm manager. For  
 26 example, let us consider a restaurant buying bananas therefore taking money from its capital to buy  
 27 it. We thus have a transaction of type ( $Tr_o$ ). The idea behind this purchase is to create a dessert  
 28 which will be sold on customers, i.e. that transactions of type ( $Tr_i$ ) are expected to take place. In this  
 29 case, the purchase of bananas should be considered as a stock. But if the dessert does not sell well or  
 30 if bananas go rotten before their actual use, the bananas should be considered as expenses. The  
 31 same goes for any means of production such as trucks or machinery. Indeed, unless they are sold,  
 32 any goods will rot finally resulting in an expense. Therefore, without the perspective of sales, i.e.  
 33 transfer of the goods against money, anything should be considered as an expense. The firm has thus  
 34 to struggle with the time constrain and the associated risk of seeing its stocks transformed into  
 35 expenses.

---

<sup>21</sup> This is even worse for households for which surveys are the main source of information.

<sup>22</sup>  $P = \sum_{i=1}^N Tr_{ii} - \sum_{i=1}^M Tr_{oi}$  in which  $Tr_{ii}$  is the price of transaction (e.g. sales)  $i$  and  $N$  the number of transactions bringing money into the firm bank account made per year ;  $Tr_{oi}$  is the cost of transaction (e.g. purchase of goods)  $i$  and  $M$  the number of transactions made per year taking money from the firm bank account.

1    Going further, in the context of expenses and stocks, money is linked to the objects rather than the  
2    persons through for example the distinction between raw materials, semi-finished products, finished  
3    products and means of production. Though the intention of the managers of the firm is important to  
4    make the difference between expenses and stocks, this intention is in fact related to the kind of  
5    activities initially chosen by the firm. For example, a farmer buying a truck to make its deliveries  
6    should consider the truck as a means of production thus an expense. On the other hand, the car  
7    dealer who bought the truck to truck producers should consider the truck as a finished product to be  
8    sold thus a stock. Nevertheless, what happens if after using for 5 years the truck the farmer sells it?  
9    As we recover some money, the expense should become a stock at the moment the farmer decides  
10    to sell it. Most of the time, the value of the used truck is supposed to be less than the new one so  
11    that the ratio of recovered value over initial value is inferior to 1. But in case of misinformation of the  
12    buyer or the change of market classification of the truck (from normal truck market sales to  
13    collection truck market sales for example), this ratio can be superior to 1. In the first case, the farmer  
14    recovers some money on a previous expense. In the second case, he makes benefits out of it.

15    I presented so far the boundaries of the two accounting systems. Based on this presentation, a first  
16    analysis can be made on the sustainability of the current accounting systems, i.e. the current  
17    representation of the economy. As we saw in 1 two perspectives must be taken into account to  
18    address sustainable issues. The first one is related to the definition of welfare and I demonstrated  
19    that the current accounting system deliberately excludes non-market driven activities. Therefore, the  
20    current accounting systems are sustainable at the only condition that market – based activities  
21    constitute the total framework of sustainability. Otherwise, one should admit the incompleteness of  
22    the current accounting systems. However, considering the three economic systems of human society  
23    as identified by (Kolm, 1984)(p.72), this incompleteness is indisputable. For (Kolm, 1984), an  
24    economic system is characterized by the use of only one type of transfer. Therefore, each of the  
25    vertexes of **Figure 17** represents an economic system ruled by only one kind of transfer. We thus  
26    differentiate the market sphere ruled by the notion of economic exchanges, the public sphere ruled  
27    by the notion of forced exchanges and the autonomous sphere ruled by the notion of gift and  
28    reciprocity (Buclet, 2011) (p.204-205). In this diagram, we can respectively represent by a point our  
29    two accounting systems based on the idea that each system of account gives different weight or  
30    importance to the different kind of transfer<sup>23</sup>. The firm accounting system thus appears very close to  
31    an exclusive market sphere with only some forced exchanges such as taxes and other law obligations.  
32    The system of national accounts is studying the same monetary flows than the system of firm  
33    accounts, therefore conferring a similar low score in regards to the autonomous sphere.  
34    Nevertheless, by taking an overhanging viewpoint on the market transfers, the SNA puts more  
35    interest on the forced exchanges and notably the redistribution process of the different taxes.  
36    Consequently, the SNA scores higher on the public sphere weight.

37    Dealing with the environmental aspects of sustainability, the boundaries of the current accounting  
38    systems have revealed that only a small part of natural resources were taken into account. For the  
39    SNA, we saw the importance of ownership right to include a natural process into the accounting  
40    framework. Therefore, the SNA is neglecting all the public goods, i.e. those on which no ownership

---

<sup>23</sup> Therefore if G is the point describing the accounting system; M, A, P respectively the points of Market sphere, Autonomous sphere, Public sphere and m, a, p respectively the weight given by the accounting system to M, A, P, we have:  $m\overrightarrow{GM} + a\overrightarrow{GA} + p\overrightarrow{GP} = \vec{0}$ .

1 rights are exercised such as air or rain. Similarly, natural resources on which no price can be  
 2 established are not taken into account. These boundaries are even more predominant in the firm  
 3 accounting system dealing with monetary flows (price issue) with a firm centered viewpoint  
 4 (ownership issue). The possibilities offered by the current accounting systems to reach  
 5 environmental sustainability are thus to put a price and an ownership right on every natural  
 6 processes and goods. Once again, the sustainability of the current accounting systems is  
 7 subordinated to a hypothesis of completeness in regards on the ability of the market world to  
 8 capture all natural processes. This study of the boundaries of accounting systems has allowed a first  
 9 understanding of the representation of production and consumption activities in the current socio-  
 10 economic framework. I demonstrated that within this framework, the sustainability is dependent on  
 11 the ability to drive any social and environmental characteristics of human life within the field of  
 12 market economy. The next sub-section will concentrate on the description of the circulation  
 13 processes within the firm and national accounting systems to complete our review of the  
 14 “production – consumption – circulation” system of goods associated with the current socio –  
 15 economic framework.

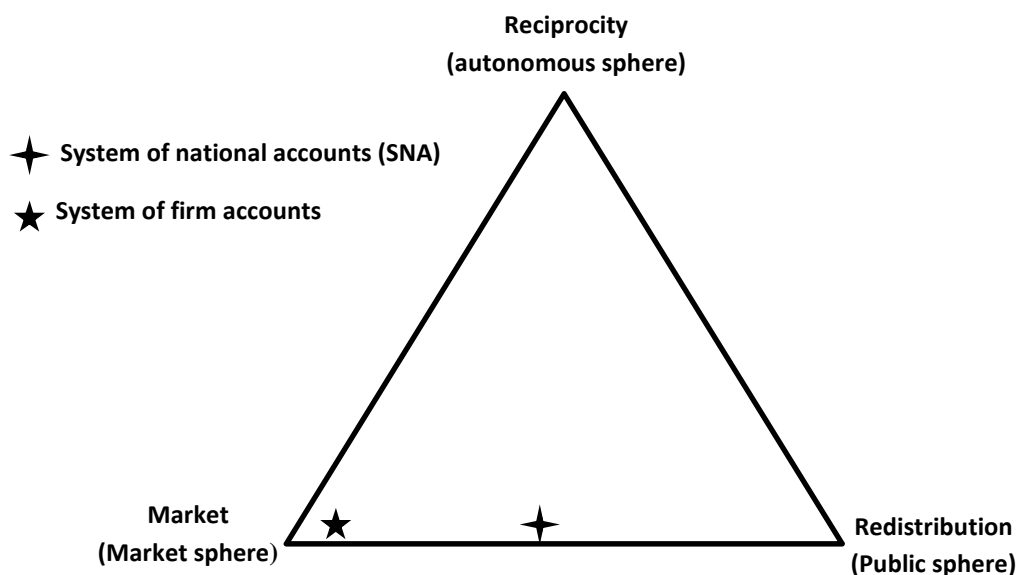

16

17 **Figure 17: the place of accounting systems in regards to the three economic systems**

18 **2.2 The circulation within accounting systems**

19

20 **2.2.1 The monetary circulation within the system of national accounts**

21

22 The object of the SNA is economic goods represented through their value. Therefore, it is important  
 23 to assess what economic goods are. According to INSEE, the economic goods form two distinct  
 24 categories:

- 25 • **Assets** are physical objects for which there is demand, on which property rights can be  
 26 established and the ownership of which can be transferred from one institutional unit to  
 27 another via transaction on markets. They are in demand because they meet the needs of

1 households or of the community, or to produce other assets or services. The production and  
2 exchange of assets are completely separate activities. Certain assets can never be exchanged,  
3 whereas others can be purchased and sold several times. The separation of the production of  
4 an asset from its subsequent sale or resale is an economically significant characteristic of an  
5 asset that is not shared by a service<sup>24</sup>.

- 6 • **Service** activity is essentially characterised by the act of making a technical or intellectual  
7 capacity available. In contrast to an industrial activity, it cannot be described solely by the  
8 characteristics of a tangible asset acquired by the client<sup>11</sup>.

9 In the INSEE framework, the notion of tangible asset refers to their materiality. Consequently, the  
10 notion of economic goods is divided by material and non – material goods framing a strategy for a  
11 dematerialization of the economy. Indeed, it is enough to transfer economic activities from the  
12 production of assets (material goods) to the production of services (non – material goods) to ensure  
13 a dematerialization of the Economy. This is further confirmed by the international structure of the  
14 economic nomenclatures<sup>25</sup> which constitute a complex system harmonized at the supra-national  
15 level through UN bodies<sup>26</sup> as shown in **Figure 18**. Indeed, while SH corresponds to a system of  
16 harmonized goods from which French statisticians have derived the statistical nomenclature of  
17 transport (NST), the Central Products Classification from which European product classification (CPA)  
18 and French product classification (CPF) are derived also include services, i.e. non – material goods.  
19 Such is the case of transportation which is included in (CPF) and not in the NST. In other terms,  
20 transportation is a service aiming at changing the space – time coordinates of the goods registered in  
21 the NST. The transportation sector is thus dependent on the existence of goods to move. Secondly,  
22 the transportation sector is also dependent on the existence of transportation materials (truck, train,  
23 ship, plane, etc.) and an energy carrier (electricity, gasoline, etc.). The example of transportation thus  
24 shows that the material intensity cannot be studied independently from the functioning of the rest of  
25 the economy. The activities of the economy are interdependent meaning that non – material  
26 products do not exist as they always depend to some extent on material goods. The  
27 dematerialization of the economy thus cannot be based on a simple substitution of assets into  
28 services but asks for the understanding of the system connecting assets and services.

---

<sup>24</sup> <http://www.insee.fr/en/methodes/default.asp?page=definitions/biens.htm>

<sup>25</sup> The international family of economic and social classifications is comprised of three major types: reference classifications, derived classifications and related classifications. Reference classifications are a product of international agreements approved by the United Nations Statistical Commission or another competent intergovernmental board, such as that of the International Labour Organization (ILO), the International Monetary Fund (IMF), the United Nations Educational, Scientific and Cultural Organization (UNESCO), World Health Organization (WHO) or the World Customs Organization (WCO) depending upon the subject of the matter area. The reference classifications have thus achieved broad acceptance and official agreement and are approved and recommended as guidelines for the preparation of classifications. Derived classification may be prepared either by adopting the reference classification structure and categories, and then possibly providing additional detail beyond that provided by the reference classification, or they may be prepared through rearrangement or aggregation of items from one or more reference classification. Derived classifications are often tailored for use at the national or multi-national level. Finally, related classifications are those that partially refer to reference classifications, or that are associated with the reference classification at specific levels of the structure only.

<sup>26</sup> <http://unstats.un.org/unsd/class/family/default.asp>



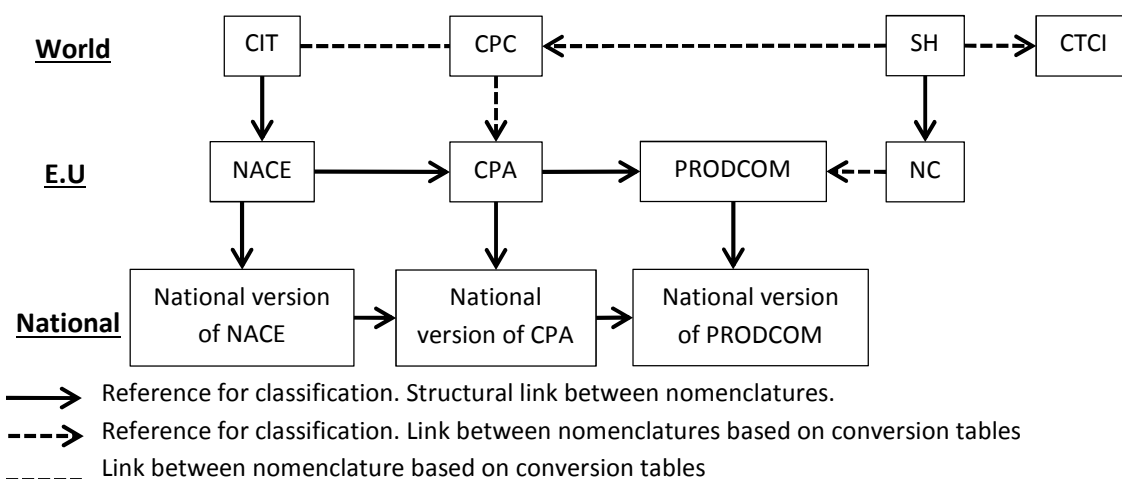

1

2 **Figure 18 : Relationships between nomenclatures**

3

4 **2.2.1.1 The product approach**

5

6 In the SNA, two approaches are generally used to describe the circulation process within the  
 7 economy: the product approach and the income approach. The approach by product is the first way  
 8 to establish a picture of the circulation of the economic goods. As a first requisite, it supposes to be  
 9 able to establish a nomenclature of products as shown in **Figure 18**. The nomenclature must be  
 10 universal, i.e. it must take into account all products, and unambiguous, i.e. that to each product  
 11 should correspond one heading (Piriou, 2008)(p.19). This unique correspondence is not always easy  
 12 to achieve. For example, shoes made in plastic could either correspond to “shoes” or to “products  
 13 from transformation of plastic materials” (Piriou, 2008) (p.19). The unambiguous character thus  
 14 relies on a set of explicit rules which influence the perception of the economic circulation of goods  
 15 since the objects exchanged are not anymore the initial products but the headings of the  
 16 nomenclature. The final structure with label or code of categories is used by economic actors to offer  
 17 a common set of actions (comparison of products and activities which helps the making of business  
 18 decisions) and by economists and other analysts to provide policy or business advice. In other terms,  
 19 the classifications of nomenclature constitute the support of economic life, making the daily  
 20 economic actions easier to make by removing the uncertainties due to the naming of products. The  
 21 purpose of economic nomenclatures are thus to accelerate the course of economic actions by  
 22 removing from daily worries questions such as the naming and grouping of products and by creating  
 23 a common set of knowledge for economic transactions. Consequently, the making of these  
 24 nomenclatures are often not questioned by economic actors and seldom by economic statisticians.

25 In addition to the nomenclature system, the product approach is based on a balance between  
 26 product resources and use all expressed in monetary units (Piriou, 2008)(p.11-32).

$$(resources) P + IM + MC + MT + IP - SP = CI + DC + FBCF + VS + EX (use)$$

27 P corresponds to the production of products at basic price, i.e. the effective revenue of the producer  
 28 by product. Indeed, when a product is sold, some part of the money earned by the company needs to  
 29 be redistributed via taxes on products (IP). These taxes on products can be fixed ones, i.e.  
 30 independent from the number of items produced, or variable ones the amount of which depending

1 on the number of items produced. Similarly, the company can also receive some subsidies on  
 2 products (SP). (IP) and (SP) correspond to the forced transfer described in **Figure 17**. The margin  
 3 applied by the company is included in the basic price. However, the national accounts distinguish two  
 4 special margins dedicated to the trade sector (retail, wholesale) or to the transportation sector. The  
 5 trade margin (MC) and (MT) are thus recorded negatively in the corresponding sectors (retail,  
 6 wholesale, transportation companies) but positively as a margin for other sectors (agricultural,  
 7 extraction and industrial companies). The products at purchaser price, i.e. what is paid by the  
 8 consumer, is thus the sum of all the previous costs ( $P_p = P + MC + MT + IP - SP$ ). The total of resources of  
 9 the national economy is thus made of the production at the purchaser price together with the  
 10 imports. The use side of the equation is characterized by intermediary consumption (CI), Final use  
 11 (DC), the formation of gross fixed capital (FBCF), the variation of stocks (VS) and exports (EX).

12 The previous equation can be rewritten in order to make appear the value added (VA) and the gross  
 13 domestic product (GDP)

$$P - CI + IM + IP - SP = DC + FBCF + VS + EX$$

$$VA + IM + IP - SP = DC + FBCF + VS + EX$$

$$GDP = DC + FBCF + VS + EX - IMP \quad \text{or} \quad GDP = VA + IP - SP$$

14 Value added corresponds to the difference between production and intermediary consumption. But  
 15 as shown in **Figure 19** value added corresponds to a sum across industries, meaning that value added  
 16 is first calculated at the scale of the industry. The GDP is thus the sum across industries of the value  
 17 added at purchaser price<sup>27</sup>. But the intermediary consumption can also be made at the product  
 18 level<sup>28</sup> so that GDP also corresponds to the value at market price of goods and services produced by  
 19 residential units for the purpose of final consumption. This index is thus very important and is taken  
 20 by national accounts as a referential for measuring the wealth of countries. Indeed, as a measure of  
 21 production value (value added expression of GDP) or as a measure of possible useful uses<sup>29</sup>, GDP  
 22 looks like a good measure of wealth. However, the GDP index suffers from some important  
 23 drawbacks in regards to environmental and social issues associated with the boundaries of the SNA  
 24 described before. However, in our viewpoint, the main problem with GDP is the belief in its  
 25 necessary growth. Indeed let us consider the initial economy made of two industries A and B, two  
 26 products 1 and 2 and for the purpose of simplification only final use (DC). We thus have  
 27  $GDP = VA^B + VA^A = DC_1 + DC_2$ . Our criticism lies in the fact this framework is based on monetary  
 28 accounts so that artificial increase can occur. For example, let us consider that the supply chain made  
 29 of two industries is enlarged to welcome a new industry C, then  $GDP = VA^B + VA^A + VA^C = DC_1 + DC_2$ .

<sup>27</sup> The value added (VA) is measured at basic price. The addition of taxes on products and subsidies on products leads to value added at purchaser price.

<sup>28</sup> **Figure 19** represents two industries – two products economy. The total intermediary consumption (IC) is simply the sum of all elements of matrices U. We can thus write  $IC = (U_{PAA}^{F,P} + U_{PCA}^{F,P}) + (U_{PAC}^{F,P} + U_{PCC}^{F,P})$  which corresponds to an industry vision of the economy or  $IC = (U_{PAA}^{F,P} + U_{PAC}^{F,P}) + (U_{PCA}^{F,P} + U_{PCC}^{F,P})$  which is a product vision of the economy.

<sup>29</sup> The notion of usefulness should be here understood as related to the final purpose of consumption. Intermediary consumption of goods and services thus corresponds to goods and services only necessary because they can allow through processes the making of final goods.

	Industries	Final demand				
Products	$U^{F,p} = \begin{pmatrix} U_{PAA}^{F,p} & U_{PAC}^{F,p} \\ U_{PCA}^{F,p} & U_{PCC}^{F,p} \end{pmatrix}$	$\begin{pmatrix} E_{PA}^{F,p} \\ E_{Pc}^{F,p} \end{pmatrix}$	$\begin{pmatrix} H_{PA}^{F,p} \\ H_{Pc}^{F,p} \end{pmatrix}$	$\begin{pmatrix} G_{PA}^{F,p} \\ G_{Pc}^{F,p} \end{pmatrix}$	$\begin{pmatrix} Cf_{PA}^{F,p} \\ Cf_{Pc}^{F,p} \end{pmatrix}$	$\begin{pmatrix} U_{PA,tot}^{F,p} \\ U_{Pc,tot}^{F,p} \end{pmatrix}$
		<b>Adj<sub>cif/fob</sub><sup>F,p</sup></b>				
			$r_G^{F,p}$			$r_G^{F,p}$
		$v_G^{F,p}$	$-v_G^{F,p}$			
	$\begin{pmatrix} U_A^{F,p} & U_C^{F,p} \end{pmatrix}$	$e^{F,p}$	$h^{F,p}$	$g^{F,p}$	$c^{F,p}$	$U_{tot}^{F,p}$
Value added	$\begin{pmatrix} W_A^{F,p} & W_C^{F,p} \end{pmatrix}$					
	$\begin{pmatrix} T_A^{F,p} & T_C^{F,p} \end{pmatrix}$					
	$\begin{pmatrix} C_A^{F,p} & C_C^{F,p} \end{pmatrix}$					
	$\begin{pmatrix} O_A^{F,p} & O_C^{F,p} \end{pmatrix}$					
	$\begin{pmatrix} v_A^{F,p} & v_C^{F,p} \end{pmatrix}$					

$U^{F,p} = \begin{pmatrix} U_{PAA}^{F,p} & U_{PAC}^{F,p} \\ U_{PCA}^{F,p} & U_{PCC}^{F,p} \end{pmatrix}$  = Use French table at purchaser's price

$E^{F,p} = \begin{pmatrix} E_{PA}^{F,p} \\ E_{Pc}^{F,p} \end{pmatrix}$  = Exports of products at purchaser's price

$H^{F,p} = \begin{pmatrix} H_{PA}^{F,p} \\ H_{Pc}^{F,p} \end{pmatrix}$  = Household consumption of products at purchaser's price

$G^{F,p} = \begin{pmatrix} G_{PA}^{F,p} \\ G_{Pc}^{F,p} \end{pmatrix}$  = Government consumption of products at purchaser's price

$Cf^{F,p} = \begin{pmatrix} Cf_{PA}^{F,p} \\ Cf_{Pc}^{F,p} \end{pmatrix}$  = Capital formation of French products at purchaser's price

$v_G^{F,p}$  = Direct purchases in France of non – resident (e.g Germans) at purchaser's price

$r_G^{F,p}$  = Direct purchases abroad (here in Germany) by French people at purchaser's price

$W^{F,p} = \begin{pmatrix} W_A^{F,p} & W_C^{F,p} \end{pmatrix}$  = Compensation of French employees at purchaser's price

$T^{F,p} = \begin{pmatrix} T_A^{F,p} & T_C^{F,p} \end{pmatrix}$  = Other taxes on products used by French industries at purchaser's price

$C^{F,p} = \begin{pmatrix} C_A^{F,p} & C_C^{F,p} \end{pmatrix}$  = Consumption of fixed capital of French industries at purchaser's price

$V^{F,p} = \begin{pmatrix} v_A^{F,p} & v_C^{F,p} \end{pmatrix}$  = Value added of French industries at purchaser's price

1

2 **Figure 19 : The product approach of the SNA**

1 In other terms, any increase in human activities implies an increase in the GDP and thus an increase  
 2 in the associated perception of wealth. Going further in our criticism, it is quite easy to demonstrate  
 3 that GDP can also increase artificially because of increase in prices. For example, if our two products  
 4 1 and 2 represent bread and water and if we consider two countries such as France (FR) and Somalia  
 5 (SO) where the prices are respectively in the ratio (br) and the ratio (wa)<sup>30</sup>, we have:

$$6 \quad \text{GDP}^{\text{FR}} = \text{DC}_1^{\text{FR}} + \text{DC}_2^{\text{FR}} = Q_1^{\text{FR}} * P_1^{\text{FR}} + Q_2^{\text{FR}} * P_2^{\text{FR}} = Q_1^{\text{FR}} * \text{br} * P_1^{\text{SO}} + Q_2^{\text{FR}} * (\text{wa}) * P_2^{\text{SO}}$$

$$7 \quad \text{GDP}^{\text{SO}} = \text{DC}_1^{\text{SO}} + \text{DC}_2^{\text{SO}} = Q_1^{\text{SO}} * P_1^{\text{SO}} + Q_2^{\text{SO}} * P_2^{\text{SO}}$$

$$8 \quad \text{GDP}^{\text{FR}} / \text{GDP}^{\text{SO}} = (Q_1^{\text{FR}} * \text{br} * P_1^{\text{SO}} + Q_2^{\text{FR}} * (\text{wa}) * P_2^{\text{SO}}) / (Q_1^{\text{SO}} * P_1^{\text{SO}} + Q_2^{\text{SO}} * P_2^{\text{SO}})$$

9 If we consider the real needs in bread and water to be almost the same for the two populations, we  
 10 can write  $Q_1^{\text{FR}} = Q_1^{\text{SO}} = Q_1$  and  $Q_2^{\text{FR}} = Q_2^{\text{SO}} = Q_2$  so that the ratio between the two GDPs is:

$$11 \quad \text{GDP}^{\text{FR}} / \text{GDP}^{\text{SO}} = (\text{br} + r * (\text{wa})) / (1+r) \text{ where } r = (P_1^{\text{SO}} * Q_1) / (P_2^{\text{SO}} * Q_2)$$

12 Of course, the equality in quantity is an oversimplification of reality but it does not withdraw  
 13 anything to the explanatory power of the previous framework. What we demonstrate with the  
 14 product approach is that GDP and the notion of wealth associated with it is misleading. Indeed, the  
 15 GDP appears to be relative to a national system of activities and pricing. There is thus no reason to  
 16 compare the GDP between countries to state such State is wealth or poor. The GDP framework is  
 17 thus relative to national borders and its absolute value has no meaning. A country with a GDP 50%  
 18 inferior to France may not be much poorer than France.<sup>31</sup> Secondly, the growth of GDP within  
 19 national borders can also be artificial due to the development of non – necessary activities. As these  
 20 activities may be associated with material consumption and discharges to the environment, it may  
 21 reveal important to identify these “useless” activities and understand how the current socio –  
 22 economic framework justifies their existence.

### 23 **2.2.1.2 The income approach**

24  
 25 We will now present the other approach provided by the national accounts: the income approach.  
 26 Unfortunately, the actor approach taken by the income view of the economy appears quite difficult  
 27 to link with the branch view and input-output table of the economy provided by the product  
 28 approach of the economy. This is a major drawback of the national accounting system as it condemns  
 29 us to dislocate the product from their associated actors and consequently makes it difficult to follow  
 30 the consequences on the economy of the making of decisions by economic actors (and thus their  
 31 responsibility). Nevertheless, as we will see in **2.2.2**, the income approach of the economy is closer to  
 32 the way the micro-accounting system is made than the product approach. However, the national  
 33 accounting system is not an accounting system such as the micro-accounting system but presents

<sup>30</sup> Of course, these ratios are superior to 1 as we consider Somalia on the denominator.

<sup>31</sup> Actually, this is true as long as the national economies remain closed. Once the borders of the lower GDP country opened to higher GDP countries, there is no other choice for the lower GDP country to try to catch up the GDP of higher countries because their goods are not accessible at the same price than within the lower GDP country. This rapid change can lead to a tremendous loss of wealth for the lower GDP country because the highest price of goods in the lower GDP country are cheap to purchase for the higher GDP countries. A spiral of poverty is thus opened with the opening of borders to higher GDP countries which can only be solved by a rapid catch up of the GDP level or a new closing of the economic such as strict import and export regulations.

1 information from many origins in an accounting framework (Piriou, 2008)(p.37). Therefore,  
2 information is lost in comparison to the micro-accounting systems as the national accounts are **not**  
3 the aggregation of the micro-accounts. The national accounts tend thus to favor the variation of  
4 balance (assets and liability) rather than the usual approach of resources and uses.

5 As said before, the national accounts distinguish non-financial corporations and financial  
6 corporations. In fact, the term “non-financial corporations” is not very correct as it could imply that  
7 these corporations do not deal with money flows. This is of course absurd as money is the only thing  
8 recorded by the accounting systems. Therefore, I advocate that the term “non-exclusively financial  
9 corporations” should be preferred. The income approach for all economic actors (non-financial and  
10 financial corporations, households, administrations, etc.) follows the pattern presented in **Figure 20**.  
11 It is made of seven accounts. The first one is the production accounts of which the outcome is the  
12 value added created by the institutional unit. This value added can be gross or net depending on the  
13 subtraction of the consumption of fixed capital, i.e. the subtraction of the value corresponding to the  
14 depreciation of goods. The exploitation accounts distribute the value added created by the  
15 institutional units to the States through other taxes on production and subsidies and to the workers  
16 through the payment of wages. Finally, the outcome of the exploitation accounts is the operating  
17 surplus (EBE) that constitutes the main income for corporations while the main income for  
18 households is made of the wages earned thanks to their workforce. The third type of accounts  
19 consists in the listing of the other sources of incomes and in the construction of the associated  
20 balance. For the non-financial corporations, these other sources of incomes come from the interest  
21 associated with the money lent to others or those associated with the financial (stock, bonds) and  
22 the non-produced tangible assets<sup>32</sup> (land rent). Symmetrically, the non-financial corporations may  
23 have to reimburse loans they made and have to pay back their shareholders. Dividends play thus a  
24 key role in this account of distribution of primary income. For households, the income also comes  
25 from interests, life insurance and other income linked to assets (land). Finally, this distribution  
26 account of primary revenue leads to the formation of the balance of gross primary income (SPRB). A  
27 secondary distribution takes place which mainly consists in the taxes on revenue. This diminishes the  
28 SPRB up to the gross disposable income (RDB). For households however, social-security benefits  
29 coming from public administration increase the available accounts. The gross disposable income can  
30 also be understood as the gross savings of the company (EB). This EB is what is left for the investment  
31 of legal entities. In fact, part of this EB should be used to pay for the consumption of fixed capital and  
32 only the remaining can be used for new investments. What remains is usually called financial capacity  
33 (CF). This is the balance of the capital accounts. This financial capacity may sometimes be negative.  
34 This means that the corresponding legal entity had to create debts towards another economic actor  
35 to make new investments and pay for its capital depreciation. This is why the financial accounts  
36 expressed through the variation of assets and liabilities are important. Indeed, they allow a direct  
37 vision of the variation of debts and receivables and the financial balance (SF) depending on it sign  
38 provide information on the health of the company.

---

<sup>32</sup> Land is not produced by anyone. On the opposite, the real estates or factories are produced by someone so that the associated rent enters in the production accounts.

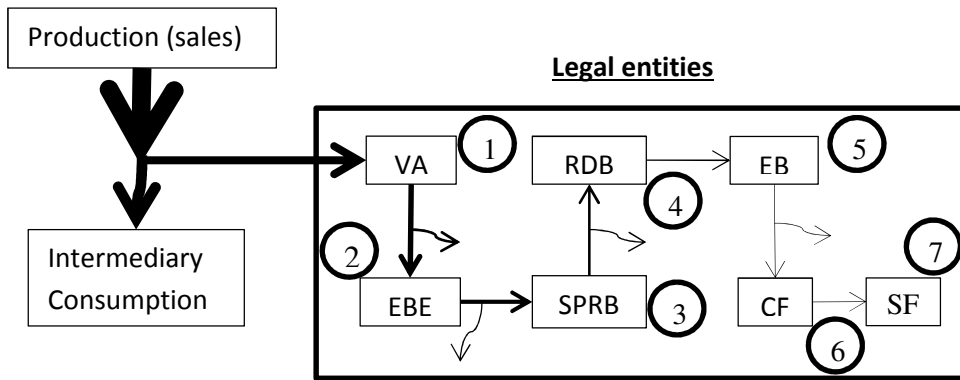

1

2 **Legend**<sup>33</sup>: VA: Value Added, EBE: Gross operating surplus, SPRB: Balance of gross primary income, RDB: Gross disposable  
3 income; EB: Gross savings; CF: Financing capacity; SF: Financial balance

4 **Figure 20: The decomposition of resources through current and financial accounts with main**  
5 **results.**

6

7 The results presented in **Figure 20** allow for the determination of important ratios for the  
8 management of non-financial corporations and other institutional units. Firstly, the variation of the  
9 value added can be analyzed providing a direct vision of the wealth created by production<sup>34</sup>.  
10 Secondly, the margin rate (EBE/VA) corresponds to what remains to the company after paying the  
11 direct cost of the production (such as wages). This is an economic indicator for non-financial  
12 corporations but not necessarily for the national economy. Indeed, the capacity to provide high  
13 salaries is often not considered as a performance indicator by non-financial corporations while it is  
14 important for the formation of the GDP<sup>35</sup>. Thirdly, the saving rate (EB/VA) corresponds to the amount  
15 of money remaining for the non-financial corporations. Finally, investment ratio (EB/CF) and the  
16 self-financing ratio (EB/FBCF) provide also interesting features for the analysis of non-financial  
17 corporations. Of course, all money transactions can be analyzed individually thus creating  
18 possibilities for new ratios. This diversity of ratios means that profitability and the accumulation of  
19 wealth are notions the measure of which depends on the analysts' choices (Piriou, 2008)(p.44). These  
20 choices should thus be clearly stated and explained. Unfortunately, this is rarely the case.

21 The financial operations are key factors in the accounting systems. This is because debts allow not  
22 only the institutional units to create more resources but help them in the space-time management of  
23 their money flows. Therefore, it is not surprising that financial flows are classified according to their  
24 liquidity character. Liquidity of an asset corresponds to its capacity to be converted immediately into  
25 means of payment, without additional cost and at a value that can be determined without  
26 uncertainty<sup>36</sup>. Because of their ability to increase the resources available at a given time by referring

<sup>33</sup> In French, VA: Valeur ajoutée, EBE: Excédent brut d'exploitation, SPRB: Solde des revenus primaires, RDB : Revenu disponible brut, EB : épargne brute ; CF : capacité de financement, SF : Solde Financier.

<sup>34</sup> For memory, only the net value added, i.e. with the withdrawing on the amount of money corresponding to the depreciation of fixed assets, can be considered as the creation of wealth by production.

<sup>35</sup> GDP can also be considered as the sum of the salaries, gross operating surplus and taxes on production and imports minus subsidies on production

<sup>36</sup> The hierarchy between financial operations based on this liquidity differentiation is thus the following: 1) monetary gold and special drawing rights, 2) money deposit, 3) securities except share equity, 4) credit, 5) share equity and undertaking for collective investment in transferable securities (UCIYTS), 6) Insurance technical

1 to values that do not already exist but are supposed to be created in the future, the financial  
2 operations have become more and more complex and important in the today's world economy. The  
3 limits that once were given by space have been extended through the dimension of time. Debts and  
4 credit may have become more important in the daily life of institutional units than the creation of  
5 value through tangible trade transactions. This extension of activities in time and in future seems to  
6 go completely against the principle of sustainable development which states the needs of the  
7 present should be met without compromising the ability of future generations to meet their own  
8 needs (World Commission on Environment and Development, 1987). Indeed, the system of debt and  
9 future expectations looks like an extension of the present time framework, bringing the future into  
10 the present. No existence is given to the future except if this future is seen as perfectly predictable  
11 from the present choices of economic actors.

12 In summary, the national accounting system is coherent but only because it leaves out of its scope  
13 everything that could matter: non – monetary transactions, material and social combination of goods  
14 and services, differentiation between future and present, etc. Besides, even its limits are not fully  
15 understood if we consider the invading communications from media, politicians, economic institution  
16 dealing with GDP growth and comparison between countries of GDP. Indeed, we showed the GDP  
17 approach and its link to wealth need to be tested with knowledge outside its bounds. After all, the  
18 SNA is only an accounting framework to assess market transactions and redistribution process within  
19 a society. It cannot replace policy actions and the associated choice of society by automatic  
20 machinery defining both the goals and the means of welfare achievement.

### 21 **2.2.2 The monetary circulation within the system of firm accounts**

22  
23 As we stated before, the system of firm accounts is close to the approach income of the SNA.  
24 Therefore, the same criticism can be addressed to this system in regards to the place given to the  
25 extension of outlets through time. However, what is interesting with the micro – economic level of  
26 the system of firm accounts is the link with capitalism. Indeed, until now, our criticism and  
27 explanation of accounts mainly concerned the market economy but did not address capitalism, i.e.  
28 the social link created through the apparition of salaried employment (Orléan, 2011)(p.23). In fact,  
29 the story of firms always starts with money brought by the firm's creators to the firm accounts. This  
30 initial money source is called the capital. Interestingly, it should be noted that the origin of this  
31 money is not questioned by the accountant, and it therefore seems that the capital brought by

---

reserves and 7) other accounts to receive or pay. The hierarchy of these financial operations can be understood through the time and property aspects. Indeed, the first financial operations deal with the creation of currencies while the second one corresponds to the currencies exchange itself. Currencies such as coins have the property to be tangible assets the presence of which is necessary for the exchange to take place. The moment of exchange of the currencies can thus not be dissociated from the moment of exchange of the corresponding values, these values being written conventionally on the coin. The securities contrary to share equities does not correspond to the owning of part of the company. It is just the way for the company to obtain more resources by creating some short-term or long-term debts towards the owners of the securities. The fourth financial operation corresponds to the usual pattern of debt and credits while the fifth one corresponds to the owning of assets related to real estate for example or shares of the non-financial corporation. The sixth financial operation is dealing with the concept of insurance which supposes a link with the future (insurance on what will happen with the future) and is thus related to particular events which will imply a valuation (life insurance, damage insurance). Finally, the seventh financial operation corresponds to supplier and customer credit and all the other operations that correspond to a delay between the reality of operations and the date of payment.

1 associates is the *deus ex-machina* allowing firm activities to exist. Therefore, the capital is similar to a  
 2 debt of the firms to the associates (Boileau, 2003) (p.11).

3 The story of firms start thus with a debt which can only be recovered by entering a cycle of activity as  
 4 described in **Table 4**. Initially, the associates put a capital of 500 euros (resource) to the bank  
 5 account of the firm (use). The associates to start their company have to pay for a real estate and they  
 6 rent it for 180 euros. These 180 euros have to be paid immediately and cannot be recovered. The  
 7 money is taken from the bank (resources) to go to the rent (use). If there are employees, wages (120  
 8 euros) must be paid. The issue here is that you can either pay these wages before the work is done or  
 9 after. In each of this case, a debt is created. Indeed, in the first case, the employees have a debt  
 10 towards the employer which they reimburse by working while in the second case the employer has a  
 11 debt towards the employees which corresponds to the wages. However, the nature of debt is  
 12 different thus creating an asymmetry in the employee-employer relationship. Clearly, as work is not  
 13 accounted in the firm accounts which are only interested in money, the employer receives an  
 14 incentive to pay the employees at the end of the working period. This way, the firm can virtually  
 15 increase its resources for a short amount of time. This is the viewpoint we take into account in **Table**  
 16 **4** by putting the available resource for the purchase of materials to 320 euros (500-180) and not 200  
 17 euros (500-180-120). Then, even with a margin rate of 60%, **Table 4** shows that the firm will not  
 18 survive over 3 cycles. Indeed, according to INSEE<sup>37</sup>, the survival rate at 3 years of firms in France is  
 19 around 66% meaning that one third of the firms shut down during their first 3 years of activities.

20 **Table 4: Evolution of firm cycles (margin: 60 %, 93.75 %, and 100 %)**

	Cycle 0			Cycle 1			Cycle 2			Cycle 3		
<b>Bank initially</b>	500	500	500	392	500	520	219	500	560	-57	500	640
<b>Rent</b>	180	180	180	180	180	180	180	180	180	180	180	180
<b>Result</b>	320	320	320	212	320	340	39.2	320	380	X	320	460
<b>Buy goods</b>	0	0	0	0	0	0	0	0	0	0	0	0
<b>Sell goods</b>	512	620	640	339	620	680	63	620	760	X	620	920
<b>Pay wages</b>	120	120	120	120	120	120	120	120	120	120	120	120

21  
 22 The company only earns money during the sales. The engine of the firm accounting system is thus  
 23 the benefits made through the margin on sales and the number of sales. However, these figures are  
 24 conditioned by several external and internal factors: the acceptance of the company's products by  
 25 the market, the internal profitability and production organization of the company, the relationships  
 26 with the suppliers notably in terms of supplier credits. Indeed, if we consider the supplier credit, the  
 27 average stock duration and the customer credit, the company may get into troubles from a solvency  
 28 perspective if the sum of the average stock duration and the customer credits exceeds largely those  
 29 allowed by the supplier credit. To cover the absence of immediate cash flow, the working capital  
 30 requirement will have to be quite enormous and probably some loans to the bank will have to be  
 31 made. Therefore, the cash management as shown in **Figure 21** is the pillar of the company as it is the  
 32 only element from a law viewpoint that can induce the bankruptcy of a company. This management  
 33 is based as for the income approach of the SNA on different ratios. Some of them are presented in  
 34 **Table 5**.

<sup>37</sup> [http://www.insee.fr/fr/themes/tableau.asp?reg\\_id=99&ref\\_id=t\\_3003R](http://www.insee.fr/fr/themes/tableau.asp?reg_id=99&ref_id=t_3003R)



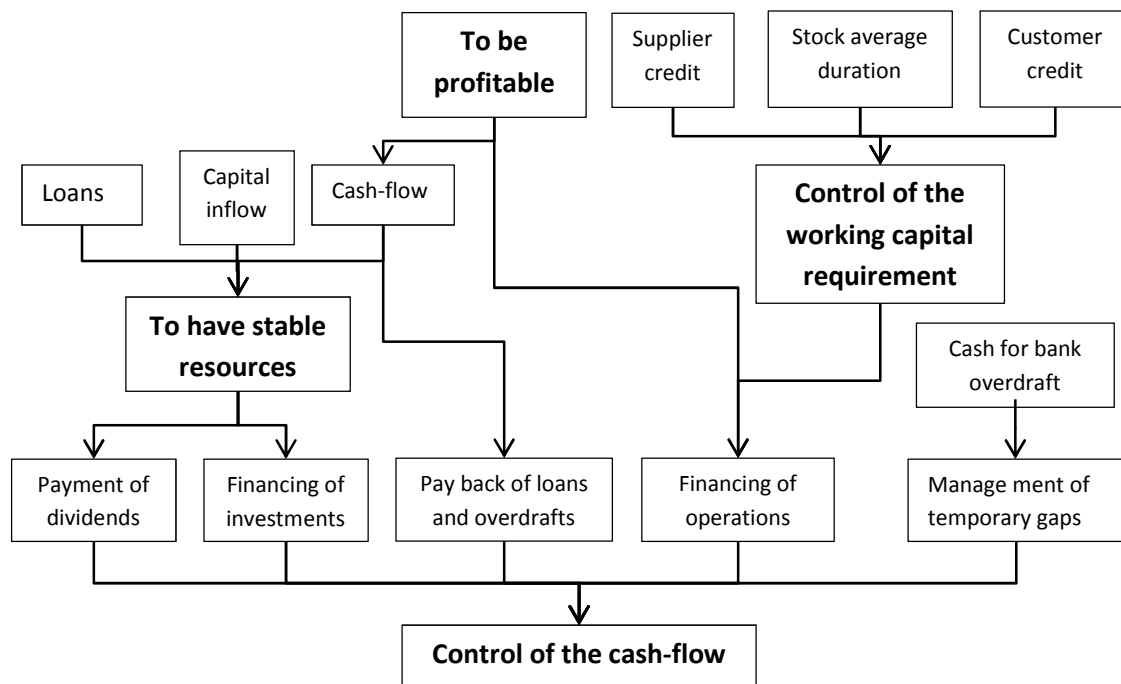

1

2 **Figure 21 : The cash-flow engine**

3 **Table 5 : Financial analysis through 12 ratios (Gérard Boileau, Comprendre les comptes d'une**  
 4 **entreprise, p.137-172)**

Ratio	Description of ratios	Calculation rules and other rules
1	Gross margin/sales	$(\text{sales}-\text{purchase}+/-\text{stock variation})/\text{sales}*100$
2	Financial expense/sales	$(\text{financial expenses})/\text{sales}*100$
3	Current statement/common equity	$\text{Current statement}/\text{common equity}*100$
4	Stock in days	$\text{Stock in balance sheet}/(\text{purchase}+/-\text{stock variation})*360$
5	Customer credit in days	$(\text{customer credit in balance sheet}+\text{discounted bills})/\text{sales including taxes}*360$
6	Supplier credit in days	$(\text{supplier credit in balance sheet})/(\text{purchase}+\text{external expenses including taxes})*360$
7	Debts and cash-flow	$\text{Middle and long term debts}<3*\text{Cash-flow}$
8	Debts and common equity	$\text{Middle and long term debts}<\text{common equity}$
9	$(\text{receivables}+ \text{liquid assets})/\text{short-term debt}$	Must be >100%
10	Total financial debt/owner's finance	Must be <50%
11	Permanent financing/fixed asset	Must be >100%
12	Hedging on invested equities	The invested equities should be financed at least at the level of 80% by stable resources

5

6 The growth of the company can be easily measured by a comparison through the years of the  
 7 number of sales but the benefits for the company are better expressed by the ratio 1 of **Table 5**.  
 8 Indeed, margins are the main sources of profits for the economy and participate to the profitability  
 9 of the company. Ratio 2 and ratio 3 of **Table 5** complete the characteristics of the profitability by  
 10 providing a vision of the expenses (ratio 2) and the difference between these expenses and the  
 11 profits made by sales (ratio 3). The ratio 4, 5 and 6 helps to define the short-term debts created by  
 12 the company by not paying immediately for the purchased goods or not being paid immediately for  
 13 the goods and services it provides. As said before, cash flow in the short term will thus be highly

1 dependent on the difference ratio 5 + ratio 4 – ratio 6. Furthermore, the ratio 4 is also important as it  
2 provides an indication on the speed of the exploitation cycle of the company. The lower this ratio 4 is  
3 the faster is the exploitation cycle of the company. On the opposite, if ratio 4 is high, it takes some  
4 time for the company to get back its invested money. Therefore, there is a high probability that the  
5 companies corresponding to a high ratio 4 are dependent on high margin (high ratio 1), i.e. expensive  
6 products. The other ratios from ratio 7 to ratio 12 are related to investments and middle and long  
7 term debts. Though this part of the accounting system does not induce risks on the cash-flow in the  
8 short term, it constitutes an important part of the company's health. Indeed, financial debts imply  
9 interest rates that constitute expenses for the company. Similarly, the investments on machinery and  
10 other long-term goods dedicated to support the future activity of the company constitute expenses  
11 for the company appreciated through for example the depreciation rate of the fixed assets.  
12 Consequently, the speed in investments and in the making of financial debts must be managed  
13 together with the overall concept of speed in the exploitation cycle of the company. Such  
14 management (choice of actions and speed of actions) is of the responsibility of the chief executives  
15 of the company.

16 The circulation of money within the firm is thus cyclical and based on debts considered as necessary  
17 to make investments (intermediary goods, capital assets, etc.). The cycle can restart only if the  
18 money created allows the purchase of new goods and the making of new investments. The creation  
19 of money at the sales point can thus either come from an increase of margin or an acceleration of  
20 the cycle described above. The difference between the two strategies is related to the behaviour of  
21 other market players. Indeed, different companies can compete on the market and a high margin can  
22 thus reveal to be penalizing preventing the sales of product. Besides, it is well known than a strict  
23 application of a perfect competitive system drives profits for companies down to zero. On the other  
24 hand, when it comes to the acceleration of the firm cycles, all market actors benefit from it as new  
25 opportunities for profits are created.

26 The monetary circulation within the system of firm accounts is thus linked to the management of the  
27 monetary circulation speed within the firm and the capacity of concentrating money to make  
28 investments. This is why the financial system has become so important in our modern society. It also  
29 explains the never solved issue concerning the repartition of wealth created in the capitalist system.  
30 Actually, the benefits made through firm activities have to be distributed among the direct  
31 stakeholders of the company, i.e. for the work that has been accomplished by employees and  
32 managers, the investments that has been made and the operating surplus that has been created to  
33 sustain the future life of the firm or pay debts and taxes. But as the capitalist system needs a  
34 concentration<sup>38</sup> of money to work, the distribution of wealth can never wander too far from the  
35 initial state of concentration. In other terms, the capitalist system as shown by the firm accounting  
36 system is ruled by the ability of money concentration from the socio – economic environment.

37 I presented in this section the principles of the monetary circulation within the two accounting  
38 systems. Firstly, I showed the importance of the nomenclature system to establish a connection

---

<sup>38</sup> Most of the time, the initial state of money concentration is a result of History. In other terms, those who were born rich remain rich and those who were born poor remain poor. Nevertheless, the financial system by allowing the poor to concentrate money by themselves and undertake activities can help bring more equality in the share of monetary resources. This is notably the role of micro – credit of which description can be found in (Sery, 2012), (Bellahcene, et al., 2006), (Guérin, et al., 2009) and (Guérin, et al., 2009).

1 between the material world (assets, services) and the monetary world. This was made through the  
 2 product approach of the system of national accounts which translates the mass balance equation, a  
 3 characteristics of physical systems, into a monetary balance equation through a resource/use  
 4 framework. This process is made by the projection of physical resources and uses into the monetary  
 5 network through price. Therefore, the physical balance is translated into a monetary balance at the  
 6 condition that a price could be settled on assets and services. I advocate the implicit hypothesis  
 7 behind this process is related to the completeness issue discussed about the boundaries of the  
 8 accounting systems. Indeed, the mass balance in physics can cover both goods having a price and  
 9 goods not having a price. Therefore, the monetary balance for a particular good is only a subsystem  
 10 of the mass balance of this product which is ruled by physics. However, the monetary unit common  
 11 to all these subsystems allows the aggregation the different products into one monetary network for  
 12 which the balance leads to the calculation of gross domestic product or gross national income used in  
 13 the Human Development Index. The current pattern of social sustainability is thus dependent on a  
 14 reduction of the physical world to a monetary network established through an incomplete process of  
 15 nomenclature.

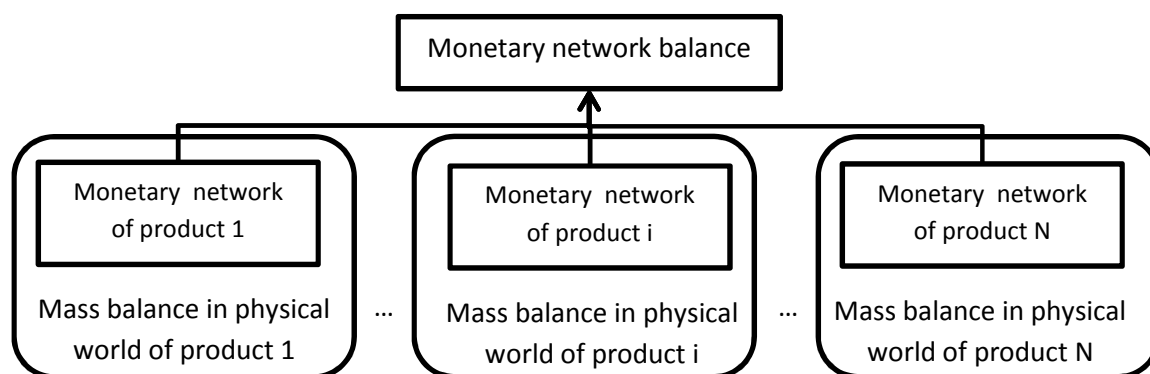

16  
 17 **Figure 22 : Link between monetary and physical network through the nomenclature system**

18 The second characteristics of the monetary circulation I showed in this subsection is the importance  
 19 of the role of nodes, namely firms for micro-accounts and institutional units for the system of  
 20 national accounts. Indeed, the nodes are characterized by their financial balance, i.e. the  
 21 relationships between their monetary inputs (profits) and their monetary output (expense). On this  
 22 aspect, the nodes, e.g. a firm, aim to drive as much money as possible from the other nodes framing  
 23 the flows of the monetary network. The monetary network is thus dependent on space only through  
 24 the belonging of firms or institutional units to a particular geographical area. If the nodes are not  
 25 localized such as it is the case for global industrial groups, distinction between geographical areas  
 26 may not be considered as an important factor to characterize the monetary network. The issue of  
 27 time is different as shown by the expectations on profits, the problem of investment and the  
 28 importance of debt management for the center of profits (nodes) of the monetary network. Each  
 29 node is thus trying to accelerate the time for its monetary inputs and to slow the time for its  
 30 monetary output. The next section is providing a critical review of the economic theories justifying  
 31 the current representation of boundaries and circulation processes described so far.

# 3 The justification and associated criticism of the representation of human activities in the current socio-economic system

## 3.1 The theories of value

The previous section has shown that the accounting system was ruled by money flows. We also saw that process of money concentration was needed for the system to operate together with a cyclical system in which the creation of profits acts as a motor engine. One of the core justifications of the current economic – system thus seems to be related to the capacity of money flows to capture the value of all material objects and the associated social interactions. To understand how this is possible, we will take a theoretical perspective to see how the economic theory deals with the concept of value. This theoretical perspective is first of all an historical one because we can differentiate two concepts of values which succeeded each other in the last three centuries. From an historical perspective, this means we have to identify two major breakpoints, the one which occurred in the beginning of the 18<sup>th</sup> century and the one which occurred mainly in the second part of the 19<sup>th</sup> century and gave birth to a concept of economic value that we can consider as dominant in today's world. To understand the first breakpoint, we will refer to authors such as Adams Smith (1723 – 1790), David Ricardo (1772 – 1823) and Karl Marx (1818 – 1883). These authors constitute what is usually called the classical economy. The second breakpoint or the neoclassical approach will on the opposite be studied through the work of Leon Walras (1834 – 1910).

So what did happen in the beginning of the 18<sup>th</sup> century which could justify a change in the way human activities are made or perceived? The answer is quantitative science and individual methodology. Indeed, after Descartes (1596 -1650) devotes himself to demonstrate that the world is one with only one scientific methodology based on mechanical principles (Denis, 2012) (p.142), we observe the development of a naturalization of the world, with laws that are eternal with predictive power. Kepler's laws (1571 – 1630) , the discovery by Edmond Halley (1656 – 1742) that the celestial body appeared in 1531, 1607 and 1682 is the same celestial body<sup>39</sup>, the discovery of Neptune by John Couch Adams (1819 – 1892) in 1843 and Urbain Le Verrier (1811 – 1877) in 1846 have all in common the prediction through calculation. The 18<sup>th</sup> century is also characterized by the development of new technologies<sup>40</sup> and the development of quantitative methodology in chemistry. This quantitative

---

<sup>39</sup> This celestial body is the Halley comet appearing every 76 years.

<sup>40</sup> The first commercial steam-powered device was a water pump, developed in 1698 by Thomas Savery. Small engines were effective though larger models were problematic. Nevertheless, it was used in mines, pumping stations and for supplying water wheels used to power textile machinery and its attractive feature was its low cost. It continued to be manufactured until the late 18th century (Landes, 1969) and one engine was still known to be operating in 1820 (Jenkins, 1936). The first commercially successful true engine was the atmospheric engine, invented by Thomas Newcomen around 1712 (Brown, 1991) which made use of technologies discovered by Savery and Papin. Newcomen's engine was relatively inefficient, and in most cases was used for pumping water. It was employed for draining mine workings at depths hitherto impossible, and also for providing a reusable water supply for driving waterwheels at factories sited away from a suitable "head". The next major step occurred when James Watt developed (1763–1775) an improved version of Newcomen's engine, with a separate condenser. Boulton and Watt's early engines used half as much coal as the Smeaton improved version of Newcomen's machine (Hunter, et al., 1991). Watt proceeded to develop his engine further, modifying it to provide a rotary motion suitable for driving factory machinery. This enabled factories to be sited away from rivers, and further accelerated the pace of the Industrial Revolution.

1 methodology is characterized by the conservation of mass and the development of atomic theory in  
2 1808 by John Dalton. The atomic theory is characterized by the five following rules (McQuarrie, et al.,  
3 1992)(p.36):

- 4 1) Every element is made of very small particles, indivisibles called atoms.
- 5 2) The atoms of a given element have all the same mass and are strictly identical, chemical  
6 behaviour included.
- 7 3) The atoms of different elements are differentiated through their mass and their chemical  
8 behaviour.
- 9 4) Chemical compounds are made of two or several atoms linked differently one with the  
10 others. The result of this combination is called a molecule but the atoms of a molecule are  
11 not necessarily different. If they are identical, the molecule is the element one. If they are  
12 different, the molecule represents a chemical compound.
- 13 5) During a chemical reaction, the atoms of the molecules in interactions are reorganized: they  
14 are rearranged, separated or recombined in such way that they form different molecules.  
15 The atoms are neither created nor destroyed and they do not undergo any change during the  
16 chemical reaction.

17 Following the previous description of the birth of the scientific methodology, the success of the  
18 mechanical science and the atomic theory, we better understand the purpose of the theory of value.  
19 Indeed, the theory of value consists in finding what constitutes the atoms of the social and economic  
20 relationships. Then, by applying the same principles than those existing in quantitative sciences, we  
21 could find economic laws with a similar prediction capacity than those existing in mechanical  
22 sciences of what the future of society will be. The first task of economists is thus to reveal the hidden  
23 unit which exists beforehand in all the monetary exchanges made daily by individuals (Orléan,  
24 2011)(p.24). Our three historical periods can thus be understood as two major breakpoints. The first  
25 one is the giving up of the usual political philosophy analytical framework of society to take the  
26 quantitative framework of natural science. This gives birth to a first concept of the “atom” of human  
27 relationship: work. The second breakpoint consists in a change of the “atom” by neoclassicists which  
28 prefer the concept of “utility” to the one of “work”.

29 The classical economists’ theory of value is based on work and is characterized by a focus on the  
30 exchange value. As stated by Adam Smith<sup>41</sup>, only the exchange value matters and the value in use of  
31 goods do not matter. Indeed, goods with the highest use value have often little exchange value and  
32 reciprocally, goods with highest exchange value have often little use value. To illustrate this idea,  
33 Adam Smith uses the example of water and diamond (Smith, 1991)(p.96-97). This viewpoint is  
34 further confirmed by Karl Marx which makes explicit the difference between use value and exchange  
35 value: *“The good is fundamentally an external object; a thing which, through its properties, sustains  
36 any kind of human needs [...].The usefulness of a thing gives it a use value. But this usefulness is  
37 nothing vague or inaccurate. Determined by the property of the good’s body, usefulness does not  
38 exist without it. This body itself may it be iron, wheat or diamond is consequently a use value and it is  
39 not the quantity of work that men needs to deliver to get it which confer it this value [...]. The  
40 exchange value first appears as a quantitative ratio, as the proportion in which exchanges values*

---

<sup>41</sup> *“The need now is to examine what are the rules that men observe naturally when exchanging a good for another, or for money. These rules determine what can be called the relative or exchange value of goods”* (Smith, 1991)(p.96-97) [own translation]

1 *from different species are exchanged one with the other, ratio which constantly change with time and*  
2 *place[...]” (Marx, 1994) (p.562 -563). The aim of classical economists is thus to find the “atom” of the*  
3 *ratio between exchange values. According to Marx, this “atom” has nothing to do with use value and*  
4 *to conclude “As use values, the goods are before all from a different quality and as exchange values,*  
5 *they are before all from different quantities. Once excluded the use value of goods, there is only one*  
6 *quality left, to be products of work” . (Marx, 1994)(p.564 – 565)[own translation]*

7 The classical economists are thus entirely concentrating their effort on the concept of work which is  
8 closely linked to the concept of production. Therefore, they do not study in details the functioning of  
9 the market where goods are exchanged (Orléan, 2011)(p.35). However, the market makes anyone in  
10 the economy materially dependent on other producer – consumer. This is clearly showed by the  
11 economic tables of Quesnay (Denis, 2012)(p.170 – 179) of which the national input – output tables of  
12 the SNA constitutes a modern version. Going further, the first history of capitalism though  
13 characterized by a powerful dynamism is also made of overproduction crises and problems related to  
14 the repartition of production, access to consumption and work, in other terms related to the issue of  
15 poverty. Finally, the 1873 overproduction crisis will put an end to the relative isolation of the  
16 production viewpoint of the classical economy to evolve towards the market viewpoint of the  
17 neoclassical economy.

18 According to Jevons, work cannot be at the origin of the value because once spent, work has no  
19 influence on the future value of an object (Denis, 2012)(p.481). Therefore, the “atom” of value has to  
20 be found somewhere else and the answer brought by neoclassicist is in utility. The neoclassical  
21 economists will thus construct laws explaining how exchanges take place such as the laws of  
22 proportion of marginal utilities to product ratio<sup>42</sup> and the law of supply and demand. Finally, the  
23 neoclassical theories will find their most synthetized expression under the form of the general  
24 equilibrium as expressed by Leon Walras. This general equilibrium leads to consider the economy as  
25 made of five groups of equations based on the notion of quantity, price and production functions.  
26 For example, if we consider that m goods are produced and sold and n “producer services” are used  
27 to make the goods, the unknown factors are the m quantity of sold goods, the m associated prices,  
28 the n quantity of “producer services”, the n price associated. Adding the making coefficients and  
29 taking into account that one goods can serve as a reference or money, the total of unknown factors  
30 is  $2*m + 2*n + m*n - 1$ . The five groups of equations are thus equations related to the demand of  
31 goods other than money ( $m - 1$ ), the associated equations of costs (m) which means that the selling  
32 price of each good is equal to its production costs, the equations related to “producer services” (n)  
33 which means that the quantity of every service sold on the market should be equal to the quantity  
34 used in the making of goods, the equations of technical substitution ( $m*n$ ) which show how making  
35 coefficients are dependent on the price of “producer services”, and finally the equations of the offer  
36 made by “producer services” (n) which indicate that the sold quantity of “producer services” are  
37 determined functions of prices of services and prices of goods (Picard, 2007)(p. 320 – 353). In spite of  
38 this interesting modeling framework, the aim of Walras is quite clear. It consists in the demonstration  
39 that a free – market economy between individuals and private firms provides the best result for  
40 society (Denis, 2012)(p.494 – 497).

---

<sup>42</sup> This law means that if  $U_A$  and  $U_B$  are respectively the marginal utility of products A and B and if  $P_A$  and  $P_B$  are respectively the price of products A and B, we have  $\frac{U_A}{U_B} = \frac{P_A}{P_B}$  (Denis, 2012)(p. 482-483).

1 This is indeed the role of the general equilibrium model to show that society can reach an optimum  
2 in regards to the allocation of scarce resources (Orléan, 2011)(p.57).

### 3 **3.2 Social criticism of the theories of value**

4

5 The two theories of value are the core concepts framing the current understanding of human  
6 activities (A). Though not conferring the same origin to value, these two theories have fundamentally  
7 the same issue which André Orléan has called the market separation. With him, we agree on the fact  
8 this market separation is based on four institutional processes which determine the social world of  
9 the current socio – economic framework. These processes are a nomenclature of goods known from  
10 all actors (nomenclature of goods hypothesis), a common representation of the uncertainty  
11 (nomenclature of world states hypothesis), a collective acknowledgement of what price mechanism  
12 are (market secretary hypothesis), and the adoption by all the actors of a strict utilitarian conception  
13 of market goods (convexity of preferences hypothesis) (Orléan, 2011)(p. 106). The classical economy  
14 by focusing on production processes naturally excluded exchanges and the social interactions  
15 associated for this analysis. The neoclassical economy also excludes the social interactions of  
16 exchanges as the Walrasian conception of the market is a place where purchasers and salesmen  
17 never communicate. In other terms, the Walrasian conception of the price mechanism is at the  
18 opposite of the analysis of Max Weber for whom *“prices [...] are the results of struggles and*  
19 *compromises; putting it differently, they ensue from the respective power of engaged stakeholders”*  
20 (Weber, 1995)(p. 158).

21 The Weberian and Walrasian conception of price mechanism are nevertheless compatible as long as  
22 the respective power and intentions of engaged stakeholders are not very different. Such is the role  
23 of the convexity of preferences hypothesis to maintain this difference as low as possible. Indeed, the  
24 core hypothesis of the utility concept is that all individuals is able to classify in an increasing order the  
25 different basket of goods and that if an individual prefers good A to good B and good B to good C, he  
26 necessarily prefers good A to good C<sup>43</sup>. This classification supposes that the different goods are very  
27 similar in terms of properties and that the preferences do not depend on the actions of others  
28 (Orléan, 2011) (p.56). The preferences or utilities are fixed in time and space as they constitute the  
29 “atoms” of the market economy. Secondly, the convexity of preferences hypothesis means that the  
30 desire of individuals reach progressively satiety so that exclusive preferences such as “only one good  
31 interest me” and exaggerated ones such as “the more I have, the more I want” cannot occur (Orléan,  
32 2011)(p. 58 – 60). The relationships between actors in the neoclassical economy are thus non –  
33 violent because all the actors have similar preferences and only interact with others indirectly  
34 through the means of goods.

35 The problem with this approach has been identified for example in the work of Brian Arthur. Indeed,  
36 by studying the VHS technology, Brian Arthur demonstrated that *“the more VHS users they are, the*  
37 *more a new VHS user will benefit from a better availability and higher diversity of products recorded*

---

<sup>43</sup> In other terms, if I prefer going to the restaurant than going to the cinema and if I prefer going to the cinema than going to the swimming pool then necessarily I prefer going to the restaurant than going to the swimming pool. This framework is a complete negation of the process of choices. Indeed, if we consider the different properties of the three options restaurant (R), cinema (C) and swimming – pool (S), they are so different in nature than we can have  $R > C$  and  $C > S$  and  $S > R$ .

1 *in VHS*" (Brian, 1988)(p.591). We thus see that in the case of innovations and associated diffusion,  
2 the utility does not follow the convexity of preference hypothesis as positive feedbacks appear. We  
3 thus see the rupture of the general equilibrium which can then evolve towards another general  
4 equilibrium or a set of different equilibriums, i.e. to the formation of different communities of actors  
5 each of them having their own convention. Among the forces that could ensure a positive feedback,  
6 we can identify the influence of information and the influence of other actors. The influence of  
7 information is related to the nomenclature hypothesis which supposes that each exchanged good  
8 must have a homogenous quality, perfectly defined and known from all economic actors (Orléan,  
9 2011)(p.87). Therefore, if uncertainties on the quality are introduced, what would be the  
10 consequence on this framework? The answer is shown by the study on second – hand car market  
11 (Akerlof, 1970). Because of the different in the use path of cars, the term "second – hand car" covers  
12 different qualities. An uncertainty is introduced. The quality is dependent on the intention of those  
13 who are selling their car. Assuming they want to maximize their profit, we thus have a positive  
14 correlation between the price of car and their quality. Consequently, the price becomes for those  
15 who purchase an indication of the average quality of second – hand cars. The quality does not exist  
16 beforehand but is a parametric interpretation of the reality of actors' decisions. Going further, the  
17 higher is the price, the higher is the quality of the product and consequently the higher is the  
18 demand for the product<sup>44</sup>. This trend is totally the opposite of the one stated by the law of supply  
19 and demand which states that increase in price implies a decrease in demand.

20 In addition to the parametric and the strategic thinking of actors, we should add the remarks of  
21 Veblen which states that as prestigious goods, goods are also subject to rivalry. But, instead of the  
22 too vertical thinking of Veblen, we prefer holding the main idea that what is prestigious in the eyes of  
23 the subject is what is desired by the model<sup>45</sup> (Orléan, 2011)(p. 132 – 134). In other terms, we observe  
24 a collision of the realities of actors. We thus understand better the attachment of the economic  
25 literature to see exchanges as the main framework of society and barter as the fundamental way to  
26 exchange. Indeed, the barter holds all the basic characteristics allowing the fantasy of the economic  
27 framework of social relationships to take place: two individuals without any other relationship that  
28 the purchase and the selling of a good. Nevertheless, the historical argument of barter has been  
29 denied by many anthropological and ethnological studies. Indeed, these studies have demonstrated  
30 the importance of gift and reciprocity in archaic societies. For example, the circular gift process or  
31 Kula<sup>46</sup> of the tribes of New Guinea was considered as the fundamental process of earning fame and  
32 friends for the tribe (Malinowski, 1920). This circular process is the following: some inhabitants leave  
33 island A for island B on their dugout with little opening gifts, they create new links with inhabitants of  
34 island B who provide them with other goods, they go on with the same process with other islands  
35 before going back to island A full of gifts; finally, some months or years later the visited friends

---

<sup>44</sup> Some could argue that not all purchasers could afford the increase in price so that if the sellers want to sale, they would have to operate a decrease in price. But this supposes that actors act on the price mechanism and they can undertake strategic thinking. Consequently, even this way, we get out of the value framework of the neoclassical economy.

<sup>45</sup> Let us consider two individuals A and B, each of them taking the other as a model. If we consider A moving in one direction without any real intention but this movement is interpreted by B as a movement of which aim is to get the object X, B will start an intended movement towards X. This B movement will be rightly analyzed by A as having X for goal and A will start desire X. This situation will thus confirm the analysis of B concerning the intention of A. The result is that without any reason except the imitation of actors, X has become a desirable object.

<sup>46</sup> Some of these objects can be found in the Oceania section of "Musée du quai branly" in Paris.



1 become the visitors. The value of the exchanged goods depends principally on the number of  
2 successive holders (Godbout, 2000)(p.152-153). Furthermore, it is important that the goods are given  
3 back at a different time than the moment of exchange. What matters is the history of exchanges the  
4 object is the symbol of. This is very far from simple bartering where two objects are exchanged  
5 simultaneously. In this perspective, we understand that the value of goods accumulated through  
6 time contrary to the accounting framework presented in previous sections in which goods  
7 experienced a depreciation of their value through time.

8 We said before that the classical economists did not consider the problem of exchange because they  
9 focused on work as value and do not get any interest on the market. In fact, it is more exact to say  
10 they concentrated on the production issue and the social relationships associated with it. They thus  
11 understand the market as a simple exchange of friendly services *“give me what I need and you will  
12 get from me what you need”* (Smith, 1991)(p.82). And this market is based on the principle of  
13 operating surplus. Indeed *“If the market is very small, nobody will be encouraged to devote himself  
14 in only one activity, for lack of being able to find ways to exchange the operating surplus of  
15 production that would exceed own consumption with other operating surplus resulting from other’s  
16 work”* (Smith, 1991)( p.85). The key is thus to increase the operating surplus of actors. And such is  
17 the role of the division of work. Indeed, the gain in productivity obtained through the division of  
18 work seems quite enormous<sup>47</sup>. Therefore, from a situation of scarcity, the division of work can  
19 increase the operating surplus of each worker with so much intensity that the risk of having a small  
20 market preventing exchanges to take place is low. With this framework, we can understand why the  
21 market is not the main issue of classical economists. From the viewpoint of our social criticism, it also  
22 means that we have to examine what the social consequences of the division of work are. We can  
23 identify three of these consequences in line with the process of work division as described by (Smith,  
24 1991)(p.75):

- 25 1) *“Firstly, the increase of worker’s technical skill increases the quantity of goods he can produce  
26 and the division of work by **reducing** the task of every man to **simple** operations and by  
27 making these operations the **only occupation of his all life** necessarily ensures that every  
28 man becomes skilful in **their** activity.”* [I underline]
- 29 2) *“In a second time, the advantage we get by **saving the time** usually lost by changing  
30 activities is most important than usually thought.”* [I underline]
- 31 3) *“In a third and last time, everyone can understand how the use of machineries dedicated to  
32 one task shortens and makes easier the work to accomplish.”*

33 We saw that the neoclassical economy identifies the desires of the actor with the quality of the  
34 object existing beforehand. We understand now that the classical economy identifies the actor with  
35 the type of objects being produced. Indeed, for those who join the work division credo, actors are  
36 identified to only one activity they should make for life. The only social recognition for these actors is  
37 through the increase of the quantity they can produce. From this point, then, time becomes a scarce  
38 resource which should thus be used efficiently. Time becomes an economic good. In this process, the  
39 final goal of the work division becomes the establishment of the kingdom of machineries. Indeed, by  
40 their capacities of working all the time and their high specialization, the machineries constitute the  
41 ideal archetype. In conclusion, we see that the classical economy condemns men to become

---

<sup>47</sup> The division of work allows for the production of 4800 pins against 20 pins thus leading to a multiplication of productivity by 240.

1 machines and the neoclassical economy condemns men to be consumers with no desire, no  
2 uncertainty, no feelings, etc. In other terms, the theories of value make the life of men varying  
3 between the state of slavery (machine) and the state of divinity (homo oeconomicus).

### 4 **3.3 Environmental criticism of the theories of value**

5

6 We will now consider the part played by the environment in the theories of value. And what is the  
7 most surprising is that though putting the object at the core of their theories, the classical and  
8 neoclassical economists totally exclude the environment from their framework. Indeed, as stated by  
9 (Marx, 1994)(p.563), *“The use value supplies background knowledge of science and commercial daily*  
10 *operations. They form the material of wealth no matter the social form associated with it. In the*  
11 *society we have to examine, they are the material support of the exchange value.”*

12 Nevertheless, as a support, the material world is supposed to exist beforehand. This corresponds to  
13 the idea we had in the 19<sup>th</sup> century about this material world such as the “atomic theory” which  
14 makes this material world indivisible and constant in quantity. Indeed, if we consider the mass  
15 conservation as the fundamental characteristic of the material world and the fact that atoms  
16 differentiate themselves by their chemical properties, the material world indeed becomes an eternal  
17 world never moving, never changing. In reality, this understanding of the material world by  
18 economists is completely different than the one revealed by scientists.

19 The main error of economists is to only consider the atoms and not the molecules. They do not get  
20 interest into how the atoms combine themselves to create different molecules with different  
21 properties. Indeed, chemistry is the science of the recombination of atoms under different  
22 environmental forces (presence of other chemical compounds, pressure, temperature, etc.) so that  
23 what is called “chemical property” of atoms is in fact its capacity to interact in a certain way with its  
24 environment. The main error of economists is to believe that the property lies within the atoms and  
25 not within the interaction between these atoms<sup>48</sup>. This is further confirmed by the nomenclature  
26 hypothesis which assumes that each heading of the nomenclature is clearly defined and do not  
27 interact in term of properties. The nomenclature hypothesis is thus fundamentally “a without  
28 interaction atomic world”. Only one atom, which does not belong to the natural world and does not  
29 interact with, it needs to be found to explain through its variation in quantity, not in properties, the  
30 movements of goods in the social world. May this atom be called “work” by classical economists or  
31 “utility” by neoclassical economists; they all consist in a misinterpretation of the atomic theory and  
32 science in general. To show an example of how different in complexity is the framework of  
33 interactions from the no interaction framework, let us consider 10 atoms with a combination  
34 possibility of only 2 atoms. The usual combinatorial mathematics shows that the total number of  
35 possible combinations is  $2^{10}$  (=1024), 100 times more possibilities than when considering only 10  
36 properties associated with the 10 atoms.

37 The understanding that material properties lie in the interaction between atoms rather than within  
38 atom itself modifies completely the link between economy and the environment. Indeed, now,

---

<sup>48</sup> In this aspect, we could say that atoms do not exist from a material viewpoint. Indeed, atoms could be understood as a set of properties P associated with a set of experiences E. The fact that the particle physics exist tends to confirm this framework by showing that the “indivisible” property is subordinated to a particular set of experiences which we call today “chemical reactions” in opposition to “nuclear reaction”.

1 though the quantity of atoms is conserved, the properties of the material world are not conserved  
2 anymore. Human actions can thus have by modifying the relationships between atoms, their  
3 concentrations, etc... direct influences on its environment. Therefore, these influences need to be  
4 studied into details to understand the pattern which links human activities to environment. In this  
5 context, the nomenclature hypothesis has to be abandoned unless as underlined by (Marx, 1994)  
6 (p.563) *“all purchasers are supposed to have an encyclopedic knowledge of goods”* which is of course  
7 more and more difficult to achieve as the number and the complexity of links constituting the  
8 properties of goods increase.

### 9 **3.4 Epistemological criticism of the theories of value**

10

11 We demonstrated in the two previous criticisms the misunderstanding of the material world and of  
12 the social world embodied in the theories of value. From an epistemological viewpoint, we can see  
13 this misunderstanding as the result of two phenomena: the confusion between rational and  
14 experimental methodologies and the confusion between descriptive and normative viewpoints. This  
15 is clearly stated by (Walras, 1952)(p.29):

16 *“The mathematical methodology is not the experimental methodology but the rational methodology.*  
17 *[...] The physico – mathematical sciences, as the mathematical sciences, get away from the*  
18 *experiences as soon as they borrow types from them. They abstract from these real types some ideal*  
19 *types they define; and, on the basis of these definitions, they construct a priori all the structure of*  
20 *their theorems and demonstrations. After this, they get back to the experience not to confirm but to*  
21 *apply their conclusions”<sup>49</sup>.*

22 It is also interesting to note that the modern revolution of science brought by the Einstein theory of  
23 relativity deals with this issue of the link between theory and experience. Actually, the modern  
24 physics takes into account the fact that space is neither physical nor metaphysical but conventional <sup>50</sup>  
25 (Eddington, 2010)(p.11).The theories of value are thus ignoring the evolution the knowledge of  
26 natural world has experienced in the last century in different areas such as physics, biology and  
27 ecology. This ignorance is deliberate because they do not correspond to the definitions made initially  
28 by the economists. The economists thus take a normative approach and not the descriptive approach  
29 of the natural sciences. We could thus apply to this framework the criticism of Auguste Comte  
30 (Goumiza, 1933-1941)(p.244) that *“everything that we call logics, metaphysics, and ideology are*  
31 *chimaeras and wild dreams, when they are not absurdities”*. For Auguste Comte, sciences restrict  
32 themselves to establish some invariable relations existing between observable facts and these  
33 relations are scientific laws simply reached by the coordination of facts (Denis, 2012)(p.460).  
34 Nevertheless, Auguste Comte commits the same mistake as economists because when it comes to  
35 social applications of his theory, he abandons the “neutral” scientific viewpoint for a normative one.  
36 Indeed, the social doctrine of Auguste Comte is based on a social order which implies the existence  
37 of a temporal power<sup>51</sup> which maintains those who must obey in a state of subordination and a

---

<sup>49</sup> See (Orléan, 2011)(p.105 -114) for a longer description of this ideal scheme.

<sup>50</sup> To go further in this discussion, we strongly advice the reader to read the wonderful introduction named « what is geometry? » of the same book of Sir Eddington.

<sup>51</sup> This power is given to industrial managers and bankers. For classical economists, this power is called the production or capital. For neoclassical economists, it is the power of the self – interest of people skillfully dulled as seen before which is at the origin of this power.

1 spiritual power<sup>52</sup> who teach subordinates how to accept their position and love those who order  
2 them (Denis, 2012)(p.463). The positivism of Auguste Comte and the economists have thus in  
3 common to completely get out of the social world social actors themselves. In other terms, people  
4 cannot interact within their ideal model and people should behave as ordered by their ideal model.  
5 What is forgotten is this world is first of all a social work since as stated by (Péguy, 2001)(p.136) “[...]”  
6 *the portions of this planet occupied by men has ceased to be purely physico – biological as soon as*  
7 *men has made its appearance: all inhabited space is from the very beginning the place of nature –*  
8 *society interaction. [...] We thus cannot conceive observers which are not in some ways, already*  
9 *actors.”*

10 The main issue of the theories of value is thus linked to their concepts. A concept is a general and  
11 abstract idea which allows the characterization of sensitive and constructed data. Following the  
12 approach of Gérard Vergnaud<sup>53</sup>, we can characterize any concept by a triplet (S, I, s) where S is the  
13 set of all situations giving a meaning to the concept, I is the set of operating invariants of the concept  
14 i.e. the common properties linking all elements of S together, and s is a set of term, denominations  
15 and symbols which indicate the concept. If we now try to apply this framework to the theories of  
16 value, we thus need to find the set of situations S which gives a meaning to the market separation of  
17 the two theories of value. This brings us back to **Figure 17** and the three economic systems. For S not  
18 to be an empty set, this means that in the barycenter equation  $m\overrightarrow{GM} + a\overrightarrow{GA} + p\overrightarrow{GP} = \vec{0}$ <sup>54</sup>, there  
19 exists situation where we have a=0 and p=0. This looks quite doubtful that such particular  
20 combination first exists<sup>55</sup> and secondly is predominant<sup>56</sup>. Adding the social criticism we have made so  
21 far, this situation made be possible if we consider G not as being the human activity but the  
22 interpretation that is made of it G'. We thus have  $m'\overrightarrow{G'M} + a'\overrightarrow{G'A} + p'\overrightarrow{G'P} = \vec{0}$  and  $m\overrightarrow{GM} + a\overrightarrow{GA} +$   
23  $p\overrightarrow{GP} = \vec{0}$ . In this context we thus see that having a'=p'=0 does not provide any information to the  
24 value of a and p. We thus have two distinct epistemologies between (m', a', p') and (m, a, p) which  
25 are intertwined together so that the world cannot be understood by only referring to one  
26 epistemology.

27 The new epistemology makes a strong reference to the problem of interpretation and I will consider  
28 that we can find its foundation in the notion of convention as introduced by the theory of  
29 convention. The theory of convention has been introduced and developed in France by a group of  
30 sociologists and economists whose objective was to bring a new framework to the tradition of  
31 institutionalized economic theory (Geindre). One of the founders of convention theory, R. Salais,

---

<sup>52</sup> This power is given to scientists and in particular sociologists who know social laws and can act as magistrate in the administration of conflict between people. For classical economists, the magistrate is the benefits taken from the exchange for each actor. For neoclassical economists, the magistrate is the market secretary which ensures a unique righteous price for all actors of the economy.

<sup>53</sup> <http://www.ardm.eu/contenu/g%C3%A9rard-vergnaud-0>

This approach has been presented during the doctoral course ED05 of the “Université de technologie de Troyes” (UTT)

<sup>54</sup> As a reminder, G is the point describing the accounting system; M, A, P respectively the points of Market sphere, Autonomous sphere, Public sphere and m, a, p respectively the weight given by the accounting system to M, A, P. (see note 23)

<sup>55</sup> We thus consider that the value (m, 0, 0) does not exist. The justification of this fact should be clearer at the end of this dissertation.

<sup>56</sup> We nevertheless already demonstrated that (m, 0, 0) was only a minor set of the human activities. Indeed, as stated before, the justification of the theories of values to make (m, 0, 0) the definition of all human activities does not stand the examination of facts.

1 defines thus the convention as a set of elements, which, at every moment for the participants to the  
2 convention, go together and on which, consequently, they share a common agreement.  
3 Furthermore, this common agreement does not proceed from a detailed prescription which would  
4 mean intentionality and rationality from each actor. Indeed, a convention is a system of reciprocal  
5 expectations on competencies and behaviours, designed as obvious and to be obvious (see for e.g.  
6 (Salais, 1989) for an application to working relationship). In this context, the theories of values are  
7 thus the basis of a conventional regime which as stated in (Buclet, 2011)(p.68) structures our  
8 understanding of society and guides our behaviours with a remarkable stability.

### 9 **3.5 Circulation criticism of the theories of value**

10

11 In the context of the neoclassical economy, the circulation of goods is quite clear and is made of two  
12 parts. First, the research by all individuals of an increase of their utility is the fundamental force that  
13 drives the movement of the market economy (Orléan, 2011)(p.57). Secondly, the exchange is  
14 dictated by the market secretary who, by referring to a value of goods ex – ante, organizes in a  
15 centralized way the exchanges of the economy. Consequently, the circulation of goods does not  
16 meet any obstacles in the process of the neoclassical economy. Going further, the convexity  
17 preference hypothesis implies that the utility of a combination of goods is always superior to those of  
18 a simple good<sup>57</sup> (Orléan, 2011)(p.60). In other terms, the more goods are diversified, the better it is  
19 for the economic actors. Similarly, for classical economists, the division of work ensures increases in  
20 production and increase in the associated exchanges. Indeed, the more you divide the process of  
21 work, the more you increase the interdependency of the actors for the meeting of their needs and  
22 consequently the exchanges between them<sup>58</sup>. Once again, the diversification of work and associated  
23 outputs (goods, service) leads to an increase of the process of circulation.

24 The idea that the current socio – economic framework is deeply associated with a circulation process  
25 is clearly expressed in the accounting framework I presented so far. These accounting systems are  
26 based on the circulation of money which for classical economists and neoclassical economist is only  
27 the veil of respectively work and utility. Nevertheless, as shown by Quesnay, in a capitalist economy,  
28 all economic activities lies in the implementation of assets or expenditure made possible by  
29 advanced assets. Everything also depends on the spending of the income generated by the profit.  
30 Therefore, for the system to work, the selling of products has to rebuild the assets, which is possible  
31 as long as the income issued from production is normally spent (Denis, 2012)(p.177). Capitalism thus  
32 depends on a permanent circulation of capital. This point is further confirmed by Adam Smith:

33 *“As soon as some assets are accumulated in the hands of some individuals, a part of them will*  
34 *naturally employ these assets to put industrious people at work, giving them materials and*  
35 *substances so that they make a profit from the sales of the products, or from the added value the*  
36 *work of workers adds to the materials. When the final work is exchanged, against money, or against*  
37 *work, or against other goods, it is necessary that in addition of what could be enough to pay salaries*

---

<sup>57</sup> Thanks to the formula of convex functions  $f(\lambda x_1 + (1 - \lambda)x_2) \leq \lambda f(x_1) + (1 - \lambda)f(x_2)$  (Claude deschamps and al., 1999, p.237).

<sup>58</sup> Let us consider 100 individuals initially working for themselves. Consequently, the exchanges in the context studied here are equals to zero. Now let us consider that the work is divided in 20 stages so that we have five persons working in each stage. As the individuals need the product in its complete form, they have 5<sup>19</sup> combination possibilities of exchanges.

1 *and materials, there remains something for the profits of the entrepreneur of the work who ventures*  
2 *his money in this enterprise. This way, the value workers add to the materials must be divided in two*  
3 *parts, one paying for wages, and the other the profit made by the entrepreneur on the amount of*  
4 *money that was used to advance salaries and materials. He would get no incentive to employ these*  
5 *workers, if he was not expected from the selling of their work something more than the mere*  
6 *replacement of his asset, and he will get no incentive to use large assets rather than small ones if his*  
7 *profits were not relative to the amount of assets invested. Profits, may we say, are nothing else than*  
8 *a different name given to a particular kind of salary, the work of management and inspection. They*  
9 *are however for a completely different nature than salary and are based on completely different*  
10 *principles as it is not related to the quantity and the nature of this work of management and*  
11 *inspection. It depends entirely on the value of used assets and they are relatively more or less*  
12 *important with the extent of invested assets [...].In this state of things, the product of work does not*  
13 *entirely belongs to the worker. He must, most often, share it with the owner of the asset who made it*  
14 *work<sup>59</sup>* (Smith, 1991)(p.118-119)

15 In other terms, the main problem created by this process is the necessity to create something more  
16 which did not exist before the act of production and the act of selling and which does not correspond  
17 to the transformation made in the material. This “something more” is the incentive for the exchange  
18 to take place which in the words of Adam Smith is “profit”. To take place, this profit needs the  
19 concentration of the capital, in other words, the concentration of money. The role of money is  
20 indeed absent of the economic analysis of the current socio – economic framework simply because  
21 for classical economists production always finds outlets and for neoclassical economists exchanges  
22 are ruled by the utilities. Therefore, money only plays a role of facilitator of exchange in economic  
23 theories. But I demonstrated so far that economic theories were suffering from a lot of shortcomings  
24 so that the role of money in real world needs further study to clearly state its consequences on real  
25 circulation processes.

26 Similarly, the place of space and time in the current economic framework is unrealistic. According to  
27 (Corpataux, et al., 2007), four questions needs to be addressed in regards to space and time:

- 28 1) Does time and space play, right from the start, a role in the explanatory framework?
- 29 2) Should space be considered as something which is unchangeable and naturally endowed or is  
30 it a social construct which can be handed down and altered?
- 31 3) Are space and time understood in an abstract sense in the same way as mathematical space?
- 32 4) Are space and time neutral and objective studies?

33 The answers to these questions are found through a comparison with the role of space and time in  
34 mechanical sciences. As said before, there are lots of similarities between economic theories (theory  
35 of value) and atomic theories. Similarly, the monetary circulation space of the neoclassical economic  
36 theory shares close similarities with the Newtonian physical space. Indeed, the Newtonian physical  
37 space is a 3 dimension Euclidian space, i.e. a fixed, intangible structure, homogenous and isotropic.  
38 Therefore, there is no qualitative difference between points and all directions are equally valid.  
39 Similarly, time line is an independent entity existing side by side with a given, pre-existing space and  
40 is thus symmetric and reversible. Space thus acts as a support of the relationships between objects  
41 which only hold a quantitative nature. Objects are reduced to points located in space and time,

---

<sup>59</sup> Own translation.

1 differing from points in the pre-existing space by having the mass. The relationships between objects  
2 is ensured by the law of gravity which states that in space, each body is at any point of time, in  
3 relation with all others. Space is thus full as there are no divisions and subgroups operating in  
4 isolation. The interactions are always global. (Corpataux, et al., 2007).

5 Compared to the Newtonian framework, the general equilibrium theory replaces objects by market.  
6 Consequently, each market is reduced to a point determined by the interaction of supply and  
7 demand; a process which is driven by two quantitative magnitudes: price and quantity. However, all  
8 markets are the same point meaning there are no separate spaces for production and demand. The  
9 Walrasian space dimension is zero. Similarly, the Walrasian time dimension is zero as market clearing  
10 is instantaneous (market secretary hypothesis) and uncertainty about the future is managed through  
11 the state of the world nomenclature hypothesis. This origin of this issue appears clearer when going  
12 back to the initial work of Walras. The main problem is, as underlined in (Buclet, 2011)(p.58) that  
13 many economic theoreticians are not read and their theories appear truncated leading to  
14 misconception of their real theories. Walras is not an exception. Indeed, Walras got interested in a  
15 particular kind of market, those made by auction: *“The markets which are best organized from the  
16 competitive standpoint are those in which purchase and sales are made by auction, through the  
17 instrumentality of stockbrokers, commercial brokers or criers acting as agents who centralize  
18 transactions in such a way that the terms of every exchange are openly announced and an  
19 opportunity is given to sellers to lower their prices, and to buyers to raise their bids”* (Walras, 1926).

20 Therefore, as shown in (Mitra-Kahn, 2008), there is no preexistence of value as the price came from  
21 the coming together of buyer and seller – i.e. exchange – and the terms of each trade (the price and  
22 quantity) are only announced post facto to the rest of the market. In Walras words, the notion of  
23 equilibrium is thus reached by trial and error made of real exchanges. As underlined by (Mitra-Kahn,  
24 2008), the notion that once the price is in equilibrium, no trade can take place outside it, is correct  
25 since no one wishes to sell or buy at that price. Rather than equilibrium, it would thus be more  
26 correct to use the term “saturation” meaning that once this point of saturation reached, buyers and  
27 sellers are not willing to exchange anymore. The space dimension in Walras theory is thus zero  
28 because all actors are situated in the same place which used to be the case in the stock exchanges of  
29 Paris and London at the time of Walras. The time dimension is more complex and if each exchange  
30 seems instantaneous (dimension zero), the procedure leading to market saturation is not  
31 instantaneous, corresponding to the one time dimension of successive exchanges. The market  
32 secretary hypothesis and the instantaneous perfect equilibrium is thus the result of an invention of  
33 the neo-Walrasian economists, notably Arrow and Debreu (Mitra-Kahn, 2008). Nevertheless, the  
34 neo-Walrasian economists tried to reintroduce a space dimension of time through the introduction  
35 of transport costs understood as a distance pattern similar to Newtonian physics (Corpataux, et al.,  
36 2007). Nevertheless, space represented by a cost vector makes it only one simple input of the  
37 economic process. It thus seems that the confusion between mathematical spaces and physical space  
38 is a characteristic of the current representation of economy and associated circulation processes  
39 (Crevoisier, 1996). It also appears that this issue is linked to the supremacy of the monetary network  
40 in the representation of the linkages between social and economic actors and in the representation  
41 of the environment. The circulation processes are thus characterizing our current socio-economic  
42 system and consequently represent a privileged way to study the associated sustainability patterns  
43 and possibilities.

## 4 Conclusion

Let us now examine what has been learned from the present chapter. I started by a presentation of the current representation of sustainability. It was found that the definition of sustainable development was not clearer and did not provide clear policy guidelines. However, the usual representation was found associating the notion of environmental carrying capacity with the issue of health, education and economic growth. This led us to wonder how human activities were represented in the current socio-economic framework. This study was made through the analysis of national accounts and firm accounts providing a clear understanding of how economic growth, health and education were perceived. It was found that it consisted in a monetary network which leaves out of the analysis many aspects of the social life and the functioning of the ecosystem. Ruled by ownership and monetary transfers, the current representation of human activities is thus dependent on a system of resource/use extending in time through the debit/credit framework and in space through globalization processes. The goods themselves are found aggregated independent of their physical nature through a supposedly unambiguous nomenclature system. Considering a simple analytical equation of material consumption, we thus have  $M = M_{A\_Mon} * A_{Mon} + M_{A\_Non-Mon} * A_{Non-Mon}$  where  $(A_{Mon})$  are activities related to monetary transactions,  $(M_{A\_Mon})$  the associated material consumptions,  $(A_{Non-Mon})$  activities related to non – monetary transactions and  $(M_{A\_Non-Mon})$  the associated material consumptions. The sustainability of the current socio – economic framework is thus not something evident. Indeed, if we consider the environmental issue, not only the monetary transactions must respect environmental carrying capacity but also non – monetary ones. Within the usual representation of sustainability, the current socio-economic system is thus mainly criticized from an environmental viewpoint while it is seen as an enabler of the social development, notably through the Human Development Index.

It was thus important to analyze the reasons justifying the trust in the current socio – economic framework to be an enabler of social development and its associated monetary network supremacy. I demonstrated such reasons were linked to a concept ex – ante of the value. Indeed, may it be the “work” value of the classical economy or the “utility” value of the neoclassical economy; the values are supposed existing before the exchanges and are thus objective and eternal. I also demonstrated the link between this framework and a misconception of the atomic theory of the experimental science. Finally, I also showed the market separation introduced by the belief in the general equilibrium was based on a negation of the existence of other social relationships than those corresponding to the “market price” unique and satisfying for all. Therefore, we understand in this context that  $(A_{Non-Mon})$  is seen as equal to zero thus not disrupting the framework  $M = M_{A\_Mon} * A_{Mon}$ . But this context does not correspond to the reality of non – monetary and monetary exchanges. They neglect the influence of actors on themselves and the associated positive feedbacks (rivalry, gift, strategy, innovation). Going further, the division of work and the hypothesis concerning the convexity of actors’ preferences lead to the expansion of the market. We thus see here a risk for the environmental sustainability of this framework as maintaining a constant material consumption implies an inverse evolution of  $M_{A\_Mon}$  which seems not credible at least on the long term.

Finally, the most important consequences of the economic theories were found on the circulation processes, which appeared as aspatial and atemporal processes. Therefore, the current representation of human activities clearly appears as a convention and a normative approach using



1 money as a veil for explaining exchanges and rejecting concrete spaces into an abstract framework.  
2 The aim of the next chapter is thus to deal further with the circulation processes to provide a clearer  
3 understanding of the relationships between concrete economic exchanges and the theoretical and  
4 conventional approaches of economic theories and accounting systems.

5

6

7

8

9

10

11

# 1 **Chapter II: Coordination in the current socio-economic** 2 **framework**

## 3 **1 Introduction**

4  
5 The previous chapter showed that the current socio – economic framework was perceived as mainly  
6 economic, the coordination happening automatically by a fixation of price existing ex – ante. There  
7 was no coordination issue until I demonstrated that the value was created and dependent on the  
8 exchange itself and consequently that concrete space and time should be analyzed.

9 Therefore, the place of time and space and associated fields (geography, logistics, and  
10 transportation) holds a particular role in the current economic world. They are indeed subordinated  
11 to the ideal representation of economic exchanges and at the same time are responsible for the  
12 transfer of this ideal representation into the concrete world. The present chapter will thus study the  
13 characteristics of the circulation process to understand the lock-in driven by the current socio-  
14 economic system. This study is made of three steps. Firstly, I will review the three theoretical aspects  
15 of circulation introduced in the present chapter. This concerns the role of money, the role of outlets  
16 and the role of proximity within the concrete world. This will lead us to consider a second time the  
17 physical aspects of transportation systems and the role of infrastructure. Finally, I will analyze the  
18 link existing between the economic theories described in the previous chapter and the logistics  
19 framework. This will lead us to extend the criticism provided so far in regards to the sustainability of  
20 the current socio-economic system.

### 21 **1.1 The role of money**

22  
23 The theories of value described in Chapter I consider the role of money as secondary. This is because  
24 the value is supposed to exist before the exchange takes place. But to abandon the theories of value  
25 leads us to reconsider the role of money in the exchange. This reconsideration will lead us to  
26 reconsider the role of money as a principal one in our modern economy.

27 For this, we have to go back to the individual level as presented in the firm accounts. Indeed, in the  
28 framework of firm accounts, the firm is only interested by the money flow going in and going out the  
29 firm. In other terms, the firm always has a situation of reference corresponding to the initial capital.  
30 Consequently, the notion of loss (deficit) and gain (profit) are quite straightforward in this approach.  
31 From my initial capital, any money flow diminishing its amount is a deficit and any money flow  
32 increasing its amount is a profit. Consequently, in a world where the amount of total money M is  
33 constant, there are winners (those having profit) and losers (those having deficits)<sup>60</sup>. The sum of

---

<sup>60</sup> For example, let us consider an economy of N individual each of them having initially  $C_i$  as a capital. Let us now consider that x individuals are experiencing profits and that y individuals are experiencing deficits and let us not  $p_i$  the profits and  $d_i$  the deficits. We thus have  $x + y = N$  and  $P = \sum_{i=1}^x p_i = -D = \sum_{i=1}^y d_i$ . So if we consider the profits to be of  $r_p\%$  i.e.  $\forall i \in \{x\} p_i = r_p C_i$  ( $r_p > 0$ ) and consequently have  $P = r_p \sum_{i=1}^x C_i = -D$  and if we consider symmetrically the deficit i.e.  $\forall i \in \{y\} d_i = r_d C_i$  ( $r_d < 0$ ), we have  $D = r_d \sum_{i=1}^y C_i$ . In conclusion we thus have  $r_p \sum_{i=1}^x C_i = -r_d \sum_{i=1}^y C_i$  and  $M = \sum_{i=1}^x C_i + \sum_{i=1}^y C_i$  so the deficit is directly dependent on the ratio of the capital of the two groups  $r_d = -r_p \times \frac{\sum_{i=1}^x C_i}{M - \sum_{i=1}^x C_i} = -r_p \times \frac{X}{1-X}$  with  $X = \frac{\sum_{i=1}^x C_i}{M}$ . In

1 profits (+) and deficits (-) is necessarily equal to zero (Orléan, 2011)(p. 149). In this context, we  
 2 understand that if one actor makes an action towards more profits, it is done at the expense of  
 3 another actor. The solution to solve these tense relationships between economic actors would thus  
 4 be the absence of profits. Indeed if no profits are made, there are no deficits. But it also completely  
 5 ruins the role of money as a mediator of exchange since as soon as money flows occur, the balance is  
 6 compromise except if we assume a steady state. In other terms, for the initial capital of all economic  
 7 actors to remain the same for all individuals, all the exchanges have to be simultaneous and of the  
 8 same intensity for all actors<sup>61</sup>. This is a strict restriction of the reality of economic actions which  
 9 corresponds very well to the Walrasian conception of exchange. In reality, for an economic exchange  
 10 to take place, it is enough that the purchaser owns the appropriate quantity of money (Orléan,  
 11 2011)(p.148).

12 Therefore, the monetary exchanges are mainly local ones and all use one same unit, the money, no  
 13 matter where they take place. Money thus acts in the same time as an enabler and a barrier to  
 14 exchange. Consequently, the market economy is ruled by the desire of money as a purchasing power.  
 15 Indeed, as money is the only way to access goods, the more money a person has, the more capacity  
 16 of actions is given to this person. In other terms, the principle of the market economy is the  
 17 concentration of money through the process of accumulation, and accumulation which can only be  
 18 made by exchanges which validate the purchasing power of money. Following Aristotle, we thus  
 19 group in two kinds all activities taking place on the acquisition of goods or wealth (under the term  
 20 chrematistics): the chrematistic that corresponds to the need to acquire goods to satisfy needs and  
 21 the chrematistic that corresponds to trade activities and having no other finality than accumulation  
 22 of money (Denis, 2012)(p.49). The main problem is that even those who only want to satisfy their  
 23 needs have to accumulate money.

24 For an exchange to take place, the two protagonists have to accept what the other has to propose.  
 25 For money to become this generalized unit of exchanges, it means that actors must accept money.  
 26 This capacity of being accepted in the exchange is named "liquidity" by economists. And following  
 27 this idea, I can write with (Orléan, 2011)(p.155) that what is liquid for an individual is what others are  
 28 considering liquid. Money is thus essentially a convention and correspond to a sociological  
 29 phenomenon (Simmel, 1987)(p.225). We can thus divide the world of exchanges as a set of  
 30 circulatory spaces, each of these spaces having its exchanges ruled by only one type of liquidity. For  
 31 example, euro (€) cannot be used to buy goods in the United States where dollar (\$) is the liquidity.  
 32 The only way for a European and an American to have an exchange is through intermediary financial  
 33 bodies called currency changer. **Figure 23** presents how money can diffuse in an economy. Any new  
 34 comer is indeed in the obligation of accepting the usual monetary representations or to convince the  
 35 rest of economic actors to change the money used.

---

other terms, the richer is initially the group making profits, the higher is the deficit ratio for others. For  
 example, if we consider a population of 65 million people, and if 1000 persons of this population are  
 concentrating initially 80% of the capital, we have  $r_d = -r_p \times \frac{0.8}{1-0.8} = -4 r_p$  even if the 1000 persons only  
 represent 0.002% of the population. Only in the hypothesis of an initial equal repartition of the capital is there  
 a link with the share of population concerned with profits  $(X = x \frac{C}{M})$ .

<sup>61</sup> If we note  $F_{ij}$  the money flow from individual  $i$  to individual  $j$ , we thus have with  $N$  total number of individuals:  
 $\forall i \forall j \forall t \sum_{j=1}^N F_{ij}(t) = \sum_{j=1}^N F_{ji}(t)$ .

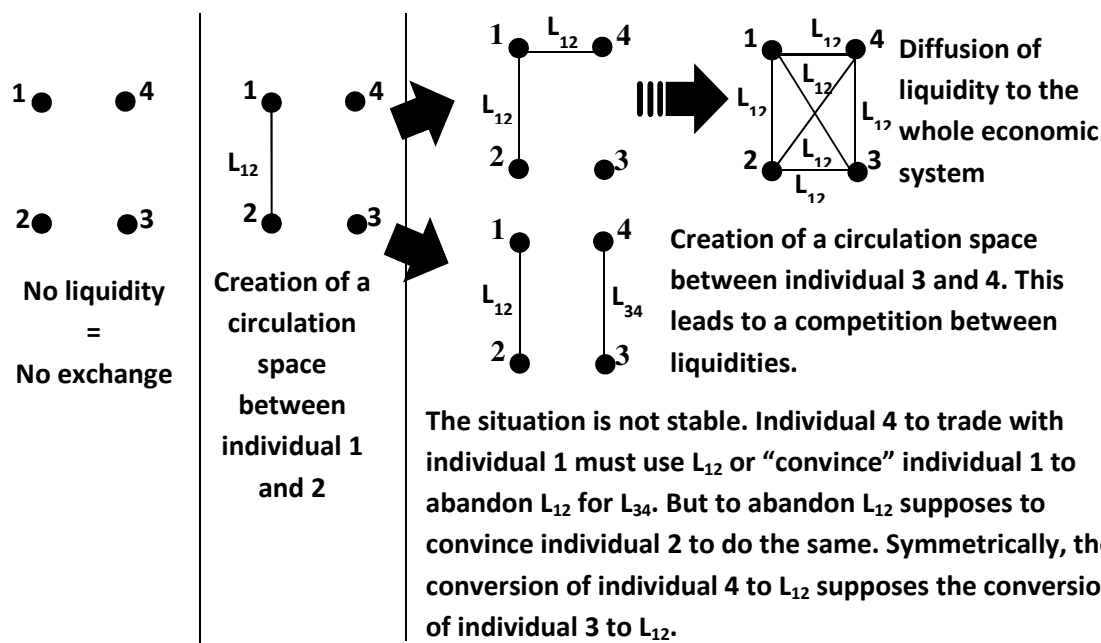

1

2 **Figure 23 : The extension of circulation spaces and money legitimacy.**

3 The money is thus a representation whose legitimacy is based on the possibility for actors to buy  
4 goods. This representation is of a globalized nature since as soon as a new exchange occurs in the  
5 vicinity of the economy, the force to include this new exchange in the pre – existing economy is much  
6 stronger than the possibility this exchange imposes its money to the rest of the economy. Therefore,  
7 the legitimacy of the money is subordinated to the possibility of purchasing goods everywhere and  
8 anytime. We also understand the importance of imports and exports which are ways for different  
9 space of circulation to communicate. Imports are a way for external economies to influence the  
10 internal space of circulation and exports are a way for the internal space of circulation to influence  
11 the external spaces of circulation. For example, French imports represented in 2006 13% of the total  
12 resources used by the French economy and French exports 12 % of the total use of the French  
13 economy<sup>62</sup>. The French economy thus seems quite equilibrate in terms of influence<sup>63</sup>.

14 In summary, the circulation of goods is subordinated to the circulation of money as only money gives  
15 the possibility to purchase all goods. Symmetrically, the circulation of money is subordinated to the  
16 circulation of goods as legitimacy supposes from time to time the realization of the money promises  
17 by real act of purchase. Money is thus leading to two struggles: a struggle between economic actors  
18 in the space of circulation and the struggle for the space of circulation to maintain and expand. In  
19 other words, the issue of outlets is at the core of the economic way of working.

20

21

<sup>62</sup> As a reminder, the rules of national accounts based on conservation of flows imply total resource = total use

<sup>63</sup> This equilibrium nevertheless only exists for the whole economy. At the sectorial level, the picture is quite different as we will see later. But we can already note that some activities are concentrating on managing imports and exports so that these activities are of course depending on the internal and external spaces of circulations in an equal intensity.

## 1.2 The role of outlets

Let us now examine briefly the historical evolution of outlets and the associated perception of the political philosophy. Trade activities and notably the loan with interest were strictly observed and controlled in the Plato and Aristotle theories though the practical economic life of Ancient Greece and Rome seemed far from this recommendation with concentration of wealth and the extension process characterized by the notion of Empire. Following the end of Roman Empire, the circulation of goods and money become clustered to villages as the rural life replaces the imperial life. In other terms, this period was characterized by the juxtaposition of small circulatory spaces having little if any interactions. This is due to the fact Christianity was characterized by a total absence of policy view since the important life was not on Earth. In this vision, what matters is to get prepared for the afterlife and the hierarchy proposed is thus the following: individual obeys State that obeys Church. Therefore, the question of individual liberty becomes absent of the social life together with the notion of policy debate leading to the interdiction of financial activities such as the loan of interest and the circumscription of trade activities to a very basic level. However, this system was not totally closed and the trade continued to be practiced in Mediterranean Sea through the Muslim civilizations. Therefore, trade and the concentration of activities in cities reappeared in the 11<sup>th</sup> and 12<sup>th</sup> century in Europe, notably in Italian cities such as Venice and Genoa. The position of the Church on trade activities and loan with interest consequently changed slightly, notably through Saint Thomas Aquinas writings which serve as a basis for the Church position until the 21<sup>th</sup> century<sup>64</sup>. From these writings, few important characteristics can be derived. Firstly, property rights are considered as natural rights. Secondly, exchanges are possible if they are done on the right price, i.e. with a real equivalence between the objects or services exchanged. Thirdly, the intervention of State within the economy should be exceptional. Its role is only to prevent abuse in trade transactions but not to interfere with individual liberty (Denis, 2012)(p.81-91). We already see here the position of liberal economists who consider economy as mainly resulting from a contract between two individuals<sup>65</sup>.

The extension brought by this new version of Christianity is that every kind of trade is allowed as long as honesty is the guiding principle of action. The State consequently became an economic actor like the others and a capitalist class emerged made of industrials, powerful traders and bankers. Money was for example lent by this class to the kings with high interest rate, as much as 50% for example to the king of France Charles VII. The possibility for profit was then multiplied by the extension of the known world due to the discoveries of new maritime ways and new type of goods such as coffee, tea, indigo, tobacco, tomato, corn, potato and vanilla. The changes were rapid such as the quantity of gold and silver put in circulation. This created an abrupt change in the extent of the space of circulations<sup>66</sup> leading to a loss of legitimacy of the usual moneys of this period. Indeed The value of gold and silver suddenly dropped leading to an increase of the prices of other goods. The years following the great discoveries were thus characterized by an enrichment of the traders, bankers and industrials and an impoverishment of the nobles who had to sell land to the wealth people and consequently had to accept their ennoblement. From 1462 to 1602, the purchasing power of French

---

<sup>64</sup> [http://www.catholiques.aladefense.cef.fr/IMG/pdf/2011-09-22\\_Le\\_juste\\_prix\\_Pierre\\_de\\_Lauzun.pdf](http://www.catholiques.aladefense.cef.fr/IMG/pdf/2011-09-22_Le_juste_prix_Pierre_de_Lauzun.pdf)

<sup>65</sup> Nevertheless, the condition for these individuals to exist is they should be initially equals and omniscient both in the knowledge of present reality (nomenclature hypothesis) and of the future reality (state of the world hypothesis). In other terms, God is replaced by gods.

<sup>66</sup> See note 31 for a modern application of these abrupt changes.

1 money decreased by 80%. It was an era of material abundance with huge social changes and the  
2 introduction of new technics. Fallow were abandoned, communal lands became private, mulberry  
3 tree culture, silkworm breeding, printing, cannon and bills of exchange became usual practice. In this  
4 period of wealth extension, war became part of daily life to get control over commercial monopolies,  
5 commercial policies and colonies. From 1494 to 1559, there was war almost every year in Europe.  
6 There were only seven years of peace in the 17<sup>th</sup> century and England was on war from 1656 to 1815  
7 (Denis, 2012)(p.95-98).

8 The historical perspective is quite straightforward. There exists tense relationships between political  
9 powers and trade powers (Christianity vs. traders, nobles vs. traders) linked to the control of the  
10 circulatory space. The purchasing power is expressing itself through the ability to act on the real  
11 economy, i.e. the circulatory space of goods. To have power, it is thus not necessary to really act on  
12 the economy by introducing new goods or make investments. The power owners just have to  
13 maintain the threat to use this power. But threat is dependent on a time framework. In other terms,  
14 to never confirm the threat through actions is to diminish the power linked to the threat. Secondly,  
15 the purchasing power is dependent on a constant space of circulation. Any changes in the circulation  
16 space symmetrically diminish the purchasing power unless you struggle to obtain more<sup>67</sup>. This fact  
17 ignored by the nobles during the great discoveries led to a loss of power for the monarchies. This  
18 mistake was not made by the capitalist system which makes the extension of the circulation space  
19 the leitmotiv of its system. Indeed, the expansion of the capitalist system can occur in two ways. On  
20 one way, the capitalist system can increase production and then find outlets to this new production  
21 through an increase of consumption. This is what we can call the pushing capitalist system. On  
22 another way, the capitalist system can increase outlets first through an increase of consumption  
23 needs and then provides the production surplus created. This is what we can call the pulling capitalist  
24 system. The choice between the pulling and the pushing capitalist systems will depend on the  
25 situation. In a context of rapid and huge “natural” development of outlets, such as the discoveries of  
26 16<sup>th</sup>-18<sup>th</sup> centuries, the globalization period of the second part of 19<sup>th</sup> century or the globalization  
27 process of the period we have experienced for the last twenty years, the pushing capitalist system is  
28 preferred. This extension period is for example characterized either by an increase of the number of  
29 countries involved in international trade (Japan since 1854, Russia since 1991, China and new  
30 emerging countries today, developing countries tomorrow), by the introduction of new products  
31 (Coffee, tea, tomatoes in the great discoveries period) or by the introduction of new technics  
32 dedicated to consumption (washing machine, computers, phones).

33 The position of capitalist systems in regards to the issue of expansion can be related to the theories  
34 of value. For classical economists, production is the main focus. Their vision is thus the one of a  
35 pushing capitalist system with the following circular model: the division of work multiplies the  
36 productivity and increases the dependency of the workers one towards the others so that the  
37 production naturally finds its outlets. The purchasing power is linked to the value “work” embodied

---

<sup>67</sup> In the case money is a material such as gold or silver which exists in a finite quantity  $M_{tot}$ , the framework is quite easy to represent. Indeed, in this context, power cannot express itself through the creation of money but only by its accumulation. In other terms, if  $M_X$  is the quantity of money possessed by individual X and  $M_{known}$  the quantity of money known to be available, the purchasing power of X is  $P_X = \frac{M_X}{M_{known}}$ . Therefore, if a new quantity of money is discovered  $M_{new}$  so that  $M_{tot} = M_{known} + M_{new}$ , the purchasing power become  $P_X^{new} = \frac{M_X}{M_{tot}}$  and consequently  $\frac{P_X^{new}}{P_X} = \frac{M_{known}}{M_{tot}}$ .

1 in capital, land and salary work. For neoclassical economists, on the opposite, the main driving force  
2 is the consumption symbolized through the value “utility”. The production system is second place  
3 and expected to adapt to the evolution of “utility” through the law of supply and demand. In other  
4 terms, in this theory, if the space of circulation increases, it is necessarily due to an increase of the  
5 “utility” for society. Consequently, as the “utility” represents the welfare of society, an increase of  
6 the space of circulation provokes an increase of welfare. The reality is of course more complex. For  
7 example, the pushing capitalist system has to adapt the pace of production to the one of the  
8 expansion of outlets. Indeed, going too fast will imply a risk of overproduction, going too slow will  
9 imply a risk of missing opportunities offered by outlets. In this perspective, war is an ideal thing as  
10 military expenses offer a continuous outlet to production and the reconstruction period following the  
11 end of war also offers outlets to production<sup>68</sup>. Great scientific discoveries extending the possibility for  
12 men to use part of Nature as means of production and consumption also offer this possibility. And it  
13 is therefore not surprising that the expansion of capitalism coincided with an industrial revolution  
14 based on the revolution of quantitative sciences. The pulling capitalist system offers a promising way  
15 to cope with the difficulty of the pushing capitalist system in period of slow innovation. Indeed,  
16 instead of waiting for outlets to come, why not create them? This is where marketing and  
17 advertisement play an important role by creating a system of need dependent on the system of  
18 production (Baudrillard, 2009)(p.102-103). Playing with the attributes of gifts, the relationships  
19 between men and objects, between men become rigged, hoodwinked and manipulated (Baudrillard,  
20 2009)(p.104). The advantage of the pulling capitalist system is to diminish the uncertainty concerning  
21 the outlets of production. However, this has a cost corresponding to the efforts to create through  
22 advertisement and marketing operations the outlets. In reality, the pushing and the pulling capitalist  
23 system coexist but the dream of a capitalist system lie in a pushing capitalist system with outlets  
24 growing forever and slowly faster than production capacity.

### 25 **1.3 The role of proximity**

26

27 In the usual framework of the theories of value, the exchange is centralized through the market. In  
28 reality, the exchange is localized in the meaning that two actors can decide to exchange without  
29 referring to the others. This exchange is thus not localized in terms of space except if barriers are  
30 erected to long – distance exchanges. Distance corresponds to the fact that the two persons  
31 exchanging are not situated in the same place on Earth. As the market sphere is dependent on the  
32 validity of the exchange through the real transfer of goods (or purchasing power), we thus have a  
33 strict barrier in the question: Can the goods be moved once the exchange decided? We can consider  
34 this is the role of the transportation system to ensure this movement. Therefore, the transportation  
35 of goods once the exchange decided is dependent on the geographic proximity of economic actors.  
36 For example, let us consider that the two actors agreed on a transfer of an object the mass of which  
37 is M. The distance between the two actors is D. If we consider the actors to be insensitive to the time  
38 taken to realize the exchange, we can consider the description of the exchange by the formula  $M \cdot D$   
39 which corresponds to the usual framework of the tonne – kilometers recorded in national statistics. If

---

<sup>68</sup> Nevertheless, war can also severely damage the capacity of production of a country through the destruction of lands, industries and the diminution of population. The ideal position is thus one of a country providing weapons and ammunition to a distant front line. This way, population and production capacity do not suffer from war but benefits from the created outlets. Such was the position of the United States during the World Wars.

1 we consider the actors to be sensitive to the time taken to realize the exchange, we have to consider  
2 the time  $T$  of the exchange corresponding to the transfer of goods. This transforms the previous  
3 framework by describing the exchange thanks to the notion of speed  $v = \frac{D}{T}$  and the notion of  
4 quantity of movement  $p = Mv = M \frac{D}{T}$ .

5 Depending on the speed availability, the geographical proximity is thus a fundamental problem once  
6 the exchange decided. But for the exchange to be agreed by the exchanging economic actors, we  
7 should admit they have a common representation of the time taken for the exchange. In other terms,  
8 the economic actors when exchanging have a common expectation on the transportation system in  
9 charge of the material realization of the exchange. If we consider the individual level, this  
10 expectation is providing a limit to the possibility of exchange but does not decide how the exchanges  
11 will be made within this limit. Let us now explain much clearer this viewpoint.

12 Our viewpoint will first be illustrated through the transportation of persons. Let us consider a person  
13 with a maximum budget time  $T$ . This means that  $T$  is the maximum amount of time the person can  
14 consecrate to his travel. Let us call  $A$  the point of origin of the travel. The question is thus: which  
15 points of the space can be reached from  $A$  in time  $T$ ? To answer this question, the person decides a  
16 point of destination  $B$ , a means of transportation  $M$  and a path  $C$ . The question thus becomes: can  $B$   
17 be reached from  $A$  in less than time  $T$  by taking the means of transportation  $M$  and the path  $C$ ? In this  
18 context, the number of transportation experiences is providing the basis for a statistical analysis  
19 linking the time of the travel with the time budget constrain, the geographical distance, the means of  
20 transportation and the path taken. This is the idea when an individual expresses: "at that period of  
21 time, from  $A$ , I have the probability  $X$  to reach  $B$  by taking path  $C$  with transportation means  $M$  in  $T$   
22 hours". If the individual experience is reproduced by other people with approximately the same  
23 results, the concept of "social expected transit time" is created. For example, everyone has already  
24 experienced when asking someone for how to go to a place the following answer "it is ten minutes  
25 from here". Sometimes, this answer gets a precision on the means of transportation ("it is ten  
26 minutes by car") or on the path to take ("take the second street to the right") but the answer is rarely  
27 referring to the concept of probability. The unit time used to describe the transit time is also a  
28 characteristic of the expectation of the individual or the society on the accuracy the transit time  
29 should be dealt with. Before the modern world, the unit time used to be counted in terms of months,  
30 weeks, days or hours whereas the modern world has narrowed down its time expectation to days,  
31 hours, minutes or seconds (Studeny, 1995). Similarly, walking used to be the main mode of  
32 transportation so that a transit time would conventionally refer to the walking mode. The modern  
33 pattern is thus much more complex due to the diversity of speed frameworks. Besides, the  
34 transportation time always having little fluctuations, there is thus an underlying concept of  
35 probability for a confidence interval in regards to the time taken to link two points of space: the  
36 reliability of the transportation system.

37 The previous framework has an important consequence in regards to the space of circulation of the  
38 economic actors. As presented in **Figure 24**, we can distinguish three areas, the one in which the  
39 transportation system ensures the economic actor situated in  $A$  that his production can reach  
40 potential customers with a probability of 100% under the time constrain set, the one in which this  
41 probability is not a certainty but is possible and the last one for which such exchange is impossible.  
42 Consequently, the transportation system only gives the maximum circulatory space for an economic



1 actor setting a time constrain on his activities. It does not state what the circulatory space will be.  
 2 This is clearly shown in **Figure 24** by the absence of identity between the space of circulation of the  
 3 firm situated in A and the portion of space that can be reached under time budget T with a  
 4 probability >0.

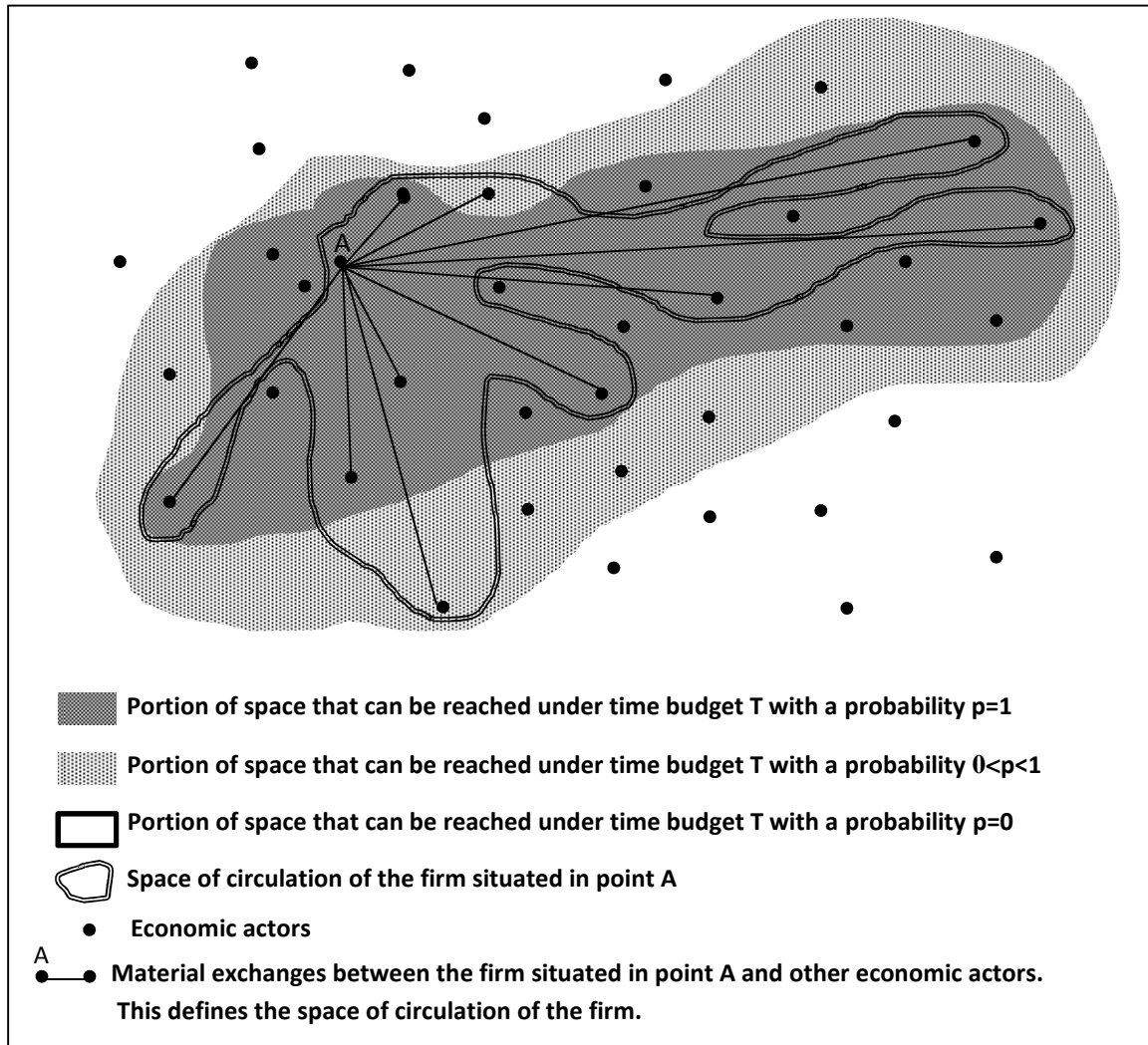

5  
 6 **Figure 24 : The role of the transportation system in the definition of the space of circulation**

7 The previous framework showed that the circulatory space was confined in a broader space  
 8 dependent on the transportation system and time budget decided by the economic actors. This  
 9 pattern is usually called geographic proximity. Indeed, the geographic proximity is defined by the  
 10 itinerary, functionally expressed in terms of cost or/and time and is of course dependent on  
 11 transport services and transport infrastructures (Rallet, et al., 2004).

12 The previous framework thus does not provide any indication on why particular actors situated in the  
 13 broader space frontiers will exchange. The geographical proximity is thus not sufficient to explain  
 14 why the actors exchange one with the others. This leads us to consider proximity as being dependent  
 15 on two other forms of proximity (Gilly, et al., 2005):

16

1 • The organizational proximity corresponds to the close similarities between the resources owned by  
2 different actors. For example, the industries which belong to the same branch have similar  
3 technology of production. The different establishments of a same firm share the financial resources,  
4 sometimes the same human resources. The organizational proximity is thus linked to the issue of  
5 resource and networks (cooperation network, activity sectors, local product system, etc.).

6 • The institutional proximity is based on the adhesion of the actors to explicit (contract) or implicit  
7 (convention) common rules, and in some case to a common system of representation and values.  
8 Such is the case as we already saw of the theories of value which guide the understanding and the  
9 normalization of the economic life. We also saw with the case of money that the legitimacy of the  
10 institution and thus the associated proximity is never acquired forever. It is indeed often the results  
11 of compromises and struggles between actors with diverging and contradictory interests or  
12 representations.

13 In summary, once abandoned the centralization of the economic exchanges (neoclassical economy)  
14 and the idea that outlets are expanding naturally for the greatest good of all, it appears clearer that  
15 every exchange is a particular process, locally linking two actors. The three types of proximities  
16 described above play an important in the description of this process as they all constrain and at the  
17 same time allow the exchange to take place. As shown in **Figure 25** the logistics theory is the study of  
18 how the three proximities combine each other through four factors (time, space, technology, and  
19 social processes) to determine the potential of exchange. In this framework, transportation is the  
20 part of the logistics theory focusing mainly on the geographical proximity while logistics is usually  
21 used to describe the influence of the two other proximities on economic exchanges.

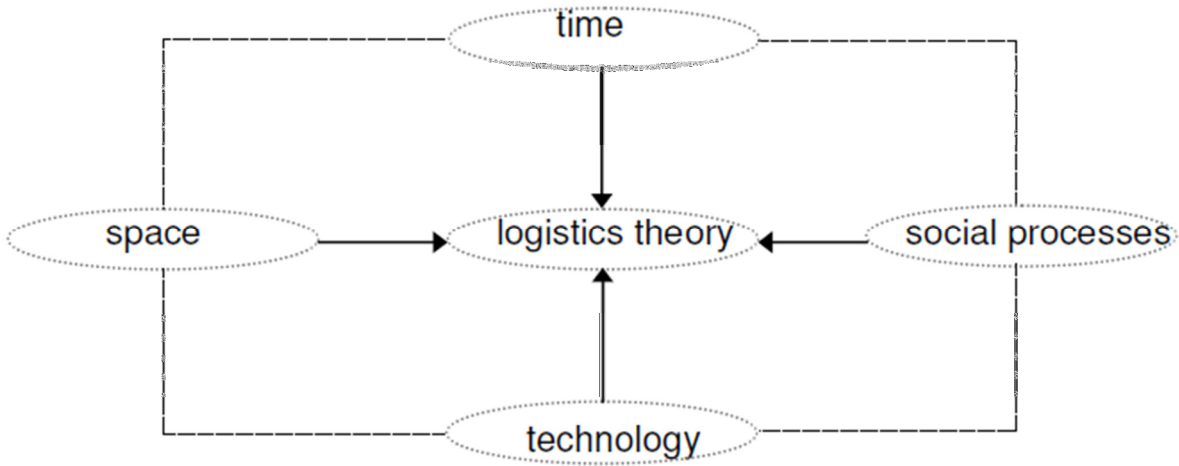

22  
23  
24  
25  
26

**Figure 25 : core concepts of logistics theory for analyzing networks (Nikkanen)**

## 2 Transportation and logistics

### 2.1 Transportation or the conditions of geographical proximity

#### 2.1.1 The physics of transportation

Transportation deals with the change of space and time coordinates of an object or a person. Therefore, let us consider an entity of mass  $M$  moving from point  $A(\varphi_A, \lambda_A, z_A, t_A)$  to point  $B(\varphi_B, \lambda_B, z_B, t_B)$ , the physics gives us the quantity of movement as the following expression:

$$\vec{p} = M\vec{v} = Mv(t) \frac{\overrightarrow{AB}}{\|\overrightarrow{AB}\|} \text{ et } \|\vec{p}\| = Mv(t)$$

The points of space A and B are described uniquely with latitude, longitude and altitude<sup>69</sup>. The time  $t_A$  thus corresponds to the moment where the object of weight  $M$  is confounded with the point A while the time  $t_B$  corresponds to the moment where  $M$  is confounded with B. Initially, the entity  $M$  is immobile in A and B, so that the transportation process implies that the speed of entity  $M$  varies in time. In other terms, the transportation process is characterized by the management of the acceleration process. We know from classical physics that acceleration and the time derivation of the quantity of movement is depending on the external forces exercising on the object. We will distinguish these forces in four categories:

- *The motrice force operated by the means of transportation.* For example, a car needs to operate its engine to move from an initial mobile position. The motrice force corresponds to a positive acceleration, i.e. an increase of speed.
- *The friction force operated by the means of transportation.* Similarly, to stop a car, there is a need to actionnate the brakes which create a negative acceleration, i.e. a decrease of speed.
- *The motrice force operated by the environment.* Due to the position of objects or persons in space, the environment can play a role in the transportation. For example, if a car is on the up of a hill the gravity can make the car go down the hill without any need of other motrice force.
- *The friction force operated by the environment.* Due to the contact of objects and persons, the movements are interrelated in a sort of network. For example, when moving the object in air, the contact with this medium generates a resistance which diminishes the speed of the object.

To obtain the desired movement, i.e. the desired speed, it is thus necessary to control the motrice and friction forces operated by the means of transportation to compensate for the motrice and friction forces of the environment which may be or vary in a unwanted manner. The framework of transportation is thus represented by the scheme of **Figure 26**. In this scheme, the friction depends on the interaction between the transportation system and its environment. Notably, such as mass, geometry of the transport system play an important role. Going further, if we consider an object, it

---

<sup>69</sup> Actually, altitude can vary in times. For example, peak of mountains can diminish or increase with time so that the period analysis should be given to obtain an accurate analysis.

1 cannot provide any motrice force by itself so that an equipment will be needed. This equipment  
 2 which is called vehicle also modifies the interface of the initial object with the environment and thus  
 3 the characteristics of the friction. Therefore, the transportation system studied is never the object  
 4 alone but the object plus its vehicle plus its manager (driver).

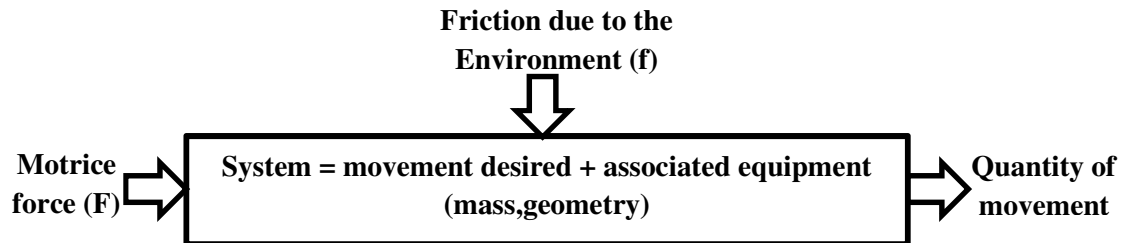

5

6 **Figure 26 : General framework of transportation issues**

7 Transportation concerns the management of the quantity of movement determined through time  
 8 constraints on a desired movement of goods or persons between two fixed points on Earth.  
 9 Depending on the quantity to be transported and the desired speed, it appears necessary to find a  
 10 source of energy able to provide a motive force to the vehicle and that can be controlled. Part A) of  
 11 **Figure 27** represents this kind of relationships between the quantity transported and the speed of  
 12 transportation. In a world where energy is rare, only a small quantity of object can be transported  
 13 and only at low speed. When the energy resources increase, two kinds of worlds are offered to  
 14 travelers. Either they decide to maintain low speed and use the supplementary energy to transport  
 15 more products, i.e. more items or heavier products, or they can also decide to increase the speed of  
 16 transportation and maintaining a control over the quantity transported. Such choice was faced at the  
 17 beginning of modernity with the apparition of railways.

18 *“By giving to travelers the habit of speed, it soon becomes a need, and consequently makes the*  
 19 *transporters load less good. [...] Some people complain about the high load of public coaches; they*  
 20 *were pushed this way; some people complain about their slowness, they were pushed this way. The*  
 21 *combination of current prices is in favor of big loads, unfavorable to speed<sup>70</sup>.”* (Caron, 1997) (p.64-68)

22 Finally, the modern world has evolved to reach today the state of a world where energy is easily  
 23 accessible in high quantity. In this perspective, both high speed and high load can be reached. The  
 24 main problem is no more related to the possibility of speed but on its organization through other  
 25 concepts such as safety and comfort. However, the depletion of petroleum resources which serve as  
 26 an energy basis for the transportation system has reached warning levels questioning the possibility  
 27 to maintain in a high energy world. In regards to this remark, there are only two possibilities. Either a  
 28 new source of energy is found for transportation and our society can maintain in a high energy world  
 29 or our society will have to evolve towards a medium or even a low energy world.

---

<sup>70</sup> Own translation

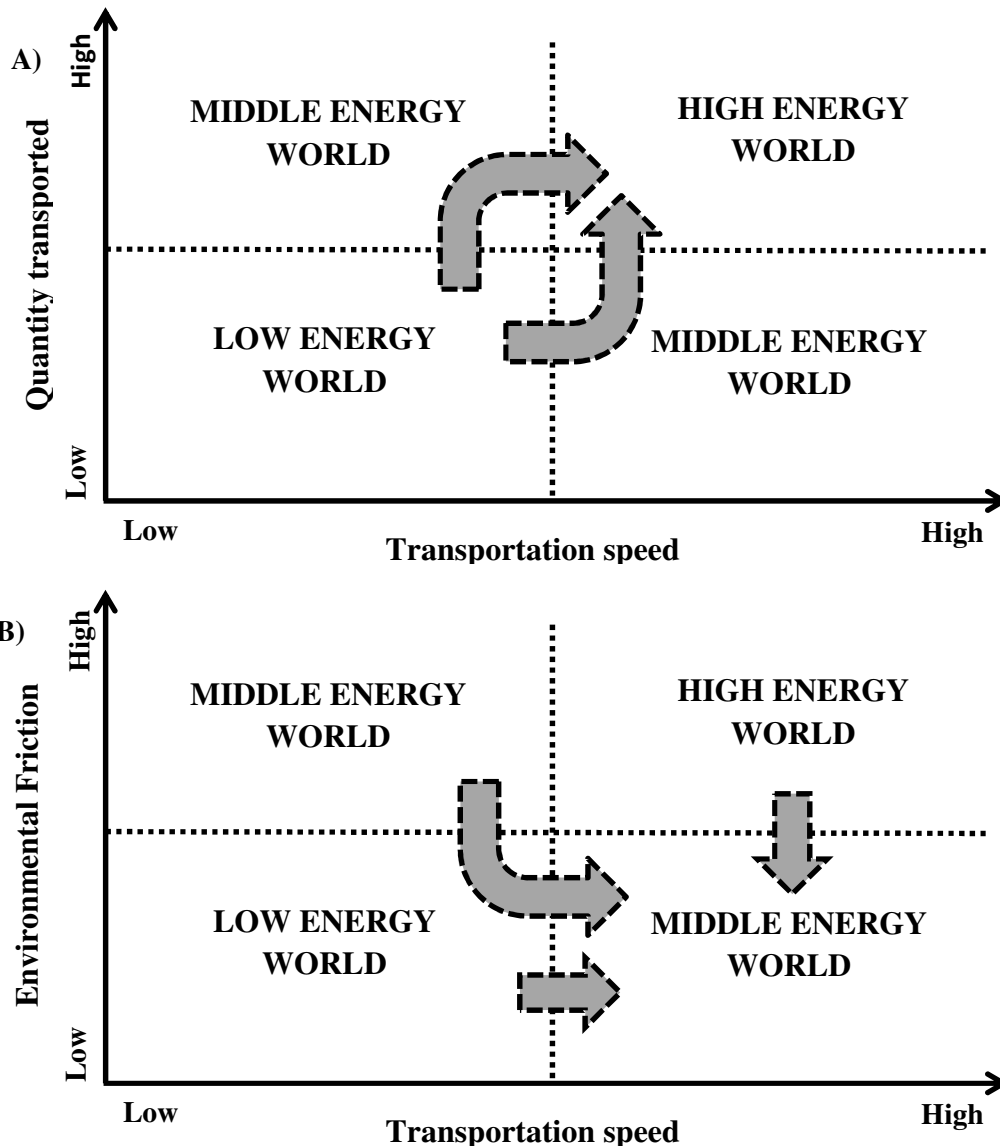

1

2 **Figure 27 : A) Energy as a trade-off between quantity transported and speed of transportation. B)**  
 3 **Relationship between speed and energy from a friction view.**

4 Similarly, part B) of **Figure 27** presents the consequences of friction on the possibility to reach the  
 5 desired speed. A high friction supposes a high opposition to movement so that speed can only be  
 6 reached with a high use of energy. A high friction world thus condemns either to a high energy world  
 7 or to a low speed world. But even if the energy may be accessible in high quantities, the energy spent  
 8 here is considered as being wasted because such energy cannot be used to increase the quantity  
 9 exchanged. The strategy thus consists in building an artificial environment in which friction is  
 10 controlled to a low level. This artificial environment must be adapted to the means of transportation  
 11 used. This artificial environment is usually called an infrastructure. We can thus differentiate  
 12 pedestrian infrastructure, road infrastructure, railway infrastructure, waterway infrastructure, etc.  
 13 The important feature is that transportation can finally be understood as a superposition of different  
 14 network. Indeed, if we follow the pattern of **Figure 28**, we can observe a connection when it comes  
 15 to transportation between an object, a person and a means of transportation. Let us consider that  
 16 we are making seven observations during a defined time period, for example one hour. At each of

1 this observation, we note the position in space of the object, the person and the means of  
 2 transportation, for example a truck. We thus create three schematic representations of networks by  
 3 linking these observations by simple lines. These schematics representation can nevertheless be  
 4 close to the real trajectory at the condition that the number of observations tends towards infinity.  
 5 These three networks can be linked by their superposition in space. For example, the use of a vehicle  
 6 by a person to transport the object is symbolized by the line 4-5. Similarly, we have the  
 7 correspondence in space of the person and the object on the line 5-6. This could correspond to the  
 8 case where a person loads his good purchased on his car in 4, drives until his house in 5, leaves the  
 9 car there which is used by another member of the family (line 5-6 of means of transportation),  
 10 transport his good purchased to his fridge in the house before leaving the good purchased there and  
 11 going for other businesses. The construction and the interconnection of these different networks are  
 12 thus essential to understand the physical principles of transportation.

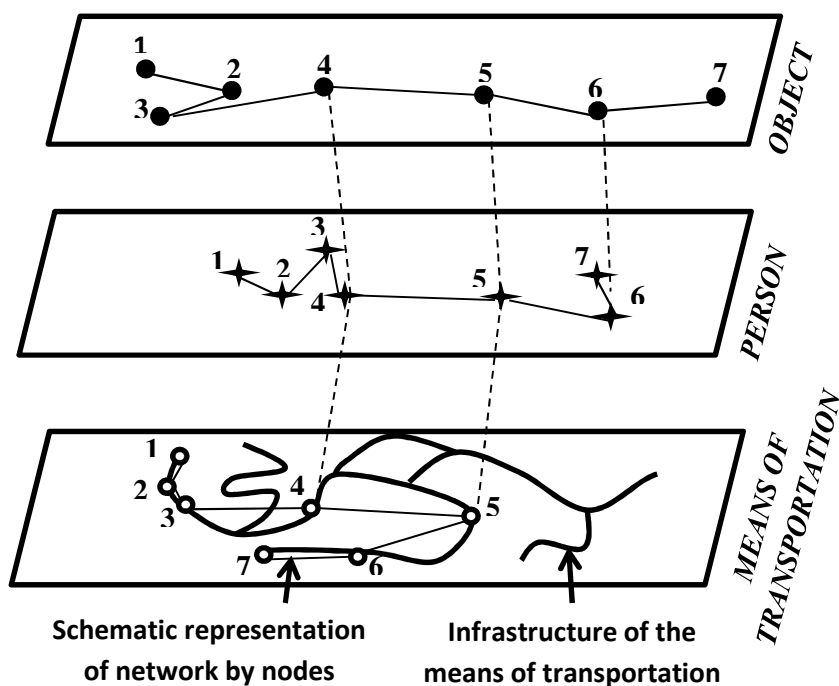

13

14 **Figure 28 : Transportation process as a superposition of networks**

15

16 **2.1.2 The role of infrastructure**

17

18 The previous schemes about the relationships between transportation speed, quantity transported,  
 19 and environmental friction are illustrated by the history of the development of infrastructure.  
 20 Indeed, the evolution of infrastructure appears to be a combination of an evolution in the area of  
 21 energy engineering and the construction of new networks. For example, if we follow the course of  
 22 history, the first transport mode to be used is road transportation together with horses as a prime  
 23 mover. At that time, both the natural and man-made infrastructures allowed for only modest  
 24 amounts to be transported at high costs with low speed and low quality of service. The average  
 25 transport speed for passengers did not exceed about 3 kilometers/hour (km/hr), i.e. walking speed  
 26 (Voigt, 1965). This was even true for France, where the highest quality transport infrastructure

1 existed as a result of Colbert's efforts in the early construction of canals and roads within the  
2 framework of a centralized mercantile policy. The transportation of goods by river or by roads was  
3 even slower (typically around 1.5 km/hr) and the costs were exceedingly high (Voigt, 1965).

4 *"Consequently, longer distances were covered only by the most valuable "objects": human beings,*  
5 *information (mail), and high-value products (salt, spices, precious metals, textiles, luxury goods, etc.).*  
6 *The inadequacy of the transport infrastructure to carry large amounts of goods at modest costs to*  
7 *areas not endowed with natural infrastructures, like rivers or seaports (one of the most decisive*  
8 *locational factors for the foundation and growth of medieval cities), resulted in the repeated scarcity*  
9 *of local resources. Frequently the supply of food to areas where harvests had failed from other*  
10 *regions with abundant supplies was not possible, resulting in famines. Similarly, the so-called*  
11 *"fuelwood crisis" (see e.g., (Sieferle, 1982)) in 16th and 17th century England was not so much an*  
12 *"energy crisis" in that there was a lack of wood, but rather it was impossible to transport fuel wood*  
13 *and charcoal from areas with large supplies to the main centers of consumption (especially to the iron*  
14 *industries and cities)." (Grübler, 1990)(p.73)*

15

16 In other terms, the physical constraints led to a strict separation of the space of circulations inside  
17 which each actor had to manage the exchanges leading under local and particular circumstances to  
18 shortages such as starvation. The first change in this situation was operated in the waterway network  
19 through the construction of canals. Indeed, water offers less resistance to movement than soil and  
20 the sails allow taking advantage of wind which can reveal a quite high natural energy source though  
21 not really flexible or reliable. The importance of canals as a transportation system was seen long  
22 before the starting of their first constructions during the 15<sup>th</sup>-18<sup>th</sup> century period. For example, the  
23 first canal plans to link the Rhine-Main river system to the Danube is as old as the period of  
24 Charlemagne, although the canal was built only in the 19<sup>th</sup> century. However, only Netherlands and  
25 France built canals to any significant extent before the industrial revolution, e.g. from 156 km at the  
26 end of the 16<sup>th</sup> century to some 1000 km at the end of the 18<sup>th</sup> century for the French inland  
27 waterway network (Toutain, 1967). The canal age nevertheless started in England as a result of rapid  
28 early industrialization. Indeed, as explained before, the industrialization through the development of  
29 technics and the division of work created a system in which the notion of profit (operating surplus)  
30 plays a fundamental role. In such context, the increase in productivity (driven by the division of work  
31 and the concentration of capital) and thus the increase in the quantity of products to be traded led to  
32 the necessity of extending the market, i.e. the space of circulations. This extension first necessarily  
33 supposed the development of a transportation system able to reach distant land and able to support  
34 the quantity traded. The research of high capacity transportation was thus the first step taken by the  
35 industrialization process. However, the poor spatial coverage of this transport system (waterways)  
36 represented a major impediment in England's early industrial development. Actually, coal deposits  
37 located only a few kilometers away from rivers or seaports were practically unexploitable, due to the  
38 inability of joining the space of circulation driven by the waterway network. Similarly, early iron  
39 works had considerable logistics problems regarding the supply of basic materials (iron ore, charcoal,  
40 and later coal and coke) and for the delivery of final products (wrought iron) (Grübler, 1990)(p.75).  
41 Over 4000 km of canals were nevertheless built in the period 1760 to 1850 with impressive economic  
42 impacts on the lowering of transport cost and the growth of new industrial centers. . For example,  
43 after the completion of the Bridgewater canal, the number of workers in the pottery industry in the  
44 area increased from 7,000 to nearly 20,000 (Voigt, 1965). Canal construction and operation were also

1 clearly linked to the principles of capitalism as dividends of 70 percent annually or even over 150  
2 percent in peak years were reported ( (Sax, 1920), and (Duckham, 1983)).

3  
4 However, the expansion of canals finally stopped for many reasons. A first one is due to the natural  
5 limits posed by canals which ask for water as a medium. In other terms, the unavailability of a  
6 sufficient energy source to allow for transport of large quantity on land (i.e. where there is no water),  
7 make the trade remain confined along the waterways. This changed with the development of  
8 railways as a new inland transportation system which overcomes the limitations of the road  
9 transportation system based on horse power. Indeed, steam power which was first used by  
10 machineries in industries to improve the productivity turned out to also be a good prime mover for  
11 inland transportation systems. However, in the same way canals represented a modification of the  
12 natural environment for the purpose of waterway transportation, the development of railways  
13 called for the development of a dedicated infrastructure, namely the iron wagon way. And it is only  
14 the combination of the two, an infrastructure and a technology quantum leap, which allowed the  
15 take-off of the new infrastructure system. The success of railway was quite tremendous  
16 accompanying the extension of the circulatory spaces. For example, the French railway network  
17 extended to as much as 42.6 thousand kilometers in 1933, date of its maximum length and  
18 accounted for a density of 9.7 km per 100 km<sup>2</sup> and 13.7 km per 10 thousand inhabitants in 1925  
19 (Grübler, 1990)(p.96). In comparison, the today's exploited French railway network is 29 273 km<sup>71</sup> for  
20 a flow of 15 000 trains per day, a 31% drop in comparison to the maximum length. However, the  
21 length of railways has always remained far beyond the importance of the road transportation  
22 network. Indeed, Extensive road networks existed long before the advent of the automobile. For  
23 example, the French road network of the 1890s consisted of over 500 000 km of roads (Toutain,  
24 1967), compared to 1985 with 800 000 km (INSEE, 1972 to 1987) and to 2010 with 1 050 117 km<sup>72</sup>.  
25 We thus see the apparition of a quantum leap of one magnitude order between the lengths of the  
26 three transportation modes network, from a 3 magnitude order for inland waterway to a 5  
27 magnitude order for road transportation. Besides, it clearly appears that the today's predominance  
28 of road transportation is not only related to the extent of its network but primarily to a shift in the  
29 kind of energy carrier used. Indeed, the diffusion of cars was made in two phases, one corresponding  
30 to the replacement of horses thus occupying its network and then the progressive replacement of  
31 railways when similar or even better speed was able to be reached thanks to motor engine. This  
32 process is clearly announced by Grübler when he wrote:

33  
34 *"Roads were first surfaced to serve horse driven vehicles and the same infrastructure could*  
35 *subsequently be used by the automobile, when in turn it started to replace the horse on the street.[...]*  
36 *Among these comparative advantages we rank in first place improved performance in terms of*  
37 *speed, range, and ease of use. Average transport speeds of automobiles increased quickly from*  
38 *around 30 to some 50 km/h [average transport speed on highways was higher; for 1940 an average*  
39 *speed of 40 miles (i.e., 60 km/h) is reported, (U.S. Department of Commerce, 1975), compared with*  
40 *the typical 10 km/h for average horse carriages. Higher speed and ease of use (no changing of horses*  
41 *over long-distance journeys) meant a considerable extension in the travel range which could be*  
42 *covered. Another aspect of ease of use of the automobile was a significant reduction in inventories*

---

<sup>71</sup> <http://www.rff.fr/fr/le-reseau/>

<sup>72</sup> [http://www.developpement-durable.gouv.fr/IMG/pdf/Rep\\_transports\\_2012.pdf](http://www.developpement-durable.gouv.fr/IMG/pdf/Rep_transports_2012.pdf)



1 [stables, storage of food - a horse consumes over 25 kg of food per day in the form of bulky hay, oats,  
 2 etc., (Montroll, et al., 1974).” (Grübler, 1990) (p.145-146)

3  
 4 The transportation system has thus always evolved towards a system of high energy allowing higher  
 5 quantity of goods to be moved at a higher speed. In other terms, under a constant travel time budget  
 6 constraint, systems that are faster and allow for a wider human activity range gain a decisive  
 7 comparative advantage over competitive systems (Grübler, 1990)(p.291). This evolution of speed is  
 8 clearly presented by the trends<sup>73</sup> observed in Figure 29 : Transport speed trends, in km/hr. (Source:  
 9 adapted from )**Figure 29.**

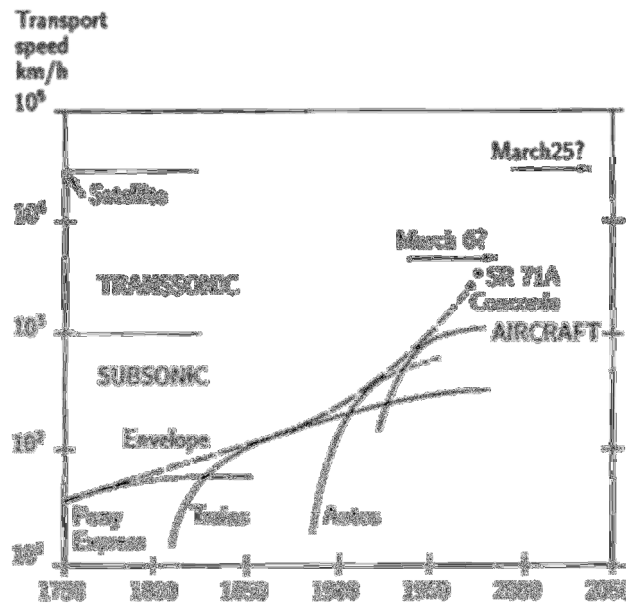

10

11 **Figure 29 : Transport speed trends, in km/hr. (Source: adapted from (Samaras, 1962))**

12 **Figure 30A)** and **Figure 30C)** also show the same exponential evolution for passenger and goods  
 13 transportation over the last two hundred years. During this period, the average distance travelled  
 14 daily for French people has been multiplied by a thousand, i.e. a 3 magnitude order, from 50 m to 50  
 15 km. Similarly, the total ton-kilometers driven have evolved from around  $10^9$  ton-km to  $2 \cdot 10^{11}$  ton-km,  
 16 i.e. a 2 magnitude order. During this expansion process, the predominance of an infrastructure  
 17 changes in what seems a substitution process from small circulatory spaces to bigger circulatory  
 18 spaces with an increase of the speed and quantity allowed on the infrastructures. Indeed, **Figure**  
 19 **30B)** and **Figure 30D)** show that road transportation is now the predominant transport mode in  
 20 terms of passenger-km shares<sup>74</sup> and tons-km shares<sup>75</sup>.

<sup>73</sup> the next main transport mode should thus be air transportation, probably followed by other transportation mode able to reach even Mach 25, i.e. 25 times the sound of speed (the sound of speed is 340 m/s or 1224 km/h)

<sup>74</sup> One could note in the graphic that the two world wars introduce a gap in the expansion and substitution process. But this gap is only a time delay, the expansion and substitution process taking over at the end of war.

<sup>75</sup> The picture for good transportation is here less clear as railways and waterways still cover an important share of the ton-km driven. Indeed the passenger market has weight limit linked to the weight of population and is also a high-value market niches while the good market is more diverse covering high-value and low market niches.

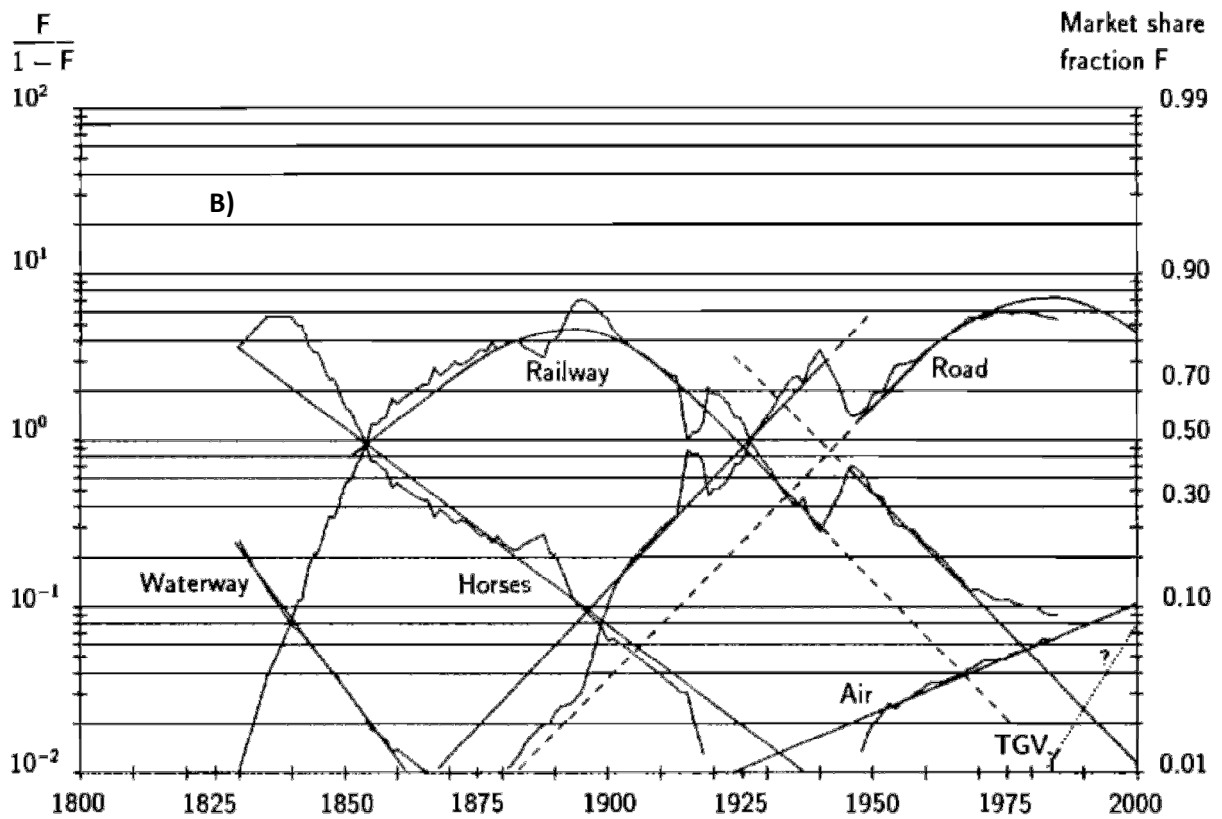
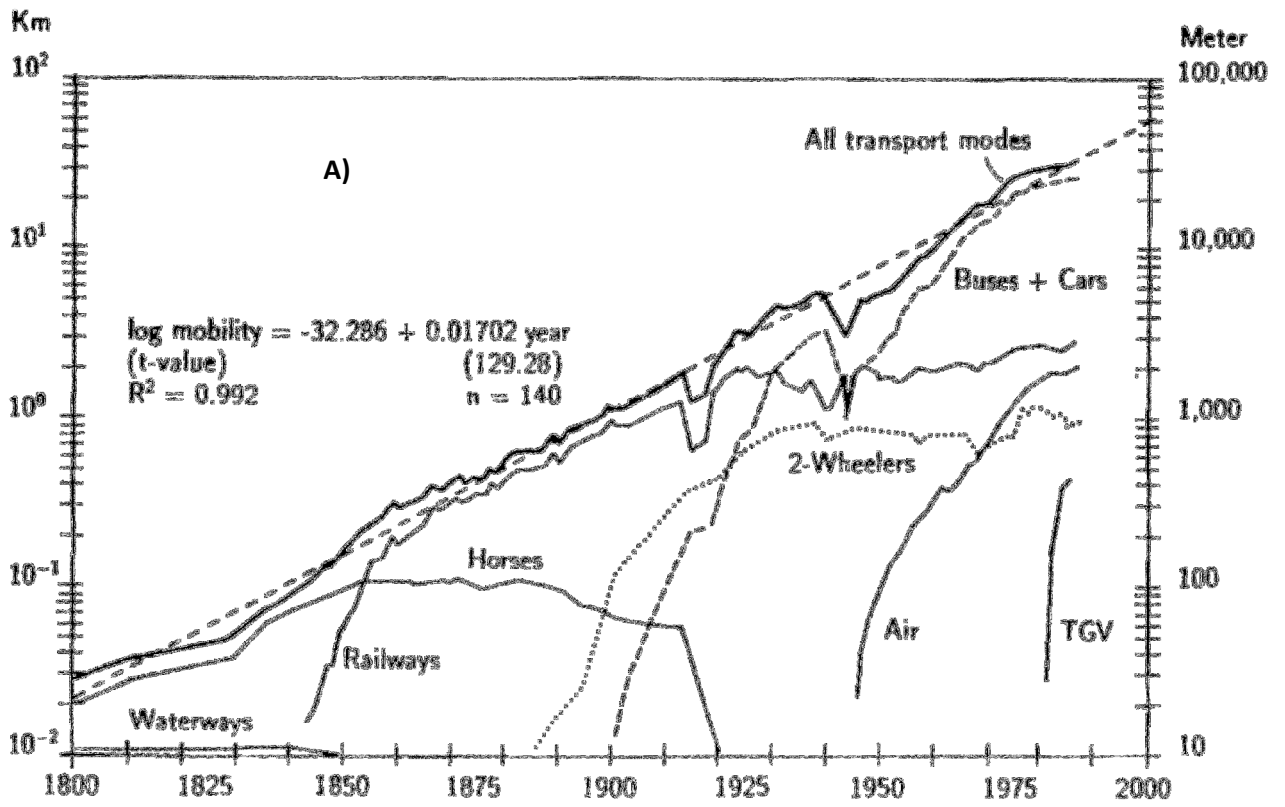

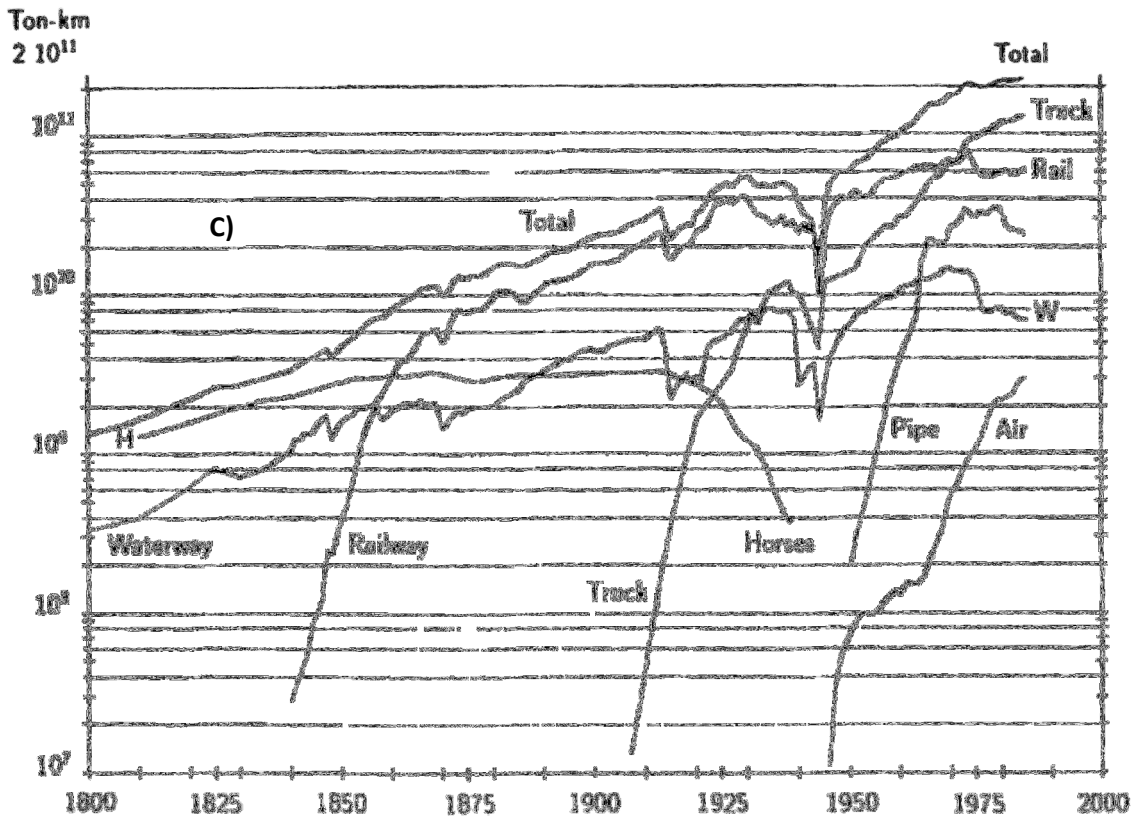

1

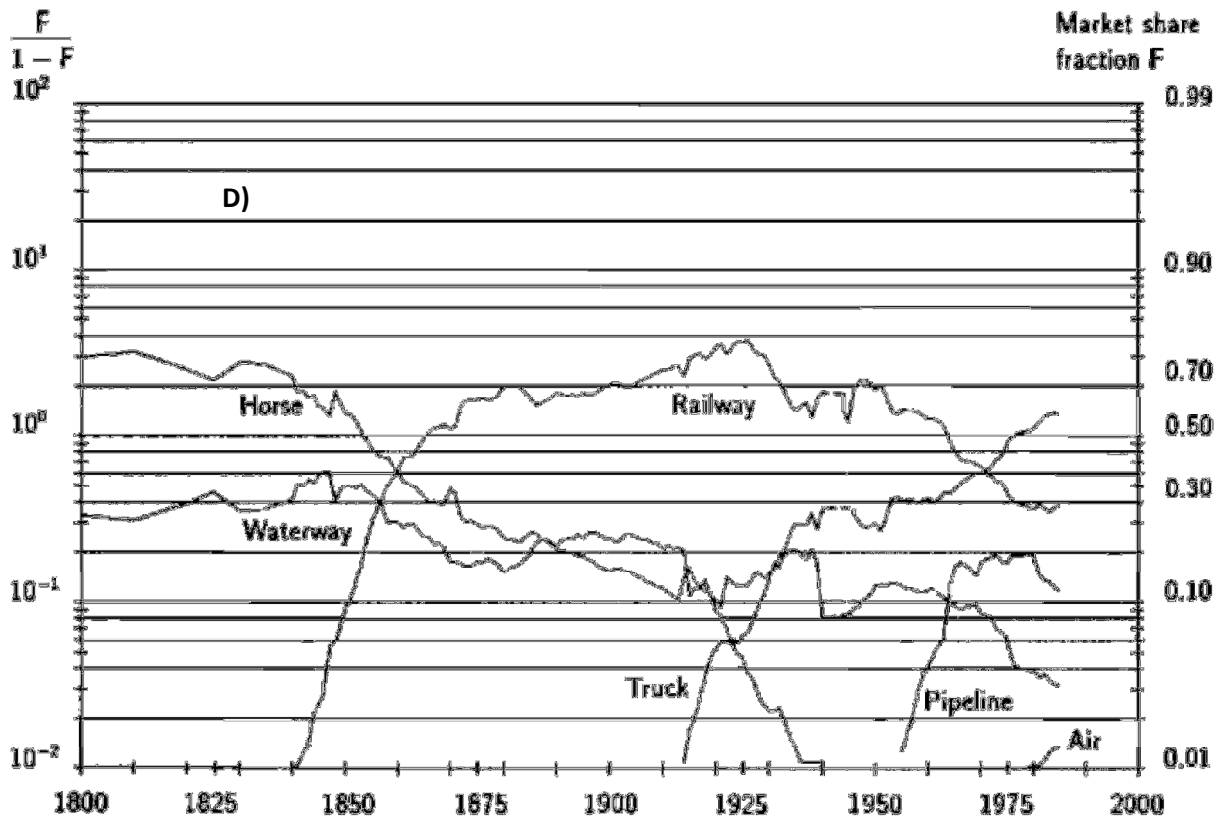

2

3

4

5

6

7

Figure 30: A) Range covered (average km travelled daily) per capita in France by mode and total since 1800. B) Passenger (intra-and intercity) modal split in France, fractional shares of passenger-km performed and model estimates. Growth trend for TGV is speculative C) Goods transport output by different mode and total in France since 1800, in  $10^9$  ton-km performed. D) Modal split in goods transport in France, in fractional shares of ton-km transported

### 2.1.3 Transportation and geographic proximity

The historical development of infrastructure described in previous section showed a pattern that can be identified to a lifecycle from high-value niches to low ones:

*“The competitive pattern outlined above stresses the importance of comparative speed and service advantages as well as of price insensitive high-value market niches (passengers and information, later high-value goods) for the growth of a new transport system. [...] The life cycle of railroads is characterized by penetrating first into the highest value market niches, and then conquering (via tariff reductions) progressively lower-value market niches. At the end of this process railways take the character of an indispensable (price and government controlled or owned) basic “commodity”, becoming in turn vulnerable to competition from new transport systems, with improved quality characteristics. In perfect symmetry to their own success story, railways started to lose high-value market niches first (passengers to cars and mail to aircraft), and in due course were forced to concentrate more and more on lower value goods to be transported.” (Grübler, 1990)(p.130)*

The development of infrastructures thus enabled to link different circulatory spaces that were first separated for physical reasons. We consequently have a pattern similar to the one presented in **Figure 23** when an existing barrier to exchange disappears. But the absence of a barrier does not mean that exchange will take place. The success of any new transport system thus depends on a number of functional criteria. These criteria include first, a synergistic development of a new technology (prime mover) base *in combination with* a new infrastructure system (this is the end of physical barrier). Second, during the initial growth phase of a new infrastructure the *complementarity to and independence of* existing infrastructures is important. Independence is possibly the most decisive factor in the emergence of new transport infrastructures because *new institutional and organizational* settings are required for the construction and successful operation of such systems (Grübler, 1990)(p.291). The independence criterion is for example linked to the different kind of environment considered. Such is the case for the rail network which developed itself on an environment (land) not reachable by the waterway network. The key notion posed by the infrastructure system and the physics associated is thus accessibility. Indeed, the accessibility of a place from another place measures the easiness of the travel linking these places together (Huriot, et al., 1994). This measure depends directly on the quality of the connection, i.e. the topology of the network together with its functional characteristics such as the authorized speed, the width of infrastructure, or the disruption of the traffic (Thévenin, 2002). Another approach consists in integrating the interest of destinations in the notion of accessibility. This new kind of accessibility is called potential accessibility (Hansen, 1959) and for example used as a definition in Annex 13 of the DGR<sup>76</sup> instruction related to the socio – economic evaluation of road projects (Direction Général des routes, 1998). This potential accessibility can be defined as the quantity of goods, employment or the volume of population an individual can reach from a given point of space, given the transportation infrastructure, his transportation behaviour and the attractiveness of possible destinations. The main idea is that the opportunities offered by a territory have a meaning only if transport conditions allow the access to these opportunities, and reciprocally the interest of the transport conditions offered by a network are dependent on served destinations (Sétra, 2008)(p.8).

---

<sup>76</sup> DGR= Direction générale des routes (General Direction of Roads)

1 Consequently, the notion of accessibility is dependent on the objectives assigned to its calculation.  
2 The diagnostic of an existing network will imply a different kind of accessibility than for the  
3 construction of a new transportation infrastructure, the diagnostic of the spatial planning of a  
4 territory or the determination of the efficiency of a particular customer catchment area. Besides, the  
5 accessibility is greatly dependent on the time and the place of definition. Indeed, two points situated  
6 a few meters away can have very different accessibilities because infrastructures are of a linear  
7 nature. For example, moving a heavy good one meter away railway supposes to abandon the  
8 railways as an infrastructure. Railways such as waterways are strictly dependent on their  
9 infrastructures. Going further, the accessibility conditions between two points of a territory vary  
10 greatly with the moment of the day or the time of the week, month or year. This leads to the  
11 necessity of being accurate in the definition of the reference accessibility in time and space<sup>77</sup> to be  
12 able to compare different situations<sup>78</sup>. For transportation of goods, the accessibility often refers to:

13

- 14 • Accessibility from/to logistics centers: level of service.
- 15 • Accessibility of heavy trucks to the territory with a comparison between highways and other road  
16 networks.
- 17 • Accessibility assessed from the comparison of two or more variables for the railway transportation.
- 18 • Accessibility to territory compared between road and railway networks.
- 19 • Hinterland of a harbour, airport, industrial district, etc.
- 20 • Variation of potential market area accessible to shippers.

21 The calculation of the previous accessibilities is also dependent on laws. For example, in the travel  
22 time of truck, the regulatory constrains (CEE, 1985) define a common rule applicable to all drivers (45  
23 minutes of rest after driving 4h30). This kind of accessibility framework is presented in **Figure 31**.<sup>79</sup>

24 However, the notion of accessibility was mainly created for the design of new infrastructures and the  
25 analysis of person transportation. It is thus less relevant to assess good flows. Indeed, the logistic  
26 chains specificities lead to the conclusion that the notion of travel distances or time distances are not  
27 relevant to represent the choice of shippers and transporters. For example, a shipper can choose a  
28 slow mode as the waterway network to realize economies on storage. Similarly, the attractiveness of  
29 a harbour for a shipper also depends on the transport services associated with it (served countries,  
30 regularity of maritime trade lines) and the quality of the services (reliability, management of hazards,  
31 rapidity of custom clearance procedures, etc.) (Sétra, 2008).

32 In other terms, the accessibility becomes only one element in the choice of logistics organization.  
33 And as long it does not forbid total access to a space of circulation, logistics are ruled by the stakes of  
34 geographical and institutional proximities.

---

<sup>77</sup> Therefore, as in relativity mechanics, a point of space must be described in 4 coordinates. The reference point is (0, 0, 0, 0). The comparison is thus made “*ceteris paribus*” which translates the beliefs in a cycle in the characteristics of the transport network.

<sup>78</sup> See for example (CETE Lyon, 2003) for examples of accessibility calculations.

<sup>79</sup> The graph is in French. A reading grid is written in English to help readers to better understand the graph. The present note also provides basic translation for some words of importance (repos = rest, port = harbor, fluvial = waterway, ferroviaire = railway).

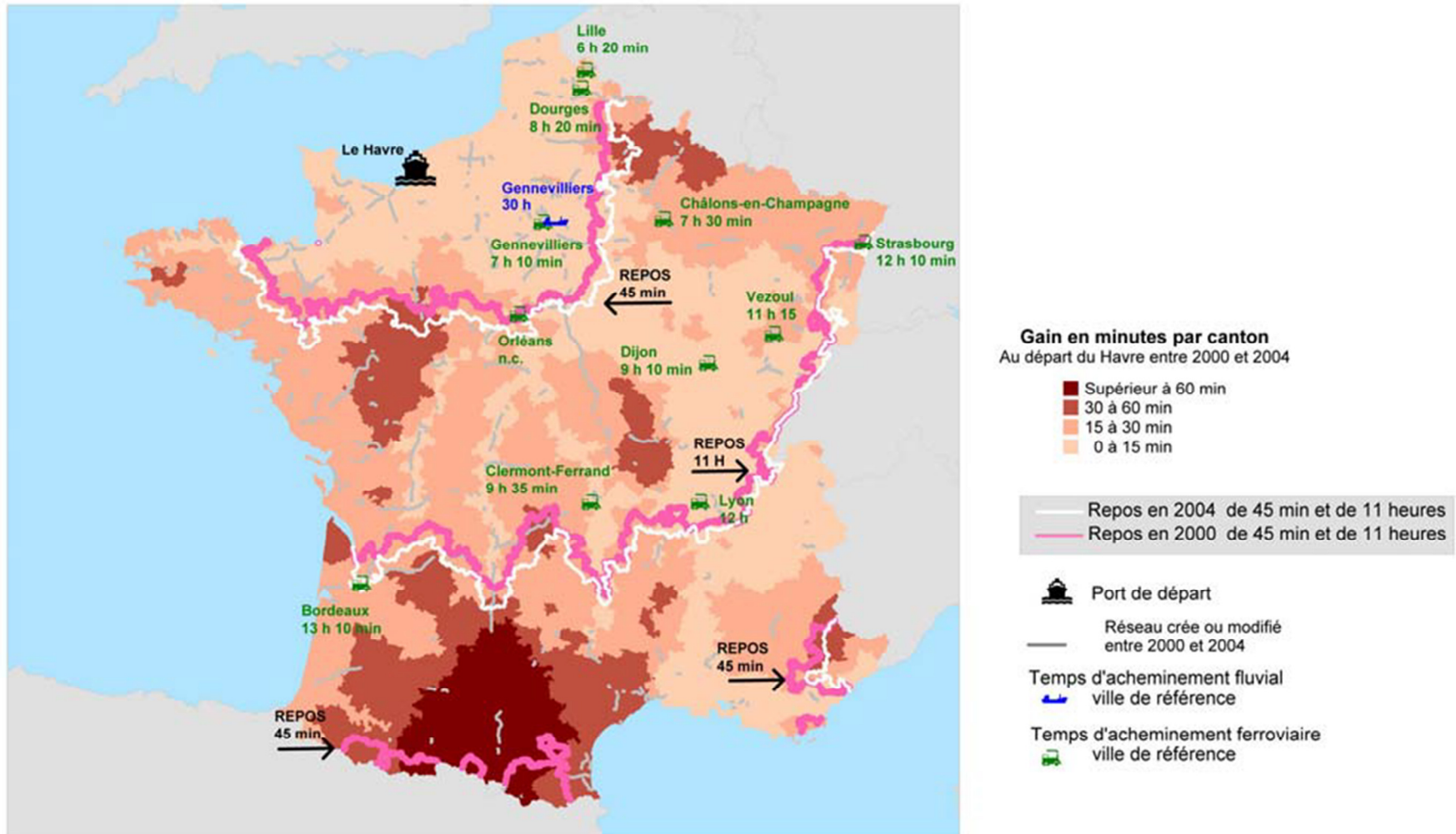

1

2 **Reading:** Genevilliers is accessible from “Le Havre” harbor in 7h10 by train and 30h by boat while it takes less than 4h30 by truck. On the opposite, it takes 13h10 by train to reach Bordeaux  
 3 from “Le Havre” harbor and much more time by truck because of two compulsory resting time (after driving 4h30, a 45 min rest is compulsory and the driver cannot drive more than 9h00 per  
 4 day without taking a 11h00 rest)

5 **Figure 31 :** The accessibility from the “Le Havre” harbor to different part of the French territory (Sétra, 2008).

1 **2.2 Logistics or the conditions of organizational and institutional**  
 2 **proximities**

3 **2.2.1 The system of firms**  
 4

5 Following what has been said in 1.3, the organizational proximity supposes to be able to identify the  
 6 similarities of the resources owned by different economic actors or firms. The first step thus consists  
 7 in the determination of the different types of existing resources as shown in **Table 6**.

8 **Table 6 : Criteria of differentiation of the productive and logistics organization (Burmeister, 2000)**

<b><i>Nature of the product</i></b>	Weight Volume Density value Bulk goods / batches Technological complexity Perishability Dangerousness Fragility Diversity, differentiation Commercial life cycle Degree of standardization
<b><i>Nature of the production process</i></b>	Economies of scale: small series, big series, unities Economies of variety: differentiation, diversification Continuous / intermittent production Capital intensity Flexibility Duration of the cycle of production, technical time limits Technological complexity of the production process
<b><i>Nature of the resources</i></b>	Nature of the productive equipments: generic or specific Degree of specialization of the means of production Qualification of the workforce (proportion of engineers and technicians, of women, unskilled workers) Importance of the investments
<b><i>Nature of the demand</i></b>	Type of customers Position in the sector industry Concentration of the customers (industrially / spatially) Relations with the customers Production on stock or on order Production on specification Standard or customized products Variability of the demand : seasonality, commercial lifecycle
<b><i>Spatial configuration</i></b>	Transnational Mono or multi-establishment Accessibility of the production site Spatial concentration / dispersion of the customers Spatial concentration / dispersion of the suppliers
<b><i>Organization of transport</i></b>	Cost of transport Size of the batches Diversity of batches Modes of transport Outsourcing of the transport Outsourcing of the logistics Delivery deadlines Frequency of delivery Frequency of supply Constraints on transport

1 In **Table 6**, one can identify four types of resources which are all linked to the concept of production.  
 2 Indeed, if we consider the principles of capitalism, we need to concentrate money from the firm's  
 3 surroundings. This takes the form of the firm's ability to answer the characteristics of the demand  
 4 (nature of the demand). The product chosen by the firm is to be related to the expectations of the  
 5 firm to obtain money from it (nature of products). The choice of the product is thus subordinated to  
 6 the representation of the nature of the demand by the firm. However, the choice of a product has  
 7 important consequences on the money flow the firm has to spend for the creation of the product.  
 8 Indeed, first of all, there are constrains emerging from the production process itself. It concerns the  
 9 knowledge related to the possibility of doing things (fundamental research) and how to do things  
 10 (applicative research). These processes are also dependent on the quantity and the diversity of  
 11 products that should be produced to satisfy the demand (nature of production processes). This leads  
 12 to the necessity for the firm to purchase and organize its means of production (workforce, machine)  
 13 which constitute the resources of the firms (nature of resource). The four types of resources thus  
 14 constitute a system with its own representation (institutional proximity) and links (organizational  
 15 proximity) as shown in **Figure 32**.

16

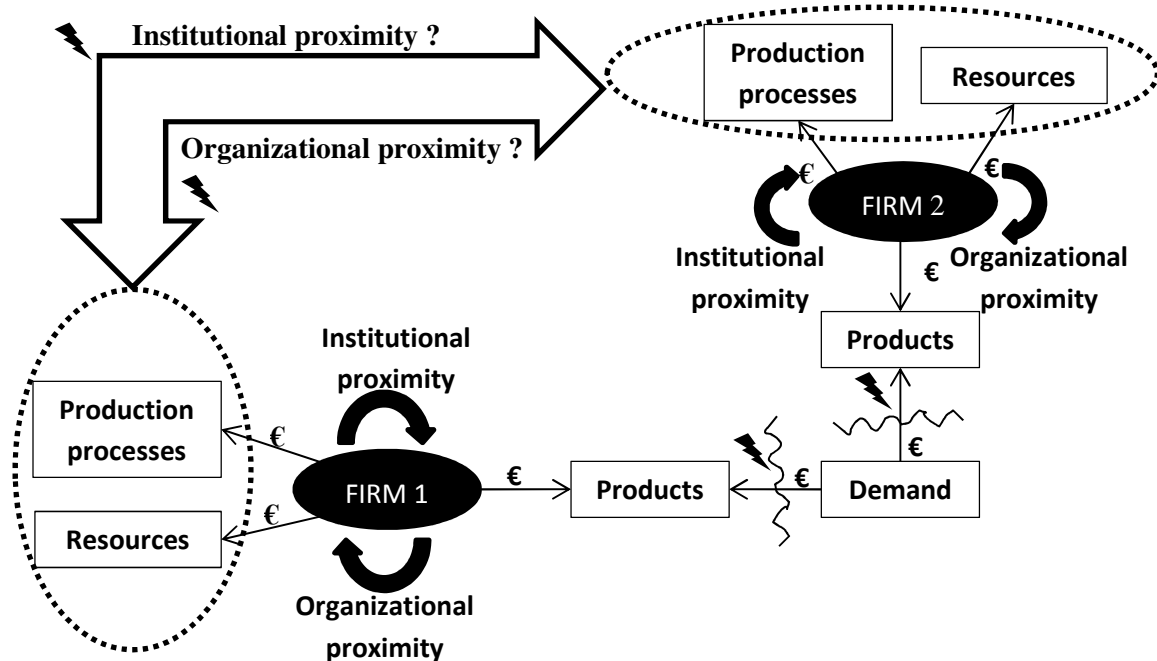

17

18 **Figure 32 : the system of proximities between firms**

19 Let us consider an establishment (firm 1), the shareholders, the managers and the workers of the  
 20 firm must share the same representation of the demand of customers and what kind of products can  
 21 meet this demand. There is thus a common system of representation and values between the  
 22 participants of the firm, an institutional proximity<sup>80</sup>. This constitutes the basis for the organization of  
 23 the firm in terms of choice of production processes, management of resources, and products to be  
 24 produced. The institutional proximity thus induces the organizational proximity which in return  
 25 stabilizes the institutional proximity by providing a structure through schemes of production, means

<sup>80</sup> Notably on this aspect can be associated the notion of corporate culture (see e.g. (Godelier, 2006))



1 of production purchased, etc. Finally, let us consider a second establishment (firm 2). We have thus  
2 the same processes with the formation of institutional and organizational proximities. The  
3 relationships between the two firms are also dependent on the framework of institutional and  
4 organizational proximities. Indeed, each establishment can be considered at the crossroads of three  
5 insertion processes (Perrat, et al., 2003):

6 - **Inside a firm (industrial group)**: This position refers to the structure (organizational proximity)  
7 driven by the expectations and representations (institutional proximity) decided at the headquarters  
8 of the firms. This concerns the functional position, the technical and productive complementary of  
9 the establishment in regards to other establishments of the group, the financial autonomy of the  
10 establishment in regards to other establishments of the group, etc.

11 - **In an industry**: This position refers to the strategy of the firm and consequently to the  
12 representations of the market to enter. For example, this concerns the choice to commit into an  
13 industrial organization or a market at a particular geographical level (regional, national, European,  
14 international, etc.).

15 - **In a territory**: an establishment is indeed spatially included in a territory, i.e. in a complex system  
16 made of relations between firms, public institutions, and other service providers. The territory is thus  
17 at the same time an organization and a system of representation spatially localized.

18 Referring to **Figure 32**, we thus see that between two firms, four types of conflicts can occur. First of  
19 all, each of them may have a conflict with the customers whose behaviors are seen as not suitable to  
20 their vision of what customers want. The advertisement is one way to solve this conflict by  
21 influencing the behavior of customers<sup>81</sup>. The second kind of conflict is the competition between firms  
22 to get customers. This supposes the firms consider they are positioning themselves on the same  
23 market, i.e. they fulfill the same kind of “utility” for the customer. In other terms, to compete, a  
24 company first has to acknowledge rivals. It is thus possible that a firm thinks of another firm as a rival  
25 but this firm reciprocally does not think the same at all. The conflict issued by competition on the  
26 customer market is thus functioning on a mimetic perception. The institutional proximity is thus a  
27 core concept of the competition between firms as they must share a common representation of the  
28 customers. On this aspect, the structure of the nomenclature of goods and the structure of the  
29 nomenclature of activities made by the SNA play the role of an important institution to help actors  
30 recognize who their rivals are. Finally, the pattern we discussed on for the customer side of the  
31 companies is the same for the supplier side. In this aspect, the firm becomes the customer and has to  
32 speak out his needs. The firm is thus dependent on establishing a more or less strong institutional  
33 proximity with the suppliers which may or may not be associated with an organizational proximity.  
34 The organizational proximity can for example become prominent if the suppliers are part of the same  
35 industrial group. Similarly, two firms producing the same things and dependent on the same  
36 production processes will have to compete for the same resources. The institutional proximity is thus  
37 in this case related to the common production factors. In the case they are production units of the  
38 same industrial group, the institutional proximity can lead to an organizational proximity.

---

<sup>81</sup> On this aspect, the whole thing is related to the fantasy of the producer. This means that for example, any increase in the sales of his products will be understood by the producer as a proof of the success of its advertisement policy. The producers will thus engage themselves in a competitive pattern of advertisements. The advertisement budget in the perfume industry is for example 1.5 billion euros, representing 12.9% of the sales (turnover) of the sector (Ministère de l'Economie des Finances et de l'Industrie, 2001).

1 **2.2.2 Two “ideal” models of circulation**

2

3 The first model of circulation corresponds to the pattern of classical economy in which the outlets of  
 4 production will always find a consumer. In this aspect, the circulation space of the firm is perceived  
 5 as made of the first supplier, the firm and the customer as shown in **Figure 33**.

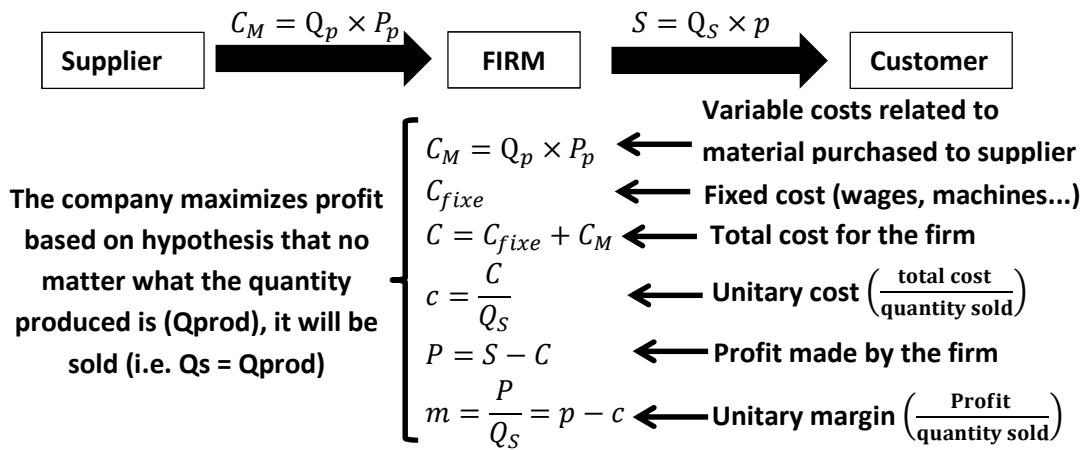

6

7 **Figure 33 : The space of the circulation of the classical economy**

8 Since the products will automatically be sold if produced, the main interest for the firm is to increase  
 9 the production (increase of  $S$ ) while diminishing the cost of production ( $C$ ). This leads to the principle  
 10 of scale economy. Indeed, let us consider the following mathematical framework:

$$C_{fixe} = C_{wage} + C_{machine} = N \times c_{wage} + M \times c_{machine}$$

$$a = \frac{Q_s}{Q_p} ; w_1 = \frac{Q_s}{N} ; w_2 = \frac{Q_s}{M}$$

$$C = Q_S \times \frac{c_{wage}}{w_1} + Q_S \times \frac{c_{machine}}{w_2} + Q_S \times \frac{P_p}{a}$$

$$c = \frac{C}{Q_S} = \frac{c_{wage}}{w_1} + \frac{c_{machine}}{w_2} + \frac{P_p}{a}$$

11 The previous mathematical framework shows six ways to ensure a diminution of unitary costs:

- 12 1) The lower a salary ( $c_{wage}$ ) is, the lower the unitary cost ( $c$ ) is.
- 13 2) The lower the cost of a machine ( $c_{machine}$ ) is, the lower the unitary cost ( $c$ ) is.
- 14 3) The lower the price of one supplied quantity ( $P_p$ ) is, the lower the unitary cost ( $c$ ) is.
- 15 4) The higher the productivity of employees ( $w_1$ ) is, the lower the unitary cost ( $c$ ) is.
- 16 5) The higher the productivity of machines ( $w_2$ ) is, the lower the unitary cost ( $c$ ) is.
- 17 6) The higher the material productivity ( $a$ ) is, the lower the unitary cost ( $c$ ) is.

18 If we consider the costs as constants (strategy 1, 2 and 3), the strategies to reduce the unitary costs  
 19 focus necessarily on the productivity aspects. As the material content is often a characteristic of a  
 20 product, there is a natural limitation to the increase of ( $a$ ) and only new production processes can  
 21 change considerably ( $a$ ). The remaining strategies are thus related to the productivities of the  
 22 employees and machines. We understand now the focus of Adam Smith on the division of work as a  
 23 strategy to increase the productivity of employees. Besides, the 18<sup>th</sup> and 19<sup>th</sup> centuries are

1 characterized, as said before, by the revolution of quantitative sciences thus considerably increasing  
 2 the previous limitations of (a) and the possibility of new machines with higher productivity ( $w_2$ ). In  
 3 other terms, the scientific discoveries ensure the development of the material productivity while  
 4 technical engineering development ensures the development of machine productivity and industrial  
 5 engineering development ensures the development of overall productivity by correctly organizing  
 6 the productivity of machines and employees for a given material productivity. The innovation  
 7 processes are thus of key importance in the classical economy perspective<sup>82</sup>.

8 The previous framework introduces a competition between the productivity of employees and the  
 9 productivity of machines. It also introduces a competition between the productivity of different  
 10 machines. Indeed, each machine has different capacities:

*Let us consider  $Q_1$  and  $Q_2$  respectively the capacities of machine 1 and machine 2*

$$\text{We thus have } w_2^1 = \frac{Q_S^1}{M_1} = \alpha_1 \times Q_1 \text{ and } w_2^2 = \frac{Q_S^2}{M_2} = \alpha_2 \times Q_2$$

*where  $M_1$  and  $M_2$  are the numbers of machines owned by the firm*

*$Q_S^1$  and  $Q_S^2$  the quantity produced by machine 1 and machines 2*

*$\alpha_1$  and  $\alpha_2$  the percentage used of the capacity of machines 1 and machines 2*

*$w_2^1$  and  $w_2^2$  are thus the average quantity produced by machine 1 and machines 2*

*the total productivity of machines is thus:*

$$w_2 = \frac{Q_S^1 + Q_S^2}{M_1 + M_2} = \frac{M_1 \times w_2^1 + M_2 \times w_2^2}{M_1 + M_2} = \frac{M_1}{M_1 + M_2} \times \alpha_1 \times Q_1 + \frac{M_2}{M_1 + M_2} \times \alpha_2 \times Q_2$$

11 The problem is thus the following: for a constant quantity to produce, what to do to minimize the  
 12 cost associated with the machines?

13 The number of machines to be used is dependent on the quantity to be produced and the capacity of  
 14 the machines<sup>83</sup>. But the cost criterion is dependent on how the machine price is dependent on the  
 15 machine capacity. Indeed if  $C_1$  is the cost of machine 1 and  $C_2$  is the cost of machine 2, we can  
 16 consider three types of cost functions:

17 **1<sup>st</sup> case:** Linear:  $C(M_1 \times Q_1 + M_2 \times Q_2) = M_1 \times C(Q_1) + \mu + M_2 \times C(Q_2)$

18 **2<sup>nd</sup> case:** Convex:  $C(M_1 \times Q_1 + M_2 \times Q_2) \geq M_1 \times C(Q_1) + \mu + M_2 \times C(Q_2)$

19 **3<sup>rd</sup> case:** Concave:  $C(M_1 \times Q_1 + M_2 \times Q_2) \leq M_1 \times C(Q_1) + \mu + M_2 \times C(Q_2)$

<sup>82</sup> This is why lots of industrials of the 18<sup>th</sup> and 19<sup>th</sup> centuries are also engineers who discovered new scientific or technical processes. Such is for example the case of Alfred Nobel with the invention of the dynamite.

<sup>83</sup> We thus have  $Q_S = \text{constant} = Q_S^1 + Q_S^2 = M_1 \times w_2^1 + M_2 \times w_2^2$  and  $M = M_1 + M_2$  the total number of machines. We also have  $\alpha_1 = \frac{w_2^1}{Q_1}$  and  $\alpha_2 = \frac{w_2^2}{Q_2}$  with  $0 \leq \alpha_1 \leq 1$  and  $0 \leq \alpha_2 \leq 1$ . If we consider the same percentages used for capacity we have  $\alpha_1 = \alpha_2 = \alpha \Rightarrow \frac{w_2^1}{w_2^2} = \frac{Q_1}{Q_2}$ . We thus have

$$\frac{Q_S}{w_2^2} = \frac{M_1 \times w_2^1}{w_2^2} + M_2 = M_1 \times \frac{Q_1}{Q_2} + M - M_1 \Rightarrow M = \frac{Q_S}{w_2^2} + M_1 \left(1 - \frac{Q_1}{Q_2}\right)$$

The number of machines is thus decided by the ratio  $\left(1 - \frac{Q_1}{Q_2}\right)$ . If  $\frac{Q_1}{Q_2} > 1$  then M is minimum for  $M_1=0$  and all the machines bought are machine 2 types. The opposites happens if  $\frac{Q_1}{Q_2} < 1$ .

1 A linear pricing makes indifferent the choice between buying N machines with production capacity P  
 2 and buying 1 machine with production capacity NP. Therefore, the choice will be made according to  
 3 other criteria of organization such as space consumption (in favour of NP) and number of employees  
 4 per machine (in favor of P). A trade – off will thus appear. The two other pricings are not indifferent  
 5 to the choice between buying N machines with production capacity P and buying 1 machine with  
 6 production capacity NP. Indeed, the convex pricing favors the first scenario with N machines while  
 7 the concave pricing favors the second scenario with 1 machine. Given that an establishment is always  
 8 confined in space, the concave pricing is more advantageous for an expansion policy, i.e. when the  
 9 quantity to produce increases. The same kind of idea can be applied by firms when selling their  
 10 products. Indeed, if we consider the machines already bought and the number of employees fixed,  
 11 the maximum quantity that can be produced is thus corresponding to the production capacity of the  
 12 firm  $Q_{\max}$  and the cost function is  $C = C_{fixe} + Q_s \times \frac{P_p}{a}$  so that the unitary cost is  $c = \frac{C_{fixe}}{Q_s} + \frac{P_p}{a}$ . The  
 13 more the firm produces, the lower the unitary cost is.

14 In summary, the space of circulation based on classical economic viewpoint sees the transportation  
 15 system as subordinated to the production. The core project is to increase the production through the  
 16 purchase of specialized machines of high capacities. Sometimes, it is the establishment itself which is  
 17 specialized. The classical economy is thus characterized by a spatial concentration of the means of  
 18 production and the associated quantity produced. The workers are thus also constrained to  
 19 concentrate around the places of production.

20 The second “ideal” model is to be related to the framework of “neoclassical economy”. In this  
 21 framework, the production does not receive any interest and the law of supply and demand prevails.  
 22 Therefore, the productivities described before are just corresponding to an offer of supply and the  
 23 general equilibrium ensures an adaptation of the supply to this demand. The aim is not to produce  
 24 higher quantity but to produce the right quantity. Indeed, let us consider the following mathematical  
 25 framework, we have:

$$C = C_{fixe} + Q \times \frac{P_p}{a} \Rightarrow c = \frac{C_{fixe}}{Q} + \frac{P_p}{a} \text{ with } Q \text{ the quantity produced by the firm}$$

*Let us note  $Q_s$  the quantity demanded by the market*

**1st case:  $Q_s > Q$  (offer insufficient)**

*Then the benefits made by the firm are  $B = (m - 1) \times C$*

*the benefits that could have been made by the firm are  $B_S = (m - 1) \times C_S$*

$$\text{The shortfall is thus } B_S - B = (Q_s - Q) \times \frac{P_p}{a}$$

**2nd case:  $Q_s < Q$  (excessive offer)**

*Then the benefits made by the firm are  $B = m \times \left( C_{fixe} + Q_s \times \frac{P_p}{a} \right) - \left( C_{fixe} + Q \times \frac{P_p}{a} \right)$*

$$B > 0 \Leftrightarrow Q < \frac{(m - 1) \times C_{fixe} \times a}{P_p} + Q_s$$

*The benefits are maximal for  $Q = Q_s$*

26  
 27 The issue for firms is thus to provide exactly the amount asked by the market. In this context, the  
 28 benefits for a particular firm can only increase by either the extension of the market area or by the  
 29 extension of the market share owned by the firm. The concentration of production is not seen any

1 more as a guarantee for benefits. The necessity of purchasing high capacity machine will thus depend  
 2 on the market size and the market share objectives of the firm. The firm strategies are multiple and  
 3 so are the associated spaces of circulation. Nevertheless, the core hypothesis of the general  
 4 equilibrium (market secretary) means that transportation is considered as having no effect on  
 5 exchanges. The neoclassical economy is unsuccessful to translate the interactions between firms and  
 6 inside firms. This is because the neoclassical economy ignores the effects of proximity.

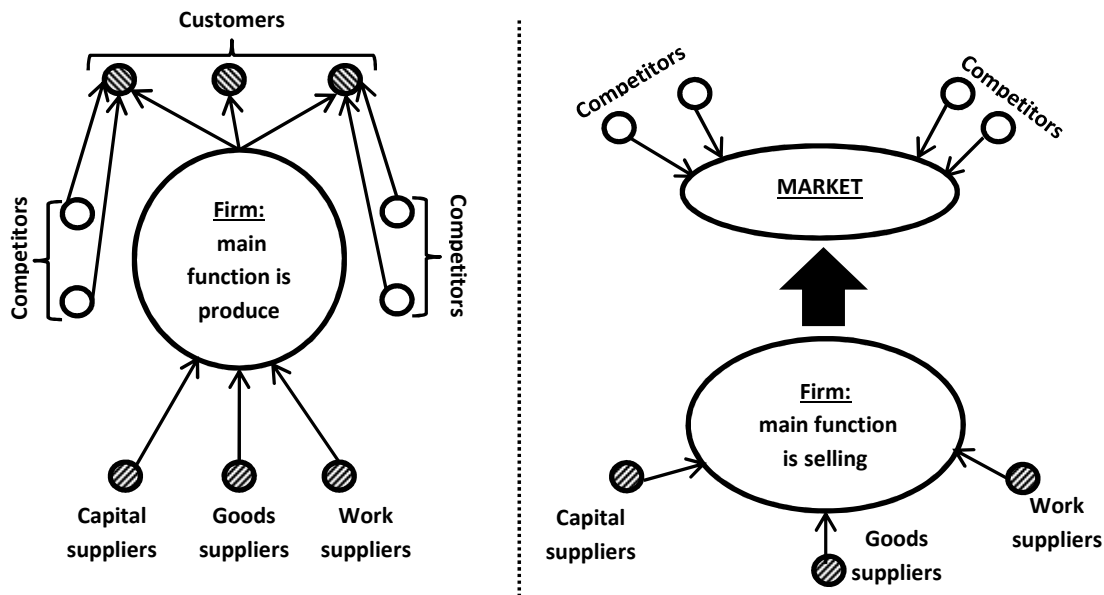

7

8 **Figure 34 : The functions and structure of the firm in an industrial (left) and a market world (right)**  
 9 **(Lendrevie, et al., 2003)(p.4-5)**

10 **Figure 34** summarizes the two “ideal” models of circulation we described above. Similarly to the  
 11 historical evolution from classical economy to the neoclassical economy, the literature on the  
 12 organization of production, marketing and logistics usually divides the recent history into two  
 13 periods. The first period concerns mainly the 19<sup>th</sup> century and the beginning of the 20<sup>th</sup> century up to  
 14 the end of First World War. This period corresponds to the development of mass production and of  
 15 the associated concentration of capital. Indeed, the stakes of this period concern the control of the  
 16 means of production with a development of machines. The geography of flows is modified as the  
 17 local production for local consumption is replaced by a concentrated production for a diffuse  
 18 consumption. While the craftsman in its local environment knows his customers, their habits and the  
 19 usual pattern of their purchase, the industrial is selling his products to undifferentiated customers.  
 20 This industrial world does not see the findings of outlets as a problem because the 19<sup>th</sup> century is a  
 21 period of scientific revolution opening a lot of new areas of development for society. In other terms,  
 22 the outlets for industrials are ensured as the number of potential customers is equal to the total  
 23 population. The general growth phase observed is also dependent on the acceptability by society of  
 24 the consequences of the new innovations. For example, we already demonstrated the development  
 25 of speed has been the results of the development of infrastructure. In the industrial world, the main  
 26 issue for firms thus is but the development of efficient production systems, through scale economy  
 27 and unitary cost reduction. The price competition is thus made through production cost reduction  
 28 which in the context of mass production implies to find time-efficient production processes able to

1 maximize capacity utilization of machineries. This explains why Ford only sold in the twenties black  
2 cars as black paints dry faster than any other paints (Marty, 1997)(p.13).

3 In a second period, namely partly in the 1920-1940 periods and mainly in the after Second World  
4 War period, the innovations of the 19<sup>th</sup> century have almost all been adopted by customers so that  
5 outlets became rare. In other terms, the markets got saturated. The introverted firms must turn  
6 towards the outside world and struggle on convincing customers to buy their goods. This is what is  
7 usually called the market economy with the associated development of methodologies to address  
8 customers known as marketing. Many books on logistics state this change from a production  
9 economy to a market economy ( (Dornier, et al., 2009); (Marty, 1997); (Pimor, et al., 2008); (Pons, et  
10 al., 1996)). Nevertheless, in these books, the production economy is presented as a period with an  
11 offer inferior to demand while the market economy is presented as a period with an offer superior to  
12 demand. This is a misconception of reality<sup>84</sup> as it implies that no overproduction could occur in a  
13 production economy while it would be a characteristic of the market economy. Actually, periods of  
14 overproduction occurred during the period of industrial economy since it is always possible that the  
15 acceleration in the outputs of production is superior to the one of diffusion or distribution into the  
16 population. Similarly, by holding a higher interest on customers, there are fewer possibilities to  
17 experience overproduction in a market economy as the “demand” is under scrutiny. The overall  
18 misconception behind the notion of “offer” and “demand” is the representation of them as  
19 independent entities that would come to equilibrium through the famous economic law of supply  
20 and demand. The reality is much more complex and leads us to develop some criticism of the  
21 coordination processes as understood by the current socio – economic framework.

## 22 **3 Criticism of the coordination processes**

### 23 **3.1 Money and economic power**

24

25 As we saw in 1.1, the money is the result of a convention which structures its legitimacy to operate in  
26 a particular space of circulation. Our interest in this section is to understand how money is related to  
27 issue of power and conflicts between the members of the society. I will use the following quotation  
28 of (Clerc, 2000) as a start for my reflection:

29 *“Money is at the same time a credit and a debt. A credit, because it supposes the users trust it<sup>85</sup>. The*  
30 *authority emitting the money has a power: it can demand credit from other member of the society,*  
31 *i.e. that other members first believe in the value of money and secondly that they accept that the*  
32 *authority can purchase their goods and productions. This credit has only a meaning if it is used, i.e. if*  
33 *money circulates. But, by doing so, the money users transfer the debt the money relies on. This way,*  
34 *the credit bank makes to one person who uses it to make its payments is in fact a debt of the bank*  
35 *towards the successive payees: At every moment, one of them can go to the bank and demand to be*  
36 *paid back in ready cash. This day, the bank’s debt is paid back and the creation of money reimbursed.*  
37 *Indeed, it is because at every moment, the debt can be reimbursed, that money can circulate. On the*  
38 *opposite, the money emitted by the supreme authority – God, prince, central bank – is never*

---

<sup>84</sup> It is a misconception of reality but corresponds well to the beliefs of the classical economy and of the neoclassical economy.

<sup>85</sup> Credit comes from the Latin “credo”, the meaning of which is “to believe”

1 *repayable: it is the supreme money [...] and it is what funds society, or at least what cements it: the*  
2 *monetary space is a space of power, of suzerainty, of a never repayable debt."*

3 The money is thus an instrument of power. More exactly, money is an instrument of transfer of  
4 power. Indeed, the main error in the previous quotation is to consider the power of money as an  
5 acceptance from all the members of society. The key question is related to the issue of legitimacy. In  
6 the same way policy and State considers the issue of legitimate force, one should consider the issue  
7 of the legitimacy of the money creation. Let us briefly analyze how this legitimacy applies to the  
8 usually three forms of political power described notably by Aristotle (Aristote, 2001) (p.410-414). In  
9 monarchy, the power is characterized by the government of only one person (the prince) which acts  
10 selfless for the account of others. We thus see here a similarity with the role played by the market  
11 secretary in the neoclassical economy. In terms of money creation, this would mean that the prince  
12 will create money for the sake of others. In other terms, the prince necessarily has to take a  
13 normative approach of the behaviors of his subjects. The liberty of the subjects is thus conditioned  
14 on the representation of good behaviors made by the prince. Therefore, the prince has to be  
15 flawless. On this aspect, we recognize the nomenclature hypothesis and the state of the world  
16 hypothesis of the neoclassical economy. Monarchy under the form of one person governing for the  
17 sake of all and ruling everybody necessarily implies the notion of God. Money in this framework  
18 simply becomes one of the attributes of God. According to Aristotle, the degenerate form of  
19 monarchy is tyranny in which the individual in charge of power only seeks its own interest. In this  
20 case, the normative approach subsists but as a deliberate one. The tyrant does not pretend knowing  
21 what a good behavior is, he uses the concentration of means he owns to pursuit his power. In this  
22 framework, tyrant and prince both need the concentration of everything, and in particular money.  
23 Indeed, *"is not real prince the one who is not self – sufficient, i.e. not have the superiority in all sort of*  
24 *goods"* (Aristote, 2001)(p.412). In aristocracy, the power is characterized by the government of a  
25 group of persons (the aristocrats) who are supposed to be the best ones to take in charge the  
26 different institutions. We thus have the same problem that for monarchy, i.e. aristocrats are also  
27 supposed to act selfless for other members of society. The risk is thus that *"rulers distribute what*  
28 *belongs to the City without any reference to the merits of individuals, and attribute to themselves all*  
29 *goods or most of them, and always reserve magistracies to the same individuals only taking into*  
30 *account their wealth"* (Aristote, 2001)(p.412-413). Finally, in the democracy, the power is  
31 characterized as belonging to the majority which governs for the sake of all.

32 The previous review shows an evolution from a concentrated power (monarchy, aristocracy) towards  
33 a decentralized power (democracy). Nevertheless, in democracy, this decentralized power is  
34 aggregated through the election of representatives. Similarly, only the national bank used to have  
35 the legitimacy to create money (banknote plate). There thus used to be a direct relationship between  
36 the legitimacy given to the State through elections and its legitimacy to create money and influence  
37 economic life. This power has been of course disputed by financial activities such as bank and  
38 insurance companies so that more flexibility has been introduced into the financial system with the  
39 credit/debit process which allows using money which is only supposed to be created in the future.  
40 The role of the State is thus restrained to the control of the risk associated with credit/debit activities  
41 through the establishment of financial laws (Essec).

1 I also demonstrated the problem of the concentration of interests which the neoclassical economy  
 2 solves by assuming a market secretary, i.e. a monarchy<sup>86</sup>, in charge of ruling the market and by  
 3 assuming economic actors who though only seeking their own interest are so soft they do respect  
 4 the choice made by the market secretary. However, the power of money lies in the possibility to  
 5 confiscate things and take actions others cannot do. In other terms, the power of money is a relative  
 6 one and depends on the types of goods accessible for a level of money possession. This explains the  
 7 conflict which existed throughout economic history in regards to money possession<sup>87</sup>. It also  
 8 concerns the difficulties to define poverty. Is poverty something absolute existing at the individual  
 9 level and concerning the incapacity of individuals to ensure the basic conditions of existence or is  
 10 poverty something relative related to a problem of capacity of actions within the monetary network?  
 11 In the first situation, a biological viewpoint is taken. In the second one, it is the notion of purchasing  
 12 power which prevails. The following example gives a further insight on the purchasing power issue.

*Population:  $N = 100$  ; Total mass of money  $M = 1000$  euros*

*Initial monetary repartition:*

$$x_1 = 300 \text{ euros} ; x_2 = 210 \text{ euros} ; \forall i \in \llbracket 3; 100 \rrbracket x_i = \frac{490}{98} = 5 ; \sum_{i=1}^{100} x_i = 1000$$

*Cost of one machine : 60 euros ; salary of workers : 4 euros*

*Cost of one unit of raw material:  $P_p = 1$  euros ;*

*To make one product unit, one needs 0.5 raw material unit and  $\frac{1}{4}$  of worker time*

*Each product unit thus costs  $0.5 \times 1 + \frac{1}{4} \times 4 = 1.5$  euros*

*The maximum production available for  $x_i$  is thus*

$$Q_1 = \frac{300 - 60}{1.5} = 160 ; Q_2 = \frac{210 - 60}{1.5} = 100 \Rightarrow \forall i \in \llbracket 3; 100 \rrbracket Q_i = 0$$

***Only two individuals can produce. There is a restriction of production space***

*However, the available working population is of 98 individuals*

*To reach a production of 160,  $x_1$  needs to employ  $\frac{1}{4} \times 160 = 40$  individuals*

13

*To reach a production of 100,  $x_2$  needs to employ  $\frac{1}{4} \times 100 = 25$  individuals*

*There is thus  $25 + 40 = 65$  individuals employed*

---

<sup>86</sup> The monarchy takes the form of a democracy since everyone can participate as long as he owns money. Its capacity of actions is nevertheless constrained by its purchasing power. The role of the prince (market secretary) lies in the law of supply and demand which ensures the "right" price for all.

<sup>87</sup> On this aspect, the history of Athens is quite straightforward: Made of the gathering of four tribes, the first evolution is from shared property (hunting and agricultural lands exploited in commons) to private properties. Land is therefore the main value and the previous hierarchy that existed in tribes is reproduced with the distributions of lands as political powers belong to nobles, heirs of the tribe chiefs. The good lands also belong to the noble class, leading slowly peasants towards poverty, debts and finally slavery. This situation gives birth in a conflict which resulted in a new constitution in 594 BC, the constitution of Solon which put the political power in an assembly of 400 members whose importance depends on their income. The power thus remains mainly in the hands of nobles. But the coalition of peasants, craftsmen and traders finally overcome the power of noble in 508 BC and give birth to a democratic political life. However, the commercial expansion of Athens distorts the repartition of wealth within the city and a new class of rich people is created. Landed property gets concentrated and mass unemployment spread through the city. (Denis, 2012)(p.9-15)



**The unitary costs are  $c_1 = \frac{300}{160} = 1.875$  euro and  $c_2 = \frac{210}{100} = 2.1$  euros**

*With a margin of 10%, we thus have as unitary prices*

1  **$p_1 = 1.1 \times 1.875 = 2.0625$  euro and  $c_2 = 1.1 \times 2.1 = 2.31$  euros**

*The total money asked from individuals is*

$$160 \times 2.0625 + 100 \times 2.31 = 330 + 231 = 561 \text{ euros}$$

**Final situation of participants**

*Unemployed people: they buy one units of the least costly product*

$\forall i \in \llbracket 68; 100 \rrbracket, x_i^{final} = 5 - 2.0625 = 2.9375$  euros with 33 units consumed  
it remains 127 units of product 1 and 100 units of product 2

*Employed people: they buy one unit of each product*

$\forall i \in \llbracket 3; 68 \rrbracket, x_i^{final} = 5 + 4 - 2.0625 - 2.31 = 4.6275$  euros with 130 units consumed  
it remains 62 units of product 1 and 35 units of product 2

*Individual  $x_1$ : he buys 31 unit of product 1 and 18 units of product 2*

$$x_i^{final} = 160 \times 2.0625 - 31 \times 2.0625 - 18 \times 2.31 = 224.4825 \text{ euros with 49 units consumed}$$

*Individual  $x_2$ : he buys 31 unit of product 1 and 17 units of product 2*

$$x_i^{final} = 100 \times 2.31 - 31 \times 2.0625 - 17 \times 2.31 = 127.7925 \text{ euros with 48 units consumed}$$

**Total product 1 = 33 + 65 + 31 + 31 = 160 ; Total product 2 = 0 + 65 + 31 + 31 = 100**

**Total money mass  $M = 33 \times 2.9375 + 65 \times 4.6275 + 224.4825 + 127.7925 = 750$**

**Difference = 1000 – 750 = 250 (corresponding to machine and raw material costs)**

2 The previous framework is a mathematical invention but raise some important issues in regards to  
3 the notion of acceptance of the power of money. Indeed, this notion supposes that workers are  
4 willing to accept the difference of purchasing power between them and industrials. This is quite  
5 doubtful and we consequently have to understand how the power of money is applying to people in  
6 spite of their non – acceptance.

7 If we examine the difference between industrials and workers, we see that it resides in the ability for  
8 industrials to buy the means of production (machine, workforce, raw materials). It also resides in the  
9 fact that the act of purchase gives an ownership right, i.e. an exclusive use which can be defended by  
10 force<sup>88</sup>. We thus see here different spaces of circulation in action. If the machines are expensive  
11 ones, the poor do not have access to it. The possibility to concentrate workforce and raw materials in  
12 a sufficient amount to make the machine useful supposes also the concentration of capital. In a way,

---

<sup>88</sup> This force can be the expression of violence such as in the case of monarchy. It can also be the expression of the legitimate force through the expression of law in a republic State. *“Miserliness and ambition of the wealthy man, aversion to work and love for well-being of the poor man, here are passions leading to invade properties[...] it is only under the aegis of a civil magistrate that the owner of a precious property [...] can sleep one night with complete peace of mind.”* (Smith, 1991) (p.332)

1 the space of circulation linked to production is forbidden to the poor who have only access to the  
 2 space of circulation linked to consumption. The only way for the poor to concentrate money is  
 3 through the sales of their time and patiently saving the money of wages. Consequently salaried  
 4 employment slowly becomes the norm. This process can even get faster if the poor are put in a  
 5 position when they cannot even fulfill their more urgent physical basic needs. In this context, as said  
 6 by (Orwell, 1982)(p.22-28), *“misery has the virtue to reject the future to nothingness”*. One of these  
 7 basic needs concern foods for which one key means of production is land. As land is of a finite  
 8 nature, the space of circulation of this asset is also limited in the extent.

9 In conclusion, the power of money is expressed through the materiality of the means of production it  
 10 allows the confiscation of. The market world ruled by money can thus lead to the strange situation in  
 11 which a good, even a basic and important one such as water, is present in sufficient quantity for all  
 12 the members of the society but some of them do not get access to it because of their insufficient  
 13 purchasing power.

### 14 3.2 The materiality of exchange

15

16 The previous section shows that the power of money was linked to the restriction of the circulation  
 17 process of the means of production. These means of production can be characterized as shown in  
 18 **Table 7** by different clusters of pervasive technologies, i.e. technologies that happen to be used  
 19 throughout the economy and not only in a few selected sectors.

20 **Table 7 : Cluster of pervasive technologies (Source: Adapted from (Pry, 1988))**

1770-1830	1820-1880	1870-1940	1930-1990	1980-2040
Water Power, Sails, Canals, Turnpikes, Iron Castings, Textiles	Coal, Iron, Steam Power, Mechanical Equipment	Railways, Steam Ships, Heavy Industry, Steel, Dyestuff, Telegraph	Electric Power, Oil, Cars, Radio, TV, Durables, Petrochemicals	Gas, Nuclear, Aircraft, Telecomm., Information, Photo-Electron.
Mechanical Equipment, Coal, Stationary Steam Power	Steel, City Gas, Indigo, Telegraph, Railways	Electricity, Cars, Trucks, Radio, Phone, Oil, Roads, Petrochemicals	Nuclear, Computers, Gas, Tele- communication, Aircraft	Biotechnology, Artificial Intelligence, Space Industry & Transport
Manufacture	Ind. Prod.	Standardization	Ford-Taylorism	Quality Control

21

22 **Table 7** shows different phases of technology development. In each phase, one can find a dominant  
 23 technology, e.g. water power for the period 1770 – 1830, and the future pervasive technology, e.g.  
 24 steam power and coal for the period 1770 – 1830. Finally, the bottom summarizes the principle  
 25 driving force and direction of economic growth (Nelson, et al., 1982). We thus see a general direction  
 26 from mass production (manufacture and industrial production) and production rationalization  
 27 process through standardization, economies of scale (Fordist production) and Taylorism to

1 economies of scope and quality control. This corresponds to a general evolution from the ideal type  
2 of classical economists towards the one of neoclassical economists. Indeed, for each phase of  
3 development, as long as the new technology has not still spread through its market, there is a high  
4 potential of development for all firms. They do not have to compete between themselves because  
5 the market is large enough to welcome them all. But the more they produce, the more the market  
6 approaches saturation and consequently the more competition becomes important. On this aspect,  
7 infrastructure is a market as the others. Consequently, as explained before, old infrastructures are  
8 replaced by new ones corresponding to the main technology and driving forces of the considered  
9 development phase. A first question thus concerns the becoming of old infrastructures. On this  
10 aspect, the answer of Grübler is straightforward: *“Transport structures are built to last, they are  
11 almost immortal. Once their original use declines in importance because of changing societal  
12 preferences and requirements for the transport system, new uses may evolve. Two good examples are  
13 the leisure activities that have evolved around former canals, e.g., the Rideau Canal in Canada, and  
14 the 19th century museum opened in Paris in the former Gare d'Orsay, an impressive monument of the  
15 railway era”* (Grübler, 1990)(p.202).

16 Since the transportation infrastructures are immortal, the material stock associated with  
17 transportation keeps on increasing and so does the associated floor area consumed. In a world  
18 constrained materially and spatially, this could lead to internal conflicts between transportation  
19 infrastructures and external conflicts between these infrastructures and those of  
20 production/consumption. This leads us to examine what happens during the phase of saturation of a  
21 market. Once again, the analysis of Grübler on infrastructure provides an interesting pattern: *“These  
22 periods [of high market development]are followed by seasons of saturations, characterized by  
23 significant decline in the average rate of technical and social change, accompanied by price flares  
24 indicating increased market volatility and turbulence. Schumpeterian “gales of creative  
25 destruction” (i.e, organizational readjustment processes like bankruptcies or intensive mergers),  
26 a lack of productive investments as a result of the saturation of traditional markets and  
27 uncertainty about the characteristics and investment opportunities of the new emerging  
28 paradigm prevail. Consequently we observe the widespread application of speculative  
29 instruments and increased market volatility in the form of “Black Fridays” or “Black Mondays”  
30 (recall here the October 1987 stock market crash). The shift in the search for profit opportunities  
31 away from productive investments is also reflected in massive investments into (speculative)  
32 mergers and acquisitions (over 300 billion US dollars in 1988 in the USA alone). From such a  
33 perspective, a redirection toward productive investments at a significant rate may only finally  
34 occur once the opportunities opened up by an emerging socio-technical paradigm become more  
35 broadly perceived, and/or after large-scale destruction of speculative capital reduces the disparities  
36 in yields between financial and productive investments (Grübler, 1990)(p.274)”*.

37 The fact that speculative or financial activities takes over as soon as the material-based activities  
38 seem to reach a physical or feasibility limit is in line with the idea that the present capitalist system  
39 depends on the perpetual research of outlets and a quantity of exchange tending towards infinity.  
40 Therefore, in these periods, the pace of incremental innovations increases to maintain a profitable  
41 quantity of exchange while waiting for a new phase of technological development which ensures  
42 bigger, faster, more profitable and perhaps more easily socially accepted exchanges. The power of  
43 money also becomes less linked to the notion of investment in productive activities which could be

1 regarded as beneficial for society as a whole. Money could in this case lose its legitimacy if those  
2 speculating activities could not use their coercive power on the material space of circulation to  
3 maintain their power. The materiality of exchanges thus exists in all cases, may it be expressed  
4 through the materiality of the exchanged goods, the materiality of the infrastructure, or the  
5 materiality of the consequences induced by speculation processes.

### 6 **3.3 A diversity of circulation processes**

7  
8 The previous section shows the dependency of the economy on innovation and diffusion processes,  
9 in other terms outlets. With (Marchetti, 1987), we should thus agree that the world economy and  
10 our societies dream about a true globalization, i.e. the possibility to reach any point on the globe  
11 within the daily time budget constraint of around one hour<sup>89</sup>. The problematic issue with this  
12 evolution is not only the increasing energy requirements which is already a huge problem in a  
13 constrained world<sup>90</sup> but also the increase of energy density of the resources used, i.e. a  
14 concentration of energy at a point of space and time which by its own existence are not dissociable  
15 from the notion of control and risk<sup>91</sup>.

16  
17 As explained before, the world of classical economist is a world where market is far from saturation.  
18 In this case, the profit comes from cost reduction and the trade – off between transportation and  
19 warehouse is in favor of warehouses. On the opposite, the world of neoclassical economists is a  
20 world where market is close to saturation. Now, the profit comes from the possibility to reach the  
21 market and speed becomes a key factor. Similarly, as the market is closed to saturation, not a lot of  
22 quantity can be produced so that producing high quantity is not a factor of efficiency. This confirms  
23 that the notion of productivity is associated to the particular Ford production regime and is thus not  
24 relevant to characterize the contemporary regime (Burmeister, et al., 2006)(p.11.). Consequently, the  
25 new regime is characterized by the ability to produce and deliver the right quantity at the right time  
26 to the market. The trade-off between the transportation system and warehouses becomes more  
27 complicated and dependent on the place of the industry in the supply chain as shown in **Figure 35**.  
28 Nevertheless, the structure of supply chains may be quite different depending on the cutting-off  
29 made by the firm and the sector or product characteristics of the firm. Indeed, the density and the  
30 divisibility character of a product also play an important role. For example, in the automotive  
31 industry, we observe throughout the supply chain an increase of density value from steel, vehicle  
32 parts to vehicle. However, though steel and vehicle parts can be reduced in small units, cars cannot

---

<sup>89</sup> The equatorial perimeter of Earth is around 40 000 km meaning that 20 000 km is the maximum distance existing between two point of the Globe. A speed of 20 000 km/h corresponds to Mach16 speed. A space-time diagram of the Nürnberg indeed shows that the time devoted by an individual to transportation appears to be close to an anthropological constant, around 1 to 1.5 hours per day, both in rural-agricultural and in urban-industrial societies (Zahavi, 1981)

<sup>90</sup> Energy is not only required for transportation but for other production activities, together with consumption activities and also by natural ecosystems. Unfortunately, the present economic theory mainly considers the use of energy as important from the viewpoint of the first two types of activities which may cause not so much difficulties if the energy resources were not finite from a quantitative perspective.

<sup>91</sup> Nuclear energy is the perfect example of constrains imposed by a high energy density. The necessity of a controlled environment to overcome the risk associated with this energy limits nevertheless his diffusion through the networks. Cars with nuclear-based engine seem far too dangerous to handle. The control of high density energy asks for means and knowledge which are not easily accessible to everyone, taken apart the question of existing resources and their viability.

1 be divided as they represent assembly. Therefore the size of dispatches measured in tons can follow  
 2 a pattern quite different from **Figure 35** from high tonnage for steel to lower tonnage for vehicle  
 3 parts and finally to higher tonnage for vehicles. In conclusion, the structure of the supply chain will  
 4 mainly depend on the logics of circulation adopted by the firm. The logics of circulation are thus  
 5 marked by their diversity.  
 6

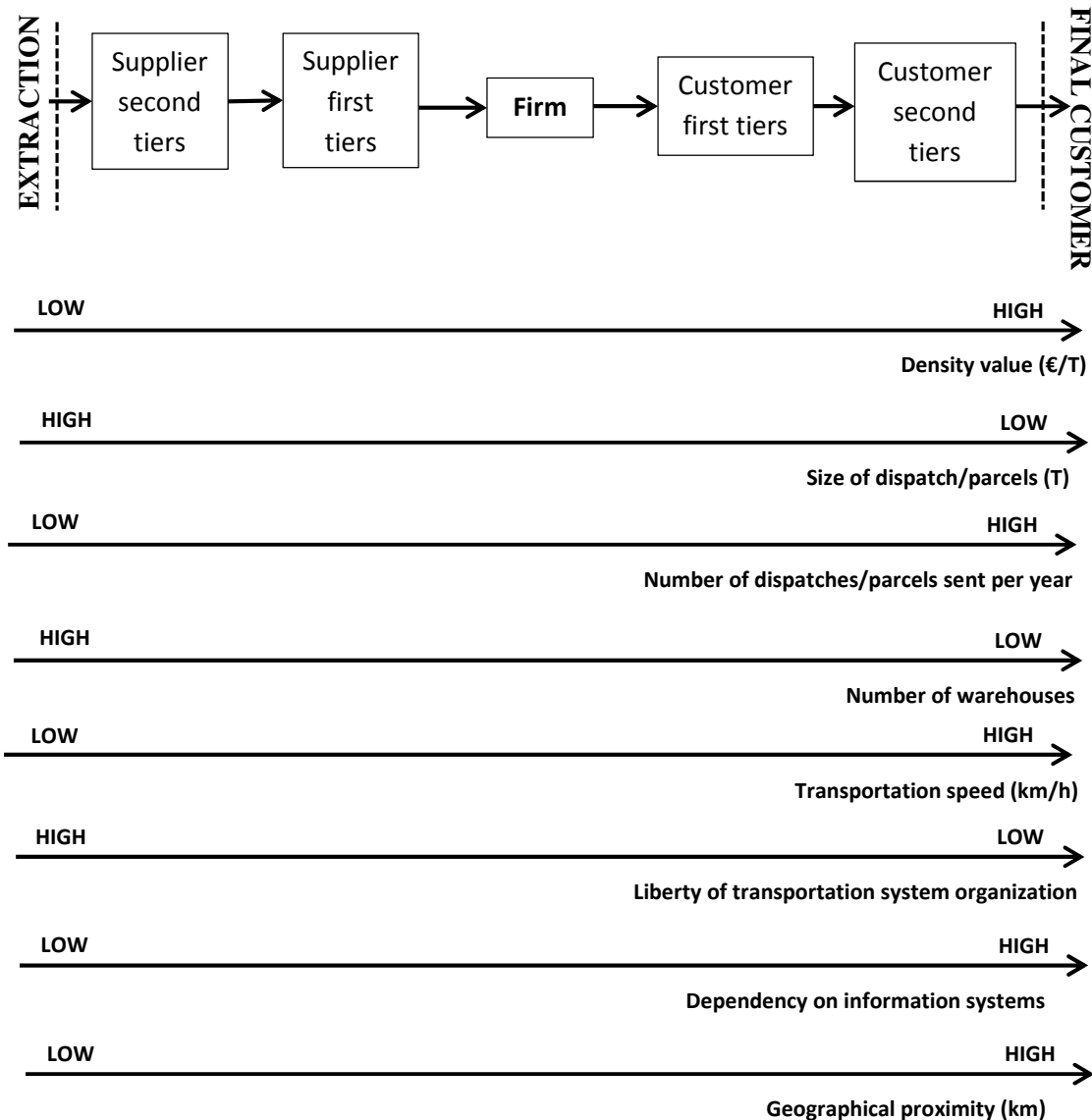

7  
 8 **Figure 35 : The structure of supply chains and the generalized simplified evolution of its indicators**

9 The logics of circulation are thus dependent on the strategy of the firms. It is thus mainly a local  
 10 framework. Nevertheless, some typology can be based on the criteria developed in **Table 6**. On this  
 11 aspect, the work developed by (Burmeister, 2000) and summarized in **Table 8** provides a typology  
 12 made of four kinds of logic of circulation. None of them are exactly corresponding to the two ideal  
 13 types described before but we can nevertheless establish a parallel between the “industrial” logic of  
 14 circulation and the ideal type of “classical economy”. Similarly a parallel can be made between  
 15 “flexible” logic of circulation and the ideal type of “neoclassical economy”.  
 16 Going further, **Table 8** shows the logics of circulation are the result of a complex system dependent  
 17 on production process, choice of strategic flow and relationships with the customers.

1 **Table 8 : A typology of the logics of circulation (Burmeister, 2000)**

<i>Logic of circulation</i>	<i>Production</i>	<i>Strategic flow</i>	<i>Logistics</i>	<i>Relations with the customers</i>	<i>Organization of transports</i>	<i>JUST IN TIME</i>
<b>Industrial</b>  ( Ex: Basic chemistry)	- Intermediate and low differentiated goods - Mass production (Big series & economies of scale) - Specialization of the sites of production	- Goods (massive and standardized flows)	- Industrial logistics based on cost criteria	- Industrial customers - Market interactions - No face to face relationships - Low use of the EDI	- Outsourced transportation (generic or specialized) - All transport modes, including heavy modes (train, waterways)	- Partially (tendency in decrease of stocks)
<b>Flexible</b>  ( Ex: Clothing, food processing industry)	- Consumer goods - Mass production (big or average series) but differentiated (high number of references in a range of products)	- Information (Fast, frequent and split flows of goods)	- Sophisticated logistics associating fast transport mode and EDI - Reliability (Delays, damages, service rate) - Flexibility (frequent changes of logistics organization)	Large distribution - Market interactions - No face to face relationships - Important use of EDI and all the means of remote communication	- Outsourced and generic transportation - High frequency of sent dispatches - Essentially road transportation, marginally railway transportation	- Yes, for the greater part (constrains set by the downstream supply chain)
<b>Professional</b>  (ex: mechanical industry)	- Units or small series - Production on demand, very differentiated, even dedicated - Specific knowledge	- Knowledge (Small size flows of goods)	- Basic and small scale logistics, often dedicated - Not outsourced logistics	- No Market interactions - Frequent face to face relationships with suppliers and customers	- Partially internal ( own account transportation) - Round transportation - Exceptional transport - Essentially road transportation, air transportation for emergency dispatches	No stocks (production on demand)
<b>Non-tangible</b> (ex: engineering, Informatics)	- New products - Specific equipment - Highly qualified work	- Knowledge	- Outsourced logistics - Refocusing on own skills	- Circulation of knowledge - Horizontal interactions	- Outsourced transportation - Essentially road and air transportation	?

## 4 Conclusion

I studied in this chapter the characteristics of the circulation within the current socio-economic system and the relationships existing with economic theories which, as seen in Chapter I, frame the core of the current representation of human activities and sustainability. In circulatory terms, the issue was to study the relationships between the abstract, a-spatial and a-temporal circulation framework of economic theories and the circulatory patterns of the concrete world. The first main difference between these two circulatory patterns concerns the position in space of production and consumption places. Indeed, in the concrete world, production and consumption places are not situated in the same geographical space so that distribution canals become necessary. The space in the concrete world is not zero dimensional anymore. However, the ideal of a zero dimensional space as wished by economic theories sets a goal to the transportation system, a globalized network. Similarly, for the time framework, economic theories set the objective of ubiquity to the transportation system. These goals are for example made clear by (Rapport de l'Académie des technologies, 2009) when they compare the speed domain and possibilities offered by the technologies of Information and Communication (ICTs) to the invisible hand of market. Indeed for them, these possibilities concern five points (fingers), namely instantaneousness, real-time optimization, real-time pricing, intra and inter-firm integration, and universal geo-localization and associated traceability able to drive down to zero all transaction costs. However, as demonstrated by (Burmeister, et al., 2003), the substitution of the physical world by a virtual world is a naïve vision and it would be more correct to talk about complementarity between ICTs and transportation systems. Consider ICTs as a transportation economy aiming at substituting distant relationships to proximity relationships is just another way to reaffirm the supremacy of economic theories' representation of space and time.

However, I demonstrated throughout this chapter the core importance of three factors to ensure an exchange to take place. These three factors are money, outlets and proximity which are interconnected together in a complex and local way. As shown in **Figure 36**, before an economic exchange takes place, there are lots of intermediary steps. For example, for an individual to engage into production activities, he needs to have access to means of production which e.g. in the case of machineries is dependent on a certain amount of money hold beforehand. Secondly, the production always occurs in a localized space even though production resources can be put together from all around the world. There is thus the creation of proximity (organizational, institutional, and geographical) for production to take place. But once produced, for the exchanges to take place, the products have to be accepted by consumers which suppose their access to the monetary network of consumption goods, access to the distribution networks and their willing to purchase such goods. The formation of exchange is thus something complex and particular in its way to put together monetary networks and good networks through different proximity patterns. As underlined by (Burmeister, et al., 2003), there is thus a diversity of circulation processes.

Nevertheless, within the present chapter, I demonstrated that classical and neoclassical economic theories still played an important role in framing two ideal and reference schemes of circulation. The first one corresponds to a situation far from market saturation in which producers do not have to worry about outlets. In this aspect, the realization of exchange is only subordinated to the connection of consumers and produced goods. The second reference scheme corresponds to a

1 situation close to market saturation. Producers have to struggle for the limited amount of outlets.  
 2 Connecting consumers and produced goods are not sufficient anymore. One must do it faster than  
 3 other producers and ensure a dependency of consumers through either development of customer  
 4 loyalty or rapid renewal of markets (role of marketing).

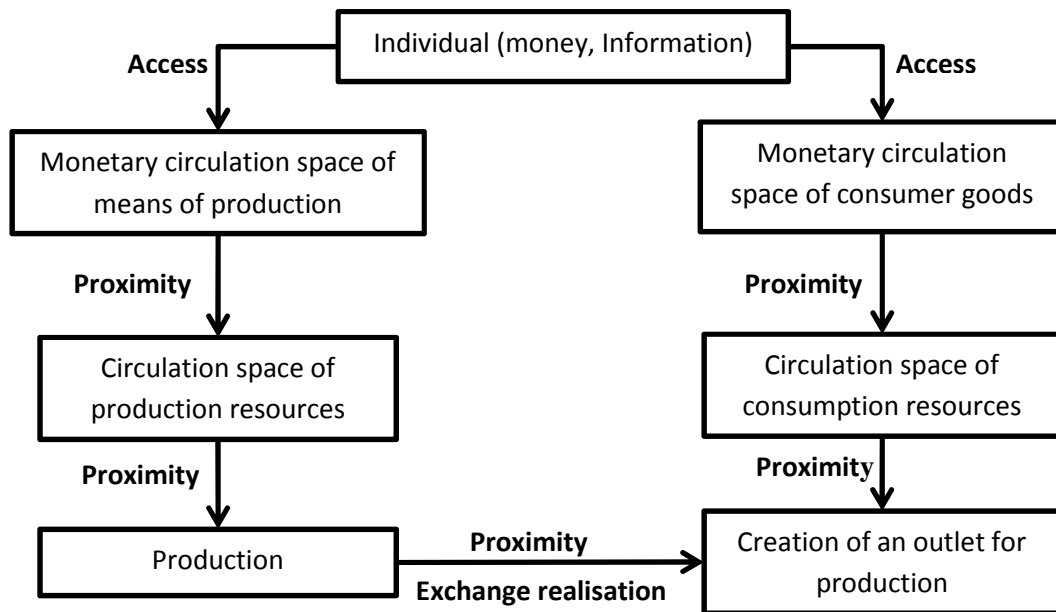

5

6 **Figure 36 : Relationships between money, outlets and proximity in the formation of economic**  
 7 **exchange**

8 From a sustainable viewpoint, the circulation processes are not neutral. Indeed, within this chapter, I  
 9 showed that through the issue of transportation, the access to energy was an important parameter  
 10 of circulation processes. Actually, transportation can be defined as the transfer of a certain quantity  
 11 M from origin A to destination B separated by a distance D within the time T. Therefore, mass and  
 12 speed, i.e. physical quantity of movement, is a major characteristic of circulation processes. The two  
 13 ideal schemes can thus be understood as the transfer from low and bulk transportation towards fast  
 14 and frequent light transportation. Therefore, the energy consumption associated with transportation  
 15 increases with the quantity transported (M) and the transportation speed. This was clearly observed  
 16 by the evolution of transportation infrastructure from slow and space restricted networks to fast and  
 17 globalized network dependent on a high availability of energy resources. In an energy constrained  
 18 world, globalized transportation system threatens environmental sustainability.

19 From a social viewpoint, the underestimation of the role of proximity condemns social interactions to  
 20 occur within a monetary network. But this monetary network is characterized by a permanent  
 21 struggle related to the access to production means and consumption goods and the issue of money  
 22 legitimacy related to the trust in its capacity of exchange facilitator. This struggle reduced to nothing  
 23 in economic theories appears clearly in the concrete world and raises the issue of the capabilities of  
 24 individuals in our current socio-economic system as an important part of its social unsustainability.  
 25 This will be developed further in Part II of this dissertation as an important characteristics of the  
 26 sustainable strategy called “functional economy”. For the moment, I will concentrate with Chapter III  
 27 on the characteristics of the environmental unsustainability of the current socio – economic system.



# 1 ***Chapter III: The attempts to solve environmental*** 2 ***unsustainability of the current socio-economic*** 3 ***system***

## 4 **1 Introduction**

5  
6 The purpose of the present chapter is to get a closer look to the attempts made within the current  
7 socio-economic system to solve environmental issue. As demonstrated in Chapter I and chapter II,  
8 the economic theories framing the basis of the convention of current socio-economic system are  
9 mainly questioned through the issue of resource availability. Consequently, considering economy as  
10 a “production – consumption – circulation” system, the presented chapter is made of two parts. The  
11 first part is related to the attempts to reinforce the environmental sustainability of the “production –  
12 consumption” subsystem. Therefore, the first part is dealing with changes currently made in the  
13 representation of human activities. These changes concern notably the changes made to the  
14 accounts and economic behavior described in Chapter I. On the opposite, the second part deals with  
15 the environmental impacts of the transportation system establishing a link with Chapter II.

16 The present chapter thus consists in an environmental review of supply chains understood as the  
17 connection of production activities and consumption activities through the circulation system. The  
18 new issue of environmental labeling of products, life cycle assessment, environmental impact  
19 internalization, and eco-calculators are all part of a supply chain greening process. Therefore, the  
20 limits of this process are important to analyze to understand the limits of the current socio –  
21 economic system in regards to environmental sustainability.

## 22 **2 The environmental issue of activities**

### 23 **2.1 Environmental labeling of products**

24

25 We demonstrated in **3.2** of chapter I that uncertainty on product quality could radically modify the  
26 demand curve by holding a positive correlation between price and demand. The “asymmetry” of  
27 information on the quality of products between buyers and seller can lead to a loss of trust and  
28 cancel the exchange. This is the role of labels to provide a common knowledge between buyers and  
29 sellers to restore trust. Environmental-labeling is this kind of framework and corresponds to the  
30 inscription of environmental information on products delivered to consumers. Indeed, as underlined  
31 in (Noussair, et al., 2004) *“in case of a citizen dimension – even attenuated – [meaning that their*  
32 *preferences take into account others’ preferences and environmental impacts] is introduced in the*  
33 *purchasing process and that the consumers value positively or negatively some production processes,*  
34 *then these production processes become full part of the products’ characteristics”.*

1 The trade of environmentally labeled products is thus linked to the building of an institutional  
 2 proximity between producers and buyers<sup>92</sup>. Nevertheless, the interest of producer lies in the  
 3 willingness to pay of the buyers for this new proximity. If the customer is sensitive to the  
 4 environment, he should be willing to pay for it. To test this hypothesis, Daniel Llerena and Céline  
 5 Michaud used the framework of experimental economy to reveal the willingness to pay (WTP) of  
 6 consumers for remanufacturing products (Llerena, et al., 2007). This consisted in three bid sessions.  
 7 In the first session, participants were only provided with information about the character “recycled”,  
 8 “new” or “remanufactured” of the products<sup>93</sup>. Environmental information about production  
 9 processes was introduced for the second bid sessions whereas distinction was made in the third  
 10 session between 30% and 70% remanufactured products. The results of the first two sessions are  
 11 shown in **Figure 37** and confirm the framework above. Before the introduction of environmental  
 12 information, remanufactured products are the third choice made by participants whereas recycled  
 13 products scores notably higher with only a slight difference with “new” products. This can be  
 14 explained through participants’ comments which directly associate recycling with environmental  
 15 protection. In other terms, the participants already had a representation of the environmental  
 16 impacts of products before the session. In the second session, “remanufactured” products raise at  
 17 first place. This tends to show that the participants have been sensitive to the explanation of the  
 18 environmental friendliness of “remanufactured” products.

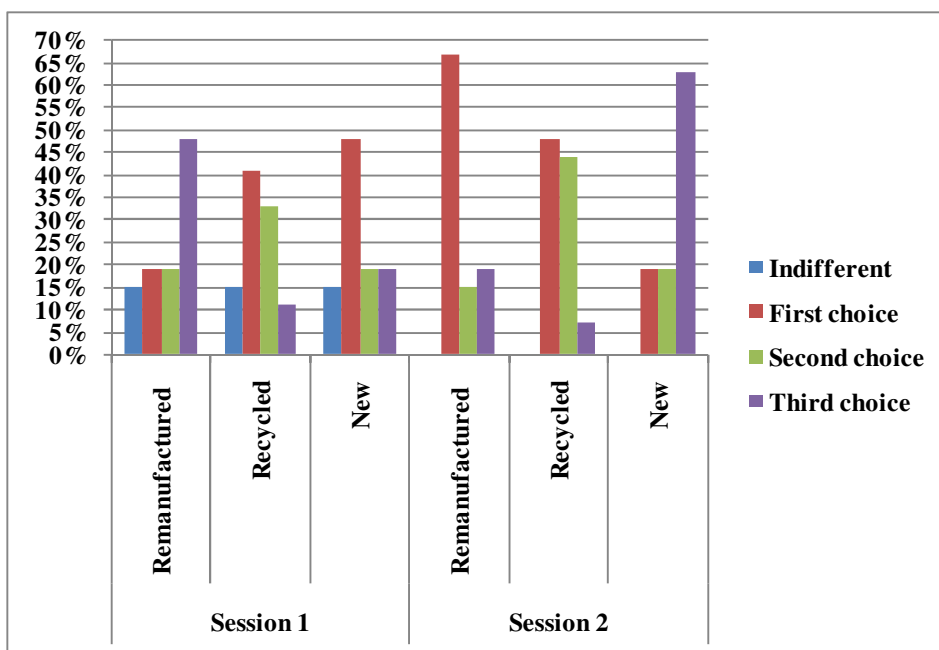

19

20 **Figure 37 : results of the two first session bids (Llerena, et al., 2007)**

<sup>92</sup> This notably explains all the commercials existing on the environmental friendliness of products. The aim of this commercial is to build “fake or not” a common knowledge between the producer and the buyer on the actions to make in favor in the environment.

<sup>93</sup> The environmental characteristic tested was related to the end – of – life of the product. We thus distinguish “new” product for which the end-of – life strategy is landfill, “recycled” product which was made based on a recycling process i.e. a transformation of used goods into raw materials, and “remanufactured products”. Remanufacturing consists in 3 steps: dismantle used products, sort the components according to their state and function and restoring elements which need such process, associate remanufactured with new components in the fabrication process (Llerena, et al., 2007).

1 The situation becomes more complex if we examine the results of the third session. Indeed, the  
2 participants emphasize the importance of the function of the remanufactured components in the  
3 product is more important than the presence of a high number of remanufactured components.  
4 Actually, they fear, without any proof, that the quality of components may diminish with the share of  
5 remanufactured components and consequently prefer that components valued as essential to the  
6 function provided are new ones. We thus see clearly here that the representation of the couple  
7 (quality, environmental friendly) is not a simple one. It nevertheless confirms the willingness to pay  
8 of customers for better environmental qualities of products.

9 However, many criticisms can be addressed to the WTP principles. Indeed, the valuation made by  
10 participants is very dependent on the test to reveal it. For example, valuations from surveys are often  
11 criticized for the hypothetical character of the answers since declarations of surveys' participants have  
12 no incident on their situation (Shogren, 2001). Valuation in laboratory offers more fixed conditions  
13 and are particular useful to evaluate consumer behavior faced to new products as other estimation  
14 sources of the demand are not available yet. Nevertheless, as in (Llerena, et al., 2007), laboratory  
15 valuation is made thanks to an initial provided budget which does not necessarily correspond to the  
16 one owned in reality by the participants. Consequently, the previous criticism against valuation from  
17 surveys is also partly valid for valuation in laboratory. But this only makes sense if those using WTP  
18 aim at knowing how the customer will behave in reality. Actually, the fact that in reality consumer  
19 behavior depends also on his budget constrains is only a proof that money acts a barrier. It is indeed  
20 two different questions to value with money what seems the best product and to be able to buy it at  
21 such a high price. Using WTP as a pricing strategy can thus lead to confine environmentally friendly  
22 products into the niche market of luxury products.

23 The previous framework can become rapidly more complex if we consider the representations  
24 producers have themselves on the environmental friendliness of their product. In this framework,  
25 the producer has two representations, the first one concerning how his product is better than those  
26 of competitors for the environment thus defining its communication strategy to customers, the  
27 second one concerning how the environmental characteristics modify the cost function of the  
28 company thus defining the level of selling price and consequently the type of market. In this  
29 framework, the power to define environmental friendliness is in the hands of producers. However,  
30 producers may not have the scientific knowledge and the legitimacy to define methodologies related  
31 to environmental assessment. Indeed, not only the history of environmental protection has shown  
32 that regulations were almost always needed to ensure an enough consideration of the  
33 environmental impacts by industrials but the environmental issue is also touching society as a whole  
34 and thus belongs to the sphere of policy and citizenship. This is even truer as environment is usually  
35 considered as a public good. Besides, the environmental world is scientifically so complex that only  
36 international and national legitimate knowledge center are able to provide these methodologies. We  
37 here understand why the eco – labels are for example supervised by the International Standard  
38 Organization (ISO)<sup>94</sup>, the European commission<sup>95</sup> or the French brand NF<sup>96</sup>. Indeed, the complexity

---

<sup>94</sup> We think here of the ISO 14020 norms which differentiate the official eco-labels (Type I-ISO 14024) supported by governments and giving the right to a certification, the environmental auto-declaration (Type II-ISO 14021) for which the retailer or distributor must present by himself a set of proofs, and finally the eco-profiles (Type III-ISO 14025) of which goals are to supply information based on Life Cycle Assessment (LCA) and other environmental information related to the product in order to help consumers comparing products on a sound basis and enhance the environmental products' improvements (2009).

1 related to environmental knowledge appears clearly in the following words of the European  
2 parliament: *“The criteria shall be determined on a scientific basis and considering the **whole life** cycle  
3 of products. In determining such criteria, the most significant environmental impacts shall be  
4 considered, in particular the impact on **climate change, impact on nature and biodiversity, energy  
5 and resource consumption, generation of waste, emissions to all environmental media, pollution  
6 through physical effects and use and release of hazardous substances.** The substitution of hazardous  
7 substances by safer substances, as such or via the use of different materials or design changes, where  
8 it is technically feasible, shall also be considered. The potential to reduce environmental impacts due  
9 to durability and reusability of products shall also be considered”*. [I underline]

10 In conclusion, the environmental labeling process is more a policy matter than an industrial one.  
11 Indeed, the fundamental idea of the European parliament behind eco - labeling is to give to the  
12 consumer a well-established eco-label to avoid confusion by contradictory information and  
13 deception though the green washing operated by the firm marketing operations. The implication of  
14 policy - makers is further confirmed by the French project of carbon labeling<sup>97</sup> and the launch of PAS  
15 2050 standards<sup>98</sup>.

## 16 **2.2 Methodologies of environmental impact assessment**

### 17 **2.2.1 The extended input-output accounts**

18

19 We saw in **Chapter I** that the national accounts are mainly concerned with monetary accounts. In  
20 order to study the interactions between different sectors and how they contribute to final  
21 consumption, the SNA statisticians have developed a powerful analytical tool known as the input-  
22 output system<sup>99</sup> (European Commission, et al., 2009)(p.507-518). Essentially an input-output (IO)  
23 table is derived from the use and supply framework of the national accounts and offer the analytical  
24 potential presented in **Figure 38**. Basically, the input-output framework corresponds to resource-use  
25 accounts put on a matrix form allowing linear analysis of the variation within these accounts.  
26 Consequently, the input-output framework is not sensitive to the kind of units, physical or monetary,  
27 used to address the resource-use accounts. From this perspective, physical IO tables and monetary  
28 IO tables should be easily convertible one into the other. Indeed, Weisz and Duchin demonstrated  
29 that under the assumption of unique sectorial prices, the physical and monetary IO frameworks are  
30 indeed identical (Duchin, et al., 2004). This assumption of unique sectorial prices is nevertheless not  
31 practical both at the macro-accounting level because of aggregations issue and at the micro-  
32 accounting level as firms compete on prices, unless considering broader and maybe artificial

---

<sup>95</sup> [http://ec.europa.eu/environment/ecolabel/about\\_ecolabel/pdf/ep\\_proposal.pdf](http://ec.europa.eu/environment/ecolabel/about_ecolabel/pdf/ep_proposal.pdf)

<sup>96</sup> [http://www.marque-nf.com/pages.asp?Lang=English&ref=quest\\_ce\\_que\\_nf](http://www.marque-nf.com/pages.asp?Lang=English&ref=quest_ce_que_nf)

<sup>97</sup> The French “Grenelle de l’environnement” operational committee n°23 entitled “Consumption, Ecological price and competitive advantage” made the announcement that compulsory environmental information will be effective for each product on 1<sup>st</sup> January 2011<sup>97</sup> (2009). It was further confirmed, though only for climate change through carbon footprints, in the French Senate law proposition (Article 85) of a compulsory carbon cost labeling inside the consumption code at the beginning of 2011 (<http://www.senat.fr/rap/l08-552-1/l08-552-1117.html>). This project has nevertheless been delayed and replaced by experimentations on the feasibility of eco-labeling together with a restriction on consumer goods.

<sup>98</sup> Sponsored by Defra and the Carbon Trust, Publicly Available Specification (PAS) 2050 has been developed in response to broad community and industry desire for a consistent method for assessing the life cycle GHG emissions of goods and services.

<sup>99</sup> <http://www.iioa.org/>

- 1 categories of products characterized by a homogenous price. Any visit by final consumers at retailer
- 2 shops confirm the diversity of the density value €/kg for similar products.

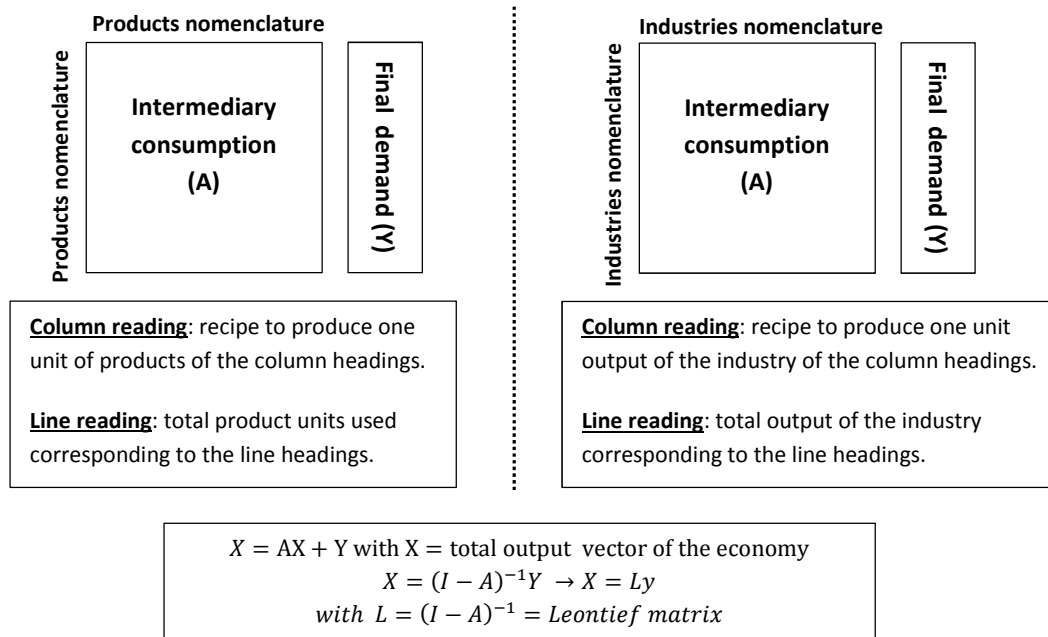

Type of analysis	Corresponding formula
<p><b>Tier analysis :</b> The Leontief matrix can be divided in an infinite number of tiers. This corresponds to the decomposition of the supply chain driven by final demand.</p>	$(I - A)^{-1} = I + A + A^2 + \dots + A^N$ $X = LY = Y + AY + A^2Y + \dots + A^NY$ $N \rightarrow \infty$
<p><b>Effects of change in final demand analysis :</b> The final demand can be changed. The Leontief matrix will automatically indicates the associated changes in the total output of the economy.</p>	$Y' = Y + \Delta Y$ $X = LY \text{ and } X' = LY'$ $\Delta X = X' - X = L\Delta Y$
<p><b>Change in the structure of economy analysis :</b> A change in the A matrix which represents the structure of the economy both in terms of efficiency of the making of products and the links between sectors can be analyzed through its consequences on the economy.</p>	$A \rightarrow A' \Rightarrow L = (I - A)^{-1} \rightarrow L' = (I - A')^{-1}$ $X = LY \text{ and } X' = L'Y \Rightarrow \Delta L = L' - L$ $\Delta X = X' - X = \Delta LY$

3

4 **Figure 38 : The analytical framework driven from the input-output tables**

5 The Physical IO tables (PIOTs) should thus be constructed separately from the monetary IO tables  
 6 (MIOTs). Unfortunately, only a few PIOTs have been compiled to date (see e.g. (Katterl, et al., 1990),  
 7 (Stahmer, et al., 1997), (Stahmer, et al., 1998), (Stahmer, 2000)(pp.43-91), (Pedersen, 1999),  
 8 (Mäenpää, et al., 2001), (Statistisches Bundesamt, 2001), and (Nebbia, 2003)). As has been pointed  
 9 out before (see e.g. (Strassert, 2000)), no standard methods for the compilation of PIOTs have yet  
 10 been developed due to the relatively young history of physical input-output accounting. Therefore, it  
 11 is highly likely that not only the factor input tables but also the inter-industry and final demand tables  
 12 of existing PIOTs differ in conventions and definitions both from each other and from monetary  
 13 input-output tables, which have become much more standardized in the course of several decades of  
 14 experience in compilation. This lack of standardization for physical input-output accounting obstructs

1 a reliable comparison between results obtained from a physical and a corresponding monetary input-  
2 output model as commensurability in the definition of the variables - a general requirement of any  
3 comparison - is not guaranteed (Duchin, et al., 2004). Consequently, until now, most environmental  
4 impact analysis based on IO tables corresponds to extension of the MIOTs by an environmental  
5 vector taken from the satellite accounts of the SNA framework.

6 There are two types of satellite accounts, serving two different functions. The first type, sometimes  
7 called an internal satellite account, takes the full set of accounting rules and conventions of the SNA  
8 but focuses on a particular aspect of interest by moving away from the standard classifications and  
9 hierarchies. Examples are tourism, coffee production and environmental protection expenditure. The  
10 second type, called an external satellite account, may add non-economic data or vary some of the  
11 accounting conventions or both (European Commission, et al., 2009)(p.531). These variations can  
12 concern (European Commission, 2011), p.526):

13 - **Production and products:**

14 When establishments, and consequently industries, are not homogeneous at a given level of the ISIC,  
15 they undertake both a principal activity and one or more secondary activities. The output of these  
16 secondary activities is identified according to its nature, following a product classification, but the  
17 inputs of secondary activities are not separated from those of the principal activities. Ancillary  
18 activities, on the other hand, are not analyzed and classified according to their own nature and the  
19 related products do not appear as autonomous products. For example, the output of transportation  
20 activities in the central framework covers only transport services rendered to third parties leaving  
21 the treatment of own-account transportation as an ancillary activity. Therefore, a broadening of  
22 transport activity which would identify and measure own-account transportation could be  
23 interesting. Similarly, to make an overall estimate of the transportation function in an economy, it  
24 might be useful to cover transport services rendered by households using their own cars to try to  
25 value the time spent using transport facilities.

26 - **Income:**

27 Externalities are impacts on third parties that are not accounted for in the value of monetary  
28 transactions between two economic units or that result from actions of these units in the absence of  
29 any monetary transaction. As such, externalities may give rise to a wide range of implicit transfers.  
30 For example, pollution and nuisance created by producers may have negative effects on final  
31 consumers. These negative effects might (with difficulty) be estimate and recorded as negative  
32 transfers from producers to households. In order to balance these negative transfers, one possibility  
33 might be to introduce a concept of production of externalities which would result in an output of  
34 negative or positive services and the corresponding final consumption.

35 - **Use of goods and assets:**

36 The services rendered to each other member of the same households if included in production would  
37 also have to be included in final consumption. Similarly, if at least part of final consumption on  
38 education and health were treated as fixed capital formation, the corresponding central framework  
39 transactions would be reclassified from consumption to fixed capital formation resulting in human  
40 capital assets. Finally, an alternative to the inclusion of expenditures on consumer durables such as

1 cars and furniture in household final consumption would be to treat them as fixed capital formation.  
2 Only that part of the resulting fixed asset estimated as the capital services provided by the durable  
3 would enter final consumption. This notably means enlarging the concept of production to include  
4 household services.

5 The system of extended accounts thus offer promising ways to address issues not addressed in the  
6 central framework of the system of national accounts. However, the development of these accounts  
7 is still low and the lack of standardization severely limits the application of extended accounts for  
8 environmental analyses. Besides, the poor sustainable use of these extended accounts lies in the  
9 idea that monetary accounts should remain the central framework. This is clearly showed by  
10 (Stahmer, 2000)(p 50) for whom measuring outputs of economic sectors in mass units has its clear  
11 limitation when it comes to sectors which normally have non-material outputs as it is typically the  
12 case in the service sectors. On the opposite, we argue that we should reverse the logics and instead  
13 of studying how non-monetary activities impact the monetary activities, we should study how the  
14 economic world and its monetary and production logics dependency impact the society and its  
15 associated ecosystems. This notably supposes that the society organizes itself according to goals not  
16 situated in the logics of the market and industrial worlds, and successfully subordinates these worlds  
17 to the society goals. We should nevertheless acknowledge that the development of external  
18 accounts has been able to raise policy awareness about environmental issues. Indeed, in a world  
19 governed from a policy viewpoint by the industrial and market worlds, the links offered between  
20 externalities and monetary activities by the external accounts allow better environmental policy.  
21 Based on (Dente, et al., 2012), the next section presents an example of application of the extended  
22 environmental Input Output framework to the issue of Climate Change and its implication on trade  
23 analysis.

## 24 **2.2.2 Applying EE-IO analysis to Climate Change and its implication on trade analysis**

25

26 In 2011, the 193 member states of the United Nations have signed the Kyoto Protocol except  
27 Afghanistan, Andorra, and South Sudan (United Nations)<sup>100</sup>. Among these 193 signatories, only the  
28 United States has not ratified the Protocol (United Nations). Being able to unify all these countries  
29 around global climate change issue constitutes without doubt an international policy success but  
30 only 41 countries<sup>101</sup> grouped under the “Annex I” label are mandated with GHG emission reduction  
31 targets. Indeed, following the principles of historical responsibility and the right to development of  
32 developing and emerging countries, the UNFCCC determined on December 11<sup>th</sup> 1997 in Kyoto that  
33 reduction targets should first applied to developed countries. Besides, the Article 3 of the UNFCCC  
34 Kyoto protocol sets their GHG emissions must be at least 5 % below 1990 levels for the commitment  
35 period 2008 to 2012 (United Nations). Therefore, build a comprehensive worldwide dataset of GHG

---

<sup>100</sup> Nevertheless, there are 193 signatories of the Kyoto Protocol as Cook Islands and Niue are considered as additional states and European Union as an added economic region.

<sup>101</sup> **Non-EU Europe:** Belarus\*, Croatia (-5%), Iceland (+10%), Liechtenstein (-8%), Monaco (-8%), Norway (+1%), Switzerland (-8%), Russian Federation (+0%), Ukraine (0%) **EU27:** Bulgaria (-8%), Romania (-8%) **EU25:** Czech Republic (-8%), Estonia (-8%), Hungary (-6%), Latvia (-8%), Lithuania (-8%), Malta\*, Poland (-6%), Slovakia (-8%), Slovenia (-8%) **EU15:** Austria (-8%), Finland (-8%), Sweden (-8%) **EU12:** Denmark (-8%), Greece (-8%), Ireland (-8%), Portugal (-8%), Spain (-8%), United Kingdom (-8%) **EU6:** Belgium (-8%), France (-8%), Germany (-8%), Italy (-8%), Luxembourg (-8%), Netherlands (-8%) **Oceania:** Australia (+8%), New Zealand (+0%) **Asia:** Japan (-6%), Turkey\* **America:** Canada (-6%), United States\* (-7%)\* **Without target Annex I countries** (United Nations)

1 emissions may be complicated due to the uncertainties associated with non-Annex I GHG emissions.  
 2 Finally, the Kyoto Protocol could only enter into force on February 16<sup>th</sup> 2005 after the rectifications of  
 3 Russia raising to more than 55% of 1990 GHG emissions of Annex I countries was concerned by the  
 4 Protocol. If we consider that 63.7% of 1990 worldwide GHG emissions (United Nations) were  
 5 associated with Annex-I countries, the lowest worldwide GHG emissions reduction target set by the  
 6 Kyoto Protocol corresponds to a 1.8% reduction of the 1990 world GHG emissions<sup>102</sup>. Has this  
 7 reduction targets been reached for?

8 The answer appears positive if we consider the Annex I countries GHG emissions dropped from 18.73  
 9 GtCO<sub>2</sub> in 1990 to 17.76 GtCO<sub>2</sub> in 2008 thus achieving a 5.2% reduction in emissions. Besides, when  
 10 comparing the average GHG annual emission level of the 1990-2008 periods with the 1990 emission  
 11 level, the reduction achieved is raising to 5.3%. However, this success covers different stories as  
 12 shown in **Figure 39** notably between Annex I countries without emission reduction targets and those  
 13 with emissions reduction targets as four main trends clearly appear:

- 14 - Countries with high increase in emission (**Canada , Oceania**)
- 15 - Countries with slow increase in emission (**Japan, Other EU6, EU12, EU15**)
- 16 - Countries with slow decrease in emission (**France**)
- 17 - Countries with high decrease in emission (**Russian Federation, Other Non-EU, Germany, EU25, EU27**)

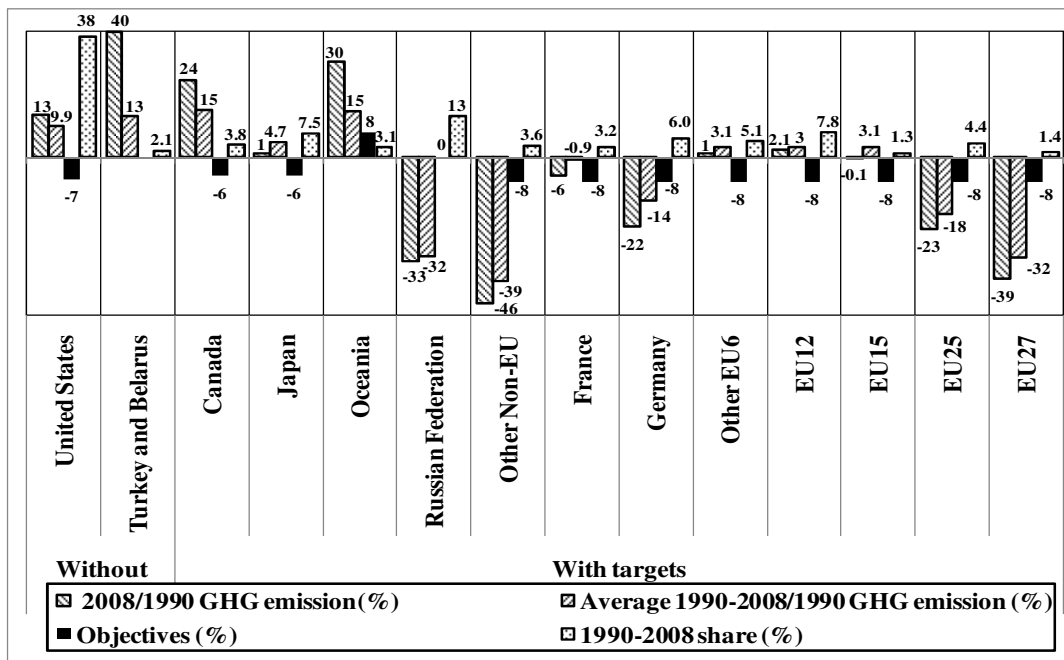

19  
 20 **Figure 39 : Has the reduction targets been reached for Annex I countries? A direct ratio and**  
 21 **cumulated ratio perspective**

22 Interestingly, while a 6.1% reduction of French GHG emissions is achieved in 2008 compared to 1990  
 23 level, this reduction drops to 0.9% when considering the average annual French GHG emissions of  
 24 the 1990-2008 periods. Respectively, Japanese emissions increase from 1% to 4.7%. Therefore,  
 25 though most statistics regarding climate change compares directly the 2008 emission level to those  
 26 of 1990, we argue that considering the level of emissions averaged over the 1990-2008 periods  
 27 better captures the historical evolution of GHG emissions as shown in **Figure 40**. In this framework,

<sup>102</sup> 5% reduction \* 55 % of Annex I GHG emissions \* 63.7% of world GHG emission = 1.8% of world GHG emissions



1 the historical perspective of Russian federation emissions is straightforward: a huge decrease due to  
 2 the former Soviet Union reconstruction until 1998 and a slow increase since then. The importance of  
 3 the former Soviet Union reconstruction in the rapid decrease of European emissions is further  
 4 confirmed by the profile of the evolution of German emissions<sup>103</sup>. Nevertheless, contrary to Russian  
 5 federation, German decreasing emission trend has been going on after 1998 though at a slower pace.  
 6 **Figure 40** also allows a clearer distinction between Japan and Oceania historical evolution of  
 7 emissions. While Oceania emissions are growing at a high rate especially in the 1995-2000 periods,  
 8 Japan experienced their main rise in emission in the 1990-1994 periods before remaining around the  
 9 same level until a huge drop in 2008 which may be due to financial crisis. Therefore, contrary to  
 10 Oceania, Japan, though not fulfilling in 2008 its Kyoto target, seems to have at least stabilized its  
 11 emissions. Finally, France, after some chaotic variation corresponding to the 1993-1994 recession  
 12 period, experienced a slow decrease in its emissions between 1998 and 2005 followed by a higher  
 13 decrease during the 2005-2008 periods. Interestingly, the beginning of this higher decreasing period  
 14 coincides with the introduction into the French V<sup>th</sup> republic constitution of an environment charter  
 15 (Digithèque MJP) and the entry into force of the Kyoto Protocol. Since then, environment has taken a  
 16 stronger place in French policy debate but it should be noted that in spite of these late efforts,  
 17 France has not in 2008 met its Kyoto targets.

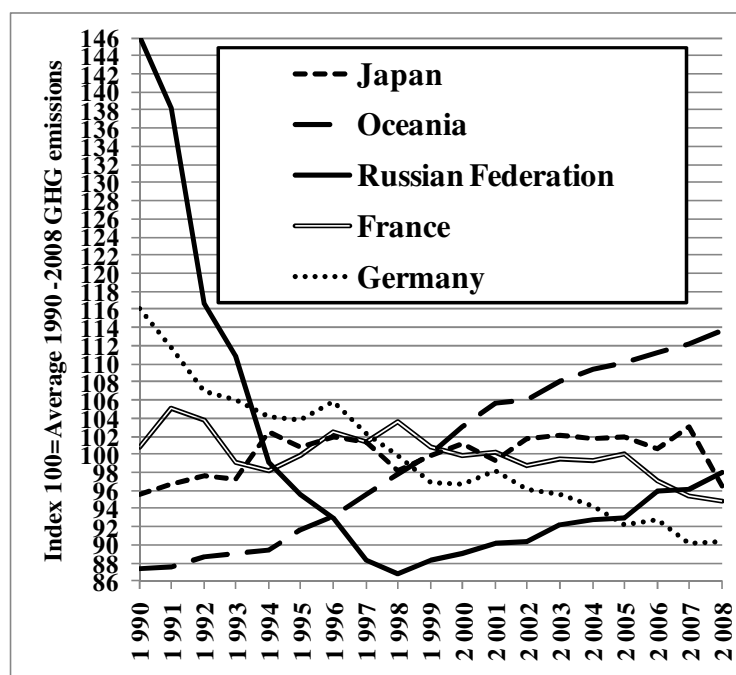

18  
 19 **Figure 40: A historical perspective of the evolution of GHG emissions compared to 2008 emission**  
 20 **level.**

21 The globalization of trade and associated GHG emissions are logically connected to an increase of  
 22 GHG emissions associated with international transportation. Actually, the 2008 CO<sub>2</sub> emission  
 23 associated with international marine bunkers fuel combustion are 63% higher than those of 1990  
 24 while those of international aviation bunkers have increased by 76% over the same period (IEA,  
 25 2010). Moreover, transport represents 22% of world CO<sub>2</sub> emissions in 2008 thus constituting an

<sup>103</sup>Indeed, the former DRG experienced a huge decrease of emission in the beginning of the nineties, 50% decrease in terms of CO<sub>2</sub> emission over the 1987 – 1993 period while the 1993 CO<sub>2</sub> emissions level of the former FRG is 2% more than 1987 level (United Nations, UNFCCC, 1994)

1 important potential for climate mitigation policy. Nevertheless transport is expecting to grow by 45%  
2 by 2030 (IEA, 2010). Noting that international bunkers emissions are not currently part of Kyoto  
3 protocol framework, the observed globalization of GHG emissions calls for the development of  
4 methodologies able to track down national and international bunkers emissions throughout the  
5 patterns of trade so as to ensure the best post-Kyoto GHG emission reduction international policy.  
6 However, current GHG emission accounting framework mostly focuses on national emission patterns  
7 and miss the trade perspective. Indeed, the GHG emission reduction targets of Annex I countries are  
8 based on a national GHG accounting framework which is thus production driven since all emissions  
9 resulting from national residents activities are assigned to the associated country. Particularly, this  
10 means that American companies, which are resident in France, will contribute to French GHG  
11 emissions and not American ones. In the same perspective, French tourists visiting the United States  
12 contribute to American GHG emissions. This framework is thus in line with the Gross Domestic  
13 Product (GDP) framework which aggregates in monetary terms the results of residents' production  
14 but not with the Gross National Income (GNI) which would associate American companies in France  
15 with the United States.

16 The on-going process of globalization will thus result in an even more increasing inter-connection of  
17 countries GHG emissions. Consequently, two perspectives are offered to policy-makers:

- 18 - **The production perspective (PP)**: GHG emission reduction should be based on the amount  
19 produced by country as following the sovereignty principle, each state is the only one able to  
20 enforce emission reduction from its resident production activities. Therefore, the GHG emissions  
21 associated with the production perspective ( $\text{GHG}_{pp}$ ) is the sum of GHG emissions associated with  
22 resident production activities for their own consumption ( $\text{GHG}_c$ ) and those for exports ( $\text{GHG}_E$ ).
- 23 - **The consumption perspective (CP)**: GHG emission reduction should be based on the amount  
24 consumed by country as following the sovereignty principle, each State is the only one able to  
25 enforce emission reduction from its resident consumption activities. Therefore, the GHG  
26 emissions associated with the consumption perspective ( $\text{GHG}_{cp}$ ) are the sum of GHG emissions  
27 associated with resident production activities for their own consumption ( $\text{GHG}_c$ ) and those  
28 associated with imports ( $\text{GHG}_I$ ).

29 The difference between CP and PP results from the difference of GHG emissions embodied in exports  
30 and those embodied in imports. Therefore, while PP policy options only aim at improving national  
31 production GHG efficiency, CP policy options are dependent on the trade partners' production GHG  
32 efficiency. Consequently, the CP policy options would have to be more collaborative raising the issue  
33 of emission allocations between actors (Lenzen, et al., 2007). Indeed, for example, Davis and Caldeira  
34 determined that 23% of 2004 CO<sub>2</sub> worldwide emissions were traded internationally primarily as  
35 exports from china and other emerging markets to consumers in developed countries (Davis, et al.,  
36 2010). This result was further confirmed by Peters and Hertwich who determined that almost one-  
37 quarter of carbon dioxide emissions released to the atmosphere is emitted in the production of  
38 internationally traded goods and services (Peters, et al., 2008) thus calling for the introduction of  
39 trade within post-Kyoto policy debate (Peters, et al., 2008). Other studies regarding carbon  
40 embodied in trade were realized in developed countries<sup>104</sup> and all of them show that CP leads to

---

<sup>104</sup> Austria (Kratena, et al., 2010), U.S (Weber, et al., 2007), France (Lenglart, et al., 2010)

1 higher GHG emissions than PP for most of the developed Annex I countries<sup>105</sup>. On a policy level, this  
2 means the risk of carbon leakage is high as the developed countries could relocate GHG-intensive  
3 activities to a cheaper labor but less GHG efficient market and then import high GHG embodied  
4 goods, which are currently not accounted in the Kyoto framework. Therefore, it would be more  
5 politically sounded to evaluate CP emissions as it could help convince new emerging countries to join  
6 Annex I and get emission reduction targets. Furthermore, CP corresponds to the product perspective  
7 of carbon labeling policy, and thus offers possibilities of bi or multi-lateral agreement between  
8 countries on the way to achieve reduction of GHG emissions for particular products or sectors.

9 Nevertheless, from a methodology perspective, CP is more data intensive than PP. Indeed, language,  
10 policy issues, non-recorded data, or data non-recorded at the same detailed level are examples of  
11 the barriers encountered to comprehensively associate data from trading countries. In other terms,  
12 the absence of institutional proximity in regards to environmental issue makes the policy debate  
13 difficult to solve. Furthermore, contrary to PP which only accounts in an aggregate way the national  
14 emissions, CP supposes to be able to track down imports, exports and production for national  
15 consumption separately thus raising the issue of data availability. This is why the EE-IO framework  
16 has been implemented in three ways depending on data availability (Hertwich, et al., 2004):

- 17 - **The single region IO framework**: The analyst has been able to differentiate imports, exports, and  
18 national production for national consumption but has no data from other regions. A mirror-  
19 economy assumption is then used by giving the same economic structure and thus the same GHG  
20 efficiency to the trade partners which allows the distribution of GHG emissions to each import  
21 from and export to these countries. Nevertheless, the mirror economy assumption may be quite  
22 far from reality. Indeed, the carbon efficiency of economies may vary a lot between developed  
23 and developing countries but also between developed countries. For example, the French  
24 electricity carbon content is cleaner than the German one.
- 25 - **The without re-import/re-export MRIO framework**: IO tables from other countries with the  
26 associated emissions are available but it is supposed that direct trade predominates. Thus, it is  
27 assumed the production of imports for one country does not induce production within this  
28 country.
- 29 - **The comprehensive MRIO framework**: IO tables from all countries with full differentiation  
30 between imports and domestic technology matrices are available. Therefore, a comprehensive  
31 multi-lateral trade analysis can be made. This framework is data intensive.

32 The development of the previous example shows the general usefulness for policy analysis of  
33 developing new comprehensive database related to environmental impacts. This kind of incentives  
34 towards better sustainable grounds of society is not limited to politicians but can reach all the  
35 members of the civil society, and notably producers and consumers by the means of environmental  
36 analysis of the products linking them. Examples of these approaches are the environmental labeling  
37 seen before and the EIPOT<sup>106</sup>, EXOPIOL<sup>107</sup>, and GTAP<sup>108</sup> projects.

---

<sup>105</sup> Carbon trade balances according to ( Sustainable Consumption institute of the University of Manchester) :  
Japan (+26%), Germany (+20%), France (+15%), U.S (+8%) to compare with Brazil (-12%), China (-18%), Russia (-  
21%)

<sup>106</sup> [http://seri.at/wp-content/uploads/2009/10/EIPOT\\_Final\\_Report\\_07Aug09.pdf](http://seri.at/wp-content/uploads/2009/10/EIPOT_Final_Report_07Aug09.pdf)

<sup>107</sup> <http://www.feem-project.net/exiopol/>

<sup>108</sup> <https://www.gtap.agecon.purdue.edu/>

### 2.2.3 A general review of environmental analysis

For products, current environmental analyses are focusing on a life cycle approach of the product from the extraction of materials to the shops where consumers buy products (cradle to gate approach) or less often from the extraction to the product end of life (cradle to cradle approach). However, such approach needs to be based on a thorough methodology such as the Life Cycle Analysis (LCA) methodology. The basic idea of LCA methodology is to calculate the environmental burden associated with the delivery of one functional unit. For example, the most often used functional unit when it comes to the transportation of goods is ton-kilometers. Going further, the LCA methodology is made of three steps (Grisel, et al., 2008). The first step is to define the goal and scope of the LCA study which corresponds to the pattern of functional units and system boundaries. The second step concerns the inventory analysis and supposes the construction of the flow model according to the system boundaries decided on in the first step, the data collection for all the activities (processes and transports) in the product system, and finally the calculation of the amount of resource use and pollutant emission of the system in relation to the functional unit. The third step concerns the impact assessment. This is made through the classification of the resource uses and pollutant emissions found in step 2 according to different impact categories such as global warming potential, eutrophication potential and acidification potential. The relative contributions of the emissions and resource consumptions to each type of environmental impacts are based on scientific models of cause-effect chains in the natural systems. The issue of these three steps are thus related the general issue of conventions. This is clearly expressed through the first step in which the boundaries and the functional units are dependent on the goal settled by LCA makers. It is also demonstrated by the weighting process made between impact categories by those using LCAs to undertake actions in favor of the environment. The environmental friendliness demonstrated by LCA is thus a local one relying on a particular structure (boundary, flow structures, weighting process). The LCA nevertheless corresponds for the firm to a broadening of its environmental awareness and is thus a great advance towards a better consideration of sustainable issues. Indeed, as shown in **Figure 41**, the usual framework to comply environmental regulations at the local level may induce a worsening of the environmental effects on a global level. As the change from the industrial world to a market world or as the change from internal logistics to integrated logistics, The LCA is thus an evolution towards more complex systems.

However, this complexity has a cost. As stated by Edgar G. Hertwich, in its critical review of LCA approaches to sustainable consumption (Hertwich, 2005), the main drawbacks of process LCA are the high-input data requirements and the cutoffs of the system which are mainly subjective. This problem is very important since if LCAs with different system boundaries are made for the same product, results can vary significantly. In the context of eco-labeling, this could lead to a lack of understanding by consumers which will result in a lack of trust due to the absence of coherent information. Actually, though consumers are willing to tackle the climate change, they emphasize as a barrier the lack of environmental information they have (*Munashinge and al., 2009*). On the other hand, IO analysis also presents several drawbacks as shown in **Table 9**. In a way, IO analysis ensures a macro-economic point of view, holistic but average whereas process LCA ensures a micro-economic point of view, specific of the firm level. Finally, **Table 10** summarizes the different possible features to conduct sustainable consumption studies.

1 **Table 9: Differences between process Life Cycle Assessment and Input-Output Analysis**

<b>Process life-cycle assessment</b>	<b>Input-output analysis</b>
Based on a detailed modeling of production, distribution, use and disposal processes of a specific product	Represents links among all industry sectors of an economy
Able to represent specific technologies and conditions along the life cycle and evaluate variations in these conditions ; able to distinguish, for example, luxury and common products	Sector-average economic output and factor intensities
Can account for cross-border inputs	Usually based on national data only; this can be a problem, especially for products not produced in the country of interest
High-input data requirements	Regularly updated by statistical bureaus
Focused only on environmental issues	Represents also the scale of economic activities as well as labor and capital requirements; useful for evaluating for example, employments effects; the “dual” price model allows for the evaluation of where the value is added and who earns scarcity rents
Incomplete system models, cutoffs specify what part of the supply chain is omitted => can lead to significant errors	Represents all linkages in an economy, but difficulties with aggregating Make and Use Tables and assigning industry emissions to products produced
Problems in accounting for overhead, service inputs usually takes a product i.e., micro, perspective	Problems in accounting for capital goods used in production facilitates the evaluation of effects on the macro level, particularly on the national scale

2

3 **Table 10 : the different environmental methodologies for sustainable consumption (Hertwich, 2005)**

<b>Process LCA</b>	“Classical” life-cycle assessment; calculation of environmental impacts based on a physical description of the processes involved in a product life cycle
<b>Input-output LCA, Environmentally extended input-output analysis</b>	Use of input-output tables and emissions per industry to calculate upstream environmental impacts
<b>Hybrid input-output analysis, energy input-output analysis</b>	Input-output analysis in which some commodity flows (usually electricity, fuels) are expressed in physical units (kWh, GJ, kg) instead of monetary units.
<b>Hybrid life-cycle assessment</b>	Combination of input-output LCA and process LCA: commonly the input-output tables are not altered, but used for some processes in a process LCA; in principle, there is duplicate information, since the information in the process LCA is, on a higher level of aggregation, also included in the input-output analysis.
<b>Social accounting matrix (SAM)</b>	Extension of an input-output table which also includes the monetary flow through households and the government ; households earn income from labour and capital and spend it on consumption. SAMs are “closed” in the sense that there is no net monetary flows outside the SAM
<b>Structural decomposition analysis</b>	Approach that can be used to analyzed the change over time in extensive variable of interest to changes in intensive and extensive variables related to the input-output tables, including changes in the structure (composition) of economic activity
<b>Ecoefficiency vector (E2 vector)</b>	Graphical analysis of impact er value (or cost), which can be used to compare alternatives and evaluate the rebound effect; analysis of impact can be based on LCA, IOA or a combination thereof

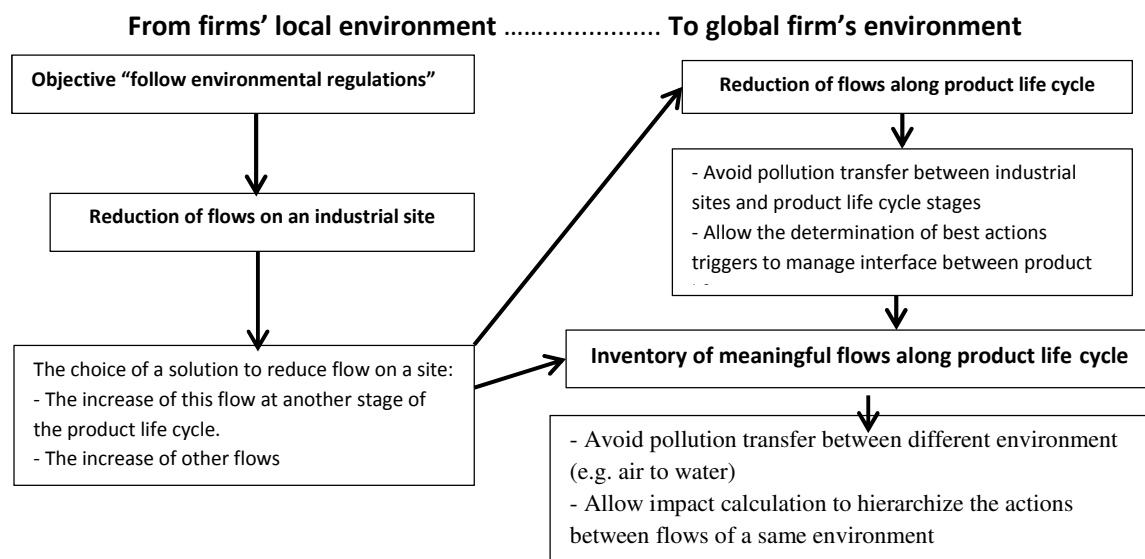

1

2 **Figure 41 : LCA as a management of interface between local and global environment of firms**  
 3 **(Grisel, et al., 2008) (p.319)**

### 4 **3 The environmental issue of the circulation process**

#### 5 **3.1 Learning from environmental analysis**

6

7 Many studies have focused on a product and supply chain approach of emissions (*see e.g.* (Rizet, et  
 8 al., 2005), (Browne, et al., 2005), (Mikiki, 2005), (Spasov, et al., 2005), (Cornelis, et al., 2005) and  
 9 (Rizet, et al., Décembre 2008)). Yoghourt, jean, apples and furniture are typically the products  
 10 studied in previous studies and the emissions are tracked along their supply chain, including the last  
 11 kilometers driven by final consumers to different types of retail shops (hypermarket, supermarket,  
 12 convenience store and e-commerce). Results show that final distribution process and handling in  
 13 stores are responsible for high variation in energy consumption. Indeed, E-commerce scores the  
 14 lower value in terms of energy consumption due to a lower need of space for stores and is followed  
 15 by the convenience store of which the low value for kilometers driven by consumers is offset by the  
 16 higher consumption of stores due to the absence of scale economy as in supermarket and  
 17 hypermarket. The picture nevertheless totally changes when dealing with GHG emissions since  
 18 French electricity has a low carbon content, thus providing low CO<sub>2</sub> value for the energy consumed  
 19 and consequently inverting the efficiency order between convenience store and e-commerce  
 20 (Hertwich, 2005). In the case of international supply chain such as the jean's one for which cotton  
 21 can come from India, Uzbekistan or Egypt, transportation related energy consumption is very high  
 22 and strongly dependent on the driven distance and transport mode chosen explaining for example  
 23 why the nearest country, Egypt, scores the lowest value. This result is even truer for greenhouse gas  
 24 emissions due to the low carbon content of French electricity which thus stresses fuel dependent  
 25 activities in comparison. This finding has been reproduced for apples in destination to France, United  
 26 Kingdom and Belgium (Rizet, et al., Décembre 2008) as shown in **Figure 42**, and another study on  
 27 jean in destination to United Kingdom which showed that most emissions were occurring during the  
 28 transportation phase from production to Britannic harbor (Browne, et al., 2005). Conducting such  
 29 studies implies the management of reliable data and consequently, the availability constrain of such

1 data can lead to an artificial cut-offs of the supply chain as it was the case in the logistic chain of  
 2 yoghurt in Greece for which energy consumption data of stores were judged insufficiently  
 3 consistent thus setting the end of the studied supply chain (Mikiki, 2005). Focus has also to be made  
 4 on the miles driven by consumers to buy goods as they represent a high share of goods supply chain  
 5 related emissions. This question was in fact the focus of the INFACT project (Cornelis, et al., 2005).  
 6 They first develop a model with three types of professional distribution delivery process which take  
 7 into account four types of costs: transportation costs, consolidation costs associated with loading  
 8 and unloading operation, storage costs monetized with time valorization and external costs issued  
 9 from congestion, accidents and pollution. Then, they develop a profile of the kilometers driven by  
 10 consumer through a survey with 250 participants. They found out that an equal share (39%) of the  
 11 survey participants used car or walked to buy their goods. Further on, they found most consumers  
 12 buy less than four bags and that old people tends to go to the stores earlier than young people which  
 13 is an important characteristic in the current context of population ageing (Cornelis, et al., 2005).  
 14 Finally, as space is a scarce resource in cities, it should not be forgotten that the store area is  
 15 composed of selling area, storage area, loading and unloading areas and parking lots. This means that  
 16 a trade-off has to be found between upstream process (storage, loading and unloading) and  
 17 downstream process (parking lots) (Cornelis, et al., 2005). Consequently, a better understanding of  
 18 the way consumers organize their shopping trips and the associated impacts on road congestion and  
 19 energy consumption are needed. Such aspects have to be studied within the framework of urban  
 20 logistics in connection with the rest of the supply chain and urban planning.

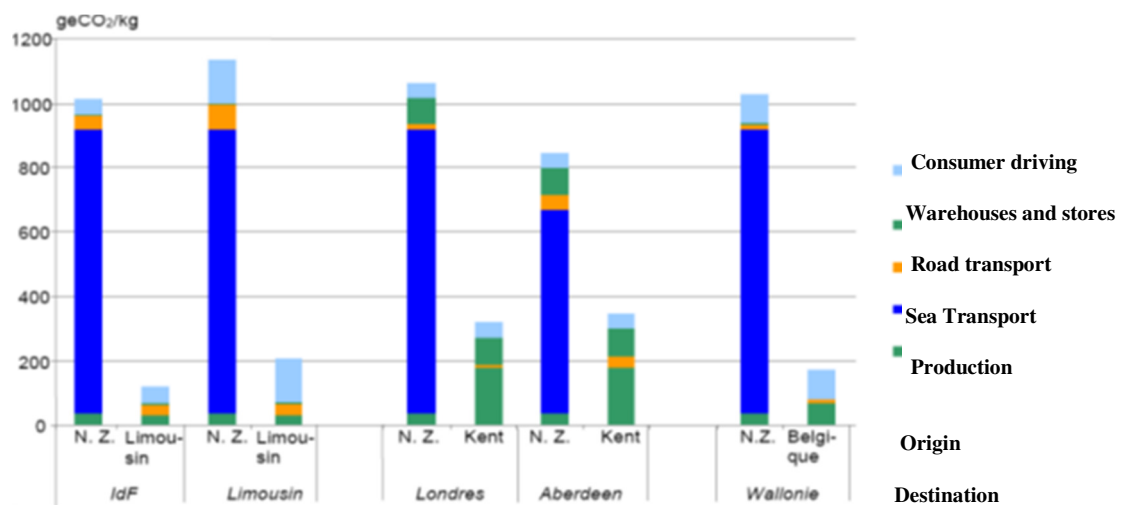

21  
 22 **Figure 42 : Comparison of logistic chains for an apple sold in a supermarket for Belgium, France and**  
 23 **United Kingdom (Rizet, et al., Décembre 2008)**

24 Overall, there are however several drawbacks in the previous studies. First, they all concern quite  
 25 simple products since supply chains are not made complex by numerous industrial processes.  
 26 Furthermore, jeans, yoghurt or apple are product dedicated to consumers and there are only few  
 27 transformations in their process. Therefore, apple remains the same from its picking in a New  
 28 Zealand farm; yoghurt is artificially considered the same as raw milk; and even jean, the most  
 29 complex product, is considered the same as cotton which is not. There are a lot of chemicals and  
 30 physical processes embodied in the production process. The chemistry used to color jean have to be  
 31 produced such as machinery. The same remark is also valid for cotton which needs energy and lots of  
 32 human, physical and chemical processes to come out of the ground. Such aspects are neglected in

1 these studies which only see production processes at the firm level through the eye of electric  
2 consumption of machinery equipment. A comprehensive framework able to take into account all  
3 relation of the economy and to differentiate between physical, chemical and biological properties of  
4 products is thus needed.

### 5 **3.2 Cost externalities**

6  
7 The “fair and efficient pricing” policy promoted by the European Commission ( (European  
8 Commission, 2001) and (European Commission, 2006)) aims to ensure that all external damages  
9 caused by person or freight transportation are fully internalized in the price of transport. It argues  
10 that pricing should be fair, meaning that “polluters” should pay the marginal social cost of their  
11 activities, and efficient, i.e. giving these “polluters” an economic incentive to reduce the negative  
12 effects of these activities (European Environmental Agency, 2006). For this purpose, the Commission  
13 recently funded a major study of the issues to be resolved in applying the polluter-pays principle to  
14 transport (CE Delft, 2008) and is currently negotiating with the European parliament and Council of  
15 ministers on how it can be implemented. One of the most contentious parts of the proposal relates  
16 to the internalization of the environmental costs of road freight transport. It is proving difficult to  
17 secure international agreement on how this should be done and how the extra revenue generated  
18 should be spent. Indeed, though there are pros for cost internalization, there are also cons. The pros  
19 refer to the notion of social justice, financial incentive and additional funds for governments’  
20 environmentally friendly projects (Mc Kinnon, et al., 2010)(p.69). Actually, the environment is not a  
21 “free good” but a “common good” and the exploitation of this resource should thus be done in  
22 regards to the community and costs internalization seems a good way to provide, by touching to the  
23 wallets, incentives to better take into account this “common good”. Nevertheless, some authors such  
24 as (Coase, 1960) argue against the polluter-pays principle. For them, all the parties are involved in  
25 the pollution process, and instead of making automatically pay the polluter, it looks better to find the  
26 “cheapest cost strategy”. This means that the pollutee can pay if it is cheapest way. Some  
27 organizations representing as the road freight sector, such as the International Road Union (IRU,  
28 2008), have used these arguments to challenge the current efforts of the EU to internalize these  
29 costs of freight transport. For example, it might be argued that it is cheaper to erect sound barriers  
30 along busy roads than to impose a charge on truck traffic to recover national noise costs. In reality,  
31 not only the arguments for the “cheapest cost strategy” are not adapted to transportation issues as  
32 demonstrated by (Maddison, et al., 1996), but the “cheapest cost strategy” looks mainly a way for  
33 the private sector to move away from its responsibility. The example of the erection of sound  
34 barriers is typical of an end-of-pipe strategy in which one prefers to cover the effects of its actions  
35 rather than solve them. Besides, in this case, the sound barriers will be built on government funds  
36 leaving untouched the private sector of road transportation. In fact, the criticism made by IRU  
37 against cost internalization is only valid if the money raised through the taxes is not reinvested on  
38 solutions to solve the problem. In this context, an efficient tax policy would target vehicles with  
39 highest associated noise pollutions and the funds raised could always serve to build sound barriers.

40 If there are some reproaches to make to the cost internalization policy, they concern two aspects.  
41 First, the idea that the usefulness of and damages made to the environment could be reduced to a  
42 sum of monetary amounts is completely absurd from a physical viewpoint. Indeed, monetary  
43 amounts are not only reversible contrary to the environmental degradations, but they cannot  
44 compete in terms of utility. Indeed, money cannot replace properties of an unpolluted environment.



1 The internalization cost strategy can thus be seen as a new way to introduce environmental related  
2 issues into the convention of the standard economy. This way, we observe and extension of the  
3 economic system on ecosystems. On the opposite, we advocate that it is the contrary that should  
4 happen namely that the logics of the economic system should be subordinated to the logics of the  
5 ecosystems. Secondly, there are some important issues in the current methodologies used to address  
6 external costs. Some examples of these methodologies are given in **Table 11**. The issues concern for  
7 example some ethics issues as the statistical value of life or the willingness to pay and willingness to  
8 accept (WTP/WTA) methodologies which we already criticized in **2.1** of this chapter. As we argued  
9 before, the problems of WTP is to refer to methodologies such as the stated preference survey or the  
10 revealed preference study (Mc Kinnon, et al., 2010)(p.73-74). By asking people without any particular  
11 knowledge on ecosystems to value species and biodiversity, one can arrive to policy decisions with  
12 dreadful consequences<sup>109</sup>. Indeed, species are not independent and are interrelated through a  
13 complex system of links generally known as ecosystem. Acting without understanding this system is  
14 totally dangerous, not only because of the possible consequences but also because of the  
15 irreversibility nature of the operated change.

16 In conclusion, we must say that the internalization of costs looks like a good intermediary strategy.  
17 Indeed, this strategy offers the advantage to introduce a first step in the interconnection of the  
18 individual level (market and firm strategies) with the collective level (externalities reduction and  
19 government strategies). Nevertheless, this strategy can reveal environmentally efficient only in the  
20 context of a broader sustainable development strategy in which ecosystems are not viewed as mere  
21 suppliers or service providers but as the central concept around which society first and in a second  
22 time the economy should organize.

23 **Table 11: External costs and methodologies, an overview (Mc Kinnon, et al., 2010)(p.76)**

Externality	Adverse effects	Cost elements	Methods of valuation	Studies
Air pollution	Ill-health Discomfort Agricultural damage Other vegetative damage Physical damage to buildings	Medical treatment value of statistical life/years lost Personal suffering Loss of agricultural output Loss of biodiversity Loss of amenity/landscape value Building value loss/repairs	Health care costs analysis Labour output analysis WTP/WTA assessments Agricultural surveys RP analysis or property prices Building repair costs	(ECMT, 2003) (INFRAS, 2004) (UNITE, 2003) (COPERT, 2009) (REMOVE, 2009)
Climate change	Sea-level rise Extreme weather events Animal extinctions Water shortages Agricultural damage Other vegetative damage Human health problems Ecosystem destruction	Medical treatment value of statistical life/years lost Personal suffering Loss of agricultural output Loss of biodiversity Loss of amenity/landscape value Flood protection Population relocation Physical adaptation etc.	Use of climatic models to predict temperature rise Assessment of future damage to human activity/ecosystems Costing of the damage Calculation of marginal abatement costs	(Stern, 2006) (INFRAS, 2004) (COPERT, 2009) (REMOVE, 2009)
Noise	Irritation Sleep disturbance Ill-health	Medical treatment Personal suffering Loss of amenity Building value loss/repairs Sound-proofing	WTP/WTA assessments RP analysis or property prices Estimate of sound proofing cost	(INFRAS, 2004) (UNITE, 2003) (COPERT, 2009) (REMOVE, 2009)
Traffic accident	Death and injury to humans and animals Damage to property	Medical treatment value of statistical life/years lost Personal suffering Building value loss/repairs	Healthcare costs analysis Labour output analysis WTP/WTA assessments Costing of property damage	(INFRAS, 2004) (UNITE, 2003) (COPERT, 2009) (REMOVE, 2009)

<sup>109</sup> These kind of surveys may nevertheless be interesting, but not for environmental policy purpose. Indeed, it may be interested to conduct this survey to understand the conventions and representations people have on the ecosystems.

### 3.3 Eco-calculators

To evaluate environmental impacts, accounting tools are needed. In France, Bilan Carbone<sup>®</sup> tool acts as a reference since it was launched by ADEME<sup>110</sup>. It consists in a method to calculate greenhouse gas emissions using easily-available data to properly assess the direct or indirect emissions produced by an activity or a territory. It applies to all activities: industrial or tertiary companies, administrations, local authorities and even the territories managed by local authorities. This method is compatible with standard ISO 14064, the GHG Protocol initiative and the terms of the "permit" Directive No. 2003/87/CE relating to the CO<sub>2</sub> quota trading system. There are 2 versions of the Bilan Carbone<sup>®</sup> tool: The "business" version which is used to evaluate the emissions of industrial or tertiary activity and the "local authorities". The latter version has two modules: The "assets & services" module which assesses the authority's operating emissions for its own activities and the "territory" module which assesses the emissions of all activities (industry, tertiary, residential, agriculture, transport, etc.) that have a stake in the local authority's territory. In practice, each Bilan Carbone<sup>®</sup> version or module is made up of a main ready – to – use Excel spreadsheet called the master-sheet which enables to calculate emissions, compare emissions between different years and assess the potential of various reduction actions<sup>111</sup>. However, many drawbacks exist in using this tool. First, the use of average data, notably for transportation for which logistics characteristics are averaged over national statistics makes it difficult to use at the company level, even with the possibility for companies to introduce to some extent their own data into the calculation process. In the same perspective, distances traveled have to be filled by users, a data particular difficult to handle and when given without references makes it unable to track particular origin/destination flows between companies and customers. In reality, the Bilan Carbone<sup>®</sup> tool aims at providing the average carbon footprint of a company and its product and thus allows for only an average repartition between the product life cycle stages. This is why the Bilan Carbone<sup>®</sup> tool is mainly dedicated to an internal ongoing progress for companies contrary to life cycle analysis based on norm ISO 14040 which allows for external communication and is of a multi-criteria approach (ADEME, 2010). Overall, the Bilan Carbone<sup>®</sup> tool appears as a first step for companies to go in carbon accounting and provides the advantage of being able to capture rapidly the full marketing life cycle of products (Association Bilan Carbone, 2011).

To solve the Bilan Carbone<sup>®</sup> problem associated with too average values for the transportation and logistics sector, a considerable number of environmental calculation tools for transportation have been developed in the past years. Nevertheless, because of the competition between transportation modes, it appears that in a first step each transport mode created dedicated calculation tool to show how well it environmentally performs. In this perspective, rail and water transport modes are the modes with the lowest gCO<sub>2</sub>/Tkm ratio. Consequently, they would be the two leaders in this kind of modal comparison tool based on environmental criteria. This explains why for a long period, road and air transporters refused to enter this competition on environmental assessment as they could not compete on the gCO<sub>2</sub>/Tkm ratio. Nevertheless, after some times road and air finally also launched tools to show that their logistic organization is not as harmful to the environment as it could be thought at first sight. Indeed, the routing of road transportation is often more direct than the one in rail transportation leading to some relativity in the environmental superiority of rail transportation. Consequently, the distance corresponding to the real routing has become a key

---

<sup>110</sup> [www.ademe.fr](http://www.ademe.fr)

<sup>111</sup> [http://www.epe-asso.org/index.php?part=publi&id\\_rap=68](http://www.epe-asso.org/index.php?part=publi&id_rap=68)

1 factor to evaluate transportation related emissions. This is often one of the main drawbacks of the  
2 eco-calculator such as the one developed by Voies Navigables de France (VNF). Indeed, the fact that  
3 distance appears in many tools as an external data constrain the user to own some information  
4 about the real distance driven. If not the operator of the transportation himself, the user usually has  
5 little information on the real distance driven but only on the origin/destination. This is notably the  
6 case of shippers who most of the time totally externalize transportation activities. Besides, even in  
7 the case of carriers, they are often specialized on their transport mode and do not have any  
8 knowledge on the routing of other modes. Consequently, eco-calculators able to internalize distance  
9 calculation present a clearer advantage on those unable to do so.

10

11 The Institute for Transport Planning and Logistics of the Hamburg University of technology has  
12 evaluated a set of tools for assessing modal shift and the resulting environmental and socio-  
13 economic impacts as shown in **Table 12**. The main objective of their study was to develop  
14 recommendations for potential users on how to fulfill the requirements of call for tenders in regards  
15 to the environmental and socio-economic impacts. Results obtained through the use of these  
16 different tools can indeed vary significantly due to differences in the system boundary and data  
17 sources. Therefore, as underlined by the authors, eco-calculator tools must be chosen on criteria  
18 such as scientific background and transparency regarding the documentation, regular up-dating of  
19 data sources (e.g. emission factors) and user-oriented interface and availability for public use. The  
20 authors further recommend that values are reviewed and updated on a regular basis e.g. after three  
21 years at maximum. These first remarks plead for the use of the EcoTransIT tool as the latter is  
22 continuously updated and freely accessible on their internet website by the public on which is freely  
23 available a scientific background stating the transparency of the tool. However, the absence of  
24 monetization of the impacts makes its use difficult to use regarding cost internalization policies and  
25 Cost Benefit Analysis. As stated by (Bickel, et al., 2006), as far as possible, impacts should be  
26 expressed both in physical and monetary terms. The results of the sensitivity analysis and the non-  
27 monetized impacts should be reported together with the central monetized results. Further on, as  
28 stated by (Tavasszy, et al., 2005), a trade-off appears between standardization of emission factors  
29 and the development of specific consumption factor only valid for example in one company. Though,  
30 the former has clear advantages in terms of transparency, using EU-wide values might be far from  
31 actual individual preferences and in any case, it will be important to indicate how proposals for use  
32 of values and preferences are located on this trade off curve. Therefore, I agree with (Tavasszy, et al.,  
33 2005) that local values should be used as much as possible. Finally, one can recently observe a new  
34 trend in the eco-calculators which makes their use much more interesting for shippers and the  
35 purpose of environmental analysis. This trend consists in stopping the opposition between modes  
36 and considers supply chains as a whole. For shippers, this means that they do not have to use  
37 different eco-calculators to account and report their emissions. From an environmental viewpoint,  
38 this new trend allows for a better evaluation of the transportation emissions and its responsibilities  
39 in the product chain. It is thus in line with LCA principles and the environmental footprints of  
40 products. This evolution also implies to get a closer eye on the issues of allocation processes as  
41 shown in next section.

1 **Table 12: Comparison of Eco – Calculators (Wolff, et al., 2010)**

2

Characteristics	Tools				
	EcoTransIT (2008)	Marco Polo calculator (2008)	ICF Tool (2005)	NTMCalc (2003)	SUTRANET tool (2007)
<b>Functions</b>	calculation of emissions and energy consumption	monetization of environmental impacts	calculation of emissions, monetization of environmental impacts	calculation of emissions and energy consumption	calculation of emissions and energy consumption
<b>Transport Modes</b>	road, rail, inland waterway, air, sea	road, rail, inland waterway	road, rail, inland waterway	road, rail, inland waterway, air, sea	sea
<b>Source</b>	<a href="http://www.ecotransit.org/">http://www.ecotransit.org/</a>	<a href="http://ec.europa.eu/transport/mar copolo/">http://ec.europa.eu/transport/mar copolo/</a>	(Llyod, et al., 2005)	<a href="http://www.ntmcalc.org/index.htm">http://www.ntmcalc.org/index.htm</a>	<a href="http://sutranel.plan.aau.dk/">http://sutranel.plan.aau.dk/</a>
<b>Impacts considered</b>	resource (energy) consumption, air pollution, global warming	air pollution, global warming, noise, safety, congestion, infrastructure	air pollution, global warming, noise, accidents, congestion	air pollution, global warming	resource (energy) consumption, air pollution, global warming
<b>Processes considered</b>	fuel consumption for transport (including pre and post haulage for non-road based options), fuel production	<i>no documentation found</i>	fuel consumption for transport, handling, loading, unloading	fuel consumption for transport, fuel production (can be chosen)	fuel consumption for transport, port processes
<b>Data input</b>	<p><b>- In standard mode:</b> transport mode, origin and destination (geographical list incl. location type e.g. harbour, station), cargo units (t or TEU), goods type (volume, mass or average)</p> <p><b>- in expert mode:</b> vehicle transport type (for lorries and trains only), EURO emission class (for lorries only), load and empty trip factors (for lorries, trains and inland ships only)</p>	<p>- transport mode</p> <p>- cargo weight (t) or cargo volume (m3)</p> <p>- length of the trip (km)</p>	<p>- transport mode</p> <p>- cargo weight (TEU)</p> <p>- length of the trip (km)</p> <p>- share of diesel and gasoline (for lorries only)</p>	<p>- transport mode</p> <p>- cargo weight (t)</p> <p>- length of the trip (km)</p> <p>- details on the vehicle e.g. fuel type, engine type, vehicle type, load factor, fuel consumption</p>	<p><b>ship input:</b> type of ship (predefined list), gross tonnage (GT), main engine type (predefined list), main Engine Power (kW), other optional data</p> <p><b>route segment input:</b> length (naut. mile)</p> <p><b>traffic input:</b> no. of passages</p> <p><b>port traffic data input:</b> calls, total port time (hrs), load/unload time (hrs), lay time(hrs)</p>
<b>Data Output</b>	<p><b>- Routing:</b> distance (km)</p> <p><b>Emissions:</b> primary energy consumption (MJ), carbon dioxide (t), nitrous oxides (kg), non-methane hydrocarbons (kg), particulate matter (kg), sulphur dioxide (kg) <i>(all results for the cargo shipped)</i></p>	<p>- sum of external costs (€).possible division into costs for air pollution, global warming, noise, safety, congestion, infrastructure <i>(all results per shipment)</i></p>	<p><b>- Emissions (g):</b> sulphur dioxide (g), nitrous oxides (g),- carbon monoxide (g), non-methane hydrocarbons (g), particulate matter (g), methane (g), carbon dioxide (g), sulphur (g)</p> <p><b>- external costs (all in €):</b> air pollutions (divided in SO<sub>2</sub>, NO<sub>x</sub>, CO, nm-VOC,PM), noise, accidents, congestion, global warming <i>(all results for the cargo shipped)</i></p>	<p><b>- Emissions:</b> carbon dioxide, thereof the fossil share (kg), nitrous oxides (g),- hydrocarbons (g), methane (g), carbon monoxide (g), particulate matter (g), sulphur dioxide (g), energy, thereof the share of renewable, fossil and nuclear (MJ) <i>(all results for the cargo shipped)</i></p>	<p><b>-Emissions:</b> fuel consumption (kg), nitrous oxides (kg), total hydrocarbons (kg), carbon monoxide (kg), total particulate matter (kg), carbon dioxide (kg), sulphur dioxide (kg) <i>(all results for the whole ship, not for the cargoshipped)</i></p>
<b>process of maintenance and updating</b>	The tool will be continuously updated and maintained	no information found (but it can be assumed, that if the MP program continues, the evaluation tool will be updated)	The tool will <b>not</b> be updated (but the values used in the Excel tables could be altered by the users)	The tool will <b>not</b> be updated, but the initiators offer a broad database for emissions calculation for a yearly fee	The tool will <b>not</b> be updated, but since calculations depend largely on very detailed input parameters, updating is not seen as of such great importance.

### 3.4 Allocation issues

The evolution of eco-calculators accounting for the environmental impacts of transportation slowly converges towards product chain perspective. This is why as for LCA methodology company data becomes more and more essential to get accurate profile of the environmental impacts of products. Nevertheless, this process of moving to company level data, essential to set environment as an economic comparative advantage for companies, must be done very carefully keeping in mind that every data needs to be checked so as to prevent green washing. More than ever, a normalization process on the way of calculating emissions is needed as to set basic and common grounds to all companies and ensure that the moving to company level data is made on fair grounds. Such is notably the role of the expert group CEN/TC 320<sup>112</sup>. In fact, the allocations principles will depend on the purpose of the tool. For example, EcoTransIT World is a tool intended to be used by shippers – the owner of a freight that is to be transported – that want to estimate the emissions associated with a particular transport activity or a set of different transport options. It may be also used by carriers – the operators and responsible parties for operating vehicles and vessels – to estimate emissions for benchmarking. Consequently, the major rule is that the shipper (freight owner) takes responsibility for the vessel utilization factor that is averaged over the entire journey, from the starting point to the destination as well as the return trip or the entire loop respectively. Thus, even if a shipper may fill a tanker to its capacity, he also needs to take responsibility for the empty return trip which would not have taken place without the loaded trip in the first place. To get a clear viewpoint on allocation problems related to road transportation, we will consider the following truck transporting ten parcels from A to B.

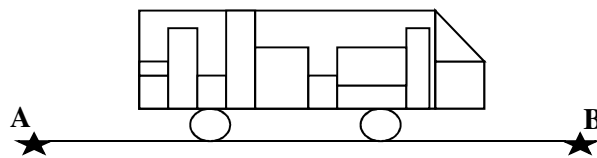

N°Parcel	1	2	3	4	5	6	7	8	9	10	Tot
Weight (in tons)	2	1	3	1.5	0.5	5	4	3	3.5	0.5	24
Volume (in m <sup>3</sup> )	1	1.5	2	3	1.5	8	4	5	2	4	32
Density (tons/m <sup>3</sup> )	2	0.67	1.5	0.5	0.33	0.625	1	0.6	1.75	0.125	0.75

The maximum load capacity of the vehicle is 26 Tons and the maximum volume capacity is 58 m<sup>3</sup>. Therefore, we can calculate the following load factors:

- Weight load factor:  $F_w = \frac{24}{26} = 92,31 \%$
- Volume load factor:  $F_v = \frac{32}{58} = 55,17 \%$

<sup>112</sup>

1 Re-writing these two factors in mathematical terms so as to derive a general framework, we obtain:

$$F_w = \frac{\sum_{i=1}^N w_i}{C_{\max}^w} \quad \text{and} \quad F_v = \frac{\sum_{i=1}^N v_i}{C_{\max}^v}$$

2 Where N is the number of parcels transported in the truck from A to B;  $C_{\max}^w$  and  $C_{\max}^v$  respectively  
 3 the maximum load capacity and the maximum volume capacity. Finally,  $w_i$  and  $v_i$  represents  
 4 respectively the weight and the volume of the parcel i.

5 Following EcoTransIT World methodology (EcoTransIT, 2011), we consider energy consumption and  
 6 the related CO<sub>2</sub> emissions to be mostly dependent on the weight transported. Taking an energy  
 7 consumption per driven km of 309 g diesel (13.3 MJ or 37.1 liter diesel/100km) for the full truck  
 8 ( $F_w = 100\%$ ) and 189 g diesel (8.1 MJ or 22,7 liter diesel/100km) for the empty truck, we can obtain  
 9 through a linear variation the energy consumption for any kind of weight load factor<sup>113</sup>. Here, to a  
 10 weight load factor of 92.31% corresponds an energy consumption of 0.36 liter diesel/km which  
 11 combined with a CO<sub>2</sub> emission factor for diesel of 2.64kg CO<sub>2</sub>/liter (Leonardi, et al., 2005) gives an  
 12 emission of 950 gCO<sub>2</sub>/km.

13 The previous framework focuses on the efficiency of the **vessel**, here the truck. In order to complete  
 14 the picture, we need to further differentiate between the parcels. Such process corresponds to an  
 15 allocation issue and is not dependent on physical or environmental perspectives but rather on the  
 16 perception of responsibility, fairness and equity. Here we consider three types of allocation and  
 17 discuss them.

### 18 **1) Allocation per weight**

N°Parcel	1	2	3	4	5	6	7	8	9	10	Tot
Weight (in tons)	2	1	3	1.5	0.5	5	4	3	3.5	0.5	24
Share weight parcel (%)	8.33	4.17	12.5	6.25	2.08	20.83	16.67	12.5	14.58	2.08	100
Emission per parcel	79.2	39.6	118.8	59.4	19.8	198.0	158.4	118.8	138.6	19.8	950.2

19

$$CO2_{parcel\ i,weight}^{fuel} = \frac{w_i}{\sum_{i=1}^N w_i} \times CO2_{vehicle}^{fuel}$$

### 20 **2) Allocation per volume**

N°Parcel	1	2	3	4	5	6	7	8	9	10	Tot
Volume (in m <sup>3</sup> )	1	1.5	2	3	1.5	8	4	5	2	4	32
Share volume parcel (%)	3.13	4.69	6.25	9.38	4.69	25	12.5	15.63	6.25	12.5	100
Emission per parcel	29.7	44.5	59.4	89.1	44.5	237.5	118.8	148.5	59.4	118.8	950.2

21

$$CO2_{parcel\ i,volume}^{fuel} = \frac{v_i}{\sum_{i=1}^N v_i} \times CO2_{vehicle}^{fuel}$$

22

---

<sup>113</sup>  $CO2_{vehicle}^{fuel} (gCO2/km) = fCO2^{fuel} \times (EC_{empty\ weight}^{fuel} + F_w \times (EC_{full\ weight}^{fuel} - EC_{empty\ weight}^{fuel}))$

1      **3) Allocation per mix units**

N°Parcel	1	2	3	4	5	6	7	8	9	10	Tot
Weight (in tons)	2	1	3	1.5	0.5	5	4	3	3.5	0.5	24
Volume (in m <sup>3</sup> )	1	1.5	2	3	1.5	8	4	5	2	4	32
volume*weight	2	1.5	6	4.5	0.75	40	16	15	7	2	94.75
Share parcel (%)	2.11	1.58	6.33	4.75	0.79	42.22	16.89	15.83	7.39	2.11	100
Emission per parcel	20.1	15.0	60.2	45.1	7.5	401.1	160.5	150.4	70.2	20.1	950.2

$$CO2_{parcel\ i,mix}^{fuel} = \frac{w_i \times v_i}{\sum_{i=1}^N (w_i \times v_i)} \times CO2_{vehicle}^{fuel}$$

2 We thus see that different types of allocations lead to different environmental responsibility of the  
3 parcel owners. However, the emissions associated with the vehicle are the same in each case. This  
4 notably means there is a concept of physical unity for transportation emissions and that going to a  
5 lower level of allocation implies to abandon any physical logics to enter the domain of policy and  
6 decision-making processes. For example, if we wanted to make clearer to the shippers that they  
7 share the same resource, a vehicle, we should admit that each parcel contributes equally to the  
8 vehicle emission. On the other way, if we want to provide incentive to carriers to load parcels in a  
9 more sustainable way, the allocation method may be quite different and depending on the nature of  
10 goods (bulk, voluminous, etc.). In conclusion, the allocation issues can either concern the accounting  
11 framework emissions such as the case of electricity (Dente, et al., 2012) but most of the time; it is  
12 mainly a problem of associating emissions with decision-making processes which belong to the policy  
13 framework rather than the scientific framework of environmental accounting.

14  
15  
16  
17  
18  
19  
20  
21  
22  
23  
24  
25  
26

### 3.5 Critical review of reduction strategies

According to (Cottignies, 2005) the different ways to solve the transportation related environmental issues are:

- 1) Technology: improvements of fuel efficiency, motor engine and vehicles
- 2) Modal shift: taking freight off the road to more environmentally-friendly transport modes such as rail and waterway could cut off emissions. Nevertheless, the shrinking of lot size combine with difficulties in speed, reliability of these two other modes make the modal shift difficult to operate.
- 3) Operational optimization of vehicles: improve the load factor of vehicles, reduce the distance driven and the empty trips along with a more environmentally-friendly way of driving can lead to reduction in energy consumption and GHG emissions.
- 4) Logistic chain organization: logistic organizations have not been conceived with the only aim of minimizing transport energy consumption, not even to reduce only transportation costs. Therefore, it seems logical that improvements can rise from this perspective, though probable not immediately applicable.
- 5) Localization: For a firm, the localization of its own sites (factories, warehouses), the choice of its suppliers and localization of customers are key factors in driving the environmental efficiency of their supply chain.
- 6) The transported product: the conception of the product, its nature, form, and packaging has non-negligible consequences on the generated amount of transport. A better thinking on the conceptions the products taking into account the criterion “energy and environment” could thus lead to a diminution of environmental impacts.
- 7) The firm skills: Proposing an enlargement of firm trade, it appears that in certain case, the firm could export its know-how rather than products, thus reducing transportation.
- 8) National level: Finally, economic choices and orientation at national level, especially, those concerning energy, agriculture and spatial planning, have important consequences on the transportation flow generation.

The improvements of fuel efficiency have been very efficient in reducing local pollutants emissions such as sulfur dioxide and nitrogen oxides through the implementation of EURO norms. Nevertheless, this gain is more difficult to achieve for pollutants such as carbon dioxide which are directly linked to the energy consumption of vehicles. Therefore gain made in energy efficiency and thus gCO<sub>2</sub> emitted by vehicle-km has been more than offset by the on-going increasing traffic. Going further, through a full discussion on the difference between heavy vehicles technology, (Plassat, 2005) found out that autonomy is a key factor in designing the choice of fuel. This notably means that in an urban area for which autonomy is not the main criteria hybrid motors make both technical and economical senses whereas liquid fuels benefits of their high energy density for long-distance journeys, namely inter-cities travels. Concerning the logistic optimization of shippers, (Vallin, 2005) points out 4 strategic axes for which the associated means are presented in **Table 13**.



1 **Table 13 : Axes and means for reducing GHG emissions through shippers' logistic reorganization**

Means	Reduction of product circulation through a shortening of connections (GHG geographic network)	Reduction of the number of empty trips	Reduction of loaded vehicle useless driven kilometers	Reduction of emission through an improved consumed fuel/T-km ratio
Site localization	X			
Network adaptation				X
Coherence upstream/downstream	X			X
Exchanges between shippers	X	X		
Frequency of delivery			X	X
Vehicle capacity			X	X
Limitation of small dispatches				X
Transport tariffs				X
Marketing decisions			X	X
Reverse logistic		X		
Regulation				X
Smoothing of the activity		X	X	
Localization tracking		X	X	
Round optimization			X	
Customer's receptiveness			X	
Freight grants		X	X	

2  
3 Let us now examine the results and acceptance of such strategies. The first strategy is de –  
4 specialization and a study on YOPLAIT production showed a 65% tkm reduction and 30% logistic cost  
5 reduction could be achieved. Nevertheless, YOPLAIT management board states that these results  
6 have to be compared with the cost of this de-specialization since this implies that each site should  
7 possess the all sets of processes and the increase in total production capacity which will be of no  
8 interest in the current context of increase in small lots production (Vallin, 2005). The second strategy  
9 concerns the optimization of distribution and it was found that the optimization of YOPLAIT  
10 downstream distribution (warehouse to customers) followed by the optimization of YOPLAIT  
11 upstream distribution (factories to warehouse) was less efficient than global optimization by around  
12 16%. The third strategy concerns the mutualization of flows between different firms. This  
13 organization was found more efficient as the situation where flows were dissociated corresponded to  
14 +15.6% of kilometers driven and +8.7% of the transportation cost. Nevertheless, the management  
15 board claimed that the cost difference is moderated and that the current organization will be kept  
16 except if the flow dissociation is combined with another location allowing reducing of driven  
17 kilometers or if the flow dissociation allows for a better service and productivity level than those  
18 provided by the current local transporter (Vallin, 2005). The final strategy examined here concerns  
19 the effects of the number of deliveries on the number of vehicle – km driven. The effects were  
20 studied for YOPLAIT middle flows and small flows, i.e. inferior to 20 pallets per day. It appears  
21 concentration of deliveries was only efficient between 3 to 6 deliveries per week for middle flows  
22 and between 1 to 2 deliveries per week for small flows. Nevertheless, the low cost reduction may be  
23 insufficient to offset the current offered flexibility of 1 delivery per day. Indeed, the variability in  
24 demand can play an important role in the context of the service given by the transportation  
25 organization such as in the flexible world. Therefore, (Vallin, 2005) compared the consequences of a  
26 daily constructed transportation planning and a typical transport planning applied each day  
27 independently from demand variability. The results are without restriction in favor of daily

1 constructed transportation planning especially for days with low activity but this implies the use of  
 2 software able to take into account final time of delivery and circulation conditions such as  
 3 congestion. All these situations demonstrate the relative inertia of management boards that are  
 4 often reluctant to change an existing organization except if the expecting benefits are monetary  
 5 important and the cost of the organization change are considerably low.

6 The previous examples show that the patterns of environmental impact reduction are multiple.  
 7 Nevertheless, these reductions suppose changes of organization actors only basing decision on cost –  
 8 criteria are reluctant to take. Nevertheless, as shown in **Figure 43**, from an initial level of costs and  
 9 environmental impacts, three phases can be typically differentiated. In the phase I, we observe both  
 10 a diminution of costs and environmental impacts. For companies, this is without doubt the phase  
 11 with the most incentive to reduce environmental impacts, the maximum being reached for the point  
 12 A (a,b). In the phase II, the environmental impacts continue to decrease while costs increase until  
 13 reaching their initial value in C(c,0). Finally, the phase III corresponds to a domain where though the  
 14 environmental impacts decreases, the costs are superior to what they used to be. The companies do  
 15 not get any incentive to go further into environmental reduction than C(c,0). Overall, reduction  
 16 strategies and policy incentives such as environmental taxes can be understood as aiming at  
 17 increasing a, b and c. Nevertheless, these values may reveal different according to the level of  
 18 analysis (company to supply chain), the organization of production and associated logics of  
 19 circulations. Understanding the circulation space of a particular firm is the first step to frame  
 20 environmental reduction strategies. Nevertheless, the strict reluctance of manager boards to engage  
 21 into real environmental friendly organizational changes is a mark of their attachment to the  
 22 unsustainable beliefs of the current socio – economic framework.

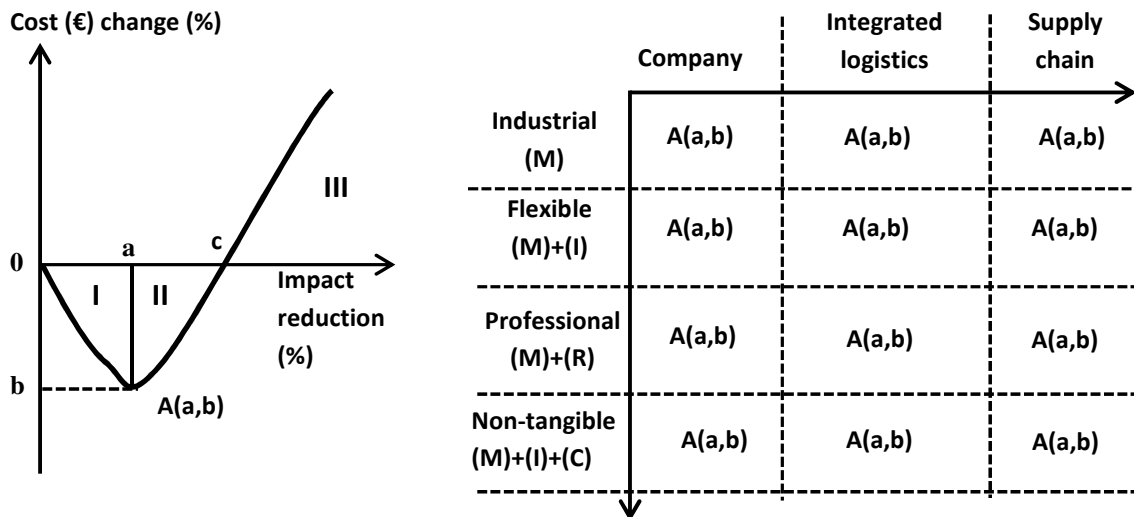

23

24 **Figure 43 : the three stages of environmental impact reduction and its dependency to system**  
 25 **boundaries and logistics typologies.**

26

27

## 4 Conclusion

Within this chapter III, I reviewed the environmental aspects of supply chains both from the production-consumption viewpoint and from the transportation/logistics viewpoint. If several elements related to the issue of environmental sustainability are positive, drawbacks also appear which are unsolvable within the current socio-economic system.

1) **A partial criticism of economic theories:** The economic theories and associated beliefs in perfect coordination through price and market mechanisms are partially shaken by the introduction of the environmental externalities. It was seen notably that the purpose of environmental labeling was to introduce other types of information in the decision of consumers. Therefore, production and consumption decisions are found dependent on other product characteristics, notably on the production system, and not only the inner product characteristics. To say it with words borrowed from economic theories described in Chapter I, making the exchange dependent on other characteristics than price means that “use value” and “exchange value” are not as independent as stated by economic theories. However, the researches made on the pricing of environmental impacts and the expectations given on cost internalization still reveal the belief that price and the associated monetary network can capture all aspect of reality. The economic theories of chapter I thus appear not valid in the sense that value is an objective thing existing prior the exchange but the concept of perfect coordination through price is not abandoned. The notion of objective value is not given initially but is the result of a pricing activity, i.e. a construction of a linkage between environmental and monetary networks.

2) **A problem of system analysis boundaries:** The second problem is related to the accounting of environmental impacts. Indeed, as environmental impacts are totally absent from the usual accounting frameworks, product labeling implies the development of new indicators and new analysis tools. Nevertheless, as seen in Chapter I, the system of national accounts and the firm accounting system still constitute the main framework of information related to transactions between economic actors. Therefore, the environmental tools such as life cycle analysis and input-output analysis are found dependent on the characterization of activities as presented in usual accounting frameworks. Nomenclatures and logics of accounting system are not changed and the adjustments to include environmental impacts are only marginal. This also has a consequence on supply chain boundaries. Indeed, the national accounting system provides very strict boundaries not including use phase of products and disregarding waste phase. Therefore, the environmental studies of supply chains are mainly concerned with boundaries extending from extraction of natural resources to product delivery to customers (cradle to gate approach). Environmental sustainability is dependent on an extension of these borders to include the product delivery – waste phase occurring within human societies (gate to grave) and the waste – resources phase (grave to cradle).

However, the development of environmental supply chain analysis is a considerable progress in regards to the usual framework of companies. In the same way the reintroduction of space and time makes the issue of coordination an important stake of firms’ strategies and the introduction of environmental impacts reinforces the importance of supply chain management for firms’ strategies. The path towards environmental sustainability is thus still on an early stage and moving to the next steps will imply to break loose from the lock-in of the conventions of the current socio – economic system .

## 1    **5    General conclusion of part I**

2

3    The purpose of part I was to study the limits of the current socio – economic system in regards to  
4    sustainability issues through the study of the associated “production – consumption – circulation”  
5    system. Such project nevertheless supposed that sustainability was a clear concept, independent in  
6    its definition from the current socio – economic system. However, I demonstrated in Chapter I that  
7    the current representation of sustainability was dependent on a certain form of positivism in regards  
8    to the current socio – economic system. Indeed, the usual representation of sustainability was found  
9    dividing the world in two, each of them with a particular focus. For developing countries, this focus  
10    concerns the development of education, health and economic growth without increasing  
11    environmental resource consumption and environmental impacts. For developed countries, this  
12    focus concerns the diminution of environmental resource consumption and environmental impacts  
13    without altering health, education and economic growth. As economic growth is a product of the  
14    current socio – economic system, there is a certain form of tautology in the current ways of  
15    addressing sustainability at least for the social part, leaving environmental sustainability as the main  
16    criterion of criticism of developed economies.

17    The study of the representation of human activities in the current framework was thus essential to  
18    reveal not only the associated difficulties in regards to environmental sustainability but also the  
19    inextricable links between social sustainability definition and current economic system. It was found  
20    human activities were only represented as money flows. Indeed, may it be the system of national  
21    accounts or the firm accounting system, only money flows are recorded. However, these money  
22    flows can cover different types of realities: payment of working hours (wages), payment of different  
23    objects (raw materials, consumer goods) and payment of means of production (capital goods, land).  
24    The recording of these flows are thus dependent on the establishment between economic actors of  
25    common nomenclatures able to capture the different realities. The recording procedure is  
26    nevertheless clearer: all the different flows are subordinated to the network of money flows as prices  
27    can always be used to establish a connection between wages, raw materials, means of production,  
28    etc. and money flows. Therefore, all aspects of realities are only sub – networks of a broader  
29    network: the money flow network. The inextricable links between social sustainability and the  
30    current economic system is thus related to this belief in the subordination of social realities to the  
31    monetary network. But what makes this subordination theoretically possible? This was the role of  
32    the second part of Chapter I to establish the important role played by economic theories on this  
33    point. Indeed, for classical and neoclassical economists, this subordination consists in an objective  
34    definition of value as existing before the exchange so that the exchange is only a realization of this  
35    value. Wages, different objects, means of production etc. have thus a secret origin which allows a  
36    perfect connection to the monetary network. In this perspective, the economic debate is reduced to  
37    disagreements about the nature of “value”. For example, for classical economists (1700 -1850), the  
38    nature of “value” is related to “work” while for neoclassical economies (1850 – present) the nature of  
39    “value” is related to the concept of “utility”.

40

41    These two theories of value are the core concepts framing the current understanding of human  
42    activities (A) and are corresponding to different production – consumption patterns. They also  
43    correspond to an abstract vision of the circulation processes. For classical economists, the “profits”

1 made by the producers are the main framework and the economy is considered on a firm level as  
2 shown in **Figure 44A)** but no spatial framework is introduced as firm is studied as a profit center.  
3 Each producer is focusing on managing its suppliers and customers thus creating local spaces of  
4 circulation. The associated principles of management are increase of production and reduction of  
5 cost thanks to the division of work, the purchase of high capacity machines, and the concentration  
6 and specialization of production sites. The local spaces of circulation are nevertheless in interaction  
7 through an unstudied process, the famous “market hand”. On the opposite, for neoclassical  
8 economists, the “market hand” is the main focus. Consequently, they attribute the coordination  
9 process to a strict expression of individuality, both from producers (utility = profits) and consumers  
10 (utility = individual preferences). This strict individuality operates by the establishment of a unique  
11 price for each good and results from the solving of the Walrasian general equilibrium equations.  
12 Consequently, for neoclassical economists, as shown in **Figure 44B)**, the space of circulation includes  
13 all actors of an economy but in a centralized way, linking each individual to an “imaginary” market  
14 secretary in charge of establishing the price of a particular good or service. Space and time are  
15 reduced in a zero dimension leaving aside the concrete world and notably the fact that production  
16 and consumption are localized in space, notably different spaces and do not constitute instantaneous  
17 processes.  
18

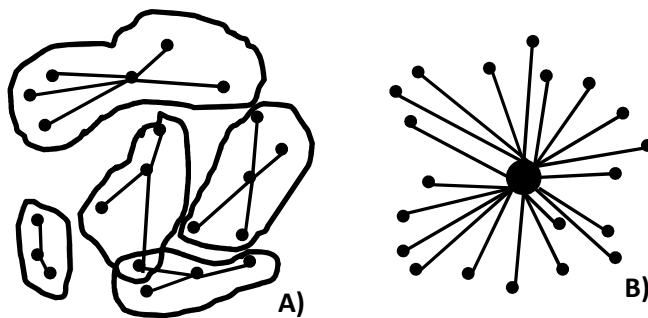

20 **Figure 44 : A) network in classical economy, B) network in neoclassical network**

21 This is where our chapter II provided interesting focuses on the role of money, outlets and proximity  
22 in the concrete world of transportation and logistics. Particularly, I demonstrated that money in the  
23 concrete world was a complex network linked with the issue of power, trust and legitimacy, far from  
24 the ideal non-violent and perfect coordination attribute it has in economic theories. Similarly,  
25 proximity revealed that an economic exchange is a complex construction dealing with resources  
26 identification and organization of these resources so that production can take place and find outlets  
27 in consumption. Therefore, space and time become unavoidable characteristics of “production –  
28 consumption – circulation “systems, in other terms economic systems and particularly sustainable  
29 ones. Logistics defined as the capacity of delivering the right product at the right place and the right  
30 time becomes the core element of any economic system. This explains notably why logistics both  
31 reveals unsustainable patterns of the current socio – economic system linked to its negation of time  
32 and space and is in a deadlock as being dependent on the beliefs of this socio – economic system.  
33 Actually, logistics should be understood as a tool of management of time and space, the associated  
34 goals being defined by the economic system. It thus becomes important to differentiate within the  
35 logistic field the principles valid for all systems and those particular to the current socio – economic  
36 system.

1  
2 Unfortunately, the influence of the two economic theories is still important and was found acting as  
3 two important ideal references to logistic systems. Indeed, the classical economy is corresponding to  
4 the emergence phase of a market when all profits come from the capacity of increasing production  
5 while diminishing production costs. On the opposite, the neoclassical economy corresponds to the  
6 saturation process when all profits come from the ability to reach rapidly a market. Actually, the law  
7 of supply and demand makes inefficient the production strategy of the classical economy which  
8 consisted in a never ending extension of the quantity produced for a particular product. The goal of  
9 producers becomes simply to produce the maximum quantity acceptable for a particular market.  
10 However, the maximum profit for a particular firm becomes linked to its capacity to be the first one  
11 filling the market associated with its products. The history of the development of infrastructures  
12 developed in Chapter II provided excellent illustration of the differences between the classical and  
13 neoclassical economy approaches. Indeed, the development of infrastructures is marked by a  
14 diffusion process from emergence to saturation, the same process differentiating the two models of  
15 circulation framed by the classical and neoclassical economic theories. The history of infrastructure  
16 development also showed clearly that geographical barriers used to be the main economic driving  
17 force because of the associated separation of circulation spaces. These geographical barriers virtually  
18 disappear with the introduction of new technologies and prime movers. From an economy mainly  
19 driven by waterways and sailboats, we thus evolved towards an economy driven by globalized  
20 transportation in which road, maritime and air transportation modes are predominant. All  
21 environments (air, water, soil) are thus presently used for the purpose of exchange. The history of  
22 infrastructure also reveals that infrastructure first developed to enable high quantity exchanges  
23 before new technologies (steam power, oil, etc.) enable exchanges to occur at higher speed. The  
24 development of the circulation process is thus marked by a geographical extension of circulation  
25 spaces thanks to the development of high capacity infrastructure and increase of the accessible  
26 speed domain. In other terms, the circulation process consumes more and more energy. This energy  
27 consumption is a characteristic of logistic systems existing in all economic systems dependent on  
28 amount transported (mass), distance separating production and consumption places (distance) and  
29 time constrains (speed). The environmental unsustainability of the current socio – economic system  
30 is thus linked to this increase of energy consumption induced by higher needs of available quantity of  
31 movement. In a way, considering energy as a scarce resource means that quantity of movement itself  
32 is a scarce resource.

33  
34 However, the environmental study of chapter III showed that environmental unsustainability was  
35 also directly linked to the borders settled by accounting systems and the monetary network.  
36 Therefore, though the environmental issue has revealed the importance of supply chain  
37 management, environmental supply chain analysis is still missing product delivery – waste phase  
38 occurring within human societies (gate to grave) and the waste – resources phase (grave to cradle).  
39 This is why “circular economy” and “functional economy” constitute rupture strategies in term of  
40 bringing environmental sustainability to the current socio – economic system as they focus on cradle  
41 to cradle approaches.

42 Nevertheless, the limits of the current socio – economic system in regards to sustainability are not  
43 only linked to these boundary issues but also to the existence of a permanent ideal representation of  
44 space and time developed by economic theories. This ideal representation deals with the notion of

1 ubiquity and uniformity of space making a-spatial and a-temporal monetary networks the ultimate  
2 achievement of economic system. This leads to consider the concrete world as full of unwanted  
3 transaction costs. In fact, the current socio – economic system plays with the ambiguity associated  
4 with the notion of transaction cost. Actually, transaction costs can be defined explicitly as the cost,  
5 e.g. the money spent by an economic actor, to make a transaction possible. In this case, there is no  
6 reference to state if this money is badly or rightly spent. Transaction costs can also refer to the  
7 difference between money spent for a transaction and the ideal zero cost of economic theories. Even  
8 with the same figure, the difference is that in the second case, no satisfaction can be reached as long  
9 as the zero cost level is not reached. This normative goal constitutes the limits set by the current  
10 economic – system to the sustainability of circulation processes by forcing logistic actors to chase  
11 wild dreams. Sustainability in regards to circulation processes thus consists in setting new goals to  
12 the logistic system, respectful of the different characteristics space and time play in the interface  
13 production – consumption within our society and in the interface Nature – society. Circular  
14 economy, functional economy, time, space and associated logistics patterns thus constitute our  
15 privilege way to address the principles of sustainable logistics as I will now develop through part II.

16  
17  
18  
19  
20  
21  
22  
23  
24  
25  
26  
27  
28  
29  
30  
31  
32  
33

1

2

3

4 *PART II: Towards*  
5 *sustainable logistics*

6

7



# 1 *Chapter IV: Circular economy and functional economy* 2 *strategies*

## 3 **1 Introduction**

4  
5 The present chapter studies circular and functional economies as rupture sustainable strategies. As  
6 demonstrated in part I of this dissertation, the current socio – economic framework is characterized  
7 by an increasing material consumption and environmental degradation and an important part of this  
8 unsustainability could be explained by the representation of production, consumption and circulation  
9 pattern in modern economic theories. For example, it was found human activities are understood in  
10 the current framework as based on a supra –network (money flows) to which all other realities can  
11 be attached to. Besides, the importance of time management and localizations of production and  
12 consumption places in concrete space were found underestimated through a globalized and abstract  
13 representation issued from modern economic theories.

14 The first strategy I will study within this chapter is circular economy which consists in the closure of  
15 usual system boundaries of supply chains (cradle to gate) by taking into account the waste phase and  
16 its link with the formation of resources (grave to cradle). Though usually labeled “industrial ecology”  
17 in European literature, I will use here the term “circular economy” notably adopted by Asian  
18 countries. Indeed, the term “circular economy” translates better the idea of an closed-loop economy  
19 and better takes into account economic aspects in comparison to the term “industrial ecology” which  
20 is more focused on an engineering approach of industrial system and ecosystems interactions. The  
21 second strategy is consumption focused and deals with a new way to associate production systems  
22 with the use phase of products. This strategy named functional economy concerns the conception of  
23 product-service systems able to change the purchase of physical products into the purchase of  
24 services.

25 These two strategies will be studied based on the triptych “sustainability – circular/functional  
26 economy – circulation processes”. The first task will thus be to explain how circular and functional  
27 economies are promising strategies in regards to sustainability. Once this done, I will study the  
28 expected consequences of the application of these strategies to the circulation process. This will lead  
29 me to establish which role space and time must have in the application of circular and functional  
30 economies to ensure sustainability.

## 31 **1.1 Circular economy**

### 32 **1.1.1 Industrial ecosystems and bio-economy**

33

34 As stated by the European Commission, in order to cope with an increasing global population, rapid  
35 depletion of many resources, increasing environmental pressures and climate change, Europe needs  
36 to radically change its approach to production, consumption, processing, storage, recycling and  
37 disposal of biological resources<sup>114</sup>. Therefore, the strategy consists in reducing the inputs and the  
38 outputs of the economy to the environment as shown in **Figure 45**. These inputs and outputs must

---

<sup>114</sup> [http://ec.europa.eu/research/bioeconomy/pdf/201202\\_innovating\\_sustainable\\_growth\\_en.pdf](http://ec.europa.eu/research/bioeconomy/pdf/201202_innovating_sustainable_growth_en.pdf)

1 be reduced for human activities to take place within the limits settled by the Earth ecosystems.  
 2 Consequently, “the traditional model of industrial activity – in which individual manufacturing  
 3 processes take in raw materials and generate products to be sold, plus waste to be disposed of –  
 4 should be transformed into a more integrated model: an industrial ecosystem. The industrial  
 5 ecosystem would function as an analogue of biological ecosystem.” (Frosch, et al., 1989)(p.95).  
 6 Industrial ecology thus consists in a mimicry of biological ecosystem and consequently depends on  
 7 the understanding industrial actors have of biological ecosystems.

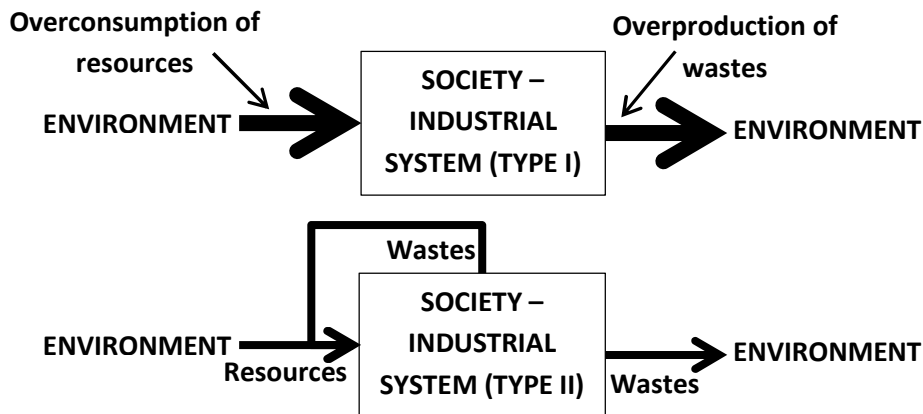

8

9 **Figure 45 : From linear to circular society**

10 In fact, industrial ecology first emerged as a criticism of the “end – of – pipe” strategy which consists  
 11 in treating pollution through technical dispositions downstream from the industrial system. This  
 12 criticism on the society’s output to the environment was essentially made of three parts. First, the  
 13 end – of – life strategy is specialized in different fields corresponding to different technical expertise.  
 14 Consequently, each actor only grasps one part of the reality of the environmental degradation, and  
 15 as in the logistic field, it results in a sub – optimization of the environmental approach. Secondly, the  
 16 end – of – life approach is incremental strengthening the dependency to a technical path at the  
 17 expense of strong innovations. Thirdly, as incremental innovations have decreasing returns, the cost  
 18 of the end – of – life strategy to reduce a same quantity of pollutants increases (Erkman, 1998)(p.14 –  
 19 19). The solution to the “end – of – pipe” strategy lies within the formation of industrial ecosystems  
 20 based on the cycling properties of flows in biological ecosystems. The fact that *an ecosystem tends to*  
 21 *recycle most essential nutrients, using only energy from the sun to “drive” the system and that all*  
 22 *other materials are recycled biologically, in the sense that each species’ waste products are the*  
 23 *“food” of another species* are the basic idea of an industrial ecosystem (Ayres, et al., 1996)(pp. 278–  
 24 279). The type I ecosystem of **Figure 45** must thus evolve towards a type II ecosystem in which the  
 25 industrial cycle ensures a limited use of material and energy inputs together with a limited  
 26 production of waste. Ultimately, the industrial society can evolve towards a type III ecosystem in  
 27 which there is no waste and the only input is energy (Erkman, 1998)(p.34 – 39). In this respect, we  
 28 should note the existence of two kinds of energy source as underlined by Nicholas Georgescu –  
 29 Roegen. Indeed, *thermodynamic free energy, men can have access to, comes from two distinct*  
 30 *sources. The first one is a stock, the free energy of the minerals deposits in bowels of Earth. The*  
 31 *second one is a flow, the Sun radiation flow. Going further, the terrestrial stock if totally used would*  
 32 *only provide a few days of Sun lights while the Sun is expected to provide a similar pattern of energy*  
 33 *flow than today for the next 5 billion years* (Georgescu-Roegen, 1979)(p.50-51). The source of energy  
 34 of type II and type III ecosystems must thus be based on the Sun radiation flow.

1 The previous discussion showed that the industrial analogy of an ecosystem is an industrial park (or  
2 some larger region) which captures and recycles all physical materials internally, consuming only  
3 energy from outside the system, and producing only non-material services for sale to consumers  
4 (Ayres, et al., 1996)(pp. 278–279). This leads us to consider two core analytical concepts: symbiosis  
5 and metabolism. The notion of symbiosis is linked to the necessity to consider the outputs of a  
6 particular industry as the inputs of another industry. The most famous example of industrial  
7 symbiosis is the Kalundborg industrial park in which industries are exchanging wastes (water, vapor,  
8 by – products).The results of this industrial symbiosis in terms of environmental impact reduction is  
9 illustrative of the concept force: reduced consumption of 45 000 tons of petroleum per year, 15 000  
10 tons of coal per year, 600 000 m<sup>3</sup> per year; reduced emissions of 175 000 tons CO<sub>2</sub> per year, 10 200  
11 tons SO<sub>2</sub> per year; and reuse of 130 000 tons of ashes, 4 500 tons of sulfur, 90 000 tons of gypsum,  
12 1 440 tons of nitrogen and 600 tons of phosphorus (Erkman, 1998)(p.26). According to the same  
13 author, the success of this industrial symbiosis is the results of three factors: a spontaneous and  
14 market driven exchanges ways, a trust and proximity facilitating informal contacts at all hierarchical  
15 levels, and the proximity of different and complementary large companies (Asnaesvaerket, Statoil,  
16 Novo Norsdisk, Gyproc and Kalundborg municipality). These three factors look nevertheless  
17 contradictory if we consider the spontaneity of exchange and the institutional, organizational and  
18 geographical proximity induced by the notion of trust and industrial complementarity. Actually, in its  
19 description, Suren Erkman seems to favor the usual contractual viewpoint linked to the standard  
20 economy market separation which I strongly criticized in part I. The cause of this mistake is in our  
21 meaning resulting from the fact that for the concept of industrial complementarity to be realized  
22 commercially, a system has to be found to transfer the industrial park concept into an associated  
23 money flow network. Concretely, this means that the industrial park construction needs a two – step  
24 operations: firstly a conceptual idea which emerges thanks to trust and identification of  
25 complementarity between industry, and secondly a translation on the supra – network of money  
26 which validates the conceptual idea through negotiations and contractual making. Finally, once the  
27 money flow established and the eco – industrial park operational, the trust or institutional proximity  
28 resulting from a common belief of actors can act as a cement of the financial and technical links at  
29 stake. In summary, the industrial symbiosis is thus a concentrated system of material, information,  
30 money flows based on a strong connection between the three patterns of proximity (geographical,  
31 organizational, institutional).

32 Industrial metabolism is in fact a prerequisite to the possibility of building industrial parks. It consists  
33 in the qualitative and quantitative reflection of the physical characteristics of human activities, i.e.  
34 material flows and stocks. The industrial metabolism methodology thus relies on the establishment  
35 of mass balances, the recording of material flow and stocks, the tracing of their itinerary and  
36 associated dynamics, and the definition of their physical and chemical states (Erkman,  
37 1998)(p.56).The pattern is thus complex for many reasons linked to the nature of the physical,  
38 chemical and biological world. For example, the effects of synergy can be counterproductive or  
39 facilitate the reduction of environmental impacts. In this aspect, the diminution of zinc emission in  
40 the Rhine basin was a consequence of the diminution of SO<sub>2</sub> emission because the zinc corrosion rate  
41 is strongly correlated with the SO<sub>2</sub> concentration in air (Erkman, 1998)(p.56). The methodologies  
42 associated with metabolism are thus those of the tracking of flows such as material flow analysis  
43 (MFA) and substance flow analysis (SFA). With such a basic principle, the uses of the MFA techniques  
44 can be multiple. One of them can consist in framing the material dependency of particular territory

1 which is usually called territorial metabolism (Barrett, et al., 2002). At a national level, this  
 2 framework is usually called Economy – wide MFA and examples for France and Finland can be found  
 3 respectively in (Commissariat Général au Développement Durable, 2009) and (Hoffrén, et al.,  
 4 2009). Going further, we can record mainly five types of MFA uses grouped under two categories  
 5 (Gregory, 2006). The first category only focuses on a physical approach through the development of  
 6 environmental policy for hazardous substances and the evaluation of product environmental impact.  
 7 The second category is concerned by the introduction of the physical approach within the economic  
 8 framework through the supply of firm environmental performance data, the derivation of  
 9 sustainability indicators and the development of material flow accounts for use in official statistics.  
 10 Indeed, as human activities are today described within the firm accounting system and the system of  
 11 national accounts, actions for the economic actors first suppose the establishment of a linkage  
 12 between physical accounts and monetary accounts. This is made through the unity principle of the  
 13 two approaches: the notion of input – output balance. Therefore, the input – output economics can  
 14 be associated with material flows directly (Duchin, 2004) (Suh, et al., 2005) or through a hybrid  
 15 combination of physical and monetary unities (Hawkins, et al., 2007).

16 The main problem with the industrial ecology approach is to remain close to the usual pattern of  
 17 human activities which we proved unsustainable. Indeed, the physical approach remains  
 18 subordinated to the monetary supra – network and associated production – consumption system.  
 19 Consequently, the industrial ecology is only a restructuration of the knowledge and beliefs associated  
 20 with environmental issues. It does not concern other beliefs notably those related to the economic  
 21 system. This restructuration nevertheless induces important changes through 4 main axes (Erkman,  
 22 1998)(p.56) leading to the concept of loop and lake economy:

- 23 1) Valorization of waste as resources
- 24 2) Closing material loop and minimizing dissipative emissions
- 25 3) Dematerialization of products and economic activities
- 26 4) Decarbonization of the economy

### 27 **1.1.2 Loop and lake economy**

28

29 The industrial ecology restructuration leads to reconsider the product life cycle within the broader  
 30 cycles of Earth ecosystem. This framework for a particular product is what we call the loop economy  
 31 as shown in **Figure 47**. This loop economy shares with the linear economy the central framework of  
 32 the product supply chain made of the parts manufacturer, the product manufacturer and the service  
 33 provider. The difference lies within the becoming of waste. Indeed, the linear economy uses the  
 34 natural ecosystems as an absorber of waste and a supplier of new resources. Therefore, the linear  
 35 economy is dependent on the following mathematical framework:

*Natural initial Stock:  $S_0^N$*

*Each year, the society extracts  $E_i$  from Nature and reject  $W_i$  to the environment*

*The material stock in society for year  $i$  ( $S_i^S$ ) is thus*

$$S_i^S = S_{i-1}^S + E_i - W_i$$

*Nevertheless, the waste are dependent on the preexisting stock of the economy*

*if we note  $b$  the share wastes represent, we have  $W_i = b \times S_{i-1}^S$*

Similarly, a part of the waste becomes a new environmental resources if we note  $a$  this share and  $T$  the time for this recovery of resources  
 We thus have as recovery ( $r$ ) made at time  $i + T$ :  $r_{i+T} = a \times W_i$

We can thus write for the natural stock evolution

$$S_i^N = S_{i-1}^N - E_i + r_i = S_{i-1}^N - E_i + a \times W_{i-T} = S_{i-1}^N - E_i + a \times b \times S_{i-T-1}^S$$

- 1 The linear economy is thus characterized as shown in **Figure 46** by a depletion of the natural stock
- 2 since the steady state is only possible when  $E_i = a \times W_{i-T} = a \times b \times S_{i-T-1}^S$ . Given for example the
- 3 geological time taken to restore a natural resource such as petroleum (20 to 350 millions years<sup>115</sup>),
- 4 this depletion is consequently proportional to the quantity extracted from Earth. This explains the
- 5 linear form of the depletion curve since the resource extraction was supposed to be constant within
- 6 the 100 year time framework ( $E_i = 10$  tons).

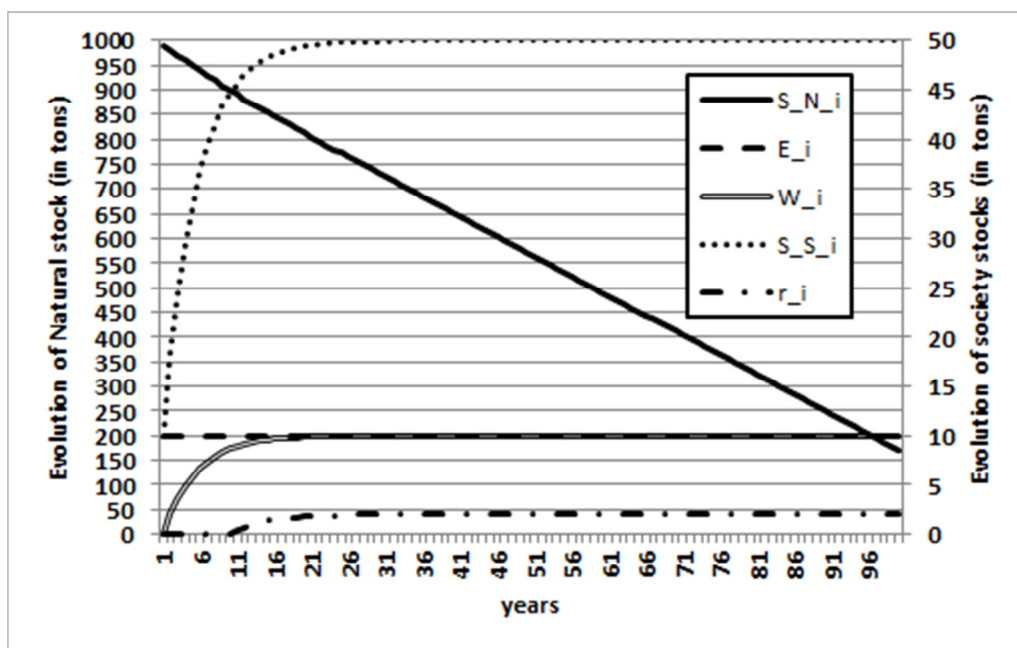

7  
 8 **Figure 46 : Consequence of the linear economy on natural stocks (a=20%, b=20%, T=10 years)**

- 9 The loop economy is primarily an answer to the depletion induced by the quantity extracted. As
- 10 shown in **Figure 47**, the loop economy operates through four cycles. These cycles all originate from
- 11 the user, i.e. from the moment the product in the hands of the final user is not able to fulfill its
- 12 function anymore. The first loop is at the level of final use and concerns maintenance and repair
- 13 activities which allow an extension of product life time. The second loop also results in an extension
- 14 of product life time. However, the main actor here is the service providers which collect goods from
- 15 different users and redistribute it to other users. The third loop supposes the breaking of the
- 16 products into its subparts which can then be refurbished to different kind of manufacturers. Finally,
- 17 the last loop supposes the transformation of the product to the most basic materials. This final loop
- 18 or recycling loop has been the first strategy to valorize waste as resources.

<sup>115</sup> <http://www.connaissancedesenergies.org/fiche-pedagogique/formation-du-petrole>



1 manufacturer, but only recycled if the recycler can make a profit or if, for example, a deposit scheme  
2 will pay him. On another hand, in the lake economy, materials and components are chosen and  
3 goods are designed to facilitate a profitable reuse of goods and/or recycling of molecules. The key  
4 issue is thus to find a business model allowing either the loop or the lake economy to be. As in the  
5 loop economy, the properties, i.e. the functionalities of the product, are degraded, the role of the  
6 product provider is not clearer except in the enhancement of remanufacturing and recycling  
7 processes by a modular design. This design must nevertheless not be at the expense of the  
8 functionalities of the product. The lake economy is a different story. This time, the product  
9 functionalities as designed by the product provider must be extended in time. The role of the product  
10 providers is consequently predominant in the lake economy. The key question is thus the economic  
11 incentives for product providers to extend their product life which leads us to consider the principles  
12 of functional economy.

## 13 **1.2 Functional economy**

### 14 **1.2.1 Principles and typology of functional economy**

15  
16 Functional economy is usually defined as a business model change from the selling of goods to the  
17 selling of services [ (Buclet, 2005) (Folz, et al., 2008)]. Functional economy is thus primarily  
18 understood as belonging to the framework of service economy and addressed in research literature  
19 under the terms of “product – service systems” (PSS), “servicizing” etc. The diversity of terms and  
20 approach of functional economy are a proof that the concept itself is still under-developed. Indeed,  
21 there is confusion between the research approach working towards more scientific understanding of  
22 the concept and the policy makers’ approach working towards the development of new policy  
23 measures (Kanda, et al., 2006). Actually, we can distinguish two origins behind the principles of  
24 functional economy. The first one is related to the service economy and depends on how the notion  
25 of service is understood in the socio – economic system. The second origin is related to  
26 environmental policy and dematerialization strategies.

27 A service economy is defined as one in which more than half of the total labor force is employed by  
28 the service sector (Schettkat, et al., 2003). This viewpoint is thus dependent on the definition of the  
29 service sector within the system of national accounts. For the INSEE economists, *a service activity is*  
30 *essentially characterized by the act of making a technical or intellectual capacity available. In contrast*  
31 *to an industrial activity, it cannot be described solely by the characteristics of a tangible asset*  
32 *acquired by the client. Services, within the broadest sense of the term, cover a vast field of activities*  
33 *ranging from commerce to administration, via transport, financial and real estate activities,*  
34 *professional, scientific, technical, administrative and support service activities, services to businesses,*  
35 *personal services, education, health and social services. Such is the meaning generally given by the*  
36 *Anglo-Saxons to the word “services”<sup>116</sup>. This definition is thus in relation with the usually*  
37 *distinguished main framework of sector classification. Indeed, an activity can be classified either in*  
38 *the primary sector<sup>117</sup>, which includes all those activities the end purpose of which consists in*  
39 *exploiting natural resources (agriculture, fishing, forestry, mining, deposits), the secondary sector<sup>118</sup>,*  
40 *which covers all those activities consisting in varying degrees of processing of raw materials*

---

<sup>116</sup> <http://www.insee.fr/en/methodes/default.asp?page=definitions/services.htm>

<sup>117</sup> <http://www.insee.fr/en/methodes/default.asp?page=definitions/secteur-primaire.htm>

<sup>118</sup> <http://www.insee.fr/en/methodes/default.asp?page=definitions/secteur-secondaire.htm>

1 (manufacturing, construction industries), and the tertiary sector<sup>119</sup> defined in complementary to the  
 2 primary and secondary sectors. The material activities are thus confined to the primary and  
 3 secondary sectors thus giving the artificial impression that services which belong to the tertiary  
 4 sector are non – tangible. However, any supply chain or input – output analysis reveals the material  
 5 and energy dependency of services (Nansai, et al., 2009), i.e. to the industrial and extraction sectors,  
 6 meaning that the evolution towards a service economy can only result from an increase of  
 7 efficiencies in the two first sectors (less labor force is needed) or/and a displacement of material  
 8 intensive production activities to other countries.

9 On the opposite, the environmental approach of services is directly targeting the relationships  
 10 between the product and the capabilities or functionalities provided by this availability. This  
 11 association of a product and service is usually called Product Service System (PSS) of which a typology  
 12 is presented in **Table 14**.

13 **Table 14 : A typology of product – service systems**

<b>Typology</b> (Mont, 2000)	<b>Typology</b> (Tukker, 2004)		<b>Description</b>	<b>Main issue</b>	<b>Examples</b> [see (Folz, et al., 2008), (Mont, 2000)( <i>Mont, 2001</i> ), <i>Source spécifiée non valide.</i> , (Mellet, 2008)]
<b>Service economy</b>	<b>Product oriented</b>	<b>Product related</b>	Extension of product life through maintenance and supply of consumables. Take – back agreement for product end – of -life	Life cycle management	Tibro, ASG, Kodak, Fuji
		<b>Advice and consultancy</b>	Consulting activities on how to increase the performance of an existing product / organization	knowledge	Consulting companies with associated software
	<b>Use oriented</b>	<b>Product lease</b>	Maintenance, repair and control under the responsibility of product provider. Payment according to a time period with a one user – provider relationship	Time	Interface
		<b>Product renting /sharing</b>	Similar to product lease but with a sequential one user – provider relationship	Time, ownership	Velib', autolib'
		<b>Product pooling</b>	Similar to product lease but with users – provider relationship	Time, ownership	Lund bilpool
	<b>Functional economy</b>	<b>Result oriented</b>	<b>Activity management</b>	Outsourcing of activities based on performance indicators	Functional definition, means of production
<b>Pay per service unit</b>			Based on a functional unit, the user pays according to the level of use	Functional definition, means of production	Michelin, Xerox
<b>Functional result</b>			Based on a common definition between client and the service provider	Functional definition, means of production	Electrolux

<sup>119</sup> <http://www.insee.fr/en/methodes/default.asp?page=definitions/secteur-tertiaire.htm>



1  
2  
3  
4  
5  
6  
7  
8  
9  
10  
11  
12  
13  
14  
15  
16  
17  
18  
19  
20  
21  
22  
23

The environmental benefits associated with the shift from an industrial or market economy to a service or functional economies are usually thought to be derived from the absence of ownership transfer between the producer and the consumer. Indeed, in this situation, any part of the life cycle not corresponding to an utilization (repair, maintenance, waste phase) is a cost for the company which thus receives an incentive to extend the use phase of product as much as possible (Buclet, 2005). The environmental benefits will thus be dependent on the mechanisms made by companies on the path of product life extension. On this aspect, (Tukker, 2004) distinguishes mechanisms leading to incremental impact reductions (10 -20%), those leading to a factor 2 (50%) and those leading to a factor 10 (90 %). The key difference between these three categories of impact reductions are related to the change of technological system. This way, the incremental impact reduction is characterized by the amelioration of the efficiency of the pre – existing technological system while the factor 2 and the factor 10 reductions correspond respectively to a redesign of the technological system or a replacement by a more environmentally performing technological system. Consequently, though all these mechanisms can appear for each of the eight PSS types, the product oriented approach is mainly focused on incremental impact reductions while the more capital goods are used and the more the use oriented PSSs are environmentally efficient. The environmental benefits related to the use oriented PSSs are thus dependent on the initial level of use. The worse the initial level of use is and the more the use oriented PSSs have a strong potential for dematerialization. Such is notably the case of the car park of which every moment 95% is not used (Godet, et al.). The result oriented PSSs offer more uncertain results as the reduction of environmental impacts will depend on the technological system chosen by the company.

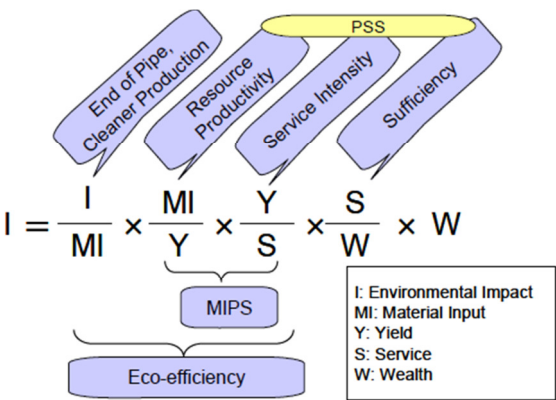

24  
25  
26  
27  
28  
29  
30  
31  
32  
33  
34  
35  
36

**Figure 48 : Environmental reduction strategies within an equation framework (Kanda, et al., 2006)**

The different environmental strategies can be further categorized within the framework presented in **Figure 48**. Looking the associated equation, one can see that product service systems are only focusing on a reduction of the material input, thus missing the framework of environmental impacts. Consequently, a technical system filling the perspective of dematerialization could reveal itself more harmful to the environment. Nevertheless except for these particular systems, a reduction of material input will imply a reduction of environmental impact. The PSS is thus consisting in reducing the material input of the system made by resource productivity, service intensity which together allows the calculation of the material input per service (MIPS) (Ritthoff, et al., 2002), and sufficiency. The functional economy perspective is thus characterized by the shifting from the pure technical view of production systems to a socio – technical system in which producers and users are jointly acting on the products and associated materiality.

## 1.2.2 Circulation principles in functional economy

The circulation principles in functional economy are multiple and correspond to the association of different management frameworks:

### **Conception management:**

The product must be designed for the purpose of use. It first supposes to have chosen a general technical system. In the case of “Velib” which is the Parisian self – service bike renting service, the technical system is the bike and its conception has been adapted to the successive use of different users. For example, the handlebars have been strengthened to allow an intensive use, the bike is mixed with a speed change easy to handle, a saddle easily adjustable and the front basket has been strengthened to resist wear and misuses<sup>120</sup>. Similarly, the Velib designers took into account the particular Paris urban environment of dense circulation making security a top priority. This way, the lights are working during the whole travel and the backward light works for 120 second when stopped. Brakes are integrated into the bike’s wheel hub and reflective strips are present on wheels<sup>120</sup>. The dematerialization associated with this new conception is difficult to assess. Primarily, we should note that the bike itself is heavier than usually commercial bike not fitted for intensive use. Secondly, the production processes, e.g. molding phase, can be different leading to higher energy and material consumption in comparison to usual production processes of bikes. Thirdly, while the importance accorded to the security issue may vary among users in the usual framework of ownership (1 bike = 1 user), the top level of importance is accorded to the security issue in the Velib framework and consequently the top level of material consumption related to the security issue. On the comparison at the end of the production chain between 1 usual bike and 1 velib, the environmental and material advantage of the Velib bike thus cannot be assessed easily and only life cycle analysis could help answering this issue. Nevertheless, if we consider the Velib system as an urbanism strategy aiming at operating a shift from the car system to the bicycle system, the material and environmental benefits are much more intuitive. This aspect leads us to consider that what is at stake from an environmental viewpoint is the whole mobility system. Its improvement consequently first supposes a comprehensive assessment of its initial state.

### **End – of – life management:**

The end – of – life management of products is not the priority of functional economy which is mainly focused on the use phase of products and consequently provides better environmental solutions for products where the use phase is the most harmful to the environment (Folz, et al., 2008). Nevertheless, a reduction of the quantity used diminishes the number of generated waste and consequently contributes to the dematerialization of the economy. Nevertheless, there is no existing study of the effects of a diminution of waste on the recycling and manufacturing system and the associated reverse logistics. For example, if the choice in favor of a material circular strategy in comparison to the choice of a liner circular strategy (landfill) is mainly dependent on the generated volume of waste, the change of strategy induced by a reduction of this volume may offset the gain obtained on the consumption of virgin material resources.

---

<sup>120</sup> <http://www.velib.paris.fr/Comment-ca-marche/Les-velos>

1 **Maintenance management:**

2  
3 The service must be guaranteed at any time. Therefore, the maintenance operations become a core  
4 issue of functional economy. Three phases can usually be defined: inspection, light repair, heavy  
5 repair. For the Velib' system, technical workers are daily traveling across the Paris city to inspect the  
6 bikes, repair on site those which only need light repair, and taking those necessitating heavy repair to  
7 the workshop (Mairie de Paris, 2012). Compared to the usual framework with no maintenance, we  
8 thus observe the formation of transport flows. These developments of downstream logistic activities  
9 could deteriorate the environmental balance of the product – service system. Nevertheless, this  
10 deterioration depends on the logistic share in the environmental life cycle and could even be  
11 diminished by the professionalization of these logistics such as efficient transportation planning of  
12 maintenance (Folz, et al., 2008). In the Velib' case, this logistic optimization takes the following form.  
13 Firstly, the inspection is made by technical workers either by bike or by utility vehicle. Secondly, the  
14 light reparations are made on site. Thirdly, the hard reparations are made in the four workshops  
15 situated in and around Paris where spare parts stock are. Finally, one of the workshops is a barge  
16 cruising along the Seine River and allowing the taking and the deposit of bikes along its shores.  
17 Therefore, this workshop is characterized by a slow (10 km) and ecological transportation mode  
18 consequently limiting the impacts of maintenance logistics (Mairie de Paris, 2012).

19  
20 **Infrastructure management:**

21  
22 A new technological system adapted to intensive use can lead to the development of new  
23 infrastructures. In the velib' system, the new infrastructures are the stations which were 750 in July  
24 2007, 1400 at the end of 2007 and 1700 today (Folz, et al., 2008)(Maire de Paris). In the same period,  
25 the number of bikes evolved from 11000 bikes (14 – 15 bikes per station) to 23000 bikes (13 -14  
26 bikes per station). This station constitutes a transformation of the urban planning through civil  
27 construction. Indeed, each station is made of electronic apparel allowing the user to subscribe,  
28 withdraw or leave a bike, and get different other services<sup>121</sup>. In every station, an underground  
29 Ethernet network is linking the electronic apparels to the “stones” to which the bikes are attached.  
30 These stones are equipped of a smart card allowing the user to directly withdraw the bikes from the  
31 “stones” (Drut, 2012). Going further, in addition to the network created by these stations, the  
32 municipality of Paris has considerably developed the urban space dedicated to biking transport  
33 mode. The construction of new cycle tracks (652 km) and the introduction of the two – way rules in  
34 September 2010 have considerably helped the spreading of the Velib system use. Indeed, since the  
35 installation of the Velib system, the number of cyclists in Paris has increased by 41% making cycling  
36 travel rising up to 3% of the vehicle – based Parisian traffic. In 2011, the Velibs represented 38% of  
37 the bikes in circulation (Mairie de Paris, 2012). The issue of infrastructure management thus  
38 concerns the installation, the maintenance and the development of this infrastructure.

39  
40  
41  
42  

---

<sup>121</sup> <http://www.velib.paris.fr/Comment-ca-marche/Les-stations>

1 **Park management:** The key issue in the use – oriented and result – oriented frameworks is related to  
2 the notion of park management. It consists in the management of a constant number of means of  
3 production with the purpose of service maximization. This phenomenon is well known in the railway  
4 network in which wagon managers aims at maximizing the use of wagons (BARCA, 2010). In fact, the  
5 main issue concerns the treatment of empty trips which allows the repositioning of non – equilibrate  
6 flows (PREDIT, 2010). In the case of the velib’ system, the non – equilibrate flows concern for  
7 example the neighborhood situated in altitude whose stations get empty as soon as nine o’clock in  
8 the morning (Mairie de Paris, 2012). The core issue is thus the flexibility of the system resulting from  
9 the diversity of mobility reasons which can lead to the absence of bikes in one station and the  
10 impossibility to leave back a bike in another station. Two strategies were taken to solve this issue.  
11 The first one is structural and concerns the presence of around 39000 “stones” for 20600 bikes (Drut,  
12 2012). This means the number of “stones” per station is in average 30, i.e. two times the number of  
13 bikes though it can reach 70 “stones” for the most frequented station<sup>121</sup>. The second strategy  
14 concerns the development of a computer and logistic system. The computer systems provide the  
15 information related to the occupancy rate to the regulation team who will consequently proceed to a  
16 redistribution of bikes across station (Mairie de Paris, 2012). The park management is thus related to  
17 a trade – off between material flow management and information flow management.

18  
19 **Risk management:** The last problem concerns the management of the risk induced by the behavior  
20 of users or other persons external to the relationships producer – user. In July 2009, the Velib’  
21 company launched a campaign against vandalism based on the observation that 16000 bikes were  
22 vandalized and 8000 bikes disappeared (Mairie de Paris, 2012). Associated with the development of  
23 customer service and padlocks<sup>122</sup>, the degradations have diminished by 46% (Mairie de Paris, 2012).  
24 The issue of risk is probably the main barrier to the adoption of functional economy but it is also the  
25 main enabler. Indeed, as shown by (Stahel, 2010)(p.90 – 92), while the industrial economy  
26 externalized the waste liabilities to the State and the liabilities for quality and utilization to the  
27 customer for all the periods of ownership, the functional economy internalizes the waste and  
28 utilization liabilities in the hands of the producer or fleet manager. Therefore, it is through the  
29 internalization of risk that the incentive for loss prevention and waste prevention is brought into the  
30 companies’ strategies. The picture is thus complex because of the new capital investment which may  
31 be needed to reduce the risk and because of the uncertainty and the risk associated in particular with  
32 the functional result PSS. For instance, if a company sells pesticides and gives advice on how to use  
33 them, the farmer bears the full risk of success of crop growth. If the provider promises a result such  
34 as an x% reduction in loss of crop due to pests, a hefty penalty might have to be paid if the provider  
35 fails. If such liabilities cannot be controlled, the provider should either refrain from such a PSS or  
36 include a (probably prohibitive) high risk premium in its cost price (Tukker, 2004).

37  
38 Functional economy is thus primarily an extension of the possible relationships existing between the  
39 producer – consumer. Therefore, this makes us question the sustainability of the functional and  
40 circular economy through two main questions:

- 41
- 42 • At which conditions is there a reduction of environmental impacts?
  - 43 • What are the social consequences of the extension of the market area associated with the extended producer responsibility?

---

<sup>122</sup> <http://www.velib.paris.fr/Comment-ca-marche/FAQ2>

1 **2 Consequences of circular and functional economy on circulation**  
 2 **process**

3 **2.1 A material and information network**

4  
 5 The industrial system of Kalundborg is characterized by rigidity. Indeed as shown in **Figure 49**, a strict  
 6 close looping makes the waste strategy totally dependent on the waste and production strategy of  
 7 other industrials. The exchange system is thus particularly sensitive to any modifications of industrial  
 8 processes which could ultimately lead to the collapse of the industrial system. The reason of this  
 9 vulnerability is the same than for all networks: absence of redundancy and small size of the network  
 10 (**Erkman, 1998**)(p.27). Besides, the exchange infrastructure, pipelines, is exclusive in the sense that  
 11 each pipeline is designed for the transport of only one product.

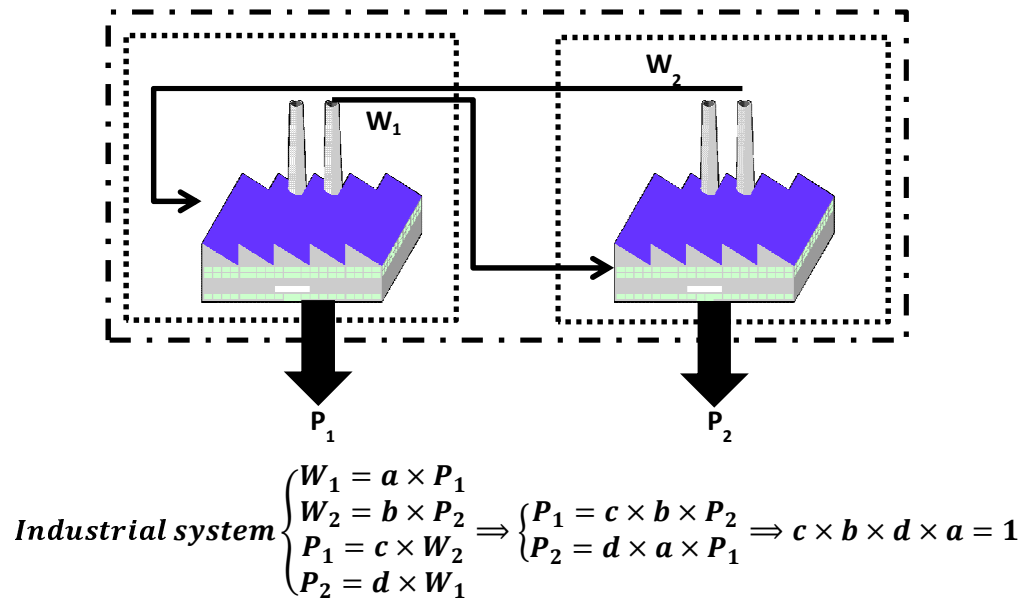

12  
 13 **Figure 49 : The rigidity of industrial eco – parks.**

14 The key issue resulting from the applications of circular and functional economy is thus related to the  
 15 theory of networks. The main mathematical framework to be applied to analyze the patterns of  
 16 circular and functional economy is consequently the theory of graph made of nodes and relationships  
 17 between these nodes [ (Cogis, et al., 2005) (Roux, 2009)]. The nodes can be an industry, a consumer  
 18 or the institutional units as defined in the SNA. In fact, the SNA framework can be understood as a  
 19 graph in which only money relationships are represented. On the opposite, the framework of circular  
 20 and functional economy adds the dimension of materiality expressed in tons to the network  
 21 framework. However, this introduction imposes the introduction of another network that was not  
 22 foreseen: the information network. Indeed, the material network cannot be reduced to the concept  
 23 of price and calls for a distinction by product types even when using the same unit, tons. Therefore, a  
 24 flow management system must be built to simultaneously organize monetary flows and material  
 25 flows. But before going further into the study of the consequences of this third unexpected network,  
 26 let us first explain the material networks induced by the circular and functional economy.

1 The usual circulation space of materials is linear. Considering the introduction of virgin materials in a  
2 particular parts manufacturer, the supply chain is successively made of the product manufacturers,  
3 service providers and consumers as presented in **Figure 50**. The successive economic actors frame  
4 the supply chain of products. They thus create a network with a certain number of actors distributed  
5 geographically. Recycling and remanufacturing activities are concerned with waste, i.e. when  
6 products are not able to fulfill their function anymore. Therefore, the new economic actors linked to  
7 the management of waste are products manufacturer for remanufacturing activities and parts  
8 manufacturer for recycling activities. There is no particularly reason for these manufacturers to be  
9 the same than those of the product supply chain. In fact, the more generic the recycling and  
10 remanufacturing physical and chemical processes are, and the more the sourcing could be extended  
11 to a diversity of waste-resource produced by different users. Therefore, supply chains dealing with  
12 waste can be extended globally for the same reasons than product supply chains become global  
13 ones. This is already happening if we consider for example that in the last 10 years United Kingdom  
14 annual exports of paper, mainly to India, China and Indonesia, have risen from 470,000 tonnes to 4.7  
15 million tonnes, while exports of old plastic bottles have gone from under 40,000 tonnes to half a  
16 million tonnes (Vidal, 2008). This practice of sending waste abroad is even justified environmentally  
17 because recycling in China produces more carbon savings than landfilling it in Britain and making new  
18 goods. Similarly, the imbalance of trade between China and the UK means that the majority of  
19 container ships head back to China empty and produce CO<sub>2</sub> emissions whether or not they are  
20 carrying cargo. Therefore, sending waste back to China reintroduces a balance in global supply  
21 chains. This constitutes a powerful economic incentive for logistic actors by offering cargo for  
22 previously empty travels. This way, the study of the Waste Resources Action Programme (WRAP)  
23 estimated the transport emissions from exports to China and compared them with benchmark  
24 savings from recycling. It found that 1300kg-1600kg of CO<sub>2</sub> was saved for each tonne of waste (Vidal,  
25 2008). Nevertheless, the results of this study are partial as no recycling activities within United  
26 Kingdom were taken into account. It is more exact to say there is now a huge market for recycling  
27 waste developing in China which makes it advantageous for China trade partners' to send their waste  
28 there (Manthey, 2012). As a matter of fact, wastepaper alone is not sufficient to keep up with China's  
29 production demands, as high quality pulp and pulpwood are also being used to supply international  
30 buyers with high quality paper (Kayo, et al., 2012). Therefore, one of the biggest environmental  
31 challenge related to China's paper industry is to prevent its growing demand for fiber from driving  
32 ever more forest destruction in places like Indonesia and Eastern Russia even if the growth of China's  
33 paper industry is playing a major role in ensuring the viability of wastepaper recycling programs in  
34 the US, Europe, and Japan (DeVries, 2007).

35 The case of functional economy is quite different as the network extension is subordinated to the  
36 kind of services sold. Indeed, in the case of the selling of customer satisfaction mainly characterized  
37 by the tracing of use activities for the purpose of maintenance optimization, the service provider  
38 initially delivering the product is also the one taking care of the life cycle management so that the  
39 number of nodes of the network is the same before and after introduction of the functional  
40 economy. In the case of the selling of system utilization, such as in the Velib' case, the benefits come  
41 from the increase of the number of users so that the network size is increasing in terms of nodes. The  
42 key issue is thus the management of the extension of these networks in terms of complexity (more  
43 nodes, differentiated material flows, and monetary flows). But this complexity is dependent on the  
44 representation of resources. The more resources are considered as generic, the more they are

1 treated as abstract and standardized goods not link to any particular geographical pattern. The  
 2 functional economy by focusing on a service approach considers products as specific resources.  
 3 Therefore, space and time becomes concrete aspects of network organization. The novelty of  
 4 functional economy is thus primarily linked to this new aspects of resources considered as specific  
 5 rather than generic. We will see throughout this part II that this change from generic to specific is the  
 6 key to develop efficient sustainable strategies. But let us first examine a bit further consequences of  
 7 circular and functional economies on the logistic field.

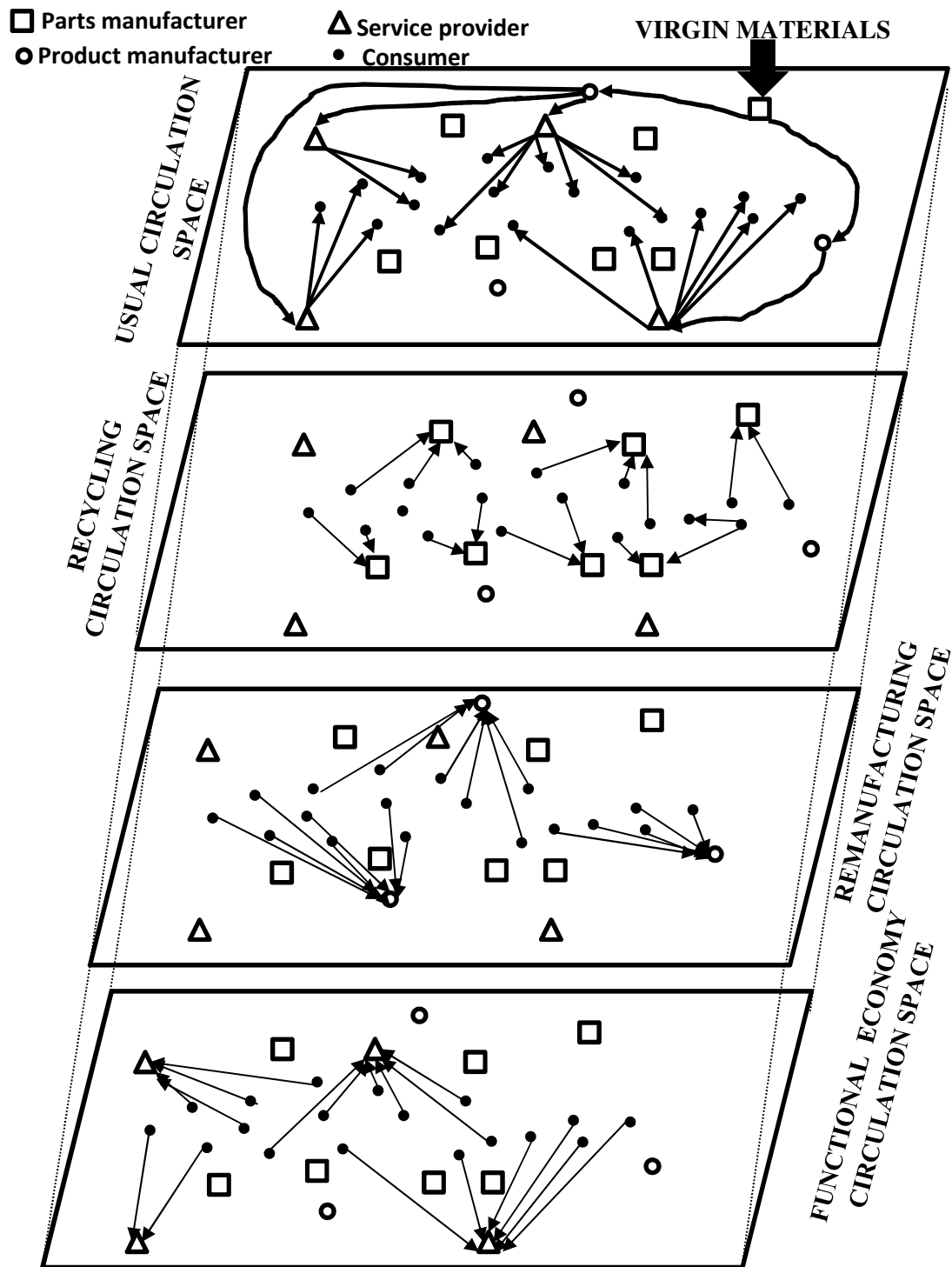

8

9 **Figure 50 : Spaces of circulation of the different dematerialization strategies**

## 2.2 Logistics, transportation and information network

The logistics principles of network management can be related to six principles: the supply chain fundamental theorem, the Orlicky theorem, the principles of transportation massification, the logistics principle, the principle of costs increase through Logistics River and the principle of cooperation (Pimor, et al., 2008)(p.41-56). These six principles are themselves the results of the evolution of the understanding of the economy network.

The story of logistics thus starts in a node considered as a center of profit: the firm. In the usual framework, the firm sells products so that the key question is related to the quantity of products to be produced. In this respect, the key question is thus to know if these quantity can be predicted in order to provide an offer as close as possible as the effective demand. The Orlicky theorem provides an answer to this issue by stating that demand external to the company is a non – controllable demand while the internal demand can be controlled and calculated. In other terms, as the means of production, i.e. the link between the final product and its subparts, are under the control of a company, the quantity of the different materials to ask to suppliers can be calculated for a given number of products made by the company. This is the role of Material Requirement Planning (MRP) to associate external demand and internal demand. The external demand becomes of key importance which leads us to consider the supply chain fundamental theorem. This theorem is concerned by the effect of intermediaries between the product consumer and the product producer. Indeed, this theorem states that the further we get from the final customer, the more the order variability is. In other terms, if the demand of final consumers varies greatly, i.e. with an uncertain prevision of what the future will be even for the entity directly in contact with the consumer, the error on the evaluation of demand will be summed across the supply chain. The solution to this issue lies within an integrated supply chain in which all intermediaries share their information (Pons, et al., 1996)(p.34). Collaboration and cooperation consequently becomes a key point of supply chain management. The producer has thus the choice between two ways of production, make to stock (MTS) and make to order (MTO). The make to stock is often presented as the traditional production technics since it consists in the making of products according to the producer planning. The link with industrial economy and the principles of classical economy where the producer has only to care about the efficiency of its production system expressed through scale economy, specialization of production sites, and so on is obvious. Nevertheless, contrary to the industrial economy where the production is naturally sold on the market, the stocks represent costs for the company. Therefore, there exists an optimum between stock and the quantity of orders made to the production system. This is represented by the Wilson formula in the logistic literature (Pimor, et al., 2008)( p.129-138) which indicates that the quantity to order is related to annual consumption, the order costs and the ownership cost<sup>123</sup>. However, this relationships is dependent on the quality of demand prediction, the demand variability and the inertia of the means of production. All these issues are of core importance in a market economy leading to the transformation of make to stock strategies towards make to order strategies. The make to order consists in the application of the fundamental supply theorem and the search for a diminution of the prevision needs and associated stocks. The material

---

<sup>123</sup> Order quantity =  $k\sqrt{\text{annual consumption}}$  with  $k = \sqrt{\frac{2a}{t}}$  where a is the cost of one order of ownership for one year.



1 requirement planning (MRP) and the distribution requirement planning (DRP) are a first approach  
2 and consist in reducing the prevision needs to only one prevision: the final demand. The second  
3 approach is related to the applications of the just –on – time and Kanban principles which consist in a  
4 minimization of stock based on a constant renewal at the pace of the final demand.

5 The logistic system in its struggle for cost optimization aims at minimizing the formation of stocks  
6 primarily because of the ownership costs associated and secondly because of the absence of profits  
7 resulting from unsold products. In other terms, an efficient logistic system as designed today is  
8 already contributing to a dematerialization of society through the minimization of wasted produced  
9 quantity for a particular market. Nevertheless, as we demonstrated in Part I, the profits for a  
10 company are dependent on its capacity to avoid competitors by controlling the market through  
11 marketing strategies and planned obsolescence or through the development of fast transport system.  
12 The dispatches of firms are thus getting in this system smaller with a higher frequency of sending.  
13 This trend has been observed in France thanks to the ECHO survey about the shippers' choice in term  
14 of number of sent dispatches and the tons of these dispatches between 1988 and 2004 (DAST/PDEI-  
15 INRETS/SLOT, 2006) (Gavaud, et al., 2009) (Beaudoux, 2006).The ECHO survey<sup>124</sup> reveals that the  
16 median lot size has diminished from 160 kg to 35 kg, a factor 4, during the 1988 – 2004 periods. In  
17 other terms, the gain made on material flows are transferred to a time framework translated into  
18 fast transportation system, i.e. high energy systems and into the use of information systems able to  
19 track flows and ensure reliability and flexibility to the delivery of products corresponding to the  
20 renewal or saturation speed rate of markets. The information and communications technologies are  
21 thus playing a key role in an efficient development of the usual circulation space.

22 The dependency on an efficient time management of assets as described by the functional economy  
23 principles also calls for the use of information and communication technologies (ICT). As illustrated  
24 by the Velib' example, the user oriented product – service systems supposes to be able to  
25 redistribute the bikes across stations and to inform in “real time” the customers in which stations  
26 bikes are available. Similarly, the functional selling based on maintenance management supposed to  
27 be able to track down misuses, breakdown of products and to react as fast as possible to maintain  
28 the functional state of the product. Therefore, as shown in **Figure 51**, functional economy can lead to  
29 a strengthening of the dependency on information technologies. Similarly, the remanufacturing and  
30 recycling strategies can lead to the use of software with principles close to Material Requirement  
31 planning. Indeed, the quantities of raw materials and product parts that can be produced from waste  
32 are dependent on the prevision of the flow of waste. Consequently, we have now to examine the  
33 environmental consequences of the use of information technologies and which kind of system could  
34 help reduce the associated impacts. This will be the object of next section.

35

36

37

38

---

<sup>124</sup> <http://www.inrets.fr/linstitut/unites-de-recherche-unites-de-service/dest/projets-expertises-et-partenariats/projets/co2-echo.html>

1  
2

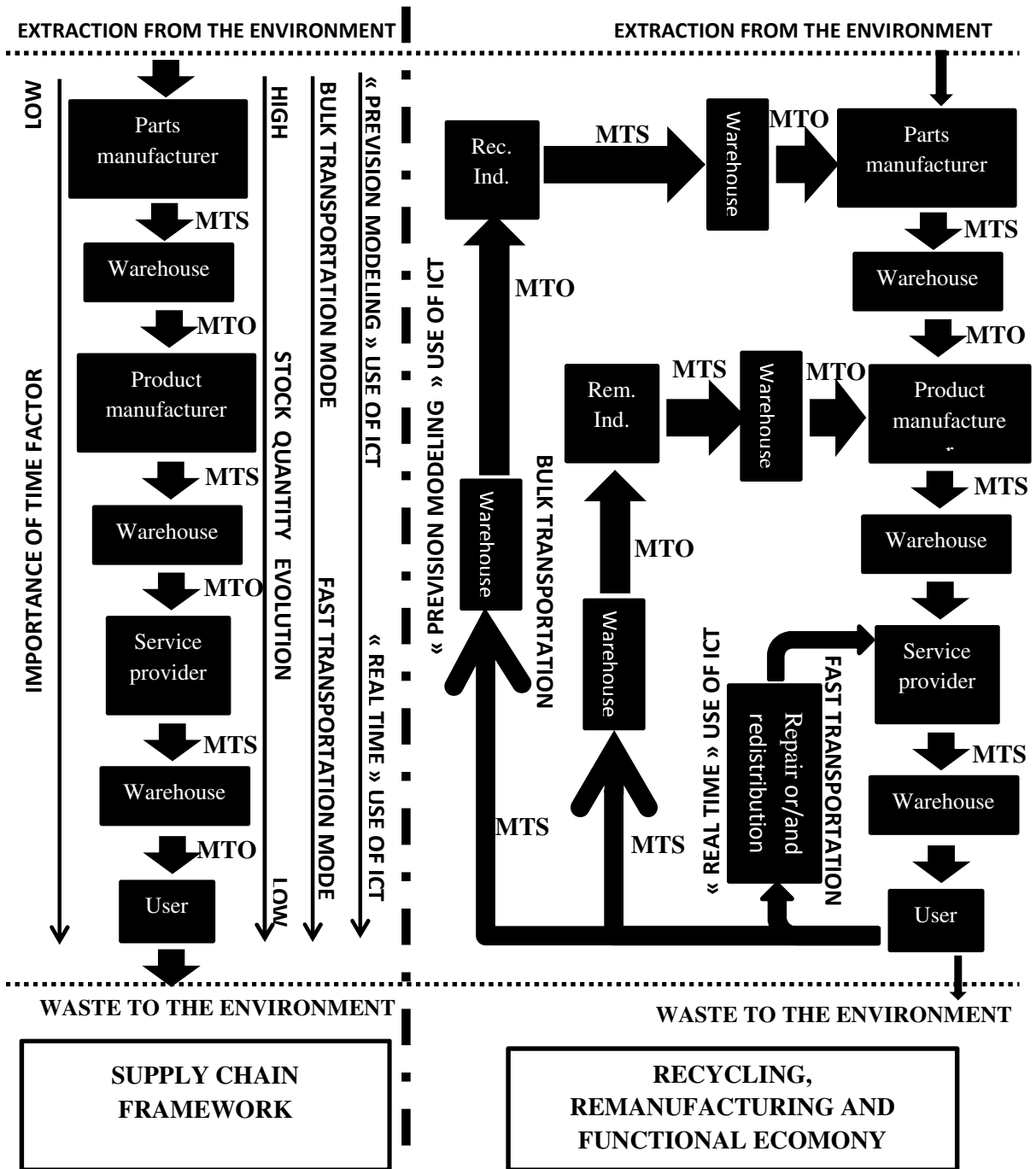

3  
4  
5  
6  
7  
8

Figure 51 : Transportation characteristics and use of ICT in supply chain and dematerialization strategies

## 2.3 Logistics services, territories and environmental issues

The environmental impacts of the information and communication technologies can be characterized as a concentration process. Firstly, the ICTs concentrate its impact in the domain of electricity – based energy. The French electricity consumption associated with ICTS has been increasing of 10% per year for the last ten years (ADEME, 2011). The climate impact of sending a 1 Mo mail to one person has been evaluated to 19 gCO<sub>2eq</sub> in France (ADEME, 2011) and will probably be more important for other countries where the electricity mix is more dependent on carbon –based resources (petroleum, coal). In 2008, 63 % of French households had at least one computer and 19 - 20% of them have more than one computer. The computer stock is thus estimated to 40 million computers, distributed equally between households and companies (Breuil, et al., 2008). Going further, the electricity consumption of households amounts to 68.1 TWh in 2006 with 9% (6.1 TWh) corresponding to computer use and 17.1% (11.6 TWh) corresponding to the use of broadcasting technology (radio, television). In comparison, the electricity consumption associated with professional computers amounts to 11 TWh per year while the server electricity consumption amounts to 4 TWh in 2008 for France and 123 TWh in 2006 for worldwide consumption (Breuil, et al., 2008). Secondly, the ICTs concentrate its impact on the depletion of the non – renewable stocks of metals. Indeed, informatics materials contain 4g of gold but also toxic heavy metals such as mercury, cadmium and lead (RODHAIN, et al., 2010). Once used and entering its waste phase, the computers and electronic materials are often discharged to developing and new emerging countries contributing to the deterioration of their environment. For example, the analysis of a soil sample of New Delhi region where are incinerated e – wastes has revealed lead and mercury concentrations enough to poison the soil for the next 500 years (RODHAIN, et al., 2010). At the opposite of the product chain, ICTs technologies lead to the depletion of many minerals and water resources with high environmental impacts and energy consumption related to production processes. Indeed, computer equipment is a complicated assembly of more than 1000 materials, many of which are highly toxic, including chlorinated and brominated substances. Workers involved in chip manufacturing have started reporting cancer clusters and computer recyclers are found to have high levels of dangerous chemicals in their blood (Yi, et al., 2007). Finally, as underlined by (Erkman, 1998)(p.90 -91), the ICTs have not met its promises of dematerialization in the domains of communication. Indeed, it was thought that the computer era would put an end to the use of paper in our societies. In reality, the annual consumption of paper in the United States has increased from 7 to 22 million tonnes per year from 1956 to 1986. As shown in **Figure 52**, the ICTs have only replaced in terms of market share previous communication uses such as paper. But by opening new possibilities of use (storage of high quantity of information, instantaneous delivery of information), it has also participated to the enlargement of the communication market. Similarly, communication appears to be complementary to transportation rather than a substitution to it. This observation could be first explained by the fact that the power of telecommunication lies in its speed rather than in the quantity transported. Indeed, no object can be transported through computers even though information is transmitted at the light of speed<sup>125</sup>. The second reason lies in the existence of difference services trajectories associated with transportation systems.

---

<sup>125</sup> The light speed is here a reference to the speed of electrons circulating in electricity.

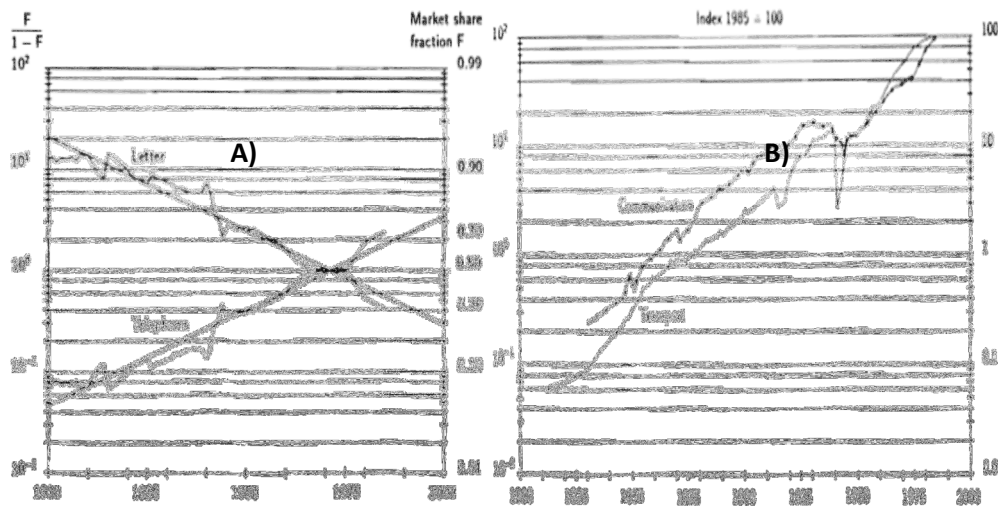

1  
 2 **Figure 52: A) Substitution of letters by telephone calls in the total number of messages**  
 3 **communicated, France 1900 to 1985. B) Growth of passenger transport and communication in**  
 4 **France, measured in passenger-km and total number of messages transmitted in form of an index**  
 5 **1985=100. (Grübler, 1990)(p.255-256)**

6 In the perspective of considering transportation as a service, the more recent service economics  
 7 literature distinguishes between “output” and “outcome” or “immediate outputs” and “mediate”  
 8 outputs” (Gadrey, 1991). This distinction was used by Corinne Blanquart and Antje Burmeister in  
 9 their work on a service approach on the performance of transportation systems. They found out that  
 10 while distances covered, tons or volumes forwarded, handling of goods (number, volume, weight)  
 11 could be considered as immediate input, geographical area covered, production capacity, safety and  
 12 security, reliability, punctuality, just-in-time, flexibility, contribution to information flow  
 13 management, and adaptation to production constraints could constitute the outcome of  
 14 transportation services (Burmeister, et al., 2008). The configuration of transport service thus  
 15 depends on the expectations of the shippers and the strategies of the carriers. Thanks to several  
 16 studies made by INRETS and summarized in **Table 15**, the configuration of transport service can be  
 17 described according to four strategies. This way, according to the logics of production, the transport  
 18 service appears a mix between physical (M), information (I), relational (R) and knowledge circulation  
 19 (C) strategies. Besides, the proximity at stakes evolves through the different worlds of production.  
 20 From a focus on infrastructure and the concept of accessibility for the industrial world, the proximity  
 21 evolves towards a progressive integration of other dimension such as information (circulatory  
 22 proximity) and relationships (organizational proximity). Finally, it should be noted that if the non-  
 23 tangible world and the professional world are characterized by an organizational proximity, the  
 24 modes of coordination can be quite different. Indeed, while the professional world is characterized  
 25 by a knowledge circulation between the producer and the user, the non-tangible world appears to  
 26 tend towards more complex networks in which knowledge circulates both between producers and  
 27 between producers and users. Therefore, transportation is evolving towards more complexity and  
 28 must handle an increasing number of parameters. In terms of the circulation space, ICTs ensures a  
 29 diminution of the transaction costs which prevented the expansion of circulation space. The  
 30 globalization of trade through e – commerce and supply chain transformation are thus using  
 31 internet, intranet and extranet as enabler technologies. Similarly, the stakes of exchanges and trip  
 32 securities, individual mobility, urbanization, intrusion of virtual realities and environmental  
 33 management are more and more dependent on tracing, tracking, stocking and delivering abilities of  
 34 ICTs (GPS, RFID, camera, mobile phone, smart highways, etc.) (ITEMS, 2009).

1 **Table 15 : Articulation between logics of production and transportation service trajectory (adapted**  
 2 **from (Burmeister, et al., 2008)(Burmeister and al) and (Burmeister, et al., 2006))**

Logics of production	Transport service operation	Transportation service trajectory	Logistics
<b>I) Industrial</b> - Low differentiated intermediary goods. - Mass production (scale economy) - Specialization of production sites (ex: Basic chemistry)	<b>Physical transport (M) [Massive and standardized flows of goods]:</b> - Handling - Loading - Unloading	<b>(M)</b> <b>-Trends towards (M)+(I)</b>	- Industrial logistics based on cost criteria - Outsourced transportation - All transport modes, including heavy modes (train, waterways)
<b>II) Flexible</b> - Consumer goods -Mass production but differentiated (high number of references in a range of products) (ex: clothing, food processing industry)	<b>Treatment of information flows (I) [Inside firms and between firms]:</b> - Association of fast, frequent and flows of goods with information flows - tracing/tracking	<b>(M)+(I)</b> <b>- Trends towards separation of this operations</b> <b>- Trends towards (M)+(I)+(C)</b>	- Sophisticated logistics associating fast transport mode and EDI - High frequency of sent dispatches - Reliability (Delays, damages, service rate) - Flexibility (frequent changes of logistics organization) - Outsourced road transportation mode
<b>III) Professional</b> - Unity or small production - Production on demand - High level of customization - specific knowledge (ex: mechanical industry)	<b>Relational and contact operations (R) [Small flows of goods but implying a close producer-customer relationships]:</b> - Direct contact between the driver and the shipper's customer - Feedback on quality of products and distribution	<b>(M)+ (R)</b>	- Basic and small scale logistics, often dedicated - Not outsourced logistics - Own account transportation
<b>IV) Non-tangible</b> - New products - Specific equipment - Highly qualified work (ex: engineering, informatics)	<b>Methodological operations (C) [Circulation of knowledge]:</b> - Coordinate and organize the different operations - Find necessary competences	<b>(M)+(I)+(C)</b> <b>- Separation of operations</b>	- Outsourced logistics - Refocusing on own skills

3 **Legend: physical (M), information (I), relational (R) and knowledge circulation (C)**

4  
 5 The previous remarks lead to consider two important roles of ICTs in regards to environmental  
 6 issues:

7 **1) Participation to an optimization of the existing system:**

8 Let us consider a particular supply chain or industry; it initially constitutes a certain type of system  
 9 with associated drawbacks and difficulty. For example, the road transporters are only loading trucks  
 10 according to their level of information regarded the dispatch of shippers. To access this level of  
 11 information can lead to the organization of a bulk transportation system and consequently a  
 12 diminution of energy and number of vehicles used. Similarly, the knowledge of "real – time"  
 13 circulation can allow the best routing of vehicles in case of traffic jam or other incidents leading to a  
 14 diminution of energy consumption and associated truck exhaust emissions. The question is thus to  
 15 know if these optimizations are offset by the energy, material and environmental impacts of the ICT  
 16 system. On this point, with (Coroama, et al., 2009), we argue that ICT energy consumption and ICT –  
 17 induced energy efficiency are two areas of research that should be integrated even if (Global e-  
 18 Sustainability Initiative, 2008) states that for 2020 the greenhouse emission saving would sum up to  
 19 7.8 GtCO<sub>2eq</sub><sup>126</sup>, i.e. 5.6 times the projected emissions of the ICT sector (1.4 GtCO<sub>2eq</sub>).

126 The largest per- sector potential are smart grids (2.03 GtCO<sub>2eq</sub>), smart buildings (1.68 GtCO<sub>2eq</sub>), smart logistics (1.52 GtCO<sub>2eq</sub>) and smart motor systems (0.97 GtCO<sub>2eq</sub>).

1           **2) Creation of new systems:**

2   The second effect of ICTs could be characterized as a rebound effect. This effect consists in the  
3   transformation of the relationships between the different social actors with the time framework.  
4   Indeed, as shown in **Figure 53**, the first effect of ICT concerns organizational proximity strengthening  
5   the existing organization by providing a better structure to the information flows and at the same  
6   time making the organization vulnerable to the breakdown of information systems. Once again, the  
7   problem linked to the absence of network redundancy appears. Secondly, the development of  
8   information system can lead to consider an extension of supply chain. Indeed, in a world of high  
9   energy, it is not physical distance that matters but time distance, in others terms speed. The end of  
10   organizational lock by the introduction of ICT, i.e. the end of the time friction associated with it, thus  
11   favors a dilution of the geographical proximity.

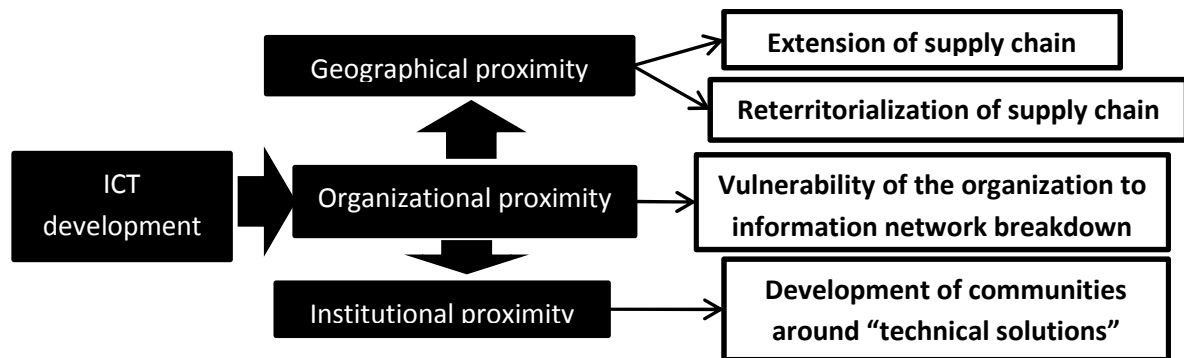

12  
13 **Figure 53 : ICTs development effects on proximity framework**  
14

15   Nevertheless, the process can be inversed if the increase in distribution frequency does not only  
16   concern information flow but also material flows. Such is notably the case for the use oriented  
17   product – service system. Indeed, for different users to use the same object, it supposes a certain  
18   form of geographical proximity enabling the transfer of use from one user to another user. This  
19   pattern was absent from the usual framework of the economy when there is only one user per  
20   product<sup>127</sup>. For functional results, the maintenance of the chosen technical system also concern one  
21   product so that the geographical proximity can increase between the service provider and the user.  
22   Functional economy can thus lead to a reterritorialization of economic activities linked to the  
23   increase of the importance of time management within the product –service system. Finally,  
24   concerning institutional proximity, the “technical solution” chosen to fulfill the functional need leads  
25   to the creation of a community sharing knowledge and a common representation of the “technical  
26   solution”. In the case of the Velib’, the choice of bike as a mobility system has led to the formation of  
27   a website where all users can share their impression, their ways of use, and their information on the  
28   Velib’ system. This web community will even get more empowered with the development of an  
29   open access data in spring 2013<sup>128</sup>.

127 Except for the circulation space associated with reciprocity. Indeed, inside particular organizations (households, companies), a same object can be transferred for free (gift, loan) from one person to another person.

128 <http://blog.velib.paris.fr/blog/2013/02/04/lopen-data-arrive-chez-velib-au-printemps-2/>

## 2.4 Co – production and resource specification

The notion of the empowerment of Velib’s users in the web community leads us to put more emphasis on the place of the user in the service provider – user relationship. According to the standard technical definition, which can be traced back to the classical view of “unproductive services” (*Smith, Marx*), a service is considered as immaterial, co-produced between user and producer, non-storable, and non-transportable (Burmeister, et al., 2008). We already demonstrated that the notion of immateriality was wrong and that services were linked to the same principles of stock and flow management than the usual logistic patterns. However, the notion of co – production appears to be a key feature of service. Indeed, if we follow further the developed socio – technical approach of (Hill, 1999), services are mainly characterized through the concept of “service relation”. A service relation is thus considered as a particular social relation between a producer and a user, leading to a change in the status of a reality owned by the user. In summary, service activities can thus be defined as operations aiming at the transformation of the state of a reality C, performed by a service provider A for a user or client B, the result of which is not an independent product which can circulate separately from the reality C (Gadrey, 1991).

Consequently, services are characterized by the definition of an initial state of reality, the definition of a final state of reality, and the trust user B gives to the service provider A. Therefore, a conflict may rise for services difficult to define in a standardized way. Such is for example the case of thermic comfort. Service providers who will pretend deliver thermic comfort to its customer first need to define what thermic comfort is. According to (ADEME, 2008), the Code of construction fixed the average temperature of occupied dwellings to 19°C during the day and 16°C – 17°C at night. The problem is that thermic comfort is a much more complex notion than temperature alone and corresponds to the well – being of individuals occupying dwelling. Therefore, persons sensitive to the cold may find themselves freezing at night while others may find the temperature too hot. Actually, there are numerous parameters of thermic comfort linked to global and external parameters such as external temperature and humidity, to local parameters such as convection flows and radiation flows and finally to the occupant himself which through his activities and own metabolism (sweat, etc.) modifies the conditions of his thermic well – being.

We thus observed in the selling of functions the formation of new complex systems. Indeed, in the usual framework of the economy, only products can be considered as complex systems and this complexity is only partially transferred to customers. For example, cars are a complex mechanical and electronic system but only the system linked to driving and simple maintenance is transferred to customers who do not have any knowledge on how the car works. This situation is not possible anymore in the case of functional economy where the absence of knowledge from the customer could exclude him from the service relation. However, the state of reality to be modified is the customer’s one. Therefore, the relation between the service – provider and the customer is centered on the customer even if the technical system and associated costs are borne by the service provider. This situation can thus rise to conflicts if the notion of co – production is forgotten and the service provider considers all actions from the customer as a generation of unnecessary costs. This situation explains where the novelty of the service approach lies compared to the usual framework of economic transactions described in part I. Resources and means of production cannot be considered as generic anymore. Providing services imply to consider the particularities associated with the construction of a relationship so that the application of any means of production is specific. This

1 change from a standardized world in which goods are easily substitutable to a customized world in  
 2 which goods are unique is of core importance for sustainability as I will demonstrate in chapter V. As  
 3 a matter of fact, customization is already happening on the market field through various applications  
 4 of information and technology communication. However, this customization is not a real one as  
 5 space and time continue to be considered as generic resources and co-production is often missing  
 6 from the analysis. As I will demonstrate in chapter V, moving away from the credo in a generic  
 7 understanding of resources, supply chain organization, the place of time and space in sustainability is  
 8 the most difficult and the most necessary step to undertake to ensure sustainable applications of  
 9 circular and functional economies. Otherwise, there is a high risk that applications of the promising  
 10 sustainable strategies of circular and functional economies strengthen the myth of objective value I  
 11 strongly criticized in Part I. The next section develops more in details this risk that can already be  
 12 found in product-service system and circular economy literature.

## 13 2.5 The risk of the resurgence of the theories of value

14  
 15 In part I, we saw that the absence of a social understanding of our society was linked to the theories  
 16 of value in which prices (in €) constitute a summarized version of all social links. This possibility was  
 17 based on the objectivity of value, i.e. the fact that value existed prior to the exchanges. For classical  
 18 economists, this value was linked to work while for neoclassical economists, this value was linked to  
 19 the concept of “utility”. The question is thus to know if functional and circular economy are also  
 20 dependent on an objective representation of value.

21  
 22 If we follow **Table 16** and the approach of performance economy as explained by Stahel, we see that  
 23 the objective representation of value lies within the €/T ratio, or the material density of value. It is  
 24 not so surprising when we think that as described in 2.1, the novelty of the functional and circular  
 25 economy approach was to recognize the existence of another network than the monetary one: the  
 26 material network. Therefore, the new indicator is simply the ratio of the two objective  
 27 representations of value within these two networks, symbolized by price for the monetary network  
 28 (€), and by tons for the material network (T).

29 **Table 16 : The objective value of the performance indicator (Stahel, 2010)(p.9)**

	Value – per – weight ratio of goods of the		
	Stone Age Economy (Cent/kg)	Industrial Economy (€/kg)	Performance Economy (mio €/g)
<b>BULK GOODS, e.g.</b> Sand and gravel Steel automobiles	1 cent/kg 40 cent/kg	20 €/kg	
<b>SMART GOODS, e.g.</b> Razor blades Remanufactured car engines Spinnaker cloth Memory stick “Rebif” interferon Enzymes		500 €/kg 500 €/kg 800 €/kg	8 €/g 5 million €/g 10 million €/g

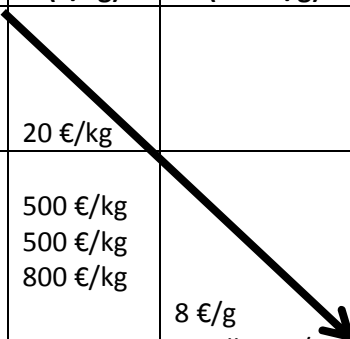



1 This framework of dematerialization is somehow misleading. Indeed, the €/T ratio only means that  
2 the value added by weight unit is increasing. In other terms, it would be more accurate to talk about  
3 “value added dematerialization” than a real dematerialization in the sense that less material are  
4 consumed (Ayres, 1989) (Herman, et al., 1989). Going further, if we observe the evolution from stone  
5 age economy to performance economy as presented in **Table 16**, the nature of goods seems to  
6 change from big size to small size goods. But the size characteristics are dependent on the functions  
7 searched. It looks indeed obvious that a car in charge of moving a group of person from one place to  
8 another will weigh more than enzymes whose actions is operating at the cellular level of a human  
9 body. Therefore, the displacement of activities towards physical space inferior to the human scale  
10 (nanotechnology, computer science, biotechnologies) leads naturally to an increase of the €/T ratio  
11 even if the effects of nanotechnology and biotechnologies may be more harmful to the  
12 environment<sup>129</sup>. Secondly, it should not be forgotten that the €/T ratio can diminish without a  
13 decrease or even a stagnation of the material consumption. To obtain this diminution, it is sufficient  
14 that the prices of the products increase. But the problem with high prices is related to the struggle of  
15 power within the monetary network. Indeed the purchasing power within the monetary network is  
16 the main barrier to access a particular product. Therefore, a high price will forbid access to many  
17 potential customers to a good. Consequently, the question is to know if the currently high price of  
18 enzymes and interferon is due to the innovative character of these products which will consequently  
19 get cheaper when becoming common consumption goods or if the high price is the result of a  
20 decision of keeping the circulation space of these goods accessible for only a small amount of actors.

21 The objective value of circular and functional economy is thus misleading for the following reasons:

- 22 1. A materiality dependent on the functional area. This area can go through the sub – atomic  
23 scale, the cellular scale, the human scale up to the space scale.
- 24 2. A price dependent on the state of the good within its development process (innovation,  
25 diffusion) and the decision made on the accessibility to this good for different purchasing  
26 powers.

27 The information and communication technologies are confirming this viewpoint. Based on electron  
28 transfer, they correspond to technology dealing with processes at the atomic scale even if computers  
29 for examples are machines at the human scale. Nevertheless, the price of computers has diminished  
30 in order to allow the diffusion of the technology within the whole economy, notably households  
31 where the purchasing power is not so high<sup>130</sup>. The ICTs dealing with information transfer are thus  
32 spreading through the economy and as we saw within this chapter, circular and functional economies  
33 are also dependent on the management of information flows. I also demonstrated that the  
34 technologies behind these flows make not acceptable the term of “immaterial” often used to  
35 describe ICTs. Finally, the issue of co – production between the customer and the service provider  
36 should act in favor of a total abandon of the belief in an objective value preexisting to the exchange.  
37 This naturally leads to consider each exchange as particular both in terms of material, information,  
38 monetary flows and in terms of social relationship as we will see in next chapter.

---

<sup>129</sup> <http://www.i-ceint.org/nanotechnologies-environnement>

<sup>130</sup> <http://www.volle.com/ENSPTT/primicro.htm>

### 3 Conclusion

This chapter examined the potential of functional economy and circular economy as sustainable strategies. The main promising innovations associated with these new economic patterns concerned the reintroduction of waste within the economy and the extension of product life. As we saw in Part I, the environmental analysis of supply chains tends to stop at the gate of customer's use phase (cradle to gate) when a transfer of product ownership happens between the producer and the consumer. Therefore, a disconnection occurs between the act of supplying products and the moment these products become waste. The first strategy "to reintroduce waste within the economy" consists in considering that wastes can be turned into resources. Consequently, wastes become part of the sourcing strategies of industries. Nevertheless, wastes as products holding a complex structure but with disabled functionality are specific resources. This makes it difficult to find direct reuse or application of wastes. A transformation process of waste to generic resource becomes necessary. Depending on how far they go into the generic transformation, these transformation processes are labeled "remanufacturing" or "recycling activities."

As wastes are reintroduced within the economy, generic resources taken from the natural environment are less depleted than in a usual linear economy. The circular economy thus consists in an artificial management of the shift specific-generic resources which used to be left to the Environment (absorption and recycling into nutrients by carbon, nitrogen cycles etc.). This new organization supposes particular knowledge on the different materials available in the different products entering waste phase and on the different transformation processes allowing the recovery of materials. This knowledge constitutes a characteristic of the remanufacturing and recycling industries. However, the transformation processes are dependent on the initial conception of products which can prevent or facilitate the dismantling of products. Similarly, the recycling and remanufacturing processes are not free from an environmental viewpoint as they consume energy and other materials. The extension of life cycle assessment to the waste phase is thus a fundamental of the sustainable evaluation of circular economy. Nevertheless, putting aside the specific – generic transformation of resources, the circular economy is also dependent on a time framework as availability of wastes may not correspond to the needs of production. As a matter of fact, there is no reason for a product entering waste phase in a particular geographic area to find immediately a possibility of reuse in the same geographic area. The management of waste phase is thus primarily linked to the formation of a new supply chain. As shown in **Figure 54**, this new supply chain acts as a completion of the product supply chain. The motor engine is the demand for products ruled by the functioning of the use phase. These products are specific corresponding to particular functionalities or properties. To make these products, industrials organize themselves through a product supply chain ruled by a demand for resources which become more generic as downstream suppliers are considered. The novelty approach of circular economy is that these resources can be obtained from wastes and not only from resources extracted to the environment. This way, the demand for resources is transformed into a demand for wastes.

However, the circular economy has several drawbacks characteristic of circulatory process. Actually, putting aside the necessity of the existence of recycling and remanufacturing activities, the availability of wastes as resources is dependent on the amount of produced products through the product supply chain and the time these products stayed in the use phase. The first risk of circular

1 economy is thus linked to the degeneration into a status quo which legitimates a certain level of  
 2 consumption by a poor understanding of the environmental issue of resource consumption. As a  
 3 matter of fact, the strategy of using wastes as resources is primarily a strategy to diminish the  
 4 depletion of the virgin natural resources. From an environmental viewpoint, this situation is of  
 5 course better than the initial one marked by a high depletion of natural resources. But it does not  
 6 mean that the current level of resource consumption is sustainable. This point is even more  
 7 important if we consider the problem of environmental degradation associated with emissions. The  
 8 second risk of circular economy is linked to the possibility to increase the availability of waste by  
 9 reducing the time duration of the use phase. The demand for products becomes more frequent and  
 10 the overall linkage between product supply chain and waste supply chain is accelerated. A  
 11 sustainable application of circular economy is thus dependent on a sustainable perspective of the  
 12 motor of the economy, i.e. the use phase of products.

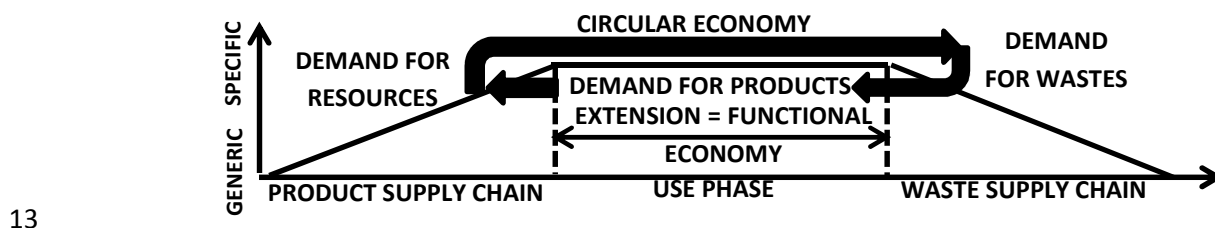

13  
 14 **Figure 54 : The three phases of products in relation with circular and functional economies and**  
 15 **generic/specific characteristics of products**

16 Functional economy is precisely this kind of strategy targeting the use phase of products. The core  
 17 idea is to consider products as particular assets developed for the fulfillment of consumption  
 18 functions. If we consider the pattern developed in **Figure 54**, functional economy is first translated by  
 19 a modification of the product supply chain which develops more specific approach of consumption.  
 20 The products are thus transformed in product-service systems one can consider as a specific resource  
 21 for consumption. Energy and materials used and consumed to make the product-service system  
 22 during the product supply chain can be considered as being embodied within the product-service  
 23 system so that the specific resource can be considered as assets. The second part of functional  
 24 economy strategy consists in a maximization of these assets. Through a business model focused on  
 25 providing services instead of products, the economic actors receive an incentive to extend the life  
 26 time of products. This notably means that the specificity of the resource associated with the product-  
 27 service system is extended in time before circular economy strategies take over by transforming the  
 28 specific asset into generic resource. Contrary to circular economy, functional economy deals with  
 29 modifications of the motor engine of the economy (use phase). The application of functional  
 30 economy supposes that industrials are transformed into service providers. This notably supposes a  
 31 better internalization of the maintenance costs and the transformation of activities into asset  
 32 management. For the user, important aspects are related to possibility to pay according to its real  
 33 use and possibility to get access to capital goods (bike, car, etc.) without high expenses. It should  
 34 nevertheless be noticed that the specific characteristics of product-service system are linked to the  
 35 co – production aspects of services with the user at the center of the relationship.

36 In spite of circular and economy are promising strategies, I also demonstrated throughout this  
 37 chapter that the circulation process could severely diminish the efficiency of these strategies. For  
 38 example, the management of waste acclaimed by circular economy is dependent on the ability to

1 predict waste flows and organize the associated logistics. Similarly, the fleet management associated  
2 with use oriented PSS conveys a dependency on “real time” logistics able to better manage time  
3 variables and ensure a 24h/24h service level. The same conclusions can be made on the  
4 management aspect of the function associated with product-service system for which maintenance  
5 requires the tracking of components’ state to ensure a continuous service supply. I thus observed an  
6 increasing importance of information flows in order to manage the two networks of the economy  
7 (monetary and material). This leads to an increase of the use of information and communications  
8 technologies. But as these technologies are characterized by high energy production processes, the  
9 extraction of rare materials and the disposal of toxic metals, the reduction of material consumption  
10 in most sectors of the economy is thus made at the expense of an increase of material consumption  
11 associated with ICTs. Besides, the relative instantaneity of the information transfer strengthens the  
12 myth of current economic economies related to zero transaction costs. Therefore, a drastic choice  
13 must be made by logistics actors in regards to ICTS use. Either they base their efforts on the  
14 possibilities offered by ICTS to extend existing supply chain and transport chain, or they engage  
15 themselves in containing the ICTs needs by a reterritorialization of the supply chain.

16 Time and space thus play an important part in circular economy and functional strategy. Actually,  
17 wastes can be considered as new sourcing and thus be part of the current global sourcing strategy of  
18 companies. For functional economy, the importance of time management should act in favor of a  
19 geographical proximity between the service provider and the customer. Nevertheless, this aspect  
20 could be offset by ICTs technologies which give the impression of far –off management ability. The  
21 risk of seeing functional and circular economies included in an abstract vision of space and time is  
22 further confirmed by the general representation of associated dematerialization. This representation  
23 concerns the establishment of the economy as a double network of material flows and monetary  
24 flows. The objective values studied in Part I represented by price are replaced by a new objective  
25 explanation of the value embodied in the exchange understood as a ratio between euro and tons.  
26 Therefore, current dematerialization framework concerns more a dematerialization of the value  
27 added than a real dematerialization of the economy. Besides, the €/T ratio appears highly dependent  
28 on the functional area of the service considered and the associated technical system. It also depends  
29 on the decision made by the service provider on making accessible through price policy its technical  
30 solution. The vision of the economy as a double network linked together by the information network  
31 is thus insufficient to frame environmental and social sustainability. It nevertheless corresponds to an  
32 important first step towards an understanding of the sustainable socio – economic system as a  
33 superposition of not reducible networks as we will demonstrate in next chapter. The core problem of  
34 dematerialization strategies is thus the poor understanding of the difference between generic and  
35 specific resources. Actually, an abstract vision of space and time is a way to standardize economic life  
36 by considering all resources as mainly generic and neglecting many aspects which make resources  
37 specific. The current product supply chain is notably characterized by this generic aspect. On this  
38 opposite, social issue related to the central position of the user in the service provider – user  
39 relationships of functional economy reveals the specific aspect of product-service system. I advocate  
40 that sustainability achievement is linked to the capacity to characterize and organize the specificity of  
41 resources and to abandon or restrict the idea of generic/standardized resource. This duality  
42 specific/generic is also linked to the duality local/global as I will demonstrate in Chapter V.

# Chapter V: The conditions for sustainable applications of circular and functional economies

## 1 Introduction

We saw in the previous chapter that circular and functional economies could be promising dematerialization strategies. Nevertheless, the issue of information and generic/specific resource management was found as a possible offset to the efficiency of these strategies. The core issue of dematerialization strategies was found linked to the understanding of the difference between generic and specific resources. This is the purpose of the present chapter to analyze further the duality specific/generic to understand how it applies to sustainability.

The first step will thus consist in studying the importance of a specific characterization of resources in regards to environmental issues. The issue of resource consumption and environmental discharges will thus be studied through the notion of ecosystem. This will characterize a first specific network with which conditions of environmental sustainability can be associated. The second step concerns the importance of specificity from a social viewpoint. This issue is related to the notion of functionalities or properties. Finally, the distinction between specific and generalize resource will build the analysis of sustainability on the duality global/local. I will notably show that sustainability is better expressed at the territorial level together with an evolution towards a knowledge economy.

## 2 Specificity as framing sustainability

### 2.1 Specificity as a key characteristic of ecosystems

#### 2.1.1 Ecosystem characterization as specific areas

Within chapter IV, we saw an example of decomposition equation related to environmental impact analysis. This equation is rewritten below and we can see that the first problem with a uniform vision of the material network is primarily the negation of the  $\frac{I}{M_I}$  factor. Indeed, a same material consumption expressed in tons can lead to different kind of environmental impacts depending on the time and the place this consumption takes place and the kind of material used.

$$I = \frac{I}{M_I} \times \frac{M_I}{Y} \times \frac{Y}{S} \times \frac{S}{W} \times W$$

with  $I$ : environmental impact ;  $M_I$ : Material Input ;  $Y$ : Yield ;  $S$ : Service,  $W$ : wealth

The first issue thus concerns the characterization of material resources and the effect their withdrawal from their initial environment have on ecosystems. It thus supposes to understand how the notion of environment is characterized. According to (Smith, et al., 2006)(p.5), the environment is a physical location in time and space in which each organism carries out the “struggle for existence”. It can be as large and stable as an ocean or as small and transient as a puddle on the soil surface after a spring rain. The environment thus includes both the physical conditions and the array of organisms that coexist within its confines. It is also specific both from its time and spatial definition. There is



1 thus not one environment but a set of environments, each of them having a certain form of  
2 autonomy within their defined borderlines. We thus observe the formation of different ecosystems  
3 typical of a physical location in time and space. Some of these ecosystems have a lifetime exceeding  
4 largely the duration of a human life and can even be expressed in geological time, and some of these  
5 ecosystems have a lifetime greatly inferior to the duration of a human life, from seconds to year. The  
6 two basic components of an ecosystem are the living environment (biotic) and the physical  
7 environment (abiotic). So within the border of an ecosystem, three main types of interactions can be  
8 recorded: internal interactions within the biotic and abiotic sub – systems and the interaction  
9 between the biotic and abiotic sub – systems.

10 The study of the physical environment is the central mission of disciplines such as geology,  
11 meteorology and hydrology. The link with ecosystems is operated through the concept of  
12 habitability, i.e. the ability of the physical environment to support life (Smith, et al., 2006)(p.42).  
13 Each organism has thus a living area which is specific and can be said as local. For example, if we  
14 consider the Climate, the atmosphere appears as not static and uniform but in a constant state of  
15 movement driven by the rising and sinking of air masses and the rotation of Earth on its axis. Besides,  
16 the disequilibrium between the input of solar radiation received by the equatorial region and the  
17 polar region create a diversity of air cells. The created patterns of winds are also influenced by the  
18 interaction with surface water flows in Earth's oceans. Indeed, the major currents of the oceans  
19 generally mimic the movement of the wind currents above until they encounter one of the  
20 continents. Going further, air temperature plays a crucial role in the exchange of water between the  
21 atmosphere and Earth's surface through the phenomenon of evaporation, condensation and  
22 humidity. The patterns of temperature, winds and ocean currents form the global pattern of  
23 precipitation with high precipitation in the region of the Equator declining as one moves north and  
24 south. At this stage, one can already observe how the process of specification related to Climate  
25 definition leads to privilege local patterns over global patterns. Going further, topography influences  
26 regional and local patterns of precipitation so that the temporal variation in climate does not always  
27 occur at regular and predictable intervals such as seasonal changes in temperature with the rotation  
28 of Earth about the Sun and the intertropical convergence zone with the resulting seasonality of  
29 rainfall in the tropics and monsoons in South – East Asia. Indeed, there exists a lot of regional  
30 variability in addition to the global variability of climate. The El Niño – Southern Oscillation (ENSO) is  
31 one of them (Trenberth, et al., 2007). In conclusion, most organisms live in local conditions that do  
32 not match the general climate profile of the larger region surrounding them. Indeed, actual  
33 conditions of specific environments will be quite different depending on whether they are  
34 underground versus on the surface, beneath vegetation or on exposed soil, on mountain slopes or at  
35 the seashore. Light, heat, moisture, and air movement all vary greatly from one part of the landscape  
36 to another influencing the transfer of heat energy and creating a wide range of localized climates  
37 called microclimates (Smith, et al., 2006)(p.60-61).

38 The climate understood in term of localized properties included in a broader pattern of generalized  
39 properties can also be found in the aquatic and terrestrial environments. Indeed, water follows a  
40 general cycle traveling from the air to Earth and returning the atmosphere through the process of  
41 cloud formation, precipitation, interception and infiltration into the ground. But the velocity of  
42 currents shapes the environment of flowing water leading to localized aquatic environment.  
43 Similarly, in aquatic environments, a close relationship exists between the diffusion of carbon dioxide  
44 into the surface waters and the degree of acidity and alkalinity. Consequently, acidity influences the

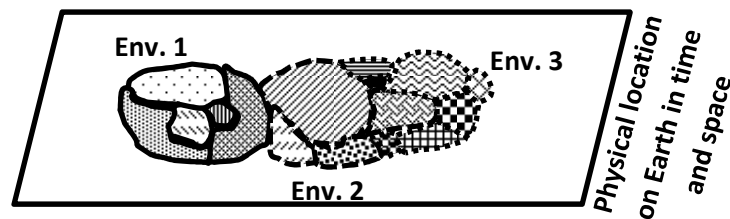
1 availability of nutrients and partitions the environment into sub – ecosystems dependent on the  
 2 sensitivity of organisms to acid situations (Smith, et al., 2006)(p.82-83). For terrestrial environment,  
 3 the local and global conditions of life have been linked to the maintenance of the water between  
 4 organisms and their surrounding environment and the investments in structural materials to  
 5 maintain erect against the force of gravity. Soil is itself a natural product of unconsolidated mineral  
 6 and organic matter resulting from five factors: parent material, climate, biotic factors, topography  
 7 and time (Smith, et al., 2006)(p.100-101).



- 8  Environment 1 with associated micro – environmental systems
-  Environment 2 with associated micro – environmental systems
-  Environment 3 with associated micro – environmental systems

9 **Figure 55 : the hierarchy in the structure of the physical environment, from global to local.**

10 As shown in **Figure 55**, the physical environment of ecosystems is thus a local one but at the  
 11 crossroads of global influences. The organisms present within this physical environment participate  
 12 to its boundaries. Therefore, the ecosystems constitute a complex interaction of different networks  
 13 defined locally in time and space.

14 **2.1.2 Relationships between discharges/resources and ecosystem viability**

15  
 16 As the physical and biological characteristics of ecosystems are local ones, the problem of ecosystem  
 17 viability associated with resource consumption and environmental pollution must thus be studied at  
 18 the local level. We found here the main reason why the material network cannot be understood by  
 19 such a simple indicator as the one of ton. Indeed, the fact that interactions framing ecosystems are  
 20 local ones indicates that the degradation and management of ecosystems are also of a local nature.

21 Let us first study the problem posed by resource consumption. If we consider the usual product  
 22 supply chain, the materials used by the economy are taken from a natural environment. Therefore,  
 23 two networks must be considered to represent the effects induced by resource consumption as  
 24 shown in **Figure 56**. One concerns the successive transformations of products framing the  
 25 material/energy space of circulation for human activities while the other network concerns the  
 26 ecosystem space of circulation, i.e. the consequences induced by the withdrawal of resources in a  
 27 particular space and time. For example, the withdrawal of one ton of water will not have the same  
 28 effect if it is made in a relative dry area or a humid one, in a place with a high renewable rate or  
 29 underground water for which the renewable rate is expressed in centuries. For the network  
 30 concerning human activities, the associated material and energy space of circulation is primarily  
 31 dependent on the places where human are. The first point is thus to locate the living areas of

1 individuals. Secondly, if we consider the transfer of goods from one living area (place of  
 2 production/extraction) to another living area<sup>131</sup> (place of consumption); we can distinguish the two  
 3 phases of resource extraction and transportation of extracted/transformed resource.

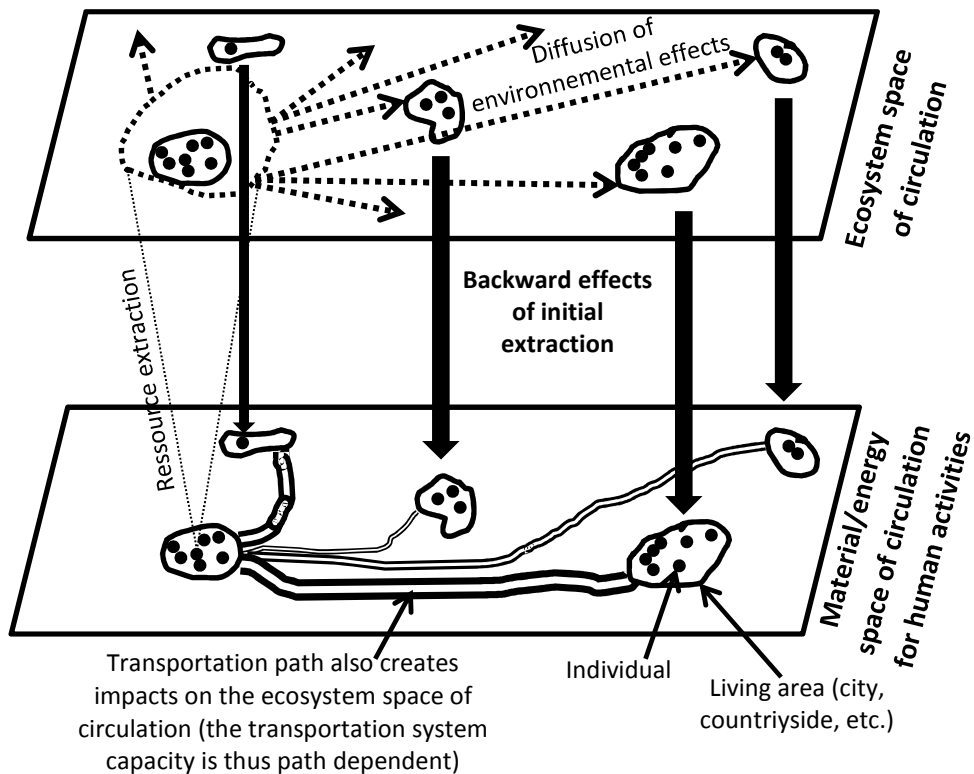

**Figure 56 : Relationships between the circulation spaces of human activities and ecosystems**

7 The problem of resource consumption is thus linked to its dynamics. Indeed, following the material  
 8 balance principle, withdrawing one ton of material from a particular environment implies the  
 9 transfer of this ton to another environment. Therefore, a first issue is related to the quantity  
 10 exchanged between ecosystems may it be driven by human activities or not. The second issue is  
 11 related to the changes associated with the shape taken by materials. Therefore, if the quantity of  
 12 atoms is conserved so that only their spatial dynamic could be studied, it is not the case of their  
 13 arrangement which frames the physical, chemical and biological properties. It is in this term that the  
 14 difference between wastes and discharges should be understood. Wastes are coming from materials  
 15 issued from the use phase. Therefore wastes are modifications of specific material shapes that were  
 16 once wished but are now unable to fulfill functions they were designed for. Discharges are unwanted  
 17 arrangements of atoms which have been created during the extraction, production, transportation  
 18 and consumption processes. Examples of discharges are the car exhaust emissions and the  
 19 modification of the physical environment e.g. induced by the wind created by cars.

20 The physical world is not uniform notably because discharges or wastes always suppose a physical  
 21 location in time and space. Consequently, a discharge can always be associated to a particular eco –

<sup>131</sup> “Another” is not to take in a restrictive meaning. Indeed, the living area of production/extraction and the one of consumption can be the same. Nevertheless, narrowing down to a particular scale of space and time, the place of production/extraction can be different<;



1 system so that the notion of degradation or pollution is also local. Besides, the notion of degradation  
2 supposes a situation of reference and an evolution from this situation perceived as negative. The  
3 notion of degradation is thus a normative one and can differ in time and in space. The definition of  
4 atmospheric pollution can for example vary between countries and for organisms within the same  
5 country. For example, the NF X 43001 1972 norm of the Normalization French association (AFNOR)  
6 defined an air pollutant as a solid, liquid and gaseous body present in the atmosphere but not being  
7 there normally or being there in abnormal quantities. Similarly, air pollution is defined as the  
8 presence of pollutants or a modification of the normal composition and/or normal properties of the  
9 air that can provoke an uncomfortable feeling. The vague notion of “uncomfortable feeling” is  
10 further specified by the 1961 August 2<sup>nd</sup> law which relates air pollution to phenomenon causing  
11 inconvenience to the population, compromising public security or health, or being harmful to  
12 agricultural production and the conservation of buildings and sites (Rollin, et al., 1980)(p.263). The  
13 same organism, AFNOR, defines later through the 1996 IPCC directive 96/61/CE pollution in two ways  
14 (Brodhag, et al., 2004). Firstly, pollution concerns all intervention from men in natural equilibrium by  
15 the introduction of toxic, harmful, cumbersome substances which disrupt the natural evolution of  
16 the environment. Secondly, pollution can be defined as the direct or indirect introduction due to  
17 human activities of substances, vibrations, heat or noise in air, water, soil able to harm human health  
18 or damage environmental quality, to provoke the degradation of material goods, or the degradation  
19 of the pleasure linked to the environment or other legitimate use of the environment. For  
20 transportation, the problem of degradation is for example seen through the vulnerability of the  
21 ecosystems to transport vehicle exhaust emissions. In France and Europe, natural sites have been  
22 identified for the scarcity and vulnerability of wild species and associated habitats and form a  
23 network called Natura 2000<sup>132</sup>. The transportation networks further participate to an artificial  
24 separation of the habitats of species<sup>133</sup> meaning that infrastructure construction and spatial planning  
25 have to take into account the ecosystem space of circulation and not only the material/energy space  
26 of circulation of human activities.

27 The degradation of ecosystems is thus a normative process from two viewpoints. First, the notion of  
28 degradation is related to a state of reference which thus supposes the possibility to define an initial  
29 situation. Besides, all shortcomings on this initial situation will result in similar shortcomings on the  
30 assessment of pollution. Secondly, the pollution framework presented is anthropocentric in the  
31 sense that only the effects of human activities on the environment and the effects of pollution on  
32 human living conditions (health, goods, pleasure...) are considered. These realities behind the current  
33 framework of pollution issues can be further understood in we consider the problem of biodiversity  
34 loss. Indeed, Earth is currently undergoing an extinction on par with previous events, with an  
35 estimated loss of species in the thousands. And the primary cause of species extinctions is habitat  
36 destruction that results from the expansion of human populations and activities (Smith, et al.,  
37 2006)(p.608). The pollution issue is thus not clear by taking the anthropocentric viewpoint. Actually,  
38 either the expansion of human populations and activities are serving mankind and consequently  
39 cannot be considered as pollutions or these expansions are considered as having harmful rebound  
40 effects and should be considered as pollutions. The main problem with the current anthropocentric  
41 viewpoint is to consider mankind as living outside the environment though the principles of  
42 ecosystem considered the interaction organism – physical environment, i.e. in particular human life –

---

<sup>132</sup> <http://www.developpement-durable.gouv.fr/-Natura-2000,2414-.html>

<sup>133</sup> <http://www.nord-pas-de-calais.developpement-durable.gouv.fr/IMG/pdf/transports.pdf>

1 physical environment, as the foundations for the definition of an ecosystem. We thus observe a  
 2 negation of the materiality of human existence even in the mere interest made by the current socio –  
 3 economic system to ecosystems and their degradation. However, as shown in **Figure 57**, in which are  
 4 presented the basic features of the organism – physical environment interactions allowing the  
 5 organism to exits (growth, fecundity, survival), there is a upper limit to the presence of non –  
 6 essential element and a path dependency for essential elements, i.e. the observation of lower and  
 7 upper limits to the conditions of existence. What consequences can be taken from these different  
 8 observations on the circulation space?

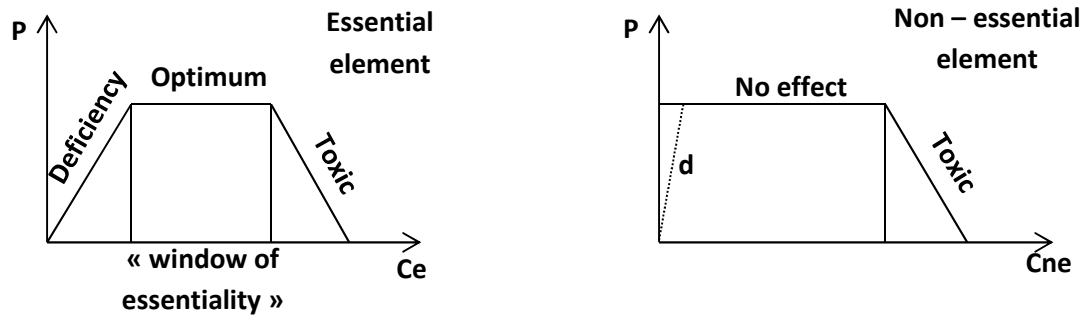

9

10 **Figure 57 : Relationships between performance (P) (growth, fecundity, survival) and concentrations**  
 11 **of an essential (Ce) or nonessential (Cne) element of the diet of animals. Possible deficiency effects**  
 12 **at ultra-trace levels (d) of an apparently nonessential element may be discovered as the**  
 13 **sensitivities of analytical techniques are improved. (Walker, et al., 2006)(p.6)**

14 The characteristics of ecosystems and the related issue of vulnerability are thus linked to the  
 15 following points:

- 16     ▪ An ecosystem is always local both in terms of space and time framework.
- 17     ▪ Ecosystems are linked together by natural processes such as global cycles.
- 18     ▪ The material network should consequently be transformed into an ecosystem network not  
 19 described by a general indicator such as tons applicable to all the physical space but  
 20 described by a set of local indicators appropriate to the studied ecosystems
- 21     ▪ The notion of pollution is normative, concern mainly human activities and consequently is  
 22 anthropocentric with all the associated shortcomings.
- 23     ▪ The conditions of existence for organisms, including human life, operate within a framework  
 24 having lower and upper limits. In other term, the conditions for existence of organisms are  
 25 forming a path.

26 The environmental sustainability is thus linked to the ability of framing the properties of circulation  
 27 spaces understood as the relationships between human activities and ecosystems. Sustainability also  
 28 supposes the possibility to define paths to human activities to stay in the path of not too harmful  
 29 impacts made to ecosystems. This supposes to totally abandon the idea that natural resources are  
 30 generic, i.e. not differentiated in structure, shape, space and time. As we will see in the next section,  
 31 specificity is also a characteristic of social sustainability.

32

## 2.2 Specificity as a key characteristic of social system

### 2.2.1 Time as a specific resource

The particularity of the time factor is to be irreversible and consequently the time needs to be organized. Each organization reveals the specificity of the representation of the value of time and associated speed demand. Let us start with **Figure 58** which corresponds to the organization of time in the current socio-economic system. The time spent in the industrial world (production) by an individual to gain money and the time spent in the market world (consumption) to spend it are made at the expense of other times which are of core importance for individuals: sphere of gift, sphere of self – organization of the goods purchased, self-produced or obtained through other kind of exchanges, sphere of non – material relationships. This separation corresponds to our criticism of the notion of productive activities in the SNA (industrial world) further extended through the Keynesian economics to the market world by making consumption the legitimate other side of production (supply and demand). This apology of a particular kind of work linked to money accumulation has been traced back by Max Weber to the notion of predestination in Protestant ethics in which commercial success becomes the sign of divine election (Weber, 1964)(p.215). This ethos of work is still working today as explained by (Russel, 2001)(p.43-52) and the evolution of the numbers of working hours, from 1440 hours per year in 14<sup>th</sup> century for a British peasant to 3105 hours per year in 1840 for a British worker (Basso, 2005)(p.116) illustrates the new passion of mankind for the industrial world. The 1936 apparition of annual leaves in France and the social advantages are just a small reduction of the extent of the industrial world made in favor to the market world as workers are expected to spend their moneys in these periods. We thus observed a circular justification between the industrial and market worlds, the condemnation of saving activities, the diminution of time available for other activities which are thus also condemned from a capability perspective.

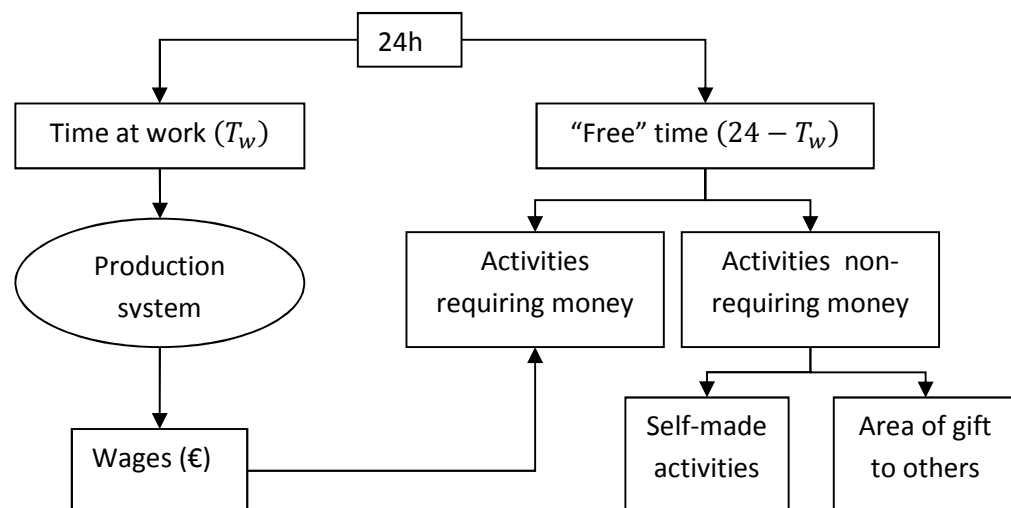

25

26 **Figure 58 : the division of individual time between money budget creation and other times**

27 The ethos of work is nevertheless limited within a 24h framework as the human body needs to  
28 recover daily from his activities. There consequently exists a biological time which makes the  
29 organization of all activities in time a local framework. Even if the 24 hours barrier can be exceeded  
30 for a short period of time, it is made at the expense of the physical and psychological integrity of the

1 individual. One can understand here the importance of machineries for production system as it  
 2 transforms a local conception of time (24h time slot) in a generic conception of time (continuous  
 3 production).

4 The distinction local/global can also be applied to the concept of speed. Indeed, following Ivan  
 5 Illich<sup>134</sup>, we can define speed as the ratio between the distance driven and all the time needed to  
 6 realize this transportation. The main idea is to take not only into account the time realized during the  
 7 transportation process but also the time needed to get the means of transportation. Let us consider  
 8 an origin A and a destination B, the distance on the transportation network is D and the speed of the  
 9 vehicle is V. Consequently the time taken to go from A to B is:

$$T = \frac{D}{V}$$

10 But the speed V is available only because the cost associated to the vehicle has been paid. Now, the  
 11 money to pay has to be gained by working. Therefore, there is a direct relationship between the  
 12 amount of wages and the total time dedicated to the transportation to go from A to B. Let us  
 13 consider  $D_{max}$  the maximum distance that can be driven during the lifetime of the vehicle, W the  
 14 wage per hour,  $P_{veh}$  the price of a vehicle, and P the price of running a vehicle on 1 km we thus have:

$$\text{Time to obtain vehicle (in hour): } T_{veh} = \frac{P_{veh}}{W}$$

$$\text{Time allocated to A to B traject (in hour) : } T_{veh}^{AB} = T_{veh} \times \frac{D}{D_{max}}$$

$$\text{Time for paying the running vehicle price: } T_{run}^{AB} = \frac{P}{W} \times D$$

$$\text{Total time: } T_{tot} = T + T_{veh}^{AB} + T_{run}^{AB} = D \times \left( \frac{1}{W} \times \left( \frac{P_{veh}}{D_{max}} + P \right) + \frac{1}{V} \right)$$

$$\text{Generalized speed: } V_{tot} = \frac{D}{T_{tot}} = \frac{W \times V}{V \times \left( \frac{P_{veh}}{D_{max}} + P \right) + W}$$

$$\text{ratio: } \frac{V_{tot}}{V} = \frac{W}{V \times \left( \frac{P_{veh}}{D_{max}} + P \right) + W}$$

15 Based on this formula, a mechanical speed of 100 km/h will turn to only 13.8 km/h with a salary  
 16 equal to the SMIC<sup>135</sup> (7.23 €/h), a running vehicle cost of 0.05 €/km, a purchase price of vehicle of  
 17 12000 € and a maximum distance driven of 30000 km. In other terms, the gain made by  
 18 transportation technologies is better understood as a reorganization of the relationships of society  
 19 with time rather than the access to high speed domain. Indeed, 18 km/h is only four to five times the  
 20 walking human speed and is in the range of bicycle speed. Therefore, the transportation system is  
 21 characterized by the following evolution at the individual level:

<sup>134</sup> <http://www.nord-nature.org/publications/bulletin/102/102b1.htm>

<sup>135</sup> <http://www.smic-horaire.fr/>

- 1 1. Initially, there is no vehicle able to reach high mechanical speed. To cover 100 km, only
- 2 walking speed (4 km/h) or horse gait (14 km/h) are available so that covering 100 km will
- 3 take between 7 and 25 hours. The traveler must engage himself in the travel.
- 4 2. A mechanical speed of 100 km/h allows the covering of the 100 km in one hour. The traveler
- 5 does not have to engage himself in the travel. Nevertheless, this non – engagement is
- 6 obtained through a three steps process:
- 7     ▪ Saving of money earned by work to buy the vehicle. During this period, the situation
- 8     of the traveler is not different from the initial one as only walking speed domain is
- 9     available. With the figures quoted before, this step takes 1666 hours<sup>136</sup>.
- 10    ▪ Saving of money to purchase the fuel and other goods or services needed during the
- 11    use phase. For 100 km, this step takes around 41 minutes.
- 12    ▪ Accomplishment of the travel which takes one hour.

13 The traveler thus first needs to lose time to in a second time gain time. 1666 hours corresponds to 66  
 14 travels of 100 km at walking speed. Similarly, 41 minutes corresponds to 2.7 km at walking speed.  
 15 The global gain in time will thus be effective if the lifetime of a vehicle is superior to  $66*(100+2.7) =$   
 16 6780 km. But the local gain in time is undisputable. Once again, we see the importance of local  
 17 patterns in the formation of social reality.

18 The previous scheme distinguishes the system speed and the local speed which is very important to  
 19 understand the organization changes induced by the transportation system. As shown in **Figure 59**, a  
 20 same speed of 12.5 km/h can reveal a variety of distribution. The access to high speed domain can  
 21 thus be seen as a concentration of time. The effect of speed is thus double. First, speed acts for a  
 22 concentration of energy which already causes environmental issues. Secondly, the speed  
 23 concentrates time and thus creates new opportunities of use for the saved time. A rebound effect  
 24 can thus occur as the saved time is invested into activities potentially harmful to the environment.  
 25 Time is thus a specific resource dependent on organization choices made by the society.

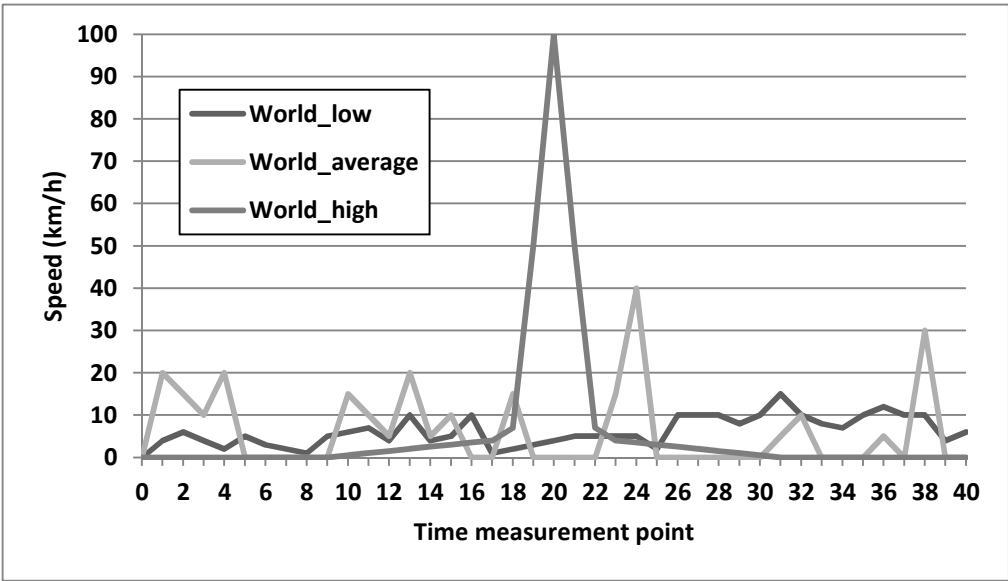

26  
 27 **Figure 59 : Difference between local and global speed represented as a timely distribution.**

<sup>136</sup> 12000/7.23=1666

### 2.2.2 Knowledge as a specific resource

As discussed in part I, the current socio – economic system is often represented as a system putting the individual at the center of everything. The market separation and the concept of utility are the main characteristics of individuality within the present system. According to (Brodhag, et al., 2004), this individuality constitutes the principal force of the neoclassical theory because it brings a rational foundation to public choice. The fact that the individual is the best judge of his preferences, supposedly ordinate, and consequently that public choice can only legitimately be based on a representation of individual preferences are thus usually thought as resulting from the standard economic theory. However, we already demonstrated in part I that the standard economy was characterized by the negation of social interactions between individuals so that the notion of public choice did not even make sense. Besides, as stated by (Crevoisier, 2010), the fundamental concept is not the actor but the relation so that actors are not autonomous, sufficient and acting with a rationality independent from the context but are institutionalized. Therefore, each actor is dependent on logics which shapes and exceeds his competence. At the same time, each actor influences these logics. This process is what has been called the modern reflexivity by (Giddens, 1994). One of the principal aspects is the circulatory of knowledge which introduces uncertainty as a core process of knowledge formation (Giddens, 1994)(p.47).

Going further, Anthony Giddens formulates modernity as related to the issue of spatio-temporal detachment. This detachment takes the form of the absence of face-to-face relationships which appears through the formation of symbols such as money and expert systems (Giddens, 1994)(p.30). Expert systems are specific knowledge may it be technical (cars, machineries in general) or professional (medicine, architect, lawyer) knowledge. Though the uses of these systems are daily made, the consultations of experts are only sporadic and irregular. Therefore, following (Giddens, 2004, p.94), the continuation of use in daily life of expert systems supposes the maintenance of trust maintained through a faith of the uninitiated in the functions of a specialty. At the opposite, trust in persons implies face – to – face relationships in which the integrity of the person is researched. Modernity is thus characterized by relocalization processes in which relationships through abstract systems are transformed into face – to – face relationships thus creating access points where uninitiated people, collectivities, and abstract system representatives can build or deconstruct their trust. This process of detachment in trust is not only a result of an increase in the complexity of objects but also the pure products of the results of the economic principles of the current socio – economic system. Actually, if price rules everything that needs to be said on products, they constitute a foundation stone of the trust in abstract system. Therefore, the individual can engage completely in the production process of division of work, becoming himself an expert in one field at the expense of a dilution of his knowledge in other fields. As rightly underlined by (Giddens, 1994)(p.95), one needs to have follow sciences for a certain amount of time to be initiated to the questioning behind each scientific statement. The rest of the population lives in a credo in regards to the primary principles learnt at school. Society is thus made of persons expert in a little field of knowledge and dependent on others for the rest. Alternately, the individual is thus either an expert in production, an uninitiated consumer, a citizen, a parent, and so on.

The previous frameworks lead us to wonder what the representation of the world at the individual level is. Is it specific or generic? Usually, reality is defined as the state of things as they actually exist, rather than as they may appear or might be imagined. Therefore, this definition supposes a generic

1 definition of reality which will be the same for all individuals. Nevertheless, this statement makes an  
2 opposition between the existence and the non-existence which are usually debated in philosophy  
3 and metaphysics studies. The purpose here is not to establish a history of the concepts related to  
4 reality which would constitute a deep crossing through the history of the different cultures of  
5 mankind. The idea is mainly to understand how reality appears in the same time independent and  
6 dependent from the mind, i.e. as a dialectic approach of specification and generalization. This  
7 notably means that the reality concerned here partly relates to what is called constructivism reality  
8 as it appeared at the beginning of the 20<sup>th</sup> century in the field of fundamental sciences. Einstein  
9 himself wrote about these basic features of our understanding of the world in his book entitled  
10 *Conceptions scientifiques*:

11 *“From the many sensitive experiences, we take, mentally and arbitrarily, some complexes of sensitive*  
12 *impressions that often repeat themselves and we associate a concept to them - the concept of*  
13 *material object. From a logical viewpoint, this concept is not identical to the total of sensitive*  
14 *impressions to which it is related, it is an arbitrary creation of human mind. Furthermore, this concept*  
15 *holds its meaning and justification exclusively on the totality of sensitive relations to which we link it.*  
16 *The second step is to attribute to this concept of material object a signification that is to a high state*  
17 *independent from the sensitive impressions that originally gave birth to it. That is what we mean by*  
18 *giving « a real existence » to the material object. The justification of such assertion lies exclusively on*  
19 *the fact that using such concepts and mental relations, we are able to get our bearings through the*  
20 *labyrinth of sensitive impressions. These notion and relationships, though they are arbitrary assertion*  
21 *of our mind, appear to us as stronger and more unalterable than the individual sensitive experience,*  
22 *the characters of which never fully guarantee that the results is other than illusion or hallucination.*  
23 *Furthermore, these concepts and relations, in particular the fact to admit real objects and, generally*  
24 *speaking, the existence of a “real world”, have justifications only as long as they are related to the*  
25 *sensitive impressions between which they create mental connections”.* (Einstein, 1990)(p.22 -23)

26 In other words, our sensitive experiences lie at the core of our construction of the world and help us  
27 define our actions. For example, the notion of color has only a meaning for those with the ability to  
28 see. The blinds do not seize the notion of color directly but can understand it through the  
29 communication with those who can see<sup>137</sup>. The blinds therefore share the same construction of  
30 reality than the seeing people. However, this knowledge about colors is not a direct one but an  
31 indirect one. The same can be said about the notion of colors understood through light properties.  
32 This knowledge is not direct in the meaning it directly comes from our senses but through  
33 experimentations. We could thus distinguish different types of knowledge, those coming directly  
34 from our senses, those indirectly found through experimentation device and those communicated by  
35 others. Looking further into the field of biology and medicine, sensitivity is defined as the capacity to  
36 identify modification in the environment or inside the body (Menche, 2006)(p.210). But this capacity  
37 is not enough to take actions as the modification must be recorded for a certain amount of time to  
38 initiate or sustain any kind of action. For example, every second, the human brain records an  
39 enormous amount of sensory stimuli. This information is conserved for a few milliseconds in the  
40 sensory memory without us being aware of it. During this second is also made the verification of the  
41 interest of these data while important information is moved on the short term memory. This short  
42 term memory lasts a little longer, from a few minutes to around three hours. Only some key

---

<sup>137</sup> <http://www.lignedevue.org/index.htm>

1 information will be transferred from the short term memory to the long term memory and stored for  
2 life (Menche, 2006)(p.206-207). The biological framework thus demonstrates the dependence on  
3 human life on sensitive framework and related information networks made possibly by the existence  
4 of a memory, i.e. the storage of the information. The recording time will thus depend on the critical  
5 aspect of the information which depends on the context. Memory itself is thus specific and  
6 dependent on the individual.

7 The construction of reality is dependent on such framework in which experiences at the individual  
8 level is fundamental. Going back to Einstein viewpoint on scientific concept, we found that *“the goal  
9 of science is from one side the understanding and the connecting of sensitive experiences in all their  
10 varieties and from another side the filling of this goal by using a minimum of primary concepts and  
11 relations”* (Einstein, 1990)(p.26). Science is thus characterized by this detachment often mistaken by  
12 a statement of standardization possibility. But even the most abstract knowledge only makes sense  
13 once contextualized. Besides, the more complex the system is, the more its particularities become  
14 important. Such is notably the cases of ecosystems and social systems associated through the  
15 abstract concept of networks. The scientific methodology is thus a method made of several steps  
16 guided by the principle of consistency which, as shown in **Figure 60**, allows a circular process. First,  
17 the daily experiences and the cumulated knowledge provided by others help scientists frame  
18 questions or objectives. Secondly, scientists collect data regarding the special question or objective  
19 they aim to address. Then, when sufficient data are collected, scientists start to formulate hypothesis  
20 which are a proposition advanced as the possible explanation or the possible prediction of an  
21 observation or a phenomenon. Finally, to test the hypothesis, scientists realize an experience and if  
22 this one is consistent with the hypothesis, they make other experiences to see if the results are  
23 reproducible. By doing so, scientists particularly want to verify the validity of the hypothesis in  
24 different experimental situations. After numerous experiences, a model can be formulated as the  
25 expression of a constant relation between phenomena occurring under the same conditions. The  
26 concise formulation of this constant relation is called natural law or scientific law. The term “natural”  
27 is here misleading as it supposes a generalized process existing from all times and everywhere.  
28 Actually, the law summarizes the existing relationships between different parameters but does not  
29 bring explanation to it. It translates better a potential of which kind of phenomena/actions could be  
30 observed in particular context. Once a law expressed, scientists try to conceive a theory, i.e. a  
31 unifying concept providing explanations to the observed law. Finally, the theory itself is tested  
32 through new experiences providing further validation or rejection of the theory. Consequently,  
33 science is essentially a self – correcting activity, dependent on the continuous process of debate.  
34 Science is thus a learning process following the principle of consistency as a guiding principle.

35 Nevertheless, the scientific framework takes the form of a mathematical model on many aspects.  
36 Indeed, the objectives or questions must have the form of a mathematical assertion, i.e. a set of  
37 words with a value of truth (true or false) and the scientific reality is constructed stone by stone from  
38 a first situation considered as true (axiom). Mathematics is thus characterized by the research of  
39 consistent systems. Biology, physics, medicine, chemistry, ecology and other experimental sciences  
40 follow the same logical but add an important axiom: there is no test of concepts other than their  
41 empirical truth. Consequently, uncertainty in scientific methodology is inherent to the way  
42 observations are made, recorded and analyzed, i.e. the management of scientific information also  
43 called statistics. *“In physics and chemistry, all experience, as every observation in astronomy, is  
44 translated by the determination of a number [...]. This number is determined with an accuracy varying*



1 with the nature of observation and experiences. Let us take the case in which three figures can be  
 2 considered as exact. The verification of a theoretical hypothesis [...] is taking the following form:  
 3 calculation tells us that the observed number should be 356.17. If the experience provides 356, 357 or  
 4 355 as numbers, then these observations are perceived as confirming the theory. In other cases, for  
 5 example if the observations gives 340 or 367, the experience should be made several times, and if we  
 6 obtain several results dispersed between 340 and 370, the average of which is close to 356.17, then  
 7 these results will also be perceived as confirming the theory" (Borel, 2009)(p.30-31). The core  
 8 problem of proof is thus related to issues such as the independence of probabilities often impossible  
 9 to determine, and the reproduction of experiences often impossible to make. Indeed, the possibility  
 10 to reproduce experiences indefinitely does not exist so that a statistical proof is not feasible.  
 11 Depending on the time to make one experience, the reproduction is dependent on the internal scale  
 12 of the studied phenomenon. Therefore, the scientific framework implies from the actors a degree of  
 13 rational belief (Bessis, 2004) which gives them trust in their findings.

14

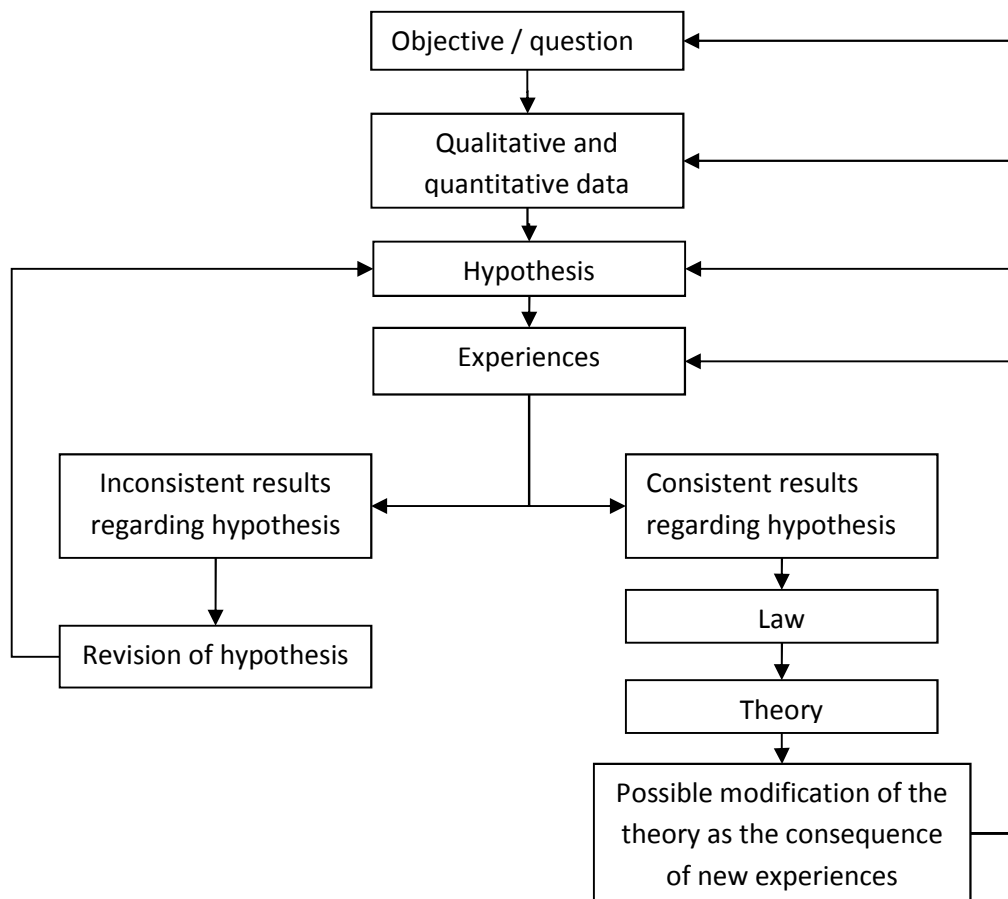

15

16 **Figure 60 : the scientific methodology (McQuarrie, et al., 1992)**

17

18

19

1 The discussion presented above on the concept of reality of scientific methodology is giving us some  
2 general guidelines for our discussion around the issue of knowledge:

- 3       ▪ A reality based on individual experiences, sensitivity and information management capacity  
4       (memory, relationship)
- 5       ▪ A particular methodology to link these experiences named scientific methodology which is  
6       driven by the principle of consistency and the perpetual search of an extension of concept  
7       validity
- 8       ▪ An epistemological issue in regards to the notion of proof dependent on probabilistic and  
9       experience frameworks not reachable in the physical space (infinity, exact reproduction, etc.)  
10      compensated by a common rational belief from scientific actors.

11 Scientific methodology is particular because of the supposedly objectivity of its findings and through  
12 the fact that its outcome can supposedly be remade by everyone. However, in daily life, no one  
13 remakes the demonstration of Newton's laws. There is thus a difference between the products of  
14 science and the way science is internalized by society. Besides, science is also a social activity created  
15 by individuals who form a community with their own representation and belief. As humans are at the  
16 center of any activity of knowledge production, reality is always related to a social process which  
17 defines the patterns of environmental sustainability. Therefore, if reality appears mainly as a  
18 construction at the individual level, knowledge is also institutionalized creating knowledge at the  
19 societal level. Besides, the knowledge at the societal level is not the sum of all the knowledge  
20 acquired and created at the individual level but the result of a particular construction based on social  
21 interactions and institutionalization of reality representation. Scientific discoveries once  
22 institutionalized are thus reciprocally influencing the representation of reality made at the individual  
23 level. Similarly, the institutionalization of the individual and social experiences which dictates what  
24 matters influences the perception of reality at the individual level. There is thus feedback loop  
25 processes between the reality created at the individual level and the reality institutionalized at the  
26 social level. The gap between these two realities can lead to serious disorder at the individual level  
27 because the individual is ordered to make a choice between an institutionalized reality and the  
28 reality resulting from his daily experiences. We are thus far from the scientific methodology which  
29 sees any gap between realities as a proof of the incompleteness of scientific knowledge, i.e. the  
30 conventions behind the present scientific theories. Concerning the standard economic theory and  
31 the associated predominance of the money network, this gap is expressed through the cynicism in  
32 regards to non – calculated acts. As demonstrated by (Godbout, 2000)(p. 46-47), the standard  
33 economic theory reduces the concept of gift to a utilitarian calculation and considers any belief in the  
34 existence of gift between individuals as an irrational belief in chimeras. Family, friends, trust do not  
35 exist in the context of the market sphere as institutionalized by the standard economic theory.  
36 Therefore, referring to **Figure 17** with market, reciprocity and redistribution spheres, the standard  
37 economic theory considers the reciprocity sphere as not existing and the redistribution sphere as  
38 non-efficient and threatening for individual liberty.

39 However, trust is at the center of any construction of reality and the project of pure determinism  
40 should be abandoned in favor of an autonomous and heteronomous approach of actors. Following  
41 (Boltanski, et al., 1991)(p.200 – 262), different worlds (industrial, market, inspired, domestic, opinion,  
42 civic), each of them being ruled by only one order, i.e. a representation or convention of mankind  
43 and its behaviors both descriptively and normatively, are used by actors to justify their actions. The

1 main difficulty for the study of autonomy and heteronomy is thus to go beyond one order and to  
2 apprehend a plurality of logics and orders and to consider that the resulting meta – network (the  
3 individual reality) cannot be reduced to an order with a unified principle (Godard, 2004). Indeed,  
4 autonomy is the fact of ruling one self, to be able to take action without being under the supervision  
5 of another person (Caumières, 2007)(p.77). Autonomy is not autarky which will suppose the total  
6 independency of actors. On the opposite, autonomy should be considered as not dissociable from  
7 heteronomy, i.e. the external influence such as institutionalized conventions and representations.  
8 Risks are thus double. Firstly, a belief in perfect individuality prevents any questioning of individuals  
9 and thus leads to a dead-end in case of mistake. Secondly, a radical heteronomy imposes fixed values  
10 not related to any particular context so that any evolution becomes impossible (Ansart-Dourlen,  
11 2005). The success of science could be thus explained by the absence of radical heteronomy as a way  
12 out of the current conventions is always possible. On the opposite, as demonstrated in chapter I, the  
13 theories of value constitutes a radical heteronomy. Therefore, as said before, the problem of homo  
14 oeconomicus is not its existence but the conditions of its existence, i.e. the determination of the  
15 circumstances in which the attributes of homo oeconomicus are an efficient representation of  
16 human actions.

17 This leads us to reconsider the notion of liberty, autonomy and vulnerability at the light of the  
18 concept of capabilities. The notion of capabilities has been introduced by (Sen, 1987) and  
19 (Nussbaum, 2012), and corresponds to the autonomy for individuals to find ways to answer their  
20 own goals. The change in regards to the usual understanding of individual liberty is important.  
21 Indeed, liberty is usually understood as positive, i.e. what a person is able to accomplish, or negative,  
22 i.e. through the hindrances of others made on my actions, but the situations faced by individuals  
23 always cover these two aspects (Sen, 2003)(p.47-51). Poverty, i.e. the relative absence of purchasing  
24 power in the monetary network, is an example of negative liberty. The individuals are thus prone to  
25 certain types of vulnerabilities. According to (Goldstein, 2011)(p.149), the capability approach of  
26 Nussbaum leads to distinguish good and bad vulnerabilities. The bad vulnerabilities concern the  
27 dangers existing for the development and blossoming of our good capacities. These dangers must  
28 thus be reduced as much as possible, notably through policy actions. The good vulnerability concerns  
29 the responsiveness to others which allows flexible and open actions and prevents from the illusion of  
30 self – sufficiency. Social sustainability is thus primarily a theory of action and is dependent on a  
31 better social integration and a better access to the means necessary to the capability of everyone  
32 (Buclet, 2011)(p.140). However, this system of capabilities respectful of borders settled by the  
33 specificity of local ecosystems and of those settled by the specific interactions between actors of the  
34 social system implies to consider the issue of sustainability as an issue of auto-limitation. Following  
35 Castoriadis, democracy is the regime of auto-limitation in opposition to an atomized society in which  
36 each individual only seeks his own interests. Therefore, intentions remain of core importance to  
37 frame this auto-limitation and maintain dialectic between specific liberties and specific constrains.

38 In conclusion, may it be the study of the role of ecosystems or of the role of social systems; a specific  
39 approach should always be preferred in order to frame the conditions of validity of the analysis.  
40 Sustainability should be understood as the management of a complexity characterized by a diversity  
41 of different logics interacting together. As will be demonstrated in the next section, an efficient scale  
42 of analysis to address the specific approach of sustainability is the territorial level.

## 1 **3 Constructing a sustainable framework for circular and functional** 2 **economies strategies**

### 3 **3.1 A territorial approach**

#### 4 **3.1.1 Territory as a place to address the issues of specificity** 5

6 The attention in the set of networks framing the different worlds should be paid to nodes rather than  
7 flows. Indeed, the dislocation between networks leads to a domination of flows over places so that  
8 the individuals and places appear partitioned. To inverse the tendency, it is important to take a  
9 territorial approach. By territory, we mean the planning of a space X by a social group to fulfill its vital  
10 functions and consequently creating a territory Y with its own functional unit (Le Berre, 1992). The  
11 outlines of a territory are thus vague and will depend on the network considered and the  
12 representations of the social group. Following the works of (Tizon, 1996)(p.21), the territory also  
13 appears as a living environment, an environment of actions and thoughts in and by which an  
14 individual or a group recognizes himself, gives a meaning to his surroundings, thus engaging himself  
15 in a process of identification.

16 Once again, the complexity is constructed within a local framework. Nevertheless, once the  
17 construction stable, it becomes possible to strengthen and extend the relationships with actors not  
18 present on the territory. The proximity approach is thus fundamental in the study of a territory and  
19 of the ways the territorial actors act within and outside the borders of their territory. Indeed,  
20 following (Rallet, et al., 2004), actors localized in a place simultaneously develop interactions at the  
21 local and global scale. But as demonstrated by (Gilly, et al., 2005), institutionalized standards occur  
22 from global to local while new standards emerge locally before spreading to the global level. The  
23 territory is thus always the main framework inside which influence of global level are validated or  
24 rejected and where innovation takes place. For example, the Fordist productivity model based on  
25 cost reduction cannot be accepted anymore at the territorial level because the difference in wages  
26 and material cost with developed and emerging countries would imply free fabrication costs.  
27 Therefore, following (Pecqueur, 2005), the production models evolve towards a quality model based  
28 on a differential advantage rather than a comparative advantage. Indeed, competition can only occur  
29 between similar products so that if a product is perceived as unique, there is no competition to face  
30 to and consequently no fabrication costs issues to cope with. As shown in **Chapter III 2.1**,  
31 environmental labeling is an example of the creation of a differential advantage for products.  
32 Similarly, the territory can become a part of the characteristics of products under the form of  
33 protected designation of origin and guaranteed quality label. Nevertheless, as discussed before, the  
34 access to goods ruled by the purchasing power within the monetary network can be considerably  
35 limited. In other terms, it is possible to observe the situation of a person living in a territory who  
36 cannot access the products produced in his territory.

37 The territory is thus fundamentally a complex system (Pecqueur, et al., 2010) (Moine, 2005). Within  
38 its internal and external relationships, the territory is thus defined by a succession of level of actions  
39 from the individual to collective entities such as households, firm, territory and global scales.  
40 Following the work of (Bouba-Olga, et al., 2006), the individual level of actions implies to reconsider  
41 the usual framework of spatial and non – spatial proximities with the typology presented in **Table 17**.  
42 In this typology, the socio – economic proximity is divided into resource proximity and coordination

1 proximity. Resources are of first importance because they, at the same time, enable and limit the  
 2 actions of individuals. The same ingredients can thus be constituted as resources if actively  
 3 mobilized, constrains if passively suffered, or stakes if struggles to their access are happening. These  
 4 resources can be directly material such as objects, energy sources or tools or indirectly material, i.e.  
 5 seemingly non – material, such as information, knowledge, rules or norms. Once transferred in the  
 6 particular context of a socio – economic relationship, the proximity of resources becomes related to  
 7 the coordination proximity which allows either by inter – personal proximity or mediation proximity  
 8 the resources proximity to be translated into an action.

9 **Table 17 : Proximity for territorial analysis (adapted from (Bouba-Olga, et al., 2006))**

Proximity		Description
Socio-economic	Resources	<b>Cognitive</b> Sharing similar or complementary values, conventions, habitus, etc., individuals are able to coordinate. This proximity can be linked to a spatial proximity (industrial district) or not (language, sectorial culture).
		<b>Material</b> Individuals are similar or complementary in regards to the resources they own (assets, incomes, diploma, social status, etc.)
	Coordination	<b>Inter-personal</b> Characterized by social networks, this coordination is based on the particular relationships between two individuals. Employment market and market acquisition can for example be based on such inter – personal coordination (professional networks)
		<b>Mediation</b> The mediation proximity is based on all the resources existing outside inter – personal relationships. We find here for example language, technical norms, but also Internet and ICTs. This means of coordination are thus shared among individuals
Spatial	Geographic	<b>Infrastructure</b> The question of accessibility to infrastructure is here important. Indeed, infrastructures conditions the speed of access, i.e. in our socio – economic system obsessed with speed, access itself to goods and means of action
		<b>Biological</b> There is biological area important for the notion of capabilities and linked to the individual health. The possibility to walk or have sportive activities is important. Similarly, the mobility of individuals is also linked to health issues (age, diseases, body conditions, etc.);
	<b>Ecosystemic</b> Finally, the social relationships are included within a broader network of physical and biological relationships. This network frames the types of actions available in a particular territory. For example, the actions available in Siberia are different than the one available on Mediterranean Coast. These availabilities are not absolute as resources (energy, material) can always be imported from other territories to overcome the limits. But to overcome these limits lead sooner or later to irreversible environmental impacts.	

10

11 The proximity economy has been established as an answer to the absence of space in the standard  
 12 economy. Indeed, the Walrasian market aims at the empowerment of the economy in regards to  
 13 policy and the working of society resulting in a total detachment to societal evolution and local  
 14 particularities. On the opposite, the proximity economy demonstrates the porosity of the market  
 15 world to the local world. It also demonstrates that global linkages not based on spatial interactions

1 are dependent historically on a local framework. As stated by (Pecqueur, 2006), territorial  
2 organizations are characterized by four main characteristics. The first one is the porosity stated  
3 before which can be observed daily in economic exchanges. The second one is the dependency on  
4 the collective and cognitive capital, produced by History, cultural life, and the daily life of a territory.  
5 The third one concerns the reciprocity which determines a relation between the exchanging actors  
6 having a lifetime much longer than the simple commercial transaction. Fidelity, gratitude and identity  
7 are characteristics of reciprocity and enable the actor to maintain his identity in more complex sets  
8 such as job community, household, social community and the territory. Finally, the territory is also  
9 the cradle of innovations because innovation is conditioned by a social context which is always fixed  
10 firmly in space. The local dimension is nevertheless dependent on the lifecycle of the innovation.  
11 Initially strong, the local dimension diminishes in importance as the innovation diffuses globally  
12 (Grosseti, et al., 2003)(p.86 – 89).

13 At the opposite of the Walrasian approach, the “local” is thus what matters. Without the “local”, the  
14 “global” could not renovate itself, experiencing no innovation, could not ensure enough trust for  
15 commercial exchanges, experiencing increase of transaction costs because of the absence of local  
16 structure, and would have to rebuild commercial exchange every moment, because of the absence of  
17 trust. There is thus an asymmetry in the relationship between the “global” and the “local”.  
18 Nevertheless, as we demonstrated in part I, the dependency of the monetary network legitimacy to  
19 the extension of its power and the perpetual search for outlets in the current socio – economic  
20 system provides a total different pattern in which the “local” should adapt to the “global”.  
21 Consequently, the current socio – economic system is characterized by an effacement of the “local”  
22 for the “global”. This creates a privileged framework for unsustainability as the specific aspects of  
23 ecosystems and capabilities are absent. On the opposite, territories appear as the natural framework  
24 for actions in favor of social sustainability. Nevertheless, to take into account environmental aspects  
25 supposes to add ecosystems to the usual framework of territory so that the core framework for  
26 sustainability is the local system “ecosystem – territory”. This pattern has important consequences  
27 on the dematerializations strategies of circular and functional economy studied in Chapter IV.

28 Indeed recycling and remanufacturing industries need to be located in ecosystems able to support  
29 these activities. Therefore, the scale of this industry remains important once localized. But because  
30 of the recycling system dependency on waste generation by consumers and producers, any  
31 diminution of the level of waste will imply the need of driving waste from several territories. They  
32 will thus be a kind of “waste proximity” between territories concretely maintained by the structure  
33 of reverse logistics. The link with the local system ecosystem – territory is clearer for functional  
34 economy. Indeed, a service relation is constitutive of a proximity relation because of the face – to –  
35 face relationships which are necessary between stakeholders to proceed to the adjustments linked to  
36 the service production such as knowledge exchange (Gilly, et al., 2005). Therefore, being co –  
37 produced and adjusted permanently, the production and consumption are territorialized.

38 Nevertheless, such local process may turn to a global one once the service initially produced in the  
39 territory is standardized and erected into norms. Therefore, the local pattern of the service relation is  
40 dependent on the maintenance of an asymmetry in favor of the service user. Sustainability thus  
41 supposes the recapture of the territory as a place of actions and the recovery of the dignity of  
42 individuals in terms of capabilities and responsibility.

1 As shown in **Figure 61**, there is thus an articulation to build from the individual level to the global  
 2 level in which local patterns constitute the main frameworks but where some regulation processes  
 3 such as World web of local ecosystems are analyzed.

4

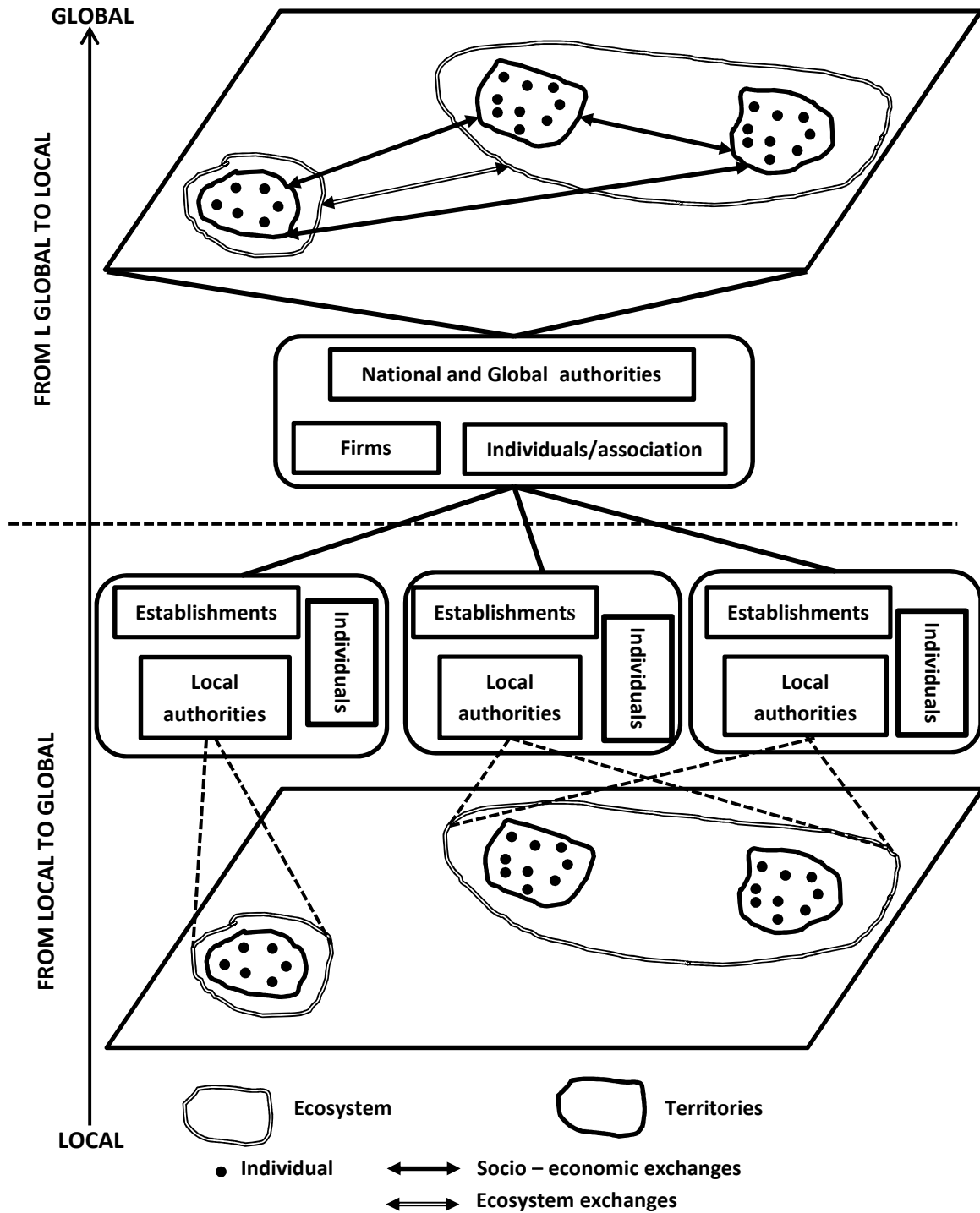

5

6 **Figure 61 : Territories and ecosystems, from local to global.**

7

### 3.1.2 Territory as a multi-resource dynamic network

As demonstrated by (Duez, 2011), the territory holds a particular place in the construction of spatial theories. First, the rationality is questioned, moving away from the perfect rationality in which decision is self-centered and individual to include interactions with other actors and the environment. The territory is thus a kind of mediator between the individual and his experience as it provides knowledge and constrains to individuals through collective and proximity processes. Secondly, the inclusion of the territory in the spatial theories has slowly led to the inversion of the embedding relationship between economic and social actions. From a total submission of social life to the economy (perfect rationality, absence of space and time) in neoclassic theories, the economy leaves more and more space to the diversity of social interactions firstly by an extension of standard economic theory (New economic geography) and secondly by leaving space to non-market interactions (socio-economic geography). Indeed, the new economic geography though recognizing a dependency path to the space for economic interactions still conserves the optimality hypothesis of market coordination. Therefore, the territory only acts as a revelation of coordination made by economic agent and remains only a medium of usable resources (Duez, 2011). For the socio-economic geographic, the issue is different as social innovations happening outside the market are considered as important to coordinate actors and solve production problems (Industrial district, Localized production systems) (Duez, 2011). The territory should thus be analyzed through the specificity of its resources which as we saw previously in this chapter concern environment and knowledge.

One of the principle issues in regards to the environment concern the belief of neoclassic theories in the perfect substitution of natural capital and technical capital (Beaurain, 2008). However, the place of ecosystems in societies goes far beyond productive service of Nature as society itself is dependent in its definition from the experience of Nature. It thus becomes essential to analyze the diversity of values attributed to numerous uses of natural resources. As underlined by (Beaurain, 2008), there cannot be a common territorial project without an acknowledgement of the diversity of these values so that a simple monetary evaluation of environment is never enough. A common institution is thus necessary to confront values associated with environment and constructs a mechanism of specific resources able to solve the problem of environmental constrains integration in production processes by economic actors. Such has been for example the case in the formation of localized tourism systems in order to counteract the usually generic use of natural resources by tourism by a search of authenticity (François, 2008). The natural resources are thus parts of the heritage of the territory which take the two faces of specific resources. Indeed, the territory appears as a socio-cultural construct which maintains and renews itself across history through a dynamic process of collective knowledge accumulation. According to (François, 2006), resources do not exist by themselves and for example the biological world is not a resource until it is inserted in a construction of society such as process production. The latent specific resources thus constitute a potential which first needs to be revealed before being valorized by territorial actors.

In regards to sustainability, the specificity is mainly created through the grouping of actors characterized by a willingness to practice auto-limitation. Considering for example the Italian experience of *La città dell' altra economia*, the movement refuses objectives of growth and perpetual search of outlets and profits, the exploitation of individuals and violation of human rights and of the renewable capacity of natural ecosystems (Buclet, 2011). However, this movement is only an auto-



1 limitation if reference considered is the dominant economic convention. But actors taking part in the  
 2 movement do not see an auto-limitation in their participation. On the opposite, they consider this  
 3 movement as a fulfillment of objectives (solidarity, justice, improvement of capacities) not reachable  
 4 in the current dominant economic convention. Far from being a constrain, the participation in the  
 5 movement is thus lived as a liberation. However, the main difficulty for actors not sharing the  
 6 viewpoint of dominant economic theory and its aspatial and atemporal patterns is to find  
 7 themselves. This is where information and communication technologies play an important role by  
 8 allowing a virtual connection between individuals based on reciprocity and other linkages than the  
 9 monetary framework of contractualization.

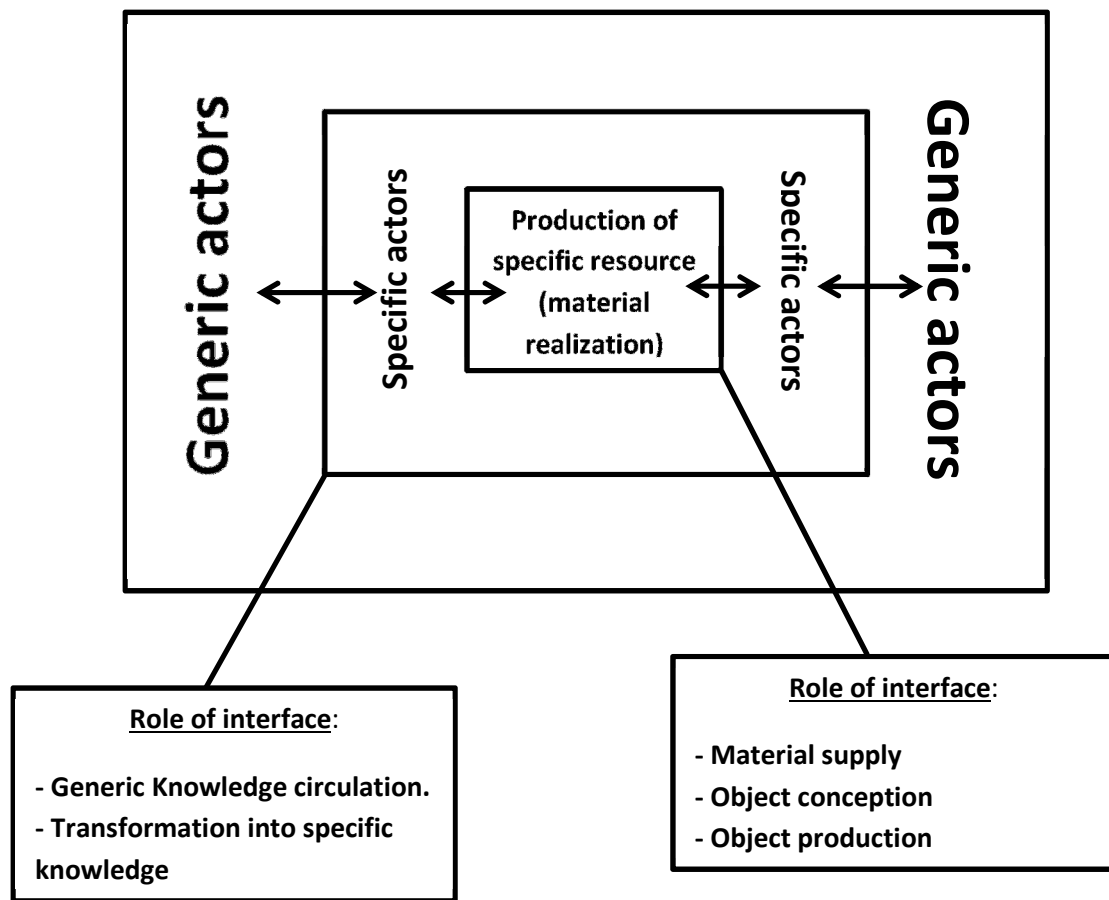

10

11 **Figure 62 : A model of territorial production based on generic-specific approach of knowledge**  
 12 **(adapted from (Buclet, 2013))**

13 As shown in **Figure 62**, the realization of the final object is localized at the territorial level. The  
 14 specific resources of the territory are thus used notably in what concerns the supply of materials and  
 15 the human capital present in the territory. However, the community of actors can extend to a global  
 16 level through a circulation of knowledge. Indeed, some part of knowledge is generic and can call for  
 17 competences and advice from all around the world. Nevertheless, the specific actors of the territory  
 18 will adapt this generic knowledge to the specificities of their territory. Symmetrically, the territorial  
 19 project once done provides feedback experiences for the global community. This kind of experience  
 20 have for example been applied by Muhamad Yunus through a joint-venture between Danone and  
 21 Grameen bank or the fablabs of the Usinette project (Buclet, 2011). One of the main interesting

1 characteristics of these projects is the size of production units usually small and not dependent on a  
2 scale economy perspective. The Muhamad Yunus factory is a little one with an opposite concept of  
3 the usual Danone factory able to supply the demand of 200 millions persons. The aim is to construct  
4 a factory close to consumer through an integration of the factory in the local system. Therefore,  
5 yoghurts are made with local milk and sugar and the customers are also local people. Besides, the  
6 success of this proximity system should not lead to an increase of the factory size but to a  
7 reproduction of the system (Buclet, 2011).

8 This kind of local circular system is efficient because the scale allows the suppression of lots of  
9 constrains imposed by great size factories for huge markets. Indeed, the main idea behind factories  
10 holding a high size is scale economy which supposes a “make to stock” logistics strategy. Therefore,  
11 there is the cost issue linked to stock management, demand prevision and distribution from  
12 concentrate area to far away diffused area. The principles of scale economy could work in a generic  
13 world but the generic aspects of our world are mainly virtual ones, potentials which once turned into  
14 action become specific. Therefore, as shown in **Figure 63**, a locally “make to order” logistics can turn  
15 more (or as) efficient than large scale factories notably y revealing the diversity of coordination  
16 mechanisms.

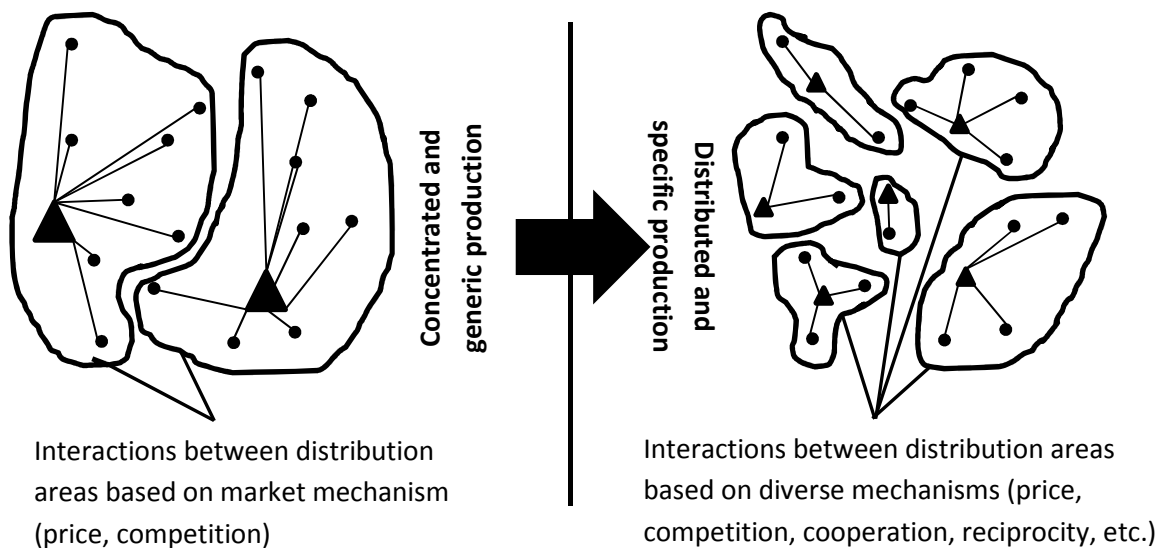

17

18 **Figure 63 : From concentration and generic production to distributed and specific production.**

19 In regards to the strategies of circular and functional economy, these production patterns become  
20 very important. Indeed, if the product production is more distributed geographically, it would be the  
21 same for associated waste. The problem of current transaction costs linked to the collecting and  
22 sorting of wastes is thus completely different in this new pattern and local actors receive more  
23 incentive to internalize in their circular production- consumption system the waste they produce.  
24 Similarly, functional economy shares a lot of common patterns with territorial based production-  
25 consumption organization. Indeed, the co-production characteristic of services suppose coordination  
26 between producers and consumers based on other mechanism than market ones. Reciprocity, trust,  
27 and cooperation for system adjustment become key components of the producer-consumer  
28 relationships in functional economy. Therefore, the problem of production is changed and  
29 considered from a totally different manner than in the standard economic theory. And the territory

1 holds a particular place as a vector of operational change by confronting actors with production and  
2 consumption issue in-situ (Landel, et al., 2011). From an economic viewpoint, this made the  
3 management of information and the construction of specific database a core issue for firm  
4 development. This new pattern is called economic intelligence and notably represents the capacity  
5 of firms to combine efficiently internal and external knowledge to solve unusual production problem.  
6 This notably means that firms are able to anticipate the production problem and to identify  
7 permanently the competences existing within the company or with potential partners and organize  
8 these competences (Colletis, 2007). Environmental problems of overconsumption of resources and  
9 overproduction of discharges and social problems posed by the loss of capabilities of individuals in  
10 the current economic system form the core project for a new production system. Sustainability is  
11 thus better addressed through a territorial approach though, as shown in **Figure 62**, a global  
12 community can be based on knowledge exchanges related to sustainability applications at the  
13 territorial level.

14 However, a major problem subsists which is related to the generic and abstract patterns of current  
15 nomenclatures. As a matter of fact, comparing different scales of actions to state that one scale is  
16 more efficient than the other, as it is made by the scale economy theory, is dependent on a linear  
17 understanding of system. On the contrary, through our previous study of territorial patterns, I  
18 demonstrated that small size of high size production units does not answer to the same logics and  
19 organization types. Therefore, the criterion of efficiency for one system does not make any sense as  
20 an absolute criterion. Respectively to their logics, small size production-consumption system appears  
21 inefficient to huge and concentrated system, and huge/concentrated system inefficient to small scale  
22 production-consumption system. The choice between the two systems must thus be based externally  
23 and reveals the society choice of individuals. The previous discussion nevertheless showed that a  
24 choice in favor of sustainability favors the small size-production system and the representation of  
25 interactions between actors (local/local, local/global), between actors and their local ecosystem and  
26 between ecosystems. These interactions are specific in their nature and I advocate that they should  
27 be used as the basis to frame nomenclature of goods to ensure sustainability. This is what I call a  
28 property based nomenclature as presented in the next section.

## 29 **3.2 A property based nomenclature for sustainability**

### 30 **3.2.1 Discussion around the concept of properties**

31  
32 Goods are characterized by a set of properties, but these properties can only be identified through  
33 the means of experiences. Consequently, depending on the accuracy and the number of led  
34 experiences, the definition and the properties of goods can change.

35 Let be P the total set of properties for a material. Based on the previous sections, it should be clear  
36 now that the extent of this set highly depends on the knowledge gained through experiences in  
37 different environmental conditions. The difficulty is that the description of environmental conditions  
38 also evolves based on new knowledge. Properties lie at the core of these environments – material  
39 relationships. Definition refers to a particular environment – material relationship taken as a  
40 reference. For example, salt might have been described in first times based on the white aspect salt  
41 crystals have in air. However, salt crystals put into water dissolves immediately and this experience  
42 result will be qualified as a property. On this aspect, many other substances may have the same

1 property than salt thus constituting a qualitative group. The revolution of quantitative sciences is to  
2 offer a refinement of these qualitative groups by characterizing for example the particular solubility  
3 of salt into water, i.e. the maximum mass of salt dissolvable in water. At this moment, salt can be  
4 redefined based on this solubility constant: "salt is any substance that can have such mass  
5 dissolvable in water". Therefore, definition is always a property which has been given arbitrarily a  
6 special status.

7 The material description is thus made of two parts: a stable and fixed one, definition and a changing  
8 one, properties. This notion refers to the total set of experiences made by a particular individual.  
9 With the ability of communication, the individual experiences can nevertheless be combined to  
10 design a new set of total experiences. Knowledge does not consist only in the collection of  
11 experiences but lies within the relationship made between the elements of this collection. The  
12 exploration of these relationships has provided the description of the environment in terms of  
13 variables and the description of materials in terms of properties.

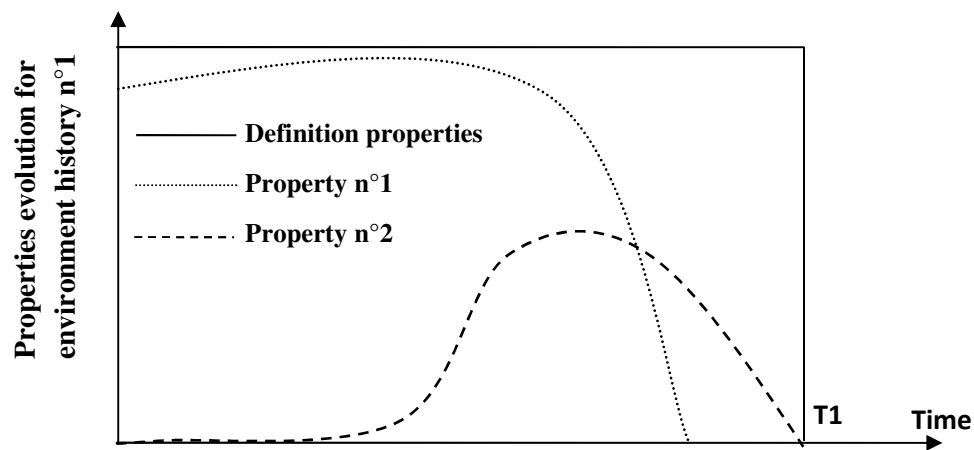

14

15 **Figure 64 : Properties have their own time framework**

16 As shown in **Figure 64**, the life time of material is dependent on the time duration of its definition  
17 properties. Other properties can thus appear or disappear during this time period; they do not  
18 constitute a modification of the object studied. The existence of a material depends on two things:

- 19 - Its actual environment which should be compatible with definition properties  
20 - Its environmental history which gives the remaining expected life span of the material

21 The life cycle of products from extraction to waste can be understood as a succession of modification  
22 of properties for the sake of creating functional properties, i.e. properties useful in the  
23 environmental context of the final user. Industrial processes, through the control of environmental  
24 conditions, aim at creating new properties leading or not to the definition of a new material.  
25 Similarly, transportation by transferring the product from the production environment to the  
26 consumption environment makes the product cross different environments which can lead to a  
27 change of properties. Finally, the functional properties, at least for household, are usually sought to  
28 occur within the human framework, i.e. in a set of environment suitable with human life. This  
29 suitable environment can be basically described as the atmospheric pressure and a 20°C-30°C  
30 temperature interval. On the opposite, the controlled environment of production processes in  
31 industries is often far from this suitable environment with high pressure and high temperature.

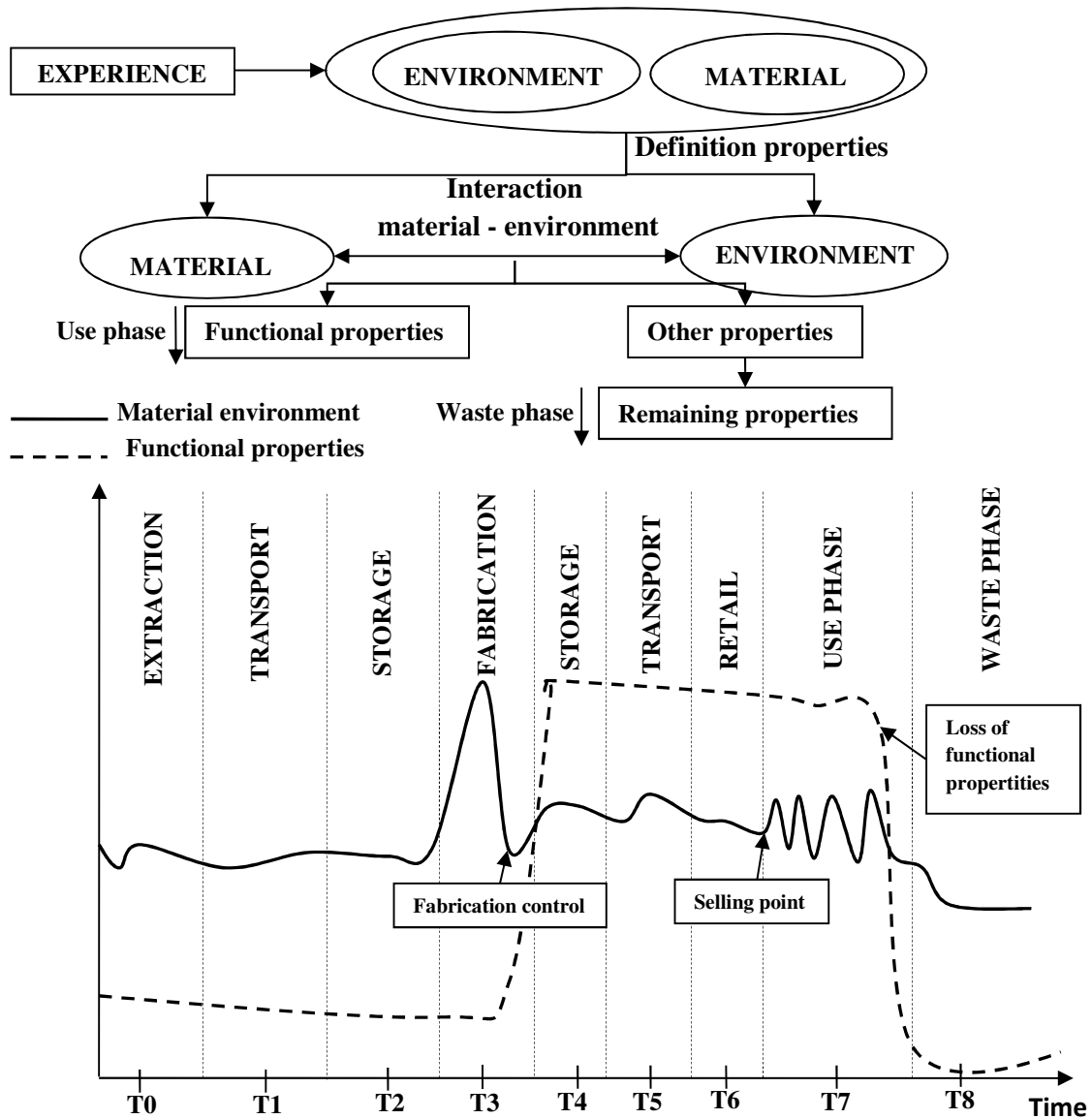

1

2 **Figure 65 : The life cycle of a product, an environment and property perspective**

3 The choice of a material is usually made by engineers and covers two main different perspectives.  
 4 Indeed, the engineer creates a new product or only proposes substitutes to materials already existing  
 5 in a product. In either case, the choice of materials is very important and is usually led by four types  
 6 of requirements. Firstly, one can note the functional requirement which consists in the satisfaction of  
 7 use condition. The material will also have to satisfy these conditions for a certain amount of time  
 8 (longevity) with a minimized risk of failures (reliability). Secondly, we observe technical requirements  
 9 resulting for the gap existing between properties wished for the use phase and the natural properties  
 10 of materials found in the natural environment. Technical requirements are thus dealing with the  
 11 fabrication processes which have a direct effect on the use phase and associated characteristics:  
 12 longevity, reliability, and compatibility. Thirdly, when several materials are found to fulfill functional  
 13 and technical requirements, the price will play a major role in the final choice of a material. The price  
 14 is made of two factors, price of raw materials usually sold according to weight except for wood and  
 15 concrete, i.e. their value density or euro/ton ratio, and production costs. Indeed, the price of raw  
 16 materials is always only a part of the total cost of a product and production costs depend on

1 investments on equipment, energy price, labor cost and the productivity of processes. Therefore, a  
2 costlier material can be chosen if a sufficient drop of production costs is associated with it as the key  
3 rule here is the minimization of the total product cost. Finally, the social requirements concern the  
4 norms regarding the use and making of products dictated by many private and public organisms.  
5 These norms are often used as guidance for contracts between customers and manufacturers and  
6 ensure minimum quality for the products. Some of these norms can be made compulsory when they  
7 concern health and public safety. For instance, the social requirements for the improvement of  
8 passenger safety, reduction of pollutant emission rates and fuel consumption have induced the use  
9 of new materials such as plastics to make smaller and lighter vehicles.

10 The framework presented so far for the choice of a material may seem to be linear. It may also seem  
11 that final optimal and objective decision can be made but the reality is utterly more complex. Indeed,  
12 the choice of a material is always a compromise between different solutions. Furthermore, new  
13 information and issues can always appear leading to a total reevaluation of a solution. Environmental  
14 issues are one of these new constraints for material choice as explained in the next section. Finally,  
15 most of the time, for a particular industry, prices are considered as external forces decided by the  
16 market. On this aspect, prices of suppliers can be compared and the minimizing cost solutions can be  
17 decided by the purchase department. This behavior does not take out the fact that prices are not  
18 linked in a straightforward way to physical properties. Prices are rather based on a market  
19 convention than a thorough analysis of physical and social properties of materials. On this aspect,  
20 prices are dependent on the social and economic dominant convention such as the one of the homo  
21 oeconomicus. And this is where current framework of properties should be changed to include all the  
22 specificities of territorialized actions, internalization of nature-society relationships (circular  
23 economy) and co-production aspects of services (functional economy). Nomenclatures based on  
24 properties thus appear as a new field of research to favor the blossoming of circular and functional  
25 economy strategies by removing the barriers of current nomenclatures which do not provide any  
26 value to waste, social and environmental dynamics.

### 27 **3.2.2 The effects on circulation spaces**

28  
29 The previous discussion on the concept of properties provides a new pattern to analyze the  
30 relationships between the material/energy space of circulation for human activities and the  
31 ecosystem space of circulation. Indeed, the concept of properties links the definition of a material to  
32 a particular interaction within a particular environment. In the same way organisms can live in only a  
33 certain type of physical environment with which they form an ecosystem. The core concept to  
34 analyze the circulation spaces is thus the couple material – environment, i.e. properties (both natural  
35 and social). The characterization of properties is resulting from a social process and the application of  
36 a sensitive framework and scientific methodology. In other terms, the knowledge gained through  
37 History and through daily experiences helps define material and design the expected properties  
38 useful for human activities and those harmful and not wished for human activities or ecosystems.  
39 This pattern is very similar to the one existing in the concept of field in physical sciences. Referring  
40 for example to the electric field (Auvray, 2001)( p.1 -6), an electric particle is found to generate an  
41 electric field in all the physical space but only the presence of another particle can reveal it through  
42 the formation of an electric force. Therefore, the electric field is as a potential only revealed with the  
43 presence of another electric particles. For the framework of properties, the field corresponds to all  
44 the couple material – environment recorded or experienced not degrading the definition properties.

1 In other terms, this field is a set of knowledge existing individually or collectively and constantly  
2 updated. The force corresponds to the confrontation of this knowledge to a particular environment,  
3 leading to the observation of already known or unknown properties.

4 The nomenclature of goods existing in the system of national accounts (SNA) and theories of value  
5 should thus be replaced by the present framework of properties. This framework, an evolving one in  
6 contradiction with nomenclature of world states hypothesis, does not suppose that all purchasers or  
7 economic actors have an encyclopedic knowledge of goods, and enable anyone to participate to this  
8 framework. The choice remaining concerns the space of circulation, i.e. which properties path will be  
9 taken by goods from their extraction to their final use. The scheme of **Figure 56** can thus be  
10 reinterpreted on the following form:

- 11 1. Determination of functional properties for the purpose of final human activities.
- 12 2. Determination of production chain properties, through the examination of the different  
13 properties of materials in Nature (raw material), the capacity offered by production technics  
14 to modify the properties of material as existed in nature into products with the functional  
15 properties required (transformation process), and the transformation induced by the  
16 different environments encountered during the transportation phase on the functional  
17 properties.
- 18 3. Determination of the modifications of properties made on the environment and  
19 consequently on ecosystems made by the withdrawal of raw material from Nature where  
20 they play a role, the concentration and discharges of production systems induced by the  
21 creation of particular physical environment able to transform initial properties into  
22 functional properties (production processes) or by the crossing and maintenance of  
23 functional properties within transportation and logistics systems.

24 Sustainability is thus based on the balance between the results of the previous three steps. In other  
25 terms, for a particular set of functional properties desired, the different paths of property must be  
26 chosen in step 2 in order to minimize the impacts on the property framework in step 3. On this  
27 aspect, the more straightforward are the shifts from natural properties to functional properties and  
28 the less environmental impacts are. Ultimately, functional properties wished by a group of actors  
29 may enter in conflict with the maintenance of ecosystems properties either directly or indirectly  
30 through production and transportation systems. A choice will in this case have to be made between  
31 the maintenance of ecosystems and the satisfactions obtained through functional properties. Such  
32 choice is a choice of Society in regards to the future of worldwide ecosystems maintaining life on  
33 Earth. Environmental sustainability thus concerns the determination of property paths able to  
34 maintain the ecosystem properties, in other terms the borderlines for human actions. It does not  
35 provide any indications on how society should behave within this limit but only concerns with the  
36 fact that society does not overthrow these limits. Social sustainability on this opposite is concerned  
37 with the behavior of Society within the limits set by environmental sustainability. Here are addressed  
38 the problems of welfare and capabilities of individuals which as demonstrated throughout this  
39 dissertation cannot be covered by the market area but called for the establishment at territorial level  
40 of specific equilibrium between market, reciprocity and redistribution sphere. Finally, social and  
41 environmental sustainability cannot be apprehended separately but must be the subject of  
42 coordinated territorial actions. Indeed, each action is localized in time and space and owns social and  
43 environmental aspects that cannot be separated.

## 4 Conclusion

The present Chapter started with the findings of Chapter IV that dematerialization usually found in functional and circular economies only concern value added. Throughout this chapter, I demonstrated that this dematerialization pattern was not enough to frame sustainability. Indeed, there is a fundamental mistake in basing dematerialization on only business models as social and environmental sustainability appear based on a multi-network of which individuals constitute the important nodes. The core aspects of sustainability were found related to the acknowledgement of specificity of resources over abstract generalization of resource. These resources are both material and immaterial, leading to the acknowledgement of local patterns of ecosystems and the importance of knowledge construction and interaction. The flows must thus appear at the service of the nodes (territories and individuals) and should respect external constraints such as ecosystem properties and other limits established locally which we can call territorial properties. We thus obtain the imbrications of network presented in **Figure 66**. Individuals interact with local authorities framing a system in charge of local ecosystems which interacts at the global level through global authorities framing a system in charge of global ecosystems.

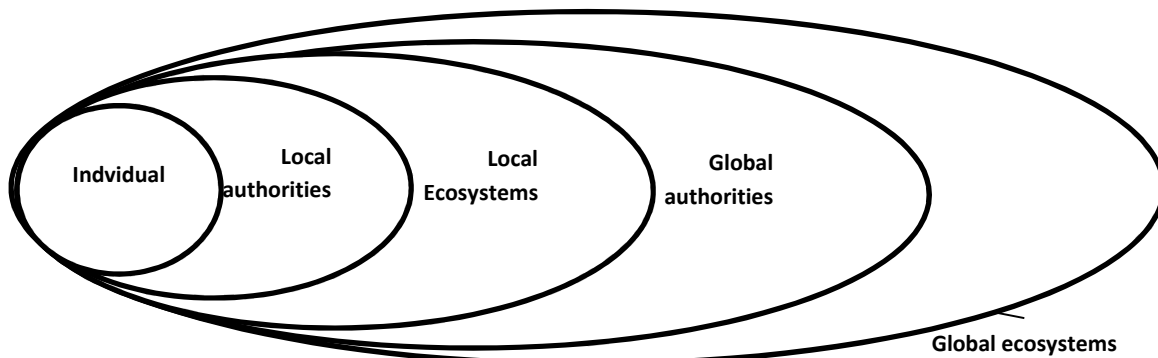

**Figure 66 : The imbrications of networks in sustainability**

The righteous place for sustainable development is thus the territorial level at the conditions that the specificity of associated resources are identified and organized in an auto-limited way. This calls for a property approach of ecosystem and associated use by societies and a property approach of the use phase through a capability approach. Circular economy is mainly targeting the link nature-society thus dealing with an ecosystem approach. Functional economy deals with the use phase and thus concerns the issue of capability development. Sustainability is thus based on the combination of circular and functional economy within the local framework of territories. The establishment of these different local worlds, all legitimate from a sustainable viewpoint, calls for new research, notably in terms of specific nomenclature building and goes beyond the scope of the present work. It nevertheless demonstrates that business models or economy understood as movements on the monetary networks are not enough to establish and maintain sustainable circulations. The next chapter will provide a basic quantitative understanding of the implications of sustainability in current transportation modeling



1 *Chapter VI: Sustainability in quantitative*  
 2 *transportation modeling*

3 **1 Introduction**

4  
 5 In chapter V, I gave arguments in favor of the thesis that the biggest issue in regards to sustainability  
 6 is the characterization of what makes resources specific. The present chapter thus tries to  
 7 understand how specificity is represented in quantitative transportation modeling. Following **Table**  
 8 **18**, the application of the dichotomy specific/generic to the supplier and demand side of a company  
 9 leads to a four type typology. The present chapter is thus also dealing with logistic typologies able to  
 10 welcome the sustainable patterns of functional and circular economy.

11 **Table 18 : The dichotomy specific/generic and associated four worlds**

		Resource	
		Specific	generic
Demand	specific	I	II
	generic	III	IV

12  
 13 Nevertheless, as described in Chapter III, some efforts are already made to diminish the  
 14 environmental impacts of the transportation and logistics operations, notably through the  
 15 internalization of external costs. The present chapter is thus made of two main parts. The first part  
 16 consists in a review of the different transportation and logistics models with the specific/generic  
 17 dichotomy as a guideline. The second part consists in a basic translation of the principles of  
 18 functional economy into the dichotomy specific/generic which allows the meso-economic modeling  
 19 at the level of French regions dealing with the effects of dematerialization on the transportation  
 20 system. Concretely, the model will lead to the establishment of tons repartition by regions and  
 21 sectors and associated emissions level for six types of scenarios as shown in **Table 19**.

22 **Table 19 : The six scenarios studied in the economic modeling**

		Specific/generic dichotomy		
		Reference	Non sustainable functional economy	Sustainable functional economy
External costs	without	I	III	V
	with	II	IV	VI

23  
 24 As a matter of fact, the specificity/generic dichotomy is applied to differentiate between reference,  
 25 non-sustainable functional economy and functional economy scenarios. The other three scenarios  
 26 are obtained through the internalization of external costs related to air pollution, infrastructure,  
 27 noise and accidents into the modeling process. More explanations on these distinctions between  
 28 scenarios can be found in part **3** of this chapter.

29

## 2 Sustainable review of quantitative transport modeling

### 2.1 The problem of generic nomenclature

The dichotomy specific/generic leads naturally to question how goods are represented in the current transportation framework. Firstly, goods are found distributed through headings of nomenclature systems such as the Harmonized system. The Harmonized Commodity Description and Coding System generally referred to as "Harmonized System" or simply "HS" is a multipurpose international product nomenclature developed by the World Customs Organization (WCO). It comprises about 5,000 commodity groups; each identified by a six digit code, arranged in a legal and logical structure and is supported by well-defined rules to achieve uniform classification. The system is used by more than 200 countries and economies as a basis for their Customs tariffs and for the collection of international trade statistics. Over 98 % of the merchandise in international trade is classified in terms of the HS. The HS contributes to the harmonization of Customs and trade procedures, and the non-documentary trade data interchange in connection with such procedures, thus reducing the costs related to international trade. It is also extensively used by governments, international organizations and the private sector for many other purposes such as internal taxes, trade policies, monitoring of controlled goods, rules of origin, freight tariffs, transport statistics, price monitoring, quota controls, compilation of national accounts, and economic research and analysis. The HS is thus a universal economic language and code for goods, and an indispensable tool for international trade.

**Table 20 : NST nomenclature composition<sup>138</sup>**

Chapter (10)	Section (19)	Group (52)	Position (175)
Agriculture products and live animals	Agriculture products and live animals	8	26
Food products and fodder	Food products and fodder	7	34
Solid mineral fuel	Solid mineral fuel	3	7
Petroleum products	Crude petroleum products	1	1
	Refined petroleum products	3	8
ores and metallurgy wastes	Ferrous ores and metallurgy wastes	2	6
	Ores and non-ferrous wastes	1	5
Metallurgy products	Ferrous metallurgy products	5	16
	Non-ferrous metallurgy products	1	6
Crude or manufactured minerals and construction materials	Crude or manufactured minerals and construction materials	5	15
	Raw materials for Chemical industry	1	3
Fertilizer	Fertilizer	2	9
Chemical products	Basic chemical products	2	6
	Paper pulp and cellulose	1	2
	Other chemical products	2	8
Machineries, vehicles, manufactured objects and special transactions	Transport and agriculture materials	2	2
	Metallic articles and machinery	2	4
	Glass, earthenware, porcelain	1	2
	Other manufactured articles	3	15

21

<sup>138</sup> [http://www.statistiques.developpement-durable.gouv.fr/fileadmin/documents/Sources et Methodes/Nomenclatures/NST version 1974 cle134c1e.pdf](http://www.statistiques.developpement-durable.gouv.fr/fileadmin/documents/Sources_et_Methodes/Nomenclatures/NST_version_1974_cle134c1e.pdf)

1 The HS is thus a conventional nomenclature and is a perfect illustration of the strength of convention  
2 or standardization process to enable fast and reliable actions and transactions. The HS is thus found  
3 developed at the European level with the Combine Nomenclature (NC) and is often known from  
4 freight transporters as the NHM codes system. On a statistical level, the HS also serves as a basis to  
5 classify goods. As shown in **Table 20**, the statistical nomenclature of transport (NST) is sharing the  
6 same structure of the HS nomenclature. The only difference lies thus in the aggregation of HS  
7 headings from 5000 entrances up to the 175 positions of the NST nomenclature.

8 The standardization process existing behind nomenclature is not a bad thing in itself. However, the  
9 issues not covered by the nomenclature will get out of the analysis. Therefore, the nomenclature  
10 system can degenerate in a status quo dictating a representation of reality and penalizing other  
11 standardization and coordination processes. The revision of nomenclature is thus a necessity. In  
12 other terms, the nomenclature system is a standard with a dynamic evolution based on political  
13 decisions and knowledge evolution. For example, the World Customs Organization (WCO) has  
14 created subheadings for ozone depleting substances, precursor chemicals to manufacture illicit  
15 drugs, hazardous wastes, endangered species, and narcotics and psychotropic substances are  
16 examples of this responsiveness to international concerns. The reviewing process is nevertheless  
17 quite long, five years, meaning that a status quo is ruling economic life for a period of five years.

18 Therefore, the main problem with current nomenclature is related to the fact that even the  
19 reviewing process is remaining within the borders set by standard economic theories. In other terms,  
20 the current nomenclature of goods does not take into account both environmental and social  
21 aspects. Consequently, the specificity approach developed in chapter V cannot be fully apprehended  
22 with the current nomenclature of goods. The criticism in regards to existing typology has notably  
23 been developed by (Burmeister, 2000). For example, the analysis of the transportation organization  
24 of firms through branch decomposition means to hypothesize that firms belonging to the same  
25 branch are exposed to common constrains leading to very similar strategies. Similarly, using the NST  
26 makes implicit the hypothesis that physical characteristics of transported products determine  
27 primarily the transportation volumes. The general issue is thus to be found in the concept of  
28 typology itself. Indeed, a typology corresponds to the classification of a population with similar  
29 characteristics in regards to the particular question asked. Therefore, a typology (T) can thus be  
30 apprehended as a function (f) dependent of question (Q):  $T_i = f(Q_i)$ . If the question changes, the  
31 typology also changes. This viewpoint illustrates particularly well the differentiation between a  
32 wrong standardization process and the specific approach developed in chapter V. In a misleading  
33 standardization process such as the one of standard economic theory, a typology built for one  
34 question is considered as valid for all questions, i.e.  $\forall Q_i \quad T = T_i$ . Therefore, even questions that may  
35 be asked in the future are falling under the rules of the existing typology. There is no uncertainty.  
36 The process is very different from the specific approach which considers each question as framing a  
37 particular aspect of reality. For example, if a first question leads to a typology with 100 headings and  
38 another question to a typology with 4 headings, the typology covering the two questions has 400  
39 headings ( $T_{Q_1 \dots Q_N} = \prod_{i=1}^N T_{Q_i}$ ).

40 The process of standardization is thus a characteristic of each typology. However, this  
41 standardization pattern must be subordinated to a correcting and self-updating specific approach  
42 able to capture typologies resulting from different questions.

1 **Table 21 : Surveys of typologies (adapted from (Burmeister, 2000))**

	Authors	Field and theoretical foundations	Typology
<b>Production</b>	(Woodward, 1965)	<b>Industrial economy Mainstream</b>	<b>3 production types:</b> 1. Units/small series 2. Big series/mass 3. Process (continue)
	(Tarondeau, 1982)	<b>Marketing management based on (Woodward, 1965)</b>	<b>4 types (based on two axes):</b> 1. project 2. workshop 3. Mass 4. Process
	(Pavitt, 1984)	<b>Innovation ; evolution theory</b>	<b>3 types of sectorial technology trajectories:</b> 1. Firms dominated by supplier 2. Firms with intensive production 3. Firm based on science
	(Delattre, et al., 1983)	<b>Cutting of production system Industrial economy</b>	1. Leading-edge technology 2. heavy industry 3. commercial function 4. automotive industry 5. skilled, unskilled, and woman labor
<b>Conventions</b>	(Boltanski, et al., 1991)	<b>Justification of human actions ; convention economy ; sociology</b>	Six "cités": market, industrial, domestic, civic, inspired, opinion
	(Salais, et al., 1993)	<b>Typology of production logics of firms and regions; convention economy</b>	2 axes: nature of demand, nature of resources 4 production world: industrial, market, interpersonal, immaterial
<b>Logistics</b>	(Browne, 1993)	<b>Concentration of production sites and warehouses Trade-off between scale economy and transportation costs</b>	Analysis table of production sites spatial concentration potential Value per ton and delivery frequency
	(Duong, 1998)	<b>Externalization of logistics</b>	9 Logistics segments: - product constrains: weight, dangerousness, perishability, commercial life duration, variety of products within a range - distribution constrains (customer relationships)
	(Tavasszy, 2000)	<b>Transportation flow modeling</b>	Definition of 50 logistics families based on following criteria: delivery strategies, order frequency, value density, packaging density, delivery delay distribution, distribution of shipment size
	(Girault M., 2000) (Girault, et al., 2000)	<b>Transportation flow modeling</b>	Definition of six logistic families according to goods nature (bulk or not), volume density, value density
	(Bolis, et al., 1999)	<b>Transportation and logistics choice modeling</b>	Typology of firm spatial networks upstream and downstream: - High number of suppliers/customers, spatially dispersed, long and short distance market. - High number of suppliers/customers, spatially concentrated, long distance market. - High number of suppliers/customers, spatially concentrated, regional market. - Limited number of suppliers/customers, spatially concentrated, long distance market.
	(Maier, et al., 2000)	<b>Transportation and logistics choice modeling</b>	Cutting of production system into cluster to analyze the valuation of logistic choice criteria: cost, time, reliability, frequency, flexibility.

2

1 **Table 21** presents different typologies that have been used in logistics, production and convention  
 2 literature. One can see the evolution of complexity of the analytical pattern in comparison to the  
 3 usual framework of branch (national accounts nomenclature) and physical characteristics of products  
 4 (NST). The notion of quantity is for example introduced in the (Woodward, 1965) typology. Similarly,  
 5 the (Duong, 1998) and (Tavasszy, 2000) typologies considerably extend the description of products to  
 6 include the interaction between the production and consumption part of the economic system.

7 However, except for the conventions' framework and in particular the (Salais, et al., 1993) typology,  
 8 the new nomenclatures associated with typologies of **Table 21** mainly deal with the interactions  
 9 within the production-transportation network. Therefore, reflection about the nature of resources  
 10 and the nature of demand is missing. However, following the description of chapter V on what  
 11 frames sustainability, a better understanding of the nature of resources and demands is a  
 12 compulsory first step on the way to sustainability. **Table 22** summarizes the generic/specific  
 13 approach by considering the circulation of goods within the economy as a three step framework.  
 14 Firstly, goods are extracted from the environment becoming resources. Secondly, the production  
 15 system transforms these resources into products able to meet the final demand (third steps). In this  
 16 framework, the production system is understood as a means linking the understanding of (natural)  
 17 resources and the expectation of final demand.

18 **Table 22: classification of typologies in regards of generic/specific dichotomy**

	<b>Resources (1)</b>	<b>Production system (2)</b>	<b>Final demand (3)</b>	<b>Main focus</b>
<b>Usual typology</b>	generic	Generic	Generic	2
<b>Table 21 typologies except convention typologies</b>	generic	generic/specific	generic	2
<b>Convention typologies</b>	generic	Generic	specific	3
<b>Future evolution of Table 21 typologies</b>	generic	specific	Generic /specific	2 – (3)
<b>Future evolution of convention typologies</b>	generic	generic/specific	specific	(2) – 3
<b>Typology associated with Chapter V</b>	specific	specific	specific	1 – 3

19  
 20 The usual typology (branch, NST) considers the three steps of circulation (resource, production  
 21 system and final demand) from a generic approach. Because resources and final demand are seen as  
 22 generic, the emphasis is made on the production system understood as a price based coordination  
 23 system. The new typologies introduced in **Table 21** slightly develop more specific approach of the  
 24 production system but conserves the production system as a main focus. On the opposite, the  
 25 convention typologies by focusing on a sociological approach lead to develop a specific approach of  
 26 the final demand. The expected evolutions of typologies thus concern both the development of more  
 27 specific approach in the field of their main focus and the extension of their focus. However, the  
 28 problem of the specificity of resources is only addressed within the sustainable approach developed  
 29 in Chapter V. Indeed, the core idea in a sustainable approach of production-consumption-circulation  
 30 system leads in a refocus on the resources and final demand aspects. The key issue is thus first the  
 31 determination of what makes resources and final demand specific. The question of the production  
 32 system comes only in a second time and its specificity becomes dependent on the characterization of  
 33 the specificity of resources and final demand.

1 Within the present subsection, I demonstrate the usefulness of typology is always specific and  
 2 dependent on the hypothesis associated with the solving of a particular question. The framework of  
 3 typology thus corresponds to the description of knowledge as a specific resource as described in  
 4 **Chapter V 2.2.2**. Going further, the new nomenclature for logistics analysis should develop more  
 5 specific approach of resources, notably associated environmental aspects and of the consumption  
 6 patterns. Convention theories and the development of property based nomenclature as described in  
 7 **chapter V 3.2** thus constitute a promising way to address the general transition of our socio-  
 8 economic system towards a specific description of spatial interactions.

9 **2.2 The issue of the representation of spatial interactions**

10  
 11 As long resources are not considered as specific, the sourcing of firms can be easily considered as  
 12 global. Actually, as shown in **Figure 67**, the network linking production and transportation though  
 13 initially extracted from a concrete network situated in space becomes easily an abstract network in  
 14 which only the network graph remains. In this perspective, a 100 km distance will be treated the  
 15 same no matter which points of the network are linked together.

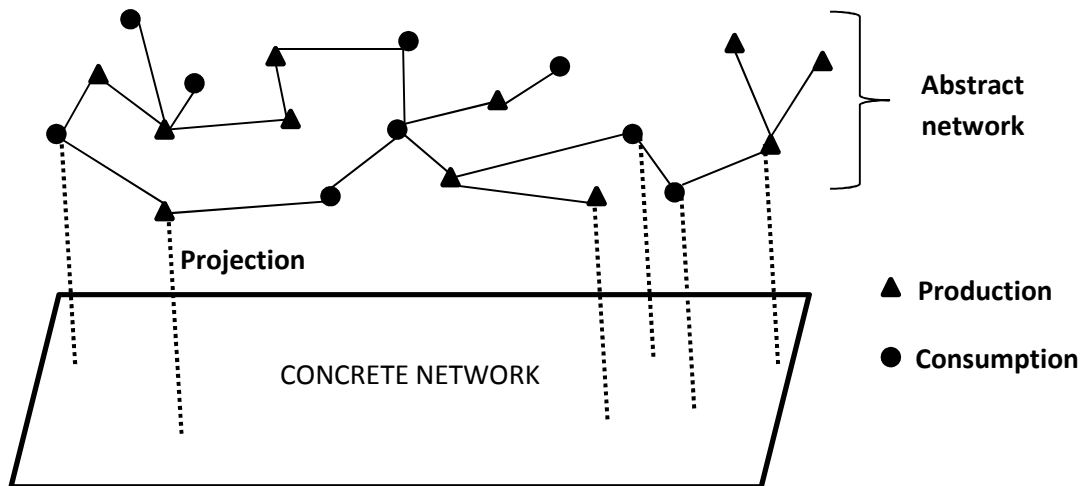

16  
 17 **Figure 67 : Inverting the projection framework between concrete and abstract network.**

18 The issue of spatial interactions consists in determining the transportation flows and its structure  
 19 between two regions. Therefore, the frequency of vehicle flows, the type of vehicles used, the load  
 20 factors and empty trips of vehicles, the shipment size, the packaging density, the level of inventories,  
 21 the perishability and the value density of products are all usual patterns of transportation modeling  
 22 framework. Nevertheless, these data are very difficult to obtain making a comprehensive modeling  
 23 framework difficult to achieve. Regarding this issue, the ECHO database (Gavaud, et al., 2009)  
 24 constitutes a huge progress as being one of the first comprehensive survey recording logistic data  
 25 other than the usual Ton-km statistics.

26 Concerning the modeling structure, a 4 step approach is usually taken as shown in **Figure 68**. Starting  
 27 with the location of production and consumption, the first step consists in determining the quantity  
 28 produced and consumed in each location. Then, these quantities are distributed in terms of  
 29 production/consumption matrix, i.e. that the quantity of a product produced in region  $i$  is distributed  
 30 in all the regions studied where the products will be consumed ( $P_i = \sum_{j=1}^N C_{ij}$ ).

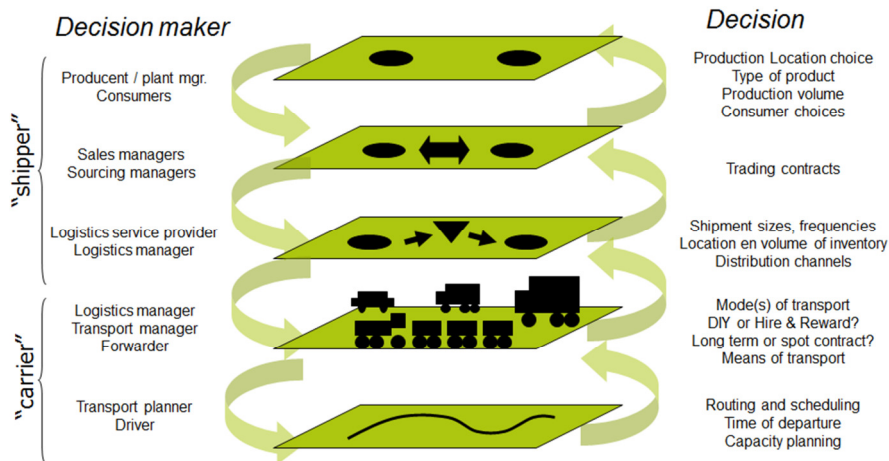

1

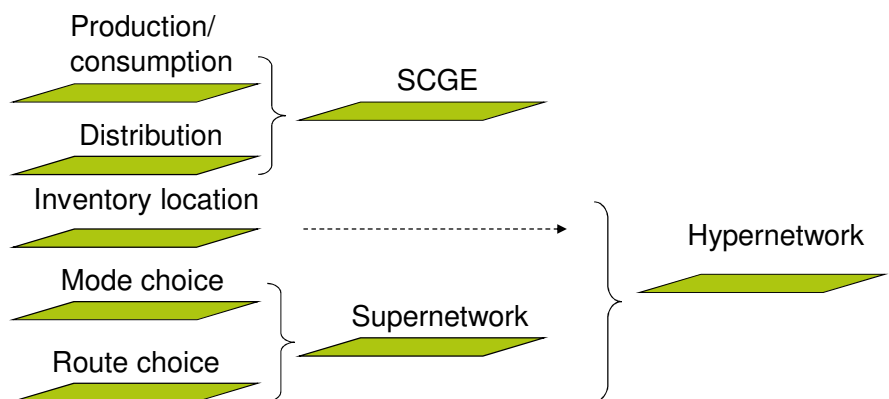

2

Decision problem	Typical modelling challenges	Typical techniques employed	
Production and consumption	trip generation and facility location freight/economy linkage consumption patterns	LUTI ('70s) and SCGE ('90s) models	trip generation models, I/O ('70's)
Trade	international trade value to volume conversion		gravity models, synthetic O/D models ('70s)
Logistics services	inventory location supply chain management considerations	logistics choice models ('90's)	
Transportation services	choice of mode intermodal transport light goods vehicles	simple trip conversion factors ('70s), discrete choice ('90s)	multimodal networks ('80s)
Network and routing	routing and congestion tour planning city access	network assignment ('80s), simulation ('90s)	

3

4 **Figure 68 : The four step models, associated decision structure and network modeling (adapted**  
 5 **from (Tavasszy, 2006))**

6 The P/C distribution is nevertheless dependent on a lot of decisions and interactions between  
 7 shippers and carriers as shown in **Figure 68**. The shipment sizes, frequency of deliveries and location  
 8 of inventories are examples of logistics choices influencing the P/C distribution. Similarly, the  
 9 difference in cost structures based on transportation network and mode choice also plays an  
 10 important role in the determination of the P/C structure. Challenges are thus rising at every step of  
 11 the 4-step modeling framework. It is therefore not surprising the modeling techniques created so far  
 12 have only laid interest on their associated stage rather than all model steps. Integrative models are

1 lacking (Tavasszy, et al., 2012). However, the modeling framework slowly evolves towards more  
 2 integrated approach. This way, mode choice and routing choice are framing new models  
 3 (supernetwork) and should develop towards an even better integrating approach with the  
 4 introduction of inventory location (hypernetwork). From the P/C and trade sides, the spatial  
 5 computable general equilibrium models (SCGE) have been so far the main way of integration.  
 6 However, this integration has still a long way to go. The facts that shipment size though well  
 7 integrated in mode choice is not with other choices, that the inventory decisions is still an emerging  
 8 research area, that the vehicle type choice is largely missing in all models and that there are no  
 9 capabilities to describe new types of distribution channel for specific product segment are all proofs  
 10 of the early development of integration.

11 In respect to issue of functional economy and notably the description of the specificity of natural  
 12 resources, the current techniques to address production/consumption suffer from taking as a data  
 13 basis the national accounting framework which has been strongly criticized in Part I. Therefore, the  
 14 trip generation models based on Input-Output tables or the spatial supply general equilibrium  
 15 models (SCGEs) also based on IO tables share the same issue. Besides, following (Mitra-Kahn, 2008),  
 16 SCGEs do not combine microeconomic theory as much as supposed by the research community.  
 17 Going further, one of the main strength of the SCGEs is to consider economic relationships as  
 18 endogenous in comparison to I/O models for which these relationships are mainly exogenous.  
 19 Nevertheless, following the criticism of part I, the endogenous character of SCGEs does not seem  
 20 well adapted to the introduction of a service approach (functional economy) and of a new  
 21 environmental comprehensive approach (circular economy). Indeed, as the standard economic  
 22 theory dealing mainly with monetary network is not well adapted to the patterns of proximity,  
 23 territorial actions and co-production frameworks, SCGEs based on such economic theory cannot  
 24 capture the complexity embodied in circular and functional economies approach. It is therefore wiser  
 25 to prefer an I/O approach in which new frameworks can be modeled exogenously. This is notably the  
 26 viewpoint taken in the dematerialization model developed in 3. Besides, as shown in **Figure 69**, the  
 27 I/O analytical framework can be used at any scale level and inherited principles from physics and  
 28 engineering (black box systems).

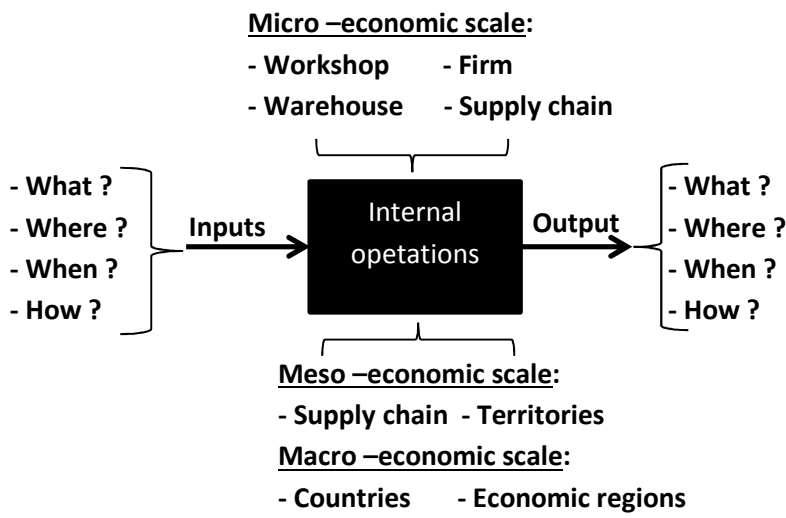

29

30 **Figure 69 : A similar pattern of questions for different scales**



1 The most promising uses of I/O in regards to sustainability issue are thus found at the micro-  
2 economic level as at this scale, products can be defined in other terms than the usual nomenclature  
3 of national accounting systems. Examples concern energy and environmental analysis of districts  
4 (Kuhntz, et al., 2010) and local supply chain (Albino, et al., 2004) through enterprise input-output  
5 models. Similarly, I/O framework is at the basis of MRP theory (Grubbström, et al., 2010).  
6 Nevertheless, one of the main drawbacks of the IO analytical framework is the linear relationship  
7 assumed between inputs and outputs. Non-linear relationships can however be modeled through a  
8 series of linear relationships<sup>139</sup>, framing conditions of validity for a particular approximate  
9 relationships. Ultimately, production functions can also be used.

10 Going further, functional economy from a social viewpoint appears in line with current servicisation  
11 experienced in the economy. According to (Tavasszy, et al., 2001), this servicisation slowly evolves  
12 towards individualized products and services through product customization and service  
13 responsiveness. This leads to new kinds of challenge such as enabling the service provider to cope  
14 with both uncertainties in demand and external factors (Corsten, et al., 2006) or to allow companies  
15 to extend its network (Chung, et al., 2004) to include non-monetary types of transactions.  
16 Transportation as a service is not absent from this challenge and collaboration models have notably  
17 been developed in order to increase the supply chain effectiveness. Collaboration is indeed one of  
18 the most promising areas of study in supply chain management [ (Albino, et al., 1999; Albino, et al.,  
19 2002) (Albino, et al., 2007)]. Though collaboration in supply chain management can take place at  
20 several stages of the chain and with different levels of intensity (Gonzalez-Feliu, et al.), the main  
21 development are occurring through information systems (Albino, et al., 2002) (Giraud-Héraud, et al.,  
22 2001) (Prindezis, et al., 2005). One can thus see here the importance of time management already  
23 described in chapter IV. Besides, one should keep in mind that two kinds of information exist, coded  
24 and treated information. While coded information is able to be standardized and used  
25 independently from individuals, treated information is knowledge calling for face-to-face interactions  
26 and cooperation between the emitter and received or the treated information. According to  
27 (Burmeister, et al., 2006), service activities can either have as main support material systems (retail,  
28 wholesale, transportation, storage, etc.), coded information (Bank, insurance, finance,  
29 telecommunication, etc.), treated information (management advise, research and development) and  
30 individuals (teaching, health care, etc.). Therefore, one observe an evolution of the complexity of  
31 spatial interactions from material networks to information networks and ultimately to relationships  
32 and inter-personal networks. From a modeling perspective, this means goods transportation model  
33 cannot consist in a simple characterization of goods flows anymore but must extend to information  
34 networks and interpersonal networks. It particularly means that person transportation and good  
35 transportation models should eventually merge together, integrated in a unique model.  
36 Nevertheless, as shown in **Table 23** and **Table 24**, the complexity induced with a transition towards  
37 specific approach implies the development of knowledge related to non-market interactions and the  
38 irreversibility associated. It also calls for the development of a further understanding of the process  
39 of trust building. Therefore, it is expected that the growing complexity of models will call for a  
40 thorough understanding and reports of the hypothesis made behind modeling framework. Similarly,  
41 surveys will cover more and more importance providing more diversified types of data on logistic  
42 choices and framing new theoretical paths to characterize the specificity of resources and demand at  
43 stakes within the system studied.

---

<sup>139</sup> Each function can be approximated by a set of affine functions.

1 **Table 23 : Complexity evolution from generic resources to specific resources ( (Colletis-Wahl, et al.,**  
 2 **2003) (Colletis-Wahl, et al., 2004) and (Burmeister, 2000))**

	Generic resources	Generic assets	Specific assets	Specific resources
<b>Decreasing portability</b>	→			<b>Increasing irreversibility</b>
<b>Characteristics</b>	potential	Existing and transferable	Existing and partially transferable	Virtual non-transferable
<b>Activation</b>	Can be activated based on profitability calculations	Localization factors determined by prices and transportation costs	Relative inertia Irrecoverable transfer costs Transaction costs	Resources only appear on the moment of strategy combination to solve particular problem
<b>Coordination</b>	Can be introduced on the market	market	Quasi-market	Coordination outside market world using institution, norms and conventions.
<b>Examples</b>	Raw materials, tools, simple work, basic formation (no used)	Similar but resources considered in activity	Qualified work, knowledge, specific equipment	Industrial atmosphere
<b>Proximity form</b>	Accessibility	Accessibility	Organizational	Institutional
<b>Transport and logistics</b>	Public transportation	Basic transport and logistics service	Dedicated and complex logistics service, Complex logistics information system, organizations methodologies of circulation systems	Know how related to goods and information circulation in the framework of just on time production systems

3  
 4 **Table 24 : The effects of the different worlds on indicators framework ( (Gadrey, 1991), (Djellal, et**  
 5 **al., 2006) and (Burmeister, et al., 2008))**

	Industrial world	Market world	Domestic world	Civic world	World of innovation	World of reputation
<b>Direct output</b>	Transfer of goods in space	Make goods available to the customer	Customer contact	Compliance with social, technical and environmental legislation and regulations	Input to information systems of the shipper	Marginal (eg. Advertising on trucks)
<b>Indicators for direct performance</b>	Tons, volume, distances, punctuality, lead times, ton-km	Transport cost	Number and frequency of delivery to each customer	Driving offences, undeclared work, emission of pollutants	Use of ICTs for tracking, tracing, EDI, RFID etc.	
<b>Outcome (long term)</b>	Efficient and reliable distribution system	Efficient consumer response	Stable and experienced distribution network	Environmental, social and spatial impacts of freight transport	Improvements of innovation in the information and management system of the supply chain	Contribution to the brand image of the good
<b>Indicators for indirect performance</b>	Reliability, just-in-time, geographical area covered, adaptation to production constraints	Flexibility, contribution to profitability of the supply chain	Turnover of transport subcontractors Type of contracts between the shipper and the transport provider	Contribution to pollution, congestion	Contribution to information and management of the supply chain	

6  
 7 **Table 25: The different types of control process**

Control of process by the customer	Operational participation of customer	
	Low	High
<b>Substantial and occasional control</b>	Passive or receiving customer just choosing a contract or a formula	Logic of open formula used either in co-production or in self-service. Consumed on site
<b>Frequent and procedural control</b>	Customized subcontracting logics. The customer has knowledge for the control but does not want to do it himself.	Strong cooperation. Co-organization. Complementarity of tasks and knowledge. Organizational and decisional interface

1 In regards to functional economy, the modeling of control procedure as shown in **Table 25**, of which  
2 maintenance procedure is only a small share, will get more and more importance. In conclusion, the  
3 modeling of spatial interactions based on non-monetary framework is expected to give birth to a  
4 diversity of typologies. The development of heuristic approach (Keskin, et al., 2007), the elaboration  
5 of logistics management table (Morana, et al., 2003) with its energy consumption consequences  
6 (Cholette, et al., 2009) are examples of current promising ways to establish new typologies.  
7 Nevertheless, they still stick mainly to the industrial and market worlds and the civic world related to  
8 externalities (pollution, corporate social responsibility) is notably missing (Ciliberti, et al., 2011).

9 Let us now summarize the expecting evolutions of modeling framework described in the present sub-  
10 sections. The general evolution of models is towards a better and more comprehensive approach of  
11 the problem of specification. On this aspect, the previous discussion leads to distinguish three points  
12 of evolution. The first point concerns the general trends towards customization and service  
13 responsiveness. This framework already complicates the usual logistics modeling framework by  
14 giving more focus on packaging density, value of time, flexibility and reliability. Important typology  
15 efforts can thus already be made at this level and most of new researches in the logistics modeling  
16 framework (e.g. hypernetworks) are heading towards better integration of customization framework  
17 (e.g. economy of scales versus economy of varieties). The second point concerns a sociological and  
18 territorial approach of service relations. The consequences on logistics models deal notably with a  
19 better integration of control and maintenance process thus leading to a better integration of goods  
20 lifecycle (production – distribution – use phases). The main issue is nevertheless related to the  
21 understanding of non-market interactions (proximity, convention framework), trust building  
22 processes, and knowledge diffusion. These sociological frameworks are indeed not introduced so far  
23 in modeling frameworks. The reasons can be found both in the new theoretical approach to good  
24 flows associated with service relations and the specific approach to take in designing typology.  
25 Therefore, there is a high chance that a typology established for a particular production-  
26 consumption-circulation system does not become valid for another system. This second point is thus  
27 characterized by the development of surveys on trade flows occurring within particular territorial  
28 metabolisms with a high focus on studying the behavior and coordination processes of actors. The  
29 third point is probably the most difficult to apprehend because the environment is generally not  
30 perceived by industrial and market worlds, and even when taken into account is always considered in  
31 a generic way. The criticism of goods nomenclature NST is thus particularly relevant for this pattern  
32 and should be replaced by a property based nomenclature as described in **chapter V 3.2**. This new  
33 nomenclature supposes notably to link the networks of the economy to the networks of the  
34 ecosystems in an unprecedented way by taking into account in a first approach the time of  
35 extraction, place of extraction and quantity extracted and in a second time the path taken by the  
36 natural resources extracted. This new nomenclature will thus act as a specification of environmental  
37 impacts but also as a classification of the possible assets to be issued from these resources.

38 The dematerialization model presented in the next section does not include the patterns of this new  
39 nomenclature which asks for more theoretical and practical researches. It nevertheless presents an  
40 idea of the potential of functional economy understood as a transition towards better customization  
41 and service approach of logistics system. The consequences on ton distribution across French regions  
42 are notably shown with a particular focus on modal split, external costs and warehouse use.

43

# 3 A dematerialization meso - economic model

## 3.1 Methodology

### 3.1.1 Principles

The model is a meso-economic model dealing with the 22 French regions through a gravity model including environmental costs and dematerialization scenarios. As shown in **Figure 70**, the model is made of five steps, two top-down steps and two bottom-up steps merging together at the level of the gravity model:

#### 1) Top-down steps

- a. The first step consists in transforming the national Input-Output (IO) table expressed in monetary units (€) into regional consumption and production vectors. This transformation is based on data such as regional value added and regional gross household income
- b. The second step consists in transforming monetary units into physical units (T). This is made thanks to the import database which records import both in physical and monetary units allowing a €/T ratio to be determined for each sector of the IO table. Following the relative dematerialization principle (increase of €/T ratio), functional economy will be modeled through hypotheses regarding the ratio increase.

#### 2) Bottom-up steps

- a. The first step is to determine costs for using each transport modes. For road transportation, four types of vehicles are considered with possibility to have indirect flows through warehousing system. On the opposite, only one vehicle and direct flow is considered for railway transportation system. Exhaust emissions of vehicles will be internalized in costs through taxes expressed for example in €/tCO<sub>2</sub>.
- b. The different sectors of the economy will be classified according to logistic characteristics (lead time, standardization level, packaging, shipment size, value of time). This logistic typology will serve through a simple probabilistic logit model to the establishment of the probability of use of the different paths for the transportation of goods. Functional economy will be modeled in this step as a change of logistic type within the previously determined logistic typology. Therefore, functional economy will result in changes in the probability of use of transportation paths.

#### 3) Gravity model

Once obtained the regional physical production and consumption vectors and the probability of use of the transportation paths, the gravity model is applied. This gravity model distributes the tons produced and consumed in each region based on the transportation costs. The total emissions, the total number of vehicles and the cost per ton can thus be determined for each production/consumption (P/C) relationships. At this level, the influence of functional economy can thus be studied in terms of dematerialization policy success and trade-off between dematerialization and air emissions.

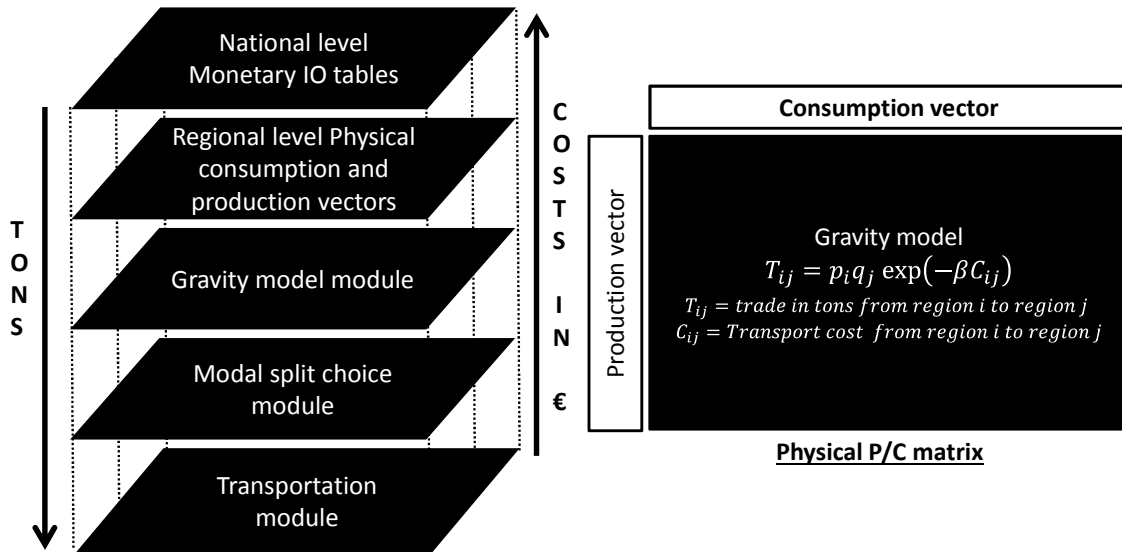

1

2 **Figure 70 : Model structure**

3 **3.1.2 Top-down approach: from national Input-Output table to gravity model**

4 **3.1.2.1 From national input-output table to production/consumption monetary vectors**

5

6 The national input-output table used for the analysis is a 2006 IO table expressed in a nomenclature  
 7 called “nomenclature de synthèse” (NES)<sup>140</sup>. This nomenclature was used by the National Institute of  
 8 Statistics and Economic Studies (INSEE) for the purpose of economic analysis until 2007 before the  
 9 2008 system of national accounts implied a revision of nomenclature (European Commission, et al.,  
 10 2009). The advantage of using the NES is primarily the high level of disaggregation quite rare for  
 11 publicly available version of IO table. Indeed, the NES as shown in **Annex 1** and **Table 26** is a 116  
 12 sector nomenclature.

13 The first step to deal with the IO table is to prepare the table so that usual Leontief analytical  
 14 framework as presented in **Figure 38** is operational. In our case, as explained in **Annex 1**, this  
 15 preparation leads to the suppression of the lines and columns concerning recycling activities (GF56)  
 16 and mining of uranium and thorium ores (GG13). Our final table is thus a 114 sector one. The second  
 17 step consists in disaggregating the IO framework into a regional framework. For this purpose, I will  
 18 first use the regional value added available for 24 regions and 14 sectors provided by the National  
 19 Institute of Statistic and Economic Studies<sup>141</sup>.

20 The 24 regions considered are the 22 French regions, the overseas territories (DOM), and the  
 21 extraterritorial activities (Hors Territoire). The latter are only concerned with public administration  
 22 and defence sector (code GR10) so that a particular treatment will be made for this region. The IO  
 23 framework provides the national value added for the 114 sectors. Therefore, following the link  
 24 between NES116 and NES14 as shown in **Table 26**, it becomes possible to obtain a disaggregation  
 25 vector of the NES14 value added for each of the 24 regions. The general procedure of disaggregation  
 26 is presented in **Figure 71**.

<sup>140</sup> <http://www.insee.fr/fr/methodes/default.asp?page=nomenclatures/nes2003/nes2003.htm>

<sup>141</sup> [http://www.insee.fr/fr/themes/detail.asp?reg\\_id=99&ref\\_id=pib-va-reg](http://www.insee.fr/fr/themes/detail.asp?reg_id=99&ref_id=pib-va-reg)

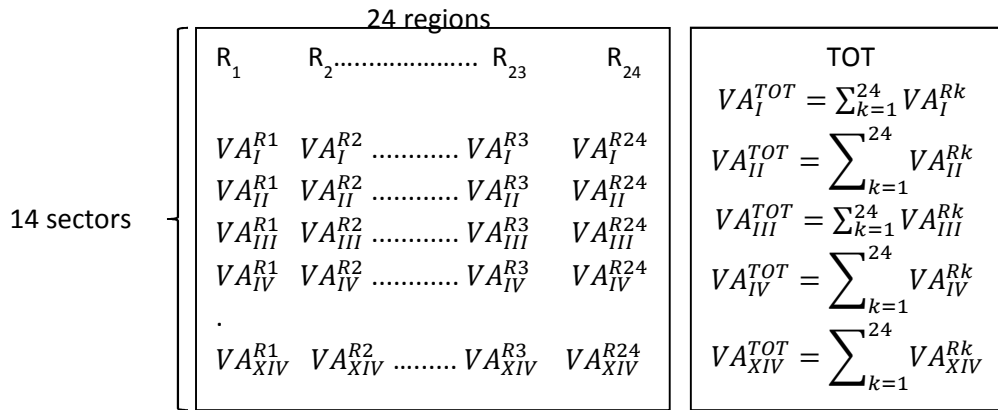

**Figure 71 : A national to regional disaggregation based on value added decomposition**

The general disaggregation framework is thus the following:

- 1) Formation of ratios for the 14 sectors and 24 regions

$$\text{for } i \in [I, XIV] \text{ and } k \in [1, 24] \quad \alpha_i^{Rk} = \alpha_i \times \frac{VA_I^{Rk}}{\sum_{k=1}^{24} VA_I^{Rk}}$$

- 2) Transformation into a 114x24 matrix based on **Table 26**

$$\begin{pmatrix} \alpha_I^{R1} & \dots & \alpha_I^{R24} \\ \vdots & \ddots & \vdots \\ \alpha_{XIV}^{R1} & \dots & \alpha_{XIV}^{R24} \end{pmatrix} \rightarrow \begin{pmatrix} \alpha_1^{R1} = \alpha_I^{R1} & \dots & \alpha_1^{R24} = \alpha_I^{R24} \\ \alpha_2^{R1} = \alpha_I^{R1} & \dots & \alpha_2^{R24} = \alpha_I^{R24} \\ \alpha_3^{R1} = \alpha_I^{R1} & \dots & \alpha_3^{R24} = \alpha_I^{R24} \\ \vdots & \dots & \vdots \\ \alpha_{112}^{R1} = \alpha_{XIV}^{R1} & \dots & \alpha_{112}^{R24} = \alpha_{XIV}^{R24} \\ \alpha_{113}^{R1} = \alpha_{XIV}^{R1} & \dots & \alpha_{113}^{R24} = \alpha_{XIV}^{R24} \\ \alpha_{114}^{R1} = \alpha_{XIV}^{R1} & \dots & \alpha_{114}^{R24} = \alpha_{XIV}^{R24} \end{pmatrix}$$

- 3) Correction for the 24<sup>th</sup> region for the sector GR10 (i = 113) receives everything

$$\forall i \neq 113 \quad \alpha_i^{R24} = 0 \quad \text{and} \quad \alpha_{113}^{R24} = 1$$

- 4) Application to the vectors of interest. As the value added concerns mainly production, the value added framework obtained is applied to production patterns of resource/use balance:

$$X = X_{REG} + IMP = INTC + Y + EXP$$

$X_{REG}$  corresponds to the production of regions so that the sum of regional production and imports (IMP) constitutes the total resource available for the economy (X). Symmetrically, the total use (X) is the sum of the intermediary consumption (INTC), the final domestic demand (Y) and the exports (EXP). The resulting production vectors are thus the following:

$$PROD = (X_{REG}^{R1} \quad \dots \quad X_{REG}^{R24} \quad IMP \quad X)$$

- 5) For the consumption patterns, gross household income source is used as it better characterizes the consumption patterns. **Table 27** provides the regional decomposition framework so that the resulting consumption vectors are thus the following:

$$CONS = (INTC_{REG}^{R1} + Y_{REG}^{R1} \quad \dots \quad INTC_{REG}^{R24} + Y_{REG}^{R24} \quad EXP \quad X)$$

1 **Table 26 : Structure of regions and sectors**

NES_116	Line_code	Line_code	NES_14	NES_116	Line_code	Line_code	NES_14	NES_116	Line_code	Line_code	NES_14	FRENCH REGION	CODE	NUM	
GA01	1	I	A	GF11	40	VI	F	GK01	77	X	K	Alsace	Al	1	
GA02	2			GF12	41			GK02	78			Aquitaine	Aq	2	
GA03	3			GF13	42			GK03	79			Auvergne	Au	3	
GB01	4	GF14	43	GK04	80			Basse-Normandie	BN			4			
GB02	5	GF21	44	GK05	81			Bourgogne	Bo			5			
GB03	6	GF22	45	GK07	82			Bretagne	Br			6			
GB04	7	GF23	46	GK08	83			Centre	Ce			7			
GB05	8	GF31	47	GK69	84			Champagne-Ardenne	CA			8			
GB06	9	GF32	48	GL01	85			Corse	C			9			
GC11	10	GF33	49	GL02	86			Franche-Comté	FC	10					
GC12	11	GF41	50	GL03	87			Haute-Normandie	HN	11					
GC20	12	GF42	51	GM01	88			Île-de-France	IDF	12					
GC31	13	GF43	52	GM02	89			Languedoc-Roussillon	LR	13					
GC32	14	GF44	53	GN10	90			Limousin	Li	14					
GC41	15	GF45	54	GN21	91			Lorraine	Lo	15					
GC42	16	GF46	55	GN22	92			Midi-Pyrénées	MP	16					
GC43	17	GF51	56	GN23	93			Nord - Pas-de-Calais	NPC	17					
GC44	18	GF52	57	GN24	94			Pays de la Loire	PL	18					
GC45	19	GF53	58	GN25	95			Picardie	Pi	19					
GC46	20	GF54	59	GN31	96			Poitou-Charentes	PC	20					
GD01	21	GF55	60	GN32	97			Provence - Alpes - Côte d'Azur	PAC	21					
GD02	22	GF56	61	GN33	98			Rhône-Alpes	RA	22					
GE11	23	GF61	62	GN34	99			DOM	DOM	23					
GE12	24	GF62	63	GN4A	100			Hors territoire	HT	24					
GE13	25	GG11	64	GN4B	101										
GE14	26	GG12	65	GP10	102			VII	G	XIII	P	XIV	QR		
GE21	27	GG13	66	GP21	103										
GE22	28	GG14	67	GP2A	104										
GE23	29	GG15	68	GP2B	105										
GE24	30	GG2A	69	GP31	106										
GE25	31	GG2B	70	GP32	107										
GE26	32	GG22	71	GQ1A	108			VIII	H	XIV	QR	XIV	QR		
GE27	33	GH01	72	GQ1B	109										
GE28	34	GH02	73	GQ2A	110										
GE31	35	GJ10	74	GQ2B	111			IX	J	XIV	QR	XIV	QR		
GE32	36	GJ20	75	GQ2C	112										
GE33	37	GJ30	76	GQ2D	113										
GE34	38			GQ2E	114										
GE35	39			GR10	115										
				GR20	116										

2

3 **Table 27 : Decomposition framework for consumption**

		Household Gross income (M€)	Household Gross income/inhabitants (€)	Inhabitants	%
Al	Alsace	33 542	18 422	1 820 736	2,8%
Aq	Aquitaine	58 007	18 514	3 133 142	4,9%
Au	Auvergne	25 144	18 800	1 337 441	2,1%
BN	Basse-Normandie	26 115	17 907	1 458 391	2,2%
Bo	Bourgogne	30 273	18 579	1 629 431	2,6%
Br	Bretagne	55 713	17 934	3 106 574	4,7%
Ce	Centre	47 069	18 645	2 524 495	4,0%
CA	Champagne-Ardenne	23 542	17 603	1 337 403	2,0%
C	Corse	5 007	16 899	296 313	0,4%
FC	Franche-Comté	20 659	17 924	1 152 566	1,8%
HN	Haute-Normandie	32 232	17 788	1 812 025	2,7%
IDF	Île-de-France	256 803	22 187	11 574 458	21,8%
LR	Languedoc-Roussillon	43 840	17 195	2 549 567	3,7%
Li	Limousin	13 805	18 860	731 972	1,2%
Lo	Lorraine	41 631	17 821	2 336 087	3,5%
MP	Midi-Pyrénées	50 630	18 138	2 791 372	4,3%
NPC	Nord - Pas-de-Calais	64 294	15 993	4 020 121	5,5%
PL	Pays de la Loire	62 246	17 962	3 465 444	5,3%
Pi	Picardie	33 145	17 480	1 896 138	2,8%
PC	Poitou-Charentes	31 288	18 095	1 729 091	2,7%
PAC	Provence-Alpes-Côte d'Azur	88 630	18 330	4 835 237	7,5%
RA	Rhône-Alpes	114 884	18 997	6 047 465	9,7%
DOM	Overseas départements	19 799	11 020	1 796 652	1,7%
HT	Extraterritorial activities	1 200	0	0	0,1%
	TOT	1 179 498	411 093	63 382 122	100,0%

4

1 **3.1.2.2 From monetary to physical vectors**

2

3 With the previous framework, we obtained the regional production and consumption vectors in  
 4 monetary unit. Following (Duchin, et al., 2004), in order to convert the monetary vectors into  
 5 physical vectors while conserving the resource/use balance, one should establish a unique €/T ratio  
 6 for each sector. The 114 €/T ratios were established by an analysis of the custom data provided by  
 7 the Sitram database<sup>142</sup> as described in **Annex 2**. The results are presented in the “REF” vector of  
 8 **Table 28**. For functional economy scenario, the sensitivity of each sector, i.e. the percentage of  
 9 expected shift to functional economy per sector, was determined based on (Combe , et al., 2008).  
 10 This study has a 20 years’ timeline and is based on the 2006 household consumption. Secondly, a  
 11 factor two (F=2) has been applied to take into account the extension of life time of systems  
 12 associated with functional economy. Therefore, the effect of a shift to functional economy is  
 13 modeled exogenously by combining a hypothesis on the lifetime extension and a sensitivity  
 14 structure:  $\forall i \in [1,114] \text{ ratio}_{FEi} = (1 + (F - 1) \times \%EF_i) \times \text{ratio}_{REFi}$

15 **Table 28 : Sensitivity of sectors to functional strategy adapted from (Combe , et al., 2008)**

	REF	FE			REF	FE			REF	FE		
	(€/T)	(€/T)	Description	%EF	(€/T)	(€/T)	Description	%EF	(€/T)	(€/T)	Description	%EF
GA01	809	809	feeding	0%	GF11	85	GF12	0%	GK05	0	Mobility	0%
GA02	130	130	feeding	0%	GF12	44	feeding, Not classified	0%	GK07	0	Mobility	0%
GA03	3935	3935	feeding	0%	GF13	476	equipment	0%	GK08	0	Leisure	50%
GB01	900	900	feeding	0%	GF14	476	equipment	0%	GK69	0	Mobility	0%
GB02	900	900	feeding	0%	GF21	4157	Clothing	0%	GL01	0	Insurance and finance	0%
GB03	900	900	feeding	0%	GF22	4157	Clothing	0%	GL02	0	Insurance and finance	0%
GB04	900	900	feeding	0%	GF23	4157	Clothing	0%	GL03	0	Insurance and finance	0%
GB05	900	900	feeding	0%	GF31	677	equipment	25%	GM01	0	housing	75%
GB06	22615	22615	Not classified	0%	GF32	991	equipment	25%	GM02	0	housing	75%
GC11	16150	20188	Clothing	25%	GF33	991	equipment	25%	GN10	0	Je communique	75%
GC12	6339	7324	Clothing	25%	GF41	1755	Not classified	0%	GN21	0	Conseil, audit, services B2B	100%
GC20	4378	5473	Leisure	25%	GF42	1755	GF43	0%	GN22	0	Conseil, audit, services B2B	100%
GC31	1755	2194	Health	25%	GF43	1755	feeding/equipment	0%	GN23	0	Conseil, audit, services B2B	100%
GC32	1755	2194	Health	25%	GF44	1755	GF46	8%	GN24	0	Conseil, audit, services B2B	100%
GC41	4740	5925	equipment	25%	GF45	2524	Mobility	50%	GN25	0	Conseil, audit, services B2B	100%
GC42	4740	5925	equipment	25%	GF46	2524	equipment/Mobility/housing	8%	GN31	0	equipment/Mobility	100%
GC43	4740	5925	equipment	25%	GF51	1141	equipment	0%	GN32	0	GN22	100%
GC44	9172	11464	equipment	25%	GF52	1141	equipment	0%	GN33	0	Conseil, audit, services B2B	100%
GC45	6575	8218	equipment	25%	GF53	0	equipment	0%	GN34	0	Health	50%
GC46	7532	9415	equipment	25%	GF54	0	equipment	0%	GN4A	0	Conseil, audit, services B2B	100%
GD01	9712	12139	Mobility	25%	GF55	3467	equipment	0%	GN4B	0	Conseil, audit, services B2B	100%
GD02	9712	12139	Mobility	25%	GF61	5064	equipment	0%	GP10	0	feeding/Leisure	54%
GE11	9377	9377	Mobility	0%	GF62	6575	equipment	0%	GP21	0	Leisure	25%
GE12	9377	9377	Mobility	0%	GG11	121	GF12	0%	GP2A	0	Leisure	25%
GE13	9377	9377	Mobility	0%	GG12	373	GF12	0%	GP2B	0	Leisure	25%
GE14	9377	9377	Mobility	0%	GG14	501	Mobility	0%	GP31	0	Clothing/Health/Housing	85%
GE21	3467	4334	GE24	25%	GG15	501	Mobility/housing	19%	GP32	0	housing	100%
GE22	3467	4334	GE24	25%	GG2A	5299	housing	50%	GQ1A	0	Education	100%
GE23	9172	11464	GE24	25%	GG2B	0	housing	50%	GQ1B	0	Education	100%
GE24	9172	11464	equipment	25%	GG22	0	housing	50%	GQ2A	0	Health	25%
GE25	9172	13757	feeding	50%	GH01	0	housing	100%	GQ2B	0	Health	25%
GE26	9172	13757	equipment	50%	GH02	0	housing	100%	GQ2C	0	Health	25%
GE27	9172	11464	Clothing	25%	GJ10	0	Mobility	100%	GQ2D	0	citizenship	100%
GE28	9172	11464	equipment	25%	GJ20	0	Pas d'activité de réparation	0%	GQ2E	0	citizenship	100%
GE31	8080	12119	equipment	50%	GJ30	0	Clothing/equipment	100%	GR10	0	citizenship	100%
GE32	5064	6330	GD01	25%	GK01	0	Mobility	0%	GR20	0	citizenship	100%
GE33	6575	9862	equipment	50%	GK02	0	Mobility	0%				
GE34	7532	7532	Health	0%	GK03	0	Mobility	0%				
GE35	7532	11298	equipment	50%	GK04	0	Mobility	0%				

16

<sup>142</sup> <http://www.statistiques.developpement-durable.gouv.fr/donnees-ligne/r/flux-marchandises-sitram-i.html>



### 1 **3.1.3 Bottom-up approach: from transportation costs to gravity model**

#### 2 **3.1.3.1 A logistic typology**

3

4 In order to determine the characteristics of transportation for the different goods of the NES  
5 nomenclature, it becomes necessary to establish a typology enable to welcome changes driven by  
6 functional economy. For this reason, I will use the typology developed in (Burmeister, 2000)  
7 (Burmeister, et al., 2006) and (Burmeister, et al., 2006). This typology consists in five production  
8 modes:

##### 9 1) Industrial world:

10 This world is characterized by mass production for a standardized demand. Transportation is thus  
11 organized in a standardized and externalized way. The logics of circulation is mainly material and the  
12 use of ICTs between firms is seldom used. Similarly, face-to-face relationships are absent and outside  
13 market interactions are marginal. The information flows are thus mainly used within the firm to  
14 operate coordination between the different establishment and headquarters. Massive and slow  
15 transportation mode is mainly used in this world.

##### 16 2) Flexible world:

17 This world is characterized by a mass production for a customized demand. There is thus a high  
18 diversity of product calling for a strong association between goods and information flows.  
19 Nevertheless, the exchange information is mainly codified in a standardized way so that there is no  
20 need of face-to-face interactions. The exchanged information thus does not require geographical  
21 proximity. From a transportation viewpoint, the flexibility of the system is dependent on fast  
22 transportation mode and just-in-time organization.

##### 23 3) Hybrid flexible-industrial world:

24 This world combines mass production based on scale economy and logistic systems able to take  
25 benefits of the variety economy. The main establishments belonging to this world are notably those  
26 of the agribusiness industries producing for mass-market retailing. As the logistic organization  
27 becomes the competitiveness center for the firm thus favouring fast transport modes and flexible  
28 organization, this hybrid world can be considered as a sub-part of the flexible world. I will thus  
29 include this world into the flexible world for the purpose of the model.

##### 30 4) Professional world:

31 In the professional world, the demand is a specific one and the transportation of goods is made at  
32 lower scale than in mass production. The just-on-time is nevertheless important and face-to-face  
33 interactions and non-market interactions are key characteristics of the professional world. There is  
34 an intensive use of all the proximity types. Information and communication technologies are highly  
35 used except Electronic Data Interchange (E.D.I.) as the latter is more appropriate to standardized  
36 information processes than the specific approach of the professional world. The professional world is  
37 thus characterized by frequent relationships between users and producers for mutual adjustments.  
38 Similarly, interpersonal networks and non-market interactions are essential to establish and maintain  
39 trust between producers and users.

1        5) Immaterial world:

2 This world is the one corresponding to the domain of creation and research. Transportation only  
 3 plays a minor role in comparison to the circulation of knowledge made through the intensive use of  
 4 Information and communication technologies. The transportation of person to establish direct  
 5 contact is as in the professional world important. Nevertheless, once created, the knowledge can be  
 6 diffused globally through ICTs technologies.

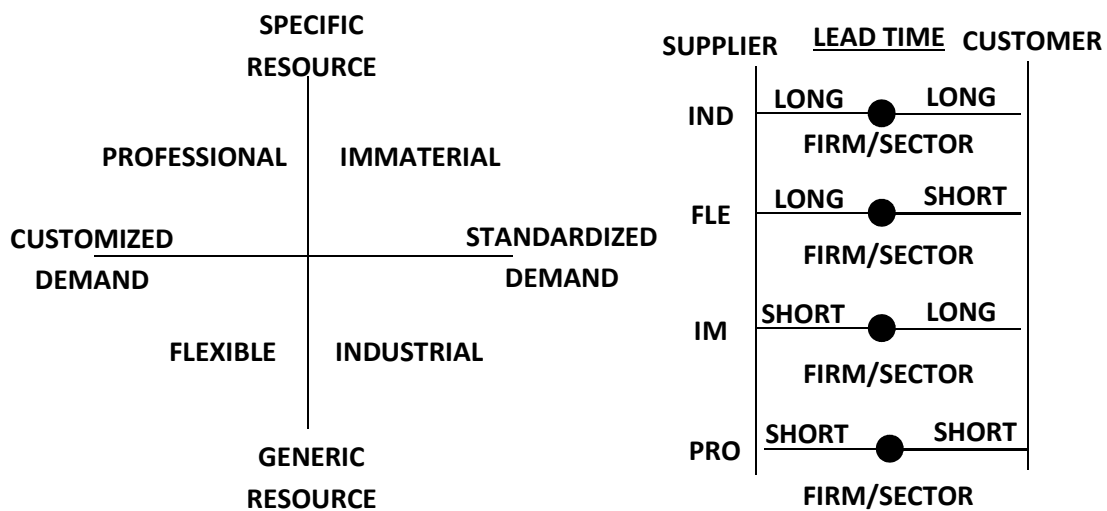

7

8 **Figure 72 : Logistic typology and associated lead time framework**

9 The five different worlds can thus be classified depending on resource and demand characteristics as  
 10 shown in **Figure 72**. Similarly, different patterns of lead time can be associated with the five different  
 11 worlds. Let us now see how functional economy transforms the different frameworks.

12 As explained in chapter V, the functional economy in its sustainable form develops both a specific  
 13 approach of resource and a customized approach of demand. Therefore, the flexible and industrial  
 14 worlds will evolve towards the professional world. For the immaterial world, the pattern is quite  
 15 different as the knowledge creation is specific while the diffusion of knowledge is generic. Therefore,  
 16 the immaterial world appears mainly unchanged by a sustainable application of functional economy.  
 17 Indeed, the immaterial world constitutes the global network of functional economy which is  
 18 expressed locally in the professional world as shown in **Figure 62**. However, as demonstrated in  
 19 chapter IV, functional economy can be applied in lines with a generic and objective perspective on  
 20 the value framework. In this case, functional economy is mainly characterized by a change from  
 21 generic demand to customized demand. Therefore, only the industrial world is found transforming  
 22 into flexible world. We thus have three scenarios, a reference scenario without functional economy,  
 23 one with an “unsustainable” application of functional economy (industrial towards flexible) and a  
 24 “sustainable” application of functional economy (industrial and flexible towards professional).

25 Once the logistic typology explained, the main issue consists in distributing the typology for the NES  
 26 nomenclature. For this purpose, I will use an industrial survey made by (Burmeister, 2000)  
 27 concerning 110 industries and 22 product types corresponding to 90 headings of the NST  
 28 nomenclature. The remaining 85 headings of NST nomenclature have then been associated in terms

1 of typology structure to the 90 headings of the survey as shown in **Table 29**. This way, the  
 2 distribution into industrial, flexible (flexible+mixte), professional and immaterial world can be  
 3 established for each of the 175 headings of NST nomenclature. Then by using the correspondence  
 4 table between NST and NES nomenclatures as determined in **Annex 2**, the final typology structure is  
 5 established for all of the 116 headings of the NES nomenclature. The typology obtained this way  
 6 constitutes the “reference” scenario and can be found in **Table 30** with the two other scenarios.

7 **Table 29 : Distribution of NST nomenclature in our logistic typology (adapted from (Burmeister,**  
 8 **2000))**

NST	Industriel	Flexible	Mixte	Professionnel	Immatériel	TOT	NST	Associated	NST
matières textiles (04)	2	0	1	0	0	3	5	(05)(09)	8
boissons (12)	2	0	1	0	0	3	4	-	0
épicerie (13)	3	1	2	0	1	7	7	-	0
périssable (14)	2	2	4	0	0	8	8	(02)(03)(06)	5
non périssable (16)	3	1	1	1	0	6	7	(00)(01)(11)	11
alim p. animaux (17)	0	0	1	0	0	1	3	-	0
oléagineux	1	0	1	0	0	2	2	-	0
hydroc.gaz (33)	0	0	0	1	0	1	1	(32)	4
dérivés non énerg. (34)	2	0	0	0	0	2	3	(21)(22)(23)(31)(41) (45)(46)(61)(62)(63) (64)(65)(69)(71)(72)	46
acier brut (51)	1	0	0	0	0	1	3	-	0
laminés (52)	1	0	0	0	0	1	2	-	0
profilés (53)	1	0	0	0	0	1	5	-	0
tôles (54)	3	0	0	0	0	3	4	-	0
tubes (55)	5	0	0	1	0	6	2	-	0
non ferreux (56)	2	0	0	0	0	2	6	-	0
chime base (81)	5	0	0	0	0	5	5	(82)(83)(84)	5
autres chimie (89)	5	3	0	1	2	11	6	(89)	1
machines agricoles (92)	1	0	1	0	0	2	1	-	0
autres machines (93)	6	0	0	7	0	13	2	-	0
articles métall. (94)	4	1	0	3	0	8	2	-	0
verre (95)	1	0	0	0	0	1	2	-	0
textiles (96)	2	10	1	7	0	20	3	-	0
pdts manuf. Divers (97)	1	1	0	0	1	3	7	(99)	5
<b>TOTAL</b>	<b>53</b>	<b>19</b>	<b>13</b>	<b>21</b>	<b>4</b>	<b>110</b>	<b>90</b>	-	<b>85</b>

9

10 The functional economy scenarios are then established according to the following equations:

11 Non-sustainable functional economy:

$$IND_{FE}^{NONSUS} = (1 - \%EF) \times IND_{REF} ; FLE_{FE}^{NONSUS} = FLE_{REF} + \%EF \times IND_{REF}$$

$$PRO_{FE}^{NONSUS} = PRO_{REF} ; IM_{FE}^{NONSUS} = IM_{REF}$$

12 Sustainable functional economy:

$$IND_{FE}^{SUS} = (1 - \%EF) \times IND_{REF} ; FLE_{FE}^{SUS} = (1 - \%EF) \times FLE_{REF}$$

$$PRO_{FE}^{SUS} = PRO_{REF} + \%EF \times IND_{REF} + \%EF \times FLE_{REF} ; IM_{FE}^{SUS} = IM_{REF}$$

13

14

1 **Table 30: Repartition of sectors within logistics typology according to scenarios**

SCENARIOS	REFERENCE				NON SUST FUNC. ECO.				SUST FUNC. ECO.				SCENARIOS	REFERENCE				NON SUST FUNC. ECO.				SUST FUNC. ECO.			
	IND	FILE	PRO	IM	IND	FILE	PRO	IM	IND	FILE	PRO	IM		TYPOLGY	IND	FILE	PRO	IM	IND	FILE	PRO	IM	IND	FILE	PRO
GA01	43%	48%	1%	8%	43%	48%	1%	8%	43%	48%	1%	8%	GF11	100%	0%	0%	0%	100%	0%	0%	0%	100%	0%	0%	0%
GA02	65%	34%	0%	0%	65%	34%	0%	0%	65%	34%	0%	0%	GF12	100%	0%	0%	0%	100%	0%	0%	0%	100%	0%	0%	0%
GA03	31%	68%	0%	1%	31%	68%	0%	1%	31%	68%	0%	1%	GF13	99%	0%	0%	0%	99%	0%	0%	0%	99%	0%	0%	0%
GB01	42%	50%	3%	5%	42%	50%	3%	5%	42%	50%	3%	5%	GF14	99%	0%	0%	0%	99%	0%	0%	0%	99%	0%	0%	0%
GB02	42%	50%	3%	5%	42%	50%	3%	5%	42%	50%	3%	5%	GF21	52%	37%	1%	10%	52%	37%	1%	10%	52%	37%	1%	10%
GB03	42%	50%	3%	5%	42%	50%	3%	5%	42%	50%	3%	5%	GF22	52%	37%	1%	10%	52%	37%	1%	10%	52%	37%	1%	10%
GB04	42%	50%	3%	5%	42%	50%	3%	5%	42%	50%	3%	5%	GF23	52%	37%	1%	10%	52%	37%	1%	10%	52%	37%	1%	10%
GB05	42%	50%	3%	5%	42%	50%	3%	5%	42%	50%	3%	5%	GF31	52%	33%	15%	0%	39%	46%	15%	0%	39%	25%	36%	0%
GB06	43%	43%	14%	0%	43%	43%	14%	0%	43%	43%	14%	0%	GF32	56%	22%	21%	1%	42%	36%	21%	1%	42%	17%	41%	1%
GC11	28%	48%	1%	23%	21%	55%	1%	23%	21%	36%	20%	23%	GF33	56%	22%	21%	1%	42%	36%	21%	1%	42%	17%	41%	1%
GC12	25%	46%	3%	26%	19%	52%	3%	26%	19%	35%	21%	26%	GF41	87%	8%	3%	2%	87%	8%	3%	2%	87%	8%	3%	2%
GC20	34%	33%	33%	1%	25%	41%	33%	1%	25%	25%	49%	1%	GF42	87%	8%	3%	2%	87%	8%	3%	2%	87%	8%	3%	2%
GC31	87%	8%	3%	2%	65%	30%	3%	2%	65%	6%	27%	2%	GF43	87%	8%	3%	2%	87%	8%	3%	2%	87%	8%	3%	2%
GC32	87%	8%	3%	2%	65%	30%	3%	2%	65%	6%	27%	2%	GF44	87%	8%	3%	2%	80%	15%	3%	2%	80%	7%	11%	2%
GC41	42%	31%	24%	3%	31%	41%	24%	3%	31%	23%	43%	3%	GF45	48%	28%	20%	4%	24%	52%	20%	4%	24%	14%	58%	4%
GC42	42%	31%	24%	3%	31%	41%	24%	3%	31%	23%	43%	3%	GF46	48%	28%	20%	4%	44%	32%	20%	4%	44%	25%	27%	4%
GC43	42%	31%	24%	3%	31%	41%	24%	3%	31%	23%	43%	3%	GF51	96%	2%	1%	1%	96%	2%	1%	1%	96%	2%	1%	1%
GC44	49%	22%	1%	27%	37%	34%	1%	27%	37%	17%	19%	27%	GF52	96%	2%	1%	1%	96%	2%	1%	1%	96%	2%	1%	1%
GC45	41%	15%	14%	30%	31%	25%	14%	30%	31%	11%	28%	30%	GF53	0%	0%	0%	0%	0%	0%	0%	0%	0%	0%	0%	0%
GC46	40%	24%	22%	13%	30%	34%	22%	13%	30%	18%	38%	13%	GF54	0%	0%	0%	0%	0%	0%	0%	0%	0%	0%	0%	0%
GD01	46%	11%	2%	40%	34%	23%	2%	40%	34%	8%	17%	40%	GF55	60%	12%	5%	24%	60%	12%	5%	24%	60%	12%	5%	24%
GD02	46%	11%	2%	40%	34%	23%	2%	40%	34%	8%	17%	40%	GF61	64%	7%	2%	27%	64%	7%	2%	27%	64%	7%	2%	27%
GE11	51%	14%	11%	23%	51%	14%	11%	23%	51%	14%	11%	23%	GF62	41%	15%	14%	30%	41%	15%	14%	30%	41%	15%	14%	30%
GE12	51%	14%	11%	23%	51%	14%	11%	23%	51%	14%	11%	23%	GG11	96%	0%	0%	4%	96%	0%	0%	4%	96%	0%	0%	4%
GE13	51%	14%	11%	23%	51%	14%	11%	23%	51%	14%	11%	23%	GG12	100%	0%	0%	0%	100%	0%	0%	0%	100%	0%	0%	0%
GE14	51%	14%	11%	23%	51%	14%	11%	23%	51%	14%	11%	23%	GG14	79%	3%	1%	18%	79%	3%	1%	18%	79%	3%	1%	18%
GE21	60%	12%	5%	24%	45%	27%	5%	24%	45%	9%	23%	24%	GG15	79%	3%	1%	18%	64%	18%	1%	18%	64%	2%	16%	18%
GE22	60%	12%	5%	24%	45%	27%	5%	24%	45%	9%	23%	24%	GG2A	40%	31%	29%	0%	20%	51%	29%	0%	20%	15%	65%	0%
GE23	49%	22%	1%	27%	37%	34%	1%	27%	37%	17%	19%	27%	GG2B	0%	0%	0%	0%	0%	0%	0%	0%	0%	0%	0%	0%
GE24	49%	22%	1%	27%	37%	34%	1%	27%	37%	17%	19%	27%	GG22	0%	0%	0%	0%	0%	0%	0%	0%	0%	0%	0%	0%
GE25	49%	22%	1%	27%	37%	34%	1%	27%	37%	17%	19%	27%													
GE26	49%	22%	1%	27%	37%	34%	1%	27%	37%	17%	19%	27%													
GE27	49%	22%	1%	27%	37%	34%	1%	27%	37%	17%	19%	27%													
GE28	49%	22%	1%	27%	37%	34%	1%	27%	37%	17%	19%	27%													
GE31	44%	21%	8%	27%	22%	43%	8%	27%	22%	10%	40%	27%													
GE32	64%	7%	2%	27%	48%	23%	2%	27%	48%	5%	20%	27%													
GE33	41%	15%	14%	30%	21%	35%	14%	30%	21%	7%	42%	30%													
GE34	40%	24%	22%	13%	40%	24%	22%	13%	40%	24%	22%	13%													
GE35	40%	24%	22%	13%	20%	44%	22%	13%	20%	12%	54%	13%													

2

3 **3.1.3.2 A transportation cost framework with internalization of environmental cost**

4

5 Let us now deal with the consequences of logistic on transportation characteristics. For example, the  
6 more a product is customized, the lower the numbers of tons per shipment and the higher the  
7 packaging density is. In the modeling framework, the first characteristics given to the goods are their  
8 volume density character. At the 175 level of NST nomenclature, the goods are thus classified in  
9 three categories, bulk goods (>2000 kg/m3), average goods (500-2000 kg/m3) and volume goods  
10 (<500 kg/m3) (see **Annex 4**). Then, using the bridge nomenclature between NES nomenclature and  
11 NST nomenclature, the volume density shares for all the NES sectors is obtained (see **Annex 4**).The  
12 next step is to establish a link between the logistics typology framework established in **3.1.3.1** and  
13 the vehicle load factors. For this purpose, I will use a typology related to load factors and empty trips  
14 as presented in the online eco-calculation tool EcoTransIT World (EcoTransIT, 2011) and reproduced  
15 in **Table 31**. The characteristics of a truck considered as bulk will thus correspond to a load factor of  
16 100% and an empty trip ratio (empty trip/loaded trip) of 60%. Our four headings typology thus  
17 develops trends favoring one of the three vehicle states (bulk, average, volume). The basic idea is  
18 that a long lead time favors consolidation of shipments while short lead time favors frequent  
19 deliveries. Therefore, as shown in **Table 32**, the industrial world is characterized by bulk shipments  
20 while the professional world is characterized by frequent deliveries and volume shipments.

1 **Table 31 : Vehicle and load factor types in EcoTransIT world tool**

Type of cargo	Examples of cargo	Load factor	Empty trip factor
<b>TRAIN</b>			
<b>Bulk</b>	<b>Hard coal, ore, oil, waste, banana</b>	100%	80%
<b>Average</b>	-	60%	50%
<b>Volume</b>	<b>Passengers cars, vehicle parts, seat, furniture, clothes</b>	30%	20%
<b>TRUCK</b>			
<b>Bulk</b>	<b>Hard coal, ore, oil, waste, banana</b>	100%	60%
<b>Average</b>	-	60%	20%
<b>Volume</b>	<b>Passengers cars, vehicle parts, seat, furniture, clothes</b>	30%	10%

2  
3 **Table 32 : Establishment of vehicle load factor trends for logistics typology**

Typology	Supplier lead time	Customer lead time	Supplier vehicle load factor	Customer vehicle load factor	Trends
<b>Industrial</b>	Long	long	Bulk	Bulk	Bulk
<b>Flexible</b>	Long	Short	Bulk	Volume	Average
<b>Professional</b>	short	Short	Volume	Volume	Volume
<b>Immaterial</b>	short	Long	volume	bulk	Average

4  
5 The trends established in **Table 32** need nevertheless to be completed with the physical  
6 characteristics of products as shown in **Table 33**. This way, while the industrial world follows the  
7 physical characteristics of products (volume density order), the professional world totally follows the  
8 trend of volume vehicle load. The flexible and immaterial worlds are distinguished at the level of  
9 average goods, the flexible world being considered as favoring frequent deliveries. This distinction  
10 can be found in the difference of logics between immaterial and flexible goods. Indeed, the long lead  
11 time for the customer side of immaterial goods is mainly explained through the fact immaterial  
12 goods are for example software, i.e. knowledge that has been codified in a standardized way.  
13 Therefore, the diffusion process is mainly through e.g. internet download and thus covers some bulk  
14 aspects (e.g. common server) which justify the classification as average in our framework in  
15 comparison to volume classification of flexible world.

16 Once the classification of **Table 33** established, the decomposition between bulk, average and  
17 volume vehicles for each sector is in line with the pattern described by the following equation and  
18 leads to **Table 34**:

$$100\% = \%_{IND}^{REF} + \%_{FLE}^{REF} + \%_{PRO}^{REF} + \%_{IM}^{REF}$$

$$100\% = \%_{BULK}^{Goods} + \%_{AVERAGE}^{Goods} + \%_{VOLUME}^{Goods}$$

$$\%_{BULK}^{Veh} = \%_{IND}^{REF} \times \%_{BULK}^{Goods}$$

$$\%_{AVERAGE}^{Veh} = (\%_{FLE}^{REF} + \%_{IM}^{REF}) \times \%_{BULK}^{Goods} + (\%_{IND}^{REF} + \%_{IM}^{REF}) \times \%_{AVERAGE}^{Goods}$$

$$\%_{VOLUME}^{Veh} = \%_{PRO}^{REF} \times \%_{BULK}^{Goods} + (\%_{FLE}^{REF} + \%_{PRO}^{REF}) \times \%_{AVERAGE}^{Goods} + \%_{VOLUME}^{Goods}$$

$$100\% = \%_{BULK}^{Veh} + \%_{AVERAGE}^{Veh} + \%_{VOLUME}^{Veh}$$

1 **Table 33 : Establishment of vehicle load factors through combination of volume density**

		Volume density		
		Bulk	Average	Volume
Vehicle load factor	Industrial (Bulk)	Bulk	average	Volume
	Flexible (Average)	average	volume	volume
	Professional (Volume)	volume	volume	Volume
	Immaterial (Average)	average	average	volume

2

3 **Table 34 : Vehicle types decomposition for each scenarios and sectors**

	PC																		
	REFERENCE			NON_SUST_FONC_ECO			SUST_FONC_ECO				REFERENCE			NON_SUST_FONC_ECO			SUST_FONC_ECO		
	BULK	AVERAGE	VOLUME	BULK	AVERAGE	VOLUME	BULK	AVERAGE	VOLUME		BULK	AVERAGE	VOLUME	BULK	AVERAGE	VOLUME	BULK	AVERAGE	VOLUME
GA01	20%	33%	47%	20%	33%	47%	20%	33%	47%	GE31	0%	0%	99%	0%	1%	99%	0%	0%	100%
GA02	2%	5%	93%	2%	5%	93%	2%	5%	93%	GE32	24%	14%	62%	18%	20%	63%	18%	13%	69%
GA03	1%	6%	93%	1%	6%	93%	1%	6%	93%	GE33	1%	1%	98%	0%	1%	98%	0%	1%	99%
GB01	20%	29%	51%	20%	29%	51%	20%	29%	51%	GE34	10%	11%	79%	10%	11%	79%	10%	11%	79%
GB02	20%	29%	51%	20%	29%	51%	20%	29%	51%	GE35	10%	11%	79%	5%	15%	80%	5%	7%	88%
GB03	20%	29%	51%	20%	29%	51%	20%	29%	51%	GF12	99%	1%	1%	99%	1%	1%	99%	1%	1%
GB04	20%	29%	51%	20%	29%	51%	20%	29%	51%	GF13	99%	1%	1%	99%	1%	1%	99%	1%	1%
GB05	20%	29%	51%	20%	29%	51%	20%	29%	51%	GF14	99%	1%	1%	99%	1%	1%	99%	1%	1%
GB06	10%	43%	47%	10%	43%	47%	10%	43%	47%	GF21	4%	4%	93%	4%	4%	93%	4%	4%	93%
GC11	1%	1%	98%	0%	2%	98%	0%	1%	98%	GF22	4%	4%	93%	4%	4%	93%	4%	4%	93%
GC12	2%	7%	91%	2%	8%	91%	2%	6%	92%	GF23	4%	4%	93%	4%	4%	93%	4%	4%	93%
GC20	0%	0%	100%	0%	0%	100%	0%	0%	100%	GF31	1%	1%	98%	1%	1%	98%	1%	0%	99%
GC31	67%	21%	11%	50%	35%	15%	50%	17%	33%	GF32	1%	1%	98%	1%	1%	98%	1%	1%	98%
GC32	67%	21%	11%	50%	35%	15%	50%	17%	33%	GF33	1%	1%	98%	1%	1%	98%	1%	1%	98%
GC41	11%	10%	79%	8%	12%	80%	8%	8%	84%	GF41	67%	21%	11%	67%	21%	11%	67%	21%	11%
GC42	11%	10%	79%	8%	12%	80%	8%	8%	84%	GF42	67%	21%	11%	67%	21%	11%	67%	21%	11%
GC43	11%	10%	79%	8%	12%	80%	8%	8%	84%	GF43	67%	21%	11%	67%	21%	11%	67%	21%	11%
GC44	4%	6%	89%	3%	7%	90%	3%	5%	91%	GF44	67%	21%	11%	62%	26%	12%	62%	20%	18%
GC45	1%	1%	98%	1%	1%	98%	1%	1%	99%	GF45	6%	19%	75%	3%	15%	82%	3%	10%	87%
GC46	10%	11%	79%	8%	13%	79%	8%	9%	84%	GF46	6%	19%	75%	6%	18%	76%	6%	17%	77%
GD01	0%	1%	99%	0%	1%	99%	0%	1%	99%	GF51	91%	3%	5%	91%	3%	5%	91%	3%	5%
GD02	0%	1%	99%	0%	1%	99%	0%	1%	99%	GF52	91%	3%	5%	91%	3%	5%	91%	3%	5%
GE11	7%	17%	76%	7%	17%	76%	7%	17%	76%	GF53	0%	0%	0%	0%	0%	0%	0%	0%	0%
GE12	7%	17%	76%	7%	17%	76%	7%	17%	76%	GF54	0%	0%	0%	0%	0%	0%	0%	0%	0%
GE13	7%	17%	76%	7%	17%	76%	7%	17%	76%	GF55	34%	36%	30%	34%	36%	30%	34%	36%	30%
GE14	7%	17%	76%	7%	17%	76%	7%	17%	76%	GF61	24%	14%	62%	24%	14%	62%	24%	14%	62%
GE21	34%	36%	30%	25%	41%	33%	25%	31%	43%	GF62	1%	1%	98%	1%	1%	98%	1%	1%	98%
GE22	34%	36%	30%	25%	41%	33%	25%	31%	43%	GG11	96%	4%	0%	96%	4%	0%	96%	4%	0%
GE23	4%	6%	89%	3%	7%	90%	3%	5%	91%	GG12	100%	0%	0%	100%	0%	0%	100%	0%	0%
GE24	4%	6%	89%	3%	7%	90%	3%	5%	91%	GG14	72%	21%	7%	72%	21%	7%	72%	21%	7%
GE25	4%	6%	89%	2%	8%	90%	2%	5%	93%	GG15	72%	21%	7%	58%	34%	7%	58%	20%	22%
GE26	4%	6%	89%	2%	8%	90%	2%	5%	93%	GG2A	3%	37%	60%	1%	21%	77%	1%	19%	80%
GE27	4%	6%	89%	3%	7%	90%	3%	5%	91%	GG2B	0%	0%	0%	0%	0%	0%	0%	0%	0%
GE28	4%	6%	89%	3%	7%	90%	3%	5%	91%	GG22	0%	0%	0%	0%	0%	0%	0%	0%	0%

4

5 We will now concentrate on costs for each type of vehicles. Six vehicles will be considered, divided in  
6 three kinds of load characteristics (bulk, average and volume). This leads thus to establish 18 vehicle  
7 types the characteristics of which are presented in **Table 35**. The figures presented in **Table 35** are  
8 obtained through the process described in Annex 6 from data issued from a Dutch study. From a cost  
9 perspective, I obtained 36 formulas depending on the fact that external costs are taking into  
10 accounts. The vehicle costs are thus the following:

$$COST_{Veh} = Cost_{fixed} + Cost_{rest} \times Hours_{rest} + Cost_{variable} \times Dist + VOT \times hours$$

$$COST_{Veh}^{Ext} = Cost_{fixed} + Cost_{rest} \times Hours_{rest} + (Cost_{variable} + Cost_{ext}) \times Dist + VOT \times hours$$

11 The resting hours follows the French regulation for road transportation and has been set to zero for  
12 rail transportation. Therefore, as shown in (Pimor, et al., 2008), the drivers must take a rest of 45  
13 minutes every 4.5 hours and a rest of 11 hours every 9 hours.

1 Therefore, 1000 km driven at 50 km/h hours will not only take 1000/50= 20 hours but  
 2 20+2\*45+2\*11=33.5 hours. In our case, the speed for truck is 68 km/h while the speed for trains is 40  
 3 km/h.

4 The value of time corresponds to the sensitivity of the product to time. Depending on the world  
 5 considered and the density value, the VOT may thus vary. The general framework of VOT is thus:

$$VOT_i^j = a_j \times Val.Density_i$$

6 The value density is directly taken from **Table 28**. For the coefficient, I used values taken from  
 7 (Tavasszy, 1995) which provide  $a_{PRO} = a_{FLE} = 0.0035$  per day and  $a_{IM} = a_{IND} = 0.0021$  per day.

8 **Table 35 : cost and emission characteristics of vehicles**

	BULK						AVERAGE						VOLUME					
	TRUCK				TRAIN		TRUCK				TRAIN		TRUCK				TRAIN	
	<7,5T	7,5T-12T	12T-24T	24T-40T	Elec	Diesel	<7,5T	7,5T-12T	12T-24T	24T-40T	Elec	Diesel	<7,5T	7,5T-12T	12T-24T	24T-40T	Elec	Diesel
average fixed cost (euro per veh)[without rest]	96,33	185,32	220,55	221,68	33 188	33 188	57,80	111,19	132,33	133,01	19 913	19 913	28,90	55,60	66,16	66,50	9 956	9 956
average variable cost (euro per veh per km) [tot]	0,15	0,20	0,26	0,38	8,23	7,62	0,12	0,16	0,20	0,30	7,07	7,53	0,12	0,15	0,19	0,27	5,94	4,02
average total external cost (euro per veh per km)	0,12	0,17	0,27	0,44	7,16	11,14	0,11	0,15	0,24	0,38	6,98	10,15	0,10	0,14	0,22	0,35	6,81	9,18
average external cost air pollutant (Euro/veh.km)	0,04	0,09	0,13	0,22	0,86	4,85	0,03	0,06	0,10	0,16	0,69	3,85	0,03	0,05	0,08	0,13	0,51	2,88
average cost noise (Euro/veh.km)	0,01	0,01	0,02	0,02	2,17	2,17	0,01	0,01	0,02	0,02	2,17	2,17	0,01	0,01	0,02	0,02	2,17	2,17
Average external cost of accidents (Euro/veh.km)	0,04	0,05	0,07	0,13	0,44	0,44	0,04	0,05	0,07	0,13	0,44	0,44	0,04	0,05	0,07	0,13	0,44	0,44
Average external cost of congestion (Euro/veh.km)	0,01	0,01	0,01	0,00	1,38	1,38	0,01	0,01	0,01	0,00	1,38	1,38	0,01	0,01	0,01	0,00	1,38	1,38
Average toll of infrastructure (Euro/veh.km)	0,02	0,02	0,05	0,07	2,30	2,30	0,02	0,02	0,05	0,07	2,30	2,30	0,02	0,02	0,05	0,07	2,30	2,30
Average payload	4,69	8,16	15,63	28,39	1 950	1 950	2,81	4,90	9,38	17,03	1 170	1 170	1,41	2,45	4,69	8,52	585	585
average energy consumption (mJ/veh.km)	5,99	7,78	12,09	20,46	318,65	351,41	4,42	5,71	8,85	14,47	253,24	279,28	3,94	5,02	7,75	11,80	189,56	209,05
average CO2 emission (gram/veh.km)	438,73	570,49	885,85	1 499,83	22 766	25 857	324,09	418,36	648,49	1 060,45	18 093	20 549	288,81	367,65	567,96	864,71	13 543	15 382
average SO2 emission (gram/veh.km)	0,13	0,17	0,26	0,44	10,51	14,52	0,10	0,12	0,19	0,31	8,35	11,54	0,09	0,11	0,17	0,25	6,25	8,64
average NOx emission (gram/veh.km)	1,95	7,53	11,65	19,65	26,10	468,99	1,44	5,52	8,53	13,89	20,74	372,73	1,28	4,85	7,47	11,33	15,53	279,00
average PM10 emission (gram/veh.km)	0,31	0,21	0,33	0,55	0,03	10,65	0,23	0,15	0,24	0,39	0,02	8,46	0,20	0,13	0,21	0,32	0,02	6,33
average NMVOC emission (gram/veh.km)	0,20	0,66	1,04	1,78	0,48	25,95	0,15	0,49	0,76	1,26	0,38	20,63	0,13	0,43	0,67	1,03	0,28	15,44
average CO emission (gram/veh.km)	0,74	1,62	2,11	3,88	2,61	39,79	0,55	1,19	1,54	2,74	2,07	31,62	0,49	1,04	1,35	2,24	1,55	23,67

9  
 10 Finally, as described in **Annex 7**, the cost per ton is simply obtained by dividing the vehicles costs per  
 11 the average payload presented in **Table 35** and by multiplying by the vehicle type associated  
 12 percentage of **Table 34**. The Direct cost (PC costs) per ton is thus:

$$COST_{PC}^{TON} = \%_{BULK}^{Veh,PC} \times \frac{COST_{BULK}^{Veh}}{TON_{BULK}} + \%_{AVERAGE}^{Veh,PC} \times \frac{COST_{AVERAGE}^{Veh}}{TON_{AVERAGE}} + \%_{VOLUME}^{Veh,PC} \times \frac{COST_{VOLUME}^{Veh}}{TON_{VOLUME}}$$

1 **3.1.3.3 Inventory model and modal choice**

2

3 The transportation between two regions can occur directly. It can also goes through warehouses as  
 4 shown in **Figure 73** leading to different tons per shipment as shown in **Figure 74**. In this case, a  
 5 consolidation framework is applied both from producer to distribution center (PD flow) and from  
 6 distribution center to consumption (DC). The different percentages of volume, average and bulk are  
 7 thus modified so that the costs become:

$$COST_{PD}^{TON} = \%_{BULK}^{Veh,PD} \times \frac{COST_{BULK}^{Veh}}{TON_{BULK}} + \%_{AVERAGE}^{Veh,PD} \times \frac{COST_{AVERAGE}^{Veh}}{TON_{AVERAGE}} + \%_{VOLUME}^{Veh,PD} \times \frac{COST_{VOLUME}^{Veh}}{TON_{VOLUME}}$$

$$COST_{DC}^{TON} = \%_{BULK}^{Veh,DC} \times \frac{COST_{BULK}^{Veh}}{TON_{BULK}} + \%_{AVERAGE}^{Veh,DC} \times \frac{COST_{AVERAGE}^{Veh}}{TON_{AVERAGE}} + \%_{VOLUME}^{Veh,DC} \times \frac{COST_{VOLUME}^{Veh}}{TON_{VOLUME}}$$

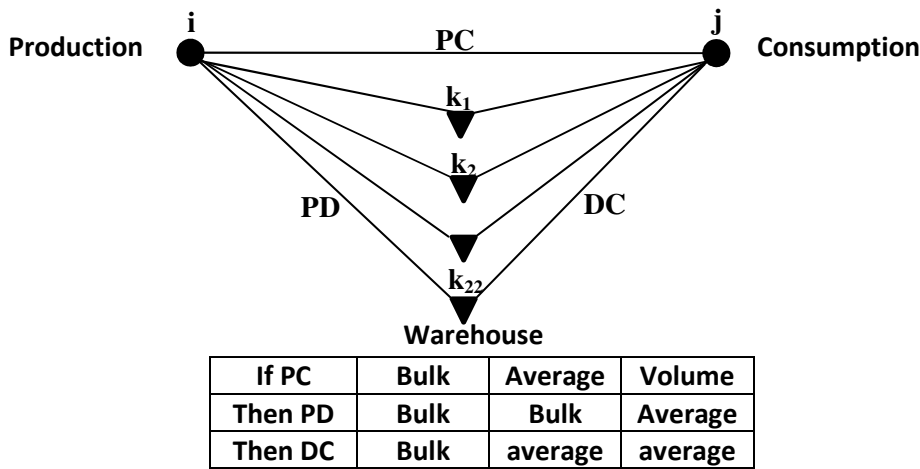

8

9 **Figure 73 : Distinction between direct and indirect transportation**

10 The costs in warehouse are understood as a combination of two costs. First, via physical  
 11 characteristics such as volume density, the amount of space and handling costs in a warehouse can  
 12 be determined (W). Secondly, value characteristics such as capital loss due to value and interest,  
 13 must be taken in to account (I). The following equations show the calculations of the two terms with  
 14 a storage period equals to 4 weeks, handling costs for bulk, average and volume goods of  
 15 respectively 2,3 and 4 euros per pallet. The pallet is taken to have an average weight of 0.5 ton per  
 16 pallet (WP).

$$COST_{WH}^{TON} = COST_W + COST_I \text{ with}$$

$$COST_W = \frac{(\%_{BULK}^{Goods} \times COST_{BULK} + \%_{AVERAGE}^{Goods} \times COST_{AVERAGE} + \%_{VOLUME}^{Goods} \times COST_{VOLUME}) \times WP}{STORAGE PERIOD}$$

$$COST_I = \frac{Value\ density \times WP \times STORAGE\ PERIOD}{52}$$

17 The previous cost framework leads to the results presented in **Table 36** and the final cost to go  
 18 through a distribution center is simply:

$$COST_{IND}^{TON} = COST_{PD}^{TON} + COST_{WH}^{TON} + COST_{DC}^{TON}$$



1 Table 36 : Warehouse costs per ton (reference and non-sustainable functional economy scenarios)

€/T	W	I	€/T	W	I	€/T	W	I	€/T	W	I
GA01	23,39	12,44	GC44	30,38	141,10	GE31	31,88	124,30	GF43	18,40	27,00
GA02	31,07	2,00	GC45	31,70	101,15	GE32	25,96	77,91	GF44	18,40	27,00
GA03	30,61	60,53	GC46	27,79	115,88	GE33	31,70	101,15	GF45	27,69	38,83
GB01	23,95	13,84	GD01	31,86	149,41	GE34	27,79	115,88	GF46	27,69	38,83
GB02	23,95	13,84	GD02	31,86	149,41	GE35	27,79	115,88	GF51	16,79	17,56
GB03	23,95	13,84	GE11	28,53	144,26	GF11	16,00	1,30	GF52	16,79	17,56
GB04	23,95	13,84	GE12	28,53	144,26	GF12	16,08	0,67	GF53	0,00	0,00
GB05	23,95	13,84	GE13	28,53	144,26	GF13	16,12	7,33	GF54	0,00	0,00
GB06	22,14	347,92	GE14	28,53	144,26	GF14	16,12	7,33	GF55	21,42	53,34
GC11	31,67	248,46	GE21	21,42	53,34	GF21	30,85	63,95	GF61	25,96	77,91
GC12	30,47	97,53	GE22	21,42	53,34	GF22	30,85	63,95	GF62	31,70	101,15
GC20	31,98	67,36	GE23	30,38	141,10	GF23	30,85	63,95	GG11	16,00	1,86
GC31	18,40	27,00	GE24	30,38	141,10	GF31	31,71	10,41	GG12	16,00	5,74
GC32	18,40	27,00	GE25	30,38	141,10	GF32	31,60	15,25	GG14	17,22	7,71
GC41	27,66	72,92	GE26	30,38	141,10	GF33	31,60	15,25	GG15	17,22	7,71
GC42	27,66	72,92	GE27	30,38	141,10	GF41	18,40	27,00	GG2A	23,82	81,52
GC43	27,66	72,92	GE28	30,38	141,10	GF42	18,40	27,00	GG2B	0,00	0,00
									GG22	0,00	0,00

2

3 Table 37 : Warehouse costs per ton (sustainable functional economy scenarios)

€/T	W	I	€/T	W	I	€/T	W	I	€/T	W	I
GA01	23,39	12,44	GC44	30,38	176,38	GE31	31,88	186,45	GF43	18,40	27,00
GA02	31,07	2,00	GC45	31,70	126,43	GE32	25,96	97,38	GF44	18,40	29,16
GA03	30,61	60,53	GC46	27,79	144,84	GE33	31,70	151,72	GF45	27,69	58,24
GB01	23,95	13,84	GD01	31,86	186,76	GE34	27,79	115,88	GF46	27,69	41,93
GB02	23,95	13,84	GD02	31,86	186,76	GE35	27,79	173,81	GF51	16,79	17,56
GB03	23,95	13,84	GE11	28,53	144,26	GF11	16,00	1,30	GF52	16,79	17,56
GB04	23,95	13,84	GE12	28,53	144,26	GF12	16,08	0,67	GF53	0,00	0,00
GB05	23,95	13,84	GE13	28,53	144,26	GF13	16,12	7,33	GF54	0,00	0,00
GB06	22,14	347,92	GE14	28,53	144,26	GF14	16,12	7,33	GF55	21,42	53,34
GC11	31,67	310,58	GE21	21,42	66,68	GF21	30,85	63,95	GF61	25,96	77,91
GC12	30,47	121,91	GE22	21,42	66,68	GF22	30,85	63,95	GF62	31,70	101,15
GC20	31,98	84,20	GE23	30,38	176,38	GF23	30,85	63,95	GG11	16,00	1,86
GC31	18,40	33,76	GE24	30,38	176,38	GF31	31,71	13,02	GG12	16,00	5,74
GC32	18,40	33,76	GE25	30,38	211,65	GF32	31,60	19,06	GG14	17,22	7,71
GC41	27,66	91,15	GE26	30,38	211,65	GF33	31,60	19,06	GG15	17,22	9,17
GC42	27,66	91,15	GE27	30,38	176,38	GF41	18,40	27,00	GG2A	23,82	122,28
GC43	27,66	91,15	GE28	30,38	176,38	GF42	18,40	27,00	GG2B	0,00	0,00
									GG22	0,00	0,00

4

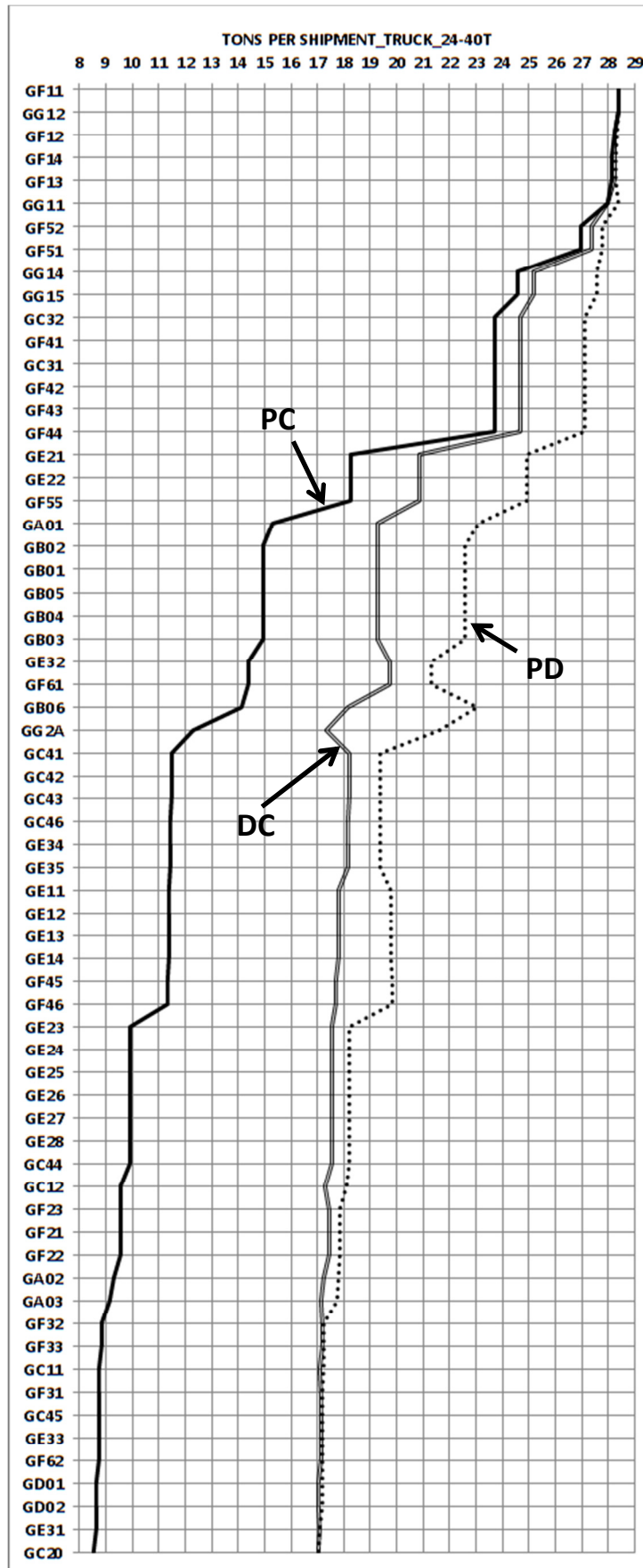

1

2 Figure 74 : Sectorial evolution of tons per shipment for a 24-40T truck (reference scenario)

1 **3.1.4 The gravity model**

2

3 With the previous framework, to go from region i of production to region j of consumption, the  
4 number of paths is quite important as shown below:

- 5 ➤ 6 paths to go directly from region i to region j (PC) corresponding to the six transport modes.
- 6 ➤ 36 X 22= 792 paths to go indirectly from region i to region j corresponding to the possibility to  
7 use combination of the six transport modes (6<sup>2</sup>=36) for production – distribution center (PC) and  
8 distribution center – consumption (DC) paths and the use of a warehouse situated in one of the  
9 22 French region.

10 The issue is thus double. Firstly, the probability of use of each of these 798 paths should be  
11 determined. Secondly, as shown in 3.1.2, for the moment we only know the number of tons  
12 produced and consumed in each region but not their distribution, i.e. from which regions come the  
13 tons consumed in region j and to which regions go the tons produced in region i. As demonstrated in  
14 (Davydenko, et al., 2011) for inventory model IO framework, this is the purpose of the gravity model  
15 to distribute tons to provide a general picture of trade.

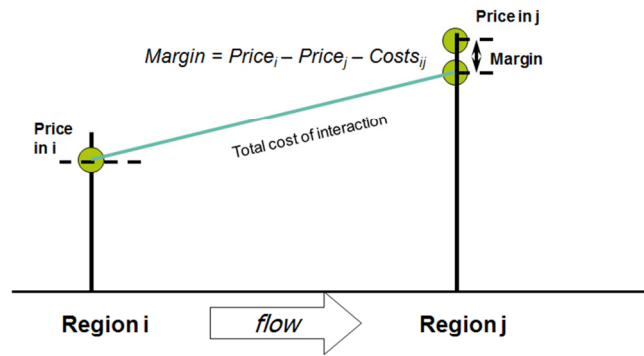

16

17 **Figure 75 : Principles of gravity model**

18 As presented in **Figure 75**, the core idea of gravity model is a spatial interaction based on cost  
19 difference between regions.

$$P_j = P_j + c_{ij} + M_{ij} \Rightarrow M_{ij} = P_j - P_i - c_{ij}$$

$$T_{ij} = Pr_{ij} \times T \quad \text{with} \quad Pr_{ij} = \frac{\exp(M_{ij})}{\sum_{i,j} \exp(M_{ij})}$$

$$T_{ij} = \exp(P_j - P_i - c_{ij}) \times \frac{T}{\sum_{i,j} \exp(M_{ij})} = \exp(P_j) \times \exp(-P_i) \times \frac{T}{\sum_{i,j} \exp(M_{ij})} \times \exp(-c_{ij})$$

20 The final equation thus provides a dependency of the distribution framework to the transportation  
21 costs which we determined before. I will thus apply the nested logit model, i.e. the exponential form  
22 of probability calculation ( $Pr_{ij}$ ) with the following form in which  $\lambda$  (=0.1 in the model) corresponds  
23 to a coefficient stating the sensitivity of trade decision making to the transportation costs.

$$Pr_{ij} = \frac{\exp(-\lambda \times c_{ij})}{\sum_{i,j} \exp(-\lambda \times c_{ij})} \Rightarrow T_{ij} = A \times B \times \exp(-\lambda \times c_{ij})$$

24 In our model, A and B are determined through an iterative process as described in **Annex 7**.

## 1 3.2 Results

### 2 3.2.1 General results of functional economy and external cost framework

3

4 Let us first analyze the results provided for all sectors. The total number of tons traded is for  
5 reference and non-sustainable functional economy scenarios is 1 487 378 019 tons. On the opposite,  
6 the total number of tons traded for the sustainable functional economy scenario is 1 401 437 191  
7 tons. Therefore, the dematerialization framework induced by the methodology developed in **3.1.2**  
8 leads to a diminution of 5.8% of the total tons traded.

9 The scenarios are better distinguished when considering the distribution of tons. Let us first consider  
10 the distribution of tons consumed (**Table 38**) and produced (**Table 39**) for the reference scenarios.  
11 This will lead us to differentiate regions with low trade and high trade patterns. Dealing with **Table**  
12 **38**, only a few regions consumed mainly products coming from their regions. This the case of Alsace  
13 (12%), Aquitaine (14%), Ile de France (16%), Midi-Pyrénées (13%), Pays de La Loire (13%), Provence-  
14 Alpes Côte d'Azur (16%) and Rhône-Alpes (21%).

15 **Table 38: Distribution of tons consumed by regions in reference scenario**

REF	1	2	3	4	5	6	7	8	9	10	11	12	13	14	15	16	17	18	19	20	21	22	23	24	25
1	12%	2%	2%	2%	4%	2%	2%	4%	4%	6%	2%	2%	2%	2%	8%	2%	2%	2%	2%	2%	2%	3%	3%	3%	3%
2	2%	14%	5%	2%	2%	3%	3%	2%	3%	2%	2%	2%	4%	8%	2%	10%	2%	5%	2%	8%	3%	2%	4%	4%	3%
3	1%	3%	5%	1%	2%	1%	2%	1%	2%	2%	1%	1%	3%	3%	1%	3%	1%	1%	1%	2%	2%	4%	2%	2%	2%
4	1%	1%	1%	5%	1%	4%	2%	1%	1%	1%	4%	3%	1%	1%	1%	1%	2%	2%	3%	2%	1%	1%	2%	2%	2%
5	3%	1%	3%	1%	5%	1%	2%	3%	2%	6%	1%	2%	2%	2%	3%	1%	1%	1%	1%	1%	2%	4%	2%	2%	2%
6	2%	3%	2%	8%	2%	11%	4%	2%	2%	2%	4%	4%	2%	3%	2%	2%	2%	10%	3%	5%	2%	2%	4%	4%	4%
7	2%	2%	4%	4%	3%	4%	6%	4%	2%	2%	4%	5%	2%	5%	2%	2%	3%	4%	4%	5%	2%	2%	4%	4%	4%
8	4%	1%	2%	2%	4%	2%	3%	6%	2%	3%	3%	4%	1%	2%	6%	1%	4%	1%	4%	2%	2%	2%	3%	3%	3%
9	0%	0%	0%	0%	0%	0%	0%	0%	8%	0%	0%	0%	0%	0%	0%	0%	0%	0%	0%	0%	0%	0%	0%	0%	0%
10	3%	1%	2%	1%	4%	1%	1%	2%	2%	4%	1%	1%	1%	1%	3%	1%	1%	1%	1%	1%	1%	3%	1%	1%	2%
11	2%	2%	2%	5%	2%	3%	4%	3%	2%	2%	5%	4%	1%	2%	2%	4%	3%	5%	3%	1%	1%	3%	3%	3%	3%
12	8%	7%	7%	14%	11%	11%	16%	15%	7%	7%	17%	16%	5%	7%	12%	6%	15%	11%	17%	11%	6%	7%	11%	11%	13%
13	1%	2%	3%	1%	1%	1%	1%	1%	3%	1%	1%	1%	7%	2%	1%	5%	1%	1%	1%	1%	6%	3%	2%	2%	2%
14	1%	2%	2%	1%	1%	1%	1%	1%	1%	1%	1%	1%	1%	3%	0%	2%	1%	1%	1%	2%	1%	1%	1%	1%	1%
15	9%	2%	2%	2%	5%	2%	2%	6%	3%	5%	2%	3%	2%	2%	8%	2%	4%	2%	3%	2%	2%	2%	3%	3%	3%
16	2%	8%	4%	2%	2%	2%	2%	1%	3%	2%	1%	2%	8%	6%	1%	13%	2%	2%	1%	3%	4%	2%	3%	3%	3%
17	4%	3%	3%	6%	3%	3%	5%	7%	4%	3%	8%	7%	3%	3%	6%	3%	13%	3%	11%	3%	3%	3%	5%	5%	5%
18	3%	7%	3%	6%	2%	13%	5%	3%	3%	3%	4%	4%	2%	6%	2%	3%	3%	13%	3%	9%	2%	2%	5%	5%	5%
19	2%	1%	1%	4%	2%	2%	3%	3%	2%	2%	5%	4%	1%	1%	3%	1%	5%	2%	5%	2%	1%	1%	3%	3%	3%
20	1%	4%	2%	2%	1%	3%	3%	1%	1%	1%	2%	2%	1%	5%	1%	2%	1%	4%	1%	5%	1%	1%	2%	2%	2%
21	3%	3%	4%	2%	3%	2%	2%	2%	9%	3%	2%	2%	13%	3%	3%	5%	2%	2%	2%	2%	2%	16%	7%	4%	4%
22	8%	5%	18%	5%	15%	5%	5%	6%	10%	16%	4%	5%	14%	10%	6%	7%	5%	5%	4%	6%	15%	21%	9%	9%	9%
23	1%	1%	1%	1%	1%	1%	1%	1%	1%	1%	1%	1%	1%	1%	1%	1%	1%	1%	1%	1%	1%	1%	1%	1%	1%
24	0%	0%	0%	0%	0%	0%	0%	0%	0%	0%	0%	0%	0%	0%	0%	0%	0%	0%	0%	0%	0%	0%	0%	0%	0%
25	24%	24%	24%	24%	24%	24%	24%	24%	24%	24%	24%	24%	24%	24%	24%	24%	24%	24%	24%	24%	24%	24%	24%	24%	23%

16

17 **Reading: 12% of the tons consumed in Alsace (region 1, see Table 26) come from the Alsace region while 8% comes from**  
18 **Ile de France (region 12). 24% are imported (region 25)**

19 Dealing with **Table 39**, a few regions are found concentrating productions from other regions. These  
20 regions are Ile de France, Aquitaine, Rhône-Alpes, Provence-Alpes Côte d'Azur, Midi Pyrénées and  
21 Corse. Interestingly, the five first regions cover 46% of the Metropolitan French population. The case  
22 of Corse is particular because the balance deficit for this region is pretty high with a very low  
23 production per capita ratio as shown in **Figure 76**.

1 **Table 39 : Distribution of tons produced by regions in reference scenario**

REF	1	2	3	4	5	6	7	8	9	10	11	12	13	14	15	16	17	18	19	20	21	22	23	24	25
1	11%	2%	1%	1%	3%	2%	2%	3%	1%	3%	1%	13%	2%	1%	9%	2%	4%	3%	2%	1%	5%	8%	1%	0%	15%
2	1%	16%	3%	1%	1%	3%	3%	1%	0%	1%	1%	10%	3%	2%	2%	10%	3%	7%	1%	5%	5%	5%	1%	0%	14%
3	2%	6%	5%	1%	3%	2%	4%	1%	0%	2%	1%	12%	5%	2%	2%	5%	3%	3%	1%	3%	6%	17%	1%	0%	14%
4	2%	2%	1%	5%	1%	8%	4%	1%	0%	1%	5%	24%	1%	1%	2%	2%	5%	6%	3%	2%	3%	4%	1%	0%	14%
5	4%	2%	2%	1%	5%	2%	3%	2%	0%	4%	1%	18%	2%	1%	5%	2%	3%	2%	1%	1%	5%	15%	1%	0%	14%
6	1%	4%	1%	4%	1%	12%	4%	1%	0%	1%	3%	18%	2%	1%	2%	2%	3%	12%	2%	3%	3%	4%	1%	0%	14%
7	1%	3%	2%	2%	2%	4%	6%	2%	0%	1%	3%	27%	2%	1%	2%	2%	4%	5%	3%	3%	3%	5%	1%	0%	15%
8	3%	2%	1%	1%	3%	2%	4%	4%	0%	2%	3%	27%	2%	1%	6%	2%	7%	2%	3%	1%	3%	6%	1%	0%	13%
9	3%	3%	2%	1%	2%	2%	2%	1%	16%	2%	1%	10%	4%	1%	3%	4%	3%	3%	1%	1%	12%	9%	1%	0%	12%
10	5%	2%	2%	1%	6%	2%	2%	2%	0%	4%	1%	13%	3%	1%	5%	3%	3%	3%	2%	1%	6%	16%	1%	0%	15%
11	1%	2%	1%	4%	1%	5%	4%	2%	0%	1%	4%	28%	1%	1%	2%	2%	7%	4%	4%	2%	3%	4%	1%	0%	14%
12	2%	2%	1%	2%	2%	4%	5%	2%	0%	1%	3%	27%	1%	1%	3%	2%	6%	4%	4%	2%	3%	5%	1%	0%	16%
13	2%	4%	3%	1%	2%	2%	2%	1%	0%	1%	1%	8%	11%	1%	2%	9%	2%	2%	1%	1%	20%	12%	1%	0%	13%
14	1%	9%	3%	1%	2%	3%	5%	1%	0%	1%	2%	13%	3%	3%	2%	7%	3%	6%	1%	5%	4%	9%	1%	0%	14%
15	7%	2%	1%	1%	3%	2%	2%	4%	0%	3%	2%	20%	2%	1%	8%	2%	6%	3%	3%	1%	4%	6%	1%	0%	15%
16	1%	11%	2%	1%	1%	2%	2%	1%	0%	1%	1%	9%	8%	2%	1%	16%	2%	3%	1%	2%	8%	6%	1%	0%	14%
17	2%	3%	1%	2%	1%	2%	3%	2%	0%	1%	3%	25%	2%	1%	4%	2%	12%	3%	5%	1%	3%	4%	1%	0%	15%
18	1%	6%	1%	2%	1%	11%	4%	1%	0%	1%	2%	17%	2%	1%	2%	3%	3%	12%	1%	5%	3%	4%	1%	0%	14%
19	2%	2%	1%	3%	1%	3%	4%	2%	0%	1%	4%	29%	1%	1%	3%	2%	10%	3%	5%	1%	3%	4%	1%	0%	15%
20	1%	9%	2%	2%	1%	5%	5%	1%	0%	1%	2%	18%	2%	2%	2%	4%	3%	9%	2%	6%	3%	6%	1%	0%	14%
21	2%	3%	2%	1%	2%	2%	2%	1%	1%	1%	1%	9%	9%	1%	2%	4%	2%	2%	1%	1%	24%	13%	1%	0%	14%
22	2%	2%	4%	1%	4%	2%	2%	1%	0%	3%	1%	11%	5%	1%	2%	3%	3%	3%	1%	1%	11%	20%	1%	0%	15%
23	2%	4%	2%	2%	2%	4%	3%	2%	0%	2%	2%	19%	3%	1%	3%	4%	5%	5%	2%	2%	7%	8%	1%	0%	13%
24	0%	0%	0%	0%	0%	0%	0%	0%	0%	0%	0%	0%	0%	0%	0%	0%	0%	0%	0%	0%	0%	0%	0%	0%	0%
25	2%	4%	2%	2%	2%	4%	3%	2%	0%	2%	2%	19%	3%	1%	3%	4%	5%	5%	2%	2%	6%	8%	1%	0%	14%

2

3 *Reading: 11% of the tons produced in Alsace (region 1, see Table 26) go to the Alsace region while 13% go to Ile de France*  
4 *(region 2). 15% are exported (region 25)*

5 The dematerialization effect of functional economy leads to a diminution of both production and  
6 consumption per capita ratio for all regions. Nevertheless, from a balance viewpoint, the patterns are  
7 quite different. If all regions with a deficit in reference and non-sustainable functional economy  
8 scenarios find their deficit diminishing, those with trade surplus are divided into two groups. Indeed,  
9 Champagne Ardennes, Picardie, Auvergne, Alsace, Bourgogne, Pays de La Loire and Franche Comté  
10 are regions experiencing an increase of their trade surplus.

11 The next section study in more details the difference observed between the six scenarios by  
12 considering a particular sector “Manufacture of pharmaceuticals, medicinal chemicals and botanical  
13 products” (GC31), a consumer good category which covers as much as 43 million tons (2.9%) and 34  
14 million tons (2.5%) respectively for the reference/non-sustainable functional economy and  
15 sustainable functional economy scenarios. The choice of this sector was guided by the necessity to  
16 take a sector for which functional economy applies and for which production is expressed in tons and  
17 not only money. As presented in **Table 28**, only 33 sectors remain and GC31 corresponds to the  
18 sector representing the highest share of total tons traded among these sectors. The modeling  
19 framework presented nevertheless allows the realization of the same study for all sectors.

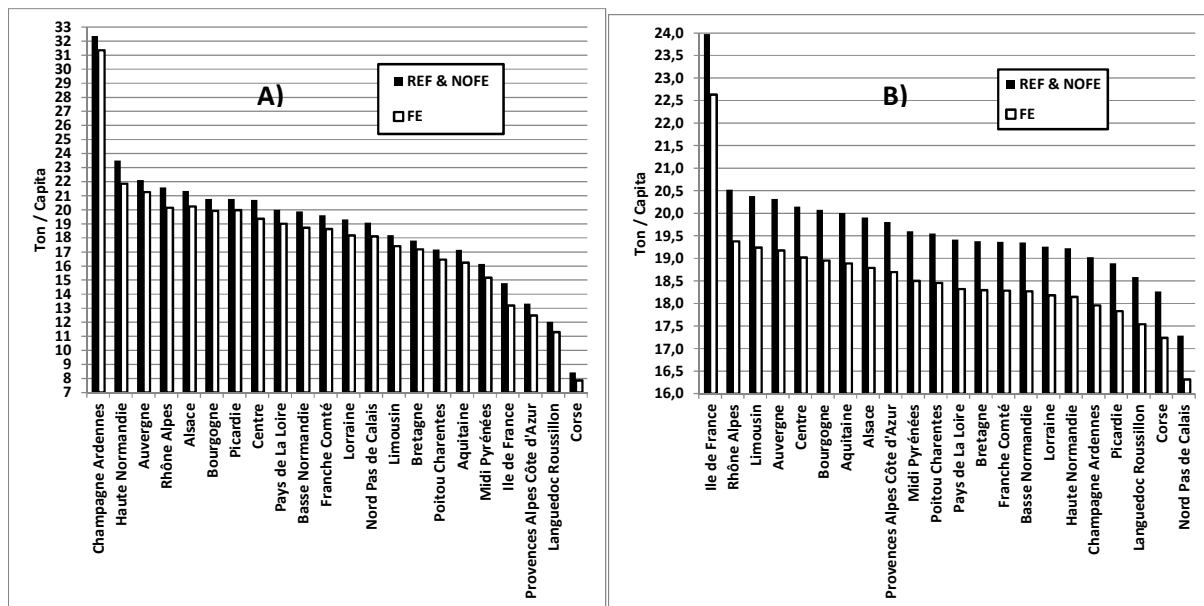

1

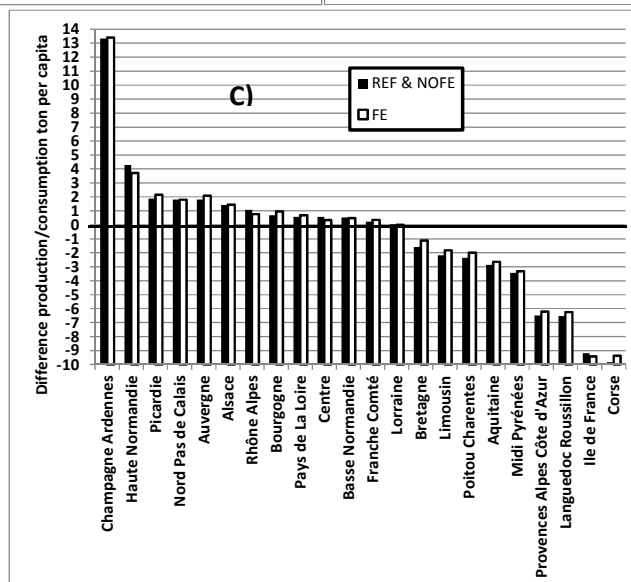

2

3 **Figure 76 : A) Tons produced per capita. B) Tons consumed per capita. C) Ton regional balance per**  
 4 **capita.**

5 **3.2.2 Particular study of “Manufacture of pharmaceuticals, medicinal chemicals and**  
 6 **botanical products”**

7

8 Though the total tons produced and consumed in each region sum up to 43 million tons, the  
 9 interregional trade between the 22 French regions only covers 23.5 million tons, i.e. 55% of the total  
 10 ton traded. Indeed, 37% of the 43 million tons concerns exports and imports, the remaining  
 11 concerning trade with and within overseas departments and extraterritorial activities. The first effect  
 12 of functional economy as derived from the dematerialization hypothesis made in the methodology  
 13 leads to a diminution of 20% the tons traded between regions with 18.8 million tons. Secondly,  
 14 through the six scenarios, the regional distributions of traded tons are changing. Representing 19.4%  
 15 of the interregional traded tons for the reference scenario, it evolves to 19.7% and 19.2%  
 16 respectively for the non-sustainable functional economy and sustainable functional economy  
 17 scenarios. The effects of functional economy are thus weak in comparison to the effects of external

1 costs. Indeed, the external costs increase the share of intraregional trade from 19.4% to 21.6% for  
 2 the reference scenario, from 19.7% to 22.3% for the non-sustainable functional economy scenario,  
 3 and from the 19.2% to 21.9% for the functional economy scenario. These effects of external costs are  
 4 further confirmed by the extension of cost per ton spectrum as shown in **Figure 77**.

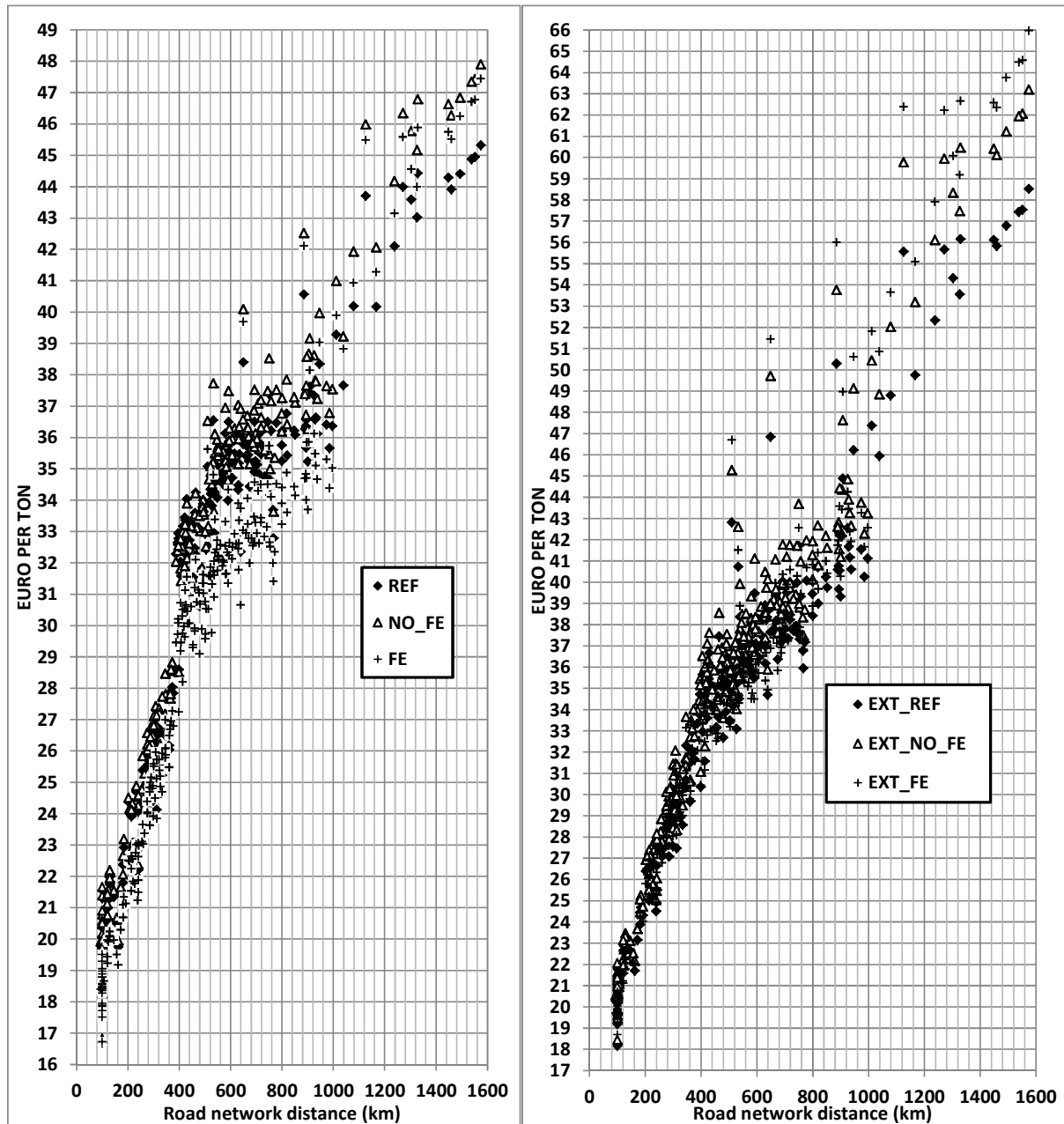

5  
 6 **Figure 77 : Evolution Cost per ton according to distance and scenarios**

7 Going further, **Figure 77** shows that functional economy scenarios provide an inversion of the cost  
 8 per ton diminishing the cost per ton for low distance and increasing the cost per ton for high  
 9 distance. From **Figure 77**, three areas can be distinguished, below 400 kilometers for which the cost  
 10 per ton of sustainable functional economy scenario (FE) is slightly lower than the one of reference  
 11 scenario (REF), between 400 and 1000 kilometers for which the difference between the two  
 12 scenarios is higher, and above 1000 kilometers for which the order is inverted. External costs  
 13 concentrate the cost per ton borderlines by diminishing the inversion limit of the 1000 kilometers.

1 This point is further confirmed by **Figure 78** which presents the share of direct shipment for each of  
2 the six scenarios. The share of direct shipment translates the importance of warehouse use which as  
3 described in our methodology allows a consolidation of shipment (PC and DC). Comparing in a first  
4 step the three scenarios without external costs (REF, NO\_FE, and FE), the three areas (<400km, 400-  
5 1000 km, >1000 km) appear clearer. The share of direct shipment is very high for the first area  
6 corresponding to short distance before considerably diminishing in two steps (400-600 km and 600-  
7 1000 km). Finally, the share of direct shipment is found increasing again above 1000 km staying  
8 around the level reached for the 400-600 km area. More interestingly are the totally different effects  
9 of scenarios on direct shipment shares as the sustainable functional economy scenario (FE)  
10 considerably favors direct shipments. On the opposite, the non-sustainable functional economy  
11 scenario slowly favors shipment via warehouse.

12 Let us now examine the effects of external costs. For the reference scenario, the external costs  
13 mainly induce more direct shipments especially for the 400-1000 km area but do not imply very  
14 different patterns for distance superior to 1000 kilometers. The story is quite different for functional  
15 economy scenarios may it be sustainable or not as the share of direct shipment for distances superior  
16 to 1000km diminishes for external costs scenarios meaning that warehouses become more used for  
17 such distance. It also means that in spite of the higher distance driven due to warehouses, their use  
18 leads to a diminution of transportation costs due to consolidation. Nevertheless, as shown in **Figure**  
19 **79**, the tons going through warehouses clearly diminished with a scenario evolution towards  
20 functional economy. This way, while in the reference scenario, tons going through warehouses cover  
21 as much as 10.3% of interregional traded tons, it diminishes down to 5.6% for the sustainable  
22 functional economy scenario (FE). The same kind of evolutions is observed for the scenarios with  
23 external costs as the share of tons going through warehouses changes from 8.2% into 4.6% when  
24 moving from reference scenario (EXT\_REF) to sustainable functional economy scenario (EXT\_REF). On  
25 the opposite, the non-sustainable functional economy scenarios (NO\_FE and EXT\_NO\_FE) almost  
26 have no influence on the number of tons going through warehouse (10.2% vs. 10.3% without  
27 external costs and 8.4% vs. 8.2% with external costs). If we consider the regions with highest and  
28 lowest tons in warehouse, not surprisingly, we found the regions with highest and lowest share of  
29 population. This way, with 11.5 million inhabitants, the tons in Ile de France's warehouses amount to  
30 198 000 tons while those of Corse with 296 000 inhabitants amounts to 5 498 tons. The previous  
31 figures are for reference scenario and lead to a ratio of 36 between Ile de France and Corse. This  
32 ratio increases up to 83 for sustainable functional economy scenario with external costs (EXT\_FE), 55  
33 for the scenario without external costs (FE). The patterns of warehouses for other regions are less  
34 clear though Haute-Normandie and Champagne-Ardennes are for examples regions with highest  
35 share of ton produced per capita. Nevertheless, though an important producing region (high ton  
36 produced per capita ratio), Rhône-Alpes scores very low, reaching the 14<sup>th</sup> rank, in terms of tons  
37 stored in warehouses. Similarly, Provence-Alpes -Côte d'Azur, a highly populated region, scores very  
38 low in terms of tons stored in warehouse. This can be explained through the dissymmetry existing  
39 between production and consumption places of pharmaceuticals, medicinal chemicals and botanical  
40 products. Indeed, Ile de France, Rhône-Alpes and Centre cover 54% of tons produced while Ile de  
41 France, Rhône-Alpes and Provence-Alpes-Côte d'Azur cover 40% of tons consumed.



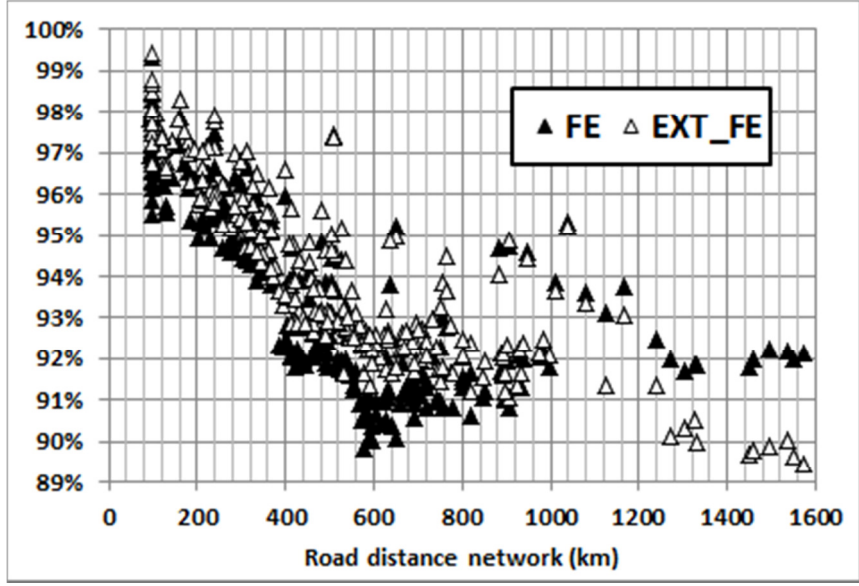
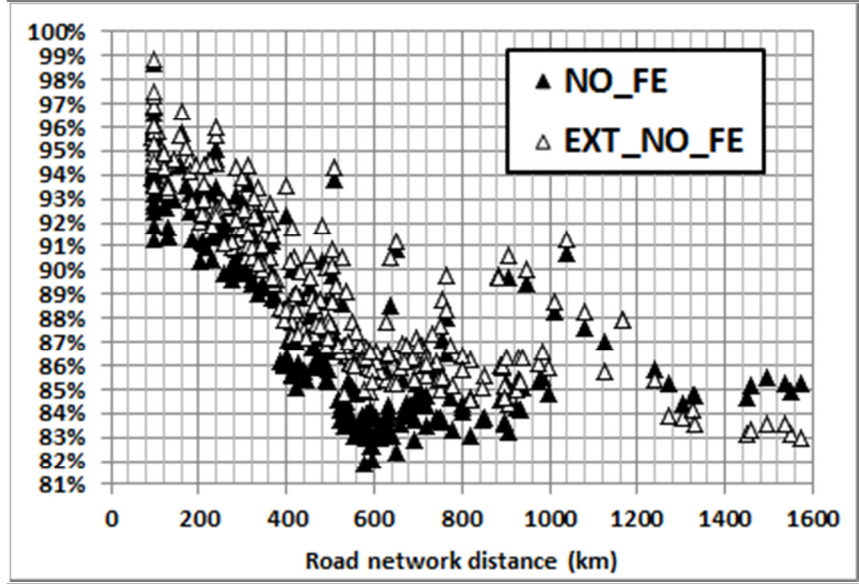
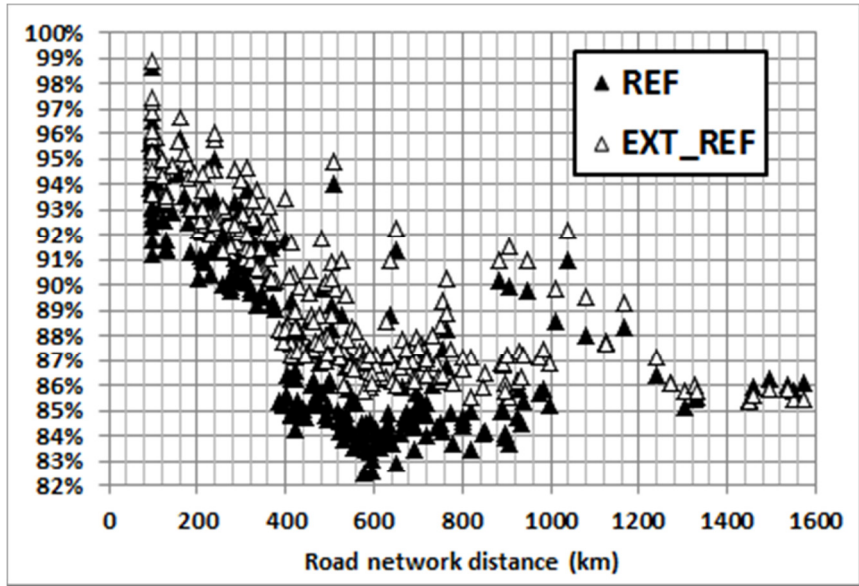

4 Figure 78: Sensitivity of direct shipment choice to distances for different scenarios

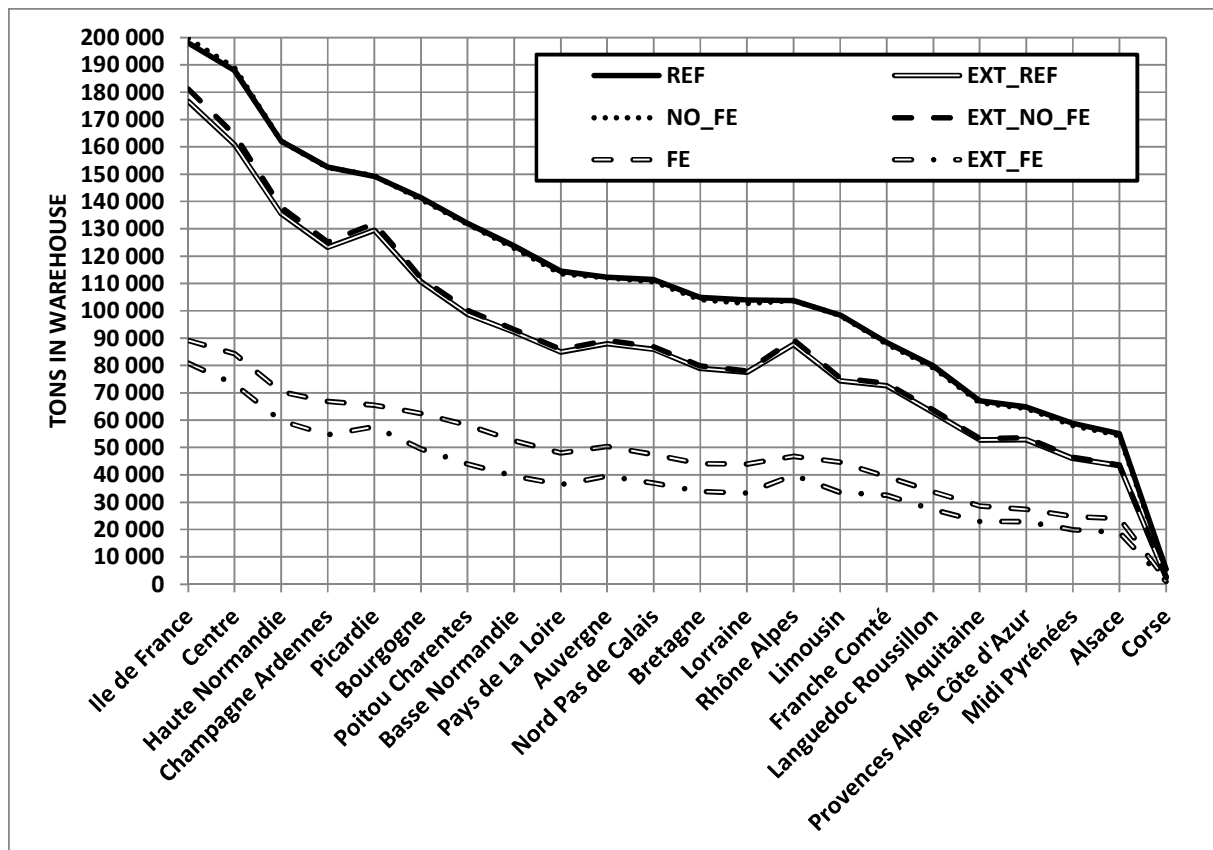

1

2 **Figure 79 : Tons going through warehouses for pharmaceuticals, medicinal chemicals and botanical**  
 3 **products**

4 Let us now analyze the evolution of the modal split with scenarios by considering **Figure 80**. The  
 5 differentiation between the effects of external costs and transition towards functional economy  
 6 appears here clearer. While the evolution towards sustainable functional economy scenario (vertical  
 7 reading) totally transforms the picture for distance driven superior to 400 km, the effects are much  
 8 less impressive for tons transported below 400 kilometers. Ultimately, in the sustainable functional  
 9 economy scenario, three areas can be clearly distinguished. Below 400 km, the rail share does not  
 10 exceed 45%. Between 400 and 600 km, there is a transition so that the rail share slowly increases  
 11 from 60% to 75%. Finally, above 600 km, the rail share is almost constant reaching 90%. The external  
 12 costs appear more efficient in shifting road transportation to rail transportation. For example,  
 13 considering the below 400 km area, the rail share for the reference scenario (REF) varies between  
 14 25% and 40% while the external costs scenario (EXT\_REF) transforms this variation are to 30%-50%.  
 15 The same kind of variations are observed for non-sustainable functional economy scenario (25-40%  
 16 to 30%-55%) and for sustainable functional economy scenario (30-45% to 35%-60%). The positive  
 17 effects of external costs on rail share are nevertheless diminishing with distance and its effects are  
 18 negligible for distance superior to 600 kilometers.

19 The difference of effects between functional economy and external costs can be easily understood if  
 20 we considered the core difference in logics between road and rail transportation from one part and  
 21 between principles of functional economy and external costs as introduced in our methodology and  
 22 for the other part. Functional economy favors movement towards flexible and professional world, i.e.  
 23 worlds for which customized demand, frequency, reliability and flexibility are important  
 24 characteristics. Therefore, these two worlds are dependent on logics other than economy of scale.

1 But rail transportation because of its high fixed costs is mainly a transportation mode adapted to  
 2 scale economy logics. Therefore, it is not surprising the functional economy scenarios do not modify  
 3 the predominance of road transportation for short distances. On the opposite, for long distance  
 4 transport, the scale economy appears more predominant so that the rail share increases. The logic  
 5 associated with external costs is completely different since as shown in **Figure 81** the external costs is  
 6 applying to every km driven in a uniform way. Similarly, **Figure 81** shows the considerably higher  
 7 emission costs associated with road transportation in comparison to rail transportation<sup>143</sup>.

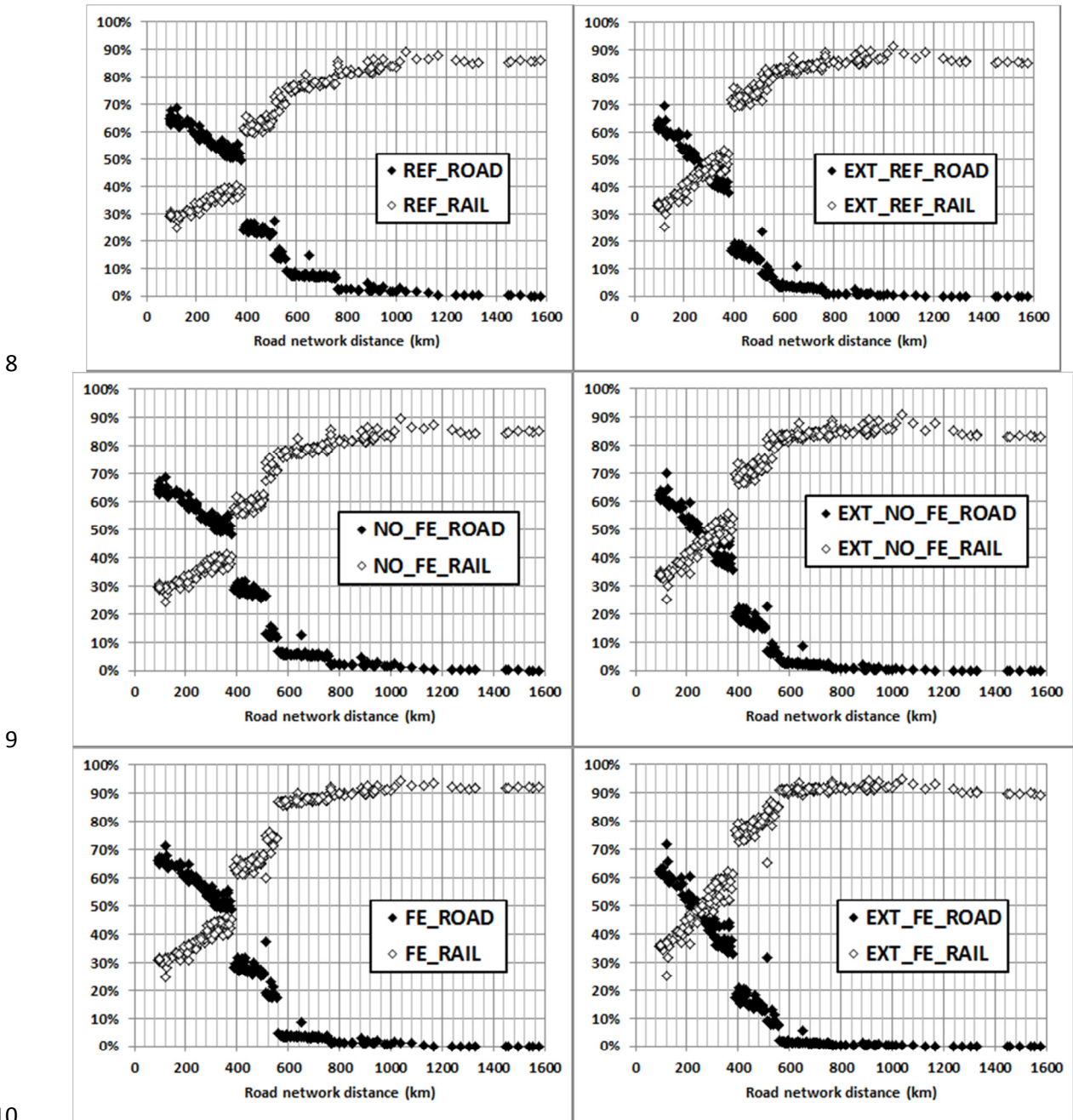

11 **Figure 80 : Modal splits for direct shipments as a function of scenarios and distance driven on the**  
 12 **road network.**

<sup>143</sup> Nevertheless, the electric rail transportation emissions are taken from a Dutch database. Therefore, the particularity of nuclear based electricity for France (low CO2 emission, 73 kg/kWh according to (EcoTransIT, 2011)) is not taken into account.

1 The external costs have thus the most important effects on the area for which road transportation is  
 2 predominant, i.e. when distance driven is below 400 kilometers. The best rail shares are nevertheless  
 3 achieved when functional economy and external costs framework are applied together.

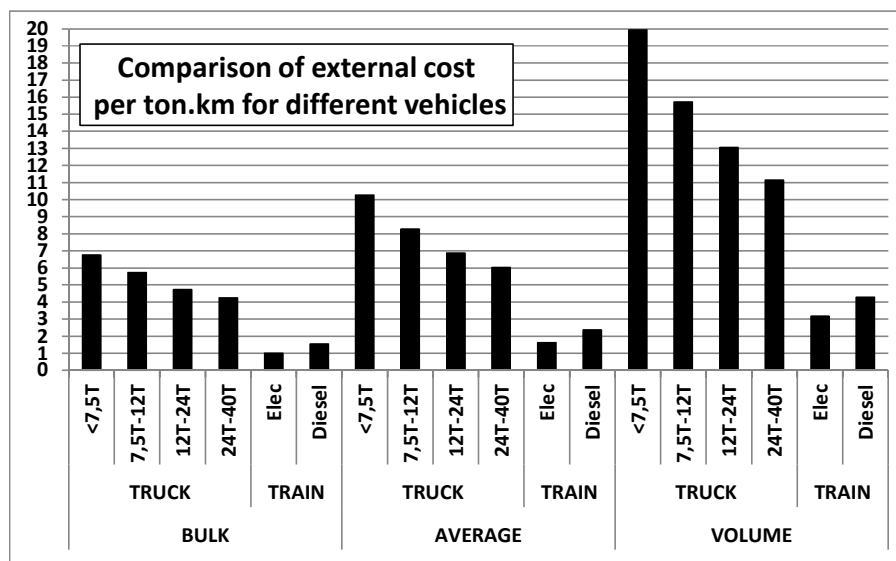

4  
 5 **Figure 81 : External cost per ton.km comparison with bulk electric train as a reference (=1)**

6 Finally, when examining the emissions associated with the transportation framework, the best  
 7 reduction is also achieved for a combination of functional economy and external costs strategies.  
 8 Nevertheless, taken alone, the external costs strategy is much more efficient as 13% of CO<sub>2</sub> reduction  
 9 is recorded for this strategy against only 3% for functional economy. The change towards a flexible  
 10 world which characterized the non-sustainable functional economy even leads to a general 5%  
 11 increase for all emissions. In conclusion, one can see here the general necessity for better  
 12 considering the specificity of the resources from an environmental viewpoint and not only through  
 13 the customization aspects. External costs by putting a price on emissions help taking into account  
 14 specificity of environmental resources better than in the usual framework even if it is in a  
 15 standardized way. This demonstrates the need to establish environmental and service supply chain  
 16 studies in which the specific character of resources and demand will receive all attention. It notably  
 17 implies the development of new statistical typologies adapted to micro-economic analysis and which  
 18 should be based on the property approach developed in Chapter V.

19 **Table 40 : Emissions associated with interregional transportation of pharmaceuticals, medicinal**  
 20 **chemicals and botanical products**

	NRJ (TJ)	CO <sub>2</sub> (kT)	SO <sub>2</sub> (T)	NO <sub>x</sub> (T)	PM <sub>10</sub> (T)	NM <sub>VOC</sub> (T)	CO (T)
REF	3 340 (100%)	244 (100%)	90 (100%)	2 837 (100%)	81 (100%)	226 (100%)	474 (100%)
NO_FE	3 499 (105%)	256 (105%)	94 (105%)	2 977 (105%)	85 (105%)	237 (105%)	498 (105%)
FE	3 236 (97%)	236 (97%)	88 (99%)	2 760 (97%)	77 (95%)	217 (96%)	451 (95%)
EXT_REF	2 917 (87%)	213 (87%)	81 (91%)	2 397 (85%)	67 (82%)	186 (82%)	385 (81%)
EXT_NO_FE	3 018 (90%)	220 (90%)	84 (94%)	2 482 (87%)	69 (85%)	192 (85%)	399 (84%)
EXT_FE	2 729 (82%)	199 (82%)	78 (86%)	2 240 (79%)	61 (75%)	171 (76%)	351 (74%)

## 4 Conclusion

The present chapter was divided in two main parts, the first one concerning the review of quantitative transportation models and the second one presenting a basic dematerialization model based on functional economy principles. Within the review process, two main obstacles to a sustainable approach of functional economy were found. The first one concerns the characterization of goods themselves. Indeed, so far, the physical classification of goods such as the Nomenclature des Transports (NST) got mainly interested in very basic characteristics such as atom types (iron, copper, etc.) or vegetable types (wheat, barley, etc.). Therefore, the goods are classified in a standardized way as the properties used to classify them does not concern their role within ecosystems and the interactions between users and goods. Similarly, spatial interactions are mainly considered through a cost minimization process and the specificities of interactions are usually missing from transport modeling. Nevertheless, recent trends show an increasing importance given in research to the framework of proximity. Therefore, more attention is driven on supply-demand interactions which lead to the establishment of new typologies mixing production, convention and logistic approach. One of these typologies was used in the dematerialization model and considered four distinct worlds dealing with the dichotomy specific/generic both for resources and demand. The first world is the industrial world characterized by mass production for a standardized demand. The second world is flexible world characterized by a mass production for a customized demand. The third world is professional and combines a specific approach of demand and resources. Finally, the fourth world is immaterial and if resources are specifically combined, their diffusion to the demand side mainly standardized through Information and Communication technologies (ICTs). Proximity in terms of face-to-face interactions and non-market interactions are key characteristics of the professional world and immaterial world. On the opposite, the industrial world does not focus so much on information exchange while the flexible world is mainly interested by standardized information system such as Electronic Data Interchange (E.D.I). This implies that the creation of resources and the associated transformation into products (standardized or not) are mainly developing outside the market world with a high focus on proximity patterns. The main difficulties for transportation quantitative modeling are thus linked to the ability of modeling these non-market interactions during the resource creation phase and the service approach for long lifetime products.

For the purpose of our modeling framework, functional economy was modeled through two ways. Firstly, a non-sustainable functional economy approach considered an evolution from industrial to flexible world meaning the focus was made on a customization of demand side. Secondly, a sustainable functional economy approach considered an evolution from industrial to professional world meaning the focus was not only made on a customization of demand side but also on a better approach of resource specificities and non-market interactions. It was found a dematerialization framework of 5.8% of the total tons traded for the sustainable functional economy – scenarios. Besides, the air pollutant emissions were found increasing by 5% in the case of non-sustainable functional economy scenario against a 1-5% decrease in the case of sustainable functional economy scenario. These three scenarios were completed with three other scenarios taking into account environmental costs through a tax framework as presented in **Annex 6**. The diminution of air emissions is much more important in these cases reaching 9-18% for single application of external cost framework and 14-26 % in the case of a combination of functional economy strategy. This confirms the importance of taking better specific approach of environmental effects and ecosystems.

1  
2  
3  
4  
5  
6  
7  
8  
9  
10  
11  
12  
13  
14  
15  
16  
17  
18

# *General Conclusion*

# 1 Research questions and methodology

2

3 The present dissertation focused on the analysis of the triptych sustainability/supply chain  
4 management/circular and functional economy. The main idea was to test the promising sustainable  
5 strategies, functional and circular economies, in regards to the objective of a sustainable circulation  
6 of goods. This point was clearly expressed in the general introduction under the form of our second  
7 research question “How strategies of functional and circular economy can influence the conception  
8 of sustainable circulation processes of goods?” However, as the circulation processes of goods are at  
9 the core of economic exchanges, it was also expected that functional and circular economies  
10 strategies could provide guidelines in regards to the conception of sustainable socio-economic  
11 systems. The main goal thus consisted in determining the conditions (circulatory conditions) for a  
12 sustainable application of the promising strategies of functional and circular economy.

13 Nevertheless, from a methodological viewpoint, functional and circular economies could not be  
14 apprehended directly. The main reason lies in the novelty approach of functional and circular  
15 economies for the analysis of economic models, meaning that relatively little literature is available on  
16 the subject. This fact is even truer for the analysis of supply chain management and  
17 functional/circular economies linkages for which no literature was found to exist. This work is thus a  
18 pioneering work aiming at including first theoretically and secondly as much as possible practically  
19 functional/circular economies strategies in the general framework of economic theories and supply  
20 chain management. This explains why a huge part of the present dissertation laid interest on the  
21 linkage between supply chain management and sustainability before dealing with the place of  
22 functional/circular economies strategies. The general methodology logical structure of the  
23 dissertation is thus the following and covers six fundamental aspects:

## 24 1) Place of exchanges in economic theories

25 In this first step of research, the main question consisted in understanding how exchanges are  
26 represented in the economy. The two aspects of this analysis covered the accounting systems and  
27 the economic theories of value. In this framework, the aim was to characterize the nature of what is  
28 exchanged during an economic transaction and the reasons advocated to justify the ways economic  
29 transaction are occurring within the current socio-economic framework.

## 30 2) Place of sustainable management in economic theories

31 From the previous discussion on the nature of exchanges, some key questions remained linked to the  
32 place of time and space, two characteristics of circulation processes. Therefore, the second step of  
33 research consisted in understanding the place of supply chain management in economic theories.  
34 Within this step, the key issue was to determine the evolution of the place given to logistics and  
35 transportation in economic theories.

## 36 3) Linkage between sustainability and supply chain management

37 The third step of my research consisted in a review of the sustainability attempts to address the  
38 environmental degradation characterizing our current society. The main goal here was to show the  
39 limitations of current environmental strategies and the relative inadequacy of dominant economic  
40 theories to frame sustainable societies.

1           4) Functional/circular economies and sustainability of exchange

2   The first three steps were dedicated on describing the current situation of the relationships made  
3   between sustainability and supply chain management. This notably led to consider as a relative  
4   failure the current attempts made towards sustainability. Therefore, the fourth step of my research  
5   dealt with the novelty approach of functional/circular economies and the expected advantages in  
6   regards to sustainability.

7           5) Functional/circular economies and sustainability of circulation processes

8   Nevertheless, in the same way dominant economic theories laid little interest on the circulatory  
9   aspects, functional/circular economies strategies in their description usually found in literature do  
10   not consider logistics and transportation aspects. Therefore, the fifth step of my research consisted  
11   in developing the criticism of functional/circular economies strategies from the viewpoint of  
12   sustainable supply chain management.

13           6) Conditions for sustainable application of functional/circular economies strategies

14   Putting the fifth previous steps into a consistent framework, the sixth step consisted in the  
15   determination of the conditions for sustainable application of functional/circular economies  
16   strategies. These conditions framed the answers to the two research questions as it will now be  
17   discussed in the next section.

18   **2 Findings and results**

19  
20   As explained in the methodology framework above, several question needed to be answered before  
21   being able to understand how strategies of functional and circular economy could influence the  
22   conception of sustainable circulation processes of goods. The first one concerns the definition of  
23   sustainability itself. It was found that in the area of practical policy the question of sustainable  
24   development was divided in three main fields: economic, environmental, and social as shown in  
25   **Figure 82**. The key issue of sustainability thus concerns the representations of resources, discharges  
26   and welfare and how the “production – consumption – circulation” system of goods is organized to  
27   fulfill these representations.

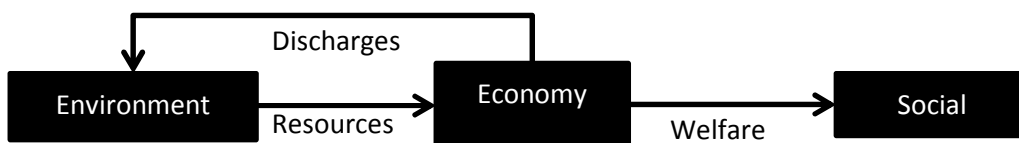

28  
29   **Figure 82 : the links between economy, social, and the environment in the current sustainability**  
30   **framework**

31   In other terms, the “production – consumption – circulation” system of goods was found dependent  
32   on the conventions ruling the representations of welfare, resources and discharges. Particularly, as  
33   shown in Chapter I, within the usual Brundtland framework of sustainability, economic growth was  
34   found to be both the main enabler of welfare and the cause of resource depletion and discharges  
35   increase.



1 Consequently, sustainability itself appeared as an unstable convention asking for stronger  
2 approaches of the link between welfare, resource consumption and control of discharges. Therefore,  
3 the study of the conventions existing behind the representation of human activities and economic  
4 exchanges was a fundamental first step. It was found human activities were only represented as  
5 money flows. Indeed, may it be the system of national accounts or the firm accounting system, only  
6 money flows are recorded. The subordination of all goods to the network of money flows as prices  
7 was found possible because of the establishment of common nomenclatures between economic  
8 actors supposedly able to capture the different realities of exchange and the theories of value. The  
9 theories of values were found consisting in an objective definition of value as existing before the  
10 exchange so that the exchange is only a realization of this value. Wages, different objects, means of  
11 production etc. have thus a secret origin which allows a perfect connection to the monetary network.  
12 In this perspective, the economic debate is reduced to disagreements about the nature of “value”.  
13 For example, for classical economists (1700 -1850), the nature of “value” is related to “work” while  
14 for neoclassical economies (1850 – present) the nature of “value” is related to the concept of  
15 “utility”. This objectivity of exchange was notably found having important consequences on the  
16 representation of circulation processes. Indeed, since the exchange cannot modify the value  
17 embodied in goods and only represents the realization of “natural” transactions, there is no need to  
18 attribute any properties to the exchange and the fact that these exchanges are happening in real  
19 economic life in particular places located in time and space does not need to receive special interest.  
20 The circulation processes are thus entirely viewed as abstract processes and production places  
21 (firms) as profit centers and consumption places as expression of strict individuality. This strict  
22 individuality notably operates by the establishment of a unique price for each good and results from  
23 the solving of the Walrasian general equilibrium equations, which in a way confirms the treatment of  
24 goods in exchange as unalterable atoms with an eternal value. In conclusion, space and time are  
25 reduced in a zero dimension leaving aside the concrete world and notably the fact that production  
26 and consumption are localized in space and do not constitute instantaneous processes.

27 However, from an environmental and social viewpoint, the present dissertation showed that  
28 sustainability appears based on a multi –network of which individuals constitute the important  
29 nodes. The core aspects of sustainability were notably found related to the acknowledgement of  
30 specificity of resources over abstract generalization of resource. These resources are both material  
31 and immaterial, leading to the acknowledgement of local patterns of ecosystems and the importance  
32 of knowledge construction and interaction. The flows of goods within the economy must thus appear  
33 at the service of the nodes (territories and individuals) and should respect external constrains such as  
34 ecosystem properties and other limits established locally which we can call territorial properties.  
35 From the viewpoint of economic theories, it notably implies to better consider the role of time and  
36 space in exchanges and consequently bring a higher focus on logistics decision as logistics should be  
37 understood as a tool of management of time and space. This also led to attribute a greater focus on  
38 the role of money, outlets and proximity in the concrete world of transportation and logistics.  
39 Particularly, I showed that money in the concrete world was a complex network linked with the issue  
40 of power, trust and legitimacy, far from the ideal non-violent and perfect coordination attribute it  
41 has in economic theories. Similarly, proximity revealed that an economic exchange is a complex  
42 construction dealing with resources identification and the organization of these resources so that  
43 production processes can take place and find outlets in consumption. Therefore, space and time are

1 unavoidable characteristics of “production – consumption – circulation “systems, may it be the  
2 current unsustainable socio-economic system or future sustainable systems which remain to define.

3 Therefore, the place of logistic systems appears much clearer. Dealing with the spatial and temporal  
4 aspects of exchange, logistic systems are dependent on the place given to time and space in the  
5 representation of exchanges. Therefore, within the current socio – economic system in which time  
6 and space are negated, little interest is made on logistic systems. There is indeed no need for supply  
7 chain management since coordination processes are ensured by price mechanisms. Nevertheless,  
8 grasping a part of the reality of coordination processes, logistic systems appear as a key for revealing  
9 the unsustainable patterns of the current socio – economic system in spite of being in a deadlock as  
10 being dependent on the beliefs of this socio – economic system. Therefore, within new theoretical  
11 patterns such as those of circular and functional economies, logistic systems will receive more  
12 interest and reveal themselves as key enablers of sustainable development.

13 The next step of the dissertation was thus to understand the particularity of the approach associated  
14 with circular economy from one side and functional economy from the other side. The answer was  
15 found in a first step by stating the origin of the environmental unsustainability of the current socio-  
16 economic system. Indeed, chapter III showed that environmental unsustainability was directly linked  
17 to the borders settled by accounting systems and the monetary network. Therefore, though the  
18 environmental issue has revealed the importance of supply chain management, environmental  
19 supply chain analysis is still missing product delivery – waste phase occurring within human societies  
20 (gate to grave) and the waste – resources phase (grave to cradle). Actually, supply chain  
21 management and life cycle analysis share a common characteristic which is to extend the usual  
22 boundaries of economic system. As a matter of fact, following **Figure 82**, the main source of  
23 unsustainability in the current socio-economic framework was found to be a too high focus on the  
24 economic aspects and notably the production system. On the opposite, circular economy equilibrates  
25 the focus by adopting a cradle to cradle approach dealing with environment. Similarly, functional  
26 economy equilibrates the focus by giving more importance on the social aspects. This is why “circular  
27 economy” and “functional economy” constitute rupture strategies as they totally go against the  
28 dominant economic theories. These two strategies were thus studied in chapter IV and their  
29 potential as sustainable strategies assessed. The main promising innovations associated with these  
30 new economic patterns from an environmental viewpoint concerned the reintroduction of waste  
31 within the economy (circular economy) and the extension of product life (functional economy).  
32 Actually, even the environmental analysis of supply chains as studied in chapter III tends to stop at  
33 the gate of customer’s use phase (cradle to gate) when a transfer of product ownership happens  
34 between the producer and the consumer. Therefore, the consumer side is only taken into account as  
35 long as an ownership link can be made by the producer. Consequently, a disconnection occurs  
36 between the act of supplying products and the moment these products become waste and between  
37 the act of supplying products and the moment and ways products are used.

38 The first strategy “to reintroduce waste within the economy” consists in considering that wastes can  
39 be turned into resources. Consequently, wastes become part of the sourcing strategies of industries.  
40 In this perspective, following **Figure 82**, resources and discharges should thus be treated the same  
41 way. The second strategy “extension of product life” targets the use phase of products and considers  
42 products as particular assets developed for the fulfillment of consumption functions. Therefore, the  
43 issue of welfare was found subordinated on a service approach. The key questions remaining were

1 thus related to the conditions to transform these strategies into sustainable approaches. For this  
2 purpose, I first considered the definition of waste itself. Indeed, wastes are products holding a  
3 complex structure which suddenly get disabled functionality. Therefore, wastes are specific resources  
4 as they are issued from a specific approach of consumption (functionality). For this reason, to find  
5 direct reuse or application of wastes appears difficult and a transformation process of waste into  
6 generic resource becomes necessary. Depending on how far they go into the generic transformation,  
7 these transformation processes are labeled “remanufacturing” or “recycling activities”. The core  
8 sustainable promises of the circular economy strategy thus concern the fact that as wastes are  
9 reintroduced within the economy, generic resources taken from the natural environment are less  
10 depleted than in a usual linear economy. However, the circular economy has several drawbacks  
11 characteristic of its circular process. Actually, putting aside the necessity of the existence of recycling  
12 and remanufacturing activities, the availability of wastes as resources is dependent on the amount of  
13 produced products through the product supply chain and the time these products stayed in the use  
14 phase. The first risk of circular economy is thus linked to the degeneration into a status quo which  
15 legitimates a certain level of consumption by a poor understanding of the environmental issue of  
16 resource consumption. As a matter of fact, the strategy of using wastes as resources is primarily a  
17 strategy to diminish the depletion of the virgin natural resources. From an environmental viewpoint,  
18 this situation is of course better than the initial one marked by a high depletion of natural resources.  
19 But it does not mean that the current level of resource consumption is sustainable. This point is even  
20 more important if we consider the problem of environmental degradation associated with emissions.  
21 The second risk of circular economy is linked to the possibility to increase the availability of waste by  
22 reducing the time duration of the use phase. The demand for products becomes more frequent and  
23 the overall linkage between product supply chain and waste supply chain is accelerated. A  
24 sustainable application of circular economy is thus dependent on a sustainable perspective of the  
25 motor of the economy, i.e. the use phase of products. This is the role of functional economy to  
26 address this use phase since functional economy is first translated by a modification of the product  
27 supply chain through the development of a specific approach of consumption. The products are thus  
28 transformed in product-service systems (PSS) one can consider as customized resources for  
29 consumption. These resources considered as assets are then maximized through a business model  
30 focused on providing services instead of products leading the economic actors to receive an incentive  
31 to extend the life time of products. The sustainable expectation of functional economy was thus  
32 found coming from an extension of product life time which diminishes the material throughout of  
33 the economy (environmental sustainability) and from the co – production aspects of services with  
34 should put the user at the center of the production-consumption relationship (social sustainability).

35 However, under their actual forms, the sustainable efficiency of circular and economy was found not  
36 clear as the circulation process could severely diminish the efficiency of these strategies. For  
37 example, the management of waste acclaimed by circular economy is dependent on the ability to  
38 predict waste flows and organize the associated logistics. Similarly, the fleet management associated  
39 with use oriented PSS conveys a dependency on “real time” logistics able to better manage time  
40 variables and ensure a 24h/24h service level. The same conclusions can be made on the  
41 management aspect of the function associated with product-service system for which maintenance  
42 requires the tracking of components’ state to ensure a continuous service supply. I thus observed an  
43 increasing importance of information flows which consequently leads to an increase of the use of  
44 information and communications technologies. But as these technologies are characterized by high

1 energy production processes, the extraction of rare materials and the disposal of toxic metals, the  
2 reduction of material consumption in most sectors of the economy is thus made at the expense of an  
3 increase of material consumption associated with ICTs. Besides, the relative instantaneity of the  
4 information transfer strengthens the myth of current economic economies related to zero  
5 transaction costs. Therefore, a drastic choice must be made by logistics actors in regards to ICTS use.  
6 Either they base their efforts on the possibilities offered by ICTS to extend existing supply chain and  
7 transport chain, or they engage themselves in containing the ICTs needs by a “reterritorialization” of  
8 the supply chain. The general issue for a sustainable application of circular and functional economies  
9 was thus found related to the existence of a permanent ideal representation of space and time  
10 developed by economic theories. This ideal representation deals with the notion of ubiquity and  
11 uniformity of space making a-spatial and a-temporal monetary networks the ultimate achievement  
12 of economic system. Therefore, the sustainability approach of these two strategies was found  
13 dependent on the ability to characterize functions and wastes in a specific way rather than the usual  
14 generic and standardized way advocated by dominant economic theories. The dichotomy  
15 generic/specific lies thus at the core of sustainability.

16 However, as shown in the next section, to apprehend the whole consequences of this dichotomy on  
17 the definition and conditions of sustainability will ask the development of new researches.  
18 Throughout this dissertation, I nevertheless framed the first steps to undertake these new research  
19 paths. Indeed, I showed the righteous place for sustainable development was the territorial level at  
20 the conditions that the specificity of associated resources are identified and organized in an auto-  
21 limited way. Therefore, new research paths call for a property approach of ecosystem and associated  
22 use by societies and a property approach of the use phase through a capability approach. Indeed,  
23 circular economy is mainly targeting the link nature-society thus dealing with an ecosystem approach  
24 while functional economy deals with the use phase and thus concerns the issue of capability  
25 development. Sustainability is thus based on the combination of circular and functional economy  
26 within the local framework of territories. The establishment of these different local worlds, all  
27 legitimate from a sustainable viewpoint, calls for new research, notably in terms of specific  
28 nomenclature building and goes beyond the scope of the present work. It nevertheless demonstrates  
29 that business models or economy understood as movements on the monetary networks are not  
30 enough to establish and maintain sustainable circulations.

31 Finally, functional economy was modeled using a typology approach based on a specific approach of  
32 demand and resources. This creates four worlds of production: an industrial world characterized by  
33 mass production for a standardized demand, a flexible world characterized by a mass production for  
34 a customized demand, a professional world which combines a specific approach of demand and  
35 resources, and an immaterial world which combines resources in a specific way but with a diffusion  
36 to the demand side mainly standardized through Information and Communication technologies  
37 (ICTs). It was found that the air pollutant emissions increased by 5% in the case of a shift from  
38 industrial to flexible world against a 1-5% decrease in the case of a shift from industrial and flexible  
39 worlds to professional world. The importance of the specific approach for sustainability was thus  
40 confirmed through these scenarios. The diminution of air emissions was nevertheless found much  
41 more important when external costs were applied with a reduction ranging between 9% and 26%.  
42 The best results were thus associated with a combination of external cost and functional economy  
43 strategy advocating that the conditions for sustainable applications of functional and circular  
44 economies lie in the development of a comprehensive framework of what makes goods unique.

# 3 Future researches and implications for sustainability

## 3.1 Transportation and logistics agenda

As revealed through this dissertation, the core issue for sustainability is to reveal and understand what makes resource and demand specific. In this framework, the place of transportation and logistics system is particular in the sense that its organization totally depends on the supply chain characteristics giving rhythm to the cradle to cradle paths of goods in an economy. There consequently are numerous evolutions possible for the transportation systems and **Table 41** presents the main characteristics of the new paths taken by the transportation and logistics system in circular and functional economy. Going further in the analysis is difficult in particular for the local versions of circular and functional economy which suppose the determination of new nomenclatures based on the system of properties, i.e. as will be shown in 3.3 of this conclusion the development of new researches. The transportation agenda is thus mainly linked with the development of these new nomenclatures and their spreading through the economic transactions. Also, the interconnection between goods network, person network, and information network is expected to increase so that information management (database, optimization and “real – time” management) and its associated rebound effects that should be watched over more closely.

**Table 41 : Transportation and logistic scenarios**

Scenario	Characteristics
<b>Reference</b>	<ul style="list-style-type: none"> <li>- No management of waste.</li> <li>- Supply chain from extraction to product delivery to customer.</li> <li>- No coverage of use and end – of – life phase</li> <li>- Global sourcing and global markets</li> <li>- Extension of outlets through market extension in space (new emerging markets) and time (marketing, planned obsolescence)</li> <li>- High quantity transported with speed as a dominant factor within a global network.</li> <li>- Increase of dependency to ICTs to manage time (“real – time” issue) and complexity (optimization issue).</li> <li>- Increase of infrastructure size to allow more goods to be transported and to solve bottlenecks</li> </ul>
<b>Global Circular economy</b>	<ul style="list-style-type: none"> <li>- Management of waste (recycling/remanufacturing)</li> <li>- Two distinct supply chain, one from extraction to product delivery to customer (usual logistics) and the second from waste collection to recycled and remanufacturing material delivery to manufacturers (reverse logistics)</li> <li>- No coverage of use phase</li> <li>- Global sourcing and global markets for the two distinct supply chains</li> <li>- Extension of outlets through market extension in space (new emerging markets) and time (marketing, planned obsolescence). The reverse logistics market is dependent on the extension made in the usual logistics market.</li> <li>- High quantity transported with speed as a dominant factor within a global network (usual logistics)</li> <li>- High quantity transported without speed as a dominant factor within a global network (reverse logistics)</li> <li>- Increase of dependency to ICTs to manage time (“real – time” issue) and complexity (optimization issue). (usual logistics)</li> <li>- Increase of dependency to ICTs to manage complexity (optimization). (reverse logistics)</li> <li>- Increase of infrastructure size to allow the double flows of goods to be transported and to solve bottlenecks</li> <li>- Development of a design allowing goods to be remanufactured/recycled</li> </ul>

<b>Global functional economy</b>	<ul style="list-style-type: none"> <li>- No management of waste.</li> <li>- Supply chain from extraction to function delivery to customer.</li> <li>- Coverage of use and end – of – life phase</li> <li>- Global sourcing and global markets</li> <li>- Extension of outlets through increase of capabilities of individuals if the service is co-produced with the customer at the center of the relationship.</li> <li>- Diminution of quantity transported with speed as a dominant factor within a global network.</li> <li>- Increase of dependency to ICTs to manage time (“real – time” issue) in the case of use oriented PSS working as asset management and complexity (optimization issue).</li> <li>- Existence of a trade – off in ICTs use between maintenance optimization and the “real – time” management of maintenance. Indeed, the development of a design allowing easier reparation and longer time intervals between maintenance operations release the “real – time” constrains and consequently the associated dependency on ICTs.</li> <li>- No need to increase infrastructure size. Bottlenecks could be solved but the reliability and flexibility in time of the network becomes the core issue.</li> </ul>
<b>Global combination</b>	<ul style="list-style-type: none"> <li>- Global sourcing and global markets</li> <li>- Usual logistic network characterized by a diminution of quantity transported and an importance of the time factor increasing from extraction phase to use phase.</li> <li>- Symmetrically, the reverse logistics network is characterized by a diminution of quantity transported and an importance of time decreasing from waste collection to delivery to manufacturers.</li> <li>- No need to increase Infrastructure size but increase of the importance of flexibility and reliability.</li> <li>- Importance of ICTs with a trade – off to find between knowledge embodied in design and supply chain structure (optimization) and real – time management.</li> </ul>
<b>Local Circular economy</b>	<p>Same characteristics than Global circular economy but:</p> <ul style="list-style-type: none"> <li>- Observation and respect of the ecosystem properties which limits the quantity and time wastes can stay in a location (location of warehouses, transportation path limited)</li> <li>- Observation and respect of territorial properties which imply notably limitations of sourcing and market in accordance to the proximity framework developed (predominance of the local for innovation process, possibility of global for standardized processes)</li> </ul>
<b>Local functional economy</b>	<p>Same characteristics than Global functional economy but:</p> <ul style="list-style-type: none"> <li>- Observation and respect of the ecosystem properties which limits the quantity and time wastes can stay in a location (location of warehouses, transportation path limited)</li> <li>- Observation and respect of individual properties which focuses on the empowerment of individuals (reappropriation of all networks at the individual level leading to a localization of action)</li> <li>- Observation and respect of territorial properties which implies a local regulation sphere.</li> </ul>
<b>Local combination</b>	<ul style="list-style-type: none"> <li>- The sourcing, the management of time and waste, the production and maintenance processes are all examined in the context of ecosystem and territorial properties for the purpose of individual properties, i.e. empowerment of individuals</li> <li>- Transportation and logistics will thus have different forms of optimization depending on the local characteristics of the combination between functional and circular economy.</li> </ul>

1  
2  
3  
4  
5  
6  
7

### 3.2 Policy agenda

From a policy viewpoint, the understanding and respect of resource and demand specificity implies

1 to change radically the current patterns of policy making. Indeed, current policies are characterized  
2 by an indifference to the local aspects and a submission to the monetary network, applying general  
3 concepts independently of the local context. Besides, the political power is often centered thus  
4 sharing a lot of similarities with the characteristics of the Walrasian market.

5 The policy agenda thus concerns the following point:

- 6     ▪ Inversion of the logics production/consumption. What matters from a political viewpoint is  
7     the use phase and the management of lifecycle in the respect of ecosystem, individual and  
8     territorial properties. Therefore, the artificial development of intermediaries and supply  
9     chain aiming at providing an artificial economic growth should be suppressed.
- 10    ▪ Regulation of competition into “canals” of competitions. Indeed, competition can be a good  
11    way of optimization at the condition that the products or services sold are similar. These  
12    similarities should be based on the framework of ecosystem, individual and territorial  
13    properties. This means the nomenclature of products is driven by the choice made at the  
14    political level and constitutes a part of his sovereignty.
- 15    ▪ The two previous points have for consequence a radical reform of the “free” trade. Indeed,  
16    following the principles of the World Trade Organization, it appears that the main idea  
17    behind current “free” trade organization is to establish a uniform world only considering  
18    individuals as embodied in a global monetary network. This uniform world is dependent on  
19    rules such as the impossibility for countries to discriminate between their trading partners,  
20    the fact that imported and locally produced goods should be treated equally, and the beliefs  
21    that lowering trade barriers (custom duties, tariffs, import bans or quotas) always encourage  
22    trade (World Trade Organization, 2011). The core idea behind the current “free” trade  
23    organization is to provide businesses with a clearer view of their future opportunities. In  
24    other terms, this is an acknowledgement of the completeness and perfect predictability of  
25    monetary network which has been criticized and acknowledged as a major source of  
26    unsustainability in the present research work. The radical reform of “free” trade does not  
27    correspond to closed economies but to “fairly” opened economies. Indeed, it means that the  
28    principles of “fair” trade and the fight against dumping do not only concern economic  
29    aspects such as the selling below production prices to obtain rapidly market shares but  
30    environmental aspects and social aspects. This way, the new political principles in regards to  
31    trade and open – economies are:
  - 32       ○ Respect of the windows (quantity, time, location) of production allowed by  
33       ecosystem properties.
  - 34       ○ Insurance of the individual properties, i.e. notably in the economic network the  
35       maintenance of purchasing power. In the social and environmental domain, this  
36       insurance goes through the maintenance of the conditions of existence and the  
37       increase of actors’ capabilities.
  - 38       ○ Moving towards a higher importance to territories and localities in policy framework  
39       (participative democracy, local authorities, etc.) with an upper structure at national  
40       or global level to manage mutual influence through ecosystems, trade or proximity  
41       effects.

### 1   **3.3 Research agenda**

2

3   The two previous policy and logistics agenda are dependent on the capacity of society to determine  
4   how the interactions within the system made of people, goods and ecosystems contributes to make  
5   each good unique. It thus deals with a comprehensive criticism of the current framework of  
6   substitutability which often takes a generic approach of goods to evolve towards a thorough  
7   understanding on how physical and social properties of goods empower the individuals in the local  
8   context of the limits set by his environment.

9   The research agenda to apprehend the specificity of demand and resources is thus a huge  
10   interdisciplinary agenda made of the three parts described below:

#### 11       **1) The study of ecosystem properties**

12   In an ecosystem, each organism has a window in which his actions can take place without  
13   threatening his existence or the existence of the ecosystem. The limits to action consequently  
14   concern those with immediate effect and those with delayed effect. For example, in ecotoxicology,  
15   there is a distinction between acute effects corresponding to a high but short exposition to a toxin  
16   and chronic effects resulting from a low but long exposition to a toxin. As the chronic effects can take  
17   some time before being revealed, it gives the impression of having a higher domain of available  
18   actions. The effect of time thus plays an important role in the determination of ecosystem  
19   properties. Besides, the anthropocentric viewpoint implies to differentiate human organisms and  
20   other organisms. Therefore, the research agenda concerns the following research questions:

- 21       ▪   What are the properties of a material useful for man use? (Physics, Chemistry, medicine)
- 22       ▪   What are the properties enabling creation of useful properties? (engineering)
- 23       ▪   What is the availability of physical resources in term of windows of action? (Hydrology,  
24       geology, geography)
- 25       ▪   What is the availability of biological resources in term of windows of action? (Ecology)
- 26       ▪   What is the window available for discharges of physical waste into the environment?  
27       (Hydrology, Geology, geography ,medicine)
- 28       ▪   What is the window available for discharges of biological waste into the environment?  
29       (Ecology, medicine)
- 30       ▪   Which paths in space and time are available for driving the properties from place of resource  
31       to man use and then back to the environment? (All previous disciplines)

32

#### 33       **2) The study of individual properties**

34   Social sustainability is concerned with the development of the capabilities at the level of individual.  
35   Therefore, the study of individual properties supposes primarily to ensure the maintenance of the  
36   existence of the individual and secondly the development of his capabilities. The research questions  
37   associated with the study of individuals properties are thus the following:

- 38       ▪   What are the biological conditions of individual existence? (Medicine)
- 39       ▪   What are the physical conditions of access to the biological area of existence? (medicine,  
40       ecology, engineering)
- 41       ▪   What are the monetary conditions of access to the biological area of existence? (economy)



- 1       ▪ What is the epistemology of individuals, i.e. how they construct reality from their daily  
2       experiences? (History of science, sociology)
- 3       ▪ What are the physical conditions of access to the social development of individuals?  
4       (Medicine, biology, sociology)
- 5       ▪ What are the monetary conditions of access to the social development of individuals?  
6       (economy)
- 7       ▪ How the factor time is/should be managed at the individual level so that each individual can  
8       actively participates to all the areas of his existence (node of networks)? (transportation,  
9       logistics, sociology, economy)
- 10      ▪ How to define the relationships at individual level between capabilities, extensive and  
11      intensive liberties, and individual and collective responsibilities? (sociology, economy)

12

### 13       **3) The study of territorial properties**

14      The coordination between the two previous levels of studies supposes a synthesis made at the  
15      territorial level. Therefore, the third research area concerns all the patterns of proximities mobilized  
16      at the territorial level to ensure the development of individual properties within the framework of  
17      ecosystem properties. The focus is thus not only made on coordination process in production process  
18      but in all the different aspects of the social and environmental construction of the territory.

19      There is little doubt that the three previous parts of the interdisciplinary research towards a  
20      sustainable approach of the demand and resource specificity cover many research projects and  
21      would imply the collaboration between many researchers. For my part, as an environmental system  
22      analyst, it appears that the window of actions allowed by ecosystem constitutes one of the main  
23      points missing for a sustainable approach of current economic system analysis. In my opinion, the  
24      research work described before concerns primarily from one side the characteristics of what makes  
25      demand specific and the characteristics of what makes resource specific. These two research  
26      directions constitute the two faces of sustainability thus pleading for integration at the territorial  
27      level. Because the current trends of logistic systems are towards customization (movement towards  
28      flexible world), the specificity of demand are expected to be better addressed though sociology and  
29      the concept of capabilities should replace at term the currently marketing based customization. The  
30      specificity of resources, on the opposite, is largely missing from environmental system analysis and  
31      my future research works will aim at filling this gap. The main path of my future research will thus  
32      consist in territorial metabolism analysis in which resources in a first time and demand in a second  
33      time will receive special interests. This way, current environmental analytical tools such as material  
34      flow analysis (MFA) and life cycle analysis (LCA) will expect to move towards better ecological  
35      approach (resource side) and better social approach (demand side) evolving from their current solely  
36      engineering viewpoint subordinated to current economic convention.

37      The following stage of my research is thus a further operationalization of the functional economy  
38      framework for a concrete product to bring it closer to application. Indeed, currently applying for a  
39      post-doctoral position in Japan, my future research project is to propose product –service systems  
40      dealing with the scarce resource of water and to compare the different metabolism paths existing  
41      between the public water system in France and Japan.

42

## 1 **References**

- 2 **Sustainable Consumption institute of the University of Manchester.** *Consumer, business and climate*  
3 *change.*
- 4 **ADEME. 2011.** *Analyse comparée des impacts environnementaux de la communication par voie*  
5 *électronique - Complément.* s.l. : BIO Intelligence Service, 2011.
- 6 —. **2010.** *Bilan Carbone - Guide méthodologique version 6.1 - Objectifs et principes de comptabilisation.*  
7 2010.
- 8 —. **2008.** *Chaleur et confort sans gaspillage, le chauffage, la régulation, l'eau chaude.* 2008.
- 9 —. **2011.** *Nouvelles technologies, nouveaux usages: les TIC, quels impacts.* 2011.
- 10 **2009.** *Affichage environnemental: quelles solutions pour objectiver la mesure.* *Environnement &*  
11 *Technique.* 2009, 287.
- 12 **Akerlof, George. 1970.** The market for "Lemons": Quality Uncertainty and the Market Mechanism.  
13 *Quarterly Journal of Economics.* 1970, Vol. 84, 3, pp. p.488-500.
- 14 **Albino, Vito and Kühtz, Silvana. 2004.** Enterprise input-model for local sustainable development -  
15 the case of a tiles manufacturer in Italy. *Resources, Conservation and Recycling.* 2004, 41, pp. 165-  
16 176.
- 17 **Albino, Vito, Carbonara, Nunzia and Giannoccaro, Ilaria. 2007.** Supply chain cooperation in industrial  
18 districts: a simulation analysis. *European Journal of Operational research.* 2007, 177, pp. 261-280.
- 19 **Albino, Vito, Garavelli, A. Claudio and Schiuma, Giovanni. 1999.** Knowledge transfer and inter-firm  
20 relationships in industrial districts: the role of the leader firm. *Technovation.* 1999, Vol. 19, pp. 53-63.
- 21 **Albino, Vito, Izzo, Carmen and Kühtz, Silvana. 2002.** Input-output models for the analysis of a  
22 local/global supply chain. *International journal of production economics.* 2002, 78, pp. 119-131.
- 23 **Albino, Vito, Pontrandolfo, Pierpaolo and Scozzi, Barbara. 2002.** Analysis of information flows to  
24 enhance the coordination of production processes. *International journal of production economics.*  
25 2002, 75, pp. 7-19.
- 26 **Angeon, Valérie and Vollet, Dominique. 2008.** Spécificité des produits et développement territorial.  
27 L'exemple paradoxal du panier de biens en émergence de l'Aubrac. *Revue d'Economie Régionale &*  
28 *Urbaine.* Armand Colin, November 2008, Vol. 4, pp. 591-615.
- 29 **Ansart-Dourlen, Michèle. 2005.** CASTORIADIS. Autonomie et hétéronomie individuelles et  
30 collectives. Les fonctions de la vie imaginaire. *Les cahiers psychologie politique.* 2005, n°7.
- 31 **Aristote. 2001.** *Ethique à Nicomaque.* [ed.] Vrin. [trans.] J. Tricot. Paris : Librairie Philosophique,  
32 2001.
- 33 **Association Bilan Carbone. 2011.** <http://www.associationbilancarbone.fr/>. [Online] 2011.

- 1 **Auvray, Marie-Hélène. 2001.** *Electrostatique, Magnétostatique, Optique géométrique.* Paris : Presses  
2 universitaires de France, 2001. ISBN: 2-13-051427-8.
- 3 **Ayres, R.U. 1989.** Industrial metabolism. [book auth.] J.H. Ausubel and H.E. Sladovich. *Technology  
4 and Environment.* Washington D.C. : US National Academy of Engineering, 1989.
- 5 **Ayres, RU and Ayres, LW. 1996.** *Industrial Ecology. Towards closing the material cycle.* Cheltenham :  
6 Elgar, 1996.
- 7 **BARCA, Valérie. 2010.** *La gestion des wagons : un paramètre de la performance du fret ferroviaire qui  
8 implique de nombreux acteurs.* s.l. : Transversales, 2010.
- 9 **Barrett, John, et al. 2002.** *A material Flow Analysis and Ecological Footprint of York.* s.l. : Stockholm  
10 Environment Institute, 2002.
- 11 **Basso, P. 2005.** *Temps modernes, horaires antiques: la durée du travail au tournant du millénaire.*  
12 Lausanne : Editions Page deux. Collection "Cahiers Libre", 2005.
- 13 **Baudrillard, Jean. 2009.** *La société de consommation.* Cher : Folio, Essais, 2009. ISBN: 978-2-07-  
14 032349-4.
- 15 **Beaudoux, Emmanuel. 2006.** *Exploitation de l'enquête ECHO sur le transport de marchandises en  
16 milieu urbain.* s.l. : Université Paris Dauphine/INRETS-SPLOT, 2006.
- 17 **Beurain, Christophe. 2008.** La construction d'un territoire à partir des ressources  
18 environnementales: l'exemple de l'agglomération dunkerquoise. *Géographie, économie, société.*  
19 Lavoisier, 2008, Vol. 10, pp. 365-384.
- 20 **Bellahcene, Attika, Berthier, Emilie and Contat, Elodie. 2006.** *Les microcrédits bouleversent-ils la vie  
21 des plus pauvres?* Grenoble : s.n., 2006.
- 22 **Bertrand, Elodie and Destais, Christophe. 2002.** Le théorème de Coase, une réflexion sur les  
23 fondements micro-économiques de l'intervention publique. *Reflets et Perspectives.* 2002, Vol. 2, XLI.
- 24 **Bessis, Franck. 2004.** *Karl Popper et la dynamique des conventions.* s.l. : Journée TIPS du 24 juin 2004,  
25 2004.
- 26 **Bickel, P., Friedrich, R. and Burgess, A. 2006.** 'Proposal for harmonised guidelines' HEATCO –  
27 *Developing Harmonised European Approaches for Transport Costing and Project Assessment. Funded  
28 by the 6th Framework RTD Programme. Deliverable 5.* Stuttgart, Germany : IER, 2006.
- 29 **Boileau, Gérard. 2003.** *Comprendre les comptes d'une entreprise.* Paris : Groupe revue fiduciaire,  
30 2003. ISBN: 2-86521-740.
- 31 **Bolis, S. and Maggi, R. 1999.** *Modelling the transport and logistics choice of a shipper.* Berne  
32 (Switzerland) : Materials of the National Research Programme NRP 41, Volume M8, Fond National de  
33 la Recherche, 1999. p. 77.
- 34 **Boltanski, L. and Thévenot, L. 1991.** *De la justification. Les économies de la grandeur.* s.l. : Gallimard,  
35 1991. p. 483.

- 1 **Boltanski, Luc and Thévenot, Laurent. 1991.** *De la justification: Les économies de la grandeur.* s.l. :  
2 Editions Gallimard, 1991.
- 3 **Borel, Emile. 2009.** *Valeur pratique et Philosophie des Probabilités.* s.l. : Editions Jacques Gabay,  
4 2009. ISBN: 978-2-87647-340-9.
- 5 **Bouba-Olga, Olivier and Grossetti, Michel. 2006.** *Socio - économie de proximité.* Bordeaux : Fifth  
6 Proximity Congress, 2006.
- 7 **Breuil, Henri, et al. 2008.** *TIC et Développement durable.* Ministère de l'Ecologie, de l'Energie, du  
8 Développement Durable et de l'Aménagement du Territoire, Ministère de l'Economie, de l'Industrie  
9 et de l'Emploi. 2008.
- 10 **Brian, Arthur W. 1988.** *Competing Technologies: an overview.* [book auth.] Giovanni Dosi, et al.  
11 *Technical Change and Economic Theory.* Londres : Pinter Publishers, 1988, pp. p.590-607.
- 12 **Brodhag, Christian, et al. 2004.** *Dictionnaire du développement durable.* Saint-Denis La plaine :  
13 AFNOR, 2004. ISBN: 2-12-486933-7.
- 14 **Brown, Richard. 1991.** *Society and economy in modern Britain 1700-1850.* London and New York :  
15 Routledge, 1991. ISBN: 0-203-71076-2.
- 16 **Browne, M. 1993.** *Logistics strategies in the Single European Market and their spatial consequences.*  
17 *Journal of Transport Geography.* June 1993, Vol. 1, 2, pp. 75-85.
- 18 **Browne, Michael, Allen, Julian and Anderson, Stephen. 2005.** *La consommation d'énergie liée à la*  
19 *distribution des jeans au Royaume-Uni.* [book auth.] Christophe Rizet. *Consommation d'énergie et*  
20 *émission de gaz à effet de serre en transport de marchandises: Actes de la Journée INRETS-PREDIT-*  
21 *COST du 18 mai 2005.* s.l. : Les collections de l'Inrets, 2005.
- 22 **Buclet, Nicolas. 2005.** *Concevoir une nouvelle relation à la consommation: l'économie de*  
23 *fonctionnalité. Responsabilité & Environnement.* Annales des Mines, 2005.
- 24 —. **2011.** *Ecologie industrielle et territoriale.* Lille : Presses Universitaires du Septentrion, 2011.  
25 ISBN:978-2-7574-0331-0.
- 26 —. **2013.** *Le territoire créateur de ressources: Une illustration autour du cas d'Usinette.* *CANAL2013 -*  
27 *Circulation et appropriations de normes et des modèles de l'action locale.* March 20-23, 2013.
- 28 —. **2011.** *Le territoire, entre liberté et durabilité.* Paris : Presses Universitaires de France, 2011. ISBN:  
29 978-2-13-057925-0.
- 30 —. **2011.** *Territoire, innovation et développement durable : l'émergence d'un nouveau régime*  
31 *conventionnel.* *Revue d'Economie Régionale & Urbaine.* Armand Colin, 2011, Vol. 5, pp. 911 - 940.
- 32 **Burmeister, Antje and Blanquart, Corinne. 2008.** *Evaluating the Performance of Freight Transport: A*  
33 *service approach.* s.l. : RSAI World Congress Sao Paolo, 2008.

- 1 **Burmeister, Antje. 2000.** *Familles logistiques: Propositions pour une typologie des produits*  
2 *transportés pour analyser les évolutions en matière d'organisation des transports et de la logistique.*  
3 Lille : PREDIT "Systèmes d'information", 2000. Convention DRAST n° 98 MT 87.
- 4 **Burmeister, Antje, et al. 2006.** *Performance logistique et développement de l'entreprise.* s.l. : PREDIT  
5 - Ministère de l'Équipement, des Transports, du Logement, du Tourisme et de la Mer, 2006.
- 6 **Burmeister, Antje, et al. 2003.** Réseaux de transports et de télécommunications et efficacité des  
7 systèmes productifs. [book auth.] Claude Dupuy and Antje Burmeister. *Entreprises et territoires: Les*  
8 *nouveaux enjeux de la proximité.* Paris : Les études de La documentation Française, 2003.
- 9 **Caron, François. 1997.** *Histoire des Chemins de fer en France: 1740-1883.* Paris : Fayard, 1997.  
10 ISBN:2-213-02153-8.
- 11 **Caumières, Philippe. 2007.** *Castoriadis: Le projet d'autonomie.* s.l. : Michalon, 2007.
- 12 **CE Delft. 2008.** *Handbook on estimation of external costs in the transport sector.* Delft : Report for  
13 the European Commission, 2008.
- 14 **CEE. 1985.** *Réglementation n°3820/85 relatif à l'harmonisation de certaines dispositions en matière*  
15 *sociale dans le domaine des transports par route.* December 20, 1985.
- 16 **CETE Lyon. 2003.** *Accessibilité VP/TC de 12 pôles d'emplois du Grand Lyon.* Lyon : s.n., 2003.
- 17 **Cetinkaya, Balkan, et al. 2011.** *Sustainable Supply Chain Management.* Heidelberg Dordrecht London  
18 New York : Springer, 2011. ISBN.
- 19 **Cholette, Susan and Venkat, Kumar. 2009.** The energy and carbon intensity of wine distribution: A  
20 study of logistical options for delivering wine to consumers. *Journal of Cleaner Production.* 2009, Vol.  
21 17, pp. 1401-1413.
- 22 **Chung, Walter W.C., Yam, Anthony Y.K. and Chan, Michael F.S. 2004.** Networked enterprise: A new  
23 business model for global sourcing. *International journal of production economics.* 2004, 87, pp. 267-  
24 280.
- 25 **Ciliberti, Francesco, et al. 2011.** CSR codes and the principal-agent problem in supply chains: four  
26 case studies. *Journal of Cleaner Production.* 2011, 19, pp. 885-894.
- 27 **CITEPA. 2011.** *Inventaire des émissions de polluants atmosphériques et de gaz à effet de serre en*  
28 *France. Séries sectorielles et analyses étendues.* 2011.
- 29 **Clerc, Denis. 2000.** La monnaie, un vecteur du lien social. *Alternatives économiques HS.* July 2000,  
30 n°45.
- 31 **Coase, RH. 1960.** The problem of social cost. *Journal of Law and Economics.* 1960, 3, pp. pp 1-44.
- 32 **Cogis, Olivier and Robert, Claudine. 2005.** *Au-delà des ponts de Königsberg: Théorie des graphes.*  
33 Paris : Vuibert, 2005. ISBN: 2-7117-5321-2.
- 34 **Colletis, Gabriel. 2007.** Intelligence économique: vers un nouveau concept en analyse économique?  
35 *Cahiers du Groupement de Recherches Economiques et Sociales.* 2007, n°03.

- 1 **Colletis-Wahl, K. and Meunier, C. 2003.** *Infrastructures de transport et développement économique*  
2 *en espace rural: quelles méthodes pour quels effets?* s.l. : PREDIT, 2003.
- 3 **Colletis-Wahl, K. and Perrat, J. 2004.** Proximités et dynamiques spatiales. [book auth.] B. Pecqueur  
4 and J-B Zimmermann. *Economie de proximités*. Paris : Hermes, 2004, pp. 115-132.
- 5 **Combe , Violette, et al. 2008.** *Etude prospective sur l'économie de fonctionnalité*. s.l. : HEC Paris,  
6 Goodwill managment and Fondation Nicolas Hulot pour la Nature et pour l'Homme, 2008.
- 7 **Commissariat Général au Développement Durable. 2009.** Matières mobilisées par l'économie  
8 française: Comptes de flux pour une gestion durable des ressources. *Etudes & documents*. Soes, June  
9 2009, 6.
- 10 **Commissariat général au développement durable. 2010.** La consommation de matière par habitant  
11 est stable. *le point sur*. 2010. n°41.
- 12 **Commission générale du développement durable. 2010.** La consommation de matière par habitant  
13 est stable. *le point sur*. 2010. n°41.
- 14 **COPERT. 2009.** <http://www.emisia.com/copert/Download.html>. [Online] 2009.
- 15 **Cornelis, Eric, et al. 2005.** Le projet INFACT: Quelques pistes pour l'interface entre logistique et  
16 transport des marchandises par les consommateurs. [book auth.] Christophe Rizet. *Consommation*  
17 *d'énergie et émission de gaz à effet de serre en transport de marchandises: Actes de la Journée*  
18 *INRETS-PREDIT-COST du 18 mai 2005*. s.l. : Les collections de l'Inrets, 2005.
- 19 **Coroama, Vlad and Hilty, Lorenz M. 2009.** Energy Consumed vs. Energy Saved by ICT – A Closer Look.  
20 2009.
- 21 **Corpataux, José and Crevoisier, Olivier. 2007.** Economic theories and spatial transformations  
22 clarifying the space-time premises and outcomes of economic theories. *Journal of Economic*  
23 *geography*. Oxford University Press, 2007, n°7, pp. 285-309.
- 24 **Corsten, Hans and Gössinger, Ralf. 2006.** Output flexibility of service enterprises - an analysis based  
25 on production theory. *International journal of production economics*. 2006, 104, pp. 296-307.
- 26 **Cottignies, Marc. 2005.** Introduction. [book auth.] Christophe Rizet. *Consommation d'énergie et*  
27 *émission de gaz à effet de serre en transport de marchandises: Actes de la Journée INRETS-PREDIT-*  
28 *COST du 18 mai 2005*. s.l. : Les collections de l'Inrets, 2005.
- 29 **Crevoisier, O. 1996.** Proximity and territory versus in regional science. *Environment and Planning*.  
30 1996, Vol. A, n°28, pp. 1683-1697.
- 31 **Crevoisier, Olivier. 2010.** La pertinence de l'approche territoriale. *Revue d'Economie Régionale &*  
32 *Urbaine*. Armand Colin, 2010, Vol. 5, pp. 969-985.
- 33 **DAST/PDEI-INRETS/SPLIT. 2006.** *Enquête des chargeurs et des opérateurs de fret (ECHO): Synthèse*  
34 *du rapport final pour le mode aérien*. 2006.

- 1 **Davis, Steven J. and Caldeira, Ken. 2010.** Consumption-based accounting of CO<sub>2</sub>- emissions. *PNAS*.  
2 2010, Vol. 107, 12.
- 3 **Davydenko, Igor Y., et al. 2011.** *Estimation of freight flow and trip generation according to transport*  
4 *purpose in urban and regional logistics networks*. Long Beach, Ca : METRANS Urban Freight  
5 Conference, 2011.
- 6 **Delattre, M. and Eymard-Duvernay, F. 1983.** Sept catégories d'entreprises pour analyser le tissu  
7 industriel. *Economie & Statistique*. October 1983, 159.
- 8 **Denis, Henri. 2012.** *Histoire de la pensée économique*. Paris : Quadrige/Presses universitaires de  
9 France, 2012. ISBN:978-2-13-056317-4/ISSN: 1630-5264.
- 10 **Dente, Sébastien and Hawkins, Troy. 2012.** The Greenhouse Stakes of Globalization. [book auth.] Dr  
11 Guoxiang Liu. *Greenhouse Gases - Emission, Measurement and Management*. s.l. : Intech, 2012, 22.  
12 available from [http://www.intechopen.com/books/greenhouse-gases-emission-measurement-and-](http://www.intechopen.com/books/greenhouse-gases-emission-measurement-and-management/the-greenhouse-gas-stakes-of-globalization)  
13 [management/the-greenhouse-gas-stakes-of-globalization](http://www.intechopen.com/books/greenhouse-gases-emission-measurement-and-management/the-greenhouse-gas-stakes-of-globalization).
- 14 **DeVries, Peter. 2007.** China's Demand For Recycle Wastepaper: A Blessing and a Curse for the  
15 World's Forests. *Boots on the ground: Business news from China*. [Online] August 16, 2007.  
16 <http://blog.supplysolutionsnetwork.com/?p=325>.
- 17 **Digithèque MJP.** Loi constitutionnelle n°2005-205 du 1er mars 2005 relative à la charte de  
18 l'environnement. *Constitution de la Vème République*. [Online] [Cited: 08 23, 2011.] [http://mjp.univ-](http://mjp.univ-perp.fr/france/co1958-19.htm)  
19 [perp.fr/france/co1958-19.htm](http://mjp.univ-perp.fr/france/co1958-19.htm).
- 20 **Direction Général des routes. 1998.** *Instruction DGR relative aux méthodes d'évaluation économique*  
21 *des investissements routiers en rase campagne*. 1998.
- 22 **Djellal, F. and Galloulj, F. 2006.** *Les services publics à l'épreuve de la productivité et la productivité à*  
23 *l'épreuve des services publics*. Lisbonne : 16ème Congrès international RESER, 2006.
- 24 **Dornier, Philippe-Pierre and Fender, Michel. 2009.** *La logistique et le supply chain management*.  
25 Paris : Eyrolles, 2009. ISBN: 978-2-7081-3384-6.
- 26 **Drut, Marion. 2012.** *Vers un système de transport opérant selon les principes de l'économie de la*  
27 *fonctionnalité*. Laboratoire EQUIPPE, Université Lille Nord de France. Lille : s.n., 2012.
- 28 **Duchin, Faye and Weisz, Helga. 2004.** Physical and Monetary Input-Output analysis: What makes the  
29 difference. *Rensselaer Working Papers in Economics*. 2004, 0422.
- 30 **Duchin, Faye. 2004.** Input-output Economics and material flows. *Rensselaer working papers in*  
31 *Economics*. Rensselaer Polytechnic Institute, 2004, 0424.
- 32 **Duckham, B.F. 1983.** Canals and River Navigations. [book auth.] D.H. Aldcroft and M.J. Freeman.  
33 *Transport in the Industrial Revolution*. Manchester : Manchester University Press, 1983.
- 34 **Duez, Philippe. 2011.** La place de l'Economie des Territoires dans la construction d'une théorie  
35 générale intégrant l'espace. *Revue d'Economie Régionale & Urbaine*. Armand Colin, 2011, Vol. 4, pp.  
36 735-764.

- 1 **Duong, P. 1998.** *Externalisation de la logistique: l'émergence d'un nouveau marché?* Anvers : 8th  
2 World Conference on Transport Research, 1998.
- 3 **ECMT. 2003.** *Efficiency Transport Taxes and Charges.* Paris : ECMT, 2003.
- 4 **EcoTransIT. 2011.** *Ecological Transport Information Tool for Worldwide Transports: Methodology and*  
5 *Data Update.* Berlin - Hannover - Heidelberg : IFEU Heidelberg, öko-Institut, IVE/RMCON, 2011.
- 6 **Eddington, Arthur Stanley. 2010.** *Espace, temps et gravitation: la théorie de la relativité générale.*  
7 s.l. : Editions Jacques Gabay, 2010. ISBN: 978-2-87647-341-6.
- 8 **Einstein, Albert. 1990.** *Conceptions scientifiques.* s.l. : Flammarion, 1990. ISBN: 2-08-081214-9.
- 9 **Ellen MacArthur Foundation. 2013.** *Towards the circular economy: Economic and business rationale*  
10 *for an accelerated transition.* 2013.
- 11 **Erkman, Suren. 1998.** *Vers une écologie industrielle: comment mettre en pratique le développement*  
12 *durable dans une société hyper-industrielle.* Paris : Editions Charles Léopold Mayer, 1998. ISBN: 2-  
13 84377-027-0.
- 14 **Essec.** Les accords de Bâle. *Essec transaction.* [Online] [http://www.essectransac.com/wp-](http://www.essectransac.com/wp-content/themes/arthemisia/images/2010/10/Les-Accords-de-B%C3%A2le.pdf)  
15 [content/themes/arthemisia/images/2010/10/Les-Accords-de-B%C3%A2le.pdf](http://www.essectransac.com/wp-content/themes/arthemisia/images/2010/10/Les-Accords-de-B%C3%A2le.pdf).
- 16 **European Commission. 2011.** *A resource-efficient Europe - Flagship initiative under the Europe 2020*  
17 *strategy.* 2011.
- 18 —. **2006.** *Keep Europe Moving: Sustainable mobility for our continent.* Luxembourg : European  
19 Commission, 2006.
- 20 —. **2001.** *White Paper: European transport policy for 2010 - time to decide.* Luxembourg : European  
21 commission, 2001.
- 22 **European Commission, et al. 2009.** *System of National Accounts 2008.* New York : s.n., 2009. ISBN:  
23 978-92-1-161522-7.
- 24 **European Environmental Agency. 2006.** *Transport and Environment facing a dilemma ; Term 2005:*  
25 *indicators tracking transport and environment in the European Union.* Copenhagen : European  
26 Environmental Agency, 2006.
- 27 **Folz, Jean-Martin, Nicklaus, Doris and Cros, Christine. 2008.** *Grenelle de l'environnement: Chantier*  
28 *n°31, Groupe d'étude "économie de fonctionnalité".* s.l. : Ministère de l'Energie, de l'Ecologie, du  
29 Développement Durable et de l'Aménagement du Territoire, 2008.
- 30 **François, Hugues. 2008.** Durabilité des ressources territoriales et tourisme durable : vers quelle  
31 convergence? *Géographie, économie, société.* Lavoisier, 2008, Vol. 10, pp. 133-152.
- 32 —. **2006.** Territoire et patrimoine: La co-construction d'une dynamique et de ses ressources. *Revue*  
33 *d'Economie Régionale & Urbaine.* Armand Colin, December 2006, Vol. 5, pp. 683-700.
- 34 **Frosch, Robert A. and Gallopoulos, Nicholas E. 1989.** Strategies for manufacturing. *Scientific*  
35 *American.* September 1989, Vol. 261, 3, pp. p.94-102.



- 1 **Gadrey, Jean. 1991.** Le service n'est pas un produit: quelques implications pour l'analyse et pour la  
2 gestion. *Politiques et management public*. Persée, 1991, Vol. 9, 1, pp. 1-24.
- 3 **Gavaud, Olivier and Brehier, Odile. 2009.** *Les chaînes organisationnelles dans le transport.*  
4 *Enseignements de l'enquête ECHO*. s.l. : Centre d'Etudes Technique de l'Equipement de l'Ouest.  
5 Division Ville et Territoire, 2009.
- 6 **Geindre, Sébastien.** L'économie des conventions comme fondement théorique des réseaux  
7 stratégiques: une application aux réseaux de P.M.E.
- 8 **Georgescu-Roegen, Nicholas. 1979.** *La décroissance: Entropie - Ecologie - Economie*. Université  
9 Vanderbilt, Nashville, Tennessee : Les classiques des sciences sociales, 1979.
- 10 **Ghertman, Michel. 2003.** Oliver Williamson et la théorie des coûts de transaction. *Revue Française*  
11 *de gestion*. Lavoisier, 2003, Vol. 1, 142, pp. 43-63.
- 12 **Giddens, Anthony. 1994.** *Les conséquences de la modernité*. Paris : L'Harmattan, 1994. ISBN: 2-7384-  
13 2506-2.
- 14 **Gilly, Jean-Pierre and Lung, Yannick. 2005.** Proximités, secteurs et territoires. *Groupement de*  
15 *Recherches Economiques et Sociales*. May 2005, 9.
- 16 **Giraud-Héraud, Eric, Soler, Louis-Georges and Tanguy, Hervé. 2001.** Internet et la distribution de  
17 biens physiques: Analyse de l'émergence de nouvelles structures verticales dans le secteur du vin.  
18 *Revue économique*. 2001, Vol. 52, pp. 213-232.
- 19 **Girault M. 2000.** Le programme de recherche REDEFINE ou comment analyser l'organisation  
20 logistique d'un secteur. *Notes de synthèse du SES*. March-avril 2000.
- 21 **Girault, M. and Leray, F. 2000.** A la recherche des familles logistiques. *Notes de synthèse du SES*. July-  
22 August 2000.
- 23 **Global e-Sustainability Initiative. 2008.** *SMART 2020: Enabling the low carbon economy in the*  
24 *information age*. s.l. : Creative commons, 2008.
- 25 **Godard, Olivier. 2004.** De la pluralité des ordres - les problèmes d'environnement et de  
26 développement durable à la lumière de la théorie de la justification. *Géographie, Economie, Société*.  
27 Lavoisier, 2004, Vol. 6, pp. 303-330.
- 28 **Godbout, Jacques T. 2000.** *L'esprit du don*. Paris : La Découverte/Poche, 2000. ISBN: 978-2-7071-  
29 5222-0.
- 30 **Godelier, Eric. 2006.** *La culture d'entreprise*. Paris : La découverte Collection Repère, 2006. n°410.
- 31 **Godet, Michel, Durance, Philippe and Mousli, Marc.** *Créativité et innovation dans les territoires*. s.l. :  
32 Conseil d'Analyse économique, Datar and Académie des Technologies.
- 33 **Goldstein, Pierre. 2011.** *Vulnérabilité et autonomie dans la pensée de Martha C. Nussbaum*. Paris :  
34 Presses Universitaires de France, 2011. ISBN: 978-2-13-057622-8.

- 1 **Gonzalez-Feliu, Jesus and Morana, Joëlle.** *Sharing services for freight distribution: concepts, stakes*  
2 *and experience comebacks.*
- 3 **Goumiza, Henri. 1933-1941.** *La jeunesse d'Auguste Comte et la fondation du positivisme.* Paris : s.n.,  
4 1933-1941. Vol. III.
- 5 **Gregory, Jeremy. 2006.** *Material Flow Analysis.* s.l. : Massachussets Institute of Technology  
6 Department of Materials science & Engineering, 2006.
- 7 **Grisel, Laurent and Osset, Philippe. 2008.** *L'anayse du cycle de vie d'un produit ou d'un service.* La  
8 Plaine Saint-Denis : AFNOR, 2008. ISBN: 978-2-12-465151-1.
- 9 **Grosseti, Michel, et al. 2003.** Proximités et activités de R&D. [book auth.] Claude Dupuy and Antje  
10 Burmeister. *Entreprises et territoires: les nouveaux enjeux de la proximité.* Paris : La documentation  
11 française, 2003.
- 12 **Grübler, Arnulf. 1990.** *The rise and fall of infrastructure: Dynamics of evolution and technological*  
13 *change in transport.* Heidelberg : Physica-Verlag, 1990. ISBN: 3-7908-0479-7.
- 14 **Guérin, Isabelle, Lapenu, Cécile and Doligez, François. 2009.** La microfinance est-elle socialement  
15 responsable? *Revue Tiers Monde.* Armand Colin, 2009, Vol. 1, 197, pp. 5-16.
- 16 **Guérin, Isabelle, Palier, Jane and Prevost, Benoît. 2009.** *Femmes et microfinances: Espoirs et*  
17 *désillusions de l'expérience indienne.* Paris : Editions des archives contemporaines , 2009. ISBN: 978-  
18 2-914610-89-6.
- 19 **Hansen, W.G. 1959.** How accessibility shapes land use? *Journal of the American Institute of Planners.*  
20 1959, n°25, pp. 73-76.
- 21 **Hashimoto, Seiji, et al. 2012.** Greening Growing Giants: A Major Challenge for Our Planet. *Journal of*  
22 *Industrial Ecology.* 2012, Vol. 00, 0, pp. 1-7.
- 23 **Hawkins, Troy R. and Dente, Sébastien M.R. 2010.** Greenhouse Gas Emissions Driven by the  
24 Transportation of Goods Associated with French Consumption. *Environmental Science and*  
25 *Technology.* 2010, 44, pp. 8656-8664.
- 26 **Hawkins, Troy, et al. 2007.** A Mixed-Unit Input-Output Model for Environmental Life-Cycle  
27 Assessment and Material Flow Analysis. *Environmental science & technology.* 2007, 41, pp. pp. 1024-  
28 1031.
- 29 **Herman, R., Ardekani, S.A. and Ausubel, J.H. 1989.** Dematerialization. [book auth.] J.H. Ausubel and  
30 H.E. Sladovich. *Technology and Environment.* Washington D.C. : US National Academy of Engineering,  
31 1989.
- 32 **Hertwich, Edgar and Peters, Glen. 2004.** *Production factors and pollution embodied in trade -*  
33 *Theoretical Development.* Trondheim : NTNU - Program for industriell økologi, 2004.
- 34 **Hertwich, Edgar G. 2005.** Life Cycle Approaches to Sustainable Consumption: A critical review.  
35 *Environmental Science & Technology.* 2005, 39, pp. pp 4673-4684.

- 1 **Hill, Peter. 1999.** Tangibles, intangibles and services: a new taxonomy for the classification of output.  
2 *Canadian Journal of Economics.* 1999, Vol. 32, 2.
- 3 **Hoffrén, Jukka, Apajalahti, Eeva-Lotta and Rättö, Hanna. 2009.** *Pilot study on Economy-wide*  
4 *Material Flow Accounting (MFA) with hidden flows in Finland.* Helsinki : Statistics Finland, Statistical  
5 R&D Unit, 2009.
- 6 **Hunter, Louis C. and Bryant, Lynwood. 1991.** *A History of Industrial Power in the U.S., 1780-1930:*  
7 *Vol.3: The Transmission of Power.* s.l. : The MIT press, 1991. ISBN.
- 8 **Huriot, J.M. and Perreux, J. 1994.** L'accessibilité. [book auth.] J.P. Auray. *Encyclopédie d'économie*  
9 *spatiale.* 1994.
- 10 **IEA. 2010.** *CO2 emissions from fuel combustion - Highlights.* s.l. : IEA, 2010.
- 11 **INFRAS. 2004.** *External Costs of Transport: update study.* Zurich/Karlsruhe : INFRAS, 2004.
- 12 **INSEE. 1972 to 1987.** *Annuaire Statistique de la France .* Paris : s.n., 1972 to 1987.
- 13 **International Energy Agency. 2006.** *World Energy Outlook.* 2006.
- 14 **IRU. 2008.** *IRU position on the internalisation of external costs.* Geneva : IRU, 2008.
- 15 **ITEMS. 2009.** *L'impact des technologies de l'information sur la logistique.* s.l. : PIPAME, 2009.
- 16 **Jenkins, Rhys. 1936.** *Savery, Newcomen and the Early History of the Steam Engine.* Cambridge :  
17 Newcomen society, 1936.
- 18 **Kanda, Yasuhiro and Nakagami, Yasuhide. 2006.** *What is Product-Service Systems (PSS)?- A review*  
19 *on PSS Researches and Relevant Policies.* s.l. : IGES Kansai Research Centre, 2006.
- 20 **Katterl, A. and Kratena, K. 1990.** *Reale Input-Output Tabelle und ökologischer Kreislauf.* Heidelberg :  
21 Physica, 1990.
- 22 **Kayo, Chihiro, hashimoto, Seiji and Moriguchi, Yuichi. 2012.** Paper and Paperboard Demand and  
23 Associated Carbon Dioxide Emissions in Asia Through 2050. *Journal of Industrial Ecology.*  
24 Wileyonlinelibrary, 2012.
- 25 **Keskin, Burcu B. and Üster, Halit. 2007.** Meta-heuristic approaches with memory and evolution for a  
26 multi-product production/distribution system design problem. *European Journal of Operational*  
27 *Research.* 2007, Vol. 1, 82, pp. 663-682.
- 28 **Kolm, S-C. 1984.** *La bonne économie : la réciprocité générale.* Paris : PUF. Collection Politique  
29 d'aujourd'hui, 1984.
- 30 **Kratena, Kurt and Meyer, Ina. 2010.** *CO2 Emissions Embodied in Austrian International Trade.* s.l. :  
31 FIW, 2010.
- 32 **Kuhtz, Silvana, et al. 2010.** Energy use in two Italian and Chinese tile manufacturers: A comparison  
33 using an enterprise input-output model. *Energy.* Elsevier, 2010, 35.

- 1 —. **2010**. energy use in two Italian en Chinese tile manufacturers: A comparison using an enterprise  
2 input-model. *Energy*. 2010, 35, pp. 364-374.
- 3 **Landel, Pierre-Antoine and Pecqueur, Bernard. 2011**. *L'opérateur territorial, vecteur du changement*.  
4 s.l. : 48ème colloque ASRDLF, 2011.
- 5 **Landes, David Saul. 1969**. *The Unbound Prometheus: Technological Change and Industrial*  
6 *Development in Western Europe from 1750 to the Present*. Cambridge : Press Syndicate of the  
7 University of Cambridge, 1969. ISBN: 0-521-09418-6.
- 8 **Le Berre, M. 1992**. Territoires. *Encyclopédie de Géographie*. Economica, 1992, pp. 620-621.
- 9 **Lendrevie, J., Lévy, J. and Lindon, D. 2003**. *Mercator*. Paris : Editions Dalloz, 2003.
- 10 **Lenglart, Fabrice, Lesieur, Christophe and Pasquier, Jean-Louis. 2010**. *Les émissions de CO2 du*  
11 *circuit économique en France*. Paris : s.n., 2010.
- 12 **Lenzen, Manfred, et al. 2007**. Shared producer and consumer responsibility - Theory and practice.  
13 *Ecological Economics*. 2007, 61, pp. 27-42.
- 14 **Leonardi, Jacques, Baumgartner, Michael and Krusch, Oliver. 2005**. Potentialités de réduction des  
15 émissions de CO2 sur une flotte de camions. Résultats d'une étude allemande. [book auth.]  
16 Christophe Rizet. *Consommation d'énergie et émission de gaz à effet de serre en transport de*  
17 *marchandises: Actes de la journée INRETS-PREDIT-COST du 18 mai 2005*. s.l. : Les collections de  
18 l'Inrets, 2005.
- 19 **Llerena, Daniel and Michaud, Céline. 2007**. Révélation des consentements à payer pour des produits  
20 remanufacturés. [book auth.] Jean-François Boujut, Daniel Llerena and Daniel Brissaud. *Les systèmes*  
21 *de production: applications interdisciplinaires et mutations*. Paris : Lavoisier, 2007.
- 22 **Llyod, Michael and Vassallo, Walter. 2005**. *REgional Action for Logistical Integration of Shipping*  
23 *accross Europe (REALISE) Final report*. Brussels : The Alliance of Maritime regional interests in Europe,  
24 2005.
- 25 **Maddison, D, et al. 1996**. *Blueprint 5: the true costs of road transport*. London : Earthscan, 1996.
- 26 **Mäenpää, I. and Muukkonen, J. 2001**. *Physical Input-Output in Finland: Methods, Preliminary Results*  
27 *and Tasks ahead*. Stockholm, Sweden : Workshop on Economic Growth, material flows and  
28 environmental pressure 25th-27th April, 2001.
- 29 **Maibach, M., et al. 2008**. *Handbook on Estimation of external costs in the transport sector*. Delft : CE  
30 Delft, 2008.
- 31 **Maier, G. and Bergman, E.M. 2000**. *Trade and transport choices of member firms in major industrial*  
32 *clusters*. Lugano : 6th RAI World Congress, 2000.
- 33 **Mairie de Paris. 2012**. *Velib' dossier de Presse*. 2012.
- 34 **Malinowski, B. 1920**. *The Kula: the circulating exchanges of valuables in the Archipelagos of Eastern*  
35 *New guinea*. s.l. : Man, 1920.

- 1 **Manthey, Ewa. 2012.** Circular economy. *Enterprise China*. [Online] March 2012.  
2 <http://www.enterprisechina.net/life/circular-economy>.
- 3 **Marchetti, C. 1987.** *Infrastructures for movement*. s.l. : Tech. Forecasting and Soc. change, 1987.
- 4 **Marty, Claude. 1997.** *Le juste à temps: Produire autrement*. Paris : Hermès, 1997. ISBN: 2-86601-600-  
5 9.
- 6 **Marx, Karl. 1994.** Le Capital (Livre premier). *Oeuvres Economie I*. s.l. : Gallimards Bibliothèque de la  
7 Pleiade, 1994.
- 8 **Maurer, Hedwig Hildeberg . 2008.** *Development of an integrated mode for estimating emissions from*  
9 *freight transport*. Leeds : University of Leeds, 2008.
- 10 **Mc Kinnon, Alan, et al. 2010.** *Green Logistics: Improving the environmental sustainability of logistics*.  
11 London : The chartered Institute of Logistics and transport (UK) (Kogan Page), 2010. ISBN: 978-0-  
12 7494-5678-8.
- 13 **McQuarrie, Carole, Mc Quarrie, Donald and Rock, Peter A. 1992.** *Chimie Générale*. Bruxelles :  
14 Editions de Boeck Université, 1992. ISBN: 2-8041-3703-1.
- 15 **Mellet, Dieter. 2008.** *Servicisation: Extending the product life cycle of high technological*  
16 *manufactured goods*. s.l. : University of Stellenbosch, 2008.
- 17 **Menche, Nicole. 2006.** *Anatomie, Physiologie, Biologie*. Paris : Maloine, 2006. ISBN: 978-2-224-  
18 02912-8.
- 19 **Mikiki, Foteini. 2005.** Analyse de la chaîne logistique de yaourt en Grèce. [book auth.] Christophe  
20 Rizet. *Consommation d'énergie et émission de gaz à effet de serre en transport de marchandises:*  
21 *Actes de la Journée INRETS-PREDIT-COST du 18 mai 2005*. s.l. : Les collections de l'Inrets, 2005.
- 22 **Ministère de l'Economie des Finances et de l'Industrie. 2001.** Les entreprises industrielles et la  
23 publicité. *Sessi*. 2001, n°155.
- 24 **Mitra-Kahn, Benjamin H. 2008.** *Debunking the Myths of Computable General Equilibrium models*.  
25 New York : The New School for Social Research, 2008.
- 26 **Moine, Alexandre. 2005.** Le territoire comme un système complexe: Des outils pour l'aménagement  
27 et la géographie. *Septièmes Rencontres de Théo Quant*. 2005.
- 28 **Mont, Oksana. 2000.** *Introducing and developing a Product-Service System (PSS) concept in Sweden*.  
29 Lund University, Sweden : The international Institute for industrial environmental economics, 2000.
- 30 —. 2000. *Product Service systems*. Lund University : The International Institute of Industrial  
31 Environmental Economics, 2000.
- 32 **Montroll, E.W. and Badger, W.W. 1974.** *Introduction to quantitative aspects of social phenomena*.  
33 New York : Gordon and Breach, 1974.
- 34 **Morana, Joëlle and Pinardi, Gilles. 2003.** Elaboration d'un tableau de bord des coûts logistiques de  
35 distribution. *Revue Française de Gestion Industrielle*. 2003, Vol. 22, 4, pp. 77-95.

- 1 **Nansai, Keisuke, et al. 2009.** Material and Energy Dependence of Services and Its implications for  
2 Climate Change. *Environmental Science and Technology*. 2009, Vol. 43, 12, pp. 4241-4246.
- 3 **Nebbia, G. 2003.** *Contabilità moneteria e contabilità ambientale*. s.l. : Estrato da "Economia  
4 Pubblica" 2000, 2003.
- 5 **Nelson, R.R. and Winter, S. 1982.** *An evolutionary theory of economic change*. Cambridge : Harvard  
6 University Press, 1982.
- 7 **Nikkanen, Markku.** *Spatial concerns in logistical networks with special reference to proximity*.  
8 Finland : Laurea Polytechnic.
- 9 **Noussair, C., Robin, S. and Ruffieux, B. 2004.** Do consumers really refuse to buy genetically modified  
10 food? *The Economic Journal*. 2004, 114.
- 11 **Nussbaum, Martha C. 2012.** *Capabilités: Comment créer les conditions d'un monde plus juste?* s.l. :  
12 Climats, Flammarion, 2012. ISBN: 978-2-0812-7077-0.
- 13 **Orléan, André. 2011.** *L'empire de la valeur: refonder l'économie*. Paris : Editions du Seuil, 2011. ISBN:  
14 978-2-02-105437-8.
- 15 **Orwell, George. 1982.** *Dans la déche à Paris et à Londres*. [ed.] Michel Pétris. Paris : Editions Ivrea,  
16 1982. ISBN: 2-264-03710-5.
- 17 **Pavitt, K. 1984.** Sectoral patterns of technical change: Towards a taxonomy an a theory. *Research*  
18 *Policy*. 1984, 13, pp. p. 343-373.
- 19 **Pecqueur, Bernard and Peyrache-Gadeau, Véronique. 2010.** Fondements interdisciplinaires et  
20 systémiques de l'approche territoriale introduction. *Revue d'Economie Régionale & Urbaine*. Armand  
21 Colin, October 2010, Vol. 4, pp. 613-623.
- 22 **Pecqueur, Bernard. 2006.** Le tournant territoriale de l'économie globale. *Espaces et Sociétés*. ERES,  
23 2006, Vol. 2, 124-125, pp. 17-32.
- 24 —. **2005.** Les territoires créateurs de nouvelles ressources productives: le cas de l'agglomération  
25 grenobloise. *Géographie, économie, société*. Lavoisier, 2005, Vol. 7, 3, pp. 255-268.
- 26 **Pedersen, O.G. 1999.** *Physical Input-Output Tables for Denmark. Products and Materials 1990. Air*  
27 *Emissions 1990-92*. Kopenhagen : Statistics Denmark, 1999.
- 28 **Péguy, Charles-Pierre. 2001.** *Espace, temps, complexité: vers une métagéographie*. Paris : Reclus,  
29 Editions Belin, 2001. ISBN: 2-7011-2965-6.
- 30 **Perrat, Jacques and Zimmermann, Jean-Benoît. 2003.** Stratégie des firmes et dynamiques  
31 territoriales. [book auth.] Claude Dupuy and Antje Burmeister. *Entreprises et territoires: Les*  
32 *nouveaux enjeux de la proximité*. Paris : La documentation Française, 2003.
- 33 **Peters, Glen P. and Hertwich, Edgar G. 2008.** Post Kyoto greenhouse gas inventories: production  
34 versus consumption. *Climatic Change*. 2008, 86: 51-66.
- 35 —. **2008.** Trading Kyoto. *nature reports climate change*. 2008, Vol. 2.

- 1 **Peyrache-Gadeau, Véronique, Perron, Loïc and Janin, Claude. 2010.** *Les temporalités de la ressource*  
2 *territoriales : Enseignements à partir d'expériences en Rhône-Alpes (version provisoire)*. s.l. :  
3 Association de Science Régionale de Langue Française, 2010.
- 4 **Picard, Pierre. 2007.** *Elements de microéconomie*. Paris : Editions Montchrestien, 2007. ISBN: 978-2-  
5 7076-1510-7.
- 6 **Pimor, Yves and Fender, Michel. 2008.** *Logistique: Production, Distribution, Soutien*. Paris : Dunod,  
7 2008. ISBN: 978-2-10-051607-0.
- 8 **Piriou, Jean-Paul. 2008.** *La comptabilité nationale*. Paris : La Découverte, 2008. ISBN: 978-2-7071-  
9 5660-0.
- 10 **Plassat, Gabriel. 2005.** Les technologies des véhicules lourds et les émissions de gaz à effet de serre  
11 associées. [book auth.] Christophe Rizet. *Consommation d'énergie et émission de gaz à effet de serre*  
12 *en transport de marchandises: Actes de la Journée INRETS-PREDIT-COST du 18 mai 2005*. s.l. : Les  
13 collections de l'Inrets, 2005.
- 14 **Pons, Jacques and Chevalier, Pascal. 1996.** *La logistique intégrée*. Paris : Hermès, 1996. ISBN:2-  
15 86601-399-9.
- 16 **PREDIT. 2010.** *Scénarios d'Amélioration de la Gestion des wagons et de l'Attractivité de l'offre*  
17 *ferroviaire*. 2010.
- 18 **Prindezis, N. and Kiranoudis, C.T. 2005.** An internet-based logistics management system for  
19 enterprise chains. *Journal of food engineering*. 2005, 70, pp. 373-381.
- 20 **Pry, R.H. 1988.** *The changing nature of industrial management*. Laxenburg, Austria : IIASA, 1988.  
21 Draft.
- 22 **Rallet, Alain and Torre, André. 2004.** Proximité et localisation. *Economie rurale*. 2004, n°284, pp. 25-  
23 41.
- 24 **Rapport de l'Académie des technologies. 2009.** *Le transport de marchandises - résumé*. 2009.
- 25 **Raupach, Michael R., et al. 2007.** Global and regional drivers of accelerating CO2 emissions. *PNAS*.  
26 June 12, 2007, Vol. 104, 24.
- 27 **Ritthoff, Michael, Rohn, Holger and Liedtke, Christa. 2002.** *Calculating MIPS: Resource productivity*  
28 *of products and services*. s.l. : Science Centre North Rhine-Westfalia, Institute of Work and  
29 Technology, Institute for Culture Studies, Wuppertal Institute for Climate, Environment and Energy,  
30 2002. ISBN: 3-929944-56-1e.
- 31 **Rizet, Christophe and Keïta, Basile. 2005.** Chaînes logistiques et consommation d'énergie: Cas du  
32 Yaourt et du Jean. [book auth.] Christophe Rizet. *Consommation d'énergie et émission de gaz à effet*  
33 *de serre en transport de marchandises: Actes de la Journée INRETS-PREDIT-COST du 18 mai 2005*. s.l. :  
34 Les collections de l'Inrets, 2005.
- 35 **Rizet, Christophe, et al. Décembre 2008.** *Chaînes logistiques et consommation d'énergie: Cas des*  
36 *meubles et des fruits & légumes*. s.l. : PREDIT, Décembre 2008.

- 1 **RODHAIN, Florence and FALLERY, Bernard. 2010.** *Après la prise de conscience écologique, les T.I.C.*  
2 *en quête de responsabilité sociale.* La Rochelle : Actes du 15ème colloque de l'AIM (Association  
3 Information et Management), 2010.
- 4 **Rollin, Philippe and Gardent, Raoul. 1980.** Chapitre 6: Le secteur "air". [book auth.] Roger Ginocchio.  
5 *Energie électrique et environnement.* Paris : Direction des Etudes et Recherches d'Electricité de  
6 France, Eyrolles, 1980.
- 7 **Rotillon, Gilles. 2010.** *Economie des ressources naturelles.* Paris : La découverte, 2010. ISBN: 978-2-  
8 7071-6455-1.
- 9 **Roux, Christian. 2009.** *Initiation à la théorie des graphes.* Paris : Ellipses, 2009. ISBN: 978-2-7298-  
10 4163-8.
- 11 **Russel, Bertrand. 2001.** *La conquête du bonheur.* Paris : Editions Payot & Rivages, 2001.
- 12 **Salais, R. and Storper, M. 1993.** *Les mondes de production. Enquête sur l'identité économique de la*  
13 *France.* s.l. : Editions de l'EHESS, 1993. p. 467.
- 14 **Salais, Robert. 1989.** L'analyse économique des conventions du travail. *Revue économique.* Persée,  
15 1989, Vol. 40, n°2, pp. 199-240.
- 16 **Salles, Maryse and Colletis, Gabriel. 2007.** Représentation de l'entreprise dans les systèmes  
17 d'information statistique et décision dans les collectivités territoriales. *Droit et Société.* Ed. Juridiques  
18 associées, 2007, Vol. 1, n°65, pp. 53-74.
- 19 **Samaras, D.G. 1962.** Nuclear Space Propulsion - a Historic Necessity. *Nuclear Energy.* September  
20 1962, pp. 351-356.
- 21 **Sax, E. 1920.** *Die Verkehrsmittel in Volks- und Staatswirtschaft.* Berlin : Julius Springer Verlag, 1920.  
22 Vol. volume 1 and volume 2. Second revised Edition.
- 23 **Schettkat, Ronald and Yocarini, Lara. 2003.** *The Shift to Services: A Review of the Literature.* Bonn,  
24 Germany : Institute for the Study of Labor, 2003. Discussion paper n°964.
- 25 **Sen, Amartya. 2003.** *L'économie est une science morale.* Paris : La Découverte/poche, 2003. ISBN:  
26 978-2-7071-4285-5.
- 27 —. **1987.** *On ethics and economics.* Oxford : Blackwell, 1987.
- 28 **Sery, Annelise. 2012.** *Le micro crédit: l'empowerment des femmes ivoiriennes.* Montpellier : Ecole  
29 doctorale n°60 "Territoires, Temps, Sociétés et Développement", Université de Paul Valéry-  
30 Montpellier III, 2012.
- 31 **Sétra. 2008.** *Accessibilité des territoires et des services: notions et représentation.* s.l. : MEEDAT,  
32 2008.
- 33 **Shogren, J.F. 2001.** Experimental methods and valuation. [book auth.] KG Mäler and J. Vincent. *The*  
34 *handbook of environmental economics.* 2001.



- 1 **Sieferle, R.P. 1982.** *Der unterirdische Wald, Energiekrise und Industrielle Revolutio.* München : C.H.  
2 Beck, 1982.
- 3 **Simmel, Georg. 1987.** *Philosophie de l'argent.* Paris : PUF, 1987.
- 4 **Smith, Adam. 1991.** *La richesse des nations tome I.* Paris : Flammarion, 1991. ISBN: 978-2-0807-0598-  
5 3.
- 6 —. **1991.** *La richesse des nations tome II.* Paris : Flammarion, 1991. ISBN: 978-2-0807-0626-3.
- 7 **Smith, Thomas M. and Smith, Robert Leo. 2006.** *Elements of Ecology.* San Francisco : Pearson  
8 Education, Inc. Benjamin Cummings, 2006. ISBN: 0-321-41029-7.
- 9 **Spassov, V. and Toney, D. 2005.** Recherche sur la diminution de la consommation énergétique dans  
10 le domaine de Supply Chain et du stockage de yaourt en Bulgarie. [book auth.] Christophe Rizet.  
11 *Consommation d'énergie et émission de gaz à effet de serre en transport de marchandises: Actes de*  
12 *la Journée INRETS-PREDIT-COST du 18 mai 2005.* s.l. : Les collections de l'Inrets, 2005.
- 13 **Stahel, Walter R. 2010.** *The performance Economy.* New Edition : Palgrave MacMillan, 2010. ISBN:  
14 978-0-230-58466-2.
- 15 **Stahmer, C. 2000.** Das magische Dreieck der Input-Output-Rechnung. [book auth.] S. Hartard, C.  
16 Stahmer and F. Hinterberger. *Magische Dreiecke. Berichte für eine nachhaltige Gesellschaft.*  
17 Marburg : Metropolis Verlag, 2000.
- 18 **Stahmer, C., Kuhn, M. and Braun, N. 1998.** Physical Input-Output Tables for Germany 1990. *Eurostat*  
19 *Working Paper.* European Comission, 1998, n° 2/1998/B/1.
- 20 —. **1997.** *Physische Input-Output Tabellen (PIOT) 1990.* Wiesbaden : Statistisches Bundesamt, 1997.
- 21 **Statistisches Bundesamt. 2001.** *Endbericht zum Projekt " A Physical Input-Output Table for Germany*  
22 *1995.* Wiesbaden : Statistisches Bundesamt, 2001.
- 23 **Stern, N. 2006.** *Stern review: The economics of climate change.* London : HM treasury, 2006.
- 24 **Strassert, Gunter. 2000.** *Physical Input-Output accounting and analysis: new perspectives.* Macerata,  
25 Italy : 13th International Conference on Input-Output techniques 21-25 August, 2000.
- 26 **Studený, Christophe. 1995.** *L'invention de la vitesse: France, XVIIIe-XXe siècle.* s.l. : Editions  
27 Gallimard, 1995. ISBN: 2-07-073179-0.
- 28 **Suh, Sangwon and Kagawa, Shigemi. 2005.** Industrial ecology and input-output economics: an  
29 introduction. *Economic Systems Research.* 2005, Vol. 17, n°4, pp. 349-364.
- 30 **Tarondeau, J.-C. 1982.** *Produits et technologies. Choix politiques de l'entreprise industrielle.* Paris :  
31 Dalloz, collection Gestion Management, 1982. p. 222.
- 32 **Tavasszy, L. 2000.** *Aggregate modelling of logistics networks.* Siena (Italy) : NECTAR Cluster 2  
33 Workshop, 2000.

- 1 **Tavasszy, L., Jonkhoff, W. and Burgess, A. 2005.** 'Key Issues in the Development of Harmonised  
2 Guidelines for Project Assessment and Transport Costing' HEATCO – Developing Harmonised  
3 European Approaches for Transport Costing and Project Assessment. Funded by the 6th Framework  
4 RTD Programme. Deliverable 3. Delft, Netherlands : TNO, 2005.
- 5 **Tavasszy, L.A. 2006.** *Freight Modelling - An overview of international experiences.* Washington DC :  
6 TRB Conference on Freight Demand Modelling: Tools for Public Sector Decision Making, 2006.
- 7 **Tavasszy, L.A. 1995.** *De FastShip: het einde van twee marktreservaten.* 1995.
- 8 **Tavasszy, Lóránt A., Ruijgrok, Kees and Davydenko, Igor. 2012.** Incorporating Logistics in Freight  
9 Transport Demand Models: State-of-the art and Research opportunities. *Transport Reviews: A*  
10 *Transnational Transdisciplinary Journal.* 2012, Vol. 32, 2, pp. 203-219.
- 11 **Tavasszy, Lóri, Iding, Mirjam and Groothede, Bas. 2001.** *Innovations in freight transport systems*  
12 *that respect trends in logistics services.* Cambridge : European Transport Conference, 2001.
- 13 **Thévenin, T. 2002.** *Quand la géographie se met au service des transports publics urbains : une*  
14 *approche spatio-temporelle appliquée à Besançon.* 2002.
- 15 **Tizon, Philippe. 1996.** Qu'est-ce que le territoire? [book auth.] Guy Di Méo. *Les territoires du*  
16 *quotidien.* Paris : L'Harmattan, 1996.
- 17 **Toutain, J.C. 1967.** Les transports en France de 1830 à 1965. *Cahiers de l'ISEA, Série Histoire*  
18 *Quantitative de l'Economie Française.* Presses Universitaires de France, 1967, n°8.
- 19 **TREMOVE. 2009.** <http://www.tremove.org/>. [Online] 2009.
- 20 **Trenberth, K.E., et al. 2007.** Observations: Surface and Atmospheric Climate Change. [book auth.] S.  
21 Solomon, et al. *Climate Change 2007: The Physical Science Basis. Contribution to Working Group I to*  
22 *the Fourth Assessment Report of the Intergovernmental Panel on Climate Change.* Cambridge, United  
23 Kingdom and New York, NY, USA : Cambridge University Press, 2007.
- 24 **Tukker, Arnold. 2004.** Eight types of product-service system: eight ways to sustainability?  
25 Experiences from Suspronet. *Business Strategy and the Environment.* Wiley InterScience, 2004, Vol.  
26 13, pp. 246-260.
- 27 **U.S. Department of Commerce. 1975.** *Historical Statistics of the United States, Colonial times to*  
28 *1970.* Washington D.C. : Bureau of the Census, 1975.
- 29 **UNITE. 2003.** *Unification of Accounts and Marginal Costs for Transport Efficiency (UNITE): Final*  
30 *report.* Leeds : Institute of Transport Studies, University of Leeds, 2003.
- 31 **United Nations.** Member States of the United Nations. *United Nations.* [Online] [Cited: 08 19, 2011.]  
32 <http://www.un.org/en/members/#n>.
- 33 —. Protocole de Kyoto à la convention cadre des nations Unies sur les changements climatiques.  
34 [Online] [Cited: 08 1, 2011.] <http://unfccc.int/resource/docs/convkp/kpfrench.pdf>.

- 1 —. Status of Ratification of the Kyoto Protocol. *UNFCCC*. [Online] [Cited: 08 19, 2011.]  
2 [http://unfccc.int/kyoto\\_protocol/status\\_of\\_ratification/items/2613.php](http://unfccc.int/kyoto_protocol/status_of_ratification/items/2613.php).
- 3 —. **1992**. *United Nations Framework Convention on Climate Change*. 1992.
- 4 **United Nations, UNFCCC. 1994**. *Résumé analytique de la communication nationale de l'Allemagne*.  
5 1994.
- 6 **Vallin, Philippe. 2005**. Réorganisation logistique chez les chargeurs - étude des possibilités de  
7 réduction de la mobilité des marchandises. [book auth.] Christophe Rizet. *Consommation d'énergie et*  
8 *émission de gaz à effet de serre en transport de marchandises: Actes de la Journée INRETS-PREDIT-*  
9 *COST du 18 mai 2005*. s.l. : Les collections de l'Inrets, 2005.
- 10 **Vidal, John. 2008**. Sending waste to China saves carbon emissions. *The Guardian*. [Online] August 19,  
11 2008. <http://www.guardian.co.uk/environment/2008/aug/19/recycling.waste>.
- 12 **VNF**. <http://www.vnf.fr/eve/>. [Online]
- 13 **Voigt, F. 1965**. *Verkehr*. Berlin : Dunker & Humblot, 1965.
- 14 **Waggoner, E. P. and Ausubel, H. J. 2002**. A framework for sustainability science: A renovated IPAT  
15 identity. *PNAS*. June 11, 2002, Vol. 99, 12.
- 16 **Walker, C.H., et al. 2006**. *Principles of ecotoxicology*. Boca Raton : Taylor & Francis Group, 2006. 978-  
17 0-8493-3635-5.
- 18 **Walras, L. 1926**. *Eléments d'économie politique pure*. [trans.] W. Jaffe. London : George Allen and  
19 Unwin Ltd, 1926.
- 20 **Walras, Léon. 1952**. *Eléments d'économie politique pure ou théorie de la richesse sociale*. Paris :  
21 Librairie Générale de droit et de jurisprudence, 1952.
- 22 **Weber, C. and Matthews, H.S. 2007**. Embodied Environmental Emissions in U.S. International Trade,  
23 1997 – 2004. *Environmental Science and Technology*. 2007, Vol. 41, 4875 – 4881.
- 24 **Weber, Max. 1995**. *Economie et Société, tome I: Les Catégories de la sociologie*. Paris : Plon, 1995.
- 25 —. **1964**. *L'éthique protestante et l'esprit du capitalisme*. Paris : s.n., 1964.
- 26 **Wolff, Jutta, Gaffron, Philine and Fläming, Heike. 2010**. *Tools and Guidelines for Assessing Modal*  
27 *Shift, Environmental Impact & Socio-economic impacts in MoS-applications*. s.l. : Institute for  
28 Transport Planning and Logistics, Hamburg University of technology (TUHH), 2010.
- 29 **Woodward, J. 1965**. *Industrial Organization: Theory and Practice*. 2nd edition 1980. s.l. : Oxford  
30 University Press, 1965. p. 281.
- 31 **World Commission on Environment and Development. 1987**. *Our common future*. Oxford : Oxford  
32 University Press, 1987. p. 43.
- 33 **World Trade Organization. 2010**. *Les ressources naturelles: définitions, structure des échanges et*  
34 *mondialisation*. 2010.

1 —. **2011.** *Understanding the WTO.* s.l. : World Trade Organization Information and External Relations  
2 Division, 2011.

3 **WWF. 2006.** *Living planet report.* 2006.

4 **Yi, Lan and Thomas, Hywel R. 2007.** A review of research on the environmental impact of e-business  
5 and ICT. [ed.] Elsevier. *Environment International.* august 2007, Vol. 33 issue 6, pp. 841-849.

6 **Zahavi, Y. 1981.** *The UMOT-urban Interactions.* Washington D.C : U.S. Department of transportation,  
7 1981. DOT-RSPA-DPB 10/7.

8

9

1 **ANNEX:**

2 **1 National IO-Table structure**

3  
4 The IO table from INSEE is made of 116 sectors. The code and headings of the nomenclature are  
5 presented in **Table 42**. Besides, the figures of 2006 national IO table are presented successively in  
6 **Table 43, Table 44, Table 45, Table 46, and Table 47**. The intermediary flow matrix (Z) is presented in  
7 the four former tables while the latter table introduces the final demand flow matrix (Y) with the  
8 resulting total (X).

9 **Table 42 : Nomenclature headings of the National French IO Table**

CATEGORIES	ACTIVITIES	ACTIVITY	CODE NES	
<b>Agriculture, forestry and fishing</b>	Agriculture, hunting, trapping and related service activities	AGRICULTURE CHASSE SERVICES ANNEXES	GA01	1
	Forestry, logging and related service activities	SYLVICULTURE, EXPLOITATION FORESTIERE, SERVICES ANNEXES	GA02	2
	Fishing, fish farming and related service activities	PECHE, AQUACULTURE	GA03	3
<b>Manufacture of food products, beverage and tobacco</b>	Production, processing and preserving of meat and meat products	INDUSTRIE DES VIANDES	GB01	4
	Manufacture of dairy products	INDUSTRIE DU LAIT	GB02	5
	Manufacture of beverages	INDUSTRIE DES BOISSONS	GB03	6
	Manufacture of grain mill products, starches and starch products, prepared animal feeds	TRAVAIL DU GRAIN: FABRICATION D'ALIMENTS POUR ANIMAUX	GB04	7
	Manufacture of other food products	INDUSTRIES ALIMENTAIRES DIVERSES	GB05	8
	Manufacture of tobacco products	INDUSTRIE DU TABAC	GB06	9
<b>Manufacture of consumer goods</b>	Manufacture of wearing apparel; dressing and dyeing of fur	INDUSTRIE DE L HABILLEMENT ET DES FOURRURES	GC11	10
	Manufacture of leather and leather products and footwear	INDUSTRIE DU CUIR ET DE LA CHAUSSURE	GC12	11
	Publishing, printing and reproduction of recorded media	EDITION, IMPRIMERIE, REPRODUCTION	GC20	12
	Manufacture of pharmaceuticals, medicinal chemicals and botanical products	INDUSTRIE PHARMACEUTIQUE	GC31	13
	Manufacture of soap and detergents, cleaning and polishing preparations, perfumes and toilet preparations	FABRICATION DE SAVONS DE PARFUM ET DE PRODUITS D'ENTRETIEN	GC32	14
	Manufacture of furniture	FABRICATION DE MEUBLES	GC41	15
	Manufacture of jewellery and musical instruments	BIJOUTERIE ET FABRICATION D INSTRUMENTS DE MUSIQUE	GC42	16
	Manufacture of sports goods, games, toys and others n.e.c.	FABRICATION D ARTICLES DE SPORT, DE JEUX ET INDUSTRIES DIVERSES	GC43	17
	Manufacture of domestic appliances	FABRICATION D APPAREILS DOMESTIQUES	GC44	18
	Manufacture of television and radio receivers, sound or video recording or reproducing apparatus and associated goods	FABRICATION D APPAREILS DE RECEPTION, D'ENREGISTREMENT ET DE REPRODUCTION (SON, IMAGE)	GC45	19
Manufacture of optical instruments, photographic equipment, watches and clocks	FABRICATION DE MATERIEL OPTIQUE ET PHOTOGRAPHIQUE, HORLOGERIE	GC46	20	
<b>Manufacture of motor vehicles</b>	Manufacture of motor vehicles, bodies and trailers	CONSTRUCTION AUTOMOBILE	GD01	21
	Manufacture of parts and accessories for motor vehicles	FABRICATION D'EQUIPEMENTS AUTOMOBILES	GD02	22

10

11

<b>Manufacture of capital goods</b>	Building and repairing of ships and boats	CONSTRUCTION NAVALE	GE11	23
	Manufacture of railway and tramway locomotives and rolling stock	CONSTRUCTION DE MATERIEL FERROVIAIRE ROULANT	GE12	24
	Manufacture of aircraft and spacecraft	CONSTRUCTION AERONAUTIQUE ET SPATIALE	GE13	25
	Manufacture of motorcycles, bicycles and other transport equipment n.e.c.	FABRICATION DE CYCLES, MOTOCYCLES, MATERIEL DE TRANSPORT N.C.A	GE14	26
	Manufacture of structural metal products	FABRICATION D'ELEMENTS EN METAL POUR LA CONSTRUCTION	GE21	27
	Manufacture of tanks, reservoirs, containers of metal ; manufacture of central heating radiators and boilers and steam generators	CHAUDRONNERIE, FABRICATION DE RESERVOIRS METALLIQUES ET DE CHAUDIERES	GE22	28
	Manufacture of machinery for the production and use of mechanical power	FABRICATION D'EQUIPEMENTS MECANIQUES	GE23	29
	Manufacture of other general purpose machinery	FABRICATION DE MACHINES D'USAGE GENERAL	GE24	30
	Manufacture of agricultural and forestry machinery	FABRICATION DE MACHINES AGRICOLES	GE25	31
	Manufacture of machine tools	FABRICATION DE MACHINES OUTILS	GE26	32
	Manufacture of other special purpose machinery	FABRICATION D'AUTRES MACHINES D'USAGE SPECIFIQUE	GE27	33
	Manufacture of weapons and ammunition	FABRICATION D'ARMES ET MUNITIONS	GE28	34
	Manufacture of office machinery and computers	FABRICATION DE MACHINES DE BUREAU ET DE MATERIEL INFORMATIQUE	GE31	35
	Manufacture of electric motors, generators and transformers	FABRICATION DE MOTEURS GENERATRICES ET TRANSFORMATEURS ELECTRIQUES	GE32	36
	Manufacture of television and radio transmitters and apparatus for line telephony and line telegraphy	FABRICATION D'APPAREILS D'EMISSION ET DE TRANSMISSION	GE33	37
	Manufacture of medical and surgical equipment and orthopaedic appliances	FABRICATION DE MATERIEL MEDICOCHIRURGICAL ET D'ORTHOPEDIE	GE34	38
	Manufacture of industrial process control equipment, instruments and appliances for measuring, checking, testing, navigating	FABRICATION DE MATERIEL DE MESURE ET DE CONTRÔLE	GE35	39
	<b>Manufacture of intermediate goods</b>	Mining of metal ores	EXTRACTION DE MINERAIS METALLIQUES	GF11
Other mining and quarrying		AUTRES INDUSTRIES EXTRACTIVES	GF12	41
Manufacture of glass and glass products		FABRICATION DE VERRE ET D'ARTICLES EN VERRE	GF13	42
Manufacture of ceramic goods, products for construction purposes and other non-metallic mineral products		FABRICATION DE PRODUITS CERAMIQUES ET DE MATERIAUX DE CONSTRUCTION	GF14	43
Preparation and spinning of textile fibres, weaving and finishing of textiles		FILATURE ET TISSAGE	GF21	44
Manufacture of textile articles, except apparel		FABRICATION DE PRODUITS TEXTILES	GF22	45
Manufacture of knitted and crocheted fabrics and articles		FABRICATION D'ETOFFES ET D'ARTICLES A MAILLE	GF23	46
Manufacture of wood and wood products		TRAVAIL DU BOIS ET FABRICATION D'ARTICLES EN BOIS	GF31	47
Manufacture of pulp, paper and paperboard		FABRICATION DE PATE A PAPIER, DE PAPIER ET DE CARTON	GF32	48
Manufacture of articles of paper and paperboard		FABRICATION D'ARTICLES EN PAPIER OU EN CARTON	GF33	49
Manufacture of basic inorganic chemicals		INDUSTRIE CHIMIQUE MINERALE	GF41	50
Manufacture of basic organic chemicals		INDUSTRIE CHIMIQUE ORGANIQUE	GF42	51
Manufacture of agro-chemical products, paints and other chemical products		PARACHIMIE	GF43	52
Manufacture of man-made fibres		FABRICATION DE FIBRES ARTIFICIELLES OU SYNTHETIQUES	GF44	53
Manufacture of rubber products		INDUSTRIE DU CAOUTCHOUC	GF45	54
Manufacture of plastic products		TRANSFORMATION DES MATIERES PLASTIQUES	GF46	55
First processing of iron and steel		SIDERURGIE ET PREMIERE TRANSFORMATION DE L'ACIER	GF51	56
Manufacture of basic precious and non-ferrous metals		PRODUCTION DE METAUX NON FERREUX	GF52	57
Casting of metals		FONDERIE	GF53	58
Industrial services for treatment of metals		SERVICES INDUSTRIELS DU TRAVAIL DES METAUX	GF54	59
Manufacture of fabricated metal products		FABRICATION DE PRODUITS METALLIQUES	GF55	60
Recycling		RECUPERATION	GF56	61
Manufacture of electrical equipments and apparatus n.e.c.		FABRICATION DE MATERIEL ELECTRIQUE	GF61	62
Manufacture of electronic valves, tubes and other electronic components		FABRICATION DE COMPOSANTS ELECTRONIQUES	GF62	63

<b>Energy</b>	Mining of coal and lignite; extraction of peat	EXTRACTION DE HOUILLE, DE LIGNITE ET DE TOURBE	GG11	64
	Extraction of crude petroleum and natural gas; service activities incidental to oil and gas extraction	EXTRACTION D'HYDROCARBURES ET SERVICES ANNEXES	GG12	65
	Mining of uranium and thorium ores	EXTRACTION DE MINERAIS D URANIUM	GG13	66
	Manufacture of coke oven products and processing of nuclear fuel	COKEFACTION ET INDUSTRIE NUCLEAIRE	GG14	67
	Manufacture of refined petroleum products	RAFFINAGE DE PETROLE	GG15	68
	Electricity supply	PRODUCTION ET DISTRIBUTION D'ELECTRICITE	GG2A	69
	Gas, steam and hot water supply	PRODUCTION ET DISTRIBUTION DE GAZ, VAPEUR ET EAU CHAUDE	GG2B	70
	Collection, purification and distribution of water	CAPTAGE TRAITEMENT ET DISTRIBUTION D'EAU	GG22	71
<b>Services</b>	Construction and installation of buildings	BATIMENT	GH01	72
	Civil engineering works	TRAVAUX PUBLICS	GH02	73
	Sale, maintenance and repair of motor vehicles and motorcycles, retail sale of automotive fuel	COMMERCE ET REPARATION AUTOMOBILE	GI10	74
	Wholesale trade and commission trade	COMMERCE DE GROS, INTERMEDIAIRES	GI20	75
	Retail trade, repair of personal and household goods	COMMERCE DE DETAIL ET REPARATIONS	GI30	76
	Transport via railways	TRANSPORTS FERROVIAIRES	GK01	77
	Other passenger land transport	TRANSPORT ROUTIER DE VOYAGEURS	GK02	78
	Freight transport by road or via pipelines	TRANSPORT ROUTIER (OU PAR CONDUITES) DE MARCHANDISES	GK03	79
	Water transport	TRANSPORTS PAR EAU	GK04	80
	Air transport	TRANSPORTS AERIENS	GK05	81
	Cargo handling, storage and other supporting transport activities	MANUTENTION, ENTREPOSAGE ET GESTION D'INFRASTRUCTURES	GK07	82
	Activities of travel agencies and tour operators; tourist assistance activities n.e.c.	AGENCES DE VOYAGE	GK08	83
	Activities of other transport agencies, Space transport	ORGANISATION DU TRANSPORT DE FRET ET TRANSPORT SPATIAL	GK69	84
	Financial intermediation	INTERMEDIATION FINANCIERE	GL01	85
	Insurance and pension funding	ASSURANCES	GL02	86
	Activities auxiliary to financial intermediation, insurance and pension funding	AUXILIAIRES FINANCIERS ET D'ASSURANCE	GL03	87
	Real estate activities with own property, and on a fee or contract basis	PROMOTION, GESTION IMMOBILIERE	GM01	88
	Letting of own property	LOCATION IMMOBILIERE	GM02	89
	Post and courier activities, Telecommunications	TELECOMMUNICATION, POSTE ET COURRIER	GN10	90
	Computer and related activities	ACTIVITES INFORMATIQUES	GN21	91
	Legal, accounting, book-keeping and auditing activities ; business and management consultancy activities	SERVICES PROFESSIONNELS	GN22	92
	Management activities of holding companies	ADMINISTRATION D ENTREPRISES	GN23	93
	Advertising and market research	PUBLICITE ET ETUDES DE MARCHÉ	GN24	94
	Architectural and engineering activities ; technical testing and consultancy activities	ARCHITECTURE INGENIERIE CONTROLE	GN25	95
	Renting of machinery and equipment without operator and of personal and household goods	LOCATION SANS OPERATEUR	GN31	96
	Labour recruitment and provision of personnel	SELECTION ET FOURNITURE DE PERSONNEL	GN32	97
	Investigation and security activities, industrial cleaning and miscellaneous business activities n.e.c.	SECURITE, NETTOYAGE ET SERVICES DIVERS AUX ENTREPRISES	GN33	98
	Sewage and refuse disposal, sanitation and similar activities	ASSAINISSEMENT, VOIRIE ET GESTION DES DECHETS	GN34	99
	Market Research and development	RECHERCHE ET DEVELOPPEMENT MARCHANDS	GN4A	100
	Non-Market Research and development	RECHERCHE ET DEVELOPPEMENT NON MARCHANDS	GN4B	101

1

2

<b>Services</b>	Hotels and restaurants	HOTELS ET RESTAURANTS	GP 10	102
	Motion picture, video, radio and television activities	ACTIVITES AUDIOVISUELLES	GP 21	103
	Non-market other entertainment, cultural and sporting activities	AUTRES ACTIVITES RECREATIVES, CULTURELLES ET SPORTIVES MARCHANDES	GP 2A	104
	Market other entertainment, cultural and sporting activities	AUTRES ACTIVITES RECREATIVES CULTURELLES ET SPORTIVES NON MARCHANDES	GP 2B	105
	Other service activities	SERVICES PERSONNELS	GP 31	106
	Activities of households as employers of domestic staff and producers of goods and services for own use	SERVICES DOMESTIQUES	GP 32	107
	Market Education	EDUCATION MARCHANDE	GQ 1A	108
	Non-Market Education	EDUCATION NON MARCHANDE	GQ 1B	109
	Market Human health	SANTE HUMAINE (PARTIE MARCHANDE)	GQ 2A	110
	Non-Market Human health	SANTE NON MARCHANDE	GQ 2B	111
	Veterinary activities	ACTIVITES VETERINAIRES	GQ 2C	112
	Social work activities	ACTION SOCIALE (PARTIE MARCHANDE)	GQ 2D	113
	Social work activities	ACTION SOCIALE NON MARCHANDE	GQ 2E	114
	Public administration and defence	ADMINISTRATION PUBLIQUE	GR 10	115
	Activities of membership organizations and extra-territorial activities	ACTIVITES ASSOCIATIVES	GR 20	116

1

2 As it has been said in **Chapter VI 3.1.2.1**, two conditions are necessary to be able to derive the usual  
3 Leontief framework analysis from the IO table. The first condition is that each element of the vector  
4 X is not equal to zero in order to enable the creation of the A matrix (Z/X). This condition eliminates  
5 the sector GF56, i.e. the one concerning recycling. This notably explains why the current national IO  
6 framework does not allow modeling of circular economy as no recycling activities are taken into  
7 account and the management of waste is hardly explicit. The second condition is due to the  
8 possibility of inversion of the (I-A) matrix to create the Leontief matrix. But for the code GG13, the  
9 matrix (I-A) has a line equal to zero so that the (I-A) determinant is equal to zero. For (I-A) to be  
10 invertible, we should thus remove from the lines and columns GG13 and GF56 thus giving a new total  
11 production vector (X). An easy way to apprehend this change of national IO table is to understand  
12 that the IO table (Z) represents the monetary circulation between industries. Therefore, the  
13 elimination of GF56 is made because this sector does not produce anything though consuming  
14 outputs from other activities. The elimination of GG13 is made because this sector has no linked with  
15 any other sector. The pattern of IO table is thus clearer. Each sector must have at least an input and  
16 an output to be taken into account in the analysis.

17 We thus have with i, line index and j, column index:

$$\forall i X_i = Y_i + \sum_{j=1}^{116} Z_{ij}$$

$$\forall i X'_i = Y_i + \sum_{j=1}^{116} Z_{ij} - Z_{i61} - Z_{i66}$$

18











1 Table 47: 2006 Final Demand table

	Y																X	
	Dépenses de consommation finale (Final demand)						Formation brute de capital fixe (Fixed capital formation)											
	Ménages (Household)	Collective APU (Government)	Individuelle APU (Government)	Total APU (Government)	ISBLSM (NPISH)		SNFEI	Ménages (Household)	Sociétés financières (Financial society)	APU (Government)	ISBLSM (NPISH)		Objets de valeur	Variation de stocks	FBC totale	Exportations		Total des emplois finals
GA 01	26268	0	0	0	0	26268	995	0	0	10	0	1005	0	983	1988	9929	38 185	84 751
GA 02	733	0	0	0	0	733	299	0	0	120	0	419	0	2245	2664	357	3 754	7 712
GA 03	3510	0	0	0	0	3510	0	0	0	0	0	0	0	0	0	539	4 049	6 295
GB 01	35962	0	0	0	0	35962	0	0	0	0	0	0	0	21	21	3894	39 877	49 483
GB 02	20631	0	0	0	0	20631	0	0	0	0	0	0	0	0	0	4650	25 281	33 768
GB 03	20059	0	0	0	0	20059	0	0	0	0	0	0	0	-597	-597	11038	30 500	42 631
GB 04	3801	0	0	0	0	3801	0	0	0	0	0	0	0	-216	-216	3403	6 988	19 363
GB 05	49142	0	0	0	0	49142	0	0	0	0	0	0	0	100	100	9504	58 746	84 291
GB 06	15838	0	0	0	0	15838	0	0	0	0	0	0	0	147	147	405	16 390	16 460
GC 11	30390	0	0	0	0	30390	0	0	0	0	0	0	0	276	276	6563	37 229	40 658
GC 12	10514	0	0	0	0	10514	0	0	0	0	0	0	0	-454	-454	4335	14 395	15 492
GC 20	13027	0	6	6	0	13033	0	0	0	0	0	0	0	129	129	2320	15 482	41 270
GC 31	10815	0	23431	23431	0	34246	0	0	0	0	0	0	0	446	446	21222	55 914	75 367
GC 32	17759	0	0	0	0	17759	0	0	0	0	0	0	0	-320	-320	9980	27 419	31 595
GC 41	13866	0	0	0	0	13866	2224	0	391	1561	193	4369	0	-121	4248	2509	20 623	26 236
GC 42	3740	0	0	0	0	3740	60	0	0	0	0	60	637	-103	594	1650	5 984	6 569
GC 43	13068	0	0	0	0	13068	138	0	0	0	0	138	0	-8	130	2667	15 865	18 646
GC 44	8614	0	0	0	0	8614	1	0	0	0	0	1	0	86	87	1979	10 680	12 003
GC 45	9107	0	0	0	0	9107	1510	0	15	0	7	1532	0	204	1736	3862	14 705	16 214
GC 46	5643	0	185	185	0	5828	57	0	0	0	0	57	0	57	114	1909	7 851	8 713
GD 01	35874	0	0	0	0	35874	20583	0	244	2032	267	23126	0	27	23153	35829	94 856	116 285
GD 02	20843	0	0	0	0	20843	0	0	0	0	0	0	0	727	727	15299	36 869	51 169
GE 11	1562	0	0	0	0	1562	100	0	0	10	0	110	0	1435	1545	1917	5 024	7 689
GE 12	0	0	0	0	0	0	2500	0	0	0	0	2500	0	-53	2447	860	3 307	4 119
GE 13	43	0	0	0	0	43	2457	0	0	12	0	2569	0	1121	3690	29057	32 790	60 954
GE 14	3162	0	126	126	0	3288	20	0	0	199	0	219	0	-157	62	868	4 218	4 432
GE 21	0	0	0	0	0	0	3504	0	165	22	0	3691	0	115	3806	819	4 625	12 015
GE 22	0	0	0	0	0	0	4194	0	0	0	0	4194	0	-78	4116	806	4 922	12 832
GE 23	0	0	0	0	0	0	2662	0	0	0	0	2662	0	-83	2579	9916	12 495	25 027
GE 24	972	0	0	0	0	972	10856	0	537	112	0	11505	0	298	11803	9422	22 197	37 069
GE 25	760	0	0	0	0	760	4780	0	0	1	0	4781	0	23	4804	1974	7 538	11 134
GE 26	976	0	0	0	0	976	2078	0	0	10	299	2387	0	18	2405	1677	5 058	6 259
GE 27	37	0	0	0	0	37	6471	0	0	252	0	6723	0	96	6819	8844	15 700	20 436
GE 28	305	0	0	0	0	305	17	0	0	80	0	97	0	-49	48	1288	1 641	4 879
GE 31	6242	0	0	0	0	6242	4360	0	2342	1970	179	8851	0	-231	8620	6623	21 485	27 396
GE 32	0	0	0	0	0	0	1635	0	15	6	0	1656	0	-135	1521	3512	5 033	10 557
GE 33	1794	0	0	0	0	1794	5724	0	187	261	0	6172	0	-10	6162	5647	13 603	19 699
GE 34	753	0	3975	3975	0	4728	1371	0	0	863	0	2234	0	62	2296	5300	12 324	16 691
GE 35	487	0	0	0	0	487	1253	0	0	354	0	1607	0	-75	1532	5836	7 855	20 623
GF 11	0	0	0	0	0	0	0	0	0	0	0	0	0	68	68	86	154	2 777
GF 12	201	0	0	0	0	201	0	0	0	0	0	0	0	-1	-1	543	743	7 737
GF 13	1898	0	0	0	0	1898	0	0	0	0	0	0	0	-72	-72	2845	4 671	10 286
GF 14	1821	0	0	0	0	1821	7	0	0	0	0	7	0	121	128	2434	4 383	32 934
GF 21	418	0	0	0	0	418	0	0	0	0	0	0	0	-188	-188	2454	2 684	7 574
GF 22	3571	0	0	0	0	3571	0	0	0	0	0	0	0	1	1	2470	6 042	11 719
GF 23	4792	0	0	0	0	4792	0	0	0	0	0	0	0	-156	-156	1204	5 840	6 287
GF 31	1791	0	0	0	0	1791	0	0	0	0	0	0	0	0	0	2287	4 078	19 180
GF 32	0	0	0	0	0	0	0	0	0	0	0	0	0	13	13	4917	4 930	16 421

2

3

GF33	3939	0	0	0	0	3939	0	0	0	0	0	0	0	-184	-184	1786	5 541	17 414	
GF41	97	0	0	0	0	97	0	0	0	0	0	0	0	-49	-49	2703	2 751	12 449	
GF42	20	0	0	0	0	20	0	0	0	0	0	0	0	183	183	18870	19 073	46 433	
GF43	2820	0	0	0	0	2820	0	0	0	0	0	0	0	-115	-115	11744	14 449	29 164	
GF44	0	0	0	0	0	0	0	0	0	0	0	0	0	11	11	600	611	1 350	
GF45	2143	0	0	0	0	2143	0	0	0	0	0	0	0	17	17	4821	6 981	15 503	
GF46	5064	0	0	0	0	5064	0	0	0	0	0	0	0	43	43	7015	12 122	38 849	
GF51	0	0	0	0	0	0	0	0	0	0	0	0	0	311	311	16496	16 807	46 373	
GF52	164	0	0	0	0	164	0	0	0	0	0	0	0	330	-81	249	9356	9 769	27 695
GF53	0	0	0	0	0	0	0	0	0	0	0	0	0	-57	-57	0	-57	5 446	
GF54	0	0	0	0	0	0	3546	0	0	0	0	3546	0	272	3818	0	3 818	30 320	
GF55	4485	0	0	0	0	4485	0	0	15	0	15	0	142	157	7346	11 988	30 295		
GF56	0	0	0	0	0	0	0	0	0	0	0	0	0	0	0	0	0	0	
GF61	5086	0	0	0	0	5086	2371	0	0	6	0	2377	0	-197	2180	12819	20 085	36 697	
GF62	21	0	0	0	0	21	7	0	0	0	0	7	0	-132	-125	7442	7 338	18 992	
GG11	66	0	0	0	0	66	0	0	0	0	0	0	0	-75	-75	12	3	1 911	
GG12	0	0	0	0	0	0	0	0	0	0	0	0	0	195	195	1776	1 971	44 067	
GG13	0	0	0	0	0	0	0	0	0	0	0	0	0	0	0	0	0	2	
GG14	1	0	0	0	0	1	0	0	0	0	0	0	0	383	383	1584	1 968	6 606	
GG15	43718	0	0	0	0	43718	0	0	0	0	0	0	0	81	81	12873	56 672	119 102	
GG2A	17845	0	0	0	0	17845	0	0	0	0	0	0	0	0	0	3121	20 966	51 728	
GG2B	10448	0	5	5	0	10453	0	0	0	0	0	0	0	35	35	0	10 488	27 069	
GG22	3859	0	0	0	0	3859	0	0	0	0	0	0	0	322	322	0	4 181	9 588	
GH01	10503	0	0	0	0	10503	29641	77025	8198	27475	1303	143642	0	0	143642	0	154 145	195 258	
GH02	0	0	0	0	0	0	21129	2392	0	16929	0	40450	0	2	40452	0	40 452	54 323	
GJ10	18001	0	0	0	0	18001	0	0	0	0	0	0	0	0	0	0	18 001	21 962	
GJ20	0	0	0	0	0	0	0	0	0	0	0	0	0	0	0	3549	3 549	33 745	
GJ30	2558	0	0	0	0	2558	0	0	0	0	0	0	0	0	0	0	2 558	2 875	
GK01	4185	0	190	190	0	4375	0	0	0	0	0	0	0	0	0	1232	5 607	7 397	
GK02	9269	0	1615	1615	0	10884	0	0	0	0	0	0	0	0	0	0	10 884	15 144	
GK03	640	0	4	4	0	644	0	0	0	0	0	0	0	0	0	1481	2 125	12 747	
GK04	349	0	0	0	0	349	0	0	0	0	0	0	0	0	0	4093	4 442	6 458	
GK05	7333	0	0	0	0	7333	0	0	0	0	0	0	0	0	0	7440	14 773	22 818	
GK07	5773	0	0	0	0	5773	0	0	0	0	0	0	0	0	0	1281	7 054	33 021	
GK08	1156	0	0	0	0	1156	0	0	0	0	0	0	0	0	0	0	1 156	7 904	
GK69	55	0	0	0	0	55	0	0	0	0	0	0	0	-48	-48	3773	3 780	17 295	
GL01	17498	0	0	0	0	17498	0	0	0	0	0	0	0	0	0	5358	22 856	96 439	
GL02	35541	0	0	0	0	35541	0	0	0	0	0	0	0	0	0	849	36 390	55 068	
GL03	642	0	0	0	0	642	0	0	0	0	0	0	0	0	0	0	642	32 823	
GM 01	1151	0	0	0	0	1151	11402	13302	297	0	0	25001	0	0	25001	0	26 152	39 276	
GM 02	183735	0	12422	12422	0	196157	0	0	0	0	0	0	0	0	0	0	196 157	248 558	
GN10	25521	0	0	0	0	25521	0	0	0	0	0	0	0	0	0	3012	28 533	71 714	
GN21	1443	0	0	0	0	1443	22491	0	2986	3546	0	29023	0	61	29084	1774	32 301	69 804	
GN22	7668	0	0	0	0	7668	2603	10705	0	326	148	13782	0	94	13876	3267	24 811	75 777	
GN23	0	0	0	0	0	0	0	0	0	0	0	0	0	0	0	0	0	42 083	
GN24	369	0	0	0	0	369	0	0	0	0	0	0	0	66	66	0	435	29 799	
GN25	687	0	0	0	0	687	15556	2642	76	1303	0	19577	0	365	19942	8309	28 938	62 311	

1

2

GN31	3152	0	0	0	0	3152	0	0	0	0	0	0	0	0	0	0	3 152	27 451
GN32	0	0	0	0	0	0	0	0	0	0	0	0	0	0	0	0	0	29 305
GN33	2718	0	0	0	0	2718	0	0	0	0	0	0	0	0	0	8449	11 167	119 163
GN34	7110	0	0	0	0	7110	0	0	0	0	0	0	0	7	7	0	7 117	25 191
GN4A	0	0	0	0	0	0	0	0	0	0	0	0	0	-4	-4	3367	3 363	28 788
GN4B	19	8485	0	8485	0	8504	0	0	0	0	0	0	0	0	0	0	8 504	8 504
GP10	63350	0	429	429	0	63779	0	0	0	0	0	0	0	0	0	0	63 779	86 300
GP21	8876	0	513	513	0	9389	2714	0	0	0	0	2714	0	14	2728	867	12 984	22 794
GP2A	19989	0	14	14	0	20003	142	0	0	257	0	399	0	27	426	1099	21 528	26 460
GP2B	3797	0	15518	15518	4109	23424	0	0	0	0	0	0	0	0	0	0	23 424	23 424
GP31	12701	0	236	236	0	12937	0	0	0	0	0	0	0	0	0	0	12 937	15 667
GP32	8234	0	0	0	0	8234	0	0	0	0	0	0	0	0	0	0	8 234	9 027
GQ1A	6882	0	48	48	0	6930	0	0	0	0	0	0	0	0	0	0	6 930	17 955
GQ1B	1936	0	82369	82369	1449	85754	0	0	0	0	0	0	0	0	0	0	85 754	85 754
GQ2A	15665	0	42010	42010	0	57675	0	0	0	0	0	0	0	0	0	516	58 191	64 485
GQ2B	3618	0	52035	52035	0	55653	0	0	0	0	0	0	0	0	0	0	55 653	55 653
GQ2C	1901	0	0	0	0	1901	0	0	0	0	0	0	0	0	0	0	1 901	2 624
GQ2D	12845	0	10704	10704	0	23549	0	0	0	0	0	0	0	0	0	0	23 549	23 549
GQ2E	4220	0	14274	14274	1504	33628	0	0	0	0	0	0	0	0	0	0	33 628	33 628
GR10	421	137475	15073	152548	0	152969	0	0	0	0	0	0	0	0	0	0	152 969	152 969
GR20	0	1095	0	1095	3505	4600	0	0	0	0	0	0	0	0	0	0	4 600	7 300
PCHTR	-10147	0	0	0	0	-10147	0	0	0	0	0	0	0	0	0	35512	25 365	25 365
PCAFAB	0	0	0	0	0	0	0	0	0	0	0	0	0	0	0	0	0	0
TOTAL	1001929	147055	275182	422237	24197	1448363	191458	106066	15468	57817	2396	373205	967	7400	381572	483041	2 312 976	3 984 704

1

## 2 Formation of €/T ratio based on import data analysis

3

4 The import data are taken from the Sitram database, a French ministry database concerning national  
5 transportation, international transportation, transit and external trade. While the first three  
6 databases are based on surveys recording the origin/destination of vehicles, the external trade or  
7 custom database records the origin and final destination of goods. As I try to form production and  
8 consumption vectors, the custom database is thus preferred over the three others. This database  
9 concerns 175 types of products as described by the NST-R (Table 51) and covers the 22 French  
10 regions as destination and 226 regions of origin (Table 49). Besides, six transport modes are recorded  
11 (Table 50). Though a free and light version of the Sitram database is available on the internet<sup>142</sup>, the  
12 present 175 product level of the database was provided by the French ministry at the Trade Show  
13 Logistics Solutions (SITL) for the year 2006.

14 The first step is to report in a common table the national imports in tons and value for the 175  
15 products. As shown in the example of Table 48, a unique density of value for the 175 products can  
16 thus be calculated. The remaining issue thus concerns the transformation of the NST good  
17 nomenclatures into the NES sector nomenclature.

18 **Table 48 : National Imports in value and tons for "00" and "01" NST codes**

NAT	001	011	012	013	014	015	016	019
Value (k€)	237718	27134	4914	467	363	122008	184976	8250
Tons	46959	160897	33121	1156	1907	233750	370730	12756
€/T	5062	169	148	404	190	522	499	647

19

20 Unfortunately, there is no directly available correspondence table between the NST and NES  
21 nomenclature. The correspondence table needs thus to be constructed in a four step approach. First,  
22 a correspondence table  $b_{NES116\_CPA2002}$  is made between the NES nomenclature (116 sectors) and

1 the CPA2002 nomenclature (59 sectors). As the NES nomenclature is a disaggregated form of the  
 2 CPA2002 nomenclature, this is made quite easily. However, this table is transformed based on the  
 3 import data for goods available in the IO framework. Indeed, the IO table also gives an import vector  
 4 for goods with NES nomenclature  $IMP_{NES}^{REF}$

$$IMP_{2002} = b_{NES116\_CPA2002}^{transpose} \times IMP_{NES}^{REF}$$

5 The elements of table  $b_{NES116\_CPA2002}$  is then replaced by 0 if  $IMP_{2002} = 0$  and in other cases by  
 6  $b_{NES116\_CPA2002} \times \frac{IMP_{NES}}{IMP_{CPA2002}}$ . This forms a new table  $b_{NES116\_CPA2002}^{new}$ .

7 **Table 49 : countries available in Sitram custom database**

Afghanistan	Chili	Haiti	Macao	Polynésie Française	Tadjikistan
Albanie	Chine	Honduras	Madagascar	Portugal	Taiwan
Algérie	Chypre	Hong Kong	Malawi	Qatar	Tanzanie
Allemagne	Colombie	Hongrie	Malaysia	Régions polaires	Tchad
Andorre	Comores	Iles Canaries	Maldives	République Centrafricaine	Territoires Britanniques de l'Océan Indien
Angola	Congo	Iles Cayman	Mali	République d'Afrique du Sud	Thaïlande
Anguilla	Corée du Nord	Iles Falkland et dépendances	Malte - Gozo - Gominio	République Dominicaine	Timor Portuguais
Antigua et Barbuda	Corée du Sud	Iles Féroé	Maroc	République du Cap-Vert	Togo
Antilles néerlandaises	Costa Rica	Iles Marianne du Nord	Martinique	République Tchèque	Trinidad et Tobago
Arabie Saoudite	Cote d'Ivoire	Iles Marshall	Maurice	Réunion	Tunisie
Argentine	Croatie	Iles Pitcairn	Mauritanie	Roumanie	Turkmenistan
Arménie	Cuba	Iles Salomon	Mayotte (Grande Terre et Pamanz)	Royaume Uni	Turquie
Aruba	Danemark	Iles Turks et Caicos	Mexique	Russie	Tuvalu
Australie	Djibouti	Iles Vierges Britanniques	Moldova	Rwanda	Ukraine
Autriche	Dominique	Iles Vierges des Etats-Unis	Mongolie	Saint Christophe et Névis	Uruguay
Azerbaïdjan	Egypte	Iles Wallis et Futuna	Montserrat	Saint Vincent et Grenadines Nord	USA - Porto Rico
Bahamas	El Savador	Inde et Sikkim	Mozambique	Sainte Lucie	Vanuatu
Bahreïn	Emirats Arabes Unis	Indonésie	Nauru	Sainte-Hélène et dépendances	Vatican
Bangladesh	Equateur	Irak	Népal	Saint-Marin	Venezuela
Belarus	Erythée	Iran	Nicaragua	Saint-Pierre et Miquelon	Vietnam
Belgique	Espagne	Irlande	Niger	Samoa Occidentales	Yemen
Belize	Estonie	Islande	Nigéria	Sao Tomé et Principe	Yougoslavie
Bénin	Ethiopie	Israël	Norvège	Sénégal	Yougoslavie - Macédoine
Bermudes	Fidji	Italie	Nouvelle Guinée et Papouasie	Serbie - Monténégro	Zaire
Bhoutan	Finlande	Jamaïque	Nouvelle-Calédonie et dépendances	Seychelles et dépendances	Zambie
Birmanie	France - Monaco	Japon	Nouvelle-Zélande	Sierra-Leone	Zimbabwe
Bolivie	Gabon	Jordanie	Océanie Américaine	Singapour	
Bosnie-Herzégovine	Gambie	Kazakhstan	Océanie Australienne	Slovaquie	
Botswana	Gaza et Jericho	Kenya	Océanie Néo-zélandaise	Slovénie	
Bésil	Georgie	Kirghistan	Oman	Somalie	
Brunei	Ghana	Kiribati	Ouganda	Soudan	
Bulgarie	Gibraltar	Koweït	Ouzbekistan	Sri Lanka	
Burkina Faso	Grèce	La Barbade	Pakistan	Suède	
Burundi	Grenade	Laos	Panama y compris Zone du canal	Suisse	
Cambodge	Groenland	Lesotho	Paraguay	Surinam	
		Lettonie	Pays et territoires non déterminés, avitaillement et comptoir de vente dans les échanges avec les pays	Swaziland	
Cameroun	Guadeloupe	Liban	avitaillement et comptoir de vente dans les échanges intracommunautaires	Syrie	
Canada	Guatemala	Liberia	Pays non identifiés et non classés		
	Guinée Equatoriale	Libye	Pays-Bas		
	Guinée	Liechtenstein	Pérou		
	Guinée-Bissau	Lituanie	Philippines		
	Guyana	Luxembourg	Pologne		
	Guyane Française				

9 **Table 50 : Transport mode available in Sitram custom database**

1	Transport par mer
4	Transport par chemin de fer
7	Transport par air
8	Transport par route
9	Transport par voie navigable
A	Autre mode de transport

10



1 **Table 51 : Goods available in Sitram database (NST-R code)**

001 Animaux vivants	512 Fonte brute, fonte spiegel, ferromanganèse carburé (CECA)
011 Froment, épeautre, méteil	513 Ferro-alliages, sauf ferromanganèse carburé (non CECA)
012 Orge	515 Acier brut (CECA)
013 Seigle	522 Demi-produits sidérurgiques laminés, blooms, billettes, brames, largets, ébauches en rouleaux pour tôles (CECA)
014 Avoine	523 Autres demi-produits sidérurgiques (non CECA)
015 Maïs	532 Barres laminées et profilées à chaud (CECA)
016 Riz	533 barres laminées et profilées à froid ou forgées (non CECA)
019 Autres céréales n.d.a	535 Fil machine (CECA)
020 Pommes de terre	536 Fil de fer ou d'acier (non CECA)
031 Agrumes	537 Rails et éléments de voie ferrée en acier (non CECA)
035 Autres fruits et noix, frais	542 Tôles d'acier laminées en feuilles ou en rouleaux, larges plats (CECA)
039 Autres légumes frais ou congelés	543 Autres tôles d'acier (non CECA)
041 Laine et poils d'origine animale	545 Feuillards et bandes en acier, fer blanc (CECA)
042 Coton	546 Autres feuillards et bandes en acier (non CECA)
043 Fibres textiles artificielles ou synthétiques	551 Tubes, tuyaux et accessoires de tuyauterie
045 Soie, lin, jute, chanvre et autres fibres textiles végétales	552 Moulages et pièces de forge de fer ou d'acier
049 Chiffons, déchets de textiles	561 Cuivre et ses alliages, bruts
051 Bois à papier, bois à pulpe	562 Aluminium et ses alliages, bruts
052 Bois de mines	563 Plomb et ses alliages, bruts
055 Autres bois en grumes	564 Zinc et ses alliages, bruts
056 Traverses de bois pour voies ferrées, autres bois équarris ou sciés	565 Autres métaux non ferreux et leurs alliages, bruts
057 Bois de chauffage, charbon de bois, déchets, liège brut et déchets	568 Produits finis et semi-finis de métaux non ferreux, sauf articles manufacturés
060 Betteraves à sucre	611 Sables pour usage industriel
091 Peaux et pelleteries brutes, déchets	612 Sables communs et graviers
092 Caoutchouc naturel et synthétique, brut ou régénéré	613 Pierre ponce, sables et graviers ponceux
099 Matières premières et autres produits bruts, non comestible, d'origine animale ou végétale n.d.a	614 Argiles et terres argileuses
111 Sucre brut	615 Scories non destinées à la refonte, cendres, laitiers
112 Sucre raffiné	621 Sel brut ou raffiné
113 Mélasses	622 Pyrites de fer non grillées
121 Vins, moûts de raisin	623 Soufre
122 Bière	631 Pierres concassées, cailloux, macadam, tarmacadam
125 Autres boissons alcoolisées	632 Pierres de taille ou de construction brutes
128 Boissons non alcoolisées	633 Pierres calcaires pour l'industrie
131 Café	634 Craie
132 Cacao et chocolat	639 Autres minéraux bruts
133 Thé, maté, épices	641 Ciments
134 Tabacs, bruts et déchets	642 Chaux
135 Tabacs manufacturés	650 Plâtre
136 Glucose, dextrose, autres sucres, confiseries, sucreries, miel	691 Agglomérés ponceux, pièces en béton et en ciment ou similaires
139 Préparations alimentaires n.d.a.	692 Briques, tuiles et autres matériaux de construction en argile et matériaux de construction réfractaires
141 Viande fraîche, réfrigérée et congelée	711 Nitrate de soude naturel
142 Poissons, crustacés, mollusques, frais, congelés, séchés, salés, fumés	712 Phosphates naturels bruts
143 Lait frais et crème fraîche	713 Sels de potasse naturels bruts
144 Beurre, fromage, autres pays laitiers	719 Autres engrais naturels
145 Margarine, saindoux, graisses alimentaires	721 Scories de déphosphoration
146 Œufs	722 Autres engrais phosphatés
147 Viande séchée, salée, fumée, préparations et conserves de viande	723 Engrais potassiques
148 Préparation et conserve de poissons, crustacés ou mollusques	724 Engrais nitrés
161 Farines, semoules, gruaux de céréales	729 Engrais composés et autres engrais manufacturés
162 Malt	811 Acide sulfurique, oleum
163 Autres produits à base de céréales	812 Soude caustique et lessive de soude
164 Fruits congelés, séchés ou deshydratés, préparations et conserves de fruits	813 Carbonate de sodium
165 Légumes secs	814 Carbure de calcium
166 Préparations et conserves de légumes	819 Autres produits chimiques de base
167 Houblon	820 Alumine
171 Paille, foin, balle de céréales	831 Benzols
172 Tourteaux et résidus de l'extraction des huiles végétales	839 Brais, goudron minéral et autres produits chimiques bruts dérivés du charbon et des gaz naturels
179 Sons et issues, autres nourriture pour animaux, déchets des industries alimentaires	841 Pâte à papier, cellulose
181 Graines oléagineuses, noix, amandes oléagineuses	842 Déchets de papier, vieux papiers
182 Huiles et graisses d'origine animale ou végétale et produits dérivés	891 Matières plastiques brutes
211 Houille (CECA)	892 Produits pour teinture, tannage et colorants
213 Agglomérés de houille (CECA)	893 Produits médicaux et pharmaceutiques, parfumerie, produits d'entretien
221 Lignite (CECA)	894 Explosifs manufacturés, pyrotechnie, munitions de chasse et de sport
223 Agglomérés de lignite (CECA)	895 Amidons, féculs, gluten
224 Tourbe	896 Matières et produits chimiques divers
231 Coke et semi-coke de houille (CECA)	910 Véhicules et matériels de transport, même démontés et pièces
233 Coke et semi-coke de lignite (CECA)	920 Tracteurs, machines et appareillage agricoles, même démontés et pièces
310 Pétrole brut	931 Machines, appareillage, moteurs électriques et pièces
321 Essence de pétrole	939 Autres machines, appareillage, moteurs non électriques et pièces
323 Pétrole lampant, kérosène, carburéacteur, white spirit	941 Eléments de construction finis et constructions en métal
325 Gasoil, fueloils légers et domestiques	949 Autres articles manufacturés en métal
327 Fueloils lourds	951 Verre
330 Hydrocarbures énergétiques gazeux, liquéfiés ou comprimés	952 Verrerie, poterie et autres articles minéraux manufacturés
341 Huiles et graisses lubrifiantes	961 Cuir, articles manufacturés en cuir ou en peau
343 Bitumes de pétrole et mélanges bitumineux	962 Fils, tissus, articles textiles et produits connexes
349 Autres dérivés du pétrole non énergétiques	963 Articles de voyage, vêtements, bonneterie, chaussures
410 Minerais de fer et concentrés, sauf pyrites (CECA)	971 Demi-produits et articles manufacturés en caoutchouc
451 Déchets de métaux non ferreux	972 Papier et cartons bruts
452 Minerais de cuivre et concentrés, mattes de cuivre	973 Articles manufacturés en papier et carton
453 Minerais d'aluminium et concentrés, bauxite	974 Imprimés
455 Minerais de manganèse et concentrés (CECA)	975 Meubles et articles d'ameublement neufs
459 Autres minerais de métaux non ferreux et concentrés	976 Articles manufacturés en bois et en liège, sauf meubles
462 Ferrailles pour la refonte (CECA)	979 Articles manufacturés non désignés ailleurs
463 Déchets de fer et d'acier autres que pour la refonte (non CECA)	991 Emballage usagés
465 Scories à refondre (non CECA)	992 Matériel d'entreprises de construction, voitures et matériels de cirque, usagés
466 Poussières de hauts fourneaux (CECA)	993 Mobilier de déménagement
467 Pyrites de fer grillées (non CECA)	994 Or, monnaie, médailles
	999 Marchandises impossible de classer selon leur nature

1 The second step is very similar to the first one and corresponds to the construction of a  
 2 correspondence table  $b_{CPA2002\_CPA2008}$  made between the CPA2002 nomenclature (59 sectors) and  
 3 the CPA2008 nomenclature (86 sectors). We thus have:

$$IMP_{2008} = b_{CPA2008\_CPA2002}^{transpose} \times IMP_{2002}$$

4 The elements of table  $b_{CPA2002\_CPA2008}$  is then replaced by 0 if  $IMP_{2008} = 0$  and in other cases by  
 5  $b_{CPA2002\_CPA2008} \times \frac{IMP_{CPA2002}}{IMP_{CPA2008}}$ . This forms a new table  $b_{CPA2002\_CPA2008}^{new}$ .

6 The third step is similar and corresponds to the construction of a correspondence table  $b_{NST\_CPA2008}$   
 7 is made between the CPA2008 nomenclature (86 sectors) and the NST nomenclature (175  
 8 sectors). We thus have:

$$IMP_{NST} = b_{CPA2008\_NST}^{transpose} \times IMP_{2008}$$

9 The elements of table  $b_{NST\_CPA2008}$  is then replaced by 0 if  $IMP_{2008} = 0$  and in other cases by  
 10  $b_{NST\_CPA2008} \times \frac{IMP_{CPA2008}}{IMP_{NST}}$ . This forms a new table  $b_{NST\_CPA2008}^{new}$ .

11 The following tables are then applied to  $IMP_{NST}^{REF}$ , the import vector issue from the custom data. We  
 12 thus have:

$$b_{NES116\_NST}^{new} = b_{NES116\_CPA2002}^{new} \times b_{CPA2002\_CPA2008}^{new} \times b_{CPA2008\_NST}^{new}$$

$$IMP_{NES} = b_{NES116\_NST}^{new} \times IMP_{NST}^{REF}$$

13 There is thus a difference existing between  $IMP_{NES}$  and  $IMP_{NES}^{REF}$  as shown in **Table 53**. Nevertheless,  
 14 this difference may be corrected giving a final bridge of nomenclature as shown in **Table 52**. Then the  
 15 application of the final bridge to **Table 48** provides the desired €/T ratio in NES nomenclature.

16 **Table 52: Correction process to establishing final bridge between NES and NST nomenclatures**

$$\begin{array}{c}
 \begin{array}{ccc}
 & \text{NST} & \\
 \text{N} & \begin{pmatrix} x_{11} & \cdots & x_{1175} \\ \vdots & \ddots & \vdots \\ x_{1116} & \cdots & x_{1175} \end{pmatrix} & \\
 \text{E} & & \\
 \text{S} & & 
 \end{array}
 \begin{array}{c}
 \text{IMP}_{NES} \\
 \begin{pmatrix} \sum_{j=1}^{175} x_{1j} \\ \vdots \\ \sum_{j=1}^{175} x_{116j} \end{pmatrix}
 \end{array}
 \Rightarrow
 \begin{array}{ccc}
 & \text{NST} & \\
 \text{N} & \begin{pmatrix} \frac{x_{11}}{\sum_{j=1}^{175} x_{1j}} & \cdots & \frac{x_{1175}}{\sum_{j=1}^{175} x_{1j}} \\ \vdots & \ddots & \vdots \\ \frac{x_{1116}}{\sum_{j=1}^{175} x_{116j}} & \cdots & \frac{x_{1175}}{\sum_{j=1}^{175} x_{116j}} \end{pmatrix} & \\
 \text{E} & & \\
 \text{S} & & 
 \end{array}
 = \alpha
 \end{array}
 \end{array}$$

Distribution of difference

$$\begin{array}{c}
 \begin{array}{ccc}
 & \text{NST} & \\
 \text{N} & \begin{pmatrix} \gamma_{11} = x_{11} + \beta_{11} & \cdots & \gamma_{1175} = x_{1175} + \beta_{1175} \\ \vdots & \ddots & \vdots \\ \gamma_{1161} = x_{1116} + \beta_{1116} & \cdots & \gamma_{116175} = x_{1175} + \beta_{1175} \end{pmatrix} & \\
 \text{E} & & \\
 \text{S} & & 
 \end{array}
 \begin{array}{c}
 \text{IMP}_{NES}^{REF} \\
 \left[ \begin{array}{c} \text{Correction} \\ \leftarrow (\alpha_{ij} \times (IMP_{NESi}^{REF} - IMP_{NESi})) = \beta \end{array} \right]
 \end{array}
 \end{array}$$

Final bridge

$$\begin{array}{ccc}
 \text{IMP}_{NST}^2 & \begin{pmatrix} \sum_{i=1}^{116} \gamma_{i1} & \cdots & \sum_{i=1}^{116} \gamma_{i175} \end{pmatrix} & \begin{array}{ccc}
 & \text{NST} & \\
 \text{N} & \begin{pmatrix} \frac{\gamma_{11}}{\sum_{j=1}^{175} \gamma_{1j}} & \cdots & \frac{\gamma}{\sum_{j=1}^{175} x_{1j}} \\ \vdots & \ddots & \vdots \\ \frac{\gamma_{1116}}{\sum_{j=1}^{175} \gamma_{116j}} & \cdots & \frac{\gamma_{1175}}{\sum_{j=1}^{175} \gamma_{116j}} \end{pmatrix} & \\
 \text{E} & & \\
 \text{S} & & 
 \end{array}
 = b_{NES116\_NST}^{final}
 \end{array}$$

1 Table 53 : Difference between IO table import reference and calculated imports (NES  
2 nomenclature)

	IMP_NES (k€)	IMP_NES_REF (k€)	DIFFERENCE	GF54	0	0	0
GA01	6 065 258	7 577 000	1 511 742	GF55	6 438 115	8 529 000	2 090 885
GA02	243 638	391 000	147 362	GF56	0	0	0
GA03	718 956	1 141 000	422 044	GF61	12 247 674	11 466 000	-781 674
GB01	3 588 504	4 145 000	556 496	GF62	6 065 798	6 175 000	109 202
GB02	1 931 472	2 231 000	299 528	GG11	1 810 796	1 568 000	-242 796
GB03	1 999 866	2 310 000	310 134	GG12	31 574 542	43 249 000	11 674 458
GB04	1 332 378	1 539 000	206 622	GG13	1 319	2 000	681
GB05	11 929 937	13 780 000	1 850 063	GG14	1 956 968	2 034 000	77 032
GB06	1 691 595	1 799 000	107 405	GG15	16 977 704	17 646 000	668 296
GC11	14 743 799	12 521 000	-2 222 799	GG2A	232 820	548 000	315 180
GC12	4 358 669	5 958 000	1 599 331	GG2B	0	0	0
GC20	2 947 521	2 870 000	-77 521	GG22	0	0	0
GC31	14 560 634	16 501 000	1 940 366	GH01	0	0	0
GC32	2 892 537	3 278 000	385 463	GH02	0	0	0
GC41	5 424 557	5 429 000	4 443	GJ10	0	0	0
GC42	1 813 515	1 815 000	1 485	GJ20	0	0	0
GC43	4 633 205	4 637 000	3 795	GJ30	0	0	0
GC44	4 005 397	3 998 000	-7 397	GK01	0	0	0
GC45	8 014 712	8 159 000	144 288	GK02	0	0	0
GC46	2 389 973	2 502 000	112 027	GK03	0	0	0
GD01	44 382 364	32 136 000	-12 246 364	GK04	0	0	0
GD02	18 455 363	13 363 000	-5 092 363	GK05	0	0	0
GE11	2 215 156	1 578 000	-637 156	GK07	0	0	0
GE12	533 434	380 000	-153 434	GK08	0	0	0
GE13	20 346 308	14 494 000	-5 852 308	GJ69	0	0	0
GE14	2 733 149	1 947 000	-786 149	GL01	0	0	0
GE21	1 117 178	1 480 000	362 822	GL02	0	0	0
GE22	621 996	824 000	202 004	GL03	0	0	0
GE23	9 013 647	8 997 000	-16 647	GM01	0	0	0
GE24	8 431 572	8 416 000	-15 572	GM02	0	0	0
GE25	2 388 411	2 384 000	-4 411	GN10	0	0	0
GE26	2 907 369	2 902 000	-5 369	GN21	0	0	0
GE27	6 924 789	6 912 000	-12 789	GN22	0	0	0
GE28	345 638	345 000	-638	GN23	0	0	0
GE31	14 987 465	15 216 000	228 535	GN24	0	0	0
GE32	3 343 382	3 130 000	-213 382	GN25	0	0	0
GE33	6 400 767	6 516 000	115 233	GN31	0	0	0
GE34	5 539 350	5 799 000	259 650	GN32	0	0	0
GE35	5 340 663	5 591 000	250 337	GN33	0	0	0
GF11	872 385	1 323 000	450 615	GN34	0	0	0
GF12	299 936	681 000	381 064	GN4A	0	0	0
GF13	1 894 279	2 395 000	500 721	GN4B	0	0	0
GF14	2 919 325	3 691 000	771 675	GP10	0	0	0
GF21	1 173 461	2 051 000	877 539	GP21	0	0	0
GF22	1 973 313	3 449 000	1 475 687	GP2A	0	0	0
GF23	1 550 501	2 710 000	1 159 499	GP2B	0	0	0
GF31	2 928 752	3 589 000	660 248	GP31	0	0	0
GF32	5 526 926	5 892 000	365 074	GP32	0	0	0
GF33	2 577 731	2 748 000	170 269	GQ1A	0	0	0
GF41	3 915 250	4 437 000	521 750	GQ1B	0	0	0
GF42	15 751 004	17 850 000	2 098 996	GQ2A	0	0	0
GF43	8 793 208	9 965 000	1 171 792	GQ2B	0	0	0
GF44	760 637	862 000	101 363	GQ2C	0	0	0
GF45	3 400 157	3 805 000	404 843	GQ2D	0	0	0
GF46	8 096 931	9 061 000	964 069	GQ2E	0	0	0
GF51	12 436 572	14 704 000	2 267 428	GR10	0	0	0
GF52	10 515 771	12 433 000	1 917 229	GR20	0	0	0
GF53	0	0	0	TOTAL	414 005 998	427 854 000	13 848 002

3

### 1 3 Matlab script for top-down approach

```
2
3 clear all
4 clc
5 %-----
6 %-----
7 % Importation de données / Data imports
8 %-----
9 % YEAR 2006: Tableau entrée-sortie niveau 118 / 118 sectors Input-output
10 table
11     Z_MON=xlsread('Supply chain','IO','C6:DN121');
12     Y_MON=xlsread('Supply chain','IO','DP6:EE121');
13     X_MON=xlsread('Supply chain','IO','EG6:EG121');
14 %-----
15 % Préparation Tableau entrée-sortie / Input-Output table preparation
16 %-----
17 Z=[Z_MON(1:60,1:60) Z_MON(1:60,62:65) Z_MON(1:60,67:116);
18     Z_MON(62:65,1:60) Z_MON(62:65,62:65) Z_MON(62:65,67:116);
19     Z_MON(67:116,1:60) Z_MON(67:116,62:65) Z_MON(67:116,67:116)];
20 Y=[Y_MON(1:60,1:16);Y_MON(62:65,1:16);Y_MON(67:116,1:16)];
21 X_INT=X_MON-Z_MON(:,61)-Z_MON(:,66);
22 X=[X_INT(1:60,1);X_INT(62:65,1);X_INT(67:116,1)];
23 %-----
24 % Création des matrices d'analyse/ Analysis matrices creation
25 %-----
26 A=Z*diag(1./X);
27 L=(eye(114,114)-A)^(-1);
28 %-----
29 % Importation de données / Data imports
30 %-----
31 % Valeur ajoutée régionale NES14 / Regional value added NES 14
32 VA_14=xlsread('Supply chain','VA','B6:P36');
33 % Tableau des ressources en produit / resource table
34 TRP_116=xlsread('Supply chain','TRP','C4:N119');
35 % Passage NES14-NES116/ NES14-NES116 conversion table
36 STRUC=xlsread('Supply chain','VA','B45:O158');
37 % consommation des ménages/gross household income
38 PERC_CONS=xlsread('Supply chain','CONS','G4:G27');
39 %-----
40 % Préparation données / Data prepatation
41 %-----
42 VA_14_bis=[VA_14((1:22),(1:14));VA_14((29:30),(1:14))];
43 TRP_114=[TRP_116(1:60,1:12);TRP_116(62:65,1:12); TRP_116(67:116,1:12)];
44 PERC_14=VA_14_bis*diag(1./sum(VA_14_bis,1));
45 PERC_114=PERC_14*STRUC';
46 PERC_114_COR=[PERC_114(1:23,1:114);PERC_114(24,1:105) zeros(1,7) 1 0];
47 PERC_CONS_114=diag(PERC_CONS)*ones(24,114);
48 EXP=Y(:,16);
49 IMP=TRP_114(:,4);
50 PR_NAT=X-IMP;
51 CONS_NAT=X-EXP;
52 %-----
53 % Formation des vecteurs régionaux/ Regional vector creation
54 %-----
55 PR_REG=(ones(24,114)*diag(PR_NAT)).*PERC_114_COR;
56 CONS_REG=(ones(24,114)*diag(CONS_NAT)).*PERC_CONS_114;
57 %EXP_REG=(ones(24,114)*diag(EXP)).*PERC_114_COR;
58 %IMP_REG=(ones(24,114)*diag(IMP)).*PERC_CONS_114;
59 %B=PR_REG-EXP_REG;
60 %C=CONS_REG-IMP_REG;
61 %CONS_HT_REG=(ones(24,114)*diag(C(24,:))).*PERC_114_COR;
```

```

1  %CONS_DOM_REG=(ones(24,114)*diag(C(23,:))).*PERC_114_COR;
2  %PR_DOM_REG=(ones(24,114)*diag(B(23,:))).*PERC_CONS_114;
3  PROD=[PR_REG;IMP'];
4  CONS=[CONS_REG;EXP'];
5  TOT_PROD=ones(25,25)*PROD;
6  PERC_PROD=PROD./TOT_PROD;
7  PERC_CONS_BIS=CONS./(ones(25,25)*CONS);
8  IMP_REG=PERC_CONS_BIS.*(ones(25,114)*diag(PROD(25,:)));
9  PR_HT_REG=PERC_CONS_BIS.*(ones(25,114)*diag(PROD(24,:)));
10 PR_DOM_REG=PERC_CONS_BIS.*(ones(25,114)*diag(PROD(23,:)));
11 EXP_REG=PERC_PROD.*(ones(25,114)*diag(CONS(25,:)));
12 CONS_HT_REG=PERC_PROD.*(ones(25,114)*diag(CONS(24,:)));
13 CONS_DOM_REG=PERC_PROD.*(ones(25,114)*diag(CONS(23,:)));
14 %-----
15 % Importation de données/ Data imports
16 %-----
17 CONV=xlsread('Supply chain','DEM','C6:D119');
18 %-----
19 % Conversion en tonnes des vecteurs/ Ton conversion of vectors
20 %-----
21 INV_CONV=ones(size(CONV));
22 for i=1:114
23     if CONV(i,')==zeros(1,2)
24         INV_CONV(i,)=zeros(1,2);
25     else
26         INV_CONV(i,)=1./CONV(i,);
27     end
28 end
29 % production
30 PROD_PHYS_REF=(PROD*10^6).*(ones(25,114)*diag(INV_CONV(:,1)));
31 PROD_PHYS_FE=(PROD*10^6).*(ones(25,114)*diag(INV_CONV(:,2)));
32 %consommation
33 CONS_PHYS_REF=(CONS*10^6).*(ones(25,114)*diag(INV_CONV(:,1)));
34 CONS_PHYS_FE=(CONS*10^6).*(ones(25,114)*diag(INV_CONV(:,2)));
35 %exportation
36 EXP_REG_PHYS_REF=(EXP_REG*10^6).*(ones(25,114)*diag(INV_CONV(:,1)));
37 EXP_REG_PHYS_FE=(EXP_REG*10^6).*(ones(25,114)*diag(INV_CONV(:,2)));
38 %importation
39 IMP_REG_PHYS_REF=(IMP_REG*10^6).*(ones(25,114)*diag(INV_CONV(:,1)));
40 IMP_REG_PHYS_FE=(IMP_REG*10^6).*(ones(25,114)*diag(INV_CONV(:,2)));
41 % cons_HT
42 CONS_HT_REG_REF=(CONS_HT_REG*10^6).*(ones(25,114)*diag(INV_CONV(:,1)));
43 CONS_HT_REG_FE=(CONS_HT_REG*10^6).*(ones(25,114)*diag(INV_CONV(:,2)));
44 % PR_HT
45 PR_HT_REG_REF=(PR_HT_REG*10^6).*(ones(25,114)*diag(INV_CONV(:,1)));
46 PR_HT_REG_FE=(PR_HT_REG*10^6).*(ones(25,114)*diag(INV_CONV(:,2)));
47 % Cons_DOM
48 CONS_DOM_REG_REF=(CONS_DOM_REG*10^6).*(ones(25,114)*diag(INV_CONV(:,1)));
49 CONS_DOM_REG_FE=(CONS_DOM_REG*10^6).*(ones(25,114)*diag(INV_CONV(:,2)));
50 % prod_DOM
51 PR_DOM_REG_REF=(PR_DOM_REG*10^6).*(ones(25,114)*diag(INV_CONV(:,1)));
52 PR_DOM_REG_FE=(PR_DOM_REG*10^6).*(ones(25,114)*diag(INV_CONV(:,2)));
53
54
55
56
57

```



1 **5 Distance tables**

2

3 **Table 56 : Distance between regions through the road network (calculated through (EcoTransIT,**  
 4 **2011))**

	1	2	3	4	5	6	7	8	9	10	11	12	13	14	15	16	17	18	19	20	21	22
1	100	925	580	711	326	820	540	305	1039	242	574	482	754	707	157	929	503	852	505	757	767	453
2	925	100	362	592	630	430	460	740	1126	693	615	581	479	220	895	240	800	325	694	227	639	533
3	580	362	100	580	284	568	297	430	1079	348	493	394	334	214	547	366	607	532	522	313	414	173
4	711	592	580	100	537	182	276	414	1551	631	125	233	905	464	551	750	362	288	242	346	997	686
5	326	630	284	537	100	587	301	231	1012	94	434	312	489	412	260	634	469	595	440	477	502	192
6	820	430	568	182	587	100	291	523	1574	682	308	346	893	405	660	666	545	107	425	285	974	668
7	540	460	297	276	301	291	100	277	1303	396	202	129	622	265	421	548	348	322	257	214	703	397
8	305	740	430	414	231	523	277	100	1238	294	276	184	719	495	146	778	242	554	208	494	732	421
9	1039	1126	1079	1551	1012	1574	1303	1238	100	947	1448	1326	649	1271	1167	885	1494	1538	1459	1329	510	908
10	242	693	348	631	94	682	396	294	947	100	528	406	513	475	256	697	536	689	501	571	527	213
11	574	615	493	125	434	308	202	276	1448	528	100	130	818	461	414	744	241	373	120	369	894	583
12	482	581	394	233	312	346	129	184	1326	406	130	100	719	388	322	671	218	377	129	334	772	461
13	754	479	334	905	489	893	622	719	649	513	818	719	100	418	752	239	932	800	848	539	162	300
14	707	220	214	464	412	405	265	495	1271	475	461	388	418	100	640	286	607	301	516	121	630	365
15	157	895	547	551	260	660	421	146	1167	256	414	322	752	640	100	897	360	692	345	649	765	455
16	929	240	366	750	634	666	548	778	885	697	744	671	239	286	897	100	890	561	799	407	398	536
17	503	800	607	362	469	545	348	242	1494	536	241	218	932	607	360	890	100	596	121	553	985	675
18	852	325	532	288	595	107	322	554	1538	689	373	377	800	301	692	561	596	100	491	181	938	632
19	505	694	522	242	440	425	257	208	1459	501	120	129	848	516	345	799	121	491	100	447	900	590
20	757	227	313	346	477	285	214	494	1329	571	369	334	539	121	649	407	553	181	447	100	718	423
21	767	639	414	997	502	974	703	732	510	527	894	772	162	630	765	398	985	938	900	718	100	313
22	453	533	173	686	192	668	397	421	908	213	583	461	300	365	455	536	675	632	590	423	313	100

5

6 **Table 57 : Distance between regions through the rail network (calculated through (EcoTransIT,**  
 7 **2011))**

	1	2	3	4	5	6	7	8	9	10	11	12	13	14	15	16	17	18	19	20	21	22
1	100	1068	689	738	342	865	610,08	324	1538	254	636	513	812	845	155	1058	509	890	541	821	791	492
2	1068	100	399	792	773	606	461	748	2009	859	690	582	513	297	929	271	826	461	726	248	691	841
3	689	399	100	683	382	619	333	587	1616	439	580	425	357	442	642	603	665	557	574	458	430	204
4	738	792	683	100	545	254	367	418	2071	636	265	285	1015	647	599	964	467	407	349	545	1008	695
5	342	773	382	545	100	642	387	295	1528	93	442	290	523	510	266	769	513	625	435	526	529	198
6	865	606	619	254	642	100	375	544	2140	732	485	378	973	573	725	867	622	158	522	361	1045	758
7	610	461	333	367	387	375	100	290	1854	478	264	123	687	287	470	605	368	313	277	214	760	473
8	324	748	587	418	295	544	290	100	1779	343	315	193	776	569	184	887	331	570	308	501	782	451
9	1538	2009	1616	2071	1528	2140	1854	1779	100	1492	1969	1816	1498	1962	1692	1744	2039	2078	1962	1979	1323	1420
10	254	859	439	636	93	732	478	343	1492	100	533	381	563	596	339	809	604	711	526	612	542	243
11	636	690	580	265	442	485	264	315	1969	533	100	183	912	544	496	861	255	510	119	443	905	592
12	513	582	425	285	290	378	123	193	1816	381	183	100	760	403	373	721	270	403	179	335	753	440
13	812	513	357	1015	523	973	687	776	1498	563	912	760	100	562	783	249	983	911	906	752	180	330
14	845	297	442	647	510	573	287	569	1962	596	544	403	562	100	750	320	647	511	556	412	739	581
15	155	929	642	599	266	725	470	184	1692	339	496	373	783	750	100	1029	355	750	387	682	789	458
16	1058	271	603	964	769	867	605	887	1744	809	861	721	249	320	1029	100	965	722	874	510	426	576
17	509	826	665	467	513	622	368	331	2039	604	255	270	983	647	355	965	100	647	138	579	976	663
18	890	461	557	407	625	158	313	570	2078	711	510	403	911	511	750	722	647	100	547	299	983	696
19	541	726	574	349	435	522	277	308	1962	526	119	179	906	556	387	874	138	547	100	479	899	586
20	821	248	458	545	526	361	214	501	1979	612	443	335	752	412	682	510	579	299	479	100	885	598
21	791	691	430	1008	529	1045	760	782	1323	542	905	753	180	739	789	426	976	983	899	885	100	336
22	492	841	204	695	198	758	473	451	1420	243	592	440	330	581	458	576	663	696	586	598	336	100

8

9

## 6 Cost Data characterization

2

3 The basic data are issued from a Dutch study (Vergelijkingskader 1.0 beta7) and are reproduced in  
4 **Table 58**.

5 **Table 58: Cost data referential**

	TRUCK				TRAIN	
	<7,5T	7,5T-12T	12T-24T	24T-40T	Elec	Diesel
average speed (km/h)	68	68	68	68	40	40
average payload (T)	1,50	4,00	10,00	27,25	1 950	1 950
average power (kW)	56	100	130	320	6 400	4 720
Load factor	0,32	0,49	0,64	0,96	1	1
rate of empty trip	0,78	0,75	0,70	0,48	X	X
average annual mileage (km/year)	39 400	74 850	74 850	98 500	X	X
average loading times (hour/veh)	0,25	0,75	1,20	1,20	4,00	4,00
average unloading times (hour/veh)	0,25	0,75	1,00	1,50	3,50	3,5
average handling times (hour/veh)	0,50	1,50	2,20	2,70	X	X
average waiting times (hour/veh)	0,25	0,50	0,50	0,50	X	X
rest (hour/veh)	10,00	10,00	10,00	10,00	X	X
average fixed cost (euro per veh per hour)	24,66	25,95	28,81	36,07	4 425	4 425
average variable cost (euro per veh per km)	0,11	0,14	0,18	0,28	6,37	6,82
average energy cost (euro per veh per km)	0,06	0,09	0,12	0,16	3,80	1,64
average loading costs (euro per veh)	6,17	19,46	34,57	43,28	17 700	17 700
average unloading costs (euro per veh)	6,17	19,46	28,81	54,10	15 488	15 488
average handling costs (euro per veh)	12,33	38,92	63,37	97,39	X	X
average waiting costs (euro per veh)	6,17	12,97	14,40	18,03	X	X
average energy consumption (mJ/ veh.km)	3,54	4,57	7,19	12,93	214	236
average CO2 emission (gram/veh.km)	259,48	334,69	527,32	947,55	15 290	17 365
average SO2 emission (gram/veh.km)	0,08	0,10	0,16	0,28	7,06	9,75
average NOx emission (gram/veh.km)	1,15	4,42	6,94	12,41	17,53	314,97
average PM10 emission (gram/veh.km)	0,18	0,12	0,20	0,35	0,02	7,15
average NMVOC emission (gram/veh.km)	0,12	0,39	0,62	1,12	0,32	17,43
average CO emission (gram/veh.km)	0,44	0,95	1,25	2,45	1,75	26,72
average cost CO2 emission (Euro/veh.km)	0,01	0,01	0,01	0,02	0,38	0,43
average cost SO2 emission (Euro/veh.km)	0,00	0,00	0,00	0,00	0,06	0,08
average cost NOx emission (Euro/veh.km)	0,01	0,03	0,05	0,10	0,13	2,43
average cost PM10 emission (Euro/veh.km)	0,01	0,00	0,01	0,01	0,00	0,22
average cost NMVOC emission (Euro/veh.km)	0,00	0,00	0,00	0,00	0,00	0,02
average cost CO emission (Euro/veh.km)	0,00	0,00	0,00	0,01	0,00	0,07
average cost noise (Euro/veh.km)	0,01	0,01	0,02	0,02	1,02	2,17
number of dead casualties ( per 10 <sup>9</sup> veh.km)	18,31	27,68	42,28	78,78	211	211
number of injured casualties (per10 <sup>9</sup> veh.km)	169,77	120,47	137,96	178,70	1 458	1 458
Average external cost of dead casualties (Euro/veh.km)	0,02	0,04	0,06	0,11	0,28	0,28
Average external cost of injured casualties (Euro/veh.km)	0,02	0,01	0,02	0,02	0,16	0,16
Average external cost of congestion (Euro/veh.km)	0,01	0,01	0,01	0,00	1,38	1,38
Average toll of infrastructure (Euro/veh.km)	0,02	0,02	0,05	0,07	2,30	2,30

6

7 However, in the previous table, the external costs were calculated by multiplying the emission  
8 framework (gram/veh.km) by the environmental taxes presented in **Table 59**.



1 **Table 59 : Tax framework for air emission environmental costs**

Compound	CO2	SO2	NOx	PM10	NM VOC	CO
Tax (€/T)	25	8000	7700	31400	1400	2590
Reference	(Maibach, et al., 2008), p.84	(Maibach, et al., 2008),p.58	(Maibach, et al., 2008)	(Maibach, et al., 2008),p.58	(Maibach, et al., 2008),p.58	(Maurer, 2008),p.175

2

3 I will illustrate the transformation from **Table 58** to **Table 35** through the example of the 24-40T and

4 for the bulk transportation (load factor: 100%, empty trip factor: 60%)

$$\text{Average payload} = \frac{100\%}{96\%} \times 27.25 = 28.39 \text{ Tons}$$

$$\text{Loading time} = \frac{100\%}{96\%} \times 1.2 = 1.25 \text{ hours}$$

$$\text{Unloading time} = \frac{100\%}{96\%} \times 1.5 = 1.5625 \text{ hours}$$

$$\text{Handling time} = \frac{100\%}{96\%} \times 2.7 = 2.8125 \text{ hours}$$

$$\text{Waiting time} = \frac{100\%}{96\%} \times 0.5 = 0.521 \text{ hours}$$

$$\text{Fixed cost} = (1.25 + 1.5625 + 2.8125 + 0.521) \times 36.07 = 221.68 \text{ euros}$$

5 In the next calculations, ETW stands for the EcoTransit World methodology figures (EcoTransIT, 2011)

$$\text{NRJ}_{Full}^{ETW} = 13.3 \frac{\text{MJ}}{\text{km}} ; \text{NRJ}_{Empty}^{ETW} = 8.1 \frac{\text{MJ}}{\text{km}} ; \text{Coeff}^{ETW} = \frac{\text{NRJ}_{Full}^{ETW} - \text{NRJ}_{Empty}^{ETW}}{1} = 5.20$$

$$\text{NRJ}_{loaded}^{ETW} = \text{NRJ}_{Empty}^{ETW} + \text{Load factor} \times \text{NRJ}_{Full}^{ETW} = 8.1 + 0.96 \times 5.20 = 13.092 \frac{\text{MJ}}{\text{km}}$$

$$\frac{\text{NRJ}_{loaded}^{ETW}}{\text{NRJ}_{Empty}^{ETW}} = \frac{13.092}{8.1} = 1.62 ; \frac{1 + \text{empty trip rate}}{\frac{\text{NRJ}_{loaded}^{ETW}}{\text{NRJ}_{Empty}^{ETW}} + \text{empty trip rate}} = \frac{1 + 0.48}{1.62 + 0.48} = 0.71$$

$$\text{NRJ}_{Empty} = 0.71 \times 12.93 = 9.13 \frac{\text{MJ}}{\text{km}} ; \text{NRJ}_{loaded} = 1.62 \times 9.13 = 14.75 \frac{\text{MJ}}{\text{km}}$$

$$\text{Coeff} = \frac{\text{NRJ}_{loaded} - \text{NRJ}_{Empty}}{0.96} = 5.86$$

$$\text{NRJ} = 9.13 + 1 \times 5.86 + 0.6 \times 9.13 = 20.46 \frac{\text{MJ}}{\text{km}}$$

$$\text{COST}_{NRJ} = \frac{20.46}{12.93} \times 0.16 = 0.25 \frac{\text{Euro}}{\text{Veh. km}}$$

$$\text{COST}_{variable} = 0.25 + (0.28 - 0.16) = 0.38 \frac{\text{Euro}}{\text{Veh. km}}$$

## 1 7 Matlab script for bottom-up approach

```
2
3 clear all
4 clc
5 %-----
6 % Importation de données / Data imports
7 %-----
8 DIST=xlsread('Transport','DIST','E6:Z54');
9 COST=xlsread('Transport','COST_TON','C5:T14');
10 REST=xlsread('Transport','REST','AF65:DC113');
11 PERC=xlsread('Transport','tons_per_shipment','AB4:BF72');
12 VOT=xlsread('Transport','VOT','H7:J75');
13 WH=xlsread('Transport','WH','I7:K75');
14 %-----
15 % Caractéristique voyage/ Travel characteristic
16 %-----
17 DIST_ROAD=DIST(1:22,1:22);
18 DIST_RAIL=DIST(28:49,1:22);
19 REST_BULK_ROAD=REST(1:22,1:22);
20 REST_AVERAGE_ROAD=REST(1:22,28:49);
21 REST_VOLUME_ROAD=REST(1:22,55:76);
22 REST_BULK_RAIL=REST(28:49,1:22);
23 REST_AVERAGE_RAIL=REST(28:49,28:49);
24 REST_VOLUME_RAIL=REST(28:49,55:76);
25 % Fixed cost (loading, unloading, handling and waiting costs)
26 FIXED_COST_1_BULK=COST(1,1)*ones(22,22);
27 FIXED_COST_2_BULK=COST(1,2)*ones(22,22);
28 FIXED_COST_3_BULK=COST(1,3)*ones(22,22);
29 FIXED_COST_4_BULK=COST(1,4)*ones(22,22);
30 FIXED_COST_5_BULK=COST(1,5)*ones(22,22);
31 FIXED_COST_6_BULK=COST(1,6)*ones(22,22);
32 FIXED_COST_1_AVERAGE=COST(1,7)*ones(22,22);
33 FIXED_COST_2_AVERAGE=COST(1,8)*ones(22,22);
34 FIXED_COST_3_AVERAGE=COST(1,9)*ones(22,22);
35 FIXED_COST_4_AVERAGE=COST(1,10)*ones(22,22);
36 FIXED_COST_5_AVERAGE=COST(1,11)*ones(22,22);
37 FIXED_COST_6_AVERAGE=COST(1,12)*ones(22,22);
38 FIXED_COST_1_VOLUME=COST(1,13)*ones(22,22);
39 FIXED_COST_2_VOLUME=COST(1,14)*ones(22,22);
40 FIXED_COST_3_VOLUME=COST(1,15)*ones(22,22);
41 FIXED_COST_4_VOLUME=COST(1,16)*ones(22,22);
42 FIXED_COST_5_VOLUME=COST(1,17)*ones(22,22);
43 FIXED_COST_6_VOLUME=COST(1,18)*ones(22,22);
44 % Variable cost without external cost
45 VAR_COST_1_BULK=(COST(2,1)*ones(22,22)).*DIST_ROAD;
46 VAR_COST_2_BULK=(COST(2,2)*ones(22,22)).*DIST_ROAD;
47 VAR_COST_3_BULK=(COST(2,3)*ones(22,22)).*DIST_ROAD;
48 VAR_COST_4_BULK=(COST(2,4)*ones(22,22)).*DIST_ROAD;
49 VAR_COST_5_BULK=(COST(2,5)*ones(22,22)).*DIST_RAIL;
50 VAR_COST_6_BULK=(COST(2,6)*ones(22,22)).*DIST_RAIL;
51 VAR_COST_1_AVERAGE=(COST(2,7)*ones(22,22)).*DIST_ROAD;
52 VAR_COST_2_AVERAGE=(COST(2,8)*ones(22,22)).*DIST_ROAD;
53 VAR_COST_3_AVERAGE=(COST(2,9)*ones(22,22)).*DIST_ROAD;
54 VAR_COST_4_AVERAGE=(COST(2,10)*ones(22,22)).*DIST_ROAD;
55 VAR_COST_5_AVERAGE=(COST(2,11)*ones(22,22)).*DIST_RAIL;
56 VAR_COST_6_AVERAGE=(COST(2,12)*ones(22,22)).*DIST_RAIL;
57 VAR_COST_1_VOLUME=(COST(2,13)*ones(22,22)).*DIST_ROAD;
58 VAR_COST_2_VOLUME=(COST(2,14)*ones(22,22)).*DIST_ROAD;
59 VAR_COST_3_VOLUME=(COST(2,15)*ones(22,22)).*DIST_ROAD;
60 VAR_COST_4_VOLUME=(COST(2,16)*ones(22,22)).*DIST_ROAD;
61 VAR_COST_5_VOLUME=(COST(2,17)*ones(22,22)).*DIST_RAIL;
```

```

1  VAR_COST_6_VOLUME=(COST(2,18)*ones(22,22)).*DIST_RAIL;
2  % Resting cost
3  REST_COST_1_BULK=REST_BULK_ROAD.*(COST(10,1)*ones(22,22));
4  REST_COST_2_BULK=REST_BULK_ROAD.*(COST(10,2)*ones(22,22));
5  REST_COST_3_BULK=REST_BULK_ROAD.*(COST(10,3)*ones(22,22));
6  REST_COST_4_BULK=REST_BULK_ROAD.*(COST(10,4)*ones(22,22));
7  REST_COST_5_BULK=REST_BULK_RAIL.*(COST(10,5)*ones(22,22));
8  REST_COST_6_BULK=REST_BULK_RAIL.*(COST(10,6)*ones(22,22));
9  REST_COST_1_AVERAGE=REST_AVERAGE_ROAD.*(COST(10,7)*ones(22,22));
10 REST_COST_2_AVERAGE=REST_AVERAGE_ROAD.*(COST(10,8)*ones(22,22));
11 REST_COST_3_AVERAGE=REST_AVERAGE_ROAD.*(COST(10,9)*ones(22,22));
12 REST_COST_4_AVERAGE=REST_AVERAGE_ROAD.*(COST(10,10)*ones(22,22));
13 REST_COST_5_AVERAGE=REST_AVERAGE_RAIL.*(COST(10,11)*ones(22,22));
14 REST_COST_6_AVERAGE=REST_AVERAGE_RAIL.*(COST(10,12)*ones(22,22));
15 REST_COST_1_VOLUME=REST_VOLUME_ROAD.*(COST(10,13)*ones(22,22));
16 REST_COST_2_VOLUME=REST_VOLUME_ROAD.*(COST(10,14)*ones(22,22));
17 REST_COST_3_VOLUME=REST_VOLUME_ROAD.*(COST(10,15)*ones(22,22));
18 REST_COST_4_VOLUME=REST_VOLUME_ROAD.*(COST(10,16)*ones(22,22));
19 REST_COST_5_VOLUME=REST_VOLUME_RAIL.*(COST(10,17)*ones(22,22));
20 REST_COST_6_VOLUME=REST_VOLUME_RAIL.*(COST(10,18)*ones(22,22));
21 %-----
22 % Coût véhicule/ Vehicle cost
23 %-----
24 VEH_COST_1_BULK=FIXED_COST_1_BULK+VAR_COST_1_BULK+REST_COST_1_BULK;
25 VEH_COST_2_BULK=FIXED_COST_2_BULK+VAR_COST_2_BULK+REST_COST_2_BULK;
26 VEH_COST_3_BULK=FIXED_COST_3_BULK+VAR_COST_3_BULK+REST_COST_3_BULK;
27 VEH_COST_4_BULK=FIXED_COST_4_BULK+VAR_COST_4_BULK+REST_COST_4_BULK;
28 VEH_COST_5_BULK=FIXED_COST_5_BULK+VAR_COST_5_BULK+REST_COST_5_BULK;
29 VEH_COST_6_BULK=FIXED_COST_6_BULK+VAR_COST_6_BULK+REST_COST_6_BULK;
30 VEH_COST_1_AVERAGE=FIXED_COST_1_AVERAGE+VAR_COST_1_AVERAGE+REST_COST_1_AVER
31 AGE;
32 VEH_COST_2_AVERAGE=FIXED_COST_2_AVERAGE+VAR_COST_2_AVERAGE+REST_COST_2_AVER
33 AGE;
34 VEH_COST_3_AVERAGE=FIXED_COST_3_AVERAGE+VAR_COST_3_AVERAGE+REST_COST_3_AVER
35 AGE;
36 VEH_COST_4_AVERAGE=FIXED_COST_4_AVERAGE+VAR_COST_4_AVERAGE+REST_COST_4_AVER
37 AGE;
38 VEH_COST_5_AVERAGE=FIXED_COST_5_AVERAGE+VAR_COST_5_AVERAGE+REST_COST_5_AVER
39 AGE;
40 VEH_COST_6_AVERAGE=FIXED_COST_6_AVERAGE+VAR_COST_6_AVERAGE+REST_COST_6_AVER
41 AGE;
42 VEH_COST_1_VOLUME=FIXED_COST_1_VOLUME+VAR_COST_1_VOLUME+REST_COST_1_VOLUME;
43 VEH_COST_2_VOLUME=FIXED_COST_2_VOLUME+VAR_COST_2_VOLUME+REST_COST_2_VOLUME;
44 VEH_COST_3_VOLUME=FIXED_COST_3_VOLUME+VAR_COST_3_VOLUME+REST_COST_3_VOLUME;
45 VEH_COST_4_VOLUME=FIXED_COST_4_VOLUME+VAR_COST_4_VOLUME+REST_COST_4_VOLUME;
46 VEH_COST_5_VOLUME=FIXED_COST_5_VOLUME+VAR_COST_5_VOLUME+REST_COST_5_VOLUME;
47 VEH_COST_6_VOLUME=FIXED_COST_6_VOLUME+VAR_COST_6_VOLUME+REST_COST_6_VOLUME;
48 %-----
49 % coût tonne sans VOT / Ton cost without VOT
50 %-----
51 TON_COST_1_BULK=VEH_COST_1_BULK/COST(9,1);
52 TON_COST_2_BULK=VEH_COST_2_BULK/COST(9,2);
53 TON_COST_3_BULK=VEH_COST_3_BULK/COST(9,3);
54 TON_COST_4_BULK=VEH_COST_4_BULK/COST(9,4);
55 TON_COST_5_BULK=VEH_COST_5_BULK/COST(9,5);
56 TON_COST_6_BULK=VEH_COST_6_BULK/COST(9,6);
57 TON_COST_1_AVERAGE=VEH_COST_1_AVERAGE/COST(9,7);
58 TON_COST_2_AVERAGE=VEH_COST_2_AVERAGE/COST(9,8);
59 TON_COST_3_AVERAGE=VEH_COST_3_AVERAGE/COST(9,9);
60 TON_COST_4_AVERAGE=VEH_COST_4_AVERAGE/COST(9,10);
61 TON_COST_5_AVERAGE=VEH_COST_5_AVERAGE/COST(9,11);

```

```

1  TON_COST_6_AVERAGE=VEH_COST_6_AVERAGE/COST(9,12);
2  TON_COST_1_VOLUME=VEH_COST_1_VOLUME/COST(9,13);
3  TON_COST_2_VOLUME=VEH_COST_2_VOLUME/COST(9,14);
4  TON_COST_3_VOLUME=VEH_COST_3_VOLUME/COST(9,15);
5  TON_COST_4_VOLUME=VEH_COST_4_VOLUME/COST(9,16);
6  TON_COST_5_VOLUME=VEH_COST_5_VOLUME/COST(9,17);
7  TON_COST_6_VOLUME=VEH_COST_6_VOLUME/COST(9,18);
8  %-----
9  % Coût tonne pour envoi direct/ Ton cost for direct shipment
10 %-----
11 PC_REF=PERC(1:69,1:3);
12 PC_NO_FE=PERC(1:69,4:6);
13 PC_FE=PERC(1:69,7:9);
14 %preallocation reference scenario
15 TON_VOT_REF_ROAD=zeros(22,22,69);
16 TON_VOT_REF_RAIL=zeros(22,22,69);
17 TON_COST_1_PC_REF=zeros(22,22,69);
18 TON_COST_2_PC_REF=zeros(22,22,69);
19 TON_COST_3_PC_REF=zeros(22,22,69);
20 TON_COST_4_PC_REF=zeros(22,22,69);
21 TON_COST_5_PC_REF=zeros(22,22,69);
22 TON_COST_6_PC_REF=zeros(22,22,69);
23 %Calculation of PC
24 for i=1:69
25 %reference scenario
26 TON_VOT_REF_ROAD(:, :, i)=VOT(i,1)*DIST_ROAD/68;
27 TON_VOT_REF_RAIL(:, :, i)=VOT(i,1)*DIST_RAIL/40;
28 TON_COST_1_PC_REF(:, :, i)=PC_REF(i,1)*TON_COST_1_BULK+PC_REF(i,2)*TON_COST_1
29 _AVERAGE+PC_REF(i,3)*TON_COST_1_VOLUME+TON_VOT_REF_ROAD(:, :, i);
30 TON_COST_2_PC_REF(:, :, i)=PC_REF(i,1)*TON_COST_2_BULK+PC_REF(i,2)*TON_COST_2
31 _AVERAGE+PC_REF(i,3)*TON_COST_2_VOLUME+TON_VOT_REF_ROAD(:, :, i);
32 TON_COST_3_PC_REF(:, :, i)=PC_REF(i,1)*TON_COST_3_BULK+PC_REF(i,2)*TON_COST_3
33 _AVERAGE+PC_REF(i,3)*TON_COST_3_VOLUME+TON_VOT_REF_ROAD(:, :, i);
34 TON_COST_4_PC_REF(:, :, i)=PC_REF(i,1)*TON_COST_4_BULK+PC_REF(i,2)*TON_COST_4
35 _AVERAGE+PC_REF(i,3)*TON_COST_4_VOLUME+TON_VOT_REF_ROAD(:, :, i);
36 TON_COST_5_PC_REF(:, :, i)=PC_REF(i,1)*TON_COST_5_BULK+PC_REF(i,2)*TON_COST_5
37 _AVERAGE+PC_REF(i,3)*TON_COST_5_VOLUME+TON_VOT_REF_RAIL(:, :, i);
38 TON_COST_6_PC_REF(:, :, i)=PC_REF(i,1)*TON_COST_6_BULK+PC_REF(i,2)*TON_COST_6
39 _AVERAGE+PC_REF(i,3)*TON_COST_6_VOLUME+TON_VOT_REF_RAIL(:, :, i);
40 end
41 %-----
42 % Coût tonne vers centre distribution/ Ton cost for distribution center
43 %-----
44 PD_REF=PERC(1:69,12:14);
45 PD_NO_FE=PERC(1:69,15:17);
46 PD_FE=PERC(1:69,18:20);
47 %preallocation reference scenario
48 TON_COST_1_PD_REF=zeros(22,22,69);
49 TON_COST_2_PD_REF=zeros(22,22,69);
50 TON_COST_3_PD_REF=zeros(22,22,69);
51 TON_COST_4_PD_REF=zeros(22,22,69);
52 TON_COST_5_PD_REF=zeros(22,22,69);
53 TON_COST_6_PD_REF=zeros(22,22,69);
54 %Calculation of PD
55 for i=1:69
56 %reference scenario
57 TON_COST_1_PD_REF(:, :, i)=PD_REF(i,1)*TON_COST_1_BULK+PD_REF(i,2)*TON_COST_1
58 _AVERAGE+PD_REF(i,3)*TON_COST_1_VOLUME+TON_VOT_REF_ROAD(:, :, i);
59 TON_COST_2_PD_REF(:, :, i)=PD_REF(i,1)*TON_COST_2_BULK+PD_REF(i,2)*TON_COST_2
60 _AVERAGE+PD_REF(i,3)*TON_COST_2_VOLUME+TON_VOT_REF_ROAD(:, :, i);

```

```

1  TON_COST_3_PD_REF(:, :, i)=PD_REF(i, 1)*TON_COST_3_BULK+PD_REF(i, 2)*TON_COST_3
2  _AVERAGE+PD_REF(i, 3)*TON_COST_3_VOLUME+TON_VOT_REF_ROAD(:, :, i);
3  TON_COST_4_PD_REF(:, :, i)=PD_REF(i, 1)*TON_COST_4_BULK+PD_REF(i, 2)*TON_COST_4
4  _AVERAGE+PD_REF(i, 3)*TON_COST_4_VOLUME+TON_VOT_REF_ROAD(:, :, i);
5  TON_COST_5_PD_REF(:, :, i)=PD_REF(i, 1)*TON_COST_5_BULK+PD_REF(i, 2)*TON_COST_5
6  _AVERAGE+PD_REF(i, 3)*TON_COST_5_VOLUME+TON_VOT_REF_RAIL(:, :, i);
7  TON_COST_6_PD_REF(:, :, i)=PD_REF(i, 1)*TON_COST_6_BULK+PD_REF(i, 2)*TON_COST_6
8  _AVERAGE+PD_REF(i, 3)*TON_COST_6_VOLUME+TON_VOT_REF_RAIL(:, :, i);
9  end
10 %-----
11 % Coût tonne depuis centre distribution/ Ton cost from distribution center
12 %-----
13 DC_REF=PERC(1:69, 12:14);
14 DC_NO_FE=PERC(1:69, 15:17);
15 DC_FE=PERC(1:69, 18:20);
16 %preallocation reference scenario
17 TON_COST_1_DC_REF=zeros(22, 22, 69);
18 TON_COST_2_DC_REF=zeros(22, 22, 69);
19 TON_COST_3_DC_REF=zeros(22, 22, 69);
20 TON_COST_4_DC_REF=zeros(22, 22, 69);
21 TON_COST_5_DC_REF=zeros(22, 22, 69);
22 TON_COST_6_DC_REF=zeros(22, 22, 69);
23 %Calculation of DC
24 for i=1:69
25 %reference scenario
26 TON_COST_1_DC_REF(:, :, i)=DC_REF(i, 1)*TON_COST_1_BULK+DC_REF(i, 2)*TON_COST_1
27 _AVERAGE+DC_REF(i, 3)*TON_COST_1_VOLUME+TON_VOT_REF_ROAD(:, :, i);
28 TON_COST_2_DC_REF(:, :, i)=DC_REF(i, 1)*TON_COST_2_BULK+DC_REF(i, 2)*TON_COST_2
29 _AVERAGE+DC_REF(i, 3)*TON_COST_2_VOLUME+TON_VOT_REF_ROAD(:, :, i);
30 TON_COST_3_DC_REF(:, :, i)=DC_REF(i, 1)*TON_COST_3_BULK+DC_REF(i, 2)*TON_COST_3
31 _AVERAGE+DC_REF(i, 3)*TON_COST_3_VOLUME+TON_VOT_REF_ROAD(:, :, i);
32 TON_COST_4_DC_REF(:, :, i)=DC_REF(i, 1)*TON_COST_4_BULK+DC_REF(i, 2)*TON_COST_4
33 _AVERAGE+DC_REF(i, 3)*TON_COST_4_VOLUME+TON_VOT_REF_ROAD(:, :, i);
34 TON_COST_5_DC_REF(:, :, i)=DC_REF(i, 1)*TON_COST_5_BULK+DC_REF(i, 2)*TON_COST_5
35 _AVERAGE+DC_REF(i, 3)*TON_COST_5_VOLUME+TON_VOT_REF_RAIL(:, :, i);
36 TON_COST_6_DC_REF(:, :, i)=DC_REF(i, 1)*TON_COST_6_BULK+DC_REF(i, 2)*TON_COST_6
37 _AVERAGE+DC_REF(i, 3)*TON_COST_6_VOLUME+TON_VOT_REF_RAIL(:, :, i);
38 end
39 %-----
40 % Données centre distribution/ distribution center data
41 %-----
42 WH_REF=zeros(22, 22, 69);
43 WH_NO_FE=zeros(22, 22, 69);
44 WH_FE=zeros(22, 22, 69);
45 for i=1:69
46     WH_REF(:, :, i)=WH(i, 1)*ones(22, 22);
47     WH_NO_FE(:, :, i)=WH(i, 2)*ones(22, 22);
48     WH_FE(:, :, i)=WH(i, 3)*ones(22, 22);
49 end
50 %-----
51 % Coût par tonne indirect/indirect cost
52 %-----
53 % Reference scenario without external cost
54 TON_COST_1_1_REF=zeros(22, 22, 22, 69);
55 TON_COST_1_2_REF=zeros(22, 22, 22, 69);
56 TON_COST_1_3_REF=zeros(22, 22, 22, 69);
57 TON_COST_1_4_REF=zeros(22, 22, 22, 69);
58 TON_COST_1_5_REF=zeros(22, 22, 22, 69);
59 TON_COST_1_6_REF=zeros(22, 22, 22, 69);
60 TON_COST_2_1_REF=zeros(22, 22, 22, 69);
61 TON_COST_2_2_REF=zeros(22, 22, 22, 69);

```

```

1  TON_COST_2_3_REF=zeros(22,22,22,69);
2  TON_COST_2_4_REF=zeros(22,22,22,69);
3  TON_COST_2_5_REF=zeros(22,22,22,69);
4  TON_COST_2_6_REF=zeros(22,22,22,69);
5  TON_COST_3_1_REF=zeros(22,22,22,69);
6  TON_COST_3_2_REF=zeros(22,22,22,69);
7  TON_COST_3_3_REF=zeros(22,22,22,69);
8  TON_COST_3_4_REF=zeros(22,22,22,69);
9  TON_COST_3_5_REF=zeros(22,22,22,69);
10 TON_COST_3_6_REF=zeros(22,22,22,69);
11 TON_COST_4_1_REF=zeros(22,22,22,69);
12 TON_COST_4_2_REF=zeros(22,22,22,69);
13 TON_COST_4_3_REF=zeros(22,22,22,69);
14 TON_COST_4_4_REF=zeros(22,22,22,69);
15 TON_COST_4_5_REF=zeros(22,22,22,69);
16 TON_COST_4_6_REF=zeros(22,22,22,69);
17 TON_COST_5_1_REF=zeros(22,22,22,69);
18 TON_COST_5_2_REF=zeros(22,22,22,69);
19 TON_COST_5_3_REF=zeros(22,22,22,69);
20 TON_COST_5_4_REF=zeros(22,22,22,69);
21 TON_COST_5_5_REF=zeros(22,22,22,69);
22 TON_COST_5_6_REF=zeros(22,22,22,69);
23 TON_COST_6_1_REF=zeros(22,22,22,69);
24 TON_COST_6_2_REF=zeros(22,22,22,69);
25 TON_COST_6_3_REF=zeros(22,22,22,69);
26 TON_COST_6_4_REF=zeros(22,22,22,69);
27 TON_COST_6_5_REF=zeros(22,22,22,69);
28 TON_COST_6_6_REF=zeros(22,22,22,69);
29 for k=1:69
30     for i=1:22
31         for j=1:22
32             for l=1:22
33                 % Reference scenario without external cost
34 TON_COST_1_1_REF(i,j,l,k)=TON_COST_1_PD_REF(i,l,k)+TON_COST_1_DC_REF(l,j,k)
35 +WH_REF(i,l,k);
36 TON_COST_1_2_REF(i,j,l,k)=TON_COST_1_PD_REF(i,l,k)+TON_COST_2_DC_REF(l,j,k)
37 +WH_REF(i,l,k);
38 TON_COST_1_3_REF(i,j,l,k)=TON_COST_1_PD_REF(i,l,k)+TON_COST_3_DC_REF(l,j,k)
39 +WH_REF(i,l,k);
40 TON_COST_1_4_REF(i,j,l,k)=TON_COST_1_PD_REF(i,l,k)+TON_COST_4_DC_REF(l,j,k)
41 +WH_REF(i,l,k);
42 TON_COST_1_5_REF(i,j,l,k)=TON_COST_1_PD_REF(i,l,k)+TON_COST_5_DC_REF(l,j,k)
43 +WH_REF(i,l,k);
44 TON_COST_1_6_REF(i,j,l,k)=TON_COST_1_PD_REF(i,l,k)+TON_COST_6_DC_REF(l,j,k)
45 +WH_REF(i,l,k);
46 TON_COST_2_1_REF(i,j,l,k)=TON_COST_2_PD_REF(i,l,k)+TON_COST_1_DC_REF(l,j,k)
47 +WH_REF(i,l,k);
48 TON_COST_2_2_REF(i,j,l,k)=TON_COST_2_PD_REF(i,l,k)+TON_COST_2_DC_REF(l,j,k)
49 +WH_REF(i,l,k);
50 TON_COST_2_3_REF(i,j,l,k)=TON_COST_2_PD_REF(i,l,k)+TON_COST_3_DC_REF(l,j,k)
51 +WH_REF(i,l,k);
52 TON_COST_2_4_REF(i,j,l,k)=TON_COST_2_PD_REF(i,l,k)+TON_COST_4_DC_REF(l,j,k)
53 +WH_REF(i,l,k);
54 TON_COST_2_5_REF(i,j,l,k)=TON_COST_2_PD_REF(i,l,k)+TON_COST_5_DC_REF(l,j,k)
55 +WH_REF(i,l,k);
56 TON_COST_2_6_REF(i,j,l,k)=TON_COST_2_PD_REF(i,l,k)+TON_COST_6_DC_REF(l,j,k)
57 +WH_REF(i,l,k);
58 TON_COST_3_1_REF(i,j,l,k)=TON_COST_3_PD_REF(i,l,k)+TON_COST_1_DC_REF(l,j,k)
59 +WH_REF(i,l,k);
60 TON_COST_3_2_REF(i,j,l,k)=TON_COST_3_PD_REF(i,l,k)+TON_COST_2_DC_REF(l,j,k)
61 +WH_REF(i,l,k);

```

```

1  TON_COST_3_3_REF(i,j,l,k)=TON_COST_3_PD_REF(i,l,k)+TON_COST_3_DC_REF(l,j,k)
2  +WH_REF(i,l,k);
3  TON_COST_3_4_REF(i,j,l,k)=TON_COST_3_PD_REF(i,l,k)+TON_COST_4_DC_REF(l,j,k)
4  +WH_REF(i,l,k);
5  TON_COST_3_5_REF(i,j,l,k)=TON_COST_3_PD_REF(i,l,k)+TON_COST_5_DC_REF(l,j,k)
6  +WH_REF(i,l,k);
7  TON_COST_3_6_REF(i,j,l,k)=TON_COST_3_PD_REF(i,l,k)+TON_COST_6_DC_REF(l,j,k)
8  +WH_REF(i,l,k);
9  TON_COST_4_1_REF(i,j,l,k)=TON_COST_4_PD_REF(i,l,k)+TON_COST_1_DC_REF(l,j,k)
10 +WH_REF(i,l,k);
11 TON_COST_4_2_REF(i,j,l,k)=TON_COST_4_PD_REF(i,l,k)+TON_COST_2_DC_REF(l,j,k)
12 +WH_REF(i,l,k);
13 TON_COST_4_3_REF(i,j,l,k)=TON_COST_4_PD_REF(i,l,k)+TON_COST_3_DC_REF(l,j,k)
14 +WH_REF(i,l,k);
15 TON_COST_4_4_REF(i,j,l,k)=TON_COST_4_PD_REF(i,l,k)+TON_COST_4_DC_REF(l,j,k)
16 +WH_REF(i,l,k);
17 TON_COST_4_5_REF(i,j,l,k)=TON_COST_4_PD_REF(i,l,k)+TON_COST_5_DC_REF(l,j,k)
18 +WH_REF(i,l,k);
19 TON_COST_4_6_REF(i,j,l,k)=TON_COST_4_PD_REF(i,l,k)+TON_COST_6_DC_REF(l,j,k)
20 +WH_REF(i,l,k);
21 TON_COST_5_1_REF(i,j,l,k)=TON_COST_5_PD_REF(i,l,k)+TON_COST_1_DC_REF(l,j,k)
22 +WH_REF(i,l,k);
23 TON_COST_5_2_REF(i,j,l,k)=TON_COST_5_PD_REF(i,l,k)+TON_COST_2_DC_REF(l,j,k)
24 +WH_REF(i,l,k);
25 TON_COST_5_3_REF(i,j,l,k)=TON_COST_5_PD_REF(i,l,k)+TON_COST_3_DC_REF(l,j,k)
26 +WH_REF(i,l,k);
27 TON_COST_5_4_REF(i,j,l,k)=TON_COST_5_PD_REF(i,l,k)+TON_COST_4_DC_REF(l,j,k)
28 +WH_REF(i,l,k);
29 TON_COST_5_5_REF(i,j,l,k)=TON_COST_5_PD_REF(i,l,k)+TON_COST_5_DC_REF(l,j,k)
30 +WH_REF(i,l,k);
31 TON_COST_5_6_REF(i,j,l,k)=TON_COST_5_PD_REF(i,l,k)+TON_COST_6_DC_REF(l,j,k)
32 +WH_REF(i,l,k);
33 TON_COST_6_1_REF(i,j,l,k)=TON_COST_6_PD_REF(i,l,k)+TON_COST_1_DC_REF(l,j,k)
34 +WH_REF(i,l,k);
35 TON_COST_6_2_REF(i,j,l,k)=TON_COST_6_PD_REF(i,l,k)+TON_COST_2_DC_REF(l,j,k)
36 +WH_REF(i,l,k);
37 TON_COST_6_3_REF(i,j,l,k)=TON_COST_6_PD_REF(i,l,k)+TON_COST_3_DC_REF(l,j,k)
38 +WH_REF(i,l,k);
39 TON_COST_6_4_REF(i,j,l,k)=TON_COST_6_PD_REF(i,l,k)+TON_COST_4_DC_REF(l,j,k)
40 +WH_REF(i,l,k);
41 TON_COST_6_5_REF(i,j,l,k)=TON_COST_6_PD_REF(i,l,k)+TON_COST_5_DC_REF(l,j,k)
42 +WH_REF(i,l,k);
43 TON_COST_6_6_REF(i,j,l,k)=TON_COST_6_PD_REF(i,l,k)+TON_COST_6_DC_REF(l,j,k)
44 +WH_REF(i,l,k);
45     end
46     end
47     end
48 end
49 %-----
50 % Calcul des exponentielles/ Data imports
51 %-----
52 logit=-0.1;
53 % Reference scenario without external cost
54 EXP_COST_1_REF=exp(logit*TON_COST_1_PC_REF);
55 EXP_COST_2_REF=exp(logit*TON_COST_2_PC_REF);
56 EXP_COST_3_REF=exp(logit*TON_COST_3_PC_REF);
57 EXP_COST_4_REF=exp(logit*TON_COST_4_PC_REF);
58 EXP_COST_5_REF=exp(logit*TON_COST_5_PC_REF);
59 EXP_COST_6_REF=exp(logit*TON_COST_6_PC_REF);
60 EXP_COST_1_1_REF=exp(logit*TON_COST_1_1_REF);
61 EXP_COST_1_2_REF=exp(logit*TON_COST_1_2_REF);

```

```

1  EXP_COST_1_3_REF=exp(logit*TON_COST_1_3_REF);
2  EXP_COST_1_4_REF=exp(logit*TON_COST_1_4_REF);
3  EXP_COST_1_5_REF=exp(logit*TON_COST_1_5_REF);
4  EXP_COST_1_6_REF=exp(logit*TON_COST_1_6_REF);
5  EXP_COST_2_1_REF=exp(logit*TON_COST_2_1_REF);
6  EXP_COST_2_2_REF=exp(logit*TON_COST_2_2_REF);
7  EXP_COST_2_3_REF=exp(logit*TON_COST_2_3_REF);
8  EXP_COST_2_4_REF=exp(logit*TON_COST_2_4_REF);
9  EXP_COST_2_5_REF=exp(logit*TON_COST_2_5_REF);
10 EXP_COST_2_6_REF=exp(logit*TON_COST_2_6_REF);
11 EXP_COST_3_1_REF=exp(logit*TON_COST_3_1_REF);
12 EXP_COST_3_2_REF=exp(logit*TON_COST_3_2_REF);
13 EXP_COST_3_3_REF=exp(logit*TON_COST_3_3_REF);
14 EXP_COST_3_4_REF=exp(logit*TON_COST_3_4_REF);
15 EXP_COST_3_5_REF=exp(logit*TON_COST_3_5_REF);
16 EXP_COST_3_6_REF=exp(logit*TON_COST_3_6_REF);
17 EXP_COST_4_1_REF=exp(logit*TON_COST_4_1_REF);
18 EXP_COST_4_2_REF=exp(logit*TON_COST_4_2_REF);
19 EXP_COST_4_3_REF=exp(logit*TON_COST_4_3_REF);
20 EXP_COST_4_4_REF=exp(logit*TON_COST_4_4_REF);
21 EXP_COST_4_5_REF=exp(logit*TON_COST_4_5_REF);
22 EXP_COST_4_6_REF=exp(logit*TON_COST_4_6_REF);
23 EXP_COST_5_1_REF=exp(logit*TON_COST_5_1_REF);
24 EXP_COST_5_2_REF=exp(logit*TON_COST_5_2_REF);
25 EXP_COST_5_3_REF=exp(logit*TON_COST_5_3_REF);
26 EXP_COST_5_4_REF=exp(logit*TON_COST_5_4_REF);
27 EXP_COST_5_5_REF=exp(logit*TON_COST_5_5_REF);
28 EXP_COST_5_6_REF=exp(logit*TON_COST_5_6_REF);
29 EXP_COST_6_1_REF=exp(logit*TON_COST_6_1_REF);
30 EXP_COST_6_2_REF=exp(logit*TON_COST_6_2_REF);
31 EXP_COST_6_3_REF=exp(logit*TON_COST_6_3_REF);
32 EXP_COST_6_4_REF=exp(logit*TON_COST_6_4_REF);
33 EXP_COST_6_5_REF=exp(logit*TON_COST_6_5_REF);
34 EXP_COST_6_6_REF=exp(logit*TON_COST_6_6_REF);
35 %-----
36 % Calcul des probabilités d'utilisation/ Probability of use
37 %-----
38 % Reference scenario without external cost
39 EXP_TOT_REF_PC=EXP_COST_1_REF+EXP_COST_2_REF+EXP_COST_3_REF+EXP_COST_4_REF+
40 EXP_COST_5_REF+EXP_COST_6_REF;
41 EXP_TOT_REF_PC_BIS(:, :, 1, :)=EXP_TOT_REF_PC;
42 EXP_TOT_REF_1=sum(EXP_COST_1_1_REF, 3)+sum(EXP_COST_1_2_REF, 3)+sum(EXP_COST_
43 1_3_REF, 3)+sum(EXP_COST_1_4_REF, 3)+sum(EXP_COST_1_5_REF, 3)+sum(EXP_COST_1_6
44 _REF, 3);
45 EXP_TOT_REF_2=sum(EXP_COST_2_1_REF, 3)+sum(EXP_COST_2_2_REF, 3)+sum(EXP_COST_
46 2_3_REF, 3)+sum(EXP_COST_2_4_REF, 3)+sum(EXP_COST_2_5_REF, 3)+sum(EXP_COST_2_6
47 _REF, 3);
48 EXP_TOT_REF_3=sum(EXP_COST_3_1_REF, 3)+sum(EXP_COST_3_2_REF, 3)+sum(EXP_COST_
49 3_3_REF, 3)+sum(EXP_COST_3_4_REF, 3)+sum(EXP_COST_3_5_REF, 3)+sum(EXP_COST_3_6
50 _REF, 3);
51 EXP_TOT_REF_4=sum(EXP_COST_4_1_REF, 3)+sum(EXP_COST_4_2_REF, 3)+sum(EXP_COST_
52 4_3_REF, 3)+sum(EXP_COST_4_4_REF, 3)+sum(EXP_COST_4_5_REF, 3)+sum(EXP_COST_4_6
53 _REF, 3);
54 EXP_TOT_REF_5=sum(EXP_COST_5_1_REF, 3)+sum(EXP_COST_5_2_REF, 3)+sum(EXP_COST_
55 5_3_REF, 3)+sum(EXP_COST_5_4_REF, 3)+sum(EXP_COST_5_5_REF, 3)+sum(EXP_COST_5_6
56 _REF, 3);
57 EXP_TOT_REF_6=sum(EXP_COST_6_1_REF, 3)+sum(EXP_COST_6_2_REF, 3)+sum(EXP_COST_
58 6_3_REF, 3)+sum(EXP_COST_6_4_REF, 3)+sum(EXP_COST_6_5_REF, 3)+sum(EXP_COST_6_6
59 _REF, 3);
60 EXP_TOT_REF=EXP_TOT_REF_PC_BIS+EXP_TOT_REF_1+EXP_TOT_REF_2+EXP_TOT_REF_3+EX
61 P_TOT_REF_4+EXP_TOT_REF_5+EXP_TOT_REF_6;

```



```

1  EXP_REF(:, :, :) = EXP_TOT_REF(:, :, 1, :);
2  EXP_REF_BIS = zeros(22, 22, 22, 69);
3  for l=1:22
4      EXP_REF_BIS(:, :, l, :) = EXP_REF(:, :, :);
5  end
6  PRO_1_REF = EXP_COST_1_REF ./ EXP_REF;
7  PRO_2_REF = EXP_COST_2_REF ./ EXP_REF;
8  PRO_3_REF = EXP_COST_3_REF ./ EXP_REF;
9  PRO_4_REF = EXP_COST_4_REF ./ EXP_REF;
10 PRO_5_REF = EXP_COST_5_REF ./ EXP_REF;
11 PRO_6_REF = EXP_COST_6_REF ./ EXP_REF;
12 PRO_1_1_REF = EXP_COST_1_1_REF ./ EXP_REF_BIS;
13 PRO_1_2_REF = EXP_COST_1_2_REF ./ EXP_REF_BIS;
14 PRO_1_3_REF = EXP_COST_1_3_REF ./ EXP_REF_BIS;
15 PRO_1_4_REF = EXP_COST_1_4_REF ./ EXP_REF_BIS;
16 PRO_1_5_REF = EXP_COST_1_5_REF ./ EXP_REF_BIS;
17 PRO_1_6_REF = EXP_COST_1_6_REF ./ EXP_REF_BIS;
18 PRO_2_1_REF = EXP_COST_2_1_REF ./ EXP_REF_BIS;
19 PRO_2_2_REF = EXP_COST_2_2_REF ./ EXP_REF_BIS;
20 PRO_2_3_REF = EXP_COST_2_3_REF ./ EXP_REF_BIS;
21 PRO_2_4_REF = EXP_COST_2_4_REF ./ EXP_REF_BIS;
22 PRO_2_5_REF = EXP_COST_2_5_REF ./ EXP_REF_BIS;
23 PRO_2_6_REF = EXP_COST_2_6_REF ./ EXP_REF_BIS;
24 PRO_3_1_REF = EXP_COST_3_1_REF ./ EXP_REF_BIS;
25 PRO_3_2_REF = EXP_COST_3_2_REF ./ EXP_REF_BIS;
26 PRO_3_3_REF = EXP_COST_3_3_REF ./ EXP_REF_BIS;
27 PRO_3_4_REF = EXP_COST_3_4_REF ./ EXP_REF_BIS;
28 PRO_3_5_REF = EXP_COST_3_5_REF ./ EXP_REF_BIS;
29 PRO_3_6_REF = EXP_COST_3_6_REF ./ EXP_REF_BIS;
30 PRO_4_1_REF = EXP_COST_4_1_REF ./ EXP_REF_BIS;
31 PRO_4_2_REF = EXP_COST_4_2_REF ./ EXP_REF_BIS;
32 PRO_4_3_REF = EXP_COST_4_3_REF ./ EXP_REF_BIS;
33 PRO_4_4_REF = EXP_COST_4_4_REF ./ EXP_REF_BIS;
34 PRO_4_5_REF = EXP_COST_4_5_REF ./ EXP_REF_BIS;
35 PRO_4_6_REF = EXP_COST_4_6_REF ./ EXP_REF_BIS;
36 PRO_5_1_REF = EXP_COST_5_1_REF ./ EXP_REF_BIS;
37 PRO_5_2_REF = EXP_COST_5_2_REF ./ EXP_REF_BIS;
38 PRO_5_3_REF = EXP_COST_5_3_REF ./ EXP_REF_BIS;
39 PRO_5_4_REF = EXP_COST_5_4_REF ./ EXP_REF_BIS;
40 PRO_5_5_REF = EXP_COST_5_5_REF ./ EXP_REF_BIS;
41 PRO_5_6_REF = EXP_COST_5_6_REF ./ EXP_REF_BIS;
42 PRO_6_1_REF = EXP_COST_6_1_REF ./ EXP_REF_BIS;
43 PRO_6_2_REF = EXP_COST_6_2_REF ./ EXP_REF_BIS;
44 PRO_6_3_REF = EXP_COST_6_3_REF ./ EXP_REF_BIS;
45 PRO_6_4_REF = EXP_COST_6_4_REF ./ EXP_REF_BIS;
46 PRO_6_5_REF = EXP_COST_6_5_REF ./ EXP_REF_BIS;
47 PRO_6_6_REF = EXP_COST_6_6_REF ./ EXP_REF_BIS;
48 %-----
49 % Importation de données/ Data imports
50 %-----
51 COST_PC_REF = PRO_1_REF.*TON_COST_1_PC_REF + PRO_2_REF.*TON_COST_2_PC_REF + PRO_3
52 _REF.*TON_COST_3_PC_REF + PRO_4_REF.*TON_COST_4_PC_REF + PRO_5_REF.*TON_COST_5_
53 PC_REF + PRO_6_REF.*TON_COST_6_PC_REF;
54 COST_IND_1_REF = PRO_1_1_REF.*TON_COST_1_1_REF + PRO_1_2_REF.*TON_COST_1_2_REF +
55 PRO_1_3_REF.*TON_COST_1_3_REF + PRO_1_4_REF.*TON_COST_1_4_REF + PRO_1_5_REF.*TO
56 N_COST_1_5_REF + PRO_1_6_REF.*TON_COST_1_6_REF;
57 COST_IND_2_REF = PRO_2_1_REF.*TON_COST_2_1_REF + PRO_2_2_REF.*TON_COST_2_2_REF +
58 PRO_2_3_REF.*TON_COST_2_3_REF + PRO_2_4_REF.*TON_COST_2_4_REF + PRO_2_5_REF.*TO
59 N_COST_2_5_REF + PRO_2_6_REF.*TON_COST_2_6_REF;

```

```

1  COST_IND_3_REF=PRO_3_1_REF.*TON_COST_3_1_REF+PRO_3_2_REF.*TON_COST_3_2_REF+
2  PRO_3_3_REF.*TON_COST_3_3_REF+PRO_3_4_REF.*TON_COST_3_4_REF+PRO_3_5_REF.*TO
3  N_COST_3_5_REF+PRO_3_6_REF.*TON_COST_3_6_REF;
4  COST_IND_4_REF=PRO_4_1_REF.*TON_COST_4_1_REF+PRO_4_2_REF.*TON_COST_4_2_REF+
5  PRO_4_3_REF.*TON_COST_4_3_REF+PRO_4_4_REF.*TON_COST_4_4_REF+PRO_4_5_REF.*TO
6  N_COST_4_5_REF+PRO_4_6_REF.*TON_COST_4_6_REF;
7  COST_IND_5_REF=PRO_5_1_REF.*TON_COST_5_1_REF+PRO_5_2_REF.*TON_COST_5_2_REF+
8  PRO_5_3_REF.*TON_COST_5_3_REF+PRO_5_4_REF.*TON_COST_5_4_REF+PRO_5_5_REF.*TO
9  N_COST_5_5_REF+PRO_5_6_REF.*TON_COST_5_6_REF;
10 COST_IND_6_REF=PRO_6_1_REF.*TON_COST_6_1_REF+PRO_6_2_REF.*TON_COST_6_2_REF+
11 PRO_6_3_REF.*TON_COST_6_3_REF+PRO_6_4_REF.*TON_COST_6_4_REF+PRO_6_5_REF.*TO
12 N_COST_6_5_REF+PRO_6_6_REF.*TON_COST_6_6_REF;
13 COST_IND_REF=COST_IND_1_REF+COST_IND_2_REF+COST_IND_3_REF+COST_IND_4_REF+CO
14 ST_IND_5_REF+COST_IND_6_REF;
15 COST_IND_REF_BIS=sum(COST_IND_REF,3);
16 COST_IND_REF_TER(:, :, :)=COST_IND_REF_BIS(:, :, 1, :);
17 COST_REF=COST_PC_REF+COST_IND_REF_TER;
18 %Gravity model
19 PROD_REF=xlsread('Supply chain','PHYS_VECT','D282:BT303');
20 CONS_REF=xlsread('Supply chain','PHYS_VECT','D251:BT272');
21 coeff_grav=-0.1;
22 r=exp(coeff_grav*COST_REF);
23 q=ones(22,69);
24 a=zeros(22,69);
25 p=zeros(22,69);
26 b=zeros(22,69);
27 INT=zeros(22,22,69);
28 for k=1:69
29     for i=1:100;
30         a(:,k)=r(:, :, k)*q(:,k);
31         p(:,k)=PROD_REF(:,k)./a(:,k);
32         b(:,k)=r(:, :, k)'*p(:,k);
33         q(:,k)=CONS_REF(:,k)./b(:,k);
34     end
35     INT(:, :, k)=p(:,k)*q(:,k)';
36 end
37 DIST_REF=INT.*r;
38 A=xlsread('Supply chain.xlsx','PHYS_VECT','D96:BT120');
39 B=xlsread('Supply chain.xlsx','PHYS_VECT','D65:BT89');
40 C=xlsread('Supply chain.xlsx','PHYS_VECT','D127:BT151');
41 D=xlsread('Supply chain.xlsx','PHYS_VECT','D158:BT182');
42 E=xlsread('Supply chain.xlsx','PHYS_VECT','D189:BT213');
43 F=xlsread('Supply chain.xlsx','PHYS_VECT','D220:BT244');
44 DIST_REF(:,25,:)=A(1:22,:);
45 DIST_REF(:,24,:)=C(1:22,:);
46 DIST_REF(:,23,:)=E(1:22,:);
47 DIST_REF(25, :, :)=B(:, :);
48 DIST_REF(24, :, :)=D(:, :);
49 DIST_REF(23, :, :)=F(:, :);
50
51
52

```

# Sébastien DENTE

## Doctorat : Développement Durable

### Année 2013

#### Les enjeux de la circulation dans les sociétés durables – Logistique et économie de fonctionnalité

Les économies circulaires et de fonctionnalité sont souvent présentées comme des stratégies prometteuses quant à leur capacité à résoudre les problèmes environnementaux associés aux systèmes de production et de consommation actuels. Cependant, malgré les consommations d'énergie et émissions croissantes associées à la mondialisation de nos systèmes modernes, la question de la circulation reste peu abordée. Le présent travail s'attache à combler ce manque en analysant les effets de la représentation des activités humaines et des processus de circulation sous le champ de la durabilité. En s'intéressant ainsi au triptyque durabilité/chaîne d'approvisionnement/économies circulaires et de fonctionnalités, le présent travail montre notamment la barrière à la durabilité que constitue la représentation standardisée de l'espace et du temps associée à la convention économique actuellement dominante. Ainsi, l'approche en circuit fermé de l'économie circulaire et l'approche servicielle de co-production associée à l'économie de fonctionnalité ne s'avèrent être des stratégies efficacement durables que si une approche spécifique des ressources et de la demande y est associée. Ce point a notamment été développé à travers un modèle logistique qui montre par rapport à un scénario logistique de référence une augmentation de 5% des émissions de CO2 liés au transport de marchandises entre régions françaises pour une approche générique de l'économie de fonctionnalité contre une diminution de 3% des émissions dans le cas d'une approche spécifique.

Mots clés : logistique (organisation) - transport de marchandises - économie de fonctionnalité - développement économique, aspect environnemental – développement durable.

#### The Stakes of Circulation in Sustainable Societies - Logistics and Functional Economy

Functional and circular economies are often presented as promising strategies to address the environmental issues associated with our modern production/consumption systems. Within these systems, the circulation processes themselves are usually poorly addressed, in spite of the increasing energy consumption and emissions associated with logistics under the current trends of globalization. The present thesis aims at filling this gap by analyzing the relationship between the representation of human activities and circulation processes and the issue of sustainability. Dealing with the triptych sustainability/supply chain management/circular and functional economies, the thesis shows that the standardized representation of space and time in the current dominant economic conventions acts as a barrier to the development of truly sustainable circulation processes. It finds that the closing loop approach of the circular economy and the product/service approach of the functional economy require specific definitions and policy measures for resources and demand, so that they can be considered as real sustainable strategies. This necessity to develop specific new approaches was further supported with evidence from a new logistics and freight transportation model for France. The model indicates that a generic approach towards a functional economy would lead to 5% increase of CO2 emissions (associated with French interregional traded tons) while a targeted approach would lead to a 3% reduction in comparison to the reference logistics scenario.

Keywords: business logistics - freight and freightage - economic development, environmental aspects - product-service systems – sustainable development.

Thèse réalisée en partenariat entre :

