



HAL
open science

Theory of constraints (TOC) as an operations improvement methodology at the private healthcare sector in Cyprus

Spyridon Bonatsos

► **To cite this version:**

Spyridon Bonatsos. Theory of constraints (TOC) as an operations improvement methodology at the private healthcare sector in Cyprus. Business administration. Université de Strasbourg, 2019. English. NNT : 2019STRAB021 . tel-02965900

HAL Id: tel-02965900

<https://theses.hal.science/tel-02965900v1>

Submitted on 13 Oct 2020

HAL is a multi-disciplinary open access archive for the deposit and dissemination of scientific research documents, whether they are published or not. The documents may come from teaching and research institutions in France or abroad, or from public or private research centers.

L'archive ouverte pluridisciplinaire **HAL**, est destinée au dépôt et à la diffusion de documents scientifiques de niveau recherche, publiés ou non, émanant des établissements d'enseignement et de recherche français ou étrangers, des laboratoires publics ou privés.



Université de Strasbourg

Ecole Doctorale Augustin Cournot

HuManiS (ED 221)

THESE POUR L' OBTENTION DU DOCTORAT EN SCIENCES DE GESTION

Application de la Théorie des contraintes (TOC) dans le secteur des soins de santé privé à Chypre

THESE présentée par: **Spyridon Bonatsos**

Soutenue le: 20 March 2019

“τα πάντα ρεῖ” – “Everything flows.”

Heraclitus

JURY

Directeur de thèse

Thierry Nobre

Professeur, Université de Strasbourg

Rapporteurs

Irène Georgescu

Professeur, Université de Montpellier

François Meyssonier

Professeur, Université de Nantes

Membres

Philippe Wieser

Professeur, Ecole Polytechnique Fédérale de
Lausanne

Christophe Baret

Professeur, Université de Aix Marseille

Acknowledgments

With this opportunity, I would like to convey my sincere thanks and gratitude to the University of Strasbourg for honoring me with accepting my enrollment to the doctoral program.

First and foremost, my deepest gratitude to my supervisor, Professor Thierry Nobre for his valuable support, guidance, and encouragement throughout this journey. Professor Nobre, I cannot find the right words to express my gratitude for helping me grow and develop myself. Your faith in my abilities has armed me with superpowers. Your way of encouraging me is something that I have started using to people around me. Indirectly, you positively affect the lives of people that you will never meet. This is a great contribution to the world.

I would also like to appreciate and thank the members of the jury Professors Georgescu, Meyssonier, Wieser and Baret for their time and effort reviewing, correcting and contributing to this Thesis.

Sylvie and Karin thank you for everything. You all make a powerful whole that we all of us really need to go forward. Thank you.

I would like to thank Bill Dettmer for his support and for giving so generously his knowledge on the Theory of constraints. Mr. Dettmer, I consider myself a lucky person because I had great teachers in my life. You are one of them.

And finally, a million thanks to Phillip Marris. Phillip, you are the hero behind of all these. You have encouraged me to start this Ph.D. journey and also to be trained by Dettmer. This treasure that I will carry with me through time, is because of you. Thank you, I owe you a huge debt of gratitude.

My deepest gratitude to the managers of the clinic, who have helped to enhance the success of my Ph.D. Thesis. All this time that I have been with you in the hospital, you have demonstrated how is to be a great leader. Thank you from the bottom of my heart for all of your help, care and wisdom.

Hearty thanks to my wonderful family for supporting me during this four-year adventure. I will never forget the picture of all of us sitting around the table and studying

some for the first grade and others for their Ph.D. What beautiful times... I love you all.

Abstract

It is evident all over literature that healthcare faces operational challenges. Healthcare worldwide is experiencing issues like rising costs and poor quality. Without a true solution, physicians will face lower incomes, patients will pay more, and services will be restricted. The healthcare sector faces increased demand and ineffective services. The healthcare sector is characterized by high levels of complexity, uncertainty, and variation.

The aim of this research is to explore the degree of effectiveness of the Theory of Constraints methodology, as an improvement methodology, at the operational environment of a private general-purpose hospital in Cyprus.

This research focuses, describes and analyses the implementation of the Theory of Constraints in two different healthcare sub-systems being the housekeeping function (linen management system) and the surgery department (Operating Room) of the hospital.

The research is executed into an action research framework where the action research cycles are blended with the Theory of Constraint's change approach. The action research cycles are implemented via TOC tools and components. From the TOC suite the Five Focusing Steps, the Drum Buffer Rope, the Logical Thinking process, and the Replenishment solution have been implemented.

The data collection methodology comprised of both qualitative and quantitative methods. The main approach though is qualitative. For primary data collection – Observation, Interviews (Semi-structured and unstructured) and field data collection were used. The data collected was analyzed by the TOC tools as described in the literature.

Excellent results were also measured after the implementation of TOC in one Operating Room. The practice of the Drum Buffer Rope (DBR) managed to create 10 hours of available time per week which can be used to add more surgeries, promising to increase the Throughput of that single operating room by more than 30%.

This study shows how TOC's components were adapted to specific sub-systems characteristics in order to improve the research field. Being consistent with the action research philosophy, employees were actively involved throughout the process and conclusions are drawn regarding their acceptance requirements towards the TOC methodology.

This study makes theoretical and professional contributions through its findings. Theoretical contributions have been developed for the Goal and Future Reality Trees. A managerial template has been constructed summing up all the findings from all the TOC's developments aiming to guide managers through the improvement process.

Contents

Acknowledgments	i
Abstract.....	ii
List of Figures.....	viii
List of Tables	x
List of Acronyms and Abbreviations.....	xi
Introduction.....	1
Chapter 1	7
Theory of Constraints (TOC) - the theory	7
1.1 Introduction to the Chapter	7
1.2 An evolution - Standing on the shoulders of Giants.	8
1.3 TOC Philosophy and Key principles.....	16
1.4 TOC Components	19
1.4.1 The Five Focusing Steps (5FS).....	19
1.4.2 Thinking Process Tools (TP Tools)	25
1.4.3 TOC Performance Measures.....	37
1.5 TOC Generic Solutions.....	39
1.5.1 Drum Buffer Rope (DBR)	39
1.5.2 TOC Replenishment	44
1.5.3 Critical Chain Project Management (CCPM).....	48
1.5.4 Throughput Accounting (TA).....	49
1.6 Setting the mindset.....	50
1.6.1 TOC and Process of Change	50
1.6.2 TOC and Operations	59
1.6.3 TOC and Systems	61
1.7 Chapter Summary	64
Chapter 2	65
Management of Healthcare Operations and Theory of Constraints – a synergy	65
2.1 Introduction to the Chapter	65
2.2 Service Operations Management.....	66
2.2.1 Systems categorisation and classification.....	66
2.3 Research in Improvement of healthcare Operations.....	73
2.4 Theory of Constraints (TOC) in Services	78
2.5 TOC and Healthcare.....	80
2.6 TOC and Hospital Logistics.....	81
2.7 TOC and Operating Rooms (ORs).....	82
2.8 Gap Identification	83
2.9 Purpose Statement and Research Objective.....	85

2.10	Research Questions	86
2.11	Chapter Summary	88
Chapter 3	89
Philosophical Assumptions and Methodology	89
3.1	Introduction to the Chapter	89
3.2	Philosophical Perspective and Theoretical models	90
3.3	Research Approach.....	91
3.4	Research Strategy	91
3.5	Methodological Choices.....	96
3.6	Data collection and Analysis	97
3.7	The research field.....	100
3.8	Ethical Issues	100
3.9	Chapter Summary	101
Chapter 4	102
Analysis and Findings: Theory of Constraints (TOC)	102
in linen management system	102
4.1	Introduction to the chapter	102
4.2	What to Change - Diagnosis.....	105
4.2.1	Action Step 1 – Current Reality Tree (CRT).....	105
4.2.2	Action Step 2 – Training process.....	108
4.2.3	Action Step 3 - Goal Tree (GT).....	111
4.2.4	Action Step 4 - Gap Analysis and Current Reality Tree.....	115
4.3	What to change to - Planning.....	122
4.3.1	Action Step 5 – Evaporating Cloud (EC)	122
4.3.2	Action Step 6 – Future Reality Tree (FRT)	131
4.4	How to cause the change - Action.....	135
4.4.1	Action step 7 – Implementation Five Focusing Steps	135
4.4.2	Action Step 8 - Identify the Constraint	137
4.4.3	Action Step 9 – Exploit the constraint	141
4.4.4	Action Step 10 - Choose the constraint	142
4.4.5	Action Step 11 - Convert chosen constraint – to a bottleneck.....	143
4.4.6	Action Step 12 – Categorising and unitising injections.....	144
4.4.7	Action Step 13 – Subordinate the constraint	146
4.4.8	Action Step 14 - Exploit the constraint.....	148
4.4.9	Action Step 15 – Drum Buffer Rope (DBR).....	150
4.4.10	Action Step 16 - Replenishment	151
4.4.11	Action Step 17 – Auditing and Stabilisation of the system	158
4.5	Evaluation.....	161
4.6	Summary of Overall Results in Linen Management System Case Study	161
4.7	Chapter Summary	166

Chapter 5	167
Analysis and Findings: TOC in Operating Rooms (OR).....	167
5.1 Introduction to the chapter	167
5.2 The research field - Contextual Background	170
PART 1 – FIRST ACTION RESEARCH CYCLE	180
5.3 What to Change - Diagnosis.....	180
5.3.1 Action Step 1 - Training – setting up a uniform mind set.	180
5.3.2 Action Step 2 - Goal Tree (GT)	183
5.3.3 Action Step 3 – Current Reality Tree (CRT).....	187
5.4 What to change to - Planning.....	194
5.4.1 Action step 4 - Five Focusing Steps Implementation	194
5.5 How to cause the change - Action.....	195
5.5.1 Action Step 5 - Identify the system’s Constraint	195
5.5.2 Action Step 6 - Exploit system’s constraint.....	196
5.6 Evaluation – Results of part 1 – Action Research Cycle 1	197
PART 2 – SECOND ACTION RESEARCH CYCLE	198
5.7 What to Change - Diagnosis.....	198
5.7.1 Action Step 7 - Evaporating Cloud (EC)	198
5.8 What to change to - Planning.....	207
5.8.1 Action Step 8 – Future Reality Tree (FRT)	207
5.9 How to cause the change - Action.....	209
5.9.1 Action Step 9 – Drum Buffer Rope (DBR) Implementation	209
5.10 Evaluation – Results of Part 2.....	230
PART 3 – RESULTS	231
5.11 Summary of Overall Results in Operating Room Case Study.....	233
5.12 Chapter Summary	236
Chapter 6	237
Discussion and interpretation of results.....	237
6.1 Introduction to the chapter	237
6.2 Logical Thinking Process	239
6.2.1 Current Reality Tree (CRT).....	239
6.2.2 Goal Tree (GT)	240
6.2.3 Current Reality Tree (CRT).....	247
6.2.4 Evaporating Cloud (EC)	252
6.2.5 Future Reality Tree (FRT)	254
6.2.6 Logical Thinking Process Tools - Observations and lessons learned from both case studies.....	257
6.3 Five Focusing Steps.....	259
6.3.1 Five Focusing Steps – Linen case study	259
6.3.2 Five Focusing Steps– Surgery Department case study	264
6.3.3 Five Focusing Steps – Observations and lessons learned from both case studies	267
6.4 Drum Buffer Rope (DBR)	271
6.4.1 Drum Buffer Rope (DBR) - Linen.....	272
6.4.2 Drum Buffer Rope (DBR) – Surgery Department.....	273

6.4.3 Drum Buffer Rope – Observations and lessons learned from both case studies	276
6.5 Replenishment Solution.....	278
6.5.1 Replenishment – Observations and lessons learned from the linen case study.....	280
6.6 Chapter Summary	281
Chapter 7	282
Theoretical and Practical Recommendations	282
7.1 Introduction to the chapter	282
7.2 Theoretical Recommendations	284
7.2.1 Change Sequence	284
7.2.2 Logical Thinking Process	287
7.2.3 Five Focusing Steps	290
7.3 Theoretical Development.....	294
7.3.1 Goal Tree (GT) – Theoretical development	294
7.3.2 Future Reality Tree (FRT) – Theoretical Development	304
7.4 Managerial Development - Recommended Template	317
7.5 Chapter Summary	322
Chapter 8	323
Conclusions.....	323
8.1 Introduction to the chapter	323
8.2 Overview of the Research.....	324
8.3 Research Questions Theme	326
8.3.1 What to change – Diagnosis	326
8.3.2 What to change to - Planning.....	328
8.3.3 How to cause the change - Action	329
8.3.4 Evaluation	331
8.4 Unique Contributions, implications and Significance – Purpose Statement.....	334
8.4.1 Theoretical Contribution.....	336
8.4.2 Managerial Contribution and Implications	338
8.4.3 Areas of further research.....	340
8.5 Limitations.....	341
8.6 Chapter Summary	342
References.....	343
Appendixes	369

List of Figures

Figure 1. 1: The Five Focusing Steps	22
Figure 1. 2: The Current Reality Tree.....	29
Figure 1. 3: The Evaporating Cloud	31
Figure 1. 4: The Future Reality Tree	32
Figure 1. 5: The Goal Tree.....	35
Figure 1. 6: TOC Measurements (Dettmer 2016b, p.16).....	37
Figure 1. 7: The Drum Buffer Rope (Pandit & Naik 2006).....	41
Figure 1. 8: Buffers (Chawla & Kant 2017)	44
Figure 1. 9: The Replenishment Solution	46
Figure 1. 10: Efrad’s cloud	56
Figure 1. 11: Transformational System (Dettmer 2016b, p.4).....	60
Figure 2. 1: Healthcare Transformational System (Chawla & Kant 2017, p.369)	77
Figure 3. 1: Research Onion (Saunders et al. 2009)	89
Figure 3. 2: Action Research Cycles (Saunders et al. 2009)	93
Figure 3. 3: Action Research and TOC.....	96
Figure 4. 1 : Linen flow - Functional Block Diagram (FBD).....	110
Figure 4. 2: Goal Tree	114
Figure 4. 3 : CRT part 1	119
Figure 4. 4 : CRT part 2	120
Figure 4. 5: Evaporating Cloud – On the Wall	124
Figure 4. 6 : Evaporating Cloud, Work Overtime vs DO not work Overtime.....	127
Figure 4. 7: Evaporating Cloud, throw away linen vs Do not throw away linen.....	130
Figure 4. 8: Future Reality Tree – On the Wall	133
Figure 4. 9: Future Reality Tree – Linen system	134
Figure 4. 10: Linen Resources Utilisation Profile	141
Figure 4. 11: Linen Replenishment BEFORE the Replenishment solution.....	152
Figure 4. 12: Linen Replenishment AFTER the Replenishment solution	157
Figure 4. 13: Technical Results - Linen.....	164
Figure 4. 14: Technical Results – Linen	165
Figure 5. 1: Patient Journey Flow (PJF)	179
Figure 5. 2: Goal Tree – Surgery Department	186
Figure 5. 3: Current Reality 1	190
Figure 5. 4: Current Reality 2	193
Figure 5. 5: Evaporating Cloud.....	200
Figure 5. 6: Idle Time Distribution of all ORs.....	206
Figure 5. 7: Future Reality Tree.....	208
Figure 5. 8: Patient Journey Flow (PJF)	210
Figure 5. 9: Patient Journey Flow Description	211
Figure 5. 10: Operating Room Process Flow (ORF)	216
Figure 5. 11: Operating Process Flow (ORF)	218
Figure 5. 12: Setting the Drum... ..	220

Figure 5. 13: Setting up the Buffer	221
Figure 5. 14: Setting up the rope.....	223
Figure 5. 15: Time from constraint to constraint after reduction of activities	225
Figure 5. 16: Time Distribution in OR6 AFTER the intervention – first week.....	229
Figure 5. 17: Time Distribution in OR6 AFTER the intervention – second week	230
Figure 5. 18: Technical Results – Operating Room.....	235
Figure 7. 1: The Five Focusing Steps – Output of this research work.....	293
Figure 7. 2: The Systems Engineering Process.....	296
Figure 7. 3: The Goal Tree and the Regions	297
Figure 7. 4: The System Engineering Process and the Goal Tree – a synthesis	298
Figure 7. 5: Managerial Template.....	321

List of Tables

Table 1. 1: Quality Management Gurus (Bahri et al. 2012)	12
Table 1. 2: CLRS	28
Table 1. 3: Change Questions	53
Table 1. 4: Change questions and Five Focusing Steps.....	54
Table 1. 5: Layers of Resistance	57
Table 2. 1: Chase Model (Chase 1978, p.3).....	68
Table 2. 2: Managerial distinction of services	69
Table 2. 3: The Service Process Matrix (Schmenner 1986, p.25)	70
Table 2. 4: Ackoff’s Categorisation (Ackoff 2001, p.344).....	71
Table 3. 1: Research Questions and TOC.....	94
Table 4. 1 : Structure of Chapter 4.....	104
Table 4. 2: Action Step 1 - UDEs for Current Reality.....	107
Table 4.3: Total daily linen need in kg circulating through the hospital	138
Table 4. 4: Summary of soft results	161
Table 5. 1: Chapter 5 layout.....	169
Table 5. 2: Current Reality Tree part 1	189
Table 5. 3: Weekly idle time of six ORs.....	202
Table 5. 4: Weekly morning idle time of six ORs	203
Table 5. 5: Weekly idle time between surgeries of six ORs.....	203
Table 5. 6: Weekly idle (set up) times of six ORs	204
Table 5. 7: Weekly afternoon idle time	204
Table 5. 8: Weekly utilisation % of the six ORs.....	205
Table 5. 9: Description of Patient Journey Flow (PJF).....	212
Table 5. 10: Patient Journey Flow Description.....	214
Table 5. 11: Operating Room Flow (ORF).....	217
Table 5. 12: Idle Time Distribution Profile in OR 6 (%).....	227
Table 5. 13: Idle Time Distribution Profile in OR 6 (Hours)	229
Table 5. 14: Soft Results	233
Table 7. 1: The Change Questions and the Layers of Resistance	284
Table 7. 2: The Change Questions and the Thinking Process Tools	285
Table 7. 3: The Change Sequence - Output of this research work	287
Table 7. 4: Logical thinking Process – Output of this research work.....	289

List of Acronyms and Abbreviations

5FS	Five Focusing Steps
BM	Buffer Management
CCR	Capacitive Constrained Resource
CLRs	Categories of Legitimate Reservations
CRT	Current Reality Tree
CSF	Critical Success Factor
DE	Desirable Effect
EC	Evaporating Cloud
ED	Emergency department
ERP	Enterprise Resource Planning
FBD	Functional Block Diagram
fCRT	focused Current Reality Tree
FRT	Future Reality Tree
ICU	Intensive Care Unit
NBR	Negative Branch Reservation
OE	Operating Expense
OR	Operating Room
ORF	Operating Room process Flow
PJF	Patient Journey Flow
SKU	Stock Keeping Unit
SoS	System of Systems
T	Throughput
TOC	Theory of Constraints
TP	Thinking Process
TQM	Total Quality Management
UDE	UnDesirable Effect

Introduction

Background

It is evident all over literature that healthcare faces operational challenges. Healthcare worldwide is experiencing issues like rising costs and poor quality. Without a true solution, physicians will face lower incomes, patients will pay more, and services will be restricted (Porter & Lee 2013). The healthcare sector faces increased demand and ineffective services (Godinho Filho et al. 2015; McDermott et al. 2017). The global spending on healthcare increases but service improvement is not necessarily better (Musa & Othman 2016).

Healthcare organizations are in a constant effort of streamlining and optimizing their operations by using different management principles such as lean (D'Andreamatteo et al. 2014; Waring & Bishop 2010; Spagnol et al. 2013), six-sigma (Kaplan et al. 2012; Mason et al. 2015), TQM (Nwabueze 2011) and others. None has dominated though (Howe 2013). (Ronen & Pass 2008) discuss that lean, TQM and Six Sigma aim to improve the whole system; therefore implementations and benefits are slow and difficult to maintain.

During the last decades though an improvement methodology emerged with surprising results especially in the manufacturing and project environments, (Mabin & Balderstone 2003) which is called Theory of Constraints (TOC).

Ronen highlights that academic literature in TOC is minimal and that the academic TOC community is relatively small (Cox III & Schleier 2010, p.847). TOC in the healthcare environment is a relatively new research area. Research in healthcare operations like TOC in Surgery Departments and TOC in healthcare logistics are under-researched. We were able to locate only 37 articles in various journals discussing implementations and insights of TOC in healthcare, only three articles were found to discuss TOC in the surgery function, none discussing DBR in surgery and none discussing TOC in hospital linen management.

This research study seeks to explore the effectiveness of TOC in a healthcare environment. The research topic is important because there are various healthcare subsystem challenges. Surgery is one of the most expensive healthcare systems and one

of the highest volume treating functions. Operating rooms are facing high operating costs (Jebali & Diabat 2017; May et al. 2011; Wasterlain et al. 2015) scheduling and planning is challenging (de SOUZA et al. 2016; May et al. 2011) and waiting times are long (Grida & Zeid 2018; Sahraoui & Elarref 2014).

Healthcare logistics, on the other hand, has been identified as one of the key cost drivers (Rais et al. 2018; Volland et al. 2017). This research focused on a specific logistics issue involving the improvement of the linen management system. Availability of linen is essential and often critical for proper functioning and care delivery.

Purpose Statement and Research Objective

Cyprus is about to change the healthcare delivery system in the following years (Samoutis & Paschalides 2011), significant changes have been announced, and they will take place in 2019. At the same time, the private healthcare sector in Cyprus is enormous compared to the population (Andreou et al. 2010). Since there is a need to improve the operational effectiveness of a hospital and TOC is an effective improvement methodology in the operations management context, the study will examine “change” in a hospital setting through the TOC philosophy and toolbox embraced by the operations management context. There is a great interest to explore the degree of TOC effectiveness in services and specifically in the healthcare context. It would be very beneficial if the fast results of TOC observed so far, are also introduced into the healthcare sector.

Therefore, the main purpose statement of this Thesis is: To build new knowledge and make a new contribution to the management science through the application of TOC – as an operations improvement methodology in the private healthcare segment.

Accordingly, the main research objective is to explore the degree of effectiveness of the Theory of Constraints methodology in the operational environment of a private general-purpose clinic/hospital in Cyprus.

Below research questions guide the fulfillment of the research purpose and objective.

Main Research Question

“Can the application of the Theory of Constraints lead to operational improvements in the healthcare sector, at a private general-purpose clinic/hospital in Cyprus?”

Having the general Focus Question as a starting point – the following sub research questions are formulated – in order to focus the research and future actions.

Sub-Research questions

1. What are the constraints limiting the potential of the existing operational environment of the clinic?
2. What is the desired solution which will elevate the performance of the constraints, if implemented at the “selected system”?
3. What are the main difficulties identified during the implementation of the proposed solution to the existing functionality of the system?
4. How can these difficulties be overcome?
5. Has the performance improved, of the system selected, after the implementation of the TOC?
6. What were the special challenges that the employees at the private clinic were facing regarding the adaptation of TOC?
7. Were there any unanticipated outcomes and how important were they? (Positive or negative?)

The Method

To answer the Research Questions, we implemented TOC in the largest private hospital in Cyprus with a 152-bed capacity and 12 Operating Rooms. Following (Chase 1978) system categorization, two subsystems were selected both in the healthcare context. The surgery department (TOC was practiced to one Operating Room) and the linen management system. Two real, very different working environments, with real people, facing real problems.

The research followed the action research strategy as per (Saunders et al. 2009) which makes a perfectly natural fit with the TOC methodology. The theoretical framework embraced the research environment is the Theory of Constraints in an Operations and Systems conceptual framework (Berry & Belle 2005). The guidelines followed were

based on the work of (Dettmer 2016b). Dettmer himself trained the researcher in June 2016 in Paris.

The data collection methodology comprised of both qualitative and quantitative methods. The main approach though was qualitative. For primary data collection – Observation, Interviews (Semi-structured and unstructured) and field data collection were used. The data collected was analyzed by the TOC tools as described in the literature.

Results

After the implementation of the TOC, the utilization figure of the linen management system was improved instantly by 15% (from 72% to 87%) and the reduction in operating expenses was more than €40.000.

Excellent results were also measured after the implementation of TOC in one Operating Room. The practice of the Drum Buffer Rope (DBR) managed to create 10 hours of available time per week which can be used to add more surgeries, promising to increase the Throughput of that single operating room by more than 30%. The hospital has 12 operating rooms where DBR can be implemented.

In order to produce the above results, TOC methodology was changed and adjusted accordingly to the specific need of the action progress step. Modifications and changes took place to different TOC components, such as the Thinking Process Tools, Five Focusing Steps, DBR, and the Replenishment solution. The changes were made to adjust not only the technical part of the methodology but also the level of the TOC acceptance of the people.

Conclusions

The research findings show that TOC can be applied successfully in a healthcare environment. The research outcome confirms current literature which supports that TOC can be applied to services and more specifically to healthcare.

The thesis has demonstrated that based on the Theory of Constraints conceptual framework, improvement can be realized fast and in different healthcare environments.

Thesis outline

This research work took place in the biggest private hospital in Cyprus. The duration of the study was four years starting from fall 2014. Appendix 1 shows the different phases of the research through these four years.

The thesis consists of eight chapters plus the introduction.

Introduction Introduces the problem to be solved; it gives a skeleton of the research, it states the purpose and the objective of the research and the research questions briefly.

Chapter one comprises the TOC theoretical framework. It discusses the roots of the TOC, the TOC philosophy and its components, discusses some TOC generic solutions and concludes by giving the relationship of TOC with other theoretical frameworks such as Operations Management, Systems management and Change management.

Chapter two builds up a framework of systems categorization. It then places the subsystems selected into these categories. It studies the relationship of TOC with the healthcare context and identifies the gap in the existing literature. Based on this research gap, it frames the research purpose, objective and finally the research questions.

Chapter three describes the research methodology which is used to answer the research questions. It also provides a common framework where TOC and action research principles are blended to collect and analyze data.

Chapter four implements the TOC methodology at the linen management system of the hospital and focuses on the influence of TOC on people and the research field. Results are presented as the action unfolds.

Chapter five uses the same approach with chapter four exploring the effectiveness of TOC in the surgery department. By answering the change questions, the TOC implementation seeks to improve the research field using TOC methods and concepts.

Chapter six discusses and explains the results and findings from chapter four and five. Using literature as a benchmark, the results are interpreted generating understanding and knowledge.

Chapter seven synthesizes the findings from chapter four and five and based on the discussion of chapter six, suggests theoretical developments on the TOC in order to adapt it into the healthcare environment. Additionally, the chapter deepens into literature and expands the theoretical framework of the Goal Tree and Future Reality trees. Then all the output of the research is synthesized to a managerial template which provides a set of guidelines and a roadmap for professional to improve a system using the TOC methodology.

Chapter eight concludes all the research work by identifying the main findings and the main contribution of the thesis. It also shows possible future research pathways to researchers.

Chapter 1

Theory of Constraints (TOC) - the theory

1.1 Introduction to the Chapter

Theories guide human behavior (Kouzes & Mico 1979). People manage the prediction of future consequences and control of future conditions through the development of theories.

This chapter aims to set the theoretical foundations of the research. The objective of the chapter is to specify the theoretical framework onto which the research is based on. This demands an understanding of the very core of the theory, the way it has emerged, the different elements and the different components which constitute the theory under discussion. The main theoretical approach followed in this thesis is the Theory of Constraints (TOC).

Five main sub-sections constitute the skeleton of this chapter.

The first sub-section explains briefly the evolution of the improvement process since TOC has its foundations from the times of Henry Ford.

The second sub-section discusses the Theory of Constraint's philosophy and key principles. It analyses the mindset and the assumptions which guide and shape the theory.

The third sub-section discusses the main components and tools. These tools are implemented throughout the study and based on these tools progress and findings are developed and evaluated.

The fourth sub-section discusses the generic solutions of the Theory of Constraints which are used to address specific needs in different environments. The ones that are used in the study are discussed in detail (DBR and Replenishment) whereas the others are discussed briefly since they highlight different aspects of the theory and they are used for reasons of comparison.

TOC synergizes with other theoretical frameworks in this Thesis, and this is the subject of the fifth sub-section which discusses the relationship of TOC with the Change, Operations and Systems Management domains of knowledge.

1.2 An evolution - Standing on the shoulders of Giants.

It is in the nature of human beings to improve their surroundings and make an environment that it is safer and more effective for human activity. It is a basic need for humans to strive for the best, become stronger and better in order to survive. Social comparison theory states that there is a deep rooted drive for humans trying to be better than others (Garcia et al. 2013).

The continuous improvement concept is dated back in the US in 1800 (Schroeder & Robinson 1991) as cited by (Singh & Singh 2012). Attention was directed to scientific management principles and to special methods which were used by managers to analyze performance, based on time and production unit measurements, setting accordingly standards for the workforce (Singh & Singh 2012).

Adam Smith was from the first (in 1776) who related productivity with the division of labor, which in turn led to specialization (Lillrank et al. 2011), (Roy 2004, p.6). Specialization focused on specific tasks, so management of tasks become the focus of improvement. Time-motion studies were developed to shorten the duration of the tasks. Frederick Taylor's Scientific management (in the 1990s) was devoted to completing tasks in a shorter time (Lillrank et al. 2011).

Deming and Juran shifted from the task level to the process level. The process concept is the cornerstone of Total Quality Management. A process is merely a group of tasks executed in order to achieve an objective (Lillrank et al. 2011).

Continuous improvement process (CIP) is a sequence of steps which seek to identify a problem, design and apply a solution, review and take corrective actions (Cox III & Schleier 2010, p.404). Different methodologies have different philosophies applying the sequence of the steps. Some of the best known are, TPS, Lean, Six Sigma, TQM, BPR and Theory of constraints.

The first way of making things is to focus on task level, and it is called Craft Production (Sikkandarbasha 2014).

Craft Production

One of the oldest ways that humans have invented creating things is craft production. In this type of production – humans used to take raw materials such as wood, stones, metals, etc and they were transforming them in goods that other humans wanted (Costin 2015). In this context, highly skilled workers were needed to build goods using specialized tools — the process required that the manufacturing process was proceeding with one product at a time. When the one product was completed then work would continue to the second and so on. This had the advantage that products could be made according to the specific customer’s wishes and standards. Every product could be different.

Back in 1894, craftsmen had the specialty to work the raw materials and since the concept of standardization was not existent – parts were not the same, quality was mainly based on the skills of craftsmen to fit the different parts together.

Craft production was ideal for low volume and a wide variety of products. The main disadvantage was that the quality of the product depended on the skills of the craft man (McLeod 2009). The craftsman had a very wide span of control, and he was responsible for purchasing raw materials – transforming them and inspecting them (Krafcik 1988).

These limitations allowed people like Ford to elevate improvement standards to a new era – to that of mass production.

Mass Production

Henry Ford placed next cornerstone in the operations improvement journey. He was a revolutionary mind and the creator of a whole manufacturing age and era. He laid the

foundations of today's operational world. He shifted the auto manufacturing industry to a new level, and he influenced the whole industrial economy (Krafcik 1988).

At the same time, Frederick Taylor coined the term scientific management at the beginning of the 20th century. Henry Ford used Taylor's theories to the Ford Company, and he developed the moving assembly line concept. His primary objective was to keep everything flowing. The shift from the craft era to the mass production era was a significant change. He designed that the employees would remain idle where the work items would move to them. His success was enormous. A concept that worked well but it was designed for high volume and very low flexibility. People could buy any car they wished as long as it was black.

Ford's system was called mass production (Womack et al. 1991), and he developed the concept to all his factories (Bhuiyan & Baghel 2005). Efficiency became a religion. He visualized a flow through his production lines. He focused then on shortening the length of that flow and aimed to make them run faster and more smoothly (Fox & Pirasteh 2011).

The revolutionary idea behind the concept of mass production was the interchangeability of the parts. Without this, the mass production would not be possible (Womack et al. 1991).

In contrast to craft production – the more cars that were produced, the less the cost. This allowed Ford to reduce the price and gain a huge competitive advantage (Womack et al. 1991).

To keep the lines running and the parts flowing, Ford focused on eliminating rework, defects, absenteeism and gave a special emphasis on maintenance in order to avoid idle time because of breakdowns (Fox & Pirasteh 2011). He also tried to avoid idle times because of machinery changeovers. He kept standard designs and shapes on the resources to keep costs low. He was producing only one car Model T – in one color with no variations (Womack et al. 1991).

Ford's mass-production concept was founded on the concept that the most efficient way to produce a vehicle is to minimize the time that elapses between the beginning and completing production. Ford accomplished this through huge volume, standardized products and through very high levels of vertical integration (Krafcik 1988).

Toyota Production System (TPS) and Lean

Lean manufacturing can be best described as a combination of the best techniques of mass and craft production (McLeod 2009; Joosten et al. 2009).

Ohno recognized the importance of variation and the benefits of zero inventories (Stratton et al. 2008). Ohno and Shingo focused on leveling demand and reducing variation. Ohno added on Ford's moving assembly line and created the Toyota Production System (TPS) which it was a change on the assembly moving line and made it suitable for low volume assembly lines (Stratton et al. 2008). In 1990 Womack coined the term "Lean" in his book – “The machine that changed the world” (Womack et al. 1991). TPS become the DNA of Lean (Pacheco et al. 2014; LIKER 2004, p.7).

Lean is derived from the TPS. Lean philosophy focuses on improving flow. Following the Toyota's way 4 P model it focuses on Philosophy (long term thinking), Process (eliminate waste and increase flow), People and Partners (focus and respect people) and Problem Solving (to foster continues improvement) (LIKER 2004, p.6).

Lean is a systematic method of reducing waste across the whole chain of activities in a manufacturing environment. Lean starts designing a solution by first identifying and establishing the “value” perceived by the customer. It focuses on the activities which add value and eliminate all the other.

There are four rules identified by (Spear & Bowen 1999) which characterize the DNA of the Toyota Production System and in extend the Lean philosophy.

1. Sequence, timing, and outcome must be precisely specified for every activity.
2. There must be direct communication between links in the chain and requests should be of a “yes” or “no” nature.
3. Every product or service should be of a simple and direct flow.
4. Improvements should follow the scientific method at the lowest possible level in the organization and always with the presence of an instructor.

Total Quality Management (TQM).

TQM is a methodology which focuses on providing quality of a product or of a process at minimum cost (Isaksson 2006). It aims to improve quality by eliminating or reducing

variation to the minimum. It is a set of approaches that constituted a management philosophy which is called Total Quality Management (TQM) (Jackson 2001).

TQM was widely recognized during the '80s and '90s when American companies recognized TQM value which was spread in Japan (Powell 1995). TQM was supported by quality gurus such as Jyran, Crosby and W. Edwards Deming (Powell 1995). The whole idea of TQM exists in the word "Total." It implies the involvement of the whole organization and it is strongly depended on teamwork (Brennan 2010, p.62).

There is a strong relationship between TQM approach and the ISO 9000 system (Roy 2004, p.248). ISO 9000 procedures and guidelines enhance the implementation of TQM. Later TQM movement was replaced by Six Sigma during '80s (Brennan 2010, p.63)

Below table shows how different pioneers contributed to the quality management development through the years (Bahri et al. 2012)

Table 1. 1: Quality Management Gurus (Bahri et al. 2012)

Pioneer	Year	Quality Management
Ellias Whitney	1900	Traditional Approach → Product Inspection
F.W. Taylor	1900	Management Science
Walter Shewhart	1924	Control Chart → Product Inspection
W.E. Deming	1950	14 Principles in Quality / PDCA (Plan, Do, Check, Action).
AV. Feigenbaun	1961	Concept: Make it right at the first time (One of basic TQM).
Koaru Ishikawa	1967	Statistical Approach in Quality Control, Ishikawa Diagram (Fishbone Diagram).
Yoji Akao	1972	QFD (Quality Function Deployment).
Philip B. Crosby	1979	Top Management in Quality.
Shiego Shigo	1979	Product Quality Control → Total Quality Control.
Genichi Taguchi	1980	Kaizen (Continuous Improvement), Robust Design, Taguchi Method.
Garvin	1987	8 Dimensions of Product Quality.
Joseph M. Juran	1988	SPC (Statistical Process Control), Quality Planning, Quality Control, Quality Improvement.
Zeithaml & Parasuraman	1988	10 Dimensions of Service Quality.

From the above table, it can be seen the different approaches of different quality gurus.

Six Sigma

In 1930s Walter Shewhar was doing statistical work on the concept of “quality” developing SPC techniques (Boaden et al. 2008; Shewhart 1931). The Six Sigma approach was later developed at the Motorola in the 1970s and it was initially designed for manufacturing environments (Boaden et al. 2008). Then, Bill Smith registered the term "Six Sigma" in 1986 (Boaden et al. 2008, p.61).

Six Sigma is a management system which seeks to manage variation by restricting it to 3,4 defects per million. Sigma represents the Statistical Standard deviation from the mean in a normal distribution (Young et al. 2004). It is a scientific method which demands good data, statistical procedures and clearly defined specifications.

The Six Sigma methodology consists of five phases (DMAIC):

Define the system in terms of requirements and terms of the voice of the customer.

Measure. Diagnose the system’s current state. Map the as-is situation and create a benchmark.

Analyze. Create cause and effect relationships by analyzing data.

Improve. Improve a problematic situation. Apply dedicated tools such as Design Of Experiments, Poka Yoke etc.

Control. Apply control mechanism and observe a deviation from a targeted outcome.

Common Characteristics

Reviewing the above improvement methodologies, it can be observed that people tried to improve their systems by managing flow (mainly TPS and lean philosophy) and Variation (mainly Six Sigma and TQM), the two variables of success (Boaden et al. 2008). Two monumental works, (Shewhart 1931) and later (Deming 1982) talked about the negative effects of variation and uncertainty.

Theory Of Constraints (TOC)

TOC is a continuation of the improvement evolution. TOC is a system's methodology and it focuses on systems constraints (Mabin & Davies 2003). It manages flow and variation, as the previous improvement methodologies but differently and uniquely. TOC recognizes that the performance of any given system is being governed by a very

limited number of constraints (Kosieradzka et al. 2011). TOC manages the flow through constraint management and variation through Buffer Management.

There are strong synergies between TOC and the rest of the continuous improvement methodologies. (Young et al. 2004; Pirasteh & Kannappan 2013; Hudson 2017), discuss how TOC can co-exist with Lean and Six Sigma, (Sikkandarbash 2014) analyses the blend of TOC and Lean principles in order to advance productivity in different settings. (Pirasteh & Farah 2006; Fox & Pirasteh 2011) discuss how TOC can be synthesized together with Lean and Six Sigma and form the TLS - a concept that professionals today apply in the market place.

TOC has been applied to a number of companies such as 3M, Amazon, Boeing, General Electric etc (Watson et al. 2007). Incredible results have been reported (Mabin & Balderstone 2003)

TOC is made known through a number of books which were written by Dr. Eliyahu Goldratt, the inventor of TOC. We study briefly the evolution of TOC through five eras which have marked specific innovations of the TOC. Every TOC era is marked by a relevant book. Below description of TOC eras are based on the work of (Watson et al. 2007).

The Optimized Production Technology Era (1979 – 1984)

It all started with OPT (Fry et al. 1992). Goldratt used the flow and variation concepts and in late 70s he invented the Optimized Production Technology (OPT) (Balakrishnan et al. 2008). A software for production scheduling. There were more than 60 installations reported at the beginning of the 90s. (Cox III & Schleier 2010, p.148) states that the first version of OPT was automated Kanban emphasizing the connection with the previous improvement evolutions and especially with Lean. OPT was not a success as the users had little understanding of it (Balakrishnan et al. 2008).

The Goal Era (1984 – 1990)

In order to communicate his thinking to the users of OPT, Goldratt published the Goal in 1984, (ELIYAHU M. Goldratt 1988). The term "The theory of constraints" is an effect of the success of the Goal and it was introduced in 1984. This success of the first version of the book motivated Goldratt to conceptualize a whole theory of how to manage a company.

Goldratt extended the development of the theory to three directions (ELIYAHU M. Goldratt 1988) 1. developed training to teach people how to implement TOC even if the rest of the organization works the conventional way 2. He developed the five focusing steps 3. developed the DBR - an approach which manages flow by managing the system's constraint and manages variation by buffer management principles.

The Haystack Syndrome Era (1990 – 1994)

Goldratt realized that the number one enemy of TOC was the traditional cost accounting with its local measures, the goal of any for-profit company is to make more money now and in the future. In order to measure this goal, Goldratt used three performance measures Throughput, Inventory and Operating Expense (Eliyahu M. Goldratt 1990). By giving to Throughput the highest priority a whole new paradigm was born. Throughput approach demanded a holistic and systemic view of an operation instead of looking local efficiencies. Improving flow become the most important target. Inventory was needed to protect the Throughput and Operating Expense was all the expenses needed to transform Inventory into Throughput. The rest of the methodologies were still engaged in cost thinking.

The It's Not Luck Era (1994 – 1997)

Goldratt also realized that many systems were more complex than others. Constraints instead of being physical resources were in many cases, procedures, policies and people who have emotions, attitudes, and certain behaviors. He developed a suit of 5 logical Thinking process tools (discussed in more detail section 1.4.2) which help to analyze a problematic situation, identify a core problem, design a solution and an implementation plan in order to apply the solution.

The Critical Chain Era (1997 – 2004)

Goldratt designed a solution with the TOC concepts, and he applied them to a project environment. He called the solution Critical Chain Project Management (CCPM). He used Buffer Management logic to protect and manage the whole project instead of specific tasks. CCPM is the largest TOC field practiced today.

Theory Of Constraints International Standard Organization (TOCICO)

TOCICO is a TOC community sharing information, knowledge, experience through a non- profit organization called Theory Of Constraints International Organisation (TOCICO). TOCICO is the main networking mechanism of TOC practitioners. It also provides members with certifications (thorough exams) in order to make sure that a certain level of competence is maintained. Every year there is an international meeting in different places around the world sharing experiences. Knowledge is shared through webinars, white papers, and conferences. The TOCICO is a constant source of knowledge and it has published the TOCICO Dictionary (Cox III et al. 2012).

Up to today, no Greek or Cypriot is a member of TOCICO except the researcher, who also contributed as a speaker in the international TOCICO conference in Germany in 2013.

1.3 TOC Philosophy and Key principles

TOC is a system's improvement methodology (Gardiner et al. 1994) which ignites the improvement process by identifying a problem, synthesize solutions for that problem and then guides implementation of that solution through a structured methodology (Mabin & Balderstone 2003). The methodology of TOC arms managers with tools and methods to find solutions themselves (Ronen 2005). Compared to the other methodologies it is a new philosophy, but it is evolving constantly (Reid 2007). TOC takes a systemic view and observes the behavior of the whole system instead of single processes.

TOC aims to increase flow through a system by utilizing the constraints at the maximum. It seeks first to eliminate any waste of time on those constraints (Tagaduan 2009) and at the same time make sure that the constraint is using its utilization for the right product. This standpoint is entirely different from the philosophy of other improvement methodologies like Lean, Six Sigma, TQM and others which seek to eliminate waste or eliminate variation or increase market share, etc etc. everywhere in the system (Kaye & Anderson 1999; Nave 2002).

Constraints

Archimedes once said, “Give me a lever long enough and a place to stand and I will move the earth” (Dettmer 2001). In the TOC world, this is translated, to system parts. A change in one part of a system can affect the performance of the whole system (Cox III et al. 2012, p.7). This is contrasted to the concept of the constraint (Dettmer 2003, p.107)

At the core, TOC is all about managing constraints (Tabish & Syed 2015). The constraint concept is demonstrated through the chain metaphor in TOC literature (Gardiner et al. 1994). One of the key principles of TOC is that it views systems and subsystems in the form of a chain (Motwani et al. 1996b; Gulsun et al. 2009). The chain is composed of links and the total strength of the whole chain is determined by the weakest link (not the strongest). Since a system is characterized by interdependencies - improvement is compared to the strength of the chain instead of the weight of the individual links (Gardiner et al. 1994). Since TOC is focused on increasing flow through the constraint then the chain takes the form of a chain of activities. In practice there is never a single chain but a blended grid of chains (Eliyahu M. Goldratt 1990, p.53). A chain is as strong as the weakest link. At any given moment there is only one weakest link. If the chain is to be improved, then efforts should focus on the weakest link (Eliyahu M. Goldratt 1990, p.53). Goldratt calls this weakest link - CONSTRAINT.

The mindset that guides TOC is that constraints govern all systems otherwise they would have an unlimited performance. A constraint can be a bottleneck, a machine, a person, a policy or a paradigm (Brennan 2010, p.108). The concept of the constraint is central to TOC philosophy (Ronen & Spector 1992). TOC, in contrast to other improvement methodologies, views the constraints positively and considers them leverage points (Davies et al. 2004) than something that is to be eliminated and abandoned (Pandit & Naik 2006). Managing the TOC way is managing a system around its constraints. TOC does not require costly changes just a specific way of scheduling on the constraints (Pandit & Naik 2006). The main assumption is that organizations are governed by a few constraints and improving them brings radical system improvement (Kosieradzka et al. 2011).

TOC uses three major measures. Throughput (T), Inventory or Investment (I) and Operating Expense (OE). The biggest challenge of TOC is that it gives to the measurement of Throughput the highest priority (Eliyahu M. Goldratt 1990). Throughput demands thinking in term of flow, thinking cross-functional and thinking of growth instead of downsizing and cutting costs.

TOC lays on the assumption that a system exists in order to produce more of the purpose that it is designed for; thus it recognizes Throughput as the measurement with the highest priority. The target is to optimize the flow through a system by synchronizing the logistical activities of all the links involved in the flow (Tagaduan 2009). When the flow is not money then Throughput can be represented in goal units (Breen et al. 2002) – then the goal of the system becomes to produce as many goal units as possible.

There are two fundamental assumptions of TOC. One is that all systems performance is limited by one constraint at any given moment and two that the existence of the constraint allows for focused system improvement (Peltokorpi et al. 2016).

One hour lost on the constraint is one hour lost of the entire system and it cannot be recovered (Tagaduan 2009), by unblocking the capacity of that constraint system's productivity is raised to a new level.

The idea is that all resources must be synchronized around the constraint. Resources that have excess capacity allow only the flow required by the constraint to be processed through them (Tagaduan 2009). This results in low utilization on resources with excess capacity. This comes in contrast with the traditional thinking which aims to have occupied all resources including people of-course.

The theoretical foundations of the Theory of Constraints lay in the systems management and operations management contexts (Naor et al. 2013). Systems thinking and a functional perspective to operations is a necessary requirement for successful implementation (Gupta & Boyd 2008).

1.4 TOC Components

(Spencer 1995) clarifies that TOC philosophy is composed of three different concepts 1. Logistic concepts, 2. Problem-solving concepts and 3. measurements (Spencer 1995). TOC components emanate from the above three concepts – The Five Focusing Steps for logistical issues, The Thinking Process Tools for problem-solving process and finally measurements which guide behaviors.

1.4.1 The Five Focusing Steps (5FS)

For a system to be improved the TOC way, its constraint has to be managed. The set of the steps that TOC uses to manage the flow by managing the constraints is called the Five Focusing Steps (5FS) (Berry & Belle 2005). Goldratt invented them in 1986 (Ronen & Starr 1990), and they were introduced by (Eliyahu M Goldratt 1990) and (Goldratt & Cox 1984). Up to that time, TOC was synonymous with the Five Focusing Steps since the Thinking process tools were not invented yet (Eliyahu M. Goldratt 1988). Officially, the 5FS were communicated through the revision of the book (Goldratt & Cox 1992).

As discussed, The Theory of Constraints originated from the OPT. The software that Goldratt developed to schedule a production line. The whole philosophy of that software was based on nine rules that he called the nine OPT rules (Pacheco et al. 2014).

Although the OPT rules were replaced by the 5FS (Balakrishnan et al. 2008), we strongly support that they are still valid as a philosophy and we believe that whole TOC philosophy is originating from them. This underpinning philosophy is the foundations of the success of OPT (Eliyahu M. Goldratt 1988; Watson et al. 2007; Lockamy & Spencer 1998).

The OPT software was based on the OPT rules, since then the methodology has evolved to the Theory Of Constraints (Aguilar-Escobar et al. 2015). The heart of the logistics paradigm has evolved from the nine OPT rules (Pandit & Naik 2006).

This philosophy is expressed by nine OPT rules which are:

1. Balance flow, not capacity. This forces the system's analysts to think systemically. The concept of flow reveals constraints and coordination of the different resources than looking for the capacity of the resources in isolation.

2. Level of utilization of a non-bottleneck is determined not by its own potential but by some other constraint in the system. This is the core of TOC. The flow through a system is restricted through a constraint. The same flow runs through non-constraints which by definition have excess capacity. The flow that goes through them depends on the capacity of the constraint, therefore, their utilization depends on the constraint.

3. Utilization and activation of a resource are not synonymous. This emanates from the previous rule. Utilizing a constraint means allowing only the dictated by the constraint flow to go through it.

4. An hour lost at a bottleneck is an hour lost for the total system. Since the constraint determines the total delivery of the system, one hour lost on the constraint cannot be recovered (Tagaduan 2009). If on the other hand an hour is saved on the non - bottleneck, then there is no benefit. Non - constraints should have idle time by definition. This is the root for below rule.

5. An hour saved at a non-bottleneck is just a mirage.

6. Bottlenecks govern both throughput and inventory in the system. Since the constraint restricts flow then inventory is being accumulated just before the constraint. The constraint is the spigot which adjusts the flow through the whole system.

7. A transfer batch may not, and many times should not be equal to the process batch. The transfer batch is the material flow from resource to resource. Process batch is the total material processed by a resource (it is the sum of the transfer batches). It pays emphasis to the fact that some of the process batches can be moved to the next resource (and become transfer batch) before the whole process batch has gone through the earlier resource.

8. The process batch should be variable, not fixed. This is the route of flexibility.

9. Schedules should be established by looking at all of the constraints simultaneously.

The 5FS have now replaced the above nine OPT rules, therefore the 5FS are considered to be the result of the distillation of the OPT rules (Balakrishnan et al. 2008). The 5FS

are now widely accepted by the TOC literature in order to bring change in systems especially in cases where flow is easy to be conceptualized and the big part of the process is done through machines and physical resources.

The main target of the 5FS is to identify the constraint and then reorganize the whole system around that constraint (Tulasi & Rao 2012). Since TOC was designed mainly for manufacturing systems the 5FS are designed to locate physical or resource constraints.

Literature is rich discussing the 5FS, and they are mentioned in almost every article that discusses TOC. Articles like (Tabish & Syed 2015; Eliyahu M Goldratt 1990; Mabin et al. 2001; Mabin 1999; Goldratt & Cox 1984; Lepore & Cohen 1999; Vargas et al. 2017; Eliyahu M. Goldratt 1990) just to name a few.

Although that the main body of literature discusses the 5FS - there are articles which discuss seven focusing steps where others mention the two additional steps as prerequisite steps to 5FS (Davies et al. 2005; Watson et al. 2007). The two prerequisite steps (or the additional two steps) are 1. To identify the goal of the system and 2. Define the measurements that measure that goal. The vast majority of TOC literature though discusses Five Focusing Steps.

(Burton-Houle 2001) mentions that solid results using the 5FS come from 1. Understanding the interdependencies between system elements 2. Understanding the impact that variability in these interdependencies has on the whole system 3. Buffering this variability of interdependencies.

The Process Of On-Going Improvement (POOGI) is an outcome of the 5FS and it is actually how the 5FS are implemented. The 5FS are following below sequence in figure 1.1:

Figure 1. 1: The Five Focusing Steps

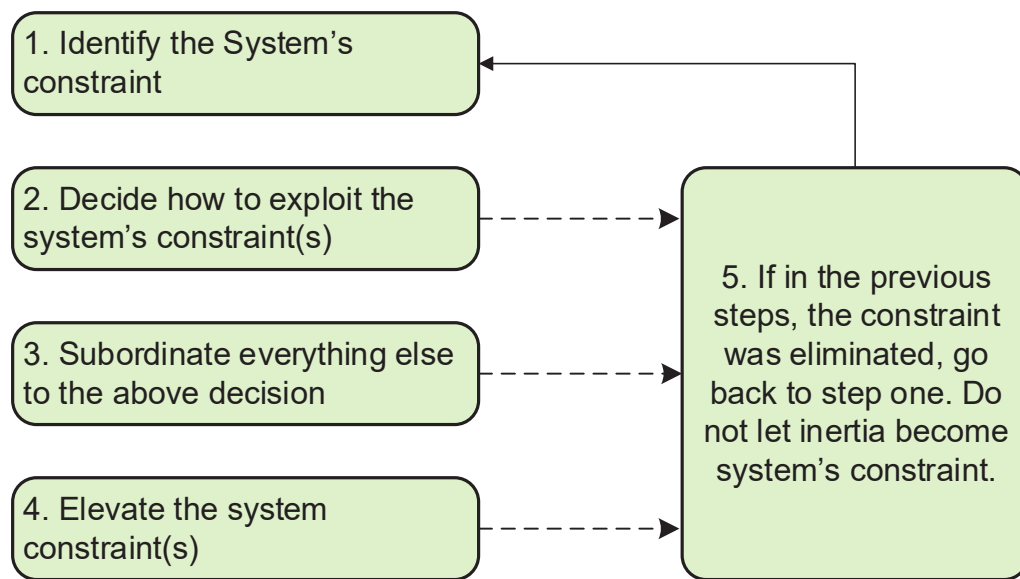

The first step is to **identify the constraint**. Important is, that the constraint must be defined at the system level (Pirasteh & Farah 2006). Goldratt defines as a constraint "anything that limits a system from achieving higher performance versus its goal" (Eliyahu M Goldratt 1990). The nature of the constraint can be a policy or a physical constraint (Mabin et al. 2001). It can be an internal constraint (a resource or a process) or an external constraint (market demand) 93. This approach is unique among the improvement methodologies because the factors that restrict the system are to be identified and not the factors which will help the system to achieve more (Ronen et al. 2012). The assumption though is that every system has one constraint. If there are more than one constraints then they should be prioritized (Eliyahu M Goldratt 1990; Eliyahu M. Goldratt 1990, p.59). Identifying the constraint presumes a good knowledge of the system (Vargas et al. 2017). The constraint can be identified usually by the pile of inventory accumulate before it; other methodologies are: brainstorming, 5 whys, Failure Mode and Effect Analysis, Pareto load analysis etc (Tabish & Syed 2015). It is recommended to work with tools from other methodologies in order to be successful. There can be basically four types of constraints in a system (Ronen et al. 2012).

1. Resource Constraint. This type of resources refers mainly to physical resources that they cannot satisfy the demand placed on them. It can be the number of beds in a clinic, a filling machine in a production line or the number of nurses at the Emergency Unit. Some characteristics of these type of constraints can be seasonality or that a resource is becoming a constraint at pick times.

2. Market Constraint. In this case, the system can produce more from the demand placed on it. Usually, this case refers to an external constraint.

3. Policy Constraint. This type of constraint is because of sub optimization. Local decisions which are against the higher system's goal usually comes in the form of policies (Ronen et al. 2012).

4. Dummy constraint. This is a situation where there is a shortage of a very cheap resource. This is usually the result of a lack of knowledge about the importance of constraints.

Constraints block flow and restrict capacities not only in manufacturing but in services as well. For example, capacity management is a big issue for surgery departments (Gupta & Boyd 2008).

Identifying the constraint is identifying the leverage point, the one point in the system which when it will be managed then flow will accelerate through the whole system. We could ask the question "if we had more of that constraint, would the whole system produce more?" if the answer is yes then the identified system element is indeed the system's constraint.

The second step is **Exploiting the constraint** which means to take the most out of the constraint and surface any hidden capacity (Vargas et al. 2017). The target is to make the constraint produce as more as possible (Gupta & Boyd 2008). This step focuses on the constraint and aims to develop strategies and tactics in order to increase its efficiency. The goal is mostly to remove obstacles which restrict flow and eliminate idle times (Mabin et al. 2001; Eliyahu M Goldratt 1990). Constraints which are machines and processes should always be running, under the attention of the best people, securing constant operation since not even a single minute should be wasted on this resource (Davies et al. 2005).

In this step, the aim is to produce more with the existing resource (Ronen et al. 2012, p.75). There are two ways of exploiting a constraint. The first way is maximizing its utilization and the second is to maximize its effectiveness.

Maximizing utilization means mainly reducing the idle times of the constraint and shortening the duration of the processes where possible. The target is to keep the constraint active 100% of the time and remove limitations which impede the flow

(Mabin et al. 2001) and non-productive time (Mabin 1999). Set up times receive an extreme focus at the constraint (Mabin & Davies 2003). SMED techniques coming from Lean have been applied with excellent results (Kosieradzka et al. 2011).

When it is secured that the constraint is working at its maximum, then all non-constraint resources must be scheduled in a way that they constantly feed the constraint (Vargas et al. 2017) ensuring the effectiveness of the constraint. This leads to the third step, the **subordination step**. This step should support the decisions made in step 2 (Cox III & Schleier 2010, p.184). Non-constraints have excess capacity (by definition) but they should be synchronized with the flow which is dictated by the constraint (Mabin et al. 2001). If they produce more then WIP will be built into the system in the expense of its flexibility. This means that they should operate lower than their capacity. This comes against the traditional logic which supports that all resources should operate at their maximum. Local optima should be abolished in the subordination phase. The subordination phase makes sure that the "right" products will reach the constraint and the ones which will generate cash in the near term (Watson et al. 2007). This step is considered to be the most difficult because people need to feel comfortable that it is acceptable not to work at 100% utilization.

Maximizing effectiveness is to minimize an ineffective time (Ronen et al. 2012, p.77) where the constraint may be active or inactive and do not contribute to the success of the system. This is where buffering takes place (Cox III & Schleier 2010, p.184) and warning signals into the system in order to protect the follow up of the schedule (Watson et al. 2007). Buffers make sure that the constraint does not stay idle.

The first three steps assume that the system works with maximum utilization and maximum effectiveness. If the constraint still remains a constraint, then the next step is to "buy" more of it (Mabin et al. 2001). This is the **elevate the constraint** step. Elevate means "lift the restriction" (Eliyahu M. Goldratt 1990, p.61). At this step, investment is usually needed to buy more capacity at the constraint's location. By having more capacity, the throughput of the whole system increases, and the constraint moves to another location into the system. This is a strategic decision though and it can be that the organization does not wish to move the constraint elsewhere (Gupta & Boyd 2008). The goal is to elevate it up to the point where another resource becomes a constraint. (Floyd & Ronen 1989) mentions that the resource with the excess capacity - the non-

constraint - should be lower cost resource since they will remain idle at some point. Another action that belongs to elevation is to offload certain activities from the constraining resource to another part in the system. This could offer the excess capacity to the system as well.

After the fourth step, the constraint has been elevated and the constraint has been moved elsewhere into the system. To continue improving the system, the sequence should be repeated again. Identify the new constraint, exploit it, subordinate all non - constraints and if it is not broken, then it should be elevated. The fifth and final step is exactly that. **Go back to step one and do not allow inertia to become the new system's constraint** (Mabin et al. 2001; ELIYAHU M. Goldratt 1988).

The 5FS can be synthesized with other methodologies so they can be further enhanced. The 5FS can produce significant results even when used on their own (Umble et al. 2006). The 5FS have been compared to Deming's Cycle of Plan, do, Check, Act (Gupta & Boyd 2008), with six sigma (Ehie & Sheu 2005).

The 5FS are used to increase the Throughput of the value chain (Burton-Houle 2001) and the Process Of On-Going Improvement (POOGI) in TOC is achieved through the 5FS (Kosieradzka et al. 2011).

1.4.2 Thinking Process Tools (TP Tools)

As previously stated the core of the TOC philosophy is the management of the constraints (Şimşit et al. 2014). As discussed there are two broad categories of constraints, physical constraints and policy constraints. The 5FS and policy constraints generally manage physical constraints are managed by another set of tools which are called The Thinking Process Tools or TP tools. Policy constraints are generally more difficult to identify, they are hidden in the form of assumptions and they guide behaviors and decisions. The TP Tools are used when a constraint is not apparent (Taylor & Churchwell 2004) or it is difficult to locate (Mabin et al. 2001; Davies et al. 2005; Mabin 1999).

The Thinking Process is based on the Aristotelean logic (Dettmer 2011), which has conceived syllogism which in turn is the basis for the TOC thinking process (Dettmer 2016a). Aristotle supported that every effect is the product of three causal factors, 1.

Means (resources) 2. Method (a way to act) and 3 Motivation (the desire to act) (Dettmer 2016b, p.143).

Eliyahu Goldratt introduced the TP Tools in the book “It’s not Luck” in 1994 (Şimşit et al. 2014). The principles of the Thinking Process have been used for many years in medicine and science but Goldratt applied them to business systems (Taylor & Churchwell 2004).

The TP Tools is a series of tools which can work as standalone tools (Gupta 2003), but they are much more powerful when used in a sequence.

The sequence of the logic trees is used to answer the basic questions of change as they appeared in (Eliyahu M Goldratt 1990). The tools are answering the following questions

1. What to change
2. To what to change to
3. How to cause the change.

The answer to the first question is the identification of one or two problems which prohibits the organization of meeting its goal. The identification and analysis tools are the Current Reality Tree (CRT) and the Evaporating Cloud (EC) (Cox III et al. 2005).

The answer to the second question is the representation of the future system state without the problem. It is all the actions and the solutions which if implemented would eliminate the core problem thus lifting the whole system closer to its goal. The tools which help to answer the second question are the Future Reality Tree (FRT) and the Negative Branch Reservation (NBR) (Cox III et al. 2005).

The answer to the third question is an implementation plan. TOC uses the Prerequisite Tree (PrT) and the Transition Tree (TrT) to create a sequence of actions necessary to create the solution identified from the second question (Cox III et al. 2005).

(Choe & Herman 2004) support that the TP tools are developed with the objective to implement change (Mabin et al. 1999) adds that the TP tools can also be used as decision-making tools.

There are three pillars where implementation of the TP tools is based on (Scheinkopf 1999), 1. Sufficiency based thinking logic, 2. Necessity-based thinking logic and 3. the Categories of Legitimate Reservations (CLRs).

TOC supports that there are two modes of thinking. The necessity and sufficiency thinking. We are normally thinking unconsciously in one of those two ways.

Necessity thinking uses necessary conditions as building blocks. Some conditions MUST exist for the result to exist. It does not mean that if those conditions are present the result will be realized but for sure the result will not be realized if these necessary conditions are not present. The way to follow this kind of thinking is by forming “*in order to.... We must...*” statements. In order to have A we must have B (Mabin et al. 2001).

The second mode of thinking is sufficiency thinking. This kind of thinking develops a logic sequence where if the steps identified are followed then the effects will be certainly realized. It uses cause and effect logic. The way to follow this kind of thinking is by asking “*if-then*” based questions. There are three types of sufficiency logic (Mabin et al. 2001): 1. A is sufficient to cause B 2. If both A and B occur together only, then they will be sufficient to cause C and 3. A or B can be sufficient to cause C.

In our everyday life, we tend to apply solutions the moment that we identify a problem. Usually, when we apply our solution there are other problems generated which then we need to solve again. TOC has a different approach. It identifies a problem from the negatives effects, analyses those negative effects and identifies the root cause problem. Then it reveals the conflict that prohibits the problem from being solved, it generates a direction for the solution which will break the conflict, it designs the future solution as a whole and it introduces a set of actions which will form a new systemic entity or solution. The TP Tools are used to address root problems, find system solutions and guide the change through the layers of resistance (Choe & Herman 2004; Cox III et al. 2012, p.120)

The validity and the rules of the necessity and sufficiency-based thinking are done through the Categories of Legitimate Reservations (CLRs).

Goldratt developed the Categories of the Legitimate Reservations (CLRs) which is a set of 7 logic rules which guide the user through the construction of the logic trees. They are used to help validation and scrutinization of the logical connections of the trees (Dettmer 2016b).

Table 1. 2: CLRS

<u>Level 1</u>
1) "Clarity: Clarifying the meaning and the wording of the cause and effect relationship."
<u>Level 2</u>
2) "Entity existence: Is the entity of cause valid?"
3) "Causality existence: does the actual cause and effect relationship really exist?"
<u>Level 3</u>
4) "Additional cause: Is the cause fully sufficient to produce the effect? Or there is an additional cause that can cause the effect?"
5) "Cause insufficiency: Is the cause enough to explain the existence of the observed effect? If not, then an additional cause is needed which in combination with the first cause will produce the effect."
6) "Tautology: Being redundant in stating the cause-effect relationship; the cause is actually a recording of the effect, thus being redundant. If a tautology exists, you can state the cause as being the effect and the effect as being the cause (e.g. the arrow could point in either direction). Therefore, the cause does not lead to the effect".
7) Predicted effect (entity) existence: Similar to circular logic. The cause produces the effect but also the effect produces the cause.

Current Reality Tree (CRT)

The TP Tools use a problem-driven approach. A problem is rarely addressed with accurate data, the right tool or the right methodology (Thomas & Dobbs 2007).

The CRT begins with the collection of negative situations of a system. These negative effects are called UnDesirable Effects (UDEs), and they are the problems or the symptoms that we see in our daily awareness level (Boyd et al. 2001). Goldratt supported that there is no reason for trying to eliminate the UDEs since they are only symptoms and that they will be regenerated by a web of cause and effects which emanate from a core problem. After collecting 10-12 UDEs an analysis follows which

surfaces the root core problem. This root core problem is what limits the system from achieving more. In these terms, the core problem is the constraint of the system (Şimşit et al. 2014). It is the reason that holds the system back from producing more. TOC uses the CRT to surface hidden problems or assumptions.

CRT is a sufficiency-based tool and uses cause and effect logic to identify the core problem in a system and map the logic that holds it alive (Boyd et al. 2001; Davies et al. 2004). CRT is a snapshot of reality (Mirzaei & Mabin 2017). It maps how constraints interact with each other and how they generate the UDEs (Unghanse 2013).

The Current Reality Tree begins with the UDEs and then it is built downwards to the root problem using sufficiency-based thinking as shown in figure 1.2.

Figure 1. 2: The Current Reality Tree

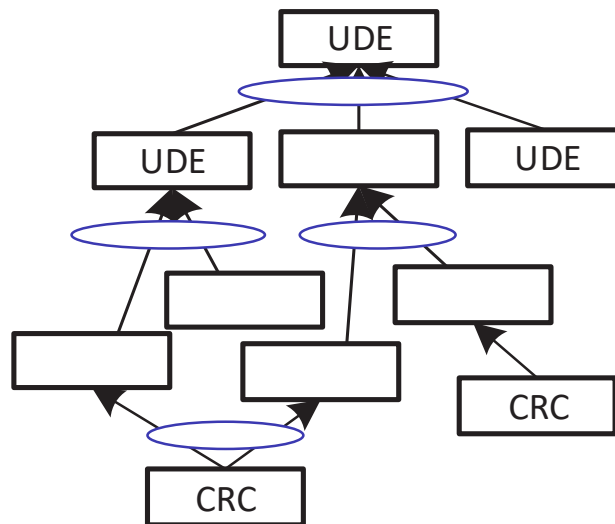

Negative feedback loops reinforce and amplify the negative effects preserving the existence of the CRT. The mapping of the problematic situation has a systemic approach (Davies et al. 2004) and connects causes and effects from different parts of the system.

Evaporating Cloud (EC)

Goldratt supports that the only reason that a core problem exists, is because some kind of dilemma or conflict keeps them alive, Dettmer adds to that and he points out that problems may exist because we do not have the knowledge to solve them (Dettmer 2016b). Conflicts arise because of conflicting needs (Boyd et al. 2001) or conflicting actions (Mirzaei & Mabin 2017).

Goldratt claims that there is no dilemmas in nature and that conflicts are the creation of our logic. Our logic is based on our assumptions and most of the time these assumptions are hidden and exist below our awareness level. Many of those assumptions are not valid anymore or they do not exist, so our thinking is based on invalid reasoning.

The evaporating cloud is a tool that is used to “evaporate” hidden conflicts and hidden assumptions, based on necessity-based thinking. It can also be used as a standalone tool.

The most common way that we manage conflicts is to compromise in different ways. The fact that conflicts are still alive it means that compromise is not a solution to a conflict (Lloyd J. Taylor III Becki Murphy William Price 2006; Taylor & Churchwell 2004). The EC aims to create a win-win solution (Davies et al. 2004).

It is composed of five elements, as shown in figure 1.3. There are two sides of the Evaporating Cloud. The one is composed of the Objective, Requirement 1 and prerequisite 1. The other side is composed of the Objective, Requirement 2 and Prerequisite 2.

The first entity is the objective. This is what it is wished to be achieved. The two-second entities are the requirements. These are the two conditions that must be present for the objective to be realized. The third two elements are prerequisites. These two entities are actionable items that they are necessary to be realized for the requirements to be true which in turn will make the objective to be true. When these two prerequisites are in conflict, or they cannot be realized at the same time then it means that one of the prerequisites will NOT be realized, therefore one of the two requirements will NOT become true which means that the objective will NOT be achieved. When the objective is not achieved, then the system will produce Undesirable effects. All the negative situations and negative emotions that the system’s users experience.

As long as the prerequisites cannot be done simultaneously, and they are conflicting the conflict will keep generating UDEs. Even if we “solve” them, the conflict (which is usually hidden) will keep regenerating them. Goldratt supports that the arrows exist because of hidden assumptions. The goal is to invalidate or force an existing assumption to be invalidated. When this happens then the mentioned arrow will stop to exist. In this case, the conflict will stop to exist, or it will be “evaporated”.

Figure 1. 3: The Evaporating Cloud

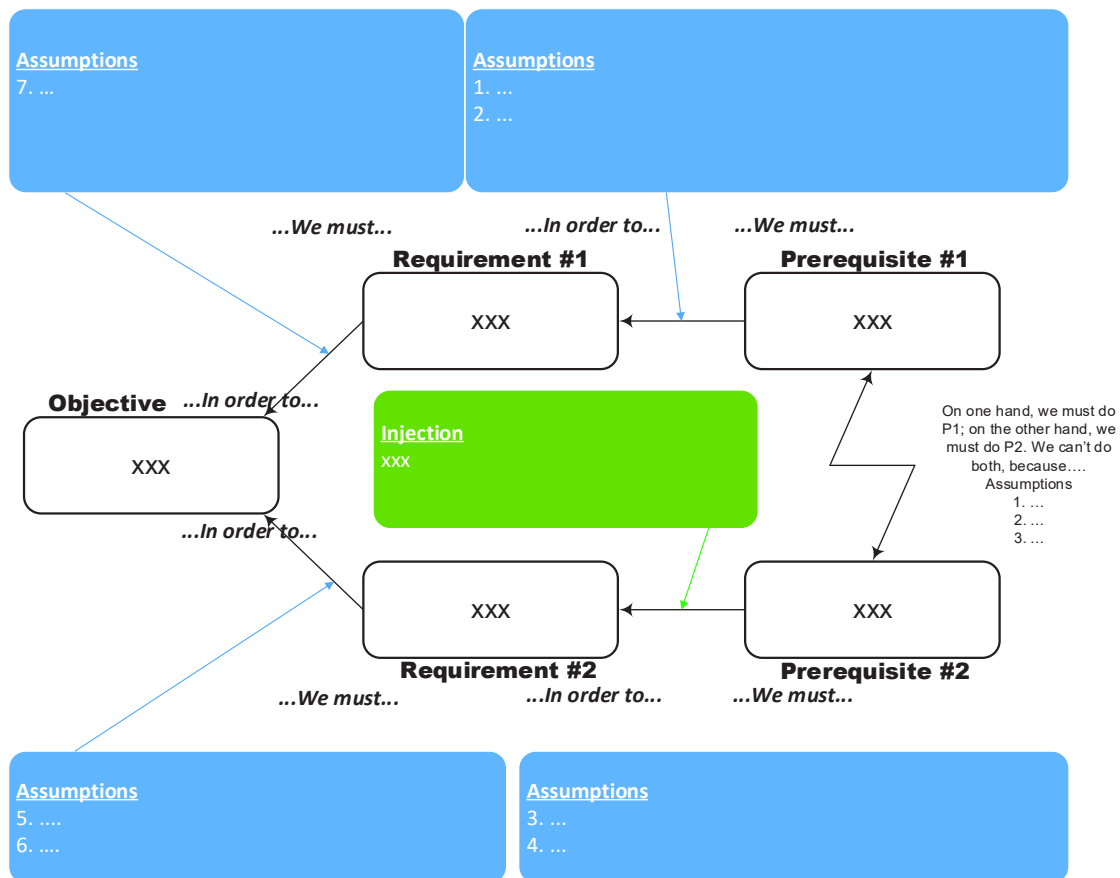

The action that will make an assumption invalid in the EC is called “injection”. It indicates the direction of the solution. The evaporating cloud is being used to analyze the product and its output is the injection.

Future Reality Tree (FRT)

The injection generated by the EC usually is a “direction of a solution” that must be realized to invalidate an assumption in order to break a conflict which in turn will realize an objective. TOC recognizes that before we apply any solution, we need to “design” the future state of the system with the injection applied and the UDEs eliminated.

Some things need to be added and others to be subtracted in combination with the identified injection in order to form a harmonized solution which will solve the UDEs but at the same time will not create new ones. The tool to do that synthesis is called Future Reality Tree (FRT). The FRT seeks to identify all the necessary actions and conditions needed to make an effective change (Davies et al. 2004). The FRT is a future

modeling tree; it tests if the selected injections will produce the desired results (Boyd et al. 2001). The FRT has mainly two objectives 1. To develop a solution and support it with injections and 2. To identify and block a new possible devastating effect before they happen.

It is a sufficiency tool that aims to identify what else is needed to change after the implementation of the injection. After the final design, one tool is used in combination with the FRT in order to foresee any negative consequences that may be created with the changes. This is done through negative criticism and negative screening (Lloyd J. Taylor III Becki Murphy William Price 2006). The name of the tool is the Negative Branch Reservation (NBR) which is also a sufficiency-based logic tree.

New injections are needed into the FRT in order to make it bulletproof. The FRT needs to make sure that all changes in the different parts of the system are identified and any negative consequences are blocked.

Figure 1. 4: The Future Reality Tree

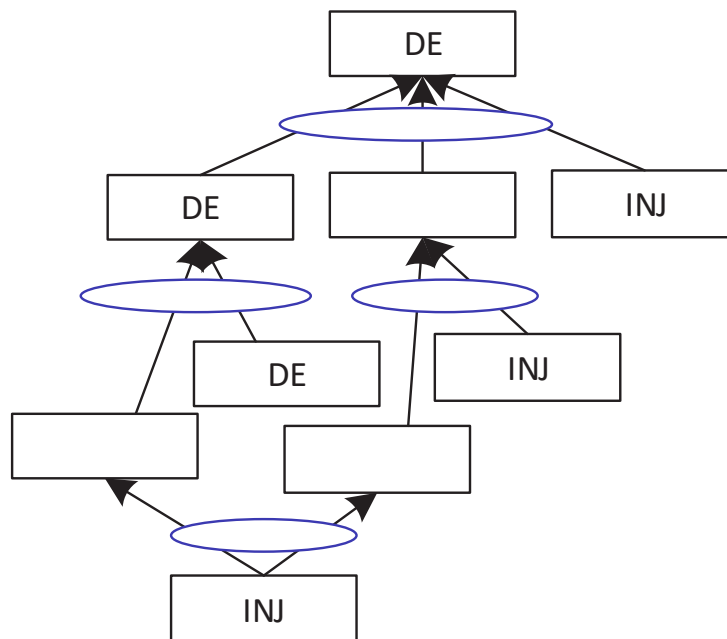

These new injections can be stated preferably as actions (when something is straightforward) or as conditions when we do not know how to make something happen or when we are in front of a complicated situation.

The FRT, through design, verifies that a Desirable Effect will be produced, and it validates the effectiveness of an injection. It evaluates the impact of the solutions.

Prerequisite Tree (PrT)

The injections identified during the FRT construction are end result conditions. These are the result of several actions that need to be performed in a sequence in order to achieve the end result which is the injection. This sequence of actions that are scheduled to be executed and deliver an end result is the PERT of the project. The tool that TOC uses to create a project management plan is called the Prerequisite Tree (PrT). The PrT is a necessity logic tool. It identifies the actions required to be performed by revealing the obstacles blocking the flow of the solution and then creates actions to remove those obstacles. These actions are called Intermediate Objectives (IO) and these are the backbone of the final project plan.

Transition Tree (TrT)

Transition Tree is the tool which is used by the TOC in order to build detail into the Prerequisite Tree. This is a sufficiency tree, and sufficiency logic is what is needed to drive action. It creates action in an implementation plan designed during the construction of the PrT (Unghanse 2013; Tulasi & Rao 2012).

The output of the TrT is a “to do” list which helps to guide action down to detail (Boyd et al. 2001). The TrT also seeks to identify obstacles that may arise during the implementation (Unghanse 2013). It uses the same principles as in FRT, the CLR's are used to scrutinize each logic step for negative branches (Tulasi & Rao 2012). The final purpose of the TrT is to implement the change (Tulasi & Rao 2012).

TP tools – General comments

The TOC TP tools stretched the TOC application boundaries into other areas of activities than manufacturing (Choe & Herman 2004) like healthcare and others. Literature describes many applications of the Thinking Process Tools in many different environments and contexts (Şimşit et al. 2014) such as in operations, finance, marketing, sales etc (Cox III et al. 2005) but also in production, logistics, distribution, project management and others (Mabin et al. 1999). (Boyd et al. 2001; Gupta et al. 2004) and (Dettmer 2003) describes how the TOC TP tools can be synthesized in order to create a strategy plan. By following a logical sequence from problem diagnosis to solution design and implementation of the solution a robust approach is formed to overcome resistance to change (Tulasi & Rao 2012).

PrT and TrT are not used in this research.

Thinking Process Tools Development

TOC's philosophy has undergone through several methodological developments (Mabin & Davies 2003).

Different authors have proposed changes in order to adopt the thinking process tools in different environments. Others, have intervened in their philosophy but they all agree that the Thinking process tools are an outcome of Dr Goldratt's thinking. One of the brightest, most influential authors and TOC thinkers is Bill Dettmer. Through his books, he explains HOW the logical thinking process tools must be applied.

Dettmer wrote a number of books and his methodology, thinking and approach are followed by this research journey. Dettmer intervenes into the very philosophy and paradigm of TOC. He invented the Goal Tree and then the logical thinking processes from a problem-solving orientation become a goal seeking methodology.

The researcher had the privilege to be trained by Dettmer for the scope of this research in Paris in 2016.

Below we are describing some of the most important TP tools developments according to our literature review research.

Goal Tree (GT)

The idea of the IO Map was first developed by (Eliyahu M Goldratt 1990) in the PrT, later it was placed as the first step toward improvement by (Dettmer 2003) and later it was renamed to Goal Tree by (Dettmer 2016b).

Articles that have used and discuss the Goal Tree are very limited like (Mirzaei & Mabin 2017) where others discuss it as IO map (Dalci & Kosan 2012).

The GT is a necessity logic tree which maps the necessity logical network of entities that must co-exist for the system to be in its ideal state. It shows what is the ideal state of the system from a necessity perspective. It is composed mainly by three different layers.

Figure 1. 5: The Goal Tree

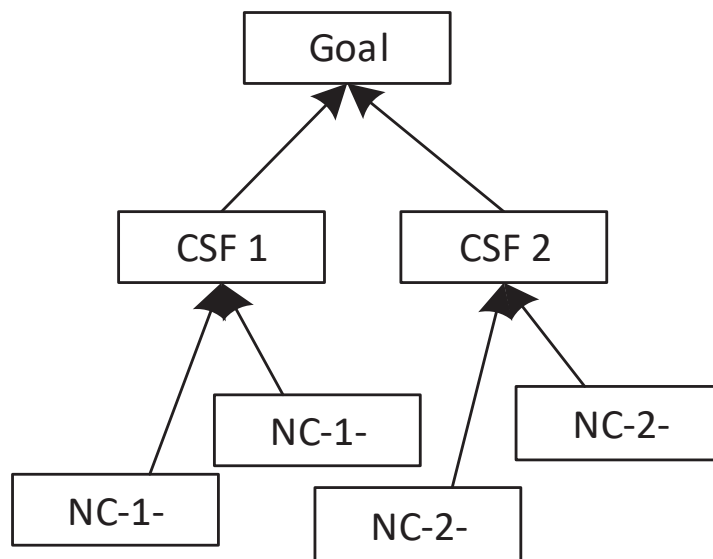

The first layer displays the goal statement. The reason for the system's existence. This is basically the reason that the system's owners want the system to exist.

The second layer is the Critical Success Factors (CSFs). These are main high-level system outcomes which must exist for the goal to be realized. They are statements just below the goal. Dettmer suggests that there should be three to five Critical Success Factor statements.

The third layer is the Necessary Conditions layers (NCs). These are statements representing actions that must be executed in order to produce the Critical Success Factors which in turn will satisfy the Goal. Dettmer suggests that no more than two to three layers of NCs should be present in a Goal Tree.

The logical necessary interdependency between the Goal, the CSFs, and the NCs represent the minimum requirements that a system must satisfy in order to be successful. It doesn't mean that if a system satisfies all the NCs and CSFs the goal will be realized but it means that if one of the NCs or CSFs is not satisfied then the Goal will not be realized.

This kind of approach represents the ultimate or the ideal status of the system in a necessity diagram of different conditions which when they would be satisfied then the goal of the system would be unavoidably be realized. The result would be a visual representation of the system, a synthesis of different system's elements and in a simple logical flow so people could just follow and understand. This is one reason why the

Critical Success Factors should be conditions or outcomes instead of actions. Necessary conditions should be stated like actions needed to produce the CSFs.

The GT under Dettmer's proposal gives a new perspective to the logical thinking process tools as they seek to satisfy an objective instead of avoiding problems.

It is a new tool into the TOC toolbox so is unresearched. Literature discussing the GT is almost non-existent. The GT is used intensively into this research.

Three-cloud approach

The three-cloud or consolidated cloud approach is a way which is developed in order to bypass the CRT and the EC tools. It is being designed to uncover core problems (Goldratt-Ashlag 2010). The CRT is being used then to validate the identification of the core problem (Tabish & Syed 2015; Shoemaker & Reid 2005).

The process of identifying the core problem starts by selecting 3 UDEs which build three different clouds (Cox III et al. 2012). Then the three different clouds are synthesized into one which represents the core conflict cloud of the system. This procedure has the advantage of looking at the system from three different perspectives (Thomas & Dobbs 2007).

(Kim et al. 2008) have found through their literature review that the three-cloud approach is widely used.

Focused Current Reality Tree (fCRT)

This development follows the CRT logic and it is used to map the causal relationships of the Undesirable Effects. It is developed by (Ronen & Pass 2008, p.115) and it basically shortlists the weaknesses into a short list of core problems (Coman & Ronen 2009).

The main difference with the traditional CRT is that it lists only the UDEs which are responsible for the presence of a leading UDE. As explained by (Ronen & Pass 2008) the leading UDE is placed on the top of the fCRT and below follow layers with the rest UDEs. The last layer is the list of the core problems to be solved (Ronen et al. 2012, chap.7).

The main advantage is that it avoids the complexity of the CRT.

Strategy & Tactics Tree (S&T)

The Strategy and Tactics Tree were developed by Dr. Eli Goldratt to define the organization's strategy. With the S&T the strategy is broken down to actions, it is validated and communicated (Cox III et al. 2012). It is a tool that provides all the logical structure of the necessary and sufficient changes needed to be made (Barnard 2016).

1.4.3 TOC Performance Measures

The aim of TOC is optimization. Therefore, TOC's measurement system is aimed at measuring the whole and not the local optima (Gupta 2003). TOC focuses on the performance of the whole system (Balderstone & Mabin 1998). It recognizes that global optima are the important ones and that local optima (or sub optimization) must be abandoned. This is in contrast with the traditional view of management which its measures look inwards emphasizing local optima and local efficiencies (Wahlers & Cox 1994). TOC's number one enemy is sub optimization which means that the goal of the local system elements is higher than the system's goal.

TOC states that for-profit organizations have one goal "make more money now and in the future". The financial measures measuring this goal is Net Profit, Return On Investment and Cash Flow. These three measurements though do not help departmental managers and supervisors to see how their local decisions affect the system's goal. In order to measure this goal, Goldratt developed a set of measurements with the aim of assisting local decision makers making decisions that affect positively not their own department but the system's goal (Stein 1996, p.349; Lockamy & Spencer 1998). He called this set Operational Measures and from these operational measures, the financial measures of the company can also be extracted.

Figure 1. 6: TOC Measurements (Dettmer 2016b, p.16)

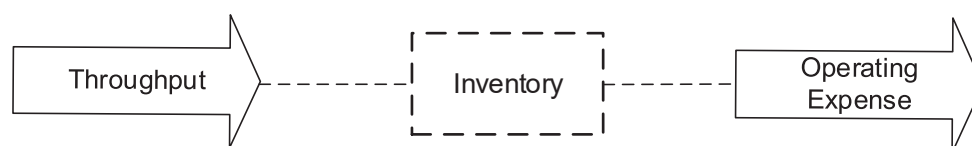

There are three operational measures and from those three all other financial measures can be derived. The operational measures are Throughput, Inventory and Operating Expense (Ronen & Starr 1990; Naor et al. 2013).

Throughput (T) – Throughput (T) is the rate at which the system generates cash through sales (Ronen & Starr 1990). TOC recognizes that if a sale has not been made then T has not been realized. T is the cash generated from sales minus the truly variable costs which in most cases are the raw materials used to produce the product. Goldratt gives to T the highest priority of the three measures, and this is the biggest revolution in the management science (Eliyahu M. Goldratt 1990) since T places emphasis on flow and into a systemic perspective. The benefit of increasing T is that there is no limit and improvement is more immediate and more significant (Tabish & Syed 2015).

Inventory (I) – Inventory (I) is sometimes called Investment (Cox III & Schleier 2010, p.862), is all the money invested into the system purchasing things that are to be sold (Ronen & Starr 1990). Inventory exists to protect Throughput. Therefore, it needs to be placed strategically. It has been the focus of other methodologies as well like Lean and TPS but it has been treated as an evil to be diminished, JIT principle stands on the elimination of Inventory. TOC uses inventory in the form of buffers to protect flow against variability. Everywhere else needs to be reduced since it requires high investment and it harms the flexibility of the system (Cox III & Schleier 2010, p.862).

Operating Expense (OE) - Operating expense is all the money that the system spends to transform Inventory into Throughput (Ronen & Starr 1990). Direct labor and all overhead are treated as OE (Ronen & Starr 1990). TOC treats OE as stable most of the time compared to the variation of the T (Watson et al. 2007). The aim is to reduce OE.

The above three measures are the operational measures which TOC uses to measure all local decisions and assist local managers in affecting positively the system's goal. T has a higher priority than the other two (Naor et al. 2013). A manager has three options to improve its system, increasing T, reducing OE or reducing OE or any blend of increasing T and reducing I and OE (Tabish & Syed 2015). (Eliyahu M Goldratt 1990, p.29) states that these three operational measurements are the only assumption made in the Goal and that everything else can be derived from those. (Dettmer & Schragenheim 2000) supports that the most strategic question that a company can have is where the

location of the constraint should be in order to have the highest T with the lowest I and OE.

The other set of performance measures are the financial measures. This set measures directly the Goal of the company and they are derived from the operational measures. The three financial measures are Net Profit (NP), Return on Investment (ROI) and Cash Flow (CF) which are extracted by the three performance measures.

TOC financial measures are not addressed in this research. More information can be found at (Eliyahu M. Goldratt 1990).

1.5 TOC Generic Solutions

Different TOC applications have been transformed into generic solutions which can be applied in different operational environments. The foundation for all of TOC's generic solutions is the Five Focusing Steps (5FS) (Breen et al. 2002). The implementation of the generic solutions saves a great amount of work since reinventing them every time is avoided.

The generic solutions have been designed for mainly three different operational environments: production, project management, and distribution. For the production the generic solution is called Drum Buffer Rope, for the project management it is called Critical Chain Project Management and for the distribution is called Replenishment Solution. There is incredible success reported in the literature from the implementation of the above generic solutions (Balderstone & Mabin 1998).

Drum Buffer Rope and the Replenishment Solution are applied in the context of healthcare through this research study.

1.5.1 Drum Buffer Rope (DBR)

The TOC has a unique method of scheduling processes with constraints, called Drum-Buffer-Rope (DBR) (Siha 1999a). It addresses mainly resource and capacity constraints. DBR uses the concept of a physical constraint which can be the market or any other Capacity Constraint Resource (CCR) (Stratton et al. 2008).

DBR is TOC's planning methodology (Dettmer & Schragenheim 2000). It is a development of OPT (Thürer et al. 2017; Russell & Fry 1997), and it was developed

initially to schedule a job shop (Gardiner et al. 1993). This was done with the help of the software "Disaster" that Goldratt developed it at the end of the 1980s (Dettmer & Schragenheim 2000). DBR was an alternative scheduling method to MRP and JIT (Russell & Fry 1997). It was developed by the novel *The Goal* as an example, using a hike with scouts (Zivaljevic 2015) and explained later in detail in the book *The Race* (Watson et al. 2007) in (Eliyahu M. Goldratt 1990) and in (Goldratt & Fox 1986). As explained by (Mohammadi & Eneyo 2012) the Drum, Buffer, Rope is the three components of the OPT scheduling system.

DBR considers and seeks to optimize the whole system, (Motwani et al. 1996b; Mohammadi & Eneyo 2012), DBR stems from the Five Focusing Steps (Motwani et al. 1996b; Mohammadi & Eneyo 2012; Ronen & Starr 1990). DBR is a scheduling mechanism used by TOC to regulate the flow through a system where buffer management is a control mechanism and the communication path where information is provided (Politou & Georgiadis 2008; Gardiner et al. 1993). The main goal of scheduling is to plan the load based on the available capacity. The advantage is that DBR synchronizes the flow without the need to schedule every single resource (Guide Jr 1996).

Although it was built on the foundations of the 5FS, the concepts of DBR preceded the 5FS (Dettmer & Schragenheim 2000) and it was designed mainly to coordinate the flow in a MTO environment (Stratton et al. 2008). Drum is consistent with the first of the 5FS, a buffer is consistent with the second of the 5FS and rope is consistent with the third - subordinate - focusing step (Mohammadi & Eneyo 2012). DBR requires a mind shift from the "cost world" to the "Throughput world". A view from the local optima to global optima.

The philosophy is that it organizes everything around only the constraint, therefore, it needs less data (Guide Jr 1996). It transforms a system to PULL philosophy (Belvedere & Grando 2005).

DBR has been well researched (Stratton & Knight 2010a). It has been researched in different environments. It is reported that DBR has very good results, for example DBR has managed to increase the output in a hospital environment (Motwani et al. 1996b) and also in job shop environments (SCHRAGENHEIM et al. 1994), it has been reported that it has positive effects in reducing inventory and in increasing throughput

(SCHRAGENHEIM et al. 1994). Authors (Mohammadi & Eneyo 2012) reported good results in managing the flow with the use of DBR where others reported very fast results with a reduction in FGs with the day usage falling from 60 to 28. There were cases where modifications need to the methodology for DBR to be effective (SCHRAGENHEIM et al. 1994). It is also reported that DBR can be used in the services context (Motwani et al. 1996b; Chawla & Kant 2017; Mohammadi & Eneyo 2012).

The DBR synthesizes a finite loading schedule combined with buffering management (Riezebos et al. 2003). It is proven that DBR scheduling mechanisms cope with the depended events and with the statistical fluctuations that exist in any system (Committee & others 1999).

The main issue of DBR is to manage the buffers (Dettmer & Schragenheim 2000) successfully.

Figure 1. 7: The Drum Buffer Rope (Pandit & Naik 2006)

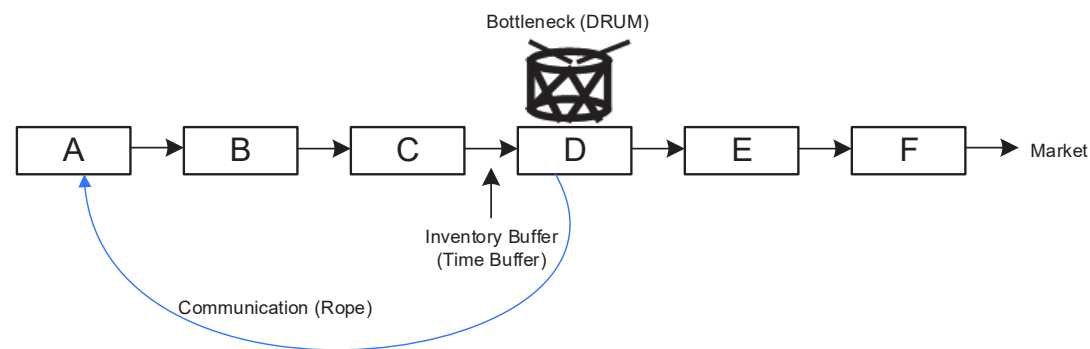

There are three steps to apply the DBR - 1. Make sure that the constraint is working efficiently and effectively 2. Determine the buffer sizes and 3. Design the rope schedule (Schragenheim & Ronen 1990). (Wu et al. 2011) reports that there are three management stages that DBR has to go through in order to be successfully applied, planning phase, executing phase and control phase.

Drum

As shown in figure 1.7 the Drum is the constraint of the system and it is the one who dictates the rhythm of the whole production flow. In the beginning, constraint and bottleneck were synonymous but later on it was clarified that a Capacity Constraint Resource (CCR) could be a non-bottleneck constraint (Politou & Georgiadis 2008). During 1985 the two meaning of bottleneck and CCR were clarified up to that time the

definition was the same (Eliyahu M. Goldratt 1988). OPT differentiated between a CCR and a bottleneck. A bottleneck is a resource whose capacity is less than the market demand - A CCR is a resource which must be adequately scheduled in order to meet due dates (Mohammadi & Eneyo 2012).

The Drum is the schedule of the constraint (Committee & others 1999; Schragenheim & Ronen 1990), the schedule which makes sure that the constraint produces at maximum (Motwani et al. 1996b). The status of the shipping buffer extracts the schedule of the drum prior to the due dates (SCHRAGENHEIM et al. 1994) and it indicates when the materials will arrive at the constraint/drum (Schragenheim & Ronen 1991; Wu et al. 2011). A finite capacity schedule is generated on an active CCR (Dettmer & Schragenheim 2000).

Buffer

One property that characterizes most of the production systems is variation. Variation exists because system elements are interdependent to each other (Zivaljevic 2015). DBR is used to regulate the flow through the constraint and manage the variation by buffering (Dettmer & Schragenheim 2000). Buffers in DBR are basically time buffers. In 1985 the "time buffer" concept emerged from the relationship between schedule delays and inventory buffers (Eliyahu M. Goldratt 1988). The buffer is to protect the schedule from the variation (Schragenheim & Ronen 1991; Zivaljevic 2015) and disruptions which can be breakdowns, set up times, human decisions, scrap et (Schragenheim & Ronen 1990). The buffer is mainly the time from the release of new work to the CCR (Committee & others 1999; Dettmer & Schragenheim 2000).

There are three types of buffers - constraint, shipping and assembly buffers (Schragenheim & Ronen 1990).

Rope

The rope is a communications mechanism or the schedule that allows more work to be released into the system (Goldratt & Fox 1986; Dettmer & Schragenheim 2000). The rope is a synchronization mechanism for all the other resources which are non-constraints (Committee & others 1999). Communication is done with a form of feedback. It monitors the Drum Buffer and when the constraint is near to end of an order, it releases more materials into the system (Chakravorty 2001).

Therefore the "length" of the rope is proportional with the inventory into the system (Mohammadi & Eneyo 2012). With this way, the rope makes sure that the flow is balanced to the market demand (SCHRAGENHEIM et al. 1994).

Buffer Management (BM)

Buffer Management is the TOC application that DBR uses to manage the buffers in the system. BM is the control mechanism of DBR (Dettmer & Schragenheim 2000). The decision making according to the status of the buffers is the core of the concept of BM. It primarily manages decisions affecting lead times (Schragenheim & Ronen 1991) and constraint protection levels (Watson et al. 2007). Buffer Management serves as a warning system (Committee & others 1999) and it is used mainly to protect the system from Murphy, from orders that will not arrive on time to the drum (Stein 1996, p.65). It is an inventory management system with the main priority to ensure the operation of the constraint by keeping the buffer intact (Boyd & Gupta 2004).

BM is the decision process which ensures that the buffer remains at the appropriate levels. One of the objectives is to identify problem orders before the constraint stops its operation (Stein 1996, p.144). Three actions are taken according to the buffer penetration, disregard, monitor or expedite (Schragenheim & Ronen 1991). BM monitors the status of the buffers and takes necessary decisions when needed (Schragenheim & Ronen 1991). The management is done with the use of colors as shown in figure 1.8. Decisions are taken based on a color coding or percentage buffer penetration (Stratton & Knight 2010a). (Knight 2011) have used a four-color based buffer to manage patient releases. The red region as shown in figure 1.8 is the emergency zone where immediate action is required. These necessary decisions serve four purposes 1. Prioritize, 2. Expedite 3. The warning signal for instability 4. sources of delay (Cox III et al. 2012, p.14; Stratton & Knight 2010a; Stratton et al. 2008)

Figure 1. 8: Buffers (Chawla & Kant 2017)

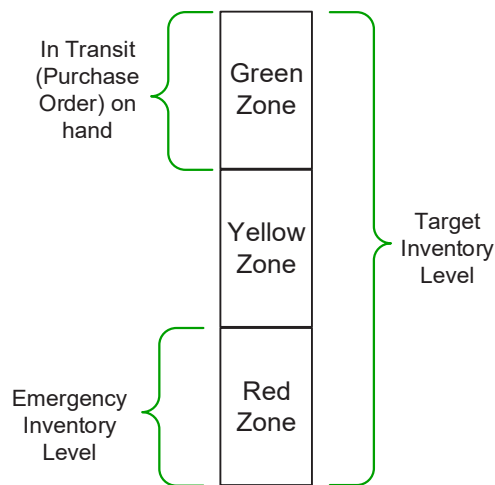

1.5.2 TOC Replenishment

A Supply chain is called all the activities, the flow and the path from the raw materials through the warehouses, production, assembly to Finished Goods Warehouse, depots and finally to the selling points (Blackstone 2001). When the flow is too high then Inventory builds into the system, when the flow is too slow then the supply chain experiences out of stock situations.

Goldratt mentions four ingredients of Supply chain efficiency 1. Improving flow 2 Prevent overproduction. 3.local efficiencies must be abolished 4. focusing methodology (Goldratt 2008). A distribution system should manage lead time - flexibility, readiness, and reliability of delivery (Šukalová & Ceniga 2015).

What is the problem?

Supply Chains experience two general problems: variation and long lead times. Variation is caused mainly because the consumption of a product is not stable and long lead times because of the complexity of the supply chains. The output of the forecasting effort is to estimate what item should be produced, how much should be produced, where should it be stored and when it should be delivered.

Variation

Variation in supply chains was observed by Forrester (Costas et al. 2015) when he noted that orders were amplified as they were going through the different supply chain links. He called this phenomenon - the Bullwhip Effect. These amplified orders are the cause of high inventory into the system (Wu et al. 2010; Dos Santos et al. 2010). This effect is illustrated around the world through the famous Beer game (Costas et al. 2015). (Blackstone 2001) adds that high inventory may also be due to different assumptions like “replenishment times are long”, “suppliers are unreliable”, “forecasts are not accurate” etc. Again, variation and long lead times.

The practice is to hold the inventory near to the customer in order to respond quickly and avoid stock-outs (Blackstone 2001). Vital is also to decide how much stock to keep by forecasting future demand.

There are four fallacies regarding statistics which are making the current practice inefficient (Cox III & Schleier 2010, p.267)

1. The Fallacy of Disaggregation - The closer we move to the end of the supply chain according to figure 1.9 the flow is spread out and disaggregated into many different smaller consumption points. The higher we move up to the supply chain, closer to the manufacturing plant or to the central warehouse the flow is aggregated into single streams. The forecast is more inaccurate when data is disaggregated (close to the consumption points) in comparison to when data is aggregated (at the central warehouse level). This is because possible fluctuations average out on the aggregated events. So, the higher the aggregation, the better the forecast.

2. The fallacy of the mean - When the consumption points have a mean consumption of x units, it doesn't mean that the consumption will be the sum of all the means of all the consumption points. This fact is what causes inventory to be high in some links in the supply chains and out of stock in others.

3. The Fallacy of the variance - Variance and standard deviation definitions make forecasting algorithms very complex and most people do not use the concepts because of the high complexity.

4. The Fallacy of sudden changes - The more sudden the change the less accurate the forecast. An unforeseen last-minute event is enough to prove any forecast wrong.

The effect of the above four fallacies is what makes forecasting an inefficient method causing excess inventories in some parts of the supply chain and less in other parts.

The Replenishment Solution

The Replenishment solution is TOC's methodology to manage distribution (Šukalová & Ceniga 2015). The Replenishment solution was first discussed in the book *It's not Luck* in 1994 as a supply chain solution (Wu et al. 2013). Little has been written in the literature about TOC and Supply Chain (Simatupang et al. 2004).

How it works

Figure 1. 9: The Replenishment Solution

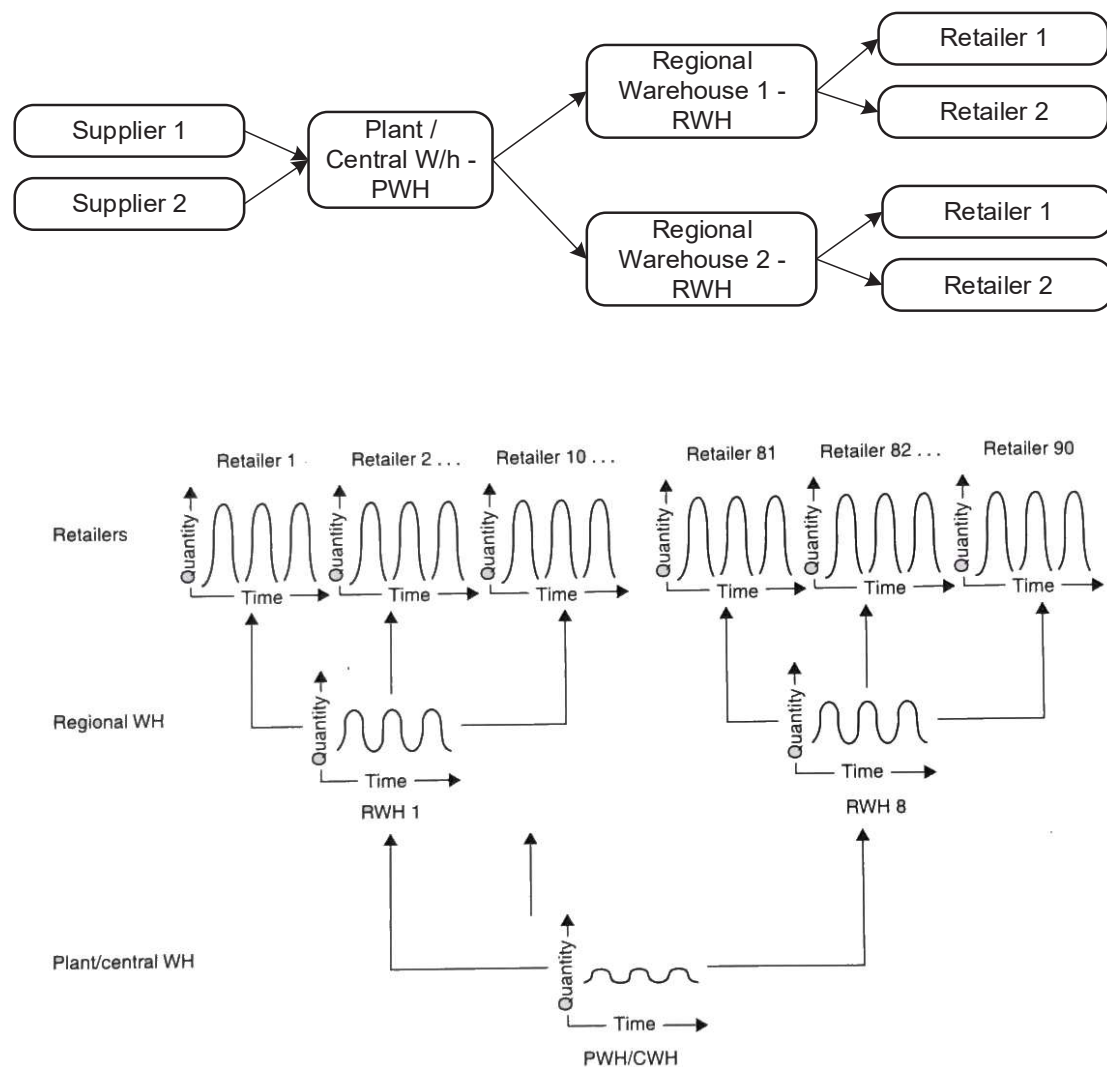

The replenishment solution aims to manage the two core problems of variation and long lead times, by applying the TOC application Buffer Management to manage variation and frequent replenishment to manage lead times. A typical supply chain network

consists of three major parts 1. The factory 2. The Central Warehouse and 3. The point of consumption (Wu et al. 2013). The factory creates the products then they are stored at the central warehouse and when required the product is moved to the consumption point figure 1.9.

Supply Chain Management seeks answers to three questions regarding product status: what should be produced, where should it be stocked and when it should be delivered, whereas (Wu et al. 2010) states that a replenishment philosophy should deal with 1. how often the inventory status should be determined 2. when an order should be placed 3. how large the order should be.

The TOC follows six steps of implementation (Cox III & Schleier 2010, p.270) in order to answer the above questions as explained below:

1. Keep the stock at the highest level in the supply chain. The stock should be kept at a high point of the supply chain where multiple consumption points can be served. At this high point the fluctuation of demand of the consumption points are canceling each other out and the fluctuation at the high point is much less. Less variation means that it's easier to manage the stocks – figure 1.9.

2. Calculate stock to be kept at the consumption points based on demand, supply, and replenishment lead time. The replenishment quantity and the maximum inventory level are determined by the replenishment frequency and the replenishment lead time (Wu et al. 2013). (Wu et al. 2010) operational model - each node holds enough stock to cover demand during the time it takes to replenish - each node orders only what was sold. The replenishment time is composed of the frequency of replenishment and of the lead time (Wu et al. 2010).

3. Increase the frequency of replenishment. The higher the replenishment frequency and the shorter the replenishment time the lower the inventory can be (Wu et al. 2013). Under this solution, the consumption point holds the largest inventory during the replenishment time.

4. Take decisions for the flow based on buffer status. The buffer is the safety of the supply chain. Buffers are divided in colors and based on the status then the relevant decisions are made. Green means that stock is high. Yellow means that stock is

adequate, and an order should be placed, red means that stock is too low and expedite should occur.

5. Use dynamic Buffer Management. This discipline has a mechanism that changes the buffer sizes accordingly according to the buffer status frequency. If red for example is too often then the DBM will increase the buffer size and vice versus.

6. Prioritize manufacturing based on buffer status.

As shown above, forecasting is replaced with buffers, buffer zones and BM (Cox III & Schleier 2010, p.279).

TOC replenishment can be applied in order to reduce inventories, improve throughput, flow, and availability (Tabish & Syed 2015). (Dos Santos et al. 2010) mentions that when all links in a Supply Chain (upstream or downstream) work in harmony as a whole there are advantages for the whole chains.

TOC replenishment is applied to this Thesis.

1.5.3 Critical Chain Project Management (CCPM)

Critical Chain Project Management (CCPM) is TOC's way of managing projects and it was introduced in the 1990s at the international Jonah conference (Watson et al. 2007). CCPM is how TOC uses Buffer Management in managing projects (Stratton & Knight 2010a).

The same principles of TOC apply to a project as well. TOC treats a critical path as the constraint. A project cannot finish earlier because it is constraint by its critical path. TOC seeks to manage three roadblocks to project implementation, precedence structure, statistical variation, and human behavior. In order to manage this TOC takes the critical path, rearranges the sequence of the task depending on resource overlap. Then it cuts the tasks durations by half and then the half of the duration is added as a buffer at the end of the critical chain. TOC recognizes that the aim is not to protect every single task but protect the project as a whole. Management of the project is done again by Buffer Management principles. The buffer is monitored via the fever chart and decisions are extracted accordingly.

The Critical Chain Project Management is probably the most researched area and the most implemented of the TOC's applications today.

1.5.4 Throughput Accounting (TA)

As already discussed in section 1.5.4 TOC recognizes two types of measures (Watson et al. 2007).

1. The global performance measures which are Net Profit (NP), Return On Investment (ROI) and Cash Flow (CF)
2. Plant or Operational performance measures Throughput (T), Inventory/Investment (I) and Operating Expense (OE).

These two sets of measures provide a link between the operational and the financial results (Tabish & Syed 2015). They provide managers with the ability to see global effects through local actions (Boyd & Cox 2002). The global measures can be extracted from the plant performance measures which are the basis for the Throughput accounting (Umble et al. 2006).

The Throughput Accounting (TA) is the outcome of the TOC's performance measurement philosophy (Gupta & Boyd 2008). It uses the three measures T,I and OE, Throughput dollar days and inventory dollar days (Boyd & Cox 2002; Umble et al. 2006) to calculate the global performance measures. The main characteristic is that emphasis and priority is given to Throughput (Tabish & Syed 2015). Goldratt supports that this shift in measures from the traditional management which places priority to cost is what makes TOC distinct (Eliyahu M. Goldratt 1990).

Throughput Accounting abandons the cost concept and recognizes operating expenses instead – which is all the money that the company sacrifices in order to convert the input to output. Operating expense is all the expenses except truly direct expenses. These are considered as inputs to be converted to outputs.

Throughput Accounting's focus is on constraint throughput. It provides management with data in order to be able to take decisions based on the TOC philosophy.

1.6 Setting the mindset...

As stated, the research unfolds by applying TOC with another three conceptual frameworks, we discuss TOC in conjunction with change management, operations management, and systems management.

1.6.1 TOC and Process of Change

It's all about change.

Management and models of Change

There is an ongoing discussion in the literature regarding change management, a discussion that continues for more than 50 years. (Dettmer 2016b) highlights that one of the most difficult elements in change management initiatives is how to make people change their behaviors in order to support the change efforts. The higher someone is in a company hierarchy the more he/she finds that managing a company is more of an art than a science (Eliyahu M Goldratt 1990, p.23). The art of managing people and take intuitive decisions when hard facts are not available (Eliyahu M Goldratt 1990).

Several authors have suggested different models of how to implement and approach change. Some of the most known models of change are

Lewin's model: In 1947, Lewin conceived the three stages of change (Berry & Belle 2005; Levasseur 2001). Since then, Lewin's model is widely accepted as a model for change (Hussain et al. 2018). Lewin's three steps of change are 1. Unfreeze existing situation, 2. change and 3. freeze or make the change stick.

At the beginning people must agree that change must take place, they must be informed why they need to change and try to get their agreement (unfreeze step) (Levasseur 2001), change must be motivated (Hill 2007, p.201). Then the existing system must be examined, analyzed and then develop and install the new system (change step) (Levasseur 2001). Finally, the measure and enhance the new system, stay with the system until new behaviors have settled in, (refreeze phase) (Levasseur 2001; Hill 2007, p.201).

Lewin's model doesn't describe though **how** change can actually be executed (Levasseur 2001).

John Kotter's 8-Step model: (Kotter 1995), describes 8 steps to implement change, he offers a template for managing change emphasizing communication, vision and short-term wins. (Mento et al. 2002) states that Kotter's 8 steps are one of the most successful models for change, aiming at the strategic level of change in (Kotter & Schlesinger 1979).

Jick's 10 step Model: (Mento et al. 2002) reports 10 steps for implementing change referring to them as Jick's model. Jick is focusing more on the tactical level of change. The General Electric – 7 step model: Garvin mentions the GE's 7 step change model, which is close to Lewin's model of change 122. A 12-step model: The authors of (Mento et al. 2002) recommend a 12-step model which is the result of reflection of the previous three models.

Hutchin discusses five steps for successful change 1. Consensus on the problem, 2. Consensus on the direction of the solution, 3 Consensus on the benefits of the solution, 4. Dealing with all possible reservations that people may have, 5. Making it happen. (Sirkin et al. 2005) offers the DICE model which focuses on aspects of Duration, Integrity, Commitment, and Effort.

In all the above models, authors seek to formulate a structured way to manage change. Different model, different strategies, different point of views. Change is still an interesting topic drawing much attention in the literature.

Although TOC deals primarily with change, TOC is not mentioned in change management literature (Mabin et al. 2001).

TOC approach to change

TOC is an improvement methodology, improvement is about change so TOC deals with change constantly. TOC has a different perspective of change than most of the mentioned models. TOC views change as a necessity (Mabin et al. 2001).

Resistance to change is the number one reason why change doesn't happen (Mabin et al. 2001; Kotter & Schlesinger 1979; Waddell & Sohal 1998). Resistance is caused by individual factors, Group factors or Organisational factors (Mabin et al. 2001).

In his book (Eliyahu M Goldratt 1990) Goldratt supported that change is perceived as a threat to security. This threat generates emotional resistance. He continues, that emotion cannot be overcome with logic but with only a stronger emotion. This stronger emotion, in turn, brings unnecessary and unproductive stress into organizations. Logic is not enough to persuade people, human emotion, motivation, and behavior play a critical role as well (Dettmer 2016b, p.337; Dettmer 2009).

Three questions of improvement

People perceive change as a threat. Goldratt noticed that resistance to change is not a threat for the person who proposes the change. He supports that the emotion of the inventor, the person who proposes the change is stronger than the emotion of the threat. Based on this He suggests that the feeling of ownership is the key to successful change, (Mol 1990) adds the feeling of pride. The feeling of ownership appears when someone has invented something himself. If all the answers are provided to someone then the person cannot be an inventor any more (Eliyahu M Goldratt 1990, p.19; Ritson & Waterfield 2005)

The technique to make someone an inventor is to allow him to propose the answers. This is the Socratic Method and it is being implemented by using the effect-cause-effect logic introduced by Socrates.

The TOC follows the Socratic Approach and it is based on effect-cause-effect like all hard sciences (Eliyahu M Goldratt 1990, p.23; Ritson & O'Neill 2006). In TOC thinking process this Socratic Approach helps the user to find the solutions himself and gives the "sense" of ownership enforcing commitment (Motwani et al. 1996b). The speaker becomes aware of his own assumptions and ways of thinking arming him with insight. The Socratic Method works as a self-help approach which is far more effective than a prescriptive approach (Mabin 1999; Watson et al. 2007).

By using the Socratic Method TOC approaches change by answering three questions (Eliyahu M Goldratt 1990, p.21) and this is the main method and roadmap adopted in this Thesis.

The first question is "what to change": The answer seeks to find the constraint (Dettmer 1998, p.25; Nagarkatte & Oley 2010, p.2). This question reveals "hard" and "soft" weaknesses. The manager must have the ability to find the core problem. The one

problem that in its' absence, the whole system will be close to its ideal state (Eliyahu M Goldratt 1990, p.8).

The second question is “what to change to” which is the solution to the problem (Dettmer 1998), this refers to a systemic change affecting resources and people. It addresses the organisational purpose and strategic development (Davies et al. 2005). It has to do with drawing the future solution. The aim is to construct simple, practical systemic solutions (Eliyahu M Goldratt 1990, p.8)

The third question is “how to implement the change”. The answer to this third question deals with how the change will be implemented. It addresses the obstacles to be removed and in what sequence tasks must be implemented, this question falls into the project management’s context. Goldratt supports that this is the most difficult question of all (Eliyahu M Goldratt 1990, p.8). This is a psychological question and this is where resistance arises.

Some authors discuss an additional question “why to change” (Mabin et al. 1999) or as (Dettmer 2016b, p.29) forms it “what the desired standard is”.

The three questions are discussed widely in TOC literature, and they are directly connected with the Thinking Process Tools and the 5FS (Gupta et al. 2004) which provide the answers to the questions. Table 1.3 shows the relationship between the three improvement questions and the corresponding TP tools.

Table 1. 3: Change Questions

Three Improvement questions (Eliyahu M Goldratt 1990, p.8)	Thinking Process Tools (Gupta et al. 2004)
What to Change?	Current Reality Tree (CRT)
What to Change to?	Evaporating Cloud (EC) Future Reality Tree (FRT) Negative Branch Reservation (NBR)
How to cause the change?	Prerequisite Tree (PrT) Transition Tree (TrT)

(Cox III & Schleier 2010, p.284) states that the role of the manager is to determine the answers to the three change questions. (Blackstone 2001) mentions that the three improvement questions should be followed through a cycling process. These are system level questions and they should be applied to a system and not to a process (Dettmer 1997, p.11). Always the whole system should be taken into consideration (Patrick 2001).

(Şimşit et al. 2014) connects the three questions with the Five Focusing Steps - What to change - identify the constraints, what to change to - exploit and subordinate - how to cause the change - elevation (Dettmer 1997) table 1.4.

Table 1. 4: Change questions and Five Focusing Steps

Three Improvement questions (Eliyahu M Goldratt 1990, p.8)	Five Focusing Tools (Şimşit et al. 2014)
What to Change?	Identify the constraint
What to Change to?	Exploit and subornation steps
How to cause the change?	Elevate the constraint

Resistance to Change

As already mentioned change initiatives often fail because of people’s resistance. People naturally resist change (Moran & Brightman 1998; Khourshed 2011). Our brain is physically hardwired to be protected by threats, meaning preserving the status quo, which is known, in contrast to something unknown that change brings (Dettmer 2016b, p.317).

Resistance to change is a behavior and behavior is driven by unfulfilled needs, needs that are discussed by Maslow, Herzberg, McClelland (Dettmer 2016b, p.3). Misunderstanding can also be a source of resistance (Kotter & Schlesinger 1979). Others (Moran & Brightman 1998) believe that the ingredients for successful change and dealing with resistance exist in the concept of leadership, management, employee involvement, organization of work and resource utilization.

Resistance is considered an evil in the literature (Mabin et al. 2001), something to get rid of, something to “overcome”. People in positions with authority see fear and they react, lower level immediate threats "do it or else..." (Eliyahu M Goldratt 1990, p.15). People see a change as a threat, so this is called emotional resistance and the way to overcome this is by stronger emotion, fear (Eliyahu M Goldratt 1990, p.14).

Change needs to be managed by education, participation, and involvement, facilitation and support, negotiation and agreement, manipulation and co-optation, explicit and implicit coercion (Schroeder & Robinson 1991) special emphasis is given to communication which is vital to have an effective change, this is a common ingredient found in different papers (Waddell & Sohal 1998; Levasseur 2001; Kotter & Schlesinger 1979).

Efrat’s cloud and the layers of resistance

Efrat's cloud discusses and analyses the change dilemma from a TOC perspective (Goldratt-Ashlag 2010; Dettmer 2009). People's target, she claims, is to be happy in their lives (Dettmer 2016b, p.320). She gives two dimensions to people’s happiness. Security and Satisfaction. To feel secure, she said is to have a sense of predictability and to be satisfied is to have the feeling that you have achieved a challenging objective. These two requirements, she continues, are in conflict: embrace change (be satisfied) vs resist change (feel secure) (Dettmer 2016b, p.320).

Efrat's cloud refers to the soft part of the system like emotions, feelings, and security of people. Because of the soft nature of the conflict, she supported that effective leadership is a necessity (Dettmer 2016b), Mabin adds the importance of vision, communication, participation, and trust (Mabin et al. 2001).

Dettmer cites Chet Richards who discusses leadership around four principles: mutual trust, personal professional skill, a moral contract and focus (Dettmer 2016b, p.323). Leaders must create a passion and a mindset for winning (Longenecker et al. 2009).

Efrat’s cloud is being schematically shown in below figure 1.10.

Figure 1. 10: Efrad's cloud

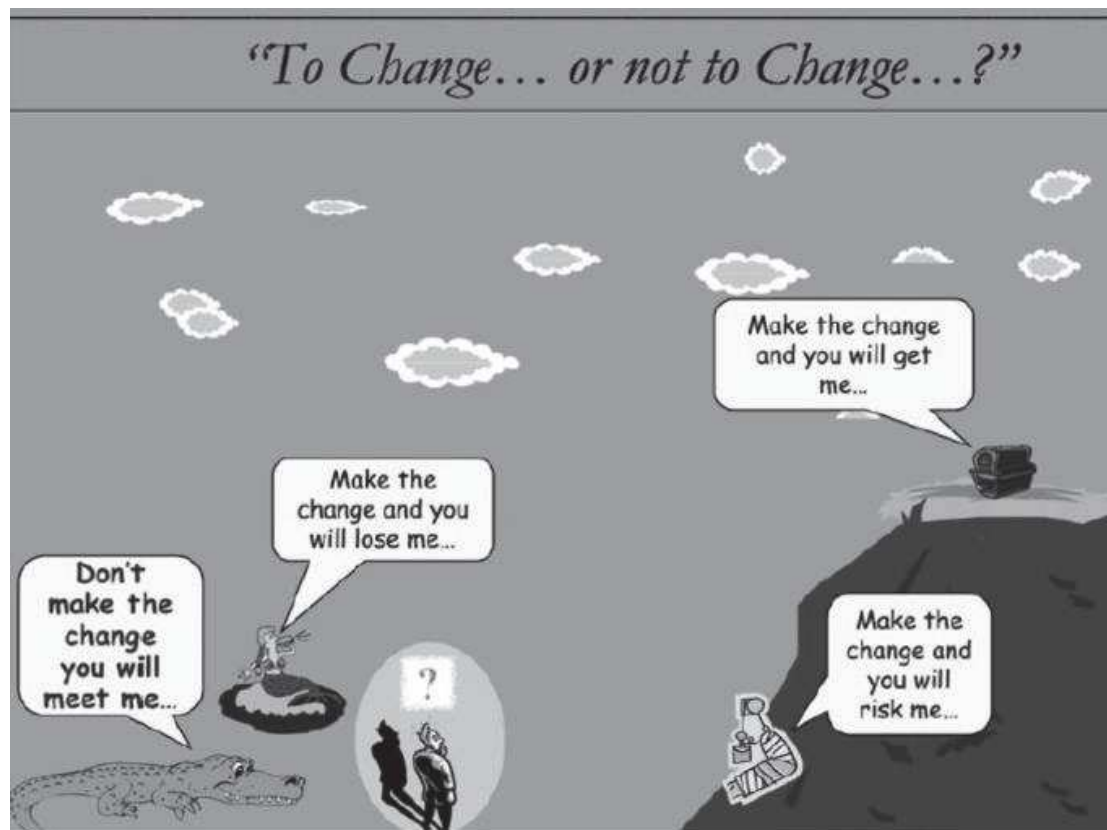

Figure 1.10 is being widely used in TOC training programs in order to explain the logic behind the change.

The "layers of resistance" first appeared in (Goldratt 1996; Goldratt-Ashlag 2010). The layers of resistance originate from the questions of improvement (Goldratt-Ashlag 2010), therefore, there are three basic layers of resistance – one layer for each question. The first layer is disagreement about the problem, the second layer is disagreement about the solution and the third is disagreement about the implementation. These three basic layers are breaking down to 3 layers each as shown in table 1.5. Layers of resistance show step by step how to succeed a buy-in of the people (Cox III & Schleier 2010, p.571).

In table (Goldratt-Ashlag 2010) Table with 9 layers of change, (Patrick 2001; Burton-Houle 2001; Chalice 2007), reports six layers, (Roy 2004; Perry 2016) discusses five layers of resistance. (Goldratt-Ashlag 2010) suggests that depending on the type of change there may be deeper layers to change.

Table 1. 5: Layers of Resistance

Layer 0: 'There Is No problem	Problem
Layer 1: Disagreement on the problem	
Layer 2: The problem is out of my control	
Layer 3: Disagreement on the direction for the solution	Solution
Layer 4: Disagreement on the details of the solution	
Layer 5: Yes, but...the solution has negative ramification(s)	
Layer 6: Yes, but...we can't implement the solution	Implementation
Layer 7: Disagreement on the details of the implementation	
Layer 8: You know the solution holds risk	
Layer 9: "I don't think so" - Social and Psychological Barriers	

Disagreement on the problem

Layer 0: “There is no problem” – The belief that everything works fine and there is nothing causing negative effects. No need to change. There is not an alligator behind me.

Layer 1: Disagreement on the problem – People believe in different causes for the negative consequences. They do not agree on what is the exact problem that must be solved. There is no alligator but a vulture, so climbing up the cliff will not save me.

Layer 2: The problem is out of my control – The problem is out of the sphere of control and out of the sphere of the influence of the person we are talking to. Other people may be needed to be talked to manage the problem.

The TP tools to help us overcome the above three layers is the Evaporating Cloud (EC) and the Current Reality Tree (CRT).

Disagreement on the solution

Layer 3: Disagreement on the direction for the solution – There are more than one ways to solve a problem. This layer appears when people try to convince each other that their solution is better. I will not climb the cliff, but I will stay to fight the alligator.

Layer 4: Disagreement on the details of the solution – People argue that the agreed solution (from layer 3) is incomplete and it does not solve the problem in all dimensions. We need to make sure that the solution will truly solve the problem (Patrick 2001).

Layer 5: Yes, but... the solution has negative ramification (s) – Worries about side effects. Discussions that the solution will solve the problem BUT there are other problems that will be created. There is no final agreement about the solution yet. The structure of it needs still to be completed. I may climb the cliff but I will lose the mermaid. Mainly people resist change because they believe that they will lose something of value (Kotter & Schlesinger 1979).

The TOC thinking process tools which help to overcome Layers 3,4 and 5 is the Future Reality Tree (FRT) and the Negative Branch Reservation (NBR).

Disagreement on the implementation

Layer 6: Yes, but... we can't implement the solution. The solution is agreed. Reservations about the feasibility of the solution. There are too many obstacles and the proposed implementation will not be able to be realized. Layer 6 and layer 5 are usually confusing but the difference is that in Layer 5 – we haven't agreed on the solution yet. In Layer 6, we have agreed on the solution we just have difficulties in implementing it – too many obstacles.

Layer 7: Disagreement on the details of the implementation - Objections about schedules, due dates, delegation, tasks clarity etc.

Layer 8: You know the solution holds risk – Things might go wrong while we implement the solution. We need to evaluate and decide how risks are bypassed. There is a risk of breaking a leg while climbing the cliff.

The TOC thinking process tools which help to overcome layers 6,7 and 8 is the Prerequisite Trees (PrT) and the Transition Trees (TrT).

Finally, there is a last layer 9: “I do not think so” – Social and psychological barriers. This has to do with personal and psychological reasons that are below the surface. Humans are operating at many different levels at the same time. Ethics, beliefs, worries etc can cause us to behave and resist for reasons that are not obvious. When such a reason is detected then we need to fine-tune our approach accordingly.

The layers of resistance must be followed in the correct sequence – from layer 0 down to layer 9 and not mix them up in order to be effective. Following the layers of resistance, gives us a sense of control and focus through the process than just arguing and discussing intuitively.

As discussed, the key to true buy-in is the sense of ownership (Goldratt-Ashlag 2010). People do not resist to the change that they have proposed. We need to accept their reservations, listen and ask for their input on how to overcome them; then they become part of it.

1.6.2 TOC and Operations

“Operations management deals with the design, operation, and improvement of the production systems that create the organization’s primary products or services” (Chase et al. 1998).

The main operations management function is described by the transformational process which is described through the mainstream of the operations management literature. Almost all production systems can be modeled by the transformation process model as shown in figure 1.11. The idea is that a process is transforming inputs to an output (product or service) which is used to satisfy a need.

An input can be a customer, a patient, an output from another system, information etc. These inputs are being transformed by operations resources (people, plants, parts, processes, and planning and control) to an output, a product or a service.

Figure 1. 11: Transformational System (Dettmer 2016b, p.4)

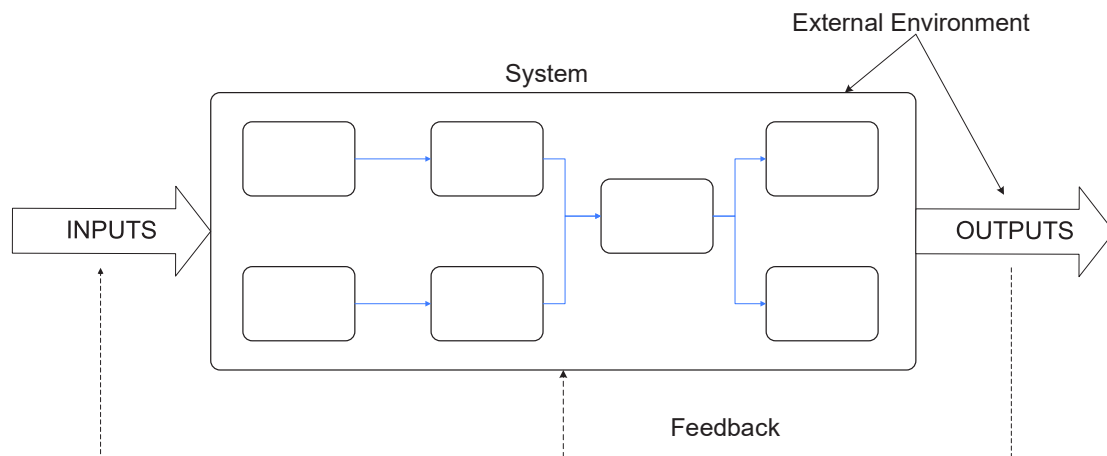

Following (Chase et al. 1998) description the transformational process includes Physical, (e.g. manufacturing), location (e.g. transportation), exchange (e.g. retailing), storage (e.g. warehousing), physiological (e.g. Healthcare), or informational (e.g. telecommunications).

We find that the model of the transformation process is very useful in the Theory of Constraints context because it gives a notion of flow. When several transformation processes are connected then there is a systemic flow which sets the right mindset for TOC application, it also separates the human element from the functional elements, which provide the system with objectivity. This model is being used by TOC authors like (Motwani et al. 1996b) showing a transformational model for healthcare or (Riezebos et al. 2003; Kosieradzka et al. 2011; Berry & Belle 2005) and others.

(Balderstone & Mabin 1998) add that TOC offers much to operational research and to the operations management context. At the same time (Ronen 2005) discusses that the Five Focusing Steps and other TOC practices emanate from the Operations Research concepts. The use of the Five Focusing Steps has a different operations management perspective than the traditional approach (Reid 2007) which instead of focusing on the utilization of the constraint, it looks to improve everything.

TOC has been discussed in many different operations management disciplines (Watson et al. 2007) like project management, supply chains, process improvement, and in many production environments.

Authors like (Ronen & Spector 1992), mention that TOC has a very tight relevance with the Operational Research context. TOC has offered a lot to the Operating

Management context (Mabin et al. 2006; Trietsch 2005; Gupta et al. 2009). TOC has started appearing in OM books, like (Brennan 2010; Johnston & Clark 2008; Slack et al. 2013; Chase et al. 1998) and others. Whereas (Davies et al. 2004) finds that TOC has started growing into the academic community.

Operational Research has started focusing on TOC (Panizzolo 2016) with special emphasis on logistics. TOC has started becoming a successful application into the operations management context (Vargas et al. 2017). From an operations management perspective, many TOC academicians and practitioners advocate an integrated approach to continuous improvement (Pirasteh & Farah 2006; Reid 2007; Ringim et al. 2010).

1.6.3 TOC and Systems

Systems thinking originated in the 20s from biology and engineering (Iles & Sutherland 2001, p.16). It gives meaning to wholes which are formed from different parts (Lepore & Cohen 1999, p.17). This is something that scientific analysis fail to offer. The elements of a system are coupled together through a network of interdependence and interaction, systems thinking is the opposite of reductionism (Chen 2016). Systems thinking, and reductionism is the two edges of the theoretical spectrum.

TOC is a systemic process. It is an approach that it is designed into the systemic context (Berry & Belle 2005). (Mabin & Davies 2003) find that TOC frame of knowledge has strong synergies and linkages with the systems thinking domain. TOC has much in common with systems approaches like soft systems methodology (SSM) (Balderstone & Mabin 1998; Sommer & Mabin 2016) or Causal Loop Diagrams (CLD) and Stock Flow Diagrams (SFD) (Davies et al. 2004). (Mabin 1999) discusses the relation of TOC and hard and soft systems. One difference is that TOC does not model the whole system but only the part in interest (Mabin 1999).

In 1980's Checkland developed a methodology of working with the soft part of the systems (Iles & Sutherland 2001, p.90). Using action research methodology, he applied systems engineering principles to management problems (Burge 2015). Synergies and synthesis between TOC and Checkland's work can be found in (Mabin 1999; Mabin et al. 2006; Davies et al. 2004; Sommer & Mabin 2016) and (Rahman 2002).

In (Mabin et al. 2006) the authors conclude that system's dynamic (SD) and TOC can give deeper insights to situations when blending together, whereas in (Balderstone 1999) they illustrate how system dynamics modeling validation can be enhanced by using the Categories of Legitimate Reservation which is the cornerstone behind the TOC's Logical thinking process tools. (Mabin et al. 2006) discusses Causal Loop Diagrams and TOC Thinking Process. The authors suggest that the TOC thinking process take a more detailed look on the cause and effect connections surfacing assumptions which are actually the building blocks of our thinking. CRDs, on the other hand, provide a holistic view of the whole behavioral structure.

(Dettmer 2011) Dettmer discusses the relationship between the CYNAFIN framework and TOC. The CYNEFIN framework is one representation which shows how a system operates in different domains. He also analyses in (Cox III & Schleier 2010, p.559) how the TP tools are used to apply system concepts to practice, like the OODA loop.

(Fanta & Erasmus 2014) sees ehealth through system engineering lenses. They found a positive correlation between successful results and the implementation of systems engineering management principles.

TOC and systems share common concepts like:

Feedbacks: They both utilize the concept of feedbacks, although they have different meanings, the effect is the same.

Synthesis: System Science believes that analysis doesn't help to explain the behavior of a system. The same holds true for TOC – a current reality Tree, for example, runs through different functional areas of a system ignoring hierarchies.

Boundaries: Systems have boundaries. The boundaries separate the system from its environment.

We strongly support that OM concepts, TOC and Systems concepts synthesize a powerful whole to answer the research questions and produce useful results and insights through this study.

On the other hand, Dettmer supports that there are systems where TOC is not applicable. He supports that the logical thinking process tools are not applicable in

chaotic systems and in several complex systems. He sees a use though in simple and complicated systems (Dettmer 2011).

TOC and Academia

It is a topic that has attracted attention from the academic world. TOC has been evolved to a managerial philosophy in the last decades (Ronen 2005). There are many successful results reported but there is a need for more research (Ronen 2005). In 2014, the first TOC Ph.D. Thesis was completed in France at the University of Strasbourg (Jaeck 2014), this research is the second one.

TOC though is becoming more popular in academia through the years. TOC now appears in several operations management books such as (Slack et al. 2013; Johnston & Clark 2008; Chase et al. 1998) and others. Universities have developed courses, research, and interest in TOC such as the University of Strasbourg, Victoria University of Wellington, Nottingham Trent University, Washington State University, and others.

The theoretical underpinnings of TOC have been discussed in different articles such as (Boyd & Gupta 2004; Naor et al. 2013; Gupta & Boyd 2008). During the last decades, there is an increasing number of articles being published in top rank journals as shown in (Mabin 2017). TOC is not so well researched as other concepts e.g. Lean. The TOC academic community is still small (Ronen 2005).

On the other hand, it has been observed an academic emerging literature trend and an increased level of acceptance of TOC research.

1.7 Chapter Summary

The Chapter discussed the theoretical framework of the Theory of constraints. TOC has its roots into the continuous improvement evolution and the chapter unfolded the evolution from the time of Adam Smith to the latest developments of TOC.

The philosophy and the main components and tools of TOC are also discussed and analyzed. TOC's component's like The Five Focusing Steps, the logical thinking process tools, and the TOC measures were explained in order to familiarise the reader with the concepts.

Finally, the DBR and the Replenishment solution, which are readymade generic solutions, were discussed which are used in the Thesis.

The last section of the chapter set the theoretical foundation of the research. The relationship between TOC and change management, TOC in the Operations and Systems management theoretical domains has also been discussed since they are the oxygen surrounding this research.

Chapter 2

Management of Healthcare Operations and Theory of Constraints – a synergy

2.1 Introduction to the Chapter

Since TOC is the theoretical framework held in this Thesis, the previous chapter analyzed the TOC structure from a theoretical perspective.

This chapter discusses how TOC is applied to services and specifically in healthcare, then it frames the research gap, the purpose statement, and the research objective. It unfolds the research questions to be answered in the quest of closing the research gap in order to satisfy the purpose and the research objective.

As previously explained TOC is a systemic approach. Different type of systems has different characteristics. Since TOC is being used in manufacturing and now it is to be used in services – the characteristics of these two extremes must be discussed. We describe systems categorization in order to justify the reasons that subsystems were chosen in the way that there is chosen.

The discussion in this chapter starts from the services as a whole and narrows down to healthcare and then down to the hospital materials logistics and operating rooms.

2.2 Service Operations Management

Many studies show that services play a dominant role as a driver of economic growth in the economy. Literature indicates that with a few exceptions high-growth countries have mostly expanded on account of their services sectors, not manufacturing. 67.01% of the Gross Domestic Product (GDP) is being contributed by the services sector (Castaño et al. 2013).

2.2.1 Systems categorization and classification

(Nie & Kellogg 2009) reports that the operations management field started considering the service arena as a different entity than manufacturing from the mid-70s. Because of that, a number of improvement methodologies, which were developed in the manufacturing world have been applied into services as well, like Lean (Soliman & Saurin 2017), Six Sigma (Sufahani et al. 2012), Agile (Sara et al. 2015), TQM (Watson et al. 1992). TOC is one of these theories as well (Siha 1999b; Reid 2007; Reid & Cormier 2003).

TOC is designed and has been applied intensively into the manufacturing context. Since this thesis explores TOC effectiveness in healthcare (services), it is worth examining the difference between manufacturing and services in order to adjust the TOC approach accordingly. We examine this difference through three different perspectives as defined by the work of Chase, Schmenner, and Ackoff. They have defined and categorized the systems according to some main criteria. Chase used the criteria of the level of customer contact in the creation of service, Schmenner used the criterium of customer interaction with the creation of service and Ackoff categorized systems based on their level of choice. We will try through the mentioned models to identify the main differences between services and manufacturing.

A detailed analysis of the evolvement of service operations is beyond the interest of this Thesis and details can be found at (R. 2005).

Chase Model

(Chase 1978) has categorized systems and subsystems according to their exposure to customers. The author claims that different operational characteristics define the systems according to the customer's level of contact with the creation of service. The author also supports that the level of the system's efficiency is counter proportional to the level of customer contact. The higher the contact, the less the system's efficiency.

In table 2.1 (Chase 1978) shows the classification of the systems according to the customer contact in the creation of the service.

Table 2. 1: Chase Model (Chase 1978, p.3)

Classification of Service Systems by Extent of Required Customer Contact in Creation of the Service		
High contact	Pure service	Increasing freedom in designing efficient production procedures
	Health care	
	Restaurants	
	Schools	
	Personal Services	
	Mixed Services	
	Branch offices of	
	Banks	
	Computer companies	
	Government administration	
Low Contact	Wholesale houses	
	Post offices	
	Manufacturing	
	Factories producing:	
	Durable goods	
	Food Processions	
	Mining companies	
Chemical plans		

Worth to note that manufacturing systems have the least level of customer contact, therefore they are easier to standardize and stabilize (Glushko 2010). (Sampson 2014) summarises the managerial distinctions of services in below table 2.2 based on the work of (Chase 1978). Improvement process can be different depending on which point of the scale the system belongs (Scott 2012).

Table 2. 2: Managerial distinction of services

Managerial issue	Non – service process (manufacturing)	Service process
Facility Layout	Organized to enhance process flow	Accommodate customer needs and expectations
Worker Skills	Focus on efficiency and consistency; Rote training	Focus on interaction skills and responsiveness
Job Design	Tightly defined with precise steps and cycle times	Broadly defined
Sales opportunity	Mass marketing	Personal selling

Schmenner’s model

(Schmenner 1986) adds to Chase model the concept of a system’s customization to the customer needs. (Schmenner 1986) considers the level of interaction of the customer to the system, in contrast to Chase categorization who considers the time of the presence of the customer into the system (Schmenner 1986). He also highlights that a high customer’s interaction takes place when the customer intervenes into the service process. For example, restaurants and cafeterias have a high level of customization. The customer can choose what he wants to drink or eat. At universities, a student has a high presence during the delivery of the service but does not interact directly with the service process. He contrasts teaching with the healthcare delivery where the patient gives feedback, and the level of service is very customized. He mentions for example that hotels are simpler and more structured service systems than hospitals because in hotels the customer is present, but the customization is low, whereas in hospitals the customer is present but there is a high level of customization. He basically categorizes service systems based on three factors 1. The degree of labor intensity 2. The level of interaction with the service system and 3. The level of the system’s customization. Based on this categorization he identifies four different service sectors as shown in below table

Table 2. 3: The Service Process Matrix (Schmenner 1986, p.25)

Degree of Interaction & Customization

	Low	High
Degree of labor intensity	L o w Service Factory: -Airlines -Trucking -Hotels -Resorts & Recreation	Service Shop: -Hospitals -Auto Repair -Other Repair Services
	H i g h Mass Service: -Retailing -Wholesaling -Schools -Retail Aspects of Commercial Banking	Professional Service: -Doctors -Lawyers -Accountants -Architects

He considers hospitals to be as “high” regarding the degree of interaction and customization and low regarding to the degree of labor intensity. He recognizes that in industries as hospitals, capacity cannot be augmented easily therefore scheduling is of high importance.

(Schmenner 1986) adds also the labor intensity ratio. This is the ratio of people compared to the investment of the system. The author claims that hospitals have a low labor intensity ratio because although many people are working – at the same time a high level of investment is required. Based on the high investment needed, utilization of that investment is of high importance as well.

Ackoff's model.

Ackoff, on the other hand, categorizes systems based on their purpose (Ackoff 2001), and he categorizes systems in four broad categories as shown in table 2.4.

Basic types of systems

Table 2. 4: Ackoff's Categorisation (Ackoff 2001, p.344)

	Parts	Whole	Example
Deterministic	No choice	No choice	Mechanism such as automobile
Animate	No choice	Choice	People
Social	Choice	Choice	Corporations, governments, institutions
Ecological	Choice	No choice	Nature

Deterministic systems are systems which they have no purpose on their own. Their elements don't have any purpose either. A car can be an example which serves its higher system, but a car has no purpose on its own. Animated systems are systems which have a purpose, but their parts do not have any. An example is the human being or other systems where an individual is a system's part. Social Systems are systems which have a purpose as a whole, and their parts have their own purpose as well. Examples can be corporations, hospitals or a football team. Biological Systems which they have no purpose as a whole, but their elements are purposeful. An example can be the planet earth or a city.

Ackoff supports that mathematical modeling is appropriate for deterministic systems rather than social ones.

The main characteristic that distinguishes Ackoff's categories from other models is the level of "choice". Deterministic systems have no choice of behavior, their reaction is embedded in their design, they function according to strict and specific procedures. Social systems, on the other hand, can select how they will behave at a system's level and their element's level. Their purpose defines their motivation. Things can be very complicated for social systems when the parts of the system have different goals that the goal of the system they serve. When the goal of the parts of the system or the goal

of the system override the goal or purpose of the higher-level system then this is called sub-optimization, and this is a source of resistance and must be avoided. Need citations for Ackoff Refer also (Siha 1999b) article TOC and service organizations

Similarities of the models – manufacturing vs services

We find similarities between Ackoff's, Chase's and Schmenner's categorization. Lower-contact systems are closer to the deterministic part of the spectrum whereas higher-contact systems are towards to the social part of Ackoff's spectrum.

This distinction plays a vital role in the mode of our thinking. Deterministic systems are in a cause and effect mode of thinking (Ackoff 1979), whereas social systems can be understood from the system's thinking perspective (Ackoff 1979).

Since there are improvement methodologies which are borrowed from the manufacturing domain and used into the service domain some major distinctions between manufacturing and services need to be made. The differences affect the approach and the design of the improvement methodology's design. There are many differences between manufacturing and services such as customer influence, intangibility, perishability, and inseparability of production and consumption being some of the major ones (Nie & Kellogg 2009). Following Chase's model from table 2.1, the main differences between manufacturing and services exist because of the system's exposure to customer presence.

Some differences of the spectrum can be (derived from above models):

Level of Uncertainty: The presence of the customer can always affect the schedule of the system. Lower-contact systems can be more predictable because of the absence of the customer.

Load leveling: If a high-contact system does not operate based on an appointment method, then it will function on a forecast. Manufacturing systems (low-contact) can operate on a finite schedule model.

Social skills and abilities: high-contact systems demand that the front user uses social behavior rules and abilities than predefine and strict procedures. The presence and behavior of the customer define the level of communication between the customer and the system.

Efficiency levels: Direct contact with the customer, in most cases, does not allow efficiency methods like batching of orders or blockage of disturbances, etc.

Procedures vs. policies and rules: The lower the system's contact with the customer the more it is function and behavior can be quidded by procedures. The higher the customer impact the behavior is more quidded by rules, policies and social skills.

The main difference between manufacturing and services is that services need the presence of the customer for action to be triggered. Manufacturing does not need the presence of the customer. Manufacturing can be triggered due to a forecast request or due to an inventory status level warning signal.

The distinction between a service and a product is not very clear either. There is the notion that a service is something intangible so there is a debate whereas a methodology for manufacturing principles can be used for services as well (Brennan 2010, p.48).

2.3 Research in the Improvement of Healthcare Operations

In the services context, the customer is a part of the process service design. The customer experiences the outcome of the operations function directly.

Healthcare and Human Service Organizations (HSO)

Organizations that work on people are considered as human service organizations (Hasenfeld 1999). Their aim is to provide individuals and societies with growth and development (Larkin 2006). HSOs refer mainly to education, social welfare, and healthcare. HSO are in many ways different than business organizations (Edmonstone 1982) having the staff – client interaction at its core rather than an employee – product interaction. Focusing on healthcare, they include hospitals, medical centers, nursing homes, etc (Kouzes & Mico 1979; Edmonstone 1982). They seek to transform people from a state that is socially undesirable (ill) to a state that is socially more desirable (health) (Hasenfeld 1999). Human service in healthcare is based primarily on communication which usually is emotionally loaded (Brunton 2005).

Healthcare affects the quality of people and of communities directly. Healthcare is becoming progressively more and more complex (Martínez-García & Hernández-Lemus 2013). A very complicated segment where a “customer” or patient arrives and nobody knows what resources will be needed. Healthcare systems are complex systems (Klein & Young 2015). The complexity of the healthcare systems lies to the fact that the customer can enter any time (Bhattacharjee & Ray 2014) with nobody knowing what is exactly demanded, there is often a blend of different specialties, there is high expectations from the patients add high-level interaction between individuals.

Besides the complexity, healthcare is one of the most expensive sector of services, therefore, it seeks to optimize operational efficiency. Improvement is a necessity. Since most of the negative effects that are present in the healthcare delivery, fall into the operations management context, such as long waiting times, medical staff stress, medical errors, increased operating expenses etc (Jha et al. 2016), process improvement has been discussed through the lenses of operations management (Vissers & Beech 2005; Ronen & Pliskin 2006). The World Health Organization, supporting this view and suggests quality improvement initiatives in the healthcare context (Organization & others 2012). (Reid et al. 2005, p.14) brings into attention the fact the complexities of human diseases, human psychology, and difficulties in recovering health need to custom made improvement methods which will be implemented into the healthcare context.

Healthcare operations improvement has been approached through systemic lenses because of its complexity. (Matopoulos & Michailidou 2013) conclude that one of the main reasons is the lack of coordination among different healthcare entities. They give a systemic bias. Others have also tried to improve human services based on system thinking principles (Foster-Fishman et al. 2007).

The work of (Djellal & Gallouj 2005) divides improvement in hospitals in four main groups. The first is that of production functions. Phelps (1992) cited in (Djellal & Gallouj 2005) supports that there is no difference between producing a motor vehicle and producing health. The second is that of technological and bio-pharmacological capacities. The third is the information systems category. The fourth is that hospitals are seen as providers of complex services and healthcare system hubs. The authors try to see the different functions through a systemic perspective in order to understand what

drives innovation. Others have tried to represent healthcare through Systems Engineering modeling (Reid et al. 2005) and Discrete Event Simulation (DES) (Karnon et al. 2012).

Porter has coined the term “value chain” (Porter 2011)¹²². He proposes that health outcomes, composing the value, are: survival, ability to function, sustainability of recovery and length of care delivery (Kaplan & Porter 2011). He has applied the “value chain” into the healthcare context (Kaplan & Porter 2011), in order to analyze what are the healthcare outcomes and what is the cost of delivering those outcomes. Porter defines value as “health outcome per dollar spend” (Porter & Teisberg 2006). He calls for a systemic view of healthcare since the value is delivered through many different healthcare elements. The second part of the value equation is cost. The cost of delivering the outcomes is the cost of all resources, personnel (clinical and medical), drugs, equipment, consumables, etc. (Porter 2010) claims that there is a big confusion around the cost concept.

He offers a seven-step sequence in order to manage costs and be efficient (Kaplan & Porter 2011)

1. Select the medical condition
2. Define the care delivery value chain
3. Develop process maps of each activity in patient care delivery
4. Obtain time estimates for each process
5. Estimate the cost of supplying patient care resources
6. Estimate the capacity of each resource, and calculate the capacity cost care
7. Calculate the total cost of patient care

They also offer some guidelines on how to improve value

1. Eliminate unnecessary process variations and processes that do not add value
2. Improve resource capacity utilization.
3. Speed up cycle times.
4. Optimize the full cycle of care.

We observe the operational direction of improvement in the above proposals and point of views.

As (Litvak et al. 2005) highlights, study healthcare effectiveness from an operational point of view is critical. Returning to Schmenner's model a hospital is a service shop. It has a high degree of interaction and customization and a low degree of labor intensity which means that it requires very expensive resources. (Schmenner 1986) mentions that service shops like hospitals, plant, and equipment are the constraint, therefore resource utilization is very important. Operations management discipline has a lot to offer in this respect. Operations management in healthcare is an important topic that has motivated researchers to examine policies, tools, and methodologies to improve processes (Boyer et al. 2012). At the same time, managers and practitioners struggle with operations measurements since several decisions must be made, what measures, what to measure and what to do to improve measures (Elg et al. 2013).

Some of the methods used, have been adopted from the manufacturing domain and have been tailor-made into the healthcare context (Stratton & Knight 2010b; Hellström et al. 2010). Studies have shown that it is possible and effective to use manufacturing improvement methodologies in the healthcare context (Spear 2005) like Business Process Reengineering (Musa & Othman 2016), lean production and philosophy (Mazzocato et al. 2010; Kim et al. 2009), Total Quality Management (Swinehart & Green 1995), Six Sigma (Gowen et al. 2012) and others. There is a trend to manufacturing techniques in order to improve utilization, throughput, etc (May et al. 2011). Healthcare worldwide strives to improve operational processes in order not only to reduce expenses but to improve patient care, reduce waiting lines and cope with the complexity which healthcare faces. (Fox & Pirasteh 2011, p.17) highlights the fact that lean takes a lot of time to be implemented. It does not have a particularly focusing mechanism, and it is effective in mainly stable production environments. Literature reports that lean initiatives did not have the results expected and improvements made by Lean initiatives did not last for long (Poksinska 2010). Healthcare organizations need to focus on and improve their healthcare processes in order to become more effective. Although several improvement methodologies have been tested, there is not a clear and agreed framework of a continuous improvement approach.

Six Sigma lacks the measurements and a global approach (Fox & Pirasteh 2011, p.51). It also needs strong analytical skills (de Jesus Pacheco 2014).

The aim is not to prove one methodology better than the other but combine and augment the advantages of different approaches in order to have the best possible result. TOC is the latest of the evolution, and it is embracing synergy with other improvement methodologies (Fox & Pirasteh 2011; Coman et al. 1995; Ehie & Sheu 2005; Hudson 2017). TLS, for example, is a philosophy developed which combines Theory of Constraints, Lean and Six Sigma. TOC provides the means to focus whereas lean and six sigma tools are used to make the constraint more efficient (Pirasteh & Kannappan 2013; Pirasteh & Farah 2006).

(Yasin et al. 2002) recognises the fact that healthcare systems are open operational systems having an input which is transformed through a kind of a process into an output. This falls into the general modeling of operational production systems. They have researched applications of 7 manufacturing improvement methodologies, and the results have shown that there is an improvement and that manufacturing methodologies can be used in the healthcare context.

Figure 2. 1: Healthcare Transformational System (Chawla & Kant 2017, p.369)

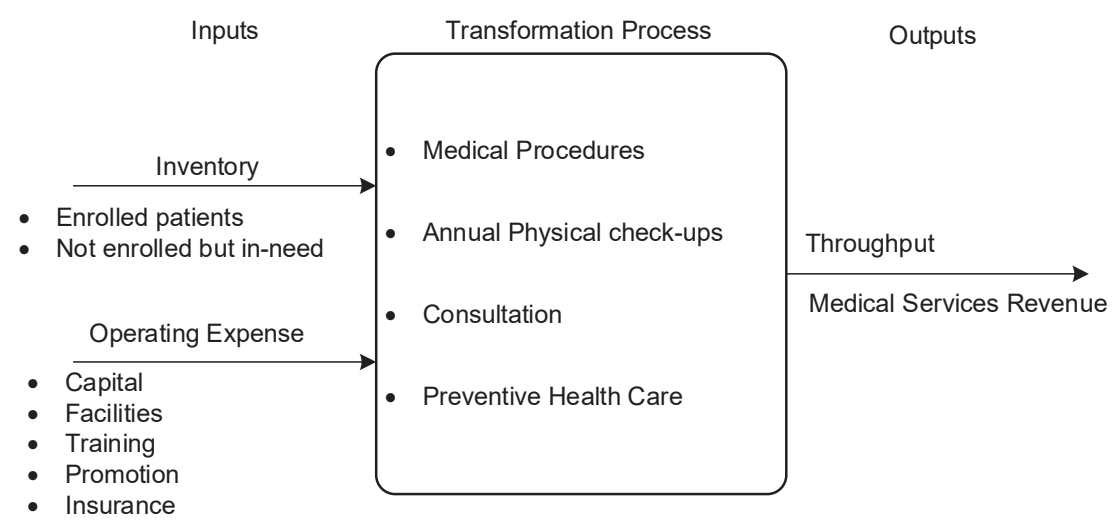

2.4 Theory of Constraints (TOC) in Services

TOC is an emerging very promising improvement methodology that can benefit services to a great extent (Cox III & Schleier 2010).

TOC is a methodology that evolved in the manufacturing world (Mabin & Balderstone 2003). The whole structure of TOC is based on the characteristics of manufacturing systems (Siha 1999a). The flow concepts, the measurements, the mindset, the metaphors used to describe TOC, they all refer to manufacturing activities where resources act on raw materials in order to transform them to finished goods (Balderstone & Mabin 1998). Tremendous improvements have been reported in manufacturing organizations increasing Throughput, minimizing Inventory and Operating Expenses (Motwani et al. 1996b). (Balderstone & Mabin 1998) has referred to more than 100 cases and all cases have reported successful results. This success is what has driven TOC practitioners and research initiatives to service operations (Motwani et al. 1996a).

TOC must be adapted though to the service context since services have differences compared to manufacturing. Terminologies and definitions may need to be changed (Motwani et al. 1996b).

Throughput in services, for example, can be conceptualized differently since no physical products are running through production lines. (Cox III & Schleier 2010, p.849) mentions several areas of differences between services and manufacturing environments such as:

1. The language and terminology are different. Terms like batch size, setup, buffer, etc are terms that are not widely used in services
2. Quick wins are more difficult to achieve in services than in manufacturing. Value and waste are easier to perceive in a production environment.
3. WIP is not physical. TOC's backbone is Buffer Management. Buffering and managing buffers in services are much more difficult because inventory is not physical.
4. Constraints are not visible since it is usually policies and behaviors.

At the same time, there are certain unique characteristics which make services distinct, such as:

1. The outcome of a service is not physical
2. There is a wide variety of service characteristics, in terms of customers, products, and ways of delivering
3. The customer is part of the process
4. Service organizations are usually labor intensive
5. Service system elements are more difficult to identify.

Despite the differences between services and manufacturing, there are indications that TOC is a very promising improvement methodology for services. (Cox III & Schleier 2010, p.862) claims that TOC can offer flexibility through time buffers, through the thinking process tools and by focusing on the constraint. (Motwani et al. 1996b) supports that TOC tools such DBR can be applied to services and that TOC's thinking process are very suitable for service environments. The Socratic method is ideal for managing people (Motwani et al. 1996b). Even though TOC implementations at the service sector are very limited compared to manufacturing (Castaño et al. 2013; Cox III & Schleier 2010, p.859), there is a growing interest of advancing TOC at the service environment. (Siha 1999a) Designed an approach of applying TOC to services. She compares and offers TOC definitions from manufacturing to the service context. The first countries that implemented TOC in services are the USA, Britain, Australia, and Israel (Castaño et al. 2013).

TOC implementations at the services sector can be found in education, banking, healthcare, etc (Castaño et al. 2013). (Shoemaker & Reid 2005) reports an application of the TOC thinking process tools in services. (Reid & Cormier 2003) explores how the thinking process tools can be applied in the service sector, (Taylor & Thomas 2008) discusses the application of TOC on an invoicing system, (Polito et al. 2006) use TOC to improve competitiveness in an airline business, (Klingenberg & Watson 2010) applies TOC thinking process tools to an intellectual property exchange etc. Most applications though are one TOC tool applications (Cox III & Schleier 2010, p.848).

2.5 TOC and Healthcare

Healthcare is one of the biggest sectors of services. TOC has been applied to healthcare, but little has been reported (Cox III & Schleier 2010, p.899). We have managed to locate only 37 published articles discussing TOC in healthcare in academic journals discussing a range of different healthcare topics. From the 37 published articles found, eight are published the last three years. There are many more written and available free on the internet.

Improving a system can be in terms of flow (Karnon et al. 2012) or in terms of variability (Litvak & Long 2000). (Litvak et al. 2005) highlights especially the importance and the effect of variability in healthcare operations. Because TOC and DBR manage variability then we can assume that healthcare context can be greatly benefited. TOC has been applied to emergency departments (Taylor & Nayak 2012; Villarreal et al. 2018; Sabbadini et al. 2014; Rotstein et al. 2002; Strear et al. 2010), to management of patient flow (Stratton & Knight 2010b; Bahall 2018) to hospital bed management (de SOUZA et al. 2016), in scheduling healthcare systems (Mohammadi & Eneyo 2012), in controlling healthcare systems (Lubitsh et al. 2005; Umble & Umble 2006), in medical decision making (Hunink 2001; Mabin et al. 1999), in medical claims (Taylor III, Lloyd J; Sheffield 2002), in capacity management (Tsitsakis et al. 2017), in managing change in healthcare (Ritson & Waterfield 2005), there is also a number of articles discussing the usefulness of TOC into healthcare environments (Tabish & Syed 2015; Motwani et al. 1996b; Breen et al. 2002). There is also a small number of books discussing TOC in healthcare such as (Ronen & Pliskin 2006; Cox III & Schleier 2010; Boaden et al. 2008; Dinham 2011; Nelson & Sproull 2015; Wright & King 2006).

(Motwani et al. 1996b) offers a great interface between the manufacturing world and healthcare regarding TOC concepts, adjusting terminology and measurements.

In order to better understand the behavior of TOC two subsystems have been chosen and based on Chase's model is that of the Operating Room and that of the housekeeping and more specifically the linen management system.

2.6 TOC and Hospital Logistics

Patient care effectiveness is supported by a series of operational activities which manage the flow and the handling of different materials and physical goods, such as pharmaceuticals, surgical medical products, linen, food and many others (Moons et al. 2019). Management of materials is one of the key cost drivers in a hospital. Hospital logistic costs consume more than 30% of the total operating expenses (Volland et al. 2017; Landry & Philippe 2004). There is an increasing research to reduce logistic costs mainly because cost reductions in logistics do not directly affect patient care.

Logistics in hospitals can be divided into external logistics which include services between external suppliers, transportation to other healthcare units, etc. The other category of logistics is the internal logistics which comprise the movement of physical goods within hospital services (Rais et al. 2018). Physical goods include food, linen, medicines, samples, waste, etc. Complexity and many operational challenges characterize the internal logistics in hospitals (Moons et al. 2019).

Logistics techniques in healthcare are lagging compared to other sectors (Moons et al. 2019) although advanced techniques using automated guided vehicles have been reported (Fragapane et al. 2018). (Moon 2004) highlights the importance of further research and strategy development on healthcare supply chains.

Linen supply is closely related to the patient's health and safety (Afreen & Iqbal 2009). Linen affects the well-being of the patient since they provide a comfortable bed, prevent pressure sores and generally feeling pleasant to the touch (Larsson & Berg 1991). Linen covers all the clothing items such as blankets, bed sheets, towels, doctor's, nurses' and patient's uniforms, surgery special clothing, etc. Linen availability also affects the overall system's effectiveness. Lack of bed linen can increase the bed cleaning time (de SOUZA et al. 2016).

Some research has been conducted regarding the hygiene of the linen (Afreen & Iqbal 2009; Taylor 1988). (Banerjea-Brodeur et al. 1998) have applied operational management concepts to linen delivery operations with successful results regarding time savings and smoother operations whereas (Sandy L. Furterer 2012) have applied Lean Six Sigma to reduce linen loss.

(Landry & Philippe 2004) highlights the fact that internal hospital distribution subsystems can be a nightmare taking into consideration not only the linen distribution but also pharmaceuticals, office supplies, food, maintenance etc.

There is no published work discussing the Theory of Constraints in improving linen processes. The only articles found discussing TOC in supportive healthcare systems is (Aguilar-Escobar et al. 2015) which focuses on the management of medical records in a hospital and (Taylor III, Lloyd J; Sheffield 2002) which discusses information management through an analysis of the TP Tools to medical claims processing.

2.7 TOC and Operating Rooms (ORs)

The demand placed on ORs is increasing mainly due to the aging population (Chung et al. 2017). Today 60% of hospital revenue can come from surgeries (Cochran et al. 2016; Rothstein & Raval 2018), but at the same time, ORs are resource intense and costly hospital units (Jebali & Diabat 2017; May et al. 2011). At the same time, other scarce hospital resources are depending on OR activity to be utilized (Jebali & Diabat 2015). Cost management and minimization of inefficiencies in operating rooms are the top priorities of healthcare professionals (Wasterlain et al. 2015; Reznick et al. 2016).

There is a high complexity in OR operations mainly because of the uncertainty of arrivals and the special needs of the patients (Grida & Zeid 2018). The systemic nature of healthcare processes adds to the ORs complexity because inefficiencies or lack of resources in other functions affect the OR efficiency, e.g. bed limitations (Jebali & Diabat 2017).

The power of performance of the OR is crucially dependent on the cooperation of the surgical, anesthesia, nursing and allied health professionals involved.

Operating Rooms efficiency is addressed from different perspectives, time management, scheduling (Malhorta 2006), workflow, capacity (Jebali & Diabat 2017). Improvement methodologies have been tested in ORs, but there is clearly an ever-increasing interest for further research (Rothstein & Raval 2018).

Most research in general conducted at operating rooms deals with how to reduce waiting lists (Grida & Zeid 2018; Siddique et al. 2012; Jebali & Diabat 2015).

Research in Operating Rooms is mainly focused on scheduling issues and capacity improvement. TOC's way to manage capacity issues is the Drum Buffer Rope (DBR). Only four publications have been found discussing TOC in Surgery and none discussing DBR in ORs. The three TOC implementations in ORs are (Sahraoui & Elarref 2014) discussing cancellations at the surgery department, (Lubitsh et al. 2005) who has implemented TOC in a Neurosurgery setting and has reported no improvement, (Grida & Zeid 2018) who applied, in a quantitative study, the 5FS in a system dynamics model and have observed a 6% increase in throughput and by (Kimbrough et al. 2015) reports great improvement into a surgery setting of a trauma centre by following TOC philosophy.

According to our knowledge, there is no published paper in any journal of any ranking discussing research of DBR and logical thinking process tools at the subsystem and functional process level of operating rooms in a hospital.

2.8 Gap Identification

Services are growing and research of TOC in services is still limited (Castaño et al. 2013; Cox III & Schleier 2010, p.859). TOC is not widely accepted despite its reported success (Fox & Pirasteh 2011, p.28). Ronen mentions that TOC community is a closed community sharing information from specific sources (Cox III & Schleier 2010). More research is needed to help TOC adaption (Cox III & Schleier 2010, p.875).

The literature of TOC in healthcare is very limited, and it is even more limited at the surgery function. (Kimbrough et al. 2015) highlights the fact that there are no clear recommendations to guide the use of improvement methodologies of healthcare processes. More research needs to be done in more specific parts of healthcare (Mohammadi & Eneyo 2012). TOC tools are mainly used in isolation. Few "complete" TOC applications have been reported (Balderstone & Mabin 1998). (Cox III & Schleier 2010, p.871) supports that DBR is still a challenge when applied to services. The practical usefulness of TOC as an improvement methodology is well-established and documented but not in the academic context (compared to lean and other improvement

methodologies). Based on the literature it is evident that TOC has not been in the focus of academic research in healthcare. At the same time, TOC has been proven to be a very successful methodology for manufacturing and project environments (Mabin & Balderstone 2003). Lately, academics have started researching TOC philosophy, but it is still unresearched (Gupta et al. 2013). Most of the research is done in English speaking countries. More research is needed focusing on other cultures and other healthcare systems (Lubitsh et al. 2005).

(Mohammadi & Eneyo 2012) supports that more research is needed on TOC in healthcare whereas (Ronen 2005) reports that there is a need for more research despite the reported TOC successful applications. He continues that academics and practitioners need to validate TOC concepts further. To the best of the author's knowledge, no application of Drum Buffer Rope methodology at the Surgery function down to the process level has never been published. The researcher contacted Ronen, and he confirmed that no DBR application to the surgery environment is known.

There is big room for validation of TOC's underlying theory (Gupta et al. 2013). (Gupta et al. 2002) gives the direction to test TOC successful applications in order to validate its theory.

Since there is a big need to further improve the healthcare sector and TOC is an improvement methodology with great results, but at the same time under-researched in healthcare, there is a big interest to research the effectiveness of TOC in healthcare further. TOC is completely unknown to Cyprus and very rare is found in Greece. DBR and logical thinking Process tools are never researched at the functional level of the Operating Rooms although it has been proved to be very effective in the flow management through a system.

To our knowledge, this study is the first that will contact research and apply DBR in a surgery department down to the process level of its function. At the same time, this is the first study which will apply TOC at the housekeeping function of linen management system at the private clinic in Cyprus.

In order to cover the spectrum of the systems defined by (Chase 1978) a high customer contact has been chosen and this is the surgery department and a low customer contact system which is the linen management system at the housekeeping function.

Since TOC research at healthcare is limited, DBR is not tested at the surgery department before, TOC is not tested at the linen system, adaptation of TOC suffers and there is a great interest in testing in other cultures and languages. There is a great interest for this research to enhance the TOC literature in services, especially in healthcare focusing in the surgery department and at the housekeeping function.

2.9 Purpose Statement and Research Objective

Following the identified gap in literature from the previous section, the purpose of the Thesis is twofold: First to advance the topic of the healthcare operations management by researching the effectiveness of TOC in the surgery function as well as in hospital logistics and secondly to build new knowledge and make a new contribution to the management science through the application of TOC – as an operations improvement methodology in the private healthcare segment into the service context.

It is of ultimate importance to continue research of TOC in healthcare and especially at the surgery department. Operating rooms are the most expensive resources of a hospital, and high utilization rates are needed first to satisfy the patients and secondly to justify the investments. The implementations at the hospital logistics will enhance the understanding of TOC characteristics to supportive systems so managers and supervisors at different levels and different functions can benefit from the advantages of the Theory of Constraints.

This work aims to contribute to the bodies of knowledge of the healthcare and services organizations – it also aims to deepen the understanding in the Theory of Constraints domain.

Accordingly, the main research objective is “to explore the degree of effectiveness of the Theory of Constraints methodology in the operational environment of a private general-purpose clinic/hospital in Cyprus taking also in consideration the obstacles to acceptance by the people exposed to TOC concepts”. This objective needs to be met to fulfill the previously mentioned purpose of the Thesis.

2.10 Research Questions

In order to fulfill the research objective which in turn will fulfill the purpose of the research, below research question, must be answered.

The main research question is: “Can the application of the TOC lead to operational improvements in the healthcare sector, at a private general-purpose clinic/hospital in Cyprus?”

The main research question seeks to answer if TOC can improve operational healthcare processes. To improve is to change. TOC approaches change by answering three questions 1. What to change 2. What to change to 3. How to cause the change. The answer to the main research question has to go through the above three steps of change. The research takes into consideration also the human acceptance factor since change goes only through people. The aim is to apply as many tools as possible and as the process of the implementation demands in every step.

To best answer the question, TOC should be investigated in the two sides of Chase’s model explained in section 2.2.1.

Therefore, below sub-research questions have been designed with the steps of change as a compass.

What to Change

1. **Sub-research question one:** What is the constraints limiting the potential of the existing operational environment of the linen management system and the operating rooms?

The first sub – research question seeks to surface the constraints prohibiting improvement in the two systems selected. TOC has dedicated designed tools for surfacing constraints and analyzing them. The methodology distinguished symptoms from problems and based on cause and effect logic seeks to identify core problems.

To What to Change to

2. **Sub-research question two:** What is the desired solution which will elevate the performance of the constraints, if implemented at the linen management system and at the operating rooms?

Once the problem is identified the next step is to decide on the solution. This sub – research question investigates the effectiveness of the TOC tools and methods of designing a systemic solution which when implemented will elevate the performance of the whole system without causing new undesirable effects.

How to cause the change

3. **Sub-research question three:** What are the main difficulties identified during the implementation of the proposed solution to the existing functionality of the linen management system and the operating theatres?

The third sub – research question focuses on the obstacles of the implementation. The answer to this question will identify any weaknesses and areas of improvement from the previous sub-research questions at the design phase.

4. **Sub-research question four:** How can the above difficulties be overcome?

The most important thing is to test and find out how TOC tools can help overcome implementation obstacles.

Evaluation

5. **Sub-research question five:** Has the performance improved, of the linen management system and the operating rooms after the implementation of the TOC?

This sub – research question evaluates the whole process. Instead of looking at every step (as the previous sub-research questions) the performance of the overall system is evaluated and concludes if the implementation is successful or not.

6. **Sub-research question six:** What were the special challenges that the employees at the private hospital were facing regarding the adaptation of TOC? This research question focuses on human behavior. It seeks to highlight the main issues which prohibit people from easily accepting the TOC methodology. In

the gap identification section, one of the needs identified is to make TOC more acceptable by people.

7. **Sub-research question seven:** Were there any unanticipated outcomes and how important were they?

The answer to this last question is to throw light on any outcomes which were not addressed by the research questions, outcomes which were not expected, or they surprised us.

2.11 Chapter Summary

This Chapter has discussed the research direction in the services and healthcare contexts. It has analyzed the literature discussing TOC applications into the healthcare subsystems, and through the analysis, the research gap was defined, the research objective and the research questions were extracted and discussed.

Chapter 3

Philosophical Assumptions and Methodology

3.1 Introduction to the Chapter

The previous chapter explained the need for the research. This chapter explains the philosophical assumptions and how the research design ensures that the research questions developed in chapter 2 will be answered.

The following chapter discusses in detail the research strategy and design of the intervention. We adopt (Saunders et al. 2009) research onion to explain the research design – but first, we discuss the philosophical perspective and the theoretical models.

Figure 3. 1: Research Onion (Saunders et al. 2009)

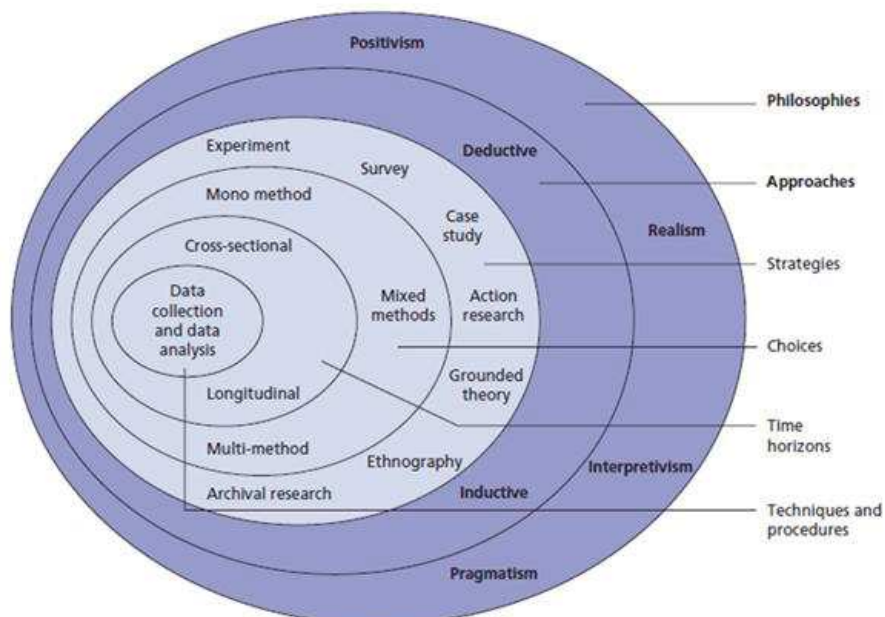

3.2 Philosophical Perspective and Theoretical models

The theoretical framework discloses the paradigms, methodology, and methods of the researcher. Theory of Constraints evolves in the theoretical operations management context with a systemic approach (Berry & Belle 2005).

(Gupta & Boyd 2008) suggests that the Theory of Constraints can serve as a general theory in operations management. They conclude that TOC offers a new paradigm in operations management after their analysis of the relationships between TOC and traditional Operations Management concepts. (Davies et al. 2004) add to (Gupta & Boyd 2008) the fact, that TOC can be seen as a methodological set that embraces and can be embraced by the Operational Research and Management Science and that it can be used to understand their characteristics and the philosophical assumptions underpinning them. (Watson et al. 2007) recognizes that TOC has been evolved from a production scheduling software package to an integrated management philosophy extending and deepening many operations management disciplines. (Naor et al. 2013) have examined the TOC characteristics and have concluded that TOC satisfies the overall requirements of a good theory under the Operations Management context of theories.

Since TOC uses logic-based modeling and analytical tools (Berry & Belle 2005), this study will be guided by an overall qualitative research approach supported by quantitative techniques to verify or to reinforce qualitative findings where needed (Morgan 1998). The goal will be to improve the workspace, uncover assumptions and evaluate results. The methodology will be mainly qualitatively supported by quantitative, interpretative and logical mind-set.

The ontology which guides the research philosophy is that of constructivism with an interactive/ transactional and subjective epistemology. TOC TP tools are developed to surface assumptions, problems, internal conflicts, and beliefs. This TOC characteristic assigns an epistemological position towards a "constructivism" philosophy than of the positivism one which holds the view that the world operates with a determined way. According to (Creswell 1998, p.20) the world under this philosophy gets a subjective

meaning and understanding. Constructivism is mostly concerned with how individuals and groups create meaning in their everyday lives (Littlejohn & Foss 2009, p.557). Constructivism is dominant in the qualitative environment (Creswell 1998, p.3).

Constructivism philosophy can also embrace a pragmatic stand (Saunders et al. 2009, p.598). This is because pragmatics see reality as something under constant change and transformation (Given 2008, p.160). Therefore, researchers under this philosophy are focused on results, actions and constant change (Creswell 1998, p.22). Reality is continuously redefined depending on the outcomes of every action. Finally, pragmatism is placing the answer to the Research Question to the highest priority (Saunders et al. 2009, p.109).

This research adopts a constructivism philosophy from a pragmatic stance.

3.3 Research Approach

Constructivism adopts inductive logic (Morgan 1998). Inductive logic uses direct observation of the actual empirical world and concludes people's actions and activities (Given 2008, p.221). John Stuart Mill, a British philosopher, argued that inductive logic is the proper starting place for justifiable knowledge (Given 2008, p.910). (Mill 1884, p.375) adds that inductive logic is the test of proof which is required to extract meanings from something observed. Inductive logic means that generalizations are produced from specific observations (Trochim 2006).

3.4 Research Strategy

The research strategy should make sure that the research question will be answered properly. Since the research purpose is to test the effectiveness of the TOC in a specific context and at the same time collaborate with the employees to understand the acceptability challenges, a relative strategy should be chosen. Qualitative strategies are the most appropriate to address the perspectives of individuals (Creswell 1998, p.287).

We support that the best way to understand and evaluate the effectiveness of the TOC in the healthcare context is that of the action research. As (McKay & Marshall 2001) have explained, the action research is a research methodology which combines both practice and theory. (Coghlan 2011) adds that the researcher together with the

employees develops action plans to address the problems and to implement them. They evaluate the outcomes of the actions and they re-plan accordingly. This action research thesis aims to assist in practical problem – solving and expand scientific knowledge in a complex social environment such as the healthcare system. Social research has two interests in its core, the general laws of a society and the diagnosis of a specific situation (Lewin 1946). The chosen research strategy is the action research implemented in two case studies.

The research methodology will state the way and the method that the research questions will be addressed. This research will follow an exploratory and explanatory approach. It will seek to investigate HOWs and WHYs in order to find the root causes and reasons for under or for over performance.

The subsystems chosen from the healthcare context were based on the (Schmenner 1986) services spectrum as explained in section 2.2.1. One system was chosen from one side of the spectrum - the low customer interaction and customization – and this was the linen management system. The other subsystem was chosen from the opposite side of the services spectrum – the high customer interaction and customization – and this was the surgery department.

These two subsystems are discussed in this research as two different case studies.

The research will be concerned with the resolution of healthcare issues such as the implications of change together with those who experience the issues directly. Great emphasis and focus will be given to action. Throughout the research journey - knowledge and its substance will be continuously questioned and validated. The research will take place in Cyprus and specifically in the private sector in Limassol.

Action Research has been practiced in healthcare studies. (Koshy et al. 2010) provides a complete guide of how to apply action research in healthcare. (Plantin & Johansson 2012) used action research to investigate scheduling improvements in a surgery setting. (Morrison & Lilford 2001) discusses that healthcare can benefit from action research. (Cifalino & Baraldi 2009) evaluated training programs in healthcare using the action research approach. More specifically, action research proved to be a successful approach in continues improvement efforts like (Potter et al. 1994; Hellström et al. 2010).

Following Kurt Lewin's Model (1946). This research methodology follows the sequence shown below and it is composed of four main phases – each phase addressing different issues and seeking to validate specific outcomes. The first phase seeks to investigate what to change. The second phase focuses on the design of the future solution. The third phase will put the TOC into practice based on the previous two phases – it will focus on the practical testing of the theory and finally, the final phase will seek to extract, verify and formulate the results and extract conclusions about the TOC effectiveness in the healthcare sector. It will also cover weaknesses, strengths, and improvements to the TOC theory in order to have practical utility value.

Figure 3. 2: Action Research Cycles (Saunders et al. 2009)

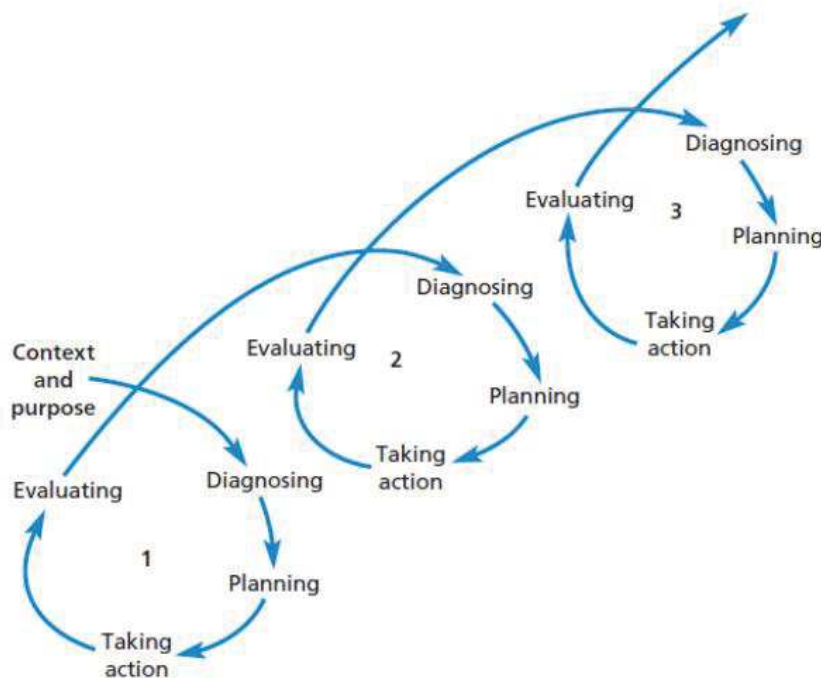

Employees were involved throughout the research process in order to scrutinize the findings of every phase. In order to answer the research questions and satisfy the research objectives, the researcher has come in agreement with the largest private clinic in Cyprus. The analysis is done by personal observation, by interviewing doctors and personnel. The research design process is contacted with the aim to answer the sub-research questions. The first phase of diagnosing aims to answer the sub-research question 1. The second phase of Planning aims to answer sub-research question 2. The third phase of Taking Action aims to give answers to sub-research questions 3 and 4 and finally the Evaluating phase will seek to answer the sub-research question 5.

Table 3. 1: Research Questions and TOC

Research Questions	Three Improvement questions (Eliyahu M Goldratt 1990, p.8)	Action Research phase (Hutchin 2001, p.142)	TOC TP tools
Research Question 1	What to Change?	Diagnosing	Current Reality Tree / Evaporating Cloud
Research Question 2	What to Change to?	Planning	Evaporating Cloud / Future Reality Tree / Negative Branch Reservation
Research Question 3,4	How to cause the change?	Action	Prerequisite Tree / Transition Tree
Research Question 5,6,7		Evaluation	

We explain figure 3.3 toc/action research from the Research Action’s perspective and steps.

The first phase – (Diagnosing). The aim is to create a “profound knowledge” of the system under research, (Zabada et al. 1998). This is the initial exploratory phase of a qualitative nature. (Coughlan & Coughlan 2002) break down this phase to Data Gathering, Data Feedback, and Data analysis. The diagnosis is happening before the intervention in order to understand what drives a “problematic” behavior (Lewin 1946). Diagnosing helps surfacing problems and identifying dilemmas prohibiting effectiveness (Flood 1999, p.105).

The next step of the first phase will be to identify the constraint. This will be done by contacting interviews, and by personal observation. The constraint can be a physical resource or a policy limiting system performance. The description of the core dilemma will be the aim of this phase. TOC thinking process tools will be used to analyze and surface hidden assumptions. At the same time, TOC measures will be placed into the systems measuring performance. After the collection of data – analysis will take place and constraints will be surfaced. All these observations will help to identify what limits the system or the systems and what factors are affecting the behavior of the specific healthcare system.

At the end of the first phase, a baseline will be created which will be used for future comparison or as a benchmark. The baseline will represent the system without the improvement and it will be used for future improvement verification at the end of the thesis.

The second phase – (Planning) The planning phase aims in creating a plan and formulating a solution with a set of actions that will create the new future state of the system. The output of this phase is the modeling of the future solution. Answers to sub-question 2 is the final target. The changes to be implemented are presented, discussed and approved by the management of the hospital. The TOC tools to go through this phase are the Evaporating Cloud / Future Reality Tree and Negative Branch Reservation.

The third phase – (Taking Action) is the implementation of the solutions. At this point execution and action take place. As explained this is done after the agreement of the management of the hospital and it is done using the resources of the clinic. Pure action research methodology is used following the cycle shown in fig 1. Answers to sub-questions 3 and 4 are the outcome of this phase. In this phase TOC tools were tested, new procedures, rules, and policies were placed to drive desired behaviors.

The fourth phase – (Evaluating) is to evaluate the new system and start extracting measures of the new operation under the TOC methodology. Procedures, laws, and structures are examined. The answer to the main research question is in focus. In this phase, measurements are compared with the baseline of phase one, and they are presented on a dashboard.

Figure 3. 3: Action Research and TOC

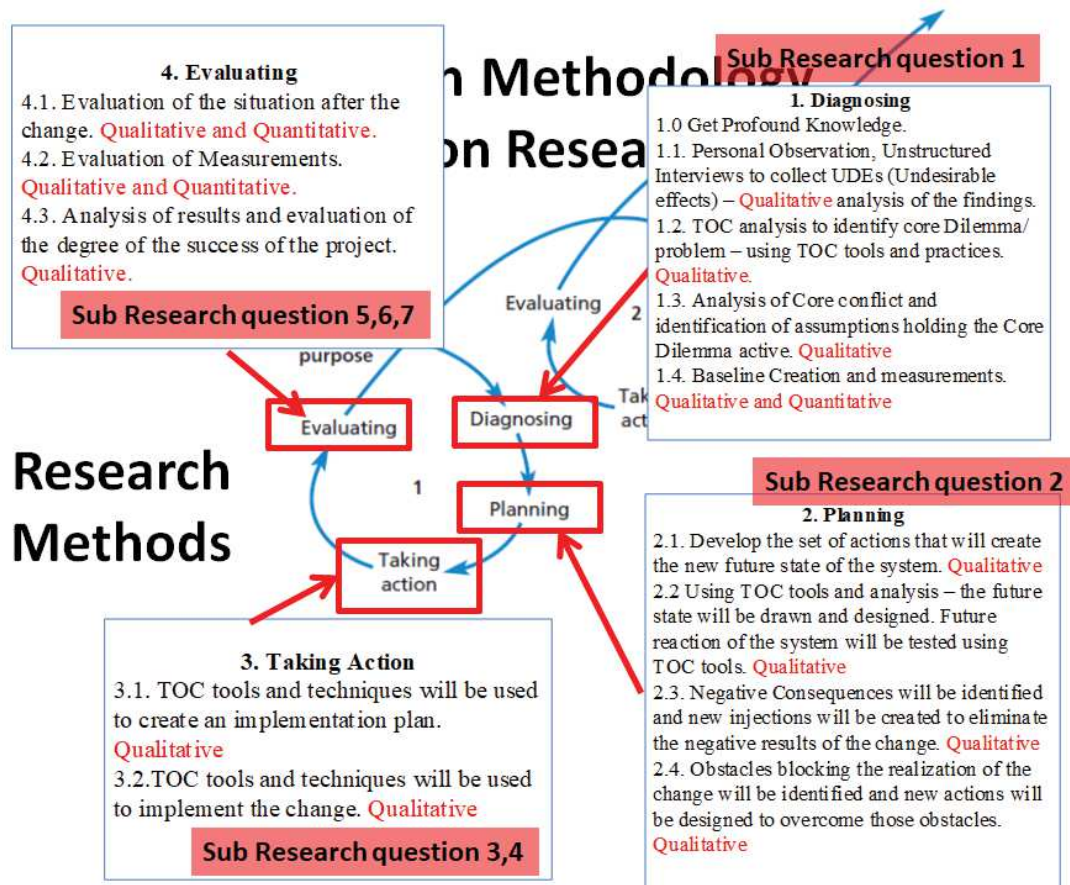

Figure 3.3 summarises the action research synthesized with TOC into one philosophy, emphasizing the techniques to be employed.

3.5 Methodological Choices

The implementation of the TOC is following the action research spiral shown in figure 3.2. Focus and efforts are narrowed every time more and more as the TOC methodology is progressed and tested.

Since a constructivism ontology was selected the main methodological choice is qualitative but, in many cases, quantitative was used as well. Therefore, as the research unfolds a mixed method is chosen as a methodological choice. Mixed methods approach means that both qualitative and quantitative data collection techniques are used (Saunders et al. 2009, p.152). Mixed methods research draws the advantages of both qualitative and quantitative approaches (Creswell & Creswell 2017, p.203). Mixed

methods have been developed mainly for practical applications (Kouritzin et al. 2009, p.172).

Although the main methodological choice is qualitative, in both case studies quantitative methods are used in order to validate assumptions, identify constraints, set measures etc. Quantitative methods as capacity calculations, cycle times, task durations and time analysis calculations are used according to the action research requirements at every stage.

The mixed method approach is towards a pragmatic approach, which gives more emphasis on what works best in every situation (Ary et al. 2018, p.559). Mixed method is a well-accepted method of capturing data in action research healthcare studies although the emphasis is given to the qualitative part of the process (Koshy et al. 2010, chap.6).

3.6 Data collection and Analysis

The data collection methodology comprised of both qualitative and quantitative. The main approach though is qualitative.

The Theory of Constraints Thinking process tools is information driven (Dettmer 2016a). The nature of the research strategy demands that people are involved throughout the process. People were participating actively in the construction of the trees and to the implementation of the tools, so data was feeding the tools constantly in different forms.

The researcher had official approval by management to contact the research, but this was not enough. Trust was needed to be developed and be accepted by the people in the workplace, so they can open up and participate freely. This level of interaction with the people in the field was informal and needed to be maintained daily. The more frequent the interaction, the friendlier people would become. Paying attention to them proved to be vital, listening to their complaints, their proposals, listening seemed to be powerful. At the same time, contributing with knowledge on the methodology, additionally participating in discussions and in some meetings seemed to be very fruitful since we had fresh eyes. This frequent contact allowed us to ask questions and get a deeper understanding of their thoughts and of their environment.

For primary data collection – Observation and Interviews (Semi-structured and unstructured) were used and explained below.

Participant Observation

Firstly, the main way of capturing data was that of **participant observation**. Participant observation is a common and accepted way of gathering data in action research approaches (MacDonald 2012) and generally in qualitative studies (Creswell & Creswell 2017; Adams et al. 2007, p.109).

Participant observation can be used when a study and understanding is required of a group of people, culture or context (Dawson 2002, p.32). It allows first hand, raw observation of an actual setting (Kouritzin et al. 2009, p.109). The researcher participates in the activities of the individuals and becomes a member of their group (Saunders et al. 2009, p.289).

The data through the case studies were collected with the active participation of the researcher. The researcher was actively involved in enhancing the concept of the action science research. The researcher was also an agent of the change since he was acting as a facilitator for building the tools but also guiding the project teams with questions and methods. The participant observation method allowed us to observe what people actually do instead of only what they say they do. It is a very efficient method for providing empirical data.

(Greener 2008, p.46) brings into attention the fact that participant observation can raise ethical or biased issues. The researcher is not an employee of the hospital and not into the healthcare business. This fact provides the researcher with objectivity, which balances the subjectivity that accompanies qualitative research.

All employees participating in the research knew precisely what was happening and what was the purpose of the study. They participated voluntarily, therefore there are no ethical issues.

Participant observation proved to be very beneficial.

Semi – Structured and Unstructured Interviews

Secondly, **semi-structured** and **unstructured interviews** were used to collect UDEs, form goals and objectives, identify critical success factors, necessary conditions and validate assumptions. According to the circumstances semi-structured or unstructured interviews were selected.

Interviews are an accepted way of gathering data in qualitative research (Greener 2008; Cohen & Crabtree 2008), in action research studies (Koshy et al. 2010; Atweh et al. 2002) and in healthcare environments (Denton 2013; Koshy et al. 2010).

Unstructured interviews were preferred when the subject was known and when we were trying to gain a deeper understanding of the situation. It was also preferred when sensitive subjects were discussed like people's relationship with management or when we were discussing with nurses about the doctors etc. They provide the researcher with a holistic view of the situation (Dawson 2002, p.27).

Semi-Structured interviews were preferred when we needed to talk with key people, available time was limited, and expectations were well defined. Although this type of interview gives some degree of freedom, the boundaries of the topic are respected and followed (Sreejesh et al. 2014, p.48).

Frequently, both interviews were used interchangeably as supported by (Rothwell & Sullivan 2005, p.291). Although unstructured interviews are less precise – they give the freedom to acquire freely more information. An open-ended question can be used and then invent new questions depending on the answer.

The most vital issue was to gain access. Access to busy groups, where everything seems to be urgent. This urgent environment provokes multitasking. This busy environment was one of the biggest obstacles for the research. Informal interviews seemed to work best since they provided the researcher with flexibility.

3.7 The research field

The hospital which will be used as a research field is the largest private hospital in Cyprus.

The Private Hospital is the oldest private hospital in Cyprus. It was established in 1983 and commenced operations in 1987. It is the largest and one of the best equipped private hospitals, situated in the heart of Limassol.

- It is a clinic based in Limassol, and it covers an area of 9000 m².
- The clinic served 13,365 patients in 2014 with 28,183 overnights.
- The clinic has 152 beds, but maximum utilization is measured on 146.
- It performs surgeries through 9 Operating rooms.
- The clinic operates under an open model approach, and it has come in agreement with 245 associate doctors who use the infrastructure of the clinic.
- It covers almost all specialties, and it is divided into several different sections such as Casualty, pediatric, Surgical, maternity, Endoscopy unit, radiology department, Oncology, Diabetology, Gynaecology, and many others.
- It has a workforce of 600 people.

Detailed descriptions of the actual operations are described in the case studies.

3.8 Ethical Issues

In both case studies, the visits and the entry to the hospital were done by gatekeepers.

From the first meeting with the management and with the employees and project team members it was very clearly explained what the intention was and what the purpose of the research was.

Data collection methods were clearly defined – it was not allowed to take any type of document outside of the hospital and the names of patients were kept confidential. No photographs or video recording was allowed. It was allowed though to record ourselves as a way to keep field notes.

It was agreed that the name of the hospital and the names of individuals would remain confidential.

Before every interview, the topics and the purpose of the interview were clearly explained.

The participation of the project team members was volunteer, and they informed the members in their groups about the purpose of the research.

3.9 Chapter Summary

The chapter analyzed the research design and strategy which will answer the research questions. The research structure was discussed through the research onion and every step provided information on how the research fits the research onion components.

Action Research is the preferred research strategy which has many similarities and forms a natural fit with the TOC. It was also explained how the action research synergizes with the TOC philosophy and tools and what is the research strategy which guides this research.

Chapter 4

Analysis and Findings: Theory of Constraints (TOC) in the linen management system

4.1 Introduction to the chapter

This chapter presents the methodology and the results of the implementation of the Theory of Constraints in the linen management system of a hospital. The purpose of the chapter is to explore the effectiveness of TOC at the specific housekeeping sub-system – the linen management system.

This is the first case study of this research - the linen management system was selected for the following three reasons:

1. Management faced a problem in this particular field – being consistent with the action research philosophy, a real problem has to be selected, and this is what management considered one of the problems at a specific moment. Management was concerned with the high costs of running the department. An investment was approved to extend the laundry section in order to increase the capacity and reduce the overtimes.
2. Management wanted to get familiar with the TOC before the research was progressed to a more “healthcare” type sub-system, meaning a high contact with the patient. The linen system was providing a “safe test-field” to test TOC with low risks involved.

3. Epistemological reasons. The linen was providing a new area for applying TOC since this is the first research of TOC into the linen. Linen is a system with a low degree of labor intensity and low degree of interaction and customization based on the work of (Schmenner 1986) and (Chase 1978) system's categorization. It is more of a "manufacturing" like environment into the healthcare context which in general is a system with a high degree of interaction and a high degree of customization. Acknowledging the behavior of TOC in this environment would enrich our understanding of the potential synergy of TOC with healthcare and in services in general.

The second case study (TOC in the surgery department in chapter five) covers the other side of the system's spectrum which has a low degree of labor intensity but a high degree of interaction and customization so the two extremes are covered through this research giving a much wider perspective of the TOC framework and applicability.

Structure of the Chapter

The chapter consists of four sections as displayed in table 4.1. The sections are based on the action research theory which is in complete harmony with the Theory Of Constraints improvement approach (Section 3.3). All action research phases took place at the linen management system of the hospital.

The first section is the Diagnosis phase or in TOC terms the "What to Change" phase. This section consists of four action steps, from action step 1 to action step 4. In this section, an analysis takes place in order to find what constraints the system. What is the reason that the system is not getting better? It is a step toward answering research question 1.

The second section is the planning phase or the "What to Change to" phase. This section consists of two action steps, from action step 5 to action step 6. This phase is designing the future with the constraints elevated. This is "the solution design phase" and seeks answers to research question 2.

The third section discusses the implementation of the plan constructed in the previous phase. It is composed of eleven action steps, from action step 7 to action step 17. This

is the intervention stage. This is the phase where plans are implemented. The solution designed in phase two is becoming a reality at this step. The intervention unfolds through eleven action steps seeking answers to research questions 3 and 4.

The last section is the results or evaluation section which summarises the results extracted in the seventeen previous action steps. The aim is to answer research questions 5,6 and 7

As explained, the methodology is to describe the theoretical part of every action step and then describe the actual implementation. The difference between the theory and the practice is the actual result of the intervention.

The data is collected through unstructured interviews, through observation, and field data collection. The data gathered in every action step is going through data analysis by using the TOC tools. The TOC tools used is a blend between the Five Focusing Steps and the Thinking process tools.

The results are focused on the soft and the hard part of the system. Results are reported at the end of each section, and they are all summarised at the evaluation section. Since the tools follow a sequential order, it was not possible to present the results in a different chapter than the methodology one.

Table 4. 1: Structure of Chapter 4

Section	Action Research Phases	TOC Change Questions	Action Steps	Research Question
1	Diagnosis	What to Change	Action Step 1 to Action Step 4.	Research Question 1
2	Planning	What to change to	Action Step 5 and Action Step 6	Research Question 2
3	Action	How to cause the change	Action Step 7 to Action Step 17.	Research Question 3 and 4
4	Evaluation			Research question 5,6 and 7

4.2 What to Change - Diagnosis

4.2.1 Action Step 1 – Current Reality Tree (CRT)

What is the need for the action step?

The first step of the action research is to diagnose the situation figure 3.2 in search of identifying the core problem responsible for the negative performance of the system (Azhar et al. 2010). This is also in agreement with the first change question of TOC which is “what to change” (Davies et al. 2005). Both approaches seek to identify the problem; that is, what needs to be changed in the existing reality to improve the entire system.

TOC answers the first change question with the Current Reality Tree tool (Gupta et al. 2004). A tool which captures and maps the problematic nature of the system via sufficiency thinking.

How should the tool be applied? (Theory)

Staying consistent with the mainstream of literature, the Thinking Process Analysis begins with the Current Reality Tree. According to Goldratt, the first step of building a CRT is to collect some Undesirable Effects (UDEs). As per (Scheinkopf 1999) ten to twelve UDES should be collected. The UDEs would be collected via semi-structured interviews with nurses, personnel and management. Then, a CRT would be constructed, in order to analyze the data collected (UDEs) using cause and effect relationships which maintain the presence of the UDEs. The aim is to find the Critical Root Cause (CRC) and eliminate it in order to elevate the whole system. The CRC is what keeps the UDEs alive; therefore, even if they are resolved, the CRC will regenerate them. The CRT is a logic-based structure supported by sufficiency thinking in order to reveal the CRC through “tight” logical cause and effect analysis (Dettmer 1997).

The first step was to enter the research field in order to understand how the system functions, in terms of product flow and information flow. The most important though was to familiarise ourselves with the people working the linen system. We had to feel comfortable with each other and build a relationship of trust if we were to work together

for some time. The housekeeping supervisor played the role of the gatekeeper. Before every visit, she would be contacted, and she would accompany us to the research field.

Literature reports that TOC is a common sense and straight forward approach, so we wanted to investigate the degree of its applicability with the help of the people in the field.

What actually happened in the research field (Practice)? UDE Collection

The first step was to construct a project team. The project team was composed by the Nursing Care Manager, the housekeeping supervisor and a lady from the laundry with excessive experience in the field. The Nursing Care Manager selected the project team because she knew the people, their capabilities and their motivation.

The idea of the constraint and the Logical Thinking Process were explained to them. It was evident from the first minutes that it would be a difficult task to educate the people about so many operational concepts that they had never heard of. Everything was very new to them.

The interviews began with the management and basically with the Nursing Care Manager and the financial manager. They reported that their real concern was the operating expenses. The biggest part of the operating expenses was the overtime hours and the purchasing of linen. To avoid the overtime working hours, they even had decided to extend the laundry area, as they wanted to buy two more washing machines.

The next source for the UDEs was the head nurses from the wards. During the interviews, they claimed that they often suffered from availability issues. They reported that they often had excess linen from one kind and nothing from another. A doctor mentioned, *“this is a private hospital, linen should be available at all times and no specific policy is needed”*.

Finally, the last source of information was the housekeeping personnel working in the linen system. They complained that nobody would understand them and despite their hard work, they were not appreciated. They did not consider that they had any serious issues except the ones that the wards were creating. They claimed that they were extremely busy.

We managed to collect twelve UDEs. These were the following:

Table 4. 2: Action Step 1 - UDEs for Current Reality

Undesirable Effects	Description	Mentioned by..
UDE 1	We are spending a lot of money buying linen	Management
UDE 2	We do not know what is happening	Management
UDE 3	Place is untidy	Management
UDE 4	Nurses come to pick up linen on their own	Nurses
UDE 5	We do not know how many linen we have in the system	Management
UDE 6	We do not know how we are performing. We have no measures	Employees
UDE 7	Linen ended up being destroyed at the washing process	Employees
UDE 8	Nurses are throwing away very dirty linen - these are not recorded	Employees
UDE 9	We pay too much overtime hours to the workforce in the housekeeping function.	Management
UDE 10	Management is dissatisfied with the performance of the linen function	Management, Employees
UDE 11	Nobody appreciates what we do	Employees
UDE 12	Nobody understands my problems	Employees

Results of Action Step 1

Even from the first visit, people become very defensive. During the whole process, the laundry personnel was very skeptical towards the experiment. It was evident that they felt threatened and they were becoming defensive. Added to that, they were quite reluctant to share their worries or problems. They did not know why they should change. They would not accept that they had problems to solve and they strongly supported that whatever problems existed, were caused by the other departments.

At the same time, they became very suspicious and they were very reluctant to participate in anything. They believed that there was no need for change. They actually believed that management was behaving with hostility and that they wanted to "spy" on them. They were focused very intensively on their own environment, on their own silo. Moving to UDEs analysis and CRT construction seemed something unthinkable.

Negativity had dominated their behavior. A fresh start was needed. A structured training process was decided in order to introduce people to TOC concepts and explain the whole initiative.

4.2.2 Action Step 2 – Training process

What is the need for the action step?

Based on our observation of people's behavior and reactions from action step 1, we concluded that formal training was needed. The outcome of the training needed to be trifold; **The first objective** would be to convey to people that their behavior is not the point of focus but the improvement of the system. The first objective was to overcome the first wall of resistance and remove fear that so easily was erected in front of us. **The second objective** (the target is the system) of the training would be to explain what system's improvement meant and to convince people why the system should change. People had no idea of the concept of a system, as their job was to finish their daily tasks and go home. **The third objective** (the target is to build skills. The "how" to improve) of the training would be to explain to people the basic idea of the technical context of the theory of constraints.

A structured approach for the intervention was required to be designed.

Training Process

From the comments that we received while in the field, it was evident that people needed communication, information, explanation, knowledge sharing, and positive intention. The first few months in the field illustrated that people could never follow academic terms, academic thinking, jargon words, and highly complicated slides.

TOC is a systemic methodology, so the training structure was based on those two concepts. In order to enhance understanding, the power of metaphors was used (Morgan 1997) to convey certain messages, for example in order to explain the idea of the system, the metaphor of a "car" was borrowed by (Ackoff et al. 2006); a car is a device that everybody is familiar with; it has specific and defined boundaries as well as a clear function and purpose. The second was the notion of a river, to explain the concept of the flow. This is what Ford used in his efforts to explain his "flow" concept (Fox & Pirasteh 2011, p.4).

The purpose of explaining systems would be to create the right mindset for TOC understanding. TOC is a systemic methodology and systems' knowledge is a necessary requirement for TOC understanding. By focusing on systems' view, it was expected that people would be convinced that the system's structure is what is important and that functions, people and departments in the hospital are all interrelated. This would be to fulfill the first and the second objective.

The next step would be to describe the TOC process briefly. The experience with the UDEs and the first attempt to build a CRT taught us that we should take things slowly and progressively. All the jargon words should be abandoned. The first step would be to explain to them the whole picture of TOC, the whole approach, without mentioning trees and complicated logic structures. TOC is all about improving flow through systems, which may be structured by physical elements or by conceptual elements. The metaphor of the river would be used to explain the flow through the different sections of the system.

Management consensus was required about the availability of people. The management's reply was positive, but they also mentioned that something fast was expected and that too much analysis was not necessary. The lack of time forced us to keep the training sessions short and frequent.

The whole approach would be explained to all the personnel and not only to the project team. We asked for the availability of the training room. The people had never received training before. It was a great opportunity to discuss and build a common understanding. This gathering was very useful because people needed to be heard, not only by us or only by the management but also among each other.

After becoming familiar with system concepts, their own system was analyzed and presented in terms of functions. Surprisingly, TOC does not have a tool to map current reality, that is to map how a system functions. The only representation of reality is the CRT which is a snapshot only of a negative part of the problematic part of the system. System's literature describes the FBD graphical representation. In order to represent the current state of the system, we used the FBD (Functional Block Diagrams). In Figure 4.1 a high level of linen FBDs show how the system works and how these functions create a whole which produces clean linen at the wards. The different functions were discussed with the team, and we were establishing a common knowledge base. There were different perceptions and different opinions in a fairly simple system as the linen. A more detailed decomposed FBD can be found in Appendix 2.

Figure 4. 1: Linen flow - Functional Block Diagram (FBD)

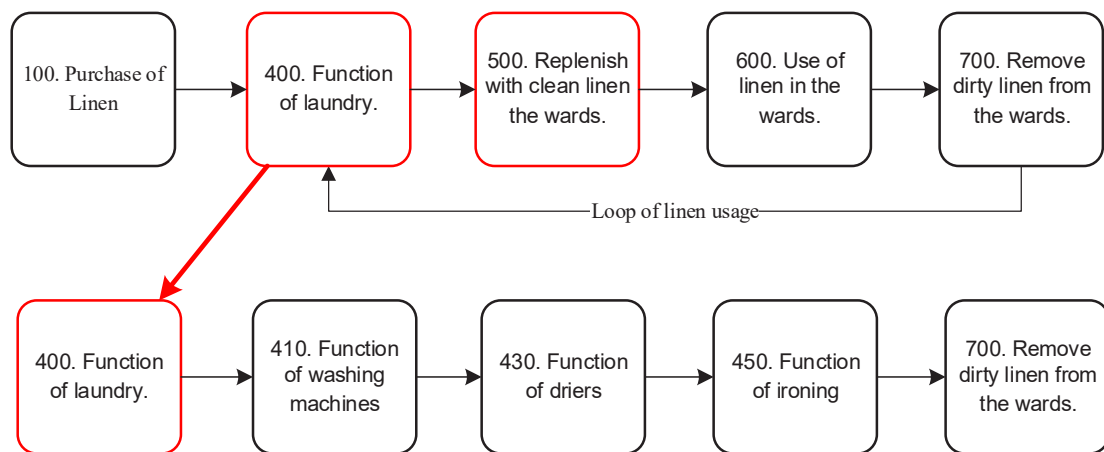

The next step was to agree on the flow; the visual representation of the system (figure 4.1) was displayed clearly so it was easy to conclude that the flow would be kilos of linen flowing through the system. Used linen would arrive at the laundry; they would be washed, dried, ironed, folded and distributed back to the wards then lastly the nurses were making the beds for the patients who kept generating more used linen.

Most of the training was done at the workplace presenting to people the flow and discussing the different characteristics of the system during the work.

Description of the operation

The laundry function is the heart of the linen management system. It is located on the fifth floor of the hospital. There are five washing machines, three driers, and two ironing presses. Ten people are working in the laundry function split into two shifts. The linen is washed, dried, iron and folded. Then they are placed on trolleys, and the housekeeping personnel distributes the linen to the different wards. There are closets on the wards where linen are stored. The housekeeping staff replenishes the linen empirically.

Next day the nursing staff replace the used linen with clean ones. The used linen was placed in dedicated trolleys, and they were returned back to the laundry by the housekeeping staff. Then the circle was repeated. Linen is replaced daily.

The operation works in two shifts – from 7:00 to 15:00 and the second shift from 14:00 to 22:00 and it is functioning seven days in the week, Sundays were considered overtime.

4.2.3 Action Step 3 - Goal Tree (GT)

What is the need for the action step?

During the first action step, it was attempted to collect the UDEs to build the CRT since it is the first step of the Thinking process tools. This raised a block of resistance from people since they did not know why a change was a necessity.

Being in accordance with the main body of TOC literature, the first step towards improvement was to answer the first question which was "what to change". This question seeks to find out what makes the system weak; what is constraining growth. There are also authors who introduce an additional question before the three and this is the "why to change" question. There is a limited number of articles found in TOC literature discussing the "why to change" such as (Tabish & Syed 2015; Mabin et al. 1999; Dalci & Kosan 2012), but they do not discuss the "how to answer this question", they do not describe any tool or any methodology except Bill Dettmer's contribution in (Dettmer 2016b).

A brief description of the Goal Tree (GT)

The idea of the Goal Tree (initially named IO Map) was invented by Bill Dettmer in (Dettmer 2003). It is a recent tool which is under research, and the only guidance available is that of Dettmer (Motwani et al. 1996b). The purpose of the tool is to show how the goal of the system is connected with its critical success factors and how these critical success factors are connected with the necessary conditions. It is a logical necessity representation of all the conditions and functions that must be in place to realize the goal of any system. This necessity structure displays the minimum that must be fulfilled for the system to deliver its goal.

The Critical Success Factors are the system's outcomes from different functional perspectives which are very close to the goal of the system. The Critical Success Factors are necessary conditions of the system which must be realized for the goal to be achieved.

With the completion of the Goal Tree the ideal state of the system would be defined in terms of needs and functions. That ideal state would be the yardstick against which current reality would be compared. The gap between the ideal and the current system's status would be the reason to change the system. It would be the answer to the "why to change" question. A more detailed explanation of the Goal Tree is in section 1.4.2.

Dettmer himself trained the researcher to be able to build the Goal Tree and the other logical tools. The training took place in Paris for one week in June 2016 and it was done for the purposes of this research.

How should the tool be applied? (Theory)

To answer the "why to change" question, we would develop a Goal Tree by following the guidelines given by Dettmer in (Dettmer 2016b, p.86) – look in appendix 3. (Before the training by Dettmer, the development was under the name of IO Map as in (H. W. Dettmer 2007) which is a very similar book to (Dettmer 2016b).

The goal and the critical success factors would be discussed and set by the owners of the system including its managers. Then the project team would define the Necessary Conditions and their relationship in order to satisfy the Critical Success Factors.

All the data would be collected from the participants and then a first draft of the tree would be developed. Then the team would fine-tune and scrutinize the tree. The data would be collected by asking participants questions like, “*if I have condition A then unavoidably and without any reservation would the next step condition B be realized?*” The Logical Thinking Process Tools are information-driven; the more information, the more scrutinization and the more the knowledge about the system the more robust the trees will be. The data collected would be synthesized instead of analyzed with the Goal Tree's logical structure.

What happened in the research field (Practice)?

According to Dettmer’s instructions, the first step is to define the system (Dettmer 2016b, p.86). During training, the system was defined by showing the flow of the linen through it, including the functions which affect the flow of the linen. The system’s elements coordinating the flow were indicating the system’s boundaries.

The second step was to define the goal. Since the goal is set by the owners (who keep the system in existence), it was asked by the Nursing Care Manager and the managing director to set the goal of the specific system. The answer was clear and straightforward; “*serve the patient effectively by providing patients with clean linen so they can be treated safely and experience proper care*”. There were some reservations though, providing the patient with clean linen was not done buy the linen system as defined but from the nurses of the wards, since they were replacing the linen. From the point of view of the managing director, the goal should also include a cost element. After discussing and analyzing the goal statements the team concluded as final goal statement “*Provide the wards with clean linen in an effective way*” – the fact that the nursing staff managed the linens at the patient level changed the terminology of the goal.

Identification of the Critical Success Factors was the next step. The term “effectiveness” in the goal statement was translated by the two Critical Success Factors which formed two main branches of the Goal Tree as shown in figure 4.2. One of the branches focused on the availability of the linen at the wards and the other branch focused on the operational cost element.

The necessary conditions below the critical success factors translate the critical success factors in a language which is understood by the system.

Figure 4. 2: Goal Tree

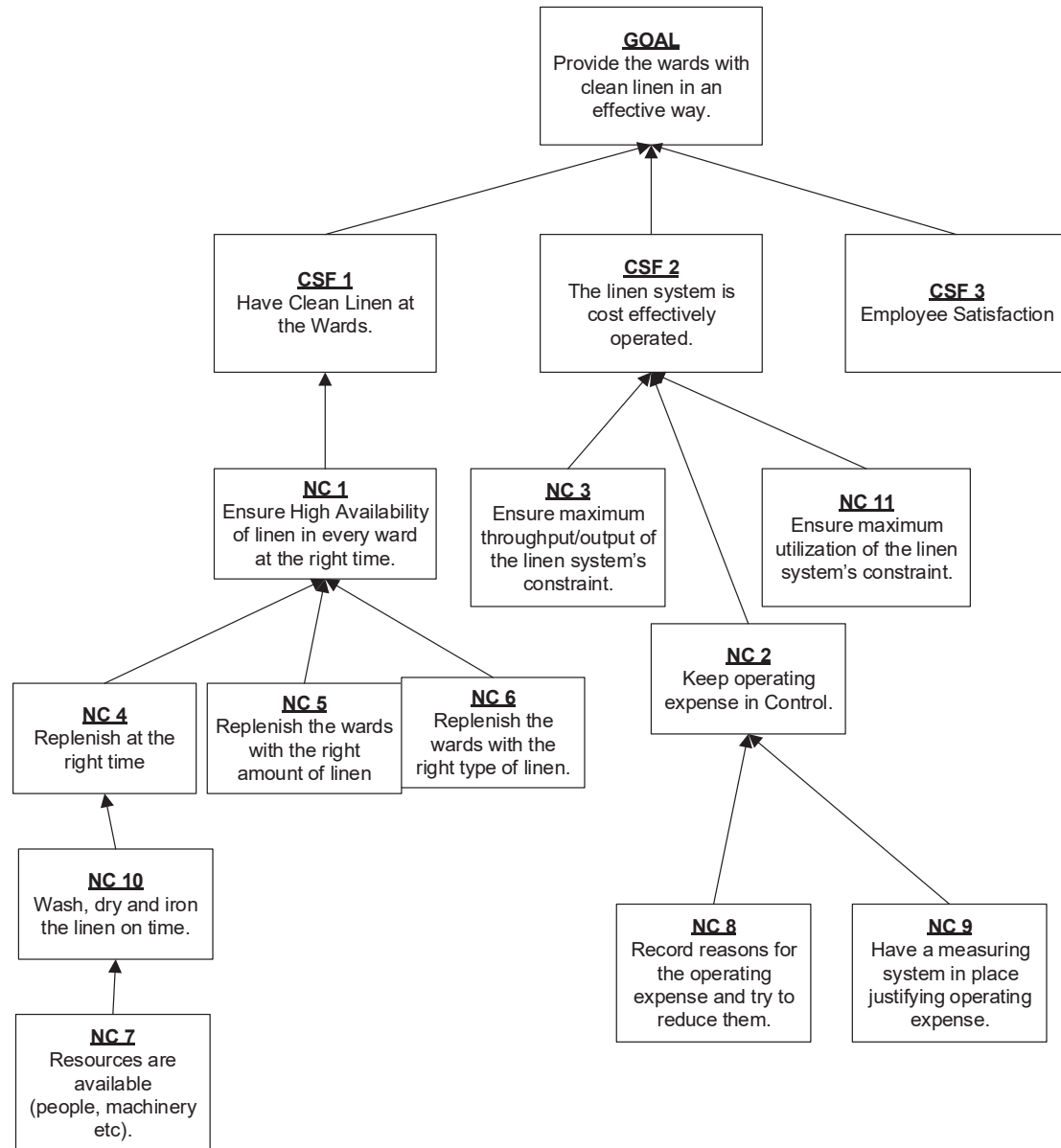

The **first** branch - that of the availability branch decomposed the meaning into three elements – “Replenish at the right time” - replenish the right type and replenish the right amount.

The **second** branch, one of the financial part of the system focused around the nature and the management of the constraint. The team suggested that the system will be cost

efficient when the constraint of the system operates at maximum throughput at maximum utilization.

The **third** branch was added because employees are the most valuable resource in the hospital.

The project team members were in a position to follow the logic of the goal tree but with rigorous guidelines.

4.2.4 Action Step 4 - Gap Analysis and Current Reality Tree

What is the need for the action step?

Having finalized the Goal Tree, the next step would be to compare it with the current reality. The resulting gap would be the answer to the “why to change” question. The gap would be the driving force behind action. By closing the gap, the whole system would move closer to the Goal Tree, that is closer to its ideal state.

The gap analysis should be able to define the distance from the ideal status in terms of Undesirable Effects. The UDEs should define the gap but also its nature. The output of this step should be three to four UDEs (Dettmer 2016b).

How should the tool be applied? (Theory)

The process is defined by (Dettmer 2016b, p.148). We would challenge and compare every CSF and every NC of the goal tree with the current reality. We would seek to evaluate how and in which degree those necessities are fulfilled or not. (Barnard 2016) supports that the gap analysis step validates the importance of the problem. (Singh & Singh 2012) on the other hand proposes that the gap analysis is an audit process and can be done continuously to be aware of the status of the system. Dettmer suggests that the UDEs to be collected should be maximum of four UDEs in contrast with the mainstream literature which suggests approximately ten UDEs. The data would be collected via semi structured interviews.

The gap analysis is actually a data capturing step which will be analysed during the next step by the Current Reality Tree.

What actually happened in the research field (Practice)?

The gap analysis started by considering the CSFs and NCs one by one and compare it with the current reality. The Goal Tree was first evaluated with the management. They believed that the linen system could be managed more efficiently. They were not convinced that there were any serious availability issues, so they focused on the costing part of the Goal Tree. In their opinion, the system was very expensive, and they believed that the whole issue would be improved by buying two additional washing machines since they would finish sooner. In fact, they were wondering why the study had not shown that so far, since it was so obvious for them. They ignored NC3 and NC11 because they did not understand what a constraint is or why the systemic nature of the system was mentioned so frequently. When asking them why they considered it to be expensive, they admitted that this was just their impression. They did not have any specific methodology for managing the system. It was simple after all, as it was merely about washing linen. They focused their concerns on two major expenses; overtime hours and buying new linen.

The next step was to discuss and get the input of the direct customers of the system, the wards. The responsible nurses responded that very often they faced availability issues. This was a remark from almost all of them. They did not have any comments regarding costs and operational issues; they focused on the first branch, which is the availability side. They said that frequently they were out of stock and they had to call or go themselves to the laundry to pick up clean sheets, towels etc.

The progress was evaluated through different meetings with the project team. After that they were further discussed at the working place in front of all employees. The workers started providing excuses and they claimed that they were doing their best and that nobody could understand them. Later, they concentrated on the employee satisfaction branch. They complained that nobody understood them or that no one recognised their effort and that they worked really hard. Discussions went on for days and everyone would jump frequently into solutions.

The results of the gap analysis were the following three UDEs:

1. The linen system is not effectively managed

2. Sometimes there are no clean lines at the wards when needed.
3. The linen System is not cost effectively operated.

These are high level systemic UDEs. These UDEs are effects and outcomes, they cannot be solved per se. Something causes those UDEs to exist. That would take us to the next step, where a detailed analysis would take place to analyse the root cause of these UDEs. In other words, to find what was causing these UDEs to exist. The data analysis tool would be the CRT.

What is the need of the action step? Current Reality Tree (CRT)

Goldratt claims that the UDEs exist because a root cause hidden away of our awareness causes the UDEs to exist. Dettmer calls these causes Critical Root Cause (CRC). The aim is to analyse the UDEs, dive down to the CRCs and solve it or cease it of existing. Then the UDEs will stop occurring.

Different improvement methodologies use different techniques. For example, the lean uses the 5whys or the fishbone diagram etc. TOC's tool for analysing current reality and finding the CRC which generates the UDEs is called Current Reality Tree (CRT) (Mabin et al. 1999). Dettmer reports that what we see and what we experience as drawbacks and we perceive as problems, are actually symptoms which are caused by a deeper cause.

A brief description of the tool -- CRT

The CRT provides a systemic, graphical representation of a snapshot of the negative part of the reality. It is systemic because the logical connections come from different parts of the system which contribute to the negative situation. It is simply a capture of the negative part of the reality, and the selection of the UDEs define the boundaries of that specific part. Goldratt explains that CRT is an appropriate tool to be used in the analysis of the negative aspect of reality.

The CRT is a proven technique, and it has been researched to a great extent. Once more, the guidelines of Dettmer will be used as described in (Dettmer 2016b, p.148) – look appendix 4.

The UDEs have already been collected so they will be used as a starting point. The team would participate, but we would seek further clarity from others as we proceed with the construction of the CRT. Again, the team is not in a position to focus on the technicalities of the CRT. Therefore we would construct it with their input and then we would discuss it all together.

A more detailed description of the CRT can be found at section 1.4.2.

How should the tool be applied? (Theory)

By following Dettmer's guidelines, a table was created with the UDEs at the top, followed by two lower level causes.

After identifying the causes, the logical structure connecting them with the UDEs was developed. The aim was to penetrate further down the tree, highlighting a cause which we could take as the Critical root Cause (CRC).

The figure 4.3 and figure 4.4 is the resulting CRT that is created from UDE 1 and UDE 2 and because of those UDEs it is being focused on the availability issues whereas the branch in figure 4.4 is concentrated on the analysis of the costing logic.

Figure 4. 3: CRT part 1

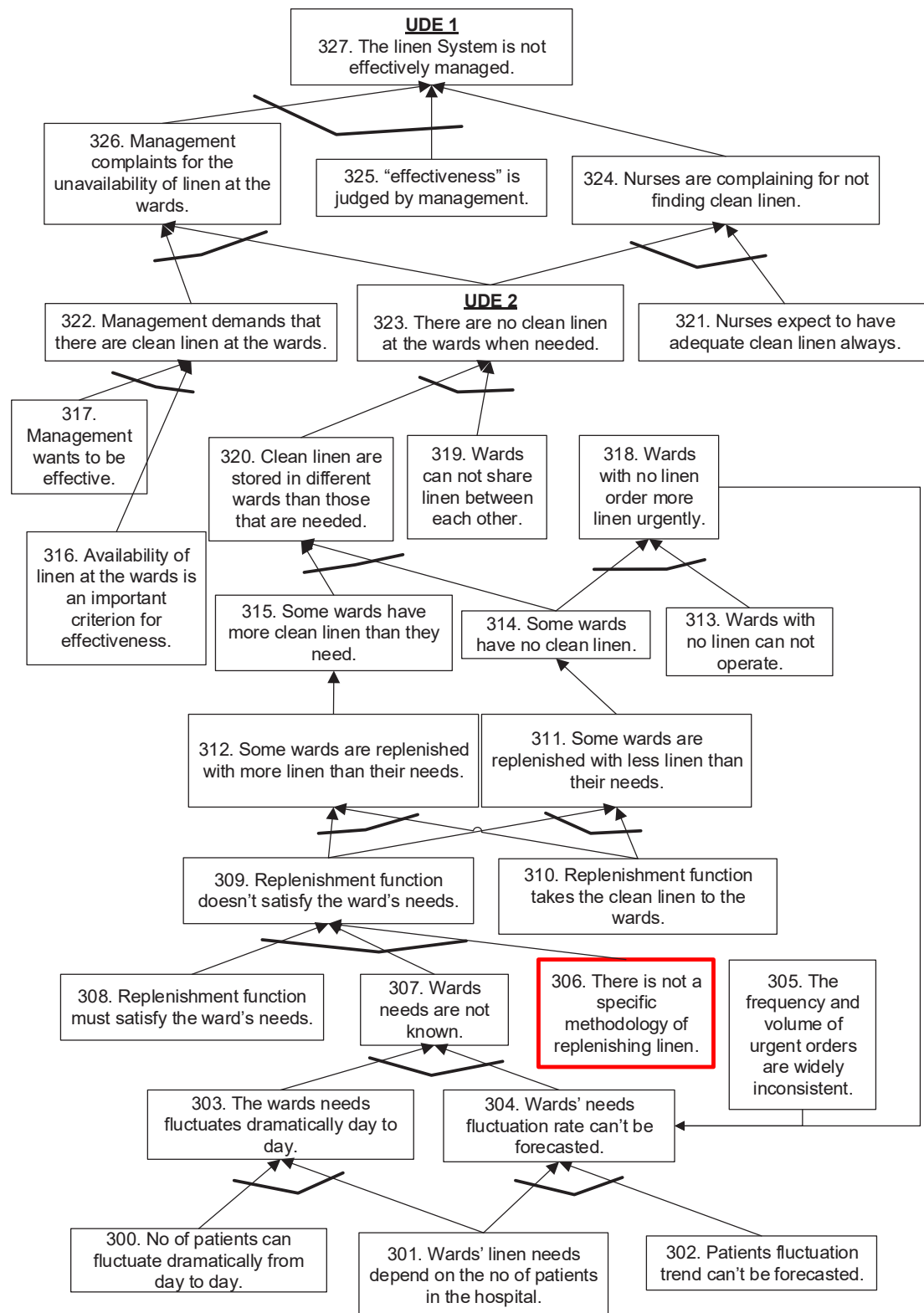

Branch 300

Figure 4. 4 : CRT part 2

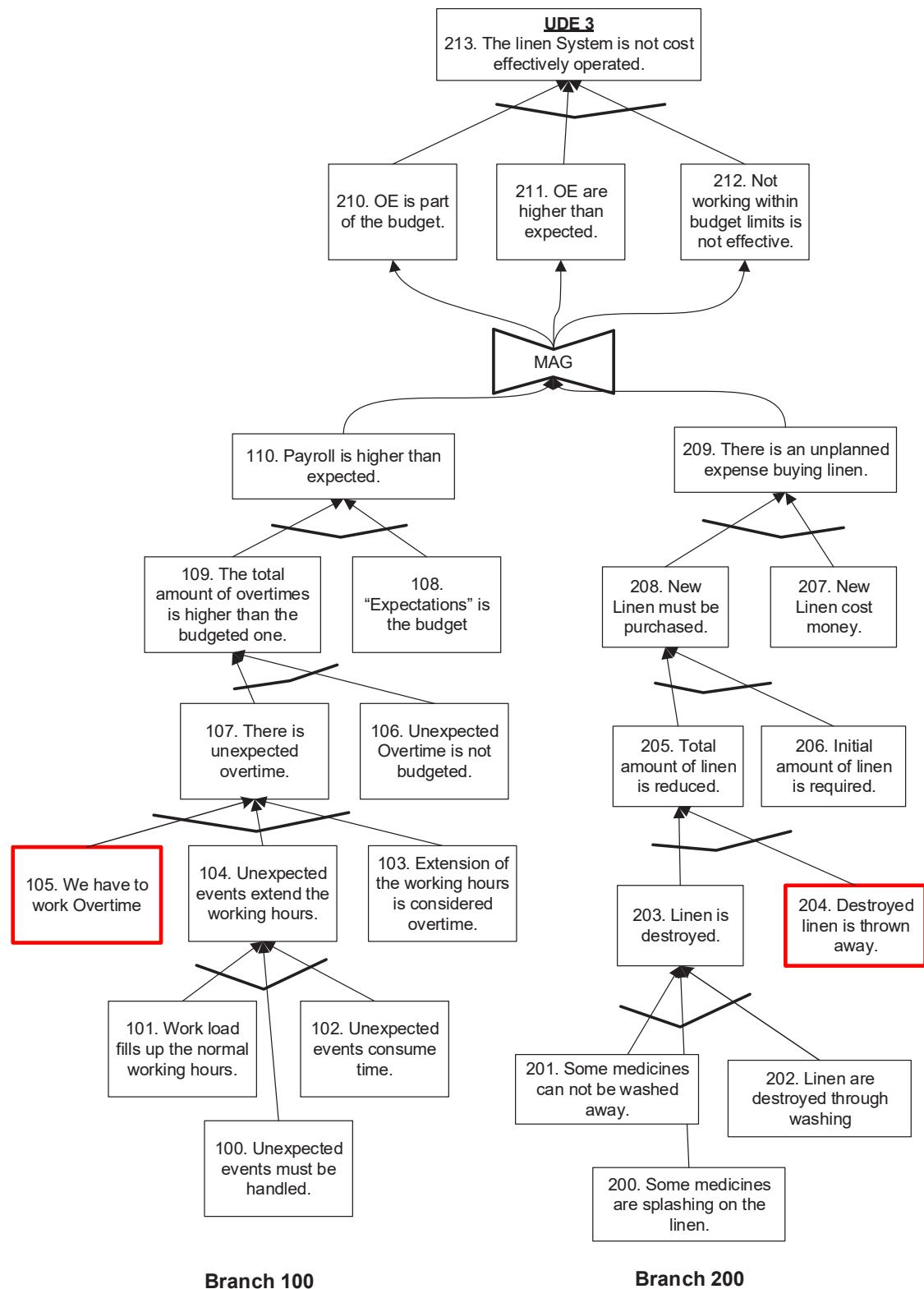

Results of Action Step 4

Critical Root Cause 1

From the CRT in figure 4.4 entity 105 was identified as a **CRC1** "we have to work overtime". The CRC can be a policy, a behavior or an action. For example, we could consider entity 103 "Extension of the working hours is considered overtime" which sounds as policy but this falls into the area of the trade unions. It is outside of our sphere of influence. The reason that we have to work overtime seems to be one of the two reasons that expenses seem to be out of control and keep management dissatisfied. Dettmer discusses that it is not necessary to choose the entity at the lowest level as the CRC. We can stop at a point where below reasons are historical events or facts of life or as (Eliyahu M Goldratt 1990) suggests fall into the psychological land.

Critical Root Cause 2

Branch 200 analyses the expenses of purchasing linen. The hospital spends a lot of money buying linens which are destroyed. As the cause and effect analysis has revealed, many linens get dirty for several reasons, and they are thrown away. This creates the need to buy more linen. Therefore, the second **CRC2** (entity 204) is that "destroyed linen is thrown away". As discussed extensively, personnel insisted that there are many reasons why linen gets destroyed, such as a broken vein could cause blood being spilled all over the sheets. Multiple hard washings will destroy sheets sooner than the sheets that are not so dirty. Other entities that could be offered for CRC is entity 200, 201 and 202. These entities would redirect the direction of the solution to minimizing the number of destroyed linen. The project team decided though first to prohibit the rate at which destroyed linen were thrown away. It was mentioned that the mentioned three entities would be revisited and treated as CRCs sometime in the future.

Critical Root Cause 3

The root cause, in this case, is **CRC3** entity no 306 which states that "there is not a specific methodology of replenishing linen". The bottom part of the CRT in figure 4.3 highlights the fact that the consumption of linen at the wards cannot really be forecasted (entity 302), as beds' occupancy cannot be forecasted. Since there is not a structured

way of replenishing the wards (entity 306) then there is nothing to improve. There is not any visibility in the stocks of linen at the wards and there is not a feedback loop to improve the practice.

Solutions were coming one after the other. It was necessary to be reminded to them regularly to concentrate on the problem and not on the solution.

The output of this action step is the three different Critical root Causes. These three root causes are what keep the linen system from its ideal state. These CRCs will be the input for the next TOC tool – the EC. The next steps will seek to establish the direction of the solution.

Results of Diagnose phase

Discussing problems created tension in the field. The content of our discussion was problems and negative situations, which brought as a result fear and suspiciousness. People had the tendency to defend themselves. They felt vulnerable. They were taking everything very personally and they were becoming defensive. Clearly, they did not see a need for change. As discussed, there was a need to approach the situation differently

The resulting Goal Tree was easy to be constructed only after having the visual representation flow of the system conceptualized. The Goal Tree, for example, showed that it is not only the washing machines and the physical resources which compose the parts of the system, but there are also conceptual system elements such as cost and the availability elements of the system as well as the replenishment methodology.

4.3 What to change to - Planning

4.3.1 Action Step 5 – Evaporating Cloud (EC)

What is the need for the action step?

The CRT has managed to identify three different Critical Root Causes (CRCs). The CRCs are the reasons that UDEs do not go away, and they are usually resting deep in our awareness. We are in a constant effort eliminating the UDEs because they are

visible, but they are regenerated by the hidden CRCs. A successful solution and approach is the one that will address the CRCs and not the UDEs.

Goldratt supports that the CRCs existence depends on the persistence of a conflict. If a conflict would not exist, then the CRCs would have been eliminated. Additionally, Dettmer believes that there may also be other reasons for the existence of the CRCs, like a lack of knowledge about how to eliminate the CRC. The next tool is the Evaporating Cloud (EC). TOC literature supports that the EC follows the CRT and analyses the CRCs. EC is the tool used by TOC to eliminate conflicts or dilemmas. An intermediate step would undeniably be to find out if the surfaced CRCs are a product of a dilemma or not.

This solution is called an injection in TOC terms.

A brief description of the Evaporating Cloud

The EC is composed of 5 entities as explained in section 1.4.2. The output of the EC must be a solution or an injection which when realized in practice, will cause the dilemma to stop to exist and as a result, the CRCs will disappear. If the CRC is not a product of a dilemma then we will think of different alternatives of eliminating it. The EC aims to invalidate assumptions which were hidden, or which were thought to be valid because probably they used to be in another environment or due to a mistaken belief.

How should the tool be applied? (Theory)

The development of the tree would be facilitated by us. All data would be provided by the project team, and they would also be asked to surface their assumption. The data acquired would be analyzed by the EC. The target is to avoid compromise and design a win-win solution.

What happened in the research field (Practice)?

The development of the EC started from the prerequisites according. A3 sheets and post it notes were used to plot initial thoughts and with the help of post-it notes as shown in figure 4.5.

Figure 4. 5: Evaporating Cloud – On the Wall

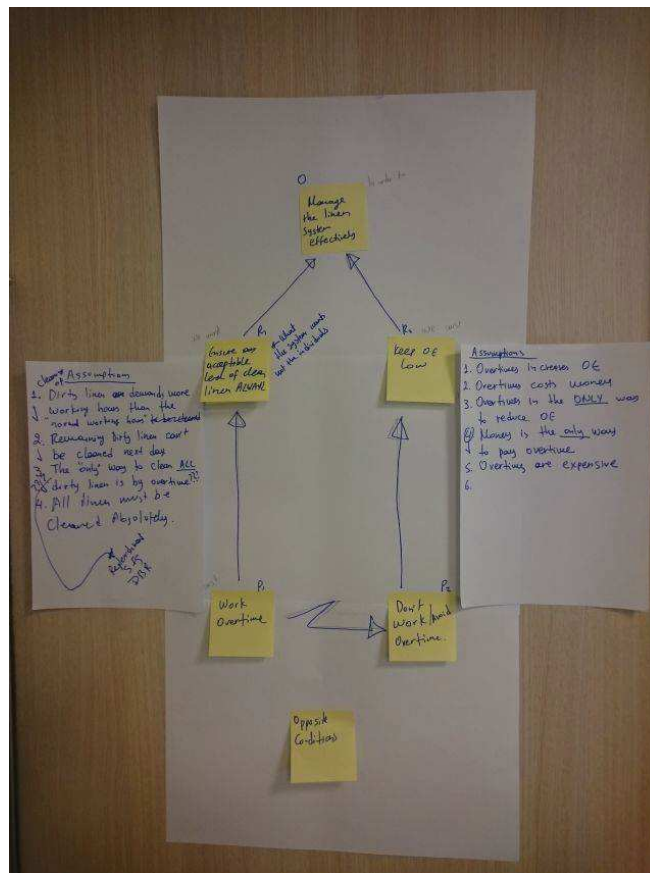

Figure 4.6 shows the resulting Evaporating Cloud. The prerequisite 1 entity is "work overtime"; the obvious opposite condition would be "not to work overtime". These are opposite conditions. They cannot coexist at the same time. The next step would be to verbalize the requirements. We must work overtime in order to ensure an available level of clean linen. The requirements must be system wants and not individual wants.

On the other hand, we must not work overtime in order to... keep OE low. Finally, both requirements are needed to satisfy the goal which is to manage the linen system effectively. By evaluating this logical structure two and three times the laundry supervisor started moving her head.... "this is my life" she stated. The EC is a necessity logic structure and the way to read it is to start from the goal statement. With the intention of managing the linen system effectively, we must keep the OE low and we must also always ensure an acceptable level of clean linen. In order to ensure an acceptable level of clean linen we must work overtime but at the same time to keep OE low we must avoid working overtime. The two entities, work overtime vs not work

overtime are in direct conflict. Every time the supervisor chooses to work overtime – availability is satisfied, but the operating expenses are increasing. Every time that she decides not to work overtime the operating expenses are kept low but there are high chances that not all the linens are washed, ironed and folded. Every time that the supervisor chooses one side of the conflict, the other side generates UDEs. The supervisor has lived in this dilemma for the last 4 years and it seems that there is no way around it. The supervisor told us that she felt so justified and relieved because this simple logical network had captured all her problems and they were known. The whole team got excited and they were looking forward to the next steps.

The next step was to surface the assumptions behind the arrows. Dettmer suggests that usually the highest chance to find and invalidate an assumption is behind the arrows which connect the Prerequisites with the Requirements. The assumptions are hidden behind the arrows connecting the entities, in order to ensure an acceptable level of clean linen, we must work overtime because... and here come the assumptions. The assumptions first challenged were the ones under the arrow connecting the prerequisite 1 with the requirement 1.

1. In order to ensure an acceptable level of clean linen, we must work overtime because... cleaning of used linen demands more working hours than the "normal working hours".
2. In order to ensure an acceptable level of clean linen we must work overtime because... Remaining used linen cannot be cleaned the next day
3. In order to ensure an acceptable level of clean linen we must work overtime because... The "only" way to clean ALL used linen is overtime.
4. In order to ensure an acceptable level of clean linen we must work overtime because... All linen must be cleaned the same day.

Then we moved to the arrow connecting the prerequisite 2 and Requirement 2.

5. In order to keep operating expenses low we must not work overtime because... Overtime increases operating expenses
6. In order to keep operating expenses low we must not work overtime because... Overtime costs money
7. In order to keep operating expenses low we must not work overtime because... avoiding overtime is the only way to reduce operating expenses.

8. In order to keep operating expenses low we must not work overtime because... money is the only way to pay overtime.

9. In order to keep operating expenses low we must not work overtime because... overtime is expensive.

The same exact procedure should be done for the arrows connecting Requirement 1 and the goal.

10. In order to manage the linen system effectively we must ensure an acceptable level of clean linen ALWAYS available because the linen system exists to provide the wards with clean linen at all times.

11. In order to manage the linen system effectively we must ensure an acceptable level of clean linen ALWAYS available because ... effectiveness for the linen system is linen availability

Then we move to the other side - to the arrow connecting the Requirement 2 with the Objective

12. In order to manage the linen system effectively we must keep the Operating Expenses low because.... operating expenses harm the bottom line of the clinic.

13. In order to manage the linen system effectively we must keep the Operating Expenses low because.... operating expenses is a bad thing.

14. In order to manage the linen system effectively we must keep the Operating Expenses low because.... the linen system can be operated with "low" operating expenses.

And finally, we need to challenge the assumptions behind the conflict arrow

15. Working Overtime and Not working overtime cannot coexist at the exact same moment.

16. The system has to run on one of the two conditions.

Figure 4. 6 : Evaporating Cloud, Work Overtime vs DO not work Overtime

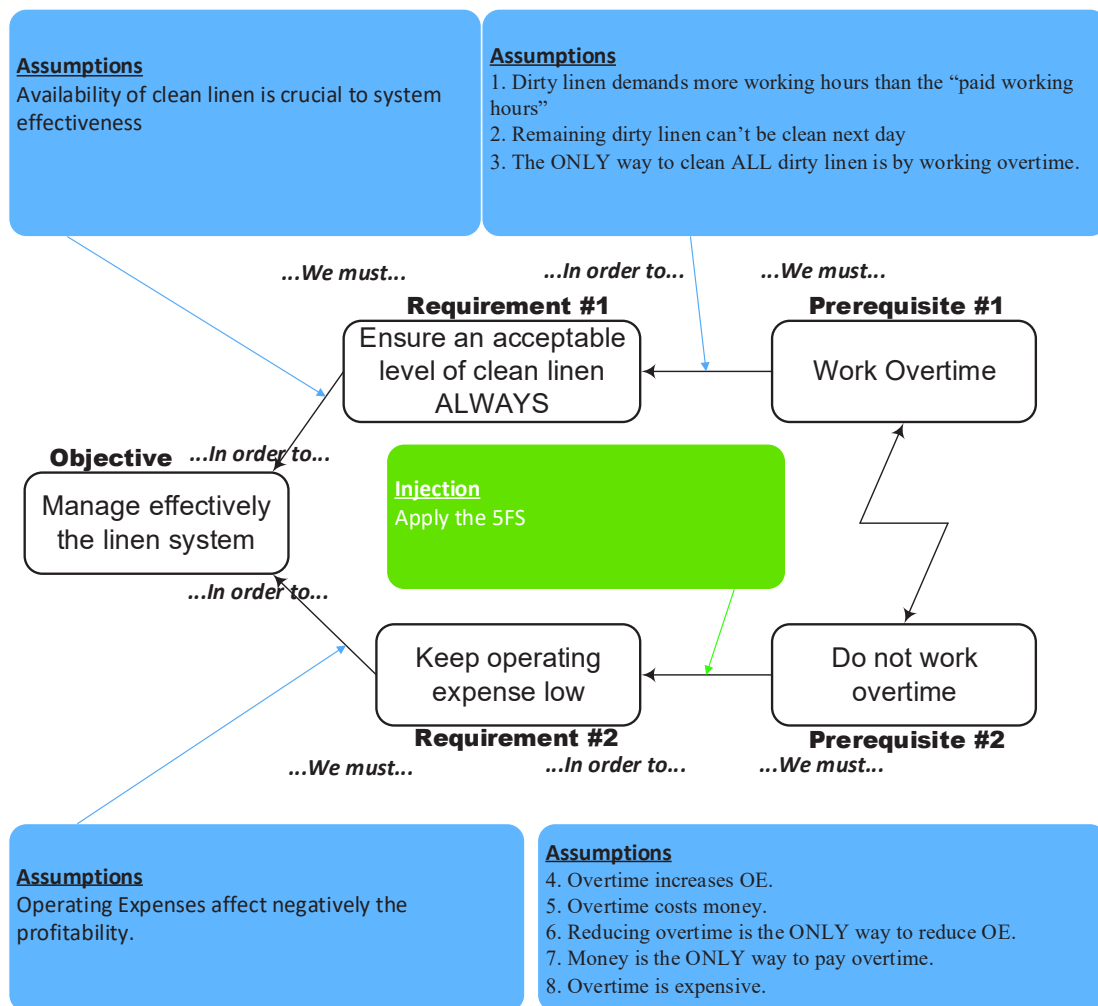

Next step was to check the validity of the identified assumptions.

The assumptions behind the arrow Prerequisite 1 and Requirement 1 seemed to all of us the most appropriate to target. For example, the first assumption was believed to be true, but it was not validated. How do people know that to clean the used linen more than 10 hours is necessary? The first assumption and the third looked the same. The second assumption and the fourth seemed similar too. Is that true? Must all linen be cleaned the same day? Even the linen that was replaced at 15.00 in the afternoon? The Nursing Care Manager pointed out that it is not necessary to clean all linen on the same day - except the ones that are dirty with blood.

The other set of assumptions seemed to be valid, but they could also be challenged. If for example management were making an agreement with the personnel that overtime would not be paid but they could be given as extra days off, then the whole cloud would be evaporated. Taking days off is also costly for the hospital. There is however no doubt that over time increases the operating expenses.

The literature mentions that it is rare that an arrow is broken at the requirements and objective level.

We decided to challenge assumption 1. It was very important to validate and measure the workload. TOC has a generic methodology of ensuring that a system produces at maximum. It is called the Five Focusing Steps. Hence, this would become our first injection - Implement the Five Focusing Steps at the linen system. If we could find the constraint, make it work at maximum and manage the rest of the system to support that constraint, and if we could elevate it then the whole cloud would be evaporated, and everybody would be satisfied.

EC 2 do not throw away destroyed linen- Practise

The second cloud took less time to build because the team was already aware of the process. The problem was that a lot of money was spent on purchasing linen. The desired state would be not to have destroyed linen, but it was not realistic. Even the natural process of using them and reusing them wears them out. Additionally, wearing out and destroying linen is not a human decision to be avoided although we felt that there were improvements to be done. One person suddenly stated, "*let's reuse them*". Describing the problem generated the solution as well. They never thought of reusing them.

The opposite of throwing away destroyed linen and the desired change would be not to throw away destroyed linen.

The next step was to identify the requirements, what is needed for the goal to be realised. Prerequisites are actions which are needed to realize the requirements. A test that can be done to validate the correct structure of the EC is to check if Prerequisite 1 produces Requirement 2 and if Prerequisite 2 produces Requirement 1.

The next step was to surface the assumptions below the arrows. The arrow connecting prerequisite 1 and requirements 1 was first challenged.

1. In order to "have new, clean and fresh linen into the system, we must throw away destroyed linen because ... destroyed linen does not look fresh or new.

2. In order to "have new, clean and fresh linen into the system, we must throw away destroyed linen because... destroyed linen cannot be used by the system.

Then we moved to the other arrow

3. In order to reduce operating expenses, we must not throw away destroyed linen because... throwing away linen means to buy new linen, and this costs money.

4. In order to reduce operating expenses, we must not throw away destroyed linen because... destroyed linen might be used in certain occasions.

The assumptions to be challenged were decided to be number 4 and number 2. By discussing alternative uses, many ideas raised, and the creative process continued. The injection was "transform and reuse destroyed linen".

It was evident that linen shouldn't be tossed. They could always be cut up and used as rags. Or you can cut them and sew them to something else. You can always patch them or change them to something else.

Sheets, for example, were torn on the corners. They could always be shortened and used as under the sheets-sheet. For this reason, a tailor was hired with the aim of transforming the destroyed linen.

Figure 4. 7: Evaporating Cloud, throw away linen vs Do not throw away linen

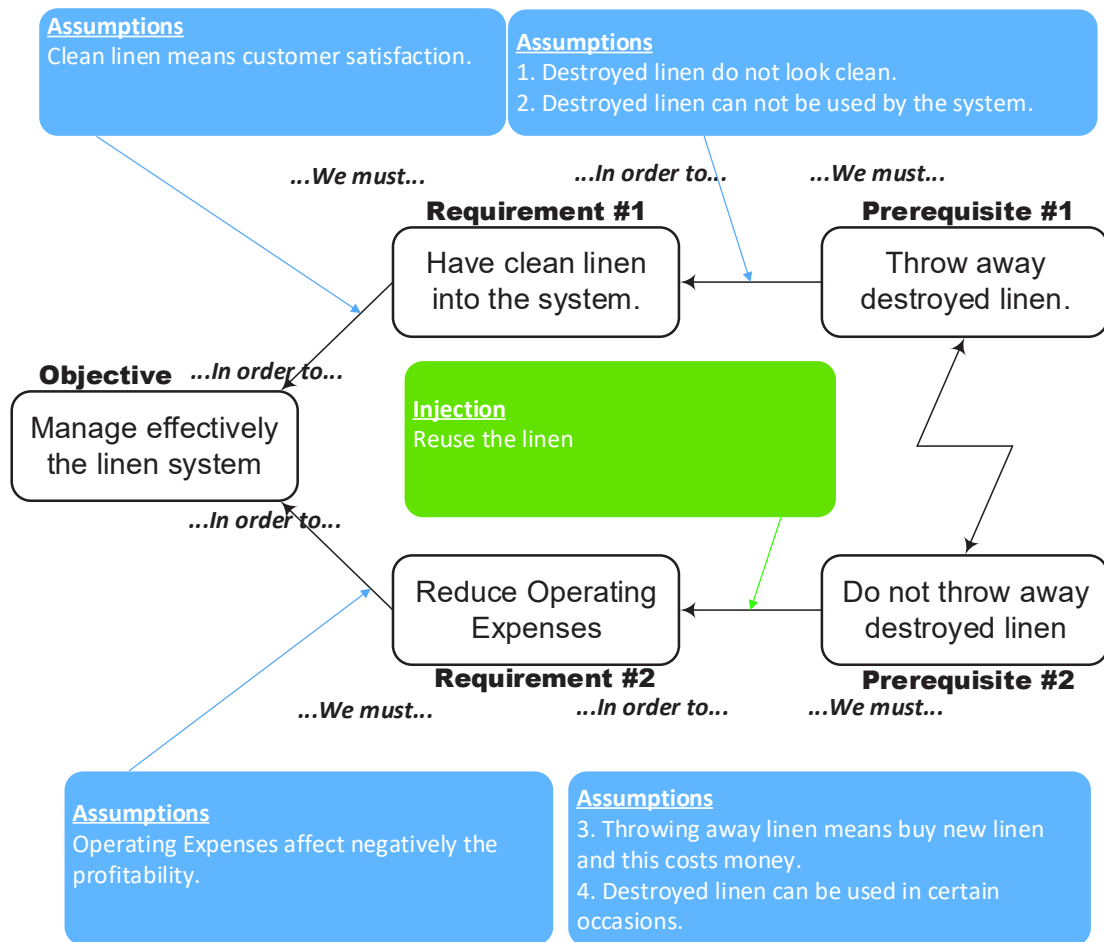

Evaporating Cloud 3 - Replenishment

The third CRC was that there is not an available methodology of replenishing linen. In this case, we realized that we did not have any conflict holding us back. Just this statement that "*we do not have an available methodology to replenish*" was not mentioned before so clearly. The people did not even have this kind of thinking - a method to replenish.

TOC has a generic solution for managing availability issues, and this has been discussed in the literature (Cox III & Schleier 2010), even though this solution has also been generated and emerged from an evaporating cloud. There is a lot of research done on replenishment, and we would follow specifically the guidelines given in (Cox III & Schleier 2010).

Evaporating clouds results

Action step 5 produced three injections – 1. Apply the 5FS, 2. Reuse destroyed linen and 3. Apply the replenishment solution.

4.3.2 Action Step 6 – Future Reality Tree (FRT)

What is the need of the action step?

The EC process generated three injections or solutions. These are the three directions that the linen system should follow in order to approach the ideal state represented by the Goal Tree. By blindly implementing the three injections, there are high chances that new problems will emerge because the status quo will be changed, or the solution will not be totally effective because additional elements maybe needed. There is a need to create a holistic solution that will not only add new conditions into the existing reality, but it will delete some existing ones and it will modify others. A new or changed state where the negative consequences will be taken care of and new UDEs will be blocked.

The FRT is the design phase, this step answers the question ‘what to change to’. In this step, the future state of the system was to be perceived with the injections and without the UDEs. It is a modeling of the future. It is a sufficiency tool that shows what needs to be done to synthesize or “engineer” a new solution by using the injections as input. Therefore, the purpose of the FRT is twofold. First is to synthesize the new solution and find out what else is additionally needed to the three injections and secondly to foresee negative consequences and block them before they take place into reality.

A brief description of the Future Reality Tree (FRT)

The main source of the FRT is an initial idea or an injection from the EC. The desired effects compose the target and the objectives of the FRT. There are many ways to proceed in the future. The presence of the DEs works like a compass. They polarise the logical structure from the present to a specific point in the future. In our case, the three injections from the EC will be used.

How should the tool be applied? (Theory)

The guidelines followed are given by Dettmer in (Dettmer 2016b, p.244). The researcher would facilitate the construction of the FRT. The team would indicate and then scrutinize the entities. The main sources of data would be the input of the team, the three injections from the EC and the DEs which would be the opposite of the UDEs. The data would be analyzed by the FRT and decisions will be made accordingly. The FRT is information driven logical tool. The more information available, the better.

The result of the FRT should be a logical structure, a logical network which will connect the new ideas and solutions to a whole solution transforming the UDEs to DEs. All actions that should be recommended by the FRT to be implemented should have mainly two purposes. Firstly to facilitate change towards the future and secondly to prohibit new UDEs to emerge.

The Goal Tree can be used as the skeleton of the FRT. There is a very high similarity between the Goal Tree and the FRT (Dettmer 2016b). The Goal Tree is a necessity tool which shows the necessary ingredients for success. The FRT shows how these ingredients blend together to form a solution as a whole. By adding assumptions to a necessity tree, it is transformed into sufficiency.

What happened in the research field (Practice)?

As explained, the guidelines followed were those of (Dettmer 2016b, p.244) as well as those given by Dr. Holt's classes at Washington State University.

At the beginning UDEs were rephrased to DEs on post-it notes figure 4.8. Then, they were placed on the top part of the page. Then at the bottom, the three injections were placed and then connecting the injections upwards to expected effects was followed. It was a slow process because the team was skipping many steps every time during the process. They would not mention entries which seemed self-explanatory to them. Long arrows were present in every step.

Figure 4. 8: Future Reality Tree – On the Wall



With guidance and facilitation, the FRT shown in figure 4.9 was developed.

Next steps were the identification of positive reinforcing loops, for actions which would reinforce the positive effects of the solution.

Last, the FRT was scrutinized to identify possible negative consequences and unfavorable effects.

Figure 4. 9: Future Reality Tree – Linen system

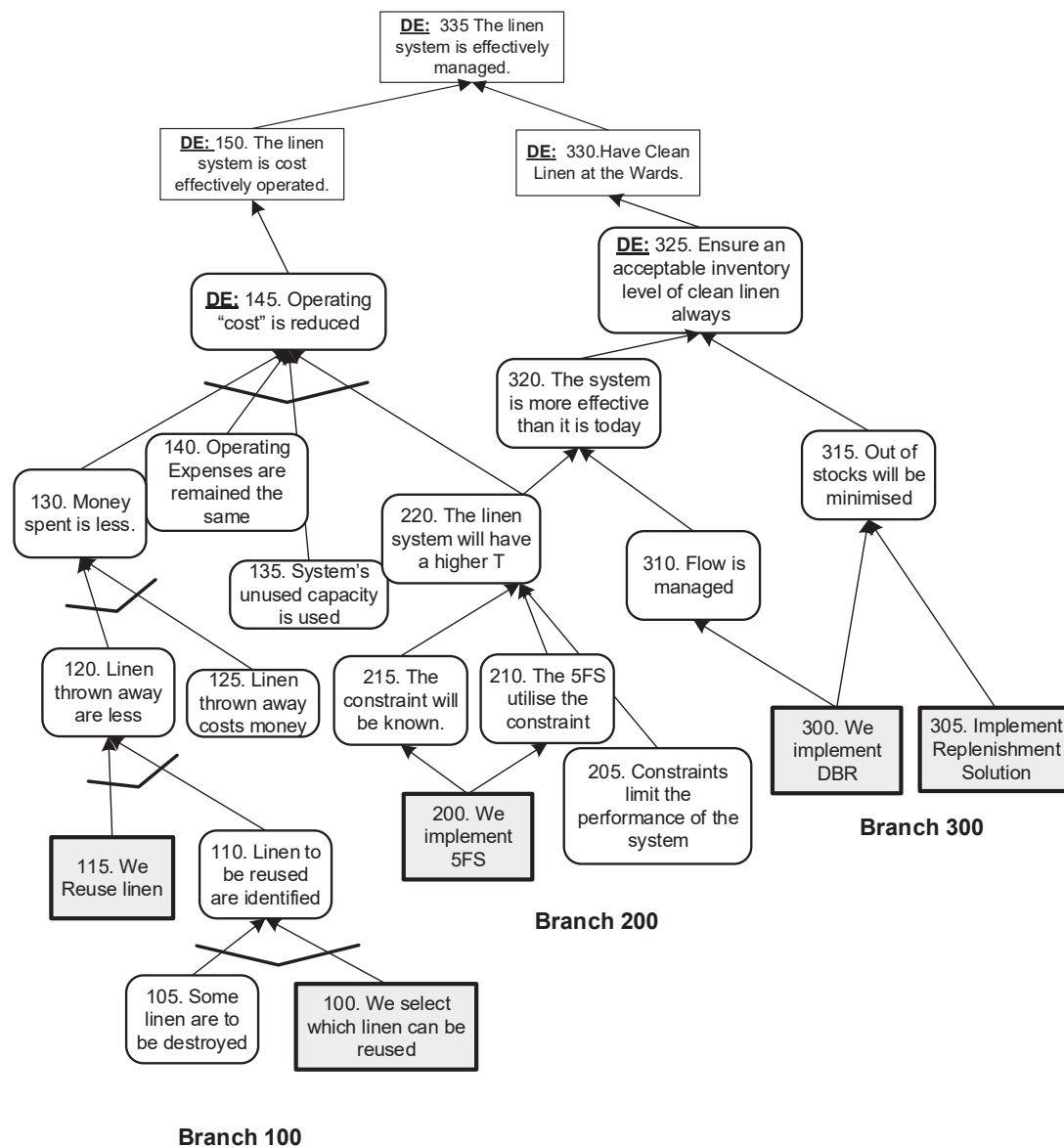

Then we spent a few days re-reading and scrutinizing the entire tree. We were constantly using the categories of Legitimate Reservations. This was done by the team because intuitive knowledge is mandatory for the FRT to be well constructed with solid logic. Employees who were in the field for years were extremely useful.

The grey color indicates the injections.

From the FRT in figure 4.9, it can be seen that the skeleton of the FRT has three major branches similar to the CRT branches. Branch 100 displays how the future will be if

After the completion, the FRT managed to produce a satisfying cause and effect map of the future. The most important was that the team felt confident that the set of injections would improve the operation of the linen system.

Results of the planning phase

The planning phase is the design of the future solution. Is the phase, where a systemic solution is put in a frame without the UDEs of the current reality. This was done using the TOC tools of the Evaporating Cloud (EC) and the Future Reality Tree (FRT). The tools showed that there are generally three actions that need to take place to improve the current system.

1. Implement the Five Focusing Steps
2. Hire a tailor to reuse the linen.
3. Implement the replenishment solution.

Next section describes the implementation of the above three injections.

4.4 How to cause the change - Action

4.4.1 Action step 7 – Implementation Five Focusing Steps

What is the need of the action step?

The 5FS is the logistical solution of the TOC. The FRT and the EC pointed the 5FS in order to increase the flow through the system. Since the work is completed in overtime hours, management assumed that the workload is more than what the system can handle in two shifts. The thinking was to analyze the system, find the constraint, utilize it at maximum in order to justify or reduce the overtimes. The purpose was to make sure that the system produces at maximum.

The 5FS are specifically designed to elevate the system's constraints. It is a series of steps that are designed to increase the flow in a system by managing its constraint. They are mainly used when there is a physical flow through the system. The 5FS are discussed in section 1.4.1.

How would the tool be applied? (Theory)

The plan is to follow the steps exactly as in literature. The first step would be to locate the constraint. The system is already defined with the aid of the FBDs. The flow is already agreed to be linen in units of kg.

Identify the constraint

To identify the constraint, a load analysis would be performed, measuring the actual flow in kg and comparing it with the nominal capacity of the resources, where the resources are humans, cycle times would be measured, and they would be compared with the actual demand placed on those resources. This calculation will show if the resource is a constraint or not.

Exploit the constraint

When the constraint would be identified, the next step would be to make it work as much as possible. This constraint is what limits the flow of the entire system. Depending on the resource, different ways of making it more efficient would be found.

Subordinate the constraint

Following the literature, the plan would be to organize all other resources around it, so the constraint does not starve. Literature gives special emphasis on this step and points out that it is the most difficult step since local policies and local efficiencies should be abolished.

Elevate the constraint

This step would come after the subordination process. If the constraint remains a constraint after the subordination process, then maybe further investment would be needed in order to buy more capacity of the constraint.

Avoid Inertia

The last step would be to educate people with the purpose of creating momentum to run the 5FS again and locate the next constraint and so on. This would be the baseline for

the Process of Ongoing Improvement (POOGI). The theory and the steps are straightforward, and they have been tested in many studies.

4.4.2 Action Step 8 - Identify the Constraint

What happened in the research field (Practice)?

The first step was to observe how the work was performed. The first attempt was to represent the actual flow in kilos. All different linen categories were weighted. The different weights are shown in table 4.3.

The next step was to find out how many kilos of those linens flow through the loop. The mix of linen was changing day after day depending on the ward's needs. On top of that, the occupancy of the wards was changing all the time. That occupancy was difficult to predict as discussed with the ward's manager.

Since the actual flow could not be measured, it was calculated. 100% occupancy of the hospital was assumed. This assumption would take into consideration the maximum demand from the linen system.

A form as shown in Appendix 7 was circulated to the different wards asking the head nurses to complete their linen needs. The assumption was that their ward was 100% occupied. The needs of linen were represented by the consumption and the safety stock needed.

After receiving the data, the report/table as shown in table 4.3 was completed.

Table 4.3: Total daily linen need in kg circulating through the hospital

Description	Ward (On the beds)		Closet		Cleaning department		Total Stocks	Dirty Daily	Weight gr	Weight Dirty/Daily
	310	0	Replenish 310	Buffer 172	Replenish 310	0				
Sheets (White)	310	0	310	172	310	0	1102	396	520	206
Σεντόνια πάνω - κάτω (Πράσινο)	0	0	0	0	0	0	0	0	0	0
Lower Sheet	150	0	0	67	0	0	217	183.5	525	96
Pillow	160	0	0	58	0	0	218	189	300	57
Pillow case	160	160	160	65	160	160	545	192.5	94	18
Προστατευτικό Μαξιλαρ.	156	0	0	58	0	0	214	185	140	26
Κουβέρτα άσπρη	0	0	0	36	0	0	36	18	1500	27
Σκέπασμα Κρεβατιού (Κίτρινο)	150	0	0	51	0	0	201	175.5	950	167
Κουβέρτα Μπλε	0	0	0	0	0	0	0	0	0	0
Πετσέτα μικρή	150	150	150	70	150	150	520	185	233	43
Πετσέτα μεγάλη	138	126	126	54	116	116	434	165	450	74
Χαλάκι - Πετσέτα πατώματος	99	23	23	48	12	12	182	123	250	31
Ρομπες Ασθενων (L)	120	116	116	63	116	116	415	151.5	200	30
Ρομπες Ασθενων (XL)	0	0	0	0	0	0	0	0	0	0
Σεντόνια παιδικά	5	0	0	5	5	5	15	7.5	200	2
Παιδικές ρόμπες	0	0	0	0	0	0	0	0	0	0
Πετσούλες (30x30)	150	150	150	70	150	150	520	185	42	8
Παντελόνια πράσινα Γιατρών	45	45	45	15	45	45	150	52.5	150	8
Μπλούζες πράσινες Γιατρών	45	45	45	15	45	45	150	52.5	133	7
Πράσινο λινό 90 x 90	0	0	0	0	0	0	0	0	175	0
Πράσινο λινό μεγάλο	0	0	0	0	0	0	0	0	700	0
Πράσινο λινό 1μ x 2 μ	0	0	0	0	0	0	0	0	350	0
Στολές προσωπικού	20	20	20	0	20	20	60	20	200	4
Λινά Spare	0	0	0	0	0	0	0	0	0	0
Λινά Spare	0	0	0	0	0	0	0	0	0	0
Λινά Spare	0	0	0	0	0	0	0	0	0	0
Λινά Spare	0	0	0	0	0	0	0	0	0	0
Λινά Spare	0	0	0	0	0	0	0	0	0	0
Λινά Spare	0	0	0	0	0	0	0	0	0	0
Λινά Spare	0	0	0	0	0	0	0	0	0	0
Λινά Spare	0	0	0	0	0	0	0	0	0	0
Σύνολο κλινικής	0	0	0	0	0	0	0	0	0	0
Total Daily Dirty (100% Occupancy)										803

From this table, it can be observed that daily flow from all the wards consuming all the buffers at 100% occupancy, is 803 kilos of linen per day.

Based on this calculation the maximum flow that the linen system would have to manage is 803kg. 803 kg which would become used, taken back to the laundry, cleaned, dried, ironed, folded and replenished back to the wards. The clinic operates seven days per week so 803kg of used linen per day give 5600 kg of used linen per week.

The second step was to measure the capacity and the cycle times of the resources managing the 803 kg of linen. The map showing this was the FBD representation figure 4.1. The capacity of the washing machines and the dryers were collected by the manuals and by discussions with the suppliers. As shown in figure 4.10 there are mainly three broad functions to be measured, and they are all in the laundry section. The first is the washing machines, the second is the drying section, the third is the ironing section and the fourth is the folding function.

In the laundry area, there are five washing machines able to wash 25kg linen per washing cycle each and one smaller one with a capacity of 15 kg per washing cycle.

We decomposed their function as shown in Appendix 2, and we measured the time of each step. The washing machines need:

1. Loading – 2 to 3 minutes each washing machine
2. Washing – 67 minutes each washing machine
3. Unloading – 3minutes each washing machine

Every washing cycle has a duration of 72 minutes. Since 72 minutes are needed to wash 25 kg of linen – the washing capacity of every washing machine is 20 kg of linen per hour. This is 100 kg of used linen per hour (for the five washing machines).

Then there is a small machine with a washing capacity of 15 kg of linen in 72 minutes or 13 kg of linen per hour.

This is a total of 113kg cleaning capacity per hour.

The laundry operates from 7.00 in the morning to 18.00 in the afternoon (Monday to Friday), 7 hours on Saturday and another 7 hours on Sunday. There are 69 operating hours per week for the washing machines. This gives a weekly washing capacity of 7797 kg of linen. Since the demand placed on the washing function is 5600 kg per week then obviously the washing machines is **not** a constraint.

The drying function

There are three driers in the laundry. Every drying cycle consists of

1. Loading - 2 to 3 minutes for each drier.
2. Drying – 35 minutes each drier
3. Unloading – 2 minutes each drier

Based on the above every drying cycle has a duration of 40 minutes. Every drier has a capacity of 30 kg each. Since 30kg can be dry every 40 minutes, 45kg can be dried every hour. This gives a total capacity of 135kg of linen every hour. Since the driers are operating 69 hours per week (as the washing machines) – 9315 kg of linen can be dried every week. Since the demand is 5600 kg of linen per week, the driers are also non-bottlenecks.

Ironing Function

The ironing function consists of 2 ironing presses. It was measured that a person can iron in one press one sheet in 43 seconds or 520gr every hour. Since there are two ironing presses, 6072 kg of linen can be ironed in a week. The demand is less than 5600 kg of linen because no all linen needs iron e.g. pillows, small towels etc. No calculation precision is needed. The ironing is a non- bottleneck as well.

Their cycle times are shown below in figure 4.10

Figure 4. 10: Linen Resources Utilisation Profile

Capacity = 113 Kgs/ Hour = 790 Kgs/7 hours (Shift)	Capacity = 135 Kgs/ Hour = 945 Kgs/7 hours (shift)	Capacity = 88 Kgs/ Hour = 616 Kgs/7 hours (shift)
Washing Machines	Driers	Ironing (presses)
5 Washing machines + 1 Small washing machine	3 Driers	2 presses
Capacity per week = 7797 kgs of linen = 69 hours Demand per Week = 5600 kgs = 50hours (when 100% occupancy) 73% Utilization	Driers can dry 9315 kgs of linen per week. Demand per week 5600 kgs of linen when 100% occupancy 60% Utilization	The two presses can iron 6072 kgs of linen per week. Demand per week is 2800 kgs of linen. 46% Utilization.

All this data was extrapolated to weekly figures since Saturday and Sunday were working with fewer people than the rest of the days.

By comparing the data, it was observed that all the resources have a higher capacity than the actual load placed on them. The system was working at extra capacity in contrast to the belief that the system was overloaded. The constraint was actually at the point of consumption. The point of consumption is at the wards where the nurses change sheets and towels to the patients. It was clear that the demand for clean linen was the point which was dictating the whole flow or the rate at which used linen are created. The first step revealed that the constraint is the consumption point.

4.4.3 Action Step 9 – Exploit the constraint

What is the need for the action step?

The second step of the Five Focusing Steps was to make the constraint produce as much as possible. It is clear that this is not applicable in this case study. Since the constraint is the consumption point, in order to increase the flow consumption should be increased which means that more used linen should be created. Obviously, this is not what was desired. The only time where this is required, is when the clinic manages to build more

rooms and more beds. The other option would be to bring more used linen from other clinics and provide laundry services. This step, however, could not be performed.

Nobody expected that the system was running in overcapacity. When a system is working at overcapacity, it leads to unnecessary expenses.

It was obvious that the system should be downsized. This is undoubtedly contrary to TOC philosophy which supports that increasing Throughput is the number one priority. TOC is designed around the concept of increasing the flow and it is designed exactly for that. TOC is based on the assumption that systems are made to produce more and more. What really happened was that throughput was not the measurement with the highest priority anymore.

The direction to follow would be to downsize the system down to the point where there would be an internal constraint. Downsizing is what management loved to hear. Our initial belief that the constraint could be exploited, was invalid.

The obvious procedure then was to select a resource to be the candidate constraint and then restructure the whole system around that constraint.

4.4.4 Action Step 10 - Choose the constraint

What is the need of the action step?

The theory behind this decision was to downsize the system based on the TOC philosophy which is constraint-based. That is, find the constraint and organize everything around it. The candidate constraint would be decided based on the utilization figures of figure 4.10. Looking at the utilization figures, it was identified that the resource with the highest utilization is the washing machines. If somehow the flow could be increased, then the first resource reaching 100% utilization, converting it to a real constraint would be the washing machines. It was decided that the washing machines would be the resource candidate.

Since the constraint was chosen, then the Five Focusing Steps should be implemented from the beginning.

We were communicating every step to the rest of the workforce. Everybody could see and follow the logic.

4.4.5 Action Step 11 - Convert chosen constraint – to a bottleneck

What is the need for the action step?

The next step would be to convert the washing machines to a bottleneck. The idea was to increase the flow on the resource or reduce the capacity of that resource. Again, the obvious decision was to keep the capacity of the washing machines and increase the flow on the constraint candidate. How? By reducing the available time of the resource. The resource should process the same flow in less time. This would increase the demand on the resource converting it to a bottleneck.

It was obvious that work on Sundays should be abandoned. Management loved it because of all the overtime hours that they would save. They even wanted to implement it immediately, but a change always brings problems with it. We proposed to go gradually, but they insisted for instant implementation. The biggest obstacle that we could see was the resistance from the people who would lose their overtime. Management's decision was discussed with the personnel and surprisingly, there were no objections. They followed the whole process, but we were also honest and open with them. All they wanted was not to lose their jobs. The financial crisis had raised unemployment rates in Cyprus up to 18%. Losing their overtime was not an issue for them as long as they would keep their jobs. Before starting the experiment, an agreement was made with management that nobody would lose their job. This was communicated and encouraged people to participate and discuss openly any issues that they might have had.

When people realized that it was not required to work on Sundays, they become resistive, and all kinds of possible problems were raised. For instance, one of their worries was that since the clinic was operating seven days per week, 24 hours per day and if the laundry does not function on Sundays then there would be a huge pile of used linen for Monday morning and they would not have enough time to process it. People became defensive but creative at the same time. When they realized that their

suggestions were heard instead of arguing them, they became more cooperative. The change in their behavior was immediately observable.

The main result of this step was the decision that we should stop working on Sundays. With all the reservations that came up from the team and the people in the field, it was decided to build a Future Reality Tree in order to synthesize the future solution.

4.4.6 Action Step 12 – Categorising and unitizing injections

What is the need for the action step?

By returning back to the Future Reality Tree, the Five Focusing Steps injection was to be progressed. Since the constraint had been chosen and being consistent with literature the next step was to exploit the constraint. Decide what actions should be taken to make the constraint produce at maximum.

A brainstorming session followed to invent injections which would realize the exploitation. The brainstorming session took place in the laundry area with all the people involved. The idea was to express openly their thinking and opinions. The method explained in (Ackoff & Vergara 1981) and in (Flood 1999, p.124) was followed. All ideas were logged and considered to be valuable.

Different ideas were coming up – not necessarily for exploiting the constraint but how to improve the system in general. It was a great opportunity to enrich our action plans. The categorisation of data followed (Saunders et al. 2009, p.492) method. The categories were developed based on the TOC theoretical framework, and those were “exploitation”, “subordination” and from the data received a third category was revealed which was “measurements”. (Saunders et al. 2009) suggests that categories can be derived not only from the theoretical framework but from the data as well.

Below is the result of the categorization and unitisation process.

Injections for Exploitation

1. Load 25kg the drum of the washing machines - according to the washing machines' manual, the nominal load of the washing machines is 25kg of linen.

2. Separation of colored and white at delivery of used linen - currently there is a lot of time wasted to separate colored linen from white ones. It has been suggested that it would be much more efficient if at the delivery the linen were kept separately; that is the colored from the white ones. This way the loading of the washing machines would speed up.

3. Load Sheets and towels together – it has also been suggested by an employee in the field that we should load the drum with the same mix made of sheets and towels. This way unloading the drum would be much faster. When the drum is loaded only with sheets, then they get tied together in huge knobs, and it delays the unloading of the washing machines.

4. Hire a man to load/unload the washing machines. Lifting all sheets and linen is a very demanding task for women. The average age of women in the field was more than 55 years old. We decided that it was better to hire a young man to execute this heavy work. Nobody could disagree with that.

5. We also decided that until hired someone, an additional woman from the dryers would come and assist the women in loading and unloading the washing machines.

6. Schedule the washing machines so they would not stop at the same time - When the washing machines stop at the same time than by the time the person fills up one, the other one remains idle, wasting the time of the constraint. We all agreed that we would schedule the operation, so the washing machines stop in a sequence.

Injections for Subordination

7. Start earlier on Mondays to have more linen when nine o'clock comes which is the making of the rooms time. On Monday morning there would be the biggest pile of used linen (since Sunday is an off day for the laundry). We agreed that we would start one hour earlier only on Mondays to make sure that everything would be fine for the rest of the day.

8. Inform suppliers and maintenance department that on a request for the washing machine problem, they should give the highest priority. Washing machines would be

the new constraint so all the support should be available to keep them live and operational.

9. Finally we agreed that the second shift would be moved one hour earlier so the overlap of the first and the second shift is larger. This way the washing machines would not stop during the breaks and the idle time would be minimized.

10. We stopped working on Sundays.

Measures

11. We made sure that the supervisor at the laundry understood well the importance of the role of the constraint.

12. We calculated that we should run all washing machines at full capacity 9 hours every day and 5 during Saturday. We added a log book in the field so that the washing cycles would be recorded.

The above 12 actionable tasks are what needed to put in effect an action plan.

By going carefully through the data, the project team concluded that Subordination should come first since there was no reason to make efficient a constraint that it does not have a product to work on. Work on Sundays should stop first and then the effort should be made for efficiency. It sounded logical despite the vast majority of literature which places exploitation before subordination.

4.4.7 Action Step 13 – Subordinate the constraint

What is the need for the action step?

Action Step 11 “selected” the resource to be the new constraint. Action Step 12 organized data around the 5FS solution. Since it was a common view that subordination should precede exploitation Action Step 13 progressed with subordination. This decision is against literature which supports that exploitation comes before subordination.

The overall plan was discussed with the managing director who was impressed with the methodology and the clarity of the actions. He resisted though to the decision to start with a pilot try and then go full scale. The MD argued that Sundays should be immediately be stopped. He could not see any negative consequences that were not thought of. He strongly insisted that no pilot testing was needed.

The personnel was involved during the whole process. They were following the process closely. They could not understand exactly the theory behind our actions, but up to this moment, everything sounded simple, logic and straightforward. They realized, and they knew that their overtime work would be affected by stopping Sundays. They were very cooperative though. The financial crisis was at its peak; hence they understood the efforts of the clinic. They had no objections or any major resistance as long as nobody would get fired. What really helped was also that meetings and discussions were happening at the actual field, in their own working environment. They felt comfortable and safe to open up and express their thoughts and concerns.

What actually happened in the research field (Practice)?

The next step was the subordination process.

The injections for subordination identified in section 4.4.6 were executed as designed. The personnel agreed to start earlier on Mondays, the second shift was moved earlier by one hour, so the overlap of the two shifts was larger. The suppliers and the maintenance team were also notified and informed about the importance of keeping the washing machines (the constraint) in a workable condition.

In order to avoid problems after stopping the Sunday operation, extra linen was purchased, and they were ready to be used since Sundays and Mondays consumption should be covered.

During the first Sunday that the operation was stopped, everything flowed smoothly because there was enough clean linen to support the wards. On Monday morning though unexpectedly, the whole clinic was in a panic. All the wards were calling at the laundry to order more and more linen. They were claiming that they were out of stock. The personnel at the laundry would stop their normal flow of work, and they were trying to

respond to the wards' requests. This brought a chaotic situation at the laundry, people started panicking and they were responding spasmodically. Nurses started coming to the laundry area and started picking up linen on their own. They were waving disappointed making the whole situation worse. Something had gone really wrong. We started discussing with the supervisors at the wards, but they were upset and angry. They needed clean linen and they were not into a discussion mood. The whole thing became very emotional. Our stocks disappeared in the first few days and the problem did not seem to go away. At the end of the first week, we were completely out of stock of linen. We were just reactive to issues coming up all the time. We did not know what was wrong. More linen needed to be urgently bought and thrown into the circulation in order to stabilize the situation. Management was very skeptical about spending all this money. After the first 10 days and after buying lots of linen, the situation finally stabilized. Although many believed and suggested to start working on Sundays again, nobody from the project team wanted to go back.

A careful walk through the wards revealed that there was clean linen everywhere. Linen in cabinets, on trolleys, more in certain areas and much less in others. Hence, we decided to discuss with the supervisors and try to understand what had happened. They claimed that they had heard rumors that a major change would happen in the laundry and they wanted to be safe by ordering linen – more than they needed. Obviously, the communication part of the project had failed.

After the subordination had finished, it could be observed that every Monday there was a large pile of used linen in front of the washing machines, the team was keeping the minimum 9 hours per day, so naturally, they were washing more linen than used ones. That was lowering the pile of linen, and up to Saturday, the pile was becoming extremely low depending on the consumption of the week.

4.4.8 Action Step 14 - Exploit the constraint

What is the need for the action step?

Despite all the obstacles and all the unforeseen circumstances appeared in action step 13 the focus was to make the system functional. The efficiency of the constraint came

into the picture only after a whole month of operation and when the system was stabilized and the people performing it were feeling comfortable.

Exploitation concerns solely the management of the constraint and nothing else. The target was to eliminate idle time in order to make the constraint more efficient. By trying to identify the idle time, just observing the operation of the washing machines could reveal the time wasted. Additionally, the injections identified in section 4.4.6 were implemented as designed.

Several injections in parallel were to be implemented. For example, it was asked from the personnel who were transporting the used linen to the laundry to separate the colored from the white and additionally to separate the sheets from the towels before leaving the laundry area. This way, time would not be wasted separating the linen before loading the drums which would keep the washing machines idle. Furthermore, the drum was filled to a point where the distance from the top of the drum was as big as a palm. The person from the dryers would come to help to load/unload the washing machines; they knew the logic, keep the constraint up and running.

We informed the supplier of the washing machines to come and visit us at the clinic. The maintenance team was also present. The approach and intention were briefly explained and how important the concept of the constraint is. The supplier also gave us a hint of loading the drums. Just load them up to the level where there is only one palm distance between the linen and the top of the drum. The aim was to make sure that maintenance schedules would be kept on time and have available spare parts at the clinic. It was also asked from the technical team to evaluate the condition of the washing machines and replace any part needed before we stopped working on Sundays.

After two months of operation, a new young man joined the team and took over the operation of the washing machines. Another employee would retire in a few months, so this was not adding anything to the operating expenses. One day a technician from our suppliers told us that he could set an alarm to sound 3 minutes before the washing machine would stop. This would alert the supervisor in advance to set up the washing machine rapidly. Soon reducing the idle time on the constraint became a passion for the young supervisor.

Highly infected linen would come in a separate bag, and this linen should be washed in a separate washing machine which was used solely for those infected cases.

The last two steps of the Five Focusing Steps were not needed. Elevation was not needed. Effort should be directed standardizing and stabilizing the operation rather than improving it.

4.4.9 Action Step 15 – Brum Buffer Rope (DBR)

What is the need for the action step?

The system was stabilized only after a month of operation. A structured methodology was needed though to ascertain that the constraint would constantly operate without starving and that flow would be maintained. A mechanism was also needed that would make the system resilient and able to absorb and recover from variations caused by different kinds of Murphy. Without a firm methodology and a solid set of procedures, the successful operation of the system could not be assured. TOC's methodology to manage flow is called Drum Buffer Rope (DBR) and the theory supporting it is explained in section 1.5.1.

A brief description of Drum Buffer Rope (DBR)

The Drum Buffer Rope (DBR) is a methodology which manages the flow by recognising that the rate of the flow depends on the constraint which is called “drum” (it sets the pace of the whole flow) and then it adjusts a “buffer” before the drum, in order to make sure that the drum will not starve. Lastly, a communication mechanism which is called “rope” releases new material into the flow stream according to the status of the buffer.

What happened in the research field (Practice)?

To implement the DBR, the first thing that needed to be done was to set the drum. The Drum is the constraint. In this case, the drum was the washing machines. It is the constraint that we purposely created. The DBR operation is based on Buffer Management. This is achieved by dividing the buffer into three colored zones. When

the buffer entered the red zone then new job was released into the system. The pile of used linen that we created before the washing machines were the buffer.

In our case, a new job was released into the system every time that a patient situation required clean linen. It was not a human decision. The system was generating the work at its own pace. By not being able to control the rope, it meant that the level of the buffer would not be controlled either, at least not by controlling the rope. The only way to control the level of the buffer was by the operation of the constraint. Since the cycle time of the washing machines was fixed then the rate at which the buffer would be reduced was a matter of calculations and not decisions. The buffer would absorb the variation of the patient flow and the patient's needs.

Based on figure 4.10 we should operate a maximum 45 cycles per day and 15 cycles every Saturday. Then the maths should work.

DBR was working by default. The flow was adjusted at a fixed rate as long as the constraint was running at the designed speed. The only addition was to measure that the washing cycles were followed as designed. A log book was placed, and the supervisor was logging the daily washing cycles. 45 cycles every day and 15 washing cycles every Saturday. These were the maximum washing cycles to run weekly.

After a few weeks, the speed and the progress were evaluated empirically by the level of the buffer in front of the washing machines.

4.4.10 Action Step 16 - Replenishment

What is the need for the action step?

This is the third injection from the FRT in figure 4.9.

Figure 4.11 demonstrates how the linen was replenished in the hospital. The replenishment was performed based on experience. The laundry personnel was filling up the trolleys with clean linen and then they were replenishing the cabinets at the wards. The local cabinets would be observed and then replenished empirically. The nurses were making the beds every day at 9 o'clock in the morning, so this was the time where most of the linen were needed. Replenishment was done between 10 and 11 o'clock when the cabinets were almost empty.

As discussed, one of the UDEs identified was that the wards were facing out of stock situations. The sheets were replaced every day at 9 o'clock in the morning, but there were many cases where linen was needed during the day. Clean linens were required after patients were discharged or when medicines, blood or other fluids would make a sheet or a towel dirty. In case of stockout, the nurses had to go to the laundry by themselves, or they should go to other wards and ask for linen.

Almost all the head nurses of the wards reported that quite often they were facing availability issues and then they should go to the laundry and take linen themselves.

The solution that TOC toolbox offers in such situations is called the replenishment solution. It is a generic solution which is to be used to manage availability issues in Supply chains.

Figure 4. 11: Linen Replenishment BEFORE the Replenishment solution

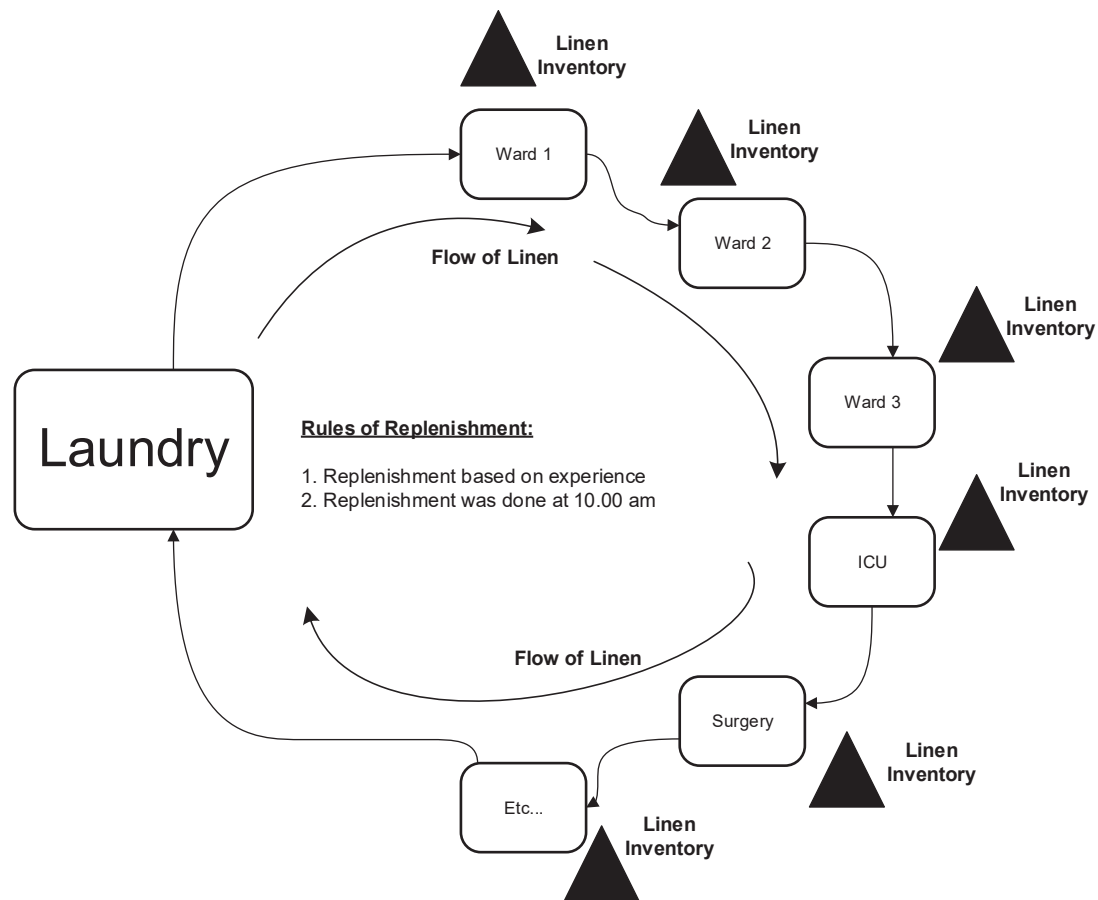

How should the tool be applied? (Theory)

The replenishment solution has key characteristics that should be taken into account when designing the system. (Šukalová & Ceniga 2015) mentions that replenishment is a movement from push to pull philosophy. Nothing is distributed unless there is demand for it. The theory is based on the fact that when a supply chain stream supplies several destinations then the variations of the consumption of these destinations cancel each other out when viewed from the high point of the supply chain (Cox III & Schleier 2010). The replenishment solution uses the buffer management methodology again to respond to variation.

An analysis of the replenishment theory can be found in section 1.5.2.

Replenishment philosophy is based on replenishing frequently only what is needed. TOC replenishment literature recommends below implementation steps and principles:

1. The stock should be kept at the highest point of the supply chain meaning that the linen should be stocked not at the wards level but at the laundry, folded and ready to be replenished whenever needed.
2. Set the buffers and the zones. Based on the table 4.3 buffer should be kept at the wards a buffer for all emergencies.
3. Then different colored zones in those buffers should be set, and replenishment should be done based on the status of those buffers.

At least this was the theory....

What happened in the research field (Practice)?

A brainstorming session was conducted in the laundry. People were free just to mention ideas about how to reach the above-mentioned four objectives. The ideas below are the outcome of several brainstorming sessions that took place in the research field. The responses and the discussions focused on how to manage the linen inventory and how the buffer management principles could work in this case study.

Idea 1 – setting the buffers by marking the zones on the cabinets

The buffers should be kept at the closets. Marks should be indicating the level of the pile of linen on the side of the walls of the cabinets. These would serve as penetration zones. The employee should pass around the ward with the linen and he/she would try to fill up the stock according to the markings. Again, the zones should be set only for the common linen and not for the specialized ones which should be replenished anyway.

Technology could not be used to set the buffer zones, so we thought of having a pile with linen in the cabinet and then mark the pile at different levels on the wall of the cabinet. When linens were used, the pile would be lower, and the replenish quantity would be such to reach the mark indicating the high point of the pile. To our surprise, we noticed that there was not enough room and space to store all the different linen in individual piles, in a way where markings could be applied. The limitation of space was forcing one type of linen to be placed on top of the other. Folded sheets, for example, had a different thickness, so our marking system was not accurate. Other wards had no storage cabinets, and they were using the trolleys from the laundry as a storage area. Another ward had only one small cabinet which was used to store other items including linen. In a specific location, there was one cabinet servicing two wards. Consequently, we could not set the buffers. The available space did not allow to set any markings practically.

Idea 2 – Setting the buffers by counting the linen

Next proposal was to count the linen and set a target for every type of linen. Instead of having marks into the cabinets, the targeted inventory would be noted, and then the cabinets would be refilled with linen targeting to reach the required number of sheets. The idea was tested in one cabinet at the pediatric ward, but it proved to be a very time-consuming process and it was not quite practical to count all the linen in every cabinet daily.

Idea 3 – Use trolleys to transport and store common linen at the wards.

An employee had the idea of keeping the cabinets solely for the specialized linen. All other linen should be kept on the trolleys. Then the trolleys would be transferred to the

wards and they would stay at the ward level. No need to unload them, fill the cabinets and then take the linen from the cabinets to make the beds. The beds would be made directly from the trolleys. Also, it would not be necessary to replenish buffers, as those should be included in the stock on the linen. All that was needed was for the trolleys to have more linen than the daily needs of every ward. This idea sounded promising, so we started discussing with the head nurses at the wards. There were certain objections that there was not enough space to let the trolleys in the wards. Logistics seemed difficult. Many trolleys would be needed in the wards but also in the laundry area in order to fill them up. The available space was not enough to handle all the trolleys. This was an interesting idea though, so we agreed to put it in practice in places where it was feasible. The whole idea of replenishment should stay the same though; namely to keep the stock at the laundry and replenish quickly wherever needed. On Sundays and on times when laundry was closed, the housekeeping employee, responsible for the cleanliness and tidiness of the wards should come and pick up whatever was missing. Despite that, the replenishment amount of linen was not solved with this solution.

Idea 4 – Use the occupancy report and use it to forecast consumption for one day.

The supervisor come up with an interesting idea. The occupancy report would be printed out every day at 14.00 from the hospital's ERP system. No significant changes were happening at the occupancy status of the hospital between 14.00 and the next morning at 9.00. Main discharges were happening between 10 am and 13.00 pm. Discharges that were scheduled after 9 o'clock - their beds were not made anyway. Then the supervisor would need 30 minutes to estimate from the occupancy report what the need would be for replenishment of the major SKUs. If that worked, then we could prepare a report from the system so that the replenishment amounts could be automatically calculated. The whole thing could be automated.

What actually happened in the research field (Practice)?

The final implementation was a synthesis from the previous ideas.

In order to prevent the same consequences which were observed during the first implementation (when the laundry stopped working on Sundays), communication was one of our priorities.

Literature says: The stock should be kept at the highest point of the supply chain meaning that the linen should be stocked not at the wards level but at the laundry, folded and ready to be replenished whenever needed. **In reality:** Specialised linen like kids robes or surgery linen were kept at the wards as there is no need to be kept at the laundry. Only commonly used linen was kept centrally like sheets, towels, pillows, blankets etc.

Literature says: Set the buffers and the color zones. **In reality:** Based on the table 4.3 buffers should be kept at the wards' closet for all emergencies. Buffer penetration could not be monitored though because the level of the buffers could not be recorded. Several methods were tested like marking the walls of the closet, counting the number of the different linen, etc.

Literature says: The colored zones in those buffers should be set and replenishment should be done based on the status of those buffers. **In reality:** Based on the fact that the buffers could not be monitored, replenishment decision was made based on the occupancy report.

Figure 4.12 demonstrates the TOC replenishment solution for the linen in the hospital.

The rules were simple; replenish all specialized linen as well as the buffer and replenish whatever the replenishment report was saying from the supervisor. It was much faster to simply fill up the buffer as indicated in table 4.3. This time a pilot ward was to be tested first; the pediatric. The head nurse was extremely helpful. At the same time the housekeeping supervisor talked to the other head nurses about our intentions to avoid unforeseen reactions.

The supervisor of the housekeeping picked up the occupancy report from the reception every day at 13.00 o'clock. Then she would prepare the replenishment report of the sheets, towels, and blankets. It was not necessary for the special dedicated linen. These special dedicated linens should be stored in the specific ward – no need to predict anything. Instead of replenishing at 10 am, we shifted the replenishment time to 2.30 pm. There were not many changes made after 13.00 so the accuracy of the replenishment report was satisfactory.

The excess stock of linen circulating into the system prohibited experiencing availability issues.

A meeting with the IT supportive company assured us that the whole system could be automated and that the system could break down the linen analysis.

Figure 4. 12: Linen Replenishment AFTER the Replenishment solution

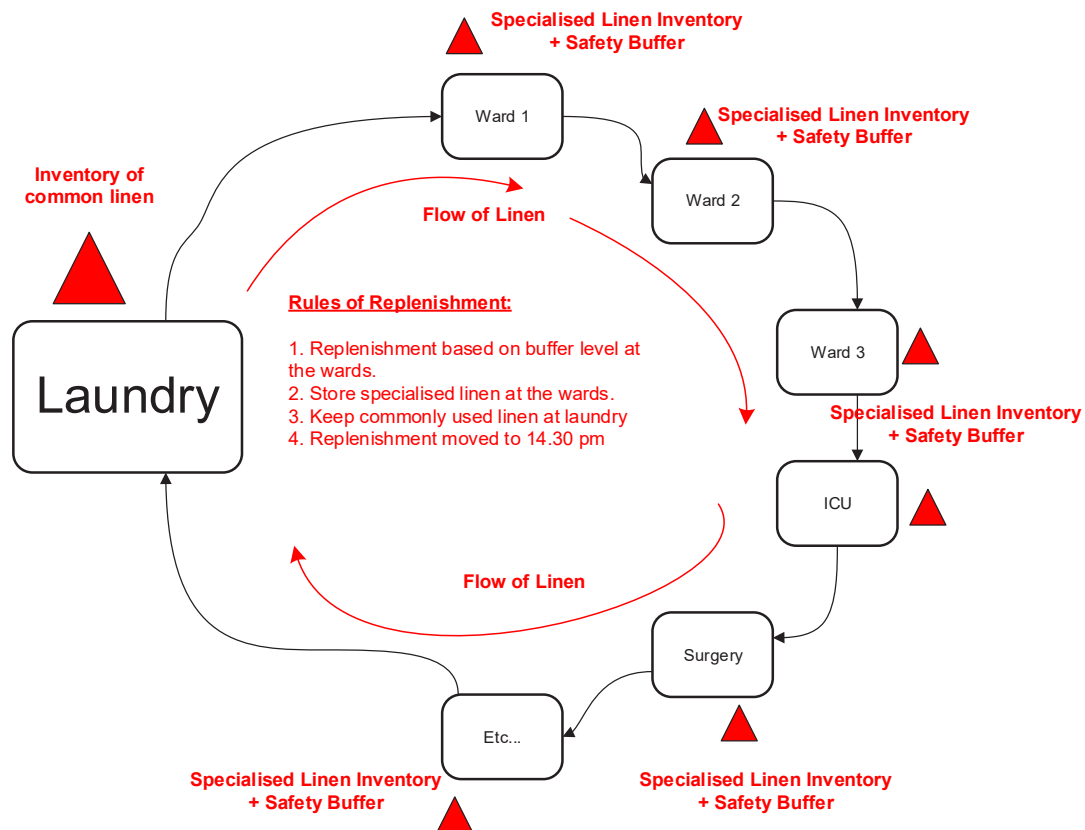

4 months later....

While being at the surgery department for the second phase of the research, we were informed from the management that there was a request to buy more linen and they also mentioned that lately there were complaints from some wards reporting unavailability issues. It was nothing major, but they thought of informing us. We were surprised because discussing with the laundry supervisor, she informed us that everything was fine and under control. After four months of operation this was the first time that a complaint was mentioned, so that was an opportunity to go back and audit the system.

4.4.11 Action Step 17 – Auditing and Stabilisation of the system

Auditing the Five Focusing Steps

Points to be audited:

1. The 5FS and the flow – the washing cycles from the log book.
2. The replenishment solution and the size of the buffers - if they are as designed.
3. The availability at the wards
4. We would ask people in order to get feedback regarding the operation and how it is after four months of operation.

Occasionally by going around at the laundry area, we could observe the pile before the washing machine. On Fridays, the pile was very low meaning that the week would start fresh again soon by Monday. By checking the log book, it was observed that the actual washing cycles were 45 as planned. The overtime work had decreased dramatically, and the people were comfortable with the new way of functioning. People's complaints concentrated on other issues like the area's temperature or holidays not being distributed fairly or that they did not have enough sheets. We were comparing the complaints/observations to the Goal Tree and most of the comments were for areas of the system which were not relevant to the throughput of the system, but they should be considered.

Auditing Replenishment

Concerning the replenishment process, the audit results were not the expected ones. Although the solution was tested and operating successfully for three months, it was not working anymore. At least not as it was designed. The replenishment process was executed as previously, before the implementation of the TOC replenishment solution. By auditing the buffers in the wards' cabinets, the situation was as it used to be before the implementation. The stocks in the cabinets were replenished empirically.

The nurses did not want to make a big deal out of it as they said because the problem was not serious, but they observed that with the time the problem was getting worse. They complained that one day they had many linens and the next day they had much less. The system was not consistent anymore.

Discussing with the person who was taking the trolleys with the clean linen to the wards, we were told that the replenishment volumes of linen were done based on experience. She knew by experience what the wards needed, and this was the replenishing method followed.

At the end of the route and to avoid returning clean linen to the laundry she was filling up the last cabinets with the linen left on the trolley.

Analyzing the situation, it was discovered that one day the supervisor was away for two weeks and nobody else could analyze the occupancy report. People having no alternative started doing what they knew from before. It worked, so they kept doing what they knew, their behavior was reinforced because they believed that what they were doing was working fine. It was a slow degrade though, and it was passing unnoticed.

When the supervisor returned, she realized that everything was working fine so she decided not to change anything. Unavailability in some wards and excess stocks in others was the result.

Implementation had to start all over again. All the linen was stock controlled again from the beginning. The supervisor would print the occupancy report and then she would issue the report with the linen to be replenished.

It was not difficult to start all over again, it was only made sure that all the hospital and especially the nurses knew what we were doing.

Soon the system was back on track.

Stabilizing the system

It was explained to the supervisor how important it was to follow the design. She realized immediately why the system fell back to the previous state.

The question was what should be done to prevent such an incident again. TOC stabilizes flow through the buffers, but in this case, we had no buffers. A way to stabilize the operation by stabilizing the procedures and making sure that they were followed as designed was needed.

Therefore, it was decided to have a review meeting, every 15 days, at the laundry place with the Nursing Care Manager and the project team to evaluate the process. Then we would gradually hold the meetings once a month discussing issues of the linen handling.

Additionally, the safety stock buffers were used as alarm signals. The head nurses should inform the Nursing Care Manager in case the buffers were no longer available. It would be an indication that buffer levels should be recalculated or that something went wrong during the process. The feedback directly from the system's customer would be an effective way of getting feedback for the system's effectiveness.

It was also obvious that more linens were into the circulation loop than needed. This extra amount of linen into the system gave a false sense of security, and it also delayed problems to be surfaced. Stock covers and hides problems.

The housekeeping store was extended where all cleaning materials were held. Shelves were installed, and the extra linens were placed into that store. The linen indicated by table 4.3 remained into the loop. The rest were stored away. This way shortages would be noticed immediately, and corrective actions would be taken instantly. The stock into the housekeeping store would be a protection for the whole hospital.

The most important though seemed to be the feeling of accountability felt by the supervisor. She was engaged 100% this time and she would do everything possible to keep the replenishment system in shape.

4.5 Evaluation

4.6 Summary of Overall Results in the Linen Management System Case Study

The last section is the results or evaluation section which summarises the results extracted in the seventeen previous action steps. The aim is to answer research questions 5 and 6.

After the implementation of the TOC, the utilization figure of the linen management system was improved instantly by 15% (from 72% to 87%) because the available time of the constraint was reduced. The investment was canceled and the result of working only six days per week (excluding holidays) led to a saving of €40.000 per year. Important is, that management had a guide to judge if the operation was “costly” and they were in a position to understand the behavior of the system.

Below Table 4.4 shows the people’s reaction in every step of the process.

Table 4. 4: Summary of soft results

Action Steps	TOC Tool/Process Used	People’s Perception and the reaction of TOC tool/Process used
Action Step 1	Training, CRT – UDE Collection	<ul style="list-style-type: none">• People become curious and suspicious.• Difficult for the people to understand the basic concepts of TOC.• Discussing about problems (UDEs) created negativity and fear of blame.• UDEs were mentioned randomly – many were not systemic.• People felt threatened, become negative and defensive.• COULDN’T CONTINUE WITH THE CRT.
Action Step 2	Training Redesign	<ul style="list-style-type: none">• Management was impatient. They expected results FAST.• Visualization of flow was very effective.• Discussing their system kept people motivated and cooperative.

		<ul style="list-style-type: none"> It is much more efficient when all the TOC tools are explained as a whole first instead of one by one.
Action Step 3	Goal Tree	<ul style="list-style-type: none"> Goal Tree is an easy tool to build but it needs guidance. CSFs and NCs are subjective. Participants could not understand how exactly they should approach CSFs and NCs. Visualizing of the flow helped the development of the tool. Focusing on the tools – fear evaporates. System’s structure and performance must be in focus NOT people. Participants did not know how to form CSFs and NCs.
Action Step 4	CRT and Gap Analysis	<ul style="list-style-type: none"> Participants were preoccupied about the problems. They “knew” what the problems were. Every stakeholder was evaluating the current status based on their status and position into the system. Employees at the laundry felt threatened and become very defensive to the UDEs raised by the other stakeholders. Employees felt that the whole system was unfair to them and that nobody appreciated their hard work.
Action Step 5	Evaporating Cloud	<ul style="list-style-type: none"> Very efficient tool It is simplicity shocked everyone. It had to be done under strict guidance though.
Action Step 6	Future Reality Tree	<ul style="list-style-type: none"> Participants liked the idea that they can plot the future. Desirable effects are very subjective even when they come from the Goal Tree. Participants strongly supported that they need more guidance in stating the Desirable Effects. Building the FRT is a long process and people cannot stay focused. They cannot develop the tool on their own.
Action Step 7	Five Focusing Steps	<ul style="list-style-type: none"> Sounded logical.
Action Step 8	Identify the Constraint	<ul style="list-style-type: none"> People were surprised when they realized that they were working on overcapacity. The system operates in overcapacity, but still, everybody looked extremely busy.
Action Step 9	Exploit the Constraint	<ul style="list-style-type: none"> Downsize the constraint Management loved the concept of downsizing.
Action Step 10	Choose the Constraint	<ul style="list-style-type: none">
Action Step 11	Convert Chosen Constraint to a bottleneck	<ul style="list-style-type: none"> Understandable by everyone.
Action Step 12	Brainstorming solutions. Categorizing and Unitising data	<ul style="list-style-type: none"> Brainstorming was used to overcome layer of resistance 9. The general manager loved the clarity of the actions to be taken. Very creative process. People loved to participate. Brainstorming is a very subjective process. This view was highly supported by everyone.
Action Step 13	Subordinate everything to the Constraint	<ul style="list-style-type: none"> 1st Step of actual implementation. No resistance is observed. People are taking part in every step. People gave priority to subordination than Exploitation.

		<ul style="list-style-type: none"> • Management was impatient – they insisted implementing everything at once. • No piloting was used. • An experienced member of the shop floor played a crucial role in overcoming resistance. • System went unstable. People panicked. Acting out of instinct.
Action Step 14	Exploit the new Constraint	<ul style="list-style-type: none"> • Most of the exploitation decisions were forgotten. • FRT helped to focus again.
Action Step 15	Drum Buffer Rope	<ul style="list-style-type: none"> • DBR was built into design. • Workers just needed a clear description and rules of what to follow and what to monitor. • 45 washing cycles every day was a clear-cut target. No other measurements were needed.
Action Step 16	Replenishment Solution	<ul style="list-style-type: none"> • People were very creative in finding ways of how to implement replenishment. • The supervisor underestimated the logic of the replenishment report. • The fact that the system was working was illusionary. •
Action Step 17	Standardisation / Stabilisation	<ul style="list-style-type: none"> • Standardization and stabilization concept was interesting only for the Nursing Care Manager. • The rest of the team believed that it all depends only on the human ability, skills, and interest.

Figure 4. 13: Technical Results - Linen

TECHNICAL (HARD) RESULTS OF THE LINEN CASE STUDY

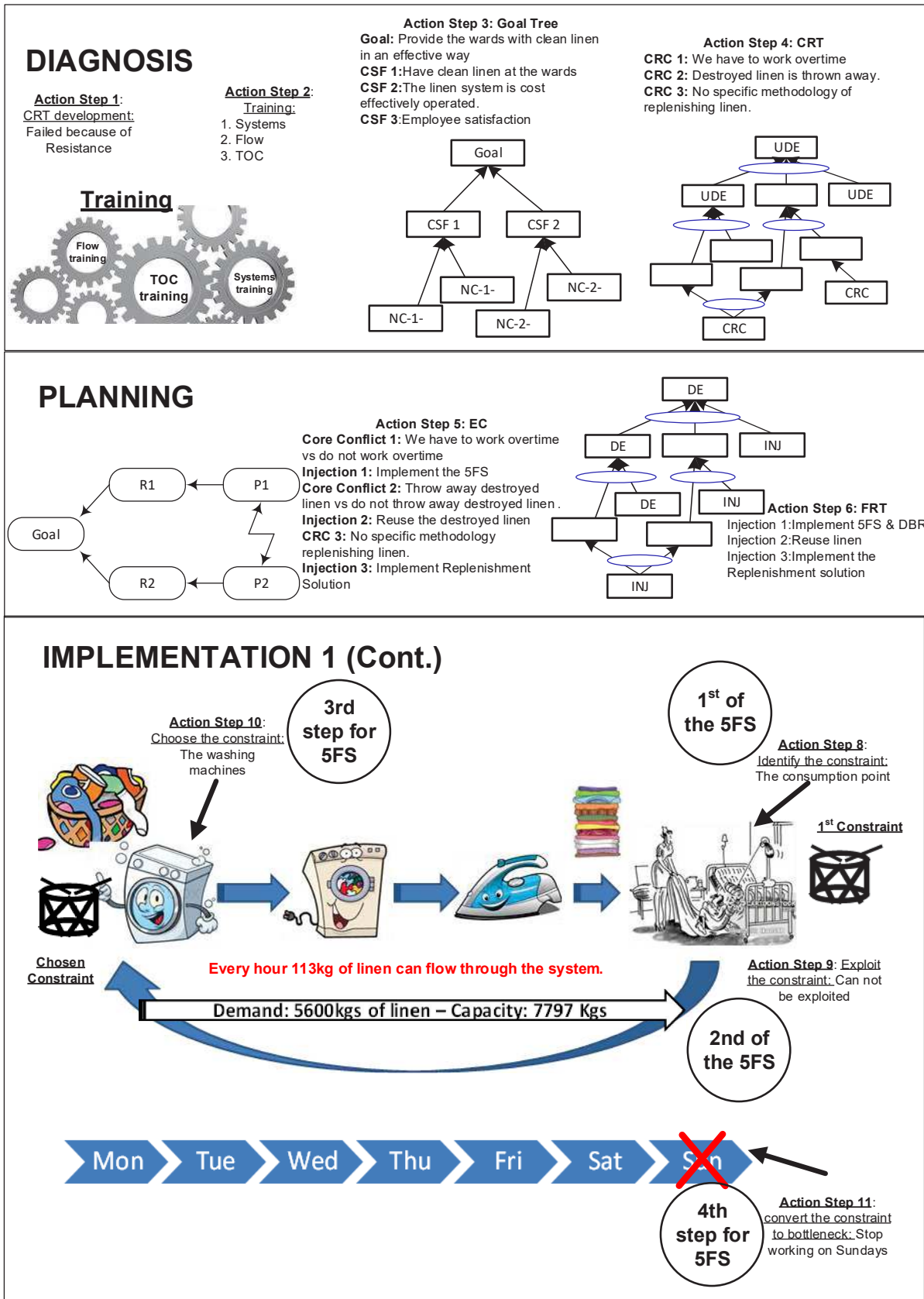

Figure 4. 14: Technical Results – Linen

Implementation 2 (Cont.)

Action Step 12: Categorising and Unitising Data

Injections for Exploitation

1. Load 25kgs the drum of the washing machines.
2. Separation of coloured and white at delivery of dirty linen.
3. Load Sheets and towels together.
4. Hire a man to load/unload the washing machines.
5. Support from the driers for loading/unloading the washing machines.
6. Schedule the washing machines so they would not stop at the same time .

Injections for Subordination

7. Start earlier on Mondays
8. Inform suppliers and maintenance that washing machines have the highest priority.
9. Move the second shift earlier by one hour.
10. Stopped working on Sundays.

Injections for Measures

11. Run 45 washing cycles every day and 15 during Saturday. Add measures in a log book.

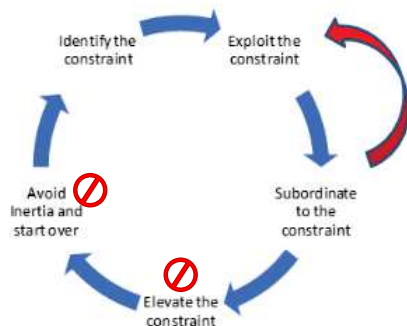

Action Step 13: Subordinate everything to the constraint

SUBORDINATION PRECEDES EXPLOITATION

Subordination steps (from FRT)

9. Start earlier on Mondays
10. Inform suppliers and maintenance that washing machines have the highest priority.
11. Move the second shift earlier by one hour.
12. Stopped working on Sundays.

Action Step 14: Exploit the new constraint (from FRT)

Injections for Exploitation

3. Load 25kgs the drum of the washing machines.
4. Separation of coloured and white at delivery of dirty linen.
5. Load Sheets and towels together.
6. Hire a man to load/unload the washing machines.
7. Support from the driers for loading/unloading the washing machines.
8. Schedule the washing machines so they would not stop at the same time .

Action Step 15: Drum Buffer Rope

Worked by design



Action Step 16: Replenishment Solution

Steps:

1. Replenish all specialised linen when available
2. Replenish common linen based on the occupancy report.
3. Shifted replenishment from 10.00 to 14.30
4. Kept clean common linen at the laundry.

AFTER 4 MONTHS STOPPED WORKING AS DESIGNED.

Action Step 17: Auditing and Stabilisation

Occupancy report was not followed after 4 months. Everything fall back to previous operation – Entropy.

Stabilise

1. Placed review meeting for stabilisation purposes.
2. Trained the supervisor
3. Removed excess stock from the system – false sense of security
4. Monitor the buffers
5. Ownership to the supervisor

4.7 Chapter Summary

This chapter described the implementation of TOC in a housekeeping function – the linen management system. The implementation took place through 17 action steps. Every action step implemented a TOC tool or concept in order to go through the four action research phases, Diagnosis, Planning, Action, and Evaluation.

Results were also presented in the same chapter since the results of one tool are the input of the next tool, making difficult to separate results from the actual implementation.

The case study showed that TOC has improved the linen management system by downsizing it around the constraint. The system was operating in overcapacity and there was no need to use that overcapacity despite the fact the TOC places Throughput as number one priority. The Goal Tree proved to be an excellent and very effective tool in setting the mindset of the participants into the system's improvement mode.

Next Chapter discusses the second case study which is the TOC implementation into the surgery department.

Chapter 5

Analysis and Findings: TOC in Operating Rooms (OR)

5.1 Introduction to the chapter

The purpose of this chapter is to describe the implementation and the findings of the Theory of Constraints at the surgical department of the largest private hospital in Cyprus. The implementation of the TOC is required in order to answer the research questions stated in section 2.10.

The TOC tools follow a sequential pattern by design. Every tool uses input data that it is being “produced” by the preceding tool. The methodology and the execution of every step flow naturally out of the results of the previous steps. This sequential pattern complicates the presentation and the separation of the methodology and the results in different chapters. For easy of understanding, we have divided the case study into different sections following the action research logic. This case study is divided into two action research cycles.

In order to answer the research questions, two categories of results have been produced. Results which affect the soft part of the system, which concerns entities that cannot be measured, it usually concerns humans and the hard part of the system – which is the technical aspect of the TOC in the healthcare context, it can be measured, quantified or given clear boundaries. The results produced by the action steps are presented in section 5.11.

Following the action research philosophy of figure 3.3, the first action research cycle stops when the first intervention has produced no results or when the problem has not

been solved. The second action research cycle follows the same pattern again advancing the action, by diagnosing the new constraint blocking improvement and causing the first action research cycle to stop.

This chapter begins by describing the contextual background which includes the description of the specific operation of the surgical department in order to help the reader understand the overall setting.

In every sub-section and in every action step different TOC tools are used in order to analyze the data collected from the field. There is nice match between the action research phases and of the TOC as shown in figure 3.3.

Being consistent with the action research theory four steps have been followed. The Diagnosis step answers the first TOC question “what to change”, the Planning step answers the “what to change to”, the Action step answers the question “how to cause the change” and the Evaluation phase which summarises the results of the previous steps.

The chapter then is divided into three parts as shown in table 5.1.

Part one describes the first action research cycle which is divided into four sub-sections following the logic of the action research spiral. Following action research literature, the four sub-sections are Diagnosis, Planning, Action, and Evaluation. Every sub-section is further divided into action steps which help realize the Action Research sub-sections. These action steps describe the specific actions and observations taken in the surgery department to improve the setting. Part one is composed of 6 action steps.

Part two describes the second action research cycle in another four sub-sections with the corresponding action steps. The logic is exactly the same with the format of Part One and the first action research cycle. The second research action advances improvement. Part two is implemented through 3 action steps.

Part three summarises then the findings of the first two parts. The findings are presented in a sequence according to the action steps. This part isolates and summarises the results for analysis purposes.

The results are twofold and have been extracted following the sequence of the research questions. 1. First the theory of the action step is discussed, meaning how the specific

tool should be applied and then the actual implementation is discussed. The difference observed between the theory and the practice is one of the results of the action step, the other is the actual output of the action step and the last one is recording how the people perceived and behave to the TOC exposure.

Results have been extracted through the lenses of the soft and the hard parts of the system.

Table 5. 1: Chapter 5 layout

Part 1	1 st Action Research Cycle	TOC Change Questions	Action Steps	Description of the process
	Diagnosis	What to Change	Action Step 1 Action Step 2 Action Step 3	Training Goal Tree Current Reality Tree
	Planning	What to change to	Action Step 4	Five Focusing Steps
	Action	How to cause the change	Action Step 5 Action Step 6	Identify the constraint Exploit the constraint
	Evaluation			
Part 2	2 nd Action Research Cycle			
	Diagnosis	What to Change	Action Step 7	Evaporating Cloud
	Planning	What to change to	Action Step 8	Future Reality Tree
	Action	How to cause the change	Action Step 9	Drum Buffer Rope
	Evaluation			
Part 3	Results			

The case study is written in a narrative form whereas certain sections contain descriptive information. Because of the narrative nature of the case study, facts are described in a sequential chronological sequence in the form of action steps. Every action step describes a specific event that took place. Findings are extracted after the implementation of the action steps.

5.2 The research field - Contextual Background

Groups of people in the operating room

The surgical department of the hospital has 12 operating rooms. Three of those operating rooms are in different areas in the clinic like the Dentistry, Gynaecology and Obstetrics Department, etc. The research took place in studying 8 operating rooms at the surgical department, in one block, located on the 1st floor.

In the operating room, three groups of professionals coexist and synergize in order to work harmoniously - surgeons, anesthesiologists and nurses, a fact which is also recognized by (Cunningham 2017). They are all supported in their work by many, different and specialized teams of technical and other personnel. These professional teams share some basic common elements, two of which are their dedication to caring of patients and faith in their professions. However, these groups differ as to the educational background, work activities, professional approach to different issues as well as to their working status within the organization. Surgeons and anesthesiologists are self-employed, although recently some anesthesiologists are employed by the hospital, some surgeons are related to the hospital through various contractual or non-contractual relationships. In this private hospital, many surgeons or anesthesiologists are shareholders with active participation in the board of directors. Unlike doctors, surgeon nurses are all employees of the hospital.

Surgical specialties

The hospital covers a variety of surgical specialties, some are explained below.

General surgery involves abdominal surgery (e.g., esophagus, stomach, small intestine, colon, rectum, liver, kidney, spleen, and pancreas), including also soft tissue surgery (e.g., thyroid and breast), general surgery has always been and is the most important surgical specialty in the hospital. The general surgeons perform the largest number of interventions, have the most patients and the most variety of incidents. A general surgeon is selected as the director of the surgical department and he is also the president of the board of directors.

Other surgical specialties include cardiac surgery and cardiac surgery thoracic surgery, vascular surgery, but also neurological, ophthalmic, otorhinolaryngology (ORL), pediatric, plastic, urological surgery. The specialties are mainly characterized by the field of education, which determined by the councils/committees of surgical specialties and provided through specialty programs, as well as from the anatomical region or structure which is the subject of each specialty.

Often there are no clear boundaries between different surgeon's specializations. For example, most neurosurgeons, who are generally deal with the brain, the spine and generally the nervous tissue have, also trained to deal with disturbances of peripheral nerves, such as carpal tunnel syndrome, and intervertebral problems discs. Orthopedic surgeons have also been trained to perform this type intervention.

Doctors of other specialties, other than surgeons, may have access surgery to perform specific, specialized interventions. In this category includes dentists, pediatricians, family doctors, but also physicians who need essential aseptic conditions (sterile area) narcosis, specialized equipment, and appropriate nursing staff, for performing invasive, not necessarily surgical, operations.

The Surgeon and the hospital

Surgeons carry out their work either individually, or in groups with members of different specialties. For surgeons, the hospital is an exercise room for surgical "art". In this context, the surgeon is an important customer who brings "work" to the hospital. This parameter is an important incentive for the hospital to seek satisfaction the surgeon's needs, as it would do with any customer.

The surgeons have their own private practice. They have their own customers and they are responsible for their patients.

In the hospital, surgeons are responsible for pre-surgery, for the surgery and for the post-surgery phases. Pre-surgery assessment may require work or x-rays, as well as a series of visits to the surgeon. When the surgeon has reached to diagnosis, he/She informs his/her patient, suggests appropriate surgical treatment and any alternative treatment, if any. Then, if the patient agrees to the surgery, the surgeon receives the written consent of the patient and schedules the intervention in a time appropriate for the patient taking in consideration the scheduling of the surgical department. For the

efficient use of time, surgeons are trying to plan successive interventions on the same day of the surgery. Surgery shows significant differences in time, lasting from a few minutes to over twelve hours, but also in terms of the required tools and equipment.

Also, pre-planned surgery and the actual plan which is performed often differ due to additional findings that arise during surgery and complications that can also be observed. The surgical complications ranging from insignificant to severe and the possibility of death, albeit very low for the majority of interventions, it is never zero. In many diseases, the recovery period may take a long time, and the surgeon undertakes post-surgery follow-up for the rest of the patient's life. Most surgeons consume longer pre-surgery and post-surgery following-up patients, rather than performing the actual surgery.

Scheduling of surgical services

The surgical department has allocated surgeries through the weekdays to different doctors and specialties. For example, certain days are allocated for the performance of orthopedic interventions; or for general surgery etc. Surgeons have a specific day allocated to them to perform surgeries. All surgeons prefer to perform surgeries in the mornings because they have their own private practice to run in the afternoons. This is one of the major scheduling constraints. Scheduling considers interventions made by surgeons visiting from other countries as heart surgeries, where the hospital has come into an agreement with Swedish surgeons.

Finally, the leading surgical team, the manager and the surgeons must communicate and share their concerns about the schedules. The problems that are usually expressed refer to: a program of interventions, time allocation, selection and timeliness supply of supplies and equipment, qualifications and nursing skills staff, quality and availability of anesthesia services.

The surgery department manager allocates the requested surgeries in the various operating rooms and allocates a specific time slot. From experience, the surgery department manager predicts the duration of every surgery. She also points out any specialized set of tools that might be needed. Changes to the program are made only by the surgery department manager and only after consultation with the anesthetist or surgeon.

If the patient is not an inpatient, the administration office of the surgery department calls the patient and reminds him of the time of arrival to the hospital.

Anesthetics and the surgical department

At the hospital, anesthesiologists provide their services in a mixed system. Some doctors work independently, more often, however, are members of organized anaesthesiologic groups. There are also some exclusive employment contracts which give some privileges to both anesthetists and the hospital.

The anesthetist's role in an operating room is relatively clear. She/he is responsible for the patient's pre-surgery assessment, for her anesthesia- psychological care based on the clinical condition of the patient and its type intervention, taking into account, at the same time, the surgeons' preferences, but also of the patients themselves. The anesthetist performs a focused and detailed clinical examination, explains the alternative methods of the patient and receives the patient's written consent for narcosis.

Finally, the anesthetist, often with the help of anesthetist nurses, implements the plan of anaesthesiologic care. As a large number of surgeries is being executed daily, often pre-surgery assessment is done during the day of the operation. Therefore, in these cases, the patient's first meeting with the anesthetist who will give him the narcosis, is just a few minutes before the beginning of the surgery.

The patient, after the surgery, is transported to the Unit Resuscitation for monitoring during the anaesthetic withdrawal period and it regained a normal level of consciousness. Then, he/she is transferred to the nursing units of the hospital.

However, with use of regional or local anesthesia, the need for close, postoperative monitoring of the patient's recovery is limited. In cases, many patients can be transported directly to the daily hospitalization unit, for the second stage resuscitation and for their immediate exit from the hospital.

Also, due to the use of modern anesthetics, the rate resuscitation of patients has been accelerated even after total narcosis when these patients meet the objective criteria for their safe transport to daycare unit rather than in the intensive care unit.

Eventually, patients who are not restored to the level of consciousness or in their respiratory function in the next hours or days after surgery, they need intensive

monitoring and treatment, so they are transferred to the intensive unit after surgery. This rarely happens though.

Unlike surgeons, most anesthetists consume most of their time in the operating room. Although there are anaesthesiologic sub-specialties (e.g. cardiac surgery, neurosurgery, pediatric anesthesia, etc.) most anesthetists give anesthesia in a wide range of surgical procedures.

Nursing service

Nurses are involved in every function and activity, from the pre-surgery follow-up a clinic to the post-surgery follow-up. Nurses are responsible for pre-surgery care, prepare patients, facilitate prenatal, participate in the execution of intervention, provide support for resuscitation and postoperative care.

The duties of the nurses start from the pre-surgery preparation of the patients as well as the preparation of the necessary equipment and tools to be effective and efficient execution of the surgeries. Then, during the intervention, nurses are concerned with ensuring the safety of the patient, supplying all the necessary consumables, tools, medicines to ensuring the proper operation of the equipment to complete the operation as well as the support of anesthesiologists and surgeons.

The three main nursing groups are:

Scrub nurse – who assists the surgeon at the table with the tools and instruments. The scrub nurse prepares the OR with all the sterile equipment before the patient enters the room. This is mainly for sterility reasons but also for space requirements while preparing the equipment. The preparation of the equipment takes place in the OR in contrast with other hospitals where sterile equipment is prepared on a trolley in a sterile corridor, as a surgeon commented. The role of the Scrub nurse is to "organize and provide a surgeon, accurately, all the tools and equipment required during the duration of the operation".

Circulating nurses – they help the surgeons bringing in the operating room the supplies needed. They also manage surgical inventory, feel up documents and perform patient care activities. She moves the patient into and out of the OR. She basically interacts with the patient while he is awake. Also, the circulating nurse is responsible for the documentation of the nursing process, recording the course of the operation. He/She

also takes care of the patient's safety and provides all required consumables and equipment. The circulating nurse is the coordinator of the group, the person who performs the perioperative monitoring and assessing the condition of the patient and who are generally responsible for the smooth conduct of the operation

Anesthetic nurses. He/She is working with the anesthetic surgeon and provide the patient with anesthetic care. They are responsible for advising the patient about the anesthetic procedure, monitor the anesthesia status during the surgery and ensures the availability of anesthetic supplies.

The above group of nurses plays a vital role in the duration of the surgery. Especially in short operations (less than an hour) the speed of the anesthesia and of the nurses maybe more important than the speed of the surgeon determining surgery length (Eugene et al. 2006, p.105).

The three nursing groups report (administratively) to one surgery department manager.

The average age of surgical nurses is between 30 to 40 years; the hospital is constantly looking for ways to attract nursing staff for the staffing of their surgeries since it takes almost a year to train a nurse to a satisfactory level. The supervisor commented, *“In larger hospitals, which have more and more complex equipment; education has a longer duration”*. Many times, they gain further specialization, and they work on specialized cases (e.g. gynecological, ophthalmological, dental), or are employed in specialized surgeries where they deal only specific cases (e.g. cardiac surgery, arthroplasty, neurosurgery, etc.). These nursing staffs is distinguished for the specialized their knowledge and skills and often serve as advisers for others in dealing with incidents of their specialty. All major surgeries need groups of both generic and specialized nurses to ensure the efficient provision of services to different patients, whose hospitalization requires specialization and use of appropriate equipment. Some large organizations organize their nursing staff at specialized groups for cultivating team spirit and encouraging its cooperation and communication. These organizations plan the programs work so that there are nursing teams that provide cover to shifts.

In order to prepare for the surgery, the surgery department requires information from the surgeon on the type of surgery. This information is collected by the surgery administration office [scheduling office] while scheduling for the surgery. However, when it comes to emergency and emergency interventions, the collection of this

information is critical. Typically, the information is transferred from the responsible surgeon to the secretary of the surgery and from there directly to nursing staff. There is also direct communication between the surgeon and the surgical department manager. Intervention protocols, which are specific to each surgeon, include the following sections: (1) nursing care plan, (2) tools and consumables, and (3) special equipment. Before starting an operation, the nursing team must confirm that the correct/appropriate intervention protocol has been selected. Afterward, must ensure that all consumables, tools, and equipment that provided by the protocol have been collected, are in good condition and have properly organized. Before sterilized material and equipment is opened, a nursing team checks that the site is safe (asepsis conditions, etc.) and that required equipment works. Finally, the nursing team creates sterile surgical fields, opens and places, in the appropriate order, the tools and at the end (crucial step) counts all the materials (e.g. gauzes, needles, tools) that are going to be used in the surgery. Standard exemplary practices are published by the Association of Surgery Nurses, who direct the nurses in their work.

As soon as the surgery is ready to begin, the circulating nurse performs a pre-operative nursing assessment of the patient. She/he follows the following steps: (1) Recognizing his / her identity patient, asking him/herself and crossing the data from his / her envelope the patient and the identity that he wears on the wrist. (2) Confirms its type the intervention programmed, the anatomical point and the side in which will be the operation. (3) Controls the patient consent form to confirm that it is fully and properly completed by the procedures of the hospital. The duration of the pre-surgery nursing assessment is short, but it requires the nurse to collect useful data about the clinical condition of the patient. The stage of pre-surgery nursing assessment allows the nurse to develop a nursing care plan, aiming at an optimal outpatient clinic basis for the patient. Subsequently, the patient is transferred to the surgery usually by the nurse and the anesthetist or the anesthesiologist (anesthetist, anesthetist and nurse anesthetist) or by the surgeon and the anesthetist. When the patient enters the surgery, the role of the circulating nurse is to ensure the patient's safety and help him to adapt to the operating environment by providing him with the information he has psychological support and means of comfort (e.g., blanket, etc.). The nurse helps the anesthetist. After the patient has been treated, the surgical team places him/her in the appropriate position, makes skin prophylaxis and prepares the surgical field for the execution of the surgery.

The surgery department and operational mode

The hospital has 152 beds and 12 operating rooms. The 8 operating rooms are on the 1st floor of the hospital where the other four are located on different floors.

The surgical ward is composed of 8 operating rooms or theatres which are dedicated to different surgical needs and is as follows:

No2 – Microsurgery

No3 – General Surgery

No4 – Orthopaedic and Cardiothoracic Surgery.

No5 – Orthopaedic Surgery

No6 – General Surgery

No7 – General Surgery

No8 – General Surgery

No9 – Neurosurgery

The operating hours of the surgery department are from 7.30 to 15.30, but because of delays, increased number of incidents and surgeries with longer duration, the nursing staff works on overtime.

Every day the surgery program is finalized at about 13.00 o'clock for the next day. The surgery department manager confirms the availability of the tools, blood or anything else is needed. Anaesthesiologists control the clinical picture of patients in the afternoon of the same day (in the case of inpatient). If the patient is outpatient, then his surgeon has arranged for the patient's diet as well as the medical examinations which are needed.

The nursing staff on every ward prepares each patient promptly according to the surgeon instructions. Also, due to the severity of the illness of the hospitalized, there is a general, detailed monitoring of their clinical picture.

Based on the program, the secretary from the surgery department calls the first surgeries, and the nursing staff of each ward transports the patient to the surgical ward.

The transfer is via a dedicated elevator. The medical records of each patient accompany the patient.

When the patient arrives at the surgical ward, the nurse from the ward does not enter into the surgical ward but calls for a circulating nurse. The nurse receives the patient and his / her medical file.

The surgical ward does not have a reception or waiting room for patients. Operating Room No 3, is the only one that has a narcosis room. In this room, until the patient's preliminary actions (hearing, throttle, etc.) are completed, the surgical set and other materials are transferred to the surgical room.

Under ideal conditions, as soon as patients arrive in surgery, they are transported to the operating room where they will be operated. When the OR is not ready, then the patient has to wait in the surgery corridor. In these cases, a nurse stays with the patient, speaks to him to release him from stress. The whole environment loads the patient emotionally and is something that the nursing staff tries to avoid.

The anesthesiologist administers narcosis, and then the operation begins. The surgeon decides when the next patient will be called, but it is usually after the surgery is completed and during the surgical room cleaning. The nurse moves this information to the operating theatre manager, which in turn calls the next patient.

By relocating the patient out of the surgery room, the nurse will also ask the cleaning crew to take the necessary action. During the interval between interventions, the surgical team has time to rest in a recreation room located on the same floor.

Process mapping

What really helped at the linen throughout the analysis was the “visualization” of the flow. This “visual” representation of the flow through the different resources makes it very understandable to people who were never exposed to system concepts. The “flow” experience from the linen would be applied at the operating rooms as well.

The description of the processes as flows are called “process mapping of a chain” (Vissers & Beech 2005, p.74). It is a way to map a service process in order to analyze it or improve it (Johnston & Clark 2008, p.198). Processing mapping can be used as a template to collect data on time, volumes, resource consumption etc (Lillrank et al.

2011). It is a technique that it has already been used to map healthcare processes (Buchanan & Wilson 1996).

The first “river” flow was created by the researcher and then it was redefined and fine-tuned with the team members. The “flow unit” was decided to be the patient. The linen case study showed that the constraint concept is understood more easily when a type of “flow” is conceptualized.

Below figure 5.1 displays the patient journey or the Patient Journey Flow through the hospital to the surgery department and back to the wards. The interest of this research work is between point A to point B which is the steps of the patient through the surgery department. The three steps of the Pre-Operational process, Surgery, and Post – Operational process are further decomposed for purposes of analysis, from Step 1 to Step 8.

Figure 5. 1: Patient Journey Flow (PJF)

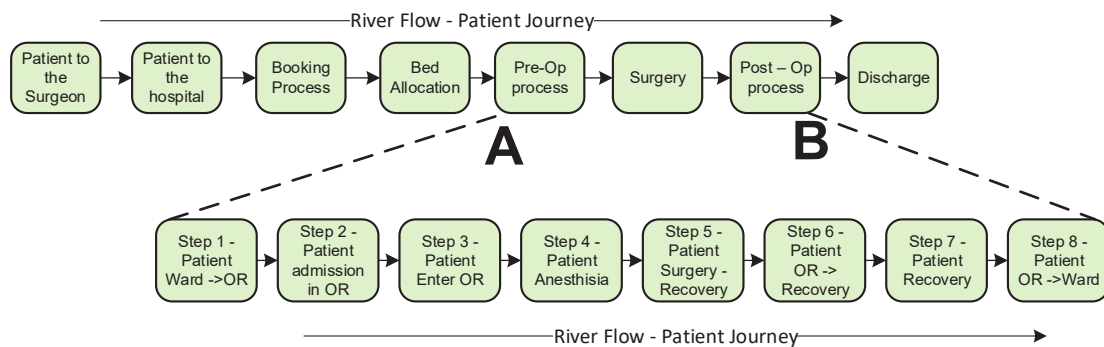

PART 1 – FIRST ACTION RESEARCH CYCLE

5.3 What to Change - Diagnosis

The diagnosis phase seeks to identify the problem to be solved or the situation to be corrected. In this research the diagnosis is composed of three action steps:

Action Step 1 – Training

Action Step 2 – Goal Tree (GT)

Action Step 3 – Current Reality Tree (CRT)

5.3.1 Action Step 1 - Training – setting up a uniform mindset.

During the implementation of TOC at the linen management system, it was observed that people could not engage themselves in a change if they are not convinced that a change is needed. (Kotter 1995) supports that the first step in the change quest is to establish a great enough sense of urgency.

The mainstream of TOC literature supports that there are three questions to be answered in order to navigate through change. 1. What to change 2. What to change to and 3. How to cause change. There are authors who recognize that an additional question needs to be answered before the above three and this the “why to change” question. The findings of the linen case study support that the “why to change” question is mandatory since it liberates people’s psychological barriers. The above improvement questions guide people through the layers of resistance as explained in section 1.6.1

At the linen system, “the why to change” step was initially skipped and ignored. The people could not accept anything until they were explained and trained. The lack of training and the miscommunication resulted in a wall of resistance where progress was not possible. In order to avoid the same effects of confusion and resistance, the first process step at the OR case study would be the training part.

The main objectives of the training process step would be (based on the experience of the linen):

1. To block the resistance by explaining that humans and human behaviors are not in focus, but the structure of the system is.
2. To block fear and doubt by explaining the methodology of the improvement.
3. To establish a common mindset for improvement and the need to get better continuously.

Training and education is also the first step of other continuous improvement initiatives like Kaizen concept, (Scott 2011). Training and the topics of training are not emphasized enough in TOC literature.

In order to make the concepts understandable, metaphors would be used, and the message would be conveyed with simple terminology by avoiding jargon words, which proved to switch off people's mind at the linen case study. (Morgan 1997) describes the power of metaphors and how our imagination is stretched to create powerful insights through evocative and expressive images.

To meet the objectives, the following topics would be discussed:

1. Maintenance vs. improvement concepts. The linen case study showed that not all systems have the purpose to grow. The difference between maintenance and improvement approaches would be discussed in detail as explained in (Kaizen 1986, p.6).
2. Improvement concept and change questions. From the TOC measurements, Throughput (T) has the highest priority at the surgery department. The more surgeries, the better it is. This is because the surgery department is one of the most heavily invested but also profitable departments.
3. System concept. Since TOC evolves into the system's conceptual framework and it seeks to manage flow - the main concepts to be explained are three. The concept of the term system, the concept of the flow through that system and the management of that flow by explaining the TOC tools and how these tools are synthesized in a whole. The metaphor of the car would be used once more since it proved to be so effective at the linen case. The same metaphor was used by

Ackoff when he used to explain system characteristics (Ackoff et al. 2006; Ackoff 2001).

4. Discussion on flow – The aim would be to “visualize” the flow through a system. Visualization of flow gives meaning to terms like constraints, lead times, wip etc.
5. TOC – Flow management. Last the TOC methodology would be discussed as a methodology of managing a system and the flow through its components.

The duration of the training sessions would be kept minimum because the team was extremely busy. The idea was that the big picture and the explanation of the concepts would be explained at the training room of the hospital and after that, we would support them in the day to day hands-on training. The training sessions would be done with slides in the training room.

Summarising, the output of the training session would be to agree on why we need to change, what to change, what to change to and how to cause the change. This change sequence would be explained in the system’s conceptual framework, what are the methodology and the tools to do so and finally show and emphasize the fact that the aim is the improvement of the system and not their behavior or areas of their personalities.

The clinic had no previous experience or previous training in any continuous improvement methodology.

Setting up the project team

Since it was not possible to involve all the people, a small flexible project team was to be formed. A seven members project team was formed consisting of the researcher, the head of Nursing Care Manager, the surgery department manager, his assistant, a surgeon and two circulating nurses from different Operating Rooms. The surgeon was an orthopedic surgeon. The structure of the project team covered different functional areas. The project team had the role of identifying an area of improvement and suggest solutions based on the TOC philosophy. One of the goals also was to evaluate changes before they happen. It was agreed that change would pass through the project team’s

approval always. We agreed that the project team would be the central authority which would take decisions.

After that, we moved to their environment, and we started "mapping" their ORs with simple system's terms.

It was agreed that the flow unit through the OR system is the patient. This is what constitutes the flow - the more the patients, the higher the flow of the "river".

The training sessions were divided into two sections. The first one was executed in the training room with the aid of PowerPoint and slides and the other one was on the field mostly learning how to recognize flow and waste of time and motion. Training was covered in two months with short, frequent training meetings.

Most of the training were done in the afternoons.

5.3.2 Action Step 2 - Goal Tree (GT)

What is the need for the action step?

Although it is widely accepted by TOC community that the three change questions are successful, the linen management system case study showed that they are not enough. The additional question of the "why to change" was mandatory and crucial since it addresses psychological level issues than technical ones. Without the "why to change" answered, people did not have any reason to change.

TOC answers the "why to change" with the application of the Goal Tree (GT). The GT proved to be a very effective tool at the linen case study. The theory of the GT is found in section 1.4.2. The GT is a system level tool than a process level one. It maps the whole system starting from the system's goal and connecting requirements from different system's functional areas. The GT is a necessity logic-based tree.

The GT had tremendous effects on the psychological level of people at linen. It released positive energy of creation and innovation. It evaporated negative emotions as threats, fears, doubts and misbeliefs. It showed clearly that the efforts are toward improving the system and not catching the people doing things wrong. It motivated people toward

action, and it affected the psychology of people in a very positive way. It proved to be a very strong antidote to people's resistance.

Since it was so successful, the GT was decided to be used in this case study as well, from the very beginning. The aim was to set the goal and highlight the systemic nature of the approach to avoid people's resistance.

Setting the boundaries of the system before modeling it, is the first requirement (W. Dettmer 2007). Meaning what "conceptual" elements are separating the system from its environment. The GT was intended to be used as the benchmark of system performance by mapping the ideal state of the system. Deficiencies of system's current state would be the result of the comparison of the current state vs. the ideal state of the system represented by the GT. The aim would be to represent the ideal state of the surgery department, in order to compare with how it actually functions and what current standards are.

The main source of data would be the management and the project team. Data would be captured by semi-structured interviews with the help of the different groups involved, management, doctors and nursing staff. The data from the different stakeholders would be presented on the GT.

The GT would be discussed in one of the training sessions since people were exposed in this kind of thinking for the first time.

What actually happened in the research field (Practice)?

Determining the Goal of the System

The GT was developed during the training sessions.

Goldratt supports that the system owner must set the goal of any system. We considered the project team to be the system owner. TOC states and the project team agreed that the goal is to "make more money now and in the future". This goal statement was not well accepted by the project team though. The younger members of the team particularly argued that the only true goal of the surgery department is to provide high-value surgical services to the patients. They hated the idea that their goal is to make more money. Their nursing educational training and their objective were to provide the safest environment for surgery, their care to the patient and the support to the surgeon.

They could not accept that their goal had a financial smell. The disagreement led to long philosophical discussions about what a CSF and what a goal is. We decided to include both elements into the goal statement. The medical and the financial one. The resulting goal of the system is to " *Provide high-quality surgery services with maximum profitability now and in the Future*".

Identifying the Critical Success Factors and the Necessary Conditions of the system

As per (Dettmer 2016b) the Critical Success Factors of the system should not be more than five. With the management's and the project team's agreement, we concluded to three main Critical Success Factors as shown in figure 5.2.

CSF1 - Financial Effectiveness. This CSF comes from the managerial function of the organization. It was the first CSF mentioned by management.

The Goal Tree and the specific branch continued with the NCs. In order to realize "Financial Effectiveness" two conditions must be present. Maximum Revenues (NC1) but at the same time with optimized cost (NC2) – which means that the cost must be fully justified. In order to have "maximum revenues" three necessary conditions must be present. "High-value surgeries" (NC3) with the aim to have a higher throughput for the time that the OR is occupied. Then the "high OR utilization" (NC4) which means to have many high-value surgeries and at the same time be "competitive" (NC5) from a price perspective.

This logical network below CSF1 shows all the necessities that must be in place in order to have "Financial Effectiveness".

CSF2 – Provide Successful Surgeries. This Critical Success Factor (CSF) comes from the medical part of the healthcare context. This CSF represents what the surgery department must accomplish to have maximum profitability now and in the future. It is depended on three Necessary Conditions. In order to provide Successful Strategies, a safe environment for execution of surgeries (NC7) MUST be provided in combination with the "best possible care to patients" (NC10). Additionally, "state of the art treatment capabilities" MUST also be provided (NC11).

In return, in order to have "a safe environment for execution of the surgeries" (NC7) "procedures must be strictly followed" (NC8) by "trained personnel" (NC9).

CSF3 – Have quality workforce. The most valuable resource of any system. It is present, and it is recommended to be present in every GT.

The GT was erected by asking and answering questions. We kept asking the team “what needs to be in place for “x” to exist?”

All the participants accepted the resulting GT of figure 5.2. Management though required that we focus on the “Financial Effectiveness” branch and not on the other two. This request was completely in line with the purpose of this research since the operational part of the surgery function was to be researched and not the medical one.

Figure 5. 2: Goal Tree – Surgery Department

GOAL TREE OF HOSPITAL’S SURGERY DEPARTMENT

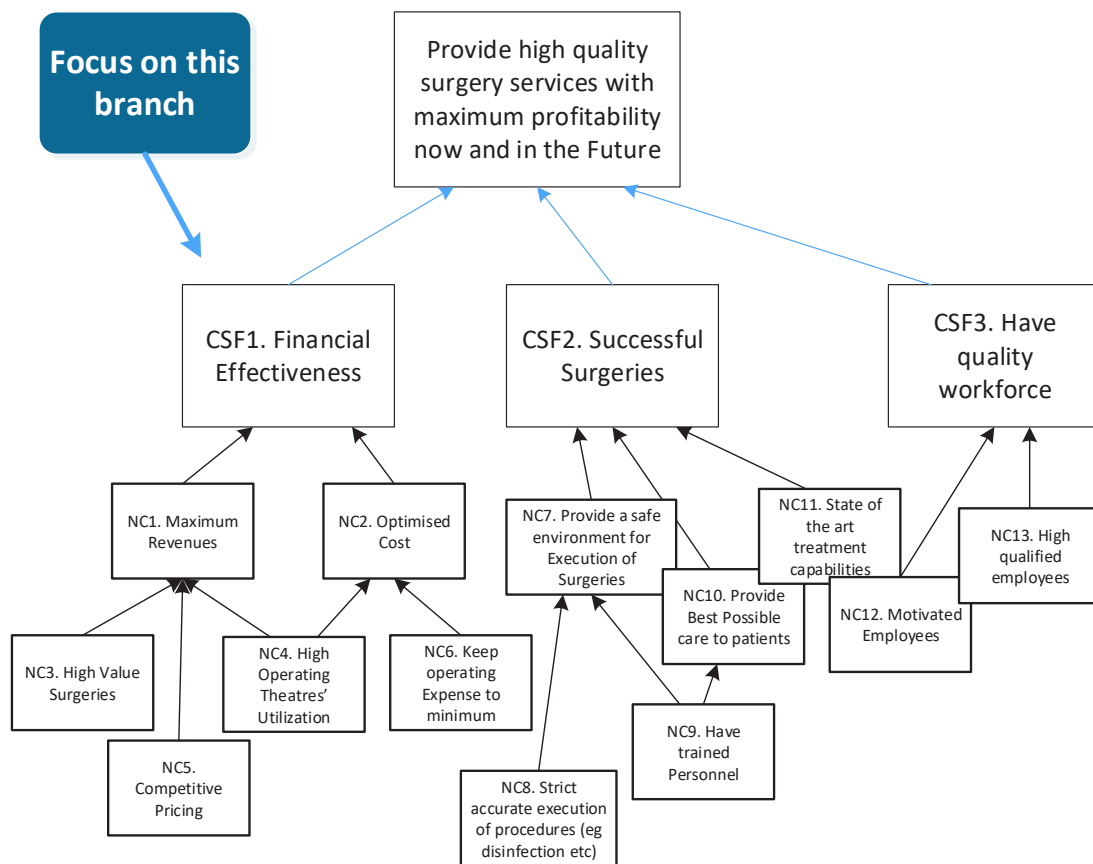

5.3.3 Action Step 3 – Current Reality Tree (CRT)

What is the need for the action step?

Action step 2 simulated the ideal state of the system, how the system must be in order to realize its goal. Since the system is now defined, the next step is to identify if there is a gap between the current state and the ideal state. If there is a gap, then the aim is to identify the reason for the existence of the gap.

This action step 3 is composed of two steps. The first one is to identify the gap and the second is to identify the core problem that keeps the gap present.

What actually happened in the research field (Practice)?

Gap Analysis

The purpose of the gap analysis is to identify differences between the existing system and an ideal state (Wilson Perumal & Company 2015) or a difference between of an AS-IS situation vs. a “TO BE” architecture (MITRE 2004). Ideally, the current state should be the same as the ideal one although this is rare. The gap is the answer to the question “why to change” and it is expressed in the form of UDEs. It is the reason for the change.

The UDEs are the output of this process, and at the same time, they are the feeding data to the CRT. In contrast with the main body of literature where it is advised that UDEs are collected directly from the field - we followed the recognition of the UDEs by comparing the ideal state of the GT with the status quo as per (Dettmer 2016b).

The project team evaluated every CSF and every NC. UDEs and opinions were collected by unstructured interviews and by discussions with the project team and with the supervisors.

The gap analysis stage highlighted the differences in the reality compared to the ideal state of the system. It was fairly easy for the team to understand that UDEs should be replaced with something else. The most useful outcome of all though was that people

felt secure that they were not part of the problem, the point of discussion was the system and not their behavior.

The outcome of the gap analysis

The outcome of the gap analysis was the following three UDES.

1. There is no Financial Effectiveness (UDE 1). The financial crisis in Cyprus had brought the issue of the expenses at the top of every priority list. At the same time, medical insurances were putting a strict control on the hospital's charges. Many people owed much money to the hospital, and this has been a huge headache to the hospital's operation. Surgery is a very costly procedure not only for the patient but for the hospital as well.
2. High Operating Expenses (UDE 2) - This comes directly from management. They insisted that they were paying many overtime. They did not comment about the size of the workforce but what really bothered them is that they paid a lot of overtime. They believed that if the work is organized more efficiently, then the overtimes could be reduced. They reported that they were not able to prove it though.
3. Nurses reported that many patients complain in the morning because they wait for too long to get operated (UDE 3). This is mostly for outpatients. They reported that the clinic operates regarding bed availability and the patients to be operated are waiting for bed availability.

Current Reality Tree (CRT) development

Following Dettmer's template appendix 4 (Dettmer 2016b), we started building the causality relationship of the current reality tree, starting with the UDEs.

By using the clustering method as explained by (Dettmer 2016b, p.130) the first two levels of causality were determined and then they were connected to a uniform tree. Table 5.2 shows the two levels of causality.

Table 5. 2: Current Reality Tree part 1

UDEs	There is no Financial Effectiveness	Operating Rooms have high operating costs	Some Patients complain that they wait too long to be operated.
Cause Layer 1	There are high operating costs	There are a lot of overtimes.	There are no ORs available.
Cause Layer 2	There are high running expenses (this is because they thought that they were fully occupied)	There is no time to perform all surgeries at the normal available working hours	All ORs are occupied.

The CRT development took place in the training room. CRT development requires effort and discipline. Progress was difficult because people could not concentrate for long following the guidelines of CRT development.

Therefore, the researcher built the initial skeleton and the initial CRT. The project team scrutinised the logic of the tree. The team could not be occupied for long though, and the development was done over multiple small meetings. The mental “set-up” time was prolonging the development.

Figure 5. 3: Current Reality 1

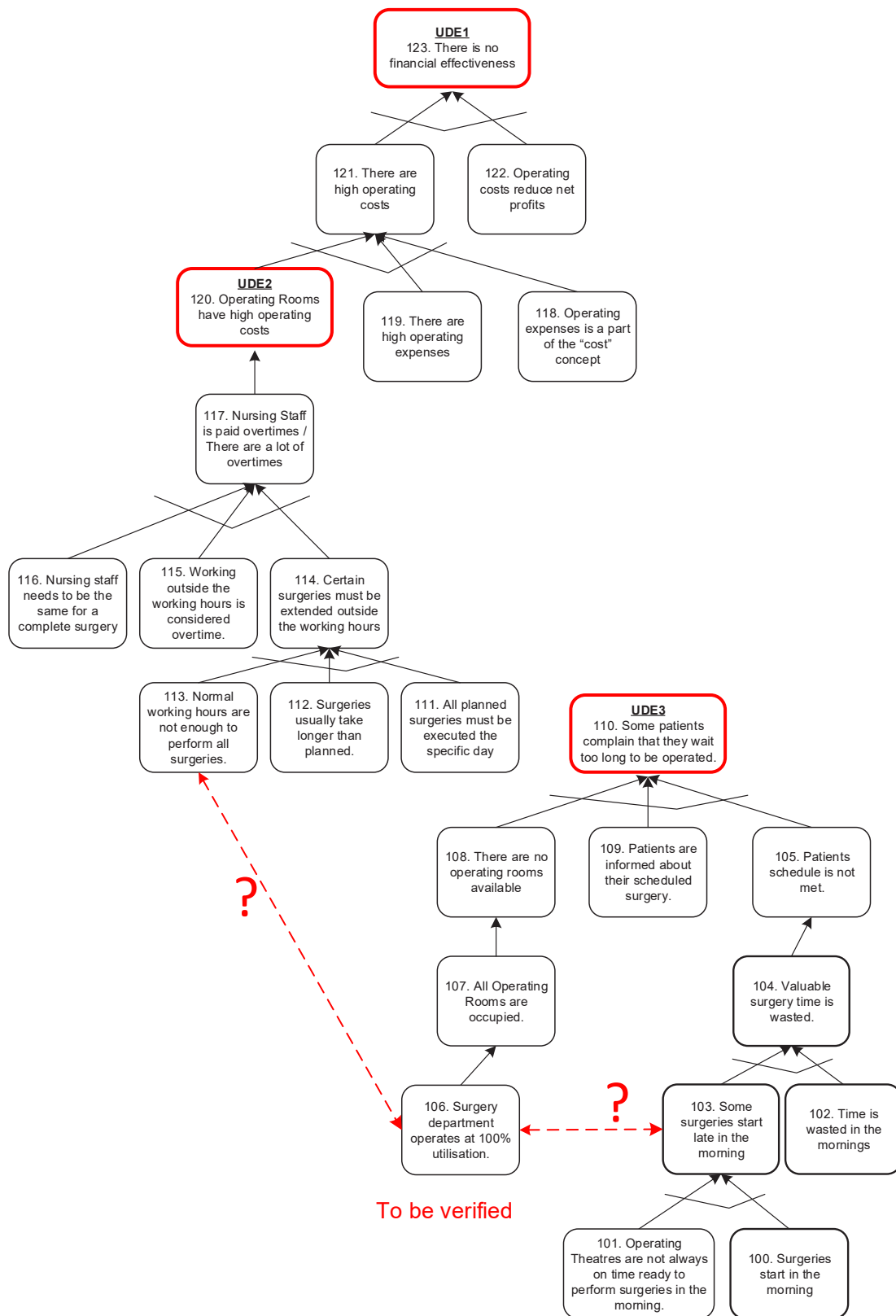

Following figure 5.3 the entities UDE1, UDE2, and UDE3 are the starting point of the CRT.

Following Dettmer's directions and with the use of the CLR's we reached to a point where the team members had different opinions. Entity 106 of the CRT in figure 5.3 opposed entity 103. If the surgery department was operating at 100% utilization (as entity 106 claims) that meant, by definition, that no idle time was wasted. On the other hand, entity 103 indicated that a number of operations were starting late in the morning making entity 106 invalid. If entity 103 is true, then entity 113 is also not valid "normal working hours are not enough to perform all surgeries".

In order to dive down into the CRT and reach the core problem, data and information needed to be verified and validated as it was admitted that some factors were not measured and most of the data was based on subjective judgment.

Late morning starts was a fact that it was confirmed by the team very easily. Additionally, the fact that there were no waiting lines in the ORs it was a strong indication that somehow the system was operating at excess capacity.

Since the CRT is a logical representation of the core problem - validating it through actual numbers would be very beneficial and possibly very convincing. The OR teams were not logging the use of the time anywhere. They had a lot of paperwork for the medical staff already.

Supervisors were not aware of the existence of any utilization reports. Discussions with the IT showed that the system was generating a number of reports and one of those was named "Theatres Utilisation". A sample from the system is shown in the appendix 11, processing the data for all ORs showed an utilization of 56%. The team though questioned the validity of the assumptions of the system and how the system calculated those utilisations. It was found that utilisations were calculated based on the duration that was logged for billing purposes.

The CRT was completed based on the assumption that the system's figures were correct and valid. The resulting CRT is shown in figure 5.4.

Being aware of the low utilization numbers, it was easy to spot idle times at the ORs, the more we were focused on the idle times, the more visible they were becoming. It was evident that the surgery department was not operating at 100% utilization. It was easily accepted that the effect of these idle times was the low utilization and the low utilization was keeping the system back of satisfying some NCs.

People agreed on the problem, but they started denying the addition of more work into the surgery department. They had started already discussing not about the solution but about the problems the solution would bring.

Figure 5. 4: Current Reality 2

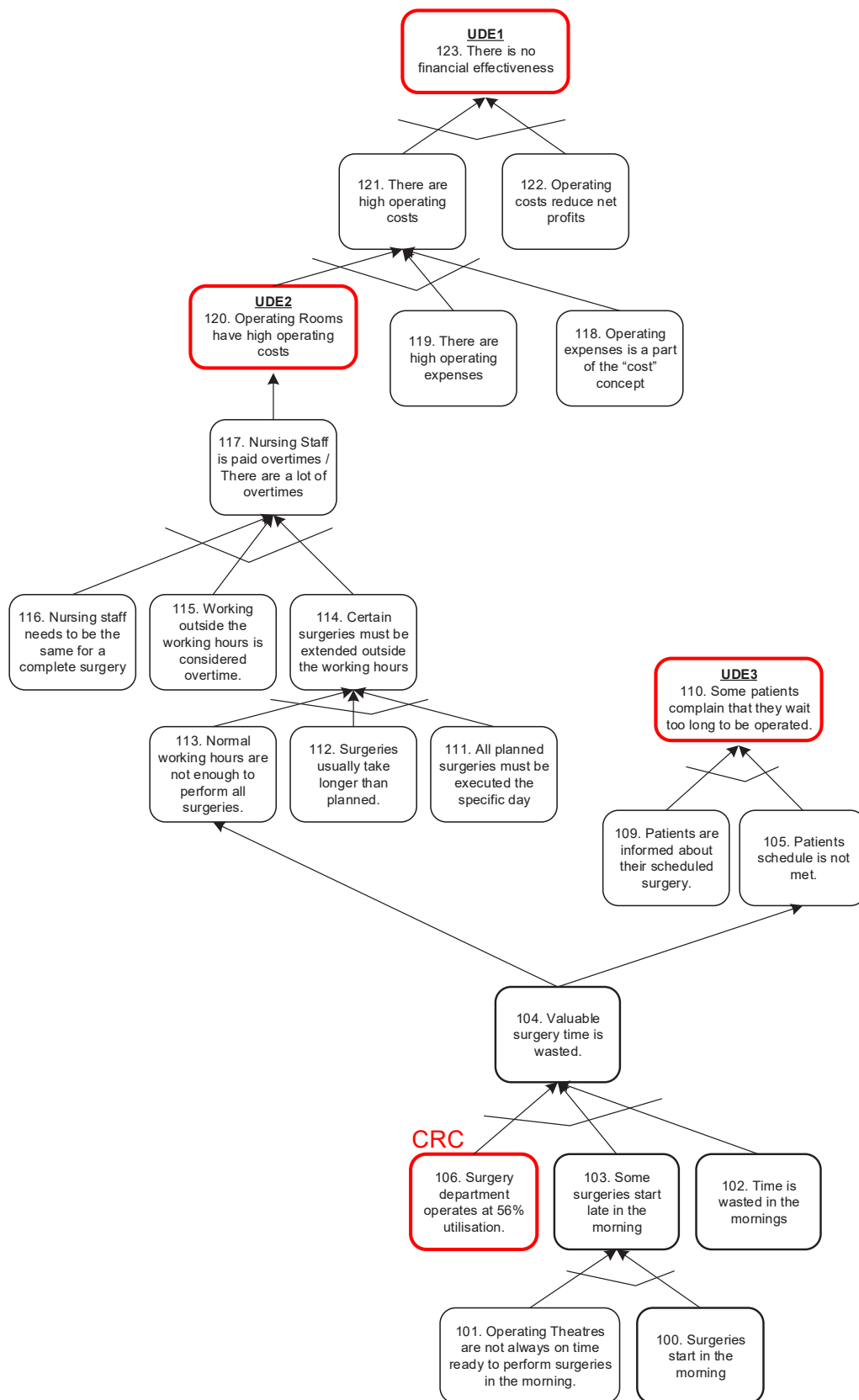

5.4 What to change to - Planning

The previous phase analyzed the situation indicating the root problem to be solved.

The planning phase of the action research seeks to design the solution, which when implemented the problem will be solved, and the system will be elevated resulting in better performance.

5.4.1 Action step 4 - Five Focusing Steps Implementation

What is the need for the action step?

The CRT answered the second improvement question of "what to change". The cause that was holding the system back of having better measurements was the fact that the ORs were operating at a low utilization (56%). If a solution could be found, which would increase the utilization rates of the ORs, then the UDEs would be evaporated and the system would come closer to its goal.

According to literature, we should proceed with the rest of the Thinking Process tools, but since the direction is to increase the flow, then the 5FS and the DBR could be applied which are designed especially for this purpose. To increase the flow in a given system. FRT was not needed at this point since the implementation of the 5FS is well documented.

The case at the ORs seemed to be a straight case of implementation of the 5FS, or at least this is what we thought of...

5.5 How to cause the change - Action

5.5.1 Action Step 5 - Identify the system's Constraint

How should the tool be applied? (Theory)

Five Focusing Steps literature reports that the first step is to identify the constraint (Eliyahu M Goldratt 1990). This was indirectly pointed by the CRT. The low utilization assumes that the market constraint is the weakest linking constraining the system. To confirm the assumption and to represent the flow in actual numbers a better understanding of the actual flow and of the loading profile of the ORs was required. The loading profile of the resources should be mapped.

Even though we were sure that the market was constraining the system, we thought of getting a clear picture of the flow profile of the system, the capacity of every step was to be measured and get a clear picture of the loading characteristics of the system. The initial plan was to perform a loading analysis as it was done at the linen.

What actually happened in the research field (Practice)?

Performing a loading analysis of the surgery department proved to be a very challenging task. Interviewing doctors and nurses, become very quickly evident that this is just not possible because every surgery is different, durations and cycle times are not fixed, and they can only be forecasted. Loading analysis, as in linen case study, could not be performed.

Additionally, all surgery functions are performed by one resource – the Operating Room. When one function is taking place, e.g. cleaning or preparation, other functions cannot be performed, e.g. surgery, because the resource is occupied.

There are job shop characteristics found.

The step after the identification of the constraint is to make the constraint produce as much as possible.

5.5.2 Action Step 6 - Exploit the system's constraint

What is the need for the action step?

The exploitation step concerns only and only the constraint (Eliyahu M. Goldratt 1990). It deals with the ability of the constraint to produce at its maximum. Since the system was constraint by the market demand, the proposal to management would be to introduce more surgeries into the surgery department.

When management realized that the ORs were operating at extra capacity, they immediately supported the fact that maximizing Throughput is the way to go forward.

They recommended that the direction should be to sign more contracts with new surgeons in an effort to fully occupy the ORs. It was also mentioned that high-value surgeries should be preferred and take advantage of the extra time of the constraint.

From the moment that the decision was taken to increase the Throughput of the ORs, the behavior of the people changed. Suddenly there were reservations from everywhere about adding more work into the ORs. The supervisors were supporting that there is no available time and that they did not believe the utilization numbers. Their intuition was telling them that the ORs did not have all these available capacities. They considered it impossible to add more work. Their gut feeling was telling them that the current infrastructure cannot handle more work. Many different reasons was coming up like "*we would need more overtime*", or "*we would need more personnel*", or "*we do not believe that we have all this extra mentioned capacity*". Suddenly, there was a new wall of resistance raised in front of us. We should step backward and look more closely in the idle time of the ORs. It seemed that for some reason we could not just add more work into the system even with 56% utilization. Exploitation and the rest of the 5FS could not proceed. What was wrong?

5.6 Evaluation – Results of part 1 – Action Research Cycle 1

The purpose of this sub-section is to evaluate the first Action Research Cycle. The first action research cycle was composed of six action steps.

The first action step was the training: The structure of the training had three main sections.

1. Explanation between Maintenance vs Improvement.
2. Explanation of Systems and flows.
3. Explanation of TOC philosophy and tools.

The second action step was the GT: The goal of the surgery department was decided to be “Provide high-quality surgery services with maximum profitability now and in the future”. There were 3 main Critical Success Factors identified

CSF1: Financial Effectiveness.

CSF2: Successful Surgeries.

CSF3: Have a quality workforce.

The three CSFs are what the surgery “system” must deliver in order to satisfy the goal.

The third action step was the development of the Current Reality Tree: From the GT a gap analysis was performed and 4 UnDesirable Effects (UDEs) were concluded.

UDE1: There is no Financial Effectiveness

UDE2: Management complaints that the Surgery Department runs with high operating Expenses

UDE3: Operating expense is not minimum.

UDE4: Some surgeries in the morning delay to begin and there are customers who complain.

By unfolding the cause and effect relationship that keeps UDE alive, the core problem indicated was that “the Operating Rooms are operating at a low Utilization rate”.

At the same time people tended to hide their assumptions and use long arrows. They tended to bring up their personal UDEs. It was difficult for them to stay focused and they were constantly jumping into solutions.

Regarding the Five Focusing Steps, only the first step was applicable to the “identify the constraint”. The constraint found to be the consumption, and this was the reason that the surgery department was operating at 56% utilization.

The first action research cycle stopped at the exploitation step. Negativity and people’s resistance prohibited from exploiting the market demand and bring more surgeries into the hospital.

A new action research cycle was needed with diagnosing again the problem that does not allow the market to be exploited, what the solution would be to overcome the problem and finally implement the solution using TOC.

PART 2 – SECOND ACTION RESEARCH CYCLE

Part 2 describes the second action research cycle as per figure 3.2. The first action research cycle stopped because no further action could be taken since the constraint could not be exploited. The second action research cycle follows again the sequence of Diagnosing, Planning, Action, and Evaluation.

5.7 What to Change - Diagnosis

5.7.1 Action Step 7 - Evaporating Cloud (EC)

What is the need for the action step?

The exploitation step could not be completed. There were many different opinions, and many assumptions were not surfaced. In order to deeply understand the nature of a problem, TOC uses the EC, section 1.4.2. The EC should be able to provide us with a deeper understanding of the arguments. Since there were so many reservations in

bringing more work into the field, a closer look behind the opinions and into the assumptions was required, in order to be able to proceed with any kind of solution.

The situation needed to be diagnosed again.

How should the tool be applied? (Theory)

Goldratt supports that a problem is the outcome of a dilemma (Dettmer 2016b). The EC is the appropriate tool to uncover and resolve that dilemma. By following the guidelines of (Dettmer 2016b) then we would be able to challenge people's assumptions. An evaporating cloud should be constructed with the help of the project team and with the help of the people defending that no more work can be added. The data to be used would be statements, opinions and views from the people. Further progress would be decided after the construction and analysis of the tool. The data would be analyzed by the EC tool. An excellent tool analyzing thought.

What actually happened in the research field (Practice)? - Implementing the evaporating cloud (EC)

Although there are different guidelines found in the literature of how to build an evaporating cloud (Fedurko 2013; Scheinkopf 1999; Cooper & Loe 2000), Dettmer's directions are followed as presented in (Dettmer 2016b, p.199), look in appendix 5.

At the beginning, the two conflicting sides were developed. Since Throughput has the highest priority, the goal was set to be "maximize profitability". Then the dilemma side was developed. The dilemma was straight forward and worded as "Add more surgeries" vs "Do not add more surgeries". This is opposite conditions. The two entries cannot co-exist at the same time. The definition of the requirements followed. Additional surgeries needed to be added in order to increase the utilization but at the same time we did not want to add more surgeries in order to control the OE. The logic and the tool are shown in the following figure.

Figure 5. 5: Evaporating Cloud

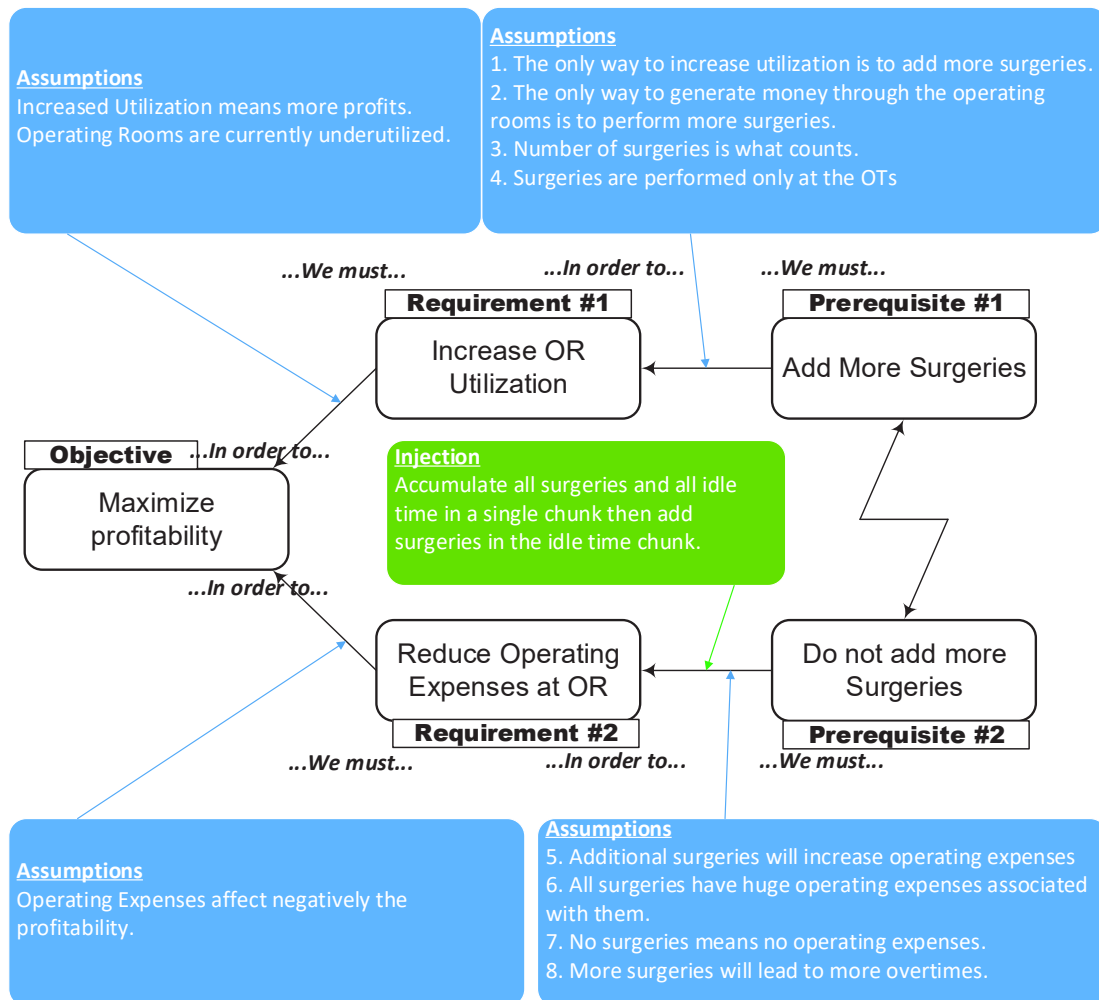

There are many more requirements to manage the ORs effectively but the focus was on the specific dilemma. The next step was to challenge the assumptions behind the arrows. The assumptions were surfaced by asking different questions - in order to control cost, we need to NOT add additional surgeries because... The assumption that we challenged was "Additional surgeries will increase operating expenses". This seemed an invalidated and weak assumption. Since the system was operating at low capacity why additional work would increase OE? This did not sound logical, but this is what the people in the field believed.

Capturing Data

It was evident that the ORs had excess capacity, but people were invalidating the data from the system. They believed that the extra capacity was much less and that this was the reason that the OE would increase by adding more work.

In order to get a deeper look into the capacity profile of the day, it was necessary to measure and plot the flow through the ORs.

In order to challenge people's intuition, it was decided that the utilization profile would be recorded in detail in all ORs for two months. A form was created which is shown in appendix 8 and was given to the head nurses of the ORs. They were also asked to log the reason causing the idle time. The form did not function satisfactorily since it was time-consuming and complicated to fill it up. The head nurse comes back with a suggestion, and then we redesigned the forms (look in appendix 9). The forms were created in Greek and in English as well. The data was recorded for two months. Every week we were discussing some preliminary findings. As an example, after the first week, we decided to exclude from the measurements OR2 and OR4. The reason was that OR2 was occupied constantly by one orthopedic surgeon and he was doing many small operations during the day. The OR was occupied completely by him. Additionally, OR4 was excluded because it was used for cardiothoracic operations. They had taken a conscious decision to keep the OR only for that. Because if this policy OR4 was remaining idle for several days (it was used as an emergency OR). We concentrated on the rest of six ORs.

The time was monitored only for the first shift and from 8 o'clock to 15.30. Overtimes were neglected since our only concern was to maximize utilization through the working hours. The data was logged for five days per week, for six operating rooms.

Idle time refers to the time that an OR is without a patient. Even if other activities are taking place into the OR such as cleaning etc, it is recorded as "idle" time. So idle time is expected to be recorded.

Data Analysis

The data collected was divided into three categories. In the first category, the idle time was logged from 8.00 o'clock to the first surgery. The second idle time category was all the idle time of the OR between the surgeries, and the third category was the idle time from the last surgery to 15:30.

The data was collected from the time that the patient was entering into the OR.

From data received based on the sample shown in appendix 10, a total of 672 cases were included over the eight weeks study period. There was an average of 17,23 cases per day and ranged from 9 to 24 surgeries/day. It is worth reminding that two operating rooms (OR2 and OR4) were excluded from the measurements. Based on table 5.3, 837 hours in total were without patient during the

A sample of the data captured, which was the source for the below analysis is shown in appendix 10.

Table 5. 3: Weekly idle time of six ORs

Date	OR	Description	Duration (Hrs)
Week 40	OR_Week_40	Idle Time	98:20:00
Week 41	OR_Week_41	Idle Time	115:55:00
Week 42	OR_Week_42	Idle Time	112:20:00
Week 43	OR_Week_43	Idle Time	83:20:00
Week 44	OR_Week_44	Idle Time	101:50:00
Week 45	OR_Week_45	Idle Time	109:20:00
Week 46	OR_Week_46	Idle Time	107:45:00
Week 47	OR_Week_47	Idle Time	108:15:00
Total			837:05:00

Morning idle time

Since the data was captured for five days per week, in six operating rooms, for eight weeks, 240 surgeries started in the morning. From those, there were only 65 surgeries which started on time in the morning (within 10 minutes delay), or 27% of the cases. 73% of the cases had a delay ranging from 15 to 120 mins. 168 hours were lost in total (or 28 hours per OR on average) due to delays in the mornings as per table 5.4.

Table 5. 4: Weekly morning idle time of six ORs

Date/2016	OR	Description	Duration (Hrs)
Week 40	OR_Week_40	Idle Time - Morning	24:15:00
Week 41	OR_Week_41	Idle Time - Morning	14:30:00
Week 42	OR_Week_42	Idle Time - Morning	30:30:00
Week 43	OR_Week_43	Idle Time - Morning	25:50:00
Week 44	OR_Week_44	Idle Time - Morning	10:10:00
Week 45	OR_Week_45	Idle Time - Morning	23:50:00
Week 46	OR_Week_46	Idle Time - Morning	11:20:00
Week 47	OR_Week_47	Idle Time - Morning	27:20:00
Total			167:45:00

Idle time between Surgeries (or Set Up Time)

The data also showed that 40.9% of the total idle time was located between surgeries. This is 342 hours including all six operating rooms table 5.5. 40,9% of the idle time was founded to be idle between the surgeries (a total of 342 hours of the six operating rooms added together (or 57 hrs per OR on average)).

Table 5. 5: Weekly idle time between surgeries of six ORs

Date	OR	Description	Duration (Hrs)
Week 40	OR_Week_40	Idle Time - Between Surgeries	46:25:00
Week 41	OR_Week_41	Idle Time - Between Surgeries	41:00:00
Week 42	OR_Week_42	Idle Time - Between Surgeries	40:25:00
Week 43	OR_Week_43	Idle Time - Between Surgeries	40:30:00
Week 44	OR_Week_44	Idle Time - Between Surgeries	44:10:00
Week 45	OR_Week_45	Idle Time - Between Surgeries	38:00:00
Week 46	OR_Week_46	Idle Time - Between Surgeries	49:15:00
Week 47	OR_Week_47	Idle Time - Between Surgeries	42:15:00
Total			342:00:00

Table 5.6 shows the length of the idle time chunks, or the average set up time of every week, based on the total number of surgeries and on the total idle time between surgeries. It can be observed (table 5.6) that the average length of the idle chunks is 21,3 minutes.

Table 5. 6: Weekly idle (set up) times of six ORs

Date	OR	Description	Duration (mins)
Week 40	OR_Week_40	Calculated Set Up time	19:41:40
Week 41	OR_Week_41	Calculated Set Up time	23:05:50
Week 42	OR_Week_42	Calculated Set Up time	20:54:00
Week 43	OR_Week_43	Calculated Set Up time	18:16:40
Week 44	OR_Week_44	Calculated Set Up time	24:27:30
Week 45	OR_Week_45	Calculated Set Up time	20:01:20
Week 46	OR_Week_46	Calculated Set Up time	24:52:00
Week 47	OR_Week_47	Calculated Set Up time	20:42:55
Average			21:30:14

Afternoon Idle time

Finally, 42,3% of the total time was wasted in the afternoons or 354 hours of all six operating rooms (or 59 hours per OR on average) table 5.7. The surgical department manager supported that this is not time wasted because she could not do much. There were no more surgeries to be performed. At the end, she was convinced that this time, was time wasted since the hospital was reserving resources to cover the operating rooms up to 15.30. During these eight weeks, there were on average 1 hour and 28 minutes idle time for every OR every day.

Table 5. 7: Weekly afternoon idle time

Date	OR	Description	Duration (Hrs)	Average afternoon idle chunk per week in Hrs
Week 40	OR_Week_40	Idle Time - Afternoon	27:40:00	0:55:20
Week 41	OR_Week_41	Idle Time - Afternoon	60:25:00	2:00:50
Week 42	OR_Week_42	Idle Time - Afternoon	56:25:00	1:52:50
Week 43	OR_Week_43	Idle Time - Afternoon	17:00:00	0:34:00
Week 44	OR_Week_44	Idle Time - Afternoon	47:30:00	1:35:00
Week 45	OR_Week_45	Idle Time - Afternoon	55:00:00	1:50:00
Week 46	OR_Week_46	Idle Time - Afternoon	44:10:00	1:28:20
Week 47	OR_Week_47	Idle Time - Afternoon	46:10:00	1:32:20
			Total	Average
			354:20:00	1:28:35

Utilization of operating rooms

The operating rooms are available for 7,5 hrs every day which equals to 225 hrs for the six operating rooms for five days per week (for the first shift).

Below table 5.8 illustrates the surgery time of the 8 weeks of the six operating rooms, available time of the operating rooms and the utilization during those eight weeks. The utilization was calculated to be 52.3% on average. Previous year data had shown a utilization of 56% through the hospital's ERP.

Table 5. 8: Weekly utilization % of the six ORs.

Date	OR	Description	Duration
Week 40	OR_Week_40	Surgery Time	126:40:00
Week 40	OR_Week_40	Utilisation %	56.30%
Week 40	OR_Week_40	OR available time	225:00:00
Week 41	OR_Week_41	Surgery Time	109:05:00
Week 41	OR_Week_41	Utilisation %	48.48%
Week 41	OR_Week_41	OR available time	225:00:00
Week 42	OR_Week_42	Surgery Time	112:40:00
Week 42	OR_Week_42	Utilisation %	50.07%
Week 42	OR_Week_42	OR available time	225:00:00
Week 43	OR_Week_43	Surgery Time	96:40:00
Week 43	OR_Week_43	Utilisation %	53.70%
Week 43	OR_Week_43	OR available time	180:00:00
Week 44	OR_Week_44	Surgery Time	123:10:00
Week 44	OR_Week_44	Utilisation %	54.74%
Week 44	OR_Week_44	OR available time	225:00:00
Week 45	OR_Week_45	Surgery Time	115:40:00
Week 45	OR_Week_45	Utilisation %	51.41%
Week 45	OR_Week_45	OR available time	225:00:00
Week 46	OR_Week_46	Surgery Time	117:15:00
Week 46	OR_Week_46	Utilisation %	52.11%
Week 46	OR_Week_46	OR available time	225:00:00
Week 47	OR_Week_47	Surgery Time	116:45:00
Week 47	OR_Week_47	Utilisation %	51.89%
Week 47	OR_Week_47	OR available time	225:00:00
Totals of the eight weeks			
Surgery Time			917:55:00
OR available time			1755:00:00
Utilisation %			52.3%

Below figure 5.6 contracts the idle time of the three categories so it can be observed the spread of the idle times throughout the day by giving a graphical representation of the distribution of the idle times.

Figure 5. 6: Idle Time Distribution of all ORs

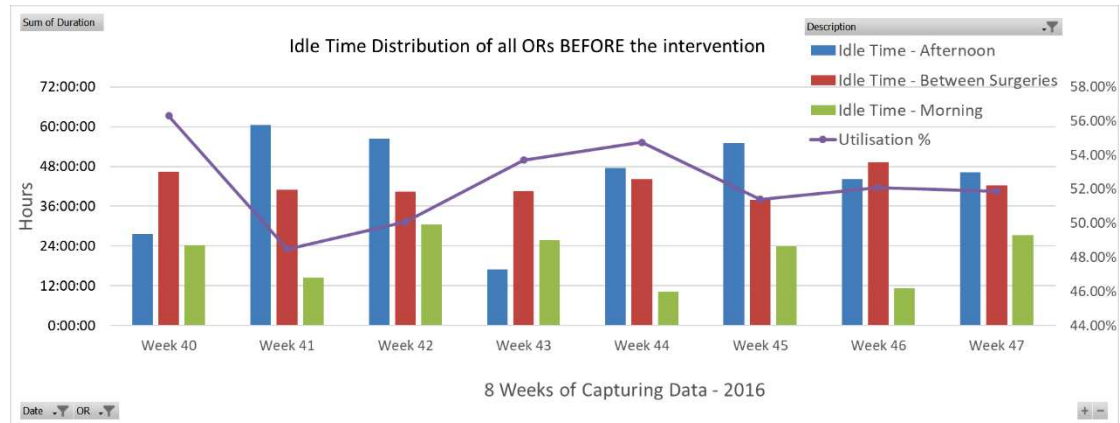

Injection Generation - the outcome of the action step?

One observation made was that the idle times were spread all over the 8 hours span. If more surgeries would be added, then the only available time would be in the afternoon, after the last surgery. As per table 5.7, there are 1 hour and 28 minutes available on average that surgeries could be added. From the graph, in figure 5.6 we observe that there is a great span and variation from one week to the other. Team participants mentioned that this time could not be forecasted as it depends a lot on the magnitude of the previous idle times.

It can clearly be seen now, why the team members had the intuition that no more surgeries could be added without increasing the overtime. The reason that resisted and objected was clear through the above tables and graph.

If we could accumulate all idle time in the afternoon, then the length of the average idle chunk would greatly be increased and then more surgeries could be safely added. This scenario invalidates assumption 5 from the EC in figure 5.5 and then the conflict evaporates. This also was the direction of the solution and the injection becomes “Accumulate all surgeries and all idle time in a single chunk then add surgeries in that idle time chunk”.

5.8 What to change to - Planning

5.8.1 Action Step 8 – Future Reality Tree (FRT)

Previous action step 7, generated the direction of the solution. The injection statement that shows an idea of how the future should be shaped. The injection formed was “*Accumulate all surgeries and all idle time in a single chunk then add surgeries in that idle time chunk*”. TOC uses the Future Reality Tree in order to design the future state in order to indicate what else might be needed, what needs to be changed at the current reality and prevent negative sequences because of the solution.

The team had great difficulties building the FRT and they considered it some type of guessing. The researcher guided the effort and the resulting FRT is shown in figure 5.7.

On the bottom of the FRT the injection from the EC is added. Since the solution that will satisfy EC’s injection is added as entity 100. The DBR solution saves a lot of time since it is a generic solution offered by the TOC body of knowledge. Otherwise, the FRT should be much larger seeking to optimize the flow. As shown by the FRT, implementation of the DBR should be enough to “accumulate” enough idle time so more surgeries can be added, as shown in entity 240.

Figure 5. 7: Future Reality Tree

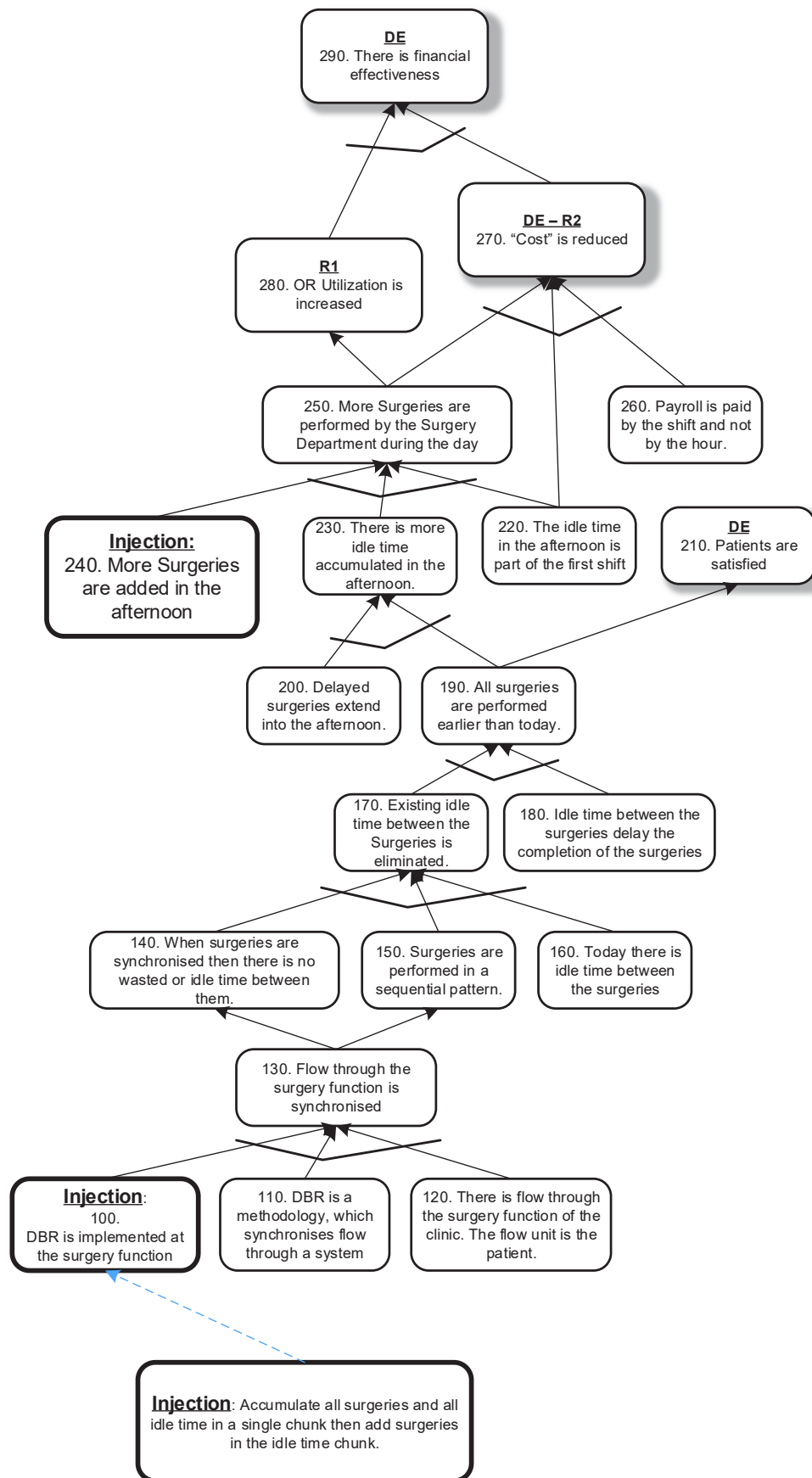

5.9 How to cause the change - Action

5.9.1 Action Step 9 – Drum Buffer Rope (DBR) Implementation

Management's support and approval were needed to proceed with the DBR since different groups would be required to be involved.

Management allowed to experiment in one OR for two weeks. The project team selected operating room six for the experiment. A general surgery operating room which was well suited for the experiment. OR6 had similar characteristics with most of the other operating rooms regarding size, configuration and type of surgeries performed.

A look into the system's structure

Drum Buffer Rope is about scheduling and controlling the flow through the resources and through the functions. Therefore, it is necessary to visualize the flows in an effort to break down the processes, the resources, understand the different steps that the patient is going through and the different steps that the operating room goes through in order to be able to “accept” the patient.

In the surgery department, there are two main flows that must be coordinated in order to perform one surgery effectively. As shown in figure 5.8 the one flow is that of the Patient Journey Flow (PJF) which concerns all the different steps that a patient goes through in order to have surgery and recovery. The patient is “flowing” through the different functions of the hospital until coming to the surgery department. The other one is the Operating Room Process Flow (ORF) which represents all the functions that are performed in an OR in order to be ready to support the surgeon of performing effective surgeries.

This PJF can be a very complicated flow since nobody knows what exactly the patient will need during his/her stay at the hospital.

Since the OR is one resource that performs all the processes, then it is treated at the process level in order to break down the functions and get a closer look.

These two flows are a series of functions or processes which transform the “flow units” from one state to another.

Figure 5. 8: Patient Journey Flow (PJF)

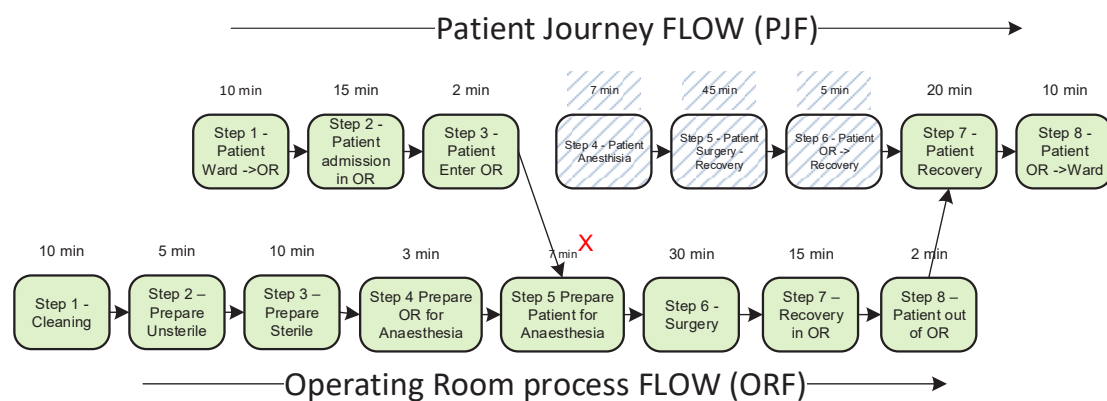

The Patient Journey Flow (PJF) and the Operating Room Process Flow (ORF) run in parallel and they meet at a point X as shown in figure 5.8. When both flows are synchronized then there is no delay at all. The patient (PJF) arrives at the exact moment where the Operating Room (ORF) is just ready from the preparations and accepts the patient (at point X). In this case, there is no time wasted, and the surgery begins on time. If for any reason the operating room is ready, but the patient is not present then the precious time of the operating room is wasted and utilization figures fall. If the patient is at the surgery ward before the operating room is ready then the patient waits at the surgery ward, he/she becomes stressed and frustrated. The solution is to synchronize the two flows, in order to provide maximum patient satisfaction and at the same time be productive.

The coordination of the two flows can be compared to the different flows of the raw materials through a production line which needs to be synchronized in order to keep the constraint busy constantly.

Based on that, there are two requirements in order to have effective surgeries

1. Synchronize the two flows and
2. Make the flows as fast as possible.

The two flows are discussed separately in detail, in an effort to satisfy the above two requirements.

FIRST FLOW - Patient Journey Flow (PJF) through the Operating Room

The first step is to understand the Patient Journey Flow (PJF) in enough detail in order to be able to design the DBR method.

For analysis purposes, the flow is broken down into three main function blocks and then they are further decomposed to eight more detailed functional steps. We focus on the part of the flows which are relevant to the surgery function (e.g. We omit examinations flows etc).

Figure 5. 9: Patient Journey Flow Description

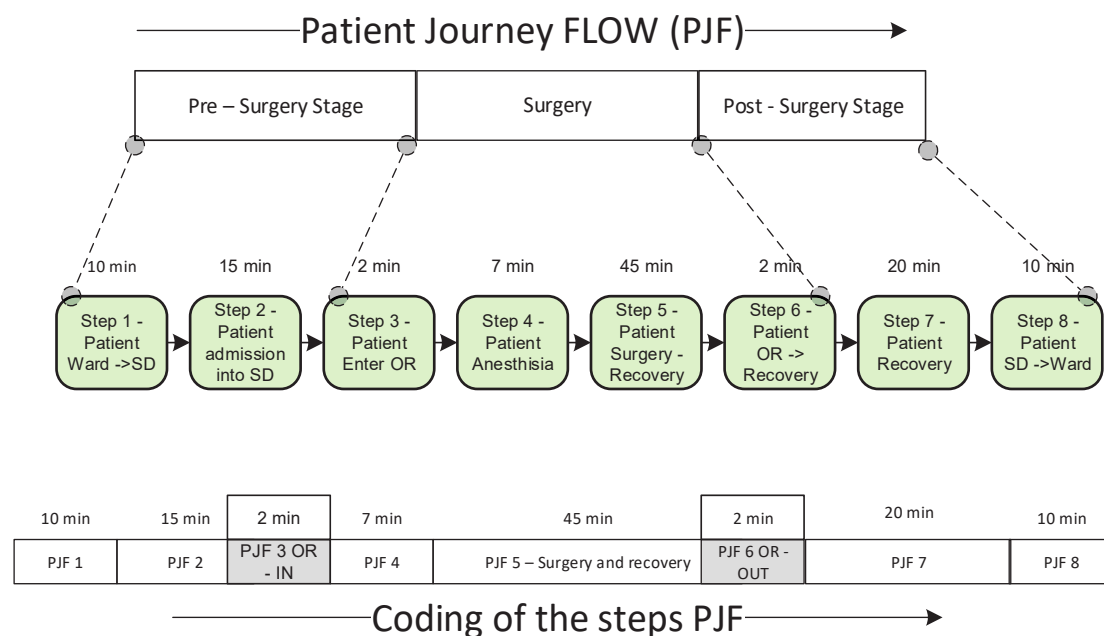

Figure 5.9 represents the three main functions, the eight more detailed decomposed functions and finally, the steps are coded for purposes of the analysis.

Every step of the PJF chain was counted, and the duration of the different functions and steps was logged. The steps, the descriptions, and the durations are shown in table 5.9. Table 5.9 display the Patient Journey with the time duration of each step if there are no delays. Time durations were measured, and average values were allocated to the process steps. Time estimates were decided after discussing with the nurses and the doctors. Most of the steps do not have a fixed cycle time. Following the patient journey on the clinic, actual times varied

The three broad functions are:

1. The pre-surgery stage: According to table 5.9 there are two steps involved in this stage PJF1 and PJF2 with a total duration of 25 minutes
2. The Surgery stage: This stage includes four steps, from PJF3 to PJF 6 The stage has a duration of 56 minutes.
3. The post-surgery stage: which has a duration of 30 minutes.

During the pre-surgery and post-surgery stage the patient is outside the operating room.

Table 5. 9: Description of Patient Journey Flow (PJF)

	STEP	Description of the Step	Step Duration (Average)
Pre-surgery	PJF 1	Transport the patient from the ward to the operating room ward	10 min
	PJF 2	Patient admission in operating theatres ward	15 min
Surgery	PJF 3	Patients enter the Operating Theatre	2 min
	PJF 4	Anesthesia to the patient	7 min
	PJF 5	Surgery and Partial Recovery	30 min + 15 min
	PJF 6	Transport the patient from OR to recovery	2 min
Post Surgery	PJF 7	The patient remains in the recovery until fully recovery	20 min
	PJF 8	Transport the patient from the recovery to the ward.	10 min
	TOTAL PJF Duration		111 min

From table 5.9 it can be observed that the theoretical total patient journey for operation of 30 minutes is 111 minutes.

During the collection of the data at action step 7 (at section 5.7.1) it was recorded that more than 80% of the delays were because of delays of the patient to the surgery. This was mainly the reason to map the PJF from the ward to the surgery, in an effort to streamline the process.

During the PJF development, necessary requirements for a smooth flow were identified. Table 5.10 shows the requirements that must be satisfied in order to have a smooth flow without interruptions from the ward to the operating room. Any requirement that it is not fulfilled then there is a high possibility that the PJF will take more than required. The entries in the table 5.10 were raised from the head nurse of ward 2 and the Nursing Care Manager.

Table 5. 10: Patient Journey Flow Description

Code	STEP	Activities and Requirements for completion of the step	
PJF 1	Transport the patient from the ward to the operating room ward	1.1	Get the patient ready for the surgery (eg shaving, diet etc)
		1.2	Availability of the patient's medical record
		1.3	Ensure that the patient can be operated eg. No fever
		1.4	Availability of the nurse to approve delivery of the patient
		1.5	Availability of nurse to transport the patient
		1.6	Move through the corridors
		1.7	Move through the elevators
PJF 2	Patient admission in Surgery Department (SD)	2.1	Availability of nurse to receive the patient
		2.2	Availability of anaesthesiologist to fill up the documents
		2.3	Availability of anaesthesiologist to evaluate patient's medical record
		2.4	Availability of nurse to interview the patient
PJF 3	Patients enter the Operating Theatre	3.1	Availability of Nurse to transport the patient
		3.2	Move the patient through the corridors
		3.3	Operating Theatre ready for the operation
PJF 4	Anesthesia to the patient	4.1	Availability of anesthesiologist
		4.2	Availability of necessary resources (equipment and drugs)
PJF 5	Surgery and Partial Recovery	5.1	The readiness of operating Theatre
		5.2	Availability of the surgeon
		5.3	Availability of Nurses
		5.4	Availability of anesthesiologist
		5.5	Availability of equipment (monitors etc)
		5.6	Availability of blood
		5.7	Availability of medicines
		5.8	Availability of sterile consumables
		5.9	Availability of tools
PJF 6		6.1	Readiness of Recovery room to accept the patient

	Transport the patient from OR to recovery	6.2	Free bed in the recovery room
		6.3	Availability of nurses to transport the patient
		6.4	Availability of responsible nurse in recovery to accept the patient

PJF 7	The patient remains in the recovery until fully recovery	7.1	Availability of nurse
-------	--	-----	-----------------------

PJF 8	Transport the patient from the recovery to the ward.	8.1	Availability of bed at the ward
		8.2	Time availability for the nursing staff to inform relatives etc
		8.3	Availability of nurse to transport the patient
		8.4	Moving through the corridors of the operating theatres
		8.5	Moving through the elevators
		8.6	Moving through the corridors of the ward
		8.7	Availability of Nurse to accept the patient.

The above break down into Function Blocks is necessary if the flow is to be coordinated and if the patient is to arrive on time at the point of surgery.

There are basically two objectives for the patient flow:

1. Provide the patient to the operating theatre – on time – for the surgery and
2. Transport and carry the patient as fast as possible. This means keep the flow short and effective.

SECOND FLOW - Operating Room Process Flow (ORF)

The second flow manages the status of the operating room at any given point in time is shown in figure 5.10 which displays the different functions that are performed on the operating room through the surgery process of the selected operating room.

For analysis purposes, the functions are divided into three areas and then they are further decomposed further down to another 8 more detailed functions:

Pre–Surgery: these are all the functions that are taking place into the operating theatre before the surgery function.

Surgery: This group contains all the functions necessary for the surgery process.

Post-Surgery: These are all the functions that are taking place after the surgery and by the time that the patient leaves the operating room.

Figure 5. 10: Operating Room Process Flow (ORF)

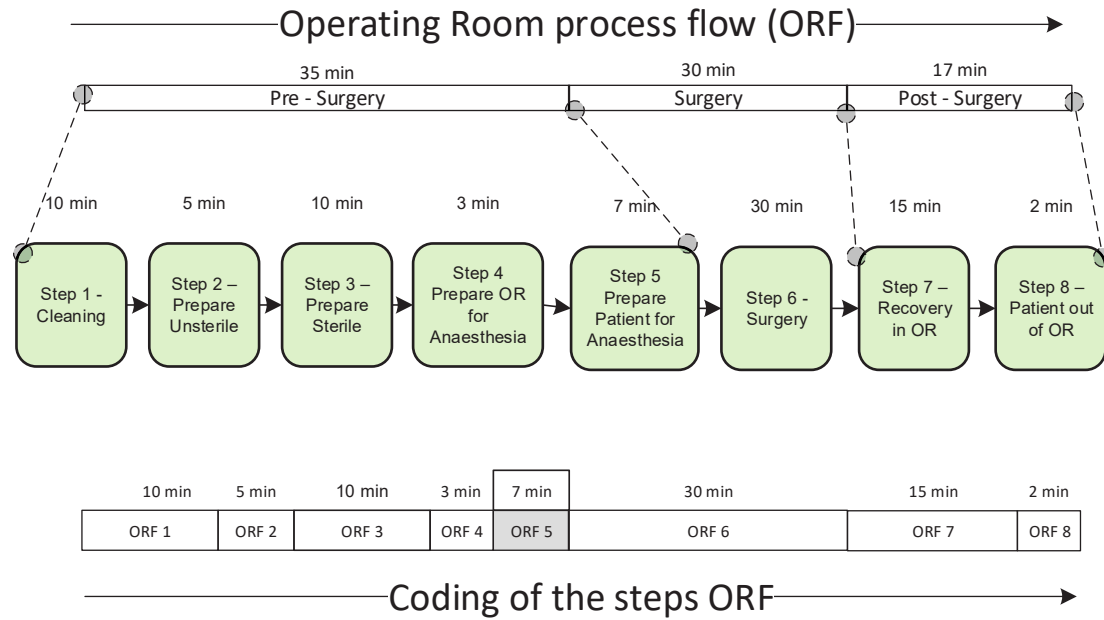

Time analysis in OR

Table 5.11 shows the different steps, a short description and the approximate duration of every step.

Table 5. 11: Operating Room Flow (ORF)

	STEP	Description of the Step	Step Duration (Average)
Pre-surgery	ORF 1	Cleaning the OR. The duration varies depending on the nature of the surgery which has finished.	10 min
	ORF 2	Non – sterile equipment into the OR. Supportive equipment, monitors or any other electronic equipment.	5 min
	ORF 3	Sterile equipment preparation. Tools, linen, and sterile equipment.	10 min
	ORF 4	Preparation of anesthetic equipment	3 min
	ORF 5	Preparation of patient for anesthesia. Placing probes, masks etc.	7 min
Surgery	ORF 6	Actual Surgery. It can not be calculated only estimated. We have chosen 30 minutes as an average acceptable time.	30 min
Post Surgery	ORF 7	Recovery and the free area around the patient.	15 min
	ORF 8	Transport the patient from the OR to the recovery room.	2 min
	TOTAL ORF duration		82 min

As in PJF, the cycle times are approximate and vary from case to case, from surgery to surgery and from patient to patient. This is in contrast to manufacturing where cycle times are relatively fixed. Based on the above analysis then the main stages have the following duration.

From the above – it can be observed that a typical average surgery cycle takes 82 minutes to be completed.

Figure 5. 11: Operating Process Flow (ORF)

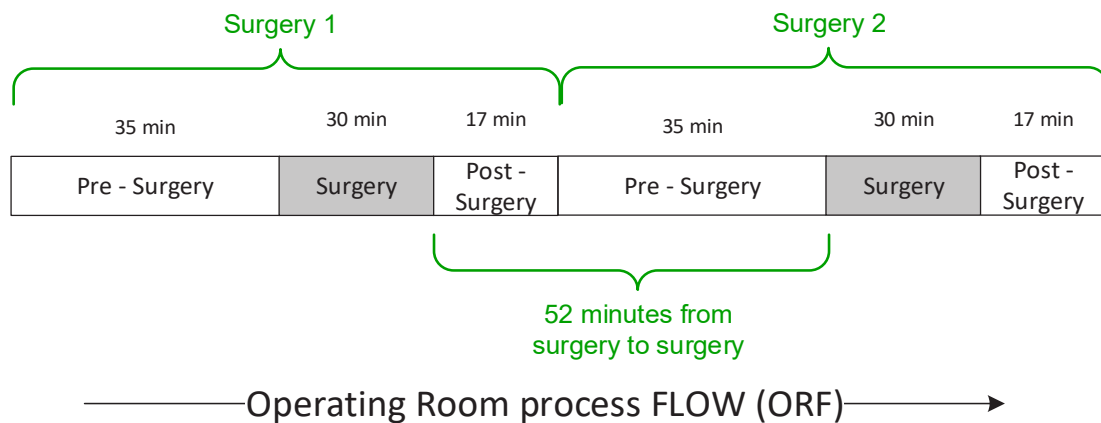

Figure 5.11 shows how the Operating Room Process Flows happen in a sequence. The OR is a single resource which requires a “set up” in order to be able to perform a second surgery after it has finished the first. There is a 52 minute “set up” time from surgery to surgery when surgeries are completely different and a total set-up is needed from surgery to another.

Drum Buffer Rope Implementation

As measured and shown from the action step 7, there is a lot of idle time distributed between the surgeries in small chunks which do not allow additional surgeries to be added safely. The injection proposed by the EC was to accumulate all the idle chunks together and form one unified idle time block where the hospital could take advantage of. The solution proposed by the FRT was the implementation of the Drum Buffer Rope methodology which is explained in detail in section 1.5.1.

TOC’s way to manage the flow through a system is the Drum Buffer Rope methodology (Dettmer & Schragenheim 2000). DBR is a method that it is independent of fixed cycle times. (Siha 1999a) comments that the DBR can be applied to services. The schedule of the resources and functions should be calculated from the constraint and backward in contrast to MRP scheduling where schedules are done backward from the end (Polito et al. 2006).

According to (Schragenheim & Ronen 1990) three basic steps are applying the DBR

1. Schedule the Drum. This step also includes the exploitation step. This does not mean only to keep the constraint busy but effective as well.
2. Determine the buffer size and
3. Schedule the rope according to step 1 and step 2. Rope is a mechanism derived from the subordination process (Schrageheim & Ronen 1990).

In order to use the principles of the DBR - the resource with the lowest flow rate should be identified. The one which will set the pace of the whole production rate. This is the Drum, and it was agreed to set as Drum the constraint (doctor's time), The idea was to set the Drum as the Doctor's time and then organize everything around the Drum. As a buffer, a time buffer would be created. This is the time buffer which is created to make sure that the patient will arrive at the constraint before he is operated. The rope is a communication design which connects the ORs status with the ward to release the patient to the OR, it is a trigger signal which would be used to call in the next patient, in an appropriate time before the OR and the doctor are ready to perform a surgery. The rope would be a communication signal to the ward to release the patient to arrive at the OR. Release the patient too soon, and then the patient will have to wait in the corridors of the ORs – something that we want to avoid as we do not want the patient to see other operated patients trying to recover. Release the patient too late, and the constraint will starve. The doctor will waste time waiting for his patient.

STEP 1 - Setting up the Drum

To accumulate the work internally into the system we needed to choose a new internal constraint and then plan the whole operation around it.

The most valuable resource was chosen as a drum, and this was the surgeon's time being in line with (Cox III & Schleier 2010).

Taking a closer look...

Figure 5. 12: Setting the Drum...

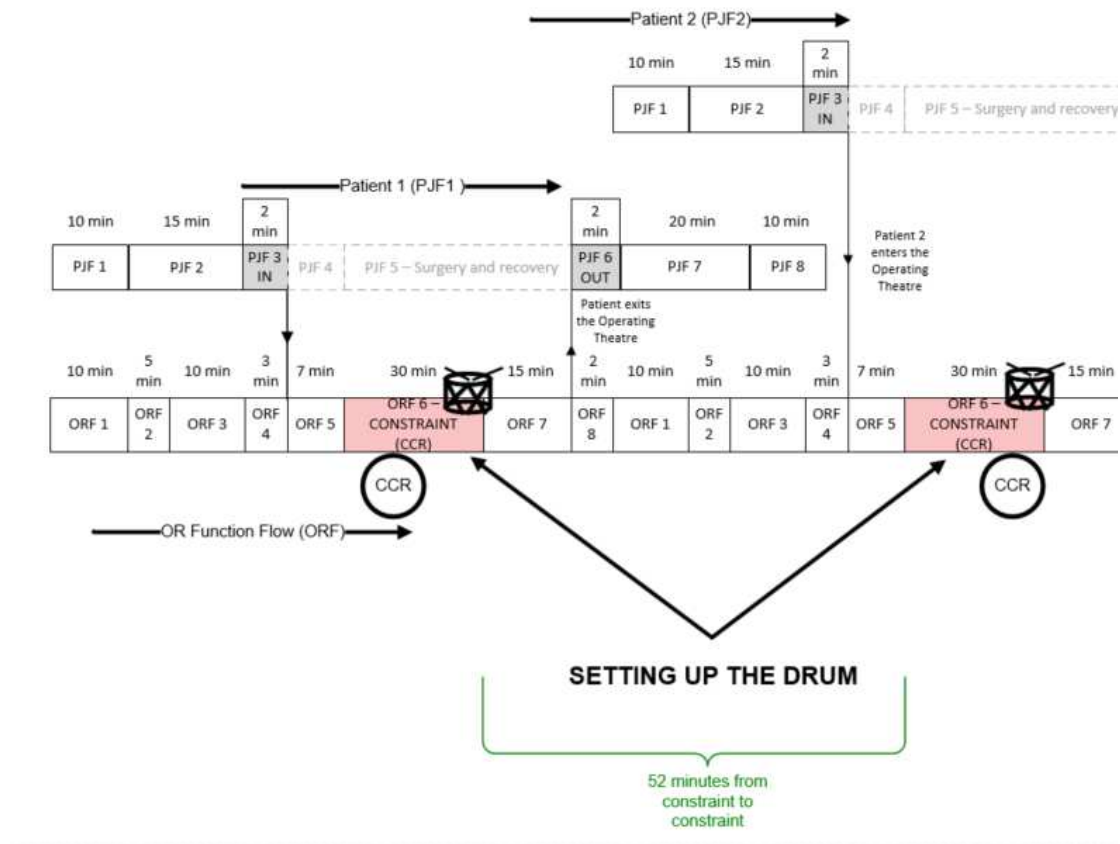

The above figure 5.13 is a synthesis of figure 5.9 and figure 5.10.

In the above picture, the ideal situation is shown after the Drum has been chosen. The Drum or CCR is the doctor’s time, and it is the step ORF 6 as shown in figure 5.10. The flow unit through the CCR is the patient, and it is shown as Patient Journey Flow 1 (PJF1) and Patient Journey Flow 2 (PJF2).

The moment that the patient is at the PJF3 step then the OR status must be in ORF4 step – this will allow the patient to enter the OR without delay and then the surgery will begin.

STEP 2 - Setting up the buffer

The buffer in an industrial environment is synonymous with finished good and WIP, in healthcare terms is waiting times or lead times (Mohammadi & Eneyo 2012).

The only buffer needed to be was a constraint buffer: This is the buffer needed to protect the operation of the Drum. This buffer absorbs disturbances reaching the constraint and which comes from the non-constraints (Duclos & Spencer 1995). The buffer in front of the drum is actually a time buffer, and it needs to be calculated. Usually, this buffer and on certain occasions this buffer is set empirically.

In order to keep the constraint busy continuously, the patient must be at the Surgery Department earlier than ORF 5 and preferably in the middle of ORF3. It was decided to have the patient at the surgery department before ORF 3 finishes and use the 7 minutes as a protection mechanism against variability. These 7 minutes is the protection for the CCR in order to avoid keeping it idle. These 7 minutes play the role of the system's buffer. Figure 5.14 illustrates graphically the place of the buffer, which as mentioned is a time buffer.

To apply the buffer, it simply means that the JPF must begin 7 minutes earlier than the 25 minutes which is the transportation time of the patient.

Figure 5. 13: Setting up the Buffer

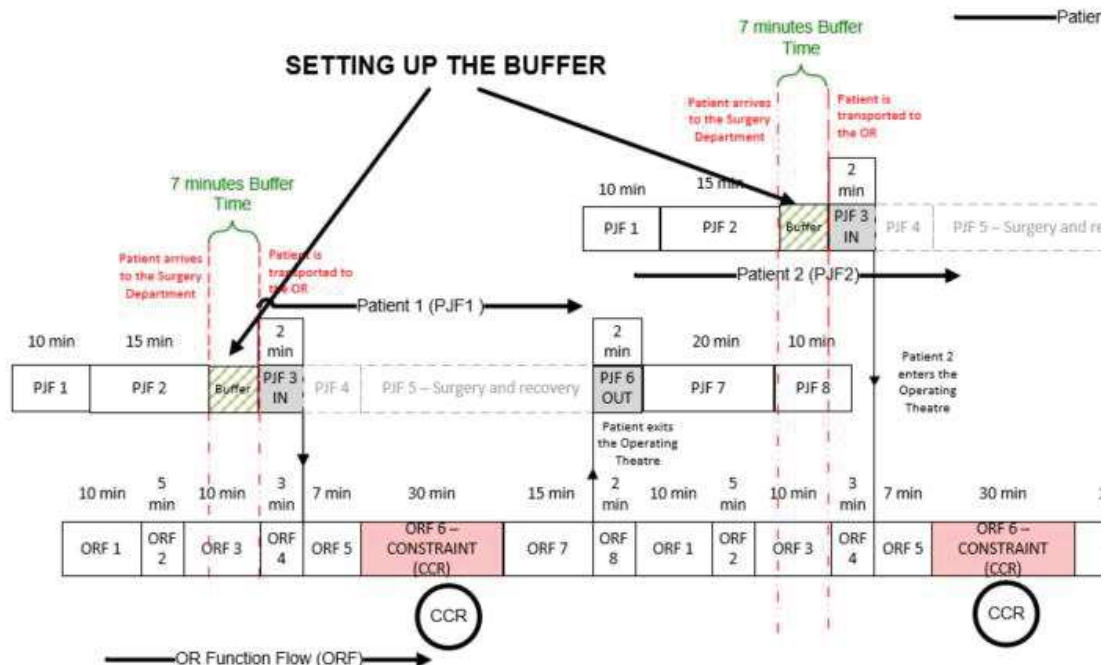

STEP 3 - Setting up the Rope

As discussed in order to keep the DRUM or the CCR busy and fully utilized the patient must be ready for surgery 7 minutes before the OR is ready to perform a surgery. In order to secure that the patient will be at the OR 7 minutes before entering into the OR, a communication mechanism must signal for the next patient. This mechanism is the Rope part of the DBR which allows the next patient to leave the wards and be transported to the surgery department.

The rope is a communication mechanism which releases work into the system (Cox III & Schleier 2010, p.871). It is a mechanism which ensures that non-constraints are working at the pace of the constraint and no more. This is done by releasing raw materials (or patients) into the system (Motwani et al. 1996b). It is the balancing and coordinating communication mechanism between the non-constraints and the buffer (Chawla & Kant 2017). If everything runs ideally and in the complete absence of Murphy, the buffer size could be zero. Murphy though is a fact of life therefore empirically a buffer of 7 minutes was set. This means that the patient should be ready to enter the OR 7 minutes before the actual surgery.

As it can be observed from figure 5.15 the transportation time – the time it takes for a patient to be transferred from the ward to the OR is 25 minutes. Additionally, a 7 minutes buffer is required, therefore the patient should leave from the ward 34 minutes before the actual surgery. This means that 34 minutes before the constraint is ready a signal should.

Figure 5. 14: Setting up the rope

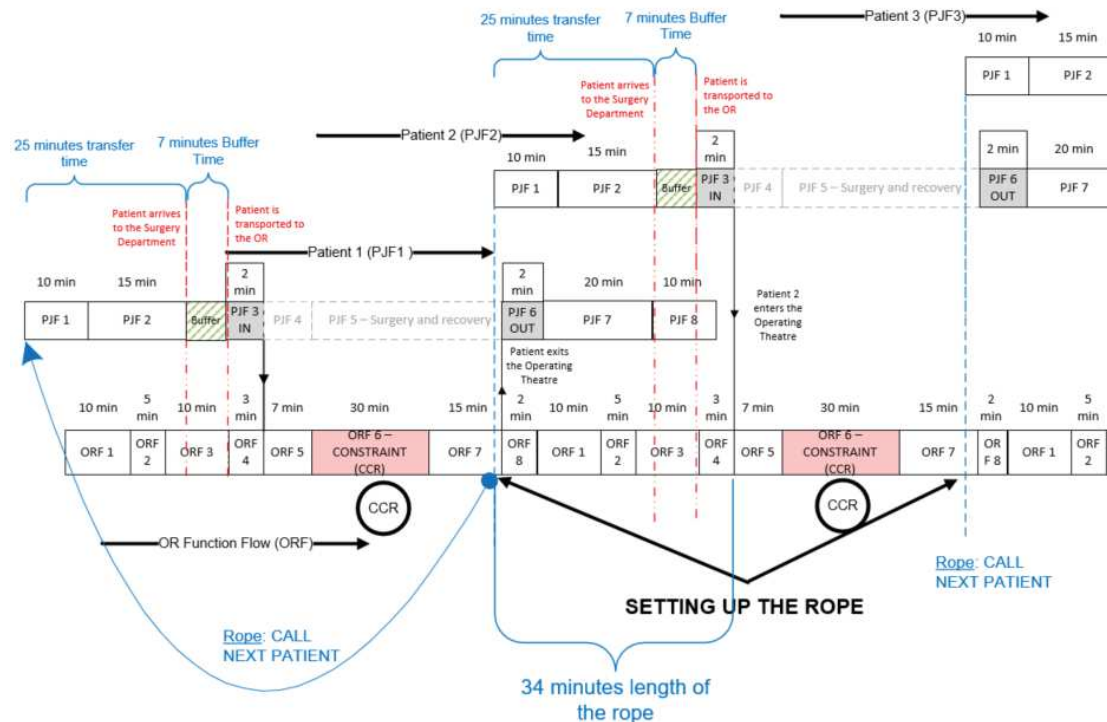

As shown in the above figure 5.15 the CALL NEXT PATIENT signal should be initiated some time at the end of ORF 7 which is the recovery process of the patient into the OR. It can be observed that the rest of the ORF steps can be controlled since the patient is not involved. The same holds true for the PJF, the steps are fairly controllable and predictable.

Implementation

The design was executed with the help of the project team. Duration of the steps was agreed with the team. Decisions were easy to be made with the visualization of the flows.

There were two challenges to address – the first was to start on time in the mornings and the second was to execute the DBR plan.

A discussion took place with all the doctors that would perform surgeries in OR6 the assigned two weeks. The discussions took place individually in their private office by the researcher. It was explained to them the philosophy of the methodology, and they all believed that it would help.

“the earlier we finish, the better” – a doctor said.

Doctors were used to seeing us in the research field, and they were very willing to help and support to make the surgery department a better place. They claimed that they had mentioned several times that things could become better at the surgery department.

Doctors were very willing to help to start on time in the mornings. They did not accept the fact that they were the reason for the delays, but they promised that they would support the effort. They loved the fact that they were the constraint.

The same level of commitment was promised by the three head nurses of the wards that they should support and give priority to the transportation of the patients.

Regarding the mornings, one of the obstacles recorded for starting on time was that the patients could not be allocated a room early enough. Discharges were taking place after 10 o'clock in the morning.

The solution that was proposed by the head of the operations was to use the beds of the emergency department. They agreed, they had done it before. The outpatients were getting ready for the operation at the ED, at the same time that their room was getting ready. In the mornings though priority was given to the inpatients for these two weeks. These two actions had a great effect on morning delays.

How was it applied throughout the week?

From the first day of the implementation, things run smoothly. One surgery was following the other, some surgeries finished earlier some lasted longer than 30 minutes, but the plan seemed to work independently from the duration of the surgery. The rope signal was initiated approximately 10 minutes after the surgery had finished.

After the first week of operation, the supervisor's assistant of the ORs started seeing tasks that could be done in parallel thus reducing pre-surgery time by approximately 70%. Tasks such as bring in equipment, prepare for the cleaning, etc would be prepared during the after-surgery time - we managed under his ideas to reduce the pre-surgery time down to 15 minutes or even less. At the same time, the transportation of the patient to the ORs was reduced by another 10 minutes. After a couple of weeks, the signal

(rope) would go on when the cleaning would have started. The time from constraint to constraint was reduced from 52 minutes down to approximately 38 minutes. This is an approximate reduction of 27 % from constraint to constraint as shown in figure 5.15.

Figure 5. 15: Time from constraint to constraint after reduction of activities

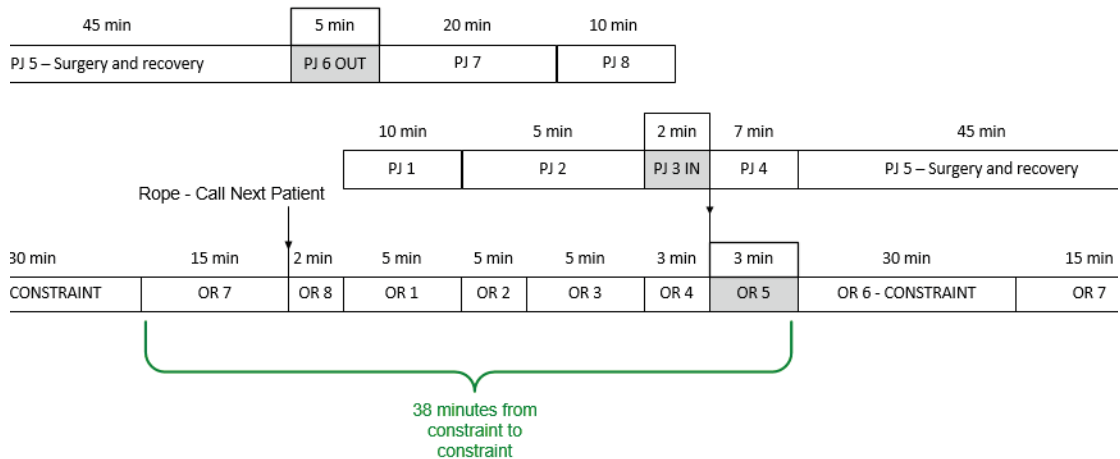

How was data captured? During those specific weeks?

For two weeks the same forms which were used for capturing data were used, to evaluate the results.

The assistant of the head nurse in the Surgery was committed to the experiment. He was available during all the morning shifts, and he was coordinating the communication and the activities.

He was calling for example for the next patient, he was calling for the cleaning team, and he was coordinating the functions and their sequence.

Implementation

The surgeon was the constraint or CCR, we did not intervene at all to the surgery process, the nursing staff was well educated, and the surgeon was fully supported. The

surgery process was running smoothly, and all the necessary equipment was available. No problem was observed.

The buffer time of the 7 minutes worked well, although it could be less. We probably had overestimated the duration of the transportation. When the personnel knew that they should focus on transportation – things were running much more efficient. During the implementation we allowed the buffer to be 7 minutes although it could be less. The nursing staff was spending time with the patient, talking to him/her and relaxing him.

The rope signal worked really well. A phone call initiated the signal. The supervisor assistant would call the head nurse of the ward directly and she was speeding up the whole process.

The target was to reduce idle time. By reducing the idle time, the whole process can be improved (Mohammadi & Eneyo 2012, p.15).

Results of DBR IMPLEMENTATION

The experiment took place at operating room 6 for two weeks. Below table 5.12 illustrates the results which were significant from the first day.

Below graphs, tables and numbers concern only Operating Room 6, in contrast to section 5.7.1 where data was for the whole surgery department.

Table 5. 12: Idle Time Distribution Profile in OR 6 (%)

Idle Time Distribution Profile in OR 6 (%)										
	2016								2017	
	Before the Intervention								After the Intervention	
	Wk 40	Wk 41	Wk 42	Wk 43	Wk 44	Wk 45	Wk 46	Wk 47	Wk 50	Wk 51
Total Idle Time	12:40	12:15	17:20	07:40	13:50	16:00	13:35	13:40	14:35	15:10
Idle Time - Morning	13%	12%	18%	10%	9%	16%	13%	9%	2,3%	3,8%
Idle Time – Between Surgeries	64%	50%	29%	62%	46%	21%	56%	49%	21%	19,2%
Idle Time - Afternoon	24%	38%	53%	28%	45%	64%	31%	43%	77,2%	76,9%
No Of Surgeries	16	12	14	11	17	13	13	13	19	21
Surgery time (h/min)	24:50	25:15	20:10	22:20	23:40	21:30	23:55	23:50	22:55	22:20
Utilization	66%	67%	54%	74%	63%	57%	64%	64%	61%	60%

Above table 5.12 shows the change in the idle time of the selected Operating Theatre before the implementation of the DBR and after the DBR in percentages. Table 5.13 displays the same data but in actual hours.

The data before the intervention was taken during the Evaporating Cloud development at section 5.7.1 and was based on the sample shown in appendix 10. Table 5.12 shows the results in a period of two months, on a weekly scale. The idle time was divided into three sections

1. The idle time in the morning. It can be observed from table 5.12 the tremendous improvement and the reduction of the wasted time in the mornings. 12% of the total idle time was taking place in the mornings. After the intervention, this percentage falls down to 3%. The time wasted before the intervention was 1,40 hours on a weekly average, after the intervention the average fall to 30 minutes freeing 1 hour per week. If we take into consideration that there are 5 more ORs

and if we assume that the same situation exists then there is a potential of saving 6 hours every week only from the morning delays.

2. The idle time between the surgeries. This is the time that no activity is taking place in the ORs for different reasons. This is wasted time as well. Before the intervention, and during the 8 weeks of data recording, the average time wasted was 47% of the total idle time. After the intervention, this category was reduced down to 21%. The DBR implementation managed to reduce by half the idle time in just one week. Based on table 5.13 this is translated into 3 hours of free time because of the setups.
3. The idle time in the afternoon. The idle time in the afternoon was 41% of the total idle time before the intervention and after the intervention increased to 77%. This was also the objective of the intervention. To accumulate the idle time in one chunk so more surgeries can be added. This dramatic change in the idle time resulted in 11,30 hours of free time in contrast to 5,40 hours during the eight weeks as per table 5.13. This made available 6 more hours in the afternoon.

The utilization figures reduced by 3%. It was 64% before the intervention and 61% after the intervention. No major change was expected in utilization figures as no more surgeries were added. The only way to increase the utilization is by actually adding more surgeries into the ORs.

Table 5. 13: Idle Time Distribution Profile in OR 6 (Hours)

Idle Time Distribution Profile in OR 6 (Hours)										
	2016								2017	
	Before the Intervention								After the Intervention	
	Wk 40	Wk 41	Wk 42	Wk 43	Wk 44	Wk 45	Wk 46	Wk 47	Wk 50	Wk 51
Total Idle Time	12:40	12:15	17:20	07:40	13:50	16:00	13:35	13:40	14:35	15:10
Idle Time - Morning	1:35	1:25	3:05	00:45	1:15	2:30	1:50	1:10	00:20	00:35
Idle Time - Between Surgeries	8:05	6:10	5:00	4:45	6:20	3:20	7:35	6:40	3:00	2:55
Idle Time - Afternoon	3:00	4:40	9:15	2:10	6:15	10:10	4:10	5:50	11:15	11:40
No Of Surgeries	16	12	14	11	17	13	13	13	19	21
Surgery time (h/min)	24:50	25:15	20:10	22:20	23:40	21:30	23:55	23:50	22:55	22:20
Utilization	66%	67%	54%	74%	63%	57%	64%	64%	61%	60%

Figure 5. 16: Time Distribution in OR6 AFTER the intervention – first week

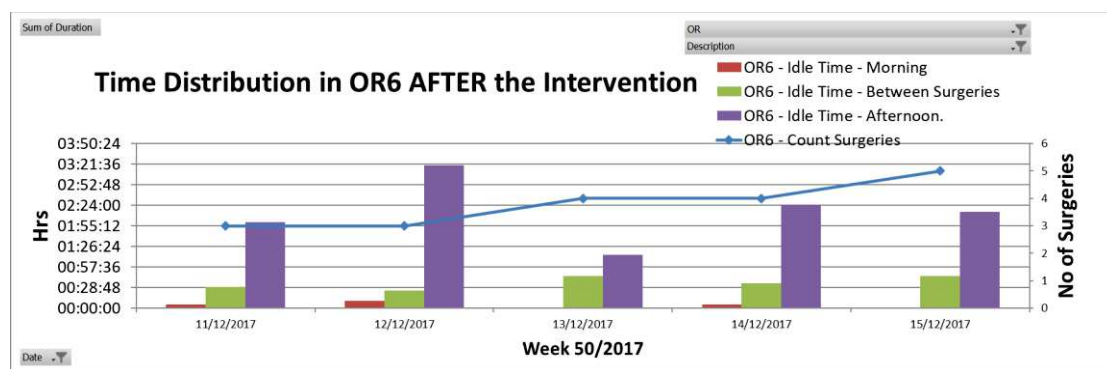
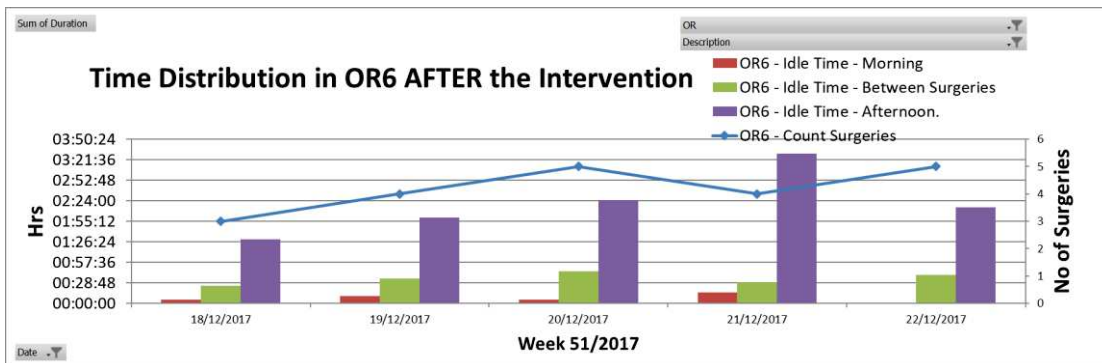

Figure 5. 17: Time Distribution in OR6 AFTER the intervention – second week



Graph 5.16 and graph 5.17 display the idle time distribution in hours. Graph 5.16 for week 50 of 2017 and graph 5.17 for week 51 of 2017. From the graphs, it can be clearly observed that the idle times have been moved from the morning and from between the surgeries and that they have been accumulated in the afternoon (purple color).

The management of the hospital did not wish to proceed though and bring more work into the surgery in such a short time. The time frame of the research did not allow to apply the DBR in all ORs and observe how the surgery would behave with more surgeries. The team was confident though that the length of the idle time was so large that it would be completely safe to add more surgeries. Additionally, more nurses were required because the ORs would be constantly occupied that more personnel was needed. It was mentioned that it takes almost a year to train new personnel in the surgery environment.

5.10 Evaluation – Results of Part 2

The second action research cycle is composed of three action steps. The first phase was the diagnosis phase.

The first action step was used for the diagnosis phase, and it was implemented via the evaporating cloud. The evaporating cloud started from the dilemma “add more work into the system” vs “do not add more work into the system”. The analysis of the dilemma revealed several assumptions that hold the dilemma in place. In order to be in a position to invalidate or validate the assumptions, data was gathered from the field for two months.

The data showed that the idle time was spread out throughout the day without allowing more surgeries to be added. This trend was keeping the utilization figures low. After several discussions with the project team, the injection decided was “accumulate all the surgeries into one single chunk and accumulate all idle time in one long time chunk. Then add surgeries into the idle time chunk”. This was the direction of the solution.

The planning stage was completed with the development of the FRT. The injection was to implement Drum Buffer Rope with the drum being the doctor’s time.

The last action step concerned the implementation of the DBR in OR6.

The result of the implementation of the drum buffer rope was that the accumulation of the idle time in the afternoon generated 6 more hours of free time, where more surgeries could be safely added.

The DBR implementation proved to be satisfactory.

PART 3 – RESULTS

This section of the chapter sums up the results of the two action research cycles. The implementation of TOC used both components of the TOC methodology, the thinking process tools, and the Five Focusing Steps.

The first action research cycle was composed of 6 action steps.

The implementation started with training which aimed to explain to people that there is no reason to feel threatened and that the aim of the research was the performance of the system and not human behavior. Through the training, the framework of the research was also explained and the approach to improvement.

The thinking process tools used were the GT and the CRT. The goal of the surgery “system” was to “Provide high-quality surgery services with maximum profitability now and in the Future”. As shown in figure 5.2 there were three Critical Success Factors identified with their Necessary Conditions Network.

Comparison of the current reality with the necessary conditions revealed 4 UDEs and their cause and effect analysis showed that the core problem is the “low utilization of

the ORs". The surgery department was founded to operate at a utilization of 56%. TOC's generic solution of the Five Focusing Steps is the solution to be implemented in order to increase the utilization figures.

The constraint identified was the consumption. The exploitation step was to increase the consumption by adding more surgeries. Negativity and people's resentment did not allow the progress. The research entered the second action research cycle phase.

The second research cycle started again with the diagnosis with the help of the evaporating cloud in order to get a deeper insight into the problem. With an analysis of people's comments, the dilemma which was fuelling the discussions and the stress was "add more work" vs. "do not add more work". Extra data was collected for two months, and it was revealed that the profile of the idle time was spread through the day in multiple blocks of time. No additional work could be added because there was not enough time in a single block. With the help of the FRT, it was decided that the injection was to "accumulate all idle time in one single chunk of time so more surgeries could be added".

The solution was the drum buffer rope. The implementation of the drum buffer rope resulted in 77% of idle time accumulation as shown in table 5.12.

The results below are summarised into two categories.

Below Table 5.11 summarises the results of the whole case study which concern the soft part of the system – the humans. Figure 5.18 displays the technical results of the case study.

5.11 Summary of Overall Results in Operating Room Case Study

Table 5. 14: Soft Results

Action Steps	TOC Tool/Process Used	People’s Perception and reaction of TOC tool/Process used
Action Step 1	Training	<ul style="list-style-type: none"> • Silo Thinking very dominant. • Concepts were found to be interesting. • Metaphors of car and river worked very well. • Need time to digest system concepts. • People realized that they are not the target, but the system’s structure is. • Jargon word must be avoided. They confuse the participants.
Action Step 2	GT	<ul style="list-style-type: none"> • People did not like that their goal is to make more money now and in the future. • They accepted it when the goal included their specialty. • People were mentioning the positives they already had, as necessities. • Even people who were at the clinic for years were thrilled with the way that several conditions were interconnected and shown. • Positive energy for creation and motivation. • Fears and threats originally raised, were evaporated. • People’s psychology was very positively affected. • The freedom to create the ideal state inspired people, they felt powerful, proud for participating and excited.
Action Step 3	Current Reality Tree	<ul style="list-style-type: none"> • GAP ANALYSIS • People were mentioning that they had many problems, but they could not define them clearly. • Tendency to discuss their personal UDEs. • Tendency to jump to causes and to solutions. • People were discussing the problems that their solutions would bring. • They were claiming that most of the UDEs were other people’s fault. • CURRENT REALITY TREE • Development of the tree is difficult. • People did not surface all assumptions – long arrows. • Fear of blame when discussing assumptions • People did not know that the ERP was calculating utilization figures. • They were surprised finding out that the ORs were working at 56% of their capacity.

		<ul style="list-style-type: none"> • Observing carefully the OR's people could see the idle times. • Participants cannot stay concentrated for long • Difficult to focus on the CLRs. • Failed on the entity existence reservation. • Agreed on the CRC.
Action Step 4	5FS Implementation	<ul style="list-style-type: none"> • People founded the approach very logical. • They found the river metaphor very helpful.
Action Step 5	Identify the Constraint	<ul style="list-style-type: none"> • When trying to identify the constraint by loading calculations, nurses were saying that a hospital is very different from a factory. • Everybody in the field was very willing to help and support our efforts.
Action Step 6	Exploit the Constraint	<ul style="list-style-type: none"> • When decided to increase the work load by introducing more work, people resisted very intensively. • The resistance spread out very quickly to the whole department. • They were very frustrated and supported that the assumptions of the ERP were wrong. They did not believe the 56% utilization figure. • People trusted their intuition. • People had many reservations
Action Step 7	Evaporating Cloud	<ul style="list-style-type: none"> • Easy tool to use. • It organized the arguments. • People were surprised by the nature of the conflict and with the simplicity of the tool. • We needed to collect data to invalidate assumptions.
Action Step 8	Future Reality Tree	<ul style="list-style-type: none"> • They conceive it as a guess. • They found the whole approach very subjective. • When a Desirable Effect is not added from the beginning, then the solution will not design it, and it will be missed.
Action Step 9	Drum Buffer Rope	<ul style="list-style-type: none"> • People loved the approach. • They become very creative. • They had solutions for almost everything. • After two weeks of trials, they complained that more people are needed. • People were very helpful, very relaxed and very engaged. • They loved improving the process.

Figure 5. 18: Technical Results – Operating Room

TECHNICAL RESULTS OF THE OR CASE STUDY

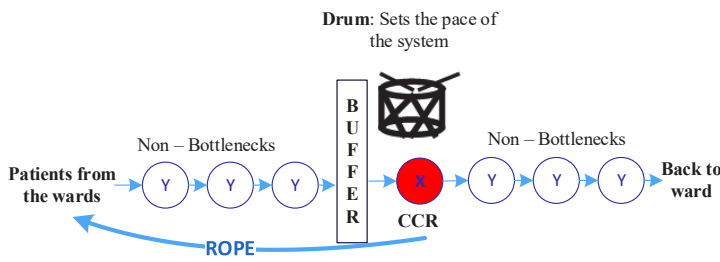

Action Step 9: Drum Buffer Rope (DBR)
Drum: Surgeon's time
Buffer: 7 minutes
Rope: Call Signal – rope length 34 minutes.
RESULT: Idle time accumulated in the afternoon by 36%
 - MORE SURGERIES can be added now.



Action Step 1: Training
 Five Topics
 1. Maintenance vs Improvement
 2. Improvement Concept and change questions
 3. System concept - Car
 4. Flow - River
 5. TOC philosophy – manage flow through the system

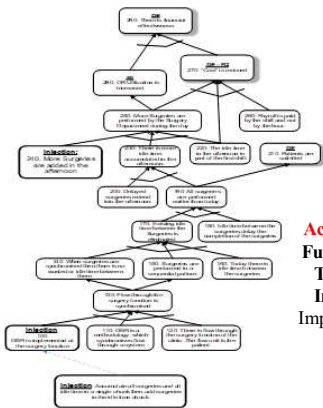

Action Step 8: Future Reality Tree (FRT)
Injection 1: Implement DBR

GOAL TREE OF HOSPITAL'S SURGERY DEPARTMENT



Action Step 2: Goal Tree
Goal: Provide high quality surgery services with maximum profitability now and in the future
 CSF 1: Financial Effectiveness - FOCUS
 CSF 2: Successful Surgeries
 CSF 3: Have quality workforce

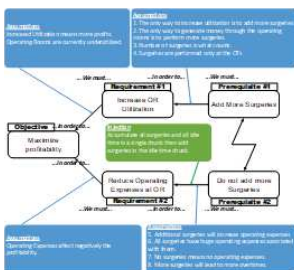

Action Step 7: Evaporating Cloud
Core Conflict: Add more work vs Do not add more work
Captured Data 8 weeks to invalidate assumption "Additional surgeries will increase OE" – Utilization 56% and idle space distributed along the whole day
Injection: Accumulate all surgeries and all idle time in a single chunk then add surgeries in the idle time chunk.

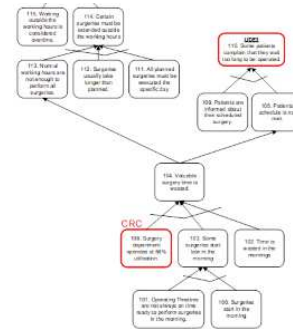

Action Step 3: Current Reality Tree (CRT)
 UDE 1: There is no Financial Effectiveness
 UDE 2: High Operating Expenses
 UDE 3: Patient complains - Late start in the morning
Core Root Cause: Low Utilization of Ors – Retrieved from the system 56%

Action Step 6: Exploit the Constraint
Result: Constraint can not be exploited. Too many reservations from the employees.

Action Step 5: Identify the Constraint
Constraint: Market consumption.



5.12 Chapter Summary

This case study concentrated on the application of TOC at the hospital's surgical department. The research methodology followed the action research philosophy. For easy of analysis, the application happened in two action research cycles.

A blend of thinking process tools and of the Five Focusing Steps was used in both action research cycles. Although the surgical function is acknowledged to have a high level of complexity, TOC has managed to guide the improvement path in a clear and structured way. The implementation was realized through nine action steps. The first eight steps described why DBR was selected as an improvement method and the ninth step explains in detail the implementation of the DBR in one single Operating Room.

The result showed that DBR managed to subordinate the flow through the chosen constraint which was the doctor's time. The subordination resulted in an accumulation of the extra capacity into a continuous chunk of time that can now be used to increase Throughput.

The chapter concludes the results in two themes being the soft and hard elements of the system.

Chapter 6

Discussion and interpretation of results

6.1 Introduction to the chapter

This is the first chapter of the discussion process, chapter seven is the second part of the discussion.

Chapter 4 and chapter 5 focused on describing the implementation and the findings of TOC in two different healthcare sub-systems based on the action research philosophy explained in chapter 3 and shown in fig 3.3. The sub-systems chosen are the linen management system and the surgery department of the biggest private hospital in Cyprus.

The action research phases were executed using TOC tools through groups of actions called the “action steps”. Every action research phase was completed through several action steps. Every action step produced “outputs” which were “inputs” for the following “action step”. At the end of every action research cycle, the findings were summarised in order to separate the outputs from the action steps. Every action step was evaluated against the TOC effectiveness (hard) and the level of TOC acceptance of people (soft). The findings were extracted based on these two attributes.

This chapter discusses the findings of chapter four and chapter five. It focuses on the theoretical part of the explanation since a certain level of discussions were done at the evaluation phase of the action research in chapters four and five. It seeks to contribute

to the thesis by generating knowledge from the findings of the case studies. It states what the meaning of the results is and why they are important.

This discussion chapter unfolds based on the recommendations of (Saunders et al. 2009, p.536).

1. The focus of the chapter will be mainly the interpretation of the results of chapter 4 and chapter 5. The discussion will focus on the most important findings.
2. The relationship of the findings will be discussed in reference to the research questions and the research objective.
3. The discussion will take place under the light of what is already known by the body of literature.

Subjects to be discussed

Having as a core, the main research question, which is “*Can the application of the Theory of Constraints lead to operational improvements in the healthcare sector, at a private general-purpose clinic/hospital in Cyprus?*”, the discussion takes place around the TOC components and solutions.

Discussing the findings following the action steps approach would be a complicated task since the TOC tools and components are used in a mix sequence as the situation demanded every time.

For ease of analysis, we discuss the findings of every case study separately, following the TOC categories of

1. Logical Thinking Process
2. Five Focusing Steps
3. Drum Buffer Rope
4. Replenishment solution

At the end of every category, a joint discussion takes place which synthesizes a view from the results and discussions of both case studies.

6.2 Logical Thinking Process

The implementation of the logical thinking process used in both case studies was based on the guidelines of (Dettmer 2016b). The guidelines are according to the main body of literature as described by many different authors starting from Goldratt in (Goldratt n.d.), and followed by (Scheinkopf 1999; Cox III & Schleier 2010; Fedurko 2013). Nearly all the authors agree on the methodology of how to use the logical thinking process tools.

Sub-research question six is pointing to the direction of investigating, how people perceive TOC and what are the obstacles which prohibit TOC acceptance. Therefore, people were involved actively during the whole study being consistent with the action research philosophy.

In below section, the focus of the discussion is around the TOC perspective than the actual nature of the output of the tool.

6.2.1 Current Reality Tree (CRT)

As discussed in action step 1 (section 4.2), the thinking process sequence started with the CRT development. Twelve UDEs were collected, but further development of the CRT could not be achieved.

The main reason for the failure of the CRT was people's resistance. The results of the action step 1 support the view of (W. Dettmer 2007) that CRT has difficulties and introduces the IO Map, which is later renamed to Goal Tree (GT) (Dettmer 2016b). People watching the researcher walking into their environment trying to "improve" their job felt "threatened". The process of collecting UDEs required discussing about negatives and dysfunctions. Very soon a wall of resistance was raised as people saw themselves as being the root cause of all the negatives. People tended finding excuses for every UDE raised, except the ones mentioned by them personally. Goldratt supports that people resist changing except the ones who are proposing the change (Eliyahu M Goldratt 1990).

The request for improvement was not initiated by them after all. People did not know why they should change, and the CRT did not help toward answering this question. On the contrary, the mapping of the negative situation fuelled the resistance even more. Since progress could not be maintained, we used the GT in order to answer the “why to change” question.

6.2.2 Goal Tree (GT)

The GT was used because the CRT failed. It was a tool that greatly facilitated the change sequence and offered a bright new perspective on the initiative.

It is worth evaluating and discussing the GT based on the findings in detail since the literature discussing the GT is very limited, almost non-existent. The only information available is given by Dettmer through his books and through training courses that he delivers. Dettmer himself taught the researcher on the Thinking Process Tools including the Goal Tree, in Paris in 2016 for the purpose of this research.

We consider the GT addition a vital step towards TOC’s evolution, therefore, we will discuss the GT findings in detail in an effort to enrich TOC’s literature. A much more in-depth analysis is found in chapter seven where we approach and enhance the GT structure from a clear theoretical perspective.

Goal Tree (GT) Development – Linen case study

Discussing about Critical Success Factors (CSFs), Necessary Conditions (NCs) and their logical interdependent relationship helped the participants to see relationships than isolated entities. Additionally, the fact that attention was directed to the structure of the system helped the participants to better conceptualize systemic concepts and be convinced that they are not personally the target for system’s “improvements”.

The goal indicated by the GT (figure 4.2) at the linen management system was to “*Provide the wards with clean linen in an effective way.*” Although the statement of the goal was a product of a uniform team’s conscious agreement – the interpretation was not clear to everyone. Meanings of expressions like “effective way” were not clear until

the CSFs were identified. The individuals in the project team were interpreting the goal through their own perspective. The surgeon once said

“we are a private hospital, we need to have clean and in perfect condition linen independently of the cost ... a very clear statement but in direct contradiction with management’s belief, who considered the cost as a vital part of the equation.

The CSFs helped to break down the components of the goal and explain what “effective” means. The CSFs indicated that the goal is composed of three different components. One operational, one financial and one soft element – the human resource which is recognized always as a NC (Cox III & Schleier 2010, chap.31). From the GT it is evident that there are three main branches where the supervisor must focus on.

The linen supervisor claimed that the representations of the GT added nothing new to what she already knew. From one point of view, she was right, nothing new was added. System elements were remaining the same. The visualization of the flow though in terms of functions ignited a systemic approach to the thinking process. (Meadows 2008) explains that only the arrows provide understanding, the elements remained the same, but the understanding of the interconnections between those elements provided a common deeper understanding not only to one individual but to the whole team. The interconnections added meaning to the purpose. The deeper the analysis, the more the acknowledgment of the systemic nature of the system. The analysis of the necessity relationships enlightened the understanding of the cause and effect network map. This shift of mind to systemic views facilitates greatly the implementation of TOC.

When the GT was discussed with the management team (the MD, the CFO and the Nursing Care Manager), they realized that to achieve an objective, a systemic approach should be used instead of pushing the supervisor to achieve more, as it was done for years. The supervisor can only affect parts of the GT – not all of them. This relates to the sphere of control and to the sphere of influence, as explained by (Dettmer 2016b, p.71), we can, and we should only operate and do our best into our sphere of influence, not only from our sphere of control (Forster 2005, p.263). The GT was a useful tool for the supervisor to show what is needed in order to perform her duties effectively.

The GT though shows the minimum requirements that must be met in order to achieve the goal. Since it is a necessity logic structure, all entities must be fulfilled otherwise the goal will not be satisfied in full. For example, the supervisor can partially affect NC7 (figure 4.2) which is “resources are available” – during the discussion with management, the supervisor said

“washing machine 5 is broken for 3 weeks now, there are no parts available, what can I do?” and then she continued *...I supposed to have 9 people working at the laundry at any time but two people are on sick leave, how can I work at the same speed, and without overtimes?”*.

Regarding NC11 she said *... what that means? I do not know how to do that!”* the same exact comment she did for NC3, *“I know what that means but I do not know how to do it”*.

After the discussion of the GT the team knew that a common understanding was achieved. The biggest difficulty though was in identifying the nature and the level of detail of the CSFs and the NCs, since they come from subjective judgment and thought. We went through endless discussions trying to form the statements, securing everybody’s agreement because of the subjectivity of the process.

Goal Tree (GT) Development - Surgery Department case study

The experiences from the linen case study were transferred to the surgery department. The use of the GT initiated the logical thinking process tools and not by the CRT as indicated by the mainstream of literature. This approach helped to set a positive mindset at the field and at the same time minimize the levels of resistance. Additionally, a structured training procedure was followed as explained in section 5.3.

The purpose of the GT was to create a common agreement of what is needed to realize the goal. However, first of all, to start thinking in terms of accomplishing goals and necessary conditions. The main purpose though was to explain why to change. People could follow the logic, with the use of the GT it was managed to focus on the system and not on human behaviors. Jargon words were avoided as much as possible. The focused and structured training process coupled with the higher level of education and

more procedure-oriented way of thinking at surgery facilitated and provided a much smoother GT development compared to the linen case study implementation.

The GT was completed with the aid of questions. The difficulty was for the people to think necessary conditions from other parts of the system, the same observation that was done at the linen case study. The subjectivity of formulating GT entities led to discussions, and some people were difficult to be convinced.

The first goal was stated as “Make more money now and in the future” as advised by (Eliyahu M Goldratt 1990). This goal statement was not motivating for the people though and particularly the young members of the team. It did not inspire them with a sense of purpose as they mentioned. The goal was restated as “*provide high-quality surgery services with maximum profitability now and in the future*”. CSFs were blended into the statement of the goal “specializing” the statement. The new goal statement was much more acceptable. (Senge 2006, p.132) mentions that for a person with a high level of personal mastery the vision must inspire since it is a calling rather than just a good idea.

At the end of the process, the GT formed a common view and formulated a common agreement. It unified the team, and they liked the simplicity and the visual, graphical presentation of the necessary conditions of their system particularly. As in linen, people had difficulties defining the CSFs. There are no clear guidelines on how to build GT’s entities.

Definition of CSFs is crucial because the whole thinking process development starts from them. It was observed, as in linen, that the CSFs were addressing three different functional areas of the system. The first one was focused on the financial effectiveness; the second CSF was focused on the output of the system (from the patient’s point of view) which is to perform successful surgeries, and the third is to have a high quality workforce. Again, the difficulty was on how to guide thinking to form the CSFs and the NCs.

Goal Tree – Common Observations

Goal Tree - The benefits

The GT proved to be a very effective tool in different dimensions, methodologically, technically, and behaviorally.

GT managed the first barrier to change, by answering the “why to change” question. Literature is weak in explaining how practically to display and communicate the reasons to change – what tools to be used, in a practical way. We find that the GT is providing a great contribution to this direction.

The discussion was about vision and goals - not about problems and negatives. Having the goal statement as a compass fuelled everyone with positive energy and positive intention. Building the GT was a very enlightening process in both case studies. The fact that they had participated in building their vision made them feel “owners” of that vision. A step toward the Socratic method and the vital ingredient of ownership which is necessary for effective change according to (Eliyahu M Goldratt 1990). Instead of talking about problems, people focused on creating a desired future state. Instead of focusing on obstacles people started looking for opportunities.

This was especially noticeable at the linen management case study where the GT seemed to be a strong antidote to people’s resistance and negativity. After finalizing the GT, the project team felt united. The common vision and the sense of a common purpose of the whole engraved into the parts (GT’s entities) can be parallelized to the concept of the “corporate DNA” coined by (Morgan 1997, p.102).

The graphical representation of the necessity relationship makes the GT very understandable, very friendly and a very effective communication tool. The project team was impressed with the simplicity of the representation despite the technical difficulty of building the Tree.

The GT has a dynamic momentum because of the actionable nature of the NCs. The term “goal” is different from the term “anticipation”. (Talcott 2013, p.48) distinguishes the term “goal” than the term “anticipation” by mentioning that a “goal” is something that the actor actively wants to make something happen and this the reason why the

NCs are worded as actions, where “anticipation” is something that the actor waits to happen. Wording the NCs as actions create a dynamic momentum to the situation

The findings of Chapter five show that including the operational purpose of the system into the goal statement is also very rewarding.

The idea of having a desired future as a compass is found in other approaches as well. The lean initiatives start by building the “Future State” of a system (Hoss & ten Caten 2013; Godinho Filho et al. 2015) as a step after the current state mapping (Kumar et al. 2018; Fong et al. 2016). (Ackoff et al. 2006, p.5) discusses about Interactivism and he explains his proposed idealized design model that begins by “drawing” where you want to be and then plan backward to the current state of the system. Ackoff claims that planning from the end and going backward reduces the choices, makes the planning more effective and more accurate (Ackoff et al. 2006)– a very similar approach to the GT.

(Senge 2006, p.138) describes that the vision is “the picture of the desired future”. He also adds that a shared vision is the foundation of team learning and team alignment. Team learning is the cornerstone of development and growth of organizations (Senge 2006, p.217). The GT proved to be a very effective tool projecting, communicating and sharing the vision –the ideal state of the system. The relationship between the GT and the vision makes the GT a strategic tool (Dettmer 2003), but it also places the GT at the beginning of the initiation of the Thinking process tools.

The GT seemed to be an excellent “how to” tool to create

1. A common purpose and vision
2. Give a systemic perspective
3. Soften people’s resistance
4. A boost of positive energy.
5. Team building.

Goal Tree Challenges

The findings of chapter 4 and chapter 5 show that a more structured and objective way is needed to build the GT – especially for people with no systems and no TOC background.

Displaying the system in terms of necessities and functions proved to be a real challenge. Constructing the GT demands thinking from different perspectives of the system. It takes time and effort to think in term of functions and system parts with interconnections than resources and hierarchies which empower silo thinking. At the same time, the GT gives a mechanistic form of a vision of how things should be. This mechanistic nature of the necessity network gives the feeling that there are no choices and that the GT is the deterministic view of the ideal state of the system. It lays on the assumption that there is only one ideal state. (Morgan 1997, p.11) discusses this mechanistic character of a system through the lenses of the machine metaphor. The GT, as in the case of a machine, the “functional” parts or the NCs, must behave as designed in order to achieve the goal. There are no shortcuts. The whole philosophy of the TOC thinking process tools follows this philosophical pattern. The roots of the TOC logic is based on Aristotelean logic (Dettmer 2011). Aristotle used mechanistic principles to interpret animal movements and behaviors (Morgan 1997, p.381). We observed that when people in the field were exposed to this kind of thinking they felt that their choice was limited.

The process of building the GT is straightforward, but it was difficult to guide the team to think systemically. People were never exposed to the systems’ world. Definitions like assumptions or necessity thinking were mentioned to them for the first time. The biggest challenge faced in the field was the subjectivity in building the tree. CSFs and NCs are the outcome of subjective judgment and thought. People had the tendency to raise strengths that they already had, and they were considering them as necessary conditions. There are no clear-cut methods and guidelines on how to identify CSFs and NCs.

With the GT introduction, the purpose of the entire set of the logical thinking process tools becomes of making sure that the NCs are effective so that the whole GT can exist. The GT sets the skeleton and the path for the development of the whole thinking

process. It is very important that the logical network is as close as possible to “ideal representation of the necessities’ network”. This subjectivity is magnified when it is applied by people who are not masters of the GT, and it can lead to “improper” construction of the tree. The guidelines need to be enriched with more detailed and structured guidance in order to avoid missing functional entities. It is crucial that the structure of the GT is the most accurate representation of the conceptual ideal state of the system or the TP tools will not work. Section 7.3 is devoted to developing guidelines for developing CSFs and NCs. We blend TOC and systemic concepts in order to build a set of attributes that the GT must fulfill. A certain degree of detachment was necessary.

These are described in Chapter seven in great depth.

6.2.3 Current Reality Tree (CRT)

Current Reality Tree Development (CRT) – Linen case study

The GT represents the ideal state of the system. The CRT, on the other hand, maps a snapshot of a negative part of the current reality. This negative part emerges after comparing the current reality with the GT’s entities. It maps the distance and the reasons for keeping the system away from the ideal state. The CRT was applied and tested in both case studies.

CRT Challenges

The “soft” perspective of the CRT

During the first action step, UDEs were perceived by different viewpoints because people had different perceptions of the system. TOC does not possess a tool to capture the behavior of a system. It only looks at the current reality of a system from the problematic perspective. We used the Block Function Diagram representation as explained in (Blanchard 2008a), but we believe that a tool needs to be developed based on the “constraints” philosophy.

Sufficiency Logic needs discipline. Maintaining a “tight” logic in the tree demands cognitive effort and focus, but people could not stay focused too long. The skeleton of the CRT was prepared mainly by the researcher using inputs from the project team.

During the development of the CRT, people had the tendency to run into solutions, and they needed to be constantly reminded that they are still in the analysis of the problem; solutions would come at a later stage.

They all had the tendency to surface their own UDEs and not the system's UDEs. It was very easy for them to understand that our aim was not to eliminate individual UDEs but to go down to the root cause.

Seeking to establish the cause and effect relationships step by step prohibits emotional tension. The process of unfolding the cause and effect relationships is eye-opening, and this comes from discussions that people have in the field, especially from people who are in the field for years.

The “hard” perspective of the CRT

Three to four UDEs were found to be enough for the CRT development. Building the CRT from the GT as a starting point seemed to be a much more efficient way than the first attempt where twelve UDEs were collected directly from the field and as guided by literature. The UDEs were systemic because they emerged from the comparison with the GT. The contrast against the GT shows very clearly to people what the objective is and what the current status is. It also highlights the systemic nature of the system’s behavior.

The CRT development was a very enlightening process, and the discussions started pointing out the nature of the dilemma.

There were three different root causes found in contrast to (Eliyahu M Goldratt 1990) who supports that there is only one root cause blocking system’s improvement. By stating clearing the CRCs the nature of the solution was becoming evident.

What was of a great value was that the participants become aware of how management was seeing the linen management function. They had never realized that the “linen system is not effectively managed” as UDE1 states.

Current Reality Tree Development (CRT) - Surgery Department case study

The “soft” perspective of the CRT

At the surgery department case study, the CRT revealed a problem that it was unnoticed. Low utilization seemed the problem that caused all the UDEs, although low utilization is a result itself. The CRT surfaced a problem that nobody had realized that existed, that the ORs were not fully occupied. When we tried to retrieve data from the system nobody knew that this measurement existed either. When the measurements were brought to light, everybody was claiming that the data was wrong. People were convinced that the ORs were fully occupied.

During the CRT construction, it was observed that people would dive very fast down the logic of the tree. They had difficulty surfacing and verbalizing their assumptions, and they felt threatened because blaming was the first thing that was coming to their minds. Sometimes the discussion went loud, so we had to interrupt the informal meeting or training. The most common problem observed was that people would omit several layers in their logic. In TOC terms, this phenomenon of “thinking ahead” creates a gap in logic, which is called long arrow (Cox III et al. 2012, p.75) - people were missing adding enough sufficiency to the logical statements.

The other tendency observed was that participants could not stay at the present, they were mentioning things that could happen in the future. Again, the role of the facilitator is vital to keep the process in balance.

The “hard” perspective of the CRT

The "critical root cause" of the CRT was revealed to be the low utilization of the ORs. People had never realized that the utilisation was so low. Even if the utilization was at 56% - people in the field had the impression that the OR's were fully utilized.

When we realized from the first visits, that there are no waiting lines – we were almost sure that ORs were operating at a lower capacity, but the magnitude was not known. In healthcare, inventory is patients (Kershaw 2000; Motwani et al. 1996b). Inventory or queues build before the bottleneck (Cox III & Schleier 2010). Since there is no queue or waiting lines before the OR, then the OR's is not the constraint. In reality, all surgeries were performed as planned during the day, but with overtime.

The researcher did the technical part of the CRT. The team could not follow the detail of the CRT, they could not stay focused. Again, asking the right questions is vital to building the CRT. Questions like “what is causing the effect?”, “why the effect is being generated?” The CRT uncovered a hidden and false assumption as illustrated in figure 5.3 - that the ORs are operating at maximum utilization. The CRT offered clarity in different circumstances. For example, management did not consider afternoon idle time as a waste. The afternoon shift would finish at 15.30 but when the last surgery would finish at 13.30 they did not consider the two hours a waste. They perceived it as an unavoidable phenomenon.

When the UDEs were formed for the surgery department, people started discussing solutions. The UDE statement “Operating expense is not minimum” geared people to start thinking about how to reduce operating expenses. The discussions focused on how to reduce overtime and how expensive running an operating room is. Soon the surgery department manager felt offended, and she became defensive explaining how hard the whole team was working and how hard they were trying. Suddenly this argument reached nowhere. Obviously, these discussions were going on and on for years. It was not long that the discussion moved towards blaming doctors for delaying etc.

CRT – Common Observations

CRT was the data analysis tool. It was used to analyze data and find the critical root cause of the two systems tested.

The project team was composed of different groups with different functions and roles. This is in line with (Ronen et al. 2012, chap.7) who highlights that building a CRT is a subjective process and participants from different system’s perspective are needed in order for the CRT to be effectively developed.

Senge supports that as important is to have a clear vision is also important to have a clear view of the current reality (Senge 2006). We were not able to locate a TOC tool to capture how the current reality works even though knowledge of the system is vital (Dettmer 2016b, p.4). The CRT is completely information driven. The better the knowledge of the system the better and the more accurate the CRT.

The CRT is the gap analysis tool which identifies why the current reality is different from the ideal state (Tabish & Syed 2015; Mabin et al. 1999), and it also validates the importance of the problem (Barnard 2016). The gap between the current and ideal state is recognized by (Senge 2006) as “creative tension” and is the one which keeps teams together and advances learning.

Both case studies produced similar results. In both case studies, the revealed CRC was hidden from people’s awareness. Both highlighted the fact that CRT is a time-consuming tool, requires discipline and guidance in order to produce a structure with tight logic. These are the reasons that caused the development of the fCRT by (Coman & Ronen 2009). People had the tendency to run into solutions than concentrate on problem analysis. Solutions were extrapolated in their minds, and soon negativity had again dominated their thinking. Long arrows were common in both case studies. Long arrows keep unclear how a cause and an effect are related (Cox III et al. 2012, p.75), as (Dettmer 2016a) observes, long arrows are not the most critical errors but the most common ones. Holding on assumptions and failing on entity existence reservation were two of the most usual weaknesses often observed to the development of both CRTs. People do not have the discipline of staying focused for too long.

In surgery, the CRT revealed the utilization issue, and suddenly the core of the discussion changed. Filling up the operating rooms was suddenly the focus of the discussions. This is the power of the current reality tree, showing a simple way through the chaotic systemic complexity as it is supported by (Dettmer 2016b).

CLRs and thinking in a structured way take a lot of effort. The tensed environment of healthcare makes it difficult for people to stay focused. Constant reminding needs to keep people on the analysis of the problem and avoid running into solutions.

The first attempt of building the CRT failed, the second attempt though which went through the GT development was much easier and more effective since the GT was showing the way.

The CRT worked well despite of the difficulties. The input data and the validation were done by the team. They perceived the whole construction of the tree as a very difficult task.

On the other hand, the CRT proved to be an effective tool in isolating what is important from the total complexity of the environment. At the end of the day, when the core problems were eliminated the environment improved.

6.2.4 Evaporating Cloud (EC)

The Current Reality Tree revealed the critical root cause, which was responsible for keeping the UDEs alive. The existence of the gap is the product of the root cause. The EC was used to analyze the reasons which keep the root cause active. The EC tool was used in both case studies.

Evaporating Cloud Development – linen case study

People at linen case study were enthusiastic about the simplicity of the EC. The EC gave the opportunity to the whole team to work on the problems, to analyze them and map the assumptions that hold the dilemmas in place; a very effective and simple tool to use.

The EC produced three injections. The first injection was to implement the Five Focusing Steps. In this way, we would obtain a clear view of the operating ability of the system. The Five Focusing Steps would validate (or not) the need for the overtimes. As already mentioned the Thinking Process (TP) tools are information driven. If we were not aware of the Five Focusing tools existence, then they would not be mentioned as an injection, and other solutions could probably be brought up. Despite that, the EC leads to a deep analysis of the problem.

The second injection was about reusing the destroyed linen. We did not know exactly how it would be done but we were provided with a direction of the solution.

The third injection was to implement the replenishment solution to the linen. This injection was adopted from the literature. The Replenishment solution is a readymade solution offered by the TOC. We had a production line (the laundry) and then we needed to distribute the goods (the linen) to the depots (the wards). There was no reason to construct any EC or any FRT.

Evaporating Cloud (EC) Development – Surgery Department case study

The project team at the surgery found the development of the EC to be simple and straightforward. Participants found that the speed of its development is a big advantage.

When the magnitude of the low utilization was revealed, it was evident that more work should be introduced in order to take advantage of the extra capacity. When suddenly many reservations started from everywhere (Nurses, doctors, etc) it was obvious that a conflict was holding everybody back. More data was needed to be collected in order to validate or invalidate certain assumptions.

During the discussions of how to bring more work into the hospital, the project team knew intuitively that this was not possible. They did not know how to support their worries, but intuitively they knew that they could not just add more work into the system. The EC focused the discussion to the systemic structure and not to the people's behavior. It helped to align thinking and see things differently.

The data collected from the field (from the ORs) showed that idle time is spread all over the duration of the first shift. This had misled people to believe that there is no extra capacity.

The EC managed to surface the assumptions and also generated the direction of the solution as shown in figure 5.5.

Evaporating Cloud (EC) – Common Observations

By design, the EC is a conflict resolution tool which is used effectively in different environments like projects (Gupta & Kerrick 2014) or purchasing, quality etc (Onursal et al. 2018).

The EC was the easiest tool to build. It is short, quick and very effective. It stimulated discussions and participants were able to express themselves freely, openly and focused on the specific problem. The EC proved to be a powerful analytic tool. The data was given by the participants who did not have any difficulty surfacing and naming their assumptions.

The view of problems as conflicts gives a different approach to the problem-solving procedure. It offers a deep understanding of a problem by representing it as a conflict or dilemma. A great understanding emerged through the creative discussions and through the systemic view since the requirements are usually coming from different systemic areas. It reveals what blocks progress.

The low utilization issue caused endless discussions and arguments. The EC managed to put the argument in a simple form, so people can discuss and move from the argument to the solution.

The effects of the conflicts on humans have been discussed in TOC literature. Findings are in line with (Mabin et al. 1999) who suggest that the EC avoids personal friction and all attention is on the problem. Senge recognizes the power of hidden assumptions and beliefs that are hidden away from our awareness and supports that they cause internal conflicts which Fritz calls them “structural conflicts” (Senge 2006, p.144).

Although (Eliyahu M Goldratt 1990) supports that the cause of problems is always systemic conflicts, results showed that lack of knowledge could also maintain a problem (Dettmer 1998). The lack of a replenishment methodology was keeping UDEs alive for years.

6.2.5 Future Reality Tree (FRT)

The EC showed the direction of the solution in both case studies. Using the injections revealed by the EC, the Future Reality Tree (FRT) was used in both case studies to investigate what it needs to be added, deleted or changed in order to make the injections effective.

Future Reality Tree Development (FRT) – linen case study

The main difficulties observed in developing the FRT were because people perceived the process as a kind of prediction of the future. Although the guidelines are clear and the connections progressing the FRT must obey to a tight logic - people used to fall in the trap of long arrows. Instead of pointing out just the next logical step - they were jumping layers of logic because they perceived the next step as self-understandable and self-explanatory. By placing the Desirable Effects (DE) at the top of the tree, the FRT was polarised towards them.

The resulting FRT highlighted different parts of the system. The DE came from the UDEs which were generated after comparing the current reality with the GT. As mentioned, when used, the structure of the GT affects the whole Thinking Process.

The Categories of Legitimate Reservations although simple in principle, they need the discipline to be implemented. It was a very time-consuming process to go through every logical connection. The working environment and the pressure of the moment did not create an environment motivating thinking and analyzing, only for acting and responding.

The NBR was also a very creative process as well but it did not manage to reveal all the negative effects. Scrutinizing the FRT and trying to identify what could go wrong, correcting it by changing entities into the FRT was a very constructive process. The FRT was erected by asking questions and plotting the answers. People paid much more attention to the question asked to them than the technicalities of building the trees. Soon they did not pay any attention to the technical structure of the trees. They considered them to be researcher's tools, not theirs. They could not follow the guidelines. The NBR was extremely efficient when the right questions were asked. It seems that people knew all the answers. In certain instances, there were more answers than one. Extensive discussions were leading to a solution synthesizing the different views. They needed a lot of coordination though because the discussion would lead to arguments and emotional tension.

Technically the FRT failed in different ways although no failure of the FRT has been reported in literature so far. It did not reveal that the system could become chaotic at start-up or that the replenishment solution would not last more than four months.

Future Reality Tree Development - Surgery Department case study

At the surgery department, one of the major obstacles was that many causes were falling outside of our sphere of influence. Everything had to do with the doctors or with the patients. Everything seemed outside of what we could do as a team.

People were again trying to predict the future (as in linen) – the team had a difficulty of concentrating in order to obey the CLR rules. The sufficiency thinking appeared to be much more challenging than the necessity thinking. Employees who were for a long time in the field had strong opinions and it was difficult for them to change their mind. On the other hand, the visualization of the future helped and inspired the people to think.

When challenging what could go wrong - people were very creative and they proved to be much more creative and motivated to spot problems than solutions.

Future Reality Tree – General Observations

The FRT failed in different areas. The FRT and the NBR process did not reveal that the system would become unstable at startup or that the replenishment solution would not last for more than four months. There were assumptions behind the arrows which were invalid, and they went unnoticed during the CLR testing. Strong, deep beliefs seem difficult to be challenged.

CLRs are of the ultimate importance to check the validity and surface the assumptions of every arrow. This makes the FRT a demanding thinking tool, and this is one of its difficulties.

Since the effectiveness of the FRT is only known during or after the implementation of the solution, the research findings show that the FRT development should continue throughout the implementation process and that it should be seen as a dynamic process than a static one. It should be constantly scrutinized.

Even though participants had the tendency to predict the future instead of moving into the future with tight logic, the communication process was greatly enhanced, a fact which is also observed by (Mabin 1999). In this tool pessimists, optimists and realists find room to express themselves.

We consider the FRT a very important tool, therefore a section 7.3 analyzing in depth the weaknesses of the FRT and what should be improved in order to make the FRT more effective has been devoted.

6.2.6 Logical Thinking Process Tools - Observations and lessons learned from both case studies

Research findings show that TOC is not simple. To use the TOC trees, a facilitator is needed with a deep knowledge of TOC. The healthcare environment is a very crowded environment with high priorities everywhere, and employees cannot focus on other things than their current moment. Guidance is essential.

The tools need to be developed after training on systems has been contacted. Training is necessary to explain the purpose of the change, convey that humans are not under research, but the system is. Jargon words and complicated terms are to be avoided. This is also observed by (CENTENARY 1998) who claim that TOC language and terms are not ingrained in our everyday language.

Aristotle once said that “the soul never thinks without a picture”. The graphical representation was a great help to the participants to understand the logic behind of the actions.

The research findings support that the use of the GT facilitates the improvement process. Although the vast body of literature recommends that the sequence of the thinking process tools should be initiated with the use of the CRT, we found that the GT is a much more effective way to start the thinking process. It motivates and creates a positive energy instead of seeing and discussing about problems. It was a catalyst to people’s resistance. Excessive time was needed to conclude and agree on the CSFs and on the NCs though. GT development is a very subjective process and literature doesn’t exist.

Building the GT and the FRT is a very subjective process. If something is missed or omitted in these two trees, then it will be missed from the final solution and implementation. It is crucial that a more systematic process is found to guide the implementation of the trees in addition to Dettmer's directions. Chapter 7 is devoted to the theoretical development of these two trees.

Below is a summary of combined recommendations made from both case studies and after distillation of this discussion section:

1. Training is a necessity for systemic and operational concepts.
2. Initiate the Logical Thinking process with the GT instead of CRT. The GT proved to be a very effective tool.
3. The goal statement must contain components from different dimensions of system's output.
4. GT and FRT development is a very subjective process. For this reason, chapter 7 is devoted to developing certain system attributes and guidelines. We propose that they are advised during the CSFs, NCs and DEs development.
5. CRT is the most difficult tool to build. fCRT is advised to be used, although it is not tested in this research. Guidelines for the fCRT can be found at (Coman & Ronen 2009) and at (Ronen et al. 2012).
6. It is recommended to create a "process mapping" of the system to be changed before building the CRT. A tool based on TOC philosophy needs to be developed.
7. FRT needs to be revised and challenged throughout the implementation. Assumptions embedded into the designed solution, may not be visible at the beginning but only after additional knowledge has been gained during the implementation. Development of the FRT should be seen as a dynamic process instead of a static one.
8. Desirable Effects shape the polarisation of the FRT. Attributes and concepts developed in Chapter 7 must be advised during the development of the FRT (like feedbacks etc).

6.3 Five Focusing Steps

We were not in a position to identify a research where both TOC components were blended as one. There are papers discussing the TOC components separately though like (Mabin & Davies 2003) which discusses LTPs and (Reid 2007) which discusses the implementation of the 5FS.

The Five Focusing Steps is one of the two main components of TOC (Spencer 1995). The Five Focusing Steps have been widely tested in TOC literature with incredible successful reported results (Mabin & Balderstone 2003). Despite the success though, published literature discussing the Five Focusing Steps in hospital's housekeeping function and in a surgery environment is limited (except (Sahraoui & Elarref 2014; Lubitsh et al. 2005) making the comparison of these research findings difficult with previous reported results.

6.3.1 Five Focusing Steps – Linen case study

This subsection discusses the findings of the implementation of the Five Focusing Steps at the linen case study. #

In order to identify the system's constraints as a first step of the TOC, the utilization of the resources is calculated (Grida & Zeid 2018).

Identify the constraint - linen

The process of identifying the constraint was greatly facilitated with the visualization of the flow. Since the "river" concept was easy to be conceptualized and since most of the flow was depended on physical resources, calculating the utilization with load analysis was selected as an "identifying" method. Identifying the constraint by calculating the utilisation of the resources in a healthcare environment is also used by (Grida & Zeid 2018), by (Villarreal et al. 2018) in load analysis in an emergency medical system, and in a study of a hospital capacity situation (Chan & Chan 2017; Grida & Zeid 2018).

At the beginning, the project team supported that the constraint is the section of the washing machines. Management was also convinced, and they had approved a budget of expanding the laundry area in order to add more washing machines in an effort to eliminate the overtime before this research.

The triangulation method was chosen in order to validate the results of the first step. The quantitative results did not support the views of the project team. The people working on the field were misled obviously by the fact that everybody was constantly busy. Everybody was overloaded with everything and people were complaining about having too much work to do. It could be observed that when there was no used linen before the washing machines, people would just walk to the other working station to help in folding, ironing, etc. A deeper and more detailed look into the data was needed to observe what was actually happening.

The data collected showed that the resources of the system could produce more (reference figure 4.10). The whole system was able to produce more, therefore, the constraint was at the consumption point. At first glance, the system indeed seemed to be very busy. This masked the real behavior of the system.

After the implementation of the TOC, the utilization figure of the linen management system was improved instantly by 15% (from 72% to 87%) because the available time of the constraint was reduced. The investment was canceled and the result of working only six days per week (including holidays) led to a saving of €40.000 per year. Important is, that management had a guide to judge if the operation was “costly” and they were in a position to understand the behavior of the system.

The above outcome shows that even if everybody seemed busy - this was not an indication of the system’s utilization status. At the same time, the inventory is not a clear and straightforward indication that there is a constraint as the literature suggests. The used linen would come to the laundry in bulks, so a lot of inventory could be seen in the laundry space. Careful observation was needed to really see how this inventory fluctuated and how the resources were used.

What is of great interest is that the real constraint behind the “river flow” concept is a policy one. The decision to work seven days per week had moved the constraint to the

market. Goldratt supports that usually physical constraints are because of policy constraints.

Exploit the constraint – linen

A major assumption of TOC was also challenged in this case study. TOC stands on the assumption that a system is expected to produce as much as possible, this is the reason that Throughput has the highest priority (Eliyahu M. Goldratt 1990). This case study proved otherwise as it was not required from the system to produce more than necessary. This is of high importance because if the system is not to produce more, then the priority of the measurements changes. Operating Expense then becomes of a higher priority than Throughput. Not all systems are made to produce more and grow.

This happened because the system was at the subordination part of a higher system. The higher system is the flow of patients. The flow of patients is the main flow of the hospital and the main flow which generates most of the Throughput for the hospital. The linen system is a supportive flow to the patient's flow.

Since operating expense had the highest priority, then there was no need for exploitation. According to our knowledge, this is the first work reporting that a constraint cannot be exploited.

Choose the constraint - linen

For the TOC implementation to continue, a candidate resource should be chosen that would become the future constraint. According to the figure 4.10, the candidate resource with the highest utilization was selected. This was the washing machines.

Recognition of the fact that a constraint can be chosen instead of only be identified is rarely found in the Five Focusing literature. (Pretorius 2014) mentions the need to choose and manage constraints in his study to enhance the Five Focusing Tools, (Cox III & Schleier 2010, p.180) supports the fact that choosing the constraint can be a strategic decision. The most known area “choosing” constraints is in DBR applications where a CCR is to be chosen – assuming that the market is the constraint (Dettmer & Schragenheim 2000).

Convert the chosen resource into a constraint - linen

After analyzing the situation with the project team, it was decided to transform the chosen resource into a bottleneck by increasing the demand on that resource. This was achieved by reducing the hours of its availability and by keeping the same flow through it. The obvious solution was to stop working on Sundays. By eliminating Sundays, the available hours of the week were reduced, forcing the resources to have the same output as before but in less time.

Stopping the laundry function on Sundays would be a loss of income for the personnel but a gain for the hospital which in turn would be beneficial for the employees. Losing their overtime hours were handled by the people in a rational manner. Keeping in mind the economic crisis in Cyprus their biggest concern was to keep their jobs.

The outcome of this step was to downsize the system, or right-size the system around the chosen constraint. According to our knowledge, this is the first time where downsizing is achieved with the use of TOC.

The fact that people were aware of the thinking process, made every step easier and people were more cooperative.

Subordinate everything to the constraint - linen

According to literature, exploitation follows the identification of the constraint (Tabish & Syed 2015; Gupta et al. 2013; Coman et al. 1995). The project team though decided to emphasize effectiveness over efficiency. In this case, study subordination preceded exploitation. This is an important finding because not concentrating on the effectiveness first could result in an efficient constraint with nothing to work on.

During the subordination the system became unstable. The wards were informed about the change. It was assumed that this change was an internal system's change and that the wards did not need to be involved. Nothing was changing for them after all. The service level was to be kept the same as before. Humans though proved to be unpredictable. Rumors were going through the whole clinic that we would stop working on Sundays to reduce operating expenses. This information that went out to everyone

lacked the explanation of all the other steps that we were taking. The half information was misleading.

This caused the supervisors of the wards to assume that the whole effort would fail and that the result would be that they would remain out of clean linen. Their belief guided their behavior to collect as much as clean linen as they could to protect their patients. They started ordering big amounts of linen. When they realized that their orders were not fulfilled, they thought that their belief was justified, and this fired back a stronger emotion and a verified assumption. This insecurity leads to a chaotic situation where the whole system went to instability. In order to stabilize a chaotic situation, you have to increase the inventory or increase the capacity of the system. We went with the first one as we were trying to get rid of the second. A deep explanation is discussed in section 7.3 where a proposition is made to overcome such situations.

After two weeks, the operation returned to normal levels. Trust to the system was re-established.

Subordination was fairly easy because of the straight-line configuration of the flow. The most difficult part was to subordinate people, change shifts, hours, rules, etc. Long discussions and explanations needed before every change.

Exploit the constraint - linen

The exploitation step is the management of the constraint (Cox III & Schleier 2010). It ensures that the constraint works at maximum efficiency and that there is no time wasted on the constraint. One hour lost on the constraint is one hour lost for the entire system (Tagaduan 2009). In this application, subordination preceded exploitation, so the constraint (the washing machines) was constantly buffered with a pile of linen to be washed.

Exploitation was constituted by all the activities to eliminate idle times on the constraint and force it to work as much as possible. People were very creative generating all possible ways to keep the washing machines running.

Elevate the constraint - linen

TOC literature supports that if the previous steps have not revealed enough capacity to elevate the constraint then more of the constraint must be acquired. At this step usually, expenditure is required.

In this specific case study though, elevation was not needed as it was not needed to elevate the whole system and increase Throughput. Since Throughput was not priority number one then this step was just skipped.

Do not allow Inertia to become the constraint - linen

This final step ensures the cycling nature and the momentum of the 5FS. It is the necessary step that keeps the term “continues improvement” alive.

In this case study, this step was also skipped because improvement was not desired – at least not an improvement in TOC terms.

6.3.2 Five Focusing Steps– Surgery Department case study

As mentioned before, we could not locate any published work describing a DBR application in the surgery department at the process level. This case study described the implementation of the DBR in a patient flow through a specific OR. Hints and tips of TOC design and execution in surgery can be found in (Cox III & Schleier 2010, chap.31) and in (Kimbrough et al. 2015). Other work describing the 5FS in surgery but not at the process level of the patient flow is (Sahraoui & Elarref 2014) where the study concentrated on surgery cancellations.

The 5FS were applied, in this research, on a specific OR as part of the DBR implementation, in order to manage and control the flow through a Capacity Constraint Resource (CCR) which was the doctor’s time. The aim was to streamline the flow through the CCR in order to accumulate the idle time in a single block of time in order to introduce more surgeries.

Identify the Constraint - surgery

In order to identify the constraint, the first attempt was to follow the same procedure as in linen case study and use loading analysis. The attempt was not successful. Resources do not have a standardized behavior - every job and every cycle time is different. There is much variability in patient's arrival time, the medical condition of every patient is different, the skills of the surgeons and of the nursing staff also varies, variance that is analyzed by (Cox III & Schleier 2010, p.913). Because of the variability, the load analysis could not be done as it was performed in linen. The complexity, variability and difficulty of quantitative measuring efficiencies in ORs is well documented by different authors such as (Soliman & Saurin 2017; Sufahani et al. 2012; Stanciu et al. 2010), and others.

The difficulty of identifying the capacities of resources motivated us to search for any available data existing in the hospital. We found a forgotten report at the ERP that the ORs were working at a 56% utilization. Everybody was surprised since they thought that they were working at full capacity. It was a common belief in the department that the operating rooms were 100% utilized. At the announcement of the 56% utilization people started defending themselves. They considered that the afternoon time is not a waste and that it should not be taken into consideration. It is not their fault that there are no more surgeries - pure silo mentality. We needed considerable effort to convince them that during the afternoon the ORs are active but idle. They claimed that they were cleaning and tidying the space, in an effort to defend themselves against the “demon” of free capacity. The fact that the constraint is at the market could be assumed in the absence of waiting lists. The numbers of the ERP were questioned, they did not believe that the extra capacity was 44% - they could not prove it, but they were not convinced.

During the second action research cycle and the second diagnosis step hard data was needed to support that ORs are underutilized. Seeking to identify the constraint, triangulation was used as a method. Quantitative data were searched to justify the qualitative. This data was validated by capturing data for three months from all the Operating Rooms. The aim was to measure idle times instead of resource capacities.

Low utilization meant that the constraint is in the market.

Exploit the Constraint Discussion - surgery

The first step of the 5FS revealed that the constraint was the market. The second step of the 5FS is the exploitation where the objective is to make the constraint work as much as possible. Even though the system was operating with overcapacity adding more work was not possible because of the intensive resistance of the team members. The data given by the system was questioned. It was not believed that the ORs were operating at only 56% utilization. Although exploitation is a straight forward process, it could not be applied. After analyzing data from three months it was concluded that the overcapacity was spread out during the day and it could not be utilized.

The EC showed that the solution to be implemented was to accumulate all idle time in a single chunk, so the system could take benefit of it. Only then exploitation could work. The way to go forward was to select a new constraint and streamline the flow on this newly chosen constraint. The management of the flow follows into the subordination area. Once more subordination would precede exploitation.

Choose the Constraint - surgery

Following the direction laid out by the FRT, a new constraint was to be found. Without hard data on hand, the constraint to be used should be chosen with a strategic mindset.

Subordination - Surgery

As mentioned subordination is the stage where all other resources are organized to feed the constraint with work. So, in order to subordinate all other functions, we needed to understand how time is managed throughout the day. The subordination was the implementation of the DBR as pointed out by (Dettmer & Schragenheim 2000). DBR implementation is discussed in section 5.9.

6.3.3 Five Focusing Steps – Observations and lessons learned from both case studies

The main approach was to test the 5FS as described in TOC literature. The guidelines are the same in all published articles without any deviation.

Identify the constraint

The first step is to “identify the constraint” – In both case studies, the constraint was at the consumption. Both systems had overcapacity, and in both case study, this overcapacity was masked. An explanation could be the Parkinson’s law – which claims that a given task expands to fill the time available (Parkinson & Osborn 1957, p.3; Cooper 2013) and multitasking (Schneider-Kamp 2002). Both phenomena are discussed widely in Critical Chain Project Management as one of the main reasons that projects delay, people have the tendency to fill the time available and look extremely busy (Lechler et al. 2005). In both case studies, the employees believed that their systems are fully occupied. At the linen case study, the overcapacity could not be identified easily from the first run because people were allowing a buffer of used linen to emerge and then they would start the cleaning process. A quantitative approach was needed. The load analysis revealed the overcapacity. Triangulation was a necessity.

At the surgery department, it was easier to assume that the system had overcapacity because of the absence of a waiting list. A waiting list before the ORs would identify the ORs as a constraint – but this was not the case. Since the OR is a single resource performing all activities, it was easier to observe idle times and suspect that there is overcapacity. Again through triangulation, data was collected from the field, we validated that the ORs had excess capacity.

Exploit the Constraint

Literature supports that exploitation follows the identification of the constraint. In both case studies, exploitation failed. In the first case study we did not want the system to produce more and in the second case study, even if we wanted to produce more, it was not possible.

Choose the constraint

Other internal constraints should be chosen in both case studies. At linen, since Throughput was not the measure with the highest priority, an internal resource was found in order to downsize the system. In OR doctor's time was chosen in order to organize work around that constraint and accumulate all idle time in a single chunk. A mind shift was needed though from the resource level to the process level to be able to "see" functions that the resources were producing.

Subordinate the constraint

The third step is the subordination step. In both case studies, the subordination step preceded the exploitation step. It was a very successful change. At the OR the subordination took place into the context of the DBR and managed to feed the constraint with patients. We believe that this is a big change in the 5FS domain. Through this research, it was shown that in both case studies, the actual constraint hiding behind of the visible constraints was the subordination philosophy. In linen, working on Sundays was creating excess capacity, and in ORs the rhythm that the patients were arriving at the ORs was causing multiple blocks of idle time, reducing the utilization. We interpret the phenomenon as follows: When the constraint is not fed with work controllably, and when the constraint is human, then the constraint (the human) will never show that it starves and that there is no work to do. Humans will generate more work, more multitasking, procrastination, longer duration of tasks, etc. This behavior blares reality and hides the actual constraints. There is nothing to elevate because idle times are not visible. When focus is placed first on the subordination, then the effort of understanding how the flow reaches the constraint becomes a priority. When we make sure that the flow is stream lined, then we elevate the constraint based on the rhythm of the flow. Humans will have meaningful work to do and still show busy. The fact that elevation is reported before subordination in literature, it is most probably because TOC was developed in a manufacturing environment, where physical resources do not really care about showing busy.

In both case studies, the real constraint was the policy of subordination.

Elevate the Constraint

The fourth step is the elevation step. At the linen system elevation was not needed since Throughput was not the first priority. Only the first three steps were enough. The next addition had to do with stabilization steps.

At the ORs, elevation was also not needed because the system had excess capacity. Elevation takes place when more capacity is required.

Avoid Inertia vs. Stabilisation

The cycling sequence was also not required for the linen system. The system was needed to be stabilized and standardized and work in a controlled matter. TOC manages only stabilization of flow, through the Buffer Management principles and the Drum Buffer Rope but it does not provide any guidelines of how to manage stability in the structure of a system.

People's acceptance

The 5FS were accepted easily by the employees. Resistance was not an issue because all attention was on the system's behavior. At the laundry, they were shocked though that they had to reduce hours instead of expanding the plant. They even had the drawings ready. Something had slipped their attention. They found everything so logical after the implementation. Management, on the other hand, was enthusiastic because they avoided the overtime based on a specific logic and method. They had never seen the linen as a system or as a flow before. They thought of applying the 5FS to the kitchen too.

Visualization of the flow makes the comprehension of the 5FS very digestible even for people who have no previous experience in operations management concepts. People loved participating because everything made a greater sense to them. They even accepted losing their overtime on Sundays because it was unavoidable. They supported all the solutions proposed, even the one which required for them to come earlier on Mondays.

Increasing the Throughput in a system is NOT always the goal - now we know that this assumption is not valid anymore. TOC can be used in systems which exist in the subordination of higher systems. From the moment that we realized that we had to manage a system which is not desired to produce more, we had to replace the 'identify the constraint' with 'choose the constraint'. This affected the sequence of the following steps as well. Since the system needed to be designed around the new constraint, the system needed to be redesigned. Subordination came before exploitation, and this was one of the biggest changes. The 5FS, therefore, became three. We had to replace the 'identify the constraint' with 'choose the constraint' and also delete the last two steps.

Contrary to the literature, at linen, the 5FS worked to "right" size the system instead of improving it. Even in this case though the assumption is that the system can grow and produce more of its goal units. The whole TOC concept is designed and evolved around this assumption. This research has proved that this is not always the case though. There are systems where growth is not their target. In this case, effort must be directed to maintain a system than growing it. In these types of systems, improvement must be seen in the light of standardization, stabilization and maintenance.

The 5FS is a simple logical approach to improvement. The understanding of flow through different system elements seems to be enough to ignite the improvement process. It is a logical, simple and effective way of going forward. Even if the 5FS did not work as stated in the literature, after amendments, they were very successful, and they brought results very fast.

Lessons learned regarding the 5FS can be summarised as:

1. The 5FS can improve healthcare sub-systems with different characteristics.
2. The 5FS is a straight forward method and can be applied by people who are not experts in TOC or in systemic concepts. The constraint is much easier to be conceptualized through the "river flow" concept.
3. Representing the system with flow units facilitates substantially the implementation of the 5FS. Resistance is less because the focus is on the system's attributes and not on human behaviors.
4. People have the tendency to look busy – masking the real constraint.
5. Cycle times of resources in surgery are not fixed.

6. Supporting the identification of the constraint with values and hard data, if possible, is a necessity.
7. The subordination policy was the reason behind of both constraints identified in both case studies. Look for the policy supporting the constraints existence.
8. Throughput is not always the measurement with the highest priority in systems. There are systems where Operating Expense has the highest priority. Growing is not the goal of all systems.
9. When maintenance is desired, then the last two steps of the 5FS are not applicable.
10. The 5FS can be implemented in sub-systems and in environments where Throughput is not a priority.
11. Research results from both case studies support that it is more efficient when subordination precedes exploitation – people in the field had the tendency to mask the real constraints by unconsciously looking busy.
12. In both case studies, TOC was implemented based on the constraint chosen instead of the identified constraint. Compare the identified constraint with the desired one.
13. TOC can be used for downsizing or rightsizing.
14. Use a pilot period before applying TOC solutions full scale.
15. Standardization and stabilization processes should be embedded into the system's design in order to stabilize the system after the change.

6.4 Drum Buffer Rope (DBR)

The DBR is a sub-product of the 5FS, and it is TOC's way to ensure that maximum flow exists through the system at all times. The drum is set at the first step of the Five Focusing Steps, the position of the buffers is set at the second step, and the Rope element is scheduled during the subordination step.

The DBR was implemented and tested in both case studies.

6.4.1 Drum Buffer Rope (DBR) - Linen

At the linen management system, improvement came through the implementation of the 5FS as explained in section 4.4. DBR was appeared to be an unavoidable outcome of the 5FS implementation.

As already mentioned, there are three steps to apply the DBR - 1. Make sure that the constraint is working efficiently and effectively 2. Determine the buffer sizes and 3. Design the rope schedule (Schrageheim & Ronen 1990). The 5FS methodology fulfilled the first step. The other two were emanating from the behavior of the system.

The Drum was selected to be the washing machines and the Buffer was the pile of the used linen before the washing machines located at the laundry area or at the wards. By not working on Sundays, the buffer was an unavoidable outcome. Since on Sundays, the laundry would not operate, but the bed linen would still be replaced, every Monday there was a big pile of used linen in front of the washing machines, that kept the constraint busy during the whole week.

The fact that the constraint could handle the load at maximum occupancy meant that the system had a safety net. The constraint was chosen based on 100% occupancy which is 152 beds, but the highest occupancy measured was not more than 90 beds because of a number of restrictions.

The Rope part did not work as in theory because used linen (release work into the system) is not a result of a human decision, the luck of human decision regarding the Rope function is also mentioned in ED at (Stratton & Knight 2010a). Work was released into the system as soon as it was generated. There was no need to set color zones and apply buffer management principles. The buffer size was automatically adjusted since it was the outcome of the flow adjusted by the washing machines and by the amount of used linen generated by the patients.

The system's structure determined how the system would behave. This is supported by (Senge 2006) who mentions that the system's structure is crucial to how a system behaves, (Meadows 2008, p.89) adds that behavior follows the structure in a system. In this case study, the flow had no choice but to follow the structure of the new design.

DBR principles were included in the design. The level of the inventory was a result of the system's design, not of a human decision. The users of the system did not need to take any decisions – just run the system by following clear instructions by aiming to keep 45 washing cycles every day. As long as the workers would follow the rules, then the DBR would be applied. The system seemed to have adopted deterministic characteristics, and deterministic systems have a given set behavior of its functions (Ackoff 1999).

6.4.2 Drum Buffer Rope (DBR) – Surgery Department

The improvement in surgery was a result of DBR's implementation. The implementation of the 5FS was not enough to improve the system because they do not specify how decisions are taken to coordinate the flow through that system. At DBR the resources (OR, professional groups, etc) were used only at the level that contributed to the organization's ability to achieve throughput (Rahman 1998).

Jointly with the project team, it was decided that as Drum (CRC) would be used the doctor's time and the Buffer is the safety time (7 mins) added to the patient's lead time. The rope is the signal for the next patient plus the schedule of everything to make sure that the patient arrives at the ORs on time (Kimbrough et al. 2015).

The DBR aimed to keep the CCR (Doctor's time) operating as much as possible in order to streamline the flow, finish earlier and accumulate all extra capacity in one chunk so it can be utilized with more surgeries.

The DBR became an obvious option when we decided to choose a constraint instead of identifying the constraint.

When the constraint is the consumption, then there is a variation of DBR developed which is simple and effective – it is called Simplified Drum Buffer Rope (S-DBR), and it is developed by (Dettmer & Schragenheim 2000).

The main obstacle to fully apply the DBR as in literature was that the Throughput of the constraint was not known. It varies depending on the patient, on the kind of the

surgery and on the surgeon. It is not possible to know exactly how long a surgery will last as in the case of a machine with fixed cycle times in manufacturing.

Another characteristic observed was that the OR has Job Shop's characteristics. One resource is doing almost everything. At the process level, all processes were executed on or in that resource. DBR in Job Shops is also under researched. The only articles found are (Russell & Fry 1997; Thürer et al. 2017; Gupta et al. 2002; Chakravorty 2001).

The Rope mechanism of the DBR in a theoretical implementation is triggered by the level of the buffer - in this research the trigger point was activated 34 minutes before the end of the surgery. The buffer was allocated as time before the constraint, as it is advised by (Eliyahu M. Goldratt 1990).

The whole DBR implementation worked very satisfactory. It was managed to streamline the flow and as a result all the idle time was accumulated in the afternoon. The result was that 11 hours were free in the afternoon to be taken advantage of.

Drum

The drum is a detailed schedule built for the constraint in order to protect its capacity (Riezebos et al. 2003). In the case of the surgery an exact drum schedule cannot exist from before as every surgery is different. There is a preliminary plan for the medical intervention and the operational part is there, to support medical decisions and instructions. Since the CCR was chosen to be doctor's time, then the doctor has full control over his time, decisions and methodology. Intervening into the surgeons' schedule is beyond the scope of this research.

At the surgery case study, the CCR was chosen to be doctor's time even though the real constraint was the consumption. The part of the literature discusses the concept of CCR as an internal constraint and assumes that the real constraint is the market is the Simplified DBR (S-DBR) studied by (Dettmer & Schragenheim 2000). The concept of the CCR actually exists only when the market is the constraint. In other cases, the DRUM is the real constraint of the system.

Buffer

DBR is clearly designed for manufacturing operations where goods can be stocked (Gupta & Boyd 2008). This stock or buffer provides safety to the constraint with time. This is the reason that (Goldratt & Fox 1986, p.104) suggests that a time buffer is actually used to protect the constraint. Then that time buffer is connected with a mechanism (rope) to the release of new work into the system. In this case study, the time buffer was based on an estimation of the surgeon. The triggering system was activated during the operation of the constraint itself. That triggering system was communicated to the wards, and the process of transporting the patient to the ward was initiated. The buffer time existed to absorb any variations coming from the non-constraints (Duclos & Spencer 1995).

Rope – The Schedule

The rope schedule is the lead time to the constraint (Schragenheim & Ronen 1991). Since the constraint is not working constantly - the shorter the rope schedule, the shorter the lead time and the faster the flow through the system. DBR for services should focus on the rope as well.

(Goldratt & Fox 1986, p.110) mentions four conditions that complicate scheduling

1. The first is when the time between the CCR and the completion of the product varies. When this is the case, then the priorities on the CCR's schedule may change.
2. The second is when a CCR feeds an another CCR. CCR's in series complicate scheduling as all CCR's should always have work to work on.
3. The third is when there is a setup time on the CCR when switching from one product to another. In this case, setup time should be taken into consideration.
4. The fourth case is when the CCR produces more than one parts for the same product.

In this research, there is a fifth as well. The time to treat every patient (product) is different and cannot be forecasted with certainty, cycle times are not stable.

In many cases, DBR schedules are computerized, especially when the combinations of the resources before the CCR is complicated. In this case, the situation is complicated, but it can be estimated, measured and programmed. In the case of the OR though, we have much fewer resources to be synchronized before the CCR, but the behavior of those resources cannot be predicted.

6.4.3 Drum Buffer Rope – Observations and lessons learned from both case studies

At the linen system, the DBR was embedded into the design of the system. The system by itself was accumulating the inventory before the drum, the rope could not be adjusted so categorising the stock in buffer zones had no meaning as no decisions were taken. It could be a topic for future research, how to build systems where rope is embedded into the design. It could be even more interesting for social systems.

At the OR the Drum Buffer Rope worked very well on the process level. Because of the short lead times and because of the nature of the buffer which it was time – categorization of the buffer was not performed with three zones as discussed in literature but only with two. Before and after the thirty-four minutes trigger. Lead time from release to the CCR was very low so monitoring the buffer penetration was not very effective.

In both cases, DBR worked well in a straightforward way. At the OR the results were immediate.

Dr. James Holt at the Washington State University, in EM 530 TOC course supports that Multi-Project environment shares the same variability as the flow in a hospital environment, and the Multi-Project Solution is basically DBR for highly variable product flow. (Stratton & Knight 2010b) discusses the differences and similarities between CCPM and DBR in healthcare. They show how time buffers, which is a common mechanism for CCPM and DBR can improve flow in healthcare. They claim that DBR stands on the assumption that the “touch time” or “processing time” is just a fraction of the overall lead time whereas in CCPM the “processing time” occupies a considerable amount of the total lead time, and this the reason that in CCPM the time buffer is separated from the process time. (Bacelar-Silva & Rodrigues 2012) confirms

(Stratton & Knight 2010b) view, about time buffer management effectiveness, through a literature review of buffer management in healthcare. (Cox III & Schleier 2010, chap.31) believes that in healthcare CCPM is better than the DBR. (Umble & Umble 2006; Mabin et al. 1999) report successful implementations of DBR in healthcare.

Alex Knight and QFI who are recognized as experts by the TOC community applying TOC into healthcare environments, they use buffer management and CCPM concepts to manage the flow of the patient through the whole system of the hospital. They describe their method in (Stratton & Knight 2010b) and (Knight 2011).

We have observed that the more the “river flows”, the more the DBR and CCPM become one.

Healthcare environment showed to be more of a process-oriented environment where many processes are performed by one resource than different resources feeding one another in a sequential pattern. The operating room was found to have more of the characteristics of a job shop, where one resource performs multiple processes than of a flow shop, where several jobs are processed through multiple workstations (Framinan 2005). Literature discussing DBR at a job shop environment is very limited, and this is also one of the major contributions of this research. Only three articles published (Thürer et al. 2017; Gupta et al. 2002) and (Chakravorty 2001) were found to discuss TOC in a job shop environment.

The research results support that DBR is successful in the operating room implementation because the processes seemed to be interdependent. One process must finish for the next to start. This is in accordance with (Breen et al. 2002) who supports that TOC views organizations as interdependent events.

The results of this thesis enhance the findings from other works where Five Focusing Steps and Drum Buffer Rope has worked well in other parts of the healthcare system such as in Emergency Department (Stratton & Knight 2010b; Sabbadini et al. 2014), and radiotherapy scheduling (Mohammadi & Eneyo 2012).

The outcome of this research supports the view of (Siha 1999a) who supports that DBR can be used in services. (Motwani et al. 1996b) reports a case where DBR was used in

a hospital setting - it is even mentioned that a DBR type solution was used at the ORs to increase the utilization rates.

The implementation in both case studies has shown that DBR can be very effective in the management of the flow in both environments. A summary of the observations and lessons learned regarding the Drum Buffer Rope methodology can be found below:

1. The DBR is effective, and it can have quick results at the housekeeping function and at the operating room environment.
2. No massive data is needed.
3. It is far more effective when the rope can be automated, and the DBR concept is embedded into the system's structure.
4. In the absence of software, red buffer zones could not be defined.
5. At surgery, since the rope was very short, only a trigger point in the buffer was very efficient.
6. The OR is similar to a job shop environment. Although (Schragenheim & Ronen 1990) proposes that DBR can be improved by improving exploitation or/and by improving subordination, we find that the flow can be improved by shortening the time between the constraint to constraint
7. DBR was successful in the OR even if the cycle times of resources in surgery are not fixed.

6.5 Replenishment Solution

The replenishment solution is designed by TOC to ensure availability at the consumption point of a supply chain. It was interesting that such a solution was applied to manage the linen flow in a hospital.

The core of the replenishment solution is the location and the management of the buffers.. According to the replenishment philosophy, the stock is held at a high point in the supply chain, at the point where flow is more stable. At this point, variation which comes from the consumption points cancels each other out.

The success of the replenishment was because the replenishment time was shifted by 4 hours into the afternoon and the replenishment was based not on empirical data but on the occupancy report. The linen continued to be replenished daily and the replenishment time was only 30 minutes maximum. The main problem was the huge variation at the consumption points. TOC seeks to manage this variation and not to eliminate it.

The dedicated linen which was used only by a specific consumption point was stored at the consumption point. Linen which was common such as sheets, pillows, towels, etc were stored at the laundry area, clean and folded. When there was a need, then the replenishment would need to take place directly from the laundry area. In the period of the four months, no need was required to replenishment outside of the replenishment schedule. Extra requirements were covered by the safety stock. The main idea that we followed is that we replenished what would be consumed, not on predictability and forecast but based on a plan indicated by the occupancy report. The speed of the replenishment and the frequency of the replenishment were so high that covered the need for the buffer zones.

Why the theory did not work as it should.

The main difficulty was to set the buffers.

Replenishment solution replenishes what has been consumed. The assumption is that what has been consumed can be measured or counted. Buffer Management decides what to replenish by monitoring the penetration into the buffers. This could not be done in our case because we could not set the buffers. There was not enough space in the wards' cabinets to allow us storage of linen in a way that they could be measured.

Replenishment works best when common “flow units” are consumed by many different consumption points. Many linens were dedicated for specific use at specific wards, for example, the pediatric had colorful small size sheets and children clothes, which could not be used anywhere else the same as in surgery where special dedicated green linen was needed for surgery purposes. Since their use was specific, there was no reason for holding them on stock at the laundry, so they were sent directly to their specific use space. What was kept in stock though was common linen-like pillows, sheets, towels, etc.

The best next solution was to replenish what would be consumed. In order to avoid forecasting and predicting, we delayed the replenishment time by 4 hours, where we had a much better indication of the possible consumption of the next day. The “better” indication was provided through the clinic’s occupancy report. Based on that report the replenishment quantity of the common use linen was calculated.

6.5.1 Replenishment – Observations and lessons learned from the linen case study

The replenishment solution was tested only at the linen management system. Although the solution is designed for supply chains distributing manufacturing products, it worked well and fast. The key to its success was the fast replenishment time. By keeping common linen at the laundry area, the fluctuation of the consumption was much smoother than the individual consumption points. Key observations based on the case study are:

1. A pilot plan is needed before going to full implementation.
2. Replenishment solution is possible when one item (e.g., white sheets) can be used by several points (e.g., ward 1, emergency department, etc). In cases, where dedicated items (e.g., children robes) are to be used by one consumption point then the specific item must be stored at that specific consumption point and not on a higher point in the supply chain.
3. The implementation of the replenishment solution revealed how important is to incorporate stabilization and standardization concepts into the solution.
4. It was important for the supervisor to know the logic of the replenishment function in order to maintain it and improve it. It was not necessary though for all the people to know the theory that supported the practice. The rules were very simple – just replenish what will be consumed, through the occupancy report.

6.6 Chapter Summary

This chapter outlined the achievements and contributions by discussing the findings of chapter four and chapter five. The discussion took place around four themes. The logical thinking process tools, the Five Focusing Steps, the Drum Buffer Rope, and the Replenishment solution. Since the research objective is to add to managerial knowledge, then the chapter discussed how TOC components changed and why in order to be custom made to the specific case studies in the healthcare contexts.

The research found that TOC was able to improve both systems even though they are very different from each other. TOC also managed to guide the participants through the change process, motivate them and encourage them to move towards the GTs ideal representations.

Chapter 7

Theoretical and Practical Recommendations

7.1 Introduction to the chapter

This chapter is a continuation of the research discussion of chapter six.

The chapter is addressing mainly sub research question four, how the difficulties of TOC implementation can be overcome. Additionally, it adds to the research purpose by generating knowledge and by enriching TOC literature.

Chapter 6 discussed the findings of the two case studies through the lenses of the TOC components and solutions (Logical Thinking Process, Five Focusing Steps, Drum Buffer Rope, and the Replenishment Solution). This chapter summarises the theoretical changes, discussed in chapter six, relative to the literature, as an outcome of this research. Additionally, the chapter deepens in the theoretical developments of the GT and FRT. Finally, a managerial template concludes almost all the findings of this Thesis.

This study proposes a number of changes. The Chapter aims to show in a clear way what additions and changes can be done to the existing literature as an output of this research.

Layout of the chapter

There are two main sections of this chapter excluding the introduction:

1. Theoretical Changes: The discussion of chapter six is displayed from a theoretical perspective and,
2. Theoretical and practical recommendations based on the findings and discussions.

Layout of the Theoretical Changes

We summarise and discuss the findings from the perspective of three themes. Since the discussion chapter must discuss meanings from a synthesis of the findings, we have chosen to discuss categorization of findings instead of the sequence of the action steps. Therefore, we discuss the overall findings in three themes or through three lenses:

TOC themes:

- a. Change Sequence
- b. Logical thinking process
- c. Five Focusing Steps

Layout of the recommendations and developments of the study

Finally, recommendations are made which are extracted from the discussion chapter in an effort to contribute to theoretical development of the TOC and to the practical development as well. A deep investigation in literature and a blend of concepts of different theoretical frameworks constitute our proposition. Therefore, the last three subsections discuss in great detail:

1. GT theoretical development
2. FRT theoretical development
3. Practical development – managerial template

Below theoretical recommendations and developments, sections will help to evaluate the findings of chapter four, chapter five and the discussions of chapter 6 in an effort to finalize and conclude the managerial development of this thesis which is a management system's template that can be used by different layers of managers. The level of detail of the template is kept at a level where it can be used in different systems.

7.2 Theoretical Recommendations

The answer to sub research question four begins with the evaluation of the meanings and of the findings discussed in chapter six, and it recommends theoretical changes based on the findings of this research. We evaluate the research outcomes by comparing the original theory described and proposed in the literature to the resulting one which is the output of this research work.

7.2.1 Change Sequence

This subsection evaluates the research outcomes through the perspective of the change framework. TOC approaches change by answering the three change questions (Eliyahu M Goldratt 1990). The change questions seek to progress change by overcoming obstacles which are stated by the layers of resistance (Goldratt-Ashlag 2010).

Table 7.1 illustrates the relationship between the improvement questions, their purpose and the layers of resistance. A detailed description of the TOC change approach can be found in section 1.6.

Table 7. 1: The Change Questions and the Layers of Resistance

Three Improvement questions (Eliyahu M Goldratt 1990, p.8)	Purpose of the improvement questions (Hutchin 2001, p.142)	Layers of Resistance to overcome by the improvement questions (Goldratt-Ashlag 2010)
What to Change?	1. Consensus on the problem.	0. There is no problem 1. Disagreeing on the problem 2. The problem is out of my control
What to Change to?	2. Consensus on the direction of the solution 3. Consensus on the benefits of the solution 4. Dealing with all possible reservations people might have about the proposal.	3. Disagreeing on the direction of a solution 4. Disagreeing on the details of the solution. 5. Yes, but... we can't implement the solution
How to cause the change?	5. Consensus regarding what to do and how to make it happen.	6. Yes, but... we can't implement the solution. 7. Disagreement on the details of the implementation 8. You know the solution holds risks 9. Social and psychological barriers

TOC’s logical thinking process tools are used in order to overcome the layers of resistance. Table 7.2 displays the relationship between the change questions and the TOC tools as given by literature.

Table 7. 2: The Change Questions and the Thinking Process Tools

Three Improvement questions (Eliyahu M Goldratt 1990, p.8)	Thinking Process Tools (Gupta et al. 2004)	Layers of Resistance to overcome by the improvement questions (Goldratt-Ashlag 2010)
What to Change?	Current Reality Tree (CRT)	0 There is no problem 1 Disagreeing on the problem 2 The problem is out of my control
What to Change to?	EC (EC) Future Reality Tree (FRT) Negative Branch Reservation (NBR)	3 Disagreeing on the direction of a solution 4 Disagreeing on the details of the solution. 5 Yes, but... we can't implement the solution
How to cause the change?	Prerequisite Tree (PrT) Transition Tree (TrT)	6 Yes, but... we cannot implement the solution. 7 Disagreement on the details of the implementation 8 You know the solution holds risks 9 Social and psychological barriers

Above tables are widely discussed and accepted in the literature (Eliyahu M Goldratt 1990; Hutchin 2001; Goldratt-Ashlag 2010; Patrick 2001) and many others.

Based on the understanding of the previous tables, the attempt was to start with the Current Reality Tree (CRT) in order to execute the first phase of the action research, the Diagnose phase. The first action step developing the CRT failed because we met layer nine as the first layer of table 7.2. People become negative, they felt threatened, and they did not want to cooperate. This psychological stress blended with the lack of knowledge of the methodology and the tools made it impossible to proceed with the change and generally with the change. This confirms the observation that resistance to change is one of the main reasons which block change (Mabin et al. 2001). To overcome this situation, we inserted one more question before “what to change” as shown in table 7.3. The first question added is the “why change”. This finding is in line only with (Barnard 2016; Tabish & Syed 2015; Mabin et al. 1999; Sommer & Mabin 2016), the rest of the TOC literature begins the change sequence with the “what to change”.

The “why to change question” is the answer given by the “Goal Tree”. Additionally, the soft part of the initiation is managed by the training session which offers much more than knowledge and skills. Layer nine is managed basically through the training session which included five concepts:

1. Maintenance vs. improvement concepts.
2. Improvement concept and change questions.
3. System concepts.
4. Flow and constraint concepts.
5. TOC – Flow management.

The research findings also coined the importance of stabilization. This is the reason that a fifth question was added - “how to make the change stick”. This finding is in agreement with other managerial methodologies as (Kaizen 1986) which recognizes that stability is a vital step not only to maintenance but also to the improvement cycle. The recognition of stability of the structure of systems in TOC literature is not addressed in detail. The replenishment solution experiment showed how important is stability in systems. The fifth question is in line with the authors of (Cox III et al. 2012, p.25; Sommer & Mabin 2016; Lepore & Cohen 1999). Section 7.3 discusses stability in detail about the FRT theoretical development.

As an outcome of the above, the following addition/changes were made to table 7.1 and table 7.2, shaping table 7.3.

1. The “why change” question is added
2. Layer nine is placed before the other layers
3. The training process becomes a part of the thinking process tools to manage layer nine.
4. A fifth question “How to make the change stick?” is added
5. Standardization and stabilization concepts must be designed into the FRT development to answer the fifth question.

Table 7. 3: The Change Sequence - Output of this research work

Five Change questions as output of this research work	Thinking Process Tools (Gupta et al. 2004)	Layers of Resistance to overcome by the improvement questions (Goldratt-Ashlag 2010)
Why Change	Training GT	Overcome Social and psychological barriers
What to Change?	Current Reality Tree (CRT)	0 There is no problem 1 Disagreeing on the problem 2 The problem is out of my control
What to Change to?	EC (EC) Future Reality Tree (FRT) Negative Branch Reservation (NBR)	3 Disagreeing on the direction of a solution 4 Disagreeing on the details of the solution. 5 Yes, but... we cannot implement the solution
How to cause the change?	Prerequisite Tree (PrT) Transition Tree (TrT)	6 Yes, but... we cannot implement the solution. 7 Disagreement on the details of the implementation 8 You know the solution holds risks
How to make the change stick?	Standardization and stabilization concepts must be designed into the FRT structure.	

7.2.2 Logical Thinking Process

The logical thinking process tools are discussed in detail in TOC literature. There is also research examining their effectiveness and their validity (Mabin et al. 2001). All literature found has shown positive results (Mabin & Balderstone 2003).

In this research, we followed the development provided by Dettmer with the addition of the GT. The prerequisite tree was not researched though as it was not needed. The research findings support that initiating the logical thinking process sequence from the GT is a very effective way with tremendously positive results on people's resistance levels. The only research found on the GT is by the Wellington University. The GT is not used in any other TOC work. Other authors have been used the I/O map which Dettmer renamed it to Goal Tree.

Research findings have shaped table 7.4. Certain additions should be made in order to implement the suit of the Logical Thinking Process Tools. Knowledge of systems and

flow concepts must be known to the TP tools practitioner before applying the tools. Even though literature begins the process with the CRT, we strongly believe that beginning with the GT is much more effective, the UDEs are systemic statements, and the CRT is easier to build. After the development of the GT, current system's state should be mapped and not only the negative aspect of the reality. Further developments are needed to map a system from a constraint point of view.

Based on the research results, we also propose that a stabilization step should be added. Section 7.3 describes in detail how stabilization characteristics should be considered at the FRT development stage, but we also support that stabilization should be considered as an additional step with focus, audits and stability measurements.

The tools tested in this research are shown below in contrast to the initial suite of tools offered by Goldratt at (Eliyahu M Goldratt 1990).

Table 7. 4: Logical thinking Process – Output of this research work

Thinking Process Tools as developed by (Eliyahu M Goldratt 1990)	Changes to initial Theory as an output of the present work	Comments
	Training	When other people are involved, then training is a necessity. We propose that the training should discuss the concepts of improvement/maintenance, systems, flows, TOC TP Tools.
	Goal Tree (GT)	Section 7.3 builds on Dettmer’s guidelines and proposes a theoretical development based on the findings of this research work.
	Process mapping	TOC does not offer any tool to capture how a system works. CRT captures only the negative aspects of the system. Process mapping was used for this research based on Function Block Diagrams, but we believe that a more dedicated tool is needed able to capture TOC system’s characteristics.
CRT	Current Reality Tree/ focused Current Reality Tree (CRT/fCRT)	The CRT was used as in literature. We propose though that fCRT should be used as explained in (Coman & Ronen 2009).
EC	Evaporating Cloud (EC)	The EC was used as in literature (Dettmer 2016b).
FRT/NBR	Future Reality Tree and Negative Branch Reservation (FRT/NBR)	Section 7.3 builds on Dettmer’s guidelines and proposes a theoretical development based on the findings of this research work.
PrT	Prerequisite Tree (PrT)	PrT was not implemented in this research. Implementation was not complicated in order to demand the use of the PrT. Implementation was driven by the FRT.
TrT	-	TrT is not recommended any more by Dettmer. He considers the tool unnecessary detailed and he has included TrT concepts into the PrT structure.
	Stabilisation / Standardisation	TOC offers solutions to stabilise the flow through a system, but it doesn’t include system’s structure stability methods. This research findings support that stabilisation and standardisation attributes should be included into system’s design. Section 7.3 proposes how TOC should take such attributes into consideration.

7.2.3 Five Focusing Steps

Literature discusses extensively the 5FS, and there are no variations found through the years. The 5FS presented by literature are of the same initial form given by Goldratt (Eliyahu M Goldratt 1990), and they have been remained the same since then.

1. Identify the System's Constraint
2. Decide How to Exploit the System's Constraints
3. Subordinate Everything Else to the Above Decision
4. Elevate the System's Constraints
5. If the Previous Steps a constraint has been broken, Go back to step 1.

The above Five Focusing Steps have been applied in this research on the above sequence, but research findings suggest that certain aspects of them should change to make them successful in a healthcare environment. Below steps are illustrated by figure 7.1

1. **Identify the System's Constraint.** This step is applied to both case studies, and it was found (in both case studies) that the constraint was the consumption. Initially, the people from the field (in both case studies) were believing that their systems did not have enough capacity. This is in line with (Dettmer & Schragenheim 2000) who believe that the most usual constraint of systems is found in the market.

1a. Decide on Throughput - Research findings show that before applying the "Identify the System's Constraint" a decision should be made if T is the highest priority or not. The linen case study showed that T was not the highest priority and a constraint should be chosen instead of identified. At the surgery department, T was the highest priority, so the constraint should be identified and then choose the internal constraint or the Capacitive Constrained Resource (CRC).

1b. Choose the Constraint – In both case studies, TOC was not implemented around the identified constraint but around the chosen constraint. At the linen management function, the system was downsized around the constraint. At the surgery department, the constraint identified could not be exploited because the subordination was prohibiting exploitation. Both implementations were

successful, so choosing the constraint should be clearly considered. In both case studies, an internal constraint should be chosen in order to improve the system. In the linen case study an internal constraint was chosen in order to down size the system around it, and at the Operating Room, an internal constraint was chosen as a CCR in order to manage the flow by applying the DBR solution. Exploitation then had to be repeated.

2. **Decide How to Exploit the System's Constraints.** In both case studies, the constraint could not be exploited. In the linen case study, exploitation was not wished because the system was a supportive system and at the Operating Room exploitation was not possible until systems subordination philosophy was changed.
3. **Subordinate Everything Else to the Above Decision.** In both case studies, subordination took place on the chosen constraint.

3a. Subordination comes before exploitation. As discussed in the previous step, subordination in both cases come before exploitation. In both case studies, this change worked very satisfactorily. We support that this step must come before exploitation. The research findings of the surgery department showed that if exploitation happens and for any reason, subordination cannot support the extra demand, then the results could be dangerous for the whole system, eg. If the constraint would have been exploited and more surgeries would come into the system, and the flow was not synchronized, then the system could fall into a chaotic state. This could also be the case (according to the researcher's experience) for a manufacturing company, where more orders are coming into the system, but the subsystems are not synchronized to a satisfactory level – the system can also go to instability and eventually to a chaotic state. Efficient systems should be in place to support solutions.

3b. Decide How to Exploit the System's Constraints. This step was to be repeated since a new constraint was chosen. In both case studies though it happened after the subordination step (in literature it always comes before subordination). The logic was that since it is not a constraint yet, there is nothing to exploit. In both case studies, the project teams claimed that it is more effective to provide the constraint with work – make it a constraint and exploit it afterward.

4. **Elevate the System's Constraints.** This step was not applied for different reasons. At the linen case study, elevation was not needed. Throughput was not the first priority for the overall hospital's system. The purpose of the system is not to grow but to provide a stable service and support. At the operating theatres, the step was not tested because of time limitations. We managed though to provide the system with the requirement of elevation. We managed in the available time to eliminate the obstacle prohibiting elevation. This step is still valid as it is developed but for systems which are made to grow and for a system where Throughput has the highest priority.
5. **If the Previous Steps a constraint has been broken, Go back to step 1.** This step was not implemented since the previous step was not implemented. We strongly believe that the same rules of the previous step are valid for this as well. It can be applied only where growth is required, and Throughput has the highest priority.

5a. Stabilization and Standardisation. In the first case study, the findings support the need for stabilization and standardization. The structural stabilization of systems is not supported by TOC literature. Because of the linen case study results, we believe that stability and standardization are important concepts to include in the system's design. We support that this final step is a crucial addition to the focusing steps especially for systems which do not have Throughput as the number one priority.

Research findings have shaped the 5FS as in figure 7.1. Below figure 7.1 shows the theoretical changes needed at the 5FS to make TOC effective at the operational environment of the private hospital.

Figure 7. 1: The Five Focusing Steps – Output of this research work

**Five Focusing Steps
as in Literature**
(Eliyahu M Goldratt 1990)

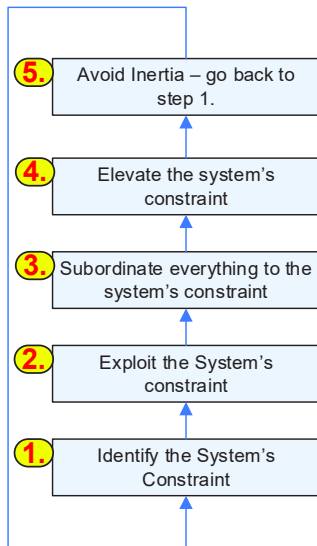

**Five Focusing Steps
as an output of this
research work**

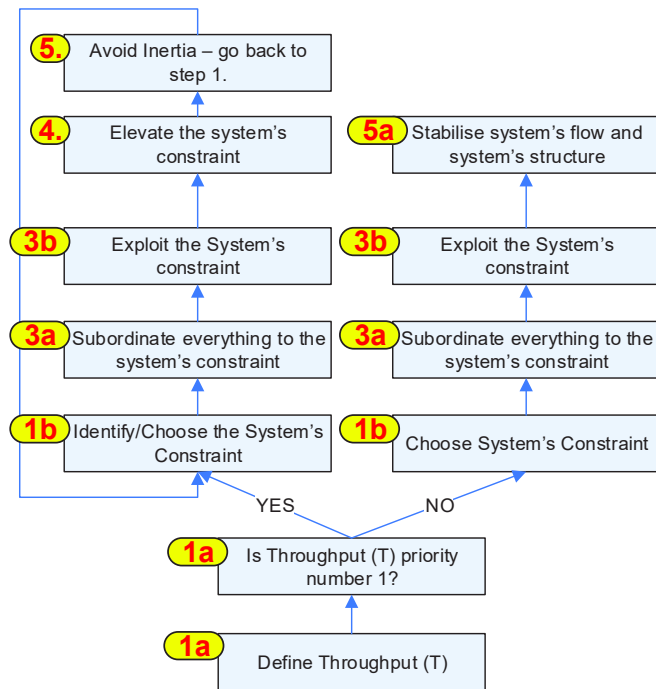

7.3 Theoretical Development

This section synthesizes the findings of chapter 4 and 5 with a deep literature review in a quest of developing design criteria for the Goal Tree and the Future Reality Tree. This initiative is to help Tree users identify CSFs, NCs and Desirable Effects. Below study is not bounded into a healthcare environment.

7.3.1 Goal Tree (GT) – Theoretical development

Goal Tree and Requirements Loop

The research findings during the GT development outlined the need for a structured way of determining the CSFs and the NCs. In both case studies, it was observed that concluding the CSFs and the NCs is a subjective process, and people had great difficulties thinking of the system in functional terms.

This section aims to build and to expand the theoretical boundaries of the GT as developed by (Dettmer 2016b), in an effort to define a set of guidelines of building CSFs and NCs.

Goal Tree – Need for improvement

During this research – the GT was practiced twice, in the housekeeping and at the surgery department. In both case studies, the GT was developed during the training phase by the project team and then validated by the project team and by management.

The main difficulty of the participants was to conceptualize domains from different functional areas, “needs” and system attributes in order to identify and verbalize the CSFs and then the NCs. It was observed that people were identifying the CSFs based on their own individual perspective, their hierarchical position or their specialty.

Healthcare is a very complicated environment with many different entities synergizing to achieve a desirable result. The systemic nature of the processes and of the methodology demand that different parts of the system are evaluated. Because of the complexity, there is always the danger that important CSFs are not identified and vital UDEs are missed.

The GT has enormous importance because all the effectiveness of the Thinking Process Tools depends on the GT's structure. We have observed that the guidelines proposed by Dettmer are clear and straightforward for people who have a system's thinking developed or a certain degree of exposure to systemic concepts.

Why Systems Engineering (SE)

Recognizing the importance of the identification of the CSFs and those of NCs, we looked elsewhere in the system's theoretical framework and literature trying to identify a more structured way to identify the CSFs on the top of the one proposed by Dettmer. TOC welcomes other philosophies, and other approaches, (Mabin & Davies 2003) for example supports that TOC should be considered with other conceptual systemic frameworks such as systems dynamics, causal loop diagramming soft systems methodologies and viable systems methodology.

After a detailed examination of the literature, we observed that the structure of the GT is similar to the Systems Engineering process structure.

System Engineering (SE) principles can be applied in Health care systems (Wheeler et al. 2016; Erasmus et al. 2012; Blanchard & Fabrycky 2011b, p.47) as well as in other domains such as financial service systems, educational systems, waste disposal system, etc (Blanchard 2008b).

Systems Engineering Process

As shown in below figure 7.2, the Systems Engineering Process begins with the Requirement Analysis, which is a process of describing a system into functional terms (Higgins 1966, p.4.4) in the form of requirements. The second step is the Functional Analysis and Allocation where the different functions are further decomposed, and the requirements developed at the Requirement Analysis level are assigned to the different functions of the Functional analysis step. Finally, the Design synthesis phase is where the physical resources or actual processes are designed in order to perform the functions of the functional analysis step which in turn will satisfy the functional requirements. At the same time, the SE discipline gives a very high emphasis on the maintenance and logistics process (Higgins 1966, p.4.19; Blanchard & Fabrycky 2011b).

Figure 7. 2: The Systems Engineering Process

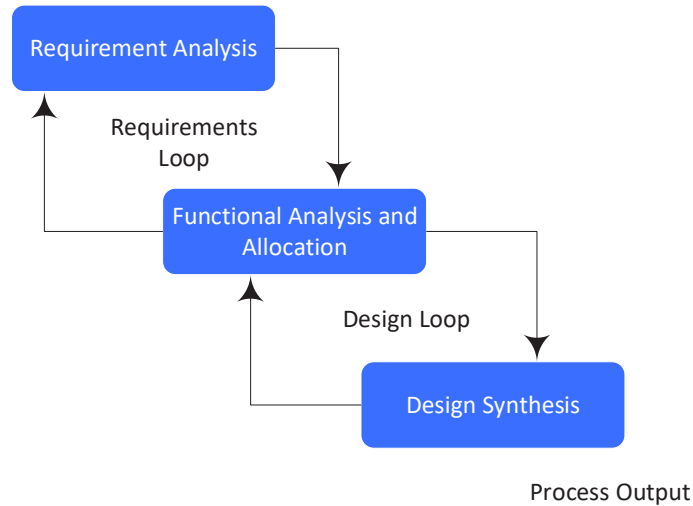

Systems Engineering is a well-established discipline, very well researched and we believe that the requested guidelines can be developed from the SE domain to strengthen the GT development.

How the Goal Tree and Systems Engineering can be synthesized//similarities.

As discussed, the fundamental systems engineering process activities are three, requirement analysis, functional analysis and allocation and design synthesis (Clark 2011, p.31). We strongly believe that there is a very tight relationship between the systems engineering process elements and the structure of the GT as shown in figure 7.4.

For the purposes of analysis, we divide the GT into two regions figure 7.3 – we define as the first Region “Region 1” the logical network between the Goal and the Critical Success Factors and as the second region “Region 2” the area representing the logical network between the CSFs and the NCs figure 7.3.

Figure 7.3: The Goal Tree and the Regions

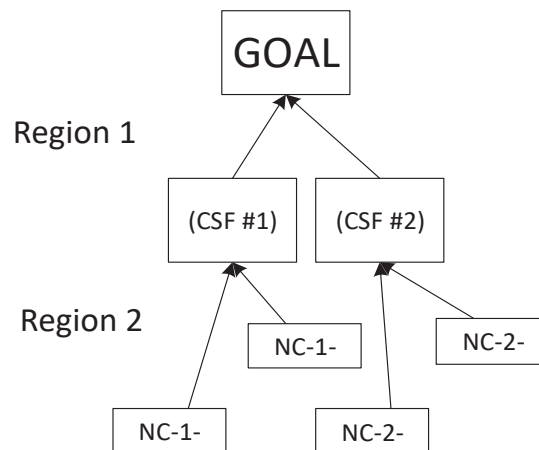

We compare and analyze in detail the two regions and how they can be synthesized with the system engineering process as shown in figure 7.4.

Region 1 includes the identification of the goal, the identification of the CSFs and their relationship. We observe that region 1 has many similarities with the first loop of the engineering process which is the “requirement loop” figure 7.4.

Region 2 includes the identification of the NCs in subsequent levels – their relationship and their relationship to the CSFs. This second region has many similarities with the second loop of the systems engineering process which is the “Design loop” figure 7.4. The NCs are displayed as the outcome of a “production” or “transformational” process as shown below in figure 7.4.

Figure 7. 4: The System Engineering Process and the Goal Tree – a synthesis

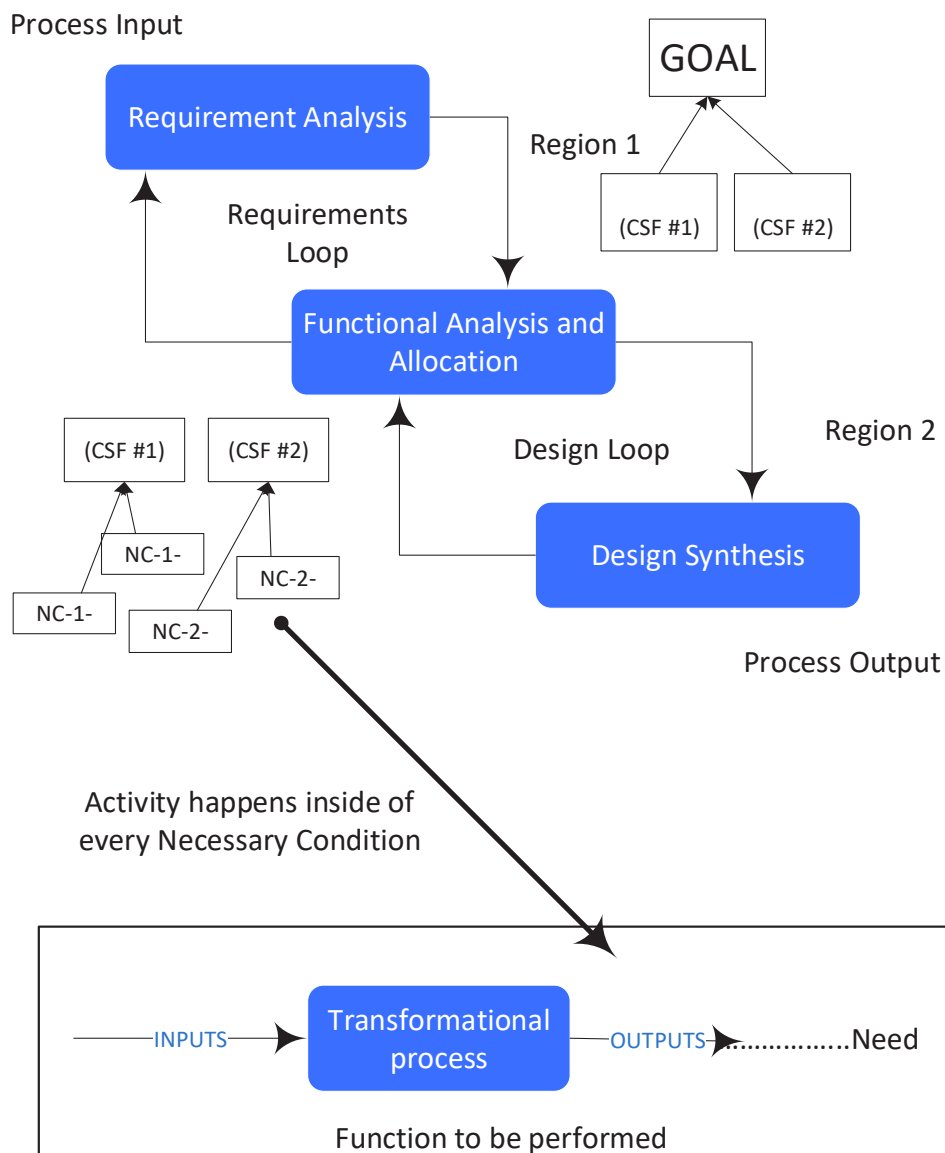

Region 1 (Goal & CSF) and Requirements loop

We define as Region 1 the area between the goal and the CSF figure 7.4. This area represents the goal statement, the identification of the CSFs and their logical connection network.

The process of establishing Region 1 can be compared with the process of establishing the requirements loop in the Systems Engineering context. Systems Engineering literature gives a very detailed description of how to extract requirements which is the main output of the requirements analysis (Blanchard 2008b; Blanchard & Fabrycky 2011b). The outcome of the requirements analysis is to identify functional requirements and define/refine performance and design constraint requirements (Clark 2011, p.31).

The requirements loop is the activity of establishing the requirements and functional analysis. This description in certain occasions can be expressed in drawings, in documents or in any other form. In the TOC context is displayed in a logical network or a logical tree diagram.

Recognizing the Need/Opportunity/Goal

Systems Engineering process starts with the requirement analysis which begins with the need analysis in a quest to highlight the customer's expectations (Clark 2011). With the implementation of the needs analysis, this expectation is translated to the system's goal (Shisko & Aster 2007, p.21). Contrary, in TOC philosophy the goal is defined by the owner of the system (Dettmer 2016b, p.78). The goal is the reason that the system exists – to serve the wish of its owner. We believe and support that it is of ultimate importance that the goal of the owner is aligned with the goal of the customer. We support that the goal statement must describe the aim of both worlds.

The customer's need is translated into the system's requirements (Clark 2011, p.35) through the requirements analysis which analyses different system areas of the goal. The requirements of the system are established by describing the functions to be performed (Blanchard & Fabrycky 2011b, p.38). The requirements play a crucial and central role since the whole process revolves around them. There are several techniques to perform the needs analysis such as the Quality Functional Deployment method (QFD) (Shisko & Aster 2007; Blanchard & Fabrycky 2011b) or prototyping (Adcock 2015).

Following the logical level below the goal are the CSFs. These are the absolutely necessary conditions that must exist for the goal to be realized. When these needs are satisfied, then the goal emerges unavoidably. The CSFs emerge from different functional parts of the system. If we look at it from a different perspective, those CSFs are actually the minimum requirements to be met by the system. The CSFs are the system's requirements. (W. Dettmer 2007) mentions that these CSFs can be used as requirements and they can be placed in the requirements box in the EC. We note the similarities of the definitions as well of the two worlds.

The relationship between the goal and the CSFs is a very tight one.

Functional Requirements and identification of the Critical Success factors

During the requirement analysis, different kind of requirements are extracted like customer requirements, functional requirements, performance requirements, design requirements, derived and allocated requirements (Clark 2011, p.36). Others add to those with usability requirements, interface requirements, operational requirements, adaptability requirements, logistical requirements (Adcock 2015), while (INCOSE Technical Board 2004, p.222) emphasizes reliability, availability, safety and security, transportability, infrastructure, and others. A special focus though is given to functional and performance requirements (Clark 2011, p.32) what the system must do and how well will perform in order to meet the requirements which in turn will satisfy the goal, whereas (Blanchard & Fabrycky 2011b, p.39) focuses on feasibility analysis, operational requirements, maintenance, support, effectiveness and performance measures. (Blanchard & Fabrycky 2011b, p.35) highlights the fact that the “whats” are identified during the requirements analysis phase. These “whats” actually defines the needs that need to be fulfilled. According to (Clark 2011) functional requirements define quantity (how many), quality (how good), coverage (how far), timelines (when and how long) and availability (how often).

(Clark 2011) expands the requirements developments to design constraints which are those factors that limit design flexibility, such as: environmental conditions, defense against internal or external threats; and contract, customer or regulatory standards. These are very useful especially when a new system is to be designed rather than improve an existing structure.

The CSFs must consider all mentioned groups and categories of requirements in the TOC world.

Additionally, we also believe that the maintenance and logistical needs should also be analyzed at this high level (Higgins 1966, p.4.19) as well as Human Factors (Higgins 1966, p.9.7)

The outcome of the Region 1 is the CSFs which as (Dettmer 2016b, p.80) calls them are “functional subsets of the goal” as exactly the outcome of the requirements analysis is to identify functional requirements and define/refine performance and design constraint requirements (Clark 2011, p.31).

In general, requirement analysis should result in a clear understanding of functions – what the system has to do and how well the functions have to be performed (Clark 2011, p.37).

(Clark 2011) provides certain questions that help to go through the requirements analysis (and obviously CSF development)

- What are the customer expectations?
- What are the reasons behind the system development?
- Who are the users and how do they intend to use the product?
- What do the users expect of the product?
- What is their level of expertise?
- With what environmental characteristics must the system comply?
- What are existing and planned interfaces?
- What functions will the system perform, expressed in customer language?
- What are the constraints (hardware, software, economic, procedural) to which the system must comply?

Region 2 (CSFs & NCs) and Design Loop

The goal and the CSFs were developed during the formulation of Region 1.

The next step will be to develop Region 2. Region 2 is the area that includes the CSFs, the NCs and the logical connections between them. In System's Engineering (SE) terms Region 2 is the design loop which develops the functional analysis together with the synthesis as shown in figure 7.2. Starting from the system's requirements, the functional analysis dives down through decomposition of the functionality levels (Blanchard 2008b).

The input to the functional step is the requirements (or CSF) to be met from Region 1 (requirement analysis). This region describes what must be done to achieve next higher level goals (Shisko & Aster 2007, p.21). The tool to decompose the functions to sub-functions in the systems engineering context is the Functional Block Diagrams or FBDs or FFBDs (Functional Flow Block Diagrams) (Shisko & Aster 2007, p.82). In the TOC context is similar to the logical structure of the NCs as they unfold in the GT. (Viola et al. 2012; Sage & Rouse 2009, p.1000) proposes the use of the functional tree which serves a similar purpose as the GT.

(W. Dettmer 2007) states that the CSFs are more conceptual whereas the NCs are more functional in nature and that they are functional components of the CSF they support. (Clark 2011, p.38)and (INCOSE Technical Board 2004, p.4)adds that the functional view focuses on WHAT the system must do to produce the required operational behavior. It describes the system's functions.

Functional Analysis vs. CSFs and NCs

The step of the functional analysis is the one that decomposes a function to sub-functions and their relationships, (INCOSE Technical Board 2004, p.123). As (Viola et al. 2012) adds that functional analysis is a conceptual design. (INCOSE Technical Board 2004, p.129) reports that functional analysis is a logical analysis of the requirements in functional terms. The same way that the NCs form a logical functional network supporting the CSFs (or the requirements).

The purpose of the functional model is to establish all the functions and sub-functions to be performed by the system in order to satisfy the CSFs or the requirements. According to (Shisko & Aster 2007, p.82) this is a systematic process of identifying, describing and relating the functions (NCs) that the system must perform in order to meet higher level goals. The functional analysis describes the functions like, what needs to be performed, where they need to be performed, how often under what operational concept etc (Shisko & Aster 2007, p.82). The GT does not go into that detail of functional description, it just describes only what needs to be done. Embracing the Operations model of figure 7.4 only the result of the activity or transformational process is described. The activity and the operations model evolve into the NCs statement as shown in figure 7.4. Therefore, the NCs are described as the outcome of functional activities or as (Dettmer 2016b, p.68) frames it, the conclusion of significant activities required to complete the CSFs.

During this step, many aspects of system functionality should be addressed including logistical support and operations (INCOSE Technical Board 2004, p.124)(as long as they are stated as CSFs).

What is important is that the functional analysis describes what the system must do, not how it will do it (INCOSE Technical Board 2004, p.124). All the “whats” will become “hows” at the next level which is the “synthesis” phase. At that “synthesis step” (figure 7.2) the functions that are indicated at the functional analysis are attached to physical

elements or physical actions which will realize the functions which in turn will realize the CSFs (or requirements) which in turn will realize the goal. (Dettmer 2016b, p.80) supports that the NCs are functionally related to the CSFs.

Concluding

Requirements are going to be transformed into designs (Clark 2011, p.35) with the same way that CSFs and NCs will be transformed into designs through the GTs and FRTs.

In order to realize the CSFs certain functions must be performed which will produce outputs which in turn will satisfy certain needs. These higher needs are identified during the requirements analysis, and they are identifying the different systems functions that must be performed (Clark 2011, p.32). These needs are the necessary conditions that must coexist to realize the CSFs which in turn will satisfy the goal. The necessary conditions below the goal are called NCs and according to (Dettmer 2016b) is preferable that they are named in functional terms instead of satisfied needs.

Goal Tree development guidelines - conclusion

Finally, we propose that every goal should be compared against the following broad areas which should be used for evaluation – these are emanated after categorization and synthesis of all above theoretical topics discussed and system properties.

We could divide the CSFs into the following five areas which are shown below including their subfactors – below factors is a synthesis of different works found in (Blanchard & Fabrycky 2011b; Hill 2007; Dettmer 2016b; Dettmer 2003; Clark 2011; Adcock 2015), Dettmer suggests that no more than 5 CSFs are to be used:

1. **Operational Feasibility** like Supportability (Support Functions) – Maintenance and logistics, sustainability, POOGI (T, I and OE), quality, knowledge, new product development, reliability, dependability and as indicated by this work standardization and stability
2. **Financial Effectiveness** like Profit, Cash Flow, operating expenses, ROI measures.
3. **Commercial acceptance** like product acceptance, product awareness, customer satisfaction, functionality, place, price, promotion, product availability, freshness, important product attributes, product attractiveness attributes (quality, price, delivery delay, functionality, compatibility), market share,

suitability to customer needs, quality, reliability, service and support, reputation, competitive advantage, maintain robust marketing and sales functions, customers satisfaction, brand name.

4. **Human Factors** like motivation, safety, training, abilities on task, behavioral issues, politeness, security, and satisfaction.
5. **Environmental conditions** like laws, certifications, obligations that must be followed.

All the above can be written as needs or functions depending on their position in the hierarchy of needs, eg. “Have motivated employees” (when a CSF) or “motivate employees” (when NC). The description of the goal will polarise the system giving priority to certain attributes than others.

7.3.2 Future Reality Tree (FRT) – Theoretical Development

The FRT was practiced twice during the research, and it was found to have specific weaknesses, based on the two failures recorded.

The FRT is a well-researched tree compared to the GT, and there is a great amount of literature reporting how successful it is. We could not locate any negative criticism about the FRT.

During this research, the FRT managed to create a uniform picture of the future solution, but it failed mainly in the following two conceptual regions of the solution in the linen case study:

1. It did not reveal that the system would go unstable at startup.
2. It did not reveal that the replenishment solution would not last.

This section aims to explore literature, discuss the findings, try to understand the cause of the failures and finally conclude on what needs to be changed so that the weaknesses are taken into consideration in future implementations.

Failure 1 - It did not reveal that the system would become unstable at startup.

During the implementation, the system of the linen became unstable, it went into an unstable situation for almost two weeks.

Future Reality Tree – Build for Stability

By interviewing the head nurses of the wards, they mentioned that they did not have reliable information. They heard, that management in an effort to reduce costs would reduce operating hours of the laundry. They did not trust what was about to change so they assumed that something would go wrong. To feel safe, they thought of ordering more linen than what was needed in order to be protected. At the first indication that they would remain out of linen (because their orders were not fulfilled), their worries were becoming a reality, so they kept ordering more.

Piloting was skipped. Areas for improvement were not identified. Communication was not effective, so people were speculating things. The system went completely unstable when the wards started panicking and started ordering without any specific pattern and logic.

Stability

It was observed that the system went unstable at startup. The issue of stability is something that it was not considered at all by the FRT. We did not find any mention in the literature concerning the FRT with the system's stability issues.

A system can be called stable when it produces the same results at different points in time (Pyzdek 2003, p.281) or if it experiences “common cause” variation in specific limits (Roy 2004, p.222) or if the process has predictable results (Lepore & Cohen 1999, p.45).

Stability is important in order to maintain the output and the gains of a process (Pyzdek 2003). (Lepore & Cohen 1999, p.45) highlights that stability is not an inherent property in a system; it is instead a necessary condition to be satisfied.

Stability can be divided in “static stability”, which can be measured (Meadows 2008, p.77) and “dynamic stability” which is the underlying support between the system elements which interact in a way to keep the system stable. (MITRE 2004, p.38) supports that any apparent stability is actually “dynamic stability”. Abrahamson suggests that the goal of organizations should be a status with “dynamic stability” and that companies should improve and progress through small but incremental efforts and actions (Brennan 2010, p.40), a concept which is also the Kaizen philosophy (Kaizen 1986). Kaizen is an improvement methodology which considers stability as a vital

element in systems. Kaizen is based on the assumption that management has two main components; the first is maintenance and the second is improvement (Kaizen 1986, p.7). Maintenance means to establish procedures, policies and rules in an effort to maintain standards over and over again. The output of this activity is to stabilize a system. According to the Kaizen philosophy, a system must be standardized and stabilized before it is improved. Only when stability has been achieved the behavior can be predicted, making improvement easier to introduce. An unstable system cannot be improved. Managing a stable system is much easier than managing an unstable system. Lean philosophy is also based on stability (Kim et al. 2009). A system is considered stable when its future behavior fluctuates in the predefined “control within limits”. They can be mapped using linear, negative feedback maps.

On the opposite side of stability is chaos (Lepore & Cohen 1999, p.51). A situation where the process is out of statistical control and the product that is produced is completely out of specs as well. Chaos theory and complexity theory support that in environments where positive feedback dominates, stability is not possible (Sterman 2000).

Complexity theory suggests that for a system to exist, just the “right” amount of perturbation so as to maintain its dynamic stability must exist. Almost everything in nature seems to preserve its dynamic stability through feedback loops. These feedback loops seek to bring the system back to stability (Given 2008, p.76).

(Forrester 1997) also explains that information through feedback mechanisms is the ultimate control function of humans and nature.

The question is what can go wrong in a system and force a system to lose its dynamic stability and become unstable. Senge notes that organizations and systems have to manage a conflict, stay stable and efficient or change and innovate (Oliver 1990), this sounds like the Kaizen’s position (Kaizen 1986) or even the dilemma of Efrat’s cloud (Goldratt-Ashlag 2010).

Literature addresses stability through different stand points. Stability is handled in nature with several ways but (Flood 1999) suggests that concepts of physics are not useful when studying organizations. Physics promotes reductionism which means breaking things apart and analyzing them. In contrast, Shewhart based his work on

natural laws seeking to achieve “control within limits”; this is what Shewhart used to call behavior in statistical limits (Pyzdek 2003, p.249).

Different approaches have been evolved through time. One is the systemic perspective which addresses balance through interactions, balance loops, feedbacks, and cyclic logic; seminal works like (Senge 2006) and (Meadows 2008) discuss these concepts in depth.

Cybernetic is the general theory of control (McLoughlin & Webster 1970). Warren McCulloch and Norbert Weiner made Cybernetics known to the world in the 1940s (Flood 1999, p.37). Feedback and control are what characterizes cybernetic systems (Morgan 1997, p.394). Stafford Beer, a specialist in cybernetics with research in ORMS (Operational Research and Management Science) supports that models must be used based on hard sciences like mathematics and statistics (Flood 1999, p.38).

The other approach is based on works from Shewhart (Shewhart 1931) and Deming. Shewhart analyzed variation from the physics perspective, and statistical process control tools and Deming made it worldwide known (Goldratt 2008).

There are different techniques like buffer management (Stratton et al. 2008) or six sigma (Pyzdek 2003) which seek to stabilize systems and load leveling for TPS (LIKER 2004, p.113).

(Stratton & Knight 2010b) points that by operating in the buffers of DBR then stability of flow can be achieved. Buffers also provide a measurement of stability and give early warnings (Stratton et al. 2008). (Pretorius 2014) highlights the fact that the subordination step is the one that makes sure that the organization stays stable even though elevation has taken place.

How can systems become unstable?

Searching in literature, three main sources were found to be responsible for instability. These are Entropy, Archetypes, and Variation.

Entropy

Entropy is the natural tendency for degrading and disorder (Johnston & Clark 2008, p.476). For a system to stay in a stable mode, it must have mechanisms against entropy. Entropy exists and prevents the stability of our systems, it directs them back to the old

state of disorder (Hill 2007, p.83; Lepore & Cohen 1999, p.52). (Dettmer 2011) mentions that human systems tend to shift from organization to conflict and chaos.

It is upon the system's owners to monitor and maintain the system in order to prevent entropy settle in a system (Pirasteh & Kannappan 2013).

(Peery 1975) and (Kast & Rosenzweig 1972) discusses that a closed system is one that does not react with its environment. This fact makes the system exposed to the phenomenon of entropy which degrades and destroys the system. An open system, such as social organizations, on the other hand, can preserve its steady state, homeostasis and retain its dynamic equilibrium through the continuous use of materials, energy, and information. Therefore, keeping a system closed and isolated from the environment, without feedback and communication, destroys it. It is a question how to design a system that takes into consideration entropy issues through interaction with the external environment.

Archetypes

Structural forms of systems cause the behavior of the system to follow specific patterns. This pattern is what Senge calls archetypes (Senge 2006). These behaviors dominate systems across different contexts such as biology, economy, management, and others. By knowing how they behave and what their mechanisms are, a system's designer can manage them and affect them in a positive way (Meadows 2008, p.6). Archetypes are problem – causing structures (Monat & Gannon 2015).

Archetypes are certain behaviors of systems which prevent stability. (Meadows 2008, p.6) mention that archetypes can cause problems, but they can also be the source for system improvements.

Below summary of archetypes is an outcome of a synthesis of Senge (Senge 2006) and (Meadows 2008) work. The purpose is to investigate what forces can push a system off balance into instability and what can be done to prevent such effects so that we can conclude them into the FRT structure. Some of the basic archetypes are:

Limits to Growth – In this system there is an activity which promotes growth to the state of the system. This current state grows until a “limiting state” fires back an activity which promotes delay. This archetype is based on the constraint concept, a concept which is the cornerstone of TOC.

Shifting the Burden – treating symptoms and not root causes. This pattern is what causes addiction and dependence (Meadows 2008, p.131). The root problem is not addressed but just the symptom. A “solution” is applied causing the symptom to go away. When the symptom goes away, then the problem regenerates another symptom with a delay. Then the intervenor applies more of the same “solution,” and the loop repeats itself. This could be managed with the use of the CRT and the EC.

Balancing process with delay – when the system shifts from the desired state then a correction is made to bring the system back on track but because there is a delay, overcorrecting or giving up may occur because of no visible results.

Growth and Underinvestment – The system becomes better up to a point where a system element prohibits further growth. Since there is no further growth, no decision is made to invest justifying that no further growth can be achieved (Kim 2000).

Eroding goals (Drift to low performance) – The goal is lowered because lower standards are perceived as true. The whole system adjusts to the new lower goal. The system, in this case, keeps deteriorating.

Success to the successful – This pattern is a reinforcing loop where the winner receives a reward which makes the winner stronger and can have more rewards in the future that will make the winning system even stronger. The winner always wins, and the loser always loses.

Escalation – One competitor tries to beat the other. There is no absolute goal, but the goal changes when compared to the competitor’s one. This is a reinforcing loop that can push competition to the limits.

Policy resistance - This archetype is the root of resistance to change. When the goals of the subsystems are not aligned, then each subsystem tries to polarise action to satisfy its own goal violating the other goals. This generates resistance from the other subsystems (Meadows 2008, p.113). The source of subordination.

The tragedy of the commons – Each person in the system acts for his/her own benefit ignoring the benefit of the whole (Kim 2000). When the common resource is limited, then the system will come to a point where this common resource will not be able to support demand, and the whole system will fail.

What observed at the linen system could be explained through the tragedy of commons. There was no direct information between the resource (the linen) and the user (the wards). Because of the distorted information to the users that “something bad would happen” the wards believed that soon they would remain out of linen – this triggered escalating ordering of linen. The more linen ordered, the more the availability was suffering in the other wards. The initial assumption that something would go wrong was validated, and they were ordering more and more. This caused an escalation, and the system oscillated to a chaotic state. The users had no information or knowledge about the behavior of the system, the linen replenishment system was uncontrollable, and everybody panicked and stressed. The resource that was commonly shared was the linen. The lack of information and the lack of communication to the users of the system caused this out of control oscillation.

System’s archetypes, Theory of Constraints and building stability

All of the above archetypes may take place in a system and push the system out of stability into a degrading snowball. The literature mentions several actions that can be taken to avoid or manage above archetypes. Some corrective actions reported are:

Limits to growth: (Meadows 2008, p.102) states that a system cannot grow forever, and a constraint will prohibit growth. The action is to manage growth by strategically choosing and managing the constraint.

Shifting the burden: Treat the core problem and not the symptom. A classic case of the CRT. By applying the CRT, the core problem is addressed, and this archetype can easily be managed. Periodic auditing of the UDEs of the system will flame the necessary awareness.

Balancing Processes with delay: Behaviour follows feedback structure (Bayer 2004, p.133). Feedback is the building block of balancing loops, and its primary goal is to keep a system stable (Meadows 2008, p.153). Design quick feedback loops and design fast system responses. A balancing feedback loop needs a goal, a monitoring mechanism, a sensor to detect the gap from the goal and a response mechanism. The accuracy of monitoring, quickness of response are properties that must be designed into the system (Lockamy & Spencer 1998, p.154). TOC does not address feedback concepts as controlling mechanisms.

Growth and underinvestment: Analyse the assumptions that guide investment decisions. Look at future impact instead of immediate performance (Kim 2000).

Eroding goals: The way out is to keep performance standards absolute (Meadows 2008, p.123) and place a monitoring mechanism out of the system (Kim 2000).

Success to the successful: The success to the successful loop can be kept under control by putting into place feedback loops rules and policies that keep any competitor from taking over entirely (Meadows 2008, p.129).

Escalation: A quick and effective way out of the escalation is to come to a win-win agreement and avoid competing (Meadows 2008, p.126). When the focus is in synergy then reinforcing loop will stop. Refuse competition. The EC is designed especially for that.

Policy resistance: The antidote is to come to a win-win situation where all goals are satisfied. This is the target of the EC. Invalidate assumptions which hold actors acting in favor of one part of the dilemma (Kim 2000).

The tragedy of the commons:

(Meadows 2008, p.121) reports three ways to avoid the tragedy of commons

1. Educate and exhort – Visibility is vital. Show and inform people about the consequences of eliminating the common resource. Feedback information.
2. Privatize the commons – Allocate the common resource to the users. Inform the people about the status of the resource through a feedback loop.
3. Regulate the commons – Apply rules and restrictions regarding the use of the common resource. Prohibit specific behaviors by controlling, policing and penalizing. Allocate accountability of resource sustainability to a specific governing body (Kim 2000).

All the above solutions are to be embedded as system attributes and taken into consideration when designing a system with the aid of the FRT.

Variation is also a topic that can cause instability in a system.

Variation is the deviation of an accepted standard. To understand variation requires a deep understanding of the interdependencies of system elements and how they react. Understanding and managing variation was the main work of Deming (Deming 2018).

There are basically two types of variations; the common cause and the special cause.

Special causes (or assignable causes) can usually be located and eliminated before they occur. They are usually managed by Risk analysis (Lechler et al. 2005).

Common causes (or natural causes) are random sources of variation that cannot be avoided in a process (Brennan 2010, p.122). These common causes could be managed in the long run but not in the short term. Common causes are usually managed by control charts which are tools to study variability in the process. It is a tool to measure stability (Lepore & Cohen 1999, p.45).

A process where deviation fluctuates in the “common cause range” can also be called a stable process whereas a process which behaves out of the “common cause range” can be called an unstable process (Roy 2004, p.222).

Variation is a well-researched subject also in the TOC context (Costas et al. 2015; Lepore & Cohen 1999). TOC’s way to manage variation is by buffer management (Stratton et al. 2008). It manages variation based on buffer penetration (Umble & Umble 2006). Buffers in systems language are called stocks, that is when stocks are large compared to their flows then they provide systems with stability. A system can be stabilized by increasing its buffers (Meadows 2008, p.150).

TOC’s variation management is also researched in the healthcare sector (Umble & Umble 2006; Stratton & Knight 2010b; Tabish & Syed 2015). TOC can be empowered by Six Sigma Techniques to eliminate or reduce variation as much as possible (Pirasteh & Kannappan 2013; de Jesus Pacheco 2014; Steven 2009).

Why did the FRT fail to address stability?

Based on the output of the previous discussion, the FRT failed to protect the system from going unstable because stability issues are not addressed by the FRT. The FRT focuses on the sufficiency to create certain conditions, but it does not manage stability issues. TOC seeks to stabilize the operation of the flow in a system via buffer management principles. Variation of flow is absorbed by penetration into the buffers being a DBR or a replenishment solution, but when the source of variation is human behavior then it is not addressed. Feedback has a different role in TOC context and balancing loops concepts are missing from the TOC literature.

How can we accommodate above concepts into the FRT for future improvement?

What can we do?

The organization's ability to rapidly respond to changes and opportunities is enhanced by finding ways to accelerate and share learning (Hill 2007, p.57).

Conclusion

When building the FRT, we are actually bringing a new system in life, either by changing an existing one or by designing a completely new one. We are logically modeling it into the future to see what is needed. We adjust its behavior by adding injections. (Dettmer 2003, p.158) reports that the FRT is a presentation of the Future Reality. As discussed, the statement of the Goal and the CSFs define the system level of the analysis. Since the desire effects are guiding the end point of the logical cause and effect, the subsystem to be analyzed is defined by the DEs which in turn are defined by the GT.

Operational system outcomes, which were concluded from the GT are: reliability, maintainability, supportability, usability, producibility, disposability, sustainability, affordability, and others (Blanchard & Fabrycky 2011a, p.361) labels then as the "design to" parameters. All the above must be taken into consideration when building the FRT and other things from the system's domain like feedback loops, stability, information design, etc.

Failure two - It did not reveal that the replenishment solution would not last.

FRT and Reliability

Field observations

As observed, the replenishment solution at linen did not last for more than four months. In the absence of the supervisor, everybody slipped back to the old way of operating. They did not even realize it because the degrade was so slow, that nobody noticed. The problem appeared after a month of operating with the old way. It was observed that the implemented solution was lacking reliability characteristics.

Reliability

The literature discusses that in many implementations change does not last for long. Systems tend to fall back to their previous state of operation. The phenomenon of a system not to be in a position to operate as designed is addressed by different scholars researching in the system's context.

(Blanchard & Fabrycky 2011a, p.363) surfaces the issue of reliability and defines reliability as the probability that a system will function satisfactorily for a given period of time or as per (Hill 2007, p.288) the probability that a product will malfunction over a given period of time. (Avizienis 2001) defines reliability as continuity of correct service.

Reliability is discussed in literature from different viewpoints. In systems engineering, reliability is addressed as one of the basic Design for X-factors. (Hill 2007) names that program Design for Reliability (DFR) and it focuses to embed reliable processes into systems.

The work of (De Meyer & Ferdows 1990) develops an approach of building systems from a focus point of view. They developed the sand cone model which is a model of how to build a solid system. They suggested a gradual process where the first improvement is made on the quality of the product, the second on dependability, the third on speed and lastly on cost efficiency. It is a cumulative model composed of different layers where every layer is addressed only when the previous has been addressed.

The second layer of the sand cone model is that of dependability. (Avizienis 2001) defines dependability as the system's property to integrate availability, reliability, and security mentioning reliability as an important system's attribute.

(Hill 2007, p.312) discusses the sand cone model and they have even replaced the term dependability with that of reliability. They suggest that designing for performance and reliability makes a system better and that this is true for tangible and intangible product attributes. When a system is better (stable and reliable), then the cycle times can be reduced in order to make it faster – they mention, among others, that the Theory of Constraints is a suitable methodology to make a system faster. When a system is stable and faster, then it can become cheaper by balancing supply and demand and through

product design in order to achieve customization of the product (Meyer et al. 2008). Finally, when a system is better, faster and cheaper then the processes can be aligned with strategy and goals to make it stronger. They give a high emphasis on reliability though, where (Blanchard 2008b, p.33) considers the concept of “design for reliability” as a critical system-level parameter that should be addressed early at the design phase.

(Hashim 1984) discusses reliability for service industries and recognizes that industries as healthcare cannot be effective without paying attention to the concept of reliability. Reliability has been discussed in depth for physical products and the concepts that have been evolved through time are difficult to be conceived and be implemented for services. (Hashim 1984) discusses that reliability in service systems (systems which produce untouchable products) should be a factor of availability, dependability, security, safety, and maintainability.

(Flood 1999, p.40) suggests that even system dynamics could be employed to model the operations as processes in order to estimate their reliability. They also suggest that there are four strategies to process reliability improvement.

1. Process improvement
2. Process redesign
3. Business reengineering and
4. Process transformation

In above-mentioned literature addressing reliability, certain factors are highlighted, which are key to ensure reliability,

1. Avoidance of human errors by training, auditing (Blanchard & Fabrycky 2011b, p.150),
2. Feedback from the customer.
3. Process improvement programs (Flood 1999, p.40),
4. Availability of resources (Hashim 1984) or ready for correct service (Avizienis 2001),
5. Safety and maintainability (Hashim 1984).

Reliability and Theory of Constraints

Reliability is not addressed by FRT design, if the reliability concepts do not appear as desirable effects, then they will not be addressed, and the design of the system will not

encounter reliability issues. We strongly believe that reliability concepts should be incorporated into the FRT design.

Future Reality Tree development guidelines - Conclusion

From the previous discussion, we suggest that the points below must become part of the FRT constructing guidelines and design criteria – below points are missing from the current FRT literature and are extracted based on the findings of this research:

1. **Negative feedback or balancing feedback loops.** (Meadows 2008, p.157) another reason can be missing information flows. Adding or restoring information can be a powerful intervention, usually much easier and cheaper than rebuilding physical infrastructure. (Cox III et al. 2012) use of feedback is different in TOC than other methodologies.
2. **Characteristics of feedback** – information must arrive on time, to the correct place, easy to be interpreted. Feedback should also be designed to incorporate reliability issues.
3. **The response that is triggered by the feedback must be designed.** It must be strong, fast and effective, the feedback should be direct and avoid going through layers. (Meadows 2008, p.151) – Delays in the system can cause a common cause of variation or instability in systems. It is a matter of design.
4. **Build “sensors”** able to “sense”, receive and interpret information.
5. **Build in warning systems and react to those.** Warnings are -ve feedback (Kauffman 1980, p.15).
6. **Build hierarchies**, this is design clear boundaries to subsystems and design how they are synchronized together. (Kauffman 1980, p.4) discusses that big structures that are made of smaller, clear structures are more stable.
7. **Perform audits.** The root of stability. Find core sources of instability and remove them.
8. **Build rules, policies, and standards.** Boundaries of a system are defined by its rules (Meadows 2008, p.158). Stability can be achieved by controlling the rules instead of controlling the players. Change criteria and modify procedures and standards (Pyzdek 2003, p.649). Templates need to be revised, and the new changes included to avoid instability.
9. **Build measurements.** Monitor performance against standards.

10. **Availability of resources.** Have effective systems in place to support solutions. Show emphasis on logistics and maintenance.
11. **Training:** Provide training on the above issues and on issues of reliability to the key members of the system.

7.4 Managerial Development - Recommended Template

The template in figure 7.5 synthesizes almost all the findings of this research in a graphical representation. The aim of the template is to arm professionals with a structured way of managing a system using TOC principles.

Although tested in one hospital – it is presented as a generic representation of the findings so that it can be accommodated to specific needs and environments by healthcare and service professionals. The template forms a synthesis of the findings and composes a sequence of steps which can be used by professionals to improve or standardize a given system. It is subject for further verification and improvement

The discoveries from this research can greatly help professionals implement a methodological step by step guide as found in the template figure 7.5. The value of the template is that it is useful for all managers at all levels and it is useful for the different type of systems.

The template shows how a professional can be guided through the change process and with which tools.

The reasoning and the steps of the template figure 7.5 are as follows:

Step 1 – Define the system – The first step puts in context the system under study. Visualizing the flow that runs through the system helps to create a mutual understanding and set the boundaries of the system under improvement, this is what was highlighted by the conclusion no 2 at section 6.3.3. This step proved to be very effective in overcoming resistance at a psychological level as well. Humans do not feel threatened when they realize that the system and the flow is the object for improvement and not

themselves. At this early point, the decision must be made if Throughput is number one priority or if operating expense is of number one priority. This decision will define the criteria for the next step which were developed at the GT theoretical development at section 7.3.1.

Step 2 – Train the people involved – This is an outcome from the discussion at section 7.2.1. The target of this step is to engage people in the management of the system and replace resistance into passion and engagement. The main steps are:

Training:

1. Maintenance vs. improvement concepts.
2. Improvement concept and change questions.
3. System concepts.
4. Flow and constraint concepts
5. TOC – Flow management.

Managing change through the layers of resistance is mainly managing people. After cooperating with different people and implementing the TOC for four years in the hospital, we could summarise in broad terms that management of people is about:

Leadership:

1. Remove resistance. Place layer nine as first (finding from section 7.2.1)
2. Show the way. With the implementation of the GT.
3. Remove Obstacles. With the EC and obviously with the PrT (although not tested).
4. Provide feedback and learn. This is an outcome of section 7.3.2

Step 3 – Create a Goal Tree. By conceptualizing the system from step 1, the GT will help the user to understand and identify the necessity network map which displays the necessities that must be satisfied to keep the system successful. At this point is useful to set the measures which measure the goal and the measures which measure the necessary conditions. The appropriate criteria should be chosen as developed at section 7.3.1.

Step 4 – Process mapping. This step takes place after the development of the GT in an effort to understand how the system behaves about its goal and to it is necessary conditions. Visualize the flow and understand the information and the trigger signals which keep the value flowing. At this step, UDEs should also be collected in relation to the GT. The system should be seen as a network of interdependent processes. Seek to understand the cause and effects relationship of the system. Create a benchmark and a baseline of current performance to be used for future evaluation. Representation of the system in terms of functions is necessary in order to be able to create an understanding in functional terms. This step emanates from

If Throughput is priority number one, then the path of step 5 is to be followed. If Operating Expense is priority number one, then the path of step 6 is to be followed.

Step 5 – What is the constraint. Identify areas to improve the operational measurements (T,I and OE), give priority to Throughput. What is blocking the system of having better measurements? What is blocking the flow through the system? What makes the system weak? This can be a physical or a policy constraint.

Step 5a – Develop the Thinking Process Tools. Develop the CRT, EC, FRT, and PrT in order to improve the system. We support that the FRT should be implemented before the implementation of the Five Focusing Steps in order to create a synthetic solution taking into consideration the criteria developed at the theoretical development at section 7.3.2. A Prerequisite Tree should be developed if the number of tasks and complexity is justifying the development of a Prerequisite Tree.

Step 5b – Develop the Five Focusing Steps. This step may or may not be needed. If it is needed, then we propose that it should come after the logical thinking process. We note that the sequence should be first subordination and then exploitation and finally elevation.

Step 5c – Implement fast the injections. The injections should be executed fast by constant communication of the plan. The FRT should be scrutinized continuously throughout the implementation in order to evaluate and validate assumptions under the new reality that is formed because of the implementation.

Step 6 – Maintenance - Choose the constraint. This step decides what the constraint is or which one it should be. It could be decided based on load analysis as in linen or it could be a critical resource controlling the flow through the system (doctor’s time at the operating theatres).

Step 6a – Develop a Future Reality Tree. This step ensures that everything is designed as a whole, before applying any solutions. The NBR will make sure that any negative consequences will be blocked before they happen. Visualize end result. Always take into consideration the criteria developed for the FRT in section 7.3.2. Design a pilot plan before going full scale. Ensure and design a constant information flow.

Step 6b – Subordinate to the system’s chosen constraint - “Right-Size” the system around the constraint. This means that depending on the utilization of the constraint exploitation should take place in order to free capacity of the existing constraint or subordinate (down-size) to the chosen constraint. This can be done by reducing its capacity or reduce its availability. This step comes from case studies as explained in sections 4.4.7 and 5.7.1, where subordination was suggested by the EC.

Step 6c – Exploit the chosen constraint. When the system is subordinated around the chosen to constrain then exploitation should take place to make sure that the constraint works efficiently. This step emanates from both case studies as in both exploitation follows subordination.

Step 7 – Standardise and stabilize the system. Create rules, policies, and procedures. Train people and convey the importance of the rules of the system. Stabilize the system as explained in section 4.4.10 and 7.3.2.

Step 8 – Check Measurements and Review Indicators. Audit standardized work. Create performance monitoring system. Evaluate feedback systems and change if required.

Figure 7. 5: Managerial Template

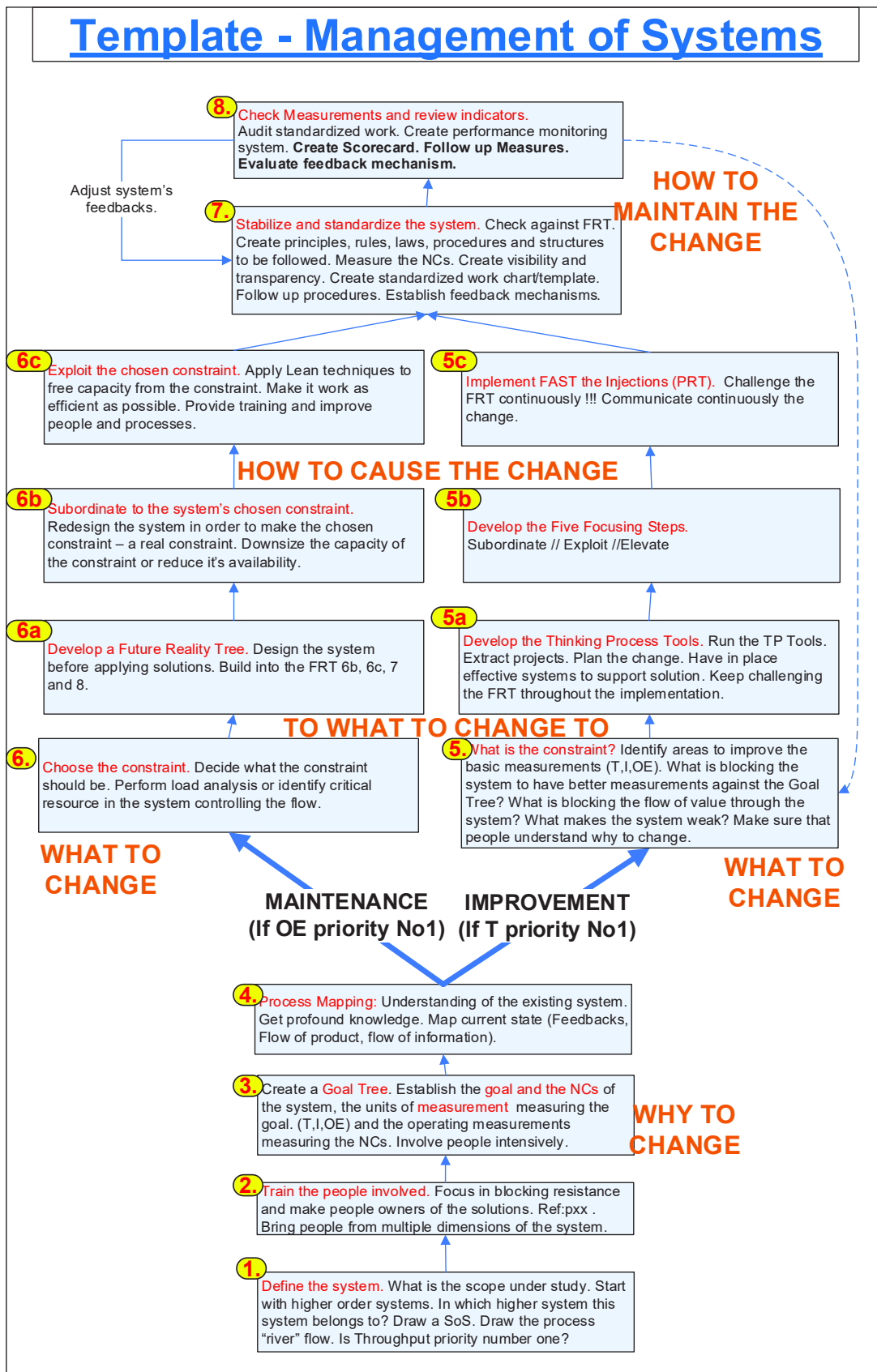

7.5 Chapter Summary

This chapter advanced the theoretical framework of the Theory of Constraints. Based on the research findings, different weaknesses were spotted, and they were enhanced through a deep literature review.

The chapter highlights the theoretical changes that were applied as an outcome of this thesis. Theoretical changes regarding the logical thinking process, Five Focusing Steps and to the change sequence approach.

The second section enhanced the literature review of the GT and of the FRT based on the findings of chapter four and chapter five and on the discussion of chapter 6. The section formulated certain system's attributes that must be taken into consideration during the GT and FRT development.

The third section formulated a management template synthesizing all the output of the research. This template is for professional use and provides a guide of how to apply the improvement process not only into the healthcare context but in services in general.

Chapter 8

Conclusions

8.1 Introduction to the chapter

The conclusions chapter concludes the final contributions of the research. The chapter takes place in light of the purpose statement and the research objective, therefore, one by one the research questions are answered in a clear-cut fashion.

The chapter draws conclusions from the research findings in chapter four, chapter five, from their interpretation chapter six and the recommendations for improvement in chapter seven.

The chapter begins with a brief overview of the research and the methodological approach, in an effort to frame the chapter.

The purpose statement finally is addressed by a specific section which is allocated for the unique contributions, implications, and Significance. The discussion provides an evaluation of how effectively the purpose statement has been fulfilled. This sub-section is further divided in three sub-sections explaining the following three categories:

1. The theoretical contribution, which is the contribution to the academic world.
2. The managerial contribution, which is the contribution to the professionals who want to implement TOC in healthcare.
3. The contribution to the researchers, where recommendations for future research are proposed.

The chapter concludes by identifying the limitations of the research and weaknesses.

8.2 Overview of the Research

The challenge of healthcare is clear: deliver more, better, faster, cheaper.

TOC has been proven very successful in manufacturing environments (Balderstone & Mabin 1998; Tulasi & Rao 2012). At the same time healthcare is a very complicated sector of services desperate for operational improvement (Chahal et al. 2018; Lillrank et al. 2011). The motivation of this research was to investigate the effectiveness of TOC into the healthcare context. The research was focused on the management/operational context of healthcare and not to the medical one. The thesis aimed to investigate the effectiveness of TOC at the biggest private hospital in Cyprus with a 152-bed capacity and 12 operating rooms.

The purpose statement of this study is to build new knowledge and make a new contribution to management science through the application of TOC, as an operations improvement methodology in the private healthcare segment. The research objective which will fulfill the purpose of the research study is to explore the degree of effectiveness of the Theory of Constraints methodology in the operational environment of a private general-purpose hospital in Cyprus.

This research sought to investigate the effectiveness and applicability of the Theory Of Constraints in a private healthcare operations environment. One of the aims of this dissertation is to contribute to a broader understanding of the synthesis between TOC and healthcare context and how well TOC can be adapted into the healthcare's distinctive characteristics. This would be achieved by investigating the applicability of its components and change them accordingly, as needed, in order to make them successful.

To satisfy the above purpose and objective, a number of research questions are answered through this study. The appropriate research methodology selected, was the action research in an operations and systems conceptual framework – where Theory of Constraints is developed. This research implemented TOC in two real-world case studies. We collaborated with the hospital's management, doctors, nursing staff and employees in order to implement TOC philosophy and tools.

In this dissertation, the principles of the Theory of Constraints were used to improve two subsystems in a private hospital environment. The theory of constraints was implemented in two distant systems of the systems' spectrum as proposed by (Chase 1978). The linen management system which is a system with low customer contact to the creation of the service and the surgery function where there is a high customer contact to the creation of the service.

In chapter two, we identified the following gaps in the literature:

1. TOC community is a closed community sharing information from specific sources (Cox III & Schleier 2010). More research is needed to help TOC adaption (Cox III & Schleier 2010, p.875). (Gupta et al. 2013) mentions that TOC philosophy is under-researched.
2. The literature of TOC in healthcare is very limited, and it is even more limited at the surgery function. (Mohammadi & Eneyo 2012) supports that more research is needed on TOC in healthcare.
3. There is no published implementation of DBR at the operating rooms environment at the process level. Only two publications are discussing TOC at operating rooms (Kimbrough et al. 2015) and (Lubitsh et al. 2005). Current research at the operational improvement in operating rooms is an ongoing event (Kimbrough et al. 2015; Godinho Filho et al. 2015; Vashdi et al. 2013). (Cox III & Schleier 2010, p.871) supports that DBR is still a challenge when applied to services.
4. Literature researching TOC in healthcare is limited (only 37 published articles were located in total).
5. TOC in Greek-speaking countries is unknown. TOCICO has no members of Greek or Cypriot nationality except the researcher. The only work found discussing Theory of Constraints in Greek universities is (Tsitsakis et al. 2017) and it was published in 2017.

The guidance of the mainstream of literature was followed. The guidelines were strictly followed in an effort to test what works and what not, before alterations take place. The first steps of the research showed that the method that should be used was that of Bill Dettmer presented in (Dettmer 2016b). In an effort to strengthen the validity of the application of the TOC tools, Dettmer himself trained the researcher for six days in Paris in June 2016.

Data collection

The Thinking Process Tools are information-driven, therefore data was continually collected from the field by unstructured interviews, personal observation, and field notes. The data collected was analyzed by the TOC tools, and the output of every tool was used as data for the consequent one. The data was focused on answering the three improvement questions

1. What to Change
2. What to change to
3. How to cause the change

A project team was formed in both case studies who worked with the researcher for four years at the clinic.

8.3 Research Questions Theme

The philosophy of the research questions is based on the change sequence. The sub-research questions are perfectly in line with the TOC improvement questions which in turn are in line with the action research cycle. Sub research questions one to four progress change, where sub-research questions five to seven evaluate the change.

This sub-section discusses the findings of the two case studies through the lenses of the research questions.

The whole research initiative was a change process. The action research philosophy and TOC methodology bring change in every step of the process.

8.3.1 What to change – Diagnosis

1. **Sub-research question one:** *What is the constraints limiting the potential of the existing operational environment of the linen management system and the operating rooms?*

The purpose of the first research question is to locate the leverage point of the system. The reason that holds the system back of becoming better. This research question was

answered with the implementation of the CRT which was developed with the help of the GT.

In order to answer the first sub-research question, two case studies were conducted.

Case Study one - Linen management system: Three core problems identified during the diagnosing phase of the action research at the linen management system.

Core problem one: The system found to be operating in overcapacity. The consumption was constraining the entire system. The real constraint though was the hospital's policy to operate seven days a week. This policy kept the system active longer than necessary. The system's operating expenses were maintaining an unnecessarily large system. Contrary to the TOC literature, Throughput was not priority number one, so the decision was taken to downsize the system. The washing machines were chosen as the new constraint.

Core problem two: The nurses from the wards were complaining that they were facing out of stocks situations in linen. More than the required linen was found in certain wards and less in others. The lack of a replenishment methodology was the constraint of the replenishment system.

Core problem three: The hospital was purchasing many new linens resulting in high operating expenses. Many linens would get destroyed because of the heavy use, and they were thrown away. The lack of a problem-solving methodology was keeping the problem alive for years.

Case Study two – Operating Rooms: In this system, the lack of visibility was covering the fact that the operating rooms were operating at excess capacity. As in the linen case, consumption was constraining the Throughput of the system. The system was operating at a low utilization of 56%. After the implementation of TOC, the real constraint proved to be the lack of subordination of the flow. Only when subordination is overcome (as this study did), then the constraint of the consumption can be elevated.

The subordination philosophy was the root cause constraining both systems.

8.3.2 What to change to - Planning

- 2. Sub-research question two:** *What is the desired solution which will elevate the performance of the constraints, if implemented at the linen management system and at the operating rooms?*

The second research question seeks to investigate the ability and the effectiveness of the TOC tools into generating solutions. The EC and the FRT were used to synthesize solutions and design the future state of the system.

Case Study one - Linen management system:

Solution to core problem one: Since the linen system was operating at overcapacity and no further increase of the flow was desired, the obvious solution was to downsize the system. The washing machines were chosen as the candidate constraint, as it was the one with the highest utilization. When the decision was taken to stop operating the laundry on Sundays, where the rest of the system was active seven days per week, then the flow converted the washing machines into a prospective bottleneck. The entire system was organized around this new constraint, so the operating expenses were reduced. All the management effort, attention, and focus were at the washing machines since they were controlling the flow of the system. Implementation of the Five Focusing Steps is TOC's managed the flow through the system.

Solution to core problem two: TOC has developed a generic solution which is called the "Replenishment Solution". Although the Replenishment Solution is designed to manage the flow of physical products through Supply Chains, the applicability of the solution in the case of linen was evident. The research proved the applicability of the Replenishment Solution to the linen management system.

Solution to core problem three: Lack of a problem-solving methodology. TOC places the problem-solving methodology into the scientific domain with the use of the Current Reality Tree and the Evaporating Cloud. The use of the EC generated an injection of reusing the destroyed linen.

Case Study two – Operating rooms: Since the constraint was at the consumption point, the solution was to increase the demand by introducing more surgeries into the operating theatres. Further careful study of the system showed that the real constraint was the subordination of the flow. The DBR designed to be applied in order to subordinate the flow through the OR.

8.3.3 How to cause the change - Action

- 3. Sub-research question three:** *What are the main difficulties identified during the implementation of the proposed solution to the existing functionality of the linen management system and of the operating rooms?*

Case Study one - Linen management system:

Difficulties in the implementation of the solution in one: The first main difficulty was people's resistance in building the CRT. People did not have a reason to change. Their silo mode of thinking put them into the defensive mode. The second difficulty was that the mismanagement of information and the lack of communication in combination with the absence of a piloting exercise caused the system to go into a chaotic state at the start-up of the implementation.

Difficulties in the implementation of the solution in two: Replenishment solution is based on buffer management principles. The lack of visualization of the buffers did not allow the management of the flow through the buffers penetration. Additionally, the Replenishment Solution worked for four months before returning back to the old way of operation.

Difficulties in the implementation of the solution in problem three: No difficulties were observed. A tailor was hired, and the majority of the linen were reused.

Case Study two – Operating Rooms: More surgeries could not be introduced because the available idle time was spread during the day in short blocks of time, making impossible to add additional work. The constraint could not be exploited. A new constraint should be chosen in order to manage the flow and isolate the idle times in a single chunk so that more surgeries could be introduced.

4. Sub-research question four: *How can the above difficulties be overcome?*

Case Study one - Linen management system:

Difficulties in the implementation of the solution in problem one: To overcome people's resistance, a structured training process was designed and implemented section 4.2.2. Additionally, the Goal Tree was used with incredible results. The participation of people and the positive energy from the Goal Tree facilitated the change process. Regarding the unstable status of the implementation, standardization concepts were introduced.

Difficulties in the implementation of the solution in problem two: Instead of replenishing based on buffer management, replenishment happened based on the occupancy report. This extended the planning horizon only one day forward, so replenishment was happening on demand.

Difficulties in the implementation of the solution in problem three: No difficulties were observed.

Case Study two – Operating Rooms: Drum Buffer Rope was applied by using doctor's time as Capacity Constraint Resource (CCR). This resulted in a continuation of flow pushing the idle times in the afternoon.

At the operating rooms, the job shop characteristics changed the philosophy of the DBR implementation since the focus should shift from the resource level to the process level. From the process level, the implementation was easier and clearer.

8.3.4 Evaluation

5. **Sub-research question five:** *Has the performance improved, of the linen management system and of the operating rooms after the implementation of the TOC?*

Case Study one - Linen management system:

Performance of solution one: Yes, the system improved. After the implementation of the TOC, the utilization figure of the linen management system was improved instantly by 15% (from 72% to 87%) because the available time of the constraint was reduced. The investment was canceled and the result of working only six days per week (including holidays) led to a saving of €40.000 per year. Important is, that management had a guide to judge if the operation was “costly” and they were in a position to understand the behavior of the system.

Performance of solution in two: Yes, the system improved but for only four months. The system then fell back to the previous state. We needed to reapply the Replenishment solution and design stabilization mechanisms into the system as explained in section 4.4.10.

Performance in solution three: Yes, the linen expenses fall by 40.000 euros after three years of operation when compared to the occupancy of the hospital.

Case Study two – Operating Rooms: The DBR worked very satisfactory at the chosen operating room. The idle time, as demonstrated, was accumulated in the afternoon to a three hour continues block of free time. Two more surgeries (of one hour each) or a two-hour surgery could be added in those three hours. Introducing more surgeries into the hospital though is a time-consuming process because agreements with more doctors should be made. At the same time, the supervisors at the surgery department should take detailed training on Drum Buffer Rope in order to apply the methodology to all operating rooms. The hospital’s management did not want to proceed at this moment in time with more additions, but they would seriously consider it shortly. The time limits of the research did not allow observation of how the system would behave with more surgeries, but we are confident that the addition of the extra surgeries it would be

a success. Management, doctors and the head nurse were confident as well. Assuming that the same situation is in the other five operating rooms then more than twelve surgeries could be added on a daily basis.

6. Sub-research question six: *What were the special challenges that the employees at the private hospital were facing regarding the adaptation of TOC?*

Soft issues – By initiating the change process with the “what to change”, resistance emerged. There are three main layers of resistance reported at TOC literature 1. Disagreement on the problem 2. Disagreement on solution 3. Disagreement on the implementation. This research showed though that before the three layers, a psychological resistance emerged. People felt insecure and threatened by not being convinced of our real intentions. This insecurity was strengthened during the construction of the CRT.

The development of the GT helped towards convincing them that the point of focus is the system and not human behavior. The fact that the GT discusses and analyses positive and constructive elements of the system elevated the energy of the team becoming more cooperative.

Hard issues - In both cases the findings were similar. Contrary to the TOC literature, TOC is not simple, and it is not straightforward. People need to shift their thinking to the systemic mode in order to be able to use the TOC philosophy and tools. A facilitator is needed for the development of the tools as it is a lengthy process with focused attention and disciplined procedures. Jargon words confuse people and must be abandoned from the beginning.

Training is vital before any attempt of TOC implementation. The training covered below areas:

1. Maintenance vs. improvement concepts.
2. Improvement concept and change questions.
3. System concepts.
4. Flow and constraint concepts.
5. TOC – Flow management.

7. Sub-research question seven: *Were there any unanticipated outcomes and how important were they?*

Yes, the unanticipated outcomes, their importance, and significance are discussed in detail in this chapter in the section “Unique Contributions, implications and Significance section 8.4. We would like to highlight the following though:

1. The Goal Tree changes the TOC perspective, and it also leverages the management of people’s resistance.
2. At the Five Focusing Steps, the subordination preceded exploitation. Humans, unconsciously have the tendency to mask the constraint, making exploitation very challenging. Placing the subordination first, the whole process of exploitation is facilitated.
3. There were theoretical developments proposed in chapter seven regarding the change sequence process, the logical thinking process, the five focusing steps, the Goal Tree and the Future Reality Tree. The theoretical contribution was based on the research findings.
4. A managerial template is developed accumulating and synthesizing all the output of this research work. The template can be used by managers and supervisors managing different type of systems, discussed in section 7.4.

The main research question is: *“Can the application of the TOC lead to operational improvements in the healthcare sector, at a private general-purpose clinic/hospital in Cyprus?”*

The answer is absolutely yes. Theory of Constraints was implemented in two different types of systems. In both systems, the TOC was successful but only after certain modifications were made according to the characteristics of every specific case. Theory of constraints has been proven to be an effective methodology at improving both systems. It can be used to Maximize Throughput in a healthcare environment, but it can also be applied to a system where Throughput does not have the highest priority.

TOC is applicable for different levels of management. It can be applied to high order systems from top managers in the hierarchy as well as from supervisors managing lower level systems.

8.4 Unique Contributions, implications and Significance – Purpose Statement

Theory of Constraints can be applied successfully in a healthcare environment. More specifically it has been proven an effective methodology at the OR environment as well as in a supportive system such as linen. The research outcome confirms current literature which supports that TOC can be applied to services and more specifically to healthcare, provided that certain adaptations and alterations must be made according to the specific use of the TOC and as it is proven by this research work.

The **uniqueness** of the research outcome lies in different dimensions of the TOC context. The uniqueness of the findings can be summarised as below:

1. Drum Buffer Rope was tested at the process level of an operating room for the first time. Subordination and managing the flow from the non-constraints to the operating room was proved to be straightforward and shifting the focus from the resource level to the process level seemed to be very satisfactory.
2. Implementation of the Theory of Constraints at the linen management system is reported for the first time. The implementation proved to be successful but only after certain changes to the approach.
3. This is the first research analyzing how to improve a system by “downsizing” a system based on the Theory Of Constraints theoretical framework. We succeeded, by managing the constraints of the system, to “right size” the whole system around that constraint.
4. This is the first study researching TOC application in an environment where Throughput is not priority number one. Since TOC is designed for improving

and growing systems, modifications to the theory was needed to adjust it in cases where downsizing and stabilization are required.

5. This is the first study placing subordination before exploitation. Humans, unconsciously have the tendency to mask the constraint, making exploitation very challenging. In both case studies, the real constraint was the subordination philosophy. Placing the subordination first, the whole process of exploitation is facilitated.
6. This research enriches the understanding of the GT. It is proved that the change process is facilitated when it begins with the GT.
7. Tested the TOC to people who have no systemic or operational knowledge.
8. This research recommends a training structure before the implementation of TOC.
9. Enriching literature by defining theoretical criteria for the GT and for the FRT to be used by people who are not TOC experts.
10. Concluding to a managerial template which can be used by professionals managing different systems in the Systems Of Systems hierarchy in order to improve a system.
11. This research describes a TOC implementation based on a blend of the Thinking Process Logical Tools and the Five Focusing Steps as required by the action research framework.

The **significance** of the findings can be summarised in four broad categories as:

1. Goal Tree significance – The Goal Tree shifts the TOC from a problem-solving methodology to a goal seeking methodology. Resistance evaporated in both case studies, and it transformed the whole experiment to a very constructive process.
2. Subordination precedes Exploitation significance – by placing subordination as the second step of the five focusing steps, exploitation becomes more effective. In both case studies, subordination policy was the actual constraint. In both cases, the systems were improved when subordination was streamlined. Section 6.3.3 describes the logic behind of this change.
3. Theoretical and practical development significance – Chapter seven produced theoretical changes which can assist and help TOC users to build robust trees

and to strengthen the TOC implementation. Additionally, the managerial template developed in chapter seven synthesizes all the research output in one diagram with the aim of guiding professionals implementing the TOC methodology.

4. Stability significance – Even of TOC is an improvement methodology, and by definition, it requires constant change, this research showed that stability is a system attribute that must be taken in consideration and be part of the design.

The implications of the research outcomes are discussed in three different contexts: 1. To the sphere of theory 2. To the sphere of practice and 3. To the sphere of future research.

8.4.1 Theoretical Contribution

This section discusses the theoretical contribution of this dissertation. It concludes and highlights the contribution of this research study to the management theory.

This research contributes to the Operations Management Theory by building on the conceptualization on how transformational processes are perceived through a causality perspective. The two components of the Theory of Constraints, Five Focusing Steps, and TP Tools, were blended to present a systemic solution. Most TOC research published is done on one of the two components at a time.

The research findings revealed different areas of improvement of the GT and FRT. Through a comprehensive review of the Systems Theory recommended criteria were proposed for both Trees as described in sections 7.3.1 and sections 7.3.2.

Criteria developed for the Goal Tree:

1. Operational Feasibility like Supportability (Support Functions) – Maintenance and logistics, sustainability, POOGI (T, I and OE), quality, knowledge, new product development, reliability, dependability, standardization and stability.
2. Financial Effectiveness like Profit, Cash Flow, operating expenses, ROI,
3. Commercial Acceptance like product acceptance, product awareness, inform customers about your product, customer satisfaction, functionality, place, price, promotion, product availability, freshness, important product attributes, product attractiveness attributes (quality, price, delivery delay, functionality, compatibility), market share, suitability to customer needs, quality, reliability, service and support, quality, reputation, competitive advantage, maintain robust marketing and sales functions, satisfy customers, preserve good name.
4. Human Factors like motivation, safety, training, abilities on task, behavioral issues, politeness, security.
5. Environmental conditions like laws, certifications,

Criteria developed for the FRT are the following:

1. Negative feedbacks or balancing feedback loops.
2. Characteristics of feedbacks.
3. The response that is triggered by the feedback must be strong, fast and effective, the feedback should be direct and avoid going through layers.
4. Build “sensors” able to “sense”, receive and interpret information.
5. Build in warning systems and react to those.
6. Build hierarchies, this is design clear boundaries to subsystems and design how they are synchronized together.
7. Perform audits. The root of stability. Find core sources of instability and remove them.
8. Build rules, policies, and standards.
9. Build measurements. Monitor performance against standards.

Other theoretical proposals drawn from chapter seven are:

1. The research confirms the importance of the addition of two more questions in the change sequence (described in section 7.2.1)
 - a. Why to change
 - b. How to cause the change
2. Places layer nine of resistance as first, which deals with social and psychological barriers.
3. The research confirms the proposal of Dettmer that the Logical Thinking Process should be initiated with the use of the Goal Tree (described in section 7.2.2)
4. The research proved that subordination should precede exploitation (described in section 7.2.3).

The main assumption of Theory of Constraints that Throughput has the highest priority of the three measurements was also challenged. The research findings showed that Theory of constraints philosophy could be used when Throughput does not have the highest priority as long as the Five Focusing Steps adopt to the new priority of measurements.

8.4.2 Managerial Contribution and Implications

The findings of this research support the fact that the Theory Of Constraints is an effective methodology in managing healthcare systems. It was shown that the TOC philosophy is applicable and effective in main healthcare systems (where Throughput is the number one priority) as well as in supportive systems (where Throughput is not priority number one). This characteristic makes TOC ideal for all levels of managers, supervisors, and professionals. TOC is suitable, as a management methodology, by different levels of management.

It was proven that TOC could be used not only for growing a system but for down-sizing as well. At the operating rooms, TOC's approach for scheduling all non-constraint activities on the basis of the constraint managed to allocate all the idle time in a single chunk where it is easier to take advantage and add additional surgeries.

It was also shown that even if the problem to be corrected is not known, the Theory of Constraints methodology follows a robust way of identifying the Critical Root Cause. The problem diagnosis is scientifically contacted in a way that core problems are addressed which when corrected the whole system is improved.

The keys to the success of the DBR methodology used at the operating room is the rope function which is the activation signal for the next patient to be released for surgery and the subordination function which delivers the patient to the operating room. We believe that this philosophy can be used to different operating room setups as long the activation signal and subordination are adjusted according to every specific case. We also support that this application of the Drum Buffer Rope to the process level and not to the resource level can be used to other job shop environments as well.

The GT facilitated the change process dramatically and influenced the participation of the people in the field positively. The implementation of the GT in combination with the fast results encouraged participants to participate in improvement initiatives and learning. We believe that the GT is a cornerstone to the TOC evolution.

Findings showed that TOC is not simple, and it is not straightforward. Special training is required before anyone is engaged in the TOC journey. A facilitator is needed especially in countries where TOC literature doesn't exist in the countries' language, eg Cyprus or Greece.

The template recommended at section 7.4, we believe that it is also a breakthrough as a result of this research. It forms a synthesis of the theoretical developments of the Five Focusing Steps, logical thinking process tools and change sequence as presented in the last chapter. It blends the Five Focusing Steps and the logical thinking tools in a single template with simple language and sequence, so it can be used by any level of manager. The template summarises the findings of this research, and it is subject for further verification and improvement. Although tested in one hospital – it is presented as a generic representation of the findings, so it can be accommodated to specific needs and environments by healthcare and service professionals.

8.4.3 Areas of further research

The outcomes of this research have placed the foundation for future researchers to take the knowledge further and in different directions. Additional studies could focus on expanding the TOC Logical Thinking Process Tools, 5FS and DBR implementations in other areas in the healthcare operational context.

Based on the knowledge acquired through this research, the following is recommended for future research:

1. Apply DBR in a constraint surgery department and observe waiting line improvements.
2. Apply more DBR implementations so comparisons can be made, and the existing findings can be further generalized.
3. Apply and examine DBR in job shop environments. Research in this area is very limited.
4. Research on how to embed DBR into the system's design. In this way, no management of the system is needed since the DBR will work by default as in the linen management system.
5. Design and test a network of multiple implementations of DBRs. For example, a DBR could be applied to manage the patient flow from the ward to the OR and another DBR manage the readiness of the OR. The two flows then could be synchronized by one central mechanism.
6. The GT should be researched in detail under the change process lenses and generalize this thesis's results.
7. The managerial template needs to be tested in other subsystems in the healthcare context.
8. Additionally, TOC should be tested in other support systems such as for medicine stock keeping and replenishing, applications in a different type of operating rooms to validate the applicability of DBR.
9. TOC's effect on leadership and human development traits.
10. Longer implementations should be researched in different specialties operating rooms and test the results. In linen, for example, the replenishment system

stopped working as designed because of reliability and stabilization issues after four months.

11. Development of a process mapping tool. TOC does not have a tool to capture the current reality of how an existing system behaves. A new tool should be developed examining an existing system through the TOC components.
12. Apply the theoretical developments described in chapter seven and verify empirically the recommendations.
13. We encourage future research of TOC measures and TOC accounting in the healthcare sector so the knowledge field can be completed and a more complete judgment on TOC effectiveness can be made.

8.5 Limitations

This research study has the following limitations:

1. Generalisation of results. The TOC was tested in only one hospital. TOC should be tested in more environments to be able to generalize results.
2. Sample size. DBR was tested on only one operating room. More operating rooms with a variety of types of surgeries should be tested in order to create a more unified view of the DBR.
3. Limited Time. Because of time constraints and hospital's policy the Theory Of Constraints and DBR, in particular, was tested only in one operating room for a limited time. A longer period of DBR implementation should give a deeper inside to the various aspects of the DBR.
4. Comparison. No previous DBR application at the process level of the operating room has been published. Comparison with other cases could provide a more objective view.
5. Not all TOC components were tested. For example, CCPM was not tested, or the effectiveness of the Prerequisite Tree was not tested since they were not needed.
6. Human responses. If the TOC had been applied for a longer period, doctors and nurses would maybe have reacted differently. It was known to the participants

that the research study would last for only a limited time and this may have affected their behavior.

8.6 Chapter Summary

This chapter concludes the overall thesis. It provides an overview of the whole thesis, its objectives and research questions. Then it concludes the thesis through two different themes.

The Chapter answers the research questions one by one in a clear way highlighting the output of the research and it also summarises the unique contributions of the findings through three different lenses – theoretical, managerial and future research perspectives.

References

- Ackoff, R.L., 2001. COMMUNICATIONS OR: after the post mortem. *System Dynamics Review*, 17(4), pp.341–346.
- Ackoff, R.L., 1999. *Re-creating the corporation: A design of organization for the 21st century.*, Oxford University Press, USA, 1 edition (July 29, 1999).
- Ackoff, R.L., 1979. The Future of Operational Research is Past." *Journal of the Operational Research Society*. *Journal of the operational research society*, 30(2), p.30(2): 93–104.
- Ackoff, R.L., Magidson, J. & Addison, H.J., 2006. *Idealized design: How to dissolve tomorrow's crisis... today*, Wharton School Publishing.
- Ackoff, R.L. & Vergara, E., 1981. Creativity in problem solving and planning: a review. *European Journal of Operational Research*, 7(1), pp.1–13.
- Adams, J. et al., 2007. *Research methods for graduate business and social science students*, SAGE publications India.
- Adcock, R., 2015. Guide to the Systems Engineering Body of Knowledge (SEBoK). *Hoboken, NJ: The Trustees of the Stevens Institute of Technology (SIT), April*, 14, p.v1.
- Afreen, M. & Iqbal, N., 2009. Evaluation of Laundry process applied to bed linen in selected hospitals of Karachi. *NURTURE: Journal of Pakistan Home Economics Association*, 3.
- Aguilar-Escobar, V.-G., Garrido-Vega, P. & González-Zamora, M.-M., 2015. Applying the theory of constraints to the logistics service of medical records of a hospital. *European Research on Management and Business Economics*, 22, pp.139–146.
- Andreou, M., Pasiardes, P. & Pasiourtidou, N., 2010. *Cost and value of health care in Cyprus*, University of Cyprus.
- Ary, D. et al., 2018. *Introduction to research in education*, Cengage Learning.
- Atweh, B., Kemmis, S. & Weeks, P., 2002. *Action research in practice: Partnership for social justice in education*, Routledge.
- Avizienis, A., 2001. *Fundamental Concepts of*, University of Newcastle upon Tyne, Computing Science.
- Azhar, S., Ahmad, I. & Sein, M.K., 2010. Action Research as a Proactive Research Method for Construction Engineering and Management. *Journal of Construction*

Engineering and Management, 136(1), pp.87–98.

- Bacelar-Silva, G.M. & Rodrigues, P.P., 2012. Applying TOC Buffer Management in Health Information Systems to Improve Hospital Performance. In *HEALTHINF*. pp. 345–349.
- Bahall, M., 2018. Health services in Trinidad: throughput, throughput challenges, and the impact of a throughput intervention on overcrowding in a public health institution. *BMC health services research*, 18(1), p.129.
- Bahri, S., Hamzah, D. & Yusuf, R.M., 2012. Implementation of Total Quality Management and Its Effect on Organizational Performance of Manufacturing Industries Through Organizational Culture in South Sulawesi, Indonesia. *IOSR journal of business and management*, 5(1), pp.10–24.
- Balakrishnan, J., Cheng, C.H. & Trietsch, D., 2008. The Theory of Constraints in Academia: Its Evolution, Influence, Controversies, and Lessons. *Operations Management Education Review*, 2, pp.97–114.
- Balderstone, S.J., 1999. Increasing User Confidence in System Dynamics Models Through Use of an Established Set of Logic Rules to Enhance Forrester and Senge's Validation Tests. In *The 17th International Conference of The System Dynamics Society*. pp. 1–9.
- Balderstone, S.J. & Mabin, V.J., 1998. A Review of Goldratt's Theory of Constraints (TOC) – lessons from the international literature. *Operational Research Society of New Zealand 33rd Annual Conference*, p.10.
- Banerjea-Brodeur, M. et al., 1998. Scheduling linen deliveries in a large hospital. *Journal of the Operational Research Society*, 49(8), pp.777–780.
- Barnard, A., 2016. *The Change Matrix Cloud Process*,
- Bayer, S., 2004. *Systems Thinking and Modeling for a Complex World*,
- Belvedere, V. & Grando, A., 2005. Implementing a pull system in batch/mix process industry through theory of constraints: A case-study. *Human Systems Management*, 24(1), pp.3–12.
- Berry, R. & Belle, L., 2005. Conceptual foundations for The Theory of Constraints. *Human Systems Management*, 24(1), pp.83–94.
- Bhattacharjee, P. & Ray, P.K., 2014. Patient flow modelling and performance analysis of healthcare delivery processes in hospitals: A review and reflections. *Computers & Industrial Engineering*, 78, pp.299–312.
- Bhuiyan, N. & Baghel, A., 2005. An overview of continuous improvement: from the past to the present. *Management Decision*, 43(5), pp.761–771.
- Blackstone, J.H., 2001. Theory of constraints - A status report. *International Journal*

- of Production Research*, 39(6), pp.1053–1080.
- Blanchard, B.S., 2008a. *SYSTEM ENGINEERING MANAGEMENT*,
- Blanchard, B.S., 2008b. *SYSTEM ENGINEERING MANAGEMENT*,
- Blanchard, B.S. & Fabrycky, W.J., 2011a. *Systems Engineering and Analysis*,
- Blanchard, B.S. & Fabrycky, W.J., 2011b. *Systems Engineering and Analysis - 5th Ed.*,
- Boaden, R. et al., 2008. *Quality improvement: theory and practice in healthcare*, NHS Institute for Innovation and Improvement.
- Boyd, L.H. & Cox, J.F., 2002. Optimal decision making using cost accounting information. *International Journal of Production Research*, 40(8), pp.1879–1898.
- Boyd, L.H. & Gupta, M., 2004. Constraints management: What is the theory? *International Journal of Operations & Production Management*, 24, pp.350–371.
- Boyd, L.H., Gupta, M. & Sussman, L., 2001. A New Approach to Strategy Formulation: Opening the Black Box. *Journal of Education for Business*, 76(6), pp.338–344.
- Boyer, K.K., Gardner, J.W. & Schweikhart, S., 2012. Process quality improvement: An examination of general vs. outcome-specific climate and practices in hospitals. *Journal of operations management*, 30(4), pp.325–339.
- Breen, A.M., Burton-Houle, T. & Aron, D.C., 2002. Applying the Theory of Constraints in Health Care: Part 1 - The Philosophy. *Quality Management in Health Care*, 10(3), pp.40–46.
- Brennan, L.L., 2010. *The McGraw-Hill 36-hour Course: Operations Management*, McGraw Hill Professional.
- Brunton, M., 2005. Emotion in health care: The cost of caring. *Journal of Health, Organisation and Management*, 19(4–5), pp.340–354.
- Buchanan, D. & Wilson, B., 1996. Re-engineering operating theatres: the perspective assessed. *Journal of Management in Medicine*, 10(4), pp.57–74.
- Burge, S., 2015. An Overview of the Soft Systems Methodology. *System Thinking: Approaches*.
- Burton-Houle, T., 2001. The theory of constraints and its thinking processes. *Goldratt institute*.
- Castaño, J.D.M. et al., 2013. Theory of constraints in the service sector: Characterization for banking and analysis of the factors involved in its adoption. In *International Conference on Exploring Services Science*. pp. 58–72.
- CENTENARY, B., 1998. The Father of OR.
- Chahal, H., Gupta, M. & Lonial, S., 2018. Operational flexibility in hospitals: Scale

- development and validation. *International Journal of Production Research*, pp.1–23.
- Chakravorty, S.S., 2001. An evaluation of the DBR control mechanism in a job shop environment. *The International Journal of Management Science*, 29(4), pp.335–342.
- Chalice, R., 2007. *Improving healthcare using Toyota lean production methods: 46 steps for improvement*, ASQ Quality Press.
- Chan, S.Y.W. & Chan, Y.K., 2017. Exploiting Concealed Hospital Capacities-A Focus Workflow Improvement Approach.
- Chase, R.B., 1978. Where does the customer fit in a service operation? *Harvard Business Review*.
- Chase, R.B., Aquilano, N.J. & Jacobs, F.R., 1998. *Production and operations management*, Irwin/McGraw-Hill,.
- Chawla, S. & Kant, R., 2017. Application of Theory of Constraints in Service Type Organization. *International Journal*, 5(3), pp.366–371.
- Chen, H.T., 2016. Interfacing theories of program with theories of evaluation for advancing evaluation practice: Reductionism, systems thinking, and pragmatic synthesis. *Evaluation and program planning*, 59, pp.109–118.
- Choe, K. & Herman, S., 2004. Using theory of constraints tools to manage organizational change: a case study of Euripa Labs. *International Journal of Management & organisational behavior*, 8(6), pp.540–558.
- Chung, R.D. et al., 2017. A systematic review of intraoperative process mapping in surgery. *Gland surgery*, 6(6), p.715.
- Cifalino, A. & Baraldi, S., 2009. Training programs and performance measurement: Evidence from healthcare organisations. *Journal of Human Resource Costing & Accounting*, 13(4), pp.294–315.
- Clark, J., 2011. Systems Engineering Fundamentals Tutorial. *DoD, Department of Defense (USA)*.
- Cochran, D.S. et al., 2016. A System Design of a Rural Hospital Operating Room. *Procedia CIRP*, 50, pp.672–677.
- Coghlan, D., 2011. Action research: Exploring perspectives on a philosophy of practical knowing. *Academy of Management Annals*, 5(1), pp.53–87.
- Cohen, D.J. & Crabtree, B.F., 2008. Evaluative criteria for qualitative research in health care: controversies and recommendations. *The Annals of Family Medicine*, 6(4), pp.331–339.

- Coman, A. et al., 1995. Information technology in operations management: A theory-of-constraints approach. *INTERNATIONAL JOURNAL OF PRODUCTION RESEARCH*, 33(5), pp.1403–1415.
- Coman, A. & Ronen, B., 2009. Focused SWOT: diagnosing critical strengths and weaknesses. *International Journal of Production Research*, 47(20), pp.5677–5689.
- Committee, M.A. & others, 1999. Theory of Constraints (TOC) management system fundamentals. *New Jersey: Institute of Management Accounts*.
- Cooper, M.J., 2013. Improving Focus and Predictability with Critical Chain Project Management.
- Cooper, M.J. & Loe, T.W., 2000. Using the theory of constraints' thinking processes to improve problem-solving skills in marketing. *Journal of Marketing Education*, 22(2), pp.137–146.
- Costas, J. et al., 2015. Applying Goldratt's Theory of Constraints to reduce the Bullwhip Effect through agent-based modeling. *Expert Systems with Applications*, 42(4), pp.2049–2060.
- Costin, C.L., 2015. Craft Specialization. *The International Encyclopedia of Human Sexuality, First Edition*.
- Coughlan, P. & Coughlan, D., 2002. Action research for operations management. *International Journal of Operations & Production Management*, 22(1995), pp.220–240.
- Cox III, J.F. et al., 2012. *The Theory of Constraints International Certification Organization Dictionary* Second Edi.,
- Cox III, J.F., Mabin, V.J. & Davies, J., 2005. A case of personal productivity: Illustrating methodological developments in TOC. *Human Systems Management*, 24(1), pp.39–65.
- Cox III, J.F. & Schleier, J.G., 2010. *Theory of Constraints Handbook*, McGraw-Hill.
- Creswell, J.W., 1998. Qualitative inquiry and research design: Choosing among five tradition.
- Creswell, J.W. & Creswell, J.D., 2017. *Research design: Qualitative, quantitative, and mixed methods approaches*, Sage publications.
- Cunningham, A.J., 2017. Improving operating room productivity and efficiency--are there any simple strategies? *Romanian journal of anaesthesia and intensive care*, 24(2), p.87.
- D'Andreamatteo, A. et al., 2014. Lean in healthcare: A comprehensive review. *Health Policy*, 119(9), pp.1197–1209.

- Dalci, I. & Kosan, L., 2012. Theory of Constraints Thinking-Process Tools Facilitate Goal Achievement for Hotel Management: A Case Study of Improving Customer Satisfaction. *Journal of Hospitality Marketing & Management*, 21(5), pp.541–568.
- Davies, J., Mabin, V. & Cox, J., 2004. The theory of constraints and system dynamics: a suitable case for multi-methodology. *Proceedings of the 22nd Systems Dynamics Conference*, pp.1–27.
- Davies, J., Mabin, V.J. & Balderstone, S.J., 2005. The theory of constraints: A methodology apart? - A comparison with selected OR/MS methodologies. *Omega*, 33(6), pp.506–524.
- Dawson, C., 2002. *Practical research methods: a user-friendly guide to mastering research techniques and projects*, How to books Ltd.
- Deming, W.E., 2018. *Out of the Crisis*, MIT press.
- Deming, W.E., 1982. Quality, productivity, and competitive position. *MIT Center for Advanced Engineering, Cambridge*.
- Denton, B.T., 2013. Handbook of healthcare operations management. *New York: Springer*, 10, pp.971–978.
- Dettmer, H.W., 2001. Beyond Lean manufacturing: Combining Lean and the Theory of Constraints for higher performance. *Goal System International. Port Angeles, WA, USA*.
- Dettmer, H.W., 1998. *Breaking the Constraints to World-Class Performance*, American Society for Quality.
- Dettmer, H.W., Changing the Status Quo.
- Dettmer, H.W., 1997. *Goldratt's theory of constraints: a systems approach to continuous improvement*, ASQ Quality Press.
- Dettmer, H.W., 2016a. *Logic and Hare Krishnas*,
- Dettmer, H.W., 2003. *Strategic navigation: A systems approach to business strategy*, ASQ Quality Press.
- Dettmer, H.W., 2011. Systems thinking and the cynefin framework: A strategic approach to managing complex systems. *Goal Systems International*, pp.1–41.
- Dettmer, H.W., 2016b. *The logical thinking process: a systems approach to complex problem solving*, ASQ Quality Press.
- Dettmer, H.W., 2007. *The logical thinking process: A systems approach to complex problem solving*, ASQ Quality Press.
- Dettmer, H.W. & Schragenheim, E., 2000. *Simplified Drum-Buffer-Rope A Whole*

- System Approach to High Velocity Manufacturing*,
Dettmer, W., 2007. *The Intermediate Objectives Map*,
- Dinham, A., 2011. Why patients get delayed. , pp.1–28.
- Djellal, F. & Gallouj, F., 2005. Mapping innovation dynamics in hospitals. *Research policy*, 34(6), pp.817–835.
- Duclos, L.K. & Spencer, M.S., 1995. The impact of a constraint buffer in a flow shop. *International journal of production economics*, 42(2), pp.175–185.
- Edmonstone, J., 1982. Human service organisations: implications for management and organisation development. *Management Education and Development*, 13(3), pp.163–173.
- Ehie, I. & Sheu, C., 2005. Integrating six sigma and theory of constraints for continuous improvement: A case study. *Journal of Manufacturing Technology Management*, 16(5), pp.542–553.
- Elg, M., Palmberg Broryd, K. & Kollberg, B., 2013. Performance measurement to drive improvements in healthcare practice. *International Journal of Operations & Production Management*, 33(11/12), pp.1623–1651.
- Erasmus, L., Poluta, M. & Weeks, R., 2012. Integrated assessment and management of health care infrastructure and technology. *Features Innovate* 7, 7, pp.1–9.
- Eugene, L. et al., 2006. *Improving Patient Flow and Throughput in California Hospitals Operating Room Services*,
- Fanta, G.B. & Erasmus, L., 2014. A Systems Engineering Perspective on eHealth Implementations' Efficiency and Effectiveness: A Case Study involving suppliers. In *INCOSE International Symposium*. pp. 55–68.
- Fedurko, J., 2013. *Through Clouds to Solutions*, Tallin, Estonia: TOC Strategic Solutions, Ltd.
- Flood, R.L., 1999. *Rethinking the Fifth Discipline: knowing with the unknowable*, Routledge.
- Floyd, B. & Ronen, B., 1989. Where best to system invest. *Datamation*, 35(22), p.111.
- Fong, A.J., Smith, M. & Langerman, A., 2016. Efficiency improvement in the operating room. *journal of surgical research*, 204(2), pp.371–383.
- Forrester, J.W., 1997. Industrial dynamics. *Journal of the Operational Research Society*, 48(10), pp.1037–1041.
- Forster, N., 2005. *Maximum performance: A practical guide to leading and managing people at work*, Edward Elgar Publishing.
- Foster-Fishman, P.G., Nowell, B. & Yang, H., 2007. Putting the system back into

- systems change: A framework for understanding and changing organizational and community systems. *American journal of community psychology*, 39(3–4), pp.197–215.
- Fox, R.E. & Pirasteh, R.M., 2011. *Profitability with No Boundaries*, ASQ Quality Press.
- Fragapane, G.I. et al., 2018. Material Distribution and Transportation in a Norwegian Hospital: A Case Study. *IFAC-PapersOnLine*, 51(11), pp.352–357.
- Framinan, J.M., 2005. Efficient heuristic approaches to transform job shops into flow shops. *IIE Transactions*, 37(5), pp.441–451.
- Fry, T.D., Cox, J.F. & Blackstone Jr., J.H., 1992. An analysis and discussion of the Optimized Production Technology software and its use. *Production and Operations Management*, 1(2), pp.229–242.
- Garcia, S.M., Tor, A. & Schiff, T.M., 2013. The Psychology of Competition: A Social Comparison Perspective. *Perspectives on Psychological Science*, 8(6), pp.634–650.
- Gardiner, S.C., Blackstone, J.H. & Gardiner, L.R., 1994. The evolution of the theory of constraints. *INDUSTRIAL MANAGEMENT-CHICAGO THEN ATLANTA-*, 36, p.13.
- Gardiner, S.C., Blackstone Jr, J.H. & Gardiner, L.R., 1993. Drum-buffer-rope and buffer management: impact on production management study and practices. *International Journal of Operations & Production Management*, 13(6), pp.68–78.
- Given, L.M., 2008. *The Sage encyclopedia of qualitative research methods*, Sage Publications.
- Glushko, R.J., 2010. Where does the customer fit in a service operation? In *Harvard Business Review*. Springer, pp. 137–142.
- Godinho Filho, M. et al., 2015. Improving hospital performance by use of lean techniques: An action research project in Brazil. *Quality Engineering*.
- Goldratt-Ashlag, E., 2010. The layers of resistance – The buy-in process according to TOC. *Theory of Constraints Handbook*, pp.571–601.
- Goldratt, E.M., 1994, *It's Not Luck*, (Great Barrington, MA: North River).
- Goldratt, E.M., 1988. Computerised Shop Floor Scheduling. *International Journal of Production Research*, 26(3), pp.443–456.
- Goldratt, E.M., 1988. Computerized shop floor scheduling. *International Journal of Production Research*, 26(3), pp.443–455.
- Goldratt, E.M., 1996. My saga to improve production. *APICS THE PERFORMANCE*

ADVANTAGE, 6, pp.34–37.

- Goldratt, E.M., 2008. *Standing on the Shoulders of Giants*,
- Goldratt, E.M., 1990. *The Haystack Syndrome*,
- Goldratt, E.M., 1990. Theory of Constraints. *Great Barrington: North River Press*, pp.1–159.
- Goldratt, E.M. & Cox, J., 1992. *The Goal*. Great Barrington, MA. *North River Press*, 10, pp.343–354.
- Goldratt, E.M. & Cox, J., 1984. *The Goal*,
- Goldratt, E.M. & Fox, R.E., 1986. *The Race*, New York: North River Press.
- Gowen, C.R., Kathleen, M.F. & Settaluri, S., 2012. Contrasting continuous quality improvement, Six Sigma, and lean management for enhanced outcomes in US hospitals. *American Journal of Business*, 27(2), pp.133–153.
- Greener, S., 2008. *Business research methods*, BookBoon.
- Grida, M. & Zeid, M., 2018. A system dynamics-based model to implement the Theory of Constraints in a healthcare system. *SIMULATION*, p.0037549718788953.
- Guide Jr, V.D.R., 1996. Scheduling using drum-buffer-rope in a remanufacturing environment. *International Journal of Production Research*, 34(4), pp.1081–1091.
- Gulsun, B. et al., 2009. Improving system performance: the theory of constraints and an application in a production firm. *Society of Manufacturing Engineers*.
- Gupta, M., 2003. Constraints management--recent advances and practices. *International Journal of Production Research*, 41(4), pp.647–659.
- Gupta, M., Boyd, L. & Sussman, L., 2004. To better maps: A TOC primer for strategic planning. *Business Horizons*, 47(2), pp.15–26.
- Gupta, M., Ko, H. & Min, H., 2002. TOC-based performance measures and ® ve focusing steps in a job-shop. *International Journal of Production Research*, 40(4), pp.907–930.
- Gupta, M., Snyder, & D. & Snyder, D., 2009. Comparing TOC with MRP and JIT: a literature review. *International Journal of Production Research*, 47(13), pp.3705–3739.
- Gupta, M.C. & Boyd, L.H., 2008. Theory of constraints: a theory for operations management. *International Journal of Operations & Production Management*, 28(10), pp.991–1012.
- Gupta, M.C. & Kerrick, S.A., 2014. A Conflict Resolution Tool for Project Managers: Evaporating Cloud. *Journal of International Technology & Information*

- Management*, 23(3/4), pp.61–74.
- Gupta, M.C., Sahi, G.K. & Chahal, H., 2013. Improving market orientation: the theory of constraints-based framework. *Journal of Strategic Marketing*, 21(4), pp.305–322.
- Hasenfeld, Y.Z., 1999. Human service organizations and the production of moral categories.
- Hashim, M., 1984. Reliability Concepts Applied to Service Industries. *International Journal of Quality & Reliability Management*, 1(1), pp.39–50.
- Hellström, A., Lifvergren, S. & Quist, J., 2010. Process management in healthcare: investigating why it's easier said than done. *Journal of Manufacturing Technology Management*, 21(4), pp.499–511.
- Higgins, T.J., 1966. Systems engineering handbook. In *Journal of the Franklin Institute*. pp. 522–523.
- Hill, A. V, 2007. The Encyclopedia of Operations Management Terms. *A Field Manu.*
- Hoss, M. & ten Caten, C.S., 2013. Lean schools of thought. *International Journal of Production Research*, 51(11), pp.3270–3282.
- Howe, C., 2013. Quality improvement in health care: is it mustard or ketchup? *Journal of health services research & policy*, 18(3), pp.179–81.
- Hudson, J.D., 2017. Cl6 allows three shots at better improvement. *ISE Magazine*.
- Hunink, M.G.M., 2001. In search of tools to aid logical thinking and communicating about medical decision making. *Medical Decision Making*, 21(4), pp.267–277.
- Hussain, S.T. et al., 2018. Kurt Lewin's change model: A critical review of the role of leadership and employee involvement in organizational change. *Journal of Innovation & Knowledge*, 3(3), pp.123–127.
- Hutchin, T., 2001. *Unconstrained Organisations: Managing Sustainable Change: Unlocking the Potential of People Within Organisations*, Thomas Telford.
- Iles, V. & Sutherland, K., 2001. *Managing change in the NHS: Organisational change: A review for health care managers, professionals and researchers*, National Co-ordinating Centre for NHS Service Delivery & Organisation R & D.
- INCOSE Technical Board, 2004. Systems Engineering Handbook: A “What To” Guide for All SE Practitioners. In *Systems Engineering*. p. 308.
- Isaksson, R., 2006. Total quality management for sustainable development. *Business Process Management Journal*, 12(5), pp.632–645.
- Jackson, S., 2001. Successfully implementing total quality management tools within healthcare: what are the key actions? *International Journal of Health Care Quality*

- Assurance*, 14(4), pp.157–163.
- Jaeck, P., 2014. *Pratiques Manageriales et “Theory of Constraints.”* University Of Strasbourg.
- Jebali, A. & Diabat, A., 2017. A Chance-constrained operating room planning with elective and emergency cases under downstream capacity constraints. *Computers and Industrial Engineering*.
- Jebali, A. & Diabat, A., 2015. A stochastic model for operating room planning under capacity constraints. *International Journal of Production Research*, 53(24), pp.7252–7270.
- de Jesus Pacheco, D.A., 2014. Theory of constraints and Six Sigma: investigating differences and similarities for continuous improvement. *Independent Journal of Management & Production*, 5(2), p.331.
- Jha, R.K., Sahay, B.S. & Charan, P., 2016. Healthcare operations management: a structured literature review. *Decision*, 43(3), pp.259–279.
- Johnston, R. & Clark, G., 2008. *Service operations management: improving service delivery*, Pearson Education.
- Joosten, T., Bongers, I. & Janssen, R., 2009. Application of lean thinking to health care: issues and observations. *International Journal for Quality in Health Care*, 21(5), pp.341–347.
- Kaizen, I.M., 1986. *The Key to Japan’s Competitive Success*. MacGraw-Hill, New York.
- Kaplan, R.S. & Porter, M.E., 2011. How to solve the cost crisis in health care. *Harv Bus Rev*, 89(9), pp.46–52.
- Kaplan, R.S., Witkowski, M.L. & Hohman, J.A., 2012. Schön Klinik: Measuring Cost and Value. *Harvard Business School Case*.
- Karnon, J. et al., 2012. Modeling using discrete event simulation: a report of the ISPOR-SMDM Modeling Good Research Practices Task Force--4. *Medical decision making*, 32(5), pp.701–711.
- Kast, F.E. & Rosenzweig, J.E., 1972. General Systems Theory: Applications for Organization and Management. *Academy of Management Journal*, 15(4), pp.447–465.
- Kauffman, D.L., 1980. *Systems One: An Introduction to Systems Thinking*, Future Systems Minneapolis, MN.
- Kaye, M. & Anderson, R., 1999. Continuous improvement: the ten essential criteria. *international journal of quality & Reliability Management*, 16(5), pp.485–506.

- Kershaw, R., 2000. USING TOC TO “CURE” Healthcare Problems. *Management Accounting Quarterly*, 1(3), p.1.
- Khourshed, N.F., 2011. The Relation between Resistance to Change and Theory of Constraints. In *The Eight International Conference of Global Academy Of Business & Economic*.
- Kim, C.S., Spahlinger, D. a & Billi, J.E., 2009. Creating Value in Health Care: The Case for Lean Thinking. *JCOM*, 16(12), pp.557–562.
- Kim, D.H., 2000. Systems Archetypes I: Diagnosing Systemic Issues and Designing High-Leverage Interventions Pegasus Communications.
- Kim, S., Mabin, V.J. & Davies, J., 2008. The theory of constraints thinking processes: retrospect and prospect. *International Journal of Operations & Production Management*, 28(2), pp.155–184.
- Kimbrough, C.W. et al., 2015. Improved Operating Room Efficiency via Constraint Management: Experience of a Tertiary-Care Academic Medical Center. *Journal of the American College of Surgeons*, 221(1), pp.154–62.
- Klein, J.H. & Young, T., 2015. Health care: a case of hypercomplexity? *Health Systems*, 4(2), pp.104–110.
- Klingenberg, B. & Watson, K., 2010. Intellectual Property Exchange Between Two Partner Companies-Application of the Theory of Constraints Thinking Processes. *Journal of Business and Management*, 16(2), p.125.
- Knight, A., 2011. *The Theory of Constraints in health and social care*,
- Koshy, E., Koshy, V. & Waterman, H., 2010. *Action research in healthcare*, Sage.
- Kosieradzka, A., Kakol, U. & Krupa, A., 2011. The Development of Production Management Concepts. *Foundations of Management*, 3(2), p.55.
- Kotter, J.P., 1995. Leading Change: Why Transformation Efforts Fail. (cover story). *Harvard Business Review*, 73(2), pp.59–67.
- Kotter, J.P. & Schlesinger, L.A., 1979. Choosing strategies for change for overcoming it. *Harvard Business Review*, 57(2), pp.106–114.
- Kouritzin, S.G., Piquemal, N.A.C. & Norman, R., 2009. *Qualitative research: Challenging the orthodoxies in standard academic discourse (s)*, Routledge.
- Kouzes, J.M. & Mico, P.R., 1979. Domain Theory: An Introduction to Organizational Behavior in Human Service Organizations. *The Journal of Applied Behavioral Science*, 15(4), pp.449–469.
- Krafcik, J.F., 1988. Triumph of the lean production system. *Sloan Management Review*, 30(1), pp.41–52.

- Kumar, S., Dhingra, A. & Singh, B., 2018. Lean-Kaizen implementation: A roadmap for identifying continuous improvement opportunities in Indian small and medium sized enterprise. *Journal of Engineering, Design and Technology*, 16(1), pp.143–160.
- Landry, S. & Philippe, R., 2004. How logistics can service healthcare. In *Supply Chain Forum: An International Journal*. pp. 24–30.
- Larkin, H., 2006. Integral management and the effective human service organization. *AQAL: The Journal of Integral Theory and Practice*, 1 (3), 184, 203.
- Larsson, G. & Berg, V., 1991. Linen in the hospital bed: effects on patients' well-being. *Journal of advanced nursing*, 16(8), pp.1004–1008.
- Lechler, T.G., Ronen, B. & Stohr, E.A., 2005. Critical Chain: A New Project Management Paradigm or Old Wine in New Bottles? *Engineering Management Journal*, 17(4), pp.45–58.
- Lepore, D. & Cohen, O., 1999. *Deming and Goldratt: the theory of constraints and the system of profound knowledge: the decalogue*, North River Press.
- Levasseur, R.E., 2001. People Skills : Change Management Tools — Lewin ' s Change Model. *Interfaces*, 31(August), pp.71–73.
- Lewin, K., 1946. Action Research and Minority Problems. *Journal of Social Issues*, 2(4), pp.34–46.
- LIKER, J.K., 2004. *The Toyota Way*, McGraw-Hill.
- Lillrank, P., Groop, J. & Venesmaa, J., 2011. Processes, episodes and events in health service supply chains. *Supply Chain Management: An International Journal*, 16(3), pp.194–201.
- Littlejohn, S.W. & Foss, K.A., 2009. *Encyclopedia of communication theory*, Sage.
- Litvak, E. et al., 2005. Managing unnecessary variability in patient demand to reduce nursing stress and improve patient safety. *The Joint Commission Journal on Quality and Patient Safety*, 31(6), pp.330–338.
- Litvak, E. & Long, M.C., 2000. Cost and quality under managed care: Irreconcilable differences. *Am J Manag Care*, 6(3), pp.305–312.
- Lloyd J. Taylor III Becki Murphy William Price, (2006), 2006. Goldratt's thinking process applied to employee retention. *Business Process Management Journal*, 12(5), pp.646–670.
- Lockamy, a. & Spencer, M.S., 1998. Performance measurement in a theory of constraints environment. *International Journal of Production Research*, 36(8), pp.2045–2060.

- Longenecker, C.O., Papp, G. & Stansfield, T., 2009. Quarterbacking real and rapid organizational improvement. *Leader to Leader*, 2009(51), pp.17–23.
- Lubitsh, G., Doyle, C. & Valentine, J., 2005. The impact of theory of constraints (TOC) in an NHS trust. *Journal of Management Development*, 24(2), pp.116–131.
- Mabin, V.J. et al., 1999. A change is a good as a rest: Using the theory of constraints to resolve resource constraints in a large public hospital. In *Proceedings of the 42nd Annual Meeting of Decision Sciences Institute, Boston, November 19-22 2011*. pp. 4271–4279.
- Mabin, V.J., 1999. "Goldratt's" Theory of Constraints" thinking processes: A systems methodology linking soft with hard.". In *Proceedings of the 17th International System Dynamics Conference and 5th Australian and New Zealand Systems Conference*. pp. 1–12.
- Mabin, V.J., 2017. Theory of Constraints: A Research Data Base. Available at: <https://www.victoria.ac.nz/som/research/theory-of-constraints>.
- Mabin, V.J. & Balderstone, S.J., 2003. The performance of the theory of constraints methodology: Analysis and discussion of successful TOC applications. *International Journal of Operations & Production Management*, 23(6), pp.568–595.
- Mabin, V.J. & Davies, J., 2003. Framework for understanding the complementary nature of TOC frames: Insights from the product mix dilemma. *International Journal of Production Research*, 41(4), pp.661–680.
- Mabin, V.J., Davies, J. & Cox, J.F., 2006. Using the theory of constraints thinking processes to complement system dynamics' causal loop diagrams in developing fundamental solutions. *International Transactions in Operational Research*, 13(1), pp.33–57.
- Mabin, V.J., Forgeson, S. & Lawrence, G., 2001. Harnessing resistance: using the theory of constraints to assist change management. *Journal of European Industrial Training*, 25(2–4), pp.168–191.
- MacDonald, C., 2012. Understanding Participation Action Research: A Qualitative Research Methodology Option. *The Canadian Journal of Action Research*, 13(2), pp.34–50.
- Malhorta, V., 2006. What should anesthesiologists Know about operating room management. *Revista Mexicana de Anestesiología*, 29(S1), pp.83–88.
- Martínez-García, M. & Hernández-Lemus, E., 2013. Health systems as complex systems. *American Journal of Operations Research*, 2013(January), pp.113–126.
- Mason, S.E., Nicolay, C.R. & Darzi, A., 2015. The use of Lean and Six Sigma methodologies in surgery: a systematic review. *The Surgeon*, 13(2), pp.91–100.

- Matopoulos, A. & Michailidou, L., 2013. Healthcare supply chains: a case study of hospital-vendor collaborative practices. *International Journal of Logistics Systems and Management*, 15(2), pp.288–303.
- May, J.H. et al., 2011. The surgical scheduling problem: Current research and future opportunities. *Production and Operations Management*.
- Mazzocato, P. et al., 2010. Lean thinking in healthcare: a realist review of the literature. *BMJ Quality & Safety*, p.qshc--2009.
- McDermott, A.M. et al., 2017. Performance management in context: formative cross-functional performance monitoring for improvement and the mediating role of relational coordination in hospitals. *International Journal of Human Resource Management*, pp.1–21.
- McKay, J. & Marshall, P., 2001. The dual imperatives of action research. *Information Technology & People*, 14(1), pp.46–59.
- Mcleod, A., 2009. Conceptual development of an introductory lean manufacturing course for freshmen and sophomore level students in industrial technology. *Technology Interface Journal*, 10(1), pp.1–13.
- McLoughlin, J.B. & Webster, J.N., 1970. Cybernetic and general-system approaches to urban and regional research: a review of the literature. *Environment and Planning A*, 2(4), pp.369–408.
- Meadows, D.H., 2008. *Thinking in Systems: A Primer*,
- Mento, A., Jones, R. & Dirndorfer, W., 2002. A change management process: Grounded in both theory and practice. *Journal of Change Management*, 3(1), pp.45–59.
- Meyer, A. De et al., 2008. the Next Competitive Battle Flexibility : the Manufacturing Futures Survey. *Management*, 10(2), pp.135–144.
- De Meyer, A. & Ferdows, K., 1990. Lasting Improvements In Manufacturing Performance: In Search Of A New Theory. *Journal of Operations Management*, 9(2), pp.168–184.
- Mill, J.S., 1884. *A system of logic, ratiocinative and inductive: Being a connected view of the principles of evidence and the methods of scientific investigation*, Longmans, green, and Company.
- Mirzaei, M. & Mabin, V., 2017. Agile project management and public policy development projects: A case study from New Zealand. *New Zealand Journal of applied Business Research*, 15(1), pp.59–76.
- MITRE, 2004. *Systems Engineering guide*,
- Mohammadi, A. & Eneyo, E.S., 2012. Application of Drum-Buffer-Rope Methodology

- in Scheduling of Healthcare System. In *POMS 23rd Annual Conference*. pp. 1–18.
- Mol, A., 1990. *Help! I'am a Manager*, Tafelberg.
- Monat, J. & Gannon, T., 2015. What is Systems Thinking? A Review of Selected Literature Plus Recommendations. *American Journal of Systems Science*, 4(1), pp.11–26.
- Moon, S., 2004. Taking cost off supply shelf. Healthcare turning to supply chain management techniques honed by retail, manufacturing to limit inventory, slash expenses. *Modern healthcare*, 34(47), p.26.
- Moons, K., Waeyenbergh, G. & Pintelon, L., 2019. Measuring the logistics performance of internal hospital supply chains--a literature study. *Omega*, 82, pp.205–217.
- Moran, J.W. & Brightman, B.K., 1998. Effective management of healthcare change. *The TQM Magazine*, 10(1), p.27.
- Morgan, D.L., 1998. Practical strategies for combining qualitative and quantitative methods: Applications to health research. *Qualitative Health Research*, 8(3), pp.362–376.
- Morgan, G., 1997. *Images of Organization* 2nd Editio., SAGE Publications, Inc.
- Morrison, B. & Lilford, R., 2001. How can action research apply to health services? *Qualitative Health Research*, 11(4), pp.436–449.
- Motwani, J., Klein, D. & Harowitz, R., 1996a. The theory of constraints in services: part 1-the basics. *Managing Service Quality: An International Journal*, 6(1), pp.53–56.
- Motwani, J., Klein, D. & Harowitz, R., 1996b. The theory of constraints in services: part 2 - examples from health care. *Managing Service Quality*, 6(2), pp.30–34.
- Musa, M.A. & Othman, M.S., 2016. Business Process Reengineering in Healthcare: Literature Review on the Methodologies and Approaches. *Review of European Studies*, 8(1), p.20.
- Nagarkatte, U. & Oley, N., 2010. *Theory of Constraints (TOC) Thinking Process (TP) Tools in academia*,
- Naor, M., Bernardes, E.S. & Coman, A., 2013. Theory of constraints: is it a theory and a good one? *International Journal of Production Research*, 51(May 2015), pp.1–13.
- Nave, D., 2002. How to compare six sigma, lean and the theory of constraints. *Quality progress*, 35(3), pp.73–80.
- Nelson, B. & Sproull, R., 2015. *Focus and leverage : the critical methodology for*

- theory of constraints, lean, and six sigma (TLS)*, Routledge.
- Nie, W. & Kellogg, D.L., 2009. How Professors of Operations Management View Service Operations? *Production and Operations Management*, 8(3), pp.339–355.
- Nwabueze, U., 2011. Implementing TQM in healthcare: The critical leadership traits. *Total Quality Management*, 22(3), pp.331–343.
- Oliver, N., 1990. Can JIT Concepts Improve Personal Productivity? *Leadership & Organization Development Journal*, 11(7), pp.22–27.
- Onursal, F.S., Birgün, S. & Mızrak, E., 2018. Analyzing the Delivery Process with TOC. In *The International Symposium for Production Research*. pp. 645–659.
- Organization, W.H. & others, 2012. Introduction to quality improvement methods.
- Pacheco, D. et al., 2014. Strategies for Increasing Productivity in Production Systems. *Independent Journal of Management & Production*, 5(2), pp.344–359.
- Pandit, S. V. & Naik, G.R., 2006. Application of theory of constraints on scheduling of drum-buffer-rope system. *IOSR Journal of Mechanical and Civil Engineering*, pp.15–20.
- Panizzolo, R., 2016. Theory of constraints (TOC) production and manufacturing performance. *International Journal of Industrial Engineering and Management*, 7(1), pp.15–23.
- Parkinson, C.N. & Osborn, R., 1957. *Parkinson's Law, and Other Studies in Administration: And Other Studies in Administration*, Houghton Mifflin.
- Patrick, F.S., 2001. Using Resistance to Change (and the TOC Thinking Processes) to Improve Improvements. In *IIE Solutions Conference, Institute of Industrial Engineers*,.
- Peery, N.S., 1975. GENERAL SYSTEMS THEORY APPROACHES TO ORGANIZATIONS: SOME PROBLEMS IN APPLICATION. *Journal of Management Studies*, 12(3), pp.266–275.
- Peltokorpi, A. et al., 2016. Applying the Theory of Constraints to Improve Throughput in a Forensic DNA Laboratory. *Forensic Science Policy & Management: An International Journal*, 7(1–2), pp.37–49.
- Perry, C., 2016. Applying a systems approach to resolving complex, in the voluntary sector. In *The Voluntary Sector and Volunteering Research Conference*.
- Pirasteh, R.M. & Farah, K.S., 2006. Continuous improvement trio: The top elements of TOC, lean and six sigma make beautiful music together. *APICS, May 2006*.
- Pirasteh, R.M. & Kannappan, S., 2013. The synergy of continuous process improvement. *Industrial Engineer*, 45(6), pp.41–45.

- Plantin, A. & Johansson, M.I., 2012. Implementing production planning processes in health care--a case study of a surgery clinic. In *Proceedings of PLAN Research and Application Conference, Lund, August 2012*.
- Poksinska, B., 2010. The current state of Lean implementation in health care: literature review. *Quality Management in Healthcare*, 19(4), pp.319–329.
- Polito, T., Watson, K. & Vokurka, R.J., 2006. Using the theory of constraints to improve competitiveness: an airline case study. *Competitiveness Review*, 16(1), pp.44–50.
- Politou, A. & Georgiadis, P., 2008. Production planning and control in flow shop operations using drum buffer rope methodology: a system dynamics approach. In *Proceedings of the 26th International Conference of the System Dynamics Society, Athens, Greece, Curran Associates, Inc., New York, NY*. pp. 1–18.
- Porter, M.E., 2011. *Competitive advantage of nations: creating and sustaining superior performance*, Simon and Schuster.
- Porter, M.E., 2010. What Is Value in Health Care? *The NEW ENGLAND JOURNAL of MEDICINE*, 363(26), p.5.
- Porter, M.E. & Lee, T.H., 2013. The strategy that will fix health care. *Harvard Business Review*.
- Porter, M.E. & Teisberg, E.O., 2006. Redefining health care: creating value-based competition on results Harvard Business School Press. *Boston, Mass.*, pp. xvii.
- Potter, C., Morgan, P. & Thompson, A., 1994. Continuous quality improvement in an acute hospital: a report of an action research project in three hospital departments. *International Journal of Health Care Quality Assurance*, 7(1), pp.4–29.
- Powell, T.C., 1995. Total quality management as competitive advantage: a review and empirical study. *Strategic management journal*, 16(1), pp.15–37.
- Pretorius, P., 2014. Introducing in-between decision points to TOC's five focusing steps. *International Journal of Production Research*, 52(2), pp.496–506.
- Pyzdek, T., 2003. The six sigma handbook :The six sigma handbook: The complete guide for greenbelts, blackbelts, and managers at all levels, revised and expanded edition. , p.830.
- R., J., 2005. Service operations management: Return to roots. *International Journal of Operations and Production Management*, 25(12), pp.1278–1297.
- Rahman, S., Goldratt's Thinking Process Approach to Developing Strategies in Supply Chain. *Copyright Warning*, p.299.
- Rahman, S., 1998. Theory of constraints A review of the philosophy and its applications. *International Journal of Operations & Production Management*,

- 18(4), pp.336–355.
- Rais, A. et al., 2018. Optimization of logistics services in hospitals. *International Transactions in Operational Research*.
- Reid, P.P. et al., 2005. Building a better delivery system a new engineering/health care partnership.
- Reid, R. a. & Cormier, J.R., 2003. Applying the TOC TP: a case study in the service sector. *Managing Service Quality*, 13, pp.349–369.
- Reid, R.A., 2007. Applying the TOC five-step focusing process in the service sector. *Managing Service Quality: An International Journal*, 17(2), pp.209–234.
- Reznick, D. et al., 2016. Dedicated teams to improve operative room efficiency. *Perioperative Care and Operating Room Management*, 3, pp.1–5.
- Riezebos, J., Korte, G.J. & Land, M.J., 2003. Improving a practical DBR buffering approach using workload control. *International Journal of Production Research*, 41(4), pp.699–712.
- RINGIM, K.J., HASNAN, N. & RAZALLI, M.R., APPLYING THEORY OF CONSTRAINTS TO ACHIEVE THE OPERATIONAL PERFORMANCE OF BANKS.
- Ritson, N. & O'Neill, M., 2006. Strategic implementation: a comparison of three methodologies. *Strategic Change*, 15(4), pp.187–196.
- Ritson, N. & Waterfield, N., 2005. Managing change: the theory of constraints in the mental health service. *Strategic Change*, 14(8), pp.449–458.
- Ronen, B., 2005. Special issue on the Theory of Constraints--Practice and Research. *Human Systems Management*, 24(1), pp.1–2.
- Ronen, B. & Pass, S., 2008. *Focused operations management: Achieving more with existing resources*, John Wiley & Sons.
- Ronen, B. & Pliskin, J.S., 2006. *Focused operations management for health services organizations*, Jossey-Bass.
- Ronen, B., Pliskin, J.S. & Pass, S., 2012. *Focused operations management for health services organizations*, John Wiley & Sons.
- Ronen, B. & Spector, Y., 1992. Managing system constraints: a cost/utilization approach. *The International Journal Of Production Research*, 30(9), pp.2045–2061.
- Ronen, B. & Starr, M.K., 1990. Synchronized manufacturing as in OPT: from practice to theory. *Computers & Industrial Engineering*, 18(4), pp.585–600.
- Rothstein, D.H. & Raval, M. V, 2018. Operating room efficiency. In *Seminars in*

- pediatric surgery*. pp. 79–85.
- Rothwell, W.J. & Sullivan, R.L., 2005. *Practicing organization development: A guide for consultants*, John Wiley & Sons.
- Rotstein, Z. et al., 2002. Management by constraints: Considering patient volume when adding medical staff to the emergency department. *Israel Medical Association Journal*, 4(3), pp.170–173.
- Roy, R.N., 2004. A modern Approach to OPERATIONS MANAGEMENT. *New Age International Publishers*, 162.
- Russell, G.R. & Fry, T.D., 1997. Order review/release and lot splitting in drum-buffer-rop. *International journal of production research*, 35(3), pp.827–845.
- Sabbadini, F. et al., 2014. A Method to Improve the Accessibility and Quality of a Brazilian Public Emergency Hospital Service. In *Fourth International Conference on Industrial Engineering and Operations Management (IEOM 2014)*.
- Sage, A.P. & Rouse, W.B., 2009. *Handbook of systems engineering and management*, John Wiley & Sons.
- Sahraoui, A. & Elarref, M., 2014. Bed crisis and elective surgery late cancellations: An approach using the theory of constraints. *Qatar Medical Journal*.
- Samoutis, G. & Paschalides, C., 2011. When will the sun shine on Cyprus’s National Health Service? *The Lancet*.
- Sampson, S.E., 2014. *Essentials of service design and innovation developing high-value service businesses with PCN analysis*, SES.
- Sandy L. Furterer, 2012. Applying lean Six Sigma to reduce linen loss in an acute care hospital. *International Journal of Engineering, Science and Technology*, 3(7), pp.39–55.
- Dos Santos, R.F. et al., 2010. A real application of the theory of constraints to supply chain management in Brazil. *Brazilian Journal of Operations & Production Management*, 7(2), pp.81–100.
- Sara, T. et al., 2015. Agile, a guiding principle for health care improvement? *International Journal of Health Care Quality Assurance*, 28(5), pp.468–493.
- Saunders, M., Lewis, P. & Thornhill, A., 2009. *Research Methods for Business Students*,
- Scheinkopf, L.J., 1999. Thinking for a Change: Putting the TOC Thinking Processes to Use. *The St Lucie Press APICS Series on Constraints Management*, p.xiv, 255 p. : ill.
- Schmenner, R.W., 1986. How can service businesses survive and prosper. *Sloan*

- management review*, 27(3), pp.21–32.
- Schneider-Kamp, P., 2002. An analysis of Critical Chain concepts in the context of their possible application to traditional project management. *Electronic Theses and Dissertations*.
- SCHRAGENHEIM, E., COX, J. & RONEN, B., 1994. Process flow industry—scheduling and control using theory of constraints. *International Journal of Production Research*, 32(8), pp.1867–1877.
- Schragenheim, E. & Ronen, B., 1991. Buffer management: a diagnostic tool for production control. *Production and Inventory Management Journal*, 32(2), pp.74–79.
- Schragenheim, E. & Ronen, B., 1990. Drum-buffer-rope shop floor control. *Production and Inventory Management Journal*, 31(3), pp.18–22.
- Schroeder, D.M. & Robinson, A.G., 1991. America’s most successful export to Japan: continuous improvement programs. *Sloan Management Review*, 32(3), pp.67–81.
- Scott, D.L., 2011. *Process principles and improvements: A case study of the healthcare industry*. Capella University.
- Scott, E.S., 2012. Visualizing Service Operations. *Journal of Service Research*, 15(2), pp.182–198.
- Senge, P.M., 2006. *The fifth discipline: the art and practice of the learning organization.*, Crown Pub.
- Shewhart, W.A., 1931. *Economic control of quality of manufactured product*, ASQ Quality Press.
- Shisko, R. & Aster, R., 2007. NASA Systems Engineering Handbook. *Systems Engineering*, 6105, p.360.
- Shoemaker, T.E. & Reid, R.A., 2005. Applying the TOC Thinking Process: A case study in the government sector. *Human Systems Management*, 24(1), pp.21–37.
- Siddique, K. et al., 2012. One-stop cholecystectomy clinic: an application of lean thinking-can it improve the outcomes? *Journal of perioperative practice*, 22(11), pp.360–365.
- Siha, S., 1999a. A classified model for applying the theory of constraints to service organizations. *Managing Service Quality*, 9(4), pp.255–264.
- Siha, S., 1999b. A classified model for applying the theory of constraints to service organizations. *Managing Service Quality: An International Journal*, 9(4), pp.255–264.
- Sikkandarbash, B.A.N., 2014. Productivity improvement through application of

- theory of constraints and lean principles. In *International Journal of Innovative Research in Science, Engineering and Technology*. p. 7.
- Simatupang, T.M., Wright, A.C. & Sridharan, R., 2004. Applying the theory of constraints to supply chain collaboration. *Supply Chain Management-an International Journal*, 9(1), pp.57–70.
- Şimşit, Z.T., Günay, N.S. & Vayvay, Ö., 2014. Theory of Constraints: A Literature Review. *Procedia - Social and Behavioral Sciences*, 150(231), pp.930–936.
- Singh, J. & Singh, H., 2012. Continuous improvement approach: state-of-art review and future implications. *International Journal of Lean Six Sigma*, 3(2), pp.88–111.
- Sirkin, H.L., Keenan, P. & Jackson, A., 2005. The hard side of change management. *Harvard business review*, 83(10), p.108.
- Slack, N., Brandon-Jones, A. & Johnston, R., 2013. *Operations management*, Pearson.
- Soliman, M. & Saurin, T.A., 2017. Lean production in complex socio-technical systems: a systematic literature review. *Journal of Manufacturing Systems*, 45, pp.135–148.
- Sommer, K.A. & Mabin, V.J., 2016. Insights into the eldercare conundrum through complementary lenses of Boardman’s SSM and TOC’s Evaporating Cloud. *European Journal of Operational Research*, 248(1), pp.286–300.
- de SOUZA, M.C., SOUZA, T.A. & VACCARO, G.L.R., 2016. Hospital bed management: an analysis from the perspective of the theory of constraints. *Revista ESPACIOS| Vol. 37 (Nº30) Año 2016*.
- Spagnol, G.S., Min, L.L. & Newbold, D., 2013. Lean principles in Healthcare: an overview of challenges and improvements. *IFAC Proceedings Volumes*, 46(24), pp.229–234.
- Spear, S. & Bowen, H.K., 1999. Decoding the DNA of the Toyota production system. *Harvard business review*, 77(5), pp.96–106.
- Spear, S.J., 2005. Fixing health care from the inside, today. *Harvard business review*, 83(9), p.78.
- Spencer, M.S.& J.F.C., 1995. Optimum production technology (OPT) and the theory of constraints (TOC): Analysis and geneology. *International Journal of Production Economics*, 33(6), pp.37–41.
- Sreejesh, S., Mohapatra, S. & Anusree, M.R., 2014. *Business research methods: An applied orientation*, Springer.
- Stanciu, A., Vargas, L. & May, J., 2010. A revenue management approach for managing operating room capacity. In *Proceedings of the Winter Simulation Conference*. pp. 2444–2454.

- Stein, R.E., 1996. *Re-engineering the manufacturing system*, Marcel Dekker.
- Sterman, J.D., 2000. *Business dynamics: systems thinking and modeling for a complex world*,
- Steven, M., 2009. Trimming waste?: A guide to six sigma, lean, and the theory of constraints. *Canadian Plastics*, p.19.
- Stratton, R. & Knight, A., 2010a. Managing patient flow using time buffers. *Journal of Manufacturing Technology Management*, 21(4), pp.484–498.
- Stratton, R. & Knight, A., 2010b. Managing patient flow using time buffers M. Leseure, ed. *Journal of Manufacturing Technology Management*, 21(4), pp.484–498.
- Stratton, R., Robey, D. & Allison, I., 2008. Utilising buffer management to manage uncertainty and focus improvement. In *International Annual Conference of EurOMA*. pp. 1–10.
- Strear, C. et al., 2010. 30: Applying the Theory of Constraints to Emergency Department Workflow: Reducing Ambulance Diversion Through Basic Business Practice. *Annals of Emergency Medicine*, 56(3), p.S11.
- Sufahani, S.F., Razali, S.N.A. & Ismail, Z., 2012. A scheduling problem for hospital operating theatre. *arXiv preprint arXiv:1205.2108*.
- Šukalová, V. & Ceniga, P., 2015. Application of the Theory of Constraints Instrument in the Enterprise Distribution System. In *Procedia Economics and Finance*. Elsevier B.V., pp. 134–139.
- Swinehart, K. & Green, R.F., 1995. Continuous improvement and TQM in health care: an emerging operational paradigm becomes a strategic imperative. *International journal of health care quality assurance*, 8(1), pp.23–27.
- Tabish, S.A. & Syed, N., 2015. Securing the Future: A Systems Approach to Continuous Improvement in Health Care by Applying the Theory of Constraints. *International Journal of Science and Research (IJSR)*, 4(1), pp.2674–2695.
- Tagaduan, D., 2009. Consideration about theory of constraints (TOC). *Agricultural Management/Lucrari Stiintifice Seria I, Management Agricol*, 11(3).
- Talcott, P., 2013. *The social system*, Routledge.
- Taylor III, Lloyd J; Sheffield, D., 2002. Goldratt's Thinking Process Applied to Medical Claims Processing. *Hospital Topics*, 80(4), p.13.
- Taylor, J.L. & Nayak, S., 2012. Goldratt's Theory Applied to the Problems Associated with an Emergency Department at a Hospital. *Administrative Sciences*, 2(4), pp.235–249.
- Taylor, L.J., 1988. Segregation, collection and disposal of hospital laundry and waste.

- Journal of Hospital Infection*, 11, pp.57–63.
- Taylor, L.J. & Churchwell, L., 2004. Goldratt's thinking process applied to the budget constraints of a Texas MHMR facility. *Journal of health and human services administration*, 26(4), pp.416–37.
- Taylor, L.J. & Thomas, E.E., 2008. Applying Goldratt's thinking process and the theory of constraints to the invoicing system of an oil and gas engineering consulting firm. *Performance Improvement*, 47(9), pp.26–34.
- Thomas, H. & Dobbs, M.E., 2007. Addressing ill-structured problems using Goldratt's thinking processes. *Management Decision Journal of Management Development*, 43(1), pp.113–122.
- Thürer, M. et al., 2017. Drum-buffer-rope and workload control in High-variety flow and job shops with bottlenecks: An assessment by simulation. *International Journal of Production Economics*, 188, pp.116–127.
- Trietsch, D., 2005. WHY A CRITICAL PATH BY ANY OTHER NAME WOULD SMELL LESS SWEET? *Project Management Journal*, 36(1), pp.27–36.
- Trochim, W.M., 2006. The Research Methods Knowledge Base, 2nd Edition. Available at: <http://www.socialresearchmethods.net/kb> [Accessed August 31, 2016].
- Tsitsakis, C., Polychronidou, P. & Karasavoglou, A., 2017. The problem of capacity management in Greek public hospitals. *KnE Social Sciences*, 1(2), pp.414–420.
- Tulasi, C.L. & Rao, A.R., 2012. REVIEW ON THEORY OF CONSTRAINTS. *International Journal of Advances in Engineering & Technology*, 30(2), pp.357–399.
- Umble, M., Umble, E. & Murakami, S., 2006. Implementing theory of constraints in a traditional Japanese manufacturing environment: The case of Hitachi Tool Engineering. *International Journal of Production Research*, 44(10), pp.1863–1880.
- Umble, M. & Umble, E.J., 2006. Utilizing buffer management to improve performance in a healthcare environment. *European Journal of Operational Research*, 174(2), pp.1060–1075.
- Unghanse, F., 2013. Employing Theory of Constraints in Warehousing Operation: Case Study at Harald Pihl AB.
- Vargas, P. et al., TOC'S Five-Step Cycle: An Approach to Instant Results and Cultural Change.
- Vashdi, D.R., Bamberger, P.A. & Erez, M., 2013. Can surgical teams ever learn. *The role of*.
- Villarreal, B. et al., 2018. Improve an emergency medical system capacity with theory

- of constraints. In *Proceedings of the 2nd European Conference on Industrial Engineering and Operations Management (IEOM)*.
- Viola, N. et al., 2012. Functional Analysis in Systems Engineering. In *Methodology and Applications in Systems Engineering – Practice and Theory*. InTech.
- Vissers, J. & Beech, R., 2005. *Health operations management: patient flow logistics in health care*, Psychology Press.
- Volland, J. et al., 2017. Material logistics in hospitals: A literature review. *Omega (United Kingdom)*.
- Waddell, D. & Sohal, A.S., 1998. Resistance: a constructive tool for change management. *Management decision*, 36(8), pp.543–548.
- Wahlers, J.L. & Cox, J.F., 1994. Competitive factors and performance measurement: Applying the theory of constraints to meet customer needs. *International Journal of Production Economics*, 37(2–3), pp.229–240.
- Waring, J.J. & Bishop, S., 2010. Social Science & Medicine Lean healthcare : Rhetoric , ritual and resistance. *Social Science & Medicine*, 71(7), pp.1–9.
- Wasterlain, A.S. et al., 2015. Can We Improve Workflows in the OR? *Bulletin of the Hospital for Joint Diseases*, 73(1).
- Watson, H.E., McKenna, M.A. & McLean, G.M., 1992. TQM and services: implementing change in the NHS. *International Journal of Contemporary Hospitality Management*, 4(2).
- Watson, K.J., Blackstone, J.H. & Gardiner, S.C., 2007. The evolution of a management philosophy: The theory of constraints. *Journal of Operations Management*, 25(2), pp.387–402.
- Wheeler, D.S., Tofani, B. & Morris, B., 2016. Transformational Change in Health Care Through Operational Excellence. *Current Treatment Options in Pediatrics*, 2(4), pp.332–338.
- Wilson Perumal & Company, 2015. Creating High Reliability Organizations. *National Energy Board Pipeline Safety Forum*, 145(22), p.46.
- Womack, J.P. et al., 1991. *The machine that changed the world: the story of lean production*, Harper Collins.
- Wright, J. & King, R., 2006. *We all fall down: Goldratt's theory of constraints for healthcare systems*, North River Press Great Barrington, MA.
- Wu, H.-H. et al., 2010. A study of an enhanced simulation model for TOC supply chain replenishment system under capacity constraint. *Expert Systems with Applications*, 37(9), pp.6435–6440.

- Wu, H.-H. et al., 2013. A study of theory of constraints supply chain replenishment system. *International Journal of Academic Research in Accounting, Finance and Management Sciences*, 3(3), pp.78–88.
- Wu, H.-H. et al., 2011. Simulation and Implementation Study of Robust Drum-Buffer-Rope Management System to Improve Shop Performance. *International Journal of Humanities and Social Science*, 1(1), pp.14–22.
- Yasin, M.M. et al., 2002. An empirical investigation of the effectiveness of contemporary managerial philosophies in a hospital operational setting. *International Journal of Health Care Quality Assurance*, 15(6), pp.268–276.
- Young, T. et al., 2004. Using industrial processes to improve patient care. *British Medical Journal*, 328(7432), pp.162–164.
- Zabada, C., Rivers, P.A. & Munchus, G., 1998. Obstacles to the application of total quality management in health-care organizations. *Total Quality Management*, 9(1), pp.57–66.
- Zivaljevic, A., 2015. Theory of constraints – application in land transportation systems. *Management of Environmental Quality: An International Journal*, 26(4), pp.505–517.

Appendix

Appendix 1: Thesis Timeline

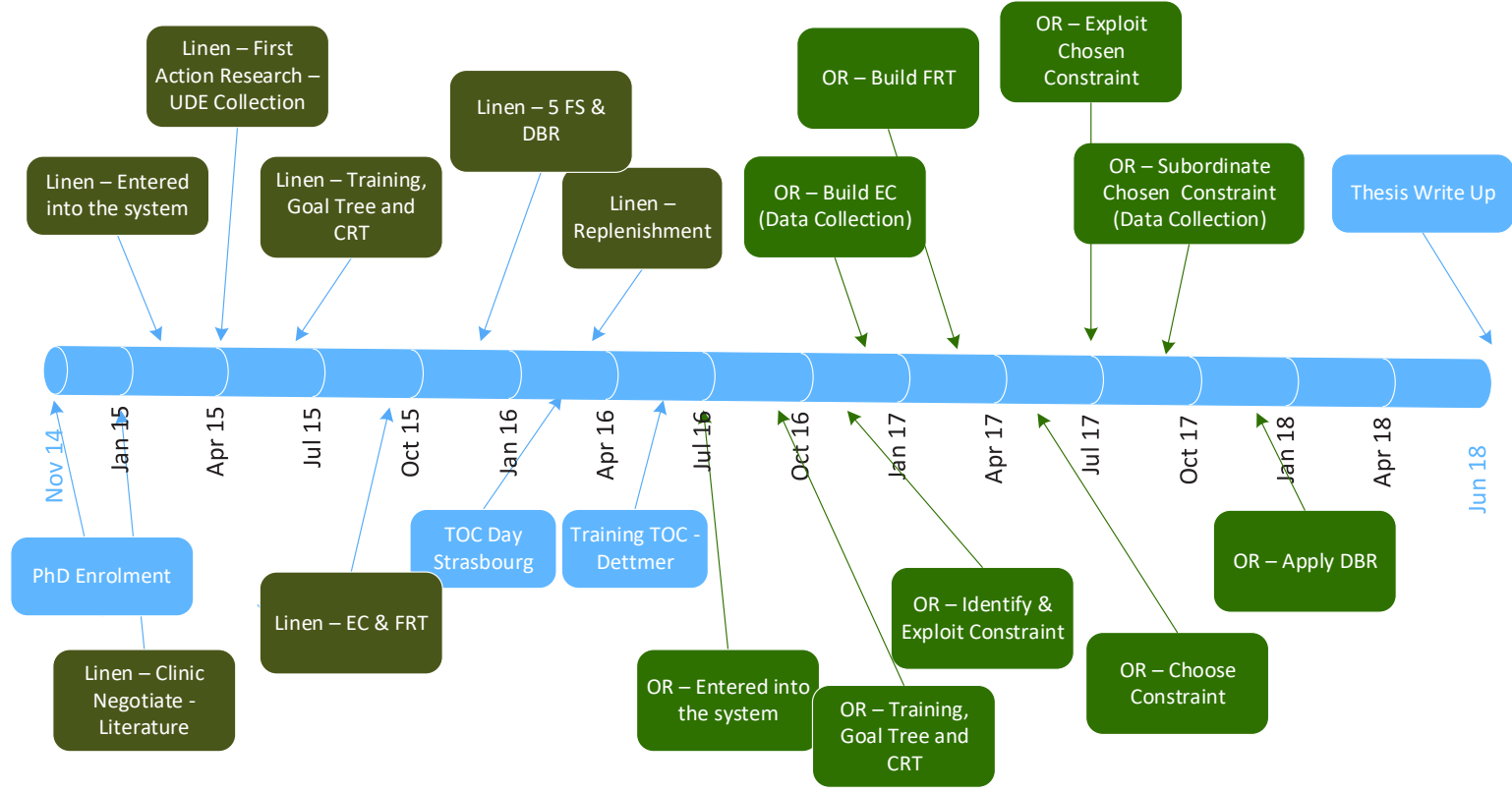

Appendix 2: FBDs of the linen management system

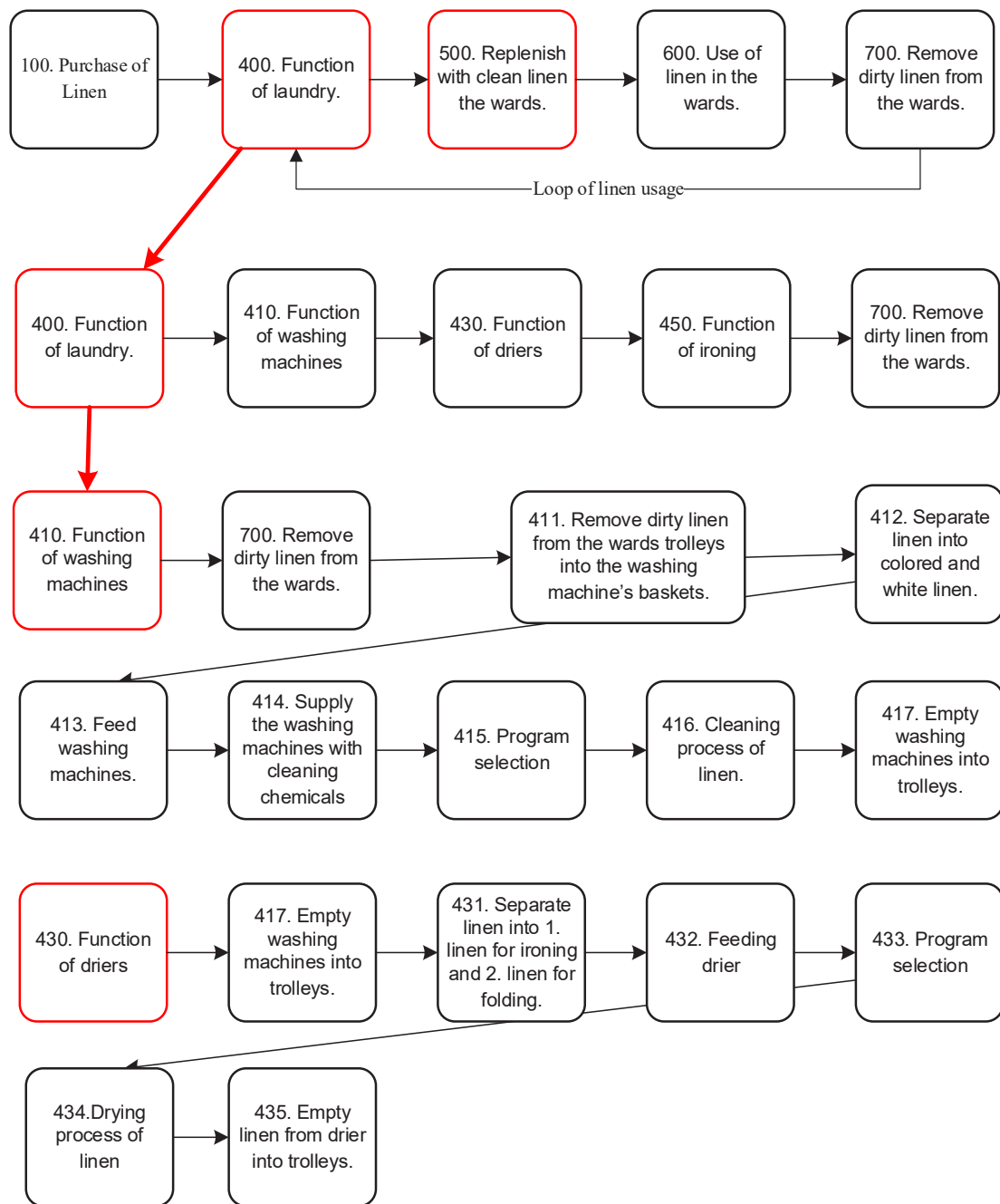

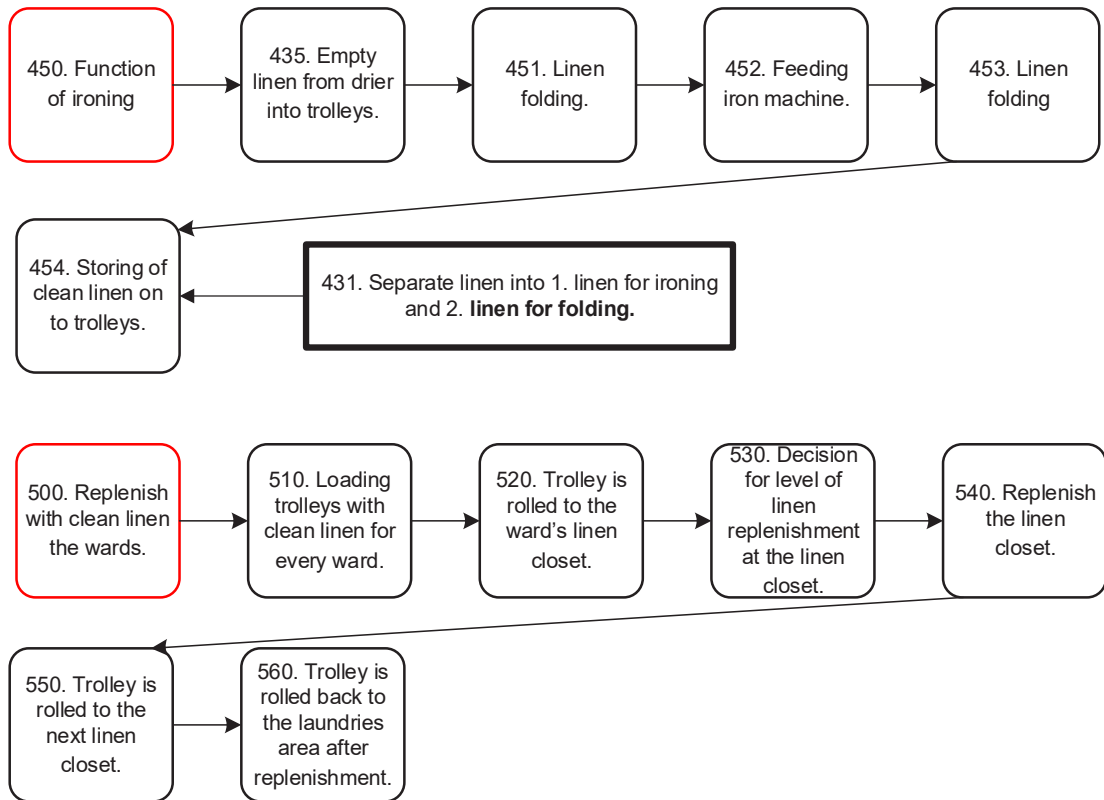

Appendix 3: Goal Tree Template (Dettmer 2016b)

1. Define the System

- Decide on the system boundary: international, national, state, corporate, division, family, personal, and so on.

2. Determine the System Goal

- What is the single outcome for which the system exists?
- What would the system's owners say it is?
- Obtain consensus on the goal if others are responsible for setting it.

3. Determine the Critical Success Factors (CSFs)

- What are the 3-5 high-level terminal conditions that must be satisfied for the goal to be achieved?
- Ensure that they are the last milestones to be achieved before the goal can be declared satisfied.

4. Determine the Key Necessary Conditions (NCs)

- What key activities or tasks are required to realize the CSFs? (No more than 3-5 per CSFs.)
- Limit your NCs to no more than two layers in the final IO Map. (If you have more, trim some off.)

5. Arrange the GT Components

- Goal at the top
- CSFs below the goal
- NC below the CSFs

6. Connect the Goal, CSFs, and NCs

- Use single arrows (no ellipses or magnitudinal "AND" symbols).
- Connect vertically.
- Connect horizontally, as dictated by the situation.

7. Verify the Connections

- Necessity logic, not sufficiency
- Cross-check finished connections with your intuition ("10,000-foot view")

8. Enlist Outside Scrutiny of the Entire GT

- Identify and insert any missing CSFs.
- Identify and insert any missing NCs.
- Identify and attach any missing connections.
- Rearrange entities to minimize "cross-overs."
- "Trim off" any low-level NCs that would be better addressed in execution planning (not "destination determination").
- Obtain outside scrutiny when you think its complete and as good as you can make it.



GOAL

CSF #1

CSF #2

CSF #3

NC-1a

NC-1b

NC-2a

NC-3a

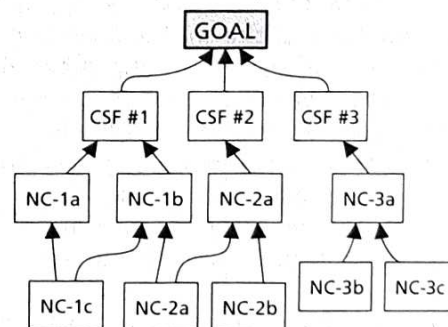

Appendix 4: Current Reality Tree Template (Dettmer 2016b)

1. Define the system to be modeled.

- Is it:
 - A person?
 - An organization?
 - A process?
 - A historical event?
- Create a clear mental image of what lies within the system and what lies in the external environment in which the system operates.

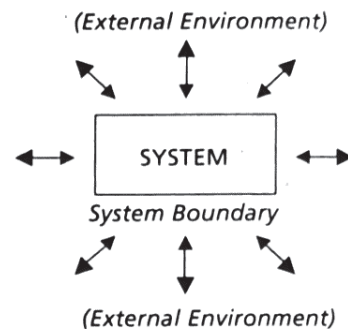

2. Determine the Undesirable Effects (UDE).

- Construct a GT (if not already done).
- Identify the system performance benchmarks:
 - Goal
 - Critical Success Factors (CSF)
 - Necessary Conditions (NC)
- Assess current reality against each benchmark:
 - Is there a deviation?
 - If so, define and articulate it in a complete sentence.
- Write and number the deviation as an UDE on a uniquely-colored Post-it Note.
- Arrange the UDEs horizontally on the workspace.

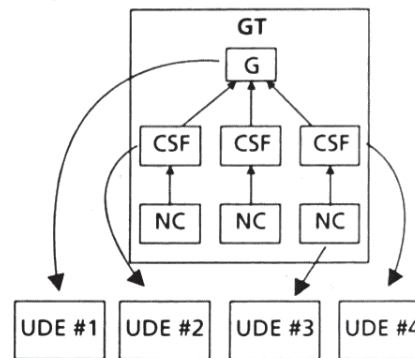

3. Determine the Two Preceding Layers of Causes.

- On a tablet, create a two-layer matrix of causes for each UDE:
 - Determine the two preceding causes of each UDE.
 - Enter these as complete sentences in the appropriate block of the matrix.
- When the matrix is completely filled, transfer the causal statements to Post-it Notes.
- Position the causal Post-it Notes directly beneath their respective UDEs.
- Connect the three entities vertically with dotted-line arrows.

UDE #	1	2	3	4
Cause Layer #1	xxxx	xxxx	xxxx	xxxx
Cause Layer #2	xxxx	xxxx	xxxx	xxxx

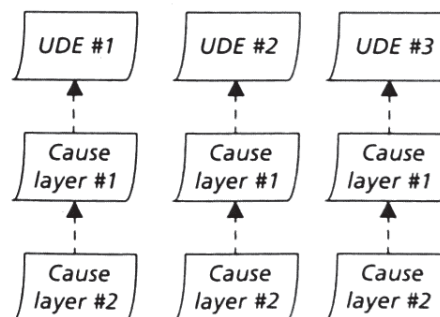

4. Begin the Current Reality Tree.

- Transfer the Post-it Notes you created in Step-3 to a large sheet of paper.
- Arrange the Post-it Notes with the UDEs at the top, the FIRST causal layer below them, and the second causal layer below that layer.
- Retain the same relative position as in the matrix.
- Connect causal layers with a single dotted-line arrow.
- Allow adequate lateral space between clusters.

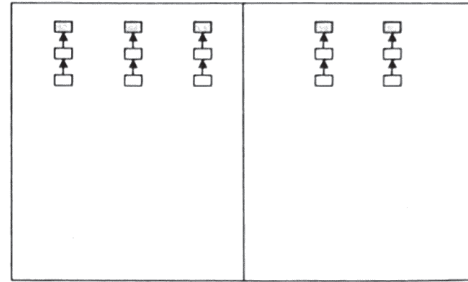

5. Improve the Logic of the Initial Clusters

- Use the CLR to evaluate and perfect each connection in each cluster:
 - Clarity
 - Entity Existence
 - Causality Existence
 - Cause Insufficiency
- Add entities, arrows, and ellipses where required.
- Stop only when you are sure the logic of each cluster individually is "tight."
- Reposition as required to place related clusters beside each other.

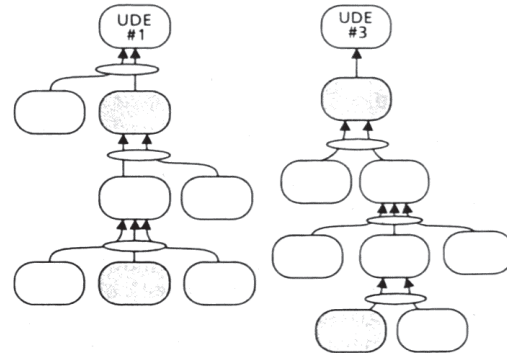

6. Identify Possible Additional Causes.

- Look for other independent causes of the same observed effect.
- Any proposed additional cause must be:
 - REALISTIC
 - PROBABLE
- Write the additional cause on a Post-it Note.
- Place it in the tree and connect it to the appropriate effect.

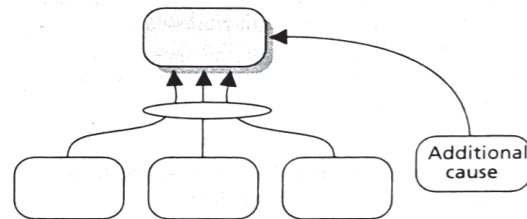

7. Look for lateral connections.

- Identify causes in one cluster that produce effects in another.
- Examine first the related clusters (Step 5) related to one another (but don't ignore other clusters as well).
- Connect the causes to their effects with causality arrows.
- Refine the logic of the new connections (refer to Step-5).
- Re-position the clusters as necessary to eliminate as much as possible arrows that cross over one another.

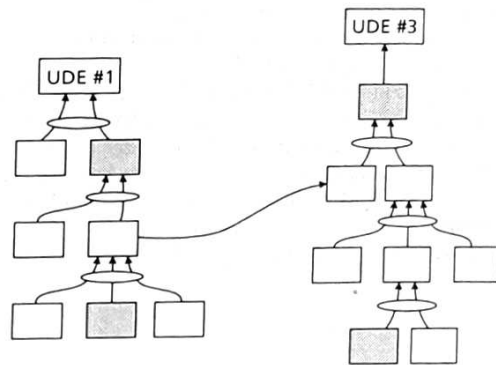

8. Build the Cause-and-Effect Chain Downward.

- Extend the cause-and-effect of each cluster downward:
 - Continue by asking "why?" for each lowermost cause.
 - With each new layer of cause, look for lateral connections with other clusters.
 - As you add each new layer, look also for new additional causes.
 - Look for negative reinforcing loops, label them where they occur.
- Stop:
 - When you reach the lowest level of cause that is within a decision maker's sphere of influence to change.
 - When all clusters have converged into a single tree.

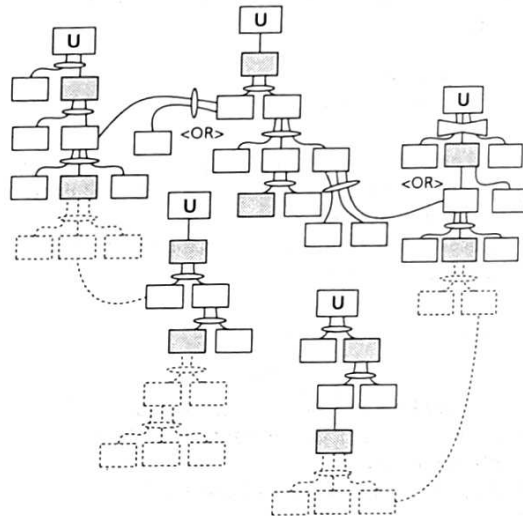

9. Scrutinize the Entire Current Reality Tree.

- Examine the tree in its entirety:
 - Is it complete? (Are all the important UDEs and critical root causes included?)
 - Is the logic of each connection sufficient?
 - Will it make sense (that is, achieve consensus) for those who did not participate in building the tree?
 - o Enlist the aid of others who were not part of the construction process to scrutinize the tree.
 - o Their knowledge of the CLR is not required, only subject matter knowledge of the situation.

10. Decide Which Root Causes to Attack.

- Identify critical root causes (those few causes that account for *all* the UDEs):
 - Trace the chain of dependency from each root cause to each UDE.
 - Determine which root causes are within your sphere of influence.
 - Identify the ones that offer the most potential for improvement as *critical root causes*.

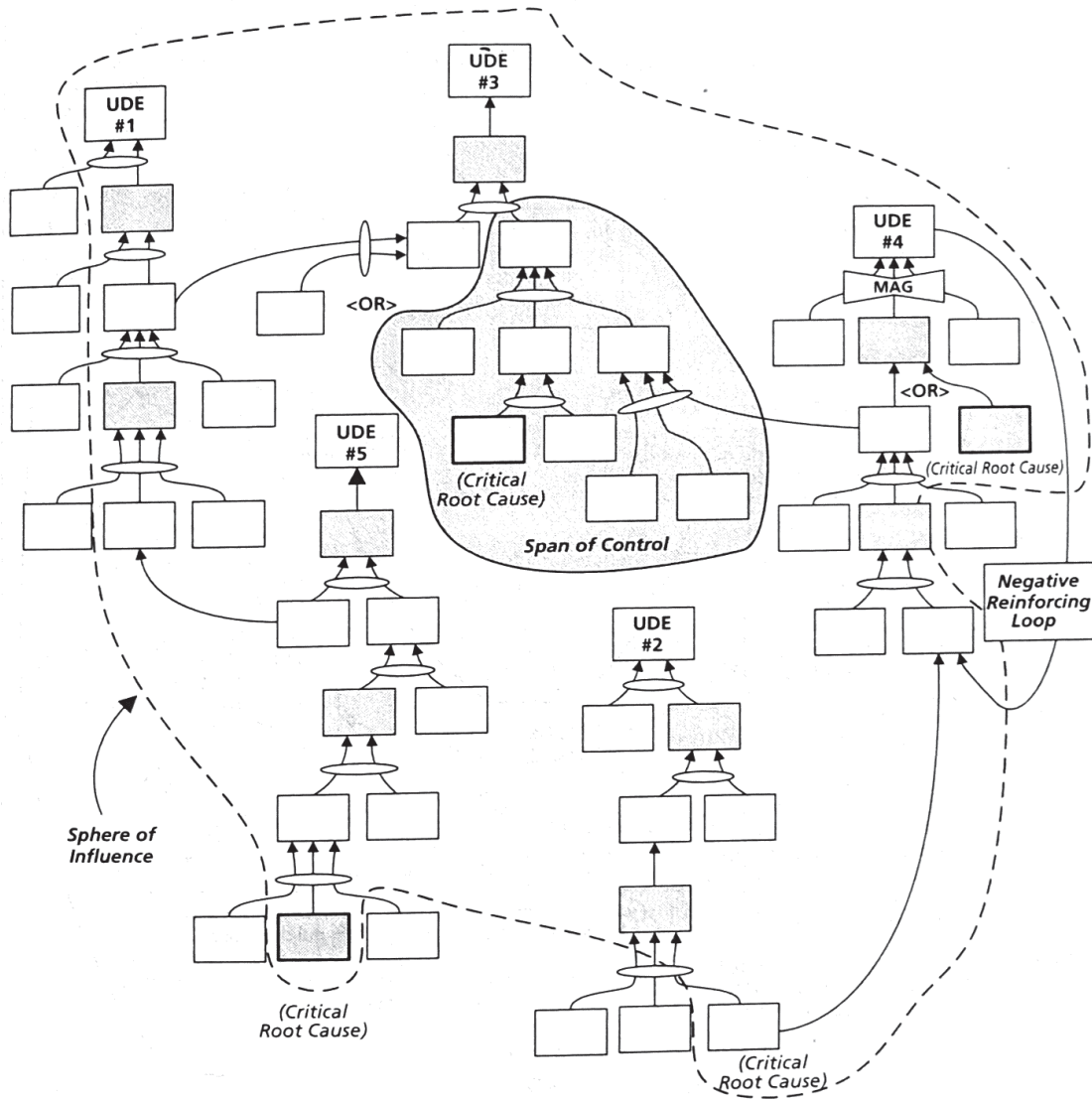

Appendix 5: Evaporating Cloud Template (Dettmer 2016b)

1. Create a Blank Evaporating Cloud

- One Objective (O)
- Two Requirements (R1 and R2)
- Two Prerequisites (P1 and P2)
- Connect with arrows, as shown
- Allow space at the top and bottom for Assumptions

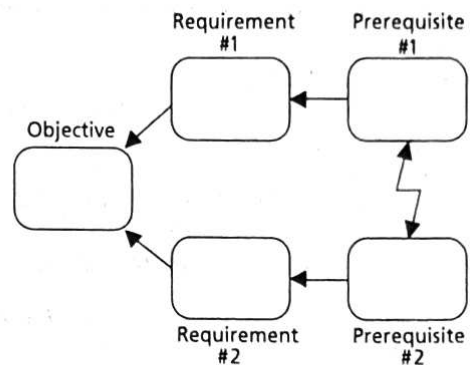

2. Articulate the Conflict (P1 and P2)

- Succinctly (5 words or less)
 - What does ONE side want?
 - What does the OTHER side want?
- Word the two “want” statements so that the conflict is obvious
 - Use clearly opposing alternatives, or
 - Word one side as “not” the other (e.g., “Don’t...” or “...is not...”)
- Write the opposing conflict statements in the boxes marked “P1” and “P2”

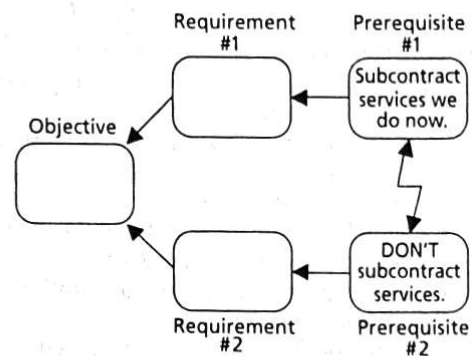

3. Determine the Non-negotiable Requirements (R1 and R2) of Each Side

- These should be high-level needs
- Refer to your GT
 - Consider the system GOAL to be the objective (if appropriate)
 - Identify Critical Success Factors (CSF) or key Necessary Conditions (NC) that each Prerequisite is attempting to satisfy
 - If both P1 and P2 are associated with the same CSF, make that the GOAL and find two supporting NCs below it related to P1 and P2
- Write the CSF or NCs in the appropriate R1 and R2 blocks

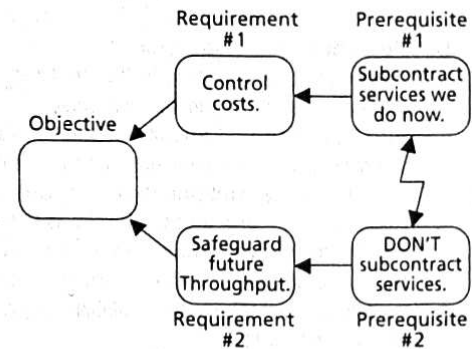

4. Formulate the Objective (O)

- Determine the common objective of both Requirements (R1 and R2)
- Refer to your IO Map
 - If you used CSF in Step 3, use the GOAL in this step
 - If you used NC in Step 3, use a CSF in this step
- Write the GOAL or CSF, as appropriate, in the Objective block

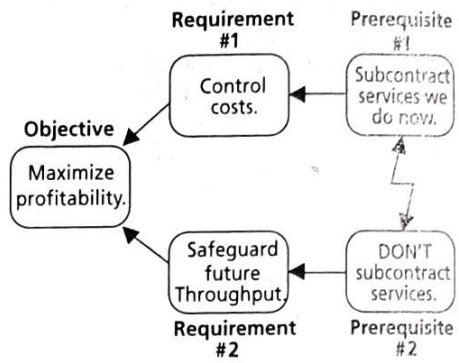

5. Evaluate the Entire Relationship

- Read the Evaporating Cloud from left to right
 - Verbalize "In order to...we must..."
 - Read the top leg first, then the bottom leg
 - Then read the conflict (P1 and P2) as "On one hand... on the other hand..."
- Determine whether the verbalization "sounds right"
 - Adjust the wording as needed
- Does the entire conflict accurately reflect the perceptions of both sides?
 - If not, adjust the wording as needed

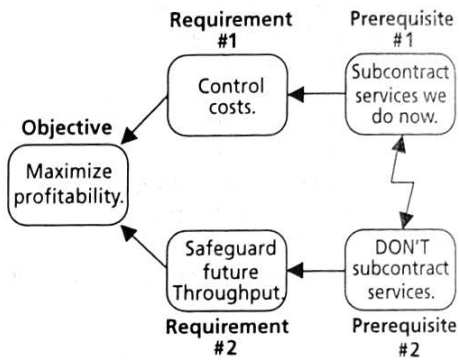

6. Develop Underlying Assumptions

- Start with the relationship between R1 and P1
 - Re-read it as "In order to...we must..."
 - Add "...because..." and list as many reasons why as you can think of (first-order assumptions)
 - For each "why" statement, if practical add "...because..." and add to the list as many reasons why (second-order assumptions) as you can think of
 - Use *extreme* wording where appropriate
- List all the assumptions on the EC diagram in the space above the R1-P1 leg
- Repeat this process for the R2-to-P2 leg
- Repeat the process again for the O-to-R1 and O-to-R2 legs

ASSUMPTIONS (R1-to-P1):

1. Services done internally *always* impose high overhead on the company.
2. Overhead *always* includes salary and fringe benefits for full-time employees.
3. Subcontracting services *always* allows headcount reductions.
4. Headcount reductions *always* save money.
5. Savings from headcount reductions *always* offset the cost of subcontracted services.
6. Subcontractors *always* provide equivalent service with never a compromise to reliability, quality, or timeliness.

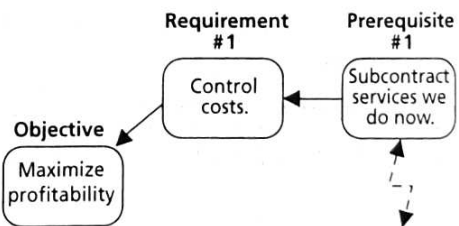

7. Evaluate the Assumptions

- Start with the R1-to-P1 leg
- Differentiate the VALID assumptions from the INVALID ones
 - Examine each assumption individually
 - Pay close attention to the ones that use extreme wording
- Highlight the INVALID assumptions with a distinctive mark

ASSUMPTIONS (R1-to-P1):

1. Services done internally *always* impose high overhead on the company.
2. Overhead *always* includes salary and fringe benefits for full-time employees.
- ★ 3. Subcontracting services *always* allows significant headcount reductions.
4. Headcount reductions *always* save money.
- ★ 5. Savings from headcount reductions *always* offset the cost of subcontracted services.
- ★ 6. Subcontractors *always* provide equivalent service with never a compromise to reliability, quality, or timeliness.

8. Create "Injections"

- For each leg of the conflict, think of alternatives that can satisfy R1 or R2 without having to be committed to P1 or P2
 - Let the INVALID assumptions suggest alternatives
 - Use an "idea generation" technique such as alternative environment, brainstorming, etc.
 - List as many alternative ideas as you can think of
 - Don't pre-judge or rank-order alternatives until all are identified
- Determine which Prerequisite each potential injection replaces
 - Annotate the injection with a "P1" or "P2"
- Word the injection as an action or condition, as appropriate
 - Action, if the injection is a simple activity or task you know how to do
 - Condition, if the injection is a complex condition of future reality, or the outcome of a series of component activities

INJECTION
Hire a subcontractor that guarantees its work.

(Action)

INJECTION
Identify Throughput generating work that can be done with the surplus headcount.

(Condition)

9. Select the Best Injection(s)

- Decide on a decision rule. E.g., "Select the injection that..."
 - Is easiest to do
 - Is completed the fastest
 - Is least expensive
 - Breaks the most critical assumption
 - Produces the maximum positive benefit for the system
- Recognize that there are no "silver bullets"
 - More than one injection will likely be required in most cases

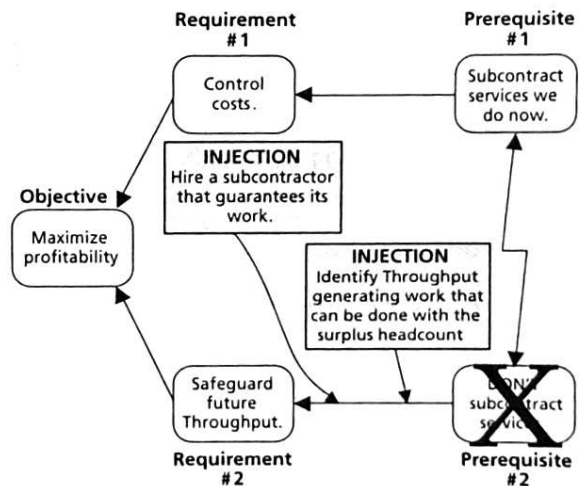

Appendix 6: Future Reality Tree Template (Dettmer 2016b)

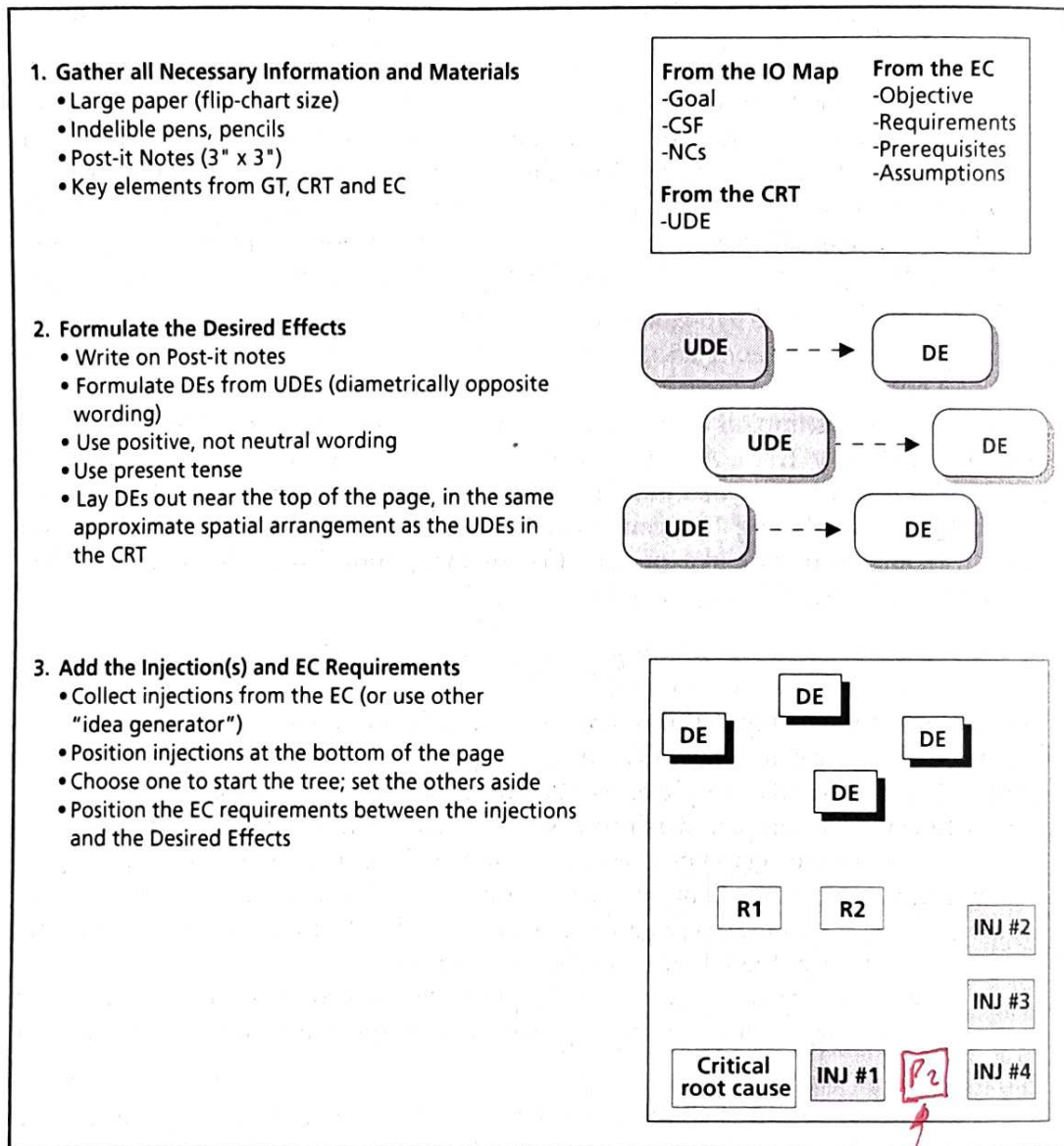

4. Fill in the Gaps

- Build UPWARD from injections to expected effects
- Add existing statements of reality as required
- Include entities from CRT that are still relevant in the future
- Build upward from one level to the next
- Work consistently toward:
 - Requirements from EC
 - Desired Effects
- Add injections as required to maintain progress toward the Desired Effects

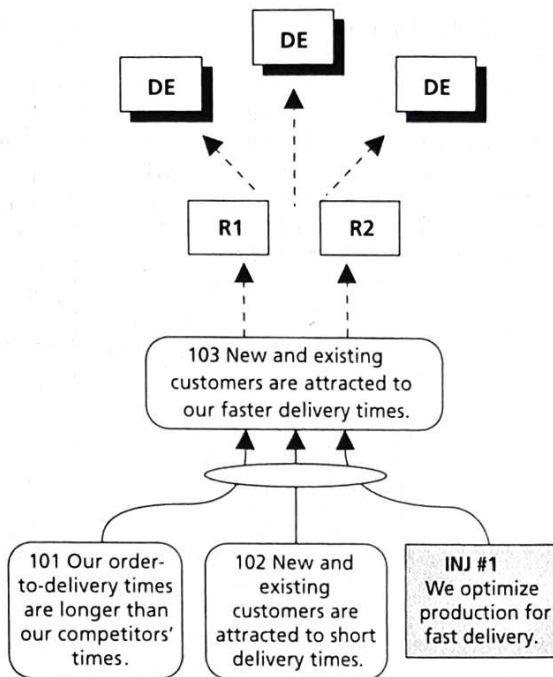

5. Build in Positive Reinforcing Loops

- Find Desired Effects that might amplify other effects lower in the tree
- Identify the effects they amplify
- Connect the DE to the amplified effect with an arrow
- Add injections, reality entities, and ellipses as required
- Check to be sure the re-entry (amplified) entity can withstand an additional cause reservation
 - That is, could some completely different cause (not previously identified) cause the amplification?

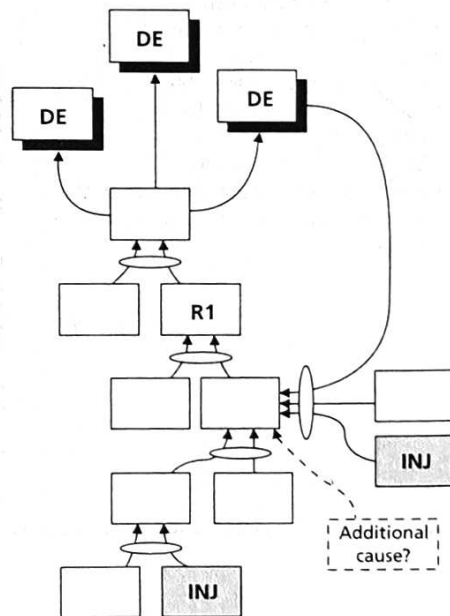

- 6. Look for Negative Branches**
- AFTER the FRT is completed to the Desired Effects
 - Solicit outside help if necessary
 - Evaluate each expected effect
 - Besides *this* effect, what *else* could result that might be unfavorable?
 - Don't overlook Negative Branches that might grow out of Desired Effects

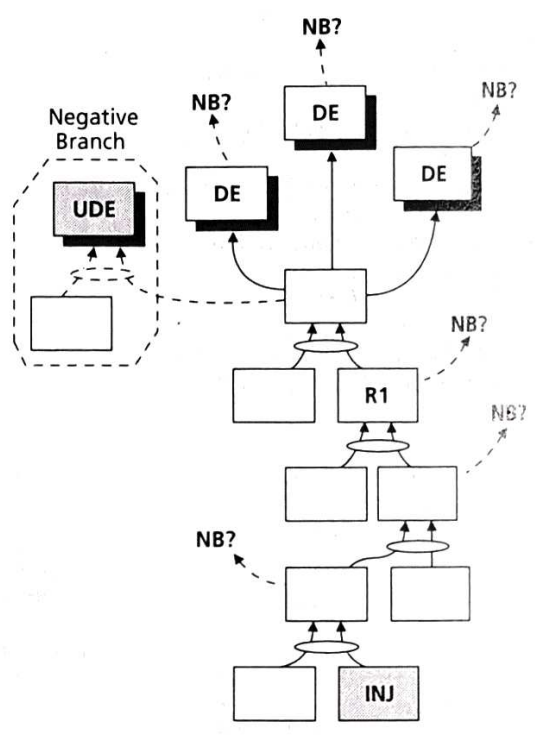

- 7. Develop Negative Branches**
- Use a separate sheet of paper
 - Build upward from the originating injection to the Undesirable Effect(s)
 - Add previously unstated entities, if required
 - Identify the "turning point"
 - Identify all assumptions underlying the transitional arrow; list them to one side of the NB

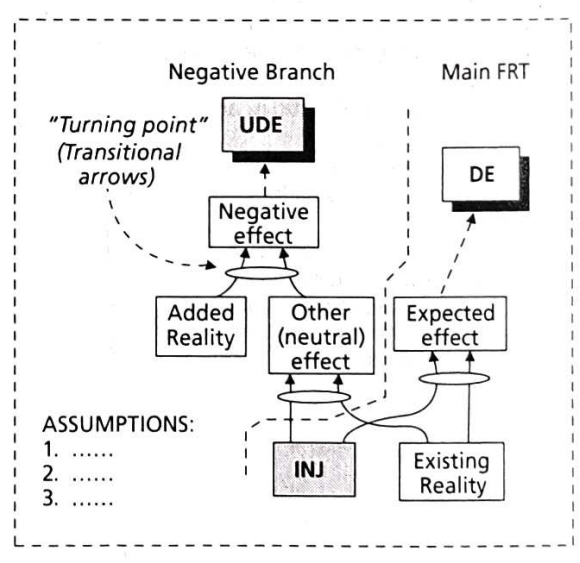

8. Trim Negative Branches

- Develop branch-trimming injection(s) to break key assumptions
- Validate injection(s) on a separate sheet of paper
- Logically project the direct and unavoidable consequences of the injection(s)
- Combine injection(s) and effects with additional, previously unstated reality entities as required
- Build upward until you reach the opposite condition of the Negative Branch's Undesirable Effect
- Make sure the branch-trimming injection doesn't create any new UDEs of its own

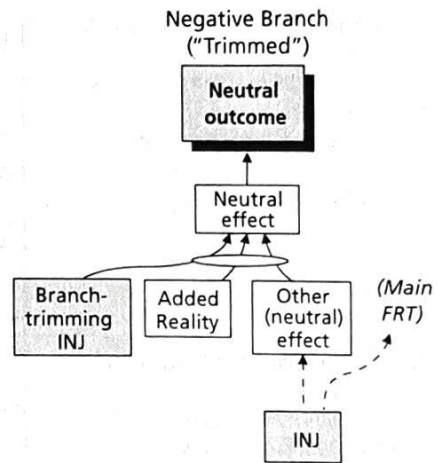

9. Incorporate the Branch-Trimming Injection into the FRT

- On the original FRT, combine the branch-trimming Injection with the effect entity from the Injection that caused the Negative Branch
- Write a reference to the NB beside the branch-trimming Injection
- Save the supporting NB pages

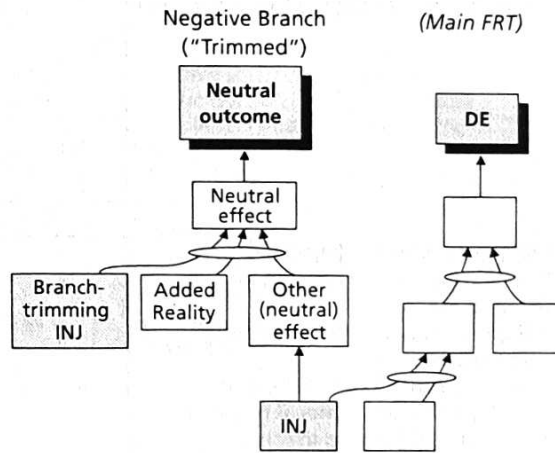

10. Scrutinize the Entire FRT

- Re-read and scrutinize the entire tree
- Use the Categories of Legitimate Reservation
- Enlist someone else to assist you
 - Understanding of CLR *not* required
 - Intuitive knowledge of the content *is* required
- Identify any parts of the FRT not needed to reach the Desired Effects or trim Negative Branches
- Trim superfluous entities from the FRT

Appendix 7: Form for logging linen needs

(48)

Ημερομηνία 30/7/2015

Έντυπο Ανατροφοδότησης Λινοθηκών

Περιγραφή	Βάρος	Α Βοήθειες		Εντατική		Παιδιατρικό (2 ^{ος} όροφος)		Παθολογικό (2 ^{ος} όροφος)		Παθολογικό (3 ^{ος} όροφος)		Σουίτες/Private		Χειρουργεία		Μαιευτικό (4 ^{ος})	
		Λινοθήκη	Λινοθήκη	Λινοθήκη	Λινοθήκη	Λινοθήκη 1	Λινοθήκη 2	Λινοθήκη 1	Λινοθήκη 2	Λινοθήκη 1	Λινοθήκη 2	Λινοθήκη	Λινοθήκη	Λινοθήκη	Λινοθήκη	Λινοθήκη	Λινοθήκη
Σεντόνι πάνω-κάτω (Άσπρο)						18	30										
Σεντόνι πάνω - κάτω (Πράσινο)						4											
Υποσέντονο						15											
Μαξιλάρι						16	10										
Μαξιλαροθήκη																	
Προστατευτικό Μαξιλάρι																	
Κουβέρτα άσπρη						5	1										
Σκέπασμα Κρεβατιού (Κίτρινο)																	
Κουβέρτα Μπλε						19											
Πετσέτα μικρή						1											
Πετσέτα μεγάλη							4										
Χαλάκι - Πετσέτα πατώματος																	
Ρομπες Ασθενών (L)						3											
Ρομπες Ασθενών (M)																	
Σεντόνια παιδικά																	
Παιδικές ρόμπες						2											
Πετσουλιές (30x30)																	

Appendix 8: Form for logging idle times – Ver 1

Operating Theaters - Utilisation Monitoring Form

Operating Theater										Date.....
	Operation in progress...	STOP - No beds	STOP - No Patient	STOP - No Doctor	STOP - No anaesthesiologist	STOP - Not Scheduled	STOP - Set up	STOP - No equipment	STOP - Maintenance	Comments
07:30										
08:00										
08:15										
08:30										
08:45										
09:00										
09:15										
09:30										
09:45										
10:00										
10:15										
10:30										
10:45										
11:00										
11:15										
11:30										
11:45										
12:00										
12:15										
12:30										
12:45										
13:00										
13:15										
13:30										
13:45										
14:00										
14:15										
14:30										
14:45										
15:00										
15:15										
15:30										
15:45										
16:00										
16:15										
16:30										
16:45										
17:00										
17:15										
17:30										
17:45										
18:00										

Legend

Operation in progress.. -- The moment that the patient enters the OP theater until the patient leaves the OP theater

STOP - No beds -- Waiting for available bed in the clinic

STOP - No Patient -- Waiting for the Patient

STOP - No Doctor -- Waiting for the Doctor

STOP - No Anaesthesiologist -- waiting for the anaesthesiologist

STOP - Not Scheduled -- No demand

STOP - Set up -- Preparing the Operating Theater for next Operation

STOP - No equipment -- Equipment and tools are not available

STOP - Maintenance -- Waiting for engineering to repair an equipment

Appendix 9: Form for logging idle times – Ver 2

Operating Theaters - Utilisation Monitoring Form V1

Operating Theater No. 05.....

Date 22/09/16.....

Surgery		Reason of idle time
Start	Stop	
07:00	07:00	
07:15	07:15	
07:30	07:30	
07:45	07:45	
08:00	08:00	
<u>08:15</u>	08:15	4
08:30	08:30	
08:45	08:45	
09:00	09:00	
09:15	09:15	
09:30	09:30	
09:45	09:45	
10:00	10:00	
10:15	10:15	
10:30	<u>10:30</u>	
10:45	10:45	(+)
11:00	11:00	
<u>11:15</u>	11:15	
11:30	11:30	
11:45	11:45	
12:00	12:00	
12:15	12:15	
12:30	<u>12:30</u>	
12:45	12:45	(+)
13:00	13:00	(+)
13:15	13:15	
13:30	13:30	(S)
13:45	13:45	
14:00	14:00	
<u>14:15</u>	14:15	
14:30	14:30	
14:45	14:45	
15:00	15:00	
15:15	15:15	
15:30	15:30	
15:45	15:45	
16:00	16:00	
16:15	16:15	
16:30	16:30	
16:45	16:45	
17:00	17:00	
17:15	17:15	
17:30	17:30	
17:45	17:45	
18:00	18:00	

- Reasons of idle times**
1. Patient - NOT in clinic
 2. Patient - NO beds
 3. Patient Cancellation
 4. Patient - NOT in OR
Reason.....
 5. Doctor Delayed
 6. Anesthesiologist Delayed
 7. Turnover / Setup
 8. Emergency Surgery
 9. Change Theater
 10. No equipment
 11. Not scheduled/No need

Έντυπο χρήσης χειρουργικών θαλάμων V1

Χειρουργικός Θάλαμος Νο... 6

Ημερ... 22/9/16

Χειρουργική Επέμβαση		Λόγος νεκρού χρόνου
Έναρξη	Τέλος	
07:00	07:00	
07:15	07:15	
07:30	07:30	
07:45	07:45	
08:00	08:00	
08:15	08:15	
08:30	08:30	
08:45	08:45	
09:00	09:00	
09:15	09:15	
09:30	09:30	
09:45	09:45	
10:00	10:00	
10:15	10:15	
10:30	10:30	
10:45	10:45	
11:00	11:00	
11:15	11:15	
11:30	11:30	
11:45	11:45	
12:00	12:00	
12:15	12:15	
12:30	12:30	
12:45	12:45	
13:00	13:00	
13:15	13:15	
13:30	13:30	
13:45	13:45	
14:00	14:00	
14:15	14:15	
14:30	14:30	
14:45	14:45	
15:00	15:00	
15:15	15:15	
15:30	15:30	
15:45	15:45	
16:00	16:00	
16:15	16:15	
16:30	16:30	
16:45	16:45	
17:00	17:00	
17:15	17:15	
17:30	17:30	
17:45	17:45	
18:00	18:00	

- Λόγοι νεκρών χρόνων**
1. Ασθενής - ΌΧΙ στην κλινική
 2. Ασθενής - ΌΧΙ κρεβάτι
 3. Ασθενής - Ακύρωση
 4. Ασθενής - ΌΧΙ σε OR
Λόγος.....
 5. Γιατρός Καθυστέρηση
 6. Ανασθησιολόγος καθυστέρηση
 7. ~~Ετοιμασία θαλάμου~~
 8. Επείγον περιστατικό
 9. Αλλαγή θαλάμου
 10. Έλλειψη οργάνου
 11. Δεν υπάρχει ανάγκη

Appendix 11: Utilization report from the hospital's ERP (as a sample)

Theatre Utilisation For Period

Show Theatre from to

Operating Theatre	Hours Used	Hours Available	% Utilisation
ENDOSCOPY THEATRE	0.75	252.00	0.30
OPHTHALMOGY THEATRE	28.33	252.00	11.24
Theatre 2(1st Floor)	83.17	252.00	33.00
Theatre 3(1st Floor)	75.42	252.00	29.93
Theatre 4(1st Floor)	107.92	252.00	42.82
Theatre 5(1st Floor)	110.17	252.00	43.72
Theatre 6(1st Floor)	77.33	252.00	30.69
Theatre 7(1st Floor)	78.58	252.00	31.18
Theatre 8(1st Floor)	43.33	252.00	17.20
Theatre 9(1st Floor)	80.33	252.00	31.88
Theatre10-Lithotrips	0.33	252.00	0.13
Theatre13(4th Floor)	27.42	252.00	10.88
Theatre14(4th Floor)	11.83	252.00	4.70
Theatre15-Deliv.Room	21.50	252.00	8.53
Theatre16-Deliv.Room	4.92	252.00	1.95

Overall Utilisation 19.88



Université de Strasbourg

Ecole Doctorale Augustin Cournot

HuManiS (ED 221)

RÉSUMÉ

THESE POUR L' OBTENTION DU DOCTORAT EN SCIENCES DE GESTION
**Application de la Théorie des contraintes (TOC) dans
le secteur des soins de santé privé à Chypre**

THESE présentée par: **Spyridon Bonatsos**

Soutenue le: 20 March 2019

JURY

Directeur de thèse

Thierry Nobre

Professeur, Université de Strasbourg

Rapporteurs

Irène GEORGESCU

Professeur, Université de Montpellier

François MEYSSONNIER

Professeur, Université de Nantes

Membres

Philippe WIESER

Professeur, Ecole Polytechnique Fédérale de
Lausanne

Christophe BARET

Professeur, Université de Aix Marseille

Introduction - Contexte

Il est clair, à travers toute la littérature, que le domaine de la santé fait face à des défis liés à son mode de fonctionnement. Dans le monde entier, les systèmes médicaux sont confrontés à des problèmes, tels que la hausse des coûts et une qualité des prestations insuffisante. Sans de véritables solutions, les médecins verront leurs revenus diminuer, les patients en viendront à payer davantage et les services proposés seront réduits (Porter & Lee 2013). Le secteur de la santé connaît à la fois un accroissement de la demande et un certain manque d'efficacité dans ses services (Godinho Filho et al. 2015; McDermott et al. 2017).

Au fil du temps, on a tenté de mettre en œuvre plusieurs protocoles généraux de Qualité, présentés comme des voies prometteuses d'optimisation, dont aucune ne s'est vraiment imposée, comme Prince2, Six Sigma, Lean Thinking, Lean Sigma, le Cycle Recherche-Action, etc (Howe 2013). Mais, au cours des dernières décennies, une méthodologie d'amélioration est apparue, amenant des résultats probants, particulièrement dans le contexte industriel de la fabrication et du projet (Mabin & Balderstone 2003). Elle se nomme la Théorie des Contraintes (*Theory Of Constraints* ou TOC en anglais).

La Théorie des Contraintes – La Théorie

La Philosophie de la TOC et ses Principes Clés.

La TOC est une méthodologie d'amélioration des systèmes (Gardiner et al. 1994). Elle propose un mécanisme d'optimisation fondé sur une démarche claire et globale : elle s'attache à l'identification d'un problème ; elle synthétise des solutions pour ledit problème ; elle pilote ensuite la mise en œuvre de la résolution à travers un schéma méthodologique structuré (Mabin & Balderstone 2003). La méthodologie de la TOC dote les managers d'outils et de recettes pour qu'ils puissent trouver des solutions par eux-mêmes. En outre, la TOC adopte un point de vue systémique et observe le comportement de l'ensemble de la chaîne plutôt que de se focaliser sur tel ou tel maillon.

Les Composantes de la TOC

La philosophie de la TOC est fondée sur trois différentes familles de concepts. 1. Des concepts logistiques. 2. Des concepts de solution de problème. 3. Des mesures (Spencer 1995). Les composantes de la TOC émanent de ces trois types de principes : les Cinq Étapes de Focalisation permettent d'identifier les problèmes logistiques, les Outils du Processus de Réflexion engendrent la procédure de résolution du problème et, pour terminer, les mesures encadrent les conduites à tenir.

Contraintes

Par essence, la TOC est avant tout une démarche de gestion des contraintes (Tabish & Syed 2015). Le principe qui innerve la TOC s'ancre dans l'idée que des contraintes régissent tous les systèmes ; s'il n'en était pas ainsi, ces derniers auraient un rendement illimité. Il y a deux larges catégories de contraintes : les contraintes physiques et les contraintes pratiques (Brennan 2010, p.108).

Les Cinq Étapes de Focalisation - *Five Focusing Steps* (5FS) en anglais- s'occupent généralement des contraintes physiques, tandis que les contraintes pratiques sont principalement traitées par un ensemble d'instruments que l'on nomme les Outils du Processus de Réflexion - *The Thinking Process Tools* (TP tools) en anglais.

Les Cinq Étapes de Focalisation

La série d'étapes que la TOC utilise pour gérer le flux en s'intéressant principalement aux contraintes physiques, s'appelle les Cinq Étapes de Focalisation (Berry & Belle 2005). Elles ont été théorisées par Goldratt en 1986 (Ronen & Starr 1990), et introduites dans le monde de l'entreprise par (Eliyahu M Goldratt 1990; Goldratt & Cox 1984)

Fondées sur les définitions de (Mabin n.d.), elles se déclinent de la façon suivante :

1. Identifier la contrainte : identifier l'opération ou la ressource qui restreint la productivité du système.

2. Exploiter la contrainte : tirer le meilleur parti possible de la contrainte. Eliminer les limitations qui contraignent le flux et réduire les temps morts de sorte que la contrainte soit utilisée de la manière la plus efficace possible.
3. Subordonner d'autres activités à la contrainte : combiner le résultat d'autres opérations pour les faire coïncider avec la contrainte et faciliter le flux de production. Eviter de faire attendre la contrainte au cours du travail.
4. Hausser la performance de la contrainte : dans des situations où la contrainte du système ne parvient toujours pas à générer un résultat suffisant, investir dans de nouveaux équipements ou augmenter la taille des équipes pour améliorer la productivité.
5. Si rien n'évolue, revenir à la première étape : déterminer si une autre opération ou une autre pratique est devenue à son tour la contrainte du système. (Eliyahu M. Goldratt 1990) énonce que cette étape correspond au protocole d'amélioration continue - process of ongoing improvement (POOGI) en anglais-.

Les Outils du Processus de Réflexion (TP Tools)

Les "TP Tools" sont employés quand une contrainte n'est pas flagrante (Taylor & Churchwell 2004), ou lorsqu'elle est difficile à localiser (Mabin et al. 2001; Davies et al. 2005; Mabin n.d.). C'est là un cas typique de contraintes pratiques. Ces dernières sont généralement plus problématiques à repérer : elles se cachent sous la forme de postulats et elles influencent les comportements et les décisions.

Les cinq outils logiques du Processus de Pensée sont les suivants : (Tabish & Syed 2015)

1. L'arbre actuel de réalité -Current reality tree (CRT)-. Il aide les systèmes à éliminer un effet indésirable (UDE en anglais) afin de déceler le problème majeur ou la cause critique essentielle -critical root cause (CRC)-.
2. Le Nuage d'Evaporation -Evaporating Cloud (EC)-. Il permet aux systèmes et aux structures de résoudre des conflits cachés qui entretiennent habituellement des problèmes chroniques.

3. Le Futur arbre de réalité -Future reality tree (FRT)-. Il sert pour les organisations à vérifier qu'une action produit les résultats escomptés. De même, il identifie et supprime toute nouvelle conséquence défavorable induite par l'action.
4. L'arbre des prérequis -Prerequisite tree (PRT)-. Il aide les organisations à mettre en œuvre une résolution en fournissant une séquence recommandée de tâches à effectuer et en cernant des obstacles potentiels.
5. L'arbre de transition -Transition tree (TT)-. Il offre aux structures un plan d'action détaillé, étape par étape, pour appliquer une décision.

Les PRT et les TT ne sont pas utilisés dans cette thèse.

Les Mesures de la TOC

L'objectif de la TOC tient dans l'optimisation. Par conséquent, le système de mesure de la TOC vise à prendre des mesures sur la totalité et non sur des optima locaux (Gupta 2003). Il existe trois mesures opérationnelles et de ces trois points peuvent dériver toutes les autres mesures financières. Ces mesures opérationnelles sont le Débit (Throughput), le Stock (Inventory) et le Coût d'Exploitation (Operating Expense) (Ronen & Starr 1990; Naor et al. 2013).

Les Solutions Génériques de la TOC

Tambour-Tampon-Corde -Drum-Buffer-Rope (DBR)- Le DBR est une méthodologie propre à la TOC, qui s'attache à gérer le flux à travers un système. Cette démarche est bien documentée et a été développée dans une approche concrète au sein de l'environnement industriel (Goldratt, 1990 ; Umble et Srikanth, 1997 ; Schragenheim et Detmer, 2001 ; Stratton et al., 2008).

Tambour. Le tambour peut être défini par une contrainte de ressource ou la demande du marché qui contraint un système.

Corde. Il s'agit du mécanisme de planification qui permet de diffuser le travail dans le système. C'est le mécanisme interne au DBR qui évite la surproduction ou les situations de rupture de stock.

Tampon. Une fois que la matière est lancée dans le système, le temps nécessaire pour atteindre la contrainte est nommé 'temps tampon'. La durée pendant laquelle la contrainte agit est négligeable comparée à ce 'temps tampon'.

La solution de réapprovisionnement -La solution de réapprovisionnement est le protocole de la TOC pour piloter la distribution (Šukalová & Ceniga 2015). La solution de réapprovisionnement a été abordée pour la première fois dans le livre de Goldratt *Réussir n'est pas une question de chance* en 1994 en tant que solution pour une chaîne d'approvisionnement (Wu et al. 2013). Depuis, bien peu de choses ont été écrites sur la TOC dans ses liens avec les chaînes d'approvisionnement (Simatupang et al. 2004).

La solution de réapprovisionnement vise à manager les deux problèmes essentiels des variations et des délais importants, en appliquant la TOC par la gestion du tampon qui règle les variations et par le réapprovisionnement fréquent pour gérer les délais (Wu et al. 2013).

Le DBR et la solution de réapprovisionnement ont été utilisés au cours de cette recherche.

Le Management des soins de Santé et la Théorie des Contraintes : une Synergie.

La TOC dans le domaine de la Santé est une aire de recherche relativement nouvelle. Les études de Santé dans les opérations comme la TOC dans les Départements de Chirurgie et la TOC dans la logistique hospitalière sont bien minces. Nous n'avons pu trouver que quarante articles dans diverses publications s'intéressant à différents aspects couplant la TOC et la Santé en général, et uniquement trois textes traitant de la TOC dans le secteur chirurgical, aucun parlant du DBR en chirurgie et également aucun sur la TOC en rapport avec la gestion du linge à l'hôpital. Ronen souligne que

la littérature académique sur la TOC est très limitée et que la communauté scientifique qui traite de la TOC assez peu nombreuse (Cox III & Schleier 2010, p.847).

Ce thème de recherche est important parce qu'il existe différents défis à relever dans les sous-systèmes de santé. Les salles d'opération doivent faire face à des coûts d'exploitation importants (Jebali & Diabat 2017; May et al. 2011; Wasterlain et al. 2015). En outre, la programmation et la planification sont problématiques (de SOUZA et al. 2016; May et al. 2011) et les temps d'attente sont conséquents (Grida & Zeid 2018; Sahraoui & Elarref 2014). D'un autre côté, la logistique des soins de santé a été identifiée comme l'un des principaux générateurs de coûts dans ce secteur (Rais et al. 2018 ; Volland et al. 2017). La recherche présente se focalise sur une question spécifique liée à la logistique visant à améliorer le système de gestion du linge. Disposer de suffisamment de linge est un facteur essentiel, souvent crucial pour un bon fonctionnement de la prestation des soins.

Énoncé de la Thèse et Objectifs de la Recherche

Chypre est sur le point de changer son système de Santé dans les années à venir (Samoutis & Paschalides 2011). Des mutations significatives ont été annoncées qui vont prendre effet en 2019. Dans le même temps, le secteur de santé privé à Chypre est gigantesque rapporté à la population de l'île (Andreou et al. 2010). Puisque la TOC est une méthodologie d'amélioration éprouvée dans le domaine de la fabrication, il existe un intérêt sérieux à explorer le degré d'efficacité de la TOC concernant les services et plus spécifiquement le domaine de la santé. Il serait extrêmement bénéfique si la méthode et ses résultats rapides, observés jusqu'ici, étaient aussi introduits dans le secteur de la santé.

De là, la principale visée de cette Thèse est la suivante : produire un nouveau savoir et apporter une nouvelle contribution à la science du management à travers l'usage de la TOC, en tant que méthodologie opérationnelle d'amélioration sur le segment du système de santé privé. En conséquence, l'objectif premier de cette Recherche est d'explorer le degré d'efficacité de la méthodologie de la Théorie des Contraintes,

appliquée à l'environnement fonctionnel d'une clinique généraliste/d'un hôpital privés à Chypre. La mise en œuvre de ce but de recherche et de ses objectifs est pilotée à partir des questions de recherche ci-dessous.

Question principale de la Recherche

“Est-ce que la mise en application de la Théorie des Contraintes peut apporter des améliorations opérationnelles dans le secteur de la santé, au sein d'une clinique généraliste/d'un hôpital privés à Chypre ? ”

En s'appuyant cette question centrale comme point de départ, les questions de recherche secondaires suivantes sont formulées afin de préciser la recherche et les actions futures.

Questions de Recherche secondaires :

1. Quelles sont les contraintes limitant le potentiel de l'environnement opérationnel existant dans la clinique ?
2. Quelle est la solution appropriée qui va accroître la performance des contraintes, si elle est appliquée au “système sélectionné” ?
3. Quelles sont les difficultés principales apparues lors de la mise en place de la solution considérée face à la fonctionnalité inhérente du système ?
4. Comment ces difficultés peuvent-elles être surpassées ?
5. La performance du système sélectionné a-t-elle été améliorée après la mise en œuvre de la TOC ?
6. Quels ont été les défis singuliers auxquels les employés de l'hôpital privé ont dû faire face concernant la transposition à ce secteur ?
7. Y a-t-il eu des conséquences imprévues et quelles ont été leurs tailles ?

La Méthodologie

Pour répondre aux différentes questions élaborées pour la recherche, nous avons mis en œuvre la TOC dans le plus grand hôpital privé de Chypre qui possède une capacité de 152 lits et compte 12 salles d'opération. En se fondant (Chase 1978) sur le système de catégorisation, deux sous-systèmes ont été choisis dans le contexte des prestations de santé : le service de chirurgie (La TOC a été appliquée à une Salle d'Opération) et le système de gestion du linge. Deux véritables environnements de travail, quoique très différents, avec de vraies personnes, affrontant de vrais problèmes.

La recherche a suivi la stratégie de recherche-action conformément à (Saunders et al. 2009) qui correspond parfaitement à la méthodologie de la TOC. Le cadre théorique structurant l'environnement de recherche est la Théorie des Contraintes dans un cadre conceptuel pour les Opérations et les Systèmes (Berry & Belle 2005). Les lignes directrices empruntées sont inspirées du travail de (Dettmer 2007). Le chercheur a été formé par Monsieur Dettmer lui-même à Paris en juin 2016.

La méthodologie de recueil des données a associé à la fois des méthodes qualitatives et quantitatives. Toutefois l'approche principale a été qualitative. Pour le recueil de données primaires, on a employé l'Observation, les Interviews (semi-structurées et non structurées) et la Récolte de Données sur le terrain. Les données collectées ont été analysées à l'aide des outils de la TOC, tels qu'ils sont décrits dans la littérature.

Analyse et Observations – le système de gestion du linge

Au cours de la première étude de cas, on a mis en œuvre la TOC dans le cadre du système de gestion du linge hospitalier (service d'entretien). Trois raisons principales ont motivé le choix de ce secteur. 1. Le management rencontrait un problème dans ce domaine particulier : il était dit que les coûts de fonctionnement y étaient très élevés. L'hôpital avait ainsi donné son aval à une extension de la blanchisserie existante dans le but d'acquiescer et d'installer deux nouvelles machines à laver destinées à réduire le nombre d'heures supplémentaires. 2. Les responsables souhaitaient utiliser le département du linge comme « un champ d'expérimentation » et se familiariser avec la TOC avant de se lancer vers un autre type de sous-système plus spécifiquement en prise avec la santé. 3. Des raisons épistémologiques sont venues au jour. L'étude de cas nous donnait l'opportunité de tester la TOC dans deux environnements distincts. La TOC n'avait jamais été introduite auparavant dans un service d'entretien d'hôpital, et plus particulièrement dans un département chargé du linge. En s'appuyant sur la classification (Schmenner 1986), on peut dire que le système afférent à ce domaine tient plus d'un environnement de « fabrication » : il y a effectivement peu de contacts avec les malades (clients). Cela contraste avec la chirurgie qui, elle, développe un système complexe disposant d'un contact accru avec les patients. Scruter les caractères de la TOC dans ce milieu permettait d'enrichir notre compréhension.

Le processus global est simple et clair : le linge est collecté dans les différentes salles, ramené à la blanchisserie, lavé, séché, repassé, plié, rangé sur des chariots et redistribué aux salles.

Afin d'entrer en cohérence avec la philosophie de l'action-recherche, le travail a été mis en œuvre à travers quatre phases comme pour (Saunders et al. 2009):

1^{ère} Phase : Le Diagnostic – Ce qu'il faut changer

La première phase est la phase de diagnostic ou, dans la terminologie de la TOC, la phase « Ce qu'il faut Changer ». Cette rubrique recouvre quatre étapes à suivre, de l'étape 1 à l'étape 4. Dans cette section, une analyse s'est construite afin de

déterminer ce qui contraignait le système, l'empêchant de parvenir à de meilleurs résultats. C'était un premier pas pour répondre à la question de recherche n° 1.

En suivant les directives fournies par la littérature, le processus de réflexion a débuté avec la création de l'Arbre Actuel de Réalité (CRT). Cette réalisation s'est déployée durant **l'étape 1**. La première opération a consisté à sélectionner l'équipe du projet, qui était composée du Directeur des Soins Infirmiers, du Responsable de l'Entretien et d'un employé de la blanchisserie qui possède une excellente expérience sur le terrain. Ils ont participé à une formation préliminaire qui leur a exposé la nature de la recherche et les principes fondamentaux de la TOC.

Dès la toute première visite dans le service, les employés se sont entièrement mis sur la défensive. Ils se sont montrés extrêmement sceptiques concernant l'expérimentation. Il était clair qu'ils se sentaient menacés et qu'ils adoptaient une attitude de grande méfiance. En outre, ils étaient peu disposés à partager leurs difficultés ou leurs embarras. Ils ne voyaient pas pourquoi ils devaient modifier leurs pratiques. Ils ne pouvaient accepter de reconnaître qu'ils avaient des problèmes à résoudre et ils soutenaient vigoureusement que, quels que soient les soucis existants, ils trouvaient leurs origines dans les autres départements. Passer à l'analyse des Effets Indésirables (UDE en anglais) et à la construction du CRT paraissait quelque chose d'impensable. On est seulement parvenu à recueillir 12 UDE.

La résistance opposée par le personnel sur le terrain a amené vers **l'étape 2**, qui a conduit à provoquer une session de formation plus structurée. Celle-ci s'est avérée nécessaire pour expliquer ce qu'était une amélioration, ce qui la composait. Elle a permis aussi de préciser que l'objectif n'était pas d'amender les comportements humains, mais bien la structure du système.

Les gens se sont montrés réticents parce qu'ils ne voyaient pas pourquoi ils devaient changer. Afin de fournir une réponse, un Arbre du But -Goal Tree en anglais (GT)- a été produit au cours de **l'étape 3**. Le GT est une arborescence de nécessité logique, développée par Dettmer. Il cartographie ainsi le réseau de nécessités logiques des entités qui doivent coexister pour que le système soit dans sa configuration idéale.

Malheureusement c'est un outil qui n'a fait l'objet que de peu de recherches : la littérature le concernant est quasi inexistante. D'ailleurs, c'est Dettmer lui-même qui a fait découvrir cet instrument à l'auteur de ce travail. Le GT représentait l'état optimal du système pour la gestion du linge. L'étape suivante a consisté à déterminer la performance du système en vigueur, au prisme du GT. La distance avérée entre les deux stades permettait de révéler les raisons d'appeler à un changement. Cela a conduit la recherche à **l'étape 4**, au cours de laquelle on a développé un Arbre Actuel de Réalité (CRT). La première partie du CRT élabore une analyse des lacunes qui sont traduites en termes d'Effets Indésirables (UDE). Ces derniers apparaissent à la suite de la comparaison entre l'état courant avec le GT (l'état idéal). Les données recueillies ont été analysées à l'aide du CRT, et les trois Causes Critiques Principales suivantes (CRC en anglais) ont été identifiées. Il fallait les résoudre pour rendre le système plus efficace.

1. On doit faire des heures supplémentaires.
2. On dépense beaucoup d'argent pour acheter du linge.
3. Il n'y a pas de méthodologie spécifique pour le réapprovisionnement du linge.

2^{ème} Phase : Programmation – Pour quoi changer

La deuxième phase est la phase de programmation ou la phase dite du « Pour quoi changer ». Cette phase s'attache à concevoir l'avenir avec des contraintes réévaluées. C'est la « phase de conception de la solution », celle qui cherche des réponses à la question de recherche n° 2.

L'outil qui sert à répondre à l'interrogation « Pour quoi changer » s'exprime dans le Nuage d'Evaporation (EC) et dans le Futur Arbre de Réalité (FRT). Goldratt suggère que les CRC (Causes Critiques Principales) identifiées à partir du CRT (Arbre Actuel de Réalité) perdurent parce qu'un dilemme les maintient en place. Dettmer ajoute qu'une raison supplémentaire de préserver une CRC provient du manque de connaissances nécessaires pour la réduire. La TOC utilise l'EC pour « faire s'évaporer les dilemmes » et parvenir à une solution « gagnant-gagnant », que l'on nomme « injection ».

Pour traiter les deux premières CRC, **l'étape 5** développe deux EC, en s'appuyant sur les travaux de (Dettmer 2007). La troisième CRC devait être dénouée grâce à la mise en œuvre d'une solution générique de la TOC, le Réapprovisionnement.

Les EC ont produit les injections suivantes :

CRC 1 : On doit faire des heures supplémentaires. -Injection 1 : Exécuter les Cinq Étapes de Focalisation (5FS) afin d'utiliser entièrement les capacités du système.

CRC 2 : On dépense beaucoup d'argent pour acheter du linge. -Injection 2 : Réutiliser le linge abîmé.

CRC 3 : Il n'y a pas de méthodologie spécifique pour le réapprovisionnement du linge. -Injection 3 : Mettre en œuvre la solution de Réapprovisionnement.

L'outil suivant que la TOC utilise est le Futur arbre de réalité (FRT). Il teste les injections pour vérifier qu'elles apportent les solutions souhaitées et qu'elles ne vont pas susciter de nouveaux Effets Indésirables ou des problèmes inédits. Le FRT a été employé dans **l'étape 6**. Les injections supplémentaires que l'on a dégagées se trouvent dans la mise en œuvre du processus Tambour-Tampon-Corde (DBR) et dans l'embauche d'un tailleur pour ravauder le linge plutôt que de le jeter.

3^{ème} Phase : Action – Comment provoquer le changement

La troisième phase se définissait comme la phase d'intervention et elle visait à exécuter les injections avancées dans la phase précédente. Cette action spécifique se déroulait à travers onze mesures qui tentaient de trouver des réponses aux questions de recherche 3 et 4.

L'étape 7 a initié la mise en place des 5FS. La première opération a consisté à identifier la contrainte (**étape 8**). Une analyse de la mise en charge des ressources du système a révélé que celui-ci travaillait en surcapacité, de sorte que la contrainte paraissait clairement être la consommation (ou le marché). Le système pouvait produire plus. Comme le flux réel de linge traité ne pouvait pas être réellement quantifié, il était estimé sur la base théorique d'un taux de remplissage de l'hôpital de 100%. En fait, on a calculé que la structure fonctionnait à 72% d'occupation. L'opération suivante (**l'étape 9**) s'appelle l'étape d'exploitation. Cette démarche

s'intéresse à toutes les activités requises pour que la contrainte produise davantage. Comme le rendement contraignait le débit du système, l'exploitation appelait à augmenter ce rendement et traiter plus de linge sale. Dans le cas que nous étudions, l'étape d'exploitation n'a pu être effectuée dans la mesure où le but du système n'était pas de laver le plus possible, mais seulement ce qui était nécessaire. Le chemin évident pour améliorer le système suivait l'idée de réduire la taille du système autour d'une contrainte interne. Les Coûts d'Exploitation avaient une plus grande importance que le Débit. Choisir une contrainte interne a été l'action suivante (**Etape 10**). A partir de l'analyse de la mise en charge des ressources, celle qui avait la plus grande utilisation a été retenue. Il s'agissait des machines à laver. Pour convertir la contrainte choisie en contrainte réelle, on a décidé d'augmenter le flux qui passait au travers des machines à laver en arrêtant de travailler le dimanche (**Etape 11**). Par ce biais, les machines seraient disponibles seulement six jours par semaine (au lieu de sept), mais le flux de linge resterait sur sept jours (puisque l'hôpital fonctionne en permanence). Le plan était de générer une grosse pile de linge sale en attente devant les machines pendant le week-end et de la faire diminuer à la fin de la semaine, période durant laquelle elle serait à nouveau reconstituée. Même avec les six jours de disponibilité, la contrainte avait plus de débit que le taux d'arrivée de linge utilisé. Pour **l'étape 12**, plusieurs séances de brainstorming ont eu lieu. Par catégorisation et unitisation, les injections ci-dessous ont été identifiées pour mettre en place les phases d'exploitation et de subordination :

Injections d'Exploitation

1. Remplir le tambour des machines à laver avec 25 kg de linge -Selon les spécifications de leurs manuels d'utilisation, la charge nominale de ces appareils correspond à ce poids.-
2. Séparer, lors du dépôt des « linges sales », le blanc et la couleur. – beaucoup de temps était gaspillé auparavant pour trier les linges de couleur des blancs. On a suggéré qu'il serait beaucoup plus efficace si, à la livraison, on distinguait les deux catégories : blanc et couleur. De cette manière, le chargement des machines s'en trouverait accéléré.
3. Mettre les draps et les serviettes ensemble -Un employé de terrain a aussi proposé de charger le tambour avec un mélange de draps et de serviettes. De cette façon, on pourrait sortir la lessive beaucoup plus rapidement. Quand la machine est remplie

seulement de draps, ils se mettent en gros nœuds, ce qui retarde l'opération pour vider les machines à laver.

4. Embaucher un homme pour charger/décharger les machines. -Remuer tous les draps et le linge est une tâche ardue pour les femmes. En attendant cette arrivée, une femme qui travaille sur les séchoirs (hors de la contrainte) viendra prêter main-forte au personnel féminin affecté au remplissage et au vidage des machines à laver.

5. Programmer les machines pour qu'elles ne s'arrêtent pas toutes en même temps. - Quand deux machines finissent simultanément, l'employé ne peut s'occuper que d'une à la fois et l'autre reste en suspens, faisant perdre du temps à la contrainte. Tous, nous sommes tombés d'accord sur le fait de programmer le cycle de lavage de sorte que les lessives se terminent de manière séquencée.

Injections pour la Subordination

7. Commencer plus tôt le lundi afin d'avoir plus de linge disponible quand arrive le temps de faire les chambres. C'est le lundi matin qu'il y a la plus grosse pile de « linge sale » (puisque le dimanche est un jour de repos pour la blanchisserie.).

8. Informer les fournisseurs et le département de la maintenance que, s'il y a une demande concernant un problème sur les machines à laver, elle doit être traitée en priorité absolue. Les machines à laver seraient en passe de devenir la nouvelle contrainte, donc toute l'assistance nécessaire devrait être disponible pour les garder en état de marche et opérationnelles.

9. Finalement, nous avons convenu que la seconde équipe prendrait son travail une heure plus tôt. De la sorte, le chevauchement de la première et de la seconde équipe serait plus long ; ce qui aurait pour conséquence que les machines à laver ne s'arrêtent pas durant les pauses et que le temps d'inactivité s'en trouverait minimisé.

10. Nous avons cessé de travailler le dimanche.

Mesures

11. On s'est assuré que le manager de la blanchisserie a bien compris l'importance du rôle joué par la contrainte.

12. On a calculé que l'on devrait pouvoir faire tourner 45 cycles de lavage chaque jour de la semaine ouvrée et 15 le samedi. On a instauré un carnet dans le service afin de relever les cycles.

Plutôt que de procéder à la phase d'exploitation (tel que cela est indiqué dans la littérature), l'équipe a décidé de commencer par la subordination, puis de passer à l'exploitation. **L'étape 13** a mis en place en premier lieu les injections de

subordination qui ont été répertoriées à l'étape 12. L'activité du dimanche a été interrompue. Pendant deux semaines, le système tout entier a basculé sur un mode instable dans la mesure où les services commandaient du linge de manière imprévisible. Les blanchisseurs réagissaient aux demandes soudaines des services et la situation était chaotique. Au bout de deux semaines, la conjoncture s'est normalisée et un tampon de « linges sales » posé devant la contrainte (les machines à laver) assurait un travail régulier. L'exploitation a pris le relais à **l'étape 14**, visant à fournir au système un Débit maximal. De nouveau, les phases repérées dans l'étape 12 ont été exécutées, donnant lieu à des résultats extraordinaires.

Tambour-Tampon-Corde (DBR)

Les Cinq Étapes de Focalisation sont conçues pour élever et développer un système, mais elles ne produisent pas les décisions pour gérer le flux. La méthode de la TOC pour piloter et contrôler celui-ci passe par le DBR. Le Tambour dans le système du linge était constitué par les machines à laver. Comme la Corde n'était pas le produit d'une décision humaine (qui aurait lancé le linge utilisé dans le système), le Tampon se définissait alors comme le résultat entre le « linge sale » généré et le Débit du Tambour. Dans cette étude de cas, le DBR et le contrôle du flux étaient freinés par la conception même du système.

La Solution de Réapprovisionnement

Le réapprovisionnement en linge propre vers les salles et vers les différents départements était réalisé, en se fondant sur l'expérience. Le personnel de la blanchisserie remplissait les chariots avec du linge propre, puis il regarnissait les armoires dans les salles. Il vérifiait le niveau de linge dans les placards des services et il les réassortissait de façon empirique. Tout le stock de linge était conservé près des points de consommation, dans les placards des salles communes. Quand il y avait beaucoup de linge dans le système, aucune plainte quant à la disponibilité ne remontait. Lorsque le niveau du stock venait à baisser, les réclamations arrivaient de toutes parts. Des réserves importantes pouvaient apparaître dans certains endroits et de la pénurie ailleurs. La solution élaborée se fondait sur le concept de la solution de

réapprovisionnement. Les linges spécialisés seraient stockés dans les services spécifiques qui en avaient l'usage, et ceux, plus courants, conservés à la blanchisserie. Les besoins en linge ordinaire se calculeraient à partir du compte-rendu d'occupation et, seul, le montant calculé serait fourni. Les tampons se trouveraient indiqués par les infirmières surveillantes en charge des salles. Le système a parfaitement fonctionné pendant quatre mois. Au-delà de cette période, des situations de rupture de stock sont réapparues : un audit a été diligenté pour découvrir ce qui dysfonctionnait.

Audit et Stabilisation

Après quatre mois, la mise en œuvre de la TOC à la blanchisserie a fait l'objet d'un nouvel audit. Les 5FS marchaient toujours très bien, mais la solution de réapprovisionnement avait laissé la place à l'ancien mode de fonctionnement. En l'absence du superviseur, le personnel avait cessé d'utiliser le compte-rendu de réapprovisionnement et l'opération se passait à nouveau à partir de l'expérience. Pour y remédier, la solution de réapprovisionnement a été de nouveau instaurée, et des réunions d'examen ont été tenues chaque quinzaine pour auditer et évaluer la solution dans son ensemble afin que les améliorations ne s'effacent pas et que le système reste stabilisé.

4^{ème} Phase : Evaluation

La dernière section (ou section d'évaluation) présente un bilan. Elle condense les résultats extraits des dix-sept étapes précédentes. Son objectif est de répondre aux questions de recherche 5 et 6.

Après la mise en place de la TOC, le pourcentage d'utilisation du système de gestion du linge a progressé instantanément de 15% (de 72% à 87%), car le temps disponible de la Contrainte a été réduit. Les investissements ont été annulés et le fait de ne travailler que six jours par semaine (jours fériés inclus) a entraîné une économie de 40 000 € par an. Un point important : le management a acquis des critères pour juger si l'opération était « coûteuse » et il se trouvait dans la position de comprendre le comportement complet du système.

Le tableau ci-dessous table montre les réactions du personnel à chaque phase du processus :

Etapes	Outil / Protocole de la TOC Utilisé	Perception des personnels et réaction à l’outil/au Protocole de la TOC utilisé
Etape 1	Formation, CRT – Recueil des UDE	<ul style="list-style-type: none"> • Le personnel est devenu suspicieux. • Difficulté pour les employés de comprendre les concepts de base de la TOC. • La discussion au sujet des problèmes (UDE) a produit des réactions hostiles et une peur d’être critiqué. • Les UDE ont été avancés de manière aléatoire - beaucoup n’avaient aucun caractère systémique. • Le personnel s’est senti menacé, il s’est montré négatif et sur la défensive. • IMPOSSIBLE DE POURSUIVRE AVEC LE CRT.
Etape 2	Refonte de la formation	<ul style="list-style-type: none"> • Le management se révélait impatient. Il attendait des résultats RAPIDEMENT. • La visualisation du flux s’est révélée très efficace. • Parler de leur système a permis de garder les employés motivés et coopératifs. • Il est beaucoup plus productif d’expliquer tous les outils de la TOC en une fois plutôt qu’un par un.
Etape 3	Arbre du But	<ul style="list-style-type: none"> • L’Arbre du But est un outil facile à construire, même s’il requiert un cadrage précis. • Les Facteurs Critiques de Succès (CSF) et les Conditions Nécessaires (NC) sont subjectifs. Les participants pouvaient avoir du mal à appréhender exactement ces deux notions. • Visualiser le flux a aidé au développement de l’arbre. • Si on se focalise sur les outils, la peur disparaît. On doit se concentrer sur la structure du système et sur sa performance, et NON sur les personnes. • Les participants ne savaient pas formuler les CSF et les NC.
Etape 4	CRT et Analyse des lacunes	<ul style="list-style-type: none"> • Les participants étaient préoccupés par les problèmes. Ils « connaissaient » ce qu’étaient les problèmes. • Chaque intervenant évaluait la situation courante en fonction de son statut et de sa position dans le système. • Les employés de la blanchisserie se sont sentis fragilisés et se sont mis vraiment sur la défensive à propos des UDE soulevés par les autres intervenants. • Les employés considéraient que le système tout entier était injuste envers eux et que personne ne reconnaissait leur travail acharné.
Etape 5	Nuage d’Evaporation	<ul style="list-style-type: none"> • Outil très efficace. • Sa simplicité a surpris tout le monde. • Il a été développé sous de strictes directives.
Etape 6	Arbre Futur de Réalité	<ul style="list-style-type: none"> • Les participants ont aimé l’idée qu’ils pouvaient

		<p>préparer l'avenir.</p> <ul style="list-style-type: none"> • Les Effets Désirables sont très subjectifs, y compris lorsqu'ils proviennent de l'Arbre du But. • Les participants ont fortement soutenu l'idée qu'ils avaient besoin de plus de directives pour énoncer les Effets Désirables. • Construire le FRT est une longue démarche et les gens ne peuvent rester focalisés sur cette opération. Ils ne peuvent pas développer cet outil par eux-mêmes.
Etape 7	5FS	<ul style="list-style-type: none"> • Cela est apparu logique.
Etape 8	Identifier la Contrainte	<ul style="list-style-type: none"> • Les gens ont été surpris quand ils ont réalisé qu'ils travaillaient en surcapacité. • Le système opérait en surcapacité, mais tout le monde semblait toujours extrêmement occupé.
Etape 9	Exploiter la Contrainte	<ul style="list-style-type: none"> • Réduire la taille de la Contrainte. • Le Management a adoré le concept de réduction de taille.
Etape 10	Choisir la Contrainte	<ul style="list-style-type: none"> • Les données concrètes ont facilité le processus.
Etape 11	Convertir la Contrainte choisie en goulot d'étranglement.	<ul style="list-style-type: none"> • Compréhensible par tout le monde.
Etape 12	Solutions de brainstorming. Données de Catégorisation et d'Unitisation.	<ul style="list-style-type: none"> • Le Brainstorming a été utilisé pour passer un niveau • Le Manager Général a apprécié la clarté des mesures à prendre. • Processus très créatif. Les gens ont aimé participer. • Le Brainstorming est une procédure très subjective. Cet aspect a été fortement souligné par tout le monde.
Etape 13	Tout subordonner à la Contrainte	<ul style="list-style-type: none"> • 1^{ère} étape de la mise en œuvre concrète. • Aucune résistance n'est observée. Le personnel prend part à chaque phase. • Les employés donnaient la priorité à la subordination sur l'exploitation. • Le management était impatient – Il insistait sur le fait de tout mettre en œuvre tout de suite. • Aucun pilotage n'a été utilisé. • Un membre expérimenté appartenant à l'atelier a joué un rôle clé pour surmonter les résistances. • Le système a été instable pendant deux semaines. Le personnel paniquait.
Etape 14	Exploiter la nouvelle Contrainte	<ul style="list-style-type: none"> • La plupart des décisions concernant l'exploitation ont été oubliées. • Le FRT a aidé à se focaliser à nouveau.
Etape 15	Tambour-Tampon-Corde	<ul style="list-style-type: none"> • Le DBR a été intégré dans la conception. • Les employés avaient juste besoin d'une description et des règles claires concernant ce qu'il fallait suivre et ce qu'il fallait surveiller. • Quarante-cinq cycles de lavage par jour constituaient un objectif précis. Aucune autre mesure n'était nécessaire.
Etape 16	Solution de Réapprovisionnement	<ul style="list-style-type: none"> • Les gens faisaient preuve d'une très grande créativité pour trouver des moyens de mettre en place le réapprovisionnement. • Le superviseur a sous-estimé le principe logique du compte-rendu de réapprovisionnement.

		<ul style="list-style-type: none"> Le fait que le système fonctionnait sans le compte-rendu de réapprovisionnement pendant une certaine période est passé inaperçu.
Etape 17	Standardisation / Stabilisation	<ul style="list-style-type: none"> Les concepts de Standardisation et de Stabilisation n'ont intéressé que le Responsable des Soins Infirmiers. Le reste de l'équipe croyait que tout dépendait seulement des compétences humaines, des capacités et de l'intérêt.

Analyse et Observations – Le Service de Chirurgie

Cette étude de cas décrit et analyse la mise en pratique de la TOC dans un service de chirurgie situé au sein du plus grand hôpital privé à Chypre. Notre recherche a porté sur le rendement de six salles d'opération sur le plan de leurs profils d'utilisation. Un programme pilote a été lancé afin d'appliquer la méthodologie du DBR dans l'un des six blocs opératoires.

L'intervention s'est déroulée à travers deux cycles de recherche-action et neuf étapes. Chacune de ces phases de l'action a produit un ensemble d'activités où l'on a exploité des outils de la TOC afin d'améliorer la situation dans le champ spécifique de la recherche.

Premier Cycle de Recherche-Action

1^{ère} Phase : Le Diagnostic – Ce qu'il faut Changer

Dans le cas précédent du service de blanchisserie, la question liminaire « pourquoi changer » avait été initialement omise. Cet oubli s'était traduit par une hostilité de la part des employés : rien ne pouvait être accepté tant que la démarche n'était pas exposée et clarifiée. Dans le but d'éviter la même confusion et la même opposition dans la seconde étude, la première étape de l'action, au bloc opératoire, s'est ouverte par le processus de formation (**étape 1**). On a voulu présenter l'intervention et sensibiliser l'équipe aux concepts de la TOC.

Comme il n'était pas possible d'impliquer tout le personnel du service de chirurgie, une équipe de projet, à la fois réduite et flexible, a été instituée, comprenant sept personnes. Ce groupe se composait du doctorant, du directeur des soins infirmiers, de la responsable du service de chirurgie, de son assistant, d'un chirurgien (orthopédique) et de deux infirmières qui travaillaient sur plusieurs salles d'opération. L'équipe du projet constituait l'autorité centrale chargée de prendre toutes les décisions.

Comme l'arbre du but (GT) avait rencontré un très vif succès dans l'étude précédente, résolution a été prise de l'utiliser aussi dans ce deuxième cas de figure, depuis le tout début (**étape 2**). La visée était simple. Il s'agissait de répondre à la question « Pourquoi changer » en fixant l'objectif, en essayant de tenir à l'écart toute résistance due à l'émotion ainsi qu'à tout sentiment de culpabilité. Pour cela on a mis en avant la nature systémique de l'approche, en la dissociant de tout comportement humain.

La mesure qui relevait de la plus forte priorité dans le service de chirurgie concernait le Débit. En conséquence, la finalité admise se libellait ainsi : « *fournir des services de chirurgie de haute qualité avec une rentabilité maximale à la fois au présent et à l'avenir* ». Trois Facteurs Critiques de Succès -Critical Success Factors (CSFs) en anglais- se dégagèrent de cette formule. 1. Être efficace sur le plan financier. 2. Accomplir des actes chirurgicaux performants. 3. Compter sur un personnel de qualité. L'équipe autour du projet a décidé de se focaliser sur le premier CSF et d'étudier le volet de l'efficacité économique. Au cours de **l'étape 3**, on a employé l'Arbre Actuel de Réalité (CRT) afin de déterminer les raisons pour lesquelles le système en vigueur ne se montrait pas assez intéressant financièrement, ainsi que les responsables le proclamaient.

2^{ème} Phase : Programmation – Pour quoi changer

Le développement du CRT a révélé, à partir des données recueillies dans le progiciel de gestion de l'hôpital, que la Cause Critique Principale (CRC) se condensait dans le constat que les blocs ne fonctionnaient qu'à hauteur de 56% d'occupation. En s'adossant à ce fait, la solution appelait à un accroissement de l'utilisation des salles d'opération. On a alors appliqué les principes fondamentaux de la TOC. Le chemin emprunté par celle-ci pour intensifier le rendement à travers un système se trouve dans la mise en œuvre des Cinq Étapes de Focalisation (5FS) (**étape 4**) et le processus Tambour-Tampon-Corde (DBR). Le premier point requis pour lancer les 5FS demande d'identifier la contrainte.

3^{ème} Phase : Action – Comment provoquer le changement

Au cours de l'**étape 5**, on a isolé la contrainte : elle était due à la consommation (ou au marché). Cette perspective est apparue nettement, d'une part en vertu des termes mêmes du problème (56% d'utilisation suppose une surcapacité) et d'autre part grâce à l'observation. Conformément à la littérature, on est passé à l'**étape 6**, où l'on doit exploiter la contrainte. Dans le cas d'espèce, lorsque celle-ci tient au marché, il convient d'impulser du travail supplémentaire dans le système. De manière surprenante, l'équipe du projet s'est opposée à la proposition de majorer la quantité d'actes chirurgicaux. Cela a créé une autre vague de résistance. Les membres du comité, guidés par leur intuition, considéraient qu'il était impossible d'amplifier le nombre de soins opératoires. Ils affirmaient que les données recueillies étaient erronées et que les blocs connaissaient une occupation maximale. Ils ne pouvaient pas admettre que le problème résidait dans l'utilisation imparfaite des salles d'opération.

4^{ème} Phase : Evaluation

On en est arrivé à un blocage : le premier cycle de recherche-action a donc indiqué que les blocs fonctionnaient à un taux de 56%. Cela implique que les salles d'opération avaient une capacité excédentaire. Comme le débit formait la première des priorités et qu'on observait une surcapacité, la proposition la plus évidente était d'accroître le total d'actes chirurgicaux. Les membres de l'équipe s'y sont pourtant opposés. Ils ont soutenu qu'il était impossible d'effectuer plus d'opérations et que les dépenses de fonctionnement augmenteraient considérablement. Le premier cycle de recherche-action s'est arrêté ainsi là, car nous ne pouvions plus aller de l'avant.

Deuxième Cycle de Recherche-Action

1^{ère} Phase : Le Diagnostic – Ce qu'il faut Changer

La première recherche-action ne pouvait pas être achevée à cause de la résistance et des réserves dont les membres de l'équipe faisaient preuve. Il n'y avait pas d'accord sur le problème et, par conséquent, pas non plus sur la solution. Pour analyser plus profondément la situation et creuser davantage la compréhension de la difficulté, on a établi un nuage d'évaporation (EC) (**étape 7**). Les EC trouvent leur mesure quand il s'agit de faire émerger, puis d'interroger des postulats qui entretiennent un conflit. Le

dilemme manifeste se résumait à ajouter ou ne pas ajouter des opérations chirurgicales dans le système. L'opinion à combattre était que plus d'interventions gonfleraient les dépenses d'exploitation, même si, de fait, le taux d'occupation des locaux était faible. C'était une affirmation appuyée sur l'intuition et elle n'était confirmée par aucun chiffre. Afin de mieux comprendre le profil de capacité, il était nécessaire de mesurer et de retracer le flux qui circulait à travers les blocs chirurgicaux.

Nous avons décidé de relever les périodes d'inactivité dans six salles d'opération sur huit semaines.

Analyse des données.

Les données ont été recueillies par les infirmières qui travaillaient sur plusieurs blocs. Elles ont été divisées en trois catégories. Dans la première, le temps d'inactivité était enregistré à partir de 8 heures du matin jusqu'à la première opération. La deuxième correspondait aux périodes creuses entre les actes et la troisième coïncidait avec la durée d'inoccupation depuis la dernière intervention chirurgicale jusqu'à 15 h 30.

L'élément déclencheur pour réaliser la capture de données était l'entrée ou la sortie du patient des salles d'opération.

Au total, 672 cas ont été recensés au cours de la période d'étude. Avec une moyenne quotidienne de 17,23 cas et une amplitude de 9 à 24 chirurgies par jour.

Temps d'inactivité le matin.

Dans la mesure où les données étaient saisies cinq jours par semaine dans six salles d'opération pendant huit semaines, on a relevé 240 interventions chirurgicales qui ont débuté le matin. Parmi celles-ci, seules 65 ont commencé à l'heure prévue (avec une latence acceptée de 10 minutes), soit 27% des cas. Les autres 73% montraient un délai allant de 15 à 120 minutes. 168 heures étaient donc perdues, au total, en raison de retards matinaux pendant la seule période des huit semaines. Ceux-ci étaient principalement dus à l'heure à laquelle arrivaient les médecins ou au manque de lits à ce moment de la journée, ce qui différait l'admission des patients au bloc.

Temps d'inactivité entre les interventions.

Les chiffres soulignaient également que 40,9% du temps global d'inactivité se déroulait entre les opérations. Ce qui faisait 342 heures cumulées pour les six salles. La raison principale de ce fait était imputable aux acheminements tardifs des patients depuis les services vers les salles d'opération.

Temps d'inactivité l'après-midi.

Enfin, 42,3% du temps total a été perdu au cours des après-midi, ce qui revient à 354 heures pour les six blocs opératoires.

En se penchant sur le profil précis du temps d'inactivité, on percevait bien que ce temps était disséminé quotidiennement en petites pertes ou en très courtes périodes. Ce type de répartition ne permettait pas d'ajouter des actes chirurgicaux supplémentaires sans risque. L'observation ainsi que des entretiens non structurés ont indiqué que l'obstacle majeur pour rationaliser la fréquence des interventions se situait dans l'arrivée des patients dans les salles d'opération. « L'injection » ou le pas vers la solution consistait à aligner et à organiser les actes chirurgicaux en un flux continu. De la sorte, on pourrait concentrer la période d'inactivité en un seul grand bloc et ainsi programmer plus d'interventions.

2^{ème} Phase : Programmation – Pour quoi changer

Le chercheur a construit le Futur Arbre de Réalité initial et de nombreuses réserves ont été levées au moment où on a esquissé le planning de la procédure à suivre (**étape 8**). La nouvelle injection instaurait la mise en œuvre de la méthode Corde-Tampon-Tambour (DBR).

On a exposé la philosophie du DBR à l'équipe et nous avons décidé d'installer cette solution pendant seulement une OU deux semaines (**étape 9**). On a choisi le bloc numéro six pour champ de l'expérimentation.

3^{ème} Phase : Action – Comment provoquer le changement

Dans le service de chirurgie, deux flux principaux doivent être synchronisés pour pouvoir réaliser une intervention dans les meilleures conditions. Comme le montre la figure ci-dessous, le premier flux est celui qui correspond au Parcours du Patient (PJF) : il recoupe les différentes étapes qu'un malade franchit afin de subir une opération, puis de récupérer. La personne « s'écoule » à travers diverses fonctions de l'hôpital jusqu'à son arrivée au service de chirurgie. Comme indiqué, le flux se divise en trois phases. Le stade préopératoire, qui court environ sur 25 minutes ; le stade chirurgical qui varie selon la situation (on admet une durée moyenne de 56 minutes) ; le troisième stade recouvre le stade postopératoire, qui s'étend sur à peu près 30 minutes. Le codage des étapes se fait à des fins d'analyse et se trouve exposé dans ce schéma :

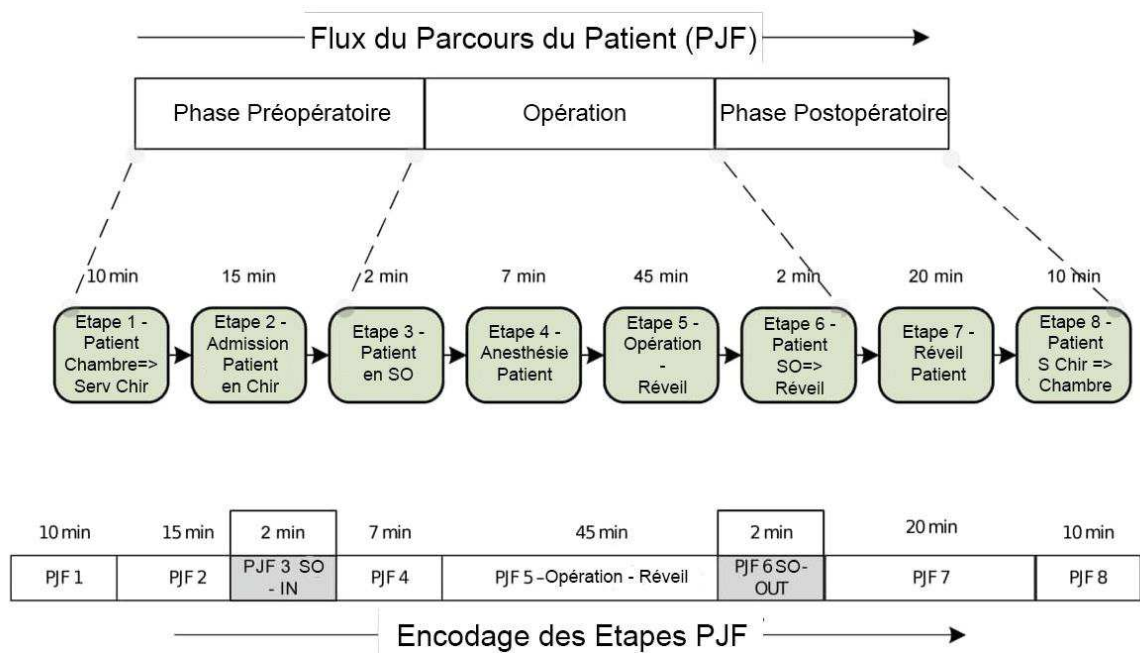

Le deuxième flux est celui qui retrace le processus qui a lieu dans la salle d'opération (ORF), illustré sur la figure suivante. Il réunit toutes les fonctions activées dans un bloc opératoire afin que le chirurgien puisse exercer son acte de manière optimale. Le flux d'activité de la salle est lui aussi divisé en trois étapes : la phase préopératoire est antérieure à l'intervention proprement dite ; le stade de la chirurgie constitue le moment où l'opération, elle-même, se déroule : il est supposé durer 30 minutes ;

enfin, le stade post-chirurgical répond à la période de réveil partiel du patient au sein du bloc. Encore une fois, le codage est réalisé à des fins d'analyse.

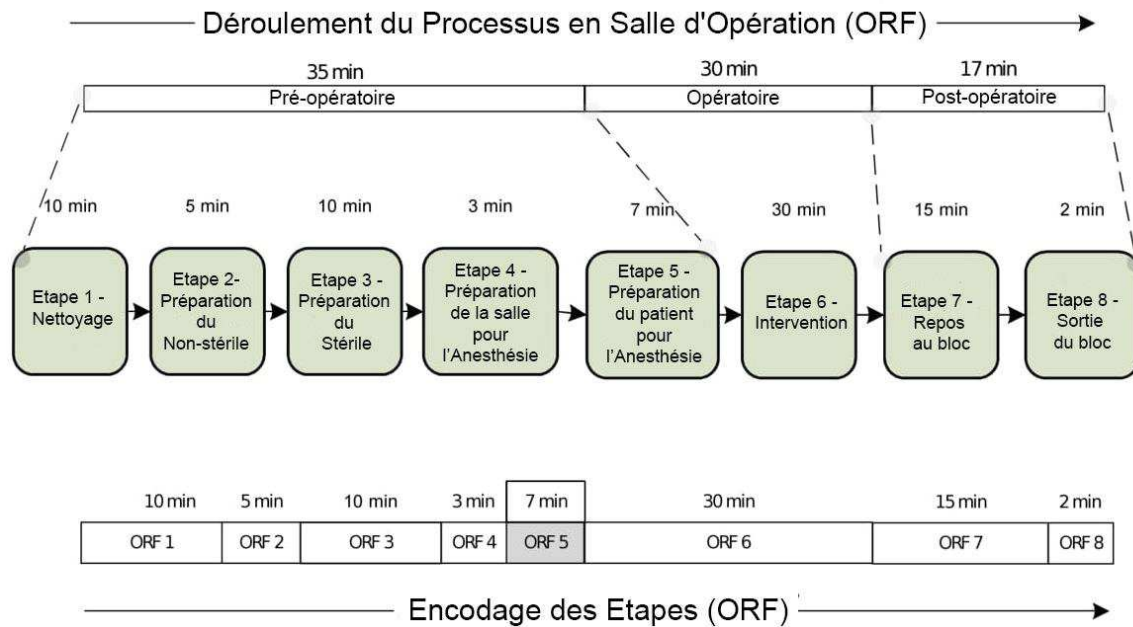

Dans la phase préopératoire et postopératoire, le patient se trouve à l'extérieur de la salle d'opération.

Si les deux flux ci-dessus ne sont pas synchronisés, on perd alors du temps. Si l'étape 5 de l'ORF est prête tandis que le patient ne l'est pas, la salle d'opération reste vide et inactive. Si l'étape 3 du PJJ est prête, mais que le bloc ne l'est pas, le patient doit attendre dans un environnement très stressant. L'objectif vise donc à faire concorder les deux flux pour produire un flot continu.

ETAPE 1 - Configuration du Tambour

La première étape de la mise en œuvre du DBR consiste à configurer le Tambour qui constitue la contrainte du système. La contrainte choisie était le temps du médecin. L'objectif cherche à faire fonctionner l'instrument en continu. La figure ci-dessous montre que 52 minutes séparent les Tambours l'un de l'autre en raison des étapes qu'il faut nécessairement suivre.

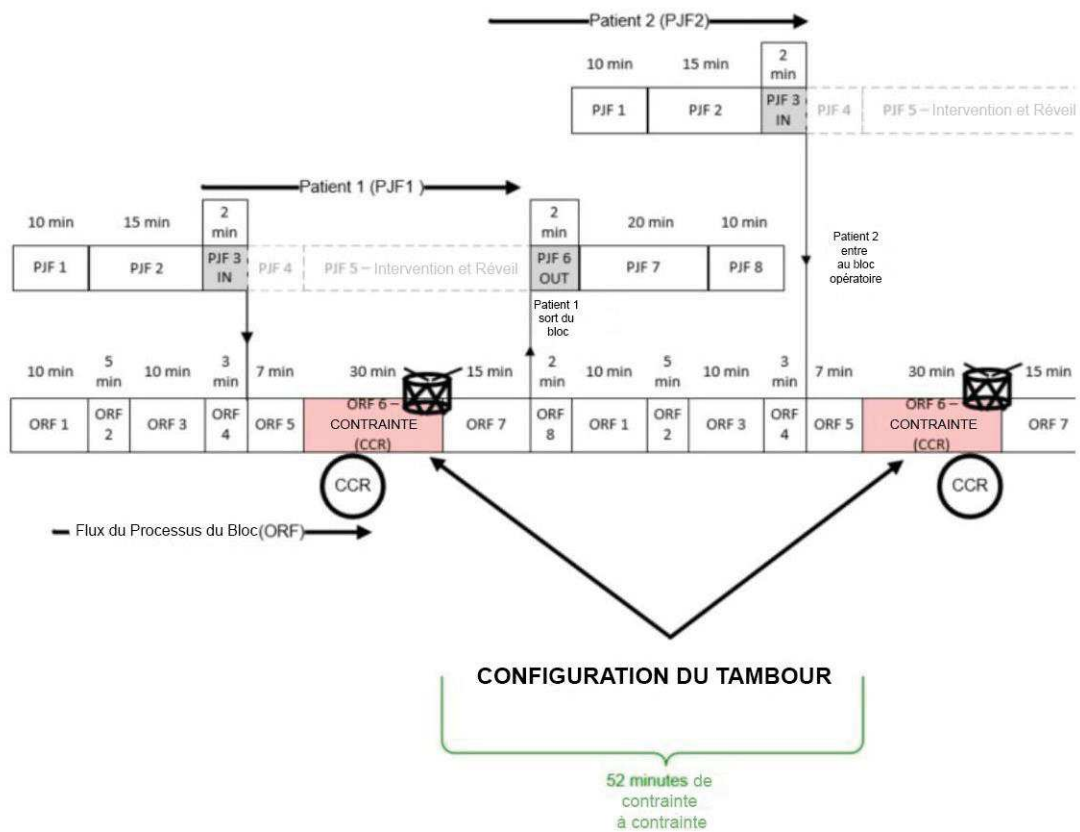

ETAPE 2 - Configuration du Tampon

La deuxième étape consiste à configurer le Tampon. Il s'agit du temps de couverture placé avant le tambour pour s'assurer que celui-ci ne restera pas inactif en raison d'une rupture dans le travail. Le Tampon a été réglé empiriquement à sept minutes (voir le diagramme plus bas). Le patient doit donc être dans l'unité de chirurgie sept minutes avant d'entrer effectivement dans la salle d'opération.

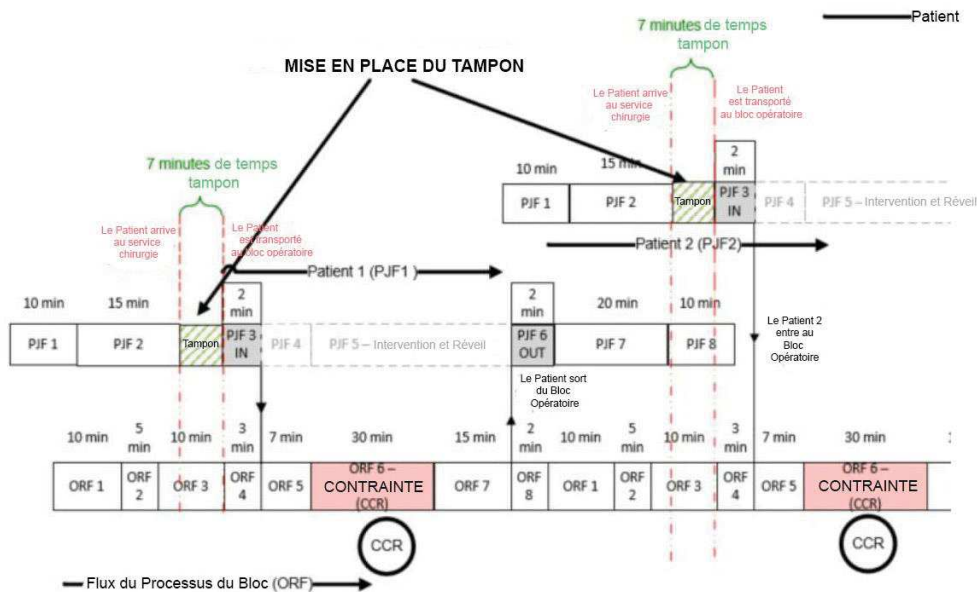

Etape 3 - Configuration de la Corde

La troisième et dernière étape consiste à mettre en place le mécanisme de la Corde. Il s'agit du dispositif de communication qui permet de libérer davantage de travail dans le système. Dans le cas présent, c'est un signal qui déclenchera le transport du malade de son lieu d'attente à l'unité chirurgicale. Comme indiqué sur la figure suivante, la longueur de la Corde a été fixée à 34 minutes : il faut 10 minutes liminaires pour amener le patient de sa chambre à l'unité chirurgicale, 15 minutes pour le processus d'admission, 7 minutes pour le temps tampon et 2 minutes pour procéder au transfert jusqu'à la salle d'opération. Cela signifie que 34 minutes avant que la contrainte ne soit prête, le fichier P1F doit commencer. On peut remarquer que le reste des étapes de l'ORF peut se contrôler facilement dans la mesure où le patient n'est pas impliqué. Le personnel a évoqué des motifs d'étendre les premières 10 minutes qui ont conduit à une analyse. Des raisons élémentaires ont été avancées qui provoquaient d'autant plus de problèmes par le passé qu'elles ne s'exprimaient pas clairement. On a proposé des réponses rapides à ces difficultés : elles ont débouché sur des solutions simples. Pour ce qui touche au P1F, les étapes sont devenues relativement maîtrisables et prévisibles.

Afin de gérer le manque possible de lits le matin, l'équipe du projet a suggéré d'avoir recours à ceux du service d'urgence, au moins pendant la période d'essai des deux semaines.

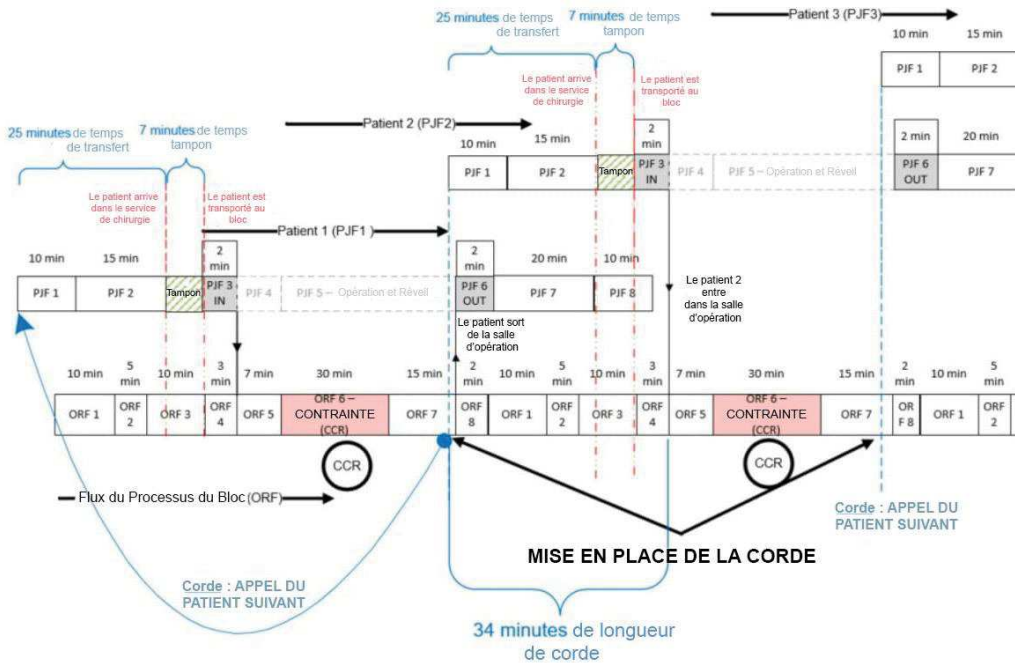

4^{ème} Phase : Evaluation

Le DBR a été instauré pendant deux semaines. L'objectif était de regrouper les périodes d'inactivité en un seul bloc de temps, de sorte que l'on puisse procéder à plus d'opérations chirurgicales sans risque. Les données recueillies avant les modifications entreprises ont été réalisées pendant le développement du Nuage d'Évaporation. Suite à la mise en œuvre du DBR, on a observé ce qui suit :

- 1. Les moments d'inactivité le matin.** On a constaté une amélioration considérable dans cette partie avec une nette réduction du temps gaspillé. 12% du total de ce temps avait lieu le matin dans l'environnement spécifique du Bloc 6. Après la mise en place de l'exercice, ce pourcentage a été ramené à 3%.

2. **Les moments d'inactivité entre les interventions.** Ce sont les périodes où il n'y a pas d'activité dans la salle d'opération pour différents motifs. Mais il s'agit tout autant d'une perte de temps. Avant notre action, et pendant les huit semaines d'enregistrement des données, la moyenne du temps perdu atteignait 47% du montant total de l'inactivité. Après notre initiative, ce secteur a été réduit à 21%. La mise en place du DBR a réussi à résorber de moitié le temps d'inutilisation en seulement deux semaines.
3. **Les moments d'inactivité dans l'après-midi.** Ils concernaient 41% de l'ensemble avant notre intervention ; par la suite, ils sont passés à 77%. C'était bien là l'objectif affiché : accumuler le temps libre en une période continue afin que l'on puisse programmer facilement plus d'opérations chirurgicales.

La pratique du Tambour-Tampon-Corde (DBR) a permis de dégager 10 heures par semaine et accroître mécaniquement le nombre d'actes chirurgicaux. Cela ouvre des perspectives d'augmentation du Débit du seul bloc n° 6 de plus de 30%. L'hôpital dispose de 12 salles d'opération où le DBR peut être utilisé avec le même type de résultats prometteurs.

Le tableau ci-dessous résume l'observation faite concernant la perception des différents outils de la TOC par les participants. Il se focalise sur la partie flexible du système.

Etapes	Outil / Protocole de la TOC Utilisé	Perception des personnels et réaction à l'Outil/au Protocole de la TOC utilisé
Etape 1	Formation	<ul style="list-style-type: none"> • On constate un cloisonnement de pensée très marqué. • Les concepts ont été jugés très intéressants. • Les métaphores de la voiture et de la rivière ont très bien fonctionné. • Besoin de temps pour digérer les concepts du système. • Le personnel a réalisé qu'il n'est pas la cible, c'est la structure du système qui l'était. • Le jargon doit être évité. Il crée la confusion chez les participants.
Etape 2	Arbre du But	<ul style="list-style-type: none"> • Le personnel n'a pas aimé l'idée que leur but était de faire plus de profits dans le présent et à l'avenir.

		<ul style="list-style-type: none"> • Ils l'ont acceptée quand le but incluait leur spécialité. • Le personnel mentionnait les avantages qu'il avait acquis, comme si c'étaient des nécessités naturelles. • Même des gens qui étaient employés à la clinique depuis des années étaient frappés de la façon dont un grand nombre de conditions étaient interconnectées et apparaissaient. • Cette étape a dégagé une énergie positive pour la création et la motivation. • Les craintes et les menaces survenues initialement se sont évaporées. • La psychologie du personnel a été affectée très positivement. • La liberté de créer « l'état idéal » a inspiré les gens, ils se sont sentis forts, fiers de participer et enthousiastes.
Etape 3	Arbre Actuel de Réalité	<ul style="list-style-type: none"> • ANALYSE DES ECARTS • Les employés indiquaient qu'ils avaient de nombreux problèmes, mais ils ne pouvaient pas les définir clairement. • Tendance à discuter de leurs UDE personnels. • Tendance à bondir aux causes et aux solutions. • Les employés discutaient des problèmes que leurs solutions amèneraient. • Ils soutenaient que la plupart des UDE étaient de la faute des autres. • ARBRE ACTUEL DE REALITE • Le Développement de l'Arbre s'est révélé difficile. • Les gens n'ont pas relevé toutes les hypothèses - tous les champs. • Peur du blâme lors de la discussion des hypothèses. • Les employés ne savaient pas que le progiciel de gestion intégré calculait les ratios d'occupation. • Ils ont été surpris d'apprendre que les salles d'opération fonctionnaient à 56% de leur capacité. • En observant avec attention, le personnel des blocs pouvait discerner les périodes d'inactivité. • Les participants ne peuvent rester longtemps concentrés. • Difficulté à se focaliser sur les Catégories de Réserve Légitime (CLR). • Echec sur la Réserve concernant la Réalité de l'Enoncé Logique. (Entity Existence Reservation.) • Accord sur le CRC.
Etape 4	Mise en œuvre des 5FS	<ul style="list-style-type: none"> • Le personnel a trouvé l'approche très logique. • Ils ont considéré la métaphore de la rivière comme très éclairante.
Etape 5	Identifier la Contrainte	<ul style="list-style-type: none"> • Lorsqu'elles essayaient d'identifier la Contrainte en compilant des calculs, les infirmières disaient qu'un hôpital est très différent d'une usine. • Tout le monde sur le terrain était très désireux d'aider et appuyait nos efforts.
Etape 6	Exploiter la Contrainte	<ul style="list-style-type: none"> • Quand on a décidé d'augmenter la charge de travail, en introduisant plus d'actes chirurgicaux, le

		<p>personnel a fortement résisté.</p> <ul style="list-style-type: none"> • La résistance s'est étendue très rapidement à l'ensemble de l'unité. • Les employés étaient très contrariés et ils prétendaient que les conjectures du progiciel étaient fausses. Ils ne croyaient pas aux 56%. • Les gens faisaient confiance à leur intuition. • Ils émettaient beaucoup de réserves.
Etape 7	Nuage d'Evaporation	<ul style="list-style-type: none"> • Outil facile à utiliser. • Cela organise les arguments. • Les gens ont été surpris par la nature du conflit et par la simplicité de l'outil. • Nous avons dû collecter des données pour invalider des présomptions.
Etape 8	Arbre Futur de Réalité	<ul style="list-style-type: none"> • Les participants le conçoivent comme une supposition. • Ils ont trouvé ce type d'approche très subjectif. • Lorsqu'un Effet Désiré n'est pas évoqué dès le début, la solution ne le dégagera pas par elle-même et on passera à côté.
Etape 9	Tambour-Tampon-Corde	<ul style="list-style-type: none"> • Le personnel a apprécié l'approche. • Il devient très créatif. • Il propose des solutions pour presque tout. • Après deux semaines d'essai, il s'est plaint qu'il fallait davantage d'employés. • Les gens étaient très serviables, très détendus et très impliqués. • Ils ont aimé améliorer le processus.

Discussion et Conclusion

Tout n'est qu'une question de changement.

En se servant de la principale interrogation de recherche comme point d'appui, le débat doit s'articuler autour des composantes de la TOC et des solutions qu'elle apporte.

Juger directement les observations et les résultats à partir de la mise en œuvre concrète apparaît comme un exercice compliqué. En effet, dans les expérimentations effectuées, les outils de la TOC sont intriqués et utilisés tous ensemble. Par conséquent, à des fins d'analyse, la discussion doit avoir lieu sur les principaux éléments constitutifs de la TOC, en les détachant les uns des autres. C'est à cela que l'on va s'attacher dans notre conclusion.

Les Processus de Pensée Logique (LTP)

En premier lieu, les constats, issus des deux études de cas présentées dans la recherche, ont montré que pour employer les différents Arbres de la TOC, une personne facilitatrice, possédant une connaissance approfondie de cette théorie, s'impose : elle dispense, tout d'abord, une formation sur les systèmes, elle explique ensuite les outils dont on a besoin : cela semble nécessaire pour atteindre une certaine efficacité auprès de ceux qui collaborent.

En second lieu, on doit procéder à un ajustement : bien que le vaste ensemble de la littérature recommande que l'Arbre Actuel de Réalité débute la séquence traitant des Outils du Processus de Réflexion, on a constaté que l'Arbre du But est un biais beaucoup plus judicieux pour entamer la démarche réflexive. De fait, au lieu de faire surgir les problèmes, d'alimenter les débats et de fonctionner comme un catalyseur de la résistance des employés, il motive les personnes et permet de susciter une énergie positive.

Troisième point concernant les LTP : une observation a communément frappé les esprits de l'équipe. Le développement du GT et du FRT est un cheminement qui relève essentiellement de la subjectivité.

Les Cinq Etapes de Focalisation (5FS)

Les 5FS ont été mises en œuvre avec succès. Mais, là encore, des modifications dans leur emploi ont paru utiles. Ainsi, au cours de nos deux expériences, l'étape de subordination a précédé celle de l'exploitation. Il s'agit là d'un changement qui s'est avéré très heureux. Au bloc opératoire, la subordination a bien trouvé place dans le contexte du DBR et a réussi à nourrir la contrainte, en augmentant le nombre de patients traités. Nous croyons que cette permutation peut avoir une grande importance dans la séquence des 5FS. En effet, à travers cette recherche, on a montré, dans les deux cas de figure qui nous ont intéressés, que la contrainte réelle qui se cachait derrière les contraintes visibles tombait sous le coup de la subordination. A la blanchisserie, le travail du dimanche amenait une surcapacité ; au service de chirurgie, le rythme d'arrivée des patients au bloc suscitait de multiples moments d'inactivité, ce qui réduisait l'utilisation des locaux et nuisait au rendement.

En outre, à côté de ce changement, on a procédé à une autre adaptation tout aussi notable au sein de nos expériences de terrain, quoique sur un plan différent : la phase « identifier la Contrainte » a été remplacée par « choisir la Contrainte ».

Enfin, une constatation à fort pouvoir de transformation a aussi été découverte : lorsque le débit n'est pas la priorité la plus haute, on doit avoir recours à une étape supplémentaire pour stabiliser le système, dans la mesure où l'on cherche non à le faire croître (ce qui est l'objectif naturel visé par la TOC), mais à lui donner plus d'assises.

Tambour-Tampon-Corde (DBR)

La mise en pratique des deux expérimentations a montré que le DBR peut se révéler très opérant dans la gestion du flux au sein des deux contextes pourtant bien distincts.

Plus spécifiquement :

1. Le DBR est efficace et peut donner des résultats rapides à la fois au niveau de la fonction d'entretien et de l'environnement du bloc chirurgical.
2. Aucune collecte massive de données n'est requise.
3. Les résultats sont bien meilleurs si on peut automatiser la Corde et intégrer le concept du DBR à la structure du système.
4. En l'absence d'un logiciel, les zones-limites des tampons ne peuvent être définies avec précision.
5. Comme la longueur de la corde était très courte dans nos cas concrets, un seul point de déclenchement dans le tampon était nécessaire -nul besoin de trois niveaux de tampon.

Contribution théorique à la TOC

Les résultats de ce travail permettent de susciter quelques apports formels dans l'utilisation de la TOC. Certains ont déjà été évoqués, mais il nous paraît nécessaire de les reprendre. Ainsi, comme on l'a noté auparavant, on a vu que le développement de l'Arbre du But et du Futur Arbre de Réalité se fonde sur un processus très subjectif. Ce sujet n'est, hélas, guère renseigné : la littérature et la recherche sur le premier mentionné sont quasi inexistantes, à l'exception des directives détaillées fournies par Dettmer. Un champ entier reste à explorer, à approfondir.

Pour notre part, nous avons essayé de fouiller davantage ce domaine. Aussi a-t-on choisi de consacrer un chapitre complet à l'élaboration d'éléments théoriques pour la construction de ces outils, de ces deux Arbres, en s'appuyant sur les concepts et sur les réflexions liés au système. Cet effort se conclut par un ensemble de critères sur lesquels l'utilisateur peut compter afin de s'assurer que certains attributs du système à l'étude ne sont pas oubliés.

Une autre perspective a retenu notre attention et nous a poussés à proposer une modification de la doctrine, telle qu'elle se trouvait présentée dans les textes de référence. Il nous a semblé intéressant d'affiner les trois « questions du changement » : en l'état, elles ne permettaient pas de traiter tous les aspects de la situation et des problèmes qu'elle contenait. Aussi sont-elles devenues cinq. On a ajouté deux interrogations supplémentaires qui paraissaient indispensables : « Pourquoi un changement est-il nécessaire ? » et « Comment faire pour que le changement persiste ? ».

Contribution et implications concernant le management.

Au-delà de cette dimension théorique, notre travail s'est aventuré sur des chemins plus concrets, en prise directe avec le tangible : on a pu vérifier quelques hypothèses liminaires dans le domaine réel. Ainsi, les conclusions de cette thèse confirment le fait que la Théorie des Contraintes contient une méthodologie efficace pour la gestion des systèmes de soins. On est arrivé à montrer que la philosophie de la TOC s'applique efficacement aux principaux systèmes de santé (où le Débit est la priorité numéro un) ainsi que dans les systèmes qui viennent en soutien (où le Débit n'est pas la priorité numéro un). Cette caractéristique fait de la TOC un outil idéal pour des responsables de tous niveaux, superviseurs et professionnels, et dans des secteurs variés. On peut dire qu'elle s'adapte, en tant que méthode de gestion, à différentes hauteurs de management.

De plus, on a décelé toute la flexibilité de la TOC : on a saisi qu'elle peut être employée non seulement pour faire croître un système, mais aussi pour en réduire la taille. Le recours à la TOC dans le domaine de l'entretien comme dans celui des salles d'opération a indiqué qu'elle pouvait s'appliquer à différents types de systèmes et à différents modes de management. Aux blocs opératoires, l'approche qui a consisté à faire passer toutes les activités non-contraintes sur le plan de la contrainte a permis de concentrer tous les instants perdus en une seule période continue, dont il a été plus facile de tirer parti, en ajoutant aisément des interventions supplémentaires.

Toutefois, ce travail a cherché à dépasser la dimension descriptive et figée d'environnements circonscrits. Il a tenté, -modestement il est vrai-, de produire un schéma réutilisable à l'avenir. De fait, il offre une synthèse des développements théoriques à propos des Cinq Etapes de Focalisation, des outils pour le Processus de Pensée Logique ainsi qu'une séquence de changement telle qu'elle est présentée dans la thèse. Il propose une combinaison qui allie les Cinq Etapes de Focalisation aux outils de Pensée Logique en un seul modèle, utilisant un langage abordable et une notion de flux simple, de sorte qu'il puisse être employé par tout type de manager. On aimerait imaginer que ces points puissent quelque peu aider les professionnels à mettre en œuvre un guide méthodologique étape par étape.

Contributions à la Recherche

La TOC n'est pas une méthodologie qui bénéficie d'une littérature riche et variée, ainsi qu'on a pu le souligner. Nous nous réjouissons d'apporter une petite pierre à cet édifice et de contribuer à son approfondissement et à son élargissement. Nous voudrions croire que nous avons introduit quelques éléments nouveaux, quelques compléments à cette théorie si pleine de promesses. Un certain nombre de constatations émises dans ce travail méritent peut-être d'être épinglées dans la mesure où elles peuvent fournir un éclairage neuf, voire inédit. En voici les aspects les plus significatifs repris dans cette liste en manière de bilan :

1. Le Tambour-Tampon-Corde a été testé au niveau du processus d'une salle d'opération, semble-t-il, pour la première fois. On a montré que la subordination et la gestion du flux depuis les secteurs non-contraints jusqu'au bloc opératoire se révélaient simples et que le fait de déplacer l'attention du niveau des ressources vers celui des processus paraissait apporter de belles satisfactions.
2. C'est sans doute la première fois aussi qu'est décrite la mise en œuvre de la Théorie des Contraintes au niveau d'un système de management du linge. Cette opération s'est avérée fructueuse, mais seulement après certaines modifications de l'approche, comme on l'a indiqué.

3. Cette étude fondée sur le cadre théorique de la TOC analyse les moyens d'améliorer un système, en en « réduisant la taille ». Nous sommes parvenus, grâce à la gestion fine d'une contrainte du système, à « ajuster » l'un autour de l'autre.
4. Il s'agit d'un travail sur une application de la TOC dans un environnement où le débit n'est pas la priorité numéro un. Puisque la méthode est avant tout conçue dans le but d'améliorer et amplifier les systèmes, il était essentiel de modifier la théorie pour l'adapter dans les cas où une réduction de taille et une stabilisation étaient nécessaires.
5. La Subordination dépasse l'exploitation. Ce point est également éprouvé et mentionné pour la première fois dans la littérature.
6. Cette recherche a montré à quel point le processus de changement se trouve facilité quand on commence par l'élaboration d'un Arbre du But.
7. Elle a essayé la TOC auprès de personnes qui n'avaient aucune connaissance systémique ou opérationnelle.
8. Elle a contribué à la Recherche en définissant des critères théoriques pour le GT et le FRT qui puissent être utilisés par des personnes qui ne sont pas experts de la TOC.
9. Elle a amené à produire un modèle susceptible de pouvoir être pris en main par des professionnels qui gèrent différents systèmes au sein de la hiérarchie des Systèmes de Systèmes afin d'améliorer l'un d'entre eux.
10. La mise en œuvre de la TOC s'est déployée à travers un alliage entre les Outils inhérents aux Processus de Pensée Logique et les Cinq Etapes de Focalisation, comme le prescrivait le cadre de la recherche-action.

Bibliography

- Andreou, M., Pasiardes, P. & Pasiourtidou, N., 2010. *Cost and value of health care in Cyprus*, University of Cyprus.
- Berry, R. & Belle, L., 2005. Conceptual foundations for The Theory of Constraints. *Human Systems Management*, 24(1), pp.83–94.
- Brennan, L.L., 2010. *The McGraw-Hill 36-hour Course: Operations Management*, McGraw Hill Professional.
- Chase, R.B., 1978. Where does the customer fit in a service operation? *Harvard Business Review*.
- Cox III, J.F. & Schleier, J.G., 2010. *Theory of Constraints Handbook*, McGraw-Hill.
- Davies, J., Mabin, V.J. & Balderstone, S.J., 2005. The theory of constraints: A methodology apart? - A comparison with selected OR/MS methodologies. *Omega*, 33(6), pp.506–524.
- Dettmer, H.W., 2007. *The logical thinking process: a systems approach to complex problem solving*, ASQ Quality Press.
- Gardiner, S.C., Blackstone, J.H. & Gardiner, L.R., 1994. The evolution of the theory of constraints. *INDUSTRIAL MANAGEMENT-CHICAGO THEN ATLANTA-*, 36, p.13.
- Godinho Filho, M. et al., 2015. Improving hospital performance by use of lean techniques: An action research project in Brazil. *Quality Engineering*.
- Goldratt, E.M., 1990. *The Haystack Syndrome*,
- Goldratt, E.M., 1990. Theory of Constraints. *Great Barrington: North River Press*, pp.1–159.
- Goldratt, E.M. & Cox, J., 1984. *The Goal*,
- Grida, M. & Zeid, M., 2018. A system dynamics-based model to implement the Theory of Constraints in a healthcare system. *SIMULATION*, p.0037549718788953.

- Gupta, M., 2003. Constraints management--recent advances and practices. *International Journal of Production Research*, 41(4), pp.647–659.
- Howe, C., 2013. Quality improvement in health care: is it mustard or ketchup? *Journal of health services research & policy*, 18(3), pp.179–81.
- Jebali, A. & Diabat, A., 2017. A Chance-constrained operating room planning with elective and emergency cases under downstream capacity constraints. *Computers and Industrial Engineering*.
- Mabin, V., "Goldratt's" Theory of Constraints" thinking processes: A systems methodology linking soft with hard.". *History*, pp.1–12.
- Mabin, V.J. & Balderstone, S.J., 2003. The performance of the theory of constraints methodology: Analysis and discussion of successful TOC applications. *International Journal of Operations & Production Management*, 23(6), pp.568–595.
- Mabin, V.J., Forgeson, S. & Lawrence, G., 2001. Harnessing resistance: using the theory of constraints to assist change management. *Journal of European Industrial Training*, 25(2–4), pp.168–191.
- May, J.H. et al., 2011. The surgical scheduling problem: Current research and future opportunities. *Production and Operations Management*.
- McDermott, A.M. et al., 2017. Performance management in context: formative cross-functional performance monitoring for improvement and the mediating role of relational coordination in hospitals. *International Journal of Human Resource Management*, pp.1–21.
- Naor, M., Bernardes, E.S. & Coman, A., 2013. Theory of constraints: is it a theory and a good one? *International Journal of Production Research*, 51(May 2015), pp.1–13.
- Porter, M.E. & Lee, T.H., 2013. The strategy that will fix health care. *Harvard Business Review*.
- Ronen, B. & Starr, M.K., 1990. Synchronized manufacturing as in OPT: from practice to theory. *Computers & Industrial Engineering*, 18(4), pp.585–600.
- Sahraoui, A. & Elarref, M., 2014. Bed crisis and elective surgery late cancellations: An approach using the theory of constraints. *Qatar Medical Journal*.

- Samoutis, G. & Paschalides, C., 2011. When will the sun shine on Cyprus's National Health Service? *The Lancet*.
- Saunders, M., Lewis, P. & Thornhill, A., 2009. *Research Methods for Business Students*,
- Schmenner, R.W., 1986. How can service businesses survive and prosper. *Sloan management review*, 27(3), pp.21–32.
- Simatupang, T.M., Wright, A.C. & Sridharan, R., 2004. Applying the theory of constraints to supply chain collaboration. *Supply Chain Management-an International Journal*, 9(1), pp.57–70.
- de SOUZA, M.C., SOUZA, T.A. & VACCARO, G.L.R., 2016. Hospital bed management: an analysis from the perspective of the theory of constraints. *Revista ESPACIOS| Vol. 37 (Nº30) Año 2016*.
- Spencer, M.S.& J.F.C., 1995. Optimum production technology (OPT) and the theory of constraints (TOC): Analysis and geneology. *International Journal of Production Economics*, 33(6), pp.37–41.
- Šukalová, V. & Ceniga, P., 2015. Application of the Theory of Constraints Instrument in the Enterprise Distribution System. In *Procedia Economics and Finance*. Elsevier B.V., pp. 134–139.
- Tabish, S.A. & Syed, N., 2015. Securing the Future: A Systems Approach to Continuous Improvement in Health Care by Applying the Theory of Constraints. *International Journal of Science and Research (IJSR)*, 4(1), pp.2674–2695.
- Taylor, L.J. & Churchwell, L., 2004. Goldratt's thinking process applied to the budget constraints of a Texas MHMR facility. *Journal of health and human services administration*, 26(4), pp.416–37.
- Wasterlain, A.S. et al., 2015. Can We Improve Workflows in the OR? *Bulletin of the Hospital for Joint Diseases*, 73(1).
- Wu, H.-H. et al., 2013. A study of theory of constraints supply chain replenishment system. *International Journal of Academic Research in Accounting, Finance and Management Sciences*, 3(3), pp.78–88.