



HAL
open science

Around the Domino Problem - Combinatorial Structures and Algebraic Tools

Etienne Moutot

► **To cite this version:**

Etienne Moutot. Around the Domino Problem - Combinatorial Structures and Algebraic Tools. Discrete Mathematics [cs.DM]. Université de Lyon; Turun yliopisto, 2020. English. NNT: 2020LY-SEN027 . tel-02967024

HAL Id: tel-02967024

<https://theses.hal.science/tel-02967024>

Submitted on 14 Oct 2020

HAL is a multi-disciplinary open access archive for the deposit and dissemination of scientific research documents, whether they are published or not. The documents may come from teaching and research institutions in France or abroad, or from public or private research centers.

L'archive ouverte pluridisciplinaire **HAL**, est destinée au dépôt et à la diffusion de documents scientifiques de niveau recherche, publiés ou non, émanant des établissements d'enseignement et de recherche français ou étrangers, des laboratoires publics ou privés.



N° National de Thèse : 2020LYSEN027

THÈSE DE DOCTORAT DE L'UNIVERSITÉ DE LYON
opérée par
l'École Normale Supérieure de Lyon
en cotutelle avec
Turun Yliopisto

École doctorale n° 512
École doctorale en Informatique et Mathématiques de Lyon

Spécialité : Informatique

Soutenue publiquement le 15 juillet 2020 par

Etienne Moutot

Autour du problème du domino
Structures combinatoires et outils algébriques

Devant le jury composé de :

Valérie BERTHÉ	Directrice de Recherche, Université Paris Diderot	Rapporteuse
Fabien DURAND	Professeur, Université de Picardie Jules Verne	Rapporteur
Bryna KRA	Professeure, Northwestern University	Rapporteuse
Andrei ROMASHCHENKO	Chargé de Recherche, Université de Montpellier	Examineur
Guillaume THEYSSIER	Chargé de Recherche, Université Aix-Marseille	Examineur
Stéphan THOMASSÉ	Professeur, ENS de Lyon	Directeur
Jarkko KARI	Professeur, University of Turku	Co-tuteur
Nathalie AUBRUN	Chargée de Recherche, ENS de Lyon	Co-encadrante

Acknowledgements

Finally. This is where I can thank many people without whom this thesis would probably not exist.

First of all, I have to thank Nathalie. She trusted me all the way, more than I did myself. She encouraged me at every step, and always found the time to answer all my questions. But she is also the one who started everything, as five years ago she helped me to find my first internship, not even with her, that happened to be about tiling. Obviously she was not aware of what she was signing for... Here I am today, still tiling.

It is impossible not to thank Jarkko, who helped me feeling at home in Finland, with or without snow. He also had the patience to listen to so many stupid ideas, and never call them as such. I am very grateful that I have been able to bring home a tiny fraction of his never-ending knowledge.

Thanks also to Stéphan, for his contagious optimism and motivation. Even without publishing any results together, he influenced a lot how I think and how I present my research.

In a way, this thesis would have never been written without Pascal, who gave me the best possible taste of tilings, computability and research in general. I am looking forward to work and climb again with him in the future (as soon as he finds a position in a more attractive place than Créteil). The whole LACL lab was an amazing place to discover the world of research and I thank everyone that I met there five years ago.

Thanks to Bryna, Fabien and Valérie who kindly accepted to read this manuscript. Thanks also to the rest of the jury, Andrei and Guillaume, for their interest in my work.

I cannot forget my co-authors: Sebastián, whose mind is always as fast as it is fruitful. And Julien, with whom working was more enjoyable than taking breaks.

I had the pleasure to meet Michal before I even thought about doing a PhD, I will always remember him for welcoming me in Finland. I also thank him for his amazing PhD thesis, without all his work my thesis would be half its current size.

Dewi, Thibault, Alexandre and Timothée, thanks for sharing an office with me, at LUG, LIP, UTU and finally the queens'/king's office. (Don't you love acronyms ?)

Many thanks to Markus, who welcomed me in Finland with Michal four years ago. With Joonatan you were certainly the best support I had at the University of Turku. Especially for keeping (or not) my trash when I leave. I will miss lunches, dinner and

sometimes climbing with you two. In Lyon, the whole MC2 team, past and present, was so nice with me. I cannot thank Marie and Chiraz enough for handling so well the administrative maze around my PhD and the LIP in general.

One of the reasons I kept doing tilings is probably the French community of symbolic dynamics. It was so welcoming that I felt home from the first SDA2 meeting I attended during my Master's internship. Among them, I want to thank Emmanuel, Pierre, Benjamin and Anaël for their deeply interesting conversations and beers.

My year in Finland would have been totally different without my Finnish friends. Mikko, who showed me how amazing Finnish people could be. His curiosity and appetite for French cheese resonated with my own curiosity and appetite for Finnish experiences. Long and late discussions with him are among my best memories of these three years of PhD. Thanks also to Hanne and her energy for showing me that Finnish people can actually be talkative, so much that it can sometimes be hard to say a word. She also changed my life by making me discover and love *avanto*. Thanks to Elina, Tommi and Rilda for sharing most of these moments of climbing, cycling and drinking. Kiitos !

Les remerciements internationaux étant terminés, je passe maintenant à toutes ces personnes fantastiques dont j'ai croisé le chemin grâce à l'ENS. Évidemment, un grand merci au groupe de l'âge d'or de l'impro-BDthek : Titouan, Grimaud, Charles, Paul, Pierre, Yohann, Maria, Caroline, Théo, Arilès, Laurent. Sans vous, toutes ces années à l'ENS et cette thèse auraient été bien monotones. Merci pour votre bonne humeur, votre folie permanente, vos discussions des fois philosophiques, des fois pas, et tout ce que vous m'avez fait découvrir. Merci aussi à Solène, pour tellement de choses.

Merci aux Improfesseurs en général, et en particulier à Hugh, pour m'avoir doucement métamorphosé au cours de ces six années de pratique de sauts dans le vide expérimentaux chaque semaine.

Pour que la liste des colocs soit complète il manque Pauline, que je remercie de supporter ma présence... et mon absence à l'appartement (qui est si bien). Je peux également citer Toni, pour m'avoir montré que la colocation n'est pas nécessairement une expérience agréable.

Merci à la Fanfarovis d'avoir agrémenté musicalement (mais pas que!) cette thèse. Merci particulièrement à Antton pour ses projets plus fous les uns que les autres, sans lesquels la vie associative de l'ENS aurait été bien différente. Justin, pour ton sourire si communicatif, Romain, Élise, Sophie, Lucas, Eva, Tomtom, Charlotte, Camille, Ronan et bien d'autres... La Fanfaralouest restera parmi les 10 jours les plus mémorables de ma vie, grace à vous tous.

Je serai éternellement reconnaissant envers Bertrand Philibert, qui a cru en moi et m'a poussé vers les portes de l'ENS dès le début de la prépa. Je ne serais certainement pas ce que je suis aujourd'hui sans mon passage à Decroly, et citer toutes les personnes importantes pour moi là bas serait beaucoup trop long. Mais je dois quand même mentionner Julien et Florence, qui m'ont très largement donné goût aux sciences, ainsi que Johan, qui sans le savoir m'a permis de me plonger dans l'informatique au plus tôt. Merci à Clément et Evan d'être encore à mes côtés après si longtemps.

Pour terminer, ma famille évidemment. Maman, Papa, Grand-Mère, Grand-Père, Mamie, Papy. Sans vous et votre soutien permanent, rien n'aurait été possible (et pas que cette thèse).

Et enfin, merci Chloé.

Abstract

Given a finite set of square tiles, the *domino problem* is the question of whether it is possible to tile the plane using these tiles. This problem is known to be undecidable in the planar case, and is strongly linked to the question of the *periodicity* of the tiling. In this thesis we look at this problem in two different ways: first, we look at the particular case of low complexity tilings and second we generalize it to more general structures than the plane, groups.

A tiling of the plane is said *of low complexity* if there are at most mn rectangles of size $m \times n$ appearing in it. Nivat conjectured in 1997 that any such tiling must be periodic, with the consequence that the domino problem would be decidable for low complexity tilings. Using algebraic tools introduced by Kari and Szabados, we prove a generalized version of Nivat's conjecture for a particular class of tilings (a subclass of what is called of algebraic subshifts). We also manage to prove that Nivat's conjecture holds for uniformly recurrent tilings, with the consequence that the domino problem is indeed decidable for low-complexity tilings.

The domino problem can be formulated in the more general context of Cayley graphs of groups. In this thesis, we develop new techniques allowing to relate the Cayley graph of some groups with graphs of substitutions on words. A first technique allows us to show that there exists both strongly periodic and weakly-but-not-strongly aperiodic tilings of the Baumslag-Solitar groups $BS(1, n)$. A second technique is used to show that the domino problem is undecidable for surface groups. Which provides yet another class of groups verifying the conjecture saying that the domino problem of a group is decidable if and only if the group is virtually free.

Étant donné un ensemble fini de tuiles carrés, le *problème du domino* est la question : «est-il possible de paver le plan entier en utilisant ces tuiles?» Ce problème est connu pour être indécidable dans le cas des pavages du plan, et est très fortement lié à la question de la *périodicité* des pavages. Dans cette thèse nous abordons ce problème de deux points de vue différents : d'abord en regardant le cas particulier des pavages de faible complexité, ensuite en le généralisant aux structures plus générales des groupes.

Un pavage du plan est dit de faible complexité s'il y apparaît moins de mn rectangles de taille $m \times n$. Nivat conjecture en 1997 qu'un tel pavage est nécessairement périodique, avec comme conséquence que le problème du domino serait décidable pour les pavages de faible complexité. En continuant de développer des outils algébriques introduits par Kari et Szabados, nous prouvons une version généralisée de la conjecture de Nivat pour une classe de pavages particuliers (certains des sous-décalages algébriques). Nous parvenons également à montrer que la conjecture de Nivat est vraie pour tout pavage uniformément récurrent, avec comme conséquence que le problème du domino est effectivement décidable pour les pavages de faible complexité.

Le problème du domino peut également se formuler dans le cadre plus général des graphes de Cayley de groupes. Dans cette thèse nous développons de nouvelles techniques permettant de relier les graphes de Cayley de certains groupes à des graphes de substitutions. Une première technique nous permet de montrer qu'il existe à la fois des pavages fortement apériodiques et faiblement-non-fortement apériodiques pour les groupes de Baumslag-Solitar $BS(1, n)$. Une seconde nous permet de montrer que le problème du domino est indécidable pour les groupes de surface, ce qui fournit une nouvelle classe de groupe vérifiant la conjecture disant que le problème du domino d'un groupe est décidable si et seulement si le groupe est virtuellement libre.

Domino-ongelma on algoritminen kysymys, jossa kysyjä antaa äärellisen joukon kiellettyjä paikallisia värikuvioita ja haluaa tietää, voidaanko diskreetti taso \mathbb{Z}^2 värittää niin, että mikään kielletyistä kuvioista ei esiinny värityksessä. Ongelma tiedetään algoritmisesti ratkeamattomaksi, eli ei ole olemassa yleispätevää algoritmia sen ratkaisemiseksi. Kysymys liittyy läheisesti väritysten *jaksollisuuteen*. Väitöskirjassa tarkastellaan domino-ongelmaa kahdesta näkökulmasta: sitä tutkitaan sellaisissa erityistapauksissa, joissa sallittuja paikallisia värikuvioita on vain vähän, ja kysymys yleistetään diskreetistä tasosta muihin ryhmiin.

Diskreetin tason \mathbb{Z}^2 värityksellä on *alhainen kompleksisuus*, jos joillain positiiviluvuilla n ja m värityksessä esiintyy korkeintaan mn erilaista $m \times n$ suorakulmion väritystä. M. Nivat esitti vuonna 1997 otaksuman, että alhaisen kompleksisuuden väritys on väistämättä jaksollinen. Tästä edelleen seuraisi, että domino-ongelma olisi algoritmisesti ratkeava alhaisen kompleksisuuden tapauksessa, eli kunhan sallittujen $m \times n$ kuvioden määrä on korkeintaan mn . Karin ja Szabadoksen kehittämää algebrallista lähestymistapaa käyttäen osoitamme yleistetyn version Nivat'n otaksumasta eräissä algebrallisissa väritysjoukoissa. Todistamme myös, että Nivat'n otaksuma pätee uniformisesti rekurrenttien väritysten joukossa, mikä puolestaan riittää todistamaan, että domino-ongelma on kuin onkin ratkeava alhaisen kompleksisuuden tapauksissa.

Domino-ongelma voidaan myös esittää muissa ryhmissä kuin diskreetissä tasossa \mathbb{Z}^2 . Väitöskirjassa käytetään sanojen substituutiograafien ja joidenkin ryhmien Cayley-graafien välisiä yhteyksiä. Tällaista menetelmää käyttäen osoitetaan, että Baumslag-Solitar ryhmissä $BS(1, n)$ on vahvasti jaksottomia alisiirtoja, mutta myös sellaisia, jotka ovat heikosti jaksottomia mutta eivät vahvasti jaksottomia. Toinen vastaava menetelmä puolestaan osoittaa, että domino-ongelma on ratkeamaton ns. pintaryhmissä. Tämä on jälleen uusi luokka ryhmiä, joka tukee otaksun, että domino-ongelma on ratkeava ainoastaan virtuaalisesti vapaissa ryhmissä.

Contents

Abstract	C
Résumé	E
Tiivistelmä	G
Introduction	1
1 Preliminaries	9
1.1 Subshifts and Wang Tilings	10
1.1.1 Subshifts	10
1.1.2 Wang Tiles	12
1.1.3 Periodicity and Domino Problem	13
1.2 Pattern Complexity	17
1.2.1 Dimension 1	17
1.2.2 Higher Dimension	17
2 Nivat’s Conjecture	21
2.1 Preliminaries	21
2.1.1 Algebra	21
2.1.2 Geometry	22
2.1.3 Links with Nivat’s Conjecture	24
2.2 Algebraic Subshifts	28
2.2.1 The 3-dot System	28
2.2.2 Annihilators with Line Polynomial Factors in One Direction	30
2.2.3 Square Annihilators	33
2.3 Low Complexity Subshifts	36
2.3.1 Concepts from Dynamical Systems	37
2.3.2 Extracting Periodicity from Low Complexity	38
2.3.3 Deciding the Domino Problem	44
2.3.4 The Uniformly Recurrent Case	45
2.3.5 Non-rectangular Shape	45
3 Substitutions and Groups	47
3.1 Subshifts on Groups and Graphs	47
3.1.1 Group Presentation and Cayley Graphs	47
3.1.2 Periodicity, Aperiodicity	49
3.1.3 Subshifts over Graphs	51
3.2 Substitutions	51
3.2.1 Definition and Properties	51

CONTENTS

3.2.2	Orbit Graphs and Tilings	53
3.2.3	The Domino Problem on the Hyperbolic Plane	55
3.3	Periodicity in Baumslag-Solitar Groups	58
3.3.1	Baumslag-Solitar Groups	58
3.3.2	Aubrun-Kari Tileset is Strongly Aperiodic	59
3.3.3	A Weakly not Strongly Aperiodic Tileset of $BS(1, n)$	64
3.3.4	Shift-similar Substitutions	68
3.4	The Domino Problem on Surface Groups	70
3.4.1	Finding Orbit Graphs in Surface Groups	71
3.4.2	The Domino Problem on Orbit Graphs	82
	Conclusion and Open Problems	93
	Bibliography	99
	Personal Bibliography	106

List of Figures

1	A partition of X in three sets indexed by colors and the corresponding coding of an orbit.	2
2	The two configurations of the subshift of finite type defined by the set of forbidden patterns $\{\square\square, \blacksquare\blacksquare\}$	3
1.1	The four types of configurations in X_F defined in Example 1.1.	10
1.2	Configurations of $\mathcal{O}(x)$ and $\overline{\mathcal{O}(x)}$ of Example 1.2.	12
1.3	A two-dimensional Wang tile and a portion of valid tiling.	13
1.4	Periodic configurations.	14
1.5	The counterexample configuration disproving an analogue of Nivat's conjecture in 3D.	19
2.1	Open (a) and closed (b) discrete half-planes with $\mathbf{u} = (-1, 2)$	23
2.2	L is a discrete line with direction $(2, 1)$ and L' is the next line in direction $\mathbf{w} = (-1, 2)$	23
2.3	The set of square cells has an outer edge perpendicular to vector $\mathbf{u} = (-1, 2)$	23
2.4	Closed stripe $S_{\mathbf{u}}^k$ with $u = (-1, 2)$ and $k = 10$	24
2.5	The opposite is also interesting: the configuration gives a way of visualizing a formal series, and by extension any polynomials. Here are two examples for $d = 2$	25
2.6	The snowflake configuration with α the golden ratio.	27
2.7	The shape D of low complexity.	36
2.8	Sublattices of c and shape D superimposed. The horizontal line is from h and the vertical one from v	36
2.9	The discrete box $B_{\mathbf{u}}^k$ with $\mathbf{u} = (-1, 2)$ and $k = 10$	38
2.10	Discrete regions $H = H_{-\mathbf{u}}$, $B = B_{\mathbf{u}}^k$ and S in the proof of Lemma 2.3.6. In the illustration $\mathbf{u} = (-1, 2)$ and $k = 10$	40
3.1	Application of a substitution σ to a biinfinite word w	52
3.2	Part of an orbit graph. Dashed arrow are edges of the graph labeled with next	54
3.3	An (a, w) -tile for some production rule $(a, w) \in R$ with $w = w_1 \dots w_k$	55
3.4	A tiling Ψ_{Ω} of an orbit into \mathbb{R}^2	55
3.5	Pentagonal tiling of \mathbb{H}^2	57
3.6	Illustration of the neighbor rules for $BS(1, 2)$	59
3.7	Preservation of the oriented arc distance d_{arc} by r and intersection of the arc $(r^l(x), r^l(z))$ and the boundary between A and B	62
3.8	Illustration of Lemma 3.3.6.	64

3.9	Tiles of τ_σ : left and right colors are identical and equal to i , top color is l and bottom colors are all letters of $\sigma_i(l)$	66
3.10	The three cases for S_i to be of cardinal 2: the window in green represents an equality, and the colored portions are the consequent parts of α and β made equal.	69
3.11	An elementary cycle of \mathcal{C}_G with the added cords of $\Gamma(G, D)$	72
3.12	The two types of elements in \mathcal{C}_G and the corresponding sequences of type under them in C_{i+1}	72
3.13	The two possible types of colorings of elementary cycles. There are no color constraints on $\boxed{*}$, and the cycle $g_1 \dots g_8$ is any cyclic permutation of $[a, b][c, d]$	74
3.14	Coloring of B_1	75
3.15	From B_i to B_{i+1}	75
3.16	Top neighbors of rings are smaller rings.	76
3.17	Infinite lines of X	77
3.18	Possible cases for the induction. The cycle γ' (in green) is obtained from the cycle γ (in black) by deletion of one elementary cycle γ_0 (in blue).	78
3.19	Transformation to get only \downarrow_1 down operations.	79
3.20	Transformation to reorder the operations.	79
3.21	A $0 \mapsto 00$ -tile, and a $(3, 4)$ -block in position $(x, y) \in \mathbb{R}^2$	84
3.22	The blue $(3, 2)$ -block intersects the (\mathcal{A}, R) -tile in the manner described above. The bottom vertices of the (\mathcal{A}, R) -tile have horizontal coordinates corresponding to tiles on the last line of the $0 \mapsto 00$ -block. Namely the 2nd (index 1), the 3rd (index 2) and the 7th (index 6). These vertices are respectively on the left, right and right child of these $0 \mapsto 00$ -tiles. Therefore, the associated symbol of \mathcal{B} is given by: $((a, w_1 w_2 w_3), (3, 2), [(1, 0), (2, 1), (6, 1)])$	84
3.23	Illustration of the third item in the definition of the set of forbidden patterns F : there are $8 = b_2 - b_1$ tiles in the bottom row of the top tile and $s_2 = 1, s_1 = 0$. Thus there must be $2(b_2 - b_1) + (s_1 - s_2) = 17$ tiles on the top row of the pattern coded by the tile appearing below u (which is called w). To make the picture smaller, the bottom tile is drawn shorter than it should be. If the rightmost tile is considered, we must add the number of tiles $2^{h-1}t$ to b_0 of the rightmost tile for the formula to add up.	86
3.24	A $(3, 3)$ -block and its associated $\Gamma_{(3,3)}$ graph. The next edges are shown as dashed lines.	88
3.25	The rules for pasting graphs.	89
3.26	On the left a pattern $p \in F_{\mathcal{B}, \Sigma}^n$. The corresponding patterns have the support shown on the right and coincide with p in the three colored vertices.	91

Introduction

Tilings consist in covering a surface – most of the time the Euclidean plane – by copies of geometric tiles, placed next to each other without holes nor overlaps. They are at the origin of many computationally hard problems, starting with the domino problem, asking whether a given set of tiles can tile the plane or not, which is already undecidable in the planar case. In this thesis we are interested in understanding what makes this problem hard, with two different approaches. The first one is to look at the impact that the number of patterns appearing in tilings have on the decidability of the domino problem. The second one is to consider tilings over more general combinatorial structures, to try to understand the role that the structure itself can have on the decidability of the domino problem. We will use two – *a priori* different – models of tilings of the combinatorial structures that have been introduced with different motivations: subshifts and Wang tiles.

Wang tiles were introduced by Wang [Wan61], whose goal was to study fragments of first order logics. In this simple model, every tile is a square with colored edges. Two tiles can be placed next to each other if the colors of their common edge match. A tiling of the plane consists in positioning copies of tiles from a tileset in every position of \mathbb{Z}^2 such that shared edges have the same color. This model has been used to prove most of the computability results about tilings of the plane [Ber66; Rob71; Luk09], and extended to other surfaces like the hyperbolic plane \mathbb{H}^2 [Goo05; Kar08]. Wang tiles are also naturally linked to cellular automata, and this connection provided many undecidability results about cellular automata [Kar90; Kar92; Kar94]. They have also been successfully used in texture synthesis thanks to the non-repetitive properties of particular tilesets [Sta97; Coh+03; Kop+06]. Finally, a refined model of Wang tiles has been used to produce self-assembly structures performing computations using DNA [Win98; RPW04; Eva14].

Subshifts have been introduced by Morse and Hedlund in the late 30's [MH38] to study discrete time dynamical systems, giving birth to symbolic dynamics. A discrete time dynamical system is usually defined by a couple (X, F) , where X is a compact set of configurations and $F : X \rightarrow X$ is a continuous and bijective function. To every point x_0 of X , one can associate the trajectory (or orbit) of F , which is the sequence $(x_n)_{n \in \mathbb{Z}} = (F^n(x_0))_{n \in \mathbb{Z}}$. One way of simplifying the setting is to partition X into a finite number of sets $X = \bigcup_{i=1}^n A_i$. One can then encode the orbit of the point according to its

trajectory with respect to the partition (see Fig. 1). Formally, we can define the function

$$\varphi : \begin{cases} X & \rightarrow \{1, \dots, n\} \\ x & \mapsto (\varphi(x)_k)_{k \in \mathbb{Z}} \end{cases}$$

where

$$\varphi(x)_k = i \Leftrightarrow F^k(x) \in A_i.$$

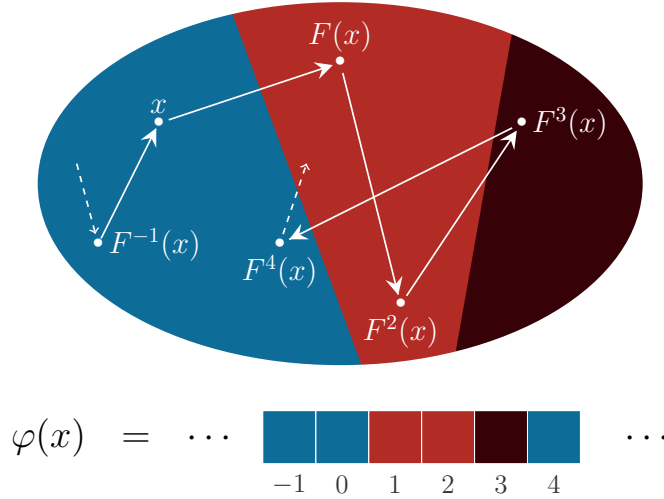

Figure 1 – A partition of X in three sets indexed by colors and the corresponding coding of an orbit.

Let σ be the shift action on $\{1, \dots, n\}^{\mathbb{Z}}$, defined by:

$$\forall i \in \mathbb{Z}, \forall w \in \{1, \dots, n\}^{\mathbb{Z}}, \sigma(w)_i = w_{i+1}.$$

Then, $(\varphi(X), \sigma)$ is itself a dynamical system, usually much simpler than the initial one. Obviously it depends on the chosen partition $\{A_k\}$, as choosing too small a partition might lose information about (X, F) , and choosing one that is too big might lead to an unnecessarily complicated dynamical system. However, for a large class of dynamical systems (namely, when (X, F) is expansive), it can be shown that one can always choose a partition such that $(\varphi(X), \sigma)$ has the same dynamical properties as (X, F) [Hed69].

The dynamical system $(\varphi(X), \sigma)$ is called a *subshift*, and the study of these particular symbolic encodings of dynamical systems is exactly the subject of symbolic dynamics. This approach has two main interests. First, the shift action σ is usually much simpler to understand than F . Second, when the subshift $(\varphi(X), \sigma)$ has a finite description, it can be studied using tools from computability and complexity theory.

Subshifts are also studied independently of their dynamical origin. They can be defined as subsets of $\mathcal{A}^{\mathbb{Z}}$ closed and invariant by the shift action σ , where \mathcal{A} is any finite alphabet. Subshifts have an equivalent combinatorial definition: $X \subseteq \mathcal{A}^{\mathbb{Z}}$ is a subshift if it can be described as a set of colorings of \mathbb{Z} , called configurations, that avoid a certain set of patterns. If this set of forbidden patterns is finite, the subshift is called a subshift of finite type (SFT for short). SFTs are the most interesting subshifts from a computability point

of view since they have a finite description: a finite alphabet and a finite set of forbidden patterns.



Figure 2 – The two configurations of the subshift of finite type defined by the set of forbidden patterns $\{\square\square, \blacksquare\blacksquare\}$.

Subshifts over \mathbb{Z} have been extensively studied, and the theory is well-developed. A good reference about it is the book of Lind and Marcus [LM95]. An SFT is called *nearest-neighbor* if its set of forbidden patterns contains only words of size two. It turns out that any SFT is conjugate to a nearest-neighbor one. This allows to characterize SFTs using finite labeled graphs, with the consequence that there is an algorithm deciding if an SFT is empty or not given its set of forbidden patterns. As a nearest-neighbor SFT is equivalent to a set of Wang dominoes (one-dimensional Wang tiles), this emptiness problem is also called the *domino problem*. This characterization of SFTs using graphs also allowed to characterize entropies of SFTs, that express the growth of the number of patterns of configurations of the SFT. Despite the vast knowledge on the structure of SFTs over \mathbb{Z} , some problems are still open, for example it is still unknown if there is an algorithm to decide if two SFTs are conjugate to each other [Boy08].

Naturally, the next step is to look for a more general model. One way to do this is to inspect colorings of a two dimensional grid instead of a line. These higher dimensional models have attracted more and more attention recently [Hoc10; HM10; AS13; HV17]. A two dimensional subshift is a subset of $\mathcal{A}^{\mathbb{Z}^2}$ closed and stable by the two dimensional shift action. As in dimension one, subshifts are also subsets of $\mathcal{A}^{\mathbb{Z}^2}$ whose elements avoid a set of forbidden patterns, and if this set of patterns is finite the subshift is again called an SFT. Any SFT is again conjugate to an SFT which is (two dimensional) nearest-neighbor. Therefore, for any SFT X it is possible to find a set of Wang tiles such that its set of valid tilings is conjugate to X . Conversely, the set of valid patterns of a set of Wang tiles is an SFT, these two models are therefore equivalent. In dimension two however, there is no straightforward representation as a graph, with the consequence that most problems become much more involved. First, the domino problem – or emptiness problem – becomes undecidable [Ber66]. The main explanation of this result is that the extra dimension adds a lot of possibilities for the patterns that can appear in tilings; so much that there exist SFTs containing only configurations that are not periodic, called aperiodic SFTs. This was unexpected, as Wang conjectured that just like in dimension one, all SFTs contain a periodic configuration. His conjecture would have implied the decidability of the domino problem, as the existence of a periodic configuration is enough to ensure the decidability of the domino problem. The link between SFTs and Wang tiles was not clear initially, and when the two communities realized that Wang tiles and subshifts were essentially the same models, it became clear that computability was a very powerful tool to understand subshifts of dimension two and higher. An impressive result of Hochman and Meyerovitch shows that the entropies of two dimensional SFTs correspond exactly to right-recursively enumerable numbers [Hoc08; HM10]. Sets of periods of SFTs of dimensions two and three have also been characterized in terms of complexity and computability classes [JV13a; MV18; GMV18; JMV20], and many other results showed the strong links between higher dimensional subshifts and computability [JV13b; JV15; HV17].

There are several ways to measure the complexity of configurations and complexity of subshifts. A natural one is the size of the alphabet, as one can build more complex configurations using a bigger alphabet. Notably, this led researchers to look for a set of aperiodic Wang tiles – or an aperiodic SFT – with the smallest number of tiles. Berger’s initial set had 20426 tiles [Ber66], or 104 in his PhD thesis [Ber64]. It was improved, among others, to 35 by Robinson [Rob71], 14 by Kari [Kar96], 13 by Culik [Cul96]. It was finally lowered to 11 by Jeandel and Rao [JR15], who proved that it was the minimum possible number for an aperiodic tiling. Although a bigger tiling provides more freedom to produce complex patterns, the number of tiles does not represent how the different tiles can match together, and how complex are the patterns that appear in the tilings. Already in 1938, Morse and Hedlund used another notion, pattern complexity, and remarked that it was strongly linked with periodicity, at least in dimension one. It is also the basis of the definition of the entropy of subshifts. The *pattern complexity* of a one dimensional configuration is the number of subwords of a given size n appearing in the configuration, denoted by $P(n)$. Morse and Hedlund proved that a one dimensional configuration is periodic if and only if there exists n such that $P(n) \leq n$ [MH38]. In dimension two, there is a similar definition of pattern complexity, counting the number $P(m, n)$ of $m \times n$ rectangles, in contrast to subwords. An analogue of Morse and Hedlund’s theorem would be that a configuration is periodic if and only if $P(m, n) \leq mn$ for some m, n , as mn is the area of the rectangle. However this does not hold, as there exists a periodic configuration with complexity higher than mn [Cas00]. Nonetheless, the other direction was conjectured in 1997 by Maurice Nivat [Niv97]: a configuration with pattern complexity $P(m, n) \leq mn$ – called a *low complexity configuration* – must be periodic. Today, the conjecture is known as *Nivat’s conjecture*. It is also conjectured that a similar property would hold not only for rectangles, but for other convex shapes as well. Cassaigne proved that it cannot hold for arbitrary non convex shapes, by giving a non periodic configuration whose complexity relative to some (connected) shape is still low [Cas00]. In the same paper he remarks that the natural generalization of Nivat’s conjecture to dimension three and higher does not hold. Similarly, there is no hope of a similar conjecture with $mn+1$ bound, as there are non periodic configurations with pattern complexity $mn + 1$. Such configurations have been characterized by Cassaigne as two dimensional generalizations of Sturmian words [Cas99]. Another motivation to study the link between complexity and (a)periodicity arises from questions of computer graphics, more precisely concerning procedural texture generation. One of the goals is to develop efficient algorithms generating big portions of aperiodic configurations, to generate non-repetitive textures. Having an aperiodic SFT with low complexity would provide a hope for such efficient algorithms, as only few rectangles would be valid for the SFT.

There have been numerous advances towards proving Nivat’s conjecture, which is still open today. One way of approaching it is to look at particular complexity cases. For example Sanders and Tijdeman proved that if there exists n such that $P(2, n) \leq 2n$, then the configuration must be periodic [ST02], later generalized to $P(3, n) \leq 3n$ by Cyr and Kra [CK16]. Another direction is to look at configurations with lower complexity than mn , say $P(m, n) \leq \alpha mn$ with $\alpha < 1$. Epifanio, Koskas and Mignosi showed Nivat’s conjecture holds for $\alpha = 1/144$ [EKM03]. It was improved by Quas and Zamponi to $\alpha = 1/16$ [QZ04], and lastly by Cyr and Kra to $\alpha = 1/2$ [CK15]. Colle and Garibaldi refined Cyr and Kra’s bound to $\frac{mn}{2} + |\mathcal{A}| - 1$ where $|\mathcal{A}|$ is the size of the alphabet of the configuration [CG19].

Recently, Kari and Szabados introduced algebraic tools to tackle Nivat’s conjecture, which lead to many interesting results. Their main result is that low complexity configurations can be decomposed into a sum of finitely many periodic configurations, but with possibly infinite alphabet [KS15b; KS15a; Sza18a]. A first consequence of this decomposition is an asymptotic version of Nivat’s conjecture: if there are infinitely many m, n such that $P(m, n) \leq mn$, then the configuration is periodic [KS15b]. Using the same tools, Szabados proved that in the particular case where the low-complexity configuration is a sum of only two periodic configurations, then Nivat’s conjecture holds [Sza18b]. As a corollary of this last result they give a simpler proof of Cyr and Kra’s $\alpha = 1/2$ mentioned above. Note that a priori the periodic configurations of the decomposition might have unbounded coefficients, even if Szabados shows in his thesis [Sza18b] that they can be chosen bounded (but still with infinite alphabet).

Over the last years, even more general subshifts have gathered interest: subshifts on groups instead of multidimensional grids [Pia08; CP15; FT17]. In these models, configurations are colorings of a finitely presented group G , and subshifts are subsets of \mathcal{A}^G closed and invariant by the shift action

$$\sigma : \begin{cases} G \times \mathcal{A}^G & \rightarrow \mathcal{A}^G \\ (g, x) & \mapsto \sigma^g(x) \end{cases},$$

where for all $h \in G$, $\sigma^g(x)_h = x_{g^{-1}h}$. The situation gets even more complicated in this setting, for example it might not even be possible to algorithmically draw the Cayley graph of the group if its word problem is undecidable [ABJ18]. Still, it is interesting to try to understand what causes these complicated behavior to happen, and link group theoretical properties to dynamical ones. The decidability of the domino problem obviously depends on the group considered, as it is decidable for $G = \mathbb{Z}$ and undecidable for $G = \mathbb{Z}^2$. A conjecture attributed to Ballier and Stein [BS13] states that the domino problem of a group is decidable if and only if it is virtually free. It is known that all virtually free groups have a decidable domino problem [ABJ18]. For the other direction, the domino problem is known to be undecidable only for particular classes of groups: groups with undecidable word problem [ABJ18], Baumslag-Solitar groups [AK13], non-virtually \mathbb{Z} polycyclic groups [Jea15b], and groups of the form $G_1 \times G_2$ with G_1 and G_2 two infinite groups [Jea15c]. Exactly as for grids, periodicity is still a key concept, but even its definition becomes more complicated. There are two definitions of periodicity: weak and strong, which are equivalent for \mathbb{Z} (and \mathbb{Z}^2 in the case of SFTs) but not for more general groups. Historically, the existence of an aperiodic SFT is often the first step before proving that the domino problem of a group is undecidable: for \mathbb{Z}^2 the aperiodic SFT is used as a step of the proof; Goodman-Strauss found an aperiodic SFT over the hyperbolic plane [Goo05], and Kari showed that its domino problem is undecidable [Kar08]. Although conjectured to exist, there are currently no examples of groups having an undecidable domino problem, a weakly aperiodic SFT but no strongly aperiodic SFT.

Main contributions

Contributions of this thesis revolve around the domino problem, and understanding exactly what makes it a computationally hard problem in many cases. As aperiodicity is a key ingredient of the undecidability of the domino problem, it makes sense to focus on it

to tackle the domino problem.

With this in mind, we continue on Kari and Szabados work on Nivat's conjecture. We further develop the algebraic tools they introduced to study low complexity configurations. First, we use techniques from elimination theory to study configurations under linear constraints. We prove that the generalized Nivat's conjecture holds for all configurations of the 3-dot system. That is, a configuration of the 3-dot system with low complexity with respect to any shape (even a non-connected one) has to be periodic. Then, we look at algebraic subshifts, defined by a linear condition on the coefficient of their configurations, of which the 3-dot system is a particular case. With our algebraic vocabulary, we ask for all configurations of an algebraic subshift to be annihilated by a polynomial in a finite field. A line polynomial is a polynomial whose coefficients are all aligned along a line, and which is not a monomial. It turns out that an important property is the direction of line polynomial factors of the polynomial defining the algebraic subshift. We prove that the generalized Nivat's conjecture holds for algebraic subshifts defined by polynomials having all their line polynomial factors in the same direction. When the defining polynomial has line polynomial factors in two different directions, the situation becomes more complex. Indeed, we are able to find an example of such polynomial for which the generalized Nivat's conjecture holds and another one where it does not. This work can be found in [KM19].

Then, we use techniques from Cyr and Kra's paper [CK15], which are inspired by dynamical systems notions. We study directions of determinism (or of one-sided expansiveness) of low complexity configurations. We look in particular at directions of one-sided determinism: directions that are deterministic along a vector \mathbf{u} and non-deterministic along $-\mathbf{u}$). We prove that for a low-complexity configuration c , one can find a configuration c' in its orbit closure such that the orbit closure of c' has no directions of one-sided determinism. Combined with results from Boyle and Lind [BL97] and Cyr and Kra [CK15], it shows that the orbit closure of any low complexity configuration (with respect to a rectangle or a convex shape) contains a periodic configuration; solving Conjecture 8.2 from [Sza18a]. This has two important implications. First, it proves that Nivat's conjecture holds for uniformly recurrent configurations, which may be a big step towards proving the conjecture itself. Second, it shows that there can be no aperiodic SFTs of low complexity. More precisely, as soon as a subshift contains a low complexity configuration, it also contains a periodic one. Consequently, the domino problem is decidable for low complexity SFTs. These results have been published in [KM20].

After pattern complexity, we look at another reason that can make the domino problem hard: the underlying structure on which the SFTs are built on. We mainly investigate the links between some groups and orbit graphs of substitutions on words. We first show that for particular Baumslag-Solitar groups, of the form $BS(1, n)$, Aubrun and Kari's weakly aperiodic tilingset [AK13] is in fact strongly aperiodic. After that, we use the similarities between $BS(1, n)$ and the substitution $0 \mapsto 0^n$ to encode substitutions in a tilingset over $BS(1, n)$, leading to a weakly but not strongly aperiodic tilingset. This shows that both strongly and weakly aperiodic tilingsets exist over $BS(1, n)$, which was an open problem until now. These two results are a joint work with Julien Esnay [EM20].

The last result presented here is the undecidability of the domino problem for surface groups [ABM19]. The first step of our construction is to remark that the Cayley graph of surface groups is very similar to orbit graphs of particular substitutions. After that,

we use a result inspired by Cohen and Goodman-Strauss aperiodic tiling over surface groups [CG17] to superimpose tilings of orbit graphs of substitutions in a computable way. Interpreting Kari's proof of the undecidability of the domino problem for the hyperbolic plane [Kar08] as the undecidability of the domino problem over the orbit graph of the substitution $0 \mapsto 00$, we are able to prove the undecidability of the domino problem for orbit graphs of many substitutions, including the ones looking like surface groups. This provides a reduction of the domino problem of the surface groups from the domino problem of the hyperbolic plane.

Organization of the manuscript

This manuscript is organized in three chapters, the second and the third being independent from each other.

The first chapter is a general introduction to symbolic dynamics. Without delving too much into details, we introduce the necessary notions about subshifts, the domino problem and pattern complexity. Most of these notions will be known by an advanced reader, and thus may be skipped.

The second chapter deals with approaching Nivat's conjecture using algebraic tools. In Section 2.1 we introduce the necessary algebraic background and the work of Kari and Szabados. Then we start with proving that the generalized Nivat's conjecture holds for the 3-dot system (Theorem 2.2.5), and for a subclass of algebraic subshifts (Corollary 2.2.10). After that, we detail some tools from Cyr and Kra's paper and use them to show that low complexity configurations have a periodic configuration in their orbit closure (Theorem 2.3.4), and the immediate consequences of this (Corollary 2.3.17 and Corollary 2.3.18).

The third and last chapter explains our results about subshifts on groups. We start by generalizing the definitions of Chapter 1 in the cases of groups in Section 3.1. Section 3.1.1 and 3.1.2 may be skipped by a reader already familiar with subshifts on groups. Section 3.1.3 generalizes even further the definition of subshifts over infinite graphs. Then we introduce a few required notions about substitutions in Section 3.2. After that we study periodicity of SFTs on the Baumslag-Solitar groups $BS(1, n)$, starting by remarking that Aubrun and Kari's construction is strongly aperiodic in this case (Theorem 3.3.5), and then explaining our weakly but not strongly aperiodic tiling (Theorem 3.3.12). Finally, we show the undecidability of the domino problem of surface groups (Corollary 3.4.14) and orbit graphs of particular substitutions (Theorem 3.4.12). The Bibliography is cut in two parts, the [second part](#) containing all the papers in which the author is a co-author, and not only the four papers constituting this thesis.

CHAPTER 1

Preliminaries

There are two equivalent formalisms used to study tilings of multidimensional grids: subshifts of finite type and Wang tiles. Introduced by different communities, they turned out to define the same objects, but using different notations

Subshifts have been introduced by Morse and Hedlund in 1938 to study dynamical systems [MH38]. By partitioning the space in a finite number of sets, it is possible to deduce properties of the general dynamical system by studying the much simpler subshift associated to it: a set of colorings of \mathbb{Z} satisfying stability properties. A good introduction to one dimensional subshifts can be found in the book of Lind and Marcus [LM95]. More recently, higher dimension subshifts have been studied (colorings of \mathbb{Z}^d with $d \geq 2$) [Ber66; Hoc10; HM10], and even subshifts on arbitrary groups (more about them in Chapter 3).

Forgetting the dynamical aspect of subshifts and only looking at individual colorings of \mathbb{Z} falls in an another broad field: combinatorics on words. In this thesis we will scratch this topic by looking at pattern complexity of individual colorings, and the natural generalization over dimension higher than one.

On the other hand, the formalism of Wang tiles was introduced by Wang in 1961 [Wan61], motivated by the study of particular fragments of first order logics. Most of the early results of computability about tilings of the plane have been proved in this setting. The link between these two formalisms is not clear at first sight, but we will see that subshifts of finite type of dimension two are actually equivalent to Wang tiles. Thereby both formalisms can be used indifferently depending on the context, or combined, as Hochman and Meyerovitch did to characterize entropies of two-dimensional subshifts [Hoc08; HM10].

In this chapter we will formally define subshifts, Wang tiles and their main properties. Then we define the notion of pattern complexity and its relation with periodicity of colorings.

1.1 Subshifts and Wang Tilings

In this thesis, \mathcal{A} is a finite alphabet and for a vector $\mathbf{v} = (v_1, \dots, v_d) \in \mathbb{Z}^d$, $|\mathbf{v}| = \sum_i |v_i|$ is the 1-norm.

1.1.1 Subshifts

A function $x \in \mathcal{A}^{\mathbb{Z}^d}$ is called a *configuration* (or a coloring of \mathbb{Z}^d) and the symbol at position $\mathbf{u} \in \mathbb{Z}^d$ is denoted by $x_{\mathbf{u}}$ (we also say that $x_{\mathbf{u}}$ is the color of the cell \mathbf{u}). The set of all configurations $\mathcal{A}^{\mathbb{Z}^d}$ is called the *full-shift* (of dimension d). Let $P \subset \mathbb{Z}^d$ be a finite set, an element $p \in \mathcal{A}^P$ is a *pattern* of support P , also called a coloring of P , and we say that a pattern *appears* in a configuration $x \in \mathcal{A}^{\mathbb{Z}^d}$ (resp. another pattern $p' \in \mathcal{A}^{P'}$) if there exists \mathbf{u} in \mathbb{Z}^d (resp. there exists \mathbf{u} in P') such that for all \mathbf{v} in P , $p_{\mathbf{v}} = x_{\mathbf{u}+\mathbf{v}}$ (resp. $p_{\mathbf{v}} = p'_{\mathbf{u}+\mathbf{v}}$). In this case, we denote $p \sqsubset x$ (resp. $p \sqsubset p'$). We denote $\text{Supp}(p)$ its support P .

Definition 1.1.1 (Subshift). Let F be a set of patterns. A *subshift* X_F is the set of configurations avoiding all patterns from F .

$$X_F = \{x \in \mathcal{A}^{\mathbb{Z}^d} \mid \forall p \in F, p \not\sqsubset x\}.$$

Example 1.1. As first example, one can consider the finite alphabet $\mathcal{A} = \{\square, \blacksquare\}$ in dimension two, and $F = \{\square\blacksquare, \blacksquare\square\}$. Then X_F is constituted of all configurations with an horizontal half-plane filled with black and the rest filled with white, as well as all white and all black configurations (see Fig. 1.1).

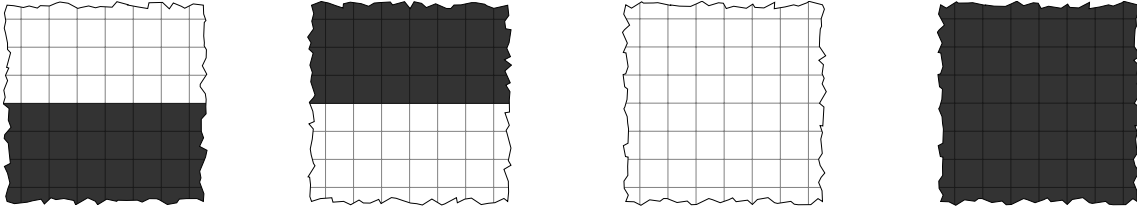

Figure 1.1 – The four types of configurations in X_F defined in Example 1.1.

Note that F can be infinite, and that several sets of forbidden patterns may define the same subshift.

Definition 1.1.2 (Subshift of finite type). A subshift $X \subseteq \mathcal{A}^{\mathbb{Z}^d}$ is of *finite type* (or *SFT* for short) if there exists a finite set of patterns F such that $X = X_F$.

From a computability point of view subshifts of finite type are the most interesting, since they can be encoded by a finite description: they are uniquely defined by d , \mathcal{A} and F , which are all finite. SFTs can also be equivalently defined by a set of allowed patterns (which is not the case for general subshifts). To prove this, we need to define the language of a subshift.

Definition 1.1.3. The *language* $L(X)$ of a subshift $X \subseteq \mathcal{A}^{\mathbb{Z}^d}$ is the set of patterns that appear in configurations of X :

$$L(X) = \{p \sqsubset x \mid \exists D \subset \mathbb{Z}^d, D \text{ finite and } \exists x \in X\}.$$

For any finite support $D \subset \mathbb{Z}^d$, we set $L_D(X) = L(X) \cap \mathcal{A}^D$ and call it the language restricted to patterns of support D . If C is an hypercube of size n , we denote $L_C(X) = L_n(X)$.

Proposition 1.1.1. *Let X be an SFT. Then there exists n such that*

$$X = X_{\overline{L_n(X)}},$$

where $\overline{L_n(X)} = \mathcal{A}^{C_n} \setminus L_n(X)$ and C_n is the hypercube of size n . In other words, X can be defined by allowing the set of patterns $L_n(X)$.

Proof. Let $X = X_F$ with F a finite set of patterns and $n \in \mathbb{N}$ such that all supports of patterns of F fit in an $n \times n \times \cdots \times n$ hypercube of dimension d , denoted C_n . We prove the contrapositive:

$$x \notin X \Leftrightarrow x \notin X_{\overline{L_n(X)}}. \quad (1.1)$$

By definition, we have

$$x \notin X \Leftrightarrow \exists p \in F, p \sqsubset x$$

and

$$x \notin X_{\overline{L_n(X)}} \Leftrightarrow \exists p' \in \overline{L_n(X)}, p' \sqsubset x$$

Then, $\exists p \in F, p \sqsubset x \Leftrightarrow \exists p' \in \overline{L_n(X)}, p' \sqsubset x$ is true because:

- if there exists $p \in F, p \sqsubset x$, then extract a coloring p' of x of support C_n around p , then p' belongs to $\overline{L_n(X)}$,
- if there exists $p' \in \overline{L_n(X)}$, as n is big enough, by definition of $X = X_F$, there exists $p \in F$ such that $p \sqsubset p'$.

Which proves Eq. (1.1). □

Let us remark that $\mathcal{A}^{\mathbb{Z}^d}$ is a metric space when equipped with the following distance:

$$d_{\mathcal{A}^{\mathbb{Z}^d}}(x, y) = 2^{-\min\{|\mathbf{v}| \mid \mathbf{v} \in \mathbb{Z}^d, x_{\mathbf{v}} \neq y_{\mathbf{v}}\}}.$$

The bigger is the disk on which x and y are the same, the closer they are for $\mathcal{A}^{\mathbb{Z}^d}$. We denote $T^{\mathbf{v}}$ the *shift action* by $\mathbf{v} \in \mathbb{Z}^d$, that translates a configuration by vector \mathbf{v} :

$$\forall \mathbf{u} \in \mathbb{Z}^d, T^{\mathbf{v}}(x)_{\mathbf{u}} = x_{\mathbf{u}-\mathbf{v}}.$$

Subshifts can equivalently be defined topologically, which was the original definition by Morse and Hedlund.

Definition 1.1.1 bis (Subshift). The set $X \subseteq \mathcal{A}^{\mathbb{Z}^d}$ is a subshift if and only if it is closed and shift-invariant.

We do not detail the equivalence here, which can be found in [Bar17] (Proposition 1.1) for example. An immediate consequence is the following proposition.

Proposition 1.1.2. $\mathcal{A}^{\mathbb{Z}^d}$ is a compact space.

In particular, given a set of patterns p_n of support S_n , if none of the p_n contain a forbidden pattern from F , and the S_n converges to \mathbb{Z}^d , then $\lim_n p_n$ exists and belongs to X_F .

The *orbit* of a configuration $x \in \mathcal{A}^{\mathbb{Z}^d}$ is the set of all its shifts: $\mathcal{O}(x) = \{T^{\mathbf{u}}(x) \mid \mathbf{u} \in \mathbb{Z}^2\}$ and its *orbit closure* $\overline{\mathcal{O}(x)}$ is the topological closure of $\mathcal{O}(x)$. The orbit closure being shift invariant and closed (which is not the case of the orbit which is just shift-invariant), it is a subshift. It is also the intersection of all subshifts containing x . In terms of finite patterns, c' belongs to $\overline{\mathcal{O}(c)}$ if and only if every finite pattern that appears in c' appears also in c . Note that it can be different of $\mathcal{O}(c)$ (see Example 1.2).

Example 1.2. Consider the two-dimensional configuration x defined by

$$\begin{cases} x_{0,0} &= \blacksquare \\ x_{i,j} &= \square \quad \text{for all } (i,j) \neq (0,0) \end{cases}$$

The orbit $\mathcal{O}(x)$ contains all configurations with exactly one black cell. By definition, $\overline{\mathcal{O}(x)}$ also contains $\lim_{n \rightarrow \infty} T^{(0,n)}(x) = \square^{\mathbb{Z}^2}$. This one is not in $\mathcal{O}(x)$ as it does not contain any black cell, thus $\mathcal{O}(x) \neq \overline{\mathcal{O}(x)}$. See Fig. 1.2 for an illustration.

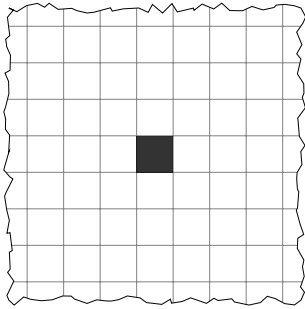

(a) All configurations of $\mathcal{O}(x)$ are shifts of c : they have exactly one black cell.

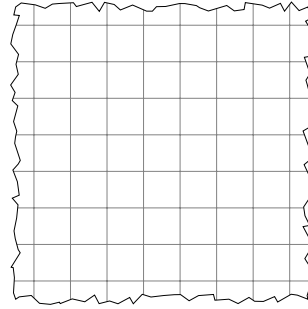

(b) The all white configuration is in $\overline{\mathcal{O}(x)}$ but is not a translation of c .

Figure 1.2 – Configurations of $\mathcal{O}(x)$ and $\overline{\mathcal{O}(x)}$ of Example 1.2.

Finally, we say that two subshifts are (*topologically*) *conjugate* if there is a homeomorphism (a bijective factor map) which commutes with the shift action between the two.

1.1.2 Wang Tiles

Definition 1.1.4 (Wang cubes). A *Wang cube* of dimension d is a $2d$ tuple of colors from a finite alphabet \mathcal{B} , each color corresponding to a side of a d -dimensional hypercube. We denote it $t = (a_1, b_1, \dots, a_d, b_d) \in \mathcal{B}^{2d}$, and by abuse of notation, $a_1(t) = a_1, b_1(t) = b_1 \dots$. We call them *Wang dominoes* if $d = 1$ and *Wang tiles* if $d = 2$.

A finite set of Wang cubes is called a *tilset*. Let τ be a tilset. A *Wang tiling* x is a coloring of \mathbb{Z}^d by cubes of τ (without rotations) : $x \in \tau^{\mathbb{Z}^d}$. It is *valid* if the color of every side of a tile matches the color of the neighbor side:

$$\begin{aligned} \forall \mathbf{u} \in \mathbb{Z}^d, b_1(x_{\mathbf{u}}) &= a_1(x_{\mathbf{u}+(1,0,\dots,0)}) \\ &\vdots \\ b_d(x_{\mathbf{u}}) &= a_d(x_{\mathbf{u}+(0,\dots,0,1)}) \end{aligned}$$

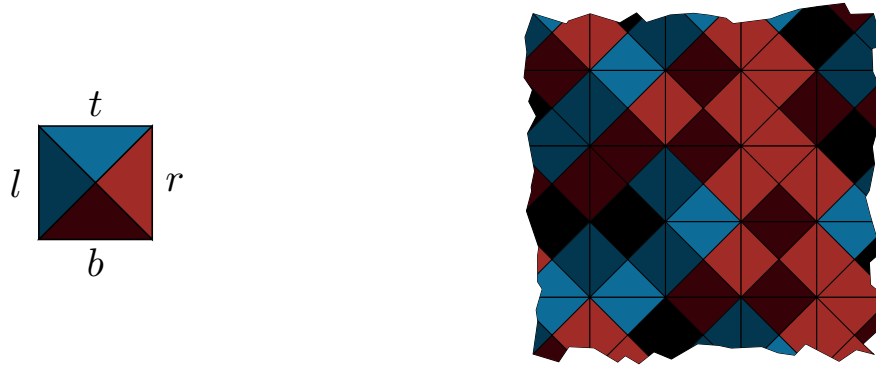

Figure 1.3 – A two-dimensional Wang tile and a portion of valid tiling.

We denote by X^τ the set of valid tilings by the tileset τ . Since the validity of a tiling can be checked locally, X^τ is an SFT. Its set of allowed patterns is simply the set of two matching Wang tiles next to each other. What is more surprising is that the other way also holds: for any SFT X , there exists a set of Wang tiles τ such that its set of valid tilings is isomorphic to X , in the sense that there exists a bijective morphism between X and X^τ . We do not enter into the details of this construction, but the reader can refer to [ABJ18].

Even though SFTs are sometimes more convenient to work with – thank to the fact that their local rules can depend on cells further away than next neighbor – Wang tiles are still an important model, since most of the computability results of next section have been proved using this formalism.

1.1.3 Periodicity and Domino Problem

Periodicity, Aperiodicity

Definition 1.1.5. A configuration $x \in \mathcal{A}^{\mathbb{Z}^d}$ is *periodic* along a vector $\mathbf{u} \in \mathbb{Z}^d - \{0\}$ if $T^{\mathbf{u}}(x) = x$, or equivalently if for all $\mathbf{v} \in \mathbb{Z}^d$, $x_{\mathbf{v}-\mathbf{u}} = x_{\mathbf{v}}$. Vector \mathbf{u} is called a *periodicity vector* of x . If a configuration is not periodic, it is called *aperiodic*.

If \mathbf{u} is a periodicity vector, the set of all vectors colinear to \mathbf{u} is called a *direction of periodicity*. If x has k non-colinear directions of periodicity, it is called *k-periodic*. In particular, if all periodicity vectors of x are colinear, x is *one-periodic*, or *weakly periodic*. And if x has d linearly independently vectors of periodicity, it is *d-periodic*, which is also called *fully periodic* or *strongly periodic*.

Example. The 2D configuration on the left of Fig. 1.4 is one-periodic along vector $(2, 2)$, and the one on the right is two-periodic along vectors $(2, 2)$ and $(2, -2)$.

Definition 1.1.6. A subshift is *aperiodic* if it is not empty and contains no periodic configurations. In the same way, a tileset τ is called aperiodic if all its valid tilings are aperiodic.

Aperiodic subshifts in any dimension are easy to build from one-dimensional aperiodic words.

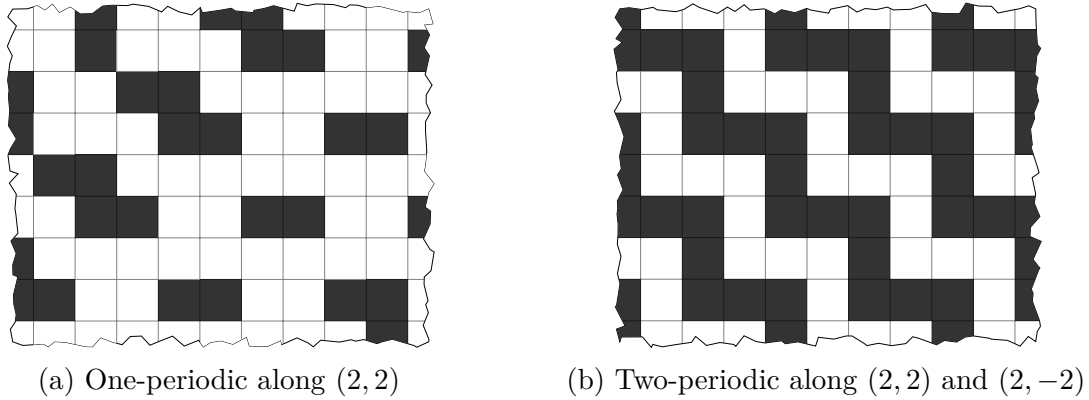

Figure 1.4 – Periodic configurations.

Example 1.3 (Two-dimensional aperiodic subshift). Let w be the binary Champerowne word, a biinfinite word containing the binary decomposition of all integers (see for example [BV00]). Let x and y be 2D configurations defined by $x_{(i,j)} = w_{i+j}$ and $y_{(i,j)} = w_{i-j}$. They are both one-periodic along $(1, -1)$ and $(1, 1)$ respectively. Then, let $z = x \times y$ be the configuration on $(\{0, 1\} \times \{0, 1\})^{\mathbb{Z}^2}$ defined by $z_{(i,j)} = (w_{i+j}, w_{i-j})$. It is easy to see that z is aperiodic, and so is $\mathcal{O}(z)$.

The same trick could be done in any dimension. However the existence of aperiodic SFT (or aperiodic tiling) is not clear, and actually depends on the dimension.

Proposition 1.1.3. *In dimension one, there exists no aperiodic tiling.*

This is mostly due to the fact that a one-dimensional tiling can be represented by a finite graph.

Proof. Wang dominoes are pairs of colors, let us call them $t = (t_l, t_r)$. To every tiling τ , we associate an oriented graph G_τ defined as follows:

- its set of vertices is the set of tiles τ ,
- for $(\alpha, \beta) \in \tau$, an edge $\alpha \rightarrow \beta$ is in the graph if and only if $\alpha_r = \beta_l$.

Then, a valid tiling of \mathbb{Z} corresponds to a bi-infinite walk in the graph. Being finite, it has a bi-infinite walk if and only if it has a cycle. The bi-infinite walk taking only this cycle then corresponds to a periodic configuration: every tiling that have a valid configuration also have a periodic one. \square

Such a simple finite graph cannot be defined for higher dimensions, where Wang tiles turn out to allow much more complex tilings.

Theorem (Berger [Ber66]). *In dimension two, there exists an aperiodic tiling.*

This result was quite surprising, since it was initially conjectured by Wang that no such tiling exists, like in dimension one. It follows easily that there exists aperiodic tilings in any dimension $d \geq 2$.

Berger's construction is quite complicated and uses 20426 tiles (or 104 for the one presented in his PhD thesis [Ber64]). It was greatly simplified by the aperiodic tiling of Robinson [Rob71], using only 56 tiles. The number of tiles was lowered by others later,

notably to 14 by Kari [Kar96], using a construction we detail in Section 3.2.3. And finally by Jeandel and Rao who build an aperiodic tileset of 11 tiles, which they prove to be the smallest possible [JR15].

SFT are still more restrictive than general subshifts, for example having a $(d - 1)$ -periodic configuration in it allows us to build a d -periodic one.

Proposition 1.1.4 (consequence of Corollary 1 of [JMV20]). *Let X be a d -dimensional SFT. If X contains a $(d - 1)$ -periodic configuration, then it contains a d -periodic one.*

This proposition can be seen as a generalization of Proposition 1.1.3, as applying it to $d = 1$ gives that any SFT of dimension one containing a 0-periodic configuration contains a periodic one. In other words, every non-empty one dimensional SFT contains a periodic configuration, which is exactly Proposition 1.1.3. In dimension two it becomes:

Proposition 1.1.5. *Let X be a two-dimensional SFT. If X contains a periodic configuration, then it contains a two-periodic one.*

Domino Problem

Given a tileset, or an SFT, it is a natural question to ask whether they can actually tile the space (or if the SFT is nonempty). This question is called the *domino problem*, the central problem of this thesis, and we are finally ready to define it and give basic propositions around it. Its name comes from the shape of one-dimensional Wang cubes, also called Wang dominoes. When talking about SFTs, it is also known as the *emptiness problem*. As we will see, it is closely related to its periodicity. We adopt here the formalism of SFTs if not mentioned otherwise, more natural than Wang cubes in any dimension.

Definition 1.1.7 (Domino Problem). The *domino problem* (DP) is the following question "given a tuple (d, \mathcal{A}, F) , is the SFT X_F non-empty?"

In terms of tilings, it is equivalent to ask if a given tileset admits a valid tiling.

Wang already remarked that in dimension two, the domino problem is semi-decidable: it is possible to recursively enumerate all empty SFTs. His idea is easily generalizable to any dimension:

Proposition 1.1.6. *There exists an algorithm with input an SFT X_F halting if and only if $X_F = \emptyset$.*

Proof. The algorithm is the naive one consisting on trying to find a support impossible to tile:

```

IS_EMPTY( $X_F$ )
  for  $i = 1$  to  $\infty$  do
    if all colorings of the hypercube of size  $i$  contain a pattern from  $F$  then
      return  $X_F = \emptyset$ 

```

If this algorithm halts, we are sure that $X_F = \emptyset$ since there is already an hypercube that is impossible to color without forbidden patterns.

Conversely, assume that the algorithm does not halt. It means that there exists an infinite sequence of pattern $(p_i)_{i \in \mathbb{N}}$ with support the hypercubes $(p_i)_{i \in \mathbb{N}}$ that contain no forbidden patterns. By compactness (Proposition 1.1.2), we have that $X_F \neq \emptyset$. Thus, the algorithm halts if and only if $X_F = \emptyset$. \square

Since the previous algorithm does not halt when the SFT is not empty, it is of no help to decide the other way of the domino problem. Wang noticed that in dimension two, it was possible to decide the domino problem for an SFT which contains a periodic configuration. Here again, his proof is easily doable in any dimension d .

Proposition 1.1.7. *With the hypothesis that the SFT is either empty or contains a $d-1$ -periodic configuration, DP is decidable.*

Proof. For this proof we adopt the Wang tile formalism and call X the SFT of all valid tilings. We already have a semi-algorithm for $X = \emptyset$, so we only need a semi-algorithm halting if and only if $X \neq \emptyset$. The algorithm simply looks for a valid hypercube with opposite sides having the same patterns, the patterns of the sides being understood as patterns of dimension $d-1$.

```

IS_NOT_EMPTY( $X$ )
  for  $i = 1$  to  $\infty$  do
    for all valid colorings of patterns  $p_i$  of support the hypercube of size  $i$  do
      if the opposite sides of  $c$  have the same pattern then
        return  $X \neq \emptyset$ 

```

If the algorithm halts there is a valid tiling of \mathbb{Z}^d : repeating this hypercube in all dimensions produces a valid tiling of the whole space.

Thanks to Proposition 1.1.4, we know that if X contains a $(d-1)$ -periodic configuration, it contains a fully periodic configuration x . Since x has d non-colinear vectors of periodicity, there are integer linear combinations of them equal to

$$(k, 0, \dots, 0), (0, k, 0, \dots, 0), \dots, (0, \dots, 0, k)$$

for some $k \in \mathbb{N}$, thus x is periodic along $(k, 0, \dots, 0), (0, k, 0, \dots, 0), \dots, (0, \dots, 0, k)$ and the algorithm will halt when the ball of size i is big enough to contain the hypercube of size k . □

In particular in dimension 1, the domino problem is decidable.

Corollary 1.1.8. *DP is decidable in dimension one.*

And in dimension two, we only need to find a one-periodic configuration to have DP decidable.

Corollary 1.1.9. *DP is decidable in dimension two with the hypothesis that the SFT is either empty or contains a periodic configuration.*

Proof. Let X be the considered SFT. If it contains a periodic configuration, it has a two-periodic one by Proposition 1.1.5. Then, DP is decidable by Proposition 1.1.7. □

Because Wang believed that there were no aperiodic SFT in dimension two, he also conjectured that the domino problem was decidable. But Berger not only proved that there are aperiodic SFTs in dimension two, he proved that the domino problem was in fact undecidable in this case.

Theorem (Berger [Ber66]). *DP is undecidable in dimension two.*

Using his aperiodic tileset as well as an encoding of Turing machines into a tileset, Berger was able to build a tileset which admits a valid tiling if and only if a Turing machine does not halt, providing a reduction from the halting problem. In Section 3.2.3 we will see an alternative construction from Kari, who is able to encode another kind of computations into a tileset.

From a straightforward reduction, we obtain that the domino problem is also undecidable in any dimension greater than two.

1.2 Pattern Complexity

Pattern complexity is a measure of complexity of configurations. However, it is "too precise" for some uses, as it is not an invariant of conjugacy between subshifts. It is used to define the entropy of a subshift, less precise, but which is invariant by conjugacy. We do not need to define the entropy of a subshift in this thesis, the interested reader can refer to [LM95] for an introduction to this topic.

1.2.1 Dimension 1

In dimension one pattern complexity is also known as factor complexity, as a pattern of a word is called a factor of it.

Definition 1.2.1 (Pattern complexity – 1D). Let $w \in \mathcal{A}^{\mathbb{Z}}$. The *pattern complexity* $P_w(n)$ of w is the number of subwords of w of size n :

$$P_w(n) = |\{u \in \mathcal{A}^n \mid u \sqsubset w\}|.$$

As we will use only this definition of complexity in this thesis, we will use simply the term complexity to designate pattern complexity. It turns out that the complexity of a word is directly linked to its periodicity.

Theorem 1.2.1 (Morse, Hedlund [MH38]). Let $w \in \mathcal{A}^{\mathbb{Z}}$. The following propositions are equivalent:

1. w is periodic,
2. there exists $n \in \mathbb{N}$ such that $P_w(n) \leq n$,
3. there exists $n_0, C \in \mathbb{N}$ such that $\forall n \geq n_0, P_w(n) \leq C$.

In other words, it is equivalent for a word to have bounded complexity (we use the term *low complexity*) and to be periodic.

1.2.2 Higher Dimension

Dimension Two

In dimension two, there is an analogous definition of low complexity configuration.

Definition 1.2.2 (Pattern complexity – 2D). Let $c \in \mathcal{A}^{\mathbb{Z}^2}$ and $D \subset \mathbb{Z}^2$ a finite shape. The *pattern complexity* $P_c(D)$ of c with respect to D is

$$P_c(D) = |\{d \in \mathcal{A}^D \mid d \sqsubset c\}|.$$

If D is a rectangle of size $m \times n$, we denote by $P_c(m, n)$ the *rectangular pattern complexity* of c , which is maybe the most natural generalization of the one-dimensional definition of complexity.

Definition 1.2.3 (Low complexity configuration). A configuration $c \in \mathcal{A}^{\mathbb{Z}^2}$ has *low complexity* with respect to D if there exists a finite $D \subset \mathbb{Z}^2$ such that

$$P_c(D) \leq |D|.$$

And if D is a rectangle of size $m \times n$ such that $P_c(m, n) \leq mn$, we say that c has *low complexity with respect to a rectangle*.

As one might guess, things get more complicated in dimension two. First, there is no hope to have an equivalence like Morse-Hedlund's theorem with our definition of periodicity, since there exists a periodic configuration of complexity 2^{m+n-1} . Take for example the Champerowne word w and a 2D configuration c defined by $x_{(i,j)} = w_{i+j}$ as in Example 1.3. For all m, n , the complexity of w is $P_w(n) = 2^n$, and the complexity of c is $P_c(m, n) = 2^{m+n-1}$, but it is $(1, -1)$ -periodic. The other direction of the equivalence was conjectured to be true by Maurice Nivat in 1997.

Conjecture (Nivat, 1997). *If c is a configuration of low complexity with respect to some rectangle, then it is periodic.*

When formulated for a general shape, we call this the generalized Nivat's conjecture, even though it was not conjectured by Nivat.

Conjecture (Generalized Nivat's conjecture). *If c is a configuration of low complexity with respect to any shape, then it is periodic.*

And Nivat was right not to conjecture this: this generalized version does not hold in general, as some shapes allow the construction of sublattices, allowing a non-periodic configuration to have low-complexity with respect to this shape. Such a counterexample can be found in Section 2.2.3. Julien Cassaigne even provided counterexamples with connected shapes [Cas00]. It is still believed that the conjecture holds for any convex shape.

In addition, Nivat's conjecture is "optimal", since there exists a configuration not periodic and with complexity $mn + 1$ for any rectangle of size $m \times n$. This configuration is also very simple, as it is the one of Example 1.2, the all white configuration except one cell. Indeed, there are mn different rectangles with the black square in them (one for each position), and one all white: $P_x(m, n) = mn + 1$.

Note that one can define periodicity in dimension two differently than what is done in this thesis. With a definition based on tool from logics, Durand and Rigo were able to prove an equivalence similar to Morse and Hedlund's one in any dimension [DR11].

Dimension Three

In dimension 3 and above, even an analogue of Nivat's conjecture does not hold anymore.

Definition 1.2.4 (Pattern complexity (3D)). Let $c \in \mathcal{A}^{\mathbb{Z}^3}$ and $D \subset \mathbb{Z}^3$ a parallelepiped of size $m \times n \times k$. The *pattern complexity* $P_c(m, n, k)$ of c with respect to D is

$$P_c(m, n, k) = \left| \{d \in \mathcal{A}^D \mid d \sqsubset c\} \right|.$$

Proposition 1.2.2. *For all $n \geq 3$, there exists an aperiodic configuration such that $P_c(n, n, n) \leq n^3$.*

Proof. Let $n \in \mathbb{N}$. The configuration is build from two infinite lines of black cells, orthogonal but not parallel, spaced by n white cells. The rest is filled with white, see Fig. 1.5 for an illustration. In this configurations, there are n^2 different cubes of size $n \times n \times n$ obtained when there is an intersection with the first line, n^2 other cubes when intersecting the other line, and one filled with white. Therefore, $P_c(n, n, n) = 2n^2 + 1 < n^3$ for $n \geq 3$.

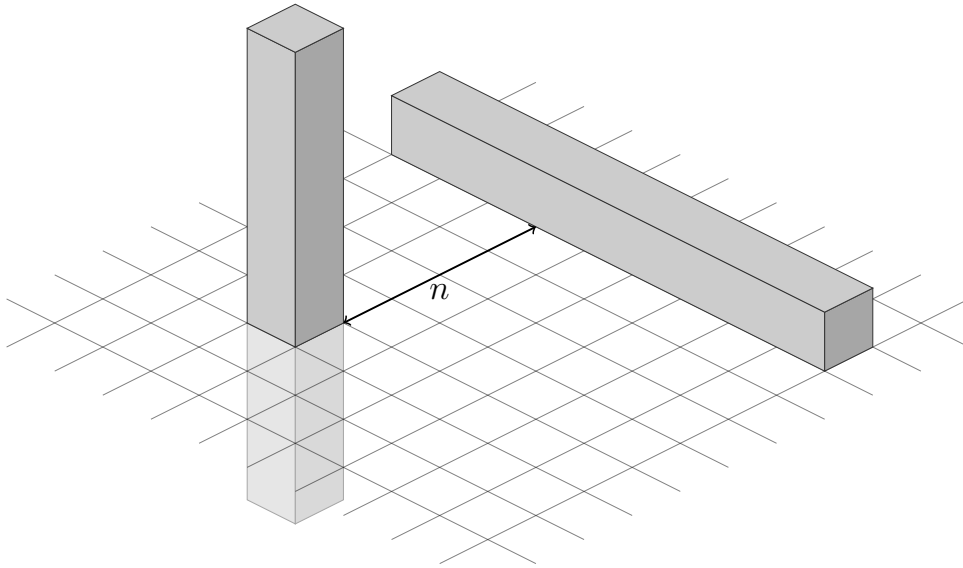

Figure 1.5 – The counterexample configuration disproving an analogue of Nivat’s conjecture in 3D.

□

Nivat's Conjecture

As detailed in Chapter 1, the complement of the domino problem is semi-decidable, the non semi-decidable part being deciding if an SFT is not empty. However, we saw that if there exists a periodic configuration in the subshift, it is actually possible to decide if it is non-empty. This provides an algorithmic motivation to look at classes of subshifts which always have a periodic configuration: their domino problem is decidable. A classical example of such a class are block-gluing subshifts, which always have a periodic configuration [PS15].

In this section we will look at the low complexity setting. If true, Nivat's conjecture would ensure that any low complexity configuration is periodic, and thus the class of subshifts containing a low complexity configuration would have decidable domino problem.

Following the work of Kari and Szabados [KS15b; KS15a; Sza18a; Sza18b], we continue to investigate Nivat's conjecture using algebraic tools they developed.

In Section 2.1 we introduce the link between algebraic geometry and Nivat's conjecture and all the vocabulary needed to understand it. In Section 2.2 we look at particular SFTs called algebraic SFTs, and prove that Nivat's conjecture holds for them. And in the last section (2.3) we use dynamical properties of subshifts to prove that any SFT containing a low complexity configuration also contains a periodic one.

2.1 Preliminaries

2.1.1 Algebra

First, we need to introduce a couple of algebraic notions. We will only go through what is needed to understand the results stated in this thesis, for a more in-depth introduction to the subject the reader can refer to [CLO15].

Let R be a commutative ring (in our case it will be \mathbb{C} , \mathbb{Z} or $\mathbb{F}_p = \mathbb{Z}/p\mathbb{Z}$). Then, $R[X_1, \dots, X_d]$ denotes the set of polynomials in d variables over R . When speaking of more than two variables, we will use the following simplifying notations: let $\mathbf{v} = (v_1, \dots, v_d) \in \mathbb{N}^d$, then we write $X^{\mathbf{v}} = X_1^{v_1} \cdots X_d^{v_d}$ and $R[X] = R[X_1, \dots, X_d]$. Any

polynomial $f \in R[X]$ can then be written

$$f = \sum_{\mathbf{v} \in V} a_{\mathbf{v}} X^{\mathbf{v}} \quad (2.1)$$

with $V \subset \mathbb{N}^d$ a finite set and $a_{\mathbf{v}} \in R$ for all $\mathbf{v} \in V$. The set $R[X^{\pm}]$ denotes the set of *Laurent polynomials* over R , which is obtained when taking V a finite set of \mathbb{Z}^d in (2.1). In other words, it is the set of polynomials where the exponents are allowed to be negative. The degree of $f \in R[X^{\pm}]$ is the maximum degree of the monomials of f : $\deg(f) = \max\{|\mathbf{v}| \mid \mathbf{v} \in V\}$ with the notation above. The *convex hull* of a polynomial is the convex hull of the set $\{\mathbf{v} \in V \mid a_{\mathbf{v}} \neq 0\}$ seen as a subset of \mathbb{R}^d . Laurent polynomials inherit many relevant properties from proper polynomials (see [Sza18a]). As a result, when not precised a *polynomial* will designate a Laurent polynomial, and when needed we use the term *proper polynomial* to talk about a polynomial in $R[X]$.

Next, the set $R[[X^{\pm}]]$ denotes the set of *formal power series* over R , that is obtained when the set V of (2.1) is also not required to be finite:

$$R[[X^{\pm}]] = \left\{ \sum_{\mathbf{v} \in V} a_{\mathbf{v}} X^{\mathbf{v}} \mid V \subseteq \mathbb{Z}^d \text{ and } \forall \mathbf{v} \in V, a_{\mathbf{v}} \in R \right\}.$$

A *line polynomial* is a polynomial whose non-zero coefficients are aligned and which is not a monomial. More precisely, f is a line polynomial if there exists $\mathbf{u} \in \mathbb{Z}^d$ and a finite set $K \subset \mathbb{Z}$ with $|K| \geq 2$ such that

$$f = \sum_{k \in K} a_k X^{k\mathbf{u}}.$$

Finally, a *polynomial ideal* I is a subset of $R[X^{\pm}]$ such that:

- the 0 polynomial is in I ,
- for all $f, g \in I$, $f + g \in I$,
- for all $f \in I$ and $h \in R[X^{\pm}]$, $hf \in I$.

For $f_1, \dots, f_n \in R[X^{\pm}]$ we denote $\langle f_1, \dots, f_n \rangle = \{\sum h_i f_i \mid h_1, \dots, h_n \in R[X^{\pm}]\}$ the ideal generated by the f_i s. An ideal I is *principal* if there exists $f \in R[X^{\pm}]$ such that $I = \langle f \rangle$. The *radical* of an ideal I is $\sqrt{I} = \{r \in R[X^{\pm}] \mid \exists n \in \mathbb{N}, r^n \in I\}$, and I is called a *radical ideal* if $I = \sqrt{I}$.

2.1.2 Geometry

Let us go through few notions of two-dimensional discrete geometry.

The *closed half plane* in a direction $\mathbf{u} \in \mathbb{Z}^2 \setminus \{\mathbf{0}\}$ is the set $\overline{H}_{\mathbf{u}} = \{\mathbf{x} \in \mathbb{Z}^2 \mid \mathbf{x} \cdot \mathbf{u} \leq 0\}$, and the *open half plane* $H_{\mathbf{u}}$ is defined analogously $H_{\mathbf{u}} = \{\mathbf{x} \in \mathbb{Z}^2 \mid \mathbf{x} \cdot \mathbf{u} < 0\}$. The *boundary* of the half plane is the discrete line $\overline{H}_{\mathbf{u}} \setminus H_{\mathbf{u}}$.

If a discrete line L has direction vector $\mathbf{v} = (v_1, v_2)$ its *slope* is $\frac{v_2}{v_1}$. Let \mathbf{w} be not colinear to \mathbf{v} . Since $\frac{v_2}{v_1}$ is rational, we can define a unique *line next to L the direction \mathbf{w}* , which is the closest line parallel to L when translating L along any vector in \mathbb{Q}^2 parallel to \mathbf{w} (see Fig. 2.2). Note that if $(-v_1, v_2) \cdot \mathbf{w} > 0$ (like in Fig. 2.2), the set of successive lines next to L in direction \mathbf{w} is the open half plane $H_{(-v_1, v_2)}$. If $(-v_1, v_2) \cdot \mathbf{w} < 0$, it is equal to $H_{(v_1, -v_2)}$.

We say that a finite set $D \subseteq \mathbb{Z}^2$ has an *outer edge* perpendicular to $\mathbf{u} \in \mathbb{Z}^2 \setminus \{\mathbf{0}\}$ if there

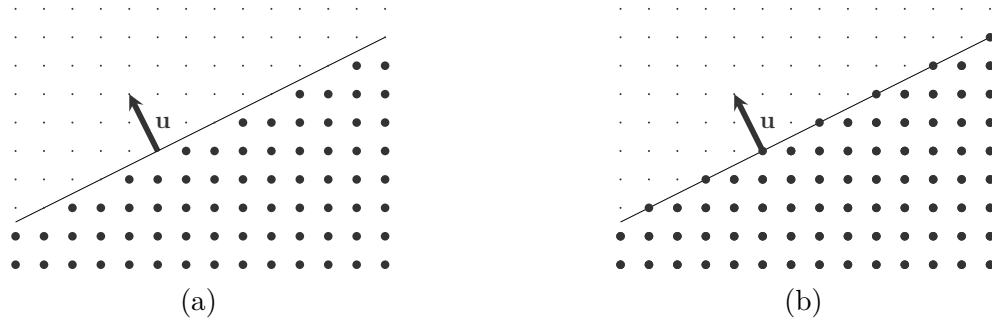

Figure 2.1 – Open (a) and closed (b) discrete half-planes with $\mathbf{u} = (-1, 2)$.

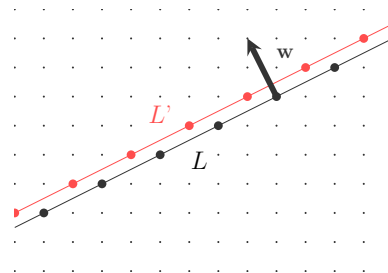

Figure 2.2 – L is a discrete line with direction $(2, 1)$ and L' is the next line in direction $\mathbf{w} = (-1, 2)$.

is $\mathbf{x} \in D$ such that $D \subseteq \mathbf{x} + \overline{H_{\mathbf{u}}}$ and there are at least two elements of D on the boundary $\mathbf{x} + (\overline{H_{\mathbf{u}}} \setminus H_{\mathbf{u}})$. See Fig. 2.3 for an illustration.

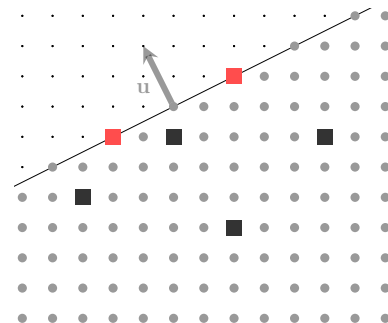

Figure 2.3 – The set of square cells has an outer edge perpendicular to vector $\mathbf{u} = (-1, 2)$.

Let $D \subseteq \mathbb{Z}^2$ be non-empty and let $\mathbf{u} \in \mathbb{Z}^2 \setminus \{\mathbf{0}\}$. The *edge* $E_{\mathbf{u}}(D)$ of D in direction \mathbf{u} consists of the cells in D that are furthest in the direction \mathbf{u} :

$$E_{\mathbf{u}}(D) = \{\mathbf{v} \in D \mid \forall \mathbf{x} \in D \ \mathbf{x} \cdot \mathbf{u} \leq \mathbf{v} \cdot \mathbf{u}\}.$$

We call D *convex* if $D = C \cap \mathbb{Z}^2$ for a convex subset $C \subseteq \mathbb{R}^2$ of the real plane. For $D, E \subseteq \mathbb{Z}^2$ we say that D *fits* in E if $D + \mathbf{t} \subseteq E$ for some $\mathbf{t} \in \mathbb{Z}^2$.

The (closed) *stripe* of width k perpendicular to \mathbf{u} is the set

$$S_{\mathbf{u}}^k = \{\mathbf{x} \in \mathbb{Z}^2 \mid -k < \mathbf{x} \cdot \mathbf{u} \leq 0\},$$

see Fig. 2.4 for an example. Clearly its edge $E_{\mathbf{u}}(S)$ in direction \mathbf{u} is the discrete line $\mathbb{Z}^2 \cap L$ where $L \subseteq \mathbb{R}^2$ is the real line through $\mathbf{0}$ that is perpendicular to \mathbf{u} . The *interior*

S° of S is $S \setminus E_{\mathbf{u}}(S)$, that is, $S^\circ = \{\mathbf{x} \in \mathbb{Z}^2 \mid -k < \mathbf{x} \cdot \mathbf{u} < 0\}$.

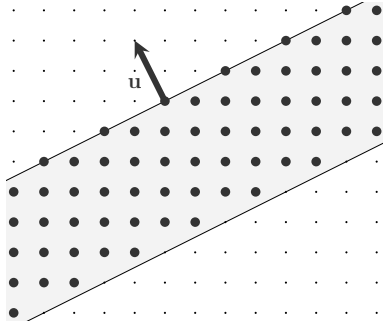

Figure 2.4 – Closed stripe $S_{\mathbf{u}}^k$ with $u = (-1, 2)$ and $k = 10$

2.1.3 Links with Nivat's Conjecture

Finally, we introduce what makes this whole chapter possible: the link between algebraic geometry and 2D configurations. We go briefly through notions and results by Jarkko Kari and Michal Szabados [KS15b; Sza18a; Sza18b], all related to algebra and Nivat's conjecture. A more complete review of these results can be found in [Kar19].

Let d be a positive integer. As defined in Section 1.1.1, a d -dimensional configuration over an alphabet \mathcal{A} is a function $c \in \mathcal{A}^{\mathbb{Z}^d}$. However, it is possible to see them as a formal series with d variables. The following series *represents* the configuration c , in the sense that it contains all the information about c :

$$\sum_{\mathbf{v} \in \mathbb{Z}^d} c_{\mathbf{v}} X^{\mathbf{v}}.$$

Such a series is called *integral* if for all $\mathbf{v}, c_{\mathbf{v}} \in \mathbb{Z}$, and *finitary* if there are only a finite number of different $c_{\mathbf{v}}$. Unlike in [KS15b; Sza18a; Sza18b], we will identify configurations with finite alphabet with finitary power series. In other words, in this thesis, a *configuration* always refers to a finitary and integral power series, unless stated otherwise. With this definition, it is equivalent to the definition of configuration of Section 1.1.1. In such case, since the actual content of the alphabet does not matter, one can always assume that the alphabet is over integers.

Now let us take a look at algebraic operations over configurations, and how they can be interpreted for the configuration. The sum of two configurations c and d is always defined:

$$c + d = \sum_{\mathbf{v} \in \mathbb{Z}^d} (c_{\mathbf{v}} + d_{\mathbf{v}}) X^{\mathbf{v}}.$$

The multiplication of two formal series is not always well defined, however, a multiplication between a power series and a Laurent polynomial is. One example is particularly interesting: multiplication of a configuration c by a monomial $X^{\mathbf{u}}$, which corresponds to a translation of c by vector \mathbf{u} :

$$X^{\mathbf{u}} c = \sum_{\mathbf{v} \in \mathbb{Z}^d} c_{\mathbf{v}} X^{\mathbf{u} + \mathbf{v}} = \sum_{\mathbf{v} \in \mathbb{Z}^d} c_{\mathbf{v} - \mathbf{u}} X^{\mathbf{v}}.$$

From these operations, we have an nice algebraic characterization of periodicity.

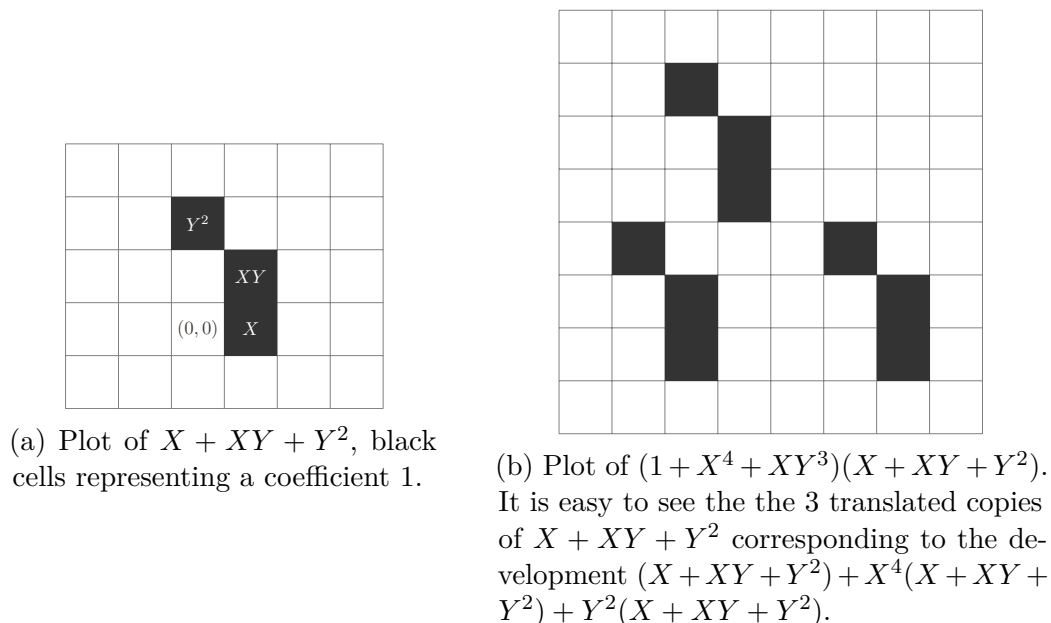

Figure 2.5 – The opposite is also interesting: the configuration gives a way of visualizing a formal series, and by extension any polynomials. Here are two examples for $d = 2$.

Proposition 2.1.1. *A configuration c is periodic of period $\mathbf{u} \in \mathbb{Z}^d$ if and only if $(X^{\mathbf{u}} - 1)c = 0$.*

And more generally, because having a line polynomial annihilator gives a recurrence relation on the configuration and the alphabet is finite, we have the following proposition.

Proposition 2.1.2. *A configuration c is periodic in direction \mathbf{u} if and only if there exists a line polynomial f in direction \mathbf{u} such that $fc = 0$.*

We say that a polynomial *annihilates* a configuration c in a ring R if fc is the zero power series in R . We call such an annihilator *non-trivial* if it is non-zero. As we will see, polynomials annihilating a configuration will play a central role in many theorems. We define

$$\text{Ann}_R(c) = \{f \in R[X^\pm] \mid fc = 0\}$$

the set of polynomials that annihilates c in R , called the *annihilator* of c . If not specified otherwise, we take $\text{Ann}(c) = \text{Ann}_{\mathbb{Z}}(c)$. Proposition 2.1.1 then shows that c is periodic if and only if there exists $\mathbf{u} \neq 0$ such that $(X^{\mathbf{u}} - 1) \in \text{Ann}(c)$. Therefore, studying the annihilator is one possible way of proving that a configuration is periodic. Its study is also motivated by the fact that it is a polynomial ideal, which provide many useful tools to understand its structure, as we will see.

The following proposition already relates the low complexity of a configuration with the existence of a non-trivial annihilator.

Proposition 2.1.3. *Let c be a configuration and $D \subset \mathbb{Z}^d$ a finite domain such that $P_c(D) \leq |D|$. Then there exist a non-trivial annihilator $f \in \text{Ann}(c)$.*

Then, using Hilbert's Nullstellensatz, Kari and Szabados are able to refine this proposition. They find a very specific form of annihilator in the ideal, close to what is needed to prove the periodicity of c using Proposition 2.1.1.

Theorem 2.1.4. *Let c be a configuration with a non-trivial annihilator. Then there exists $\mathbf{u}_1, \dots, \mathbf{u}_r \in \mathbb{Z}^d$ in pairwise distinct directions such that*

$$(X^{\mathbf{u}_1} - 1) \cdots (X^{\mathbf{u}_r} - 1) \in \text{Ann}(c).$$

In other words, to prove Nivat's conjecture it is enough to prove that if we have a low complexity 2D configuration with respect to a rectangle, then $r = 1$. This particular annihilator gives a way of decomposing a configuration into a finite number of periodic ones.

Theorem 2.1.5 (Decomposition theorem). *Let c be a configuration with a non-trivial annihilator. Then there exist periodic integral formal series (but possibly not finitary) c_1, \dots, c_r such that*

$$c = c_1 + \cdots + c_r.$$

Example 2.1. The first example illustrating this decomposition is the counter-example of the 3D generalization of Nivat's conjecture (Proposition 1.2.2, page 19). Let us call it c_n for a fixed n . It can be seen as a sum of two configurations d and e defined by

$$\begin{cases} d_{i,0,0} = 1 \text{ for every } i \in \mathbb{Z} \\ d_{i,j,k} = 0 \text{ otherwise} \end{cases} \quad \text{and} \quad \begin{cases} d_{0,j,n} = 1 \text{ for every } j \in \mathbb{Z} \\ d_{i,j,k} = 0 \text{ otherwise} \end{cases}.$$

Configurations d and e are respectively $(1, 0, 0)$ and $(0, 1, 0)$ -periodic, so they are respectively annihilated by polynomials $X^{(1,0,0)} - 1$ and $X^{(0,1,0)} - 1$. Therefore, $c_n = d + e$ is annihilated by $(X^{(1,0,0)} - 1)(X^{(0,1,0)} - 1)$.

As stated in Theorem 2.1.5, the configurations obtained in the decomposition may not be finitary. A good example of that is what is called the *snowflake configuration* c^* .

Example 2.2 (The snowflake configuration). Let α be an irrational number and define

$$c_{i,j}^1 = \lfloor (i+j)\alpha \rfloor, \quad c_{i,j}^2 = \lfloor i\alpha \rfloor, \quad c_{i,j}^3 = \lfloor j\alpha \rfloor.$$

None of these configurations are finitary, however they are all one-periodic, and therefore annihilated by $XY - 1$, $X - 1$ and $Y - 1$, respectively. Then $c^* = c^1 - c^2 - c^3$ (see Fig. 2.6) is finitary, and annihilated by $(XY - 1)(X - 1)(Y - 1)$. However, it is not periodic and cannot be decomposed as a sum of integral and finitary configurations [KS15a].

It is possible to obtain a bounded decomposition, however the coefficients might not be integers anymore.

Theorem 2.1.6 (Bounded decomposition). *Let c be a low complexity configuration. Then c can be written as a sum of finitely many bounded power series with real coefficients.*

In the two-dimensional case, Kari and Szabados proved that the annihilator ideal is radical, leading to a characterization of the annihilator ideal and a better decomposition of a low complexity configuration.

Theorem 2.1.7 (Two-dimensional decomposition). *Let c be a two-dimensional configuration with a non-trivial annihilator. Then there exist line polynomials ϕ_1, \dots, ϕ_r in pairwise distinct directions such that:*

$$\text{Ann}(c) = \phi_1 \cdots \phi_r H$$

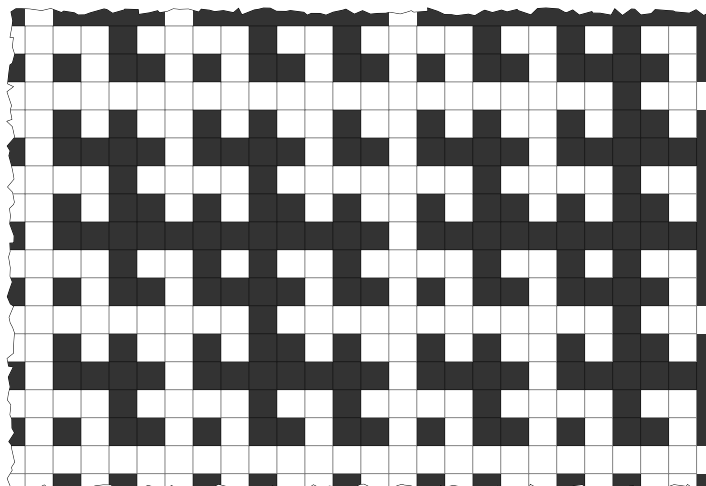

Figure 2.6 – The snowflake configuration with α the golden ratio.

with H uniquely defined and c_H a two-periodic configuration such that $H = \text{Ann}(c_H)$.

Moreover, there exist one-periodic integral formal series c_1, \dots, c_r , such that $\text{Ann}(c_i) = \langle \phi_i \rangle$, and

$$c = c_1 + \dots + c_r + c_H.$$

This decomposition relies on the primality of the annihilator ideal in the two-dimensional case. In higher dimension, Szabados and Kari conjectured that the ideal remains principal, which would lead to a similar decomposition.

Let us define $\text{ord}(c) := r$ from Theorem 2.1.7, which characterizes the periodicity of the configuration.

Corollary 2.1.8. *Let c be a two-dimensional configuration with a non-trivial annihilator. Then:*

- $\text{ord}(c) = 0$ if and only if c is two-periodic,
- $\text{ord}(c) = 1$ if and only if c is one-periodic,
- $\text{ord}(c) \geq 2$ if and only if c is not periodic.

In particular, if a configuration is annihilated by a line polynomial, $\text{ord}(c) \leq 1$ so the configuration is periodic.

This study of the annihilator ideal leads to a first major result: an asymptotic version of Nivat's conjecture.

Theorem 2.1.9 (Asymptotic Nivat's conjecture). *Let c be a two-dimensional configuration such that $P_c(m, n) \leq mn$ holds for infinitely many pairs $(m, n) \in \mathbb{Z}^2$. Then c is periodic.*

The last result proved by Kari and Szabados is the case $\text{ord}(c) = 2$, for which they are able to prove that Nivat's conjecture holds using some techniques from Cyr and Kra [CK15].

Theorem 2.1.10. *Let c be a two-dimensional configuration such that $P_c(m, n) \leq mn$ for some $m, n \in \mathbb{N}$ and $c = c_1 + c_2$ with c_1 and c_2 are periodic configurations. Then c is periodic.*

As a consequence, they provide an alternative proof of Cyr and Kra's approximation bound of Nivat's conjecture.

Theorem 2.1.11 (Cyr, Kra [CK15]). *Let c be a configuration such that there exist m, n such that $P_c(m, n) \leq \frac{mn}{2}$. Then c is periodic.*

The case $\text{ord}(c) \geq 3$ remains open, and the many particularities of the case $\text{ord}(c) = 2$ makes us believe that $\text{ord}(c) = 3$ might be the hard step separating us from proving the whole conjecture.

2.2 Algebraic Subshifts

In this section, we will introduce algebraic subshifts (similar to finite state topological Markov subgroups, also used in the literature). Using algebraic techniques introduced before, we will show that for algebraic subshifts defined with a well-chosen class of polynomials, the generalized Nivat's conjecture holds.

In this thesis, we define an algebraic subshift to be a subshift whose configurations are annihilated by the same polynomial. More precisely, let R be a finite field and $f \in R[[X^{\pm 1}, Y^{\pm 1}]]$ a non-zero polynomial. The *algebraic subshift defined by f* is

$$X_f = \{c \in R[[X^{\pm 1}, Y^{\pm 1}]] \mid fc = 0\}.$$

Since configurations of X_f are defined by a local rule, X_f is a subshift of finite type, and $c \in X_f \iff f \in \text{Ann}_R(c) \iff fc = 0$.

One motivation to study these subshifts is that if there is a counterexample of Nivat's conjecture, it belongs to some algebraic subshift. Indeed, if the configuration is finitary, the symbols can be renamed as elements of a finite field of the appropriate size. Then, Proposition 2.1.3 shows that any low complexity configuration is annihilated by some polynomial. Therefore, it would be enough to prove Nivat's conjecture for algebraic subshifts to prove it in full generality.

We will show that Nivat's conjecture is true (and even its generalized formulation) for algebraic subshifts defined by a polynomial which has all its line polynomial factors in the same direction. These results were published in [KM19].

2.2.1 The 3-dot System

In 1978 Ledrappier introduced an example of algebraic subshift which is mixing but with zero entropy [Led78]. Called the 5-dot system, it is the algebraic subshift defined by the polynomial $1 + X + Y + X^{-1} + Y^{-1}$. We will start by studying the example that initiated our results: the 3-dot system (sometimes called *Ledrappier subshift*), a variation of the 5-dot system introduced by Ledrappier. We call $\mathbb{F}_p = \mathbb{Z}/p\mathbb{Z}$.

Definition 2.2.1 (3-dot system). The 3-dot system L is the algebraic subshift X_{f_L} over \mathbb{F}_2 defined by the annihilator $f_L = 1 + X + Y$.

We will see that the generalized Nivat's property is strongly related to the number of line polynomial factors of the polynomial defining the algebraic subshift. It turns out that f_L has none, making it a simple example to start with. The easiest way of proving

that f_L has no line polynomial factor is to look at the shape of its convex hull, since it is related to the line polynomial factors of f_L , as stated by Corollary 2.2.2.

Lemma 2.2.1. *Let g, h be non-zero polynomials over a domain R such that $\text{supp}(g)$ has an outer edge perpendicular to \mathbf{v} . Then also $\text{supp}(gh)$ has an outer edge perpendicular to \mathbf{v} .*

Proof. Let vector $\mathbf{u} \in \mathbb{Z}^2 \setminus \{\mathbf{0}\}$ be perpendicular to \mathbf{v} . By hypothesis there are $\mathbf{x} \in \text{supp}(g)$ and a line polynomial α in the direction \mathbf{u} such that $\text{supp}(g) \subseteq \mathbf{x} + \overline{H}_{\mathbf{v}}$ and $\text{supp}(g - \alpha) \subseteq \mathbf{x} + H_{\mathbf{v}}$. Here α contains the terms of g along the boundary of the half plane $\mathbf{x} + H_{\mathbf{v}}$. Analogously, for any non-zero polynomial h there exists $\mathbf{y} \in \text{supp}(h)$ and polynomial $\beta \neq 0$ that is either a monomial or a line polynomial in the direction \mathbf{u} such that $\text{supp}(h) \subseteq \mathbf{y} + \overline{H}_{\mathbf{v}}$ and $\text{supp}(h - \beta) \subseteq \mathbf{y} + H_{\mathbf{v}}$. But then $\text{supp}(gh) \subseteq \mathbf{x} + \mathbf{y} + \overline{H}_{\mathbf{v}}$ and $\text{supp}(gh - \alpha\beta) \subseteq \mathbf{x} + \mathbf{y} + H_{\mathbf{v}}$. Because $\alpha\beta$ is a line polynomial in the direction \mathbf{u} , this proves that the support of gh has an outer edge perpendicular to \mathbf{v} . \square

Corollary 2.2.2. *If $f \neq 0$ has a line polynomial factor in the direction \mathbf{u} then $\text{supp}(f)$ has outer edges perpendicular to \mathbf{v} and $-\mathbf{v}$, where \mathbf{v} is a vector perpendicular to \mathbf{u} .*

Proof. A line polynomial g in the direction \mathbf{u} has outer edges perpendicular to \mathbf{v} and $-\mathbf{v}$. The claim then follows directly from Lemma 2.2.1. \square

The convex hull of f_L is a triangle, therefore, it cannot have any parallel outer edges, and so f_L has no line polynomial factors.

Corollary 2.2.3. *Polynomial $f_L = 1 + X + Y$ has no line polynomial factors.*

It is also easy to see that f_L is an irreducible polynomial in \mathbb{F}_2 , which implies Corollary 2.2.3.

We need one last lemma to prove our main result, stating that the factors of line polynomials are always line polynomials in the same direction.

Lemma 2.2.4. *Let f be a line polynomial over a domain R and let g be a factor of f . Then g is a line polynomial in the same direction as f , or a monomial.*

Proof. First, let us remark that a polynomial h is a line polynomial in direction \mathbf{u} if and only if $\text{supp}(h)$ is a segment with direction \mathbf{u} , which is its only outer edge (with the opposite one, which is the same).

Let g be a factor of f that is not a line polynomial in the same direction as f , nor a monomial. From the previous remark, it means that $\text{supp}(g)$ has an outer edge e that is not parallel to the direction of f . However, by Lemma 2.2.1, it would mean that f has an outer edge parallel to e , which is not possible. \square

Now we can prove that the 3-dot system has the generalized Nivat's property.

Theorem 2.2.5. *Any low complexity $c \in X_{f_L}$ is periodic.*

Proof. In this proof we are going to talk about annihilators of c over \mathbb{F}_2 and over \mathbb{Z} . We interpret c as a configuration over \mathbb{Z} using the renaming $\mathbb{F}_2 \rightarrow \mathbb{Z}$ that maps $0_{\mathbb{F}_2} \mapsto 0_{\mathbb{Z}}$ and $1_{\mathbb{F}_2} \mapsto 1_{\mathbb{Z}}$. In this context, $\text{Ann}_{\mathbb{Z}}(c)$ is the annihilator ideal of the configuration over \mathbb{Z} obtained after this renaming. We are going to prove the following stronger statement: if

$\text{Ann}_{\mathbb{Z}}(c)$ contains a non-zero polynomial then c is periodic. The result then follows from Proposition 2.1.3.

Let $c \in L$ be non-periodic. We first prove that $\text{Ann}_{\mathbb{F}_2}(c)$ is the principal ideal generated by f_L , that is, for every $g \in \text{Ann}_{\mathbb{F}_2}(c)$ there exists $\alpha \in \mathbb{F}_2[X^{\pm 1}, Y^{\pm 1}]$ such that $g = \alpha f_L$. Let $g \in \text{Ann}_{\mathbb{F}_2}(c)$ be a proper polynomial (which means that all exponents of variables are non-negative). Because $X = 1 + Y + f_L$ we can eliminate variable X by replacing each occurrence of X in g by $1 + Y + f_L$. This yields $g = \alpha(X, Y)f_L + \beta(Y)$ for some polynomial $\alpha(X, Y)$ and a polynomial $\beta(Y)$ which is in variable Y only. Because both f_L and g are annihilators of c , $\beta(Y) \in \text{Ann}_{\mathbb{F}_2}(c)$ as well.

If $\beta \neq 0$ then it is either a single monomial (in which case $c = 0$) or a line polynomial annihilator of c . In both cases, $\text{ord}(c) \leq 1$, and so c is periodic in the direction of the line polynomial by Corollary 2.1.8. The theorem is true in this case.

If $\beta = 0$, then $g = \alpha f_L$ as claimed. Consider then arbitrary $g \in \text{Ann}_{\mathbb{F}_2}(c)$ with possibly some negative exponents. Because $g = X^i Y^j g'$ for some $i, j \in \mathbb{Z}$ and a proper polynomial $g' \in \text{Ann}_{\mathbb{F}_2}(c)$, we conclude that also in this case g is a multiple of f_L , and therefore we have that $\text{Ann}_{\mathbb{F}_2}(c)$ is the principal ideal generated by f_L .

Now it remains to show that $\text{Ann}_{\mathbb{Z}}(c)$, the set of annihilators over \mathbb{Z} , is trivial. Suppose by contradiction that there is a non-zero annihilator in $\text{Ann}_{\mathbb{Z}}(c)$. By Theorem 2.1.4 there exist non-zero $(i_1, j_1), \dots, (i_m, j_m) \in \mathbb{Z}^2$ such that $(X^{i_1} Y^{j_1} - 1) \dots (X^{i_m} Y^{j_m} - 1) \in \text{Ann}_{\mathbb{Z}}(c)$. By performing all computations in \mathbb{F}_2 instead of \mathbb{Z} , we have that $(X^{i_1} Y^{j_1} - 1) \dots (X^{i_m} Y^{j_m} - 1) \in \text{Ann}_{\mathbb{F}_2}(c)$. But then this polynomial, which only has line polynomial factors, is a multiple of f_L . All non-trivial factors of line polynomials are line polynomials in the same direction (Lemma 2.2.4) so all irreducible factors of f_L are line polynomials, but f_L has no polynomial factors (Corollary 2.2.3). Note that we implicitly used the fact that every polynomial can be uniquely factored into its irreducible factors (see for example Theorem 5 on page 149 of [CLO15]). \square

In fact, we will see that any low complexity $c \in X_{f_L}$ is even two-periodic, as shown in Theorem 2.2.9 below.

2.2.2 Annihilators with Line Polynomial Factors in One Direction

The next step is to try to generalize the previous technique to other algebraic subshifts. In this section, we extend this technique to algebraic subshifts defined by polynomials having no polynomial factor, or all in the same direction.

Resultant

One of the key element in the proof of Theorem 2.2.5 is the fact that we can find an annihilator with one of the two variables eliminated from it. It turns out that this is something we can do with other annihilators than f_L , and to do so we will use basic notions of *elimination theory*, a theory that conveniently focuses on eliminating variables in polynomials. We will mostly use one object from it: resultants.

Resultant are usually defined for proper polynomials, so in order to stick with usual definitions we define them likewise. We will still use them for talking about Laurent

polynomials, which is not a problem since from a Laurent polynomial annihilator we can always obtain a proper one by multiplying it by a suitable monomial.

Let R be a field (for example \mathbb{F}_p for a prime p) and let $K = R[Y]$ be the ring of polynomials in one variable Y . Then $K[X] = R[X, Y]$ is the ring of polynomials in variable X and Y over R . We will only define resultants for polynomials in two variables, but note that they can be defined for any number of variables in general (see for example [CLO15]).

Definition 2.2.2 (Resultant). Let $f, g \in K[X]$ be two polynomials of positive degree, written as

$$\begin{aligned} f &= a_0 X^k + \cdots + a_k, a_0 \neq 0 \\ g &= b_0 X^l + \cdots + b_l, b_0 \neq 0. \end{aligned}$$

The *Sylvester matrix* of f and g with respect to X is the following $(k+l) \times (k+l)$ matrix:

$$\text{Syl}_X(f, g) = \begin{pmatrix} a_0 & & & & & & b_0 & & & & & & \\ a_1 & a_0 & & & & & b_1 & b_0 & & & & & \\ a_2 & a_1 & \cdots & & & & b_2 & b_1 & \cdots & & & & \\ \vdots & a_2 & \cdots & a_0 & & & \vdots & b_2 & \cdots & b_0 & & & \\ \vdots & \vdots & \cdots & a_1 & & & \vdots & \vdots & \cdots & b_1 & & & \\ a_k & \vdots & & a_2 & & & b_l & \vdots & & b_2 & & & \\ & a_k & & \vdots & & & b_l & \vdots & & \vdots & & & \\ & & \cdots & \vdots & & & & & \cdots & \vdots & & & \\ & & & a_k & & & & & & b_l & & & \end{pmatrix},$$

with 0s filling the empty spaces.

The *resultant* of f and g with respect to X is the determinant of the Sylvester matrix:

$$\text{Res}_X(f, g) = \text{Det}(\text{Syl}_X(f, g)).$$

Notably, $\text{Res}_X(f, g) \in K = R[Y]$: it is a polynomial in one variable Y .

Hopefully, we do not need to work directly with the definition of the resultant. All we need are the two key properties of the resultant, whose proofs can be found in [CLO15]. The first shows that the value of the resultant is linked to the common factors of the two polynomials.

Proposition 2.2.6. *Two polynomials f and g have a common factor in $R[X, Y]$ if and only if $\text{Res}_X(f, g) = 0$.*

Proposition 2.2.7. *There exist $\alpha, \beta \in R[X, Y]$ such that*

$$\alpha f + \beta g = \text{Res}_X(f, g).$$

The second proposition is what makes the determinant useful to eliminate variables: it explicits a linear combination of polynomials in two variable resulting in a polynomial in one variable Y : the resultant. The next lemma shows how these properties can be used in the context of annihilators of a configuration.

Lemma 2.2.8. *Let c be a power series over a field R . If c is annihilated by two non-zero polynomials f and g with no common factors then c is two-periodic.*

Proof. Using Proposition 2.2.7, let $\alpha, \beta \in R[X, Y]$ be such that

$$\alpha f + \beta g = \text{Res}_X(f, g).$$

Because f and g are both annihilators of c so is $\text{Res}_X(f, g)$. Then, f and g having no common factors, Proposition 2.2.6 tells us that $\text{Res}_X(f, g) \neq 0$. We found an annihilator which is a line polynomial or a monomial (only with variable Y) so c must be periodic along Y .

Symmetrically, there also exist $\gamma, \delta \in R[X, Y]$ such that

$$\gamma f + \delta g = \text{Res}_Y(f, g).$$

Again, $\text{Res}_Y(f, g) \neq 0$, so c is also periodic along X . □

Note that in the case where $R = \mathbb{Z}$, Lemma 2.2.8 can be directly derived from the structure of the annihilator explained in Theorem 2.1.7.

Annihilators with Line Polynomial Factors in the Same Direction

Using the previous lemma, we can easily generalize Theorem 2.2.5 for other polynomials. We consider an algebraic subshift X_f over a finite field \mathbb{F}_p defined by an annihilator $f \in \mathbb{F}_p[X^{\pm 1}, Y^{\pm 1}]$. A configuration $c \in \mathbb{F}_p[[X^{\pm 1}, Y^{\pm 1}]]$ will also be interpreted as a configuration over \mathbb{Z} by mapping the symbols by $a_{\mathbb{F}_p} \mapsto a_{\mathbb{Z}}$ for all $a \in \{0, 1, \dots, p-1\}$. Then, as in the proof of Theorem 2.2.5, we can define both $\text{Ann}_{\mathbb{F}_p}(c)$ and $\text{Ann}_{\mathbb{Z}}(c)$, and use the fact that any $g \in \text{Ann}_{\mathbb{Z}}(c)$ is also in $\text{Ann}_{\mathbb{F}_p}(c)$ when its coefficients are reduced modulo p .

Theorem 2.2.9. *Let $c \in X_f$ for a polynomial $f \in \mathbb{F}_p[X^{\pm 1}, Y^{\pm 1}]$, and suppose that $\text{Ann}_{\mathbb{Z}}(c)$ contains a non-zero polynomial.*

- *If f has no line polynomial factors then c is two-periodic.*
- *If all line polynomial factors of f are in the same direction then c is periodic in this direction.*

Proof. By Theorem 2.1.4 there exists non-zero $(i_1, j_1), \dots, (i_m, j_m) \in \mathbb{Z}^2$ such that

$$(X^{i_1}Y^{j_1} - 1) \dots (X^{i_m}Y^{j_m} - 1) \in \text{Ann}_{\mathbb{Z}}(c).$$

By performing computations modulo p instead, we have that

$$g(X, Y) = (X^{i_1}Y^{j_1} - 1) \dots (X^{i_m}Y^{j_m} - 1) \in \text{Ann}_{\mathbb{F}_p}(c).$$

If f has no line polynomial factors then f and g do not have any common factors. By Lemma 2.2.8 then c is two-periodic. This proves the first claim.

Suppose then that all line polynomial factors of f are in the same direction. Let h be the greatest common divisor of f and g so that we can write $f = f'h$ and $g = g'h$ where f' and g' do not have common factors. Note that h is a line polynomial: it is a product of line polynomials as a factor of g . And all these line polynomials are in the same direction because h is a factor f .

Because $c' = hc$ is annihilated by both f' and g' it follows from Lemma 2.2.8 that c' is two-periodic. In particular, there is a line polynomial h' in the direction of h that

annihilates c' . We have $hh' \in \text{Ann}_{\mathbb{F}_p}(c)$ so that c is annihilated by the line polynomial hh' and is therefore periodic in its direction. \square

Using Proposition 2.1.3 we now immediately get that algebraic subshifts defined by an annihilator with all its line polynomial factors in the same direction have the generalized Nivat's property.

Corollary 2.2.10. *Let $c \in X_f$ for a polynomial $f \in \mathbb{F}_p[X^{\pm 1}, Y^{\pm 1}]$ whose line polynomial factors are all in the same direction. If c has low complexity then it is periodic.*

It is interesting to remark that elements of the 3-dot system are exactly the space-time diagrams of the one-dimensional XOR cellular automaton. This can be generalized to a general one-dimensional additive cellular automata.

An *additive cellular automata* is a dynamical system acting on a one-dimensional configuration c belonging to $\mathbb{F}_p^{\mathbb{Z}}$ for example. Its rule can be represented by a polynomial $g(X) = \sum_i^k g_i X^i$ such that at each time step, the cellular automaton applies a local transformation

$$f_j : c_j \mapsto \sum_{i=j}^{j+k} g_i c_i$$

and can be naturally extended to a global transformation $f : \mathbb{F}_p^{\mathbb{Z}} \rightarrow \mathbb{F}_p^{\mathbb{Z}}$ by applying the local transformation to every position j of c . A *space-time diagram* of such a cellular automata is a two dimensional configuration c such that for all $j \in \mathbb{Z}$, $f((c_{i,j})_{i \in \mathbb{Z}}) = (c_{i,j+1})_{i \in \mathbb{Z}}$. The set of space-time diagrams of an additive cellular automata form an algebraic SFT, defined by $f(X, Y) = Y - g(X) \in \mathbb{F}_p[X^{\pm 1}, Y^{\pm 1}]$, by definition of the local rule of the cellular automata. See Section 9 of [Kar05] for a short discussion about additive cellular automata.

Corollary 2.2.11. *Let c be a configuration being the space-time diagram of a one-dimensional additive cellular automata over \mathbb{F}_p . If c has low complexity, then it is periodic.*

Proof. Let us call $g(X)$ the rule of the one-dimensional additive cellular automata considered. Since the considered one-dimensional cellular automata is additive, its rule can be expressed as a univariate polynomial $g(X)$. Its set of space-time diagrams is then the algebraic subshift X_f defined by $f(X, Y) = Y - g(X) \in \mathbb{F}_p[X^{\pm 1}, Y^{\pm 1}]$.

If $g(X)$ has at least two terms then the support of f has triangular shape and therefore f has no line polynomial factors. If $g(X)$ has one term then f itself is a line polynomial. In both case, Corollary 2.2.10 holds. \square

In dimension higher than two, we have no counterexample to Corollary 2.2.10. However, in order to use the same trick – finding a line polynomial by using resultant of known annihilators – one need to have more than two annihilating polynomials. Multipolynomial resultants are not as easy to use as usual resultants, and as a consequence we do not have a formulation of Theorem 2.2.9 working in dimension other than two.

2.2.3 Square Annihilators

After Corollary 2.2.10, it is natural to take a look at configurations annihilated by polynomials with line polynomial factors in more directions. It turns out that already products

of two line polynomials include examples with and without the generalized Nivat's property, showing that just having two different directions makes things more complex. We first prove that the 4-dot system defined by $(1 + X)(1 + Y)$ over \mathbb{F}_2 has the generalized Nivat's property and then we show that the system defined by $(1 + X^2)(1 + Y^2)$ does not.

The 4-dot System

Definition 2.2.3 (4-dot system). The 4-dot system S is the algebraic subshift X_{f_S} over \mathbb{F}_2 defined by the annihilator $f_S = 1 + X + Y + XY = (1 + X)(1 + Y)$.

Theorem 2.2.12. *Every low complexity $c \in X_{f_S}$ is periodic.*

Proof. Similarly as before, we are going to prove the more general statement that if c has a non-trivial annihilator p_0 over \mathbb{Z} then it is periodic.

We first observe that $c = h + v$ for $h, v \in \mathbb{F}_2[[X^{\pm 1}, Y^{\pm 1}]]$ that are $(1, 0)$ -periodic and $(0, 1)$ -periodic, respectively. Indeed, we can take $h_{i,j} = c_{0,j}$ and $v_{i,j} = c_{i,0} + c_{0,0}$, for all $i, j \in \mathbb{Z}$. Because $(1 + X^i)(1 + Y^j)$ is a multiple of $(1 + X)(1 + Y)$ over \mathbb{F}_2 , polynomial $(1 + X^i)(1 + Y^j)$ annihilates c , for all $i, j \in \mathbb{Z}$. This means that $c_{i,j} = c_{0,j} + c_{i,0} + c_{0,0} = h_{i,j} + v_{i,j}$.

Using the periodicity of h and v we can write $h = \mathbb{1}(X)s(Y)$ and $v = t(X)\mathbb{1}(Y)$, with $\mathbb{1}(X) = \sum_{i \in \mathbb{Z}} X^i$ and s, t two formal series depending only on one variable. Let us define another binary configuration d by

$$d(X, Y) = t(X)s(Y).$$

In other words, d is the configuration that has ones where both h and v have ones:

$$d_{i,j} = \begin{cases} 1 & \text{if } h_{i,j} = v_{i,j} = 1 \\ 0 & \text{otherwise} \end{cases}.$$

Interpreted in \mathbb{Z} , we have

$$c = h + v - 2d.$$

This is the case since the two sides are identical modulo two and both sides only contain values 0 and 1.

Consider next the polynomial

$$p = p_0(X - 1)(Y - 1)$$

over \mathbb{F}_2 . Because p_0 annihilates c , and $X - 1$ and $Y - 1$ annihilate h and v , respectively, we have that $pc = ph = pv = 0$. Therefore $pd = 0$ as well, which can be written as

$$p(X, Y)t(X)s(Y) = 0,$$

emphasizing the variable dependencies of the polynomials. We have the following two cases:

Case 1 Suppose that $p(X, Y)t(X) = 0$. Let us rewrite $p(X, Y)$ collecting together terms with the same power of variable Y , obtaining

$$p(X, Y) = \sum_{j \in \mathbb{Z}} Y^j p_j(X)$$

where at least some $p_j(X)$ is a non-zero polynomial. We have

$$\sum_{j \in \mathbb{Z}} Y^j p_j(X) t(X) = 0.$$

This is an identity of formal power series so that $p_j(X)t(X) = 0$ for all $j \in \mathbb{Z}$. But then also $p_j(X)v = p_j(X)t(X)\mathbb{1}(Y) = 0$, so that v is annihilated by a non-zero horizontal line polynomial (or a non-zero monomial) $p_j(X)$. We conclude that v is horizontally periodic. But then also $c = h + v$ is horizontally periodic as a sum of two horizontally periodic configurations.

Case 2 Suppose that $p(X, Y)t(X) \neq 0$. Now we rewrite $p(X, Y)t(X)$ grouping together variables with the same power of variable X , obtaining

$$p(X, Y)t(X) = \sum_{i \in \mathbb{Z}} X^i q_i(Y),$$

where at least some $q_i(Y)$ is a non-zero polynomial. Note that all $q_i(Y)$ are polynomials because powers of the variable Y only come from the polynomial $p(X, Y)$. Because

$$0 = p(X, Y)d(X, Y) = p(X, Y)t(X)s(Y) = \sum_{i \in \mathbb{Z}} X^i q_i(Y)s(Y),$$

we have that $q_i(Y)s(Y) = 0$ for all $i \in \mathbb{Z}$. Analogously to case 1 above, this implies that h is vertically periodic, and therefore also c is vertically periodic. □

An Algebraic Subshift Without the Generalized Nivat's Property

For some polynomials with two line polynomial factors, the associated subshift does not have the generalized Nivat's property. This is typically the case when the annihilating polynomial allows the use of sublattices. The following result can be inferred from Example 1 in [ST00].

Theorem 2.2.13. *There exists a configuration c over \mathbb{F}_2 annihilated by $f_T = (1 + X^2)(1 + Y^2)$ which is not periodic but has low complexity.*

Proof. Let us take $c = h + v$, with

$$h_{i,j} = \begin{cases} 1 & \text{if } j = 0 \text{ and } i \text{ even} \\ 0 & \text{otherwise} \end{cases} \quad \text{and} \quad v_{i,j} = \begin{cases} 2 & \text{if } i = 1 \text{ and } j \text{ even} \\ 0 & \text{otherwise} \end{cases}.$$

Visually, c is the superposition of a horizontal and a vertical line on two disjoint sublattices, see Fig. 2.8. Clearly h is one-periodic with periodicity vector $(2, 0)$ and v is one-periodic with periodicity vector $(0, 2)$. Their sum c is not periodic.

The periodicity of h and v directly implies that f_T annihilates c : h being $(2, 0)$ -periodic $(1 + X^2)h = 0$ and, analogously, v being $(0, 2)$ -periodic $(1 + Y^2)v = 0$. This means that $f_T c = (1 + X^2)(1 + Y^2)h + (1 + X^2)(1 + Y^2)v = 0$.

The last thing we have to check is that c has low complexity, i.e., there is a shape D such that $P_c(D) \leq |D|$. It is sufficient to take D to be the scattered 3×3 square, as shown in Fig. 2.7. Patterns of shape D in c will only contain values from one of the four

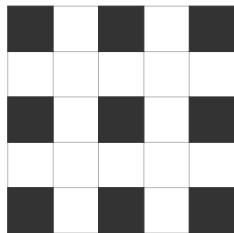

Figure 2.7 – The shape D of low complexity.

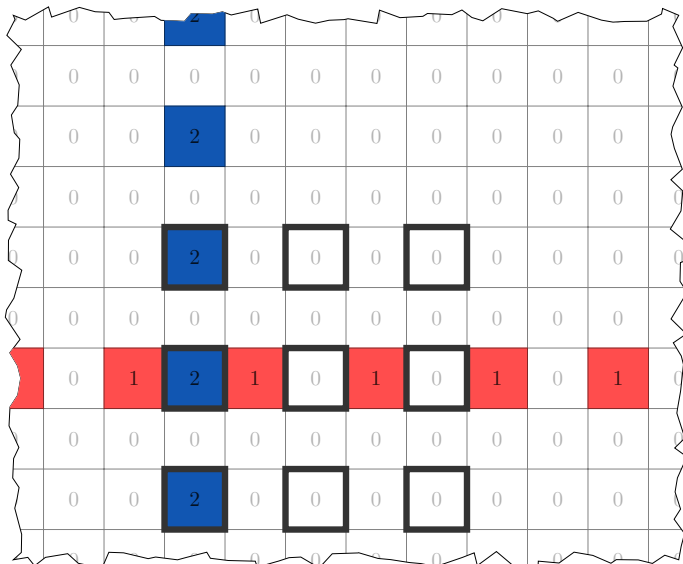

Figure 2.8 – Sublattices of c and shape D superimposed. The horizontal line is from h and the vertical one from v .

sublattices, depending on the parity of its position. If D is superimposed with the two sublattices filled with 0, the pattern is blank. With one sublattice, it can only contain values from h , so it can have four different values: blank, and the horizontal line crossing at the top, the middle or the bottom. If it is on the last sublattice, then it has values from v , and here again there are four different possibilities. Counting the blank shape only once, we obtain $P_c(D) = 1 + 3 + 3 = 7 < 9 = |D|$. \square

2.3 Low Complexity Subshifts

Instead of focusing on a single configuration of low complexity, it can be interesting to look at subshifts in which all configurations have low complexity. One of the motivations to study these subshifts is that if Nivat’s conjecture is true, then the domino problem is trivially decidable for them. Therefore the decidability alone may be an easier problem to tackle first, and from an algorithmic point of view it is the most interesting consequence of Nivat’s conjecture.

In this section we will focus on low complexity with respect to a rectangle (in opposition to the general shape of the previous section). In this setting we define low complexity subshifts and prove that they always contain a periodic configuration. As a consequence we prove that the domino problem is indeed decidable for low complexit subshifts. And

finally, we are able to use this to prove that Nivat's conjecture holds for uniformly recurrent configurations.

After introducing a few more concept from dynamical systems, we show our method to extract a periodic configuration from a low complexity one (Theorem 2.3.4). And then we detail the main consequences of this result (Corollary 2.3.17 and Corollary 2.3.18). These results can also be found in [KM20].

2.3.1 Concepts from Dynamical Systems

A configuration c is called *uniformly recurrent* if for every $c' \in \overline{\mathcal{O}(c)}$ we have $\overline{\mathcal{O}(c')} = \overline{\mathcal{O}(c)}$. This is equivalent to $\overline{\mathcal{O}(c)}$ being a *minimal subshift* in the sense that it has no proper non-empty subshifts inside it. A classical result by Birkhoff [Bir12] implies that every non-empty subshift contains a minimal subshift, so there is a uniformly recurrent configuration in every non-empty subshift.

Definition 2.3.1 (Deterministic subshift). A subshift X is *deterministic* in direction \mathbf{u} if for all $c, c' \in X$

$$c|_{H_{\mathbf{u}}} = c'|_{H_{\mathbf{u}}} \implies c = c',$$

that is, if the content of a configuration in the half plane $H_{\mathbf{u}}$ uniquely determines the contents in the rest of the cells.

Note that it is enough to verify that the value $c_{\mathbf{0}}$ on the boundary of the half plane is uniquely determined. This notion is also known as *one-sided expansiveness* in the literature, (two-sided) expansiveness meaning that the content of a single stripe uniquely determine the whole configuration.

Proposition 2.3.1. *Let X be such that for some vector \mathbf{u} and all $c, c' \in X$,*

$$c|_{H_{\mathbf{u}}} = c'|_{H_{\mathbf{u}}} \implies c_{\mathbf{0}} = c'_{\mathbf{0}}.$$

Then X is deterministic in direction \mathbf{u} .

Proof. Let $c, c' \in X$ such that $c|_{H_{\mathbf{u}}} = c'|_{H_{\mathbf{u}}}$. Since the boundary of $H_{\mathbf{u}}$ is a line intersecting the origin, there exists \mathbf{v} a vector such that $\overline{H_{\mathbf{u}}} \setminus H_{\mathbf{u}} = \{k\mathbf{v} \mid k \in \mathbb{Z}\}$. Let σ be the shift by vector \mathbf{v} . Because \mathbf{v} defines the boundary of $H_{\mathbf{u}}$, we have that for all $k \in \mathbb{Z}$, $\sigma^k(c)|_{H_{\mathbf{u}}} = \sigma^k(c')|_{H_{\mathbf{u}}}$, so $\sigma^k(c)_{\mathbf{0}} = \sigma^k(c')_{\mathbf{0}}$ by hypothesis. Or in other words, for all $k \in \mathbb{Z}$, $c_{k\mathbf{v}} = c'_{k\mathbf{v}}$: c and c' are identical on one additional line L . By applying this to successive translated c and c' we can obtain that they are identical on successive next lines to L along \mathbf{u} (as define page 22), and by induction on $\mathbb{Z} \setminus H_{\mathbf{u}}$, so $c = c'$. \square

Moreover, determinism in direction \mathbf{u} implies that only a finite region uniquely determines the content of the cell $c_{\mathbf{0}}$ (Proposition 2.3.2 below).

Definition 2.3.2 (Discrete box). Let $\mathbf{u} \in \mathbb{Z}^2$ and $k \in \mathbb{N}$. The *discrete box of direction \mathbf{u} and width k* is the set

$$B_{\mathbf{u}}^k = \{\mathbf{x} \in \mathbb{Z}^2 \mid -k < \mathbf{x} \cdot \mathbf{u} < 0 \text{ and } -k < \mathbf{x} \cdot \mathbf{u}^{\perp} < k\}.$$

where we denote by \mathbf{u}^{\perp} a vector orthogonal to \mathbf{u} and that has the same length as \mathbf{u} (for example $(n, m)^{\perp} = (m, -n)$). See Fig. 2.9 for an illustration.

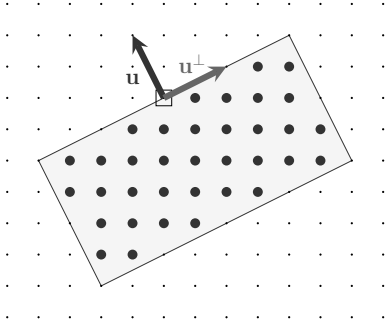

Figure 2.9 – The discrete box $B_{\mathbf{u}}^k$ with $\mathbf{u} = (-1, 2)$ and $k = 10$.

Proposition 2.3.2. *Let X be deterministic in direction \mathbf{u} . Then there exists $k \in \mathbb{Z}$ such that for all $c, c' \in X$,*

$$c|_{B_{\mathbf{u}}^k} = c'|_{B_{\mathbf{u}}^k} \implies c_0 = c'_0.$$

Proof. By contradiction, assume that for all $k \in \mathbb{Z}$, there exists $c, c' \in X$ such that

$$c|_{B_{\mathbf{u}}^k} = c'|_{B_{\mathbf{u}}^k} \text{ and } c_0 \neq c'_0.$$

Then, because $\lim_{k \rightarrow \infty} B_{\mathbf{u}}^k = H_{\mathbf{u}}$, compactness of X allow us to extract $c, c' \in X$ such that

$$c|_{H_{\mathbf{u}}} = c'|_{H_{\mathbf{u}}} \text{ and } c_0 \neq c'_0,$$

contradicting the determinism of X in direction \mathbf{u} . \square

If X is deterministic in directions \mathbf{u} and $-\mathbf{u}$ we say that \mathbf{u} is a direction of *two-sided* determinism. If X is deterministic in direction \mathbf{u} but not in direction $-\mathbf{u}$ we say that \mathbf{u} is a direction of *one-sided* determinism. Directions of two-sided determinism correspond to directions of expansivity in the symbolic dynamics literature. If X is not deterministic in direction \mathbf{u} we call \mathbf{u} a *direction of non-determinism*. Finally, note that the concept of determinism in direction \mathbf{u} only depends on the orientation of vector \mathbf{u} and not on its norm.

2.3.2 Extracting Periodicity from Low Complexity

Using these tools from dynamics systems, our goal is to *extract* periodicity from a low complexity configuration. We do that in two steps. First, we show that having an annihilator allows to find a configuration with no one-sided determinism.

Theorem 2.3.3. *Let c be a two-dimensional configuration that has a non-trivial annihilator. Then $\overline{\mathcal{O}(c)}$ contains a configuration c' such that $\overline{\mathcal{O}(c')}$ has no direction of one-sided determinism.*

Second, from this result, using a technique by Cyr and Kra [CK15], we then obtain the second main result of this section, stating that under the hypotheses of Nivat's conjecture, a configuration contains arbitrarily large periodic regions, solving Conjecture 8.2 of [Sza18a].

Theorem 2.3.4. *Let c be a two-dimensional configuration that has low complexity with respect to a convex shape. Then $\overline{\mathcal{O}(c)}$ contains a periodic configuration.*

Removing One-sided Determinism (Theorem 2.3.3)

In this section we prove Theorem 2.3.3 by showing how we can “remove” one-sided directions of determinism from subshifts with annihilators.

Let c be a configuration over alphabet $A \subseteq \mathbb{Z}$ that has a non-trivial annihilator. By Theorem 2.1.4 it has then an annihilator $\phi_1 \cdots \phi_m$ where each ϕ_i is of the form

$$\phi_i = x^{n_i} y^{m_i} - 1 \text{ for some } \mathbf{v}_i = (n_i, m_i) \in \mathbb{Z}^2. \quad (2.2)$$

Moreover, vectors \mathbf{v}_i can be chosen pairwise linearly independent, that is, in different directions. We may assume $m \geq 1$.

Denote $X = \overline{\mathcal{O}(c)}$, the subshift generated by c . A polynomial that annihilates c annihilates all elements of X , because they only have local patterns that already appear in c . It is easy to see that X can only be non-deterministic in a direction that is perpendicular to one of the directions \mathbf{v}_i of the polynomials ϕ_i :

Proposition 2.3.5. *Let c be a configuration annihilated by $\phi_1 \cdots \phi_m$ where each ϕ_i is of the form (2.2). Let $\mathbf{u} \in \mathbb{Z}^2$ be a direction that is not perpendicular to \mathbf{v}_i for any $i \in \{1, \dots, m\}$. Then $X = \overline{\mathcal{O}(c)}$ is deterministic in direction \mathbf{u} .*

Proof. Suppose X is not deterministic in direction \mathbf{u} . By definition, there exist $d, e \in X$ such that $d \neq e$ but $d|_{H_{\mathbf{u}}} = e|_{H_{\mathbf{u}}}$. Denote $\Delta = d - e$. Because $\Delta \neq 0$ but $\phi_1 \cdots \phi_m \cdot \Delta = 0$, for some i we have $\phi_1 \cdots \phi_{i-1} \cdot \Delta \neq 0$ and $\phi_1 \cdots \phi_i \cdot \Delta = 0$. Denote $\Delta' = \phi_1 \cdots \phi_{i-1} \cdot \Delta$. Because $\phi_i \cdot \Delta' = 0$, configuration Δ' is periodic in direction \mathbf{v}_i . But because Δ is zero in the half plane $H_{\mathbf{u}}$, also Δ' is zero in some translate $H' = H_{\mathbf{u}} - \mathbf{t}$ of the half plane. Since the periodicity vector \mathbf{v}_i of Δ' is not perpendicular to \mathbf{u} , the periodicity transmits the values 0 from the region H' to the entire \mathbb{Z}^2 . Hence $\Delta' = 0$, a contradiction. \square

Let $\mathbf{u} \in \mathbb{Z}^2$ be a one-sided direction of determinism of X . In other words, \mathbf{u} is a direction of determinism but $-\mathbf{u}$ is not. By the proposition above, \mathbf{u} is perpendicular to some \mathbf{v}_i . Without loss of generality, we may assume $i = 1$. We denote $\phi = \phi_1$ and $\mathbf{v} = \mathbf{v}_1$.

Let k be such that the content of the discrete box $B = B_{\mathbf{u}}^k$ determines the content of cell $\mathbf{0}$, that is, for $d, e \in X$

$$d|_B = e|_B \implies d_{\mathbf{0}} = e_{\mathbf{0}}. \quad (2.3)$$

As pointed out in Section 2.3.1, any sufficiently large k can be used. We can choose k so that $k > |\mathbf{u}^\perp \cdot \mathbf{v}|$. To shorten notations, let us also denote $H = H_{-\mathbf{u}}$.

Lemma 2.3.6. *For any $d, e \in X$ such that $\phi d = \phi e$ holds:*

$$d|_B = e|_B \implies d|_H = e|_H.$$

Proof. Let $d, e \in X$ be such that $\phi d = \phi e$ and $d|_B = e|_B$. Denote $\Delta = d - e$. Then $\phi \Delta = 0$ and $\Delta|_B = 0$. Property $\phi \Delta = 0$ means that Δ has periodicity vector \mathbf{v} , so this periodicity transmits values 0 from the region B to the stripe

$$S = \bigcup_{i \in \mathbb{Z}} (B + i\mathbf{v}) = \{\mathbf{x} \in \mathbb{Z}^2 \mid -k < \mathbf{x} \cdot \mathbf{u} < 0\},$$

See Fig. 2.10 for an illustration of the regions H , B and S . As $\Delta|_S = 0$, we have that $d|_S = e|_S$. Applying (2.3) on suitable translates of d and e allows us to conclude that $d|_H = e|_H$.

□

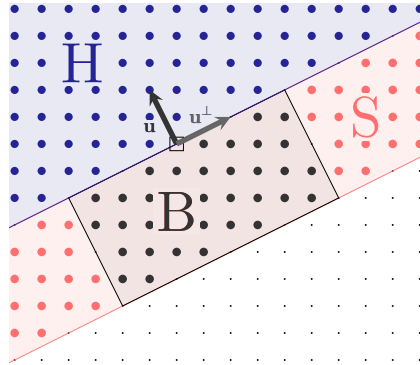

Figure 2.10 – Discrete regions $H = H_{-\mathbf{u}}$, $B = B_{\mathbf{u}}^k$ and S in the proof of Lemma 2.3.6. In the illustration $\mathbf{u} = (-1, 2)$ and $k = 10$.

A reason to prove the lemma above is the following corollary, stating that X can only contain a bounded number of configurations that have the same product with ϕ :

Corollary 2.3.7. *Let $c_1, \dots, c_n \in X$ be pairwise distinct. If $\phi c_1 = \dots = \phi c_n$ then $n \leq |A|^{|B|}$.*

Proof. Let $H' = H - \mathbf{t}$, for $\mathbf{t} \in \mathbb{Z}^2$, be a translate of the half plane $H = H_{-\mathbf{u}}$ such that c_1, \dots, c_n are pairwise different on H' . Consider the translated configurations $d_i = \tau^{\mathbf{t}}(c_i)$. We have that $d_i \in X$ are pairwise different on H and $\phi d_1 = \dots = \phi d_n$. By Lemma 2.3.6, configurations d_i must be pairwise different on domain B . There are only $|A|^{|B|}$ different patterns in domain B .

□

Let $c_1, \dots, c_n \in X$ be pairwise distinct such that $\phi c_1 = \dots = \phi c_n$, with n as large as possible. By Corollary 2.3.7 there exists such a maximal n such that c_1, \dots, c_n are pairwise distinct. Let us repeatedly translate the configurations c_i by $\tau^{\mathbf{u}}$ and take a limit: by compactness there exists $n_1 < n_2 < n_3 \dots$ such that

$$d_i = \lim_{j \rightarrow \infty} \tau^{n_j \mathbf{u}}(c_i)$$

exists for all $i \in \{1, \dots, n\}$. Configurations $d_i \in X$ inherit the following properties from c_i :

Lemma 2.3.8. *Let d_1, \dots, d_n be defined as above. Then*

- (a) $\phi d_1 = \dots = \phi d_n$, and
- (b) Configurations d_i are pairwise different on translated discrete boxes $B' = B - \mathbf{t}$ for all $\mathbf{t} \in \mathbb{Z}^2$.

Proof. Let $i_1, i_2 \in \{1, \dots, n\}$ be arbitrary, $i_1 \neq i_2$.

(a) Because $\phi c_{i_1} = \phi c_{i_2}$ we have, for any $n \in \mathbb{N}$,

$$\phi \tau^{n\mathbf{u}}(c_{i_1}) = \tau^{n\mathbf{u}}(\phi c_{i_1}) = \tau^{n\mathbf{u}}(\phi c_{i_2}) = \phi \tau^{n\mathbf{u}}(c_{i_2}).$$

Function $c \mapsto \phi c$ is continuous in the topology so

$$\phi d_{i_1} = \phi \lim_{j \rightarrow \infty} \tau^{n_j \mathbf{u}}(c_{i_1}) = \lim_{j \rightarrow \infty} \phi \tau^{n_j \mathbf{u}}(c_{i_1}) = \lim_{j \rightarrow \infty} \phi \tau^{n_j \mathbf{u}}(c_{i_2}) = \phi \lim_{j \rightarrow \infty} \tau^{n_j \mathbf{u}}(c_{i_2}) = \phi d_{i_2}.$$

(b) Let $B' = B - \mathbf{t}$ for some $\mathbf{t} \in \mathbb{Z}^2$. Suppose $d_{i_1}|_{B'} = d_{i_2}|_{B'}$. By the definition of convergence, for all sufficiently large j we have $\tau^{n_j \mathbf{u}}(c_{i_1})|_{B'} = \tau^{n_j \mathbf{u}}(c_{i_2})|_{B'}$. This is equivalent to $\tau^{n_j \mathbf{u} + \mathbf{t}}(c_{i_1})|_B = \tau^{n_j \mathbf{u} + \mathbf{t}}(c_{i_2})|_B$. By Lemma 2.3.6 then also $\tau^{n_j \mathbf{u} + \mathbf{t}}(c_{i_1})|_H = \tau^{n_j \mathbf{u} + \mathbf{t}}(c_{i_2})|_H$ where $H = H_{-\mathbf{u}}$. This means that for all sufficiently large j the configurations c_{i_1} and c_{i_2} are identical on the domain $H - n_j \mathbf{u} - \mathbf{t}$. But these domains cover the whole \mathbb{Z}^2 as $j \rightarrow \infty$ so that $c_{i_1} = c_{i_2}$, a contradiction. \square

Now we pick one of the configurations d_i and consider its orbit closure. Choose $d = d_1$ and set $Y = \overline{\mathcal{O}(d)}$. Then $Y \subseteq X$. Any direction of determinism in X is also a direction of determinism in Y . Indeed, this is trivially true for any subset of X . But, in addition, we have the following:

Lemma 2.3.9. *Subshift Y is deterministic in direction $-\mathbf{u}$.*

Proof. Suppose the contrary: there exist configurations $x, y \in Y$ such that $x \neq y$ but $x|_H = y|_H$ where, as before, $H = H_{-\mathbf{u}}$. In the following we construct $n + 1$ configurations in X that have the same product with ϕ , which contradicts the choice of n as the maximum number of such configurations.

By the definition of Y all elements of Y are limits of sequences of translates of $d = d_1$, that is, there are translations τ_1, τ_2, \dots such that $x = \lim_{i \rightarrow \infty} \tau_i(d)$, and translations $\sigma_1, \sigma_2, \dots$ such that $y = \lim_{i \rightarrow \infty} \sigma_i(d)$. Apply the translations τ_1, τ_2, \dots on configurations d_1, \dots, d_n , and take jointly converging subsequences: by compactness there are $k_1 < k_2 < \dots$ such that

$$e_i = \lim_{j \rightarrow \infty} \tau_{k_j}(d_i)$$

exists for all $i \in \{1, \dots, n\}$. Here, clearly, $e_1 = x$.

Let us prove that e_1, \dots, e_n and y are $n + 1$ configurations that (i) have the same product with ϕ , and (ii) are pairwise distinct. This contradicts the choice of n as the maximum number of such configurations, and thus completes the proof.

(i) First, $\phi x = \phi y$: Because $x|_H = y|_H$ we have $\phi x|_{H-\mathbf{t}} = \phi y|_{H-\mathbf{t}}$ for some $\mathbf{t} \in \mathbb{Z}^2$. Consider $c' = \tau^{\mathbf{t}}(\phi x - \phi y)$, so that $c'|_H = 0$. As $\phi_2 \cdots \phi_m$ annihilates ϕx and ϕy , it also annihilates c' . An application of Proposition 2.3.5 on configuration c' in place of c shows that $\overline{\mathcal{O}(c')}$ is deterministic in direction $-\mathbf{u}$. (Note that $-\mathbf{u}$ is not perpendicular to \mathbf{v}_j for any $j \neq 1$, because \mathbf{v}_1 and \mathbf{v}_j are not parallel and $-\mathbf{u}$ is perpendicular to \mathbf{v}_1 .) Due to the determinism, $c'|_H = 0$ implies that $c' = 0$, that is, $\phi x = \phi y$.

Second, $\phi e_{i_1} = \phi e_{i_2}$ for all $i_1, i_2 \in \{1, \dots, n\}$: By Lemma 2.3.8 we know that $\phi d_{i_1} = \phi d_{i_2}$. By continuity of the function $c \mapsto \phi c$ we then have

$$\begin{aligned} \phi e_{i_1} &= \phi \lim_{j \rightarrow \infty} \tau_{k_j}(d_{i_1}) = \lim_{j \rightarrow \infty} \phi \tau_{k_j}(d_{i_1}) = \lim_{j \rightarrow \infty} \tau_{k_j}(\phi d_{i_1}) \\ \phi e_{i_2} &= \phi \lim_{j \rightarrow \infty} \tau_{k_j}(d_{i_2}) = \lim_{j \rightarrow \infty} \phi \tau_{k_j}(d_{i_2}) = \lim_{j \rightarrow \infty} \tau_{k_j}(\phi d_{i_2}) \end{aligned}$$

Because $e_1 = x$, we have shown that e_1, \dots, e_n and y all have the same product with ϕ .

- (ii) Pairwise distinctness: First, y and $e_1 = x$ are distinct by the initial choice of x and y . Next, let $i_1, i_2 \in \{1, \dots, n\}$ be such that $i_1 \neq i_2$. Let $\mathbf{t} \in \mathbb{Z}^2$ be arbitrary and consider the translated discrete box $B' = B - \mathbf{t}$. By Lemma 2.3.8(b) we have $\tau_{k_j}(d_{i_1})|_{B'} \neq \tau_{k_j}(d_{i_2})|_{B'}$ for all $j \in \mathbb{N}$, so taking the limit as $j \rightarrow \infty$ gives $e_{i_1}|_{B'} \neq e_{i_2}|_{B'}$. This proves that $e_{i_1} \neq e_{i_2}$. Moreover, by taking \mathbf{t} such that $B' \subseteq H$ we see that $y|_{B'} = x|_{B'} = e_1|_{B'} \neq e_i|_{B'}$ for $i \geq 2$, so that y is also distinct from all e_i with $i \geq 2$. □

The following proposition captures the result established above.

Proposition 2.3.10. *Let c be a configuration with a non-trivial annihilator. If \mathbf{u} is a one-sided direction of determinism in $\overline{\mathcal{O}(c)}$ then there is a configuration $d \in \overline{\mathcal{O}(c)}$ such that \mathbf{u} is a two-sided direction of determinism in $\overline{\mathcal{O}(d)}$.* □

Now we are ready to prove Theorem 2.3.3.

Proof of Theorem 2.3.3. Let c be a two-dimensional configuration that has a non-trivial annihilator. Every non-empty subshift contains a minimal subshift [Bir12], and hence there is a uniformly recurrent configuration $c' \in \overline{\mathcal{O}(c)}$. If $\overline{\mathcal{O}(c')}$ has a one-sided direction of determinism \mathbf{u} , we can apply Proposition 2.3.10 on c' and find $d \in \overline{\mathcal{O}(c')}$ such that \mathbf{u} is a two-sided direction of determinism in $\overline{\mathcal{O}(d)}$. But because c' is uniformly recurrent, $\overline{\mathcal{O}(d)} = \overline{\mathcal{O}(c')}$, a contradiction. □

Periodicity in Low Complexity Subshifts (Theorem 2.3.4)

In this section we prove Theorem 2.3.4. Since every non-empty subshift contains a uniformly recurrent configuration, we assume in this subsection that c is uniformly recurrent.

Our proof of Theorem 2.3.4 splits in two cases based on Theorem 2.3.3: either $\overline{\mathcal{O}(c)}$ is deterministic in all directions or for some \mathbf{u} it is non-deterministic in both directions \mathbf{u} and $-\mathbf{u}$. The first case is handled by the following well-known corollary from a theorem of Boyle and Lind [BL97]:

Proposition 2.3.11. *A configuration c is two-periodic if and only if $\overline{\mathcal{O}(c)}$ is deterministic in all directions.* □

For the second case we apply the technique by Cyr and Kra [CK15]. This technique was also used in [Sza18b] to address Nivat's conjecture. The result that we read from [CK15; Sza18b], although not explicitly stated in this form, is the following:

Proposition 2.3.12. *Let c be a two-dimensional uniformly recurrent configuration that has low complexity with respect to a convex shape. If for some \mathbf{u} both \mathbf{u} and $-\mathbf{u}$ are directions of non-determinism in $\overline{\mathcal{O}(c)}$ then c is periodic in a direction perpendicular to \mathbf{u} .*

Let us prove this proposition using lemmas from [Sza18b]. A central concept from [CK15; Sza18b] is the following. Let c be a configuration and let $\mathbf{u} \in \mathbb{Z}^2 \setminus \{\mathbf{0}\}$ be a direction. In analogy with subshifts, we call $L_D(c)$ the set of D -patterns that c contains. A finite discrete convex set $D \subseteq \mathbb{Z}^2$ is called \mathbf{u} -balanced in c if the following three conditions are satisfied, where $E = E_{\mathbf{u}}(D)$ denotes the edge of D in direction \mathbf{u} :

- (i) $|L_D(c)| \leq |D|$,
- (ii) $|L_D(c)| < |L_{D \setminus E}(c)| + |E|$, and
- (iii) $|D \cap L| \geq |E| - 1$ for every line L perpendicular to \mathbf{u} such that $D \cap L \neq \emptyset$.

The first condition states that c has low complexity with respect to shape D . The second one implies that there are fewer than $|E|$ different $(D \setminus E)$ -patterns in c that can be extended in more than one way into a D -pattern of c . The last one states that the edge E is nearly the shortest among the parallel cuts across D .

Lemma 2.3.13 (Lemma 2 of [Sza18b]). *Let c be a two-dimensional configuration that has low complexity with respect to a rectangle, and let $\mathbf{u} \in \mathbb{Z}^2 \setminus \{\mathbf{0}\}$. Then c has a \mathbf{u} -balanced or a $(-\mathbf{u})$ -balanced set $D \subseteq \mathbb{Z}^2$.*

It turns out that this lemma relies only on the convexity of the rectangle, and it is therefore also true for a configuration with low complexity with respect to any other convex shape.

Lemma 2.3.14. *Let c be a two-dimensional configuration that has low complexity with respect to a convex shape, and let $\mathbf{u} \in \mathbb{Z}^2 \setminus \{\mathbf{0}\}$. Then c has a \mathbf{u} -balanced or a $(-\mathbf{u})$ -balanced set $D \subseteq \mathbb{Z}^2$.*

A crucial observation in [CK15] connects balanced sets and non-determinism to periodicity. This leads to the following statement.

Lemma 2.3.15 (Lemma 4 of [Sza18b]). *Let d be a two-dimensional configuration and let $\mathbf{u} \in \mathbb{Z}^2 \setminus \{\mathbf{0}\}$ be such that d admits a \mathbf{u} -balanced set $D \subseteq \mathbb{Z}^2$. Assume there is a configuration $e \in \overline{\mathcal{O}(d)}$ and a stripe $S = S_{\mathbf{u}}^k$ perpendicular to \mathbf{u} such that D fits in S and $d|_{S^\circ} = e|_{S^\circ}$ but $d|_S \neq e|_S$. Then d is periodic in direction perpendicular to \mathbf{u} .*

With these we can prove Proposition 2.3.12.

Proof of Proposition 2.3.12. Let c be a two-dimensional uniformly recurrent configuration that has low complexity with respect to a convex shape. Let \mathbf{u} be such that both \mathbf{u} and $-\mathbf{u}$ are directions of non-determinism in $\overline{\mathcal{O}(c)}$. By Lemma 2.3.14 configuration c admits a \mathbf{u} -balanced or a $(-\mathbf{u})$ -balanced set $D \subseteq \mathbb{Z}^2$. Without loss of generality, assume that D is \mathbf{u} -balanced in c . As $\overline{\mathcal{O}(c)}$ is non-deterministic in direction \mathbf{u} , there are configurations $d, e \in \overline{\mathcal{O}(c)}$ such that $d|_{H_{\mathbf{u}}} = e|_{H_{\mathbf{u}}}$ but $d|_{(0,0)} \neq e|_{(0,0)}$. Because c is uniformly recurrent, exactly the same finite patterns appear in d as in c . This means that D is \mathbf{u} -balanced also in d . From the uniform recurrence of c we also get that $e \in \overline{\mathcal{O}(d)}$. Pick any k large enough so that D fits in the stripe $S = S_{\mathbf{u}}^k$. Because $\mathbf{0} \in S$ and $S^\circ \subseteq H_{\mathbf{u}}$, the conditions in Lemma 2.3.15 are met. By the lemma, configuration d is \mathbf{p} -periodic for some \mathbf{p} that is perpendicular to \mathbf{u} . Because d has the same finite patterns as c , it follows that c cannot contain a pattern that breaks period \mathbf{p} . So c is also \mathbf{p} -periodic. \square

Now Theorem 2.3.4 follows from Propositions 2.3.11 and 2.3.12, using Theorem 2.3.3 and the fact that every subshift contains a uniformly recurrent configuration.

Proof of Theorem 2.3.4. Let c be a two-dimensional configuration that has low complexity with respect to a convex shape. Replacing c by a uniformly recurrent element of $\overline{\mathcal{O}(c)}$, we may assume that c is uniformly recurrent. Since c is a low complexity configuration,

by Proposition 2.1.3 it has a non-trivial annihilator. By Theorem 2.3.3 there exists $c' \in \overline{\mathcal{O}(c)}$ such that $\overline{\mathcal{O}(c')}$ has no direction of one-sided determinism. If all directions are deterministic in $\overline{\mathcal{O}(c')}$, it follows from Proposition 2.3.11 that c' is two-periodic. Otherwise there is a direction \mathbf{u} such that both \mathbf{u} and $-\mathbf{u}$ are directions of non-determinism in $\overline{\mathcal{O}(c')}$. Now it follows from Proposition 2.3.12 that c' is periodic. \square

2.3.3 Deciding the Domino Problem

Theorem 2.3.4 first application comes when looking at what we call *low complexity subshifts*.

Definition 2.3.3 (Low complexity subshift). Let $D = \{1, \dots, n\} \times \{1, \dots, m\}$ for some $m, n \in \mathbb{N}$. The subshift X is said to have *low complexity* (with respect to a rectangle) if all $c \in X$ have low complexity with respect to D .

Note that this definition of low complexity subshift is different of the one define by Donoso, Durand, Maass and Petite in [Don+16], where they only ask for a polynomial pattern complexity.

One motivation to introduce those subshifts is that they capture the computability aspects of Nivat's conjecture: if Nivat's conjecture holds, their domino problem is decidable. It turns out that we do not need the full Nivat's conjecture to hold, since Theorem 2.3.4 is enough to prove that their domino problem is decidable: indeed, Theorem 2.3.4 provides a periodic configuration in the subshift.

Corollary 2.3.16. *Let $X \neq \emptyset$ be a low-complexity subshift with respect to a rectangle. Then X contains a periodic configuration.*

Proof. Let $c \in X$ be arbitrary. By Theorem 2.3.4 $\overline{\mathcal{O}(c)} \subseteq X$ contains a periodic configuration. \square

Corollary 2.3.17. *Let $X \neq \emptyset$ be a low-complexity subshift with respect to a rectangle. Then there is an algorithm to determine whether $X \neq \emptyset$.*

Proof. By Corollary 2.3.16, if $X \neq \emptyset$ then X contains a periodic configuration. Hence, by Corollary 1.1.9, DP is decidable. \square

In particular, let X be an SFT defined by a set of pattern $P \subset \mathcal{A}^D$ with D some rectangle of size $m \times n$. If $|P| \leq mn$, then X is a low complexity subshift, and so there is an algorithm to decide whether it is empty or not.

It would be interesting to study similar statements for the bound $|P| \leq mn + 1$. Obviously Nivat's conjecture does not hold for such bound, but we conjecture there is no aperiodic SFT with rectangular complexity $mn + 1$, so Corollary 2.3.16 and Corollary 2.3.17 would still hold. Unfortunately most of the tools we have are designed to study the low complexity case, so the precise complexity gap between the periodicity promised by Nivat's conjecture on one side and aperiodic SFTs on the other side seems hard to grasp for now.

2.3.4 The Uniformly Recurrent Case

The most interesting, yet most direct consequence of Theorem 2.3.4 is that it solves Nivat’s conjecture for uniformly recurrent configurations.

Corollary 2.3.18 (Nivat’s conjecture, uniformly recurrent case). *A uniformly recurrent configuration c that has low complexity with respect to a convex shape is periodic.*

Proof. Because c has low complexity with respect to a convex shape then by Theorem 2.3.4 there is a periodic configuration $c' \in \overline{\mathcal{O}(c)}$. Because $\overline{\mathcal{O}(c')}$ contains only translates and limits of translates of c' , all configurations in $\overline{\mathcal{O}(c')}$ are periodic. Finally, because c is uniformly recurrent we have $\overline{\mathcal{O}(c)} = \overline{\mathcal{O}(c')}$, which implies that all elements of $\overline{\mathcal{O}(c)}$, including c itself, are periodic. \square

Solving this case is interesting because, intuitively, non uniformly recurrent configurations seem easier to handle. A configuration is not uniformly recurrent if some of its regions can disappear in a limit of translations, i.e. they cannot be found everywhere. These regions might provide artefacts allowing the configuration to have high complexity. The example of Fig. 1.2 on page 12 illustrates this in the easiest case: when the region is a single cell. In the general case however the geometry of the artefact might be much more complicated, and we believe that solving the non uniformly recurrent case might require clever case disjunction based on the discrete geometry of these regions.

2.3.5 Non-rectangular Shape

Nivat’s conjecture is usually stated for a low complexity configurations with respect to a rectangle (see page 18). We saw that our results extend quite easily to convex shapes, and it is widely believed that Nivat’s conjecture still holds for any convex shape.

In Section 2.2 our results only relied on the existence of an annihilator, thus allowing results holding for configurations of low complexity with relation to any shape. For this section however, our result needs a convex shape. Moreover, there is no hope to prove Nivat’s conjecture for arbitrary shapes, since some configurations are known to have low complexity with respect to some shape (even connected ones) but not periodic [Cas00]. For non-convex shapes Theorem 2.3.4 is not true, but all counter-examples we are aware of are based on periodic sublattices, for example the one presented in Section 2.2.3. It would be a very interesting to find counter-examples that are not based on this idea of sublattices. We conjecture that for an SFT defined using at most $|D|$ allowed patterns of support D , Corollary 2.3.16 and Corollary 2.3.17 still holds for arbitrary shapes. In other words, we conjecture that there does not exist a two-dimensional low complexity aperiodic SFT defined by at most $|D|$ patterns of arbitrary support D . A special case of this is the recently solved periodic cluster tiling problem [Sze98; Bha20].

As shown by Proposition 1.2.2, Nivat’s conjecture fails for higher dimensions. However, we believe that Corollary 2.3.16 and Corollary 2.3.17 might still hold in any dimension for SFTs defined by at most $|D|$ patterns of arbitrary support D .

Substitutions and Groups

In this chapter, we will study a generalization of the subshifts previously defined: instead of a grid we build SFT over Cayley graphs of finitely generated groups. We will focus on particular examples of groups, all sharing similar properties relating their Cayley graph with substitutions on words. We begin by defining the useful notions about subshifts on groups in Section 3.1 and substitutions in Section 3.2. Then in Section 3.3 we study periodicity problems over Baumslag-Solitar groups and the domino problem of the surface groups in Section 3.4

3.1 Subshifts on Groups and Graphs

In the previous chapter, we defined subshifts over a d -dimensional grid. We extend all the usual definitions to subshifts over finitely generated groups in Section 3.1.1 and Section 3.1.2. Then, we extend some of them to the even more general case of infinite graphs in Section 3.1.3.

3.1.1 Group Presentation and Cayley Graphs

A Grain of Group Theory

A group G can be defined combinatorially by its *presentation* $\langle S \mid R \rangle$ with S a generating set and $R \subseteq (S \cup S^{-1})^*$ a set of relators, i.e. a set of words on $S \cup S^{-1}$ that identify to the identity of G . The group $\langle S \rangle$ is the free group with generating set S . Then, every relator in R identifies a words to 1_G . Some example of classical groups defined by their presentation are:

$$\mathbb{Z} = \langle a \rangle$$

$$\mathbb{F}_2 = \langle a, b \rangle$$

$$\mathbb{Z}^2 = \langle a, b \mid aba^{-1}b^{-1} \rangle$$

Formally, $G = F_S/C$ with F_S the free group over S and C the conjugate closure of R in F_S . Obviously, different presentations can define the same group up to isomorphism. A group is *virtually free* if it has a subgroup of finite index that is free.

The *Cayley graph* Γ of a group $G = \langle S \mid R \rangle$ is a labeled graph with set of vertices elements of G . Then, the edge (g, h) is in E_Γ with label $l \in S \cup S^{-1}$ if and only if $gl = h$. Note that the Cayley graph depends on the presentation of the group and not the group itself, so one group have many different Cayley graphs.

A natural decision problem for groups is the *word problem*: "given a word w on $S \cup S^{-1}$, does w represent the identity in G ($w = 1_G$)?" There are recursively presented groups for which this problem is undecidable [Nov55; Boo58], and in this case it becomes impossible to algorithmically draw the Cayley graph. To avoid this problem, we will only consider groups with decidable word problem in this thesis.

Subshifts over Groups

A *configuration* x over $G = \langle S \mid R \rangle$ is a coloring of its Cayley graph by a finite alphabet \mathcal{A} , that we denote $x \in \mathcal{A}^G$. Let $S \subset G$ be a finite set, a *pattern* p with support S is a coloring of S : $p \in \mathcal{A}^S$. Such a pattern *appears* in a configuration x (resp. another pattern p' of support S') if there exists $g \in G$, such that for all $h \in S$, $x_{gh} = p_h$ (resp. if there exists $g \in S'$, such that for all $h \in S$, $p_{gh} = p_h$). In this case, we denote $p \sqsubset x$ (resp. $p \sqsubset p'$).

\mathcal{A}^G is called the *full-shift* over G , and $X \subseteq \mathcal{A}^G$ is called a *subshift* if there exists a set F such that X is the set of all configurations that do not contain any patterns from F . In this case we write:

$$X = X_F = \{x \in \mathcal{A}^G \mid \forall p \sqsubset x, p \notin F\}.$$

Note that there can be several set of forbidden patterns defining the same subshift. If there exists a finite F such that $X = X_F$, X is called a *subshift of finite type* (SFT for short). Like in the case of grids, SFTs can be defined using a finite set of allowed patterns instead of forbidden ones.

The left shift action on \mathcal{A}^G is defined by

$$T : \begin{cases} G \times \mathcal{A}^G & \rightarrow \mathcal{A}^G \\ (g, x) & \mapsto T^g(x) \end{cases},$$

where $\forall h \in G, T^g(x)_h = x_{g^{-1}h}$.

\mathcal{A}^G is a metric space equipped with the distance:

$$d(x, y) = 2^{-\inf\{|g| \mid g \in G, x_g \neq y_g\}}.$$

Like for subshifts over grids, subshifts over groups can be defined equivalently as the subsets of \mathcal{A}^G that are closed and shift-invariant.

Again, like in the d -dimensional case, every SFT over a group can be seen as a set of valid tilings by a set Wang tiles and vice-versa. In order to keep this introduction short we do not define Wang tile for arbitrary groups nor we prove the equivalence. We will define them more precisely in the particular case of Baumslag-Solitar groups in Section 3.3.

The Domino Problem of Groups

Definition 3.1.1 (Domino problem of a group). The domino problem of a fixed group $G = \langle S \mid R \rangle$ is the following question: "Given an SFT X_F by its alphabet \mathcal{A} and set of forbidden patterns F , is $X_F \neq \emptyset$?"

We denote $\text{DP}(G)$ the domino problem of the group G .

Interestingly, even if a Cayley graph of a group depends on the choice of generators, the decidability of the domino problem does not [ABJ18]. Hence we can talk of the domino problem of a group, without specifying a choice of generators. We introduce briefly the known results about it in this section, a more in-depth review of the topic can be found in [ABJ18].

For now, the decidability of the domino problem is known only for a few examples of groups. We know it is undecidable for:

- groups with undecidable word problem [ABJ18],
- Baumslag-Solitar groups [AK13],
- non-virtually \mathbb{Z} polycyclic groups [Jea15b],
- groups of the form $G_1 \times G_2$ with G_1 and G_2 two infinite groups [Jea15c].

And it is known to be decidable only for virtually free groups [MS85; KL05] In fact, it is even conjectured that they are the only groups with decidable domino problem.

Conjecture 1. *A group has decidable domino problem if and only if it is virtually free.*

A possible origin for this conjecture is Halins grid theorem (see [Die04] for a recent proof): every graph with a thick end has a grid as minor. Cayley graphs of non-virtually free groups having a thick end [Woe89], they have a grid as minor by Halins grid theorem. Since most proofs of undecidability for the domino problem of a group relies on finding a grid (\mathbb{Z}^2) in its Cayley graph, it seem reasonable to conjecture that all non-virtually free groups have undecidable domino problem. The obstacle to transform this intuition into a proof is that finding the subgrid as minor is not enough, in order to do a reduction from the domino problem of \mathbb{Z}^2 one must find this subgrid using local rules of an SFT. Not only known proofs of Halins grid theorem do not provide such a local way of finding a grid, they are not constructive. Thus, a general proof of this conjecture still seems out of reach.

Apart from the tilings perspective, there is also motivation from logics to study this conjecture. The domino problem can be expressed in monadic second order (MSO) logic. It turns out that MSO logic on a graph is undecidable on Cayley graphs of non-virtually free groups (MSO logic is undecidable on non-context-free groups [KL05], and a non-virtually free group is always non-context-free [MS85]). Proven true, Conjecture 1 would show that the domino problem fragment is "big" in the MSO logic.

3.1.2 Periodicity, Aperiodicity

The *orbit* of x is defined to be $\mathcal{O}_G(x) = \{T^g(x) \mid g \in G\}$, and its *stabilizer* is $\text{Stab}_g(x) = \{g \in G \mid T^g(x) = x\}$. There are two definitions of periodicity for $x \in \mathcal{A}^G$:

- x is *weakly periodic* if $\text{Stab}_G(x) \neq \{1_G\}$,
- x is *strongly periodic* if $\mathcal{O}_G(x)$ is finite.

On an infinite line ($G = \mathbb{Z}$) these two definitions are the same, because there can be only one direction of periodicity (see Section 1.1.3). For other finitely presented groups the picture looks like higher dimensional grids, weak periodicity corresponding to one-periodicity and strong periodicity to full periodicity. These notions of periodicity extend to subshifts, for which we can define aperiodicity in the two following ways:

- a subshift is *weakly aperiodic* if it is non-empty and contains no strongly periodic configuration,
- a subshift is *strongly aperiodic* if it is non-empty and contains no weakly periodic configuration.

Since we are mostly interested in the aperiodicity of subshifts, we will restrict ourself to talk about periodicity of configurations and aperiodicity of subshifts in order to not mix these terms. Thanks to Proposition 1.1.5, these two definitions coincide for \mathbb{Z} and \mathbb{Z}^2 , but again, for more general groups they might be different.

Except that strong aperiodicity implies weak aperiodicity, the link between the two notions is not really known. They seem linked to the decidability of the domino problem, since most of the proofs of undecidability make use of a strong or weak aperiodic SFT. Currently, all groups we know to have both weak and strong aperiodic SFTs have undecidable domino problem (for example \mathbb{Z}^d with $d \geq 2$), and we do not know any groups without strong aperiodic SFTs that have decidable domino problem. If the word problem is undecidable, then the domino problem is also undecidable [ABJ18]. Piantadosi also proved that virtually free groups \mathbb{F}_n for $n \geq 2$ had a weakly aperiodic SFT but no strongly aperiodic SFT [Pia08]. Not directly linked to the domino problem, Jeandel still proved that the existence of a strongly aperiodic SFT implied that the word problem of a group is decidable [Jea15a]. Cohen proved that groups with two ends or more do not have strongly aperiodic subshifts, and conjectured that the other way was also true [Coh17]. It is conjectured that some groups have undecidable domino problem and no strong aperiodic SFT – for example the lamplighter group, but we still have no proven examples of this. Table 3.1 summarizes the links known between periodicity and the decidability of the domino problem.

	(must have one end) [Coh17]	(Conjecture: two ends and more ?) [Coh17]	
Aperiocity	\exists Strongly aperiodic SFT \exists Weakly aperiodic SFT	\nexists Strongly aperiodic SFT \exists Weakly aperiodic SFT	\nexists Strongly aperiodic SFT \nexists Weakly aperiodic SFT
DP Decidable DP Decidable WP	?	Virtually free groups [Pia08]	Virtually \mathbb{Z} groups
Undecidable DP Decidable WP	(virtually) $\mathbb{Z}^d, d \geq 2$ \mathbb{H}^2 [Goo05] $BS(n, n)$ [EM20] $\mathbb{Z}^2 \rtimes H$ [BS19] $G_1 \times G_2 \times G_3$ [Bar19]	?	?
Undecidable DP Undecidable WP	[Jea15a]	?	?

Table 3.1 – Summary of known results linking periodicity and decidability of the domino problem (DP) and word problem (WP) for infinite groups. Thanks to Julien Esnay for his version of this table.

3.1.3 Subshifts over Graphs

The combinatorial definition of subshifts can be extended to more general graphs than Cayley graphs. We consider bounded degree countably infinite graphs with labeled edges. In this context, a *graph* Γ is defined to be a triple $(V_\Gamma, E_\Gamma, L_\Gamma)$ with V_Γ a countable (usually infinite) set of vertices, $E_\Gamma \subseteq V_\Gamma^2$ a set of edges such that for every $v \in V_\Gamma$ its degree $d(v) = |\{u \in V_\Gamma \mid (u, v) \in E_\Gamma \text{ or } (v, u) \in E_\Gamma\}|$ is bounded by a constant independent of v . $L_\Gamma : E_\Gamma \rightarrow L$ is a labeling function assigning to every edge a label from a finite set L . Let $S, T \subset V_\Gamma$. A mapping $\phi : S \rightarrow T$ is a *label preserving graph isomorphism* if it is a bijection and

- for all $u, v \in S$, $(u, v) \in E_\Gamma$ if and only if $(\phi(u), \phi(v)) \in E_\Gamma$;
- for all $u, v \in S$, $L_\Gamma((u, v)) = L_\Gamma((\phi(u), \phi(v)))$.

Let us fix a graph Γ and \mathcal{A} be a finite alphabet. A *configuration* over Γ is a function $x \in \mathcal{A}^\Gamma$. If $S \subset V_\Gamma$ is finite and connected, a *pattern* (with support S) is a function $p : S \rightarrow \mathcal{A}$. Such a pattern *appears in a configuration* x (resp. in a pattern $p' : T \rightarrow \mathcal{A}$) if there exists a finite set of vertices $T \subset V_\Gamma$ (resp. $T \subset S'$) and a label preserving graph isomorphism $\phi : S \rightarrow T$ such that $p_u = x_{\phi(u)}$ (resp. $p_u = p'_{\phi(u)}$) for every $u \in S$. In this case, we denote $p \sqsubset x$ (resp. $p \sqsubset p'$).

Like for groups, \mathcal{A}^Γ is called the *full shift* and a set $X_F \subseteq \mathcal{A}^\Gamma$ is called a *subshift* if there exists a set F such that X_F is the set of all configurations that do not contain any patterns from F . If there exists such a F which is finite, X_F is an SFT. X_F is a *nearest neighbor subshift* if all patterns of F have as support two vertices connected by an edge.

Definition 3.1.2 (Domino problem of a graph). The domino problem of a fixed graph Γ is the following question: "Given an SFT X_F on Γ by its alphabet \mathcal{A} and set of forbidden patterns F , is $X_F \neq \emptyset$?"

We denote $\text{DP}(\Gamma)$ the domino problem of the graph Γ .

3.2 Substitutions

The main results from this chapter come from the similarity of the Cayley graph of some groups with the graph of specific substitutions. In this section we introduce the needed material about substitutions, orbit graphs and their tilings.

3.2.1 Definition and Properties

Deterministic Substitutions

Let \mathcal{A} be a finite alphabet. In this section, $\mathcal{A}^\omega = \mathcal{A}^{\mathbb{N}}$ is the set of right-infinite words (with index starting at 0) and ${}^\omega\mathcal{A} = \mathcal{A}^{-\mathbb{N} \setminus \{0\}}$ the set of left-infinite words (with index starting at -1).

A (*deterministic*) *substitution* (also known as morphism) is a map $\sigma : \mathcal{A} \rightarrow \mathcal{A}^*$. It can naturally be extended to \mathcal{A}^* , \mathcal{A}^ω and ${}^\omega\mathcal{A}$ by applying it to every letter of a (possibly infinite) word and concatenating the resulting words. There are several ways of extending it to $\mathcal{A}^{\mathbb{Z}}$, we chose the formalism of *pointed bi-infinite words*. In this formalism, a biinfinite word $w \in \mathcal{A}^{\mathbb{Z}}$ is seen as two infinite words separated by a fixed point: $w \in {}^\omega\mathcal{A} \cdot \mathcal{A}^\omega$.

Applying a substitution σ to a (pointed) biinfinte word $w = u \cdot v$ is defined to be $\sigma(u \cdot v) = \sigma(u) \cdot \sigma(v)$ (see Fig. 3.1).

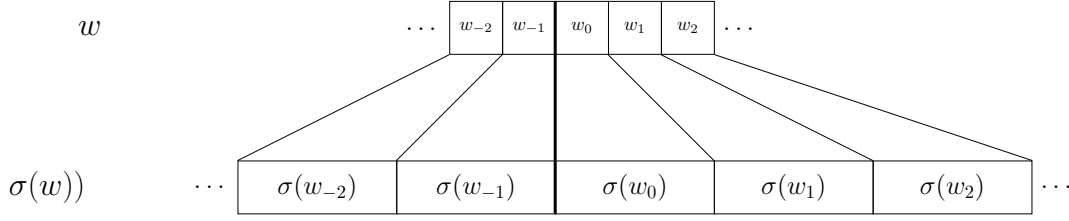

Figure 3.1 – Application of a substitution σ to a biinfinte word w .

A letter is *mortal* for σ if there exists k such that $\sigma^k(a) = \varepsilon$ and the set of mortal letters of σ is denoted by M_σ . The *mortality exponent* t of σ is the smallest integer $t \geq 0$ such that $\sigma^t(a) = \varepsilon$ for all $a \in M_\sigma$. For a letter $a \in \mathcal{A}$ such that $\sigma(a) = xaw$ with $w \in \mathcal{A}^*$ and $x \in M_\sigma^*$, we define the *positive infinite iteration* of σ on a :

$$\overrightarrow{\sigma}^\omega(a) = \sigma^{t-1}(x) \cdots \sigma(x) x a w \sigma(w) \sigma^2(w) \cdots \in \mathcal{A}^\omega.$$

Similarly, if $\sigma(a) = wax$ with $w \in \mathcal{A}^*$ and $x \in M_\sigma^*$ we define the *negative infinite iteration* of σ on a :

$$\overleftarrow{\omega}\sigma(a) = \cdots \sigma^2(w) \sigma(w) w a x \sigma(x) \cdots \sigma^{t-1}(x) \in {}^\omega\mathcal{A}.$$

Then, we define the set

$$A_\sigma = \{a \in \mathcal{A} \mid \exists x, y \in \mathcal{A}^*, \sigma(a) = xay \text{ and } xy \in M_\sigma^*\}$$

and

$$F_\sigma = \{\sigma^t(a) \mid a \in A_\sigma \text{ and } t \text{ is the mortality exponent of } \sigma\}.$$

Using these notation, we can characterize de biinfinte fixpoints of a substitution σ :

Theorem 3.2.1 (Proposition 4 of [SW99]). *Let w be a biinfinte pointed word. The equation $\sigma(w) = w$ has a solution if and only if $w = x \cdot y$ with $y \in \mathcal{A}^\omega$, $x \in {}^\omega\mathcal{A}$ such that either*

- $y \in F_\sigma^\omega$, or
- $y \in F_\sigma^* \overrightarrow{\sigma}^\omega(a)$ for some $a \in \mathcal{A}$ and there exists $u \in M_\sigma^*$ and $v \notin M_\sigma^*$ such that $\sigma(a) = uav$.

And either

- $x \in {}^\omega F_\sigma$, or
- $x \in \overleftarrow{\omega}\sigma(a) F_\sigma^*$ for some $a \in \mathcal{A}$ and there exists $u \notin M_\sigma^*$ and $v \in M_\sigma^*$ such that $\sigma(a) = uav$.

If the substitution σ has no mortal letters ($M_\sigma = \emptyset$), the definitions above becomes:

$$\overrightarrow{\sigma}^\omega(a) = a w \sigma(w) \sigma^2(w) \cdots \in \mathcal{A}^\omega,$$

$$\overleftarrow{\omega}\sigma(a) = \cdots \sigma^2(w) \sigma(w) w a \in {}^\omega\mathcal{A}.$$

And the sets A_σ and F_σ becomes empty, which also simplifies Theorem 3.2.1:

Corollary 3.2.2. *Let w be a biinfinite pointed word and σ a substitution with no mortal letters. The equation $\sigma(w) = w$ has a solution if and only if $w = x \cdot y$ with $y \in \mathcal{A}^\omega$, $x \in {}^\omega\mathcal{A}$ such that*

- $x = \overrightarrow{\sigma}(a)$ for some $a \in \mathcal{A}$ and there exists $w \in \mathcal{A}^*$ such that $\sigma(a) = aw$, and
- $y = \overleftarrow{\sigma}(a')$ for some $a' \in \mathcal{A}$ and there exists $w \in \mathcal{A}^*$ such that $\sigma(a') = wa'$.

Substitution systems

A *parent function* $P: \mathbb{Z} \rightarrow \mathbb{Z}$ is an onto and non-decreasing function. In particular, such a function P satisfies that for every $i \in \mathbb{Z}$, $P(i+1) - P(i) \in \{0, 1\}$. Let $u = (u_i)_{i \in \mathbb{Z}} \in (\mathbb{N} \setminus \{0\})^{\mathbb{Z}}$ be a biinfinite sequence of positive integers. The *accumulation function* of u is the function $\Delta: \mathbb{Z} \rightarrow \mathbb{Z}$ given by

$$\Delta(i) = \begin{cases} \sum_{k=0}^{i-1} u_k & \text{if } i \geq 1 \\ 0 & \text{if } i = 0 \\ -\sum_{k=i}^{-1} u_k & \text{if } i \leq -1 \end{cases}.$$

Note that the family of discrete intervals $(I_k)_{k \in \mathbb{Z}}$ where $I_k = [\Delta(k); \Delta(k+1) - 1]$ forms a partition of \mathbb{Z} . If P is a parent function, and if we define the sequence u by $u_i = |P^{-1}(i)|$ for every $i \in \mathbb{Z}$, then we get that $P(j) = i$ for every $j \in [\Delta(i); \Delta(i+1) - 1]$, where Δ is the accumulation function of u .

A *non-deterministic substitution* is a couple (\mathcal{A}, R) where \mathcal{A} is a finite alphabet and $R \subset \mathcal{A} \times \mathcal{A}^*$ is a finite set called the *relation*, whose elements are called *production rules*. We say that an infinite word $\omega \in \mathcal{A}^{\mathbb{Z}}$ *produces* the word $\omega' \in \mathcal{A}^{\mathbb{Z}}$ with respect to the parent function P if for every $i \in \mathbb{Z}$, one has $(\omega_i, \omega'_{[\Delta(i); \Delta(i+1)-1]}) \in R$, where $\omega'_{[\Delta(i); \Delta(i+1)-1]}$ is the finite subword of ω' that appears on indices $\{j \in \mathbb{Z} \mid P(j) = i\}$. In this case we shall extend the above notation and write $(\omega, \omega') \in R$. An *orbit* of a non-deterministic substitution (\mathcal{A}, R) is a set $\{(\omega^i, P_i)\}_{i \in \mathbb{Z}} \in (\mathcal{A}^{\mathbb{Z}} \times \mathbb{Z}^{\mathbb{Z}})^{\mathbb{Z}}$ such that for every $i \in \mathbb{Z}$, P_i is a parent function, and the word ω^i produces the word ω^{i+1} with respect to P_i . Note that the previous deterministic substitutions can be seen as non-deterministic substitutions with $|R| = 1$ and impose to the parent function $P(0) = 0$.

A non-deterministic substitution (\mathcal{A}, R) *has an expanding eigenvalue* if there exist $\lambda > 1$ and $v: \mathcal{A} \rightarrow \mathbb{R}^+ \setminus \{0\}$ such that for every $(a, w) \in R$,

$$\lambda \cdot v(a) = \sum_{i=1}^{|w|} v(w_i).$$

3.2.2 Orbit Graphs and Tilings

Let (\mathcal{A}, R) be a non-deterministic substitution and denote $M = \max_{(a,w) \in R} |w|$. Let $\Omega = \{(\omega^i, P_i)\}_{i \in \mathbb{Z}}$ of (\mathcal{A}, R) be an orbit of (\mathcal{A}, R) , with P_i parent functions (onto and non-decreasing) and $(\omega^i)_{i \in \mathbb{Z}}$ a sequence of biinfinite words such that for all $i \in \mathbb{Z}$ ω^i produces ω^{i+1} with respect to P_i . The *orbit graph* associated with the orbit Ω is the graph Γ_Ω with set of vertices \mathbb{Z}^2 , edges E_Ω given by

- for every $i, j \in \mathbb{Z}$, $((i, j), (i, j+1)) \in E_\Omega$,

- for every $i \in \mathbb{Z}$ and every $k \in [\Delta_{i+1}(j); \Delta_{i+1}(j+1) - 1]$,
 $((i, j), (i+1, k)) \in E_\Omega$,

and labeling function $L_\Omega: E_\Omega \rightarrow \{\mathbf{next}\} \cup [0; M-1]$ given by

- for every $i, j \in \mathbb{Z}$, $L_\Omega(((i, j), (i, j+1))) = \mathbf{next}$;
- for every $i \in \mathbb{Z}$ and every $k \in [\Delta_{i+1}(j); \Delta_{i+1}(j+1) - 1]$,

$$L_\Omega(((i, j), (i+1, k))) = k - \Delta_{i+1}(j),$$

where Δ_i is the accumulation function associated with $(|P_i^{-1}(j)|)_{j \in \mathbb{Z}}$ for every $i \in \mathbb{Z}$.

Note that Γ_Ω depends uniquely upon the parent functions $\{P_i\}_{i \in \mathbb{Z}}$ and not on $\{\omega^i\}_{i \in \mathbb{Z}}$. However, we implicitly require that the sequence of parent functions defines an orbit $\Omega = \{(\omega^i, P_i)\}_{i \in \mathbb{Z}}$ of (\mathcal{A}, R) .

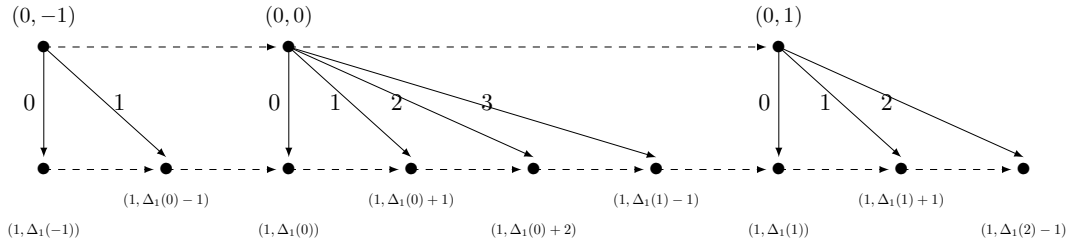

Figure 3.2 – Part of an orbit graph. Dashed arrow are edges of the graph labeled with \mathbf{next} .

Orbits as tilings of \mathbb{R}^2

In addition to orbit graphs, orbits can also be represented as tilings of the plane. Let (\mathcal{A}, R) be a non-deterministic substitution with an expanding eigenvalue $\lambda > 1$ and $v: \mathcal{A} \rightarrow \mathbb{R}^+ \setminus \{0\}$. For every production rule $(a, w) \in R$, we define the (a, w) -tile in position $(x, y) \in \mathbb{R}^2$ as the square polygon with $|w| + 3$ edges pictured in Fig. 3.3, where $w = w_1 \dots w_k$ (horizontal edges are curved to be more visible, but are in fact just straight lines).

Remark. The length of the top edge and the sum of lengths of bottom edges of this tile are the same. Since (\mathcal{A}, R) has an expanding eigenvalue $\lambda > 1$ with v , one has

$$\sum_{j=1}^k \frac{1}{\lambda} v(w_j) \cdot e^y = \frac{e^y}{\lambda} \cdot \lambda \cdot v(a) = v(a) \cdot e^y,$$

so that the bottom right vertex $(x + \frac{1}{\lambda} (v(w_1) + \dots + v(w_k)) e^y, y - \log(\lambda))$ is indeed $(x + v(a) \cdot e^y, y - \log(\lambda))$.

The (\mathcal{A}, R) -tiles is the set of all (a, w) -tiles in position (x, y) for all possible $(a, w) \in R$ and $x, y \in \mathbb{R}$. Given an orbit $\Omega = \{(\omega^i, P_i)\}_{i \in \mathbb{Z}}$ for (\mathcal{A}, R) a tiling of \mathbb{R}^2 for Ω is a function $\Psi_\Omega: \mathbb{Z}^2 \rightarrow \mathbb{R}^2$ such that for every $(i, j) \in \mathbb{Z}^2$ we have:

- $\Psi_\Omega(i, j) = (x, y)$ if and only if $\Psi_\Omega(i, j+1) = (x + v((\omega^i)_j) \cdot e^y, y)$;
- $\Psi_\Omega(i, j) = (x, y)$ if and only if $\Psi_\Omega(i+1, \min P_{i+1}^{-1}(j)) = (x, y - \log(\lambda))$.

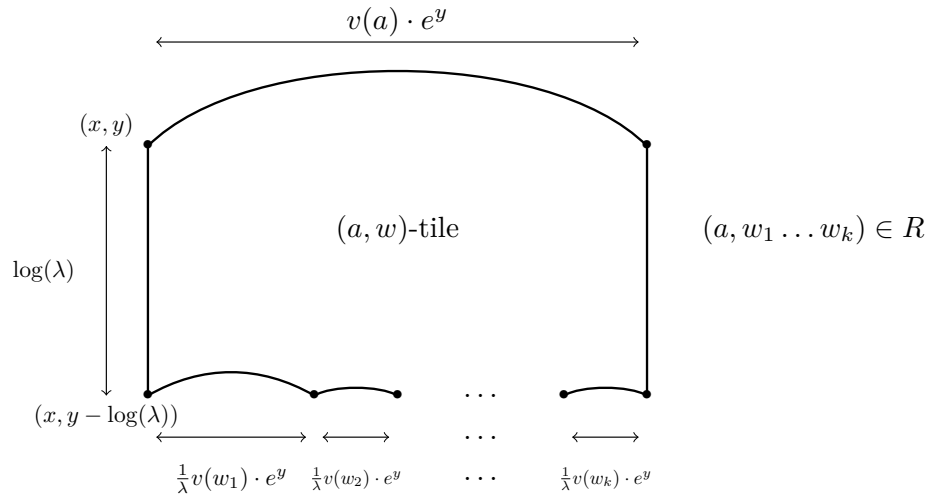

Figure 3.3 – An (a, w) -tile for some production rule $(a, w) \in R$ with $w = w_1 \dots w_k$.

Note that by the previous remark, the collection of (\mathcal{A}, R) obtained by putting an $((a^i)_j, a^{i+1}|_{[\Delta_{i+1}(j); \Delta_{i+1}(j+1)-1]})$ -tile at position $\Psi_\Omega(i, j)$ defines a tiling of \mathbb{R}^2 , that is, the collection of square polygons covers \mathbb{R}^2 and has pairwise disjoint interiors. See Fig. 3.4. Moreover, fixing one position, say $\Psi_\Omega(0, 0) = (0, 0)$ defines the function Ψ_Ω completely. It follows that for a substitution with an expanding eigenvalue, there is always a tiling for it.

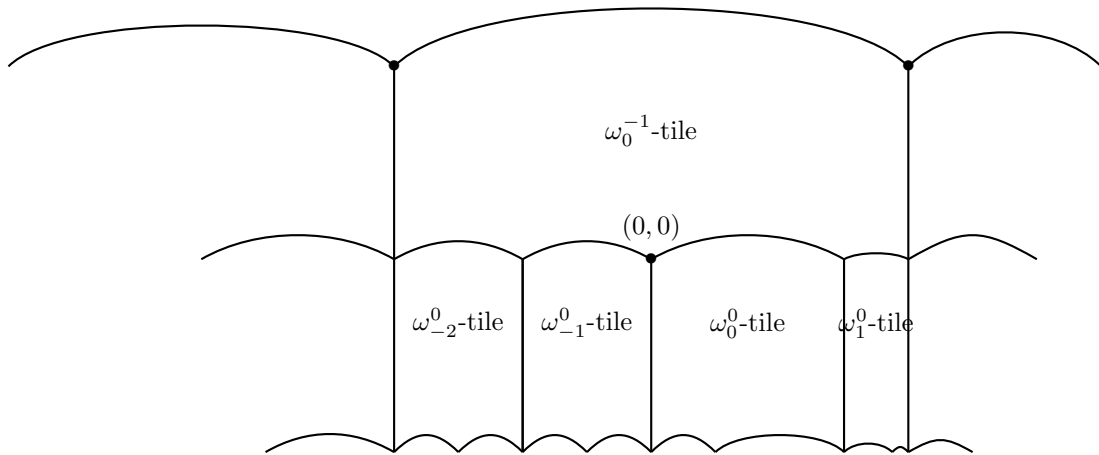

Figure 3.4 – A tiling Ψ_Ω of an orbit into \mathbb{R}^2 .

Proposition 3.2.3. *If a substitution (\mathcal{A}, R) has an expanding eigenvalue, then for every orbit Ω of (\mathcal{A}, R) there exists a tiling Ψ_Ω for Ω .*

3.2.3 The Domino Problem on the Hyperbolic Plane

The hearth of the proofs of this chapter is the construction of Kari, proving that the domino problem is undecidable for pentagonal tiling of the hyperbolic plane \mathbb{H}^2 [Kar08].

In this section we briefly review this construction on \mathbb{Z}^2 and \mathbb{H}^2 . Most of the ideas of his construction were already present in his aperiodic tilingset [Kar96].

Tiling of the plane

A *piecewise affine* map f is given by a set of rational affine maps $f_1, \dots, f_k : \mathbb{R}^2 \mapsto \mathbb{R}^R$ and disjoint unit square domains $U_1, \dots, U_k \subset \mathbb{R}^2$ with integer corners such that $U = U_1 \cup \dots \cup U_k$ and

$$f : \begin{cases} U & \rightarrow \mathbb{R}^2 \\ \mathbf{x} & \mapsto f_i(\mathbf{x}) \text{ for } \mathbf{x} \in U_i \end{cases} .$$

A point $\mathbf{x} \in \mathbb{R}^2$ is called *immortal* if for all $i \in \mathbb{N}$, $f^i(\mathbf{x}) \in U$. The *mortality problem of piecewise affine maps* is the following question: "Does a piecewise affine map with square domains U_1, \dots, U_k with integer corners have an immortal point ?" Kari showed that this problem is undecidable, and his proof of the undecidability of the domino problem consists in encoding this problem into a tiling.

We say that the Wang tile

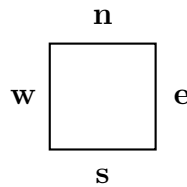

computes an affine function $f : \mathbb{R}^2 \rightarrow \mathbb{R}^2$ if:

$$f(\mathbf{n}) + \mathbf{w} = \mathbf{s} + \mathbf{e}. \tag{3.1}$$

If we tile a line of width m of such tiles

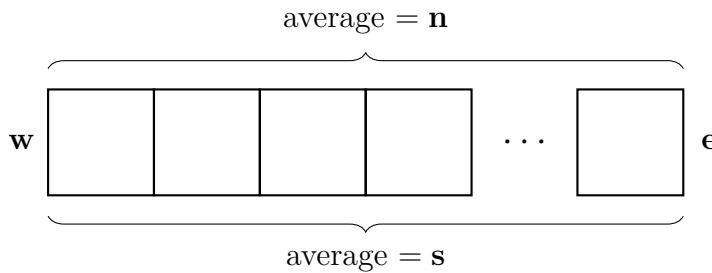

and averaging of the equation (3.1), we obtain:

$$f(\mathbf{n}) + \frac{\mathbf{w}}{m} = \mathbf{s} + \frac{\mathbf{e}}{m}, \tag{3.2}$$

with \mathbf{n} representing the average of the top labels and \mathbf{s} the average of the bottom labels.

Let $i \in \mathbb{Z}$. We say that a biinfinite sequence $(x_k)_{k \in \mathbb{Z}} \in \{i, i + 1\}^{\mathbb{Z}}$ represents a real number $x \in [i, i + 1]$ if there exists a growing sequence of intervals $I_1 \subset I_2 \subset \dots \subseteq \mathbb{Z}$ of size at least $1, 2, \dots$ such that:

$$\lim_{k \rightarrow +\infty} \frac{\sum_{j \in I_k} x_j}{|I_k|} = x.$$

Note that if $(x_k)_{k \in \mathbb{Z}}$ is a representation of x , all the shifted sequences $(x_{l+k})_{k \in \mathbb{Z}}$ for every $l \in \mathbb{Z}$ are also representations of x . A sequence $(x_k)_{k \in \mathbb{Z}}$ can *a priori* represent several distinct real numbers since different interval sequences may make it converge to different points. A sequence of vector $(\mathbf{x})_i = (x_i^1, x_i^2)$ represents a vector $\mathbf{x} = (x^1, x^2)$ if $(x_i^1)_i$ represents x^1 and $(x_i^2)_i$ represents x^2 .

When taking the limit of (3.2) over a sequence of intervals, we obtain that if the sequence of color at the top of an infinite line represents $\mathbf{x} \in \mathbb{R}$, then the bottom sequence represents $f(\mathbf{x})$.

To obtain a set of tile T computing a piecewise affine map f divided into f_1, \dots, f_k , we take the sets of tiles T_1, \dots, T_k computing f_1, \dots, f_k , then $T = \cup_i T_i$. Such a tiling admits a valid tiling of \mathbb{Z}^2 if and only if f has an immortal point. Kari showed that any piecewise affine map f whose domains have integer points can be transformed into a finite tileset that computes f in the previous sense. Which provides the reduction of the domino problem over \mathbb{Z}^2 from the mortality problem of piecewise affine maps. Moreover, if f is chosen carefully the valid tilings are necessarily aperiodic.

Tiling of the hyperbolic plane

The undecidability of the domino problem over \mathbb{Z}^2 was already known, but the novelty of this approach is that it is very easily generalizable to the hyperbolic plane. In the chosen model, the hyperbolic plane is tiled by copies of the following pentagonal tile.

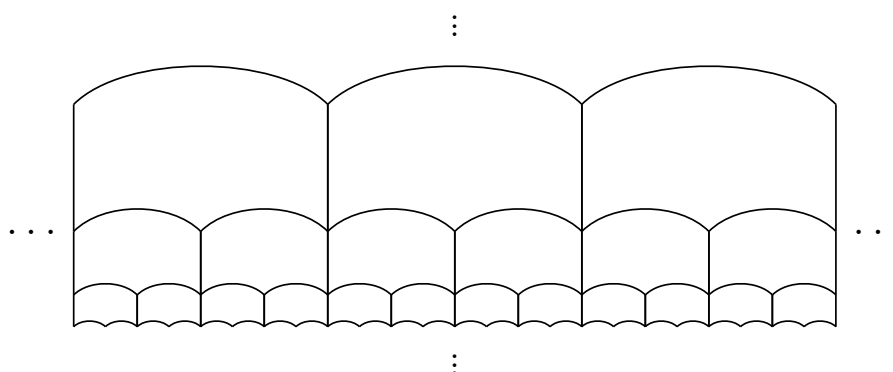
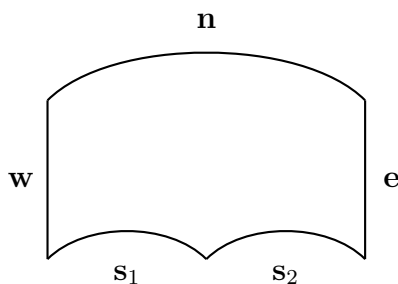

Figure 3.5 – Pentagonal tiling of \mathbb{H}^2 .

Note that the curved edges are represented as such for readability but are straight in the model. In this model, it is again possible to define a tileset that *computes* an affine function. A pentagonal tile:



computes an affine function $f : \mathbb{R}^2 \rightarrow \mathbb{R}^2$ if:

$$f(\mathbf{n}) + \mathbf{w} = \frac{\mathbf{s}_1 + \mathbf{s}_2}{2} + \mathbf{e}.$$

Tiling a line with such tiles, we obtain the same property as in \mathbb{Z}^2 that if the top colors represent \mathbf{x} , the bottom ones represent $f(\mathbf{x})$. With the same technique, we can derive a tiling that encodes a piecewise affine map f , and that admits valid tilings of \mathbb{H}^2 if and only if f has an immortal point. Here again, Kari provides a way of building a finite tiling that computes any piecewise affine map f whose domains have integer points, proving that the domino problem over \mathbb{H}^2 is undecidable.

Theorem 3.2.4 (Kari, 2008 [Kar08]). *The domino problem is undecidable in the hyperbolic plane.*

This construction was the starting point of Aubrun and Kari's proof of the undecidability of the domino problem over Baumslag-Solitar groups [AK13], as Baumslag-Solitar groups $BS(1, 2)$ are the closest group to the previous tiling model of the Hyperbolic plane. We come back on this proof in Section 3.3. Tilings of \mathbb{H}^2 with pentagons can also be seen as tilings of orbits of the substitution $0 \mapsto 00$, and we will generalize this idea to other substitutions in Section 3.4.

3.3 Periodicity in Baumslag-Solitar Groups

The pentagonal tiling of the hyperbolic plane seen previously can be seen as a Cayley graph of a monoid, and the natural group we obtain when completing it is the Baumslag-Solitar group with parameters $(1, 2)$. Using similar techniques Aubrun and Kari proved that any Baumslag-Solitar group also have undecidable domino problem. Their construction provide a weakly aperiodic SFT (or tiling) of the group. In this section, we focus on Baumslag-Solitar groups with parameters $(1, n)$, and we will show that Aubrun and Kari's construction is actually strongly aperiodic for these groups (Section 3.3.2). Then, we build a weakly but not strongly aperiodic SFT over $BS(1, n)$ (Section 3.3.3). These result are a joint work with Julien Esnay [EM20].

3.3.1 Baumslag-Solitar Groups

In general, *Baumslag-Solitar groups* depend on two parameters $m, n \in \mathbb{Z}$, and are defined by the presentation:

$$BS(m, n) = \langle a, b \mid ba^m b^{-1} = a^n \rangle.$$

We will focus on the case where $m = 1$, the case $n = 1$ being similar to it. In this case, the presentation becomes

$$BS(1, n) = \langle a, b \mid bab^{-1} = a^n \rangle.$$

As mentioned in Section 3.1.1, SFTs over a group can be equivalently defined as Wang tiles. We precise the formalism of Wang tiles in the particular case of $BS(1, n)$, since it is the one Aubrun and Kari used to define their aperiodic SFT. A *Wang tiling* is a particular SFT where the alphabet is a set of *Wang tiles* τ , which are tuples of colors of the form

$s = (n^s, l^s, r^s, b_1^s, \dots, b_n^s)$. To make notations easier, we denote:

$$\begin{aligned} s(\text{top}) &= n^s \\ s(\text{left}) &= l^s \\ s(\text{right}) &= r^s \\ s(\text{bottom}_1) &= b_1^s \\ &\vdots \\ s(\text{bottom}_n) &= b_n^s \end{aligned}$$

A *tiling* is then a configuration over the group using the alphabet τ : $t \in \tau^{BS(1,n)}$. We say that a tiling is *valid* if the colors of neighbor tiles match. That is, for any $g \in BS(1,n)$ and t_g the associated tile at position g , we have:

$$\begin{aligned} t_g(\text{right}) &= t_{ga}(\text{left}) \\ t_g(\text{top}) &= t_{gb}(\text{bottom}_1) \\ t_g(\text{top}) &= t_{ga^{-1}b}(\text{bottom}_2) \\ t_g(\text{top}) &= t_{ga^{-2}b}(\text{bottom}_3) \\ &\vdots \\ t_g(\text{top}) &= t_{ga^{-(n-1)}b}(\text{bottom}_n) \end{aligned}$$

See Fig. 3.6 for an illustration of these rules.

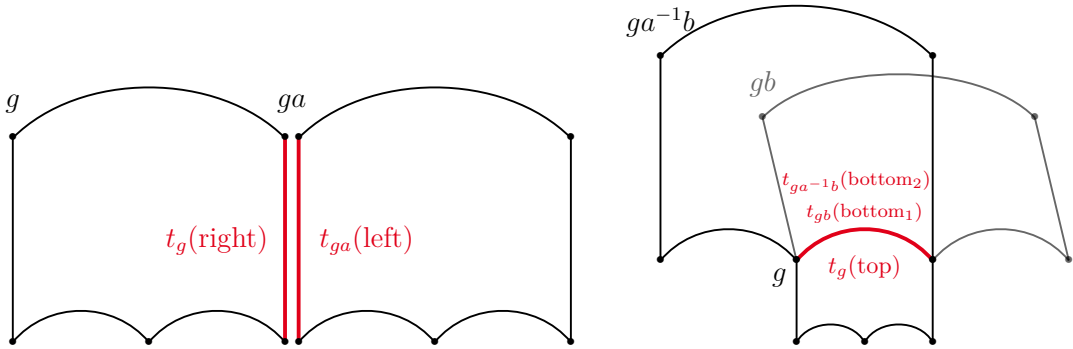

Figure 3.6 – Illustration of the neighbor rules for $BS(1,2)$.

3.3.2 Aubrun-Kari Tileset is Strongly Aperiodic

In their paper showing that the domino problem is undecidable for $BS(m,n)$, Aubrun and Kari provide a counter-example to the fact that their tileset is strongly aperiodic [AK13]: they exhibit a period $bab^{-1}a^2ba^{-1}b^{-1}a^{-2}$ in the specific case of $BS(2,3)$. One can remark that the period $bab^{-1}aba^{-1}b^{-1}a^{-1}$ works in the general case of $BS(m,n)$ with $m > 1, n > 1$. However, this counter-example does not work anymore if $m = 1$. In this section, we show that their tileset is in fact strongly aperiodic in the $BS(1,n)$ case with $n \geq 2$.

We start by a key lemma: in $BS(1,n)$, one can use a normal form to write the elements of the group.

Lemma 3.3.1 (Normal form in $BS(1, n)$). *For all $g \in BS(1, n)$, there are integers $k_1, k_2 \in \mathbb{N}_0$ and $l \in \mathbb{Z}$ such that $g = b^{-k_1} a^l b^{k_2}$.*

Proof. From the definition of $BS(1, n)$, we have that:

- (1) $ba = a^n b$,
- (2) $ba^{-1} = a^{-n} b$,
- (3) $ab^{-1} = b^{-1} a^n$,
- (4) $a^{-1} b^{-1} = b^{-1} a^{-n}$.

Consequently, taking an element of $BS(1, n)$ as a word w written with a and b , we can:

- Move each positive power of b to the right of the word using (1) and (2) repeatedly;
- Move each negative power of b to the left of the word using (3) and (4) repeatedly;

so that we finally get a form for the word w which is: $b^{-k_1} a^l b^{k_2}$ with $k_1, k_2 \in \mathbb{N}_0$ and $l \in \mathbb{Z}$. \square

Remark. This form is *not* unique ($a = b^{-1} a^n b$ for instance), unless we impose k_1 to be minimal. However, the sum $k_2 - k_1$ is constant for all forms of a given word.

Indeed, suppose we have $b^{-k_1} a^l b^{k_2} = b^{-k'_1} a^{l'} b^{k'_2}$. Then

$$\begin{aligned} b^{-k_1} a^l &= b^{-k'_1} a^{l'} b^{-(k_2 - k'_2)} \\ &= b^{-k'_1 - (k_2 - k'_2)} a^{l' n^{k_2 - k'_2}} \end{aligned}$$

Hence we get $a^{l' n^{k_2 - k'_2} - l} = b^{-k_1 + k'_1 + k_2 - k'_2}$. Since it is clear that $a^i = b^j$ if and only if $i = j = 0$ in $BS(1, n)$, we obtain $k_2 - k_1 - (k'_2 - k'_1) = 0$ which is what we wanted.

We call $\mathcal{L}_g = \{ga^k \mid k \in \mathbb{Z}\}$ the *level* of $g \in G$. The previous remark allows to properly define $|g|_b = k_2 - k_1$ the *height* of g , and it is actually the height of all elements in \mathcal{L}_g . We now tile $BS(1, n)$ using tiles as described in Section 3.3.1. We use the same vocabulary to talk about lines of tiles: for a given line of tiles located between levels \mathcal{L}_g and $\mathcal{L}_{gb^{-1}}$, we talk about the upper side of the line to refer to level \mathcal{L}_g , and the lower side of the line to refer to level $\mathcal{L}_{gb^{-1}}$. We consider tilesets with integers on the upper and lower sides of each tile.

Theorem 3.3.2 (Aubrun & Kari [AK13]). *Let $n \in \mathbb{N}$ and $f: I \rightarrow \mathbb{R}$ be a piecewise affine map with rational coefficients, with I an interval of \mathbb{R} with rational bounds. There exists Y_f an SFT on $BS(1, n)$ given by a tileset τ_f such that:*

1. *a line of tiles represents at least one real $x \in I$ on its upper side by forming a sequence that uses two integers with distance 1;*
2. *if a line of tiles represents a real $x \in I$ on its upper side, then it represents (possibly among others) $f(x)$ on its lower side;*
3. *Y_f is nonempty if and only if f has an immortal point in its domain of definition.*

We define $f: [\frac{1}{3}, 2] \rightarrow [\frac{1}{3}, 2]$, with:

$$f(x) = \begin{cases} 2x & \text{if } x \in [\frac{1}{3}, 1) \\ \frac{1}{3}x & \text{otherwise} \end{cases}$$

Since 2 and 3 are coprime, this piecewise affine map has no periodic point, so for all $x \in [\frac{1}{3}, 2]$, $f^k(x) = x \Rightarrow k = 0$. Moreover, all points in its domain of definition are

immortal. Applying Theorem 3.3.2 we can build an SFT Y_f with this specific map that is nonempty. Thanks to the fact that f has no periodic point, Y_f is weakly aperiodic (see [AK13]). We will now prove that it is also strongly aperiodic.

One key ingredient to prove this statement is the following. Usually, a given line could represent several reals, depending on the choice of the sequence of intervals. But inside a tiling of the whole group, our particular f forces any two represented reals on a line to be the same.

For a given line \mathcal{L}_g and a configuration $x \in \mathcal{A}^G$, we define the sequence $(u_i^g)_{i \in \mathbb{Z}} := x_{ga^i}$ to be the sequence of digits on the line \mathcal{L}_g (its origin depending on g).

Lemma 3.3.3. *For any $g \in BS(1, n)$, the sequence $(u_i^g)_{i \in \mathbb{Z}}$ represents a unique real number.*

Proof. Assume that u^g represents two distinct reals x and z .

This means that $u^{g \cdot b^{-1}}$ represents both $f(x)$ and $f(z)$ because of the way the SFT Y is built. Similarly, for any $k \in \mathbb{N}$, $u^{g \cdot b^{-k}}$ represents both $f^k(x)$ and $f^k(z)$.

As it is explained in [DGG14], f can be seen as a rotation on the circle \mathbb{S}^1 through the following mapping:

$$\begin{aligned} \phi: \left[\frac{1}{3}, 2\right] &\rightarrow \mathbb{S}^1 \\ \phi(x) &= \frac{\log(x) + \log(3)}{\log(2) + \log(3)} \pmod{1} \end{aligned}$$

This mapping is bijective up to the two endpoints of the interval that are identified. The map $r := \phi \circ f \circ \phi^{-1}$ appears to be a rotation of angle $\frac{\log(2)}{\log(2) + \log(3)}$. Indeed, for every $\alpha \in \phi([\frac{1}{3}, 1])$,

$$\begin{aligned} \phi \circ f \circ \phi^{-1}(\alpha) &= \phi(2\phi^{-1}(\alpha)) \\ &= \frac{\log(2) + \log(\phi^{-1}(\alpha)) + \log(3)}{\log(2) + \log(3)} \pmod{1} \\ &= \alpha + \frac{\log(2)}{\log(2) + \log(3)} \pmod{1} \end{aligned}$$

and similarly, for every $\alpha \in \phi([1, 2])$, one has

$$\begin{aligned} \phi \circ f \circ \phi^{-1}(\alpha) &= \phi\left(\frac{1}{3}\phi^{-1}(\alpha)\right) \\ &= \frac{\log(\phi^{-1}(\alpha))}{\log(2) + \log(3)} \pmod{1} \\ &= \alpha + \frac{\log(2)}{\log(2) + \log(3)} \pmod{1} \end{aligned}$$

The angle $\frac{\log(2)}{\log(2) + \log(3)}$ is irrational. As a consequence, $\{r^k(x) \mid k \in \mathbb{N}\}$ and $\{r^k(z) \mid k \in \mathbb{N}\}$ are both dense in \mathbb{S}^1 .

We introduce $d_{\text{arc}}(e^{2i\pi\theta}, e^{2i\pi\psi}) = m(\psi - \theta) \in [0, 1)$ for $\theta, \psi \in \mathbb{R}$, where $m(\psi - \theta)$ is the only real in $[0, 1)$ congruent to $\psi - \theta \pmod{1}$. We call d_{arc} the *oriented arc distance*

(measured counterclockwise) between two elements of \mathbb{S}^1 . It is not really a distance since it is not symmetric and has no triangular inequality, but its basic properties will suffice here. Since r is a rotation, it is easy to check that it preserves d_{arc} . Hence we have that $\forall k \in \mathbb{N}, d_{arc}(r^k(x), r^k(z))$ is constant equal to some $c \in [0, 1[$.

Let us partition \mathbb{S}^1 between $A = \phi((\frac{1}{3}, 1))$, $B = \phi([1, 2))$, and $C = \{\phi(2)\} = \{\phi(\frac{1}{3})\} = \{0\}$. We want to show that there is some $l \in \mathbb{N}$ for which $r^l(x) \in A$ and $r^l(z) \in B$. Were this not the case, we would have an infinite number of integers $k \in \mathbb{N}$ such that $r^k(z) \in B$ and $r^k(x) \in B$, since 0 is reached at most once by each orbit (because we have a rotation of irrational angle). Then, because r preserves the counterclockwise order, we would have $d_{arc}(r^k(x), 0) \geq d_{arc}(r^k(x), r^k(z)) = c$ (see Fig. 3.7). But by density of $\{r^k(x) \mid k \in \mathbb{Z}\}$, there exists some $k_0 \in \mathbb{N}$ such that $d_{arc}(r^{k_0}(x), 0) < c$: contradiction. Hence there exists $l \in \mathbb{N}$ such that $r^l(x) \in A$ and $r^l(z) \in B$.

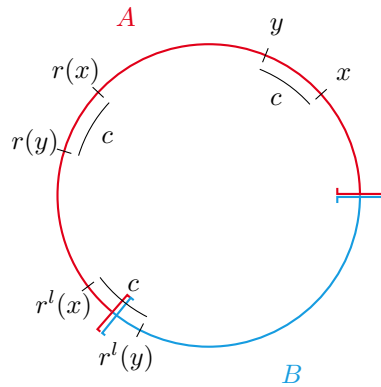

Figure 3.7 – Preservation of the oriented arc distance d_{arc} by r and intersection of the arc $(r^l(x), r^l(z))$ and the boundary between A and B .

Since $r^l = \phi \circ f^l \circ \phi^{-1}$ and considering the definitions of A and B , $f^l(x) \in (\frac{1}{3}, 1)$ and $f^l(z) \in [1, 2)$. But this would cause $f^l(x)$ to be represented by a sequence of 0's and 1's (with an infinite number of 0s) and $f^l(z)$ by a sequence of 1's and 2's (with an infinite number of 2s). However, the SFT Y_f is build such that a line contains only elements in $\{0, 1\}$ or $\{1, 2\}$, but not both (property 2 of Theorem 3.3.2): this is a contradiction.

Therefore, x and z must be equal, hence the uniqueness of the real number represented by a line of tiles. \square

Using previous results, we are now able to prove that the real represented on a line of the tiling only depends on the number of b it contains, its depth.

Lemma 3.3.4. *Let $y \in Y_f$ and 1_G the identity of $BS(1, n)$.*

If we set x as the unique real represented by the sequence u^{1_G} , then for every $g \in BS(1, n)$, u^g represents $f^{-|g|_b}(x)$ in the configuration y .

Proof. We will prove this result for $g = b^m$ first. The result is clear if $m \leq 0$ (remember that f is applied positively when we multiply by b^{-1}). Let $m > 0$. If we call x' the unique real represented by the level \mathcal{L}_{b^m} , then \mathcal{L}_{1_G} represents $f^m(x')$ by construction of Y . By Lemma 3.3.3, either $f^m(x') = x$, and on $[\frac{1}{3}, 2)$, since f is bijective, $x' = f^{-m}(x)$.

Now let us consider any $g \in BS(1, n)$ and let x' be the real represented by u^g . Using Lemma 3.3.1, we write $g = b^{-k_1} a^l b^{k_2}$, with $k_1, k_2 \in \mathbb{N}_0, l \in \mathbb{Z}$. Let us define $h = b^{-k_1} a^l$. Since $h \in \mathcal{L}_{b^{-k_1}}$, u^h represents $f^{k_1}(x)$ thanks to the previous paragraph. We also have $h = g b^{-k_1 - |g|_b}$. Because $-k_1 - |g|_b = -k_2 \leq 0$, the construction of Y implies that u^h also represents $f^{k_1 + |g|_b}(x')$. By uniqueness of the representation (Lemma 3.3.3), $f^{k_1 + |g|_b}(x') = f^{k_1}(x)$, and so $x' = f^{-|g|_b}(x)$. \square

The uniqueness in Lemma 3.3.3 may seem anecdotal but the fact that there are not several reals represented on each line is actually fundamental. Without it, we could not necessarily compare two reals represented by the same line, and thus we could have a "vertical" period (of the form b^m). Indeed, one level could represent both x and $f^m(x)$ using different interval sequences (I_k) and (J_k) , and another level m steps down would be identical, so that at the second level $f^m(x)$ is represented with the intervals (J_k) that "correspond" to the (I_k) that represent x at the first level. Then x and $f^m(x)$ could cohabit on the same line without any need to be equal.

Lemma 3.3.3 suppresses this possibility of cohabitation and allows via Lemma 3.3.4 for a non-ambiguous definition of what each level represents. This fact prevents vertical periods, and it can be used to prevent any period whatsoever. In other words we can prove that Aubrun and Kari's SFT is strongly aperiodic on $BS(1, n)$.

Theorem 3.3.5. *For every $n \geq 2$, the Baumslag-Solitar group $BS(1, n)$ admits a strongly aperiodic SFT.*

Proof. Let $y \in Y_f$, and $g \in \text{Stab}_{BS(1, n)}(y)$. Using Lemma 3.3.1, we can write $g = b^{-k_1} a^l b^{k_2}$ with $k_1, k_2, l \in \mathbb{N}$.

Let x be the real represented by u^{1_G} . By Lemma 3.3.4, u^g represents $f^{k_1 - k_2}(x)$. Since $g \in \text{Stab}_{BS(1, n)}(y)$, $u^g = u^e$ and so $f^{k_1 - k_2}(x) = x$ (using Lemma 3.3.3). The aperiodicity of f then implies that $k_1 = k_2$. We call this common value k .

Let us assume $l \neq 0$. Then $g = b^{-k} a^l b^k$ and $g^n = b^{-k} (a^n)^l b^k$. We can reduce the whole word to $b^{-k+1} a^l b^{k-1}$ using the relation $a^n = b a b^{-1}$ – and this is true even if $k = 0$. More generally, we notice that for any positive integer i , iterating the process i times, we obtain that $g^{n^i} = b^{-k+i} a^l b^{k-i} \in \text{Stab}_{BS(1, n)}(y)$.

Since for all i , $g^{n^i} \in \text{Stab}_{BS(1, n)}(y)$, we can obtain a contradiction with an argument similar to Prop 6. of [AK13]. The fact that $b^j a^l b^{-j} \in \text{Stab}_{BS(1, n)}(y)$ means that $u^{b^j} = u^{b^j a^l}$ hence u^{b^j} is a l -periodic sequence. Since this is true for any $j > -k$ and since said sequences can only use digits among $\{0, 1, 2\}$, we have a finite number of such sequences. In particular, there are $j_1 \neq j_2$ such that the two levels $\mathcal{L}_{b^{j_1}}$ and $\mathcal{L}_{b^{j_2}}$ read the same sequence (up to index translation). Then these two levels represent respectively $f^{j_1}(x)$ and $f^{j_2}(x)$, and since the two sequences on these levels are the same, $f^{j_1}(x) = f^{j_2}(x)$. This equality contradicts the fact that f has no periodic point, since we had $j_1 \neq j_2$.

As a consequence, any non-trivial $g \in BS(1, n)$ cannot be in $\text{Stab}_{BS(1, n)}(x)$, and we finally get that $\text{Stab}_{BS(1, n)}(x) = \{1_G\}$: $Y_{\mathcal{F}}$ is strongly aperiodic. \square

Following Theorem 3.3.5, a question remains: why is Aubrun and Kari's SFT strongly aperiodic? Is this because $BS(1, n)$ behaves like \mathbb{Z}^2 and all its weakly aperiodic SFTs are also strongly aperiodic? Or does Aubrun and Kari's construction happen to be strong

enough? It turns out that the latter is the correct answer, as we build in the following section an SFT on $BS(1, n)$ that is weakly but not strongly aperiodic.

3.3.3 A Weakly not Strongly Aperiodic Tileset of $BS(1, n)$

Our weakly but not strongly aperiodic SFT will work by encoding specific (deterministic) substitutions into $BS(1, n)$. In this section we consider only deterministic substitutions, so we will not specify it anymore. Indeed, looking at the Cayley graph of $BS(1, n)$, it is very similar to orbit graphs of constant-size substitutions. Indeed, one "sheet" of $BS(1, n)$ is isomorphic the orbit graph of $0 \mapsto 0^n$. In this section, we start by creating artificially a set of substitutions that are easy to encode in $BS(1, n)$. In the next section we show that in fact, these "artificial" substitutions are the only binary substitutions that are possible to encode in $BS(1, n)$ with our method.

The substitutions σ_i

Let $\mathcal{A} = \{0, 1\}$. For $r \in \{0, \dots, n-1\}$, let $\sigma_r : \mathcal{A} \rightarrow \mathcal{A}^n$ be the following substitution:

$$\sigma_r : \begin{cases} 0 \mapsto 0^{n-r-1}10^r \\ 1 \mapsto 0^n \end{cases}.$$

We may also write $\sigma = \sigma_0$ and call the other ones the *shifts* of σ .

Note that, for $l \in \{0, 1\}$ and $i \in \{0, \dots, n-1\}$, $\sigma_r(l)_i = 0$ if and only if $l = 0$ and $i = n - r - 1$. All $\sigma_r(0)$ are cyclic permutations of the same finite word. To simplify notations, we denote $\rho = T^{-1}$ the shift action on biinfinite words.

Lemma 3.3.6. *For any biinfinite word $u \in \mathcal{A}^{\mathbb{Z}}$, any $i, r \in \{0, \dots, n-1\}$ and $j \in \mathbb{Z}$,*

$$(\sigma_r \circ \rho^j(u))_i = \sigma_r(u_j)_i = (\sigma_r(u))_{nj+i}.$$

Proof. For $i \in \{0, \dots, n-1\}$, $\sigma_r(\rho^j(u))_i$ depends on the letter of $\rho^j(u)$ at position 0 only, that is u_j (See Fig. 3.8), hence $\sigma_r(\rho^j(u))_i = \sigma_r(\rho^j(u)_0)_i = \sigma_r(u_j)_i$.

Similarly, the letter $(\sigma_r(u))_{nj+i}$ does not depend on the totality of u but only on u_j : it is the i th letter of $\sigma_r(u_j)$. \square

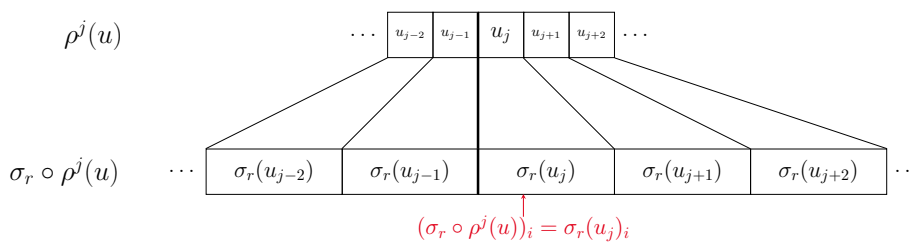

Figure 3.8 – Illustration of Lemma 3.3.6.

Lemma 3.3.7. *For any $r \in \{0, \dots, n-1\}$,*

$$\sigma_r = \rho^r \circ \sigma.$$

Proof. By Lemma 3.3.6, for any $u \in \mathcal{A}^{\mathbb{Z}}$, $j \in \mathbb{Z}$ and $i \in \{0, \dots, n-1\}$, we have

$$\sigma_r(u)_{nj+i} = (\sigma_r(u_j))_i.$$

If $i+r \in \{0, \dots, n-1\}$ then $(\sigma_r(u_j))_i = (\sigma(u_j))_{i+r}$ considering how the i th letter of $\sigma_r(u_j)$ is simply r -shifted to the right in $\sigma(u_j)$. Additionally,

$$\begin{aligned} (\sigma(u_j))_{i+r} &= (\sigma(u))_{i+r+nj} \\ &= (\rho^r \circ \sigma(u))_{i+nj} \end{aligned}$$

by Lemma 3.3.6 again. Aligning all the equalities we obtained, we can conclude in that case.

If $2n-2 \geq i+r \geq n$, $i > n-r-1$, we have $(\sigma_r(u_j))_i = 0$ by definition of σ_r . Furthermore, this is also the value of $(\sigma(u_{j+1}))_{i+r-n}$ since $i+r-n < n-1$ and by definition of σ . Then $(\sigma_r(u_j))_i = 0 = (\sigma(u_{j+1}))_{i+r-n}$. Once again, $(\sigma(u_{j+1}))_{i+r-n} = (\sigma(u))_{i+r+nj}$ by Lemma 3.3.6, which allows us to conclude. \square

Lemma 3.3.8. *For $n \geq 3$, σ_1 has a unique fixpoint. For $n = 2$, σ_1 has no fixpoint but σ_1^2 has two fixpoints.*

Proof. Since σ_1 has no mortal letters, Corollary 3.2.2 gives us that $\sigma_1(w) = w$ if and only if $w = x \cdot y$ with

- $x = \overrightarrow{\sigma_1}(a)$, a such that there exists $w \in \mathcal{A}^*$, $\sigma_1(a) = aw$;
- $y = \overleftarrow{\sigma_1}(a')$, a' such that there exists $w \in \mathcal{A}^*$, $\sigma_1(a') = wa'$.

Notice that $\sigma_1(0) = 0^{n-2}10$ and $\sigma_1(1) = 0^n$, for $n \geq 3$, so the only choice for a and a' is $a = a' = 0$. Then σ_1 has a fixpoint that is $\overleftarrow{\sigma_1}(0) \cdot \overrightarrow{\sigma_1}(0)$ and which is unique.

For $n = 2$ the same reasoning concludes that σ_1 has no fixpoint. However, since $\sigma_1^2(0) = 0010$ and $\sigma_1^2(1) = 1010$, the same reasoning also yields that σ_1^2 has two fixpoints that are $\overleftarrow{\sigma_1^2}(0) \cdot \overrightarrow{\sigma_1^2}(0)$ and $\overleftarrow{\sigma_1^2}(0) \cdot \overrightarrow{\sigma_1^2}(1)$. \square

Lemma 3.3.9. *Let $s = \sigma_{i_k} \circ \dots \circ \sigma_{i_1}$ for any $i_1, \dots, i_k \in \{0, \dots, n-1\}$. Then all fixpoints of s are aperiodic.*

Proof. Let w be a fixpoint of s . To prove its aperiodicity we follow a proof from [Pan86] simplified for our specific case.

First, let us show that the two subwords 00 and 01 can be found in w .

- For 00, let us define $s' = \sigma_{i_{k-1}} \circ \dots \circ \sigma_{i_1}$. Then, by definition, $w = \sigma_{i_k}(s'(w))$ (by convention $s'(w) = w$ if $k = 1$). We are going to prove that $s'(w)$ always contains a 1. As a consequence, $w = \sigma_{i_k}(s'(w))$ contains 00 because $\sigma_{i_k}(1) = 0^n$. Suppose $s'(w) = \dots 0 \dots$. If $k = 1$, it means that $w = \dots 0 \dots$, but then $s(w) \neq w$ so this is impossible. If $k = 2$, then $s' = \sigma_{i_1}$ so the only way to have $s'(w) = \dots 0 \dots$ is to have $w = \dots 1 \dots$, but again $s(w) \neq w$. If $k \geq 3$, let us define $t = \sigma_{i_{k-3}} \circ \dots \circ \sigma_{i_1}$. With this notation, $w = \sigma_{i_k} \circ \sigma_{i_{k-1}} \circ \sigma_{i_{k-2}}(t(w))$. The assumption $s'(w) = \dots 0 \dots$ causes $\sigma_{i_{k-2}}(t(w)) = \dots 1 \dots$. However, this is impossible since $\dots 1 \dots$ has no antecedent by $\sigma_{i_{k-2}}$. Therefore $s'(w)$ must contain a 1 and we can find 00 in w .
- For 01, the only way for w not to contain 01 is to be of the form $w = \dots 0 \dots$, $w = \dots 1 \dots$ or $w = \dots 10 \dots$. But it is clear that $s(\dots 0 \dots) \neq \dots 0 \dots$, $s(\dots 1 \dots) \neq \dots 1 \dots$ and $s(\dots 10 \dots) \neq \dots 10 \dots$ hence none of them can be fixpoints.

Hence $s(00)$ and $s(01)$ can also be found in w since $s(w) = w$. We have $s(00) \neq s(01)$; consider the largest prefix on which they agree, call it u_2 , with $|u_2| > 1$. Then both u_20 and u_21 can be found in w . Hence $s(u_20)$ and $s(u_21)$ can also be found in w . We have $s(u_20) \neq s(u_21)$; consider the largest prefix on which they agree, call it u_3 , with $|u_3| > |u_2|$. Then both u_30 and u_31 can be found in w . Hence $s(u_30)$ and $s(u_31)$ can also be found in w .

Repeating this reasoning, we can build subwords of w as large as we want, with two choices for their last letter. Hence the factor complexity of w is unbounded, and so w is aperiodic by Theorem 1.2.1 (Morse and Heldund). \square

Encoding substitutions in $BS(1, n)$

We now show how to encode such substitutions in tilings of the group $BS(1, n)$. We define the tileset τ_σ on $BS(1, n)$, $n \in \mathbb{N}$, $n \geq 2$, to be the tiles shown on Fig. 3.9 for all $l \in \{0, 1\}$ and $i \in \{0, \dots, n - 1\}$. Remark that a tile is uniquely defined by the couple (l, i) .

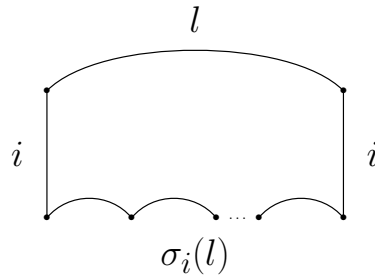

Figure 3.9 – Tiles of τ_σ : left and right colors are identical and equal to i , top color is l and bottom colors are all letters of $\sigma_i(l)$.

This tileset will be the weakly but not strongly aperiodic tileset we are looking for. Lemmas 3.3.8 and 3.3.9 study the words that can appear on lines of the tiling, by looking at the fixpoints of σ_1 . They prove that no biinfinite word can be both a fixpoint for the σ_i s and a periodic word, forbidding one direction of periodicity for any configuration we will encode with our tileset. This naturally leads to the following proposition:

Lemma 3.3.10. *No configuration of τ_σ can be a^k -periodic for any $k \in \mathbb{N}$.*

Proof. Suppose that there is a configuration x of τ_σ such that $\forall g \in BS(1, n), x_{a^k \cdot g} = x_g$ (a^k -periodicity). Call $w = (x_{a^j})_{j \in \mathbb{Z}}$. w is k -periodic by a^k -periodicity of the configuration. But w is also nk -periodic. Hence $(x_{ba^j})_{j \in \mathbb{Z}}$ is k -periodic. Indeed, by construction, when applying the correct substitution σ_i to x_{ba^j} and $x_{ba^{j+k}}$, one obtains the words $x_{a^{nj}} \dots x_{a^{nj+n-1}}$ and $x_{a^{nj+nk}} \dots x_{a^{nj+nk+n-1}}$ which are one and the same by nk -periodicity of w . With the same argument, one can show that for any integer $l > 0$, $(x_{b^l a^j})_{j \in \mathbb{Z}}$ must be k -periodic. However, these biinfinite sequences only use digits among $\{0, 1, 2\}$ so there are a finite number of such sequences. In particular, two of these sequences are the same. Since one is obtained from the other by applying the correct succession σ_i s, we get a periodic sequence that is a fixpoint of some $s = \sigma_{i_N} \circ \dots \circ \sigma_{i_1}$ for some $i_1, \dots, i_N \in \{0, \dots, n - 1\}$. This contradicts Lemma 3.3.9. \square

The case $n = 2$ being a degenerate case, we begin by building a weakly periodic configuration in the case where $n \geq 3$.

Lemma 3.3.11. *There exists a weakly periodic configuration in $X^{\tau\sigma}$ for $n \geq 3$.*

Proof. We define w as the unique fixpoint of σ_1 obtained thanks to Lemma 3.3.8.

Let $f(k) = \lfloor \frac{k}{n} \rfloor$ be the function maps k to the quotient in the euclidean division of k by n and $r(k)$ its remainder. We also define $F(k) = f(k+1)$ and $R(k) = r(k+1)$.

$X^{\tau\sigma}$ is nonempty We define a configuration x describing which tile (c_g, i_g) is assigned to g , i.e. $x_g = (c_g, i_g)$, using the canonical form $g = b^{-k}a^l b^m$. Then, we check that x does verify the adjacency rules of X^τ . Define $x \in \tau_\sigma^{BS(1,n)}$ by

$$\begin{cases} x_{b^{-k}a^l} := (w_l, 1) \\ x_{b^{-k}a^l b^m} := (w_{F^m(l)}, R \circ F^{m-1}(l)) \text{ for } m > 0. \end{cases}$$

Let us prove that $x \in X^{\tau\sigma}$. Let $g = b^{-k}a^l b^m$.

- If $m > 0$, we have

$$\begin{aligned} x_{ga}(\text{left}) &= x_{b^{-k}a^{l+n^m}b^m}(\text{left}) \\ &= R \circ F^{m-1}(l + n^m) \\ &= R \circ F^{m-1}(l) \\ &= x_g(\text{right}). \end{aligned}$$

- If $m = 0$, we have

$$\begin{aligned} x_{ga}(\text{left}) &= x_{b^{-k}a^{l+1}}(\text{left}) \\ &= R \circ F^{m-1}(1) \\ &= x_g(\text{right}). \end{aligned}$$

Let $j \in \{0, \dots, n-1\}$. We have

$$\begin{aligned} x_{ga^{-j}b}(\text{bottom}_{j+1}) &= x_{b^{-k}a^{l-jn^m}b^{m+1}}(\text{bottom}_{j+1}) \\ &= \sigma_{R \circ F^m(l-jn^m)}(w_{F^{m+1}(l-jn^m)})_j \\ (\text{Lemma 3.3.6}) &= \sigma_{R \circ F^m(l-jn^m)}(w)_{nF^{m+1}(l-jn^m)+j} \\ (\text{Lemma 3.3.7}) &= \sigma(w)_{nF^{m+1}(l-jn^m)+j+R \circ F^m(l-jn^m)} \\ (\text{by definition of } F \text{ and } R) &= \sigma(w)_{F^m(l-jn^m)+j+1} \\ (\text{Lemma 3.3.7}) &= \sigma_1(w)_{F^m(l-jn^m)+j} \\ (\text{since } w \text{ is a fixpoint of } \sigma_1) &= w_{F^m(l-jn^m)+j} \\ (F^m(l-jn^m)+j = F^m(l)-j+j) &= w_{F^m(l)} \\ &= x_g(\text{top}) \end{aligned}$$

All adjacency conditions are verified, consequently x describes a valid configuration of $X^{\tau\sigma}$.

The configuration x is b -periodic With the definition of x , it is easy to check that for any $g \in BS(1, n)$, $x_{bg} = x_g$. Hence it is a weakly periodic configuration. \square

We can now obtain our main theorem:

Theorem 3.3.12. *For $n \geq 2$, the tilename τ_σ forms a weakly aperiodic but not strongly aperiodic SFT on $BS(1, n)$.*

Proof. First, in the $n \geq 3$ case, there is a weakly periodic configuration in X^{τ_σ} by Lemma 3.3.11. Hence it is not a strongly aperiodic SFT.

In the case $n = 2$, we define u and v the two fixpoints of σ_1^2 (Lemma 3.3.8 again) and remark that $v = \sigma_1(u)$ and $u = \sigma_1(v)$. We define a configuration $x \in \tau_\sigma^{BS(1, n)}$ by:

$$x_{b^{-k}a^l} := \begin{cases} (u_l, 1) & \text{if } k + m \equiv 0 \pmod{2} \\ (v_l, 1) & \text{if } k + m \equiv 1 \pmod{2} \end{cases}$$

$$x_{b^{-k}a^l b^m} := \begin{cases} (u_{F^m(l)}, R \circ F^{m-1}(l)) & \text{for } m > 0 \text{ if } k + m \equiv 0 \pmod{2} \\ (v_{F^m(l)}, R \circ F^{m-1}(l)) & \text{for } m > 0 \text{ if } k + m \equiv 1 \pmod{2} \end{cases}$$

and we use the same notations as in the proof of Lemma 3.3.11. The reasoning is also the same, except instead of using w an alternation appears between u and v in all the equations. As a consequence, the configuration is b^2 -periodic instead of b . Once again, X^{τ_σ} is consequently not strongly aperiodic.

Now, using Lemma 3.3.10, and since all powers of a are of infinite order in $BS(1, n)$, we get that for any valid configuration x of X^{τ_σ} , $|Orb_{BS(1, n)}(x)| = +\infty$, for any $n \geq 2$. Hence no configuration of X^{τ_σ} is strongly periodic, and so the SFT is weakly aperiodic. \square

3.3.4 Shift-similar Substitutions

The main interest of the σ_i s in our proof is that if a biinfinite word can be de-substituted by one of the σ_i s, then with a proper translation it can be de-substituted by any shift of it, and the resulting word will be the same for all shifts. This fact is at the core of Lemma 3.3.6, itself central in the proof of Theorem 3.3.12. A natural question is then: can we find other substitutions ς with this convenient property? We will restrict ourselves to substitutions on the two-letter alphabet \mathcal{A} and of constant size $n \in \mathbb{N}, n \geq 2$.

Definition 3.3.1. We say that a substitution ς is *shift-similar* if for every $i \in \{0, \dots, n\}$, the sets

$$S_i = \left\{ (\varsigma(0)\varsigma(0))_{i..i+n-1}, (\varsigma(0)\varsigma(1))_{i..i+n-1}, \right. \\ \left. (\varsigma(1)\varsigma(0))_{i..i+n-1}, (\varsigma(1)\varsigma(1))_{i..i+n-1} \right\}$$

all have cardinal at most 2.

This condition reflects what we truly need to encode a substitution in the Cayley graph of $BS(1, n)$: at most two types of n -long subwords of juxtapositions like $\varsigma(0)\varsigma(1)$, so that we have at most two ways to associate a letter – that is, 0 or 1 – to each of them when going "up" in the Cayley graph.

Note that if there is some $i_0 \in \{0, \dots, n\}$ such that S_{i_0} has cardinal 1, then $(\varsigma(0)\varsigma(0))_{i_0..i_0+n-1} = (\varsigma(1)\varsigma(1))_{i_0..i_0+n-1}$ and so $\varsigma(0) = \varsigma(1)$. As a consequence, all S_i have cardinal 1. It is easy to see that these three properties are equivalent.

We say that a shift-similar substitution is *non-trivial* if one S_i has cardinal 2, or equivalently all S_i have cardinal 2, or equivalently $\varsigma(0) \neq \varsigma(1)$. In that case, we write these sets $S_i = \{A_i, B_i\}$ with $A_i = (\varsigma(0)\varsigma(0))_{i..i+n-1}$ and $B_i = (\varsigma(1)\varsigma(1))_{i..i+n-1}$. We can then define $n + 1$ substitutions $\varsigma_0, \dots, \varsigma_n$ by

$$\varsigma_i : \begin{cases} 0 \mapsto A_i \\ 1 \mapsto B_i \end{cases}.$$

As before, we call these substitutions *shifts of ς* . Note that $\varsigma_0 = \varsigma_n = \varsigma$.

For example, the substitution $\sigma_0 : \begin{cases} 0 \mapsto 001 \\ 1 \mapsto 000 \end{cases}$ defined before is shift-similar. Indeed, the two image words differ by only one letter, hence the sets S_i are of cardinal 2.

Surprisingly, it turns out that the particular definition we had in Section 3.3.3 is the only way of defining a non-trivial shift-similar substitution.

Theorem 3.3.13. *Over an alphabet of size two, ς is a non-trivial shift-similar substitution if and only if there exists i_0 such that $\varsigma(0)_i = \varsigma(1)_i$ for all $i \neq i_0$ and $\varsigma(0)_{i_0} \neq \varsigma(1)_{i_0}$.*

Proof. To simplify notations, we write $\alpha = \varsigma(0)$ and $\beta = \varsigma(1)$. It is clear that if there exists i_0 such that $\alpha_i = \beta_i$ for all $i \neq i_0$ and $\alpha_{i_0} \neq \beta_{i_0}$, then ς is a non-trivial shift-similar substitution.

For the other direction, let us consider ς a non-trivial shift-similar substitution. Let $i \in \{0, \dots, n\}$. For S_i to be of cardinal 2, necessarily one of the following cases must be true (see Fig. 3.10):

- 1) $(\alpha\alpha)_{i..i+n-1} = (\alpha\beta)_{i..i+n-1}$ and $(\beta\alpha)_{i..i+n-1} = (\beta\beta)_{i..i+n-1}$
- 2) $(\alpha\alpha)_{i..i+n-1} = (\beta\alpha)_{i..i+n-1}$ and $(\alpha\beta)_{i..i+n-1} = (\beta\beta)_{i..i+n-1}$
- 3) $(\alpha\alpha)_{i..i+n-1} = (\beta\beta)_{i..i+n-1}$ and $(\alpha\beta)_{i..i+n-1} = (\beta\alpha)_{i..i+n-1}$.

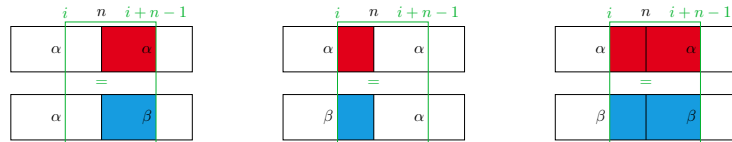

Figure 3.10 – The three cases for S_i to be of cardinal 2: the window in green represents an equality, and the colored portions are the consequent parts of α and β made equal.

First, if case 3) is true for even one single index i , then the shift-similar substitution is a trivial one, because then $\varsigma(0) = \varsigma(1)$.

Therefore, for any i , one must have either 1) or 2). Case 1) is true for $i = 0$ and 2) is true for $i = n$, otherwise $\alpha = \beta$ and the substitution is trivial. Consequently, there exists some $i_0 \in \{0, \dots, n - 1\}$ such that 1) is true for $i = i_0$ and 2) is true for $i = i_0 + 1$.

Case 1) being true for $i = i_0$ implies that α and β agree from indices 0 to $i_0 - 1$ (this being possibly an empty interval). Case 2) being true for $i = i_0 + 1$ implies that α and β agree from indices $i_0 + 1$ to $n - 1$.

Hence α and β agree everywhere except on their i_0^{th} letter. \square

Remark. The notion of recognizability by Mossé [Mos92] may seem rather close to the one of shift-similarity: it expresses the idea that for a substitution σ , any element in

X_σ (the substitutive shift, see for instance [Ber+19]) can be uniquely cut into blocks that determine its antecedent. Considering Theorem 3.3.13, one can check that any shift-similar substitution and its shifts are recognizable in the sense of Mossé.

However, consider the substitution

$$\sigma : \begin{cases} 0 \mapsto 0001 \\ 1 \mapsto 1110 \end{cases}$$

and its shifts $\sigma_1, \sigma_2, \sigma_3$. All of them are recognizable in the sense of Mossé, yet σ is not shift-similar since it is not of the form given by Theorem 3.3.13.

As a consequence, shift-similarity implies recognizability, but the converse is not true.

It is really interesting that the very particular substitution σ_0 defined above is in fact the only binary substitution that is possible to encode in $BS(1, n)$ (with our encoding method). An interesting perspective would be to find the generalization of Definition 3.3.1 for bigger alphabets and see if an analogous of Theorem 3.3.13 still holds.

Another open question is whether $BS(m, n)$ has a strongly aperiodic SFT. As our method use Aubrun and Kari's construction, it is of no use here, and there exists no other aperiodic SFT over $BS(m, n)$ to our knowledge.

3.4 The Domino Problem on Surface Groups

Surface groups are of particular interest for Conjecture 1 because they fall off all the solved cases. They can also be seen as a natural generalization of \mathbb{Z}^2 – which is the surface group of genus one – thus suggesting that the domino problem might be undecidable for them. Moreover, in 2017 Cohen and Goodman-Strauss found a strongly aperiodic SFT for the surface groups [CG17]. Although it does not formally imply anything about the domino problem, the existence of a strongly aperiodic SFT is often a strong hint towards the undecidability of the domino problem. A key element of their proof is the idea that the Cayley Graph of surface groups is very similar to an orbit graph of well-chosen substitution. Regarding the domino problem, the closest result to a substitution-related structure is Kari's proof of the undecidability of the domino problem for the hyperbolic plane [Kar08], whose tilings can be seen as SFTs over the orbit graph of the substitution $0 \mapsto 00$. However, a direct adaptation of this proof works only for substitutions of constant size, which is not the case of the surface groups. Like in the previous section, we make use of a normal form in the group. Nonetheless in this case, the normal form is harder to see in terms of generators of the group, and we need to define an SFT that "draws" directions in the Cayley Graph, allowing us to find this normal form effectively.

After showing how orbit graphs can be found inside surface groups (Section 3.4.1), we show how ideas from Cohen and Goodman-Strauss can be used to the same for more general substitutions (Section 3.4.2), including the ones we need for the surface groups. These results have been published in [ABM19].

3.4.1 Finding Orbit Graphs in Surface Groups

Surface Groups

Surface groups are the groups that are isomorphic to the fundamental group of some surface of genus $g \geq 1$. For our purpose, we are interested by the presentation of surface groups:

$$G_g = \langle a_1, b_1, \dots, a_g, b_g \mid [a_1, b_1] \cdots [a_g, b_g] \rangle,$$

where $[a, b] = aba^{-1}b^{-1}$ is the commutator of a and b . The cycles of minimum size of the Cayley graph of G_g are always $2g$ -cycles, labeled by cyclic permutations of $[a_1, b_1] \cdots [a_g, b_g]$. We call these minimal cycles the *elementary cycles* of the graph.

It is interesting to notice that the surface group of genus 1 is $\langle a, b \mid ab = ba \rangle \cong \mathbb{Z}^2$, explaining how surface groups of genus grater than one are generalization of \mathbb{Z}^2 , for which the domino problem is undecidable. In the few examples we have, the method used to prove that the domino problem is undecidable for groups often relies on finding \mathbb{Z}^2 in the group. This is for example the case of the proof of Jeandel for groups of the form $G_1 \times G_2$ with G_1 and G_2 infinite. However the hyperbolic nature of surface groups makes it hard to find a regular grid in them. Following the idea from Cohen and Goodman-Strauss [CG17], we are able to find an orbit graph of a substitution, and do a reduction from his case.

Two groups are G_1 and G_2 are *commensurable* if there exist subgroups $H_1 \subseteq G_1$ and $H_2 \subseteq G_2$ of finite index such that H_1 is isomorphic to H_2 . The decidability of the domino problem of finitely generated groups is known to be a commensurability invariant (Corollary 9.3.34 of [ABJ18]). All surface groups of genus $g \geq 2$ are commensurable (Proposition 6.7 of [CK17]). Thus, it is enough to prove that the domino problem is undecidable for the surface group of genus 2. In this section, we will call G the surface group of genus 2 (that will be simply called surface group from now on)

$$G = \langle a, b, c, d \mid [a, b][c, d] \rangle.$$

The generating set $\{a, b, c, d\}$ will be called S .

We now do the reduction of the domino problem on the surface group from the domino problem of an orbit graph of a substitution, that we will show to be undecidable in Section 3.4.2.

An Orbit Graph in the Surface Group

Let us call $\mathcal{C}_G = \Gamma(G, S)$ the Cayley graph of the surface group given by S . In order to define a distance on G we also consider $\Gamma(G, D)$, with

$$D = \{w \mid w \text{ subword of a cyclic permutation of } [a, b][c, d]\}.$$

This Cayley graph corresponds to \mathcal{C}_G with the addition of all cords in every elementary cycles (see Fig. 3.11). We then define d a distance on G :

$$d(g, h) = \min\{|w| \mid w \in D^*, gw =_G h\}.$$

Intuitively, $d(g, h)$ is the smallest number of elementary cycles that must be crossed to go from g to h in \mathcal{C}_G . Let $B_i = \{g \in G \mid d(1_G, g) \leq i\}$ be the ball of radius i for this distance and $C_i = \{g \in G \mid d(1_G, g) = i\}$ the sphere of radius i , so that $B_{i+1} \setminus B_i = C_{i+1}$ and the

C_i s partition G .

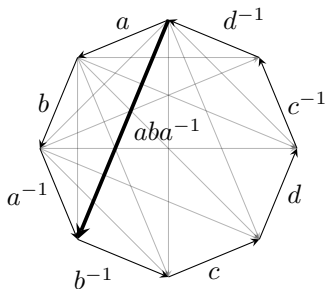

Figure 3.11 – An elementary cycle of \mathcal{C}_G with the added cords of $\Gamma(G, D)$.

The substitution then arise from the structure of the C_i s. Fix some $i \geq 1$. In \mathcal{C}_G every element of C_i have exactly two neighbors in C_i , and either:

- (a) one neighbor in C_{i-1} ;
- (b) zero neighbor in C_{i-1} .

Because of the constant degree of Cayley graphs, every element of C_i either have 5 or 6 neighbors in C_{i+1} depending of its type (a or b). For some $g \in C_i$, if we look at the types of the right neighbors of its 5 (resp. 6) neighbors in C_{i+1} , they are of types $ab^5ab^5ab^5ab^5ab^4$ (resp. $ab^5ab^5ab^5ab^5ab^5ab^4$). This leads us to define the substitution $s: \{a, b\} \rightarrow \{a, b\}^*$ by

$$\begin{cases} s(a) = (ab^5)^4ab^4 \\ s(b) = (ab^5)^5ab^4. \end{cases}$$

This substitution is defined so that neighbors of $g \in C_i$ that are in C_i can be seen as neighbor letters in the substitution, neighbors in C_{i-1} as the parents (if they exists), and neighbors in C_{i+1} as the sons of words produced by applying s (see Fig. 3.12).

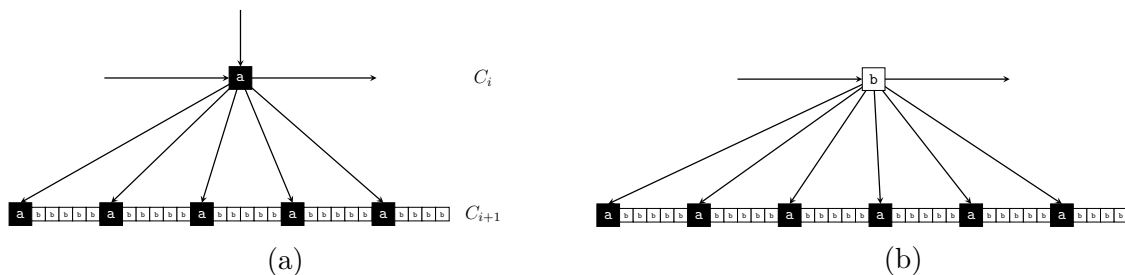

Figure 3.12 – The two types of elements in \mathcal{C}_G and the corresponding sequences of type under them in C_{i+1} .

From now on, we fix $\Omega = (\omega^i, P_i)_{i \in \mathbb{Z}}$ an orbit of the substitution s defined above, and denote by Θ its associated orbit graph. Let us note that s admits an expanding eigenvalue ($\lambda = 17 + 12\sqrt{2}$ and $v(b)/v(a) = \frac{1+\sqrt{2}}{2}$).

The two graphs \mathcal{C}_G and Θ are so similar that in fact the decidability of their domino problem is equivalent. In order to prove this we will do a reduction from the domino problem on Θ (that we will show to be undecidable in Section 3.4.2) to the domino problem on \mathcal{C}_G . Formally, it is enough to build a computable map that sends sets of

patterns over Θ to set of patterns over \mathcal{C}_G . This map is not trivial since \mathcal{C}_G has strictly less edges than Θ , therefore this "lost information" has to be reconstructed from the edges we have in \mathcal{C}_G . Fortunately, this is possible to do, and even in a local way: we are able to create an SFT X over \mathcal{C}_G that recovers the information carried by the missing edges between \mathcal{C}_G and Θ . Note that an SFT is not required to do the reduction, but it provides a locally computable map, which is a nice bonus.

Definition of X

To define the SFT X , we introduce a notion of directions that will correspond to following edges of the orbit graph. More formally, let us first consider the general alphabet \mathcal{A}_0 , consisting of the tuples

$$(c, (h_1, d_1), (h_2, d_2), \dots, (h_8, d_8))$$

such that:

- $c \in \{\blacksquare, \square\}$ is a color,
- (h_1, \dots, h_8) is a permutation of $(a, a^{-1}, b, b^{-1}, c, c^{-1}, d, d^{-1})$, the generators of G and their inverses,
- $d_1, \dots, d_8 \in \{\leftarrow, \rightarrow, \uparrow, \downarrow_1, \downarrow_2, \downarrow_3, \downarrow_4, \downarrow_5, \downarrow_6\}$ the directions associated to each generator.

Let $x \in \mathcal{A}_0^G$ be a configuration over \mathcal{A}_0 . For every $g \in G$, if the first coordinate of x_g is $c = \blacksquare$ (resp. $c = \square$), we call x_g a *black* (resp. *white*) cell.

The alphabet $\mathcal{A}_1 \subseteq \mathcal{A}_0$ is made of three types of elements with more precise directions imposed, depending on the color c :

$$(\blacksquare, (h_1, \leftarrow), (h_2, \rightarrow), (h_3, \uparrow), (h_4, \downarrow_1), (h_5, \downarrow_2), (h_6, \downarrow_3), (h_7, \downarrow_4), (h_8, \downarrow_5))$$

$$(\square, (h_1, \leftarrow), (h_2, \rightarrow), (h_3, \downarrow_1), (h_4, \downarrow_2), (h_5, \downarrow_3), (h_6, \downarrow_4), (h_7, \downarrow_5), (h_8, \downarrow_6))$$

Black cells have directions *left*, *right*, *up* and *down*, whereas whites ones have only *left*, *right* and *down*. Note that for both cells, *up*, *left* and *right* are unique. We can then define their top, left and right neighbors.

Definition 3.4.1. Let $x \in \mathcal{A}_1^G$ be a configuration over \mathcal{A}_1 and $g \in G$. We define:

- gh_1 the *left neighbor* of g in x , denoted by $\leftarrow_x(g)$,
- gh_2 is the *right neighbor* of g in x , denoted by $\rightarrow_x(g)$,
- If x_g is a black cell, gh_3 is the *top neighbor* of g in x , denoted by $\uparrow_x(g)$,
- gh_{3+i} for $i \in \{1, \dots, 5\}$, (resp. gh_{2+i} for $i \in \{1, \dots, 6\}$ for a white cell) is the *i -th bottom neighbor* of g in x , denoted by $\downarrow_{i,x}(g)$.

Let us call \mathcal{F}_1 the set of all elementary cycles that are not of the form of Fig. 3.13, and we want to forbid these patterns to appear in X . We also impose the orientations to be as drawn on the figure. For example, the right generator of $\blacksquare a$ is g_2 , its top generator is g_1^{-1} , and the other directions of a are not constrained by this cycle. Similarly, the left generator of $\square b$ is g_2^{-1} , its right generator g_3 and other directions unconstrained.

We also add the constraint that directions must be consistent between adjacent cells. To do so, we define the set \mathcal{F}_2 , which is the set of patterns on the support $\{1_G, h\}$ for

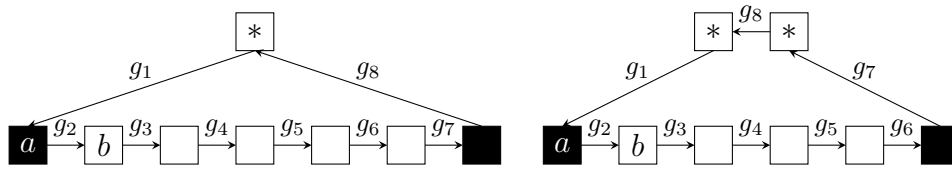

Figure 3.13 – The two possible types of colorings of elementary cycles. There are no color constraints on $\boxed{*}$, and the cycle $g_1 \dots g_8$ is any cyclic permutation of $[a, b][c, d]$.

$h \in S$, such that x_{1_G} and x_h are linked by mismatching directions. That is,

$$\mathcal{F}_2 = \left\{ \begin{array}{l} \text{pattern } p \text{ of support } \{1_G, h\} \\ \left. \begin{array}{l} \leftarrow_p(1_G) = h \text{ and } \rightarrow_p(h) \neq 1_G \text{ or} \\ \rightarrow_p(1_G) = h \text{ and } \leftarrow_p(h) \neq 1_G \text{ or} \\ \uparrow_p(1_G) = h \text{ and } \forall i, \downarrow_{i,p}(h) \neq 1_G \text{ or} \\ \exists i, \downarrow_{i,p}(1_G) = h \text{ and } \uparrow_p(h) \neq 1_G \end{array} \right\} \end{array} \right\}.$$

→ X is the subshift over G with alphabet \mathcal{A}_1 and set of forbidden patterns $\mathcal{F}_1 \cup \mathcal{F}_2$.

Note that because $\mathcal{F}_1 \cup \mathcal{F}_2$ is finite, X is an SFT.

Non-emptiness of X

A simple way to show that there is always a configuration $x \in X$ is to construct it as a limit of a sequence of configurations $(y_n)_{n \in \mathbb{N}}$ of another SFT X_2 . This other SFT will be similar to X , but with an extra orange tile. More precisely, we have $X_2 \subset (\mathcal{A}_1 \cup \{\text{orange}\})^G$, with

$$\text{orange} := \left(\blacksquare, (a, \downarrow_1), (a^{-1}, \downarrow_2), (b, \downarrow_3), (b^{-1}, \downarrow_4), (c, \downarrow_5), (c^{-1}, \downarrow_6), (d, \downarrow_7), (d^{-1}, \downarrow_8) \right).$$

We can extend the definitions of left, right, top and bottom neighbors consistently with this new element in the alphabet. Then, we call \mathcal{F}'_1 and \mathcal{F}'_2 the extensions of \mathcal{F}_1 and \mathcal{F}_2 with the new color and the extended definitions of neighbors.

→ X_2 is the subshift over G with alphabet \mathcal{A}_1 and set of forbidden patterns $\mathcal{F}'_1 \cup \mathcal{F}'_2$.

Intuitively, because the letter **orange** has only bottom neighbors, the presence of an orange cell will create *rings* (see Fig. 3.14 and Lemma 3.4.1).

Definition 3.4.2. $L \subset G$ is a set of *left-right neighbors* of $x \in X_2$ if we can access all its elements by taking only their left and right neighbors, i.e. for every $g \in L$, we have $L = \{\dots, \leftarrow_x^3(g), \leftarrow_x^2(g), \leftarrow_x(g), g, \rightarrow_x(g), \rightarrow_x^2(g), \rightarrow_x^3(g), \dots\}$.

If L is finite, it is called a *ring*, if it is infinite it is called a *line*.

Lemma 3.4.1. For all i , there exists a pattern $p_i \in (\mathcal{A}_1 \cup \{\text{orange}\})^{B_i}$ containing no forbidden patterns of \mathcal{F} and such that $(p_i)_g$ is an orange cell if and only if $g = 1_G$.

Proof. By induction on i , we prove a stronger statement:

\mathcal{H}_i : "There exists a coloring of B_i , in which the orange tile appears, but only at the origin. Moreover, in this coloring, C_j is a ring for all $j \leq i$."

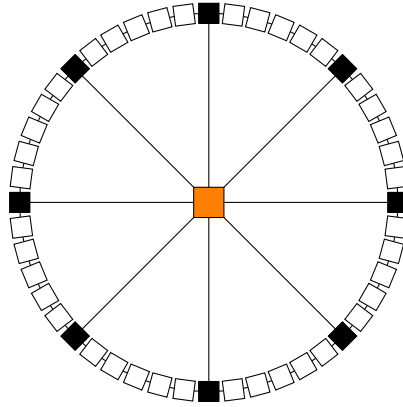

Figure 3.14 – Coloring of B_1 .

For $i = 1$, apply the first cycle of Fig. 3.13 eight times, and from the orange origin, get the sphere of radius 1, which is a cycle as stated (see Fig. 3.14).

Now suppose we have a coloring of B_i as in the statement. We will use the cycles of Fig. 3.13 on the ring C_i to build C_{i+1} . We are sure that all the cells on C_i are only black and whites due to the induction hypothesis on the orange cell. Each of the black cells on C_i must have 5 *bottom* cells, and each white one needs 6. We proceed iteratively, starting from any cell c and any *down* generator g_1 of this cell. As the two possible cycles start the same, we put the colors $\blacksquare, \square, \square, \square, \square$ following the generators g_1, g_2, g_3, g_4, g_5 , with the consistent orientation. For the two next colors, it depends where g_8 leads. If it leads to C_{i+1} , we are in the first case of Fig. 3.15, and we use the colors of the first cycle. We start the process again but with cell c and generator g_8^{-1} . If g_8 leads to C_i , we are in the second case of Fig. 3.15, and we use the corresponding colors. We then start again but with the cell c' and generator g_7^{-1} . We continue this process until all cells of C_i have their bottom neighbors colored.

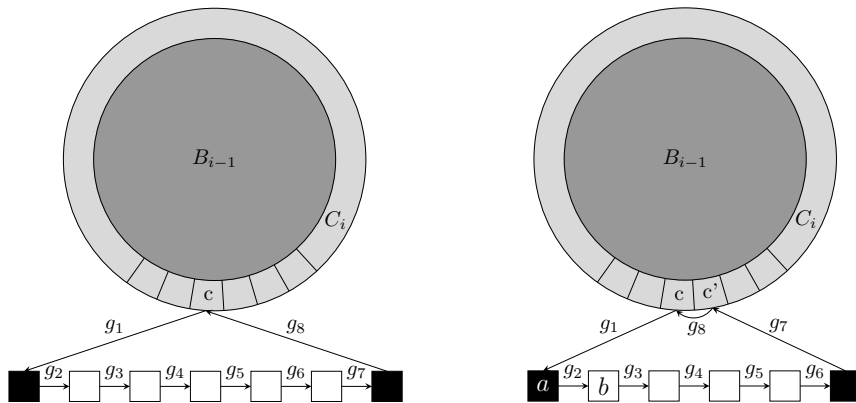

Figure 3.15 – From B_i to B_{i+1} .

With this process, we colored a new ring, which is exactly C_{i+1} . Indeed, the newly colored cells are in C_{i+1} , because one cycle separates them from C_i and there are no other cells in C_{i+1} because adding one cycle to these will increase the distance to $i + 2$.

Because $B_{i+1} = B_i \cup C_{i+1}$, we now have colored B_{i+1} . We have not placed any new orange tile, so the only one is the one from B_i i.e., by induction hypothesis, the origin.

Therefore, the statement is proved for $i + 1$. □

We can now use these patterns to build a configuration of X .

Lemma 3.4.2. *X is not empty.*

Proof. By compactness of $(\mathcal{A}_1 \cup \{\text{orange}\})^G$ there exists a configuration $\tilde{x} \in X_2$ which coincides with all p_i s of Lemma 3.4.1. In particular, the orange tile appears only at the origin of \tilde{x} . By compactness and shift-invariance of X_2 , there exists $x \in X_2$ that have no orange tile.

The last step is to remark that X contains exactly the configurations of X_2 with no orange tile, therefore $x \in X$. □

Configurations of X

Now that we know that X is non-empty, we take a look at some properties of its configurations which will be useful for our reduction.

We first show that without the orange tile, configurations cannot have rings: they can only have infinite lines. We prove the contrapositive:

Lemma 3.4.3. *If there is a ring in a configuration of X_2 , then orange must appear.*

In particular, it means that X contains no configuration with a ring.

Proof. Let $C \subset G$ be a ring of $x \in X_2$. As patterns from \mathcal{F}_1 do not appear in X_2 , unless C is a singleton and $x|_C = \text{orange}$, it must contain at least eight elements and at least two of them must be black cells and hence have top neighbors. The key point is that $C_1 := \uparrow_x(C) = \{\uparrow_x(g) \mid g \in C\}$ is also a ring, but with strictly less elements. Indeed, because all cycles are colored like Fig. 3.13, we know that the top neighbors of C are organized as a ring (we can "stick" cycles all around C). And this ring is strictly smaller than the previous one, because for each 7 our 6 cells of C we have 1 or 2 cells in C_1 (see Fig. 3.16).

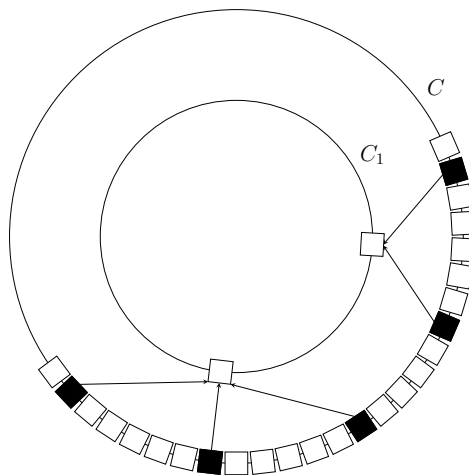

Figure 3.16 – Top neighbors of rings are smaller rings.

Iterating the process of taking the top neighbor ring every time, we reduce the size of C which is finite. The process necessarily ends with the ring of size one. Then, $\{\text{orange}\}$ the only possible ring with one element, since for any other cell x_g , $\rightarrow_x(g) \neq g$. And therefore orange appears in x . \square

Because X does not have the orange cell in its alphabet \mathcal{A}_2 , there cannot be any rings in its configurations by Lemma 3.4.3. It means that starting from any element, one can take its right neighbor infinitely many times and never loop on the initial element. This forms infinite lines (in the sense of Definition 3.4.2), which are all above and below the others (Fig. 3.17), thanks to the way cycles are colored.

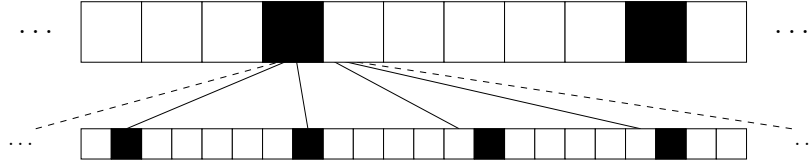

Figure 3.17 – Infinite lines of X .

These lines have the same structure as an orbit graph: each black cell has 5 (black) bottom children with 24 whites on the line, and each white cell has 6 bottom children with 29 whites on the line. Exactly the same way as in the orbit graph Θ .

Moreover, we can show that these lines induce a height function on G : when going down, one never comes back to an upper line. This is a corollary of the following lemma, stating that if one take a loop of directions (in the sense of the neighbors in X), there are the same number of "up" than "down".

Lemma 3.4.4. *Let $x \in X, g \in G$ and $a_1, \dots, a_k \in \{\leftarrow_x, \rightarrow_x, \uparrow_x, \downarrow_{1,x}, \downarrow_{2,x}, \dots\}, k > 0$ such that $a_k \circ \dots \circ a_1(g) = g$. Then*

$$|\{i \in \{1, \dots, k\} \mid a_i = \uparrow_x\}| = |\{j \in \{1, \dots, k\} \mid \exists k, a_j = \downarrow_{k,x}\}|.$$

Proof. Since $a_k \circ \dots \circ a_1(g) = g$, the sequence of moves $a_1 \dots a_k$ gives a cycle γ starting from the vertex g in the Cayley graph \mathcal{C}_G of G . By abuse of notation, we will also call a_i the labels of the edges in \mathcal{C}_G (thus from now we think of a_i as an element of $S \cup S^{-1}$). So we are given a word $w = a_1 \dots a_k \in (S \cup S^{-1})^k$ which represents the identity 1_G . Since the word problem of the surface group of genus 2 can be solved by Dehn's algorithm [SD12], this implies that we can obtain a finite sequence of words $w = w_0, w_1, w_2, \dots, w_N = 1_G$ such that $|w_i| > |w_{i+1}|$ and w_{i+1} is obtained by w_i by replacing the leftmost cyclical subword of $[a, b][c, d]$ of length at least 5 by the inverse of its complement –for instance, the word $ba^{-1}b^{-1}cd$ can be rewritten as $ba^{-1}b^{-1}cd(c^{-1}d^{-1}a)(c^{-1}d^{-1}a)^{-1} = a^{-1}cd$ – and then reducing the resulting word (eliminating pairs ss^{-1} and $s^{-1}s$ for some generator s).

Because configurations in x do not contain patterns in \mathcal{F}_2 , the operation of reducing w eliminates the same amount of up and down moves. Without loss of generality, we can replace w by its reduced version. On the Cayley graph \mathcal{C}_G , the operation of replacing a cyclical subword $u \sqsubset w$ by the inverse of its complement corresponds to decomposing the cycle γ induced by w into an elementary cycle γ_0 and the remaining cycle γ' . More precisely, if $w = w_1uw_2$, and uv is an elementary cycle with $|v| < |u|$ then w induces the cycle γ , uv the elementary cycle γ_0 and $w_1v^{-1}w_2$ the remaining cycle γ' .

We then prove the lemma by induction on the length of the chain

$$w = w_0, w_1, w_2, \dots, w_N = 1_G.$$

In what follows, if ζ is a path in \mathcal{C}_G and $a_1 \dots a_k$ its associated word on $S \cup S^{-1}$, we denote

$$\uparrow(\zeta) := |\{i \in \{1, \dots, k\} \mid a_i = \uparrow_x\}|$$

and

$$\downarrow(\zeta) := |\{j \in \{1, \dots, k\} \mid \exists k, a_j = \downarrow_{k,x}\}|.$$

If $N = 0$, then the reduced version of w is the empty word. Hence $\uparrow(\gamma) = \downarrow(\gamma)$.

If $N \geq 1$, denote $w' = w_1 v^{-1} w_2$ the word on $S \cup S^{-1}$ obtained after simplification by one cyclic permutation of $[a, b][c, d]$, γ' the resulting cycle and γ_0 the elementary cycle corresponding to the simplification as explained above (see Fig. 3.18). Denote by a_i (resp. a_j) the directed edge in γ_0 which is labeled by \uparrow_x (resp. $\downarrow_{x,k}$ for some k) in configuration x . We distinguish between four cases, depending on where a_i and a_j are located. As no patterns from \mathcal{F}_1 appear in x , the elementary cycle γ_0 satisfies $\uparrow(\gamma_0) = \downarrow(\gamma_0) = 1$, and by induction hypothesis, $\uparrow(\gamma') = \downarrow(\gamma')$. Observe also that the directed edges a_i, a_j of γ_0 are reversed if they also appear in γ' .

1. If $\gamma_0 \cap \gamma$ contains neither a_i nor a_j (see Fig. 3.18a). Then we have that

$$\uparrow(\gamma) = \uparrow(\gamma') - \downarrow(\gamma_0) = \downarrow(\gamma') - \uparrow(\gamma_0) = \downarrow(\gamma).$$

2. If $\gamma_0 \cap \gamma$ contains a_i and a_j (see Fig. 3.18b). Then we have that

$$\uparrow(\gamma) = \uparrow(\gamma') + \uparrow(\gamma_0) = \downarrow(\gamma') + \downarrow(\gamma_0) = \downarrow(\gamma).$$

3. If $\gamma_0 \cap \gamma$ contains a_i but not a_j (see Fig. 3.18c). Then we have that

$$\uparrow(\gamma) = \uparrow(\gamma') - \downarrow(\gamma_0) + \uparrow(\gamma_0) = \uparrow(\gamma') = \downarrow(\gamma') = \downarrow(\gamma).$$

4. If $\gamma_0 \cap \gamma$ contains a_j but not a_i (similar to case 3). Then we have that

$$\uparrow(\gamma) = \uparrow(\gamma') = \downarrow(\gamma') = \downarrow(\gamma') + \downarrow(\gamma_0) - \uparrow(\gamma_0) = \downarrow(\gamma).$$

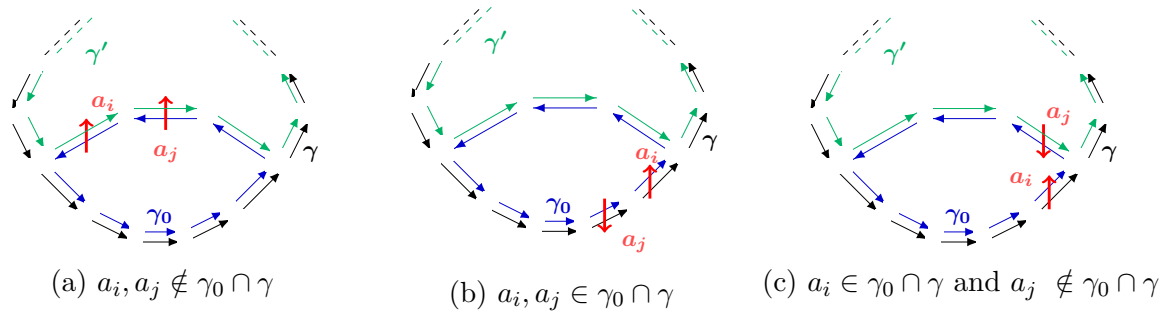

Figure 3.18 – Possible cases for the induction. The cycle γ' (in green) is obtained from the cycle γ (in black) by deletion of one elementary cycle γ_0 (in blue).

□

Let us define $\rightarrow_x^{-1}(g) = \leftarrow_x(g)$, $\downarrow_{1,x}^{-1}(g) = \uparrow_x(g)$, and 1_G to be the identity of G . Using this notation and the informations encoded by X , we can express any element of G with a normal form.

Lemma 3.4.5. *For any $g \in G$ and $x \in X$, there exists i, j such that $g = \rightarrow_x^j \circ \downarrow_{1,x}^i(1_G)$.*

Note that because it uses the neighbor notation, the generators appearing in this normal form in fact depend on the choice of the configuration x .

Proof. Let $x \in X$ and $g \in G$. As each symbol of \mathcal{A}_2 contains all 8 directions, it is clear that there exist $a_1, \dots, a_k \in \{\leftarrow_x, \rightarrow_x, \uparrow_x, \downarrow_{1,x}, \downarrow_{2,x}, \dots\}$ such that $g = a_k \circ \dots \circ a_1(1_G)$.

First, we can get rid of all \downarrow that are not \downarrow_1 , indeed for any l , $\downarrow_{l,x} = \rightarrow_x^{6(l-1)} \circ \downarrow_{1,x}$ (see Fig. 3.19). So, by transforming all \downarrow like this, we obtain $i_1, \dots, i_l \in \mathbb{Z}$ such that $g = \downarrow_{1,x}^{i_l} \circ \rightarrow_x^{i_{l-1}} \dots \circ \downarrow_{1,x}^{i_2} \circ \rightarrow_x^{i_1}(g)$.

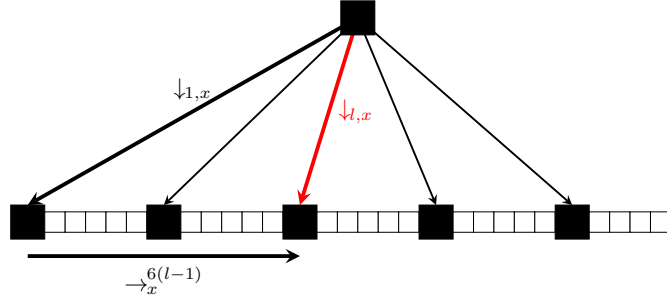

Figure 3.19 – Transformation to get only \downarrow_1 down operations.

Let us concentrate on $\downarrow_{1,x}^n \circ \rightarrow_x^m(h)$ for some $m, n \in \mathbb{Z}$ and $h \in G$. Let w be the word of size m such that $w_i = x_{\rightarrow_x}(h)$ for $i \in \{1 \dots m\}$. Then, as shown of Fig. 3.20, $\downarrow_{1,x}^n \circ \rightarrow_x^m(h) = \rightarrow_x^{|s(w)|} \circ \downarrow_{1,x}^n(h)$. By doing this operation on all incorrectly ordered operations in the sequence, and obtain i and j such that $g = \rightarrow_x^j(\downarrow_{1,x}^i(1_G))$.

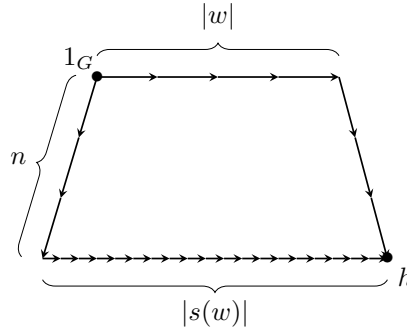

Figure 3.20 – Transformation to reorder the operations.

□

A bijection between Θ and the surface group

This normal form allows us to make a bijection between vertices of \mathcal{C}_G (that are elements of G) and vertices of θ (that are elements of \mathbb{Z}^2). Let us fix some $x \in X$, that exists since $X \neq \emptyset$. We define $f_x: \mathbb{Z}^2 \rightarrow G$ to be the following:

$$f_x(i, j) = \rightarrow_x^j \circ \downarrow_{1,x}^i(1_G).$$

Lemma 3.4.6. *For every $x \in X$, the function f_x is a bijection.*

Proof. First, f is well-defined because the operations $\rightarrow_x(g)$ and $\downarrow_{1,x}(g)$ are both well-defined for any $g \in G$. The existence of $i, j \in \mathbb{Z}$ such that $g = \rightarrow_x^j \circ \downarrow_{1,x}^i(1_G)$ is ensured by Lemma 3.4.5.

For the uniqueness of such i, j , let us assume there are $i', j' \in \mathbb{Z}$ such that $g = \rightarrow_x^{j'} \circ \downarrow_{1,x}^{i'}(1_G)$. Since $g^{-1} \cdot g = 1_G$, we get

$$\downarrow_{1,x}^{-i'} \circ \rightarrow_x^{-j'}(g) = \downarrow_{1,x}^{-i'} \circ \rightarrow_x^{-j-j'} \circ \downarrow_{1,x}^i(1_G) = 1_G.$$

Lemma 3.4.4 ensures that $i = i'$. Then, because we only consider $\downarrow_{1,x}$ operations (the first bottom neighbor and not the others), their inverses are \uparrow_x operations. It means that the only way of having a cycle is to have $\downarrow_{1,x}^{-i'}(1_G) = \downarrow_{1,x}^{-i'} \circ \rightarrow_x^{j-j'}(1_G)$. Thus we have a cycle using only right operations (or only left operations), Lemma 3.4.3 ensures that $j = j'$ since the only way of having a cycle with only right (or only left) operations is to not apply any. □

We can moreover prove that f_x also preserves locality between the two graphs.

Lemma 3.4.7. *The following equivalences are true:*

1. $\begin{cases} (u, v) \in E_\Theta \\ L_\Theta(u, v) = \mathbf{next} \end{cases} \Leftrightarrow f_x(v) = \rightarrow_x(f_x(u))$
2. $\begin{cases} (u, v) \in E_\Theta \\ L_\Theta(u, v) = k \in \{0, \dots, M-1\} \end{cases} \Leftrightarrow f_x(v) = \rightarrow_x^k \circ \downarrow_{1,x}(f_x(u))$
where M is the number of sons of u .

Proof. 1. If $L_\Theta(u, v) = \mathbf{next}$, then $(u, v) = ((i, j), (i, j + 1))$, and so $f_x(v) = \rightarrow_x^{j+1} \circ \downarrow_{1,x}^i(1_G) = \rightarrow_x(f_x(u))$.

Conversely, assume $f_x(v) = \rightarrow_x(f_x(u))$. Consider i, j such that $f_x(u) = \rightarrow_x^j \circ \downarrow_{1,x}^i(1_G)$. Then $f_x(v) = \rightarrow_x^{j+1} \circ \downarrow_{1,x}^i(1_G)$, implying that $(u, v) = ((i, j), (i, j + 1))$ by definition of f_x . Then, we can only have $L_\Theta(u, v) = \mathbf{next}$.

2. Assume that $L_\Theta(u, v) = k$, we know that $(u, v) = ((i, j), (i + 1, \Delta_{i+1}(j) + k))$ and so $f_x(v) = \rightarrow_x^{\Delta_{i+1}(j)+k} \circ \downarrow_{1,x}^{i+1}(1_G) = \rightarrow_x^k \circ \downarrow_{1,x} \circ \rightarrow_x^j \circ \downarrow_{1,x}^i(1_G) = \rightarrow_x^k \circ \downarrow_{1,x}(f_x(u))$ by definition of $\Delta_{i+1}(j)$.

Conversely suppose $f_x(v) = \rightarrow_x^k \circ \downarrow_{0,x}(f_x(u))$. Assume also that $f_x(u) = \rightarrow_x^j \circ \downarrow_{1,x}^i(1_G)$, then

$$\begin{aligned} f_x(v) &= \rightarrow_x^k \circ \downarrow_{1,x} \circ \rightarrow_x^j \circ \downarrow_{1,x}^i(1_G) = \rightarrow_x^k \circ \rightarrow_x^{\Delta_{i+1}(j)} \circ \downarrow_{1,x}^{i+1}(1_G) \\ &= \rightarrow_x^{\Delta_{i+1}(j)+k} \circ \downarrow_{1,x}^{i+1}(1_G). \end{aligned}$$

So we get $(u, v) = ((i, j), (i + 1, \Delta_{i+1}(j) + k))$ and $L_\Theta(u, v) = k$. □

The bijection f_x itself cannot be a label preserving graph isomorphism, since we lack some edges in \mathcal{C}_G , but it nevertheless enjoys a useful property: if φ is a label preserving graph isomorphism for Θ , then so is $f_x \circ \varphi \circ f_x^{-1}$ for $\mathcal{C}_{G,x}$, and if φ is a label preserving graph isomorphism for $\mathcal{C}_{G,x}$, then so is $f_x^{-1} \circ \varphi \circ f_x$ for Θ , where $\mathcal{C}_{G,x}$ is a relabeling of \mathcal{C}_g according to the configuration x . So roughly speaking, any local pattern is preserved by f_x or by f_x^{-1} (see Corollary 3.4.8 below).

Corollary 3.4.8. *Let \mathcal{A} be a finite alphabet. For any configuration $c \in \mathcal{A}^G$, $p \sqsubset c \Rightarrow f_x^{-1}(p) \sqsubset f_x^{-1}(c)$. Conversely for any $d \in \mathcal{A}^\Theta$, $q \sqsubset d \Rightarrow f_x(q) \sqsubset f_x(d)$.*

Proof. Define $\mathcal{C}_{G,x}$ the oriented labeled graph obtained from \mathcal{C}_G by replacing every label in \mathcal{C}_G by the corresponding symbol in $\{\leftarrow, \rightarrow, \uparrow, \downarrow_1, \downarrow_2, \downarrow_3, \downarrow_4, \downarrow_5, \downarrow_6\}$ found in the configuration x : if $g_i \in S \cup S^{-1}$ labels $(g, g \cdot g_i)$ in \mathcal{C}_G and $(g_i, \star) \sqsubset x_g$, then \star labels $(g, g \cdot g_i)$ in $\mathcal{C}_{G,x}$. Since there is no ambiguity here, let us write $f = f_x$ in this proof for lighter notations.

We first prove that if φ is a label preserving graph isomorphism for $\mathcal{C}_{G,x}$, then so is $\psi = f^{-1} \circ \varphi \circ f$ for Θ . Obviously, ψ is a bijection as composition of bijections. Take some edge $(u, v) \in E_\Theta$, then

$$\begin{aligned} L_\Theta(u, v) = \mathbf{next} &\Leftrightarrow f(v) = \rightarrow_x(f(u)) && \text{(by Lemma 3.4.7)} \\ &\Leftrightarrow L_{\mathcal{C}_{G,x}}(f(u), f(v)) = \rightarrow_x \\ &\Leftrightarrow L_{\mathcal{C}_{G,x}}(\varphi \circ f(u), \varphi \circ f(v)) = \rightarrow_x && (\varphi \text{ is label-preserving}) \\ &\Leftrightarrow L_\Theta(f^{-1} \circ \varphi \circ f(u), f^{-1} \circ \varphi \circ f(v)) = \mathbf{next} && \text{(by Lemma 3.4.7)} \\ &\Leftrightarrow L_\Theta(\psi(u), \psi(v)) = \mathbf{next} \end{aligned}$$

and for $k \in \{0, \dots, M-1\}$,

$$\begin{aligned} L_\Theta(u, v) = k &\Leftrightarrow f(v) = \rightarrow_x^k \circ \downarrow_{1,x}(f(u)) && \text{(by Lemma 3.4.7)} \\ &\Leftrightarrow \varphi \circ f(v) = \rightarrow_x^k \circ \downarrow_{1,x}(\varphi \circ f(u)) && (\varphi \text{ is label-preserving}) \\ &\Leftrightarrow L_\Theta(f^{-1} \circ \varphi \circ f(u), f^{-1} \circ \varphi \circ f(v)) = k && \text{(by Lemma 3.4.7)} \\ &\Leftrightarrow L_\Theta(\psi(u), \psi(v)) = k. \end{aligned}$$

Assume now that $p \in A^S$, with S a finite subset of G , is a pattern that appears in a configuration $c \in \mathcal{A}^G$. By definition, there exists $\varphi: S \rightarrow T$ a label preserving graph isomorphism for \mathcal{C}_G such that

$$\varphi(p) = c|_T.$$

Define $\psi := f^{-1} \circ \varphi \circ f$. By what precedes, ψ is also a label preserving graph isomorphism for Θ , and

$$\begin{aligned} \psi(f^{-1}(p)) &= f^{-1} \circ \varphi(p) \\ &= f^{-1}(c|_T) \\ &= f^{-1}(c)|_{f^{-1}(T)}. \end{aligned}$$

So the pattern $f^{-1}(p)$ appears in the configuration $f^{-1}(c)$.

Conversely, let us prove that if φ is a label preserving graph isomorphism for Θ , then so is $\psi = f \circ \varphi \circ f^{-1}$ for $\mathcal{C}_{G,x}$. Take some edge $(u, v) \in G$, then

$$\begin{aligned} L_{\mathcal{C}_{G,x}}(u, v) = \rightarrow_x &\Leftrightarrow L_\Theta(f^{-1}(u), f^{-1}(v)) = \mathbf{next} && \text{(by Lemma 3.4.7)} \\ &\Leftrightarrow L_\Theta(\varphi \circ f^{-1}(u), \varphi \circ f^{-1}(v)) = \mathbf{next} && (\varphi \text{ is label-preserving}) \\ &\Leftrightarrow L_{\mathcal{C}_{G,x}}(f \circ \varphi \circ f^{-1}(u), f \circ \varphi \circ f^{-1}(v)) = \rightarrow_x && \text{(by Lemma 3.4.7)} \\ &\Leftrightarrow L_{\mathcal{C}_{G,x}}(\psi(u), \psi(v)) = \rightarrow_x. \end{aligned}$$

For $l \in \{0, \dots, 7\}$, if v corresponds to the $\downarrow_{l,x}$ neighbor of u in \mathcal{C}_G , it corresponds to the $6(l-1)$ -th child of $f^{-1}(u)$ in Θ and vice-versa (see Fig. 3.19). Therefore,

$$\begin{aligned}
 L_{\mathcal{C}_{G,x}}(u, v) = \downarrow_{l,x} &\Leftrightarrow L_{\Theta}(f^{-1}(u), f^{-1}(v)) = 6(l-1) && \text{(by Lemma 3.4.7)} \\
 &\Leftrightarrow L_{\Theta}(\varphi \circ f^{-1}(u), \varphi \circ f^{-1}(v)) = 6(l-1) && (\varphi \text{ is label-preserving}) \\
 &\Leftrightarrow L_{\mathcal{C}_{G,x}}(f \circ \varphi \circ f^{-1}(u), f \circ \varphi \circ f^{-1}(v)) = \downarrow_{l,x} && \text{(by Lemma 3.4.7)} \\
 &\Leftrightarrow L_{\mathcal{C}_{G,x}}(\psi(u), \psi(v)) = \downarrow_{l,x}.
 \end{aligned}$$

As previously, let S be a finite subset of \mathbb{Z}^2 and $q \in A^S$ a pattern that appears in a configuration $d \in \mathcal{A}^{\Theta}$. By definition, there exists $\varphi: S \rightarrow T$ a label preserving graph isomorphism for Θ such that

$$\varphi(q) = d|_T.$$

With $\psi := f \circ \varphi \circ f^{-1}$, we have

$$\begin{aligned}
 \psi(f(q)) &= f \circ \varphi(q) \\
 &= f(d|_T) \\
 &= f(d)|_{f(T)}.
 \end{aligned}$$

So the pattern $f(q)$ appears in the configuration $f(d)$. □

The reduction from the orbit graph

We now have everything in hand to do the formal reduction from domino problem of the orbit graph of s to domino problem of the surface group.

Lemma 3.4.9. *Let Θ be an orbit graph of an orbit Ω of the substitution s . If DP is undecidable on Θ , then DP is undecidable on the surface group of genus 2.*

Proof. Let \mathcal{A} be a finite alphabet and $Y \subseteq \mathcal{A}^{\Theta}$ an SFT over Θ , given by a finite set of forbidden patterns \mathcal{F}_Y . We define Z the SFT over G with set of forbidden patterns $\mathcal{F}_Z := f_x(\mathcal{F}_Y)$, where f_x is defined in Lemma 3.4.6. Clearly \mathcal{F}_Z can be constructed effectively from \mathcal{F}_Y . We show that $Z = \emptyset$ if and only if $Y = \emptyset$, providing a reduction to DP(Θ).

Suppose $Z = \emptyset$ and consider a configuration $c \in \mathcal{A}^G$. The configuration $d := f_x^{-1}(c)$ is thus in \mathcal{A}^{Θ} . Since $Z = \emptyset$, necessarily c contains a forbidden pattern p from the set \mathcal{F}_Z . Since $p \sqsubset c$, Corollary 3.4.8 implies that $f_x^{-1}(p) \sqsubset f_x^{-1}(c) = d$. So a pattern $f_x^{-1}(p)$ from \mathcal{F}_Y appears in any configuration $c \in \mathcal{A}^G$, i.e. the subshift Y is empty.

Conversely, if $Y = \emptyset$, take any $d \in \mathcal{A}^{\Theta}$ and $c := f_x(d) \in \mathcal{A}^G$. Because $Y = \emptyset$, d contains a forbidden pattern $q \in \mathcal{F}_Y$. Since $q \sqsubset d$, Corollary 3.4.8 implies that $f_x(q) \sqsubset f_x(d) = c$. Therefore, the pattern $f_x(q) \in \mathcal{F}_Z$ appears in any $d \in \mathcal{A}^{\Theta}$, so $Y = \emptyset$ as well and the equivalence is proved. □

3.4.2 The Domino Problem on Orbit Graphs

The goal of this section is to show that the domino problem of any orbit graph associated to an orbit of a non-deterministic substitution with an expanding eigenvalue is undecidable. In order to prove this we show a variation of the "Technical Lemma" of Cohen

and Goodman-Strauss [CG17]. Their lemma takes two primitive expansive deterministic substitutions (\mathcal{A}, σ) and (\mathcal{A}', τ) and produces a non-deterministic one that simulates the orbits of (\mathcal{A}, σ) and (\mathcal{A}', τ) in its orbits. Their proof uses the idea of superposing two tilings associated to the substitutions and coding their intersections. For our purposes, we will consider any orbit Ω of a non-deterministic substitution (\mathcal{A}, R) with an expanding eigenvalue λ and construct a subshift of finite type Y in Γ_Ω which encodes an orbit graph of the specific substitution $(\{0\}, 0 \mapsto 00)$. We believe the same reduction can be done encoding more general substitutions than $(\{0\}, 0 \mapsto 00)$, but encoding only $(\{0\}, 0 \mapsto 00)$ simplifies the proof and is enough to prove the undecidability result we want. For technical reasons that will become clear during the proof, we will first consider the case where $\lambda > 2$ and then deduce the general case from this case.

Let us fix a non-deterministic substitution (\mathcal{A}, R) with an expanding eigenvalue $\lambda > 2$. Without loss of generality, we may choose the function $v: \mathcal{A} \rightarrow \mathbb{R}^+ \setminus \{0\}$ associated to λ such that $v(a) > 4$ for each $a \in \mathcal{A}$.

Let $\Omega = \{(\omega^i, P_i)\}_{i \in \mathbb{Z}}$ be an orbit of (\mathcal{A}, R) . We will construct a finite alphabet \mathcal{B} and a finite set of forbidden patterns F such that the subshift $Y \subset \mathcal{B}^{\Gamma_\Omega}$ defined by the set of forbidden patterns F has the following properties:

1. Y is non-empty,
2. every configuration $y \in Y$ encodes an orbit graph of the substitution $(\{0\}, 0 \mapsto 00)$.

We first give an informal description of the alphabet \mathcal{B} . Recall that $\Omega = \{(\omega^i, P_i)\}_{i \in \mathbb{Z}}$ is an orbit of (\mathcal{A}, R) and call $\Xi = \{((0^\infty)^i, Q_i)\}_{i \in \mathbb{Z}}$ an orbit of $(\{0\}, 0 \mapsto 00)$. By Proposition 3.2.3 both of these orbits can be realized as tilings of \mathbb{R}^2 . Symbols from \mathcal{B} will encode non-empty finite regions of the tiling with $(\{0\}, 0 \mapsto 00)$ that can be "seen inside" (\mathcal{A}, R) -tiles. These regions will be chosen in such a way that their union recovers the whole tiling and they are pairwise disjoint. More precisely, the alphabet \mathcal{B} will consist of

- A production rule $(a, w) \in R$ describing the type of (\mathcal{A}, R) -tile.
- Two integers (h, t) , describing a finite region of the tiling associated to an orbit of $(\{0\}, 0 \mapsto 00)$. The integer h represents the number of $(\{0\}, 0 \mapsto 00)$ tiles than can fit vertically in the current type of (\mathcal{A}, R) -tile and t is the number that fits horizontally on the top edge.
- A tuple of $|w|$ pairs of integers $((b_0, s_0), (b_1, s_1) \dots, (b_{|w|-1}, s_{|w|-1}))$ which describes how to locally paste the region with its neighboring regions. More precisely, it contains all information needed to recover the function Q_i from the finite coded regions. Each b_i represents the index of the $(\{0\}, 0 \mapsto 00)$ -tile that intersects the left corner of the i -th bottom edge of the (\mathcal{A}, R) -tile (starting from 0), and s_i its binary label, depending if the vertex intersects the left or right child of b_i (see Fig. 3.21).

The $0 \mapsto 00$ -tile in position $(x, y) \in \mathbb{R}^2$ is the square polygon whose five vertices have coordinates (x, y) , $(x, y - \log(2))$, $(x + e^y, y - \log(2))$, $(x + 2 \cdot e^y, y - \log(2))$ and $(x + 2 \cdot e^y, y)$ as pictured on the left of Fig. 3.21. The width of these tiles depends on their position—more precisely only on their second coordinate—but their height does not and is always $\log(2)$.

By Proposition 3.2.3 we can tile the plane with this family of tiles by putting tiles vertex to vertex, each tile having a left and a right neighbor, two children and one parent. In the sequel we will be interested in blocks of such tiles. The (h, t) -block in position

$(x, y) \in \mathbb{R}^2$ is a pattern of width $2te^y$ and height $h \log(2)$, filled in with tiles as pictured on Fig. 3.21, and whose top left vertex has coordinates (x, y) . Similarly, by Proposition 3.2.3 we can also tile \mathbb{R}^2 with (\mathcal{A}, R) -tiles and speak of the (a, w) -tile at position (x, y) as in Fig. 3.3.

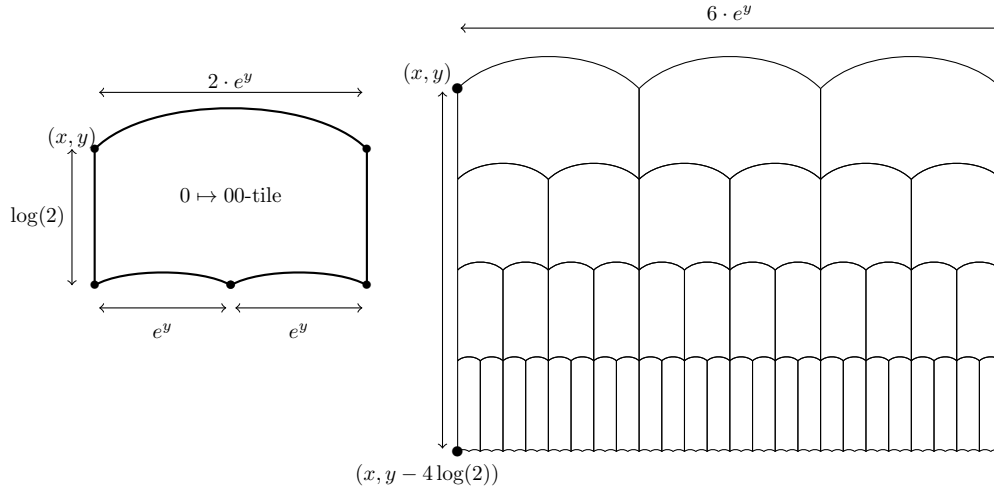

Figure 3.21 – A $0 \mapsto 00$ -tile, and a $(3, 4)$ -block in position $(x, y) \in \mathbb{R}^2$.

Let $(x, y) \in \mathbb{R}^2$, $\tilde{x} \in [0; 2 \cdot e^y[$ and $\tilde{y} \in [0; \log(2)[$. We want to consider the largest values (h, t) such that an (\mathcal{A}, R) -tile at position $(x + \tilde{x}, y - \tilde{y})$ intersects the interior of the top-left tile of the (h, t) -block at (x, y) and the bottom right corner $(x + 2te^y, y - h \log(2))$ of the (h, t) -block is contained in the (\mathcal{A}, R) -tile (see Fig. 3.22).

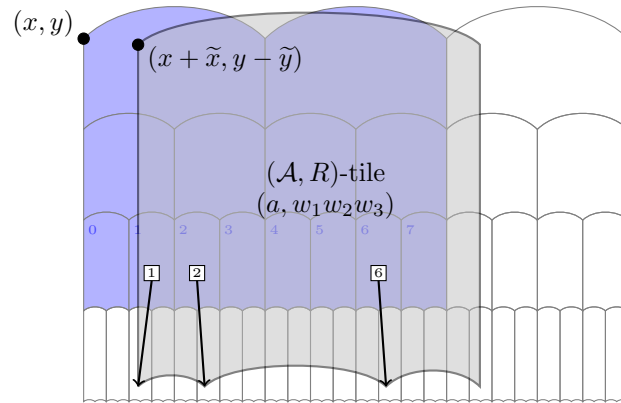

Figure 3.22 – The blue $(3, 2)$ -block intersects the (\mathcal{A}, R) -tile in the manner described above. The bottom vertices of the (\mathcal{A}, R) -tile have horizontal coordinates corresponding to tiles on the last line of the $0 \mapsto 00$ -block. Namely the 2nd (index 1), the 3rd (index 2) and the 7th (index 6). These vertices are respectively on the left, right and right child of these $0 \mapsto 00$ -tiles. Therefore, the associated symbol of \mathcal{B} is given by: $((a, w_1w_2w_3), (3, 2), [(1, 0), (2, 1), (6, 1)])$.

We also need information of how to paste consecutive coded blocks. Each integer b_i for $i \in \{0, \dots, |w| - 1\}$ will code the number counted from left to right of the tile in the

bottom row of the (h, t) -block which is the parent of the top-left tile of the block coded by the i -th son of (a, w) . The value $s_i \in \{0, 1\}$ indicates whether the top-left tile of the block coded by the i -th son of (a, w) is the left (0) or right (1) son (for an example see the caption of Fig. 3.22).

Definition of the alphabet \mathcal{B}

We now define the alphabet \mathcal{B} formally. A symbol

$$b = \left((a, w), (h, t), [(b_0, s_0), \dots, (b_{|w|-1}, s_{|w|-1})] \right)$$

is in \mathcal{B} if and only if $(a, w) \in R$ and there exists $(x, y) \in \mathbb{R}^2$, $\tilde{x} \in [0, 2 \cdot e^y[$ and $\tilde{y} \in [0, \log(2)[$ such that

1. there is a (a, w) -tile in position $(x + \tilde{x}, y - \tilde{y})$;
2. $h = \left\lfloor \frac{\log(\lambda) + \tilde{y}}{\log(2)} \right\rfloor$;
3. $t = \left\lfloor \frac{\tilde{x} + v(a) \cdot e^{y - \tilde{y}}}{2 \cdot e^y} \right\rfloor$;
4. For every $i \in \{0, \dots, |w| - 1\}$,
 - $b_i = \left\lfloor \frac{\tilde{x} + e^{y - \tilde{y} - \log(\lambda)} \sum_{k=1}^i v(w_k)}{2e^{y - (h-1)\log(2)}} \right\rfloor$;
 - $s_i = \left\lfloor \frac{\tilde{x} + e^{y - \tilde{y} - \log(\lambda)} \sum_{k=1}^i v(w_k)}{2e^{y - h\log(2)}} \right\rfloor \pmod{2}$.

The values h and t represent the height and width of the largest block of $0 \mapsto 00$ -tiles that fit in the (\mathcal{A}, R) -tile as shown on Fig. 3.22. The numbers b_i code the number of the $0 \mapsto 00$ -tile on the bottom row of the (h, t) -block (from left to right starting at 0) such that the horizontal coordinate of the i -th bottom vertex of the (\mathcal{A}, R) -tile is contained in it. The numbers s_i satisfy that the tile indicated by b_i is connected to the top-left tile coded by the i -th son of the (\mathcal{A}, R) -tile by the label s_i .

Remark that as $\lambda > 2$, we have $h \geq 1$. Furthermore, h can take only two consecutive integer values. Similarly, for a given production rule $(a, w) \in R$, the bounds impose that t is an integer satisfying $\left\lfloor \frac{v(a)}{4} \right\rfloor \leq t \leq \left\lfloor 1 + \frac{v(a)}{2} \right\rfloor$, as we chose the function $v: \mathcal{A} \rightarrow \mathbb{R}^+ \setminus \{0\}$ such that for every $a \in \mathcal{A}$ $v(a) > 4$, we get that $t \geq 1$. There are thus only finitely many possible pairs (h, t) . Finally, b_i describes the index of the tile (starting from 0) on the last row of the (h, t) block which contains the same vertical coordinate as the vertex corresponding to the i -th son of the (a, w) -tile and thus can take values in $[0; 2^{h-1}(t+1) - 1]$. As $s_i \in \{0, 1\}$ we conclude that there are finitely many symbols in \mathcal{B} .

Definition of the forbidden patterns F

The set of forbidden patterns F is build such that the pieces of $0 \mapsto 00$ tiles encoded match correctly.

All forbidden patterns in F have supports which consist of three vertices $\{u, v, w\}$ such that $(u, v), (u, w)$ are edges, $L((u, v)) = \mathbf{next}$ and $L((u, w)) = \ell$ for some ℓ appearing in the parent matching labels of the orbit graph. We denote by

$$b^u = \left((a^u, z^u), (h^u, t^u), [(b_0^u, s_0^u), \dots, (b_{|w|-1}^u, s_{|w|-1}^u)] \right)$$

the symbol appearing in u and use similar notations for v and w . The pattern $p: \{u, v, w\} \rightarrow \mathcal{B}$ will be in F if and only if one of the following conditions does not hold:

1. $a^w = (z^u)_{\ell+1}$;
2. $h^u = h^v$;
3. If $\ell < |z^u| - 1$, then $2(b_{\ell+1}^u - b_\ell^u) + s_{\ell+1}^u - s_\ell^u = t^w$.
4. If $\ell = |z^u| - 1$, then $2(2^{h^u-1}t^u + b_0^u - b_{|z^u|-1}^u) + s_0^u - s_{|z^u|-1}^u = t^w$.

The first rule says that if the rule $(a, z_1 z_2 \dots z_k)$ appears in a vertex, then a rule starting with $z_{\ell+1}$ should appear in the son labeled with ℓ . The second rule says any two symbols that lie in a row of the orbit graph have the same height h . The third and fourth rules say that if w is the ℓ -th son of u , then the length t^w of the block appearing at w must be consistent with the bottom row of the block appearing at u (see Fig. 3.23).

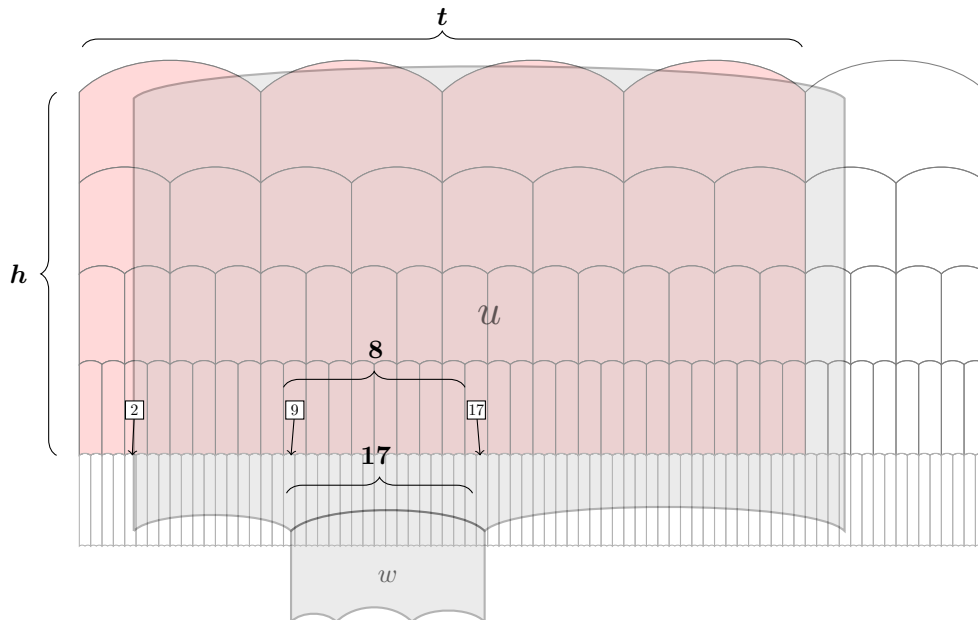

Figure 3.23 – Illustration of the third item in the definition of the set of forbidden patterns F : there are $8 = b_2 - b_1$ tiles in the bottom row of the top tile and $s_2 = 1, s_1 = 0$. Thus there must be $2(b_2 - b_1) + (s_1 - s_2) = 17$ tiles on the top row of the pattern coded by the tile appearing below u (which is called w). To make the picture smaller, the bottom tile is drawn shorter than it should be. If the rightmost tile is considered, we must add the number of tiles $2^{h-1}t$ to b_0 of the rightmost tile for the formula to add up.

Consider an orbit $\Omega = \{(w^i, P_i)\}_{i \in \mathbb{Z}}$ of (\mathcal{A}, R) and its associated orbit graph Γ_Ω . We define $Y \subset \mathcal{B}^{\Gamma_\Omega}$ as the subshift consisting of all colorings of Γ_Ω by symbols of \mathcal{B} where the patterns from F do not appear.

Lemma 3.4.10. *For every orbit $\Omega = \{(w^i, P_i)\}_{i \in \mathbb{Z}}$ of (\mathcal{A}, R) the subshift $Y \subset \mathcal{B}^{\Gamma_\Omega}$ is non-empty.*

Proof. By Proposition 3.2.3 there exists a tiling $\Psi_\Omega: \mathbb{Z}^2 \rightarrow \mathbb{R}^2$ for Ω . Similarly, fixing an orbit Ξ of $(\{0\}, 0 \mapsto 00)$ there is a tiling $\Psi_\Xi: \mathbb{Z}^2 \rightarrow \mathbb{R}^2$ for Ξ .

We claim that for every $u = (i, j) \in \mathbb{Z}^2$, there is $u^* = (i^*, j^*) \in \mathbb{Z}^2$ such that if $\Psi_{\Xi}(u^*) = (x, y)$ then $\Psi_{\Omega}(u) = (x + \tilde{x}, y - \tilde{y})$ for some $\tilde{x} \in [0, 2 \cdot e^y[$ and $\tilde{y} \in [0, \log(2)[$. Indeed, by definition of tiling, note that if $\Psi_{\Xi}(i_1, j_1) = (x_1, y_1)$ and $\Psi_{\Xi}(i_2, j_2) = (x_2, y_2)$ then $y_2 = y_1 - (i_2 - i_1) \log(2)$. Therefore if we let $\Psi_{\Omega}(u) = (a, b)$ we can first find i^* such that $\Psi_{\Xi}(i^*, k) = (\cdot, y) \in \mathbb{R} \times [b, b + \log(2)[$ for all $k \in \mathbb{Z}$. Furthermore, if $\Psi_{\Xi}(i^*, j_1) = (x_1, y_1)$ and $\Psi_{\Xi}(i^*, j_2) = (x_2, y_2)$ we have $y_1 = y_2 = y$ and $x_2 - x_1 = 2(j_2 - j_1)e^y$. Therefore we can find j^* such that $\Psi_{\Xi}(i^*, j^*) = (x, y) \in [a, a + 2e^y[\times [b, b + \log(2)[$. Hence, letting $u^* = (i^*, j^*)$ we have $\Psi_{\Omega}(u) - \Psi_{\Xi}(u^*) = (\tilde{x}, -\tilde{y})$ as required.

Let us define a configuration $c: \mathbb{Z}^2 \rightarrow \mathcal{B}$. At $c(i, j)$ we place the symbol of \mathcal{B} associated to the $((a^i)_j, a^{i+1}|_{[\Delta_{i+1}(j); \Delta_{i+1}(j+1)-1]})$ -tile at position $\Psi_{\Xi}((i, j)^*) + (\tilde{x}, -\tilde{y})$ as described in the definition of \mathcal{B} . We claim that $c \in Y$. To do so, we need to show that c does not contain any forbidden pattern from F , i.e. that any pattern with one of the supports defining F satisfies the four conditions described above.

Let $u, v, w \in \mathbb{Z}^2$ such that $L((u, v)) = \mathbf{next}$ and $L((u, w)) = \ell$ and consider the pattern $c|_{\{u, v, w\}}$. In order to prove that $c \in Y$, we have to prove that any such $c|_{\{u, v, w\}}$ is not in F , i.e. all of the four items of page 86 hold. Denote $(\bar{x}, \bar{y}) = \Psi_{\Omega}(u)$, $(x, y) = \Psi_{\Omega}(u^*)$, $(\tilde{x}, -\tilde{y}) = (\bar{x} - x, \bar{y} - y)$ and the production rule appearing at u be $(a, z_1 \dots z_k)$ and thus $0 \leq \ell < k$. By definition of c we have that $a^w = z_{\ell+1} = (z^u)_{\ell+1}$ and hence item 1 of page 86 holds. By definition of tiling we have that $\Psi_{\Omega}(v) = (\bar{x} + v(a)e^{\bar{y}}, \bar{y})$ and so if we have $u^* = (i_1^*, j_1^*)$ and $v^* = (i_2^*, j_2^*)$ then $i_2^* = i_1^*$. This implies that $h^u = h^v$ and therefore 2 of page 86 holds. To simplify the notations for the remainder of the proof, we drop the superscripts for u , that is, we denote $h = h^u$, $b_i^u = b_i$ and $s_i^u = s_i$ and maintain the superscripts for v and w .

By the Euclidean division algorithm, we have that for any $0 \leq \ell < k$:

$$2b_{\ell} + s_{\ell} = \left\lfloor \frac{\tilde{x} + e^{y-\tilde{y}-\log(\lambda)} \sum_{r=1}^{\ell} v(z_r)}{2e^{y-h \log(2)}} \right\rfloor.$$

Also, as $v(a) = e^{-\log(\lambda)} \sum_{r=1}^k v(z_r)$ we have that:

$$\begin{aligned} 2(2^{h-1}t + b_0^v) + s_0^v &= 2^h t + \left\lfloor \frac{\bar{x} + v(a)e^{y-\tilde{y}} - x - 2^h t e^y}{2e^{y-h \log(2)}} \right\rfloor \\ &= \left\lfloor \frac{\tilde{x} + e^{y-\tilde{y}} \sum_{r=1}^k v(z_r) e^{-\log(\lambda)}}{2e^{y-h \log(2)}} \right\rfloor \end{aligned}$$

and thus we will denote $2(2^{h-1}t + b_0^v) + s_0^v$ simply by $2b_k + s_k$ as it has the same expression as the numbers above.

On the other hand, we have $\Psi_{\Omega}(w) = (\bar{x} + e^{\bar{y}-\log(\lambda)} \sum_{k=1}^{\ell} v(z_k), \bar{y} - \log(\lambda))$. It is easy to verify that $\Psi_{\Xi}(w^*) = (x + 2e^{y-h \log(2)}(2b_{\ell} + s_{\ell}), y - h \log(2))$. It follows that

$$\Psi_{\Omega}(w) - \Psi_{\Xi}(w^*) = \left(\tilde{x} + e^{\bar{y}-\log(\lambda)} \sum_{k=1}^{\ell} v(z_k) - 2e^{y-h \log(2)}(2b_{\ell} + s_{\ell}), -(\tilde{y} + \log(\lambda) - h \log(2)) \right)$$

and thus

$$\begin{aligned}
 t^w &= \left\lfloor \frac{\tilde{x} + e^{\bar{y}-\log(\lambda)} \sum_{k=1}^{\ell} v(z_k) - 2e^{y-h \log(2)}(2b_{\ell} + s_{\ell}) + v(z_{\ell+1})e^{\bar{y}-\log(\lambda)}}{2e^{y-h \log(2)}} \right\rfloor \\
 &= \left\lfloor \frac{\tilde{x} + e^{\bar{y}-\log(\lambda)} \sum_{k=1}^{\ell+1} v(z_k)}{2e^{y-h \log(2)}} \right\rfloor - (2b_{\ell} + s_{\ell}) \\
 &= (2b_{\ell+1} + s_{\ell+1}) - (2b_{\ell} + s_{\ell}) \\
 &= 2(b_{\ell+1} - b_{\ell}) + s_{\ell+1} - s_{\ell}.
 \end{aligned}$$

Therefore, conditions 3 and 4 are also satisfied, which means that $c|_{\{u,v,w\}} \notin F$. It follows that $c \in Y$ and so Y is non-empty. □

Simulation of orbits of $(\{0\}, 0 \mapsto 00)$ on (\mathcal{A}, R) .

For every $b \in \mathcal{B}$ we can associate a finite graph $\Gamma_b = (V_b, E_b, L_b)$ which appears as an induced subgraph on any orbit graph of $(\{0\}, 0 \mapsto 00)$ as follows: let (h, t) be the second coordinate of b , the vertex set is

$$V_b = \{(i, j) \mid i \in [0; h - 1], j \in [0, t2^i - 1]\}$$

and the edges have labels given by

$$\begin{cases} L_b((i, j), (i, j + 1)) = \mathbf{next} & \text{for every } i \text{ and every } j < t2^i - 1 \\ L_b((i - 1, \lfloor \frac{j}{2} \rfloor), (i, j)) = j \bmod 2 & \text{for every } i \geq 1 \text{ and every } j. \end{cases}$$

See Fig. 3.24 for an illustration of this graph.

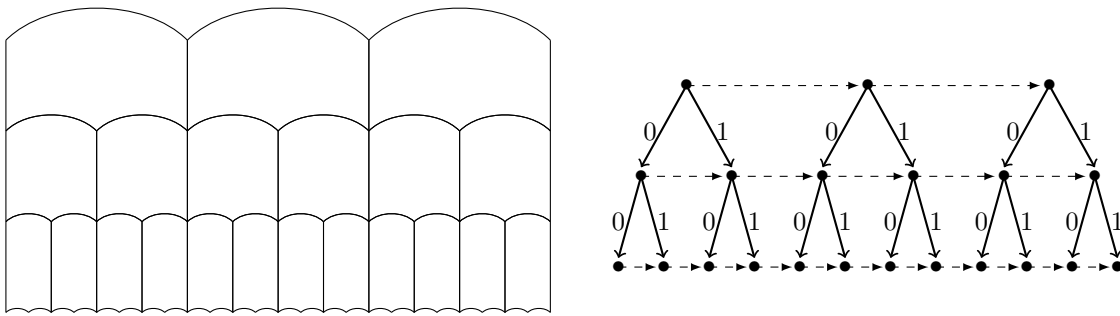

Figure 3.24 – A $(3, 3)$ -block and its associated $\Gamma_{(3,3)}$ graph. The **next** edges are shown as dashed lines.

Remark that for every $b \in \mathcal{B}$ the associated graph Γ_b is non-empty. As $\lambda > 2$ and $v(a) > 4$ for every $a \in \mathcal{A}$ we have that the numbers (h, t) associated to every $b \in \mathcal{B}$ are both larger than 1.

More generally, given a finite connected subset $S \subset \Gamma$ and a pattern $q: S \rightarrow \mathcal{B}$ which appears in some configuration of Y , we can associate a finite subgraph Γ_q by pasting together the graphs $(\Gamma_{q(s)})_{s \in S}$ in the following way:

1. Whenever $u, v \in S$ are connected by a **next** edge from u to v , we connect $\Gamma_{q(u)}$ to $\Gamma_{q(v)}$ by joining the rightmost vertices of $\Gamma_{q(u)}$ to the leftmost vertices of $\Gamma_{q(v)}$ with **next** edges. More precisely, if $q(u)$ codes an (h, t) -block, then for every $i \in [0; h - 1]$ we connect the vertex $(i, t2^i - 1)$ of $\Gamma_{q(u)}$ to $(i, 0)$ of $\Gamma_{q(v)}$ by a **next** edge.
2. Whenever $u, w \in S$ are connected by an edge with label i , we look at the coordinate (b_i, s_i) of $q(u)$ and connect the left-top vertex of $\Gamma_{q(w)}$ to b_i -th vertex on from the left on the bottom row of $\Gamma_{q(u)}$ using an s_i -edge and then connect all vertices on the top row of $\Gamma_{q(w)}$ to the bottom row of $\Gamma_{q(u)}$ alternating $0 - 1$ edges. More precisely, if $q(u)$ codes an (h, t) -block then for each j we connect vertex $(h - 1, b_i + \lfloor \frac{s_i + j}{2} \rfloor)$ of the bottom row of $\Gamma_{q(u)}$ to vertex $(0, j)$ from the top row of $\Gamma_{q(w)}$ with a label $s_i + j \bmod 2$. If $(h - 1, b_i + \lfloor \frac{s_i + j}{2} \rfloor)$ does not appear in the bottom row of $\Gamma_{q(u)}$ and u is connected to some vertex v by a **next** label, then the vertex $(h - 1, b_i + \lfloor \frac{s_i + j}{2} \rfloor)$ gets replaced by vertex $(h - 1, b_i + \lfloor \frac{s_i + j}{2} \rfloor) - 2^{h-1}t$ of $\Gamma_{q(v)}$.

These pasting rules are consistent because no pattern from F appears in q . More precisely, if two vertices are connected by a **next** edge the blocks they code have the same height by rule 2 of F and thus the first rule is coherent. If two vertices are connected by an i -edge then the sites where the graphs are pasted do not overlap and cover everything by rules 3 and 4 of F . The pasting rules are illustrated in Fig. 3.25.

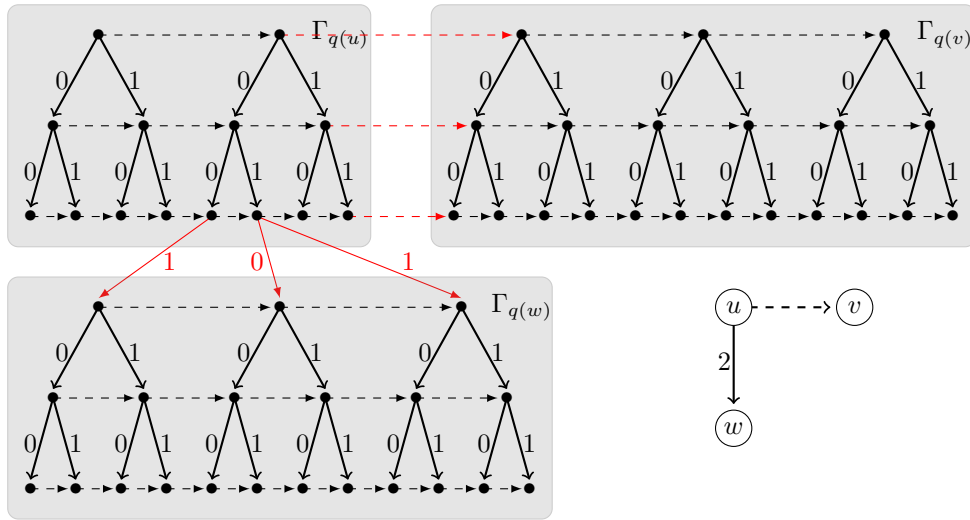

Figure 3.25 – The rules for pasting graphs.

Let Σ be a finite alphabet and F_Σ a set of nearest neighbor forbidden patterns on the orbit graph of $(\{0\}, 0 \mapsto 00)$ over the alphabet Σ . We define \mathcal{B}_Σ as the set of pairs (b, p_b) such that $b \in \mathcal{B}$ and $p_b: \Gamma_b \rightarrow \Sigma$ is a pattern. Also, for a pattern p on Γ_Ω with alphabet B_Σ denote by $\pi_{\mathcal{B}}(p)$ the restriction to the first coordinate of \mathcal{B}_Σ . Also denote by $q(p): \Gamma_{\pi_{\mathcal{B}}(p)} \rightarrow \Sigma$ the pattern over $(\{0\}, 0 \mapsto 00)$ whose support is the graph $\Gamma_{\pi_{\mathcal{B}}(p)}$ and is obtained by pasting together the corresponding patterns p_b on the second coordinate of B_Σ .

Define $F_{\mathcal{B}, \Sigma}$ as the set of all patterns p over the alphabet \mathcal{B}_Σ which have supports which consist in three vertices $\{u, v, w\}$ in Γ_Ω such that $(u, v), (u, w)$ are edges, $L((u, v)) = \mathbf{next}$

and $L((u, w)) = \ell$ for some ℓ appearing in the parent matching labels of the orbit graph Γ_Ω , and that satisfy one of the following two properties:

1. The pattern $\pi_{\mathcal{B}}(p)$ obtained by restricting p to the first coordinate of \mathcal{B}_Σ is in F ;
2. The pattern $q(p)$ obtained by pasting the patterns of p described by the second coordinate of \mathcal{B}_Σ contains a forbidden pattern from F_Σ .

Clearly $F_{\mathcal{B},\Sigma}$ has finitely many patterns (up to label preserving graph isomorphism). For any orbit Ω of (\mathcal{A}, R) we define the subshift of finite type $Y_\Sigma \subset (B_\Sigma)^{\Gamma_\Omega}$ as the set of all colorings of Γ_Ω by B_Σ where no pattern from $F_{\mathcal{B},\Sigma}$ appears.

The next lemma states that it is equivalent to look at the emptiness of a subshift over $(\{0\}, 0 \mapsto 00)$ or its encoding over an orbit graph of some substitution (\mathcal{A}, R) with an expanding eigenvalue $\lambda > 2$.

Lemma 3.4.11. *Let Ω and Ξ be orbits of (\mathcal{A}, R) and $(\{0\}, 0 \mapsto 00)$ respectively. Let $\Gamma_\Omega, \Gamma_\Xi$ be orbit graphs of Ω and Ξ respectively. Let X_Σ be the subshift on Γ_Ξ with alphabet Σ defined by the nearest neighbor forbidden patterns F_Σ and let $Y_\Sigma \subset (B_\Sigma)^{\Gamma_\Omega}$ be defined as above. Then $Y_\Sigma = \emptyset$ if and only if $X_\Sigma = \emptyset$.*

Proof. Assume there exists $\tilde{y} \in Y_\Sigma$. Let $\tilde{y}|_n$ be the restriction of \tilde{y} to the vertices $[-n, n]^2$ in Γ_Ω . By definition of $F_{\mathcal{B},\Sigma}$ the pattern $q(\tilde{y}|_n)$ does not contain any pattern from F_Σ . By a standard compactness argument, the sequence of patterns $(q(\tilde{y}|_n))_{n \in \mathbb{N}}$ subconverges to a configuration $x \in \Sigma^{\Gamma_\Xi}$ which does not contain any pattern from F_Σ and thus $x \in X_\Sigma \neq \emptyset$.

Conversely, let $x \in X_\Sigma$. By Lemma 3.4.10 there exists a configuration $y \in Y$. By identifying for each vertex $v \in \Gamma_\Omega$ the graphs $\Gamma_{y(v)}$ as a partition of the vertices of Γ_Ξ , we can construct a second coordinate $p_{x,y,v} = x|_{\Gamma_{y(v)}}$ which satisfies the second rule of $F_{\mathcal{B},\Sigma}$. By definition $\tilde{y} = (y(v), p_{x,y,v})$ is in Y_Σ which is thus non-empty. \square

Remark that in the previous lemma, the alphabet B_Σ and the set of forbidden patterns $F_{\mathcal{B},\Sigma}$ which define Y_Σ only depend upon Σ, F_Σ and the substitution (\mathcal{A}, R) . It does not depend upon the choice of orbit Ω of (\mathcal{A}, R) .

And finally, we derive the general case in the following theorem.

Theorem 3.4.12. *The domino problem is undecidable on any orbit graph of a non-deterministic substitution with an expanding eigenvalue.*

Proof. For clarity, let us first assume that the expanding eigenvalue λ associated to (\mathcal{A}, R) satisfies $\lambda > 2$. Let Σ and F_Σ be respectively an alphabet and a nearest neighbor set of forbidden patterns for an orbit graph Γ_Ξ of an orbit Ξ of $(\{0\}, 0 \mapsto 00)$ which define a nearest neighbor SFT X_Σ . By Lemma 3.4.11 we know that $X_\Sigma = \emptyset$ if and only if $Y_\Sigma = \emptyset$. Furthermore, we claim that the alphabet and set of forbidden patterns which define Y_Σ can be constructed effectively from Σ and F_Σ . Indeed, the subshift Y does not depend upon Σ and thus its alphabet \mathcal{B} and forbidden patterns F can be hard-coded in the algorithm. It is easy to see that from \mathcal{B} one can effectively construct the alphabet B_Σ and the forbidden patterns $F_{\mathcal{B},\Sigma}$ which define Y_Σ .

These two facts together show that if $\text{DP}(\Gamma_\Omega)$ is decidable and $\lambda > 2$, then so is $\text{DP}(\Gamma_\Xi)$. Using the result of Kari (Theorem 3.2.4) we have that $\text{DP}(\Gamma_\Xi)$ is undecidable, hence $\text{DP}(\Gamma_\Omega)$ is also undecidable.

We can now deal with the remaining case where $1 < \lambda \leq 2$. For an integer $m \geq 1$ we define the relation R^m recursively by:

- $R^1 = R$.
- R^{k+1} is the set of all pairs $(a, (c_1^1 \dots c_{\ell_1}^1)(c_1^2 \dots c_{\ell_2}^2) \dots (c_k^1 \dots c_{\ell_k}^1))$ in $\mathcal{A} \times \mathcal{A}^*$ for which there is a pair $(a, b_1 \dots b_k) \in R^k$ such that $(b_i, c_1^i \dots c_{\ell_i}^i) \in R$ for each $i \in \{1, \dots, k\}$.

In other words, R^m is the set of all relations that can be obtained by starting with a symbol $a \in \mathcal{A}$ and replacing m times each letter by the right hand side of a production rule of R . Let $n \in \mathbb{N}$ such that $\lambda^n > 2$ and note that the substitution (\mathcal{A}, R^n) has the expanding eigenvalue $\lambda^n > 2$.

Let $\Omega = \{(w^i, P_i)\}_{i \in \mathbb{Z}}$ be an orbit of (\mathcal{A}, R) . We have that for each $k \in \{0, \dots, n-1\}$

$$\Omega^{n,k} := \left\{ \left(w^{in+k}, P_{in+k-(n-1)} \circ \dots \circ P_{in+k-1} \circ P_{in+k} \right) \right\}_{i \in \mathbb{Z}}$$

is an orbit of (\mathcal{A}, R^n) . As before, let Σ and F_Σ be respectively an alphabet and a nearest neighbor set of forbidden patterns which define a nearest neighbor SFT X_Σ . Let $Y_\Sigma^{n,k}$ be the subshift Y_Σ we constructed above, but now for the substitution (\mathcal{A}, R^n) and orbit $\Omega^{n,k}$. Denote by \mathcal{B}_Σ^n and $F_{\mathcal{B},\Sigma}^n$ the alphabet and set of forbidden patterns of $Y_\Sigma^{n,k}$ respectively. By Lemma 3.4.11 we have that $Y_\Sigma^{n,k} = \emptyset$ if and only if $X_\Sigma = \emptyset$.

We are going to construct a subshift Z on Γ_Ω which encodes a copy of $Y_\Sigma^{k,n}$ for each $k \in \{0, \dots, n-1\}$. Consider again the alphabet \mathcal{B}_Σ^n . For every pattern $p \in F_{\mathcal{B},\Sigma}^n$ with support $\{u, v, w\}$ such that $L((u, v)) = \mathbf{next}$ and $L((u, v)) = \ell$ we define the set of patterns F_p such that every $q \in F_p$ has support $\{v, u_1, u_2, \dots, u_n = w_0, w_1, \dots, w_\ell\}$ such that $L((u_1, v)) = \mathbf{next}$, for every $i \in \{1, \dots, n\}$, $L((u_i, u_{i+1})) = 0$ and for every $j \in \{0, \dots, \ell-1\}$, $L(w_j, w_{j+1}) = \mathbf{next}$ and every pattern q in F_p has the property that $q(u_1) = p(u)$, $q(v) = p(v)$ and $q(w_\ell) = p_\ell$ (See Fig. 3.26).

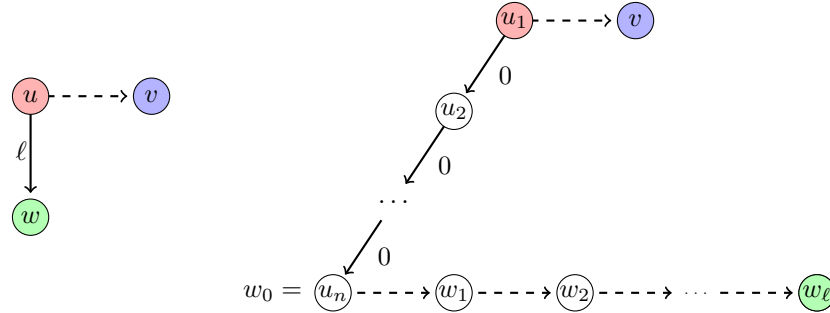

Figure 3.26 – On the left a pattern $p \in F_{\mathcal{B},\Sigma}^n$. The corresponding patterns have the support shown on the right and coincide with p in the three colored vertices.

Clearly each set F_p is finite for each p . We define $F_Z := \bigcup_{p \in F_{\mathcal{B},\Sigma}^n} F_p$. As $F_{\mathcal{B},\Sigma}^n$ is finite, we conclude that F_Z is finite. It is easy to see that it can be effectively constructed from $\tilde{F}_{\mathcal{B},\Sigma}^n$. We claim that $Z \subset (B_\Sigma^n)^{\Gamma_\Omega} = \emptyset$ if and only if $X_\Sigma = \emptyset$.

Indeed, suppose $Z \neq \emptyset$ and let $z \in Z$. We can define a configuration $y \in (B_\Sigma^n)^{\Gamma_{\Omega^{n,0}}}$ by setting $y(i, j) = z(i \cdot n, j)$. It follows from the definition of F_Z that no patterns from $\tilde{F}_{\mathcal{B},\Sigma}^n$ appear in y and hence $y \in Y_\Sigma^{0,n}$. In turn, this implies that $X_\Sigma \neq \emptyset$. Conversely, if $X_\Sigma \neq \emptyset$ we have that each $Y_\Sigma^{k,n}$ is non-empty. Let $y^{(k)} \in Y_\Sigma^{k,n}$ and define

$$z(i, j) = y^{(i \bmod n)} \left(\left\lfloor \frac{i}{n} \right\rfloor, j \right).$$

From the definition of F_Z it follows that no forbidden patterns appear in z and hence

$z \in Z$. It follows that if $\text{DP}(\Gamma_\Omega)$ is decidable, then so is $\text{DP}(\Gamma_\Xi)$. Using the result of Kari on the hyperbolic plane (page 58) we have that $\text{DP}(\Gamma_\Xi)$ is undecidable, hence $\text{DP}(\Gamma_\Omega)$ is also undecidable. \square

Using this, we can finally prove the main result of this section.

Theorem 3.4.13. *The domino problem is undecidable on the surface group of genus 2.*

Proof. Lemma 3.4.9 does the reduction from the domino problem of the orbit orbit graph of the substitution s , which is undecidable since s has an expanding eigenvalue. \square

Corollary 3.4.14. *The domino problem is undecidable for every surface group.*

Proof. The undecidability of the domino problem is a commensurability invariant (see Corollary 9.53 of [BR18]), and all surface groups of genus $g \geq 2$ are commensurable (see Proposition 6.7 of [CK17] for a recent reference). By combining these two facts with Theorem 3.4.13, we obtain the undecidability of domino problem for surface groups of any genus $g \geq 2$. As the domino problem on \mathbb{Z}^2 –the surface group of genus 1– is undecidable, we obtain our result. \square

Most of the proofs of undecidability of the domino problem for groups consist in finding a grid in its Cayley graph. Our method is new in that sense, since it "finds" the hyperbolic plane \mathbb{H}^2 in the group. It would be interesting to see for which other classes of groups this method can be used. We believe that it might be extended to more general hyperbolic groups for example.

Conclusion and Open Problems

Many interesting problems arose during the elaboration of this thesis. In the hope that some of them might be solved in the future, we recall them in this chapter.

Algebraic Approach to Nivat's Conjecture

In Chapter 2 we tackled Nivat's conjecture using algebraic tool introduced by Kari and Szabados. We proved that the generalized Nivat's conjecture holds for algebraic subshifts defined by a polynomial with all its line polynomial factors aligned (Theorem 2.2.9). Then, we showed that the orbit closure of a low-complexity configuration with respect to a convex shape contains a periodic configuration (Theorem 2.3.3).

In this chapter, the biggest open problem is obviously Nivat's conjecture. Corollary 2.3.18, showing that Nivat's conjecture holds for uniformly recurrent configurations might be a big step forward, the conjecture itself seems still pretty hard to handle. For what we know, algebraic tools do not seem particularly well-suited to handle the remaining case of non-uniformly recurrent configurations. Indeed, polynomial annihilators are a very uniform property on configurations, even if there are non-uniformly recurrent configurations with polynomial annihilators. But it might also be that the theory is not developed enough, and that we lack of the proper tools to better understand these non-uniformly recurrent configurations. We think that one step forward can be to analyze the geometry of the non-uniform patterns. For now the only thing we can deduce from Corollary 2.3.18 is that low complexity non-uniformly recurrent configurations have arbitrarily large periodic portions in them.

In Section 2.3 we mention a particular case of low complexity subshifts: SFTs defined by a set of at most $|D|$ allowed patterns of arbitrary finite support $D \subset \mathbb{Z}^d$. We call these *low complexity SFTs*. In the case of low complexity SFTs, we think that several results about low complexity subshifts may be extended. We are not aware of any aperiodic SFT with low complexity, even with respect to any shape. Thus, even if Nivat's conjecture does not hold for arbitrary shapes, Corollary 2.3.16 and Corollary 2.3.17 might hold, at least for low complexity SFTs.

Open Problem 1. *Let $D \subset \mathbb{Z}^2$ be a finite shape. Is there a low complexity SFT with respect to D without periodic configuration?*

Open Problem 2. *Is the domino problem decidable for low complexity SFT with respect to any finite $D \subset \mathbb{Z}^2$?*

Corollary 2.3.16 can be understood as the non-existence of low complexity aperiodic SFT. Understanding the complexity of aperiodic subshifts is a very interesting subject, and little is known about it. Corollary 2.3.16 provides a lower bound, and if Nivat's conjecture is true, all configurations of SFTs with low-complexity with respect to a rectangle are actually periodic. However, It would be very surprising if aperiodic SFTs of complexity $mn + 1$ existed.

Open Problem 3. *Let X be an SFT defined by $mn + 1$ allowed rectangular patterns of size $m \times n$. Does X contains a periodic configuration?*

There always exists m, n , a large constant C and a set of $mn + C$ allowed patterns defining an aperiodic SFT. It would be interesting to know what is the smallest possible constant. For know, we just know from Corollary 2.3.16 that $C = 0$ does not work. As mentioned in the introduction, finding aperiodic SFTs with low pattern complexity may have an application in procedural texture generation. Aperiodic SFTs provide a way of generating non-repetitive patterns in a certain way, the drawback being that it is sometimes computationally hard to produce large patterns that belong to such SFT. Having an aperiodic SFT with not too big complexity might provide an SFT with efficient algorithm to generate large allowed patterns.

In dimension higher than two, Nivat's conjecture does not hold (Proposition 1.2.2), but some weaker results may still hold. Already remarked by Szabados in his PhD thesis, a big obstacle of the algebraic approach for higher dimension is that the annihilator ideal is much less understood in higher dimension. He conjectures that just like in dimension two, the annihilator ideal is a radical ideal ([Sza18a], Conjecture 8.3). But even then, ideals of polynomials in three variables are much more complicated and there is no proof of a minimal decomposition of radical ideals as there is in dimension two (Theorem 2.4.6 of [Sza18a]). Thus, a nice decomposition like Theorem 2.1.7 seems hard to get in higher dimensions.

We think that Corollary 2.3.16 and Corollary 2.3.17 might also hold in any dimension for low complexity SFTs, again with respect to any shape.

Open Problem 4. *Let $D \subset \mathbb{Z}^d$ be a finite shape. Is there a low complexity SFT with respect to D without periodic configuration?*

Open Problem 5. *Is the domino problem decidable for low complexity SFTs with respect to any finite $D \subset \mathbb{Z}^d$?*

The main obstacle to generalize them is that key intermediate steps like Proposition 2.3.12 are not known in higher dimensions.

Note that there is no hope to have such generalization for low complexity *subshifts*, as Cassaigne has built (in an unpublished note) a uniformly recurrent low complexity configuration in dimension 3. Therefore, its orbit closure is a low complexity subshift and aperiodic.

Recall Corollary 2.2.10, stating that the generalized Nivat's conjecture holds for algebraic subshifts defined by a polynomial whose line polynomial factors are aligned. The

proof relies on resultants, whose value depends on the common factors of the two polynomials, which is the same as their roots for univariate resultants. To generalize Theorem 2.2.9 to higher dimensions, one may use multipolynomial resultants, but they are not as easy to use as resultant. Unfortunately this generalization of the resultant depends on roots of multivariate polynomials (which are not equivalent to their factors anymore). We do not know any formulation of Theorem 2.2.9 working in dimension other than two, but one way to achieve this could be to study more in-depth the varieties at play when using the multipolynomial resultant.

The last open problem we mention related to Chapter 2 is the *periodic tiling problem*. As we will see, it is closely related to Nivat’s conjecture, and was one of the initial motivation of Kari and Szabados’s algebraic approach. Let us state this problem, usually defined in terms of sets, using algebraic tools of Chapter 2. Let d be the dimension of the space. In this context, a *tile* is a polynomials $T \in \mathbb{F}_2[X_1, \dots, X_d] = \mathbb{F}_2[X]$ and we say it *tiles the space* if there exists $C \in \mathbb{F}_2[[X^\pm]]$ such that

$$TC = \mathbb{1} \text{ in } \mathbb{Z},$$

where $\mathbb{1} = \sum_{\mathbf{v} \in \mathbb{Z}^d} X^{\mathbf{v}}$ is the configuration over \mathbb{Z}^d with 1s in every position. It is important that the multiplication TC is done in \mathbb{Z} and not \mathbb{F}_2 . Informally, TC corresponds to the configuration with a translate of T positioned in every non-zero cell of C , adding their values if they overlap. Then, T tiles the space if there exists such a C such that translated copies of T fill the whole space ($TC \geq \mathbb{1}$) but do not overlap ($TC \leq \mathbb{1}$). The configuration C is called a *co-tiler*, and T tiles the space *periodically* if there exists a periodic co-tiler. Note that because they are binary configurations, both C and T can be seen as sets of \mathbb{Z}^d where $\mathbf{v} \in C \Leftrightarrow C_{\mathbf{v}} = 1$ and $\mathbf{v} \in T \Leftrightarrow T_{\mathbf{v}} = 1$. Lagarias and Wang conjectured the following:

Conjecture (Periodic tiling problem. Lagarias, Wang [LW96]). *If a tiles tiles \mathbb{Z}^d , then it also tiles it periodically.*

This conjecture is true for $d = 1$, where every tiling is in fact periodic. Using ergodic theory, Bhattacharya proved recently that it was true for $d = 2$ [Bha20]. For higher dimension, the conjecture is still open. It is only know to hold in any dimension in the case where $|T| = 4$ or $|T| = p$ with p a prime number [Sze98].

The link between the periodic tiling problem and Nivat’s conjecture comes from the fact that every T -pattern of C must contain exactly one 1, so $P_C(T) = T$. Therefore every co-tiler is of low complexity with respect to T . This further motivates the study of Open Problem 4 as it would imply that the period tiling problem is true in any dimension.

In his paper, Szegedy [Sze98] finds, for every tile T , an equivalent tile $S_{|T|}$ in $\mathbb{Z}^{|T|-1}$ such that if there is a fully periodic by $S_{|T|}$ then there exists a periodic tiling by T . $S_{|T|}$ turns out to be quite easy, since it can be defined as

$$S_{|T|} = \sum_{i=0}^{|T|-1} X^i.$$

$S_{|T|}$ can be seen as a $|T| - 1$ -dimensional generalization of the 2D polynomial $1 + X + Y$ defining the 3-dot system (see Section 2.2.1). This suggests that higher dimensional algebraic subshifts might also be useful to solve the periodic tiling problem.

The Domino Problem of Groups

In Chapter 3, we studied links between the structure of some groups and orbit graphs of substitutions. In Section 3.3 we proved that Baumslag-Solitar groups $BS(1, n)$ have both strongly aperiodic tilesets (Theorem 3.3.5) and weakly not strongly aperiodic tilesets (Theorem 3.3.12). Finally, in Section 3.4 we proved that the domino problem of orbit graphs of many non-deterministic substitutions is undecidable (Theorem 3.4.12) and deduce the same for the domino problem of surface groups (Corollary 3.4.14).

For general Baumslag-Solitar groups $BS(m, n)$ we only know the existence of a weakly aperiodic tileset [AK13], and it is hard to even conjecture if they have a strongly aperiodic one or not. They are among the few candidates to have no strongly aperiodic SFT but undecidable domino problem. All we know is that the potential proof will have to use the fact that Baumslag-Solitar groups are non residually finite for $m \neq n \neq 1$. Indeed, Baumslag-Solitar groups are residually finite if and only if $m = n$ or $m = 1$ or $n = 1$, and in these cases they have a strongly aperiodic tileset. The case $m = 1$ is Theorem 3.3.5 of this thesis, and the case $m = n$ is done in [EM20].

In Theorem 3.3.13 we characterize substitutions over binary alphabet that can be naturally encoded over the Cayley graph of $BS(1, n)$, called shift-similar substitutions. It would be interesting to know how shift-similar substitutions with bigger alphabet can be characterized and if they are as limited as the ones with binary alphabet. We also wonder how shift-similar substitutions can be extended to be able to encode substitutions in more general $BS(m, n)$ groups.

Conjecture 1 states that the domino problem is undecidable if and only if it is virtually free. It seems far out of reach for the moment, as not even a proof strategy has been found to tackle it, and it would be a breakthrough to be able to characterize groups with undecidable domino problem.

A more realistic goal would be to know how far the reduction of Corollary 3.4.14 can be pushed. In other words, what other groups can we find groups that have a Cayley graph close enough to an orbit graph of a substitution for our method to work and prove that they have undecidable domino problem. We believe that one-ended word-hyperbolic groups are good candidates for this. As did Cohen, Goodman-Strauss and Rieck to find a strongly aperiodic SFT over hyperbolic groups [CGR17], we can remark that the language of geodesics of a one-ended word-hyperbolic group G which are lexicographically minimal is a regular language. The intuition is that the deterministic finite automaton recognizing this language might be enough to find an orbit graph inside the Cayley graph of G . Letters of the alphabet would be the states of the automaton and the rules of the substitution would be given by the transition function of the automaton. Surface groups were easier because they have a planar Cayley graph, and exactly one orbit graph is enough to cover the whole graph. For more general word-hyperbolic groups, the main difficulty is that we have no guarantee to find such a simple structure, there may be several orbit graphs that merge and/or split.

One-ended word-hyperbolic groups are particularly interesting as they are the only case we need to treat to solve the domino problem conjecture (Conjecture 1) for all word-hyperbolic groups, as we remarked in the end of [ABM19]. By combining known results about word-hyperbolic groups we showed that if word-hyperbolic a group is not virtually free, it must contain a one-ended word-hyperbolic subgroup.

Proposition 4.1. *If the domino problem of one-ended word-hyperbolic groups is undecidable, then the domino problem conjecture holds for all word-hyperbolic groups.*

Bibliography

- [ABJ18] Nathalie Aubrun, Sebastián Barbieri, and Emmanuel Jeandel. “About the Domino Problem for Subshifts on Groups”. In: *Sequences, Groups, and Number Theory*. Ed. by Valérie Berthé and Michel Rigo. Springer, 2018, pp. 331–389. DOI: [10.1007/978-3-319-69152-7_9](https://doi.org/10.1007/978-3-319-69152-7_9).
- [ABM19] Nathalie Aubrun, Sebastián Barbieri, and Etienne Moutot. “The Domino Problem is Undecidable on Surface Groups”. In: *44th International Symposium on Mathematical Foundations of Computer Science (MFCS 2019)*. Vol. 138. 2019, 46:1–46:14. DOI: [10.4230/LIPIcs.MFCS.2019.46](https://doi.org/10.4230/LIPIcs.MFCS.2019.46).
- [AK13] Nathalie Aubrun and Jarkko Kari. “Tiling Problems on Baumslag-Solitar groups”. In: *MCU’13*. 2013, pp. 35–46.
- [AS13] Nathalie Aubrun and Mathieu Sablik. “Simulation of effective subshifts by two-dimensional subshifts of finite type”. In: *Acta Applicandae Mathematicae* 126.1 (2013), pp. 35–63. DOI: [10.1007/s10440-013-9808-5](https://doi.org/10.1007/s10440-013-9808-5).
- [Bar17] Sebastian Barbieri. “Shift spaces on groups: computability and dynamics”. PhD thesis. Université de Lyon, 2017.
- [Bar19] Sebastian Barbieri. “A geometric simulation theorem on direct products of finitely generated groups”. In: *Discrete Analysis* 9 (2019).
- [Ber+19] Valérie Berthé, Wolfgang Steiner, Jörg M. Thuswaldner, and Reem Yasawi. “Recognizability for sequences of morphisms”. In: *Ergodic Theory and Dynamical Systems* 39.11 (2019), pp. 2896–2931. DOI: [10.1017/etds.2017.144](https://doi.org/10.1017/etds.2017.144).
- [Ber64] Robert Berger. “The Undecidability of the Domino Problem”. PhD thesis. Harvard University, 1964.
- [Ber66] Robert Berger. *The Undecidability of the Domino Problem*. Memoirs of the American Mathematical Society 66. The American Mathematical Society, 1966.
- [Bha20] Siddhartha Bhattacharya. “Periodicity and decidability of tilings of \mathbb{Z}^2 ”. In: *American Journal of Mathematics* 142.1 (2020), pp. 255–266. DOI: [10.1353/ajm.2020.0006](https://doi.org/10.1353/ajm.2020.0006).

- [Bir12] George D. Birkhoff. “Quelques théorèmes sur le mouvement des systèmes dynamiques”. French. In: *Bulletin de la Société Mathématique de France* 40 (1912), pp. 305–323. DOI: [10.24033/bsmf.909](https://doi.org/10.24033/bsmf.909).
- [BL97] Mike Boyle and Douglas Lind. “Expansive Subdynamics”. In: *Transactions of the American Mathematical Society* 349.1 (1997), pp. 55–102.
- [Boo58] William W. Boone. “The Word Problem”. In: *Proceedings of the National Academy of Sciences* 44.10 (1958), pp. 1061–1065. DOI: [10.1073/pnas.44.10.1061](https://doi.org/10.1073/pnas.44.10.1061).
- [Boy08] Mike Boyle. “Open problems in symbolic dynamics”. In: *Contemporary Mathematics*. Ed. by Keith Burns, Dmitry Dolgopyat, and Yakov Pesin. Vol. 469. American Mathematical Society, 2008, pp. 69–118. DOI: [10.1090/conm/469/09161](https://doi.org/10.1090/conm/469/09161).
- [BR18] Valérie Berthé and Michel Rigo, eds. *Sequences, Groups, and Number Theory*. Springer, 2018. DOI: [10.1007/978-3-319-69152-7](https://doi.org/10.1007/978-3-319-69152-7).
- [BS13] Alexis Ballier and Maya Stein. “The domino problem on groups of polynomial growth”. In: *Groups, Geometry, and Dynamics* 12 (Nov. 2013). DOI: [10.4171/GGD/439](https://doi.org/10.4171/GGD/439).
- [BS19] Sebastián Barbieri and Mathieu Sablik. “A generalization of the simulation theorem for semidirect products”. In: *Ergodic Theory and Dynamical Systems* 39.12 (2019), pp. 3185–3206. DOI: [10.1017/etds.2018.21](https://doi.org/10.1017/etds.2018.21).
- [BV00] Valérie Berthé and Laurent Vuillon. “Tilings and rotations on the torus: a two-dimensional generalization of Sturmian sequences”. In: *Discrete Mathematics* 223.1 (2000), pp. 27–53. DOI: [10.1016/S0012-365X\(00\)00039-X](https://doi.org/10.1016/S0012-365X(00)00039-X).
- [Cas00] Julien Cassaigne. “Subword Complexity and Periodicity in Two or More Dimensions”. In: *Developments In Language Theory*. World Scientific, Nov. 2000, pp. 14–21. DOI: [10.1142/9789812792464_0002](https://doi.org/10.1142/9789812792464_0002).
- [Cas99] Julien Cassaigne. “Double Sequences with Complexity $mn+1$ ”. In: *Journal of Automata, Languages and Combinatorics* 4 (1999), pp. 153–170.
- [CG17] David Cohen and Chaim Goodman-Strauss. “Strongly aperiodic subshifts on surface groups”. In: *Groups, Geometry, and Dynamics* 11.3 (2017), pp. 1041–1059. DOI: [10.4171/ggd/421](https://doi.org/10.4171/ggd/421).
- [CG19] Cleber F. Colle and Eduardo Garibaldi. *An Alphabetical Approach to Nivat’s Conjecture*. 2019. arXiv: [1904.04897](https://arxiv.org/abs/1904.04897) [[math.DS](#)].
- [CGR17] David Bruce Cohen, Chaim Goodman-Strauss, and Yo’av Rieck. *Strongly aperiodic subshifts of finite type on hyperbolic groups*. 2017. arXiv: [1706.01387](https://arxiv.org/abs/1706.01387) [[math.GR](#)].
- [CK15] Van Cyr and Bryna Kra. “Nonexpansive \mathbb{Z}^2 -subdynamics and Nivat’s Conjecture”. In: *Transactions of the American Mathematical Society* 367.9 (Feb. 2015), pp. 6487–6537. DOI: [10.1090/s0002-9947-2015-06391-0](https://doi.org/10.1090/s0002-9947-2015-06391-0).
- [CK16] Van Cyr and Bryna Kra. “Complexity of short rectangles and periodicity”. In: *European Journal of Combinatorics* 52 (2016), pp. 146–173. DOI: [10.1016/j.ejc.2015.10.003](https://doi.org/10.1016/j.ejc.2015.10.003).

- [CK17] Vaughn Climenhaga and Anatole Katok. *From Groups to Geometry and Back*. Apr. 2017. ISBN: 9781470434793.
- [CLO15] David A Cox, John Little, and Donal O’Shea. *Ideals, Varieties, and Algorithms: An Introduction to Computational Algebraic Geometry and Commutative Algebra*. 4th. Springer, 2015. ISBN: 3-319-16720-0.
- [Coh+03] Michael F. Cohen, Jonathan Shade, Stefan Hiller, and Oliver Deussen. “Wang Tiles for Image and Texture Generation”. In: *ACM SIGGRAPH 2003 Papers*. SIGGRAPH ’03. San Diego, California, 2003, pp. 287–294. DOI: [10.1145/1201775.882265](https://doi.org/10.1145/1201775.882265).
- [Coh17] David Bruce Cohen. “The large scale geometry of strongly aperiodic subshifts of finite type”. In: *Advances in Mathematics* 308 (2017), pp. 599–626. DOI: [10.1016/j.aim.2016.12.016](https://doi.org/10.1016/j.aim.2016.12.016).
- [CP15] David Carroll and Andrew Penland. “Periodic Points on Shifts of Finite Type and Commensurability Invariants of Groups”. In: *New York Journal of Mathematics* 21 (Feb. 2015).
- [Cul96] Karel Culik. “An aperiodic set of 13 Wang tiles”. In: *Discrete Mathematics* 160.1 (1996), pp. 245–251. DOI: [10.1016/S0012-365X\(96\)00118-5](https://doi.org/10.1016/S0012-365X(96)00118-5).
- [DGG14] Bruno Durand, Guilhem Gamard, and Anaël Grandjean. “Aperiodic Tilings and Entropy”. In: *Developments in Language Theory*. Ed. by Arseny M. Shur and Mikhail V. Volkov. Springer International Publishing, 2014, pp. 166–177. DOI: [10.1007/978-3-319-09698-8_15](https://doi.org/10.1007/978-3-319-09698-8_15).
- [Die04] Reinhard Diestel. “A short proof of Halin’s grid theorem”. In: *Abhandlungen aus dem Mathematischen Seminar der Universität Hamburg* 74.1 (2004), pp. 237–242. DOI: [10.1007/BF02941538](https://doi.org/10.1007/BF02941538).
- [Don+16] Sebastian Donoso, Fabien Durand, Alejandro Maas, and Samuel Petite. “On automorphism groups of low complexity subshifts”. In: *Ergodic Theory and Dynamical Systems* 36.1 (2016), pp. 64–95. DOI: [10.1017/etds.2015.70](https://doi.org/10.1017/etds.2015.70).
- [DR11] Fabien Durand and Michel Rigo. “Multidimensional extension of the Morse–Hedlund theorem”. In: *European Journal of Combinatorics* 34 (Sept. 2011). DOI: [10.1016/j.ejc.2012.08.003](https://doi.org/10.1016/j.ejc.2012.08.003).
- [EKM03] Chiara Epifanio, Michel Koskas, and Filippo Mignosi. “On a Conjecture on Bidimensional Words”. In: *Theoretical Computer Science* 299.1 (Apr. 2003), pp. 123–150. DOI: [10.1016/S0304-3975\(01\)00386-3](https://doi.org/10.1016/S0304-3975(01)00386-3).
- [EM20] Julien Esnay and Etienne Moutot. “Weakly and Strongly Aperiodic Subshifts of Finite Type on Baumslag-Solitar Groups”. In: (2020). arXiv: [2004.02534](https://arxiv.org/abs/2004.02534) [math.DS].
- [Eva14] Constantine Glen Evans. “Crystals that Count! Physical Principles and Experimental Investigations of DNA Tile Self-Assembly”. PhD thesis. 2014. DOI: [10.7907/7FMK-9403](https://doi.org/10.7907/7FMK-9403).
- [FT17] Joshua Frisch and Omer Tamuz. “Symbolic dynamics on amenable groups: the entropy of generic shifts”. In: *Ergodic Theory and Dynamical Systems* 37.4 (2017), pp. 1187–1210. DOI: [10.1017/etds.2015.84](https://doi.org/10.1017/etds.2015.84).

- [GMV18] Anael Grandjean, Benjamin Hellouin de Menibus, and Pascal Vanier. “Aperiodic Points in \mathbb{Z}^2 -subshifts”. In: *45th International Colloquium on Automata, Languages, and Programming (ICALP 2018)*. Vol. 107. Leibniz International Proceedings in Informatics (LIPIcs). 2018, 128:1–128:13. DOI: [10.4230/LIPIcs.ICALP.2018.128](https://doi.org/10.4230/LIPIcs.ICALP.2018.128).
- [Goo05] Chaim Goodman-Strauss. “A strongly aperiodic set of tiles in the hyperbolic plane”. In: *Inventiones mathematicae* 159.1 (Jan. 2005), pp. 119–132. DOI: [10.1007/s00222-004-0384-1](https://doi.org/10.1007/s00222-004-0384-1).
- [Hed69] Gustav A. Hedlund Hedlund. “Endomorphisms and automorphisms of the shift dynamical system”. In: *Mathematical systems theory* 3.4 (Dec. 1969), pp. 320–375. DOI: [10.1007/BF01691062](https://doi.org/10.1007/BF01691062).
- [HM10] Michael Hochman and Tom Meyerovitch. “A characterization of the entropies of multidimensional shifts of finite type”. In: *Annals of Mathematics* 171.3 (May 2010), pp. 2011–2038. DOI: [10.4007/annals.2010.171.2011](https://doi.org/10.4007/annals.2010.171.2011).
- [Hoc08] Michael Hochman. “On the dynamics and recursive properties of multidimensional symbolic systems”. In: *Inventiones mathematicae* 176.1 (Dec. 2008), p. 131. DOI: [10.1007/s00222-008-0161-7](https://doi.org/10.1007/s00222-008-0161-7).
- [Hoc10] Michael Hochman. “On the automorphism groups of multidimensional shifts of finite type”. In: *Ergodic Theory and Dynamical Systems* 30.3 (2010), pp. 809–840. DOI: [10.1017/S0143385709000248](https://doi.org/10.1017/S0143385709000248).
- [HV17] Michael Hochman and Pascal Vanier. “Turing Degree Spectra of Minimal Subshifts”. In: *Computer Science – Theory and Applications*. Ed. by Pascal Weil. Cham: Springer International Publishing, 2017, pp. 154–161.
- [Jea15a] Emmanuel Jeandel. *Aperiodic Subshifts of Finite Type on Groups*. 2015. arXiv: [1501.06831](https://arxiv.org/abs/1501.06831) [[math.GR](#)].
- [Jea15b] Emmanuel Jeandel. “Aperiodic Subshifts on Polycyclic Groups”. In: (2015). arXiv: [1510.02360](https://arxiv.org/abs/1510.02360) [[cs.DM](#)].
- [Jea15c] Emmanuel Jeandel. “Translation-like Actions and Aperiodic Subshifts on Groups”. In: (2015). arXiv: [1508.06419](https://arxiv.org/abs/1508.06419) [[cs.FL](#)].
- [JMV20] Emmanuel Jeandel, Etienne Moutot, and Pascal Vanier. “Slopes of Multidimensional Subshifts”. In: *Theory of Computing Systems* 64.1 (Jan. 2020), pp. 35–61. DOI: [10.1007/s00224-019-09931-1](https://doi.org/10.1007/s00224-019-09931-1).
- [JR15] Emmanuel Jeandel and Michaël Rao. “An aperiodic set of 11 Wang tiles”. In: (2015). arXiv: [1506.06492](https://arxiv.org/abs/1506.06492).
- [JV13a] Emmanuel Jeandel and Pascal Vanier. “Characterizations of periods of multi-dimensional shifts”. In: *Ergodic Theory and Dynamical Systems* September (2013), pp. 1–30. DOI: [10.1017/etds.2013.60](https://doi.org/10.1017/etds.2013.60).
- [JV13b] Emmanuel Jeandel and Pascal Vanier. “Turing degrees of multidimensional SFTs”. In: *Theoretical Computer Science* 505 (2013). Theory and Applications of Models of Computation 2011, pp. 81–92. DOI: [10.1016/j.tcs.2012.08.027](https://doi.org/10.1016/j.tcs.2012.08.027).

-
- [JV15] Emmanuel Jeandel and Pascal Vanier. “Hardness of conjugacy, embedding and factorization of multidimensional subshifts”. In: *Journal of Computer and System Sciences* 81.8 (2015), pp. 1648–1664. DOI: [10.1016/j.jcss.2015.05.003](https://doi.org/10.1016/j.jcss.2015.05.003).
- [Kar05] Jarkko Kari. “Theory of cellular automata: A survey”. In: *Theoretical Computer Science* 334.1 (2005), pp. 3–33.
- [Kar08] Jarkko Kari. “On the Undecidability of the Tiling Problem”. In: *Current Trends in Theory and Practice of Computer Science (SOFSEM)*. 2008, pp. 74–82.
- [Kar19] Jarkko Kari. “Low-Complexity Tilings of the Plane”. In: *Descriptive Complexity of Formal Systems*. 2019, pp. 35–45. ISBN: 978-3-030-23247-4.
- [Kar90] Jarkko Kari. “Reversibility of 2D cellular automata is undecidable”. In: *Physica D: Nonlinear Phenomena* 45.1 (1990), pp. 379–385. DOI: [10.1016/0167-2789\(90\)90195-U](https://doi.org/10.1016/0167-2789(90)90195-U).
- [Kar92] Jarkko Kari. “The Nilpotency Problem of One-Dimensional Cellular Automata”. In: *SIAM Journal on Computing* 21.3 (1992), pp. 571–586.
- [Kar94] Jarkko Kari. “Reversibility and surjectivity problems of cellular automata”. In: *Journal of Computer and System Sciences* 48.1 (1994), pp. 149–182. DOI: [10.1016/S0022-0000\(05\)80025-X](https://doi.org/10.1016/S0022-0000(05)80025-X).
- [Kar96] Jarkko Kari. “A small aperiodic set of Wang tiles”. In: *Discrete Mathematics* 160.13 (1996), pp. 259–264.
- [KL05] Dietrich Kuske and Markus Lohrey. “Logical aspects of Cayley-graphs: the group case”. In: *Annals of Pure and Applied Logic* 131.1–3 (2005), pp. 263–286. DOI: [10.1016/j.apal.2004.06.002](https://doi.org/10.1016/j.apal.2004.06.002).
- [KM19] Jarkko Kari and Etienne Moutot. “Nivats conjecture and pattern complexity in algebraic subshifts”. In: *Theoretical Computer Science* (2019). DOI: [10.1016/j.tcs.2018.12.029](https://doi.org/10.1016/j.tcs.2018.12.029).
- [KM20] Jarkko Kari and Etienne Moutot. “Decidability and Periodicity of Low Complexity Tilings”. In: *37th International Symposium on Theoretical Aspects of Computer Science (STACS 2020)*. Vol. 154. Leibniz International Proceedings in Informatics (LIPIcs). 2020, 14:1–14:12. DOI: [10.4230/LIPIcs.STACS.2020.14](https://doi.org/10.4230/LIPIcs.STACS.2020.14).
- [Kop+06] Johannes Kopf, Daniel Cohen-Or, Oliver Deussen, and Dani Lischinski. “Recursive Wang Tiles for Real-Time Blue Noise”. In: *ACM SIGGRAPH 2006 Papers*. SIGGRAPH ’06. Boston, Massachusetts, 2006, pp. 509–518. DOI: [10.1145/1179352.1141916](https://doi.org/10.1145/1179352.1141916).
- [KS15a] Jarkko Kari and Michal Szabados. “An Algebraic Geometric Approach to Multidimensional Words”. In: *Algebraic Informatics*. Ed. by Andreas Maletti. Cham: Springer International Publishing, 2015, pp. 29–42. ISBN: 978-3-319-23021-4.

- [KS15b] Jarkko Kari and Michal Szabados. “An Algebraic Geometric Approach to Nivat’s Conjecture”. In: *Automata, Languages, and Programming*. Ed. by Magnús M Halldórsson, Kazuo Iwama, Naoki Kobayashi, and Bettina Speckmann. Vol. 9135. Springer Berlin Heidelberg, 2015, pp. 273–285.
- [Led78] François Ledrappier. “Un champ markovien peut être d’entropie nulle et mélangeant”. French. In: *Comptes Rendus Hebdomadaires des Séances de l’Académie des Sciences. Séries A et B* 287.7 (1978), A561–A563. ISSN: 0151-0509.
- [LM95] Douglas A Lind and Brian Marcus. *An Introduction to Symbolic Dynamics and Coding*. Cambridge University Press, 1995.
- [Luk09] Ville Lukkarila. “The 4-way deterministic tiling problem is undecidable”. In: *Theoretical Computer Science* 410.16 (2009), pp. 1516–1533. DOI: [10.1016/j.tcs.2008.12.006](https://doi.org/10.1016/j.tcs.2008.12.006).
- [LW96] Jeffrey C. Lagarias and Yang Wang. “Tiling the line with translates of one tile”. In: *Inventiones mathematicae* 124.1 (Feb. 1996), pp. 341–365. DOI: [10.1007/s002220050056](https://doi.org/10.1007/s002220050056).
- [MH38] Marston Morse and Gustav A. Hedlund. “Symbolic Dynamics”. In: *American Journal of Mathematics* 60.4 (1938), pp. 815–866. DOI: [10.2307/2371264](https://doi.org/10.2307/2371264).
- [Mos92] Brigitte Mossé. “Puissance de mots et reconnaissabilité des points fixes d’une substitution”. French. In: *Theoretical Computer Science* 99.2 (1992), pp. 327–334. DOI: [10.1016/0304-3975\(92\)90357-L](https://doi.org/10.1016/0304-3975(92)90357-L).
- [MS85] David E Muller and Paul E Schupp. “The theory of ends, pushdown automata, and second-order logic”. In: *Theoretical Computer Science* 37.0 (1985), pp. 51–75. DOI: [10.1016/0304-3975\(85\)90087-8](https://doi.org/10.1016/0304-3975(85)90087-8).
- [MV18] Etienne Moutot and Pascal Vanier. “Slopes of 3-Dimensional Subshifts of Finite Type”. In: *Computer Science Theory and Applications*. Springer International Publishing, 2018, pp. 257–268.
- [Niv97] Maurice Nivat. *Keynote address at the 25th anniversary of EATCS, during ICALP 1997, Bologna*. 1997.
- [Nov55] Pyotr Novikov. “On the algorithmic unsolvability of the word problem in group theory”. In: *Proceedings of the Steklov Institute of Mathematics* 44 (1955), pp. 3–143.
- [Pan86] Jean-Jacques Pansiot. “Decidability of periodicity for infinite words”. In: *RAIRO - Theoretical Informatics and Applications* 20.1 (1986), pp. 43–46. DOI: [10.1051/ita/1986200100431](https://doi.org/10.1051/ita/1986200100431).
- [Pia08] Steven T. Piantadosi. “Symbolic dynamics on free groups”. In: *Discrete & Continuous Dynamical Systems - A* 20 (2008), p. 725. DOI: [10.3934/dcds.2008.20.725](https://doi.org/10.3934/dcds.2008.20.725).
- [PS15] Ronnie Pavlov and Michael Schraudner. “Entropies realizable by block gluing \mathbb{Z}^d shifts of finite type”. In: *Journal d’Analyse Mathématique* 126.1 (Apr. 2015), pp. 113–174. DOI: [10.1007/s11854-015-0014-4](https://doi.org/10.1007/s11854-015-0014-4).

- [QZ04] Anthony Quas and Luca Zamboni. “Periodicity and Local Complexity”. In: *Theoretical Computer Science* 319.13 (June 2004), pp. 229–240. DOI: [10.1016/j.tcs.2004.02.026](https://doi.org/10.1016/j.tcs.2004.02.026).
- [Rob71] Raphael M. Robinson. “Undecidability and nonperiodicity for tilings of the plane”. In: *Inventiones mathematicae* 12.3 (Sept. 1971), pp. 177–209. DOI: [10.1007/BF01418780](https://doi.org/10.1007/BF01418780).
- [RPW04] Paul W. K. Rothmund, Nick Papadakis, and Erik Winfree. “Algorithmic Self-Assembly of DNA Sierpinski Triangles”. In: *PLoS Biology* 2.12 (Dec. 2004). Ed. by Anne Condon, p. 424. DOI: [10.1371/journal.pbio.0020424](https://doi.org/10.1371/journal.pbio.0020424).
- [SD12] J Stillwell and M Dehn. *Papers on Group Theory and Topology*. Springer New York, 2012. ISBN: 978-1-4612-4668-8.
- [ST00] J. W. Sander and Robert Tijdeman. “The complexity of functions on lattices”. In: *Theoretical Computer Science* 246.1-2 (2000), pp. 195–225.
- [ST02] Juergen Sander and Robert Tijdeman. “The rectangle complexity of functions on two-dimensional lattices”. In: *Theoretical Computer Science* 270 (Jan. 2002), pp. 857–863. DOI: [10.1016/S0304-3975\(01\)00281-X](https://doi.org/10.1016/S0304-3975(01)00281-X).
- [Sta97] Jos Stam. *Aperiodic Texture Mapping*. Tech. rep. European Research Consortium for Informatics and Mathematics (ERCIM), 1997.
- [SW99] Jeffrey Shallit and Ming-wei Wang. “On two-sided infinite fixed points of morphisms”. In: *Fundamentals of Computation Theory: 12th International Symposium, FCT99 Iai, Romania, Proceedings*. 1999, pp. 488–99. DOI: [10.1007/3-540-48321-7_41](https://doi.org/10.1007/3-540-48321-7_41).
- [Sza18a] Michal Szabados. “An algebraic approach to Nivat’s conjecture”. PhD thesis. University of Turku, 2018.
- [Sza18b] Michal Szabados. “Nivat’s Conjecture Holds for Sums of Two Periodic Configurations”. In: *SOFSEM 2018: Theory and Practice of Computer Science*. 2018, pp. 539–551.
- [Sze98] Mario Szegedy. “Algorithms to tile the infinite grid with finite clusters”. In: *Proceedings 39th Annual Symposium on Foundations of Computer Science*. IEEE Comput. Soc, 1998, pp. 137–145. DOI: [10.1109/SFCS.1998.743437](https://doi.org/10.1109/SFCS.1998.743437).
- [Wan61] Hao Wang. “Proving theorems by pattern recognition – II”. In: *The Bell System Technical Journal* 40.1 (1961), pp. 1–41. DOI: [10.1002/j.1538-7305.1961.tb03975.x](https://doi.org/10.1002/j.1538-7305.1961.tb03975.x).
- [Win98] Erik Winfree. “Algorithmic Self-Assembly of DNA”. PhD thesis. 1998. DOI: [10.7907/HBBV-PF79](https://doi.org/10.7907/HBBV-PF79).
- [Woe89] Wolfgang Woess. “Graphs and groups with tree-like properties”. In: *Journal of Combinatorial Theory, Series B* 47.3 (1989), pp. 361–371. DOI: [10.1016/0095-8956\(89\)90034-8](https://doi.org/10.1016/0095-8956(89)90034-8).

Personal Bibliography

- [ABM19] Nathalie Aubrun, Sebastián Barbieri, and Etienne Moutot. “The Domino Problem is Undecidable on Surface Groups”. In: *44th International Symposium on Mathematical Foundations of Computer Science (MFCS 2019)*. Vol. 138. 2019, 46:1–46:14. DOI: [10.4230/LIPIcs.MFCS.2019.46](https://doi.org/10.4230/LIPIcs.MFCS.2019.46).
- [EM20] Julien Esnay and Etienne Moutot. “Weakly and Strongly Aperiodic Subshifts of Finite Type on Baumslag-Solitar Groups”. In: (2020). arXiv: [2004.02534](https://arxiv.org/abs/2004.02534) [[math.DS](#)].
- [JMV20] Emmanuel Jeandel, Etienne Moutot, and Pascal Vanier. “Slopes of Multi-dimensional Subshifts”. In: *Theory of Computing Systems* 64.1 (Jan. 2020), pp. 35–61. DOI: [10.1007/s00224-019-09931-1](https://doi.org/10.1007/s00224-019-09931-1).
- [KM19] Jarkko Kari and Etienne Moutot. “Nivats conjecture and pattern complexity in algebraic subshifts”. In: *Theoretical Computer Science* (2019). DOI: [10.1016/j.tcs.2018.12.029](https://doi.org/10.1016/j.tcs.2018.12.029).
- [KM20] Jarkko Kari and Etienne Moutot. “Decidability and Periodicity of Low Complexity Tilings”. In: *37th International Symposium on Theoretical Aspects of Computer Science (STACS 2020)*. Vol. 154. Leibniz International Proceedings in Informatics (LIPIcs). 2020, 14:1–14:12. DOI: [10.4230/LIPIcs.STACS.2020.14](https://doi.org/10.4230/LIPIcs.STACS.2020.14).
- [MV18] Etienne Moutot and Pascal Vanier. “Slopes of 3-Dimensional Subshifts of Finite Type”. In: *Computer Science Theory and Applications*. Springer International Publishing, 2018, pp. 257–268.

Résumé

Étant donné un ensemble fini de tuiles carrés, le *problème du domino* est la question : «est-il possible de paver le plan entier en utilisant ces tuiles ?» Ce problème est connu pour être indécidable dans le cas des pavages du plan, et est très fortement lié à la question de la *périodicité* des pavages. Dans cette thèse nous abordons ce problème de deux points de vue différents : d'abord en regardant le cas particulier des pavages de faible complexité, ensuite en le généralisant aux structures plus générales des groupes.

Un pavage du plan est dit de faible complexité s'il y apparaît moins de mn rectangles de taille $m \times n$. Nivat conjecture en 1997 qu'un tel pavage est nécessairement périodique, avec comme conséquence que le problème du domino serait décidable pour les pavages de faible complexité. En continuant de développer des outils algébriques introduits par Kari et Szabados, nous prouvons une version généralisée de la conjecture de Nivat pour une classe de pavages particuliers (certains des sous-décalages algébriques). Nous parvenons également à montrer que la conjecture de Nivat est vraie pour tout pavage uniformément récurrent, avec comme conséquence que le problème du domino est effectivement décidable pour les pavages de faible complexité.

Le problème du domino peut également se formuler dans le cadre plus général des graphes de Cayley de groupes. Dans cette thèse nous développons de nouvelles techniques permettant de relier les graphes de Cayley de certains groupes à des graphes de substitutions. Une première technique nous permet de montrer qu'il existe à la fois des pavages fortement apériodiques et faiblement-non-fortement apériodiques pour les groupes de Baumslag-Solitar $BS(1, n)$. Une seconde nous permet de montrer que le problème du domino est indécidable pour les groupes de surface, ce qui fournit une nouvelle classe de groupe vérifiant la conjecture disant que le problème du domino d'un groupe est décidable si et seulement si le groupe est virtuellement libre.