



HAL
open science

Characterization of non-retroviral integrated RNA virus sequences (NIRVS) in *Aedes albopictus* populations and Relation with vector competence

Vincent Houé

► **To cite this version:**

Vincent Houé. Characterization of non-retroviral integrated RNA virus sequences (NIRVS) in *Aedes albopictus* populations and Relation with vector competence. Human health and pathology. Sorbonne Université, 2019. English. NNT : 2019SORUS139 . tel-02969504

HAL Id: tel-02969504

<https://theses.hal.science/tel-02969504v1>

Submitted on 16 Oct 2020

HAL is a multi-disciplinary open access archive for the deposit and dissemination of scientific research documents, whether they are published or not. The documents may come from teaching and research institutions in France or abroad, or from public or private research centers.

L'archive ouverte pluridisciplinaire **HAL**, est destinée au dépôt et à la diffusion de documents scientifiques de niveau recherche, publiés ou non, émanant des établissements d'enseignement et de recherche français ou étrangers, des laboratoires publics ou privés.

Sorbonne Université

Ecole doctorale 515 Compléxité du Vivant

Unité Arbovirus et Insectes Vecteurs, Institut Pasteur Paris

Characterization of non-retroviral integrated RNA virus sequences (NIRVS) in *Aedes albopictus* populations and Relation with vector competence

Par Vincent Houé

Thèse de doctorat de Virologie et Entomologie Médicale

Dirigée par Professeur Anna-Bella Failloux

Présentée et soutenue publiquement le 13 septembre 2019

Devant un jury composé de :

M. Dominique HIGUET, Professeur

Président du jury

Mme Esther SCHNETTLER, Professeur

Rapporteur

M. Jean-Michel DREZEN, Chargé de Recherche

Rapporteur

M. Xavier DE LAMBALLERIE, Professeur

Examineur

M. Jean-Philippe DAVID, Chargé de Recherche

Examineur

Mme Anna-Bella FAILLOUX, Professeur

Directrice de thèse

"Science knows no country, because knowledge belongs to humanity, and is the torch which illuminates the world."

Louis Pasteur, 1960

Acknowledgments

I have no proper words to describe the gratitude I have to my supervisor Pr. Anna-Bella Failloux. I have learned some many things standing by your side that for sure go beyond Science. Thank you for taking me as your student, for supporting me during these 3 years, and for always showing me the right way. I am fully aware of the luck I had to be in your lab, and I will always be grateful to you for the trust you gave me.

I want to thank the jury members: Pr. Dominique Higuët, Pr. Esther Schnettler, Pr. Jean-Michel Drezen, Pr. Xavier de Lamballerie and Dr. Jean-Philippe David for examining and evaluating my work. I also thank Mariangela Bonizzoni from Pavia, Italy, for funding my PhD position here in Pasteur.

My deep gratitude also goes to Catherine Dauga, who helped me keeping the right track during this PhD. Thank you for your time and your patience. I also want to thank all my collaborators (Gaëlle Gabiane, Marie Suez, Michele Marconcini, Elisa Pischedda, Juliana Pipoli Da Fonseca, Thomas Cokelaer, Yoann Dufresne, Yoann Madec and others); this thesis is not only the fruit of my work, but represents all our efforts combined together.

I also want to thank all my labmates, formers and current ones, that represent UAIV. These 3 years have been an adventure that I will remember for the rest of my life. I personally thank Laurence Mousson for finding solutions to all my technical problems, you were my savior so many times I stopped counting. I also express my deep gratitude to Pei-Shi Yen. You have no idea how precious were your advice and the time you took to teach me things. Thank you for having my back man, I will always owe you.

Finally, I want to express all my gratitude to my friends and family who encouraged me during these 3 years. Exploring the unknown can sometimes be tough, but you have always found the words to keep me going and getting through this.

Résumé

Durant les 40 dernières années, le moustique tigre *Aedes albopictus* (Skuse, 1894) est devenu un problème de santé publique majeur de par sa capacité à transmettre de nombreux virus pathogènes pour l'homme, tels que le Chikungunya (CHIKV), la dengue (DENV) et le virus Zika (ZIKV). Ce vecteur, qui a conquis tous les continents à l'exception de l'Antarctique, a été classé parmi les 100 espèces les plus invasives. Originaire des forêts tropicales d'Asie du Sud-Est, *Ae. albopictus* était confiné pendant des siècles à quelques régions d'Asie. A partir du 18^{ème} ou 19^{ème} siècle, il a été introduit dans les îles de l'Océan Indien puis à partir de la fin des années 1970, ce vecteur a profité de l'intensification du commerce mondial pour envahir la plupart des régions tropicales et subtropicales du globe. De plus, la capacité de ses œufs à réaliser une diapause hivernale a favorisé la colonisation des régions tempérées. *Ae. albopictus* a été détecté pour la première fois en Europe en 1979, en 1985 en Amérique du Nord, en 1986 en Amérique du Sud et en 1990 en Afrique.

Les routes migratoires empruntées par ce moustique pour étendre sa distribution géographique à partir de son berceau d'origine en Asie peuvent être déterminées par des approches de génétique des populations. Ces approches se basent sur l'analyse du polymorphisme génétique au sein et entre populations, et la modification de la structure allélique des populations sous l'effet de pressions évolutives (sélection, migration, mutations, dérive génétique).

Les différentes populations d'une même espèce de moustiques peuvent différer d'un point à l'autre de leur aire de répartition. Cette variation géographique peut porter sur des caractères morphologiques, physiologiques, écologiques, ou encore génétiques. La variation peut être le fait d'une adaptabilité au milieu, ou encore résulter du simple fait du hasard. L'organisation de ces populations a certainement des conséquences sur le mode de circulation des agents pathogènes tels que les arbovirus dont elles sont vectrices. La réceptivité d'une population de moustiques à un agent pathogène se mesure au travers de l'évaluation de la

compétence vectorielle. La compétence vectorielle se réfère à la capacité d'une population de moustiques à s'infecter suite à la prise d'un repas sanguin infectieux, à assurer la réplication virale et la transmission à un nouvel hôte. Le niveau de compétence vectorielle dépend des interactions complexes entre le génotype du moustique, celui du virus et des facteurs environnementaux (interactions GxGxE).

Bien que les arbovirus fassent l'objet de nombreuses investigations en raison de leur impact sur la santé humaine, un autre groupe de virus a récemment été découvert ; ce sont les virus spécifiques d'insectes (VSI), parmi lesquels, les flavivirus spécifiques d'insectes (FSI). Il est de plus en plus admis que les VSI ont un effet antiviral chez le moustique, dépendant de la combinaison VSI/arbovirus. En plus de leur potentiel effet antiviral, les VSI ont été proposés comme matrice pour générer des virus chimères contenant des protéines d'arbovirus ; les premiers résultats montrent qu'une simple injection chez la souris conférerait une immunité protectrice avec la production d'anticorps neutralisants. De plus, du fait de leur incapacité à se répliquer dans les cellules de vertébrés, ces virus chimères sont inoffensifs pour les humains et les animaux. Globalement, les VSI pourraient être un outil biologique et naturel utilisé pour la lutte contre les arboviroses.

Depuis les années 1970, il est connu que les rétrovirus s'intègrent dans le génome de leurs hôtes afin de pouvoir assurer leur réplication virale. Ceci est rendu possible grâce à la transcriptase inverse des rétrovirus, qui permet la rétro-transcription du génome rétroviral en ARN double brin puis en ADN double brin. Il est estimé qu'environ 8% du génome humain est constitué de séquences virales. Ces intégrations peuvent survenir dans le génome des gamètes, assurant une transmission verticale dans les populations hôtes. Ces éléments viraux insérés dans les lignées germinales sont appelés rétrovirus endogènes (RVE). Il a été démontré que ces RVE pouvaient évoluer afin d'acquérir des fonctions biologiques bénéfiques pour l'hôte. Par exemple, certains RVE ont des propriétés antivirales contre leurs

formes exogènes, capables d'inhiber ou de diminuer la réplication virale. Plus surprenant, hormis les rétrovirus, de l'ADN viral issu de différents virus a été retrouvé dans une grande variété de génomes d'eucaryotes. Parmi eux, des fragments de virus à ARN dont le cycle de réplication ne comprend aucune étape de production d'ADN ont été détectés dans de multiples génomes, y compris dans celui du moustique *Ae. albopictus*. Bien que leur mode de formation dans le génome de l'hôte reste encore peu connu, il semblerait que ces séquences d'origine non-rétrovirale (en anglais, « nonretroviral integrated RNA virus sequences », NIRVS) soient issues de la reverse transcription de l'ARN viral en ADN double brin réalisée par les rétrotransposons, des séquences ADN capable de se répliquer et se déplacer dans le génome hôte. De plus, grâce à l'activité intégrase des rétrotransposons, les NIRVS sont ensuite intégrés dans le génome de leur hôte. Chez le moustique du genre *Aedes*, les NIRVS issues de FSI et de rhabdovirus spécifiques d'insectes sont les plus fréquemment retrouvés et certains d'entre eux, bien que fragmentés et non traduit en protéines, pourraient avoir une fonction biologique. En effet, ils ont été retrouvés dans des régions du génome appelées Cluster de piARN, où de petits ARN non codants, les ARNs interagissant avec les protéines PIWI (piARNs) sont produits. Ces petites molécules sont connues pour réguler l'activité des éléments transposables tels que les rétrotransposons chez de nombreuses espèces, mais ont également un rôle antiviral chez les insectes, notamment lors d'infections à arbovirus. Par conséquent, ces NIRVS ont montré la capacité à produire des piARNs, ce qui suggère leur rôle antiviral chez le moustique.

Le rôle biologique des NIRVS identifiés chez *Ae. albopictus* reste encore inconnu. Ces éléments viraux peuvent être soit des éléments fossiles ou des cicatrices d'anciennes infections qui pourraient persister dans le génome hôte sans fonctions particulières soit des éléments maintenus dans le génome avec une activité particulière. Les objectifs de cette thèse ont été de caractériser les NIRVS chez les moustiques du genre *Aedes*, et en particulier chez

l'espèce invasive *Ae. albopictus*. Ces objectifs ont été divisés en trois parties centrées sur la dynamique d'évolution des NIRVS, leurs fonctions potentielles suite à une infection arbovirale et leurs formations dans le génome hôte.

Nous avons sélectionnés sept différents NIRVS, précédemment identifiés et issus de flavivirus spécifique d'insectes, et les avons caractérisé chez douze populations d'*Ae. albopictus*. Ces populations ont été choisies de par leur localisation géographique et sont issues de pays où le CHIKV et la DENV ont circulé ou circulent encore actuellement. Nous avons d'abord commencé par étudier les variations génétiques de ces populations à l'aide de marqueurs ADN à évolution neutre. Nous avons montré que ces populations sont divisées en deux principaux groupes dont l'un d'eux est subdivisé en 4 sous-groupes. Tandis que certaines populations sont hétérogènes, d'autres sont composées d'individus génétiquement similaires. Nous avons suggéré que ces variations génétiques illustrent un modèle en contact-zone, où les flux de gènes sont restreints entre des populations isolées et plus important entre populations centrales, jouant le rôle d'intermédiaires.

Nous avons ensuite utilisé les mêmes individus issus de ces populations d'*Ae. albopictus* pour étudier la distribution des sept NIRVS. Nous avons montré qu'il existait une grande variabilité au sein et entre les populations. Ces résultats nous ont indiqué qu'à l'exception d'un élément, aucun NIRVS n'était fixé dans les populations examinées. Afin de définir si les NIRVS évoluaient comme les microsatellites, de façon neutre, nous avons comparé les profils phylogénétiques en se basant sur le polymorphisme génétique obtenu avec les microsatellites et les profils d'abondance des NIRVS. Nous avons démontré que les deux profils différaient et que l'évolution des NIRVS dans le génome d'*Ae. albopictus* n'était pas neutre, ce qui suggère que ces éléments viraux ont une fonction potentielle chez le moustique.

Du fait qu'il a été précédemment suggéré que les NIRVS avaient une fonction antivirale par la production de piARNs chez les moustiques du genre *Aedes*, nous avons voulu

tester la corrélation entre ces NIRVS et la dissémination du CHIKV et de la DENV dans ces mêmes populations d'*Ae. albopictus*. En se basant sur des données de dissémination virale issues de la littérature, nous avons montré par l'utilisation de modèles de régression logistique que la majorité de ces NIRVS étaient corrélés à la dissémination de la DENV et/ou du CHIKV au niveau populationnel. Ces corrélations, différentes en fonction des NIRVS, suggèrent que ceux-ci auraient un rôle différent sur la dissémination virale. Nous avons tenté de confirmer ce résultat au niveau individuel. Pour cela nous avons choisi deux NIRVS, AlbFlavi2 et AlbFlavi36, de par leur large distribution et leur présence dans un piARN cluster et une région intergénique respectivement. Nous avons d'abord montré par des analyses phylogénétiques que les séquences AlbFlavi2 étaient très hétérogènes, et que cette variabilité était associée à des événements de délétions au cours de leur évolution. Cette variabilité était attendue, étant donné que cet élément viral était présent dans des régions subissant de forts taux de mutation. Cependant, nous avons observé une très faible variabilité dans les séquences AlbFlavi36. Lors d'une expérience pilote, nous n'avons pas pu confirmer les corrélations entre AlbFlavi2/AlbFlavi36 et la dissémination du CHIKV et de la DENV au niveau individuel. Ces résultats contradictoires avec les analyses au niveau populationnelles révèlent que le rôle antiviral des NIRVS reste à être prouvé. En effet, bien que ces éléments produisent des piARNs, la complémentarité de séquences entre ces molécules et les génomes viraux auxquels ils sont associés est limitée, et ne permet pas une reconnaissance suffisante pour déclencher des actions antivirales. Il est également possible que ces éléments soient désormais trop différents des virus exogènes dont ils sont issus, de par leur évolution différente au sein du génome de l'hôte. Néanmoins, leur conservation au sein du génome suggère une potentielle fonction qui reste encore inconnue.

Nous avons enfin étudié la formation des NIRVS en établissant des lignées cellulaires issues d'*Ae. albopictus* (U4.4) et *Ae. aegypti* (Aag2) infectées de manière persistante avec

cinq différents virus : CHIKV, DENV, deux FSI : Kamiti River virus (KRV) et le Cell Fusing Agent virus (CFAV) ainsi qu'un rhabdovirus, le virus de stomatite vésiculaire (VSV). Globalement, les résultats préliminaires ont révélés que la formation de NIRVS était un évènement rare. En effet, aucune intégration n'a été détectée dans le génome Aag2 pour le VSV et le KRV. Huit et deux NIRVS issues de la DENV et du CHIKV ont cependant été respectivement identifiés dans le génome de Aag2. De plus, de nouveaux NIRVS issues du CFAV ont été découverts dans la lignée Aag2 qui était déjà infectée de manière persistante par ce même virus. Certains NIRVS ont été trouvé à proximité d'éléments transposables, confirmant leur implication dans la formation de NIRVS dans le génome hôte. Comme attendu, la majorité des NIRVS issues de la DENV sont similaires à des fragments de séquences codant des protéines non-structurales. Ces résultats restent en revanche à être confirmés.

En résumé, nous avons montré que les NIRVS n'évoluaient pas de manière neutre et que leur histoire évolutive est rythmée par diverses pressions de sélection dans le génome du moustique *Ae. albopictus*, incluant les infections arbovirales. Bien qu'une corrélation entre ces NIRVS et la dissémination virale ait été montrée au niveau populationnel, nous n'avons pas pu confirmer ces résultats au niveau individuel, suggérant que leur rôle chez le moustique est plus complexe qu'attendu. Enfin, une expérience *in vitro* nous a permis de confirmer que la formation de NIRVS était un évènement rare impliquant l'intervention d'éléments transposables. Nous avons montré que les arbovirus pouvaient également être capables d'endogénéisation dans le génome hôte. Ces résultats nous apportent de nouveaux éléments en vue de développer de nouveaux outils biologiques pour lutter contre les arbovirus.

Table of contents

Acknowledgments	1
Résumé	2
Table of contents	9
Tables of Figures	11
Table of Tables	12
List of Abbreviations	13
Introduction	15
1.1 Symptoms, history and spread of the disease.....	19
1.2 Dengue virus characteristics	21
1.3 DENV life cycle	23
2. Chikungunya	24
2.1 Chikungunya: the burden of a historic disease.....	24
2.2 Economic issues due to chikungunya	27
2.3 Chikungunya virus.....	27
3. <i>Aedes albopictus</i> mosquito	30
3.1 <i>Aedes albopictus</i> life cycle	31
3.2 History and opportunistic expansion	32
3.3 Population genetics and genetic variability	34
3.3.1 Definition	34
3.3.2 Microsatellites as DNA marker for studying population genetic structure	39
3.3.3 Characterisation of <i>Aedes albopictus</i> fast expansion by population genetics	41
3.4 Vector of arbovirus diseases	42
3.5 <i>Aedes albopictus</i> genomic features.....	44
3.5.1 Transposable elements	46
4. Mosquito vector competence and antiviral immunity	51
4.1 Vector competence of mosquitoes.....	51
4.2 RNA interference immunity.....	54
4.2.1 siRNA pathway	55
4.2.2 miRNA pathway.....	56
4.2.3 piRNA pathway	56
5. Insect-specific viruses as mosquito virome	63
5.1 Insect-specific viruses as origin of arboviruses	63
5.2 Host-range restriction of insect-specific viruses	64
5.3 Insect-specific virus transmission.....	66
5.4 Insect-specific flaviviruses	67
5.4.1 Genome features of ISFs	71
5.4.2 Impact of insect-specific flaviviruses on the vector competence for pathogenic viruses	73
5.4.3 Insect-specific viruses as a new control strategy against arboviruses	76
6. Endogenous Viral Elements	77
6.1 Endogenous retroviral elements	77
6.1.1 Host benefits of endogenous retroviral elements	79
6.1.2 Host constraints of endogenous retroviral elements	80
6.2 Endogenous viral elements from DNA viruses	80
6.3 Non-retroviral integrated RNA virus sequences (NIRVS).....	81
6.3.1 Mechanisms of NIRVS integration.....	85
6.3.2 NIRVS biological functions.....	88
6.4 Endogenous viral elements and virus-host coevolution.....	91
6.4.1 Paleovirology	91

6.4.2 Estimates of viral origins by dating endogenous viral elements	92
Thesis objectives.....	95
Chapter 1: Evolution and potential biological role of NIRVS.....	99
1. Introduction.....	100
2. Evolution and biological significance of flaviviral elements in the genome of the arboviral vector Aedes albopictus	101
Genetic structure of populations.....	109
<i>Population genetic structure.....</i>	114
3. Conclusions	151
Chapter 2: Detection of newly produced NIRVS in mosquito persistently infected cells.....	156
1. Introduction.....	157
1. Experimental protocol.....	159
3. Results	161
3.1 Growth of infected cell cultures	161
3.2 Viral persistence in infected cell cultures	162
3.3 Detection of NIRVS following infections in cultured cells.....	165
3.3.1 Detection of NIRVS deriving from Cell Fusing Agent Virus RNA genome.....	166
3.3.2 Detection of NIRVS from Dengue virus RNA genome	168
3.3.3 Detection of NIRVS Chikungunya RNA genome	169
4. Conclusions	175
General conclusion, discussion and perspectives.....	181
References.....	195
Appendices.....	243
Appendix N°1	244
Appendix N°2	248
Appendix N°3	251
Appendix N°4	266
Appendix N°5	287

Tables of Figures

Figure 1: Global distribution of dengue-infected people from 1943 to 2013.	20
Figure 2: Genome structure of dengue virus.	22
Figure 3: Dengue virus (DENV) replication cycle.	25
Figure 4: Chikungunya virus (CHIKV) RNA genome.	28
Figure 5: Chikungunya virus (CHIKV) replication cycle.	29
Figure 6: Scutum of <i>Aedes aegypti</i> and <i>Aedes albopictus</i>.	31
Figure 7: <i>Aedes</i> mosquito life cycle defined in 8 different steps.	33
Figure 8: World distribution of <i>Aedes aegypti</i> and <i>Aedes albopictus</i>.	35
Figure 9: Complex invasion pathways inferred by population genetics analysis.	42
Figure 10: Retrotransposition mechanism of LTR retrotransposons.	48
Figure 11: Non-LTR retrotransposition mechanism.	50
Figure 12: Cut-and-paste transposition mechanism of DNA elements.	52
Figure 13: piRNA cluster mechanism to repress transposable element (TE) activity.	53
Figure 14: Schematic representation of an arboviral infection in mosquito.	54
Figure 15: siRNA and miRNA pathways.	57
Figure 16: Primary and secondary piRNA pathways.	61
Figure 17: Phylogenetic classification of the <i>Flavivirus</i> genus.	72
Figure 18: Potential NIRVS production and antiviral functions.	92
Figure 19: Dating viral evolutionary timescales using endogenous viral elements (EVEs).	94
Figure 20: Experimental protocol used to detect potential new NIRVS in cellular models.	160
Figure 21: Titers at different passages of viruses used to infect U4.4 and Aag2 cell lines.	164
Figure 22: Putative NIRVS produced following viral infection in Aag2 cell cultures.	174

Table of Tables

Tableau 1: List of insect-specific flaviviruses (ISFs) discovered.	68
Tableau 2: List of experiments studying the effects of ISVs on the vector competence to pathogenic arboviruses.	74
Tableau 3: Summary of the putative NIRVS found in Aag2 infected cells.	178

List of Abbreviations

ADE: Antibody-Dependent Enhancement	piRNA: PIWI-interacting RNA
Ago: Argonaute	PRR: Pattern Recognition Receptor
AZT: Azidothymidine	RAPD: Random Amplification of Polymorphic DNA
CFAV: Cell Fusing Agent Virus	RFLP: Restriction Fragment Length Polymorphism
CHIKV: Chikungunya	RdRp: RNA-dependent RNA Polymerase
cISF: classical ISF	RIG-I: Retinoic Acid-Inducible Gene I
CPE: Cytopathic Effect	RISC: RNA-Induced Silencing Complex
DC-SIGN: Dendritic Cell-Specific ICAM3-Grabbing Non-integrin	RNAi: RNA interference
DENV: Dengue virus	sfRNA: Subgenomic flavivirus RNA
DF: Dengue Fever	SINE: Short Interspersed Nuclear <i>Elements</i>
DHF: Dengue Hemorrhagic Fever	siRNA: Small-interfering RNA
dISF: Dual-host affiliated ISF	SNP: Single Nucleotide Polymorphism
dsRBP: double stranded RNA-Binding Protein	sRNA: Small RNA
dsRNA: double stranded RNA	SSR: Single Sequence Repeat
DSS: DENV Shock Syndrome	TCID₅₀: 50% Tissue Culture Infectious Dose
EEEV: Eastern Equine Encephalitis Virus	TE: Transposable Element
ER: Endoplasmic Reticulum	TGN: Trans-Golgi Network
ERV: Endogenous Retroviral Element	TIR: Terminal Inverted Repeat
FFA: Focus Fluorescent Assay	USD: United-State Dollars
F_{IS}: coefficient of inbreeding	UTR: Untranslated Region

F_{IT}: Global inbreeding coefficient

F_{ST}: Fixation index

HWE: Hardy-Weinberg Equilibrium

IFN: Interferon

Imd: Immune deficiency

IRF: Interferon Regulatory Factor

ISF: Insect-Specific Flavivirus

ISV: Insect-Specific Virus

ITS: Internal Transcribed Spacer

JEV: Japanese Encephalitis Virus

KRV: Kamiti River Virus

L-SIGN: Liver/Lymph node-specific intercellular adhesion molecule-3-grabbing integrin

LACV: La Crosse Virus

LINE: Long Interspersed Nuclear Element

LTR: Long Terminal Repeat

MDA5: Melanoma Differentiation-Associated protein 5

MIR: Mammalian wide Interspersed Repeats
miRNA: micro-RNA

MOI: Multiplicity of Infection

NIRVS: Non-retroviral Integrated RNA Virus Sequences

ORF: Open Reading Frame

PAMPS: Pathogen-associated molecular pattern molecules

PFU: Plaque-Forming Unit

VC: Vector Competence

vDNA: viral DNA

VEEV: Venezuelan Equine Encephalitis Virus

vRNA: Viral RNA

VSR: Viral Suppressors of RNAi

VSV: Vesicular Stomatitis Virus

WNV: West Nile Virus

YFV: Yellow Fever Virus

ZIKV: Zika Virus

Introduction

The transmission of pathogens from animal to human has been suspected for a long time without any pathogen isolation considering the small size of the infectious agents involved and the complexity of transmission cycles. The mosquito vector *Aedes aegypti* was first suggested to be involved in the transmission of the yellow fever virus (YFV) by Carlos Juan Finlay in 1881, which was further confirmed by Walter Reed early in the 20th century. This gave rise to the first description of a specific group of diseases, called arboviral diseases, for which the infectious pathogen is defined as an arbovirus.

Arboviruses stand for Arthropod-Borne Viruses, and are designated as a group of viruses that circulates through a complex transmission cycle, which requires three partners: a vector (arthropods), a vertebrate host (primates, humans, birds...) and a pathogen (arbovirus). The pathogen circulates between the vector and the host through vector bites when getting an infectious blood meal. Although vertical (from the female to the progeny) and venereal (infected male/female transmits the virus to the other sex during mating) transmissions have been reported, horizontal transmission of arboviruses is the main process ensuring the maintenance of these viruses in nature. Originally, most of the arboviruses circulate within an enzootic cycle that involves non-human primates and zoophilic (preference to feed on animals) vectors in forested environments.

The anthropo-zoophilic (i.e. feed on both animals and humans) behavior of many vectors may allow the passage of the virus from animals to humans and cause a switch from a sylvatic cycle to an urban cycle. Once in an urban environment, the virus is mainly transmitted by anthropophilic mosquitoes initiating epidemics in an immunologically naïve human population. Factors leading viral emergence or re-emergence are multiple (Ketkar, Herman, and Wang 2019). Among them, host genetic has been found as an important factor: for example in humans, single nucleotide polymorphism (SNP; which is the most common source of genetic variation) in genes related to antiviral immune pathways such as type I

interferon (IFN) responses has been linked to an increased susceptibility to certain arboviruses (Yakub et al. 2005; Bigham et al. 2011; Simon-Loriere et al. 2015). Viral polymorphisms are also included as factors leading to viral (re-) emergence; variations in the subgenomic flaviviral RNA (sfRNA) of the dengue virus (DENV) genome can increase pathogenicity in humans and transmission by mosquitoes (Chapman et al. 2014; Manokaran et al. 2015; Pompon et al. 2017) or mutations in the envelope glycoproteins of many arboviruses such as chikungunya virus (CHIKV), West Nile virus (WNV) and Zika virus (ZIKV) generating epidemic viral strains that are responsible for major outbreaks (Schuffenecker et al. 2006; Chávez et al. 2010; Ebel et al. 2004). Additionally, increased population densities in some regions of the world worsened by anarchic urbanization and intensive global transportations are at the origin of economic, technological and cultural changes. These changes triggered an increased exploitation of many different resources and modification of agricultural practices, which led to alteration of natural ecosystems (e.g. deforestation), and brought pathogens in repeated contacts with humans (Gubler Daniel J 2011; J 2001). Overall, these factors contributed to the global distribution of arboviruses.

The arthropod vectors of arboviruses belong to two main classes: insects and arachnids. The arachnid vectors are mainly represented by ticks that transmit Tick-Borne Encephalitis (TBE), Omsk hemorrhagic fever and ovine encephalomyelitis. The class of insects includes many different families. The Culicidae family comprises the main vectors of arboviruses such as CHIKV, DENV, YFV, ZIKV. Moreover, the class of insects also includes the subfamily of *Phlebotominae* with sandflies transmitting Vesicular Stomatitis Virus (VSV) and Punta Toro virus, and the *Culicoides* genus with biting midges that transmit the Bluetongue virus and the Oropouche virus.

With the exception of the African swine fever virus (Asfarviridae: *Asfarvirus*) that has a DNA virus as genome, arthropod vectors transmit exclusively RNA viruses with different

replication strategies within their hosts. Their RNA genome employs an error-prone polymerase lacking proof-reading mechanisms, which contributes to their rapid evolution and adaptation to new environments/hosts. They mainly belong to five different viral families: *Togaviridae*, *Flaviviridae*, *Bunyaviridae*, *Reoviridae*, and *Rhabdoviridae* (Fischer and Hills 2016). YFV that belongs to the *Flaviviridae* family was the first arbovirus isolated in 1927 (Stokes, Bauer, and Hudson 2001). Subsequently, this discovery led to the isolation of other Flaviviruses, such as Japanese encephalitis virus (JEV) in 1924 (MIYAKE 1964), WNV in 1937 (Smithburn et al. 1940), DENV in 1943 (Hotta 1952) and CHIKV in 1952 (M. C. Robinson 1955). Many other arboviruses were discovered thereafter, notably thanks to the contribution of the Rockefeller Foundation.

The discovery of arboviruses shed light on what was the cause of a major public health issue that was occurring for several hundred years and has dramatically increased since these last decades. However, efficient treatments and protective vaccines against arboviruses are still lacking, mostly because of the rapid evolution, adaptation and diversity of these RNA viruses in their hosts. Therefore, developing vector control strategies has become the horse battle of the scientific community to fight against vector-borne diseases but here again, inefficient, costly and unpredictable ecological impacts have highlighted the necessity of improving our knowledge on several critical points that will be detailed in this manuscript: features of endemic arboviruses (e.g. DENV, CHIKV) and their main mosquito vectors with a special focus on antiviral immunity mechanisms, mosquito virome and endogenous viral elements.

1. Dengue fever disease

1.1 Symptoms, history and spread of the disease

Just like other Flavivirus infections, most dengue infections are asymptomatic for humans (i.e. around 70-80%). Symptomatic infections can be distinguished in two different syndromes: dengue fever (DF) and dengue hemorrhagic fever (DHF). It has been well defined that secondary infection of DENV, especially if it involves a different serotype, increases the severity of the disease, i.e. increasing the probability of contracting dengue hemorrhagic fever (DHF), notably by antibody dependent enhancement (ADE)(Burke et al. 1988; Graham et al. 1999; Guzmán, Kourí, and Halstead 2000) .

DF symptoms are similar to the flu disease, with severe fever most of the time associated with arthralgia, skin rash, leukopenia, thrombocytopenia, retro-orbital headaches and myalgia (Burke et al. 1988; Kittigul et al. 2007), whereas DHF is characterized by all the symptoms of DF, plus severe bleeding and plasma leakage that involve important functional complications in many organs. Ultimately, DHF can cause dengue shock syndrome (DSS) leading in most cases, to the death of patients (Fischer and Hills 2016).

DF was originally described several times in the Chinese literature during the Chin Dynasty (265 to 420 A.D.), the Tang Dynasty (618-907 A.D.) and the Northern Sung Dynasty (960-1126 A.D.) (D J Gubler 1998). Major epidemics were thereafter described in several continents at the end of the 18th century, in Asia, Africa and North America, suggesting that the disease was already widely spread. Moreover, some events occurred throughout the past centuries, have greatly promoted an even bigger propagation of DF, such as the slave trade until the end of the 19th century and the World War II in the middle of the 20th century. These events led to a change in the epidemiological dynamic of DF, and a global pandemic became widely distributed. Historically, Southeast Asia gathered ideal conditions for the virus to spread and this region became the theater of major DHF epidemics, in Manila (Philippines) in

1953-1954 (Quintos FN, Lim LE, Juliano L 1954), Bangkok (NELSON 1960) in 1958, Malaysia, Singapore and Vietnam in the 1960s (Duane J Gubler 1998) (Fig. 1). The 1970s were marked by dengue epidemic activities in the Pacific Islands and the Americas, where the eradication program of the main YFV vector *Ae. aegypti* was interrupted in 1964 (Schliessmann D.J and Calheiros L.B 1974) (Fig. 1). It had dramatic consequences with a coming back of outbreaks in the Americas associated with *Ae. aegypti*. Thereafter, the urbanization process and increase of international exchanges during the last 50 years have further contributed to the spread of DF. Indeed, while only 9 countries were confronted to the disease in the 1970s, today more than 128 countries are highly affected by DF (Stanaway et al. 2016) (Fig. 1).

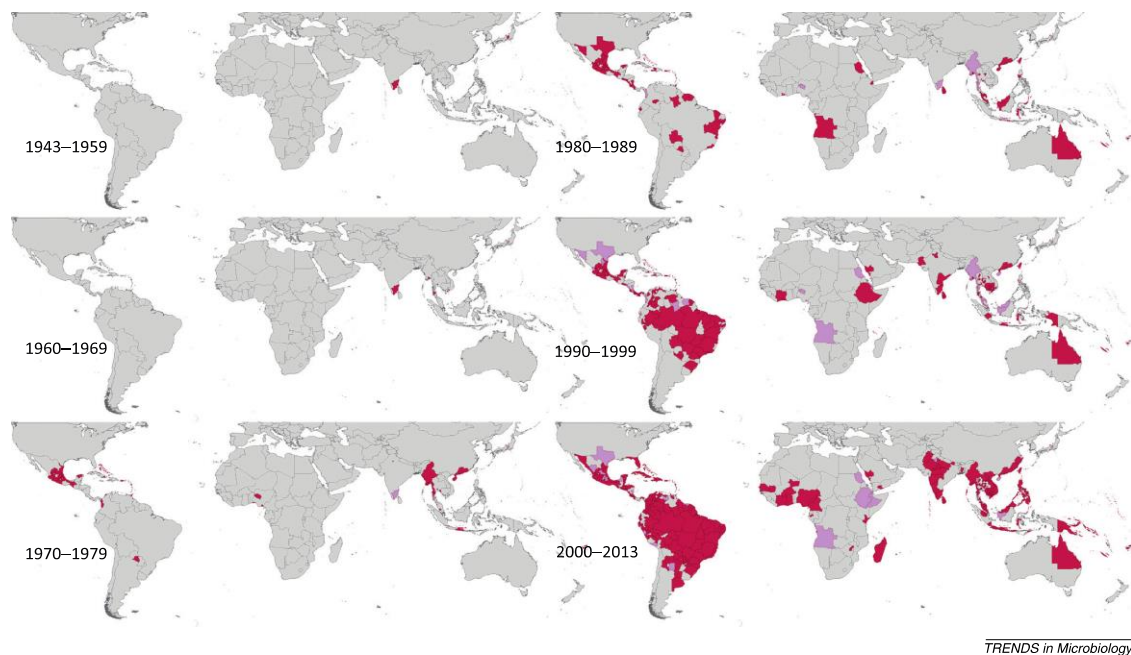

Figure 1: Global distribution of dengue-infected people from 1943 to 2013. The dark color represents cases that have been confirmed during corresponding decade, whereas the lighter color represents cases that have been reported posteriorly. From Messina et al., 2014

Currently, half of the world population (i.e. 4 billion people) is considered at risk, with 60 millions of symptomatic dengue infections and 10,000 deaths per year (Shepard et al. 2016; Stanaway et al. 2016). Moreover, it has been suggested that the number of

infections doubled every 10 years from 1990 to 2013 (Stanaway et al. 2016), with 18% of infected people admitted to hospital, 48% needing ambulatory medical care and 34% non-medical care (Stanaway et al. 2016). However, it has to be noted that these numbers could be under-estimated, due to the low awareness and poor surveillance systems in some regions of the world, such as Africa and Southeast Asia (Amarasinghe et al. 2011). Moreover, confounding symptoms with other diseases, such as CHIKV and ZIKV, makes difficult to estimate the real number of DENV cases. This highlights the expanding burden of dengue disease and its corresponding infectious agent in the past 30 years, becoming a global public health issue.

1.2 Dengue virus characteristics

Dengue virus (DENV) belongs to the *Flavivirus* genus that is included in the *Flaviviridae* family. Flaviviruses are separated into two clusters: non-vector and vector-borne clusters, with the latter being subdivided into tick-borne and mosquito-borne clusters (G Kuno et al. 1998). Dengue viruses are related to pathogenic Flaviviruses belonging to the same family such as YFV and JEV. Four serotypes of DENV phylogenetically distinct are defined and the four serotypes are antigenically distinct so that infection with one serotype does not confer protection to the others.

DENV is an RNA virus for which the virion has a diameter size of approximately 50 nm, a spherical shape and an envelope composed of a lipid bilayer and glycoproteins that form icosahedral scaffolds (Kuhn et al. 2002). Moreover, its RNA genome is made of around 10,700 nucleotides, contains a single open reading frame (ORF) and encodes a 3,411 amino acids long precursor polyprotein. The ORF is surrounded by highly structured untranslated regions (5' and 3' UTRs) involved in translation, replication and pathogenesis (Alvarez et al. 2005; Holden et al. 2006; Wei et al. 2009; Chiu, Kinney, and Dreher 2005). Indeed, 5' and 3' UTRs possess sequence complementarity that allows viral RNA cyclization for efficient RNA

synthesis by the viral RNA-dependent RNA polymerase (RdRp) NS5. Additionally, the 5' UTR with the presence of a large stem-loop is used as a promoter to trigger the replication of the RNA by NS5 (Filomatori et al. 2006). Moreover, the 3'UTR produces a subgenomic RNA (sfRNA) that could be able to modulate antiviral responses via RNA-mediated pathways (Pijlman et al. 2008). The polyprotein encompasses three structural proteins (capsid (C), precursor membrane (prM) and envelope (E)) and seven non-structural (NS) proteins (NS1, NS2A, NS2B, NS3, NS4A, NS4B and NS5) (Fig. 2).

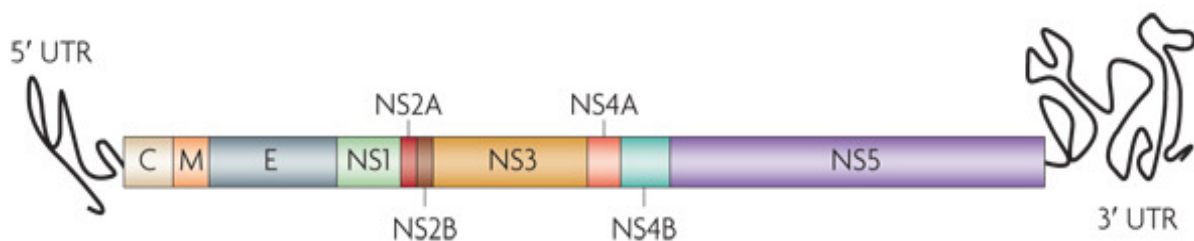

Figure 2: Genome structure of dengue virus. Structural proteins (capsid (C), membrane (M) and envelope (E)) and non-structural proteins (NS1, NS2A, NS2B, NS3, NS4A, NS4B and NS5) are flanked by 5' and 3' UTRs.

Structural proteins shape the mature virion by forming the capsid and the membranes during assembly, whereas non-structural proteins are involved in the replication of the viral genome through the formation of a replication complex that involves both viral and host proteins. NS1 protein has several roles in infected cells. This protein is involved in modulating the viral replication by association with the replication complex, especially NS4B (Youn et al. 2012). Moreover, when secreted, NS1 protein is capable of binding to complement proteins and inhibiting their functions (Avirutnan et al. 2010, 2011) Finally, NS1 is also involved in virus assembly by interacting with C and E proteins (Scaturro et al. 2015). As NS1, NS2A is important in viral RNA synthesis by being part of the replication complex, in viral assembly (Xie et al. 2013; Leung et al. 2008), and pathogenesis by inhibiting α/β interferon responses (Muñoz-Jordan et al. 2003). Besides having the role of a cofactor for

NS3, NS2B also has an antiviral role by type I interferon response in infected cells (Aguirre et al. 2017). NS3 protein cleaves the viral polyprotein into NS proteins at the early stage of infection, and is involved in virus assembly and envelope formation by its serine protease and nucleotide triphosphatase activities (Pan et al. 2017; Yamshchikov and Compans 1995). Moreover, its RNA helicase activity makes it an important factor of viral replication (Matusan et al. 2001). NS4A/B proteins play a role in viral replication (Welsch et al. 2009; Miller, Sparacio, and Bartenschlager 2006). Whereas NS4A induces membrane rearrangements (Miller et al. 2007), NS4B inhibits α/β interferon responses (Muñoz-Jordan et al. 2003; Muñoz-Jordán et al. 2005). Finally, the NS5 protein is the most conserved protein of the DENV genome and possesses two domains: a methyltransferase domain (MTase) at its N-terminus end and a RNA-dependent RNA polymerase (RdRp) at its C-terminus. The MTase domain is involved in capping the viral RNA and the RdRp domain is responsible of the RNA replication (Sahili and Lescar 2017). The functions of these viral proteins are enrolled during specific steps of the DENV life cycle.

1.3 DENV life cycle

DENV infection starts with the attachment of the virus on the cell membrane by binding to unknown receptors (Fig. 3). Potential receptors have however been previously suggested, such as heparin sulfates glycoproteins, dendritic cell-specific intercellular adhesion molecule-3-grabbing non-integrin (DC-SIGN), or a mannose receptor (H. J. Chen, Yuan, and Lobel 1997; Tassaneeritthep et al. 2003; J.L. et al. 2008). Then, the virus is vehicled by endocytosis in the cytoplasm and the low pH in the endosome leads to a change in the conformation of the E protein, which in turn leads to a fusion between the viral envelope and the vesicle membrane (Fig. 3). The nucleocapsid is then delivered in the cytoplasm and the virus uncoats and releases the positive-sense RNA genome (vRNA) (Scott B. Halstead et al. 2005). vRNA is then translated into the polyprotein and cellular as

well as viral proteases cleave junctions between the polyprotein into individual structural and non-structural proteins (Fig. 3). While NS3 protein is cleaved by host protease signal peptidases (Arias, Preugschat, and Strass 1993), the cleavage of the other proteins is carried out by viral proteases (i.e. NS3 and its cofactor NS2B). The replication complex is then formed with the different non-structural proteins in the membrane of the endoplasmic reticulum (ER) membrane, and the vRNA can now be transcribed into negative-sense RNA intermediate molecules that serve as a template to produce new positive-sense vRNA. This vRNA will then be assembled (capsid plus envelope) into immature particles at the ER membrane (Clyde, Kyle, and Harris 2006) after being capped and methylated in the replication complex (Klema et al. 2016). The immature virus is then transferred to the Trans-Golgi network (TGN) where the maturation of viral particles is completed with several modifications, including the cleavage of the prM-E complex by the host furin protease (Fig. 3). Indeed, this triggers a conformational change of the protein complex that allows the viral particle to be released from the cell (Stiasny et al. 2006).

2. Chikungunya

2.1 Chikungunya: the burden of a historic disease

The term chikungunya derived from the Makondé dialect (spoken by an ethnic group in Tanzania and Mozambic), which means “disease that bends up the joints”. Chikungunya can be traced back to the end of the 18th century, with reported epidemics in Cairo and Jakarta from 1779 to 1784, in India from 1820 to 1829 and in Zanzibar from 1870 to 1875. This was deduced by James Christie, who saw for the first time that infected patients did not develop the same symptoms as the common DF (Christie 1882).

The disease causes febrile illness with fever, rash and characteristic joint pains that can last several months or even years.

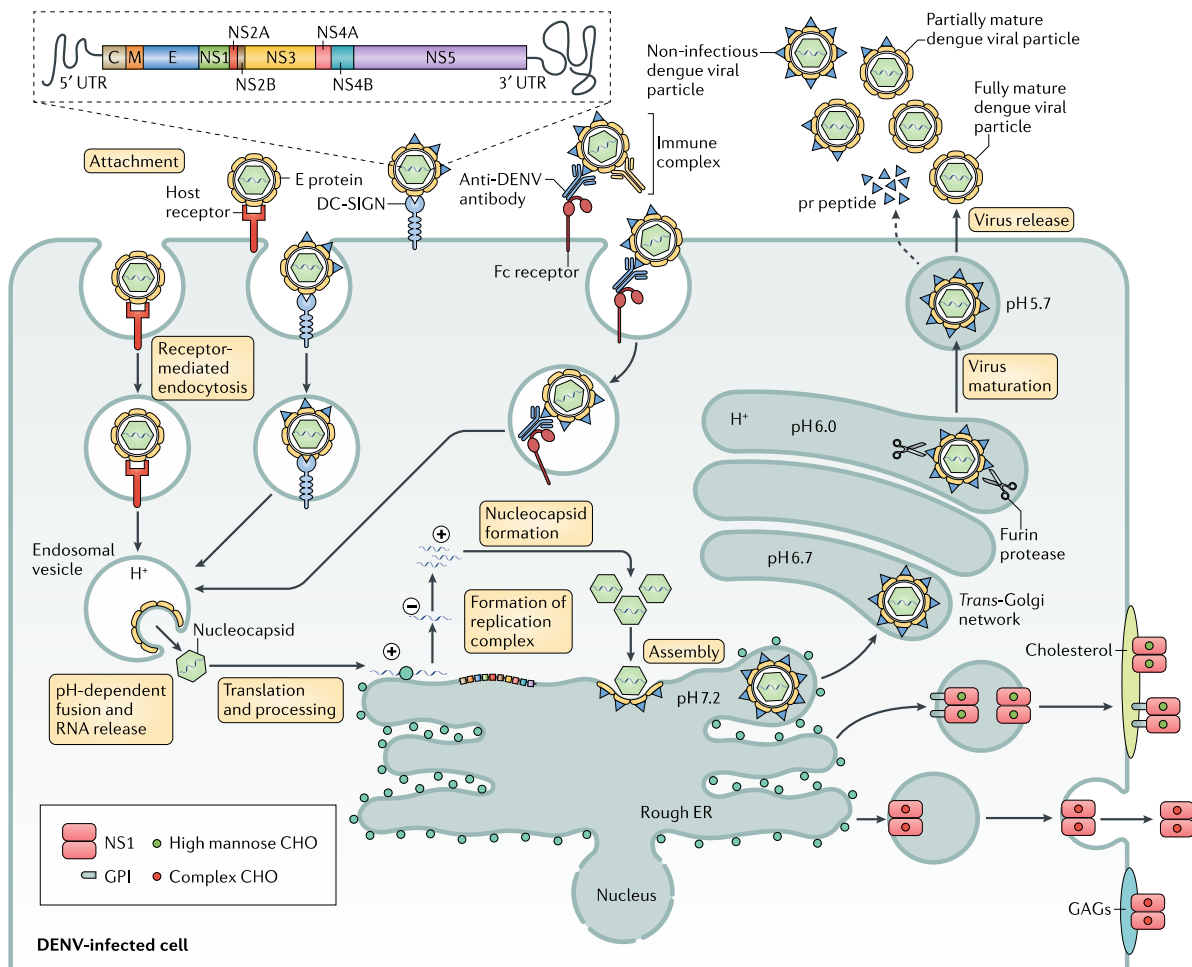

Figure 3: Dengue virus (DENV) replication cycle. DENV attaches to the host cell through the interaction between the E protein and receptors present at the cell surface. The virus is then vehicled by endocytosis and the low pH environment triggers the fusion of the viral envelope and the release of the nucleocapsid, which is then uncoated to deliver the viral positive-sense RNA (vRNA) in the cytoplasm of the host cell. vRNA is subsequently translated into a polyprotein, which is then cleaved into mature individual proteins by viral and cellular proteases. This leads to the formation of the replication complex at the membrane of the Endoplasmic Reticulum (ER). vRNA is then processed for transcription of negative-sense RNA that serves as a template to produce new vRNA molecules. vRNA is assembled (capsid and envelope) into an immature particle, which is thereafter transferred to the Trans-Golgi network (TGN). Changes in the conformation of the E protein leads to the complete maturation of the viral particle, which is now ready to be released out of the cell. From Guzman et al. (2016)

Unlike DF disease that causes asymptomatic infections, chikungunya triggers symptoms in 72-97% of infected people (Sharp et al. 2014; Sissoko et al. 2008; Moro et al. 2010; Thiberville et al. 2013). Other severe manifestations can also appear such as myocarditis, hepatitis and neurological disorders. Because the credit of many outbreaks was

given to DF in the past, chikungunya was officially discovered in 1952 during an epidemic in Tanzania (Ross 1956). Chikungunya emerged in Africa where it was circulating in an enzootic cycle between non-human primates and mosquito vectors. Many epidemics were reported in the continent: in South Africa (1956, 1975-1977), Zimbabwe (1957, 1961-1962, 1971), Democratic Republic of Congo (DRC) (1958,1960), Zambia (1959), Senegal (1960), Uganda (1961-1962), Nigeria (1964,1969 and 1974), Angola (1970–1971) and Central African Republic (1978–1979) (Powers and Logue 2007; Desdouits et al. 2015). During 20 years, only sporadic cases were reported in the continent before the virus re-emerged in the early 2000s in DRC, where 50,000 people were infected. Chikungunya was also reported in Asia early during the second half of the 20th century. First identified in Thailand in 1960 during an outbreak promoted by *Ae. aegypti*, the virus consequently spread to Southeast Asia such as Vietnam, Sri Lanka and Indonesia. In India, epidemics were also observed from 1964 to 1973 with hundreds of thousands of people infected. After many years of sporadic cases, the disease re-emerged in Asia at the end of the 1990s and early 2000s (Sam et al. 2012; Laras et al. 2005). In 2004, chikungunya expanded to Indian Ocean islands causing over 6 million cases (Schwartz and Albert 2010; Powers and Logue 2007; Staples, Breiman, and Powers 2009; Thiberville et al. 2013). A single mutation in the amino acid sequence of the glycoprotein E1 (E1-A226V) of CHIKV was proved to increase cholesterol dependence for infection and fusion, which led to a better adaptation and an increased fitness of the virus to another vector, *Aedes albopictus* (Schuffenecker et al. 2006; Kuo et al. 2012; Tsetsarkin et al. 2007b; Tsetsarkin, McGee, and Higgs 2011; Vazeille et al. 2007). Moreover, the wide distribution of the vector *Ae. albopictus* promoted the spread of the virus, even to Europe with an outbreak reported in 2007 in Italy (G Rezza et al. 2007), autochthonous cases in France in 2010 (even though the virus did not show to have the E1-226V mutation) (Grandadam et al. 2010; M. et al. 2011) and 2014 (Delisle et al. 2015). Finally, the emergence of chikungunya

was confirmed in the Americas in 2013 with first cases detected in Saint-Martin Island (Scott B Halstead 2015; Goro Kuno 2015; Cassadou et al. 2014), which led to the spread of the disease reaching 45 countries and affecting almost 3 million cases with 296 deaths (Pan American Health Organization. Number of reported cases of CHIK fever in the Americas by country or territory 2013-2014, and 2015. https://www.paho.org/hq/index.php?option=com_topics&view=rdfmore&cid=5927&item=chikungunya&type=statistics&Itemid=40931&lang=en). The distribution of the disease and its related symptoms that cause disabling consequences triggered important economic issues to endemic countries.

2.2 Economic issues due to chikungunya

Chikungunya is considered as a non-lethal illness, even though it is very likely that some deaths can be directly associated with the infection. However, this disease induces acute and chronic stages (Dupuis-Maguiraga et al. 2012). These stages coupled to the massive number of sick people contributed to a wide economic and financial burden. As example, the 2014 outbreak in Colombia has been evaluated to cost at least USD73.6 million (Cardona-Ospina et al. 2015). The 2007 chikungunya outbreak in Kerala, a region of India revealed that the out-of-pocket health expenditure (OOP) expense (that includes treatment, physician consultation, hospital stays, food and drugs) was USD7.4 per patient, which affected this district by costing in total USD13 million (Vijayakumar et al. 2013).

2.3 Chikungunya virus

CHIKV is divided into three distinct genotypes based on the glycoprotein E1: West African (WA), East/Central/South African (ECSA) and Asian genotypes (Sudeep and Parashar 2008). The ECSA genotype with the E1-A226V mutation responsible for the 2005-2006 outbreak in the Indian Ocean Islands gave rise to another lineage, the Indian Ocean Lineage (IOL),

constituting the fourth genotype (Tsetsarkin et al. 2007a; Tsetsarkin, McGee, and Higgs 2011).

CHIKV is an enveloped virus that belongs to the *Togaviridae* family, the genus *Alphavirus*, and the Semliki Forest group. Its size is about 70 nm and its genome is a positive single-stranded RNA molecule of approximately 11.8 kb. The 5' end of the genome has a 7-methylguanosine cap while the 3' end is polyadenylated. The CHIKV genome is divided into two RNAs: the 49S genomic RNA and the 26S subgenomic RNA and encodes four non-structural proteins (nsP1-4) and five structural proteins (Capsid, E3, E2, 6k and E1) (Fig. 4).

Just as DENV, CHIKV infects mosquito cells through receptor-mediated endocytosis by clathrin-dependent and independent mechanisms (Fig. 5) (R. C. H. Lee et al. 2013; Bernard et al. 2010). DC-SIGN, liver and lymph node-SIGN (L-SIGN), heparan sulfate, laminin and integrins have been suggested to be the viral receptor. Once in the endosome, the acidic environment confers conformational changes of the viral envelope that exposes the E1 glycoprotein and mediates virus-host cell membrane fusion.

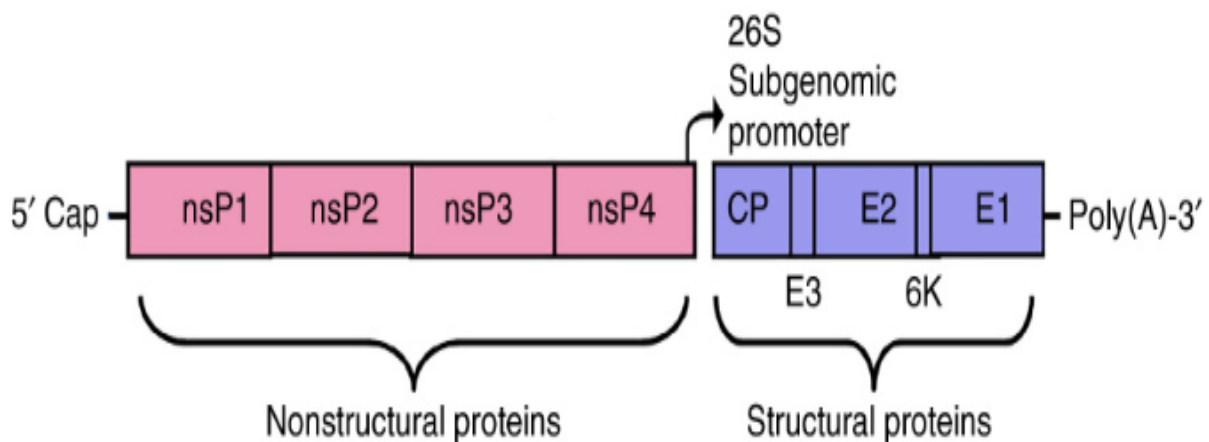

Figure 4: Chikungunya virus (CHIKV) RNA genome. The genome encodes for non-structural (pink) and structural proteins (purple), which are translated from two RNAs : the 49S genomic RNA (pink) and the 26S subgenomic RNA. From Tomar, S., Aggarwal, M., 2017. Structure and function of alphavirus proteases. In: Gupta, S.P. (Ed.), *Viral Proteases and Their Inhibitors*. Academic Press. Elsevier Inc., pp. 105e136

It triggers the release of the capsid protein and the viral genome in the cytoplasm (Chevillon et al. 2008). The host machinery then translates the 49S genomic RNA into non-structural proteins (nsP1-4) that are involved in the replication complex.

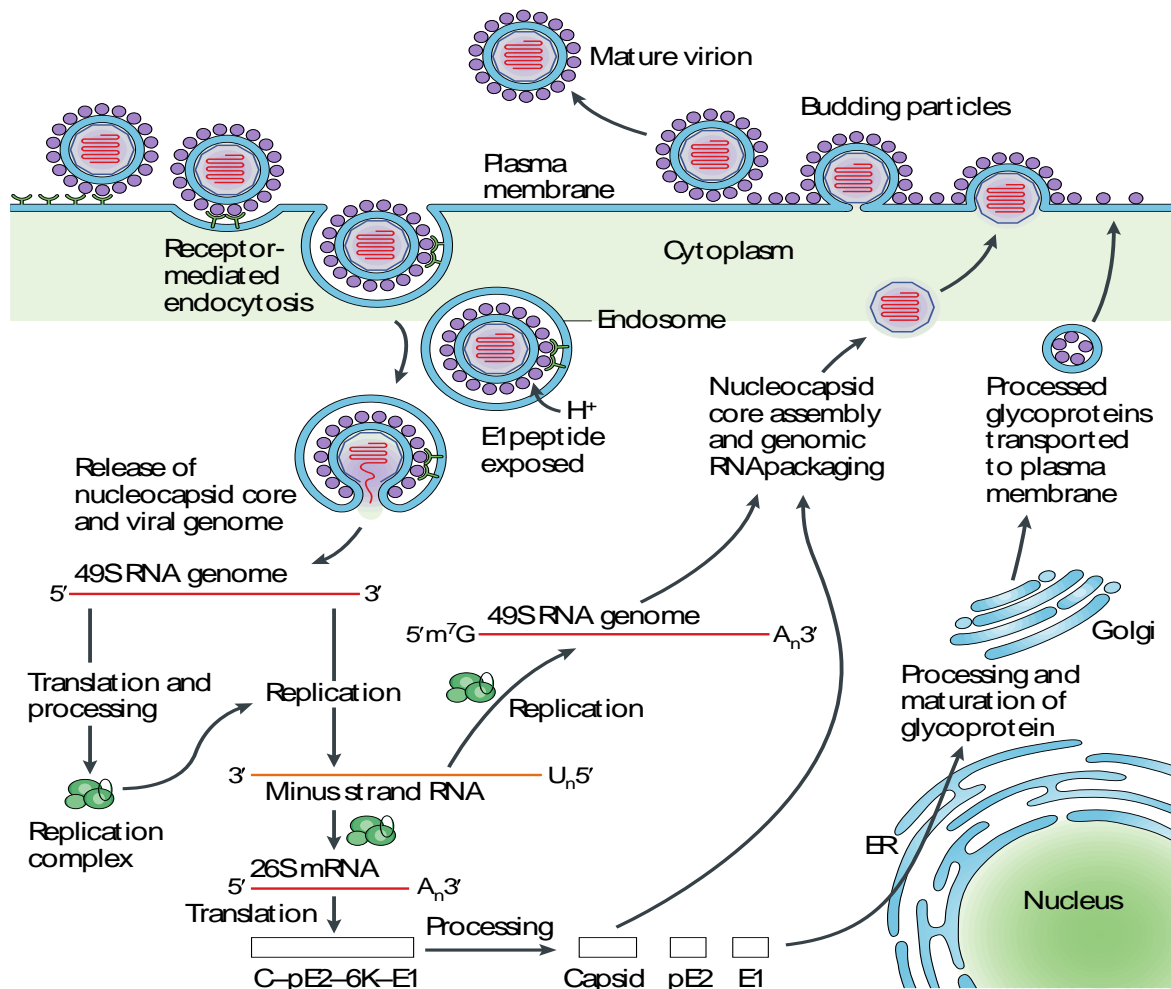

Figure 5: Chikungunya virus (CHIKV) replication cycle. CHIKV enters into the host cell by endocytosis and releases the capsid and the genome due to the acidic environment in the endosome. Thanks to the host cell machinery, non-structural proteins (nsp1-4) are translated and form the replication complex. The replication complex produces negative-strand RNA intermediates that serve as a template to produce genomic (49S) and subgenomic (26S) RNA. The subgenomic RNA is translated into a polyprotein precursor, which is processed to produce the capsid, E1 and pE2 proteins. The capsid protein is exported and forms the nucleocapsid that associates with the 49S genome RNA. E1 and pE2 are processed in the ER and the plasma membrane, where pE2 is cleaved into E2 and E3 glycoproteins. The glycoproteins interact with the nucleocapsid and form a mature viral particle that buds at the cell membrane.

nsP1 is involved in viral RNA replication and RNA capping (Salonen et al. 2003). nsP2 has RNA helicase, proteinase and RNA triphosphatase properties (Garmashova et al. 2007). nsP3 is part of the replicase unit and nsP4 is the viral RNA dependent RNA polymerase (Kamer and Argos 1984; Koonin 1991). The replication complex synthesizes negative-stranded RNA that serves as a template to produce genomic (49S) and subgenomic (26S) viral RNA. The translation of the subgenomic RNA leads to the production of polyprotein precursor, for which the maturation gives rise to the capsid protein, 6k, pE2 and E1 proteins. The role of the protein 6K is essential as it facilitates the particle morphogenesis (Gaedigk-Nitschko et al. 1990; Gaedigk-Nitschko and Schlesinger 1991; Sanz and Carrasco 2001). The capsid forms the nucleocapsid and is associated with the genomic 49S RNA, whereas E1 and pE2 are driven to the ER and the plasma membrane where pE2 is cleaved into E2 and E3 glycoproteins. Mature viral particles are produced by the interaction of glycoproteins and the nucleocapsid, which bud at the cell membrane (Fig. 5).

The common feature of these arboviruses (DENV and CHIKV) is their transmission by *Aedes* mosquitoes.

3. *Aedes albopictus* mosquito

Aedes (Meigen, 1818) is a very large genus that belongs to the Culicidae family. It contains around 950 different species distributed in 78 subgenera including the subgenus *Stegomyia*, which is the most popular *Aedes* genus due to its role in transmitting arboviruses, mainly by *Ae. aegypti* and *Ae. albopictus*. The two species are very similar morphologically, but the main morphological difference that allows distinction between them is on their scutum: while *Ae. aegypti* displays a silver lyre with two central stripes, *Ae. albopictus* is marked by a white stripe (Fig. 6). They however share a common life cycle.

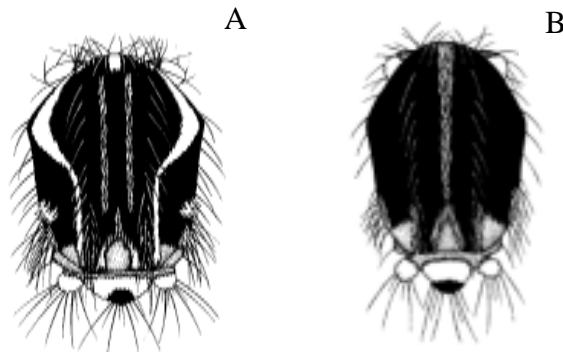

Figure 6: Scutum of *Aedes aegypti* and *Aedes albopictus*. While the scutum of *Ae. aegypti* (A) is marked by a white lyre, the scutum of *Ae. albopictus* (B) is marked by a white stripe

3.1 *Aedes albopictus* life cycle

Just like all the other mosquito species, the life cycle of *Aedes* mosquitoes is divided into eight steps and defined by two separate phases: an aqueous and an aerial phases in which they undergo several metamorphosis and modification such as changes in their microbiota diversity and composition (Fig. 7) (Minard et al. 2013). After a single mating, the fertilized females take a blood meal that offers a source of proteins that is mandatory for egg maturation. Subsequently, females lay down eggs near water surface that usually hatch into larvae within 48 hours. Larval development lasts around 10 days in which four different stages occur and are marked by physical transformations that lead notably to an increase of larva size. However, the time of larva development is modulated by several factors, such as temperature, food access and nutritional competition. The next step implies the transformation from larva to pupa (Fig. 7). Pupae are still in an aqueous environment like larvae but do not feed and breathe from two respiratory trumpets instead of a larval siphon. The transition between pupae and adults is called emergence, and gives rise to the aerial phase where adult mosquitoes move by flying (Fig. 7). Male adults usually emerge first but have a shorter lifetime than females, probably because their life purpose is mating with females and occurs within the following days of emergence. Female adults however can live from few weeks to

several months and lay 100-400 eggs, which are produced from a single mating. Indeed, they are able to store spermatozoa in an ectodermic spermatheca. The eggs of *Ae. aegypti* and *Ae. albopictus* are viable for several months after the spawn by entering in quiescence and diapause respectively (Diniz et al. 2017). This allows them to survive under unfavorable conditions and promotes their transportation.

3.2 History and opportunistic expansion

The world colonization of *Ae. albopictus* (Skuse, 1894) is much more recent than *Ae. aegypti*. Also called the tiger mosquito, *Ae. albopictus* is originated from forests located in Southeast Asia. Before the end the 20th century, this species was located only in some regions of Asia such as China, Japan, Korea and India. Probably thanks to the Indonesian colonization, *Ae. albopictus* spread to the Pacific and Ocean Indian regions (Hawley 1988). In 1979, the species was described for the first time in Europe in Albania, probably due to the trade of used tires with China (Adhami and Reiter 1998). Subsequently, in less than two decades, *Ae. albopictus* was reported in all continents except Antarctica.

Intensification of trades and travels led to the introduction of the species in other European countries, such as Italy in 1990 (Dalla Pozza, Romi, and Severini 1994), France in 1999 (F Schaffner and Karch 2000), Belgium in 2000 (Francis Schaffner, Van Bortel, and Coosemans 2004), Croatia in 2004 (Klobucar et al. 2006) and Germany in 2007 (Pluskota B, Storch V, Braunbeck T, Beck M, n.d.). It was first described in the USA in 1985 and spread through Mexico to South America where it was reported in Brazil in 1986, in Bolivia in 1997, and in Argentina in 1998. In Africa, *Ae. albopictus* was described in several countries such as Nigeria (Savage et al. 1992), Gabon (Coffinet et al. 2007), and Cameroon (Fontenille and Toto 2001). In Australia, *Ae. albopictus* was also reported as soon as 1988 (Kay et al. 1990).

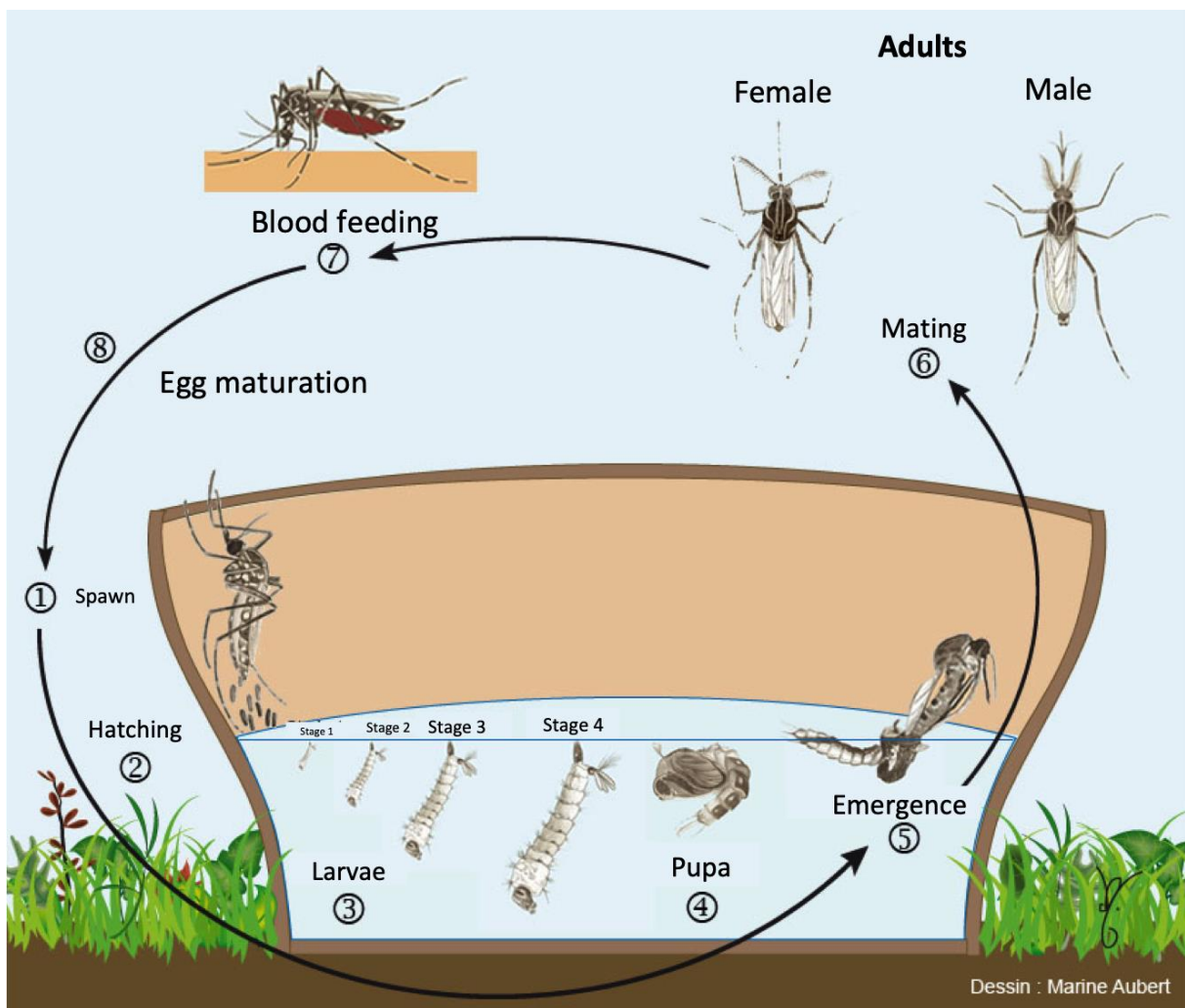

Figure 7: *Aedes* mosquito life cycle defined in 8 different steps.

Ae. albopictus is present in tropical and temperate regions (Fig. 8) and colonizes natural breeding sites such as tree holes and also artificial breeding sites such as flower pots. Moreover, its eggs are able to survive to cold temperatures during winter by entering in diapause. This allows the species to colonize temperate regions (Fig. 8). Usually, *Ae. albopictus* is predominant in periurban and urban areas with contact to both humans and animals. Because of several environmental changes such as deforestation and global warming, *Ae. albopictus* has developed close interactions with humans. Although its anthropophilic behavior was suggested not to be as strong as *Ae. aegypti*, it is likely that the proliferation of *Ae. albopictus* in close proximity with humans will increase its anthropophilic behavior in the near future. In fact, it was shown that this species prefers to feed on humans rather than on

other animals (Helene Delatte et al. 2010) when it has the choice. Moreover, *Ae. albopictus* possesses incredible genome plasticity that allows it to cope and adapt to different environmental conditions (X.-G. Chen et al. 2015) that led it to be ranked as one of the world's 100-most invasive species. These features let *Ae. albopictus* to conquer areas previously colonized by other mosquito species such as *Ae. aegypti* on La Réunion Island. The fast and widespread distribution of *Ae. albopictus* can be unraveled by studying population genetics.

3.3 Population genetics and genetic variability

3.3.1 Definition

A population is defined as a group of individuals belonging to the same species that are geographically close to each other so that they coexist. Individuals of a population are usually not distributed randomly and homogeneously; but rather gather around places that are suitable for their living. Subpopulations can cohabit in places subdivided into suitable and unsuitable areas. Then, subpopulations can be described as local populations and represent genetic units. These genetic units are interconnected through gene flow.

Population genetics is the study of distribution and changes of genes (and their different version (alleles)) within and between populations, under the effects of evolutionary pressures (mutations, migration, natural selection and genetic drift). These evolutionary pressures have different, sometimes opposite, effects on population genetic variability. Mutations are defined as any inherited modifications of the genetic information. They represent a major source of innovation in genetic as it is a source of new genetic sequences. However, mutations have only limited impact on gene fate. Indeed, the spontaneous mutation rate is very low in the eukaryotic system and is then neglected in the evolution of allelic frequencies compared to the other evolutionary pressures.

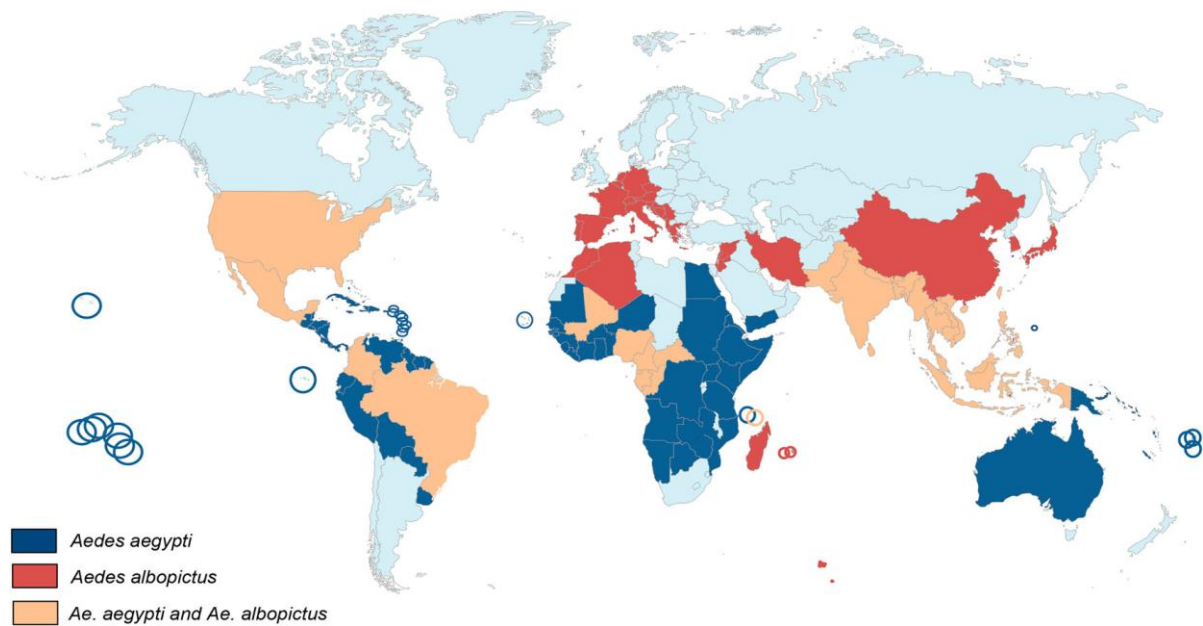

Figure 8: World distribution of *Aedes aegypti* and *Aedes albopictus*. From Houé et al. (2019)

Migration is characterized by the movement of individuals between populations of the same species. It represents then a direct source of gene flow between populations. Migration tends to homogenize allelic frequencies between populations. Unlike mutations, migration has a strong impact on gene evolution as they contribute directly to the allelic diversity. Natural selection is exerted by environmental factors on specific genes in the genome, and led to specific phenotypes according to whether they confer advantageous or disadvantageous properties (changes leading to disadvantageous properties are often rapidly lost through generations). Selection tends to homogenize allelic diversity within the population, but increases genetic variability between populations, as they usually do not cope with the same environment. Finally, genetic drift is defined as changes in allelic frequencies due to chance. Unlike natural selection, it acts on the whole genome, which means that it has non-specific effects. However, like natural selection, genetic drift promotes the decrease of genetic variability within populations but increases genetic variability between populations, as shown by the experiment realized by Peter Buri on *Drosophila* in 1956 (Buri 1956). Contrary to the

other evolutionary pressures, genetic drift always occurs. Moreover, it is important to note that smaller is a population, stronger is the effects of genetic drift and natural selection on this population.

Population genetics is of great importance in medical entomology. In recent years, vectors dispersion mostly favored by human activities triggered the (re)-emergence of many arboviruses and led to severe uncontrolled outbreaks. This is emphasized by the fact that mosquito populations of the same species, even geographically close, display different vector competence to arboviruses. In this way, population genetics is needed to predict future outbreaks, notably by elucidating the circulation of genes of interest, such as insecticide resistance or vector competence. Moreover, it allows the assessment of phylogeographical relationships between populations that helps us to decipher the genetic diversity and the migratory routes used by the vector to spread. Considering that *Ae. albopictus* mosquito conquered all continents from its Southeast Asian native zone in less than three decades, population genetics is an important and powerful tool to use for understanding how such incredible spread occurred. Finally, because populations of the same species cope with different selection pressures, the use of population genetics can help us in understanding how they adapt to each of these evolutionary forces defined above.

All these applications of population genetics rely on the study of populations by what it is called geographic structure (Roderick 1996). Geographic structure involves demographic and genetic structures. Demographic structure is defined as the processes that influence the number and distribution of individuals and their phenotypes in space and time, whereas genetic structure represents the genetic variability between and within populations under the effects of evolutionary forces (migration, selection, mutation and genetic drift). Specifically, genetic structure is defined by the study of allelic and genotypic frequencies, which are the

frequencies of the different alleles and corresponding genotypes observed respectively to a given locus.

Genetic structure is based on a model, called Hardy-Weinberg equilibrium (HWE). HWE considers that the allelic and genotypic frequencies are constant through generations of a population. In order to maintain these constant frequencies, the population needs to respect several assumptions: the population size is infinitely large; organisms are diploid, perform sexual reproduction and random mating (called panmixia); generations do not overlap; allelic frequencies are equal in males and females; and finally the population does not evolve through the effects of selection pressures (migration, mutation, and selection). These assumptions define parameters that are estimated to form theoretical models. All deviations from these assumptions lead to deviations from the HWE and indicate that the population is structured in some way.

The structure of a subdivided population can be evaluated at three different levels using the genetic heterozygosity (proportion of heterozygous individuals among all the individuals of a population):

- H_I : Heterozygosity of an individual in a subpopulation
- H_S : Expected heterozygosity of an individual in a panmictic subpopulation
- H_T : Expected heterozygosity of an individual in a total panmictic population

It allows the calculation of three different F inbreeding coefficients or “F statistics”:

F_{IS} is the coefficient of inbreeding that assesses the reduction of heterozygosity of individuals in a subpopulation that has deviated from the HWE (i.e. no panmictic). It exhibits the most likely reproductive system of the subpopulation. F_{IS} is defined by this formula :

$$F_{IS} = \frac{H_S - H_I}{H_S}$$

If $F_{IS} > 0$, the subpopulation displays a heterozygote deficiency explained by consanguinity and homogamy (reproduction between individuals exhibiting a similar

phenotype), whereas if $F_{IS} < 0$, the subpopulation displays a heterozygote excess. If $F_{IS} = 0$, the subpopulation respects the HWE.

F_{ST} is the fixation index and measures the decrease of the heterozygosity of a subpopulation performed by genetic drift. F_{ST} is often used to assess the genetic divergence between populations. F_{ST} is defined by this formula:

$$F_{ST} = \frac{H_T - H_S}{H_T}$$

Although the theoretical maximum is $F_{ST} = 1$, this is almost never reached in natural populations because genetic drift is almost never the only selection pressure that drives the evolution of a population. Therefore, Wright (Wright 1978) redefined the meaning of F_{ST} values between separate populations:

- $0 < F_{ST} < 0.05$: populations display weak genetic divergence
- $0.05 < F_{ST} < 0.15$: populations display moderate genetic divergence
- $0.15 < F_{ST} < 0.25$: populations display high genetic divergence
- $F_{ST} > 0.25$: populations display very high genetic divergence

Finally, F_{IT} is the global inbreeding coefficient, which assesses the reduction of heterozygosity in an individual from the total population. It is defined by the following formula :

$$F_{IT} = \frac{H_T - H_I}{H_T}$$

All these three inbreeding coefficients are related according to this formula:

$$(1 - F_{IT}) = (1 - F_{IS})(1 - F_{ST})$$

Studying population structure requires the use of specific neutral markers, on which evolutionary pressures have so weak effects that they can be neglected. These markers have interesting potential to decipher evolutionary processes such as migration, gene flow and

dispersal. However, the use of these markers has to be suitable for the level of resolution scale required.

Several different markers have been described and used to assess population genetic structure. The first marker used was isoenzymes (or allozymes), which are enzymes that share the same function but with a different amino acid sequence. Their polymorphism was examined by electrophoresis. Subsequently, thanks to the expansion of molecular biology, new techniques were developed to analyze nuclear DNA, such as randomly amplified polymorphic DNA (RAPDs), restriction fragment-length polymorphisms (RFLPs), introns, and internal ribosomal transcribed spacer (ITS) regions, mitochondrial DNA, single nucleotide polymorphism (SNPs) and microsatellites.

3.3.2 Microsatellites as DNA marker for studying population genetic structure

Microsatellites, also called single sequence repeats (SSR) or simple tandem repeats (SRT) is the most common marker used to study population genetics. They are short sequences; usually 2-6 nucleotides that are repeated several times in tandem. The polymorphism of microsatellites is based on their length that is highly variable between alleles and individuals of the same population. This polymorphism is caused by the DNA polymerase during replication. Indeed, during this process, the enzyme sometimes pauses and stops synthesizing the complementary strand. Because the DNA is denatured, this allows a slipped strand mispairing (SSM) in highly repeated regions such as microsatellite sequences (Levinson and Gutman 1987). This results to a gain (expansion) or a loss (contraction) of length depending on which strand the SSM occurred (gain if SSM occurred on the newly-synthesized strand, and loss if it occurred on the template strand). Microsatellite sequences can also be produced through unequal crossover recombination (Smith 1976).

There are two types of microsatellites, depending on their potential origin: neo-proto-microsatellites and imported proto-microsatellites. Neo-proto-microsatellites derived from

anonymous sequences that underwent punctual substitution (Messier, Li, and Stewart 1996) and/or insertions/deletions (Zhu, Strassmann, and Queller 2000), whereas imported proto-microsatellites derived from duplications or transposable elements (discussed further in the manuscript) that are widespread in eukaryotic genomes. Specifically, their poly-A tails have been suggested to be the source of A-enriched microsatellites (Nadir et al. 1996). Although present sometimes in coding sequences, microsatellites are mostly found in intergenic regions. Microsatellites found in intergenic regions are more often used for population genetic studies than those in coding regions to minimize the selection of microsatellites that undergo many recombinations.

Microsatellites are, with SNPs, the most used markers to study population genetics because they display useful features that provide several benefits. They are very polymorphic and are considered as fast-evolving markers, which is very useful for characterizing newly diversified populations; they are supposed to evolve neutrally with neglected effects of evolutionary pressures (no selection, migration or mutation). They are widespread in eukaryotic genomes (found every 10kB); their detection is easily performed by PCR using fluorescent primers. They are locus-specific and co-dominant (unlike other markers, homozygosity and heterozygosity can be distinguished). Unlike a single SNP that displays only two alleles maximum at a specific site, microsatellites can exhibit dozens of different alleles in a population. However, as other markers, the use of microsatellites present some disadvantages. The main one is the potential presence of null alleles (also called missing data). Null alleles are described as microsatellite sequences that cannot be amplified by PCR due to mutations present in the primer-annealing region (Lehmann, Hawley, and Collins 1996). This results in no amplification if individuals are homozygous for this locus, or the detection of only one allele out of two if the individuals are heterozygous for this sequence. This leads to a misinterpretation and a false excess of homozygous for this locus. Designing

new primer sets (Lehmann, Hawley, and Collins 1996) or sequencing from flanking regions (Callen et al. 1993) can overcome this issue.

3.3.3 Characterisation of *Aedes albopictus* fast expansion by population genetics

The reconstruction of the complex colonization pattern of *Ae. albopictus* is required to understand the migrating routes followed by the vector in order to develop sustainable control measures against its fast spread. Population genetics has been widely used to study genetic variability among *Ae. albopictus* populations using different molecular markers (Manni et al. 2015, 2017; H el ene Delatte et al. 2013; Zawani et al. 2014; Raharimalala et al. 2012; Beebe et al. 2013; Zhong et al. 2013), but only few of them have used worldwide populations to describe the international expansion of this mosquito species from its southeast Asian cradle. Its recent expansion was defined as a chaotic propagule distribution related to human activities, rather than a progressive expansion from its origin (Manni et al. 2017, 2015). A study based on several worldwide *Ae. albopictus* populations, 17 microsatellite markers and approximate Bayesian computation (ABC) method has been performed recently (Manni et al. 2017). It suggested low genetic diversity in populations from Southeast Asia, confirming an ancestral common origin. Moreover, the Japanese population used in the same study is likely to represent an admixture between the China and Thai populations, supported by multiple introductions (Fig. 9). Additionally, the population from La R eunion Island displayed high polymorphism, which is partially shared with Asian populations suggesting old populations with Asian common ancestors (Fig. 9). This reveals that the species has adapted to its environments and differentiated across the time by showing high percentage of rare and private alleles. The population structure data obtained for populations from USA and Albania were consistent with the historical records: multiple introductions are suggested to occur from Japan (and also South Asia and Hawaii) and China respectively, due to international trades between these countries (Fig. 9)(Manni et al. 2017). Together, these data highly suspected the

occurrence of multiple events of independent introductions that promoted high intra-population variability and genetic similarities between non-related geographical populations. The admixture between populations occurs in order to avoid bottleneck effects and allows the rapid adaptation of adventive populations. Therefore, the rapid expansion and adaptation of *Ae. albopictus* mosquito unraveled by population genetics represents a serious threat for public health because of the ability of this species to vector human pathogens.

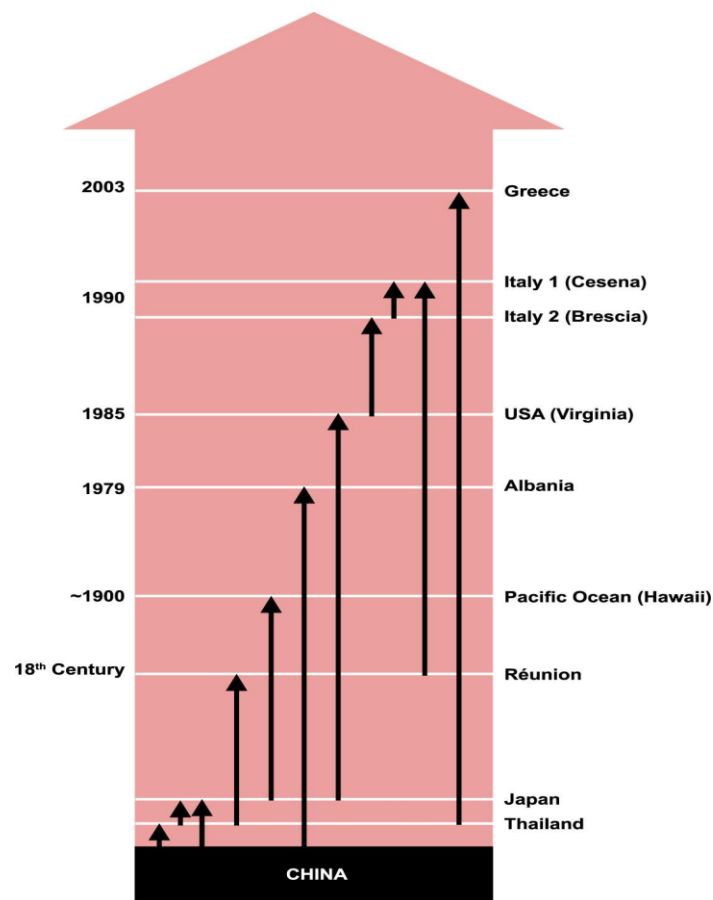

Figure 9: Complex invasion pathways inferred by population genetics analysis. From Manni et al. (2017)

3.4 Vector of arbovirus diseases

Ae. albopictus is a very competent vector as it is able to transmit at least 27 arboviruses (Houé, Bonizzoni, and Failloux 2019). Consistent with its fast adaptation and expansion throughout the world, this species has been responsible of several CHIKV

outbreaks, for which the virus was found in only a few epidemic sites before early 2000s, such as Thailand and India in the 1960s and 1970s (S B Halstead et al. 1969; Mavalankar et al. 2008). Indeed, from 2005, *Ae. albopictus* triggered outbreaks in Western and Central Africa where the species replaced *Ae. aegypti* in urban, periurban and forest areas in Cameroon and Gabon. It has become a primary vector in areas where *Ae. aegypti* was absent like in La Réunion Island where 266,000 people were reported infected in 2005-2006 (Coffey, Failloux, and Weaver 2014; Powers and Logue 2007; H Delatte et al. 2008). In 2007, *Ae. albopictus* was suspected to be the principal vector of a CHIKV outbreak in Emilia-Romagna, Italy where 205 human cases were confirmed (G Rezza et al. 2007). China also suffered in 2010 from the transmission of CHIKV by this species in Guangdong Province with 173 confirmed cases (D. Wu et al. 2012).

Ae. albopictus was also proved to be able to transmit DENV. The species was responsible for several DENV outbreaks in the past such as in Seychelles Islands (1977), La Réunion Island (1977), China (1978), the Maldives Islands (1981), Macao (2001), and Hawaii (2001) (Metselaar et al. 1980; Qiu et al. 1993; Almeida et al. 2005; Effler et al. 2005). In 2004, this species was responsible for a new DENV-1 outbreak in La Réunion Island that led to 119 confirmed cases (PIERRE V., THIRIA J., RACHOU E., SISSOKO D. and P., n.d.). More recently, *Ae. albopictus* was found responsible of a DENV-1 outbreak with 162 autochthonous cases in Tokyo, Japan in 2014 (Kobayashi et al. 2018), and a combined DENV-1, -2 outbreak in Guangzhou, China the same year (Luo et al. 2017). However, *Ae. albopictus* is considered as the secondary vector of DENV, as it was suggested to be less competent than *Ae. aegypti*, and mainly trigger minor epidemics associated with mild symptoms (Giovanni Rezza 2012; Lambrechts, Scott, and Gubler 2010a). Indeed, although it was more susceptible to DENV midgut infection, *Ae. albopictus* was proved to be less susceptible to DENV dissemination than *Ae. aegypti* (Lambrechts, Scott, and Gubler 2010).

Therefore, the replacement of *Ae. albopictus* over *Ae. aegypti* in some regions of the world will likely decrease the impact of DENV on the global human public health.

Other than being a threat to human health by transmitting both CHIKV and DENV, *Ae. albopictus* has been defined as an important vector of other arboviruses, such as La Crosse virus (LACV) that causes 30-180 cases with severe encephalitis every year in the USA (Westby et al. 2015; Rust et al. 1999). Moreover, the important co-circulation of *Ae. albopictus* and several other arboviruses such as eastern equine encephalitis virus (EEEV), Venezuelan equine encephalitis virus (VEEV), YFV and Zika virus (ZIKV) strengthens its role as a vector of potential massive outbreaks. Its high capacity to be competent to many arboviruses can partially be explained by the characteristics of its genome.

3.5 *Aedes albopictus* genomic features

The development of molecular technologies such as next-generation sequencing and the progress of bioinformatics tools in the last decades have given the opportunity to explore and understand the mosquito diversity at the genomic level. Thanks to that, it has been discovered that the size of mosquito genomes is highly variable. Globally, the species from the *Anophelinae* have been registered as the bottom part of the mosquito genome size scale, whereas the species from the *Culicinae* are defined as the upper part. The genome size of *Anopheles gambiae* and *Culex quinquefasciatus* have been reported to be 278 MB and 579 MB long respectively (R. A. Holt et al. 2002; Arensburger et al. 2010). Many attempts trying to determine the whole genome sequence of *Aedes* mosquitoes failed mostly because of its strong composition of repetitive elements, making the read alignments a real complicated task. However, Nene *et al.* released in 2007 the whole genome sequence of *Ae. aegypti* and indicated a length of 1.380 MB, which is around five times bigger than the genome of *An. gambiae* (Nene et al. 2007). The same issues were encountered for the sequencing of the *Ae.*

albopictus genome but it was finally successfully performed and published in 2015. They revealed the *Ae. albopictus* genome as the largest mosquito genome reported to date with a length of 1,967 MB (Dritsou et al. 2015; X.-G. Chen et al. 2015).

The large genome of *Ae. albopictus* is explained by the expansion of the number of genes from several gene families involved in immunity, sex determination, olfaction, insecticide-resistance mechanisms and diapause compared to other mosquito genomes (X.-G. Chen et al. 2015). More importantly, this large genome contains the highest quantity of transposable elements (TEs) ever recorded in mosquito genomes. Indeed, while *Cx. quinquefasciatus* and *Ae. aegypti* genomes contain respectively 324 MB and 988 MB, *Ae. albopictus* genome displays 1.343 MB (68% of the total genome) of TEs. Together, this could explain why *Ae. albopictus* is a successful invasive species that can adapt easily to several different environmental conditions.

Besides inter-species genomes size variation, mosquito genomes are dynamic and subject to constant evolution and intra-species variation of genome size. *Ae. albopictus* genome was previously described with a size ranging from 0.62 to 1.66 pg (Rao and Rai 1987; Kumar and Rai 1990). As in plants (which contains a high proportion of TEs), the mosquito nuclear DNA can be organized into two different domains: a constant and a fluid (Cullis 1983). The constant domain remains stable, presumably containing genes essential for mosquito survival while the fluid domain can undergo many changes in a short time in response to environmental, developmental and physical stimuli (Walbot and Cullis 2003). Just as inter-species, intra-species genome size variation in *Ae. albopictus* can also be explained by the presence of TEs in the fluid domain of the genome (McLain, Rai, and Fraser 1987; Black et al. 1988).

3.5.1 Transposable elements

TEs are considered as intragenomic parasites (Doolittle and Sapienza 1980; Orgel and Crick 1980). They were discovered in maize genome by Barbara McClintock in 1956 (MCCLINTOCK 1956). Since then, TEs were found ubiquitously in both prokaryotic and eukaryotic genomes. Indeed, more than 50% of the human genome and 90% of the maize genome are composed of TEs (de Koning et al. 2011; SanMiguel et al. 1996). They are described as sequences integrated into the host genome and capable of both independent replication and movement from one chromosomal location to another through a phenomenon called transposition. Transposition can occur in both somatic and germline cells. However, some elements transpose in specific types of cells, like *P* elements in *Drosophila melanogaster* that only insert themselves in the germline. TEs basically can transpose themselves in any genomic locations: some elements insert into specific genomic locations, like *IS4* in the galactosidase operon of *Escherichia coli* (Klaer et al. 1981) or *P* elements into the 5' end of gene-coding sequences in *D. melanogaster*, whereas others, such as the bacteriophage *Mu*, do not exhibit any preference. Transposons in some cases are also capable of escaping from one host genome to integrate into another naïve one, explaining their widespread distribution (Kidwell 1992). This phenomenon is called horizontal transfer. Transposons are major drivers of host genome function and evolution. They can act as a source of mutational variations through their transposition producing multiple copies of the same element in the host genome. These copies can facilitate regulation of gene expression, recombination and unequal crossing-overs between chromosomes and therefore, lead to chromosomal rearrangements by creating deletions, insertions, duplications, inversions and translocations. When a TE insertion occurs in an exon, the ORF can change and encodes a non-functional peptide or causes missense or nonsense mutations. A TE insertion can also create alternative splicing leading to the production of several protein isoforms or introduce a

polyadenylation signal (Konkel and Batzer 2010; Batzer and Deininger 2002). Globally, TE activity in a host genome contributes to introduce diversity. Transposons are classified into two groups, depending on their DNA structure and transposition mechanism.

The class I, also called retrotransposons, relies on RNA intermediates to transpose and is divided in two subgroups: LTR (Long Terminal Repeats) retrotransposons and non-LTR retrotransposons. LTR retrotransposons are characterized by two LTRs of a few hundred base pairs long and open reading frames between them that contain *gag* and *pol* genes, similar to those found in retroviruses (although high variability was observed). Briefly, retrotransposition occurs through several steps (Fig. 10). The reverse transcriptase encoded by the *pol* gene allows the reverse transcription of the LTR retrotransposon into cDNA, using a tRNA base-paired to the RNA sequence as a primer (Fig. 10). After synthesis of the other strand, the double-stranded cDNA is then integrated into the chromosomal DNA by the integrase encoded by the *gag* gene.

Regarding the non-LTR retrotransposons, there are different types but the only one that has coding sequences is the LINE (Long Interspersed Nuclear Elements) TEs. They contain two ORFs, ORF1 and ORF2, which do not have terminal repeats. Although they retrotranspose through the reverse transcription of an RNA intermediate, they do not use tRNA as a primer like LTR retrotransposons do. Instead, they use a genomic DNA break at an A/T rich sequence as a priming site (Fig. 11). This break is formed by the endonuclease that is encoded by ORF2. The RNA intermediate containing a 3'-end poly(A) sequence then base pairs at this specific spot of the genomic DNA (Fig. 11). Once the single-stranded cDNA is formed, the RNase H removes the RNA template and the nuclease makes a break at the opposite strand allowing the cDNA to base pair at the breaking point. Finally, the host enzymes launch the DNA reparation process and complete the retrotransposon integration (Fig. 11); (Finnegan 2012).

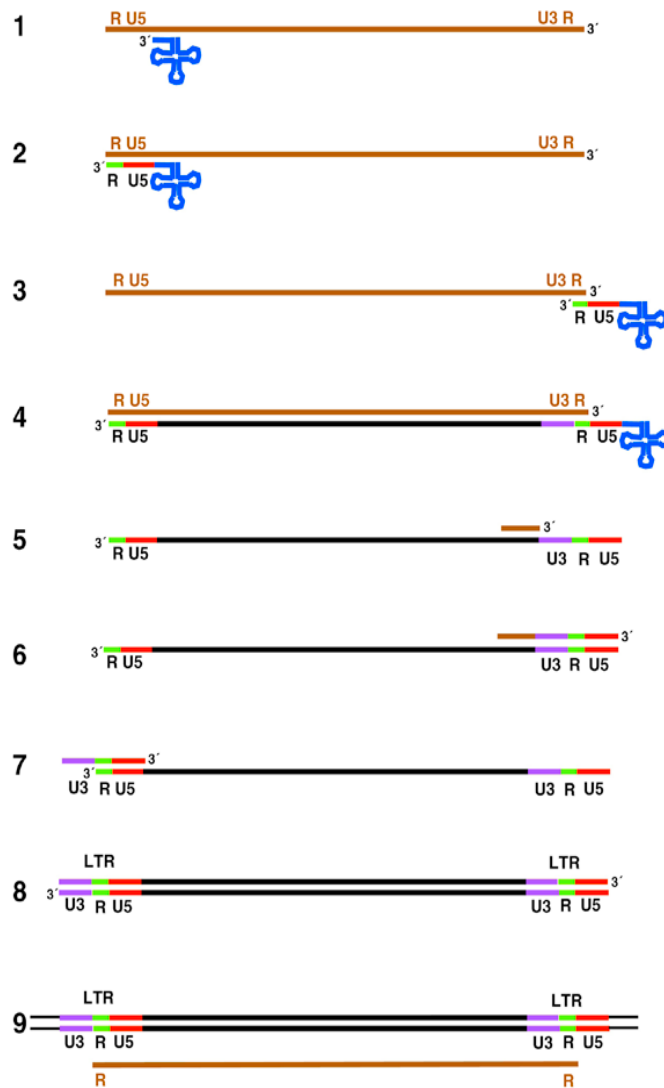

Figure 10: Retrotransposition mechanism of LTR retrotransposons. The transcription of the LTR retrotransposon results in the production of a positive strand RNA transposition intermediate (brown) that has a tRNA (blue) base-paired sequence, the PBS, near its 5' end (1). tRNA serves as a primer by annealing to the priming site and triggers the reverse transcription of the sequence at the 5' end of the RNA (U5, red) and a short repeat sequence (R, green) (2). This RNA fragment base pairs with the R sequence located at the 3' end (3) to trigger the reverse transcription from the 3' end to the 5' end of the negative strand RNA (4). RNase H degrades the RNA template but a fragment at the poly-purine tract is kept to prime second strand DNA synthesis (5). The RNA 3' end is reverse-transcribed (6) and the fragment binds to the 5' end by sequence complementarity (7), and allows the complete synthesis of a double-stranded DNA (8). Finally, the integrase allows chromosomal integration of the retrotransposon sequence, and its transcription generates genomic RNA with terminal repeats. From Finnegan (2012)

The other non-LTR retrotransposons such as Short Interspersed Nuclear *Elements* (SINEs) include SVA (SINE-VNTR-Alu), *Alu* and MIR (Mammalian-wide Interspersed Repeats) elements in mammals and are non-autonomous in nature because they do not encode for any enzymes, and they most likely use the transposition machinery of LINES for retrotransposition (Ostertag et al. 2003; Babushok and Kazazian 2007; Dewannieux, Esnault, and Heidmann 2003; Weiner 2002; W. Wang and Kirkness 2005).

The class II TEs, also called DNA elements, contains terminal inverted repeats (TIRs). Three different groups of DNA elements have been described in eukaryotes: classic transposons (R. a Holt et al. 2002; Craig NL, Craigie R, Gellert M, n.d.), Helitrons (Kapitonov and Jurka 2001) and Mavericks, also called Polintons (Pritham, Putliwala, and Feschotte 2007). Unlike retrotransposons, DNA elements do not rely on RNA intermediates for transposition. The classic DNA transposons use an enzyme, the transposase that performs transposition through a “cut and paste” mechanism (Fig. 12). Basically, once the transposase binds the TIRs, it cuts the donor DNA that frees the transposon and forms the transpososome by joining the two ends together. The target DNA is then cleaved by the transposase making a staggered break. Finally, the host DNA polymerase fills the gaps at both strands, finalizing the integration of the transposon (Fig. 12). Helitrons use a different mechanism to transpose which is a rolling circle replication that involves single-stranded DNA intermediate.

The proportion of Class I retrotransposons and Class II DNA transposons varies between insect genomes: in *D. melanogaster*, 80% of TEs are represented as retrotransposons and 20% of DNA transposons, and in *An. gambiae* 60% of TEs as retrotransposons and 40% as DNA transposons (Feschotte and Pritham 2007). When comparing the TE composition between *Ae. albopictus* and *Ae. aegypti*, *Ae. albopictus* genome contains 1,343 Mb of TEs and *Ae. aegypti* only 988 Mb. More than 20% of the repetitive sequences present in *Ae. albopictus* are absent in *Ae. aegypti*.

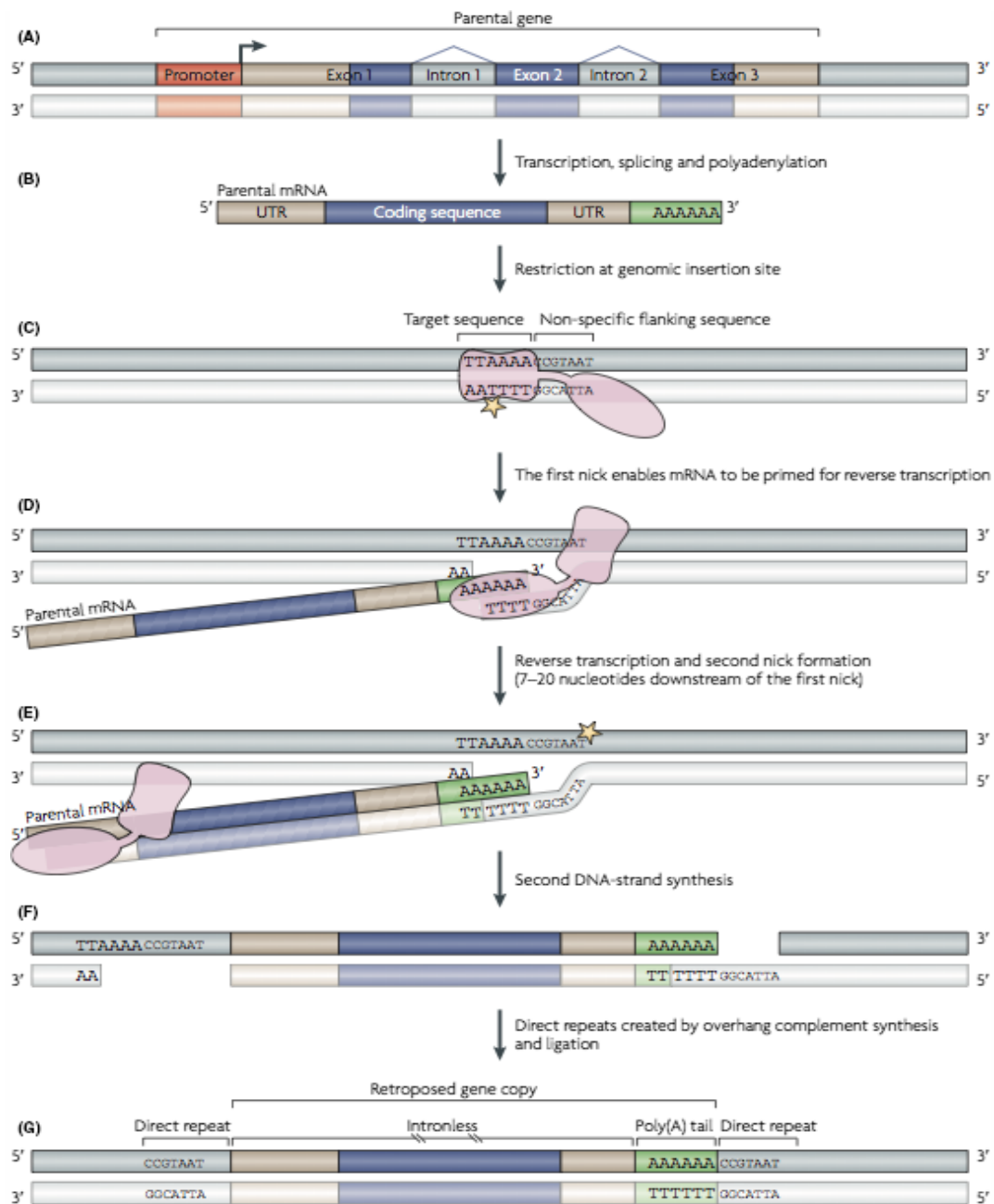

Figure 11: Non-LTR retrotransposition mechanism. A and B, Transcription parental gene and splicing/polyadenylation of the corresponding mRNA. C, The L1 endonuclease domain (pink rectangle) recognizes and creates a first nick (yellow star) at the genomic site of insertion. D, Priming of the mRNA for reverse transcription by the LINE-1 reverse transcriptase domain (pink oval), using the parental mRNA as a template. E, Generation of a nick on the other strand. F, Second DNA strand synthesis. G, cDNA synthesis in the overhang regions created by the two nicks. This process creates a duplication of the sequence flanking the target sequence, which is one of the molecular signatures of gene retroposition. From Roos and Boer (2018)

The two species have diverged 71 million years ago and most TE insertions occurred during the 10 last millions years in *Ae. albopictus* genome (X.-G. Chen et al. 2015). The non-LTR retrotransposons LINE represent one third of TEs in both genomes, followed by a high proportion of LTR retrotransposons, suggesting that retrotransposons are suspected to cause genome size variations. DNA transposons represent only 8% of TEs present in the *Ae. albopictus* genome, and 15% in the *Ae. aegypti* genome (X.-G. Chen et al. 2015).

Although most of the TEs have lost their capacity to transpose, they remain conserved in their hosts. This conservation is the result of positive selection over time because they serve a beneficial purpose for their hosts. Indeed, discrete loci were found at the edge of heterochromatin regions of *Drosophila* where vestiges of TEs remained (Brennecke et al. 2007). Moreover, they were found to produce small-interfering molecules (i.e. piRNAs for PIWI-interacting RNAs; see paragraph below on mosquito immunity) that can directly repress new transposon activities. Therefore, these loci called piRNA clusters that span from few to >100 kb, were described as a trap for TE invasion (Bergman et al. 2006) (Fig. 13). Basically, during transposition activity, TEs multiply their copies in the genome. When one of these copies inserts into these piRNA clusters, they are automatically processed to produce piRNA molecules that in turn, directly target the rest of the TE copies to silence their activities (Fig. 13). In mosquitoes, gene silencing through small RNA molecule interference is also used by the antiviral immunity system.

4. Mosquito vector competence and antiviral immunity

4.1 Vector competence of mosquitoes

During the blood meal and through their proboscis (feeding anatomical structure), female mosquitoes inject their saliva that contains anti-hemostatic molecules that prevent against coagulation, vasoconstriction and platelet aggregates.

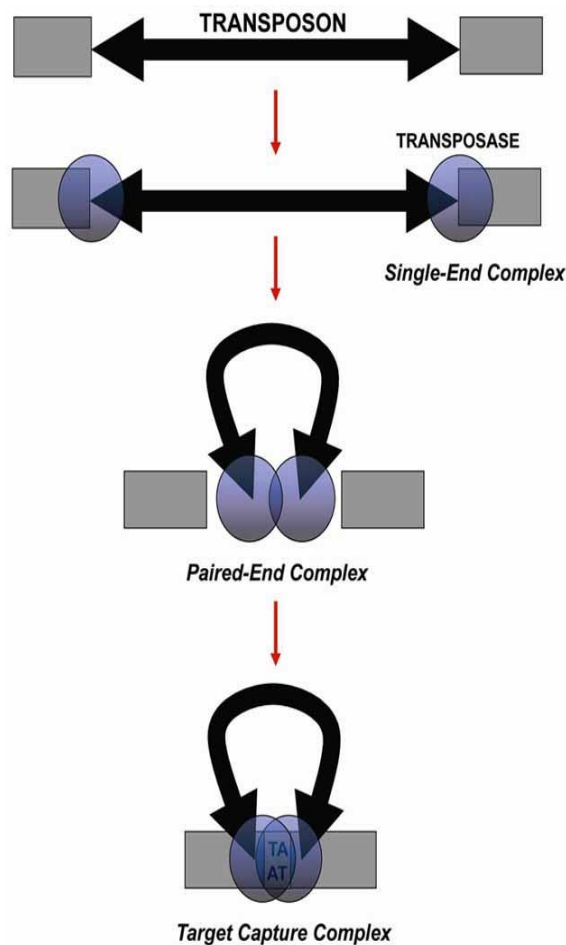

Figure 12: Cut-and-paste transposition mechanism of DNA elements. Monomers of transposase bind to the terminal inverted repeats (TIRs) at each end of the elements, forming a Single-End complex. The generation of a transposase dimer brings the two transposon ends together and form a Paired-End complex. The transposase dimer then proceeds to a transposon excision, and binds to a TA dinucleotide to form a Target Capture complex that allows transposon insertion. From Munoz-Lopez and Garcia-Perez (2010)

This ensures them to get an appropriate source of proteins that is mandatory for egg maturation. It is during this important process that a mosquito can become vector if the source of the blood meal is infected. However, all mosquito species are not vector of pathogens. Indeed, to transmit a given pathogen they have to be competent. It requires the accomplishment of several steps that are defined by vector competence (VC).

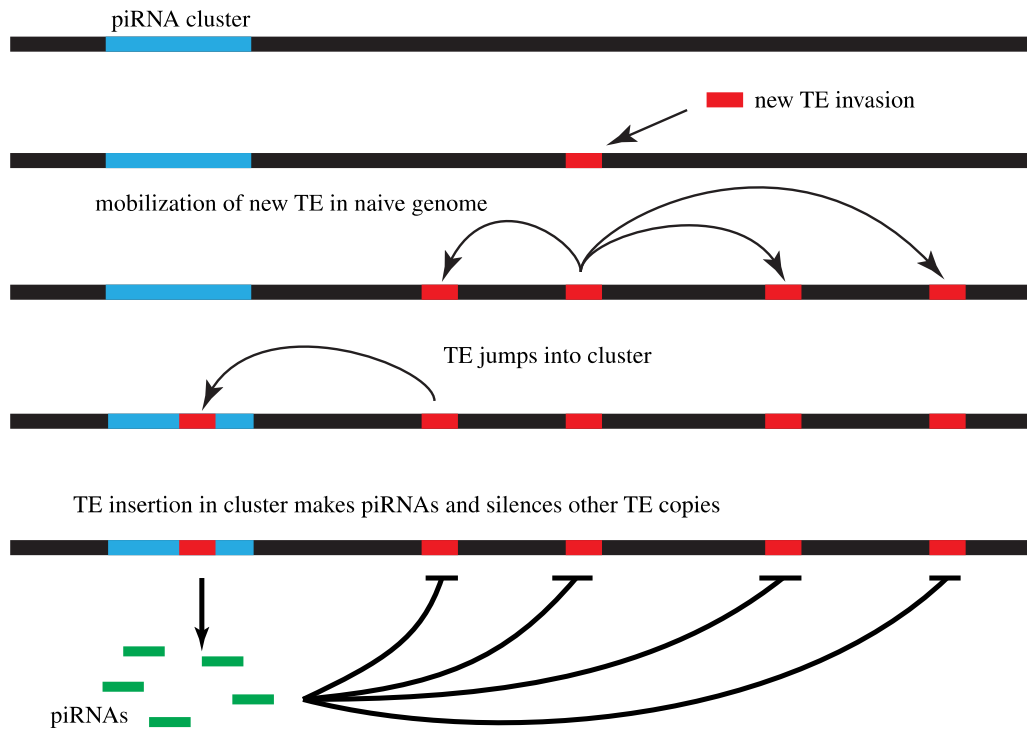

Figure 13: piRNA cluster mechanism to repress transposable element (TE) activity. From Parhad and Theurkauf (2019)

As already mentioned, the VC of a mosquito is its capacity to ingest the virus during a blood meal, maintain the viral replication and the transmission to an appropriate vertebrate host (Kramer and Ebel 2003). Specifically, once ingested, the virus needs to overcome the midgut epithelial cells, spread through the hemolymph to secondary tissues and organs, and reach the salivary glands, where it will be transmitted by the saliva during another blood meal to another competent host (Fig. 14). The interval between the time during which the virus is ingested and the time it is transmitted by the vector is called extrinsic incubation period (EIP). However, to reach saliva, the virus has to cope with four different anatomical barriers: the midgut infection barrier (MIB), the midgut escape barrier (MEB), the salivary gland infection barrier (SGIB) and the salivary gland escape barrier (SGEB) (Alexander W E Franz et al. 2015). These barriers are reinforced by the presence of the immune system, which is in part guided by the RNA interference (RNAi) system.

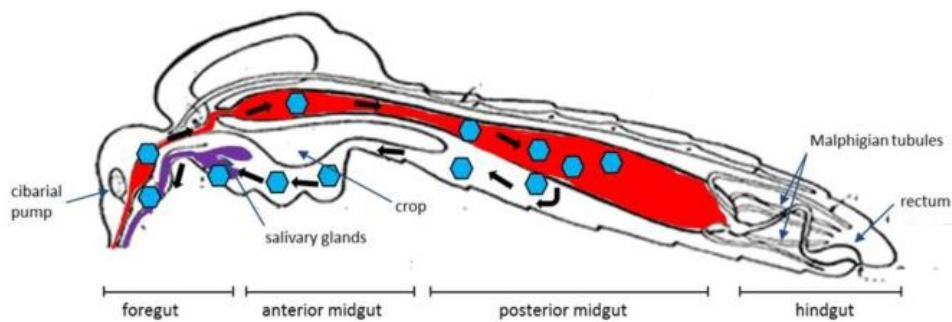

Figure 14: Schematic representation of an arboviral infection in mosquito. The arbovirus is ingested by the mosquito during a blood meal, enters in the midgut epithelial cells, and spread through the haemolymph to different tissues and organs. Finally, the virus infects the salivary glands, which promotes its release in the saliva during another blood meal. From Frantz et al. (2015)

4.2 RNA interference immunity

In order to persist in their invertebrate host, arbovirus replication needs to be controlled to avoid killing their hosts. The fat body (that produces antimicrobial peptides; (Aggarwal and Silverman 2008; Hillyer and Estévez-Lao 2010; Dolezal et al. 2019), salivary glands and midgut (that produces lytic factors) are important tissues that exert a barrier against infection. The immune response responsible for the control of the invading pathogens is triggered by the recognition of pathogen-associated molecular patterns (PAMPs) via pattern recognition receptors (PPRs). This interaction activates immune signaling pathways (JAK-STAT, Toll and Imd pathways) and immune effector mechanisms (phagocytosis, nodulation, melanization, cellular encapsulation, apoptosis, autophagy) are mainly set up by hemocytes (and lamellocytes for cellular encapsulation) present in the hemocoel.

First described in *Caenorhabditis elegans*, RNA interference (RNAi) pathways are thought to be the main antiviral mechanisms in mosquitoes (W.-X. Li et al. 2004; Keene et al. 2004; Sánchez-Vargas et al. 2009; Varjak et al. 2017b), as it is considered as an adaptive form of immunological memory. Indeed, this memory relies on gene silencing mechanisms where during infection, exogenous double-stranded RNAs are processed by the infected cell to

produce small-RNAs (sRNAs). These sRNAs associated with a protein complex interact with exogenous viral RNAs by sequence complementarity. The current knowledge of the RNAi pathways is based mainly on studies conducted on *Drosophila melanogaster*. Three different pathways have however been previously described in mosquitoes: (small-interfering (siRNA), microRNA (miRNA) and piwi-interacting RNA (piRNA) pathways), for which the silencing mechanism is similar but the biogenesis of the sRNAs and the proteins involved are different.

4.2.1 siRNA pathway

The knowledge of the siRNA pathway originated from the use of *Drosophila melanogaster* as a model organism to describe this pathway, but similar mechanism was observed in *Aedes* mosquitoes. The siRNA pathway is divided into an exogenous and an endogenous pathway (Fig. 15A). Regarding the exogenous pathway, the incoming virus produces double-stranded RNA (dsRNA) intermediates during its replication cycle, which are processed by the ribonuclease Dicer 2 (Dcr2) into 21 nt-long siRNA. Then, siRNAs are loaded into the RNA-induced silencing complex (RISC) thanks to the activity of the double-stranded RNA binding protein (dsRBP) R2D2 (Tomari, Du, and Zamore 2007; Marques et al. 2010). Once loaded into RISC, one of the two strands called the passenger strand, is cleaved by Argonaute 2 (Ago2) and then removed by the endoribonuclease activity of the C3PO protein. The remaining strand called the guide strand, is 2'-O-methylated by the methyltransferase Hen1, leading to the complete maturation of the RISC complex (Horwich et al. 2007). Therefore, the guide strand is used to bind viral RNA by sequence complementarity, and this interaction allows the RISC complex to recognize and cleave the exogenous viral RNA (thanks to the catalytic domain of Ago2), leading to the silencing of viral gene expression (Fig. 15A). Endogenous siRNAs (endo-siRNAs) can also be produced from double-stranded RNAs such as hairpins with a long, perfect stem or sense-antisense transcript hybrids, and are processed in the same way as exogenous siRNAs except that these molecules are loaded into the RISC

complex by the dsRBP Loquacious (LOQS) rather than the R2D2 (Czech et al. 2008; Okamura et al. 2008).

4.2.2 miRNA pathway

miRNAs originate from endogenous hairpin transcripts that are transcribed by the RNA polymerase II as primary miRNAs (pri-miRNAs) (Fig. 15B)(Y. Lee et al. 2004). The processing of pri-miRNAs by Drosha and the dsRBP Pasha leads to the synthesis of precursor miRNAs (pre-miRNAs) that are exported to the nucleus by Exportin-5 (Y. Lee et al. 2004). Alternatively, miRNAs can be derived from intron regions (called mirtrons), which after splicing can result in pre-miRNA molecules (Fig. 15B). An additional step of maturation performed by Dicer 1 and the dsRBP LOQS results in a duplex pre-miRNA of around 22nt-long (Y. Lee et al. 2004), which are then ready to be loaded into RISC (also called miRISC) complex that is composed of Argonaute 1 (Ago1). The cleavage of the passenger strand is not essential for maturation (Matranga et al. 2005), miRISC complex then uses the guide strand to perform RNA degradation or translational inhibition.

4.2.3 piRNA pathway

piRNA biogenesis

Discovered more recently, the piRNA pathway is present in a wide range of organisms. Although the piRNA pathway is active in the soma (Mani and Juliano 2013), it was first shown to suppress transposon activity and maintain genome integrity in *Drosophila* germ lines (Tóth et al. 2016). Indeed, dysfunctional components of the piRNA pathway lead to infertility in both oogenesis and spermatogenesis in *Drosophila* (Cox et al. 1998; Lin and Spradling 1997; Schmidt et al. 1999; Schüpbach and Wieschaus 1991).

The *Drosophila* piRNA pathways have served as a model for describing the ones in mosquitoes.

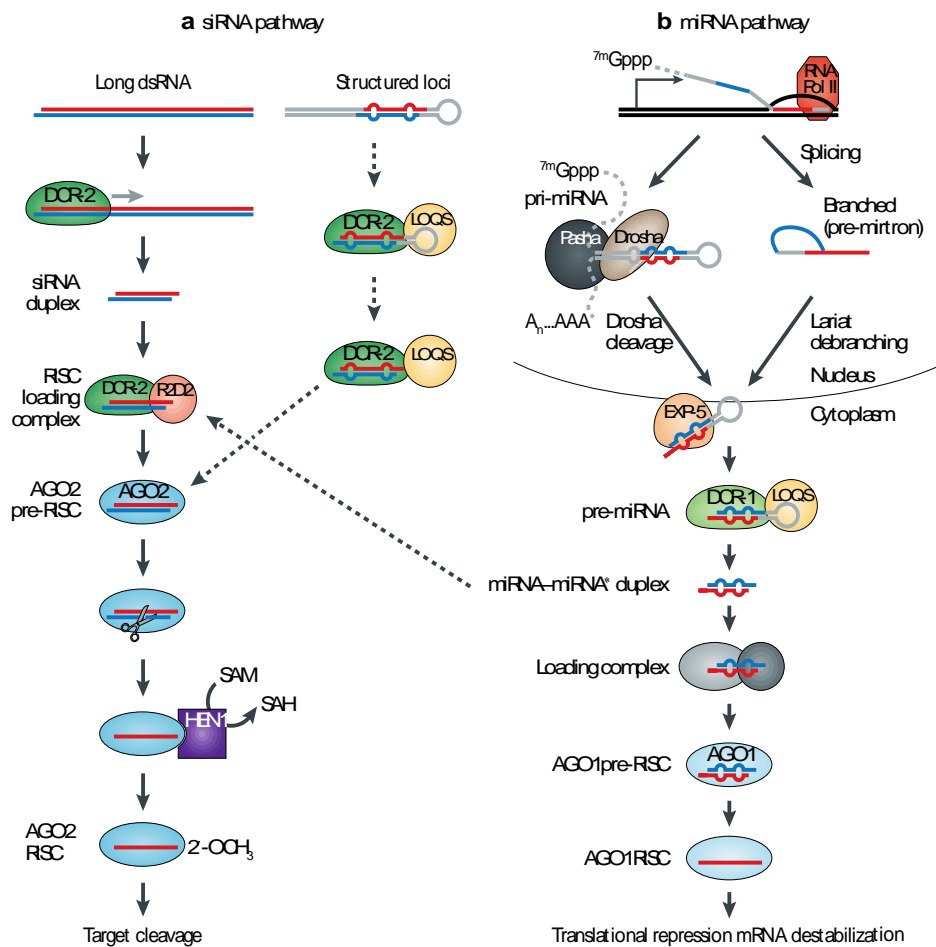

Figure 15: siRNA and miRNA pathways in *Drosophila*. **a)** The siRNA pathway (left panel) is triggered by the recognition of a long double-stranded RNA (dsRNA) by the ribonuclease Dicer 2 (DCR-2), which cleaves the dsRNA into siRNAs of 21nt long that forms the siRNA duplex. With the help of the dsRNA binding-protein R2D2, the siRNA duplex is loaded into Argonaute 2 protein (Ago2) and forms the RNA-induced silencing complex (RISC). One of the two strands (the passenger strand) is cleaved by Ago2 and the remaining strand (the guide strand) is 2'-O-methylated by the methyltransferase Hen1, leading to the complete maturation of the RISC complex. The guide strand recognizes its RNA target by sequence complementarity and the RISC complex can then cleave the target. Endogenous siRNAs (endo-siRNAs; right panel) can be produced and are processed in the same way as siRNAs except that they are loaded into the RISC complex with the help of Loquacious (LOQS) rather than R2D2. **b)** miRNAs originate from hairpin-structured primary mi-RNAs (pri-miRNAs) transcribed by the RNA polymerase II (left panel). pri-miRNAs are then cleaved by the endonuclease Drosha with the help of the dsRBP Pasha to become precursor mi-RNAs (pre-miRNAs) and exported in the cytoplasm by Exportin-5. Alternatively, miRNAs can derive from intron regions (called mirtrons), which after splicing can result of pre-miRNA molecules (left panel). pre-miRNAs are cleaved by DCR1 and LOQS into around 22nt long molecules and loaded into the RISC complex by binding to Ago1. The complex gets rid of the passenger strand and the guide strand leads to recognition of the target and cleavage by RISC. From Ghildiyal and Zamore (2009)

Contrary to the two other sRNA pathways described earlier, the piRNA pathway does not require Dicer proteins, but PIWI subfamily proteins, and involves two major pathways (Fig. 16): primary and secondary (also called ping-pong amplification loop) pathways. piRNAs are derived from long single-stranded RNA transcripts that are transcribed from specific genomic regions called piRNA clusters (Kofler 2019). These transcripts, after being exported to the cytoplasm, are then processed into 5' monophosphorylated precursor piRNAs (pre-piRNAs) by the endoribonuclease Zucchini (Zuc) (Fig. 16) (Nishimasu et al. 2012). pre-piRNAs, displaying a 5' terminal uridine (5' 1U) synonym of the primary piRNA signature, are then loaded into Aub or Piwi proteins with the help of the chaperone proteins Shutdown (Shu) and Heat shock protein 83 (Hsp83) (Olivieri et al. 2012). 5' end selection preference is similar to what was observed in *Arabidopsis* and Argonaute proteins (Mi et al. 2008). The 3'-5' exonucleolytic activity of the suspected Nibbler protein (Nbr) (H. Wang et al. 2016; Feltzin et al. 2015), reduces the size of the piRNA to 23-30 nt (Kawaoka et al. 2011). At the same time, the 3' end of the piRNA is 2'-O-methylated by the methyltransferase Hen1, which is the final step before the complete maturation of primary piRNAs (Kawaoka et al. 2011; Kamminga et al. 2010). Only the piRNAs loaded into Aub can participate in the secondary pathway. They recognize the target sequence, which is subsequently cleaved by Aub. The 3' end fragment of the targeted RNA is then loaded into Argonaute 3 protein (Ago3, another Piwi protein) with the help of the chaperone Shu. The following steps are the same as described for the primary biogenesis: the RNA loaded into Ago3 is then trimmed to reach 23-30 nt long, and its 3' end is 2'-O-methylated by the methyltransferase Hen1. The secondary piRNA biogenesis leads to an amplification of the primary piRNAs and the production of secondary piRNAs. Primary piRNAs have a bias for an uridine at the first position (U1) and are antisense transcripts, and secondary piRNAs have a bias for an adenine at the position 10

(A10). Unlike antisense transcripts, sense transcripts tend to exhibit an A10 bias. Moreover, the first 10 nucleotides of both primary and secondary piRNAs are complementary.

Potential antiviral role of piRNAs in mosquitoes

Viral siRNAs (vsiRNAs) are widely detected during arbovirus infections. Alphavirus- and flavivirus-specific viral siRNAs of positive and negative sense polarities were described in *Ae. albopictus* and *Ae. aegypti* mosquitoes and cell lines, mapping to the entire strands, with some specific hotspots (Morazzani et al. 2012; Schnettler, Donald, et al. 2013; Scott et al. 2010; Miesen, Joosten, and van Rij 2016; Varjak et al. 2017b; Hess et al. 2011; Saldaña et al. 2017).

Along with their functions in the repression of transposon activity, piRNAs have been recently thought to have potential antiviral roles in mosquitoes, although these molecules do not have antiviral functions in *Drosophila* (Petit et al. 2016). Many differences in the piRNA pathway between *Drosophila* and mosquitoes were observed which suggested expansion and functional divergence of Argonautes in Dipterans (Marconcini et al., unpublished data). Indeed, while three proteins (Ago-3, Aubergine (AUB) and PIWI proteins) interact with piRNAs in *D. melanogaster*, seven (Ago3, Piwi2, Piwi1/3, Piwi4, Piwi5, Piwi6 and Piwi7) are involved in the piRNA pathway in *Aedes* mosquitoes (Miesen, Joosten, and van Rij 2016; Akbari et al. 2013; Matthews et al. 2018). *Piwi1/3* and *Piwi7* genes are expressed in gonads and embryo whereas *Ago3*, *Piwi4*, *Piwi5* and *Piwi6* expression is highly detected in the soma and in the *Ae. aegypti* cell line Aag2 (Miesen, Joosten, and van Rij 2016; Akbari et al. 2013). Secondly, in *Aedes spp.*, the ping-pong amplification loop is not restricted to the germlines, as it is in *Drosophila* (X. Huang, Fejes Tóth, and Aravin 2017; Akbari et al. 2013; Czech and Hannon 2016; Lewis et al. 2018).

Both primary and secondary (displaying the ping-pong signature) viral piRNAs (vpiRNAs) have been described in several different mosquito cell cultures following the infection of many viruses from different families (reviewed by (Miesen, Joosten, and van Rij 2016; Varjak, Leggewie, and Schnettler 2018)). Whereas vpiRNA production from alphaviruses is dependent on Piwi5 and Ago3 proteins, Piwi6 is required for vpiRNA production following DENV flavivirus infection (Miesen, Joosten, and van Rij 2016; Miesen, Girardi, and van Rij 2015; Varjak et al. 2017b; Varjak, Leggewie, and Schnettler 2018). Additionally, *in vivo* experiments conducted mostly on *Aedes spp.* mosquitoes are consistent with these *in vitro* experiments (Varjak, Leggewie, and Schnettler 2018).

During alphavirus infection in mosquitoes, vpiRNAs have also been described, and their production is dependent on Ago3 and Piwi5 proteins (Schnettler, Donald, et al. 2013; Varjak, Leggewie, and Schnettler 2018). Most of the alphavirus-specific (including CHIKV) vpiRNAs exhibited sense polarity with a ping-pong signature (A10 bias) in mosquitoes, although antisense piRNAs with U1 bias were also detected. This suggests that alphavirus infections trigger the production of secondary vpiRNAs (Morazzani et al. 2012; Schnettler, Donald, et al. 2013; Vodovar et al. 2012; Miesen, Girardi, and van Rij 2015). Moreover, these studies highlighted the fact that alphavirus-specific vpiRNAs seem to derive mostly from the subgenomic region of the genome, which is more produced than the genomic region, suggesting that the quantity of RNA could favor vpiRNA production.

During flavivirus infection however, the vpiRNA production landscape is different. Indeed, only a few sRNAs of sense polarity and of the corresponding piRNA size were obtained through *Piwi6*, *Ago3* and *Piwi5* expressions following DENV infection in *Aedes* cell lines (Scott et al. 2010; Miesen et al. 2016). This is consistent with what was observed in *in vivo* experiments with *Ae. aegypti* (Hess et al. 2011).

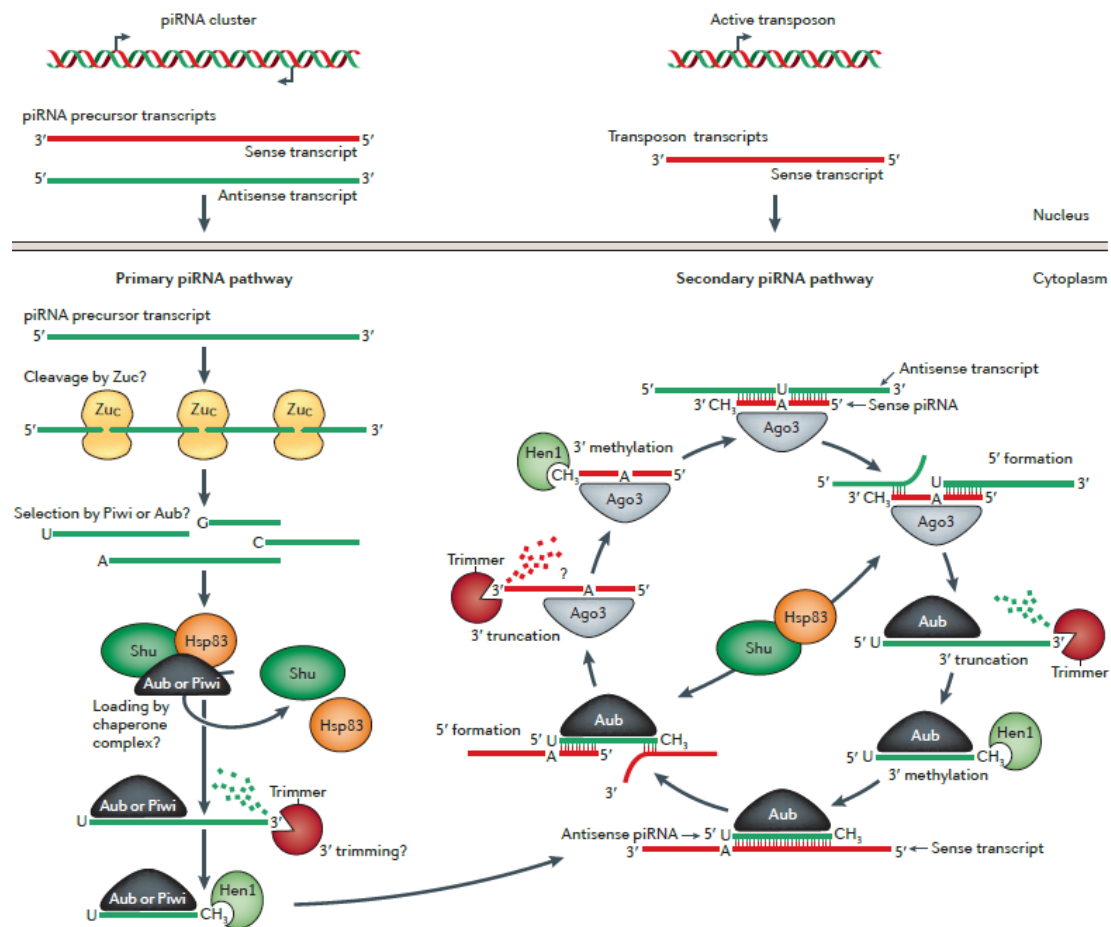

Figure 16: Primary and secondary piRNA pathways in *Drosophila*. These pathways from *Drosophila* were taken here as examples. piRNA precursor transcripts (pre-piRNAs) derived from piRNA clusters are processed through the endonuclease of Zucchini (Zuc) and loaded into Aub or Piwi proteins with the help of the chaperone proteins Shutdown (Shu) and Heat shock protein 83 (Hsp83) after a preference selection of 5'U. 3'-5' exonucleolytic activity of the suspected Nibbler protein shortens the size of primary piRNAs to 23-30nt which are 2'-O-methylated by the methyltransferase Hen1. The complex is now fully operational for gene silencing. piRNAs loaded into Aub protein can get access to the secondary pathway. piRNAs recognize target RNA molecules that are cleaved by Aub. The 3' fragment of this target is processed by Ago3 protein, Nibbler and Hen1 to become a functional piRNA, and the cycle goes on. Adapted from Luteijn and Ketting (2013)

These *in vitro* and *in vivo* studies showed no U1 or A10 bias, suggesting that the ping-pong amplification loop is not involved in the production of DENV-specific vpiRNAs in *Ae. aegypti*. In *Ae. albopictus*, DENV-specific vpiRNAs were produced after 9 days post-infection (dpi) from specific hotspots mainly located in NS5 region, and displayed a weak A10 bias (Y. Wang et al. 2018). Moreover, similar results were obtained with ZIKV in *in vivo*

and *in vitro* experiments although even fewer hotspots were described (Varjak et al. 2017a; Saldaña et al. 2017) .

Overall, the antiviral role of the piRNA pathway in mosquitoes against some arboviruses is still unclear. Indeed, whereas some arboviral infections seem to trigger the production of specific vpiRNAs supported by a ping-pong amplification cycle, others may be repressed by other sRNA mechanisms or immune responses, as only a few deep-sequencing reads corresponding to piRNA-sized molecules mapped to few genomic positions and no ping-pong signature was observed. The fact that the knockdown of Piwi5, Piwi6 and Ago3 (required for vpiRNA production) had no effect on viral replication is still an enigma regarding the proposed antiviral activity of vpiRNAs. The absence of secondary piRNA production could be the result of viral degradation products that are not produced by the piRNA pathway but possess the same size as piRNAs. Therefore, further studies are required to clarify under which conditions (type of mosquito/cell line infected with a specific viral group or genus) specific vpiRNAs are produced.

Endogenous viral elements (EVEs) and especially non-retroviral integrated RNA virus sequences (NIRVS) are virus-like sequences integrated into mosquito genomes (Houé, Bonizzoni, and Failloux 2019). Interestingly, NIRVS from different families, including the *Flaviviridae* family, were shown to be the source of vpiRNA production. Moreover, these vpiRNAs were proved to display a U1 bias (synonym of a ping-pong amplification cycle) with an antisense polarity, which highlights their potential to directly target positive-sense genomes such as flaviviruses (Palatini et al. 2017; Whitfield, Dolan, Kunitomi, Heiner, et al. 2017). The potential antiviral role of NIRVS will be further described in the manuscript.

The role of mosquito antiviral immunity is not only restricted to exogenous arboviruses, but can also play a role in mosquitoes that are persistently infected with a specific group of viruses, called insect-specific viruses (ISVs).

5. Insect-specific viruses as mosquito virome

As discussed earlier, arboviruses are subjected to deep investigation due to their emergence/re-emergence that led to tremendous outbreaks and profoundly impact human health. Additionally, another group of viruses, called insect-specific viruses (ISVs), has been aroused the curiosity of the scientist community. The first ISV was discovered more than 40 years ago by adding supernatant cultures of *Ae. aegypti* on *Ae. albopictus* cells (Stollar and Thomas 1975). These cells showed sign of syncytium formation after 60 hours of contact. The virus was therefore called cell fusing agent virus (CFAV). However, during a long time, limited interest has been given to this group of viruses due to their apparent host-range restriction phenotype. Indeed, ISVs were proved several times to be unable to replicate in vertebrate cells (Bolling, Weaver, et al. 2015; Blitvich and Firth 2015). Moreover, they have not been isolated from natural vertebrates. In the last two decades, due to molecular technologies such as next-generation sequencing and the development of bioinformatics tools, many ISVs were discovered to persistently infect their host, and then represent a part of the insect “virome”. They all are RNA viruses and belong to different taxa: *Flaviviridae*, *Rhabdoviridae*, *Bunyavirales*, *Togaviridae*, *Mesoniviridae*, *Reoviridae*, and Negevirus (family unassigned) (Bolling, Weaver, et al. 2015). Although this term refers to a group of viruses infecting insects, ISVs were mostly isolated in mosquitoes (Moureau et al. 2010). This group could then be renamed mosquito-specific viruses.

5.1 Insect-specific viruses as origin of arboviruses

Some viral families have been suspected to have ISVs as ancestral clade to arboviruses. Indeed, in the *Bunyavirales* order, ISVs from different genera (Gouléako virus, genus *Goukovirus*; Herbert herbevirus genus *Herbevirus*) were shown to have a basal position based on the phylogenetic analysis of conserved sequences. Moreover, newly discovered

insect-specific bunya-families (Feraviridae, Jonviridae and Phasmaviridae) were discovered to share their most common ancestor with orthobunyaviruses, hantaviruses and tospoviruses (Junglen 2016; Marklewitz et al. 2015; M. J. Ballinger et al. 2014). Additionally, a group of ISV belonging to the Flaviviridae family (cISF; discussed further in the manuscript) was proved to represent an ancestral lineage (Bolling, Weaver, et al. 2015). Altogether, these data reveal a strong potential of arthropod-origin of arboviruses belonging to several different families. Precisely, this suggests then that some viruses have acquired, rather than lost, the capacity to replicate in vertebrates, and have coevolved, interacted and diversified with their hosts from ancient time (Shelley Cook et al. 2013; C.-X. Li et al. 2015; Marklewitz et al. 2015). Then some ISVs may acquire in the future the capacity of replication in vertebrates and become pathogenic arboviruses for humans in the future. However, the origin of arboviruses from some genera, such as *Alphaviruses*, could not be explored as only few ISVs have so far been discovered. Therefore, it is essential to study ISVs for understanding the evolution and preventing the emergence of pathogenic dual-host viruses.

5.2 Host-range restriction of insect-specific viruses

Although almost all ISVs have been isolated in C6/36 *Ae. albopictus* cells (Stollar and Thomas 1975; Hoshino et al. 2009a, 2012, 2007; Tyler et al. 2011; Shelley Cook et al. 2009; Parreira et al. 2012; Huhtamo et al. 2012; Sang et al. 2003; Hobson-Peters et al. 2013; Mary B. Crabtree, Nga, and Miller 2009), many *in vitro* and *in vivo* studies have attempted to prove that ISVs can replicate in vertebrates. However, experiments based on inoculation of ISVs in mammalian, avian or amphibian cell lines, as well as intracerebral injection in mice failed to reveal ISV replication suggesting their host-restricted phenotype (Marklewitz et al. 2013; Nasar et al. 2012, 2015). Although high temperatures completely block the mosquito-specific bunyaviruses replication in invertebrate cells (Marklewitz et al. 2015), decreasing the temperature in vertebrate cells do not allow viral replication, suggesting that temperature is

not the only restriction factor (Marklewitz et al. 2015; Nasar et al. 2012; Huhtamo et al. 2014). Nevertheless, it was proved that viruses could adapt to the body temperature of their host, as it was shown with Rabensburg virus (flavivirus) that cannot replicate at 37°C in vertebrates cells but can replicate at 28°C in these same cells (Aliota et al. 2012; Aliota and Kramer 2012). This virus can then be considered as an intermediate between ISVs and vertebrate viruses, as it is also highly vertically transmitted but weakly orally transmitted by *Culex* mosquitoes.

The production of chimeric viruses revealed that ISV replication is restricted at many steps of the viral cycle (Nasar et al. 2012, 2015; Junglen et al. 2017). A chimeric YFV made with structural proteins of an insect-specific flaviviruses (NIEV, Niénokoué virus) proved to replicate and produce infectious particles in C6/36 cells, but not in BHK cells, suggesting a restriction at the cell entry (Junglen et al. 2017). The same study showed that after the electroporation of a NIEV reporter replicon expressing *Renilla* luciferase, a continuous decrease of *Renilla* luciferase expression was observed compared to control, suggesting a potential restriction at the RNA replication level as well. Finally, the electroporation of the chimeric virus to circumvent the cell entry failed to produce infectious viral particles, also suggesting a restriction at the assembly and release of the virus.

The vertebrate immune system against ISVs could also explain their incapacity to replicate in these organisms. Indeed, the separate knockdown of the pattern recognition receptors (PRRs) TLR3, MDA5 and RIG-I increased Kamiti River virus (KRV) vRNA levels in Vero cells (Tree et al. 2016). Moreover, KRV infection in IRF3,5,7^{-/-} mouse embryonic fibroblasts led to the production of mature viral particles associated with increased accumulation of vRNA. This was the first study showing the role of the vertebrate immune system in the host-range restriction of ISVs. However, other studies using Herbert virus,

Gouléako virus and a chimeric Eilat virus/CHIKV showed incapacity of infection in RIG-I or MDA5-deficient mouse embryonic fibroblasts (MEFs) or IFN- α /b receptor knockout mice (Drosten et al. 2011; Marklewitz et al. 2013; Erasmus et al. 2017). Therefore, the immune response might not be the major barrier to infection, and further studies (using other ISVs and cell lines) are required to puzzle out its precise role in vertebrate cells.

Finally, contrary to mammalian RNA viruses that mimic host mRNA and display low CpG dinucleotide frequencies (Rima and McFerran 1997; Belalov and Lukashev 2013), ISVs, and notably insect-specific flaviviruses (ISFs), show high frequencies of CpG dinucleotides (Lobo et al. 2009). However, it was recently proposed that through the activity of the zinc-finger antiviral protein (ZAP), the vertebrate antiviral immunity exploits the CpG suppression in order to recognize and inhibit non-self RNA, and notably RNA viruses (Takata et al. 2017). Therefore, because of high genome composition of CpG dinucleotides, ISVs could be totally or partially repressed through this mechanism (Fros et al. unpublished data).

5.3 Insect-specific virus transmission

In order to be maintained in nature, arboviruses are suspected to be mainly transmitted horizontally. Although few proofs of vertical transmission (from infected females to the progenies) have been detected (Rosen et al. 1985; Mitchell and Miller 1990), conflicting results based on field studies revealed that this mode of transmission could not explain alone the epidemiological persistence of arboviruses (Watts et al. 1985; Lequime and Lambrechts 2014). However, it has been proposed that arboviruses could be transmitted vertically during period when horizontally transmission conditions are not optimal (Lequime, Paul, and Lambrechts 2016).

On the other hand, the ancestral association between ISVs and their hosts is consistent with their mode of transmission. ISVs have been proven to be transmitted vertically, from an infected female to her progeny (Bolling et al. 2011; S. Cook and Holmes 2006; Sang et al. 2003), and the presence of ISVs at each stage of life and in males confirmed these experiments. Transovarial transmission (infection of the germinal tissues of female mosquitoes) has been revealed to be the main mechanism by which ISVs are vertically transmitted (Saiyasombat et al. 2011). Venereal transmission, previously investigated, plays a minor role in the persistence of ISV (Bolling et al. 2012b).

5.4 Insect-specific flaviviruses

Insect-specific flaviviruses (ISFs) are a group of flaviviruses that represents by itself the discovery and the growing interest of studying ISVs. Indeed, as mentioned earlier, the first ISV discovered, CFAV, was characterized in cells as a flavivirus in 1975 and was further isolated from field-collected mosquitoes from different regions of the world (Espinoza-Gómez et al. 2011; S. Cook and Holmes 2006; Yamanaka et al. 2013). Subsequently, 17 years passed before the nucleotide sequence of the virus was released (Cammisa-Parks et al. 1992). Then, almost 30 years later, a new ISF, designated Kamiti River virus (KRV), was described in field-collected *Aedes macintoshi* mosquitoes collected in 1999 in Kenya (Sang et al. 2003; M B Crabtree et al. 2003). Furthermore, *Culex* flavivirus (CxFV) was isolated in 2007 in *Culex pipiens* mosquitoes in Japan (Hoshino et al. 2007), and screening achieved on field-collected mosquitoes showed its wide distribution like many other ISFs (Farfan-Ale et al. 2009; Morales-Betoulle et al. 2008; Blitvich et al. 2009; Kyaw Kyaw et al. 2018; Goenaga et al. 2014; D. Y. Kim et al. 2009; Huanyu et al. 2012; Grisenti et al. 2015). During the last two decades, the development of new sequencing technologies and bioinformatic tools allowed a tremendous number of new

ISF discoveries (Table 1). Some viruses were even discovered simultaneously so that different names were given.

Tableau 1: List of insect-specific flaviviruses (ISFs) discovered. cISF: classical ISF. dISF: dual-host affiliated ISF. Adapted from Bolling et al. (2015) and Guzman et al. (2018)

Virus	Phylogenic group	Geographical distribution	Host	References
Aedes flavivirus (AeFV)	cISF	Japan (2003), Italy (2008), USA (2011), Thailand (2012)	<i>Ae. albopictus</i> , <i>Ae. flavopictus</i> , <i>Cx. pipiens</i>	(Hoshino et al. 2009b; Roiz et al. 2012; Bolling, Vasilakis, et al. 2015; Calzolari et al. 2012; Haddow et al. 2013; Grisenti et al. 2015)
Aedes galloisi flavivirus (AGFV)	cISF	Japan (2003)	<i>Ae. galloisi</i>	(Hoshino et al. 2012)
Calbertado virus (CLBOV)	cISF	Canada (2003), USA (2006)	<i>Cx. tarsalis</i> , <i>Cx. pipiens</i>	(Tyler et al. 2011; Bolling et al. 2011)
Assam virus	cISF	India (date not specified)	<i>Culex tritaeniorhynchus</i>	(Datta et al. 2015)
Cell Fusing Agent virus (CFAV)	cISF	Laboratory, Puerto Rico (2002), Indonesia (2004), Mexico (2007), Thailand (2008), USA (2012)	<i>Ae. albopictus</i> , <i>Ae. aegypti</i> , <i>Culex spp.</i>	(Stollar and Thomas 1975; Hoshino et al. 2009b; Espinoza-Gómez et al. 2011; S. Cook and Holmes 2006; Yamanaka et al. 2013)
Culex Flavivirus (CxFV)	cISF	Japan (2003), Indonesia (2004), China (2006), Guatemala (2006), USA (2006), Mexico (2007), Trinidad (2008), Uganda (2008), Argentina (2009),	<i>Cx. interrogator</i> , <i>Cx. maxi</i> , <i>Cx. nigripalpus</i> , <i>Cx. pipiens</i> , <i>Cx. quinquefasciatus</i> , <i>Cx. restuans</i> , <i>Cx. tarsalis</i> , <i>Cx. tritaeniorhynchus</i> , <i>Cx. usquatus</i>	(Bolling et al. 2011; Hoshino et al. 2007; Goenaga et al. 2014; Huanyu et al. 2012; Morales-Betoulle et al. 2008; Farfan-Ale et al. 2009; Saiyasombat et al. 2011; Shelley Cook et al. 2009)

Culex theileri flavivirus (CTFV)	cISF	Spain (2006), Portugal (2009-2010), Greece (2010), Thailand (date not specified)	<i>Cx. fuscocephala</i> , <i>Cx. pipiens</i> , <i>Cx. theileri</i>	(Calzolari et al. 2012; Vázquez et al. 2012; Parreira et al. 2012; Papa et al. 2014) Genbank Accession No. AY457040
Hanko virus (HANKV)	cISF	Finland (2005), Spain (2006), Italy (2007), Portugal (2007)	<i>Ae. caspius</i> , <i>Ae. detritus</i> , <i>Ae. vexans</i> , <i>Cx. pipiens</i> , <i>Cx. perexiguus</i> , <i>Cx. theileri</i>	(Calzolari et al. 2012; Vázquez et al. 2012; Huhtamo et al. 2012; Ferreira et al. 2013)
Kamiti River virus (KRV)	cISF	Kenya (1999)	<i>Ae. macintoshi</i>	(M B Crabtree et al. 2003; Sang et al. 2003)
Menghai flavivirus (MFV)	cISF	China (2010)	<i>Ae. albopictus</i>	(X. Zhang et al. 2017)
Mercadeo virus (MECDV)	cISF	Panama (2011)	<i>Culex spp.</i>	(Carrera et al. 2015)
Nakiwogo virus (NAKV)	cISF	Uganda (2008)	<i>Mansonia africana nigerrima</i>	(Shelley Cook et al. 2009)
Nienokoue virus (NIEV)	cISF	Côte d'Ivoire (2004)	<i>Culex spp.</i>	Genbank Accession No. NC_024299
Palm Creek virus (PCV)	cISF	Australia (2010)	<i>Coquillettidia xanthogaster</i>	(Hobson-Peters et al. 2013)
Phlebotomus-associated flavivirus	cISF	Algeria	<i>Phlebotomus perniciosus</i>	(Moureau et al. 2010)
Quang Binh virus (QBV)	cISF	Vietnam (2002), China (2009)	<i>An. sinensis</i> , <i>Cx. tritaeniorhynchus</i>	(Mary B. Crabtree, Nga, and Miller 2009; Zuo et al. 2014; Feng et al. 2014)
Parramatta River virus (PaRV)	cISF	Australia (2007)	<i>Aedes vigilax</i>	(McLean et al. 2015)
Sabethes flavivirus (SbFV)	cISF	Paraguay (2018), Brazil (2018)	<i>Sabethes belisarioi</i>	(Gravina et al. 2019)
Yamadai flavivirus (YDFV)	cISF	Japan (2013)	<i>Cx. tritaeniorhynchus</i>	(Kuwata et al. 2015)
Xishuangbanna flavivirus	cSIF	China (2010)	<i>Ae. albopictus</i>	(Fan et al. 2016)

(XFV)

Culiseta flavivirus (CsFV)	cISF	USA (2011-2012)	<i>Culiseta melanura</i>	(Misencik et al. 2016)
La Tina virus (LTNV)	dISF	Peru (1996)	<i>Aedes scapularis</i>	(Guzman et al. 2018)
Kampung Karu virus (KPKV)	dISF	Malaysia (2013)	<i>Anopheles tessellatus</i>	(Guzman et al. 2018)
Long Pine Key virus (LPKV)	dISF	USA (2013)	<i>Anopheles crucians</i> , <i>Aedes atlanticus</i> , <i>Culex nigripalpus</i>	(Guzman et al. 2018)
Barkedji virus (BJV)	dISF	Israel (2011), Senegal (date not specified)	<i>Culex perexiguus</i>	(Kolodziejek et al. 2013) GenBank acc. Number: EU078325
Chaoyang virus (CHAOV)	dISF	China (2008), Korea (2003)	<i>Ae. vexans</i>	(Wang, Z., A. An, Y. Wang, Y. Han 2009; R. C. H. Lee et al. 2013)
Donggang virus (DGV)	dISF	China (2009)	<i>Aedes spp.</i>	Unpublished data; GenBank acc. Number: NC_016997
Ilomantsi virus (ILOV)	dISF	Finland (2007)	<i>Ochlerotatus riparius and/or Anopheles spp</i>	(Huhtamo et al. 2014)
Marisma mosquito virus (MMV)	dISF	Spain (2001-2007)	<i>Ochlerotatus caspius</i>	(Vázquez et al. 2012)
Nanay virus (NANV)	dISF	Peru (2009)	<i>Culex (Melanoconion) ocosa</i>	(Evangelista et al. 2013)
Nhumirim virus (NHUV)	dISF	Brazil (2010)	<i>Culex (Culex) chidesteri</i>	(Pauvolid-Corrêa et al. 2015)
Lammi virus (LAMV)	dISF	Finland (2004)	<i>Likely Ae. cinereus</i>	(Huhtamo et al. 2009)
Nounane virus (NOUV)	dISF	Côte d'Ivoire	<i>Uranotaenia spp.</i>	(Junglen et al. 2009)
Aripo virus	dISF	ND	<i>Psorophora albipes</i>	Auguste et al., unpublished data

Ecuador Paraiso Escondido virus (EPEV)	dISF	Ecuador	<i>Psathyromia abonnenci</i> (sandflies)	(Alkan et al. 2015)
--	------	---------	---	---------------------

The phylogenetic studies of ISFs showed that they are separated into two distinct groups: classical ISF (cISFs) and dual-host affiliated ISF (dISFs) (Fig. 17) (Blitvich and Firth 2015). The cISF group includes the first isolated ISFs such as CFAV, KRV or CxFV, whereas the dISF group includes more-recently discovered ISFs such as Lammi virus (LAMV), Nany virus (NANV) or La Tina virus (LTNV) (Table 1).

cISFs are phylogenetically distinct from all other flaviviruses, including the human pathogenic ones. They have been largely studied, probably because every cISF was proved to replicate in the widely used C6/36 *Ae. albopictus* cell line, and found to be distributed in all continents except Antarctica (Table 1). cISFs are themselves divided into two main clades: *Aedes*-associated ISFs (CFAV, KRV, AeFV) and *Culex*-associated ISFs (CxFV, CTFV, QBV) (Blitvich and Firth 2015). Two other cISFs, NAKV and PCV isolated respectively from *Mansonia* and *Coquillettidia spp.* were grouped with the *Culex*-associated ISFs.

dISFs have been isolated from several mosquito genera and species. The dISF group seems to be monophyletic and affiliates with mosquito/vertebrate flaviviruses. Whether they have recently lost their capacity to replicate in vertebrates, or replicate in non-identified host remains to be proven. Therefore, further investigations need to be performed for this group and may provide crucial information regarding the evolution of flaviviruses.

5.4.1 Genome features of ISFs

The whole genome of many ISFs has been fully sequenced and their protein-coding structure is identical as the pathogenic flaviviruses, with three structural proteins (capsid (C),

precursor membrane (prM) and envelope (E)) and seven non-structural (NS) proteins (NS1, NS2A, NS2B, NS3, NS4A, NS4B and NS5). However, an overlapping ORF designated *fifo* (for fairly interesting flavivirus ORF), in the NS2A-NS2B region has been detected in cISFs. This occurs as a result of a programmed -1 ribosomal shifting (-1 PRF) event (Firth et al. 2010). *fifo* was suggested to encode a protein of a size that varies from 221 (NIEV) to 293 (CxFV) amino acids (Bolling, Vasilakis, et al. 2015), and seems to be specific to cISFs, but studies investigating the presence of this gene in dISFs are required.

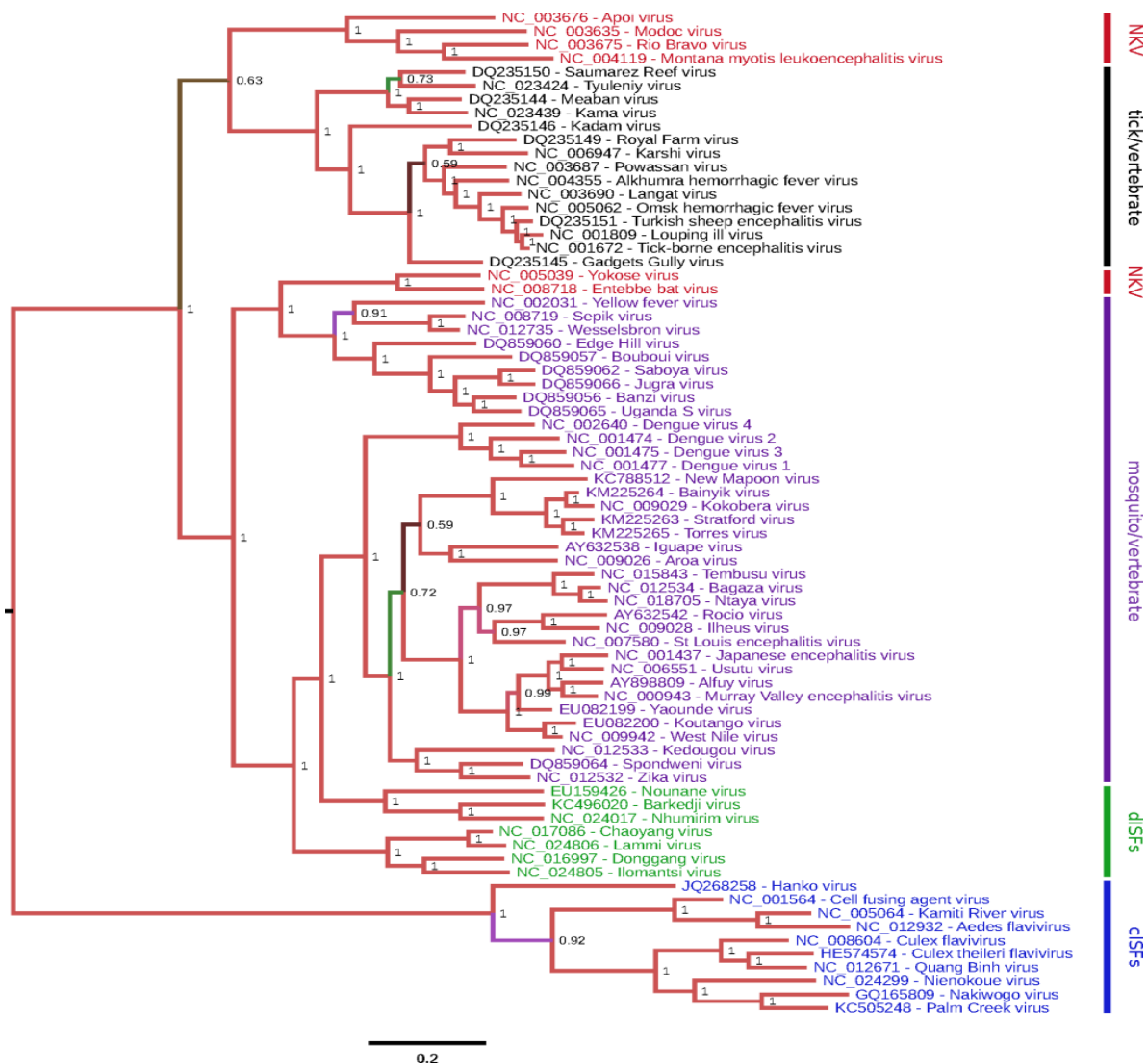

Figure 17: Phylogenetic classification of the *Flavivirus* genus. Insect-Specific flaviviruses (ISFs) are divided into two separate groups. cISFs appeared phylogenetically distinct from the rest of the flaviviruses. dISFs appeared affiliated to vertebrate/mosquito flaviviruses. cISFs: classical ISFs; dISFs: dual-hosts affiliated ISFs ; NKV: No Known Vector. From Blitvich and Firth (2015)

However, despite the fact that this protein was suspected to be an enzyme with a transmembrane domain, no studies have so far discovered the functional role of this gene (Ferreira et al. 2013; Firth et al. 2010). Further investigations must be performed on *fifo*, as it could have a major role in the replication of ISFs.

Another particularity of some ISFs is their surprising long untranslated regions (UTRs). Indeed, while ISFs share a 3'UTR of 400-700 nt long, the 3'UTR of KRV and AeFV is 1205 and 945 nt long respectively, which is sometimes twice the size of ISF 3'UTRs (Markoff 2003). Little is known about their long 3'UTR, but it has been suggested that the 3'UTR of KRV resulted from a complete duplication of a precursor sequence composed of conserved direct repeat sequences (Gritsun and Gould 2006).

As mentioned earlier with ISVs, ISFs have different dinucleotide preferences regarding the vertebrate flaviviruses. Indeed, while vertebrate flaviviruses mimic the preference of their hosts and show a suppression of CpG dinucleotides to avoid high mutation rates at these sites (Zhao et al. 2007), ISFs exhibit high CpG dinucleotide frequencies. However, ISFs and vertebrate flaviviruses both showed underuse of TA dinucleotides (Kenney et al. 2014; Lobo et al. 2009).

5.4.2 Impact of insect-specific flaviviruses on the vector competence for pathogenic viruses

As mentioned previously, the vector competence (VC) of a mosquito is its capacity to ingest the virus during a blood meal, maintain the viral replication and the transmission to an appropriate vertebrate host (Kramer and Ebel 2003). Bacterial symbionts of mosquitoes have been shown to alter the vector competence to arboviruses (Jupatanakul, Sim, and Dimopoulos 2014), so the scientific community started to think that what we call today the “mosquito virome” might also have an impact on the VC to arboviruses. Therefore, many studies have

pointed out the potential capacity of ISFs to reduce the VC to vertebrate flaviviruses (Table 2). For example, an *in vitro* experiment using C6/36 cells primo-infected with PCV and super-infected with West-Nile virus (WNV) and Murray Valley encephalitis virus (MVEV) showed viral titers significantly reduced compared to the control (Hobson-Peters et al. 2013). Moreover, an *in vivo* experiment using *Cx. quinquefasciatus* mosquitoes simultaneously co-infected with Nhumirim virus (NHUV) and WNV revealed a significant decreased of WNV titers (Goenaga et al. 2015) . Therefore, superinfection exclusion (a prior infection prevents a secondary infection of a related virus) and competition for cellular resources have been proposed by these studies to be the two main mechanisms that explain the potential anti-viral effect of ISVs on arboviruses (Hall-Mendelin et al. 2016; Hobson-Peters et al. 2013). However, other studies show no effects of ISV primo-infection on arbovirus replication and infection (Kent, Crabtree, and Miller 2010; Bolling et al. 2012a; Talavera et al. 2018), and a study even showed that ISVs promote subsequent arbovirus infection and viral release (Kuwata et al. 2015). Collectively, these experiments showed that ISVs could inhibit arbovirus replication, but only under mosquito/ISV/arbovirus specific interactions. Moreover, many of these experiments have used *Ae. albopictus* C6/36 cells that are RNAi-deficient (Brackney et al. 2010a). Thus, more studies must then be performed on RNAi-competent cell lines.

Table 2: List of experiments studying the effects of ISVs on the vector competence to pathogenic arboviruses.

Mosquito species/Cell lines	Primo-infection	Superinfection	Results	References
<i>Cx. quinquefasciatus</i> and C6/36 cells	CxFV	WNV	No significant differences	(Kent, Crabtree, and Miller 2010)
<i>Cx. pipiens</i> and C6/36 cells	CxFV (use of naturally CxFV-infected <i>Cx.</i>)	WNV	<i>In vitro</i> : WNV titers significantly reduced during early time post-	(Bolling et al. 2012a)

	<i>pipiens</i> colony)		infection <i>In vivo</i> : Lower dissemination rate than control at 7dpi but not at 14dpi	
C6/36 cells	PCV	WNV and MVEV	WNV and MVEV titers significantly reduced	(Hobson-Peters et al. 2013)
C6/36 cells	NHUV	WNV, SLEV, JEV	WNV, SLEV and JEV titers significantly reduced	(Kenney et al. 2014)
NIID-CTR cells	CxFV (use of persistent infect cells)	DENV, JEV	Pathogenicity and viral release increased	(Kuwata et al. 2015)
<i>Cx. pipiens</i> and <i>Cx. quinquefasciatus</i>	Co-infection NHUV/WNV	-	No significant transmission differences in <i>Cx. pipiens</i> , but significant decrease in <i>Cx. Quinquefasciatus</i>	(Goenaga et al. 2015)
C6/36 and C7-10 cells	NHUV	WNV	WNV titers significantly reduced	
C7-10 cells	EILV	SINV, VEEV, EEEV, WEEV, CHIKV	titers significantly reduced for all the viruses tested	(Nasar et al. 2015)
<i>Cx. Annulirostris</i>	PCV	WNV	Significant lower infection rate	(Hall-Mendelin et al. 2016)
<i>Cx. pipiens</i>	CxFV	RVFV	No effect	(Talavera et al. 2018)
Aa23 cells	CFAV, PCLV	ZIKV, DENV and LACV	Dual primo-infection reduces ZIKV, DENV and LACV titers	(Schultz, Frydman, and Connor 2018)

5.4.3 Insect-specific viruses as a new control strategy against arboviruses

As mentioned earlier, the lack of vaccine and efficient treatments against arboviral infections lead the scientist community to develop new measures against this bane. In this way, the larvicide function of the bacteria *Bacillus thuringiensis* has been exploited to reduce insect populations in the agricultural field (Bravo et al. 2011). Indeed, *Bacillus thuringiensis* produces toxins during sporulation that are able to kill mosquito larvae. Moreover, the bacterial endosymbiont *Wolbachia* has been proved to have antiviral capacities and is currently developed as biocontrol agent to fight against arboviral expansion (Moreira et al. 2009; Iturbe-Ormaetxe, Walker, and O'Neill 2011; T. Walker et al. 2011). As mentioned above, ISVs presence, but only in some cases, has also been proved to be a good weapon against arboviruses. Therefore, ISVs, and especially ISFs, could be used as a new control strategy to reduce arbovirus transmission by mosquitoes. Indeed, ISVs being mostly vertically transmitted, using a mosquito population infected with a specific strain of ISF that has anti-arboviral functions can theoretically be possible. Additionally, *Wolbachia* has been proved to stimulate ISF infection in *Ae. aegypti* mosquitoes (Amuzu et al. 2018). Using both the endosymbiont and ISF for a new control strategy could then reinforce their inhibitory effects on arboviruses.

ISVs could also be used as support to produce vaccines against arboviruses. Indeed, their incapacity to replicate in vertebrates can be used to produce chimeric viruses, ensuring production of arboviral specific antigens that stimulate the antiviral immune response without the production of mature viral particles. This has been tested with the insect-specific alphavirus Eilat virus (EILV) (Erasmus et al. 2017), which proved to be inefficient at both viral entry and replication in several vertebrate cells (Nasar et al. 2015). Chimeric EILV made with CHIKV structural proteins have been developed and showed identical structure compared to CHIKV by cryoelectron microscopy. As expected, the chimeric virus was able to

enter but failed to replicate in vertebrate cells. Its production from mosquito cells revealed the long-lasting production of neutralizing antibodies and protection in mouse models. EILV/CHIKV was even able to protect against symptoms in non-human primates. The same method has been used to generate chimeric viruses with EILV and Venezuelan equine encephalitis virus (VEEV) or Eastern equine encephalitis virus (EEEV) and also showed interesting results (Erasmus et al. 2018).

Therefore, ISF/arbovirus chimeric vaccines represent a promising cheap way for the control of arbovirus infection, as it could be as immunogenic as live-attenuated vaccines, and as safe as inactivated ones. However, other ISVs, such as ISFs, must be investigated for this vaccine system, as their related viral families contain serious vertebrate pathogenic arboviruses. The use of insect-specific alphaviruses might also be limited, as today only two have been discovered (Nasar et al. 2015; Hermanns et al. 2017).

Along with superinfection exclusion and nutritional competition, ISVs could have an additional effect on arboviruses, by their presence as endogenous viral elements (EVEs).

6. Endogenous Viral Elements

6.1 Endogenous retroviral elements

During retrovirus infection in a cell, RNA retroviral genomes are released and the reverse transcriptase encoded by the *pol* gene produces viral double-stranded DNA molecules. Viral dsDNA becomes then integrated into the host genome through the integrase protein activity. These copies of retroviral integrated DNA (also called provirus) contain all the promoters and regulatory elements located in the long terminal repeats (LTRs) that flank the provirus. They trigger the expression of what is necessary for viral assembly, including structural proteins, and allow the production of retroviral viral particles. Usually, retroviruses

mostly integrate into somatic cell genomes. However, copies of retroviral DNA are sometimes found in germlines. These copies, called endogenous retroviral elements (ERVs), are then vertically transmitted to the progenies. Discovered in late 1960s (Weiss 2006), the ERVs belong to a larger group called endogenous viral elements (EVEs) (Aris Katzourakis and Gifford 2010). Around 7-8% of the human genome is made up by ERVs (Bock and Stoye 2000), which represent approximately 300 millions of nucleotides. This is the result of multiple interactions that attest the close proximity between humans and retroviruses over time. However, ERV formation is thought to occur rarely, as germline is usually well protected against any kind of intrusions such as TEs (Siomi et al. 2011). ERVs contain either complete or fragmented portions of proviruses, and are hard to distinguish from LTR retrotransposons as they both share common ancestry with retroviruses. In fact, it was proposed a long time ago that retroviruses originated from LTR retrotransposons (Temin 1980). Depending on their effects on the host fitness (positive, neutral or negative), these ERVs will reach fixation or will be lost through genetic drift or purifying selection. The majority of the ERVs present in animal genomes have lost their capacity to express viral genes through evolution by the accumulation of substitutions, insertions or mutations. Each type of retrovirus has been found to produce ERVs in many vertebrate genomes but at different frequencies, suggesting that biological features may facilitate retroviral endogenization. As example, gammaretroviruses are often found to produce ERVs, whereas deltaretroviruses ERVs are less common and found only in bat genomes (Hayward, Grabherr, and Jern 2013; Hron et al. 2018).

Little is known about retroviruses in invertebrates. For a long time, the scientific community thought that retroviruses only infected vertebrates. The discovery of the first retrovirus, gypsy that produces infectious viral particles in *D. melanogaster* proved that it was wrong (A. Kim et al. 1994). Subsequently, several endogenous sequences have been

designated insect endogenous retroviruses (IERV; (Terzian et al. 2000)). However, many of endogenous elements described today in insects are characterized as LTR retrotransposons since they lack the *env* ORF. Then, contrary to retroviruses, they are not infectious and are transmitted vertically whereas retroviruses are both transmitted horizontally and vertically.

6.1.1 Host benefits of endogenous retroviral elements

ERVs have shaped the evolution of their hosts by providing benefits. Whereas the vast majority of ERVs are non-coding sequences, some still encode functional proteins that lead to exaptation and provide benefits to the hosts. The best-known example is the two envelope proteins, Syncytin-1 and Syncytin-2 that are important for the development and function of the mammalian placenta. These proteins allow the fusion of multiple cytotrophoblasts to form a syncytiotrophoblast layer (Lavialle et al. 2013). This layer is crucial for maintaining stability, fetal development and fetomaternal immunotolerance (Warning, McCracken, and Morris 2011; Sha et al. 2000). Another good and recent example is the endogenous gammaretrovirus MER41 in the human genome. MER41 has been proven to promote the expression of adjacent interferon-induced genes which are important in controlling incoming infections, such as viral infections, notably by activating the AIM2 inflammasome (Chuong, Elde, and Feschotte 2016). Moreover, several ERVs have been found to act as restriction factors during viral infection (Malfavon-Borja and Feschotte 2015). Several envelope-derived ERVs (*env*-ERVs) have been detected to block viral entry through receptor interference in several organisms (H. L. Robinson et al. 1981; T. Wu, Yan, and Kozak 2005; Ito et al. 2013). By this way, the most famous molecule is the *env*-ERVs *Fv4*, which is known to block murine leukaemia virus (MLV) infection in mice (Inaguma, Yoshida, and Ikeda 1992). While most of the ERVs exapted to provide advantages to their hosts are *env*-ERVs, few other ERVs have also been described. This is the case for *Fv1*, a *gag*-derived ERV (*gag*-ERV) that blocks MLV infection after viral entry in mice (Best, Tissier, et al. 1996). Another example is the

EnJS56A1 locus of domestic sheep (*Ovis aries*), which is a *gag*-ERV that blocks the virion assembly of the related Jaagsiekte sheep retrovirus (JSRV) (Mura et al. 2004; Arnaud, Murcia, and Palmarini 2007).

6.1.2 Host constraints of endogenous retroviral elements

Just as transposon activity, the formation of ERVs in host genomes does not always come with beneficial impacts to the hosts. It can lead to recombination and unequal crossing-overs between chromosomes and chromosomal rearrangements by creating deletions, insertions, duplications, inversions and translocations. If the insertion occurs in an exon, the ORF can change and codes for a non-functional peptide or cause missense or nonsense mutations. However, the endogenization of retroviruses can also sometimes occur far from coding and active regions. ERV formation can also create alternative splicing leading to the production of several protein isoforms or introduce a polyadenylation signal. Recombination between human endogenous retrovirus 15 (HERV15) on the Y chromosome leads to sterility (Sun et al. 2000). Additionally, endogenization of retroviruses can lead to cancer in humans (Antony et al. 2004; Löwer et al. 1996; Wang-Johanning et al. 2003). Moreover, the production of ERVs from the Feline Leukemia virus (FLV) can recombine with cat DNA sequences and form the highly oncogenic Feline Sarcoma virus (FeSV) (Frankel et al. 1979).

6.2 Endogenous viral elements from DNA viruses

EVEs other than ERVs originating from DNA viral families have also been detected in different genomes by *in silico* analysis. However, these viruses are suggested to endogenize less frequently than retroviruses (reviewed by (Aris Katzourakis and Gifford 2010; Aiewsakun and Katzourakis 2015; Feschotte and Gilbert 2012). As example, single-stranded DNA viruses such as dependoviruses (*Parvoviridae*) and circoviruses (*Circoviridae*) have been found integrated into diverse vertebrate genomes like dog, mouse and panda, dating their

integration around 40 to 50 million years ago (Belyi, Levine, and Skalka 2010b). Moreover, fragments of double-stranded DNA hepadnaviruses were also described in zebrafish genome (Gilbert and Feschotte 2010). EVE formation from these viruses could be easily justified by their close location to the host genome in the nucleus during their replication that could facilitate their endogenization.

Several mechanisms have been suggested to explain the production of EVEs. The endogenization of these viral sequences may be possible by non-homologous end joining (NHEJ) during the repair of double-stranded DNA breaks, as it has been described for hepadnaviruses (Bill and Summers 2004), by non-homologous DNA recombination at specific sites for adeno-associated virus (AAV) (Young and Samulski 2001; Urcelay et al. 1995; Kotin, Linden, and Berns 1992), or by homologous recombination between telomeric repeat sequence (TRS) and host telomeres for herpesviruses (Morissette and Flamand 2010).

6.3 Non-retroviral integrated RNA virus sequences (NIRVS)

Surprisingly, persistent DNA forms of non-retroviral RNA viruses that have no DNA stage in their life cycle were first detected in mouse genome, 200 days after infection with the lymphocytic choriomeningitis virus (LCMV) (Klenerman, Hengartner, and Zinkernagel 1997). More recently, non-retroviral integrated RNA virus sequences (NIRVS) from filoviruses, flaviviruses, rhabdoviruses, reoviruses and bunyaviruses for which replication occurs in the cytoplasm have also been found in many different genomes including mammals and plants, suggesting that NIRVS formation occurs more frequently than previously thought (Belyi, Levine, and Skalka 2010b; Aris Katzourakis and Gifford 2010; Tanne and Sela 2005; Cui and Holmes n.d.). Since non-retroviral RNA viruses do not encode for reverse transcriptase or integrase, endogenous enzymes or retroviruses infecting the cell at the same time must be involved in NIRVS production. Indeed, it requires three unusual steps for the

non-retroviral RNA viruses to integrate into the host genome: (i) first, the non-retroviral RNA needs to be reverse-transcribed into viral-derived double-stranded DNA (vDNA), (ii) be imported in the nucleus, and (iii) finally, be integrated into the host genome. The importation of vDNA into the nucleus has been suggested to occur during mitosis, when the nuclear envelope is temporarily disassembled or *via* the transportation of proteins that contain DNA-binding sites such as proteins involved in immunity or the viral nucleocapsid (Olson and Bonizzoni 2017). Additionally, NIRVS from bornavirus and orthomyxovirus families, which require intra-nuclear replication, have also been found in the genome of mammals, birds and insects (Horie et al. 2010; Aris Katzourakis and Gifford 2010).

The first mosquito NIRVS were identified in 2004 in *Aedes spp.* cell lines and individual mosquitoes (Crochu et al. 2004). Four different fragments of different sizes were detected: three from *Ae. albopictus* and one from *Ae. aegypti* genomes. Three of them were truncated or incorporated several stop codons, but one contained an intact ORF homologous to the NS1-NS4A region of insect-specific viruses (ISVs), i.e. Cell Fusing Agent Virus (CFAV) and Kamiti River Virus (KRV). This last fragment represents around one half of the flaviviral genome. Altogether, these NIRVS (also called Cell Silent Agent (CSA) sequences) comprised two-third of the flaviviral genome and contained enzymatic domains including helicase and serine protease. The corresponding mRNA was detected in C6/36 *Ae. albopictus* cells suggesting the expression of the NIRVS and its potential functional role in the cell at the RNA level since no protein was detected by mass spectrometry (Suzuki et al. 2017). Moreover, the presence of this NIRVS in 97-98% of field-collected *Ae. albopictus* individuals tested suggested its very likely exploitation by the host cells.

Later, the development of molecular technics and bioinformatic tools allowed finding numerous NIRVS in many mosquito genomes, mostly in *Aedes spp.* (Fort et al. 2012; Roiz et al. 2009; Rizzo et al. 2014; X.-G. Chen et al. 2015; Suzuki et al. 2017; Aris Katzourakis and

Gifford 2010; Whitfield, Dolan, Kunitomi, Tassetto, et al. 2017). Many of these NIRVS were found homologous to ISFs such as CFAV, KRV and Aedes flavivirus (AeFV) closely related to arboviruses (Bolling, Vasilakis, et al. 2015). The high prevalence of NIRVS in *Aedes spp.* genome as well as the high frequency of transposons might somehow be correlated to the size of the mosquito genome (X.-G. Chen et al. 2015; Nene et al. 2007).

An *in silico* study elaborated a pipeline allowing the detection of NIRVS from 424 RNA viruses in the 22 mosquito genomes available up to date (Palatini et al. 2017). Among the 239 NIRVS loci found, 194 were identified in *Aedes spp.* genomes, representing 81% of the total NIRVS loci detected. Among these 81%, 63% of NIRVS loci were located in the *Ae. aegypti* genome, and the remaining 37% were identified in the *Ae. albopictus* genome. Additionally, 72% of the NIRVS loci found were homologous to the *Rhabdoviridae* family whereas 27% were close to the *Flaviviridae* family, with the 1% left belonging to *Bunyaviridae* family and *Bunyavirales* order. These data are consistent with another study, which compared the “EVEome” of both *Ae. aegypti* and *Ae. albopictus* (Whitfield, Dolan, Kunitomi, Tassetto, et al. 2017). Identification of NIRVS has been extended to other host genomes (Aris Katzourakis and Gifford 2010); a higher prevalence of the *Mononegavirales* order (*Bornaviridae*, *Rhabdoviridae*, *Filoviridae* and *Paramyxoviridae*; non-segmented and negative sense RNA, ssRNA-) was reported compared to the *Flaviviridae* family harboring single-stranded polarity positive genome (ssRNA+). Many reasons behind this unbalanced distribution have been suggested (Holmes 2011; Olson and Bonizzoni 2017; Aris Katzourakis and Gifford 2010): (i) some viral genomes could have simply more chance to endogenize into germ line cells than others (Horie et al. 2010; Johnson n.d.), (ii) some could possibly have more and/or better interactions with transposable elements (see below for details), (iii) some suggested that infection intensity and prevalence could promote endogenization (Olson and Bonizzoni 2017), and (iv) others proposed that permanent virus-host interactions leading to persistent infections

could play the major role (Aris Katzourakis and Gifford 2010). Although these hypotheses are pertinent and nonexclusive, further investigations are required to explain these inequalities of endogenization. Indeed, no effect of the MOI (Multiplicity of Infection) was found for vDNA detection at 6 days post-infection in *Ae. albopictus* cell culture infected by La Crosse virus (LACV), DENV and WNV (Nag, Brecher, and Kramer 2016). Both rhabdoviruses and flaviviruses (for which differences in the number of NIRVS were detected) are capable of persistent infections (Mlera, Melik, and Bloom 2014; Fultz et al. 1982). Endogenization efficiency could also be related to mRNA abundance since ssRNA⁺ genomes are directly translated into proteins whereas ssRNA⁻ genomes have first to be transcribed. Moreover, the size of RNA could condition endogenization. Since transcription of flaviviral genome leads to a large polyprotein coding sequence, transcripts obtained are usually longer than those from ssRNA⁻ viruses, and this could decrease their chance to be integrated into the host genome (Holmes 2011).

NIRVS do not represent the entire viral genome. Palatini and colleagues found that most of the flaviviral NIRVS detected *in silico* originated from non-structural protein-coding sequences, rather than structural ones (Palatini et al. 2017). Indeed, in *Ae. aegypti* and *Ae. albopictus* genomes, 30 and 25 flaviviral NIRVS were mapped to non-structural protein-coding sequences, and respectively only 2 and 3 NIRVS represented a similarity with the structural protein coding sequences. Such unequal endogenization of different regions of viral genome was also raised for other viral families. Regarding the *Rhabdoviridae* family, half of the rhabdoviral NIRVS identified mapped to the *N* gene, which encodes the nucleoprotein. This is consistent with other studies for which almost all rhabdoviral NIRVS found in many vertebrate genomes were homologous to the *N* gene, whose assembly of around 2000 units form the capsid. Only a few NIRVS are originated from the polymerase *L* gene, and almost none detected from the *P*, *M* and *GP* genes, encoding respectively the phosphoprotein, the

matrix and the glycoprotein (Fort et al. 2012; Aris Katzourakis and Gifford 2010). Ultimately, another study decrypting NIRVS in the *Ae. aegypti* Aag2 cell line led the authors to the same conclusion (Whitfield, Dolan, Kunitomi, Tassetto, et al. 2017). Then it seems that the entire viral genome is not capable of endogenization in host cells. For rhabdoviral NIRVS at least, this observation can be justified: each gene (N, P, M, G and L) of the rhabdoviral genome is transcribed in a progressive graduated manner (Conzelmann 1998) and separately from 3' to 5' due to the recognition of stop codons/polyadenylation signals by the polymerase. This means that the transcript quantity of the genes near the 3' end (such as the N gene) is higher than for those near the 5' end (L gene) (the rhabdoviral genome being a negative-stranded RNA) (Banerjee 1987; P. J. Walker et al. 2015). This hypothesis suggests that endogenization into a host cell is dependent on mRNA abundance.

6.3.1 Mechanisms of NIRVS integration

As previously mentioned, to become integrated into the host genome, the non-retroviral RNA virus is first reverse transcribed to produce viral DNA (vDNA), imported into the cell nucleus and finally, integrate into the chromosome. vDNA production was demonstrated in several mosquito cell lines, such as RNAi-proficient Aag2 *Ae. aegypti* cells and U4.4 *Ae. albopictus* cells, and RNAi-deficient C6/36 *Ae. albopictus* cells (Brackney et al. 2010). CHIKV vDNA was found by virus-specific PCR as early as 6 hours post-infection in C6/36 and U4.4 cells and 12 hours post-infection in Aag2 cells (Goic et al. 2016). Moreover, DENV-2 vDNA was detected 24 hours post-infection in both C6/36 cells and Aag cells (Nag, Brecher, and Kramer 2016). Because RNA viruses do not possess any reverse transcription activity, these results suggest that RNA virus was processed very early by host components, not yet identified. Additionally, vDNA from WNV and ZIKV belonging to the *Flaviviridae* family was detected in *Culex tarsalis* infected cells and *Aedes spp.* cells respectively, as well as LACV vDNA of the *Bunyaviridae* family in persistently infected C6/36 cells (Nag,

Brecher, and Kramer 2016; Nag and Kramer 2017). Interestingly, only parts of the viral genomes were found as a DNA form. Then, it has been proposed that the reverse transcriptase switches from the original RNA template to a close viral RNA genome (Geuking et al. 2009; Zhdanov 1975), suggesting multiple independent reverse-transcription events. This vDNA could also be the result of replication-slippage events led by the reverse transcriptase. However, last experimental evidence converged towards the first hypothesis; vDNA has been found rearranged in *D. melanogaster* (Goic et al. 2013b) and the template of vDNA production could be defective-interfering (DI) RNA molecules (Nag, Brecher, and Kramer 2016). This suggests that there is no specific type of viral RNA genome capable to undergo reverse transcription. Whether the vDNA form belongs to the host genome or is present as an extra-chromosomal DNA element such as episomes is still unknown. RNAi-deficient cells (C6/36) possess more vDNA forms than RNAi-proficient cells (Aag2 cells) suggesting that RNAi immune system could interfere with vDNA production, or it could also be the result of the cell type used, namely C6/36 cells and Aag2 cells, which originated from two different *Aedes* species, *Ae. albopictus* and *Ae. aegypti* respectively. More importantly, after mosquito infection with CHIKV, vDNA has been found in legs and wings of infected *Aedes* individuals at 7 days post-infection, suggesting that vDNA is either capable of dissemination in mosquitoes (possibly through cellular and tissue damages), or that all infected cells produce vDNA. Moreover, FHV and Sindbis vDNA were found in infected flies at days 4 and 6 post-infection respectively at a high frequency (Goic et al. 2013).

The recent and surprising discovery of NIRVS raised the question of the underneath mechanism that enables non-retroviral RNA to reverse transcribe into vDNA and integrate into host genomes. The answer came from retrotransposons, for which an association with NIRVS has been suggested, since many of retrotransposon proteins have been found to contain viral-like helicase domains from ISVs in many insect orders such as Lepidoptera,

Hemiptera, Orthoptera, Hymenoptera and *Culicidae* species (Lazareva et al. 2015; Shi et al. 2016; Morozov, Lazareva, and Solovyev 2017). Moreover, reverse transcription activity from endogenous retrotransposons has been associated with vDNA formation in *Drosophila* (Fig. 18; (Goic et al. 2013b)). Indeed, addition of a reverse transcriptase inhibitor, azidothymidine (AZT) in S2 and Kc167 *Drosophila* cell cultures revealed no vDNA formation following infection by several RNA viruses, namely Flock House Virus, Sindbis Virus and *Drosophila C Virus* (DCV), which are known to cause persistent infections, (Goic et al. 2013b). Specifically, deep sequencing of S2p *Drosophila* cell genome revealed a fusion between vDNA and several LTR retrotransposon elements. Another study showed that CHIKV and DENV vDNA were formed following infections in both *Ae. albopictus* and *Ae. aegypti* mosquitoes and mosquito cell cultures (Goic et al. 2016). Moreover, inhibition of vDNA by AZT treatments led to mosquito death with no increase of viral titers, suggesting that vDNA has an important role in viral tolerance rather than viral resistance (Goic et al. 2016). vDNA is produced early, as early as 6 hours and 2 days post-infection in cultured cells and mosquitoes respectively. The early production of vDNA is useful for establishing an efficient immune system (Goic et al. 2016). Additionally, bioinformatic analysis of NIRVS loci in *Ae. albopictus* and *Ae. aegypti* revealed that these regions were also enriched with LTR retrotransposons as it has been shown in *Drosophila*, especially retrotransposons of the Ty3_gypsy and Pao Bell families (Palatini et al. 2017; Whitfield, Dolan, Kunitomi, Tassetto, et al. 2017). Taken together, this suggests an important role of LTR retrotransposons in the reverse transcription of vDNA (Fig. 18). However, LTR retrotransposons are not the only elements involved in the fate of vDNA. NIRVS from filoviruses and Endogenous Borna-like N elements (EBLNs) from Bornaviruses presented flanking sequences with characteristics of LINE elements (which are non-LTR retrotransposons) such as polyA tails at the 3' and Target Site Duplications

(TSDs) (Horie et al. 2010; Belyi, Levine, and Skalka 2010a; Morrish et al. 2002), meaning that several types of retrotransposons are capable of inducing NIRVS formation. Finally, retrotransposons being ubiquitous in eukaryote genomes indicate that NIRVS have a lot of opportunities to reverse transcribe and integrate into the host genome (Geuking et al. 2009).

6.3.2 NIRVS biological functions

The integration of NIRVS into host genomes has now been recognized to occur more frequently than previously thought. However, little is known about their functions, if any, in the host. Their unexpected presence could simply be related to the ubiquitous proportion of retrotransposons and the plasticity of the host genomes. Endogenization of viral sequences could also occur with a specific purpose, meaning that NIRVS could actually have a biological function.

NIRVS and antiviral RNAi-based immunity

The antiviral function of NIRVS has been linked to the innate immune system of RNAi, which is, as mentioned earlier, the main antiviral system in insects (Bronkhorst and van Rij 2014; Olson and Blair 2015; Goic et al. 2016).

Interestingly, EVEs including NIRVS present in *Aedes* mosquitoes are frequently located in TE-derived piRNA clusters (Palatini et al. 2017; Whitfield, Dolan, Kunitomi, Tassetto, et al. 2017). Indeed, a study conducted on *Ae. aegypti* and *Ae. albopictus* revealed that almost half of the NIRVS identified mapped to piRNA clusters in *Ae. aegypti* genome. Also, 12.5% of NIRVS mapped to the piRNA clusters in *Ae. albopictus* genome (Palatini et al. 2017), which is more than expected by chance according to the large genome of this species. Moreover, bioinformatic predictions on Aag2 cell line showed that piRNA clusters containing EVEs produced more piRNAs than those without EVEs, suggesting that viruses may not integrate randomly in the host genome but target specific active piRNA clusters for

endogenization (Whitfield, Dolan, Kunitomi, Tassetto, et al. 2017). Additionally, deep-sequencing analysis of Aag2 cells (from *Ae. aegypti*) showed that NIRVS produced both primary and secondary piRNAs and can target ISVs. Consistent with these results, immunoprecipitation experiments of Piwi proteins detected NIRVS-derived sRNAs of expected piRNA size (25-30nt), and the knockdown of some Piwi proteins resulted in a decrease of NIRVS-derived sRNA expression (Palatini et al. 2017). However, NIRVS-derived siRNAs were not found in uninfected *Aedes* mosquitoes indicating that NIRVS are involved in only one specific RNAi pathway. In addition, NIRVS originated from insect-specific viruses were proved to produce antisense orientation primary piRNA-like molecules and be located in active regions of both siRNA and piRNA production in *Ae. aegypti* and *Ae. albopictus* mosquitoes (Suzuki et al. 2017). The knocking-down of RNAi machinery in *Drosophila* infected cells resulted in an acute infection leading to cell death (Goic et al. 2013).

Altogether, these results suggest that NIRVS (at least some of them) are located in piRNA clusters, which are important for RNAi-based immunity, and are processed into piRNAs in *Aedes* mosquitoes (Fig. 18; (Palatini et al. 2017; Whitfield, Dolan, Kunitomi, Tassetto, et al. 2017)). Additionally, this production of sRNAs is induced following viral infections coming from different families such as *Togaviridae* and *Flaviviridae*, suggesting that this mechanism is an important antiviral system. Besides, NIRVS, or at least its vDNA intermediate, are required for mosquito tolerance to control arbovirus infection. Indeed, inhibition of vDNA synthesis by AZT treatment led to rapid death of CHIKV-infected mosquitoes (Goic et al. 2016). Finally, since vDNA have been found in many mosquito tissues following viral infection, vDNA or NIRVS could serve as a danger signal to warn the uninfected cells and implement a solid immune response through sRNA production (Goic et al. 2016). But the virus could also counteract by producing VSR (Viral Suppressor of RNAi) with insect-specific viruses (Kingsolver, Huang, and Hardy 2013; Soldan et al. 2005; van

Cleef et al. 2011). However, attention must be paid to the potential of NIRVS to produce antiviral piRNAs. Indeed, some of the NIRVS-derived piRNAs did not show any signs of ping-pong amplification and not all of them were proved to map on viral sequences, even though the recognition piRNA/target allow some mismatches (P. Zhang et al. 2015; Goh et al. 2015; Post et al. 2014). It also appears that NIRVS suggested to derive from some viral families are more likely to produce antiviral and secondary piRNAs than NIRVS originated from other viral families (Palatini et al. 2017; Whitfield, Dolan, Kunitomi, Tassetto, et al. 2017; Suzuki et al. 2017). This would then suggest that the production of antiviral and secondary piRNAs requires viral family specificity.

NIRVS at the protein level

Even though many of them have accumulated several mutations including stop codons across the time, some NIRVs have conserved their open reading frames (ORFs), suggesting that they could be translated into proteins and have a function at the protein level. Furthermore, NIRVS have also been proven to have antiviral functions at the protein level (Fig. 18). The only proof discovered so far was in the thirteen-lined ground squirrel genome, *Ictidomys tridecemlineatus*. An Endogenous Borna-like N element (EBLN) showing 77% homology with the Borna Disease Virus (BDV) N protein was proved to act as a dominant-negative form and inhibit BDV polymerase activity (Fujino et al. 2014).

Up to now, no biological functions were found at the protein level for NIRVS in mosquitoes. However, many of them were proved to produce transcripts, mostly in *Aedes* and *Anopheles* mosquitoes (Suzuki et al. 2017; Fort et al. 2012; Lequime and Lambrechts 2017; Palatini et al. 2017; Crochu et al. 2004), suggesting that related proteins should be discovered shortly.

However, some questions remain unsolved, such as to which aim, NIRVS are involved

in antiviral immunity. They could act as a warning signal and prime the antiviral immunity for allowing the host to control viral replication before the infection becomes deleterious and harmful for the vector host. Alternatively, NIRVS could also act as a keeper of persistent infection by maintaining the viral replication at a steady and low level, which would diminish the negative impacts on mosquito fitness.

NIRVS formation and potential functions proved the benefits they could provide to the infected cells. Moreover, these endogenized elements have also a different purpose regarding our understanding of virus-host coevolution, as NIRVS represent scar of ancient infections.

6.4 Endogenous viral elements and virus-host coevolution

6.4.1 Paleovirology

RNA viruses are considered as the fastest-evolving biological entity with an evolution rate of 10^{-3} substitutions/site/year (s/s/y) (Hanada, Suzuki, and Gojobori 2004; Duffy, Shackelton, and Holmes 2008; Jenkins et al. 2002; Sanjuán 2012). Therefore describing their recent expansion can be performed in very details. However, it becomes much harder to reconstruct ancient viral history as the inference will be less accurate, especially when extinct viral lineages are involved in the study.

As incoming elements, EVEs are defined as major factors of genetic diversity and represent scars of previous infections in their hosts. Though, the odds that EVEs persist through generations are very small (Johnson n.d.). However, if they provide beneficial features to the host, their frequencies can increase and they can eventually reach fixation. The discovery of EVEs has profoundly improved our knowledge of viral history. So far, viral evolution could only be limitedly inferred by phylogenetic techniques based on extant viruses, but nothing was known about extinct viruses.

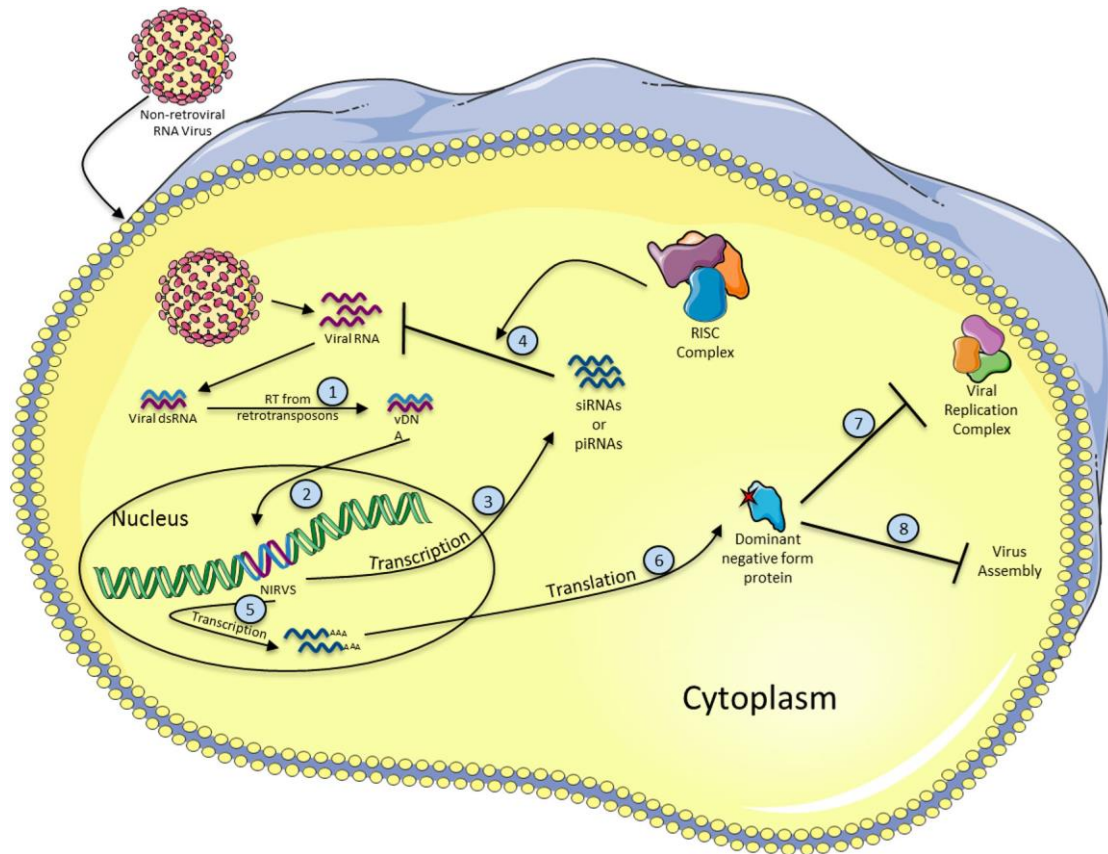

Figure 18: Potential NIRVS production and antiviral functions. From Houé et al. (2019)

Therefore, the characterization of such elements led to the expansion of the paleovirology field and allows us to better understand origins, cross-species transmissions as well as geographical distribution of viruses (Leroy et al. 2009, 2005; Peterson et al. 2004; Taylor, Leach, and Bruenn 2010). The use of EVEs, combined with studies on extant viruses, also reinforced the predictions of emerging diseases.

6.4.2 Estimates of viral origins by dating endogenous viral elements

Because EVE formation occurred after the origin of their related viral families, EVEs can be used as a tool to predict the minimum age of viral families they descended from. Several methods have been described to date EVEs (Fig. 19; (Aiewsakun and Katzourakis 2015)).

EVEs can simply be dated by using a host distribution approach, by assuming that the timescale between (both exogenous and endogenous) viruses is comparable to that of the hosts harboring them (Fig. 19A). This process has for example been performed to decipher the minimum age of begomovirus elements (Lefeuvre et al. 2011). However the accuracy of this technic is limited due to possible cross-species transmission. The age of EVEs can also be dated by ortholog dating approach (Fig. 19B). This technic is more accurate, as it is less likely that two independent integration events occurred in two different host lineages at the same genomic location. Using this method, EVEs are dated by determining the basal diversification of the two (or more) hosts. This has been used to estimate the age of hepadnavirus EVEs in birds (Suh et al. 2013). Furthermore, estimating viral integration can be performed by using the paralog dating approach, which is based on EVE duplication (Fig. 19C). The divergence of the duplicated EVE paralogs is converted into time according to the host neutral rate of evolution. The method has been used to estimate the integration time of rabbit lentiviruses (A. Katzourakis et al. 2007). A particular paralog dating method can also be used to estimate ERV formation, by estimating the divergence of the two LTRs flanking the element and assuming host neutral evolution (Fig. 19D; (Brown, Emes, and Tarlinton 2014; Martins and Villesen 2011)). Moreover, dating EVE can be performed by comparison between current EVEs and an ancestral viral state, assuming that the divergence occurred under the host neutral rate of evolution (Fig. 19E). This technic has been performed using satellite telomeric repeats (TMRs) of herpesviruses (Aswad and Katzourakis 2014). Additionally, another approach to estimate the age of EVE is by assuming their steady co-speciation with their hosts (that has to be previously confirmed by phylogenetic analyses) (Fig. 19F). Therefore, the timescale of viruses can directly be inferred to that of their hosts. For instance, the date of an EVE containing stop codons that was assumed to be a stop-codon-free sequence before endogenization can be estimated (Belyi, Levine, and Skalka 2010b). The

appearance of stop codons has to be considered as the result of neutral mutations. Lastly, EVE formation can also be estimated by adding any kind of information, such as bio-geographical distribution, phylogenetic information and effect of selection pressures (Fig. 19G).

Altogether, these different technics based on EVEs have been used to describe the exclusive ancient origins of viral families. For some viral families, the presence of related EVEs pushed back their origins to several million of years, which was previously wrongly predicted by the use of molecular clock dating techniques (Zhou and Holmes 2007; Gilbert and Feschotte 2010; Gifford et al. 2008; Aris Katzourakis and Gifford 2010).

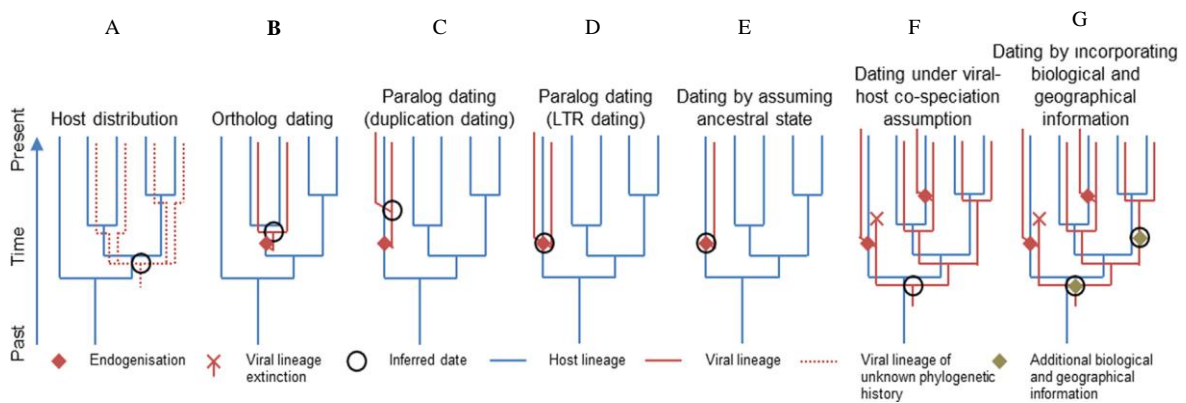

Figure 19: Dating viral evolutionary timescales using endogenous viral elements (EVEs). Origin of viral families can be estimated by comparing divergence of (exogenous and endogenous) viruses and hosts (A), by using the divergence time of hosts that contain orthologous EVEs (B), by assessing the divergence of paralogous EVEs (C and D), by comparing EVEs to an EVE ancestral state (E), by assuming co-speciation between hosts and viruses (F), and by adding several different useful information, such as impact of selective pressure, bio-geographical distribution and phylogenetic information (G). From Aiewsakun and Katzourakis (2015)

Thesis objectives

When infected with an arbovirus, competent mosquitoes are able to transmit the pathogen to humans or other susceptible hosts as many times as they bite, and during their entire life. These persistent infections can be partially explained by the fact that mosquitoes have been present on earth several million years ago and are well adapted to arbovirus infections. These long-term interactions between arboviruses and mosquitoes have limited or even no impact on the vector fitness. Mechanisms involved in the maintenance of persistent infections along with the evolutionary arms race established between arboviruses and mosquitoes have been suggested. Among them, the potential implication of defective interfering (DIs) particles/genomes, viral interference, RNAi pathways (and more generally the antiviral immune response), viral suppressors of RNAi (VSRs) and cellular factors (e.g. genes associated with the inhibition of apoptosis) revealed then that persistent infections are modulated by multifactorial mechanisms that include both viral and host factors. However, although persistently infected, the high variability of vector competence to several arboviruses was widely described between mosquito species. Indeed, while the two species both highly transmit CHIKV, *Ae. albopictus* has a lower dissemination rate for DENV than *Ae. aegypti*. Moreover, this variability has also been observed between and within populations of the same species, suggesting that optimal genotype by genotype by environment (GxGxE) interactions are required for efficient viral transmission (Zouache et al. 2014).

The discovery of ISVs as part of the mosquito virome and their potential effects on the vector competence to arboviruses have shed light on so far unexplored avenues that could help us to better understand the mechanisms involved in the modulation of vector competence to arboviruses in mosquitoes. The wide presence of NIRVS mainly originated from ISVs in *Aedes spp.* mosquitoes testified that interactions occurred for a long time between these two biological entities. However, whether NIRVS are fossil records of ancient virus-host interactions or maintained in *Aedes* mosquitoes for a specific purpose, is still unknown.

Previous studies have shown that NIRVS ended up integrating into piRNA clusters more often than expected by chance in *Ae. albopictus* and *Ae. aegypti*. Their presence in such regions triggered the production of vpiRNAs with sometimes signature of ping-pong amplification, as it has been seen both *in vitro* and *in vivo* studies for NIRVS from ISFs and insect-specific rhabdoviruses (Palatini et al. 2017). NIRVS-derived vpiRNAs were then suggested to have antiviral functions, and since limited complementarity is required for gene silencing, it could be possible that these molecules target arboviral genomes such as CHIKV and DENV. However, experimental evidence is still required and whether it is a common feature of NIRVS or a specific trait shared by only some of them is still under investigation. Moreover, although NIRVS formation was suggested to occur millions of years ago in mosquito genomes and characterize the consequence of virus-host co-evolution (Aiewsakun and Katzourakis 2015; Aris Katzourakis 2017), information describing it is still limited. Whether all or some of them play a biological function and are then under selection pressures, or represent fossil records that maintain genome integrity are still unknown. Nevertheless, there is little doubt that deciphering the characteristics of NIRVS will provide crucial information on virus-host co-evolution and potentially new control strategy against arboviruses.

The formation of NIRVS is still also unclear. Although few studies have so far been able to describe the production of vDNA following infections, nothing is known about the conditions required for viral endogenization. The intensity of infection as well as the interaction time was suggested to be factors promoting the formation of NIRVS, but no direct proofs gave credit to any of these hypotheses. Moreover, since most of the NIRVS found in mosquitoes originated from ISVs, whether arboviruses are capable of producing NIRVS is still an opened question, although there were proved to rapidly-produce vDNA after infection. Additionally, only parts of the viral genome have been found integrated and specific regions

seemed more prone to integrate into host genomes than others. This is for example the case of flaviviruses, for which more NIRVS with high similarities to non-structural protein sequences were found rather than structural protein ones. Better understand why some viral regions are more subject to endogenization than others is also important to characterize NIRVS potential functions. Finally, because NIRVS may not be randomly distributed across the mosquito genome, further identification of the sites of integration is required and could help to discover NIRVS functions. If NIRVS from ISFs or arboviruses are produced, other “hotspots” than piRNA clusters may exist in the mosquito genome that may lead to other functions, such as regulating the expression of adjacent genes, as it has been recently shown for ERVs and NIRVS from bornavirus in humans (Chuong, Elde, and Feschotte 2016).

In this thesis, we therefore aimed to characterize NIRVS in the invasive mosquito *Ae. albopictus*. We specifically focused on the evolution of NIRVS originating from ISFs in natural *Ae. albopictus* populations and their relation to vector competence to CHIKV and DENV. We also provided an ongoing experiment based on *in vitro* models persistently infected with different viruses to further understand the formation of NIRVS in cell line genomes.

Chapter 1: Evolution and potential biological role of NIRVS

1. Introduction

Ae. albopictus, originated from forests of Southeast Asia is vector of several arboviruses such as CHIKV, DENV and ZIKV. In the last three decades, due to the increase of human activities (e.g. increased trades and travels) and its high capacity of adaptation, *Ae. albopictus* has colonized tropical, subtropical and temperate regions and is currently present in every continent except Antarctica. However, *Ae. albopictus* populations displayed different vector competence to arboviruses, which is known to be regulated by complex mosquito genotype by virus genotype by environment factor (GxGxE) interactions (Zouache et al. 2014). Therefore, exploring the migration routes used by the vector to spread would help us in deciphering population genetic variability and virus-host interactions that may explain different susceptibilities to arboviruses.

Among these factors, ISFs have been proved to have potential effects on the vector competence to different arboviruses in mosquitoes. The discovery of NIRVS originated from ISFs in *Aedes* mosquitoes in 2004 has shed light on host elements of viral origin that potentially have antiviral functions through their presence in piRNA clusters. However, the distribution of NIRVS in natural *Ae. albopictus* populations is still unclear, as well as their evolution in the vector genome. NIRVS providing selective benefits to their hosts must be maintained through generations, whereas those that represent fossil records are thought to be lost due to genetic drift. Finally, direct evidence suggesting impacts of ISF-derived NIRVS on vector competence to arboviruses, are still required.

We therefore used several *Ae. albopictus* populations collected in regions where CHIKV and DENV were circulating, to characterize the distribution and evolutionary dynamics of NIRVS by comparison with the genetic variability of 10 microsatellite loci which are considered as neutral evolutionary markers. Specifically, we focused on seven NIRVS from the *Flaviviridae* family (called Flavi-NIRVS) because of its importance to human public

health. These Flavi-NIRVS originated from three ISFs, which are Aedes Flavivirus (AeFV), Kamiti River virus (KRV) and Cell Fusing Agent virus (CFAV). It includes the first and longest NIRVS described so far in 2004 (Crochu et al. 2004; Suzuki et al. 2017) as well as six other NIRVS recently detected (Palatini et al. 2017; Pischedda et al. 2019) in *Ae. albopictus* genome. All of them were described in unique copy in the genome of the Foshan colony recently sequenced (X.-G. Chen et al. 2015), except AlbFlavi41 that was found duplicated. Subsequently, we have deepened the study of two Flavi-NIRVS (AlbFlavi2 and AlbFlavi36) owing to their location in the mosquito genome.

2. Evolution and biological significance of flaviviral elements in the genome of the arboviral vector *Aedes albopictus*

In this chapter, we present an article accepted and published in the journal *Emerging Microbes and Infections* in August 2019.

Evolution and Biological significance of Flaviviral elements in the genome of the arboviral vector *Aedes albopictus*

Vincent Houé^{1,2}, Gaëlle Gabiane,¹ Catherine Dauga³, Marie Suez⁴, Yoann Madec⁵, Laurence Mousson¹, Michele Marconcini⁶, Pei-Shi Yen¹, Xavier de Lamballerie^{7,8}, Mariangela Bonizzoni⁶ and Anna-Bella Failloux^{1*}

¹ Institut Pasteur, Department of Virology, Arboviruses and Insect Vectors, F-75015 Paris, France

² Sorbonne Université, Collège Doctoral, F-75005 Paris, France

³ Institut Pasteur, Center for Bioinformatics, BioStatistics and Integrative Biology (C3BI), F-75015 Paris, France

⁴ Institut de Biologie Paris-Seine, F-75252 Paris, France

⁵ Institut Pasteur, Department of Infection and Epidemiology, Epidemiology of Emerging Diseases, F-75015 Paris, France

⁶ University of Pavia, Department of Biology and Biotechnology, 27110 Pavia, Italy

⁷ Aix Marseille Université, IRD French Institute of Research for Development, EHESP French School of Public Health, EPV UMR_D 190 ‘Emergence des Pathologies Virales’, Marseille, France

⁸ IHU Méditerranée Infection, APHM Public Hospitals of Marseille, Marseille, France

*Correspondence to: A.-B. Failloux (anna-bella.failloux@pasteur.fr; +33-(0)1 40 61 36 17)

Keywords: *Aedes albopictus*; arboviral diseases; genetic structure; vector competence; NIRVS.

Abstract

Since its genome details are publically available, the mosquito *Aedes albopictus* has become the central stage of attention for deciphering multiple biological and evolutionary aspects at the root of its success as an invasive species. Its genome of 1,967 Mb harbors an unusual high number of non-retroviral integrated RNA virus sequences (NIRVS). NIRVS are enriched in piRNA clusters and produce piRNAs, suggesting an antiviral effect.

Here, we investigated the evolutionary history of NIRVS in geographically distant *Ae. albopictus* populations by comparing genetic variation as derived by neutral microsatellite loci and seven selected NIRVS. We found that the evolution of NIRVS was far to be neutral with variations both in their distribution and sequence polymorphism among *Ae. albopictus* populations. The Flaviviral elements AlbFlavi2 and AlbFlavi36 were more deeply investigated in their association with dissemination rates of dengue virus (DENV) and chikungunya virus (CHIKV) in *Ae. albopictus* at both population and individual levels. Our results show a complex association between NIRVS and DENV/CHIKV opening a new avenue for investigating the functional role of NIRVS as antiviral elements shaping vector competence of mosquitoes to arboviruses.

Introduction

In less than four decades, the Asian tiger mosquito *Aedes albopictus* (Skuse, 1894) has become a public health concern owing to its ability to transmit several human pathogenic viruses such as Chikungunya virus (CHIKV), Dengue viruses (DENV) and Zika virus (ZIKV)¹. This vector is responsible of several recent arboviral outbreaks (reviewed by ²) and astonished by the speed at which it has conquered all continents except Antarctica ^{3,4}, thus becoming one of the world's 100-most invasive species according to the Global Invasive Species Database. Originally native to tropical forests of South-East Asia, *Ae. albopictus* was confined for centuries to a few regions in Asia. Starting in the 18th or 19th centuries, *Ae. albopictus* was introduced in the islands of the Indian Ocean by Asian immigrants. From the late 1970s, this species took advantage of the increase in global trade to invade most tropical and sub-tropical regions of the world ⁵. Additionally, the capacity of its eggs to undergo photoperiodic diapause in winter, favored *Ae. albopictus* colonization into temperate regions ⁶. *Aedes albopictus* was first reported in Europe in 1979 ⁷, in North America in 1985 ⁸, in South America in 1986 ⁹ and in Africa in 1990 ¹⁰.

Migratory routes used by *Ae. albopictus* to expand from its Asian cradle can be defined using population genetic approaches ^{11,12,13}. Mosquito populations form groups of interbreeding individuals, which coexist in space and time. These genetic units are interconnected through gene flow. The current worldwide distribution of *Ae. albopictus* is a direct consequence of increasing human activities with rapid irradiation of populations ¹⁴⁻¹⁸. Populations established locally presented a high genetic variability evidencing a mixture of individuals of distinct origins with disparate susceptibilities to arboviruses, which are reflected by different vector competences ¹⁷. Vector competence refers to the ability of a mosquito population to become infected after an infectious blood meal, to support viral replication, dissemination and

transmission to a new host in a subsequent blood-meal ¹⁹. The level of vector competence depends on the tripartite interactions among the mosquito genotype, the virus genotype and environmental factors under GxGxE interactions ²⁰.

In the early 2000s, non-retroviral integrated RNA virus sequences (NIRVS) were discovered in different metazoans, including mosquitoes ^{21,22}. *Aedes* mosquitoes can host NIRVS originated from different viruses related to arboviruses: mainly insect-specific viruses (ISVs) including insect-specific flaviviruses (ISFs) and other viruses belonging to the *Mononegavirales* order (such as rhabdoviruses) ²²⁻²⁵. Additionally, most NIRVS correspond to fragmented viral open-reading frames, are flanked by transposable elements (TEs), enriched in PIWI-interacting RNA (piRNA) clusters and produce piRNAs ²⁹. piRNA clusters are genomic regions composed of fragmented sequences of TEs which are expressed as long primary single-stranded RNAs and processed into fragments of 24-30 nucleotides called piRNAs. In the model organism *Drosophila melanogaster*, piRNAs are primarily produced in germline cells and target TE transcripts based on sequence complementarity to protect from heritable lesions ²⁶⁻²⁹. The landscape of TE fragments within piRNA clusters defines the regulatory properties of *D. melanogaster* strains to TE invasion ³⁰. The analogy between TE fragments and viral sequences in piRNA supports the hypothesis that viral sequences may contribute to mosquito susceptibility to subsequent viral infections. If viral integrations contribute in controlling virus replication, with consequences on vector competence, positive selection should be expected ³¹. On the contrary, if NIRVS stand for fossil records, these sequences should reach fixation and evolve at a neutral rate ^{32,33}.

In this study, we selected 19 *Ae. albopictus* populations that cover the geographical distribution of the species, where CHIKV and DENV were circulating, to study the evolutionary dynamics of seven selected NIRVS ²⁴. The occurrence of NIRVS in populations was compared to processes driving population genetic differentiation observed on neutral loci

(i.e. microsatellites). We showed that (i) based on microsatellite marker polymorphism, populations of *Ae. albopictus* are distributed into two different genetic clusters, one of them divided into four subclusters, without any correlation between genetic and geographical distances, (ii) the distribution of NIRVS in geographic populations and their polymorphism are not related to genetic divergences within and between populations as depicted by microsatellite markers, suggesting that NIRVS are not evolving neutrally, and (iii) all NIRVS studied, except AlbFlavi1 may have influence on vector competence to DENV and CHIKV, at the population level.

Materials and Methods

Ethic Statements

Mice were housed in the Institut Pasteur animal facilities accredited by the French Ministry of Agriculture for performing experiments on live rodents. Work on animals was performed in compliance with French and European regulations on care and protection of laboratory animals (EC Directive 2010/63, French Law 2013-118, February 6th, 2013). All experiments were approved by the Ethics Committee #89 and registered under the reference APAFIS#6573-2016061412077987 v2.

Mosquitoes

To assess genetic variation within and among *Ae. albopictus* populations, 19 samples from different geographic locations were studied (Table 1). These populations ranging from 10 to 30 mosquitoes were selected in the native range of *Ae. albopictus* where arboviral outbreaks and epidemics occurred^{17,34,35}. Only the 13 populations of 19-20 mosquitoes and the Foshan colony used as control were selected to characterize NIRVS polymorphism³⁶.

Mosquitoes were collected in the field as immature stages (larvae, pupae, eggs). Frozen mosquitoes (<13th generation) were used for population genetic and NIRVS analyses. For the pilot experiments for DENV and CHIKV infections, F1 mosquitoes from Tibati population (Cameroon) and F18 mosquitoes from Foshan laboratory strain were used. Larvae obtained after immersion in dechlorinated tap water of field-collected eggs were distributed in pans of 200 individuals. Immature stages were fed every two days with a yeast tablet dissolved in 1 liter of dechlorinated tap water and incubated at $26 \pm 1^\circ\text{C}$. Emerging adults were placed in cages and maintained at $28 \pm 1^\circ\text{C}$ with a light/dark cycle of 12h/12 h at 80% relative humidity and supplied with a 10% sucrose solution. Females were exposed three times a week to anesthetized mice (OF1 mice; Charles River Laboratories, MA, USA) as a source of blood for producing eggs.

Microsatellite genotyping

Genomic DNA was extracted from individual mosquito using the Nucleospin Tissue kit (Macherey-Nagel, Hoerd, France) according to the manufacturer's instructions. Briefly, mosquitoes were individually homogenized in 180 μL lysis buffer supplemented with 25 μL of Proteinase K. To bind total nucleic acids, homogenates were passed through columns. Silica membranes were further desalted and DNA was collected in 100 μL of elution buffer. Quality and quantity of DNA were then assessed using the Nanodrop 2000 Spectrophotometer (Thermo ScientificTM, MA, USA) and a PCR was performed using *histone h3* reference gene (NCBI: XM_019696438.1) as control. Eleven microsatellite loci were amplified using PCR specific primers flanking the repeated region¹⁶. PCR reaction mixtures in a final volume of 15 μL contained 50 ng genomic DNA, 1X PCR buffer, 1.5 mM MgCl_2 , 0.27 mM dNTPs (InvitrogenTM, CA, USA), 1U Taq polymerase (InvitrogenTM), and 10 μM of each primer (one was 5' labeled with a fluorescent dye). PCR cycling conditions consisted in a step at 94°C for

5 min, followed by 29 cycles at 94°C for 30 sec, 58°C for 30 sec, and 72°C for 30 sec with a final step at 72°C for 10 min. Aliquots of PCR products were visualized on 2% agarose gels stained with ethidium bromide under UV light. Each PCR product was then diluted 1:10 in ddH₂O water and 2 µL of this dilution was added to 10 µL of a mixture of deionized formamide and GeneScan-500 ROX size standard (Applied Biosystems, CA, USA). Genotyping was processed in an ABI3730XL sequence analyzer (Applied Biosystems) and data analyzed using GeneScan and Genemapper softwares.

Genetic diversity of populations

For statistical analyses, mosquitoes collected from each sampling site were assumed to represent local populations.

Amounts of heterozygosity at various levels of population structure were explored by using F_{IS} and F_{ST} values. The F_{IS} inbreeding coefficient indicates the level of heterozygosity within each population. The F_{ST} fixation index measures the reduction in heterozygosis due to random genetic drift between populations. The Wright's F -statistics were computed in Genetix v.4.05.2. software³⁷ and tested using 10^4 iterations according to Weir and Cockerham (1984). The number of alleles (N_A), allelic richness (A_R), expected (H_E), observed (H_O) heterozygosis, F_{IS} by locus and F_{ST} by populations were obtained. The significance of F_{IS} and F_{ST} were analyzed using FSTAT v.2.9.3.2³⁸.

Departures from Hardy-Weinberg equilibrium, linkage disequilibrium between loci and molecular variance (AMOVA) overall populations were analyzed with Arlequin v3.5.2.2 to estimate intra- and inter-population variation³⁹. The mean frequency of null alleles (a mutation in microsatellite flanking regions leading to an absence of amplification products) per population was also very low (i.e. 0.06) and ranged from 0.000 to 0.118, meaning that the selected microsatellite loci were successfully amplified and appropriate for population genetic

analysis. Relationships between geographical and genetic F_{ST} distances were tested between populations using Mantel test implemented in GenAlEx v 6.5⁴⁰.

Graphic representation of relatedness among populations

Genetic relationships between populations were estimated by using PHYLIP 3.69, as previously described⁴¹. Cavalli-Sforza & Edwards's (CSE) chord distance for each pair of populations was calculated (GENDIST module). The resulting distance matrix was used to create a phylogram based on Neighbour-Joining (NEIGHBOUR module). Node confidence was inferred via 100 bootstrap replicates (modules SEQ-BOOT, GENDIST, NEIGHBOUR and CONSENSE).

Test of isolation by distance

To test the hypothesis whether the geographical pattern of genetic differentiation is caused by isolation by distance (IBD), we ran Mantel tests for pairwise matrices between geographical distances (kilometers) and genetic differentiation (measured as $F_{ST}/(1-F_{ST})$).

Genetic structure of populations

Genetic population structure was assessed with individual-based Bayesian clustering method implemented in the program STRUCTURE v.2.3.4⁴². The likelihood of each possible number of genetic populations (K), ranging from 1 to 20, was calculated after 10 independent runs for each value of K, using a burn-in of 500 000 replications, 500 000 Markov Chain Monte Carlo steps, assuming an admixture model, with frequencies correlated between populations and without the use of sampling location as a prior. The most likely number of populations (K) was estimated by the ΔK method described by Evanno et al. (2005)⁴³ with Structure

Harvester software (<http://taylor0.biology.ucla.edu/structureHarvester/>). The results were then graphically displayed with DISTRUCT 1.1⁴⁴.

NIRVS in natural populations

Six NIRVS (AlbFlavi1, AlbFlavi2, AlbFlavi4, AlbFlavi10, AlbFlavi36, AlbFlavi41), plus CSA²¹, were studied. They were chosen based on their unique occurrence in different regions of the Foshan genome, except for AlbFlavi41, known to be duplicated. Because of its length²¹, CSA was characterized using two sets of primers (CSA-NS3 and CSA-JJL), and considered in analysis as two separated datasets (Supplementary Table 1). NIRVS were searched on the same mosquitoes as those used for microsatellite genotyping.

PCR primers flanking each NIRVS (Supplementary Table 1) were designed using PRIMER3⁴⁵. PCR reactions were performed in a final volume of 25 μ L using 5 ng of DNA, PCR buffer 1X, 2.9 mM MgCl₂, 0.25 mM dNTP mix, 0.25 μ M of each primer and 1.25 unit of *Taq* DNA polymerase (Invitrogen™). Amplifications were done using *T100™ Thermal Cycler* (Bio-Rad) according to the following cycle conditions: 95°C for 5 min, 35 cycles at 95°C for 15 sec, 59-64°C for 90 sec, 72°C for 90 sec, and a final elongation step at 72°C for 10 min. PCR products were electrophoresed on 1.5% of agarose gels stained with ethidium bromide and visualized under UV light. All negative samples were confirmed with a second-round PCR.

The number of each NIRVS per population (frequency) was represented using Graph Pad Prism version 6 (Graph Pad Software, CA, USA).

NIRVS between populations

NIRVS composition of each population was expressed in terms of relative abundance corresponding to the percentage of each NIRVS relative to the total number of tested mosquitoes. To assess variations of NIRVS abundance between populations, we calculated

Bray Curtis dissimilarities, a metrics, widely used, including data standardization ⁴⁶. A dendrogram was generated by using this dissimilarity matrix and neighbour-joining method, to visualize NIRVS compositional differences across populations ⁴⁶.

Mantel tests between NIRVS and microsatellites

Mantel tests implemented in GenAlEx v 6.5 ⁴⁰, were used to evaluate the statistical significance of the correlation between two or more distance matrices, using permutation tests. The significance of associations between matrixes of Φ^2 distance among populations as derived by microsatellite markers or NIRVS distribution was tested using the Mantel test with 999 permutations.

NIRVS association with vector competence of *Ae. albopictus* at the population level

Vector competence is assessed using several parameters ⁴⁷. The dissemination efficiency (DE) refers to the proportion of mosquitoes able to disseminate the virus beyond the midgut barrier after ingestion of infectious blood meal and active viral replication in midgut epithelial cells. Published data on DEs to DENV and CHIKV were retrieved for mosquito populations with close or identical geographical proximity with the populations analyzed (Supplementary Table 2). DEs were described using median and inter-quartile range (IQR). Logistic linear regression models were used to test the association between the presence of NIRVS and DEs at the *Ae. albopictus* population level. P-values < 0.05 were considered significant.

Sequence polymorphism and evolutionary dynamics of AlbFlavi2 and AlbFlavi36

Sequence polymorphism of AlbFlavi2 and AlbFlavi36

Amplification products for AlbFlavi2 and AlbFlavi36 were purified by using NucleoSpin[®] Gel and PCR Clean-up kit (Macherey-Nagel) according to the manufacturer's

instructions and sequenced by Eurofins Genomics (Cochin hospital platform, Paris, France). If the quality of chromatogram profiles assessed with Geneious® 10.1.3 did not meet the standard required, amplicons were subsequently cloned into pCR™II-TOPO® vector using TOPO® TA Cloning®Kit (Thermo Fisher Scientific) and transformed into One Shot® TOP10 Chemically Competent *E. coli* (Invitrogen™). Sequences were aligned in Geneious® 10.1.3 using MUSCLE algorithm ⁴⁸. p-distance values, representing the proportion of nucleotide sites at which two sequences being compared are different, were calculated after alignments using MEGA 10.0.5.

Phylogeny-based on AlbFlavi2 and AlbFlavi36

DNA sequences from AlbFlavi2 and AlbFlavi36 were aligned with MUSCLE algorithm ⁴⁸. Exogenous virus sequences were used as outgroup to determine the direction of character transformations. Phylogenetic trees were obtained by parsimony analysis implemented in the PAUP* software package (version 4.0), by using gap as 5th state or not (data not shown) and nearest neighbour interchange (NNI) for tree rearrangements ⁴⁹.

Pilot experiment assessing the association between AlbFlavi2/AlbFlavi36 and vector competence of *Ae. albopictus* at the individual level

Logistic linear regression models were used to test association between the presence of AlbFlavi2 and AlbFlavi36 and viral dissemination in single mosquitoes from the Foshan colony and a field-collected African population (Tibati collected in Tibati, Cameroon in 2018). Foshan and Tibati mosquitoes were experimentally infected with DENV (DENV-2, Accession number: MK268692 ⁵⁰) and CHIKV (06.21, Accession number: AM258992 ⁵¹) provided in blood meals as described in Amraoui et al. 2019 ⁵². All surviving mosquitoes were examined individually at 14 days post-infection to define (i) the infectious status;

presence of infectious particles in heads was estimated by focus fluorescent assay on C6/36 *Ae. albopictus* cells⁵², and (ii) the presence of AlbFlavi2 and/or AlbFlavi36 by PCR on DNA [ex](#)tracted from bodies and thorax. Statistical analyses were conducted using the Stata software (StataCorp LP, Texas, and USA). P-values < 0.05 were considered significant.

Results

Characterization of populations using microsatellite data

A total of 363 individuals (Table 1) were genotyped at 11 microsatellite markers. Ten of the 11 microsatellite loci, by showing a frequency lower than 0.95 for the most common allele, were considered polymorphic and as such, were included in the analysis. Only the A17 locus was monomorphic and then excluded from the analyses. No significant linkage disequilibrium between any pairs of loci was observed indicating that the 10 loci were statistically independent from each other. Each locus was tested for within-population deviations from HWE implementing Bonferroni correction for multiple testing: 20 deviations out of 190 combinations were found, but did not cluster at any population or locus.

The loci displayed a mean PIC of 0.59 suggesting that they were sufficiently informative for assessing the degree of variability and structuring of mosquito populations (Table 2). The number of alleles, averaged over all loci, ranged from 4 to 19, with a mean value of 10.9 per locus, and a mean allelic richness at 2.44 (Table 2). Eight of the 10 loci presented a significant difference between observed and expected heterozygosity, with a mean F_{IS} of 0.17 (p-value < 0.001; Table 2), supporting an excess of homozygotes in *Ae. albopictus* populations.

Population diversity

The overall mean number of alleles per population was 3.7 varying between 2.0 and 5.0. Private alleles were rarely found, their mean frequency per population ranged from 0.00 to 0.079 (Table 3). Mean F_{IS} value per population was -0.09, with values ranging from -0.0285 to 0.338 (Table 3). Estimation of the molecular variance within and among populations (AMOVA) revealed that most of the variation (89.6%) was detected within individuals whereas only 10.4% occurred among populations.

Population genetic structure

The overall differentiation across all 19 populations was high ($F_{ST} = 0.239$) with F_{ST} being highly significant (p-value < 0.001), suggesting a significant genetic structure. To identify genetic clusters among tested individuals, we implemented 25 independent simulations in the software Structure according to the method of Evanno; the uppermost level of structuring in the model was observed at $K = 2$ ($\Delta K = 2293.4$; Supplementary Fig. 1A). The best assignment of individuals made by Structure led to two clusters: (i) cluster 1, which includes populations from Brazil (i.e. PMNI and Manaus), Northern Africa (i.e. Rabat) and a population from Albania, and (ii) cluster 2, which includes the remaining populations (Fig. 1 and Supplementary Fig 1B). Although Structure identified only two clusters, their genetic differentiation was significantly high ($F_{ST} = 0.12$, p-value ≤ 0.001). Additionally, these two genetic clusters were found to deviate significantly (p-value ≤ 0.01) from Hardy-Weinberg proportions, with F_{IS} values of 0.23 and 0.36, respectively after implementing 10^4 permutations on allele frequencies in the software GENETIX. This result suggested a Wahlund effect which indicated a genetic substructure. As a consequence, we re-analyzed the two clusters separately and detected substructures in Cluster 2 (Fig. 1 and Supplementary Fig. 1C). Sub-structuring of Cluster 2 emphasized differentiation among populations from South

America (Jurujuba and Rio), Europe (i.e. all French and Italian populations), Africa (Bertoua and Mfilou) and Asia. On the contrary, populations from Florida (Vero Beach), Middle East (Sarba), La Reunion Island (Saint Denis) and Gabon (Franceville) appeared genetically mixed suggesting that these sites may represent cross-roads in *Ae. albopictus* colonization out of Asia. (Fig. 1).

Spatial and genetic data

When considering the genetic differentiation according to geographical distances using Mantel test, only 21% of the genetic variability was explained by the geographical distance (p-value = 0.03).

NIRVS analysis

We further chose to study NIRVS distribution in 13 *Ae. albopictus* populations selected previously for assessing genetic diversity based on epidemiological data of arboviral outbreaks and *Ae. albopictus* widespread out of its native range^{17,34,35}; we analyzed 10 females and 10 males per population (Table 1). NIRVS distribution was not homogenous across populations (Fig. 2, Supplementary Fig. 2). AlbFlavi1 (Fig. 2A) and CSA-JJL (Fig. 2H) were the most widespread NIRVS, being detected in 85 to 100% of tested mosquitoes, respectively. On the opposite, AlbFlavi10 was the rarest NIRVS, being found in 17% of the tested mosquitoes. Despite displaying the highest presence of AlbFlavi2 and AlbFlavi4 (present in most populations), Brazilian populations showed the lowest number of NIRVS, with the absence of AlbFlavi36 and AlbFlavi10 and the lower frequency of AlbFlavi41 compared to the other *Ae. albopictus* populations (Fig. 2).

Interestingly, when targeting the CSA locus, no amplification was obtained for Brazilian mosquitoes using the NS3-CSA primer set (Supplementary Table 1; Fig. 2G), which was not

consistent with the results obtained with the JIL-CSA primer set that amplified the same NIRVS but targeting a different region (Fig. 2H). This suggests then that recombination events occurred at this genomic position for Manaus, Rio and PMNI mosquitoes.

Comparison between microsatellite data and NIRVS abundance profiles

To define whether the NIRVS evolve under selective pressures or randomly, we compared (i) the relatedness between populations based on microsatellite polymorphism (Fig. 3A) with (ii) the similarity between populations based on NIRVS abundance profiles (Fig. 3B). At the population level, the Neighbour-Joining clustering analyses applied to genetic frequencies (Fig. 1, Fig. 3A, Supplementary Fig. 1B) mainly revealed two clusters of populations: one with Tirana, Rabat, Manaus and PMNI populations, and the second with the remaining populations (i.e. Binh Duong, Oahu, Vero Beach, Rio, Franceville, Alessandria, Ulcinj and Mfilou). Regarding NIRVS contents, two major clusters distantly related from each other were also obtained (Fig. 3B), one including only Brazilian populations (i.e. Manaus, PMNI and Rio) sharing a low abundance of NIRVS, and the other including geographically distant populations. Therefore, populations from Vero Beach and Rio shared closely related genetic relationships and harboured clearly different abundance profiles of NIRVS (Fig. 3A-B). Conversely, genetic distinct populations from Vero Beach, Rabat and Alessandria shared the same contents of NIRVS. In short, closely related populations can have different NIRVS contents and geographic and/or genetic distant populations can contain similar NIRVS abundance profiles. Thus, we observed significantl different relatedness between populations according to the marker used, that may indicate that random genetic drift was not the main force shaping this NIRVS distribution. In addition, no correlation was identified between the two matrices ($R^2 = 0.0006$), showing that NIRVS composition of populations was not related to the genetic structure caused by random genetic drift (Supplementary Fig. 2).

Relationships between NIRVS landscape and vector competence (from published data)

Our results showed that NIRVS were not neutrally distributed across populations supporting the hypothesis of a biological function of NIRVS, such as antiviral functions, as it has been previously suggested. To analyze whether NIRVS contribute to the control of arboviral replication, we used logistic regression models to evaluate the potential association between NIRVS distribution frequencies among populations and dissemination efficiencies (DEs) of DENV and CHIKV in corresponding or geographically close populations selected from the literature (Supplementary Table 2). On this basis, we classified our tested populations depending on their frequencies of each NIRVS using the median. Several associations between NIRVS and DENV DEs were found. Whereas high AlbFlavi2 and CSA-JJL frequencies were significantly associated to high DEs, high AlbFlavi10, AlbFlavi36, AlbFlavi41 and CSA-NS3 frequencies were however correlated to low DENV DEs (Table 4). Opposite associations to CHIKV DEs were also observed but with fewer NIRVS. Indeed, high frequencies of AlbFlavi4 were associated with high CHIKV DEs while high distribution of AlbFlavi36 and CSA-NS3 among populations was correlated to low CHIKV DEs. Together, these results indicated that the presence of NIRVS was associated with changes in DEs of arboviruses in *Ae. albopictus* at the population level.

Focus on AlbFlavi2 and AlbFlavi36

Besides its association to high DENV DEs, we further focused on AlbFlavi2 located in a piRNA cluster and presenting a large geographical distribution encompassing all continents. Moreover, AlbFlavi36 located in an intergenic region was not found in populations from South America and presented an opposite pattern of association to DENV DEs; it was used for comparison to AlbFlavi2. Therefore, sequence polymorphism, evolution and potential

association to vector competence to arboviruses were assessed in *Ae. albopictus* at the individual level.

Sequence polymorphism and evolution of AlbFlavi2 and AlbFlavi36

AlbFlavi2 and AlbFlavi36 of individual mosquitoes were successfully amplified in 10 out of the 13 *Ae. albopictus* populations studied (Fig. 2). Sequences of AlbFlavi2 and AlbFlavi36 amplified fragments were aligned with the closely related exogenous viral sequences: the Kamiti River virus (KRV) for AlbFlavi2 and the Aedes Flavivirus (AeFV) for AlbFlavi36.

The p-distance calculated between AlbFlavi2 sequences revealed a moderate diversity, with values ranging from 0% to 3.9% (data not shown). All AlbFlavi2 sequences underwent deletion events that were sometimes shared by several individuals from different populations or observed in a specific *Ae. albopictus* population (Fig. 4; Supplementary Fig. 3A).

The p-distance values calculated between AlbFlavi36 sequences were low and varied only from 0% to 0.9% (data not shown). Therefore, AlbFlavi36 sequences mapping to an intergenic region ²⁴ appeared more similar between individuals than AlbFlavi2 sequences (which are integrated into piRNA cluster 27 ⁵³).

We further performed phylogenetic analysis to describe the evolutionary history of AlbFlavi2 and AlbFlavi36 (Fig. 4; Supplementary Fig. 4). As expected, AlbFlavi2 displayed higher divergence than AlbFlavi36. The resulted trees based on AlbFlavi2 supported four major clusters sharing sequences with the same deletion events (Fig. 4). One of them, defined by a 11 bp deletion was subdivided into two subclusters of sequences sharing respectively a 248 bp and a 46 bp deletion. Overall, these clusters did not show any strict relationship with geographical origin of populations.

AlbFlavi2 from Brazilian populations (PMNI, Manaus and Rio) appeared clearly polyphyletic. Three clusters represented only sequences from Brazil: an older cluster of

sequences sharing a 405 bp insertion and two other clusters of sequences sharing respectively a 46 bp and a 6-65 bp deletions. Only AlbFlavi2 from Rabat population formed a monophyletic group, a unique cluster of sequences characterized by a 248 bp deletion.

One cluster contained most of the sequences from Tirana (Albania), Vero Beach (USA), Alessandria (Italy) and Binh Duong (Vietnam). However, some sequences from Binh Duong, Vero Beach and Alessandria populations, were also isolated or found in other clusters. Moreover, half of the AlbFlavi2 sequences from Foshan formed a unique cluster whereas the other half shared the heterogeneous cluster of sequences described above.

The polymorphism of AlbFlavi36 was low in *Ae. albopictus* populations and all the sequences showed close relationships with each other, without any significant bootstrap values (Supplementary Fig.4). However, sequences from African mosquitoes (Congo, Gabon and Morocco) in branching deeply in the tree may be more ancient than sequences of Asian (Binh Duong, Foshan) and European mosquitoes.

Collectively, phylogenetic studies revealed different histories of NIRVS in mosquito populations and, a particularly complex history of Albflavi2 evolving by both mutation and deletion events.

Association between AlbFlavi2/AlbFlavi36 and vector competence in Ae. albopictus at the individual level

To further investigate the biological role of AlbFlavi2 and AlbFlavi36, we extended our analyses of association between the presence of these two NIRVS and viral dissemination from a population level to an individual level. To do so, mosquitoes of the Foshan colony strain and the field-collected Tibati population (Cameroon) were infected with DENV-2 and CHIKV. At 14 days post-infection, mosquito dissemination status and the presence of both AlbFlavi2 and AlbFlavi36 were determined for 313 mosquitoes (Fig. 5). When comparing

DENV dissemination, Foshan better disseminated than Tibati (respectively 89.8% and 42.2%; p -value $< 10^{-4}$; data not shown). However, the presence of AlbFlavi2 or AlbFlavi36 in mosquitoes from Foshan or Tibati was not significantly associated with DENV dissemination (p -values > 0.209 ; Fig. 5A-D). Moreover, the same results were obtained regarding the association between AlbFlavi2/AlbFlavi36 presence and CHIKV dissemination (p -values > 0.3 ; Fig. 5A-D). In all, using both laboratory colony and field-collected mosquitoes, no association was found between any of the two NIRVS (AlbFlavi2 and AlbFlavi36) and DENV/CHIKV dissemination.

Discussion

The presence of sequences with similarities to Flaviviruses in the genome of *Aedes* spp. mosquitoes and their enrichment in piRNA clusters support the hypothesis that viral integrations, at least some, are not simply viral fossils, but could have a biological role^{24,25,54}. Here we demonstrated that the NIRVS studied are not neutrally distributed among *Ae. albopictus* populations and all of them (except AlbFlavi1) were significantly associated with vector competence to DENV and CHIKV.

NIRVS are not neutral markers

NIRVS are endogenous viral sequences located in protein-coding gene exons, intergenic regions, and PIWI-interacting RNA (piRNA) clusters⁵⁵. Contrary to the other categories, piRNA genes are evolving rapidly under positive selection to generate a high diversity of piRNAs⁵⁶⁻⁶³. Approximately 30 sequences of flaviviral ORFs (primarily NS1 and NS5) were detected in the Foshan colony²⁴ including the early-detected Flavivirus-like sequences^{21,64}. It has been suggested that the variable number and frequency of NIRVS across *Ae. albopictus*

populations contribute to small variations of genome size among mosquitoes ³⁶. Our study targeted seven NIRVS (AlbFlavi1, AlbFlavi2, AlbFlavi4, AlbFlavi10, AlbFlavi36, AlbFlavi41, CSA), for which their evolution under selection pressures or simply by genetic drift remained unknown.

Contrary to NIRVS deriving from flaviviruses in *Ae. aegypti* (unpublished data), the presence of the tested NIRVS was highly variable among worldwide populations, with the lowest number being detected in mosquitoes from Brazil. This suggests that these NIRVS have not reached fixation in any of the *Ae. albopictus* populations tested (with potential exception for AlbFlavi1 and a fragment of CSA). Interestingly, Brazilian populations (Manaus, Rio, and PMNI) displayed the lowest number of NIRVS studied with a total absence of AlbFlavi10, AlbFlavi36 and CSA-NS3. Considering the ancient origin of NIRVS, estimated between 6.5 thousand to 2.5 million years ago ⁶⁵, we hypothesized that they might have been less exposed to ISFs in the past, leading to fewer NIRVS in their genomes or that populations may have acquired NIRVS in the past which have been lost over time.

We showed that the microsatellite polymorphism of populations did not match with the NIRVS abundance profiles. Therefore, because microsatellites are sequences that neutrally evolve in the genome, we speculate that the evolution of NIRVS is far from neutral and NIRVS could provide benefits to the host. NIRVS may have been produced for specific purposes in the host rather than being the consequences of random endogenization of exogenous viral fragments.

The focus on NIRVS from piRNA cluster (AlbFlavi2) and intergenic region (AlbFlavi36) revealed different sequence polymorphism and evolutionary histories despite their relatively wide distribution among *Ae. albopictus* populations. Whereas AlbFlavi36 appeared monophyletic with highly conserved sequences among populations, the phylogenetic analyses showed a particularly complex history for Albflavi2 evolving by both mutation and deletion

events. We postulate that owing to its high variability, AlbFlavi2 may act similarly to TE fragments and piRNA genes, and evolve according to exposures to related exogenous virus burden.

Association between NIRVS and vector competence to arboviruses

Similar to some endogenous retroviruses (ERVs) that have an effect on viruses from different subfamilies and genera ⁶⁶, we questioned whether NIRVS deriving from ISF sequences affect the dissemination of different arboviruses and contribute to the regulation of vector competence of *Ae. albopictus* mosquitoes. Because NIRVS located in piRNA clusters, such as AlbFlavi2, produce piRNAs, are differentially distributed among populations and appeared older integrations than NIRVS located in codons ⁶⁵, they were proposed to function as novel mosquito antiviral immune factors. However, contradictory results were obtained using both population- and individual-level analysis.

At the population level, many NIRVS were present in *Ae. albopictus* populations. The frequency of some of them appears correlated (positively or negatively) to DENV dissemination. Whereas some NIRVS were associated to high viral dissemination (i.e. AlbFlavi2 and CSA-JJL), others were significantly related to low viral dissemination (AlbFlavi10, AlbFlavi36, AlbFlavi41 and CSA-NS3), suggesting different functions of NIRVS deriving from ISFs. Moreover, fewer NIRVS were positively (i.e. AlbFlavi4) and negatively (i.e. AlbFlavi36 and CSA-NS3) correlated to CHIKV dissemination. These results are consistent with the contradictory results obtained in studies assessing the impact of exogenous ISFs on arbovirus fitness in mosquitoes. Indeed, whereas some ISFs have shown to repress arboviral replication ⁶⁷, others have been proved to facilitate infection ⁶⁸. Further experiments should be performed to confirm these results, as only 20 mosquitoes per population were tested for NIRVS distribution.

At the level of individuals, our pilot experiment based on mosquitoes from both laboratory colony and field did not show any significant association between dissemination of DENV and CHIKV, and NIRVS, AlbFlavi2 or AlbFlavi36. While this does not seem surprising for the alphavirus CHIKV considering that NIRVS examined are homologous to flavivirus sequences, it is still questionable for DENV. Since it appears that they do not evolve neutrally and were preserved from purifying selection, NIRVS such as CSA has demonstrated to produce a transcript of 4671 nt long ^{21,69}; its functional role should be investigated. Lastly, other components should be considered such as the virome ⁷⁰ in addition to the anatomical barriers in the mosquito such as the salivary glands for viral transmission ¹⁹.

To conclude, our results clearly show that NIRVS in *Ae. albopictus* follow processes different from that of neutral genes such as microsatellites and most NIRVS are far from reaching fixation. Flaviviral integrations are differentially distributed among *Ae. albopictus* populations and are here suggested to be associated with the vector competence to arboviruses by mechanisms that remain to be elucidated. Finally, this study opens the way to new perspectives on evolution and biological functions of NIRVS, in part on vector competence.

References

- 1 Paupy, C., Delatte, H., Bagny, L., Corbel, V. & Fontenille, D. Aedes albopictus, an arbovirus vector: from the darkness to the light. *Microbes and infection / Institut Pasteur* **11**, 1177-1185, doi:10.1016/j.micinf.2009.05.005 (2009).
- 2 Bonizzoni, M., Gasperi, G., Chen, X. & James, A. A. The invasive mosquito species Aedes albopictus: current knowledge and future perspectives. *Trends Parasitol* **29**, 460-468, doi:10.1016/j.pt.2013.07.003 (2013).
- 3 Caminade, C. *et al.* Suitability of European climate for the Asian tiger mosquito Aedes albopictus: recent trends and future scenarios. *J R Soc Interface* **9**, 2708-2717, doi:10.1098/rsif.2012.0138 (2012).
- 4 Benedict, M. Q., Levine, R. S., Hawley, W. A. & Lounibos, L. P. Spread of the tiger: global risk of invasion by the mosquito Aedes albopictus. *Vector Borne Zoonotic Dis* **7**, 76-85, doi:10.1089/vbz.2006.0562 (2007).
- 5 Lounibos, L. P. Invasions by insect vectors of human disease. *Annu Rev Entomol* **47**, 233-266, doi:10.1146/annurev.ento.47.091201.145206 (2002).
- 6 Hawley, W. A. The biology of Aedes albopictus. *J Am Mosq Control Assoc Suppl* **1**, 1-39 (1988).
- 7 Adhami, J. & Reiter, P. Introduction and establishment of Aedes (Stegomyia) albopictus skuse (Diptera: Culicidae) in Albania. *J Am Mosq Control Assoc* **14**, 340-343 (1998).
- 8 Sprenger, D. & Wuithiranyagool, T. The discovery and distribution of Aedes albopictus in Harris County, Texas. *J Am Mosq Control Assoc* **2**, 217-219 (1986).
- 9 Consoli RAGB, O. R. Principais mosquitos de importância sanitária no Brasil. Rio de Janeiro. *Editores FIOCRUZ*, p. 228. (1994).
- 10 Cornel, A. J. & Hunt, R. H. Aedes albopictus in Africa? First records of live specimens in imported tires in Cape Town. *J Am Mosq Control Assoc* **7**, 107-108 (1991).
- 11 Goubert, C., Minard, G., Vieira, C. & Boulesteix, M. Population genetics of the Asian tiger mosquito Aedes albopictus, an invasive vector of human diseases. *Heredity (Edinb)* **117**, 125-134, doi:10.1038/hdy.2016.35 (2016).
- 12 Jackson, H. *et al.* Ancestral origins and invasion pathways in a globally invasive bird correlate with climate and influences from bird trade. *Mol Ecol* **24**, 4269-4285, doi:10.1111/mec.13307 (2015).
- 13 Powell, J. R. & Tabachnick, W. J. History of domestication and spread of Aedes aegypti--a review. *Mem Inst Oswaldo Cruz* **108 Suppl 1**, 11-17, doi:10.1590/0074-0276130395 (2013).
- 14 Maynard, A. J. *et al.* Tiger on the prowl: Invasion history and spatio-temporal genetic structure of the Asian tiger mosquito Aedes albopictus (Skuse 1894) in the Indo-Pacific. *PLoS Negl Trop Dis* **11**, e0005546, doi:10.1371/journal.pntd.0005546 (2017).
- 15 Kotsakiozi, P. *et al.* Population genomics of the Asian tiger mosquito, Aedes albopictus: insights into the recent worldwide invasion. *Ecol Evol* **7**, 10143-10157, doi:10.1002/ece3.3514 (2017).
- 16 Manni, M. *et al.* Molecular markers for analyses of intraspecific genetic diversity in the Asian Tiger mosquito, Aedes albopictus. *Parasit Vectors* **8**, 188, doi:10.1186/s13071-015-0794-5 (2015).
- 17 Manni, M. *et al.* Genetic evidence for a worldwide chaotic dispersion pattern of the arbovirus vector, Aedes albopictus. *PLoS Negl Trop Dis* **11**, e0005332, doi:10.1371/journal.pntd.0005332 (2017).
- 18 Mousson, L. *et al.* Phylogeography of Aedes (Stegomyia) aegypti (L.) and Aedes (Stegomyia) albopictus (Skuse) (Diptera: Culicidae) based on mitochondrial DNA variations. *Genetical research* **86**, 1-11, doi:10.1017/S0016672305007627 (2005).
- 19 Kramer, L. D. & Ebel, G. D. Dynamics of flavivirus infection in mosquitoes. *Advances in virus research* **60**, 187-232 (2003).
- 20 Zouache, K. *et al.* Three-way interactions between mosquito population, viral strain and temperature underlying chikungunya virus transmission potential. *Proceedings. Biological sciences / The Royal Society* **281**, doi:10.1098/rspb.2014.1078 (2014).

- 21 Crochu, S. *et al.* Sequences of flavivirus-related RNA viruses persist in DNA form integrated in the genome of *Aedes* spp. mosquitoes. *J Gen Virol* **85**, 1971-1980, doi:10.1099/vir.0.79850-0 (2004).
- 22 Katzourakis, A. & Gifford, R. J. Endogenous viral elements in animal genomes. *PLoS Genet* **6**, e1001191, doi:10.1371/journal.pgen.1001191 (2010).
- 23 Fort, P. *et al.* Fossil rhabdoviral sequences integrated into arthropod genomes: ontogeny, evolution, and potential functionality. *Molecular biology and evolution* **29**, 381-390, doi:10.1093/molbev/msr226 (2012).
- 24 Palatini, U. *et al.* Comparative genomics shows that viral integrations are abundant and express piRNAs in the arboviral vectors *Aedes aegypti* and *Aedes albopictus*. *BMC Genomics* **18**, 512, doi:10.1186/s12864-017-3903-3 (2017).
- 25 Whitfield, Z. J. *et al.* The Diversity, Structure, and Function of Heritable Adaptive Immunity Sequences in the *Aedes aegypti* Genome. *Curr Biol* **27**, 3511-3519 e3517, doi:10.1016/j.cub.2017.09.067 (2017).
- 26 Brennecke, J. *et al.* Discrete small RNA-generating loci as master regulators of transposon activity in *Drosophila*. *Cell* **128**, 1089-1103, doi:10.1016/j.cell.2007.01.043 (2007).
- 27 Pelisson, A., Sarot, E., Payen-Groschene, G. & Bucheton, A. A novel repeat-associated small interfering RNA-mediated silencing pathway downregulates complementary sense gypsy transcripts in somatic cells of the *Drosophila* ovary. *J Virol* **81**, 1951-1960, doi:10.1128/JVI.01980-06 (2007).
- 28 Saito, K. *et al.* Specific association of Piwi with rasiRNAs derived from retrotransposon and heterochromatic regions in the *Drosophila* genome. *Genes Dev* **20**, 2214-2222, doi:10.1101/gad.1454806 (2006).
- 29 Vagin, V. V. *et al.* A distinct small RNA pathway silences selfish genetic elements in the germline. *Science (New York, N.Y.)* **313**, 320-324, doi:10.1126/science.1129333 (2006).
- 30 Zanni, V. *et al.* Distribution, evolution, and diversity of retrotransposons at the flamenco locus reflect the regulatory properties of piRNA clusters. *Proc Natl Acad Sci U S A* **110**, 19842-19847, doi:10.1073/pnas.1313677110 (2013).
- 31 Frank, J. A. & Feschotte, C. Co-option of endogenous viral sequences for host cell function. *Curr Opin Virol* **25**, 81-89, doi:10.1016/j.coviro.2017.07.021 (2017).
- 32 Aswad, A. & Katzourakis, A. Paleovirology and virally derived immunity. *Trends in ecology & evolution* **27**, 627-636, doi:10.1016/j.tree.2012.07.007 (2012).
- 33 Katzourakis, A. Paleovirology: inferring viral evolution from host genome sequence data. *Philos Trans R Soc Lond B Biol Sci* **368**, 20120493, doi:10.1098/rstb.2012.0493 (2013).
- 34 Musso, D., Rodriguez-Morales, A. J., Levi, J. E., Cao-Lormeau, V. M. & Gubler, D. J. Unexpected outbreaks of arbovirus infections: lessons learned from the Pacific and tropical America. *Lancet Infect Dis* **18**, e355-e361, doi:10.1016/S1473-3099(18)30269-X (2018).
- 35 Fritzell, C. *et al.* Current challenges and implications for dengue, chikungunya and Zika seroprevalence studies worldwide: A scoping review. *PLoS Negl Trop Dis* **12**, e0006533, doi:10.1371/journal.pntd.0006533 (2018).
- 36 Chen, X. G. *et al.* Genome sequence of the Asian Tiger mosquito, *Aedes albopictus*, reveals insights into its biology, genetics, and evolution. *Proc Natl Acad Sci U S A* **112**, E5907-5915, doi:10.1073/pnas.1516410112 (2015).
- 37 GENETIX 4.05 Logiciel Sous Windows TM Pour la Génétique des Populations. (1996-2004).
- 38 FSTAT, a program to estimate and test gene diversities and fixation indices (version 2.9.3). (2001).
- 39 Excoffier, L. & Lischer, H. E. Arlequin suite ver 3.5: a new series of programs to perform population genetics analyses under Linux and Windows. *Mol Ecol Resour* **10**, 564-567, doi:10.1111/j.1755-0998.2010.02847.x (2010).
- 40 Peakall, R. & Smouse, P. E. GenAlEx 6.5: genetic analysis in Excel. Population genetic software for teaching and research--an update. *Bioinformatics* **28**, 2537-2539, doi:10.1093/bioinformatics/bts460 (2012).
- 41 Vazeille, M. *et al.* Importance of mosquito "quasispecies" in selecting an epidemic arthropod-borne virus. *Sci Rep* **6**, 29564, doi:10.1038/srep29564 (2016).

- 42 Pritchard, J. K., Stephens, M. & Donnelly, P. Inference of population structure using
multilocus genotype data. *Genetics* **155**, 945-959 (2000).
- 43 Evanno, G., Regnaut, S. & Goudet, J. Detecting the number of clusters of individuals using
the software STRUCTURE: a simulation study. *Mol Ecol* **14**, 2611-2620, doi:10.1111/j.1365-
294X.2005.02553.x (2005).
- 44 ROSENBERG, N. DISTRUCT: a program for the graphical display of population structure.
Molecular Ecology Notes **4**, 137-138, doi:doi: 10.1046/j.1471-8286.2003.00566.x (2004).
- 45 Rozen, S. & Skaletsky, H. Primer3 on the WWW for general users and for biologist
programmers. *Methods Mol Biol* **132**, 365-386 (2000).
- 46 Ricotta, C. & Podani, J. On some properties of the Bray-Curtis dissimilarity and their
ecological meaning. *Ecological Complexity* **31**, 201-205. (2017).
- 47 Vega-Rua, A., Zouache, K., Girod, R., Failloux, A. B. & Lourenco-de-Oliveira, R. High level
of vector competence of *Aedes aegypti* and *Aedes albopictus* from ten American countries as a
crucial factor in the spread of Chikungunya virus. *J Virol* **88**, 6294-6306,
doi:10.1128/JVI.00370-14 (2014).
- 48 Edgar, R. C. MUSCLE: a multiple sequence alignment method with reduced time and space
complexity. *BMC Bioinformatics* **5**, 113, doi:10.1186/1471-2105-5-113 (2004).
- 49 PAUP*. Phylogenetic analysis using parsimony (*and other methods). Version 4. (Sunderland
(MA), 1998).
- 50 Vazeille-Falcoz, M., Mousson, L., Rodhain, F., Chungue, E. & Failloux, A. B. Variation in
oral susceptibility to dengue type 2 virus of populations of *Aedes aegypti* from the islands of
Tahiti and Moorea, French Polynesia. *The American journal of tropical medicine and hygiene*
60, 292-299 (1999).
- 51 Schuffenecker, I. *et al.* Genome microevolution of chikungunya viruses causing the Indian
Ocean outbreak. *PLoS Med* **3**, e263, doi:10.1371/journal.pmed.0030263 (2006).
- 52 Amraoui, F. *et al.* Potential of *Aedes albopictus* to cause the emergence of arboviruses in
Morocco. *PLoS Negl Trop Dis* **13**, e0006997, doi:10.1371/journal.pntd.0006997 (2019).
- 53 Liu, P. *et al.* Developmental piRNA profiles of the invasive vector mosquito *Aedes*
albopictus. *Parasit Vectors* **9**, 524, doi:10.1186/s13071-016-1815-8 (2016).
- 54 Olson, K. E. & Bonizzoni, M. Nonretroviral integrated RNA viruses in arthropod vectors: an
occasional event or something more? *Curr Opin Insect Sci* **22**, 45-53,
doi:10.1016/j.cois.2017.05.010 (2017).
- 55 Houe, V., Bonizzoni, M. & Failloux, A. B. Endogenous non-retroviral elements in genomes of
Aedes mosquitoes and vector competence. *Emerg Microbes Infect* **8**, 542-555,
doi:10.1080/22221751.2019.1599302 (2019).
- 56 Lee, Y. C. & Langley, C. H. Long-term and short-term evolutionary impacts of transposable
elements on *Drosophila*. *Genetics* **192**, 1411-1432, doi:10.1534/genetics.112.145714 (2012).
- 57 Vermaak, D., Henikoff, S. & Malik, H. S. Positive selection drives the evolution of rhino, a
member of the heterochromatin protein 1 family in *Drosophila*. *PLoS Genet* **1**, 96-108,
doi:10.1371/journal.pgen.0010009 (2005).
- 58 Lewis, S. H. *et al.* Pan-arthropod analysis reveals somatic piRNAs as an ancestral defence
against transposable elements. *Nat Ecol Evol* **2**, 174-181, doi:10.1038/s41559-017-0403-4
(2018).
- 59 Heger, A. & Ponting, C. P. Evolutionary rate analyses of orthologs and paralogs from 12
Drosophila genomes. *Genome Res* **17**, 1837-1849, doi:10.1101/gr.6249707 (2007).
- 60 Obbard, D. J., Gordon, K. H., Buck, A. H. & Jiggins, F. M. The evolution of RNAi as a
defence against viruses and transposable elements. *Philos Trans R Soc Lond B Biol Sci* **364**,
99-115, doi:10.1098/rstb.2008.0168 (2009).
- 61 Kolaczkowski, B., Hupalo, D. N. & Kern, A. D. Recurrent adaptation in RNA interference
genes across the *Drosophila* phylogeny. *Molecular biology and evolution* **28**, 1033-1042,
doi:10.1093/molbev/msq284 (2011).
- 62 Yi, M. *et al.* Rapid evolution of piRNA pathway in the teleost fish: implication for an
adaptation to transposon diversity. *Genome Biol Evol* **6**, 1393-1407, doi:10.1093/gbe/evu105
(2014).

- 63 Simkin, A., Wong, A., Poh, Y. P., Theurkauf, W. E. & Jensen, J. D. Recurrent and recent selective sweeps in the piRNA pathway. *Evolution* **67**, 1081-1090, doi:10.1111/evo.12011 (2013).
- 64 Roiz, D., Vazquez, A., Seco, M. P., Tenorio, A. & Rizzoli, A. Detection of novel insect flavivirus sequences integrated in *Aedes albopictus* (Diptera: Culicidae) in Northern Italy. *Virology* **6**, 93, doi:10.1186/1743-422X-6-93 (2009).
- 65 Pischedda, E. *et al.* Insights Into an Unexplored Component of the Mosquito Repeatome: Distribution and Variability of Viral Sequences Integrated Into the Genome of the Arboviral Vector *Aedes albopictus*. *Front Genet* **10**, 93, doi:10.3389/fgene.2019.00093 (2019).
- 66 Yap, M. W., Colbeck, E., Ellis, S. A. & Stoye, J. P. Evolution of the retroviral restriction gene Fv1: inhibition of non-MLV retroviruses. *PLoS Pathog* **10**, e1003968, doi:10.1371/journal.ppat.1003968 (2014).
- 67 Hobson-Peters, J. *et al.* A new insect-specific flavivirus from northern Australia suppresses replication of West Nile virus and Murray Valley encephalitis virus in co-infected mosquito cells. *PLoS One* **8**, e56534, doi:10.1371/journal.pone.0056534 (2013).
- 68 Kuwata, R. *et al.* Analysis of Mosquito-Borne Flavivirus Superinfection in *Culex tritaeniorhynchus* (Diptera: Culicidae) Cells Persistently Infected with *Culex* Flavivirus (Flaviviridae). *J Med Entomol* **52**, 222-229, doi:10.1093/jme/tju059 (2015).
- 69 Suzuki, Y. *et al.* Uncovering the Repertoire of Endogenous Flaviviral Elements in *Aedes* Mosquito Genomes. *J Virol* **91**, doi:10.1128/JVI.00571-17 (2017).
- 70 Bolling, B. G., Weaver, S. C., Tesh, R. B. & Vasilakis, N. Insect-Specific Virus Discovery: Significance for the Arbovirus Community. *Viruses* **7**, 4911-4928, doi:10.3390/v7092851 (2015).
- 71 Talbalaghi, A., Moutailler, S., Vazeille, M. & Failloux, A. B. Are *Aedes albopictus* or other mosquito species from northern Italy competent to sustain new arboviral outbreaks? *Med Vet Entomol* **24**, 83-87, doi:10.1111/j.1365-2915.2009.00853.x (2010).
- 72 Vazeille, M., Moutailler, S., Pages, F., Jarjaval, F. & Failloux, A. B. Introduction of *Aedes albopictus* in Gabon: what consequences for dengue and chikungunya transmission? *Trop Med Int Health* **13**, 1176-1179, doi:10.1111/j.1365-3156.2008.02123.x (2008).
- 73 Paupy, C. *et al.* Comparative role of *Aedes albopictus* and *Aedes aegypti* in the emergence of Dengue and Chikungunya in central Africa. *Vector Borne and Zoonotic Diseases* **10**, 259-266, doi:10.1089/vbz.2009.0005 (2010).
- 74 Lourenço-de-Oliveira, R., Vazeille, M., de Filippis, A. M. & Failloux, A. B. Large genetic differentiation and low variation in vector competence for dengue and yellow fever viruses of *Aedes albopictus* from Brazil, the United States, and the Cayman Islands. *The American journal of tropical medicine and hygiene* **69**, 105-114 (2003).

Acknowledgments

This study was supported by the Institut Pasteur, the French Government's Investissement d'Avenir program, Laboratoire d'Excellence "Integrative Biology of Emerging Infectious Diseases" (grant n° ANR-10-LABX-62-IBEID to A-BF), the European Union's Horizon 2020 research and innovation program under ZIKAlliance grant agreement no. 734548 to A-BF, and the European Research Council (grant agreement no. 682394 - NIRV_HOST_INT to VH and MB). We are grateful to Basile Kamgang for providing mosquito samples, and Dominique Higuët, Anna Malacrida, Giuliano Gasperi for discussions.

Conflict of interests

The authors declare that they have no conflict of interest.

Author contributions

ABF and XDL designed the experiments; VH performed the research; GG did the microsatellite genotyping; CD did the phylogenetic reconstruction; MS and MM did the analysis of genetic structure; YD did the statistical analysis; LM and PSY provided a technical help; MB edited the paper; VH, CD, ABF wrote the paper.

Table 1. Details on *Aedes albopictus* populations analyzed. Except the colony Foshan, all 19 populations were genetically characterized using 10 microsatellite markers, and 13 populations (in bold) were selected for studying NIRVS diversity.

	Population name	Continent	Country	City	Generation	Year of collection	Mosquitoes	
							Females	Males
1	Alessandria	Europe	Italy	Alessandria	F2	2012	10	10
2	Ulcinj	Europe	Montenegro	Ulcinj	F1	2013	10	10
3	Cagnes-sur-mer	Europe	France	Cagnes-sur-mer	F13	2000	10	0
4	Montsecret	Europe	France	Montsecret	F4	2002	0	10
5	Bar-sur-Loup	Europe	France	Bar-sur-Loup	F1	2011	10	0

6	Tirana	Europe	Albania	Tirana	F6	2016	15	15
7	Franceville	Africa	Gabon	Franceville	F2	2015	10	10
8	Mfilou	Africa	Congo	Mfilou (Brazzaville)	F3	2012	10	10
9	Bertoua	Africa	Cameroon	Bertoua	F5	2008	10	4
10	Saint-Denis	Africa	La Réunion	Saint-Denis	F2	1998/2006	10	10
11	Rabat	Africa	Morocco	Rabat	F1	2017	15	15
12	Vero Beach	America	USA	VeroBeach	F5	2016	10	10

13	Rio	America	Brazil	Rio de Janeiro	F1	2001	10	9
14	Jurujuba	America	Brazil	Jurujuba	F1	2014	10	0
15	Manaus	America	Brazil	Manaus	F1	2015	15	15
16	PMNI	America	Brazil	PMNI (Nova Iguaçu)	F1	2015	15	15
17	Binh Duong	Asia	Vietnam	Binh Duong (Ben Cat) Phu Hoa	F9	2014	10	10
18	Sarba	Asia	Lebanon	Sarba	F0	2011	10	10

19	Foshan	Asia	China	Foshan	Lab colony	-	10	10
20	Oahu	America	Hawaii	Oahu	Lab colony	1999	10	10

Table 2. Genetic diversity at each microsatellite locus for all mosquito populations

	N_A	N	Allelic richness	PIC	H_o	H_E	F_{IS}
A1	4	288		0.44	0.16	0.47	0.59
A2	10	360	2.43	0.55	0.63	0.62	-0.15
A3	18	341	3.14	0.74	0.62	0.78	0.08
A5	19	334	2.90	0.75	0.52	0.78	0.13
A6	11	330	2.59	0.68	0.54	0.68	-0.04
A9	9	326	2.73	0.65	0.59	0.70	0.01
A11	9	323	2.81	0.71	0.53	0.75	0.15
A14	9	351	1.71	0.41	0.17	0.40	0.38
A15	6	347	1.25	0.13	0.04	0.15	0.57
A16	14	279		0.83	0.66	0.84	0.04
Mean	10.9	327.9	2.44	0.59	0.45	0.62	0.17

Na, number of alleles; N, number of individuals examined at a locus. PIC, polymorphism information content; H_o , observed heterozygosity; H_e , expected heterozygosity; F_{IS} , the inbreeding coefficient. Values in bold are significant at the 0.1% after Bonferroni correction.

Table 3. Analysis of genetic variability of different geographical populations of *Aedes albopictus*

Populations	Country	Continent	N	n_a	n_a/n	n_p	n_p/n	A_p	H_O	H_E	A_n	F_{IS}
Vero Beach	USA	America	20	4.4	0.22	2	0.10	0.07	0.48	0.53	0.08	0.12***
Oahu	Hawaii		20	2.6	0.13	0	0.00	0.00	0.25	0.34	0.08	0.30***
Manaus	Brazil		30	3.4	0.11	3	0.10	0.07	0.32	0.47	0.12	0.34***
PMNI			30	3.6	0.12	1	0.03	0.03	0.39	0.51	0.11	0.25***
Rio			19	3.4	0.18	0	0.00	0.00	0.42	0.50	0.08	0.18***
Jurujuba			10	3.3	0.33	0	0.00	0.00	0.47	0.42	0.00	-0.06
Montsecret	France	Europe	10	2.0	0.20	0	0.00	0.00	0.50	0.37	0.01	-0.29
Cagnes-sur-Mer			10	2.8	0.28	1	0.10	0.06	0.55	0.46	0.01	-0.14
Bar-sur-			10	3.8	0.38	2	0.20	0.08	0.50	0.52	0.05	0.13*

Loup												
Alessandria	Italy		20	4.1	0.21	2	0.10	0.05	0,43	0.50	0.06	0.18***
Ulcinj	Montenegro		20	3.1	0.16	0	0.00	0.00	0,40	0.39	0.03	0.02
Tirana	Albania		30	3.8	0.13	3	0.10	0.07	0,35	0.43	0.08	0.21***
Rabat	Morocco		30	3.2	0.11	0	0.00	0.00	0,42	0.47	0.06	0.11***
Bertoua	Cameroon		14	4.3	0.31	1	0.07	0.07	0,46	0.52	0.08	0.16***
Franceville	Gabon	Africa	20	4.8	0.24	1	0.05	0.03	0,44	0.56	0.08	0.25***
Mfilou	Congo		20	4.0	0.20	0	0.00	0.00	0,60	0.55	0.02	-0.06
Saint-Denis	La Réunion		20	5.1	0.26	6	0.30	0.05	0,52	0.55	0.07	0.08
Sarba	Lebanon	Asia	10	3.5	0,35	4	0,40	0.08	0,55	0.44	0.00	-0.18
Binh Duong	Vietnam		20	5.0	0,25	3	0,15	0.08	0,42	0.41	0.05	0.11**

Mean	19.1	3.7	0022	1.5	0.09	0.04	0,45	0,47	0.06	-0.09
------	------	-----	------	-----	------	------	------	------	------	-------

N, population size; n_a , mean number of alleles; n_a/N , mean number of alleles/individual; n_p , number of private alleles; n_p/N , mean number of private alleles/individual; A_p , mean frequency of private alleles; H_O , mean observed heterozygosity; H_E , mean expected heterozygosity; A_n , mean frequency of null alleles; F_{IS} , the inbreeding coefficient. **, p-value ≤ 0.01 ; ***, p-value ≤ 0.001 .

Table 4. Association between NIRVS and arboviral dissemination efficiencies in *Aedes albopictus* populations (logistic regression models). Dissemination efficiencies (DE) data were assessed from the same or geographically close *Ae. albopictus* populations (see Supplementary Table 2). Populations were characterized as high or low frequencies for each NIRVS by using the median and were analyzed with DE data by logistic regression models to find any association. Odds ratio (OR) > 1 and < 1 indicated positive and negative association respectively.

NIRVS	N	OR (95% CI)	p-value
<u>DENV</u>			
AlbFlavi1		0.82 (0.61-1.11)	NS
AlbFlavi2		3.07 (2.3-4.2)	***
AlbFlavi4		1.46 (1.0-2.1)	NS
AlbFlavi10	707	0.46 (0.3-0.6)	***
AlbFlavi36		0.46 (0.3-0.6)	***
AlbFlavi41		0.43 (0.29-0.62)	***
CSA-NS3		0.68 (0.5-0.9)	**
CSA-JJL		3.87 (1.0-14)	*
<u>CHIKV</u>			
AlbFlavi1		1.53 (0.9-2.6)	NS
AlbFlavi2		1.3 (0.7-2.1)	NS
AlbFlavi4		2.14 (1.2-3.6)	**
AlbFlavi10	360	0.60 (0.3-1.0)	NS
AlbFlavi36		0.36 (0.2-0.6)	***
AlbFlavi41		0.61 (0.4-1.0)	NS
CSA-NS3		0.56 (0.3-1.0)	*
CSA-JJL		0.68 (0.3-1.7)	NS

95% CI: 95% confidence intervals; N: sample size.

Figures Legends

Figure 1. Estimated population structure of 363 individuals (19 populations) using 10 microsatellite markers. Map with sampling sites of populations with color pie charts showing genotype frequencies, according to Cluster 1 (red) and Cluster 2, which the latest subdivided into 4 subclusters (blue, green, yellow and orange), deduced from the ΔK curve obtained (Supplementary Fig. 1A, 1B and 1C).

Figure 2. NIRVS variability among *Aedes albopictus* populations. The frequency of AlbFlavi1 (A), AlbFlavi2 (B), AlbFlavi4 (C), AlbFlavi10 (D), AlbFlavi36 (E), AlbFlavi41 (F) and CSA (G and H) was assessed for 20 individuals in each *Ae. albopictus* population (except the Rio population with 19 individuals). Populations were clustered according to their continent of origin. Oahu and Foshan correspond to laboratory colonies. The variability of CSA was assessed using two sets of primers: CSA-NS3 (G) and CSA-JJL (H).

Figure 3. *Aedes albopictus* population clustering based on microsatellite and NIRVS loci. (A) Dendrogram of *Ae. albopictus* populations based on the analysis of 8 microsatellite loci of 12 *Aedes albopictus* populations using Cavalli-Sforza & Edwards's genetic distance and Neighbour Joining method. Bootstrap values were indicated when >50%. (B) Dendrogram of *Ae. albopictus* populations based on Bray Curtis distance representing dissimilarities between NIRVS composition and abundances.

Figure 4. Divergence of AlbFlavi2 among *Aedes albopictus* individuals. Phylogram of AlbFlavi2 sequences based on parsimony with gaps considered as 5th nucleotides. Each node

was found in 98 to 100% of the trees obtained through NNI rearrangements. Significant bootstrap values were indicated at nodes. hmwb: high molecular weight band Values; in brackets: alignment coordinates of deletion. The same result was obtained by parsimony without gap as 5th nucleotide, except for the sequence cluster of mosquitoes from Morocco.

Figure 5. Pilot analysis showing the association between frequencies of AlbFlavi2/AlbFlavi36 and DENV/CHIKV dissemination efficiencies (DE) in *Aedes albopictus* populations. The Foshan colony and the Tibati population (Cameroon, generation F1) were used for the analysis. **(A)** Presence/absence of AlbFlavi2 and DEs to DENV and CHIKV obtained for the Foshan colony. **(B)** Presence/absence of AlbFlavi36 and DEs to DENV and CHIKV obtained for the Foshan colony. **(C)** Presence/absence of AlbFlavi2 and DEs to DENV and CHIKV obtained for the Tibati population. **(D)** Presence/absence of AlbFlavi36 and DEs to DENV and CHIKV obtained for the Tibati population. DEs were obtained for both viruses at 14 days post-infection. In total, 191 and 122 individuals were examined for presence of AlbFlavi2/AlbFlavi36 after infection DENV and CHIKV, respectively. Interactions of populations and frequencies of AlbFlavi2/AlbFlavi36 with DEs were tested using logistic regression models.

Fig. 1

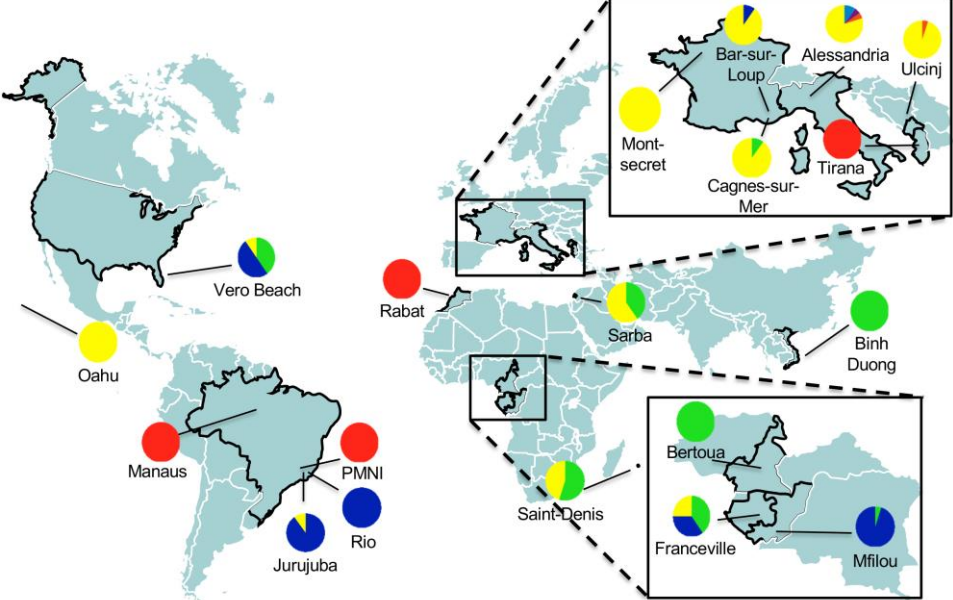

Fig. 2

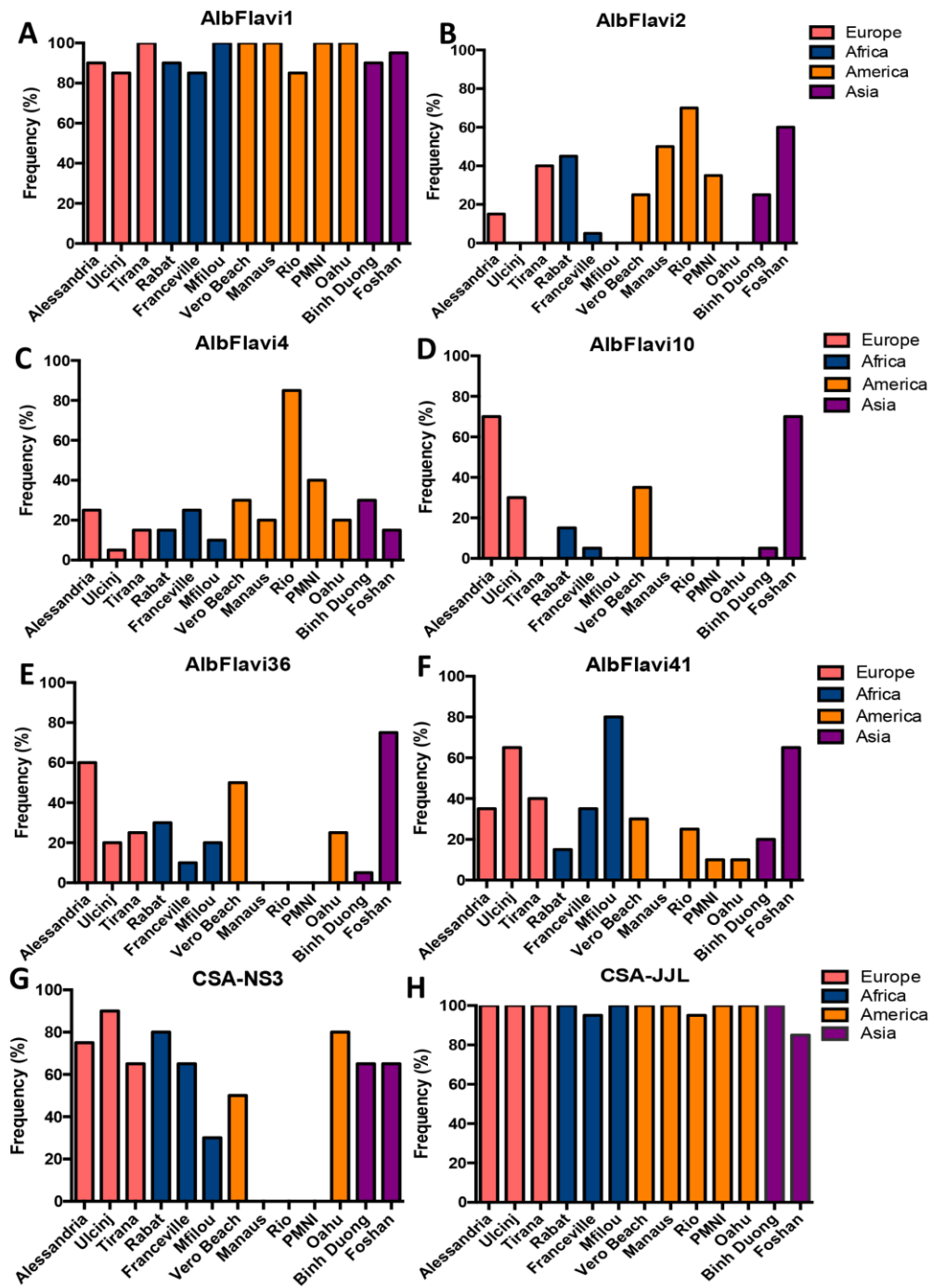

Fig. 3

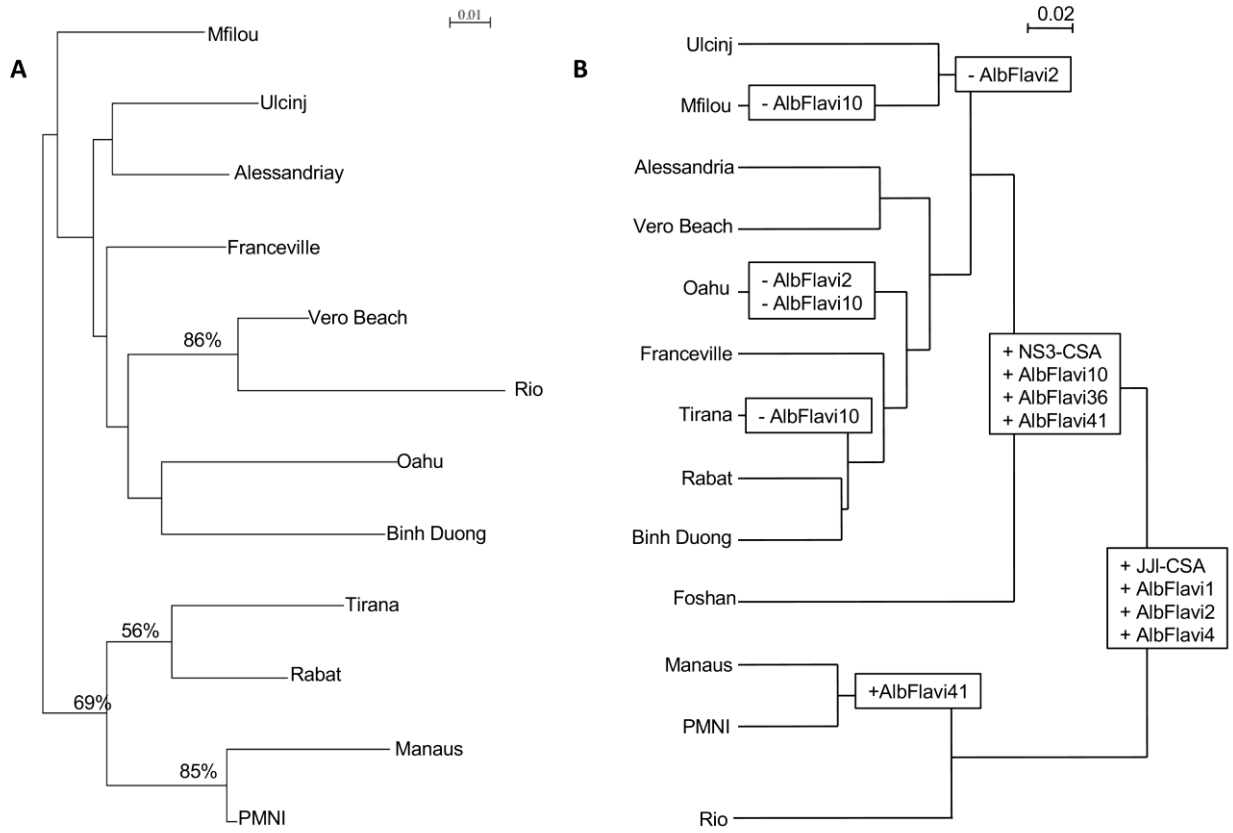

Fig. 4

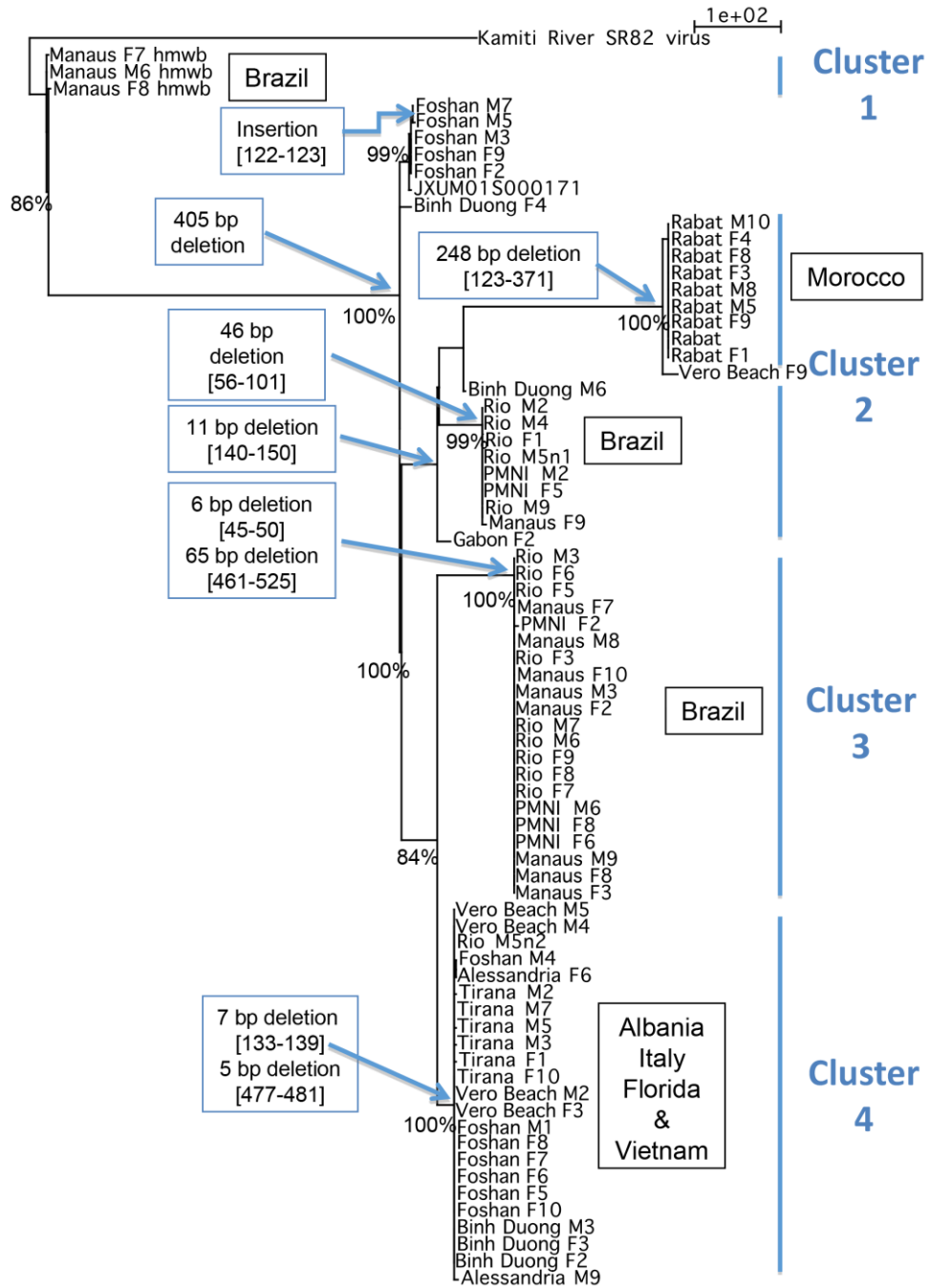
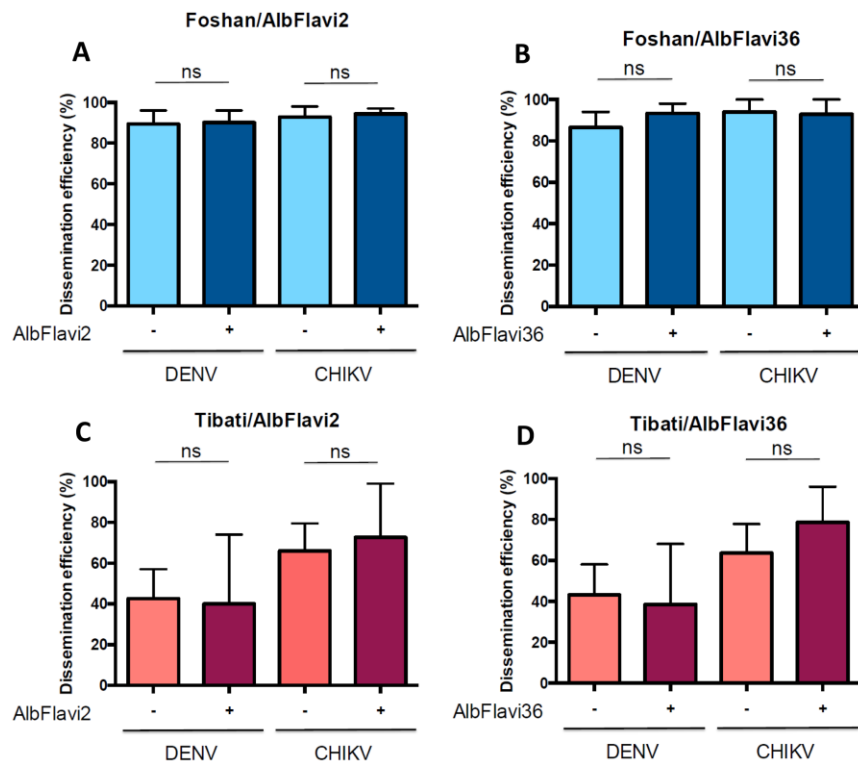

Fig. 5



Supplementary Table 1. Details on primers used to amplify fragments of NIRVS in *Ae. albopictus* genome.

NIRVS	Length (bp)	ORFs	Genomic context	Frequency	Primer sets used
AlbFlavi1	277	NS5 (partial) [AeFV]	Intergenic	Unique	F: 5'-TTTCTACTGCCTCGCCATGA-3' R: 5'-GAGTTGAATGGAGGAAGTCGTG-3'
AlbFlavi2	937	Env (partial) [KRV]	PIRC27 (intergenic)	Unique	F: 5'-TCACAAACGCATGCTACACC-3' R: 5'-CCCCTTGCTCTCAAATGAA-3'
AlbFlavi4	512	C (partial) [AeFV]	PIRC 95 (coding sequence)	Unique	F: AGGAGCGAAAAGTTCTTGGT R: TGATTCGACAGACCCGGAC
AlbFlavi10	1437	NS5 (partial) [AeFV]	Intergenic	Unique	F: CACCCACATCCGAAAGCTTC R: TTCCCGCACCAGTATTCTT
AlbFlavi36	958	NS4B-NS5 (partial) [AeFV]	Intergenic	Unique	F: AAGTTCGTGTTTTGGGTGCA R: GATGCGCTCTCCTACTACT
AlbFlavi41	449	NS1 (partial) [AeFV]	Intergenic	Duplicated	F: CCGTGACGCTTGATGAGTTT R: TGGTACTATCAACGGCATCTCT
CSA	4671	NS1-NS4B [KRV and CFAV]	Coding sequence	Unique	NS3-F: GATCATCGTGCGCAGCTTTATGG NS3-R: CCTTGGTTTCAGAAACAATGACC
					JJL-F: AGCTGGATGACTCCGGCTTGG JJL-R: CTCCGGGTGTC AATGACCAT

Supplementary Table 2. Dissemination of DENV and CHIKV in *Ae. albopictus* populations. Data are extracted from our published studies.

Population	DENV			CHIKV			References
	Mean (%)	N	95% Confidence Intervals	Mean (%)	N	95% Confidence Intervals	
Alessandria	38.46	65	26.31 - 50.61	74.19	31	57.87 - 90.50	Talbalaghi et al. (2010) ⁷¹
Montenegro	8.33	24	1.02 - 26.99	82.5	40	70.19 - 94.80	Zouache et al. (2014) ²⁰
Albania	80	20	60.79 - 99.20	83.33	18	58.58 - 96.42	Houé et al. (unpublished data)
Gabon	21.42	14	4.65 - 50.79	86.04	43	75.25 - 96.83	Houé et al. (unpublished data)
Congo	21.42	28	5.22 - 37.63	53.84	26	33.31 - 74.38	Vazeille et al. (2008) ⁷²
Morocco	60	30	41.39 - 78.60	53.33	30	34.38 - 72.28	Paupy et al. (2010) ⁷³
Vero Beach	38.58	127	30.00 - 47.16	93.33	30	77.92 - 99.18	Vazeille et al. (2016) ⁴¹
Rio	71.14	149	63.78 - 78.50	91.30	23	71.96 - 98.92	Amraoui et al. (2019) ⁵²
Manaus	50	30	31.01 - 68.98	96.66	30	82.78 - 99.91	Vega-Rua et al. (2014) ⁴⁷
PMNI	58.97	117	49.92 - 68.01	89.79	49	81.01 - 98.58	Houé et al. (unpublished data)
Vietnam	48.54	103	38.72 - 58.35	82.5	40	70.19 - 94.80	Vega-Rua et al. (2014) ⁴⁷
							Zouache et al. (2014) ²⁰
							Paupy et al. (unpublished data)

Supplementary Fig. 1. Population structure analysis of 363 *Aedes albopictus* individuals based on microsatellite markers. (A) Magnitude of ΔK as a function of K (mean over 25 replicates) calculated for the model. The modal value of ΔK was $K=2$, indicating that individual mosquitoes were divided into 2 clusters (B). The division of the dataset in two groups corresponds to the best assignment of individuals with Structure. Little magnitude of ΔK at $K=4$ suggested no subclusterization for the Cluster 1, but the Cluster 2 substructured in 3 different subclusters (C).

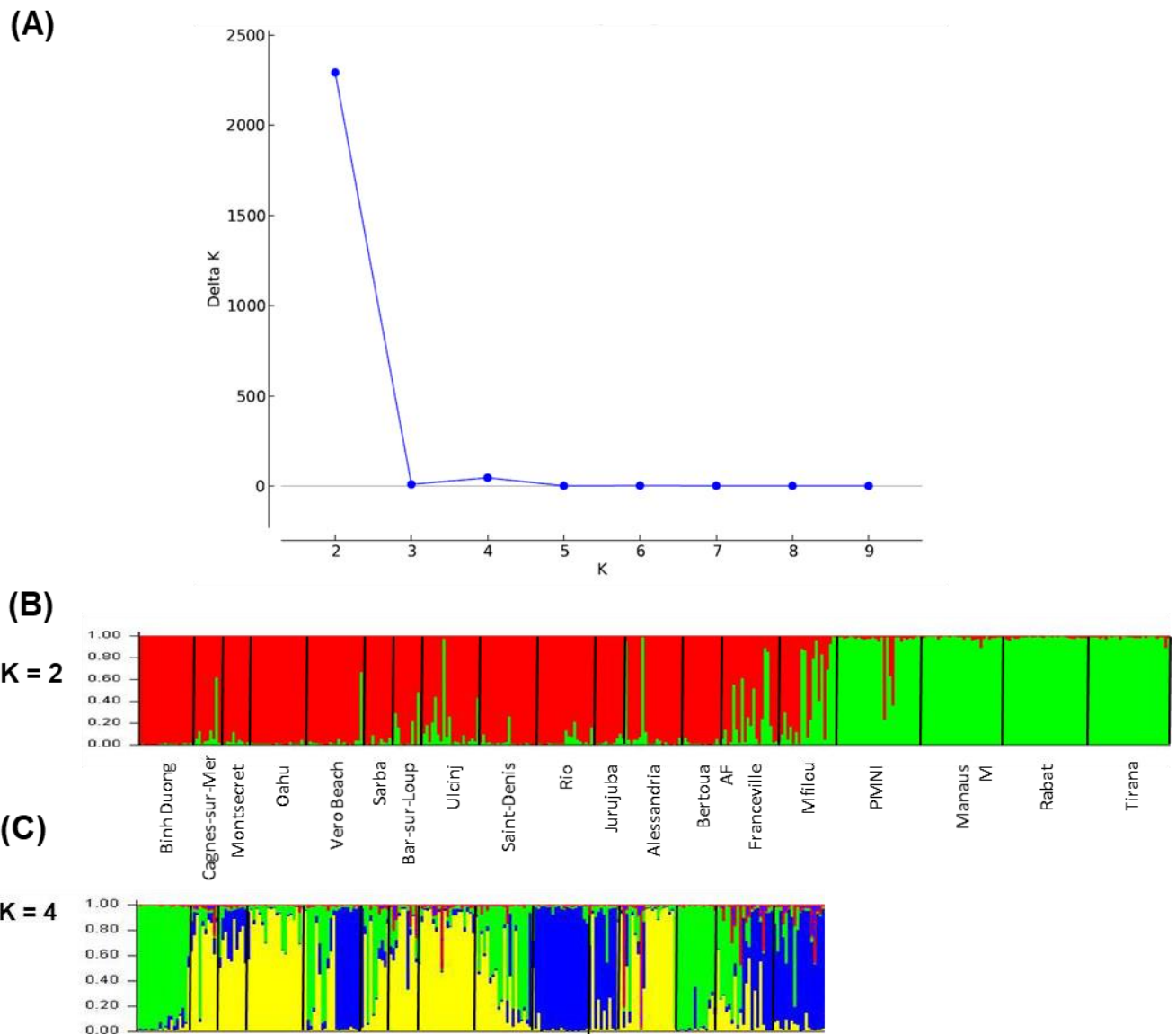

Supplementary Fig. 2. Results of the Mantel test on Φ^2_{st} matrices based on microsatellite data (x-axis) and NIRVS distribution data (y-axis).

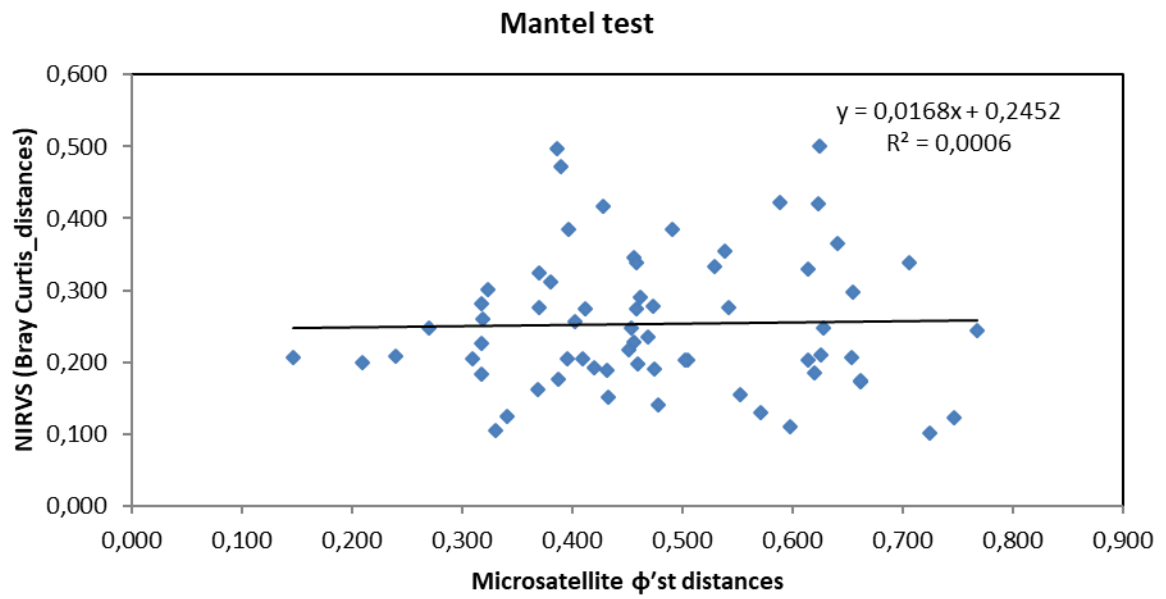

Supplementary Fig. 3. Sequence polymorphism of AlbFlavi2 and AlbFlavi36 in *Ae. albopictus* populations. Each population sequence (blue bars) of AlbFlavi2 and AlbFlavi36 was compared to its related viral sequence: partial envelope protein-coding sequence of Kamiti River Virus (green bar) (A) and partial NS4B-NS5 protein-coding sequence of Aedes Flavivirus (orange bar) (B) respectively. Deletions and insertions in population sequences were represented as gaps (blue lines) and orange triangles respectively, and their sizes and positions in the viral-related sequence were indicated. The number of individuals in a population displaying each indel was indicated below the event. For each population, the number of individuals positive for each NIRVS among the total individuals tested was indicated in the right column.

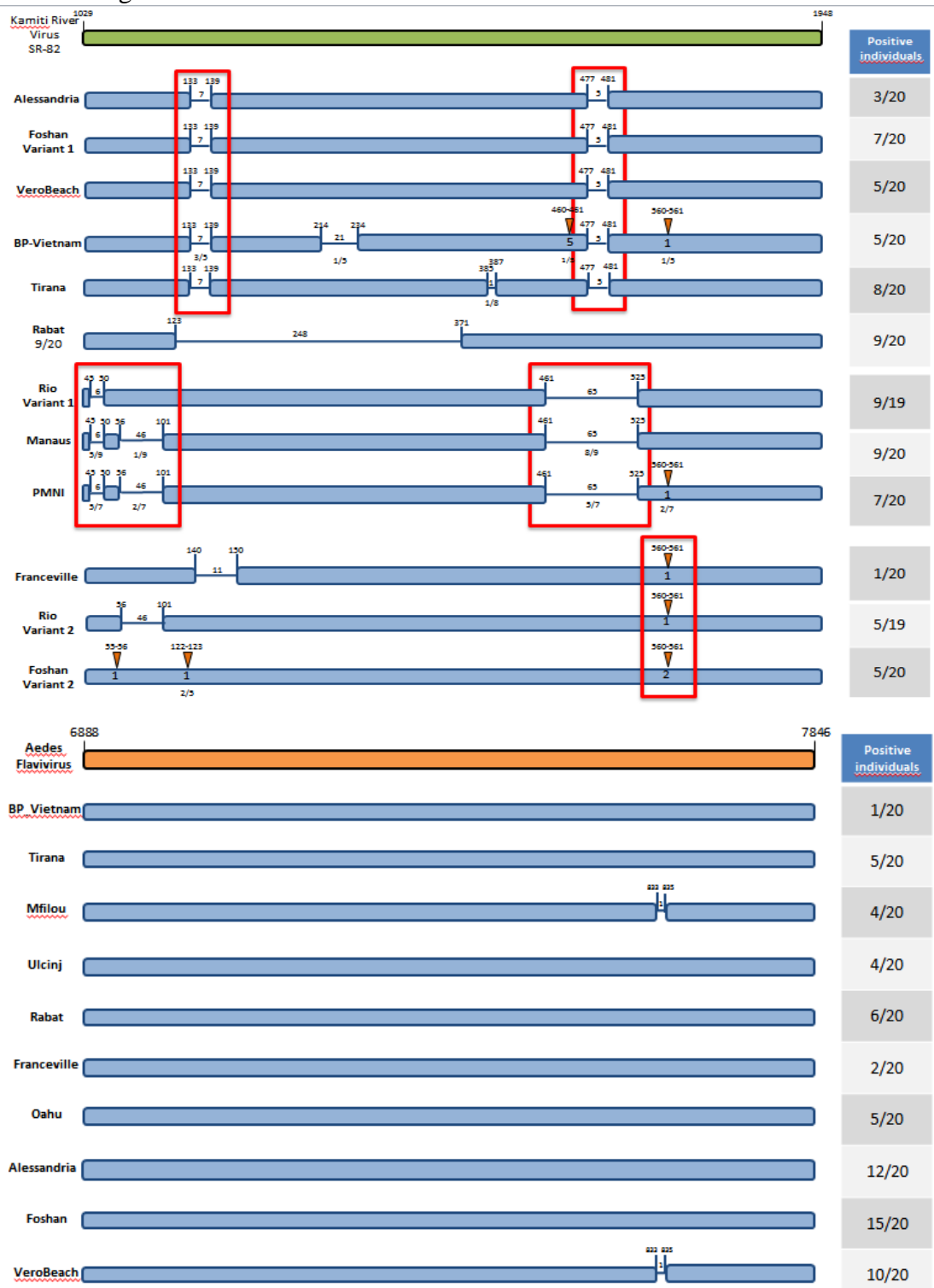

Supplementary Fig. 4. Divergence of AlbFlavi36 among *Ae. albopictus* individuals. AlbFlavi36 phylogram based on parsimony. Each node was found in 98 to 100% of trees obtained through NNI rearrangements.

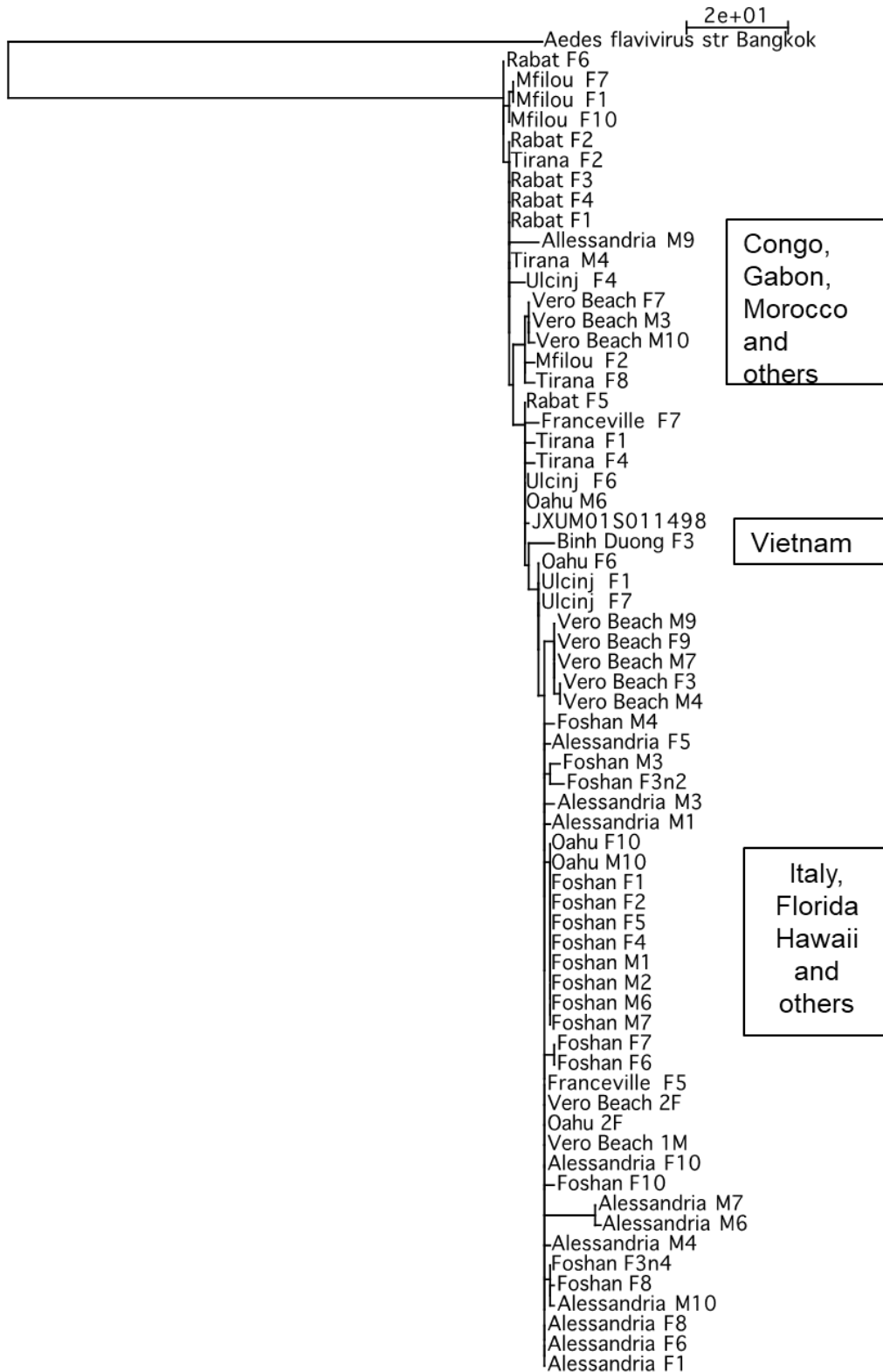

3. Conclusions

The discovery of NIRVS originating from flaviviruses in *Ae. albopictus* is recent and many questions are still unanswered regarding their presence in the genome. The unique whole genome sequence of *Ae. albopictus* available up to date comes from a single pupa of the Foshan colony (collected in Guangdong Province, China, reared in laboratory since 1981). The sequencing has permitted to detect a set of 30 Flavi-NIRVS (X.-G. Chen et al. 2015). However, little information is known about the distribution and evolution patterns of these elements in *Ae. albopictus* populations. Moreover, although these Flavi-NIRVS were proved to produce piRNAs, no biological functions have so far been clearly demonstrated in mosquitoes.

We first characterized the genetic diversity of 19 *Ae. albopictus* populations by using neutral markers (i.e. microsatellites). We showed that populations were divided into two main clusters (Cluster 1 and Cluster 2), with Cluster 2 divided into 4 sub-clusters. These results were surprising as the populations belonging to the Cluster 1 were very different from the rest of populations. Moreover, a contact zone model defined by a restricted gene flow occurring between geographically isolated populations through central populations, were suggested for the Cluster 2. We then chose 13 of these *Ae. albopictus* populations, which originated from areas where CHIKV and DENV were circulating, to assess Flavi-NIRVS distribution. We first showed high variability of NIRVS frequencies within and between populations, as it was previously shown with NIRVS in *Ae. albopictus* mosquitoes (Palatini et al. 2017; Suzuki et al. 2017) or with other EVEs in other animal genomes (e.g. shrimp and koala genomes; (Simmons et al. 2012; Taengchaiyaphum et al. 2019)). However, whether some NIRVS have always been absent in some individuals in some populations or underwent recombination events so that they were lost and are no longer detectable (as it was shown for CSA) is unknown. By describing the genetic relatedness between populations and comparing with

NIRVS polymorphism, we can state with confidence that NIRVS do not evolve neutrally as the microsatellites do. Successive phases of bottleneck and expansion events characterizing invasive species, may modulate the cost-benefit ratios provided by NIRVS (Balanovsky et al. 2005; Faure and Royer-Carenzi 2008). With the exception of AlbFlavi1 and CSA-JJL sequences, none of the NIRVS studied here reached fixation in any of *Ae. albopictus* populations tested. This suggests that the selective pressure exerting on these NIRVS may probably be not strong enough to allow their fixation. It is contrary to the pattern in *Ae. aegypti* mosquito where all Flavi-NIRVS detected have reached fixation (unpublished data).

It is likely that depending on their functions (if any) and location in the genome, each NIRVS evolves differently. We suggest that some Flavi-NIRVS play or played a role in *Ae. albopictus* genome. All NIRVS loci studied here were found to produce piRNAs (Palatini et al. 2017; Suzuki et al. 2017). Despite their non-antiviral role in *Drosophila* (Petit et al. 2016), piRNA pathway was thought to be involved in antiviral immunity in mosquitoes, as arbovirus infections trigger the production of piRNA molecules (Brackney et al. 2010). Moreover, ISFs (from which these Flavi-NIRVS studied here originated) have been proved to modulate arboviral infections in mosquitoes (Hobson-Peters et al. 2013; Kenney et al. 2014; Hall-Mendelin et al. 2016; Kuwata et al. 2015). Therefore, NIRVS may interfere in the vector competence of some arboviruses.

In this study, we showed that by examining viral dissemination efficiency (DE) in *Ae. albopictus* populations, many NIRVS were correlated to vector competence to DENV and even CHIKV (which belongs to the Togaviridae family). Whereas some NIRVS were associated with high DEs, others were associated with low DEs, suggesting different effects of NIRVS on vector competence. These results were not surprising as these NIRVS can evolve differently and have different functions in the genome. As an example, whereas some NIRVS could have an antiviral role, others could promote viral persistence, ensuring

equilibrium between viral clearance by the host and pathogenicity of the virus. However these results required to be confirmed at the individual mosquito level. In this aim, we focused our study on AlbFlavi2 and AlbFlavi36 because of their wide distribution in *Ae. albopictus* populations and their location in piRNA cluster and intergenic region of mosquito genome, respectively. We first showed that the evolutionary history of AlbFlavi2 was complex, even within populations. When comparing AlbFlavi2 sequence variability between individuals, we found different clusters characterized by several deletion events as compared to the corresponding control sequence of an exogenous virus, Kamiti River virus. We therefore suggested that AlbFlavi2 acts as TE fragments. On the other hand, AlbFlavi36 sequences were conserved in terms of sequence variability among populations, which again, suggests a potential function. Unfortunately, by using a field-collected population from Tibati, Cameroon, and the Foshan colony, we showed in a pilot experiment that the correlation between AlbFlavi2 and AlbFlavi36 presence and DENV/CHIKV dissemination at 14 days post-infection were not confirmed with neither of the two viruses. This result suggests that the phenotype of viral dissemination of DENV/CHIKV in *Ae. albopictus* mosquitoes might not be driven (or at least not entirely) by the NIRVS studied here. We can also hypothesize that the selection pressures that drive NIRVS evolution may be heterogeneous and sequential, leading to variations in terms of their presence in populations and expression and therefore, their effects on viral dissemination. This is supported by results on exogenous forms of ISFs which intervene in DENV and/or CHIKV dissemination (Baidaliuk et al. 2019) suggesting to examine more deeply the mosquito virome. We cannot exclude a sampling bias by examining a sample that is unrepresentative of the entire population. Mosquito populations can be characterized using more discriminant markers (e.g. single nucleotide polymorphism (SNPs)) with a special focus on Tibati (Cameroon) population (used in the pilot experiment) as *Ae. albopictus* populations from Central Africa are genetically different from other populations

(Vazeille et al. 2016). Moreover, looking at AlbFlavi2- and AlbFlavi36-derived piRNA expression would also be informative regarding their potential role in modulating arbovirus infections. It has been demonstrated by others that AlbFlavi4 produces piRNAs (vepi4730383) whose expression is up-regulated upon dengue infection (Y. Wang et al. 2018).

In this study, we chose to analyze viral dissemination at 14 days post-infection because of usual detection of both DENV and CHIKV dissemination in *Ae. albopictus* mosquitoes at that time (Vega-Rúa et al. 2015). However, Flavi-NIRVS could be involved in viral regulation at early or late stages of infection in *Ae. albopictus* mosquitoes suggesting to examine other time-points. Additionally, as the vector competence involves several parameters, midgut infection and transmission rates should also be assessed and compared with NIRVS frequencies.

It is also possible that DENV and CHIKV have evolved and found a way to counteract the antiviral functions of Flavi-NIRVS, as it was shown with several viruses, including flaviviruses like DENV, by producing for example suppressors of RNAi in insects and mammalian systems (Kakumani et al. 2013; Schnettler, Leung, et al. 2013; Sullivan and Ganem 2005; Van Cleef et al. 2014). Finally, to further complete this study, pilot experiments should be performed on mosquitoes harboring the other NIRVS studied in order to know if their presence correlates with DENV and/or CHIKV DE.

Overall, although many studies suggested the antiviral functions of NIRVS, our study showed that several questions on the role of Flavi-NIRVS on vector competence of *Ae. albopictus* populations remain unresolved. However, their non-neutral evolution as compared to microsatellite loci suggested an evolution under selection pressures with potential effects on biological functions. Unraveling NIRVS potential functions could also be performed by focusing on the formation of these elements in host genomes. However, except for EVRs, not

much is known about why, how and where these events occur. Globally, this would also help to characterize these virus-host interactions and potentially highlights new antiviral strategies. In the following chapter, we will be discussing on endogenization of viruses belonging to different families in persistently infected cell cultures.

**Chapter 2: Detection of newly produced
NIRVS in mosquito persistently infected
cells**

1. Introduction

Persistent infection follows an acute phase of viral replication and is characterized by the production of low levels of viral particles. Persistent infections of arboviruses and notably, flaviviruses have been previously described in both nervous system and other tissues in humans and animals. They are often associated to pathogenic effects, such as neuronal degeneration and chronic renal disorders (Adams et al. 2013; Garcia, Hasbun, and Murray 2015; Murray et al. 2017; Saxena et al. 2013). However, arthropod vectors, such as mosquitoes, are persistently infected by viruses without any significant fitness costs for the host despite impressive high viral loads measured in vectors.

The mechanisms involved in viral persistence require multiple factors and are still unclear, although several suggestions have been made. Differences in the antiviral innate immune responses between humans and mosquitoes have been described to explain different outcomes of persistent infections (Hoa et al. 2003; X.-G. Chen et al. 2015; Keene et al. 2004; Myles et al. 2008; Campbell et al. 2008; Fragkoudis et al. 2009; Cirimotich et al. 2009). Moreover, production of defective viral genomes (DVGs), extracellular viruses and alterations in post-translational processing has been suggested to participate in the establishment of persistent infections in mosquitoes (Riedel and Brown 1977; X.-G. Chen et al. 2015; Tsai et al. 2007; Ebner, Kim, and O'Callaghan 2008). Because persistent infections require equilibrium between harmful viral replication and efficient antiviral defenses, viruses are able to counteract immune defenses and especially, RNAi system by producing virus-encoded suppressors of RNAi (VSRs) (Blair 2011). Subgenomic RNA of flaviviruses as well as the capsid protein has been found to play a similar role against RNAi pathway (Pijlman et al. 2008; Samuel et al. 2016; Schnettler, Leung, et al. 2013).

Production of DNA forms from several non-retroviral RNA viruses (vDNA) has been found to promote persistent infections and prevent lethal acute infections in *Drosophila*,

Aedes mosquitoes and cell cultures (Goic et al. 2013b, 2016; Nag and Kramer 2017; Nag, Brecher, and Kramer 2016). *In vitro*, vDNA was detected at the early stage of infection (as early as 24 hours post-infection for DENV in C6/36 cells) by multiple-template switching events due to the reverse transcriptase activity of retrotransposons (Nag, Brecher, and Kramer 2016). Because only fragments of viral RNA genomes were found, vDNA was suggested to be produced from DVGs rather than from a full genome.

Currently, little is known about the production of vDNA integrated into host genomes (NIRVS). Most of the NIRVS found in *Aedes* mosquitoes and cell lines were from insect-specific viruses (ISVs) belonging to *Rhabdoviridae* and *Flaviviridae* families (Palatini et al. 2017; Whitfield, Dolan, Kunitomi, Tassetto, et al. 2017). These NIRVS were suggested to be produced thousand to million years ago due to long-lasting interactions between ISVs and hosts (Pischedda et al. 2019). So far, only a small number of NIRVS from arboviruses was described in mosquitoes, because their transmission is mainly horizontal rather than vertical, as opposed to ISVs. Among NIRVS originating from flaviviruses, most of them displayed similarities to sequences encoding non-structural proteins. Moreover, NIRVS from rhabdoviruses tended to originate from sequences encoding the nucleoprotein (N) located at the 3' end of the genome (Palatini et al. 2017; Whitfield, Dolan, Kunitomi, Tassetto, et al. 2017). Whereas no specific explanation was described for the presence of NIRVS from non-structural flaviviral protein sequences, the presence of NIRVS from rhabdoviral nucleoprotein sequences was suggested to be correlated to the quantity of transcripts, as rhabdoviral genomes are transcribed in a progressive graduated manner (Conzelmann 1998) and separately from 3' to 5' due to the recognition of stop codons/polyadenylation signals by the polymerase. These NIRVS are more often embedded in regions rich with retrotransposons and in piRNA clusters (hotspots of piRNA production) than expected by chance in *Aedes* mosquito genomes. However, little is know about the genomic location of NIRVS that do not

belong to piRNA clusters. It is likely that according to their position in the mosquito genome, NIRVS functions (if any) would be different.

In this chapter, we aim to characterize NIRVS production in *in vitro* models by establishing persistent infections. We selected five different viruses: two arboviruses causing important public health issues (CHIKV and DENV), two ISFs displaying high prevalence in *Aedes* mosquitoes (CFAV and KRV) and a rhabdovirus (vesicular stomatitis virus (VSV), which is also an arbovirus). Infections were performed in two different cell lines that are both RNAi-proficient and isolated from embryonic tissues: *Ae. aegypti* Aag2 and *Ae. albopictus* U4.4 cell lines. This ongoing experiment will help to characterize regions of the mosquito genome that are suitable for viral integration, but also parts of the viral genome that are more prone to integrate.

1. Experimental protocol

In order to characterize NIRVS formation in mosquitoes, *Ae. albopictus* U4.4 and *Ae. aegypti* Aag2 cell lines were cultured in T-25 flasks and infected with five different viruses: CHIKV 06-21 (Schuffenecker et al. 2006), DENV-1 1806 (La Ruche et al. 2010), CFAV Galveston strain (Bolling, Vasilakis, et al. 2015), KRV SR-75 strain (M B Crabtree et al. 2003) and VSV New Jersey strain (Pauszek and Rodriguez 2012) (Fig. 20). Each condition was performed in duplicates. Briefly, at passage 0 (P0), cells were counted to adjust at a multiplicity of infection (MOI) of 0.1. Each flask was then inoculated with 500 μ L of diluted virus and incubated for 1 hr at 28°C. The inoculum was then removed, cells were washed and fresh medium (Leibovitz-15 medium for U4.4 cells and Schneider medium for Aag2 cells) with 2% FBS was added to each flask. When cell confluence was obtained, cells were passed into new T-25 flasks. Supernatants were collected, mixed with 10% FBS with pH adjusted at 7. Remaining cells were harvested, washed once with phosphate-buffer saline (PBS) and

frozen at -80°C . Supernatants and cells collected at each passage were used to determine respectively, the virus titers and to detect potential newly-produced NIRVS in cell lines using next-generation sequencing (NGS) (Fig. 20).

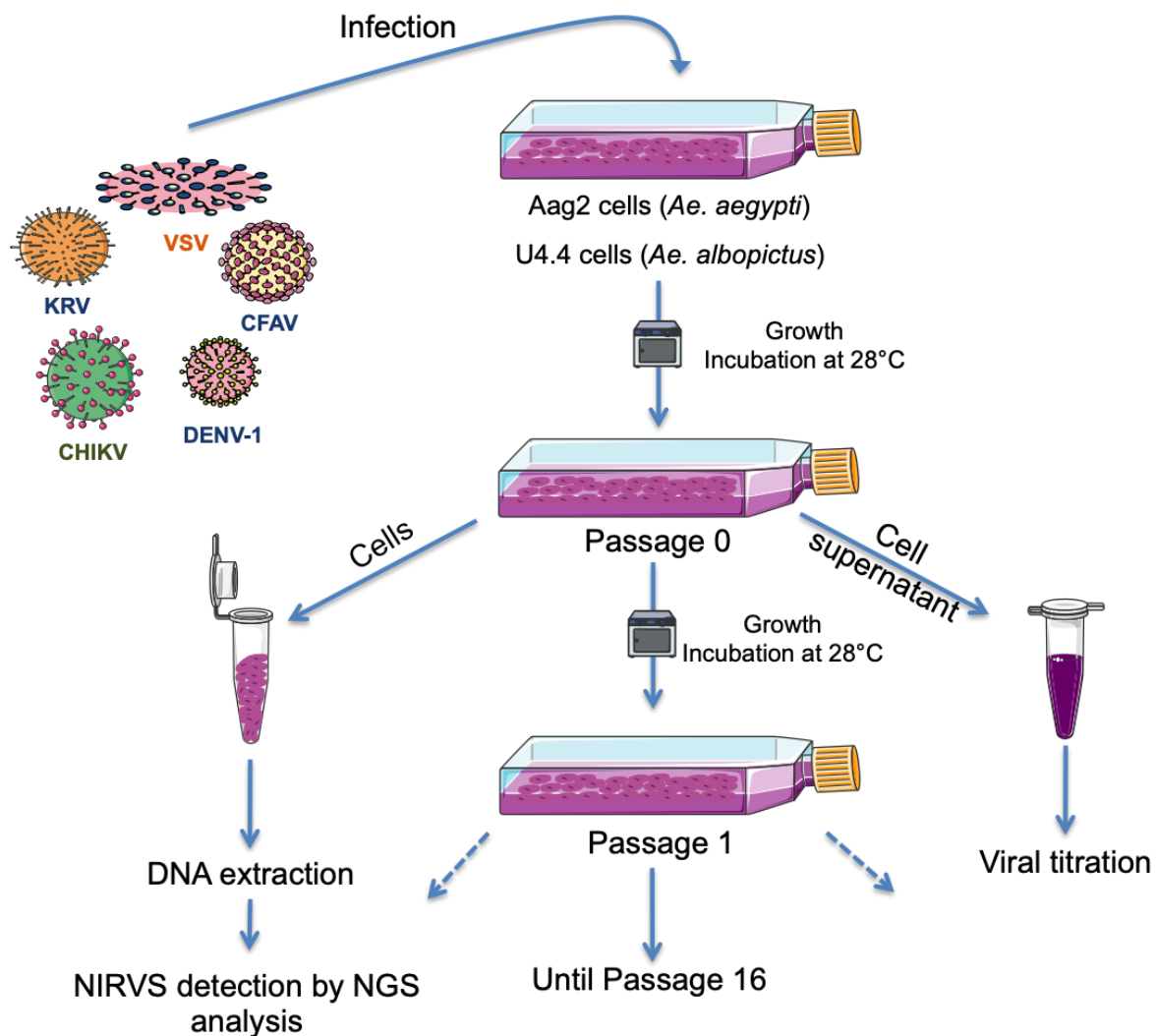

Figure 20: Experimental protocol used to detect potential new NIRVS in cellular models. Five different viruses were used to infect Aag2 and U4.4 cell lines originated from *Aedes aegypti* and *Aedes albopictus* respectively. When confluence was reached, cells were passed into a new flask and supernatant as well as remaining cells were collected and stored at -80°C . CHIKV: chikungunya virus; DENV: dengue virus; KRV: kamiti river virus; CFAV: cell fusing agent virus; VSV: vesicular stomatitis virus; NGS: next-generation sequencing.

3. Results

3.1 Growth of infected cell cultures

In total, 22 flasks were used for this experiment: U4.4 and Aag2 cells were separately infected with five different viruses (CHIKV, DENV, KRV, CFAV and VSV) in duplicated flasks and one negative control for each cell line was included. U4.4 cells and Aag2 cells were cultured for 92 days and 109 days respectively during which 16 passages were performed. U4.4 cells were much more difficult to culture (especially those infected with CFAV and KRV) and appeared more fragile than Aag2 cells, which grew faster and produced aggregates in flasks. As already observed in C6/36 *Ae. albopictus* cell line (Summers et al. 1989; Stollar and Thomas 1975), cytopathic effects (CPE) characterized by cell fusion (polykaryon), enlarged size of cells, vacuole formation in the cytoplasm and cell lysis were observed in U4.4 cells infected with DENV and CFAV as soon as 72 hrs post-infection, and persisted until the end of the experiment. These cells infected with KRV appeared to be as fragile as DENV- and CFAV-infected U4.4 cells, despite that CPE was only occasionally observed. As expected, U4.4 cells infected with VSV showed no CPE during the experiment, suggesting that the infection was well tolerated by these cells. Indeed, while VSV was able to induce high CPE on vertebrate cells, CPE was rarely observed in infected insect cells (Webster and Granoff 1999). Finally, CHIKV infection was relatively well tolerated by U4.4 cells, despite few observations of CPE, mostly characterized by cell fusion.

Globally, no major effects on growth were observed following the different infections in Aag2 cells. Cells infected with CHIKV showed limited CPE characterized by cell fusion and cell rounding that appeared 15 days post-infection. Moreover, weak CPE defined by cell fusion and vacuole formation in the cytoplasm of DENV-infected Aag2 cells was also occasionally observed. One of the two replicates of KRV-infected Aag2 cells was lost during P7 probably due to the selection of a defective cellular variant.

3.2 Viral persistence in infected cell cultures

In order to assess the viral persistence in infected U4.4 and Aag2 cell cultures, viral particles were titrated in supernatants at different passages at P1, P3, P6, P9 and P16 (Fig. 21). We performed focus fluorescent (FFA) (Payne et al. 2006) and TCID₅₀ assays on *Ae. albopictus* C6/36 cells to estimate the viral titers in infected cell cultures. If persistence was reached in cultured cells, steady viral titers should be observed in the supernatants.

Steady DENV particles were found in supernatants of both replicates of U4.4 cell cultures with titers that reached 10^7 ffu/mL at P1 and progressively decreased to 2.10^5 ffu/mL at P16 (Fig. 21A). In all replicates of Aag2 cell cultures, DENV titers also fluctuated between 10^6 and 10^7 ffu/mL at P3, P6 and P9 and P16, although only $6.3.10^3$ DENV particles were found at P1 (Fig. 21B). We obtained similar results for U4.4 and Aag2 cell cultures infected with CHIKV (Fig. 21C and Fig. 21D). Indeed, in both cell types, we first observed CHIKV titers that varied between 10^4 and 10^5 ffu/mL at all passages tested except at P1, where higher titers were obtained ($1.4.10^7$ ffu/mL and $2.7.10^8$ ffu/mL for U4.4 and Aag2 cell cultures respectively).

However, although similar patterns were observed between replicates in U4.4 cell cultures infected with VSV, variable viral titers were observed between passages (Fig. 21E). Whereas nearly 4.10^7 TCID₅₀/mL of VSV particles were found at P1, titers dropped to 14,000 and 6,300 TCID₅₀/mL at P6 and P9 for the replicate 1. At P16, VSV titers were much higher in both replicates (more than 3.10^6 TCID₅₀/mL). Variations in VSV titers were mostly observed in Aag2 cell cultures during the early passages (Fig. 21F).

Globally, steady levels of CFAV particles were detected for all replicates of all passages for the two infected cell lines (Fig. 21G and Fig. 21H). In U4.4 cell cultures, the viral titers reached 10^8 TCID₅₀/mL at P1, and became steady for the following passages, with titers varying from 3.10^6 to 10^7 TCID₅₀/mL (Fig. 21G). In Aag2 cell cultures, steady levels of

CFAV particles were found in all passages for the two replicates, with titers around 10^5 TCID₅₀/mL (Fig. 21H). This result was expected as Aag2 cells are naturally infected with CFAV (Weger-Lucarelli et al. 2018; Stollar and Thomas 1975).

In U4.4 cell cultures infected with KRV, differences of viral titers were observed at P1 and P16 for both replicates (Fig. 21I). At P1, low levels of viral particles were described, with respectively 25,000 and 1,410 TCID₅₀/mL for the replicate 1 and 2, whereas at P16, viral titers reached 10^6 TCID₅₀/mL. Between these two passages, steady KRV titers were observed with a TCID₅₀/mL of around 10^5 for both replicates (with a peak at 10^6 TCID₅₀/mL at P6 for the replicate 1). In Aag2 cells, relatively steady KRV titers were observed with values around 10^5 TCID₅₀/mL and a slight decrease observed until P16 (Fig. 21J). The second replicate was lost at P7 because the cells did not grow anymore and formed aggregates that did not attach to the flask. We hypothesized that we selected a defective cellular variant. Overall, supernatants of all infected flasks were positive for the corresponding viruses, meaning that they managed to perform efficient replication in U4.4 and Aag2 cells at least until P16.

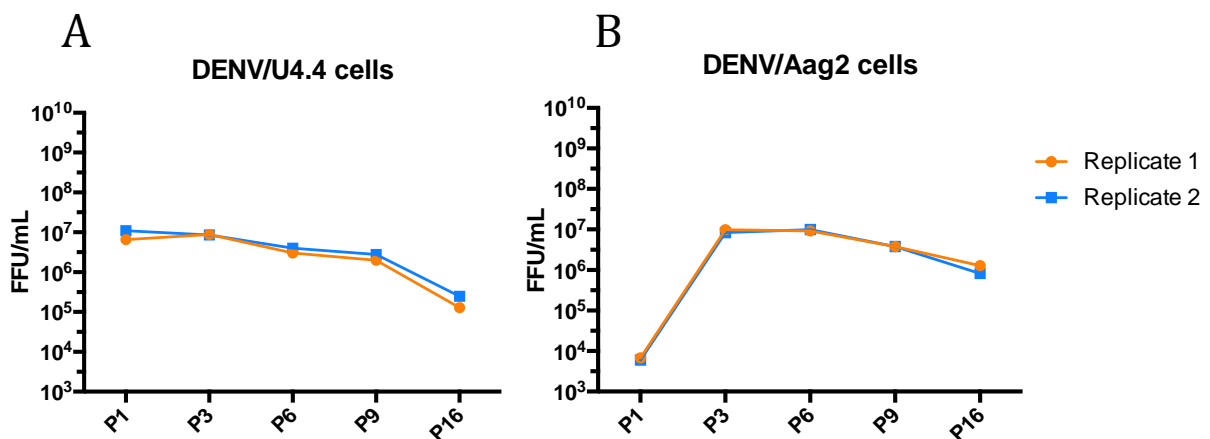

Fig. 21 (continued)

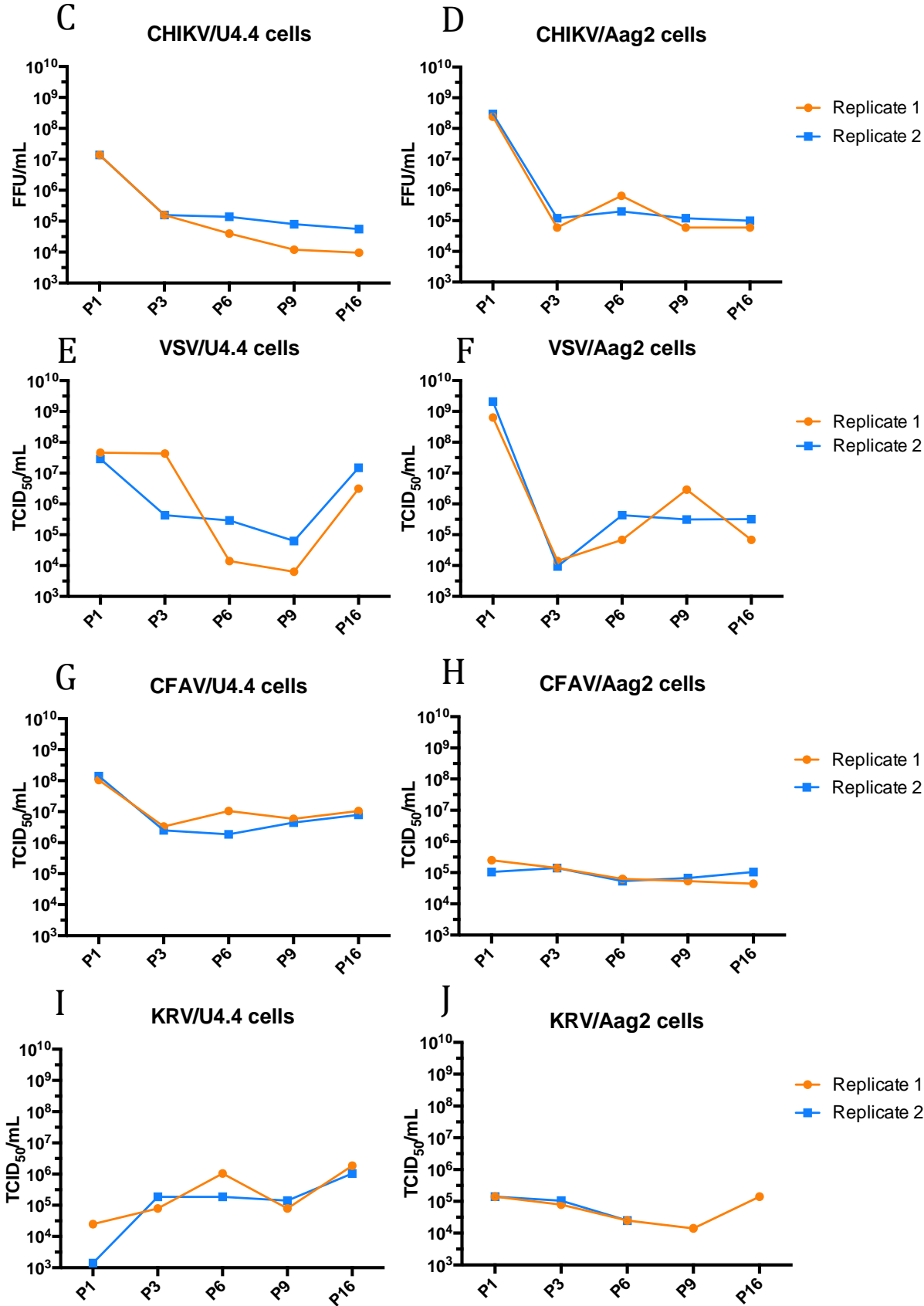

Figure 21: Titers at different passages of viruses used to infect U4.4 and Aag2 cell lines. Each condition was performed in duplicate.

3.3 Detection of NIRVS following infections in cultured cells

We further chose to perform next-generation sequencing (NGS) analysis on the passage 16 of each combination cell-virus to detect potential formation of NIRVS in mosquito infected cultured cells. Because such events are likely to occur in repetitive regions of the cellular genome, we further decided to do whole-genome sequencing (WGS) by employing single-molecule, real-time (SMRT) sequencing technology (Pacific Biosystems or PacBio) instead of Illumina sequencing, to overcome the issues of assembling complex parts of genomes. For this matter, we collaborated with the Biomix platform located at the Institut Pasteur of Paris for the sequencing and with the Bonizzoni Lab located in Pavia, Italy for the bioinformatics analysis. They first realized an *in silico* simulation to find newly formed NIRVS based on the Aag2 genome reference that is available online on VectorBase and in which existing NIRVS were described previously (<https://www.vectorbase.org>; (Whitfield, Dolan, Kunitomi, Tassetto, et al. 2017)). They were able to build scripts that allowed the simulation of a PacBio sequencing from the reference genome and create a pipeline that is efficient for detecting new NIRVS. As a test, we sequenced one replicate of Aag2 cells infected with DENV, but no reads mapping to the DENV genome were found, despite the fact that the multiqc report suggested a good sequencing quality. We therefore decided to change the strategy used to detect new NIRVS following infections by performing Illumina sequencing using a paired-end read method. We also used another bioinformatics approach by using the Vy-PER (Virus integration detection bY Paired-End Reads) pipeline, a viral integration detector that enables the elimination of most false-positive events and displayed a high sensitivity in selecting true positive events (Forster et al. 2015). Vy-PER was integrated with custom scripts developed in the Bonizzoni's lab to adapt the pipeline to the highly repetitive Aedes genomes and allow viral identification. Because time was limited, only one replicate of all Aag2 samples was sequenced, except for the DENV-infected Aag2 cells for

which the sequencing of the two replicates was performed. We however detected newly formed putative NIRVS in some conditions that were supported by a couple of reads. In Aag2 cells infected with VSV and KRV, no potential NIRVS deriving from these viruses were detected.

3.3.1 Detection of NIRVS deriving from Cell Fusing Agent Virus RNA genome

As previously published, it is known that Aag2 cells are persistently infected with CFAV, and NIRVS from this virus were already described, highlighting the ability of CFAV to integrate cell genomes. We found three potential new NIRVS in the Aag2 cells that were infected with CFAV (Galveston strain; Fig. 22A-C). We first found a couple of reads that suggested the integration of a 149 nt long CFAV sequence in Aag2 genome (Fig. 22A). This sequence matched with a partial sequence of the CFAV capsid/prM region (position 322-471). The mapped read indicated that this sequence was located at the 3' end near LTR retrotransposon sequences belonging to the Ty1/copia group. However, because the read sequence representing the 3' flanking region of the NIRVS also mapped to 170 other sites in the Aag2 genome, we used the one that displayed the highest mapping score to deduce the 5' flanking sequence. This was also performed for many other NIRVS detected. No transposable elements were detected near the 5' end of this potential NIRVS.

A second putative 151 nt long CFAV integration was discovered following the infection (Fig. 22B). This sequence matched to the NS5 protein sequence of CFAV but is actually divided in two because the two fragments did not map to a consecutive sequence on the viral genome. We found a 99 nt long fragment matching to the position 7673-7771 of the CFAV genome, and a 52 nt long fragment that matched to the position 7568-7620 of the viral genome (Fig. 22B). As observed for the first putative CFAV NIRVS discovered, this sequence was found flanked at the 5' end to a LTR Ty1/copia retrotransposon. The putative 3'

flanking region also suggested the presence of Ty1/copia retrotransposon sequences (Fig. 22B).

A third putative 212 nt long CFAV-derived NIRVS was detected in Aag2 genome. The alignment on the viral genome revealed that three fragments were detected and mapped to a close but different position in the CFAV NS3 protein gene (Fig. 22C). This potential NIRVS was not associated with any transposable elements.

In addition to the putative NIRVS described above originated from Aag2 cells infected with CFAV (strain Galveston), we also found three other NIRVS from CFAV in the Aag2 negative control. We found a 41 nt and a 151 nt CFAV-derived NIRVS surrounded by LTR Ty1/copia retrotransposon sequences and mapping to partial NS3 and NS5 regions respectively (Fig. 22D and 22E). The 151 nt NIRVS was divided into two CFAV sequences that mapped very close but at different positions on the viral genome. Moreover, a 121 nt putative NIRVS matching to a partial fragment of NS5 region was also discovered (position 8954-9074; Fig. 22F). This NIRVS was found close to Copia LTR retrotransposon and unknown TE sequences. Additionally, the sequence was found inserted into a piRNA cluster. These three last NIRVS confirmed that Aag2 genome contains naturally NIRVS from CFAV. We also discovered a newly formed CFAV NIRVS in the Aag2 sample infected with DENV (Fig. 22I). This NIRVS, which was divided into a 95 nt and a 36 nt fragments, matched to partial NS4B region (positions 6919-7018 and 6981-7018 respectively). Finally, we found two putative NIRVS of CFAV in Aag2 cells infected with KRV (Fig. 22G and 22H). These two NIRVS have a length of 77 and 49 nt and both mapped to NS5 region of the viral genome. Additionally, these putative NIRVS were present in piRNA clusters and respectively associated to Copia and Ty1/copia LTR retrotransposon sequences (Fig. 22G and 22H).

3.3.2 Detection of NIRVS from Dengue virus RNA genome

For this condition, the two replicates were sequenced. In the first replicate, the infection of Aag2 cells with DENV led to the detection of only one NIRVS with a length of 166 nt (Fig. 22J). This fragment matched with prM glycoprotein sequence in DENV genome (position 485-650) and the flanking regions were not associated with any transposable elements previously described. Using the Aag2 non-infected sample as a negative control, we performed PCR and successfully amplified the viral sequence and its 3' flanking regions, allowing us to confirm the presence of this newly formed NIRVS. However, this NIRVS was not found in the second replicate.

In the second replicate, seven putative NIRVS were detected in the DENV-infected Aag2 genome (Fig. 22K-Q). The difference in the number of putative NIRVS between the two replicates could be explained by a higher coverage obtained for the second replicate. Interestingly, only two NIRVS were found close to transposon sequences. We first found a 75 nt fragment that matched to the NS1 region (position 3309-3383) of the viral genome (Fig. 22K). Moreover, we found at the 5' flanking region, the presence of a sequence belonging to the two groups PIF and ISL2EU transposons (Fig. 22K). We found another potential NIRVS from DENV genome with a size of 463 nt (position 3099-3561) corresponding to NS1/NS2A region (Fig. 22L). Although the reads of the two NIRVS mapped 163 nt away from each other, we considered that these two sequences belonged to the same putative NIRVS. However, no sequences from the Aag2 genome were detected, which means that we do not know if this putative NIRVS is really integrated into the Aag2 genome or present as an episome in the cell.

We detected the potential presence of a 131 nt fragment mapping the NS2B region of the DENV genome (position 4177-4307; Fig. 22M). This NIRVS was not surrounded by any TE sequences previously described. We possibly found a 114 nt NIRVS mapping to the NS3

region (position 4925-5038) that was not associated with TE sequences either (Fig. 22N). Besides, another putative NIRVS of 472 bp was found (Fig. 22O). Although the two reads mapped 170 nt away from each other in the DENV genome, they mapped perfectly to the viral genome and because this distance agrees with the length of the DNA fragments of the Illumina library preparation protocol, we considered these two reads sequences and the viral portion between them as belonging to the same sequence fragment. This sequence mapped to DENV genome at the position 6074-6545, corresponding to NS3/NS4A region. Again, no sequences from the Aag2 genome were detected, which means that we do not know if this putative NIRVS is really integrated into the Aag2 genome or present as episome in the cell (Fig. 22O). We also identified a 337 nt putative NIRVS mapping the DENV NS5 region that is divided into a 40 nt fragment (position 8510-8549 on the viral genome) and a 297 nt long fragment (position 9300-9597 on the viral genome) (Fig. 22P). Both are non-associated to TE sequences. Finally, we found another potential NIRVS with a length of 149 nt for which the 3' flanking region is marked by the presence of a LTR Ty1/copia retrotransposon sequence (Fig. 22Q). This NIRVS is actually divided into two putative elements: a 63 nt and a 86 nt fragments that matched both to the NS5 region of DENV genome.

3.3.3 Detection of NIRVS Chikungunya RNA genome

In Aag2 cells infected with CHIKV, we found two couples of reads that mapped to the CHIKV genome. The first couple of reads revealed the presence of a 138 nt that matched to the 5'UTR/nsp1 (position 1-138; Fig. 22R). The suggested 3' flanking region revealed the proximity of the NIRVS to a Miniature Inverted repeat Transposable Elements (MITEs). A second couple of reads identified two putative NIRVS of 57 nt and 94 nt long (position 11545-11601 and 1-94 respectively) that are not associated to any TE sequences known (Fig. 22S). These two NIRVS matched to regions in the 3'UTR and 5'UTR/nsp1 of the CHIKV

genome. However, these sequences match perfectly to reads sequences, which means that no flanking region belonging to the Aag2 genome was identified. Therefore, so far we cannot know if these sequences are integrated into the Aag2 genome, or if they are extrachromosomal and present as episome.

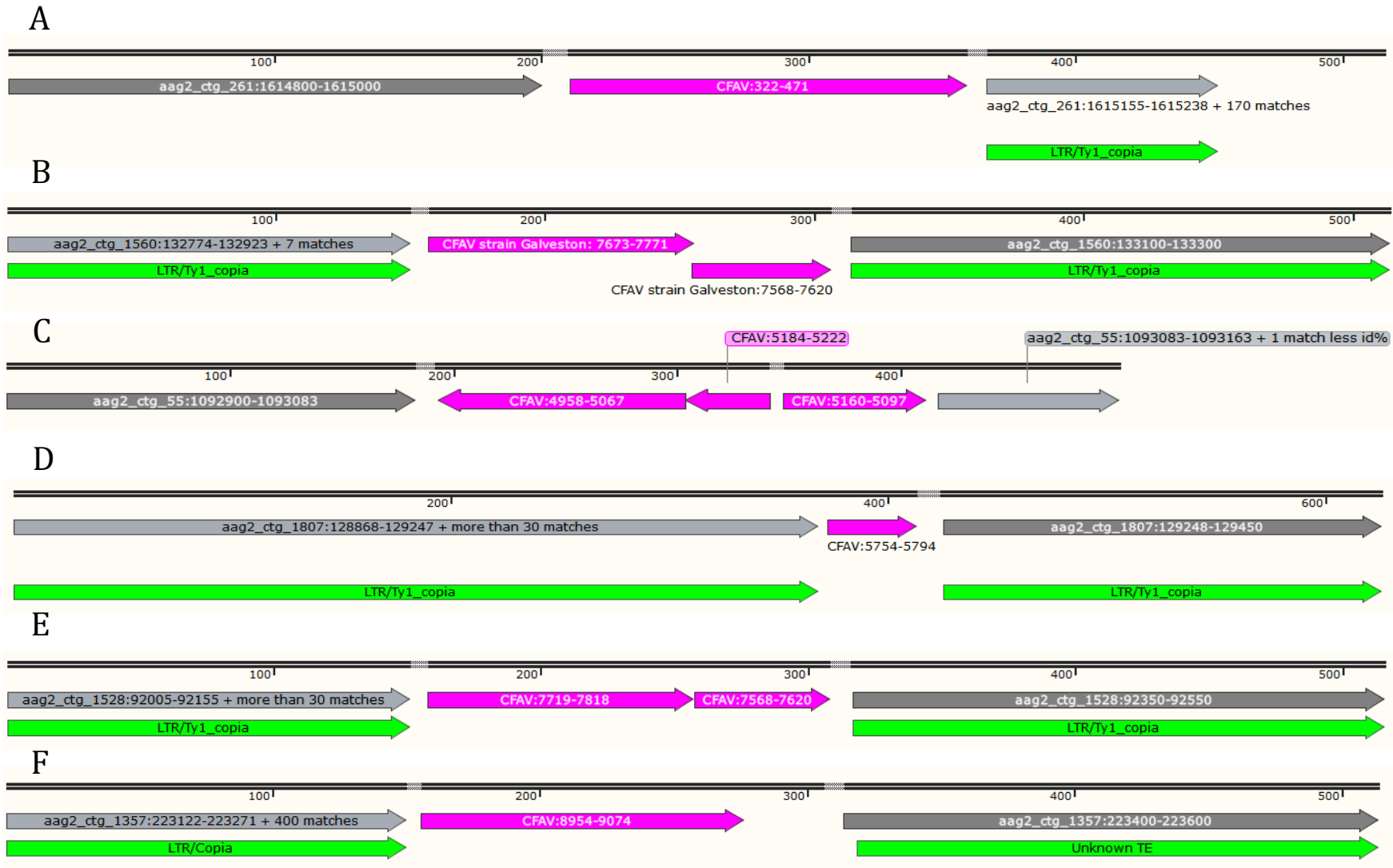

Fig. 22 (continued)



Fig. 22 (continued)



S



Figure 22: Putative NIRVS produced following viral infection in Aag2 cell cultures. Putative NIRVS bioinformatically detected in CFAV-infected Aag2 cells (**A-C**); non-infected Aag2 cells (**D-F**); KRV-infected Aag2 cells (**G-H**); DENV-infected Aag2 cells (**I-Q**) and CHIKV-infected Aag2 cells (**R-S**). The double black lines represent the sequences in both strands (in nucleotide). The fuschia arrows represent the putative NIRVS with inside of it the position in the viral genome where the reads mapped. The green arrows represent the transposable element sequences. Light grey arrows represent the portion in the Aag2 genome where the reads mapped, with contigs and positions indicated withing the arrow. Because this portion matched several times to different location in the genome, the other flanking sequence of the putative NIRVS is deduced from the portion that displays the highest probability to contain the NIRVS. This deduced sequence is represented by dark grey arrows.

4. Conclusions

Although viruses of all types have been found integrated into a large variety of genomes, the conditions required to non-retroviral integration remain unclear. While it is likely that long-lasting interactions between host and virus may increase the odds of viral endogenization, it seems that the intensity of infection is not a factor required for the occurrence of such events in mosquito cells. The production of vDNA from arboviruses (such as DENV) that are not supposed to have DNA stage in their replication cycle has been found as early as 24 hrs by multiple-template switching events due to the reverse transcriptase activity of retrotransposons (Nag, Brecher, and Kramer 2016). However, it seems that vDNA production is not the only factor required for viral endogenization, as only a few NIRVS from arboviruses have been discovered so far.

We therefore established U4.4 and Aag2 cell cultures infected persistently with five different viruses: three arboviruses (DENV, CHIKV and VSV) and 2 ISFs (CFAV, KRV), in order to characterize the formation of NIRVS. We provided preliminary data based on the whole genome sequencing performed on the infected Aag2 cells. We mainly expected higher NIRVS formation in Aag2 infected with VSV, as the *Rhabdoviridae* family is the viral family for which a high number of NIRVS was found in mosquitoes. The same was suggested for the two ISFs CFAV and KRV, as they were both found at high frequencies in *Aedes* genome. On the contrary, we expected no or few NIRVS from DENV and CHIKV, as only a few from DENV and none from CHIKV have been described so far. Finally, we expected that the newly formed NIRVS to be present near TE sequences and piRNA cluster, as it has been described before.

We first showed that U4.4 cells were more affected by viral infections than Aag2 cells, suggesting that they were less well adapted. We showed that for each combination cell-virus,

mature viral particles were produced at high amounts in supernatants during the whole experiment, suggesting efficient and long-lasting infections that occurred during 92 and 109 days for U4.4 and Aag2 cultured cells, respectively. We however did not know the percentage of infected cells at each passage, even though we postulate that owing to the viral titers in supernatants, it is likely that a high percentage of infected cells would be expected. To confirm this, we could have performed immunofluorescence assay on these cells (Nag, Brecher, and Kramer 2016).

By performing WGS on infected Aag2 cells that were passaged 16 times, we confirmed that NIRVS formation in host genome is a rare event (Fig. 22; Table 3). Indeed, we did not show any integration of KRV and VSV sequences following infections in Aag2 cell genome. This was unexpected, as these two viruses belong to viral families for which many NIRVS have been previously described in *Aedes* mosquitoes (Palatini et al. 2017; Whitfield, Dolan, Kunitomi, Tassetto, et al. 2017). It is possible that the coverage obtained for these samples was not high enough to detect any newly formed NIRVS. For VSV, the Aag2 cellular model may not be the most appropriated model to study VSV integration in host genome. Indeed, cells from black flies or sandflies may have been a better choice, as the virus has been reported to be highly transmitted by these vectors (Cupp et al. 1992; Brinson et al. 1992; Comer et al. 1993). It is also possible that the endogenization of these viruses requires specific conditions (such as intense stress, low or high temperature) that were not present in this experiment. In order to increase viral endogenization processes, treatments of cells with genotoxic chemicals could have boosted retrotransposons activities promoting viral integrations (Terasaki et al. 2013).

As expected, we found couples of reads supporting the formation of nine NIRVS deriving from CFAV RNA genome in several samples (i.e. in the negative control and in cells infected with KRV and DENV) due to the natural persistence of this virus in Aag2 cells.

These putative NIRVS represented fragments of non-structural protein sequences, mostly NS3 and NS5, two proteins that are highly conserved in Flavivirus. The length of these potential NIRVS did not exceed 150 nt, but this has to be confirmed by molecular biology, as it could largely be a bias obtained from sequencing. Moreover, almost all the putative NIRVS detected were associated with the close presence of TE sequence, mostly LTR retrotransposons. This confirmed the highly suggested role of retrotransposons in viral endogenization. Additionally, two and one putative CFAV-derived NIRVS were found in cells infected with KRV and DENV respectively, as well as one from the negative control found in piRNA clusters.

Interestingly, we found eight and two putative NIRVS from DENV and CHIKV RNA genomes respectively. Among them, only three NIRVS were described close to TE sequences. These results could suggest that arboviruses integrate host genomes by a way that is different from the one used by ISFs. This mechanism may require other conditions to be completed and could then explain why only few arboviruses have been found integrated into mosquito genomes so far. Again, we found a high number of NIRVS originated from DENV non-structural protein sequences.

For CHIKV-, CFAV- and DENV-infected Aag2 cells, we found some reads that supported the integration of several viral sequences next to each other. Some of these sequences were not mapped consecutively in the viral genome. Because we think that it is unlikely that two independent events occurred precisely next to each other, we suggest that deletion events have occurred either before or after endogenization in the genome. During arboviral infections, it is known that a lot of defective-interfering (DI) RNA molecules are produced. These molecules lack viral portions due to errors of the polymerase and display deletions that sometimes can be as large as several thousand kb. Therefore, this could explain why several portions of the viral genome can be integrated together at the same insertion sites.

Moreover, it is possible that recombination could have occurred after endogenization, as NIRVS are found in repetitive regions where such events are frequently observed.

Although these results are interesting, they have to be confirmed by molecular biology. Only one 166 nt NIRVS from DENV prM region have so far been confirmed. Once confirmed, it would be interesting to assess their presence at lower passages in order to know when the viruses integrated and if these elements are stable in Aag2 genome. Moreover, we managed to characterize their flanking regions by finding them in proximity to TE sequences and piRNA clusters, but a better characterization of these flanking sequences are required, notably by determining their location close or away from genes. This could help understanding their potential role, as some endogenous elements (mostly ERVs) were able to modulate the expression of adjacent genes. Additionally, because some of these NIRVS were found in piRNA clusters, it would be good to determine if they produce small RNAs and if their expression varies following arboviral infections. Finally, again because of the lack of time, we did not sequence U4.4 samples infected with the five viruses; U4.4. genome annotation also meet different issues. As NIRVS between *Ae. aegypti* and *Ae. albopictus* are different, we are expecting different results between Aag2 and U4.4 cells.

Tableau 3: Summary of the putative NIRVS found in Aag2 infected cells.

Sample (Replicate)	NIRVS origin	Divided into several fragments	NIRVS length (nt)	Position	Viral region	Associated to TE sequences	Present in piRNA cluster
Negative control	CFAV	No	41	5754-5794	NS3	Yes	No
Negative control	CFAV	Yes	100	7719-7818	NS5	Yes	No
			51	7568-7620			
Negative control	CFAV	No	121	8954-9074	NS5	Yes	Yes

CFAV-infected Aag2	CFAV	No	149	322-471	Capsid/prM	Yes	Yes
CFAV-infected Aag2	CFAV	Yes	99	7673-7771	NS5	Yes	No
			52	7568-7620			
CFAV-infected Aag2	CFAV	Yes	110	4958-5067	NS3	No	No
			38	5184-5222			
			64	5160-5097			
KRV-infected Aag2	CFAV	No	77	9457-9533	NS5	Yes	Yes
KRV-infected Aag2	CFAV	No	49	9009-9057	NS5	Yes	Yes
DENV-infected Aag2 (R1)	CFAV	Yes	95	6919-7018	NS4B	Yes	No
			36	6981-7018			
DENV-infected Aag2 (R1)	DENV	No	166	485-650	prM	No	No
DENV-infected Aag2 (R2)	DENV	No	75	3309-3383	NS1	Yes	No
DENV-infected Aag2 (R2)	DENV	No	463	3099-3561	NS1-NS2A	No	No
DENV-infected Aag2 (R2)	DENV	No	131	4177-4307	NS2B	No	No
DENV-infected Aag2 (R2)	DENV	No	114	4925-5038	NS3	No	No
DENV-infected Aag2 (R2)	DENV	No	472	6074-6545	NS3-NS4A	No	No

DENV-infected Aag2 (R2)	DENV	Yes	40	8510-8549	NS5	No	Yes
			297	9300-9597			
DENV-infected Aag2 (R2)	DENV	Yes	63	9744-9806	NS5	Yes	No
			86	9346-9432			
CHIKV-infected Aag2	CHIKV	No	138	1-138	5'UTR/nspl	Yes	No
CHIKV-infected Aag2	CHIKV	Yes	57	11545-11601	3'UTR	No	No
			94	1-94	5'UTR/nspl		

General conclusion, discussion and perspectives

The massive studies describing the effects of microbiota on pathogens led the scientific community to explore the virome sheltered by the environment and organisms. This triggered the discovery of many different viral groups, including the group of insect-specific flaviviruses (ISFs). In the last decade, owing to new molecular technologies such as next-generation sequencing and development of bioinformatic tools, the whole genome sequences of newly discovered viruses, including ISF genomes, are now available. These new information became the stepping-stone to the discovery of many non-retroviral integrated RNA virus sequences (NIRVS) in genomes.

In this thesis, we focused on NIRVS in the genome of the invasive mosquito species *Ae. albopictus*, which with the other mosquito species *Ae. aegypti*, was the first organism in which NIRVS were described in 2004 (Crochu et al. 2004). Because of their recent discovery, little information is known regarding the evolution of NIRVS, their functions (if any), as well as their formation within the host genome. Therefore, the aim of this work was to better understand these specific features of NIRVS that can, in a larger scale provide useful information regarding virus-host coevolution. We found that (i) the distribution of NIRVS from ISFs in geographically distant populations and their polymorphism are not related to genetic divergences within and between populations as depicted by microsatellite markers, suggesting that NIRVS are not evolving neutrally, (ii) their relation with vector competence to arboviruses was suggested at the population level, and (iii) the formation of NIRVS in *Aedes* mosquito-derived cells is likely a rare event that can nonetheless occurs at variable frequencies.

EVE evolution

The discovery of EVEs, resulting from a co-adaptation between hosts and viruses has raised many questions regarding their evolution within host genomes. While EVEs submitted to purifying selection will rapidly be lost through generations, it is important to

know if those that remain in the host genome are under positive selection suggesting their beneficial effects for hosts or are simply maintained as fossil records.

It is very likely that the EVE landscape we are discovering today represents a small portion of those that have existed in the past, mostly because many of them have been lost through random effects of genetic drift before gaining any beneficial effects for the host. Moreover, small effective population sizes (like it is often the case in mammals) or frequent bottlenecks could also lead to neutral evolution of EVEs, as effects of genetic drift increase when population size decreases (Lynch and Conery 2003). Additionally, as many EVEs are characterized by low copy numbers and fragmented ORFs, as it is the case for Flavi-NIRVS, especially in insect genomes (including *Aedes* mosquitoes), the presence of EVEs could be defined as transient in their hosts. Whereas these arguments are in favor of EVE neutral evolution, others suggested a positive selection justifying their presence in host genomes for specific purposes. Indeed, ancient viruses do not differ as much as we thought from contemporary viruses thanks to the remarkable sequence conservation of EVEs, including these fragmented EVEs found in insects. Moreover, although it is the only example found in insect genomes so far, the relationship between endogenous polydnaviruses and parasitic wasps has been characterized as symbiosis (Federici and Bigot 2003), stressing the evolution of EVEs under positive selection. In the case of EVEs having antiviral functions, their maintenance in the genome will depend on the cost they impose to their hosts *versus* the cost of the corresponding viral infection.

In this thesis, we investigated the evolution of seven NIRVS in geographically distant *Ae. albopictus* populations. They were present in almost all populations tested, suggesting their ancient origin. A recent study has estimated the introduction of NIRVS in *Ae. albopictus* genome between 6.5 thousand to 2.5 million years ago (Pischedda et al. 2019). We then assessed the evolutionary history of NIRVS in these populations based on genetic variations

derived from neutral evolving microsatellite loci. We found that the evolution of NIRVS was far to be neutral with variations both in their distribution and sequence polymorphism. Except for AlbFlavi1, none of the NIRVS were fixed in the populations examined, a result from the neutral status of NIRVS.

Despite the sequence polymorphism observed for AlbFlavi2 located in a piRNA cluster, we showed that both AlbFlavi2 and AlbFlavi36 presented a relatively low mutation rate and high sequence conservation. This result is consistent with our hypothesis that they have potential functions in *Ae. albopictus* genome (Aiewsakun and Katzourakis 2015). Overall, in addition to their role as a source for piRNA production, NIRVS are unlikely to evolve under the unique control of genetic drift. To confirm these results, evidence of purifying selection should be tested (Casillas, Barbadilla, and Bergman 2007). Finally, NIRVS are believed to evolve according to a dynamic process answering to a cyclic pattern between presence and absence of these elements within populations, depending on variable evolutionary pressures and exposition to related exogenous viruses. The antiviral functions of an EVE could lead to the clearance of the virus, which in turn would either trigger EVE degradation associated with the loss of biological roles or acquisition of other cellular functions by exaptation. If infections of corresponding viruses occur again, EVE-derived antiviral functions could also be restored (Aswad and Katzourakis 2012). These episodes of selection/counter-selection characterize the continuous evolutionary “arms race” that is occurring between viruses and hosts (Arnaud, Murcia, and Palmarini 2007).

EVE functions

EVEs are the results of endogenization of viruses within the germline cells of host genomes and are known for a long time to potentially acquire biological functions. Indeed, their conservation within the genome reveals that they provide beneficial effects. Many examples of EVEs having reached fixation serve actual functions in their hosts; as for

example, the *gag*-derived ERV (*gag*-ERV) Fv1 blocks MLV infection after viral entry in mice (Best, Le Tissier, et al. 1996). In plants, endogenous caulimovirus (dsDNA virus) have been shown to produce siRNAs that act against exogenous viruses (Blevins et al. 2006; Staginnus and Richert-Pöggeler 2006). In mammals, an Endogenous Borna-like N element (EBLN) from squirrel genome, transfected in human cells have been found to colocalize with the viral ribonucleoproteins and affect Bornavirus polymerase activity (Fujino et al. 2014). Overall, the functions of EVEs in host genomes have been mostly linked to antiviral immunity and are seen as heritable immune memory. However, other functions have been described; an endogenous form of the retrovirus feline leukemia virus (FeLV) has been found to recombine with exogenous viruses resulting in a more virulent form (Anai et al. 2012). This is the only actual example showing that EVEs can have positive effects on exogenous viruses and be a source of diversity for them. How often this phenomenon occurs in nature remains however unknown. Moreover, EVEs can also be related to other functions than antiviral immunity, such as anti-cancer properties by stimulating apoptosis in tumor cells (Bannert et al. 2018; Bustamante Rivera et al. 2018).

In insects, only two EVEs have been identified as having biological functions: while an endogenous fragment of Israeli acute paralysis virus (IAPV) in honeybee genome has been correlated to a resistant phenotype against infections (according to an unknown mechanism) (Maori, Tanne, and Sela 2007), endogenous bracoviral segments in parasitoid wasp genome are required to allow the development of wasp larvae in caterpillars as they produce viral particles having immunosuppressive functions (Bézier et al. 2013). One could conceive that very few EVEs are present in insect genomes. However, a recent study found nearly 4,061 EVEs by screening 48 different arthropod genomes (ter Horst et al. 2018). Nevertheless, most EVEs were found fragmented and did not contain complete ORFs. Their lack of function could mean that these elements will be lost by genetic drift. However, EVEs were enriched in

piRNA clusters in 28 out of the 48 arthropod genomes studied, and 77.5% of them were the source of primary piRNA production (and few also source of siRNA production). Moreover, 35.7% of EVEs were located outside piRNA clusters and produced primary piRNAs (ter Horst et al. 2018). Although the piRNA pathway does not have any antiviral role in *Drosophila*, this pathway involves a high number of Piwi genes, which have been linked to expansion and functional specialization in *Aedes* mosquitoes (Miesen, Joosten, and van Rij 2016; Campbell et al. 2008; Hess et al. 2011). Moreover, piRNA production following arboviral infections has been widely documented in mosquitoes (Hess et al. 2011; Miesen, Joosten, and van Rij 2016; Morazzani et al. 2012; Léger et al. 2013; Schnettler, Donald, et al. 2013; Scott et al. 2010; Vodovar et al. 2012). Therefore it is tempting to speculate that piRNA pathway and EVEs can be involved in antiviral immunity in mosquitoes.

In this thesis, because of their high variability at the intra- and inter-population levels as well as their ability to produce piRNAs (Palatini et al. 2017), we wondered if AlbFlavi2 and AlbFlavi36 were correlated to arboviral vector competence in *Ae. albopictus*. We showed no solid evidence of association between their presence and dissemination of DENV and CHIKV in mosquitoes, questioning their implication in modulating arboviral infections in *Ae. albopictus*. There is no doubt that piRNA production from viral integrations is not sufficient to prove their antiviral activity. As a matter of fact, although the piRNA-directed cleavage is not as stringent as the siRNA-directed one and allows few nucleotide mismatches (Reuter et al. 2011; X. A. Huang et al. 2013), perfect base pairing between nucleotides 2 and 22 are required for efficient cleavage by Miwi in mice (a homolog of Piwi) (Reuter et al. 2011). This is far from what has been obtained with EVE-derived piRNAs in arthropods (ter Horst et al. 2018) (Appendix N°1).

In the case of NIRVS, such as AlbFlavi2 and AlbFalvi36, for which no association with vector competence to arboviruses has been shown despite evidence of piRNA

production, several hypotheses can be made. We can speculate that targeted exogenous viruses could have found ways to counteract EVE-derived piRNA silencing, maybe by producing VSRs as it has been found with the siRNA pathway. These viruses could also have evolved and become so different from the time the integrations occurred in the genome that they can no longer be detectable by AlbFlavi2- and AlbFlavi36-derived piRNAs. Consistent with this hypothesis, it has been suggested that the recognition of EVE-derived piRNAs on their target could decline over time as exogenous viruses diverge (ter Horst et al. 2018). Additionally, consistent with their variable frequency in mosquito populations, the potential antiviral functions of AlbFlavi2 and AlbFlavi36 could also play a minor role in controlling arboviral infections. During epidemics, the number of infected mosquitoes is usually very low considering the whole size of a mosquito population. As example, in Rio de Janeiro (Brazil), while 68,000 thousand human DENV cases were reported in 2012-2013, only 0.81% of the wild-caught mosquitoes were found as DENV positive (N=3053; (dos Santos et al. 2017). It is then tempting to hypothesize that mosquitoes are submitted to low and heterogeneous viral selection pressures, which may contribute to modulate EVE formation and control of their variability. Moreover, experiments focusing on expression of piRNAs produced from AlbFlavi2, AlbFlavi36 and other NIRVS after viral infection of arboviruses will be very informative.

In fact, these experiments have been anticipated and already performed during this thesis. We assessed NIRVS-derived piRNA and siRNA expressions following DENV and CHIKV infections in *Ae. albopictus* Foshan (Appendix N°2). Preliminary results showed that many of them were up/down-regulated after DENV infection but not CHIKV. NIRVS-derived piRNAs were originated from Flavi-NIRVS, but surprisingly also from rhabdoviral elements. Consistent with the limited complementarity between NIRVS-derived piRNAs and current viruses, it is likely that NIRVS originated from different viral families could modulate non-

specific viral infections by acting on antiviral mechanisms that are still unknown. This would also explain how NIRVS from ISVs could act on arboviruses. It would be interesting to know if changes in expression of Flavi-NIRVS-derived piRNAs also occur following rhabdoviral infections in mosquitoes. Additionally, some EVE-derived piRNAs could also act on other EVEs that promote viral persistence instead of inhibiting viral infections. Therefore, more investigations regarding the potential antiviral role of NIRVS are needed. In this way, one promising NIRVS that requires more attention is the one found for the first time in 2004 in *Ae. albopictus* C6/36 cell line (Crochu et al. 2004). Indeed, this NIRVS contained an intact ORF of 1,557 aa homologous to ISF genomes and, although its translation into protein has not been proved yet, its transcription into a full transcript has been detected (Crochu et al. 2004; Suzuki et al. 2017).

Whether EVEs (including NIRVS) have antiviral functions remain unsolved. If not, to what purpose would they be produced? What would be their functions? While the piRNA pathway was originally proved to act on TEs, other genes/regions in insect genomes could also be targeted by EVE-derived piRNAs. Recent studies have shown that some piRNAs in *Culex pipiens pallens* are involved in the regulation of insecticide resistance (Ye et al. 2017; Guo et al. 2017). Then, further investigations are required to understand the biological functions of EVE-derived piRNAs. Finally, the role of vDNA in infected cells should be more deeply investigated. Indeed, it is also possible that instead of EVEs, vDNA present as episomes could serve as a template for piRNA production and be transcribed into primary piRNA precursors once in the nucleus of cells. However, little is known about the stability of these episomes and their persistence in mosquito cells.

EVE formation

The conditions required for the endogenization of DNA and RNA viruses into host genomes remain largely unclear. Among the potential factors influencing EVE formation, the intense (acute) and long-lasting (chronic) infections have been suggested. While an *in vitro* experiment showed no effects of the multiplicity of infection (MOI) on DENV DNA production in C6/36 cells (Nag, Brecher, and Kramer 2016), chronic rather than acute infections have been suggested to produce more EVEs (Holmes 2011). Also, it is possible that commensal and mutualistic viruses can have better chance to endogenize. But because EVE biological functions in their hosts have been mostly described as antiviral, these types of EVEs would probably have minor positive effects on hosts, then decreasing the odds of these elements to be conserved and fixed in host populations. On the contrary, punctual infections of viruses that are pathogenic for hosts would have fewer opportunities to produce EVEs but better chance to be kept and fixed in host genomes, suggesting that these elements have antiviral functions against the corresponding exogenous viruses (Gilbert and Feschotte 2016). For these reasons, further experiments should be performed in order to detect a possible association between the odds of endogenization and virus prevalence in hosts, as well as the type of virus-host interactions (commensalism, parasitism and mutualism).

Viral endogenization is directly related to retrotransposons and this association integrates into insect genomes through non-homologous recombination (Matthew J. Ballinger, Bruenn, and Taylor 2012; Goic et al. 2013b). LTR retrotransposons are more associated with vDNA, probably because their transcription occurs in the cytoplasm (as the replication of most RNA viruses), as compared to non-LTR retrotransposons, for which their transcription takes place at the insertion site in the cell nucleus (Havecker, Gao, and Voytas 2004; Geuking et al. 2009; Horie et al. 2010; Matthew J. Ballinger, Bruenn, and

Taylor 2012). It has been demonstrated that vDNA synthesis is blocked when endogenous reverse transcriptase activity is inhibited (Goic et al. 2013b). Moreover, transposable elements have been detected in the flanking regions of many EVEs. This is further supported by the discovery of ISV-like helicase domains in retrotransposon proteins of many insect orders: Lepidoptera, Hemiptera, Orthoptera, Hymenoptera and Culicidae (*Ae. aegypti*) species (Lazareva et al. 2015; Shi et al. 2016; Morozov, Lazareva, and Solovyev 2017). These proteins, in some cases, have been found acting as viral suppressors of RNAi silencing (VSRs), which in turn increase the fitness of the corresponding retrotransposons in plants (Morozov and Solovyev 2012, 2015). This would lead to higher transposition efficiency. In this way, the association between vDNA and retrotransposons would be beneficial for these mobile elements. However, excessive RNA helicase activity of such viral-like domains could also alter the balance transcription/replication of some viruses by acting on their transcription mechanisms (Morozov, Lazareva, and Solovyev 2017). Nevertheless, these hypotheses remain to be tested in insects. Therefore, further experiments are required to explore the potential benefit that retrotransposons can derive from interacting with vDNA. Overall, these results revealed the tight implication of retrotransposons in the production of EVE in host genomes.

EVE formations in host genomes are however considered as rare events. These low-frequency events could be explained by the host DNA repair machinery that is able to recognize non-self incoming DNA sequences such as viral sequences, even though some viruses have evolved to escape from this detection (Weitzman et al. 2004; Lilley, Schwartz, and Weitzman 2007). This could justify why some viruses are more frequently found as EVEs in host genomes, such as viruses from the *Rhabdoviridae*, *Chuviridae* and *Parvoviridae* families in insects, than others that are able to endogenize only sporadically (Palatini et al. 2017; Whitfield, Dolan, Kunitomi, Tassetto, et al. 2017; ter Horst et al.

2018). Moreover, the widespread distribution of these viruses and their diversity could also explain their higher ability to integrate host genomes compared to others. As example, rhabdoviruses are able to infect many different hosts by frequent cross-species transmission events (Geoghegan, Duchêne, and Holmes 2017). Potential differences in mechanisms of DNA repair machinery according to species could also explain different EVE diversity and abundance as seen between *Ae. aegypti* and *Ae. albopictus* (Palatini et al. 2017). However, different assembly and annotation qualities of their genomes could also be the source of their differences. Additionally, different replication strategies could also justify a higher probability of endogenization; the genome of negative sense ssRNA being transcribed in abundant and short transcripts could lead to higher reverse transcription efficiency by retrotransposons (Holmes 2011).

In this thesis, the culture of U4.4 and Aag2 cell lines persistently infected with five different viruses (DENV, CHIKV, VSV, CFAV and KRV) was performed during 16 passages (92 and 109 days respectively) to know if extended contacts between cells and virus trigger viral endogenization. If so, characterization of the viral sequences integrated as well as the sites of integration in the host genome should be performed. Here, we confirmed that the endogenization of non-retroviral RNA viruses is a rare event, despite high viral particles produced in cell supernatants of all combinations cell-virus examined. Surprisingly, no NIRVS from VSV or KRV have been detected in Aag2 genome. It is possible that the contact cell-virus was not long enough to allow viral integration. Despite the fact they have been cultured for 109 days, integrations of VSV and KRV in the host genome is a long-time process that probably requires a larger extended contact. In total, we found 9, 8 and 2 putative NIRVS following infections with CFAV, DENV and CHIKV respectively. Although they have been bioinformatically predicted, these NIRVS have to be confirmed by molecular biology. Interestingly, while almost all newly formed CFAV-derived NIRVS were detected

near TE sequences, only a few DENV- and CHIKV-derived NIRVS were described near these sequences. Therefore, it is possible that arboviruses use a different mechanism to integrate host genomes, as compared to insect-specific viruses. This unknown mechanism may not be as efficient as the one that involves retrotransposons, as only a few NIRVS from arboviruses have been described so far in arthropod genomes. Nevertheless, vDNA can be produced in mosquitoes following infections (Nag and Kramer 2017) and integration events in the host genome may occur at a low frequency and possibly, affect germline cells allowing vertical transmission. Additionally, we found many putative NIRVS that were composed of viral sequences that mapped to different positions on the viral genome. This actually highly suggests that the template used to produce vDNA (that is subsequently integrated into host genomes) may not be (or at least not exclusively) the viral RNA genome, but could also be defective-interfering (DI) genomes, as it has been proposed recently (Nag, Brecher, and Kramer 2016). Indeed, the production of DI genomes has been reported for many RNA viruses, both *in vivo* and *in vitro*, including DENV, CHIKV and VSV (D. Li et al. 2011; Gillies and Stollar 1980; Juárez-Martínez et al. 2013; Poirier et al. 2018). In this recent study, more vDNA from DENV was found in RNAi-deficient cells (C6/36 cells) than in RNAi-proficient cell (Aag cells), suggesting that vDNA production is negatively associated to the antiviral RNAi system. Moreover, vDNA molecules produced in DENV-infected Aag cells were also found in DENV-infected C6/36 cells, but the reverse was not true. Therefore, if vDNA is involved in the control of viral replication after integrating the host genome, then we can speculate that not all vDNA molecules, but instead some located at specific regions of the host genome, are involved in this process. As seen with endogenous retroviruses in the human genome (Medstrand, Van De Lagemaat, and Mager 2002), these specific regions could be located away from genes to avoid a significant fitness cost to the host that will trigger rapid elimination of integrations from the genome.

As expected, most of the putative Flavivirus-derived NIRVS found were similar to sequences encoding NS3 and NS5 proteins (with the latter having RNA-dependent-RNA polymerase (RdRP) activity) (Crochu et al. 2004; Aris Katzourakis and Gifford 2010; Fort et al. 2012; Matthew J. Ballinger, Bruenn, and Taylor 2012; Kondo et al. 2013; M. J. Ballinger et al. 2014; Geisler and Jarvis 2016; Lequime and Lambrechts 2017; Suzuki et al. 2017; Palatini et al. 2017; Whitfield, Dolan, Kunitomi, Tassetto, et al. 2017). Because of their important role in the viral lifecycle, these proteins are very conserved in the RNA genome and are submitted to high selection pressures (Hughes and Hughes 2007; Shi et al. 2016). This combined with the low mutation rate after their integration in the host genome makes their detection easier. Therefore it is also possible that NIRVS formation originated from lowly conserved genes occurred as much as highly conserved ones but could not be detected in the host genome because of their high divergence from their corresponding exogenous viruses. Consistent with this hypothesis, most of Flavivirus-NIRVS discovered in *Aedes* mosquitoes originated from non-structural proteins that are highly conserved among the viral family (da Fonseca et al. 2017). Abundance transcripts could also play a role in the integration of viral sequences. For instance, for rhabdoviruses, five genes are gradually transcribed from 3' to 5' (N > P > M > G > L genes) (Ogino 2013) and despite the highly conserved L gene (encoding for the polymerase), most of the NIRVS found in insect genomes were similar to the most abundant gene (N; encoding for the nucleoprotein) (Palatini et al. 2017).

Overall, the formation of EVEs in host genomes occurs more often than previously thought. The presence of EVEs from arboviruses in mosquito cells revealed that a large range of viruses is able to endogenize. However, further investigations are required to understand the stability of these EVEs *in vitro*, the regions in which they integrated as well as their potential functions.

Conclusion

This thesis provides additional information regarding the characterization of virus-host coevolution. Although viruses have been for a long time considered as harmful biological entities for humans and other organisms, scientific researches are starting to provide compelling evidence describing the beneficial effects of viral infections through mutualistic and commensal interactions. As example, viruses have been proved to help their hosts to resist to microbes and to adapt to new environments (Roossinck 2015). After all, their fluctuating pathogenic effects may result from a non-stable adaptation to their hosts.

Understanding all the consequences of long-term virus-host interactions is critical, and it includes the effects of viral integrations in host genomes, especially since RNA viruses were suggested to be used as RNA vaccine vectors (Mogler and Kamrud 2014). An insect-specific alphavirus, Eilat virus (EILV) unable to replicate in vertebrate cells, has been recently used to create chimeras containing structural proteins of pathogenic alphaviruses such as CHIKV, Eastern equine encephalitis virus (EEEV) and Venezuelan equine encephalitis virus (VEEV). Injection of a single dose of chimeras in mice conferred protective responses by generating neutralizing antibodies (Erasmus et al. 2018). The use of insect-specific alphaviruses as vaccine vectors could be a good strategy as no integrations from these viruses have been found so far. In *Ae. aegypti*, former attempts to produce antiviral transgenes associated to piggyBAC or mariner transposable elements in mosquitoes resulted in an unstable expression caused by random insertions in the host genome (Mishra et al. 2016; A. W. E. Franz et al. 2006). EVEs and piRNA clusters that are naturally maintained through generations could however provide useful information that could help to optimize and to target specific regions of the genome where transgene expressions could be steady and maintained.

References

- Adams, A. Paige, Amelia P A Travassos Da Rosa, Marcio R. Nunes, Shu Yuan Xiao, and Robert B. Tesh. 2013. "Pathogenesis of Modoc Virus (Flaviviridae; Flavivirus) in Persistently Infected Hamsters." *American Journal of Tropical Medicine and Hygiene*. <https://doi.org/10.4269/ajtmh.12-0110>.
- Adhami, J, and P Reiter. 1998. "Introduction and Establishment of Aedes (Stegomyia) Albopictus Skuse (Diptera: Culicidae) in Albania." *Journal of the American Mosquito Control Association*.
- Aggarwal, Kamna, and Neal Silverman. 2008. "Positive and Negative Regulation of the Drosophila Immune Response." *BMB Reports* 41 (4): 267–77. <https://doi.org/10.5483/bmbrep.2008.41.4.267>.
- Aguirre, Sebastian, Priya Luthra, Maria T Sanchez-Aparicio, Ana M Maestre, Jenish Patel, Francise Lamothe, Anthony C Fredericks, et al. 2017. "Dengue Virus NS2B Protein Targets CGAS for Degradation and Prevents Mitochondrial DNA Sensing during Infection." *Nature Microbiology* 2 (March): 17037. <https://doi.org/10.1038/nmicrobiol.2017.37>.
- Aiewsakun, Pakorn, and Aris Katzourakis. 2015. "Endogenous Viruses: Connecting Recent and Ancient Viral Evolution." *Virology* 479–480 (May): 26–37. <https://doi.org/10.1016/j.virol.2015.02.011>.
- Akbari, Omar S., Igor Antoshechkin, Henry Amrhein, Brian Williams, Race Diloreto, Jeremy Sandler, and Bruce A. Hay. 2013. "The Developmental Transcriptome of the Mosquito *Aedes Aegypti*, an Invasive Species and Major Arbovirus Vector." *G3 & Genes/Genomes/Genetics* 3 (9): 1493–1509. <https://doi.org/10.1534/g3.113.006742>.
- Aliota, Matthew T, Susan A Jones, Alan P Dupuis, Alexander T Ciota, Zdenek Hubalek, and Laura D Kramer. 2012. "Characterization of Rabensburg Virus, a Flavivirus Closely Related to West Nile Virus of the Japanese Encephalitis Antigenic Group." *PloS One* 7 (6): e39387. <https://doi.org/10.1371/journal.pone.0039387>.
- Aliota, Matthew T, and Laura D Kramer. 2012. "Replication of West Nile Virus, Rabensburg Lineage in Mammalian Cells Is Restricted by Temperature." *Parasites & Vectors* 5 (December): 293. <https://doi.org/10.1186/1756-3305-5-293>.
- Alkan, Cigdem, Sonia Zapata, Laurence Bichaud, Grégory Moureau, Philippe Lemey, Andrew E. Firth, Tamara S. Gritsun, et al. 2015. "Ecuador Paraiso Escondido Virus, a New Flavivirus Isolated from New World Sand Flies in Ecuador, Is the First Representative of a Novel Clade in the Genus Flavivirus." *Journal of Virology*. <https://doi.org/10.1128/jvi.01543-15>.
- Almeida, A. Paulo G., Susana S. S. G. Baptista, Carla A. G. C. C. Sousa, M. Teresa L. M. Novo, Helena C. Ramos, Nicholas A. Panella, Marvin Godsey, et al. 2005. "Bioecology and Vectorial Capacity of *Aedes Albopictus* (Diptera: Culicidae) in Macao, China, in Relation to Dengue Virus Transmission." *Journal of Medical Entomology* 42 (3): 419–28. <https://doi.org/10.1093/jmedent/42.3.419>.

- Alvarez, Diego E, Ana Laura De Lella Ezcurra, Silvana Fucito, and Andrea V Gamarnik. 2005. "Role of RNA Structures Present at the 3'UTR of Dengue Virus on Translation, RNA Synthesis, and Viral Replication." *Virology* 339 (2): 200–212. <https://doi.org/10.1016/j.virol.2005.06.009>.
- Amarasinghe, Ananda, Joel N. Kuritsky, G. William Letson, and Harold S. Margolis. 2011. "Dengue Virus Infection in Africa." *Emerging Infectious Diseases*. <https://doi.org/10.3201/eid1708.101515>.
- Amuzu, Hilaria E., Kirill Tsyganov, Cassandra Koh, Rosemarie I. Herbert, David R. Powell, and Elizabeth A. McGraw. 2018. "Wolbachia Enhances Insect-Specific Flavivirus Infection in *Aedes Aegypti* Mosquitoes." *Ecology and Evolution*. <https://doi.org/10.1002/ece3.4066>.
- Anai, Yukari, Haruyo Ochi, Shinya Watanabe, So Nakagawa, Maki Kawamura, Takashi Gojobori, and Kazuo Nishigaki. 2012. "Infectious Endogenous Retroviruses in Cats and Emergence of Recombinant Viruses." *Journal of Virology*. <https://doi.org/10.1128/jvi.00280-12>.
- Antony, Joseph M., Guido Van Marle, Wycliffe Opii, D. Allan Butterfield, François Mallet, Voon Wee Yong, John L. Wallace, Robert M. Deacon, Kenneth Warren, and Christopher Power. 2004. "Human Endogenous Retrovirus Glycoprotein-Mediated Induction of Redox Reactants Causes Oligodendrocyte Death and Demyelination." *Nature Neuroscience*. <https://doi.org/10.1038/nn1319>.
- Arensburger, Peter, Karine Megy, Robert M Waterhouse, Jenica Abrudan, Paolo Amedeo, Beatriz Antelo, Lyric Bartholomay, et al. 2010. "Sequencing of *Culex quinquefasciatus* Establishes a Platform for Mosquito Comparative Genomics." *Science (New York, N.Y.)* 330 (6000): 86–88. <https://doi.org/10.1126/science.1191864>.
- Arias, Carlos F., Frank Preugschat, and James H. Strass. 1993. "Dengue 2 Virus Ns2b and Ns3 Form a Stable Complex That Can Cleave Ns3 within the Helicase Domain." *Virology*. <https://doi.org/10.1006/viro.1993.1198>.
- Arnaud, F., P. R. Murcia, and M. Palmarini. 2007. "Mechanisms of Late Restriction Induced by an Endogenous Retrovirus." *Journal of Virology* 81 (20): 11441–51. <https://doi.org/10.1128/JVI.01214-07>.
- Aswad, Amr, and Aris Katzourakis. 2012. "Paleovirology and Virally Derived Immunity." *Trends in Ecology & Evolution* 27 (11): 627–36. <https://doi.org/10.1016/j.tree.2012.07.007>.
- Aswad, Amr, and Aris Katzourakis. 2014. "The First Endogenous Herpesvirus, Identified in the Tarsier Genome, and Novel Sequences from Primate Rhadinoviruses and Lymphocryptoviruses." *PLoS Genetics*. <https://doi.org/10.1371/journal.pgen.1004332>.
- Avirutnan, Panisadee, Anja Fuchs, Richard E. Hauhart, Pawit Somnuk, Soonjeon Youn, Michael S. Diamond, and John P. Atkinson. 2010. "Antagonism of the Complement Component C4 by Flavivirus Nonstructural Protein NS1." *The Journal of Experimental Medicine*. <https://doi.org/10.1084/jem.20092545>.

- Avirutnan, Panisadee, Richard E. Hauhart, Pawit Somnuke, Anna M. Blom, Michael S. Diamond, and John P. Atkinson. 2011. "Binding of Flavivirus Nonstructural Protein NS1 to C4b Binding Protein Modulates Complement Activation." *The Journal of Immunology*. <https://doi.org/10.4049/jimmunol.1100750>.
- Babushok, Daria V, and Haig H Kazazian. 2007. "Progress in Understanding the Biology of the Human Mutagen LINE-1." *Human Mutation* 28 (6): 527–39. <https://doi.org/10.1002/humu.20486>.
- Baidaliuk, Artem, Elliott F. Miot, Sebastian Lequime, Isabelle Moltini-Conclois, Fanny Delaigue, Stéphanie Dabo, Laura B. Dickson, et al. 2019. "Cell-Fusing Agent Virus Reduces Arbovirus Dissemination in *Aedes Aegypti* Mosquitoes in Vivo ." *Journal of Virology*. <https://doi.org/10.1128/jvi.00705-19>.
- Balanovsky, Oleg, Elvira Pocheshkhova, Andrey Pshenichnov, Daria Solovieva, Marina Kuznetsova, Olga Voronko, Michail Churnosov, et al. 2005. "Is Spatial Distribution of the HIV-1-Resistant CCR5Delta32 Allele Formed by Ecological Factors?" *Journal of Physiological Anthropology and Applied Human Science* 24 (4): 375–82. <http://www.ncbi.nlm.nih.gov/pubmed/16079584>.
- Ballinger, M. J., J. A. Bruenn, J. Hay, D. Czechowski, and D. J. Taylor. 2014. "Discovery and Evolution of Bunyavirids in Arctic Phantom Midges and Ancient Bunyavirid-Like Sequences in Insect Genomes." *Journal of Virology*. <https://doi.org/10.1128/jvi.00531-14>.
- Ballinger, Matthew J., Jeremy A. Bruenn, and Derek J. Taylor. 2012. "Phylogeny, Integration and Expression of Sigma Virus-like Genes in *Drosophila*." *Molecular Phylogenetics and Evolution*. <https://doi.org/10.1016/j.ympev.2012.06.008>.
- Banerjee, A K. 1987. "Transcription and Replication of Rhabdoviruses." *Microbiological Reviews*.
- Bannert, Norbert, Henning Hofmann, Adriana Block, and Oliver Hohn. 2018. "HERVs New Role in Cancer: From Accused Perpetrators to Cheerful Protectors." *Frontiers in Microbiology*. <https://doi.org/10.3389/fmicb.2018.00178>.
- Batzer, Mark A, and Prescott L Deininger. 2002. "Alu Repeats and Human Genomic Diversity." *Nature Reviews. Genetics* 3 (5): 370–79. <https://doi.org/10.1038/nrg798>.
- Beebe, Nigel W., Luke Ambrose, Lydia A. Hill, Joseph B. Davis, George Hapgood, Robert D. Cooper, Richard C. Russell, et al. 2013. "Tracing the Tiger: Population Genetics Provides Valuable Insights into the *Aedes (Stegomyia) Albopictus* Invasion of the Australasian Region." *PLoS Neglected Tropical Diseases*. <https://doi.org/10.1371/journal.pntd.0002361>.
- Belalov, Ilya S., and Alexander N. Lukashev. 2013. "Causes and Implications of Codon Usage Bias in RNA Viruses." *PLoS ONE*. <https://doi.org/10.1371/journal.pone.0056642>.
- Belyi, Vladimir A., Arnold J. Levine, and Anna Marie Skalka. 2010a. "Unexpected Inheritance: Multiple Integrations of Ancient Bornavirus and Ebolavirus/Marburgvirus

- Sequences in Vertebrate Genomes.” Edited by Michael J. Buchmeier. *PLoS Pathogens* 6 (7): e1001030. <https://doi.org/10.1371/journal.ppat.1001030>.
- Belyi, Vladimir A, Arnold J Levine, and Anna Marie Skalka. 2010b. “Sequences from Ancestral Single-Stranded DNA Viruses in Vertebrate Genomes: The Parvoviridae and Circoviridae Are More than 40 to 50 Million Years Old.” *Journal of Virology* 84 (23): 12458–62. <https://doi.org/10.1128/JVI.01789-10>.
- Bergman, Casey M, Hadi Quesneville, Dominique Anxolabéhère, and Michael Ashburner. 2006. “Recurrent Insertion and Duplication Generate Networks of Transposable Element Sequences in the *Drosophila Melanogaster* Genome.” *Genome Biology*. <https://doi.org/10.1186/gb-2006-7-11-r112>.
- Bernard, Eric, Maxime Solignat, Bernard Gay, Nathalie Chazal, Stephen Higgs, Christian Devaux, and Laurence Briant. 2010. “Endocytosis of Chikungunya Virus into Mammalian Cells: Role of Clathrin and Early Endosomal Compartments.” *PloS One* 5 (7): e11479. <https://doi.org/10.1371/journal.pone.0011479>.
- Best, S., P. L. Tissier, G. Towers, and J. P. Stoye. 1996. “Positional Cloning of the Mouse Retrovirus Restriction Gene Fv1.” *Nature*. <https://doi.org/10.1038/382826a0>.
- Best, S, P Le Tissier, G Towers, and J P Stoye. 1996. “Positional Cloning of the Mouse Retrovirus Restriction Gene Fv1.” *Nature* 382 (6594): 826–29. <https://doi.org/10.1038/382826a0>.
- Bézier, Annie, Faustine Louis, Séverine Jancek, Georges Periquet, Julien Thézé, Gabor Gyapay, Karine Musset, et al. 2013. “Functional Endogenous Viral Elements in the Genome of the Parasitoid Wasp *Cotesia Congregata*: Insights into the Evolutionary Dynamics of Bracoviruses.” *Philosophical Transactions of the Royal Society B: Biological Sciences*. <https://doi.org/10.1098/rstb.2013.0047>.
- Bigham, Abigail W., Kati J. Buckingham, Sofia Husain, Mary J. Emond, Kathryn M. Bofferding, Heidi Gildersleeve, Ann Rutherford, et al. 2011. “Host Genetic Risk Factors for West Nile Virus Infection and Disease Progression.” *PLoS ONE*. <https://doi.org/10.1371/journal.pone.0024745>.
- Bill, C. A., and J. Summers. 2004. “Genomic DNA Double-Strand Breaks Are Targets for Hepadnaviral DNA Integration.” *Proceedings of the National Academy of Sciences*. <https://doi.org/10.1073/pnas.0403925101>.
- Black, W C, J A Ferrari, K S Rai, and D Sprenger. 1988. “Breeding Structure of a Colonising Species: *Aedes Albopictus* (Skuse) in the United States.” *Heredity* 60 (Pt 2) (April): 173–81. <http://www.ncbi.nlm.nih.gov/pubmed/3366625>.
- Blair, Carol D. 2011. “Mosquito RNAi Is the Major Innate Immune Pathway Controlling Arbovirus Infection and Transmission.” *Future Microbiology* 6 (3): 265–77. <https://doi.org/10.2217/fmb.11.11>.
- Blevins, Todd, Rajendran Rajeswaran, Padubidri V. Shivaprasad, Daria Beknazariants, Azeddine Si-Ammour, Hyun Sook Park, Franck Vazquez, et al. 2006. “Four Plant Dicers

- Mediate Viral Small RNA Biogenesis and DNA Virus Induced Silencing.” *Nucleic Acids Research*. <https://doi.org/10.1093/nar/gkl886>.
- Blitvich, Bradley J, and Andrew E Firth. 2015. “Insect-Specific Flaviviruses: A Systematic Review of Their Discovery, Host Range, Mode of Transmission, Superinfection Exclusion Potential and Genomic Organization.” *Viruses* 7: 1927–59. <https://doi.org/10.3390/v7041927>.
- Blitvich, Bradley J, Ming Lin, Karin S Dorman, Victor Soto, Einat Hovav, Bradley J Tucker, Molly Staley, Kenneth B Platt, and Lyric C Bartholomay. 2009. “Genomic Sequence and Phylogenetic Analysis of Culex Flavivirus, an Insect-Specific Flavivirus, Isolated from Culex Pipiens (Diptera: Culicidae) in Iowa.” *Journal of Medical Entomology* 46 (4): 934–41. <https://doi.org/10.1603/033.046.0428>.
- Bock, M, and J P Stoye. 2000. “Endogenous Retroviruses and the Human Germline.” *Current Opinion in Genetics & Development* 10 (6): 651–55. <http://www.ncbi.nlm.nih.gov/pubmed/11088016>.
- Bolling, Bethany G., Francisco J. Olea-Popelka, Lars Eisen, Chester G. Moore, and Carol D. Blair. 2012a. “Transmission Dynamics of an Insect-Specific Flavivirus in a Naturally Infected Culex Pipiens Laboratory Colony and Effects of Co-Infection on Vector Competence for West Nile Virus.” *Virology* 427 (2): 90–97. <https://doi.org/10.1016/j.virol.2012.02.016>.
- Bolling, Bethany G, Lars Eisen, Chester G Moore, and Carol D Blair. 2011. “Insect-Specific Flaviviruses from Culex Mosquitoes in Colorado, with Evidence of Vertical Transmission.” *The American Journal of Tropical Medicine and Hygiene* 85 (1): 169–77. <https://doi.org/10.4269/ajtmh.2011.10-0474>.
- Bolling, Bethany G, Francisco J Olea-Popelka, Lars Eisen, Chester G Moore, and Carol D Blair. 2012b. “Transmission Dynamics of an Insect-Specific Flavivirus in a Naturally Infected Culex Pipiens Laboratory Colony and Effects of Co-Infection on Vector Competence for West Nile Virus.” *Virology* 427 (2): 90–97. <https://doi.org/10.1016/j.virol.2012.02.016>.
- Bolling, Bethany G, Nikos Vasilakis, Hilda Guzman, Steven G Widen, Thomas G Wood, Vsevolod L Popov, Saravanan Thangamani, and Robert B Tesh. 2015. “Insect-Specific Viruses Detected in Laboratory Mosquito Colonies and Their Potential Implications for Experiments Evaluating Arbovirus Vector Competence.” *Am. J. Trop. Med. Hyg* 92 (2): 422–28. <https://doi.org/10.4269/ajtmh.14-0330>.
- Bolling, Bethany G, Scott C Weaver, Robert B Tesh, Nikos Vasilakis, and Karyn Johnson. 2015. “Insect-Specific Virus Discovery: Significance for the Arbovirus Community.” <https://doi.org/10.3390/v7092851>.
- Brackney, Doug E, Jaclyn C Scott, Fumihiko Sagawa, Jimmy E Woodward, Neil A Miller, Faye D Schilkey, Joann Mudge, et al. 2010. “C6/36 Aedes Albopictus Cells Have a Dysfunctional Antiviral RNA Interference Response.” *PLoS Neglected Tropical Diseases* 4 (10): e856. <https://doi.org/10.1371/journal.pntd.0000856>.

- Bravo, Alejandra, Supaporn Likitvivatanavong, Sarjeet S. Gill, and Mario Soberón. 2011. "Bacillus Thuringiensis: A Story of a Successful Bioinsecticide." *Insect Biochemistry and Molecular Biology*. <https://doi.org/10.1016/j.ibmb.2011.02.006>.
- Brennecke, Julius, Alexei A Aravin, Alexander Stark, Monica Dus, Manolis Kellis, Ravi Sachidanandam, and Gregory J Hannon. 2007. "Discrete Small RNA-Generating Loci as Master Regulators of Transposon Activity in Drosophila." *Cell* 128 (6): 1089–1103. <https://doi.org/10.1016/j.cell.2007.01.043>.
- Brinson, F J, D V Hagan, J A Comer, and D A Strohle. 1992. "Seasonal Abundance of Lutzomyia Shannoni (Diptera: Psychodidae) on Ossabaw Island, Georgia." *Journal of Medical Entomology* 29 (2): 178–82. <https://doi.org/10.1093/jmedent/29.2.178>.
- Bronkhorst, Alfred W, and Ronald P van Rij. 2014. "The Long and Short of Antiviral Defense: Small RNA-Based Immunity in Insects." *Current Opinion in Virology* 7 (August): 19–28. <https://doi.org/10.1016/j.coviro.2014.03.010>.
- Brown, K., R. D. Emes, and R. E. Tarlinton. 2014. "Multiple Groups of Endogenous Epsilon-Like Retroviruses Conserved across Primates." *Journal of Virology*. <https://doi.org/10.1128/jvi.00966-14>.
- Buri, P. 1956. "Gene Frequency in Small Populations of Mutant Drosophila." *Evolution* 10: 367–402.
- Burke, D. S., A. Nisalak, D. E. Johnson, and R. Scott McN. 1988. "A Prospective Study of Dengue Infections in Bangkok." *American Journal of Tropical Medicine and Hygiene*. <https://doi.org/10.4269/ajtmh.1988.38.172>.
- Bustamante Rivera, Yomara Y., Christine Brütting, Caroline Schmidt, Ines Volkmer, and Martin S. Staeger. 2018. "Endogenous Retrovirus 3-History, Physiology, and Pathology." *Frontiers in Microbiology*. <https://doi.org/10.3389/fmicb.2017.02691>.
- Callen, D F, A D Thompson, Y Shen, H A Phillips, R I Richards, J C Mulley, and G R Sutherland. 1993. "Incidence and Origin of 'Null' Alleles in the (AC)_n Microsatellite Markers." *American Journal of Human Genetics*.
- Calzolari, Mattia, Líbia Zé-Zé, Daniel Růžek, Ana Vázquez, Claire Jeffries, Francesco Defilippo, Hugo Costa Osório, et al. 2012. "Detection of Mosquito-Only Flaviviruses in Europe." *The Journal of General Virology* 93 (Pt 6): 1215–25. <https://doi.org/10.1099/vir.0.040485-0>.
- Cammissa-Parks, Helen, Laura A. Cisar, Arlene Kane, and Victor Stollar. 1992. "The Complete Nucleotide Sequence of Cell Fusing Agent (CFA): Homology between the Nonstructural Proteins Encoded by CFA and the Nonstructural Proteins Encoded by Arthropod-Borne Flaviviruses." *Virology*. [https://doi.org/10.1016/0042-6822\(92\)90575-A](https://doi.org/10.1016/0042-6822(92)90575-A).
- Campbell, Corey L., Kimberly M. Keene, Douglas E. Brackney, Ken E. Olson, Carol D. Blair, Jeffrey Wilusz, and Brian D. Foy. 2008. "Aedes Aegypti Uses RNA Interference

- in Defense against Sindbis Virus Infection.” *BMC Microbiology*.
<https://doi.org/10.1186/1471-2180-8-47>.
- Cardona-Ospina, Jaime A., Wilmer E. Villamil-Gómez, Carlos E. Jimenez-Canizales, Diana M. Castañeda-Hernández, and Alfonso J. Rodríguez-Morales. 2015. “Estimating the Burden of Disease and the Economic Cost Attributable to Chikungunya, Colombia, 2014.” *Transactions of the Royal Society of Tropical Medicine and Hygiene*.
<https://doi.org/10.1093/trstmh/trv094>.
- Carrera, Jean-Paul, Hilda Guzman, Davis Beltrán, Yamilka Díaz, Sandra López-Vergès, Rolando Torres-Cosme, Vsevolod Popov, et al. 2015. “Mercadeo Virus: A Novel Mosquito-Specific Flavivirus from Panama.” *The American Journal of Tropical Medicine and Hygiene* 93 (5): 1014–19. <https://doi.org/10.4269/ajtmh.15-0117>.
- Casillas, Sònia, Antonio Barbadilla, and Casey M. Bergman. 2007. “Purifying Selection Maintains Highly Conserved Noncoding Sequences in Drosophila.” *Molecular Biology and Evolution*. <https://doi.org/10.1093/molbev/msm150>.
- Cassadou, S., S. Boucau, M. Petit-Sinturel, P. Huc, I. Leparç-Goffart, and M. Ledrans. 2014. “Emergence of Chikungunya Fever on the French Side of Saint Martin Island, October to December 2013.” *Eurosurveillance*. <https://doi.org/10.2807/1560-7917.ES2014.19.13.20752>.
- Chapman, Erich G., Stephanie L. Moon, Jeffrey Wilusz, and Jeffrey S. Kieft. 2014. “RNA Structures That Resist Degradation by Xrn1 Produce a Pathogenic Dengue Virus RNA.” *ELife*. <https://doi.org/10.7554/eLife.01892>.
- Chávez, Juliana Helena, Jaqueline Raymondi Silva, Alberto Anastacio Amarilla, and Luiz Tadeu Moraes Figueiredo. 2010. “Domain III Peptides from Flavivirus Envelope Protein Are Useful Antigens for Serologic Diagnosis and Targets for Immunization.” *Biologicals*. <https://doi.org/10.1016/j.biologicals.2010.07.004>.
- Chen, H J, J Yuan, and P Lobel. 1997. “Systematic Mutational Analysis of the Cation-Independent Mannose 6-Phosphate/Insulin-like Growth Factor II Receptor Cytoplasmic Domain. An Acidic Cluster Containing a Key Aspartate Is Important for Function in Lysosomal Enzyme Sorting.” *The Journal of Biological Chemistry* 272 (11): 7003–12. <https://doi.org/10.1074/jbc.272.11.7003>.
- Chen, Xiao-Guang, Xuanting Jiang, Jinbao Gu, Meng Xu, Yang Wu, Yuhua Deng, Chi Zhang, et al. 2015a. “Genome Sequence of the Asian Tiger Mosquito, *Aedes Albopictus*, Reveals Insights into Its Biology, Genetics, and Evolution.” *Proceedings of the National Academy of Sciences* 112 (44): E5907–15. <https://doi.org/10.1073/pnas.1516410112>.
- Chevillon, Christine, Laurence Briant, François Renaud, and Christian Devaux. 2008. “The Chikungunya Threat: An Ecological and Evolutionary Perspective.” *Trends in Microbiology*. <https://doi.org/10.1016/j.tim.2007.12.003>.
- Chiu, Wei-Wei, Richard M Kinney, and Theo W Dreher. 2005. “Control of Translation by the 5’- and 3’-Terminal Regions of the Dengue Virus Genome.” *Journal of Virology* 79 (13):

8303–15. <https://doi.org/10.1128/JVI.79.13.8303-8315.2005>.

- Christie, James. 1882. “On Epidemics of Dengue Fever; Their Diffusion and Etiology.” *The Indian Medical Gazette* 17 (3): 76–79. <http://www.ncbi.nlm.nih.gov/pubmed/28998889>.
- Chuong, Edward B., Nels C. Elde, and Cédric Feschotte. 2016. “Regulatory Evolution of Innate Immunity through Co-Option of Endogenous Retroviruses.” *Science*. <https://doi.org/10.1126/science.aad5497>.
- Cirimotich, Chris M., Jaclyn C. Scott, Aaron T. Phillips, Brian J. Geiss, and Ken E. Olson. 2009. “Suppression of RNA Interference Increases Alphavirus Replication and Virus-Associated Mortality in *Aedes Aegypti* Mosquitoes.” *BMC Microbiology*. <https://doi.org/10.1186/1471-2180-9-49>.
- Cleef, Koen W R Van, Joël T. Van Mierlo, Pascal Miesen, Gijs J. Overheul, Jelke J. Fros, Susan Schuster, Marco Marklewitz, Gorben P. Pijlman, Sandra Junglen, and Ronald P. Van Rij. 2014. “Mosquito and *Drosophila* Entomobirnaviruses Suppress DsRNA- and SiRNA-Induced RNAi.” *Nucleic Acids Research*. <https://doi.org/10.1093/nar/gku528>.
- Cleef, Koen W R van, Joël T van Mierlo, Marius van den Beek, and Ronald P van Rij. 2011. “Identification of Viral Suppressors of RNAi by a Reporter Assay in *Drosophila* S2 Cell Culture.” *Methods in Molecular Biology (Clifton, N.J.)* 721: 201–13. https://doi.org/10.1007/978-1-61779-037-9_12.
- Clyde, Karen, Jennifer L Kyle, and Eva Harris. 2006. “Recent Advances in Deciphering Viral and Host Determinants of Dengue Virus Replication and Pathogenesis.” *Journal of Virology* 80 (23): 11418–31. <https://doi.org/10.1128/JVI.01257-06>.
- Coffey, Lark, Anna-Bella Failloux, and Scott Weaver. 2014. “Chikungunya Virus–Vector Interactions.” *Viruses* 6 (11): 4628–63. <https://doi.org/10.3390/v6114628>.
- Coffinet, T, J R Mourou, B Pradines, J C Toto, F Jarjaval, R Amalvict, M Kombila, P Carnevale, and F Pages. 2007. “First Record of *Aedes Albopictus* in Gabon.” *J Am Mosq Control Assoc*.
- Comer, J. A., D. M. Kavanaugh, D. E. Stallknecht, G. O. Ware, J. L. Corn, and V. F. Nettles. 1993. “Effect of Forest Type on the Distribution of *Lutzomyia Shannoni* (Diptera: Psychodidae) and Vesicular Stomatitis Virus on Ossabaw Island, Georgia.” *Journal of Medical Entomology*. <https://doi.org/10.1093/jmedent/30.3.555>.
- Conzelmann, K K. 1998. “Nonsegmented Negative-Strand RNA Viruses: Genetics and Manipulation of Viral Genomes.” *Annual Review of Genetics* 32 (1): 123–62. <https://doi.org/10.1146/annurev.genet.32.1.123>.
- Cook, S., and E. C. Holmes. 2006. “A Multigene Analysis of the Phylogenetic Relationships among the Flaviviruses (Family: Flaviviridae) and the Evolution of Vector Transmission.” *Archives of Virology*. <https://doi.org/10.1007/s00705-005-0626-6>.
- Cook, Shelley, Betty Y-W Chung, David Bass, Gregory Moureau, Shuoya Tang, Erica McAlister, C Lorna Culverwell, et al. 2013. “Novel Virus Discovery and Genome Reconstruction from Field RNA Samples Reveals Highly Divergent Viruses in Dipteran

- Hosts.” *PloS One* 8 (11): e80720. <https://doi.org/10.1371/journal.pone.0080720>.
- Cook, Shelley, Gregory Moureau, Ralph E Harbach, Louis Mukwaya, Kim Goodger, Fred Ssenfuka, Ernest Gould, Edward C Holmes, and Xavier de Lamballerie. 2009. “Isolation of a Novel Species of Flavivirus and a New Strain of Culex Flavivirus (Flaviviridae) from a Natural Mosquito Population in Uganda.” *The Journal of General Virology* 90 (Pt 11): 2669–78. <https://doi.org/10.1099/vir.0.014183-0>.
- Cox, Daniel N, Anna Chao, Jeff Baker, Lisa Chang, Dan Qiao, and Haifan Lin. 1998. “A Novel Class of Evolutionarily Conserved Genes Defined By.” *Genes & Development*. <https://doi.org/10.1101/gad.12.23.3715>.
- Crabtree, M B, R C Sang, V Stollar, L M Dunster, and B R Miller. 2003. “Genetic and Phenotypic Characterization of the Newly Described Insect Flavivirus, Kamiti River Virus.” *Arch Virol* 148: 1095–1118. <https://doi.org/10.1007/s00705-003-0019-7>.
- Crabtree, Mary B., Phan T. Nga, and Barry R. Miller. 2009. “Isolation and Characterization of a New Mosquito Flavivirus, Quang Binh Virus, from Vietnam.” *Archives of Virology*. <https://doi.org/10.1007/s00705-009-0373-1>.
- Craig NL, Craigie R, Gellert M, Lambowitz AM. n.d. “Mobile DNA II.” *Washington (DC): American Society for Microbiology Press*.
- Crochu, Sandrine, Shelley Cook, Houssam Attoui, Remi N. Charrel, Reine De Chesse, Mourad Belhouchet, Jean Jacques Lemasson, Philippe de Micco, and Xavier de Lamballerie. 2004. “Sequences of Flavivirus-Related RNA Viruses Persist in DNA Form Integrated in the Genome of Aedes Spp. Mosquitoes.” *Journal of General Virology* 85 (7): 1971–80. <https://doi.org/10.1099/vir.0.79850-0>.
- Cui, Jie, and Edward C Holmes. n.d. “Endogenous RNA Viruses of Plants in Insect Genomes.” Accessed March 13, 2018. <https://doi.org/10.1016/j.virol.2012.02.014>.
- Cullis. 1983. “Environmentally Induced DNA Changes in Plants.” *CRC Crit. Rev. Plant Sci* 1: 117–31.
- Cupp, E. W., C. J. Maré, M. S. Cupp, and F. B. Ramberg. 1992. “Biological Transmission of Vesicular Stomatitis Virus (New Jersey) by Simulium Vittatum (Diptera: Simuliidae).” *Journal of Medical Entomology*. <https://doi.org/10.1093/jmedent/29.2.137>.
- Czech, Benjamin, and Gregory J Hannon. 2016. “One Loop to Rule Them All: The Ping-Pong Cycle and PiRNA-Guided Silencing.” *Trends in Biochemical Sciences* 41 (4): 324–37. <https://doi.org/10.1016/j.tibs.2015.12.008>.
- Czech, Benjamin, Colin D. Malone, Rui Zhou, Alexander Stark, Catherine Schlingeheyde, Monica Dus, Norbert Perrimon, et al. 2008. “An Endogenous Small Interfering RNA Pathway in Drosophila.” *Nature*. <https://doi.org/10.1038/nature07007>.
- Dalla Pozza, G L, R Romi, and C Severini. 1994. “Source and Spread of Aedes Albopictus in the Veneto Region of Italy.” *Journal of the American Mosquito Control Association* 10 (4): 589–92. <http://www.ncbi.nlm.nih.gov/pubmed/7707070>.

- Datta, Sibnarayan, Reji Gopalakrishnan, Soumya Chatterjee, and Vijay Veer. 2015. "Phylogenetic Characterization of a Novel Insect-Specific Flavivirus Detected in a Culex Pool, Collected from Assam, India." *Intervirology* 58 (3): 149–54. <https://doi.org/10.1159/000381901>.
- Delatte, H, C Paupy, J S Dehecq, J Thiria, A B Failloux, and D Fontenille. 2008. "[Aedes Albopictus, Vector of Chikungunya and Dengue Viruses in Reunion Island: Biology and Control]." *Parasite (Paris, France)* 15 (1): 3–13. <https://doi.org/10.1051/parasite/2008151003>.
- Delatte, Helene, Amelie Desvars, Anthony Bouétard, Séverine Bord, Geoffrey Gimonneau, Gwenaël Vourc'h, and Didier Fontenille. 2010. "Blood-Feeding Behavior of Aedes Albopictus, a Vector of Chikungunya on La Réunion." *Vector-Borne and Zoonotic Diseases*. <https://doi.org/10.1089/vbz.2009.0026>.
- Delatte, Hélène, Céline Toty, Sébastien Boyer, Anthony Bouetard, Fanny Bastien, and Didier Fontenille. 2013. "Evidence of Habitat Structuring Aedes Albopictus Populations in Réunion Island." *PLoS Neglected Tropical Diseases* 7 (3): e2111. <https://doi.org/10.1371/journal.pntd.0002111>.
- Delisle, E, C Rousseau, B Broche, I Leparc-Goffart, G L'Ambert, A Cochet, C Prat, et al. 2015. "Chikungunya Outbreak in Montpellier, France, September to October 2014." *Euro Surveillance: Bulletin European Sur Les Maladies Transmissibles = European Communicable Disease Bulletin* 20 (17). <https://doi.org/10.2807/1560-7917.es2015.20.17.21108>.
- Desdouts, Marion, Basile Kamgang, Nicolas Berthet, Vianney Tricou, Carine Ngoagouni, Antoine Gessain, Jean Claude Manuguerra, Emmanuel Nakouné, and Mirdad Kazanji. 2015. "Genetic Characterization of Chikungunya Virus in the Central African Republic." *Infection, Genetics and Evolution*. <https://doi.org/10.1016/j.meegid.2015.04.006>.
- Dewannieux, Marie, Cécile Esnault, and Thierry Heidmann. 2003. "LINE-Mediated Retrotransposition of Marked Alu Sequences." *Nature Genetics*. <https://doi.org/10.1038/ng1223>.
- Diniz, Diego Felipe Araujo, Cleide Maria Ribeiro de Albuquerque, Luciana Oliveira Oliva, Maria Alice Varjal de Melo-Santos, and Constância Flávia Junqueira Ayres. 2017. "Diapause and Quiescence: Dormancy Mechanisms That Contribute to the Geographical Expansion of Mosquitoes and Their Evolutionary Success." *Parasites & Vectors* 10 (1): 310. <https://doi.org/10.1186/s13071-017-2235-0>.
- Dolezal, Tomas, Gabriela Krejcova, Adam Bajgar, Pavla Nedbalova, and Paul Strasser. 2019. "Molecular Regulations of Metabolism during Immune Response in Insects." *Insect Biochemistry and Molecular Biology* 109 (June): 31–42. <https://doi.org/10.1016/j.ibmb.2019.04.005>.
- Doolittle, W F, and C Sapienza. 1980. "Selfish Genes, the Phenotype Paradigm and Genome Evolution." *Nature* 284 (5757): 601–3. <https://doi.org/10.1038/284601a0>.

- Dritsou, Vicky, Pantelis Topalis, Nikolai Windbichler, Alekos Simoni, Ann Hall, Daniel Lawson, Malcolm Hinsley, et al. 2015. "A Draft Genome Sequence of an Invasive Mosquito: An Italian *Aedes Albopictus*." *Pathogens and Global Health* 109 (5): 207–20. <https://doi.org/10.1179/2047773215Y.0000000031>.
- Drosten, C., S. Junglen, G. Pauli, W. Grasse, H. Ellerbrok, S. Handrick, A. Lukashev, F. H. Leendertz, M. Marklewitz, and A. Kurth. 2011. "Gouleako Virus Isolated from West African Mosquitoes Constitutes a Proposed Novel Genus in the Family Bunyaviridae." *Journal of Virology*. <https://doi.org/10.1128/jvi.00230-11>.
- Duffy, Siobain, Laura A. Shackelton, and Edward C. Holmes. 2008. "Rates of Evolutionary Change in Viruses: Patterns and Determinants." *Nature Reviews Genetics* 9 (4): 267–76. <https://doi.org/10.1038/nrg2323>.
- Dupuis-Maguiraga, Laurence, Marion Noret, Sonia Brun, Roger Le Grand, Gabriel Gras, and Pierre Roques. 2012. "Chikungunya Disease: Infection-Associated Markers from the Acute to the Chronic Phase of Arbovirus-Induced Arthralgia." *PLoS Neglected Tropical Diseases*. <https://doi.org/10.1371/journal.pntd.0001446>.
- Ebel, Gregory D, Justin Carricaburu, David Young, Kristen A Bernard, and Laura D Kramer. 2004. "Genetic and Phenotypic Variation of West Nile Virus in New York, 2000-2003." *The American Journal of Tropical Medicine and Hygiene* 71 (4): 493–500. <http://www.ncbi.nlm.nih.gov/pubmed/15516648>.
- Ebner, Paul D., Seong K. Kim, and Dennis J. O’Callaghan. 2008. "Biological and Genotypic Properties of Defective Interfering Particles of Equine Herpesvirus 1 That Mediate Persistent Infection." *Virology*. <https://doi.org/10.1016/j.virol.2008.08.024>.
- Effler, Paul V, Lorrin Pang, Paul Kitsutani, Vance Vorndam, Michele Nakata, Tracy Ayers, Joe Elm, et al. 2005. "Dengue Fever, Hawaii, 2001-2002." *Emerging Infectious Diseases* 11 (5): 742–49. <https://doi.org/10.3201/eid1105.041063>.
- Erasmus, Jesse H, Albert J Auguste, Jason T Kaelber, Huanle Luo, Shannan L Rossi, Karla Fenton, Grace Leal, et al. 2017. "A Chikungunya Fever Vaccine Utilizing an Insect-Specific Virus Platform." *Nature Medicine* 23 (2): 192–99. <https://doi.org/10.1038/nm.4253>.
- Erasmus, Jesse H, Robert L Seymour, Jason T Kaelber, Dal Y Kim, Grace Leal, Michael B Sherman, Ilya Frolov, Wah Chiu, Scott C Weaver, and Farooq Nasar. 2018. "Novel Insect-Specific Eilat Virus-Based Chimeric Vaccine Candidates Provide Durable, Mono- and Multivalent, Single-Dose Protection against Lethal Alphavirus Challenge." *Journal of Virology* 92 (4). <https://doi.org/10.1128/JVI.01274-17>.
- Espinoza-Gómez, Francisco, Alejandro U. López-Lemus, Irám P. Rodríguez-Sánchez, Margarita L. Martínez-Fierro, Oscar A. Newton-Sánchez, Edgar Chávez-Flores, and Iván Delgado-Enciso. 2011. "Detection of Sequences from a Potentially Novel Strain of Cell Fusing Agent Virus in Mexican *Stegomyia (Aedes) Aegypti* Mosquitoes." *Archives of Virology*. <https://doi.org/10.1007/s00705-011-0967-2>.

- Evangelista, Julio, Cristhopher Cruz, Carolina Guevara, Helvio Astete, Cristiam Carey, Tadeusz J. Kochel, Amy C. Morrison, Maya Williams, Eric S. Halsey, and Brett M. Forshey. 2013. "Characterization of a Novel Flavivirus Isolated from *Culex* (Melanoconion) Ocosa Mosquitoes from Iquitos, Peru." *Journal of General Virology*. <https://doi.org/10.1099/vir.0.050575-0>.
- Fan, Hang, Qiumin Zhao, Xiaofang Guo, Qiang Sun, Shuqing Zuo, Chao Wu, Hongning Zhou, et al. 2016. "Complete Genome Sequence of Xishuangbanna Flavivirus, a Novel Mosquito-Specific Flavivirus from China." *Archives of Virology* 161 (6): 1723–27. <https://doi.org/10.1007/s00705-016-2827-6>.
- Farfan-Ale, Jose A, Maria A Loroño-Pino, Julian E Garcia-Rejon, Einat Hovav, Ann M Powers, Ming Lin, Karin S Dorman, et al. 2009. "Detection of RNA from a Novel West Nile-like Virus and High Prevalence of an Insect-Specific Flavivirus in Mosquitoes in the Yucatan Peninsula of Mexico NIH Public Access." *Am J Trop Med Hyg*. Vol. 80.
- Faure, Eric, and Manuela Royer-Carenzi. 2008. "Is the European Spatial Distribution of the HIV-1-Resistant CCR5-Δ32 Allele Formed by a Breakdown of the Pathocenosis Due to the Historical Roman Expansion?" *Infection, Genetics and Evolution*. <https://doi.org/10.1016/j.meegid.2008.08.007>.
- Federici, B A, and Y Bigot. 2003. "Origin and Evolution of Polydnviruses by Symbiogenesis of Insect DNA Viruses in Endoparasitic Wasps." *Journal of Insect Physiology* 49 (5): 419–32. <http://www.ncbi.nlm.nih.gov/pubmed/12770621>.
- Feltzin, Virzhiniya L., Mugdha Khaladkar, Masashi Abe, Michael Parisi, Gert Jan Hendriks, Junhyong Kim, and Nancy M. Bonini. 2015. "The Exonuclease Nibbler Regulates Age-Associated Traits and Modulates PiRNA Length in *Drosophila*." *Aging Cell*. <https://doi.org/10.1111/accel.12323>.
- Feng, Yun, Hong-Bin Li, Jin Zhu, Yu-Zhen Zhang, Wei-Hong Yang, Jian-Hua Fan, Guo-Dong Liang, and Hai-Lin Zhang. 2014. "[First Isolation of Quang Binh-like Virus from Mosquitoes in China]." *Bing Du Xue Bao = Chinese Journal of Virology* 30 (1): 57–61. <http://www.ncbi.nlm.nih.gov/pubmed/24772899>.
- Ferreira, Daniela Duque, Shelley Cook, Ângela Lopes, António Pedro de Matos, Aida Esteves, Ana Abecasis, António Paulo Gouveia de Almeida, João Piedade, and Ricardo Parreira. 2013. "Characterization of an Insect-Specific Flavivirus (OCFVPT) Co-Isolated from *Ochlerotatus Caspius* Collected in Southern Portugal along with a Putative New Negev-like Virus." *Virus Genes* 47 (3): 532–45. <https://doi.org/10.1007/s11262-013-0960-9>.
- Feschotte, Cédric, and Clément Gilbert. 2012. "Endogenous Viruses: Insights into Viral Evolution and Impact on Host Biology." *Nature Reviews Genetics* 13 (4): 283–96. <https://doi.org/10.1038/nrg3199>.
- Feschotte, Cédric, and Ellen J. Pritham. 2007. "DNA Transposons and the Evolution of Eukaryotic Genomes." *Annual Review of Genetics*. <https://doi.org/10.1146/annurev.genet.40.110405.090448>.

- Filomatori, Claudia V, Maria F Lodeiro, Diego E Alvarez, Marcelo M Samsa, Lía Pietrasanta, and Andrea V Gamarnik. 2006. "A 5' RNA Element Promotes Dengue Virus RNA Synthesis on a Circular Genome." *Genes & Development* 20 (16): 2238–49. <https://doi.org/10.1101/gad.1444206>.
- Finnegan, David J. 2012. "Retrotransposons." *Current Biology* 22 (11): R432–37. <https://doi.org/10.1016/J.CUB.2012.04.025>.
- Firth, Andrew E, Bradley J Blitvich, Norma M Wills, Cathy L Miller, and John F Atkins. 2010. "Evidence for Ribosomal Frameshifting and a Novel Overlapping Gene in the Genomes of Insect-Specific Flaviviruses." *Virology* 399 (1): 153–66. <https://doi.org/10.1016/j.virol.2009.12.033>.
- Fischer, M., and S. L. Hills. 2016. "Arboviral Diseases." *Control of Communicable Diseases Manual* 33: 330–42. <https://doi.org/10.2105/ccdm.2745.022>.
- Fonseca, Néli José da, Marcelo Querino Lima Afonso, Natan Gonçalves Pedersolli, Lucas Carrijo de Oliveira, Dhiego Souto Andrade, and Lucas Bleicher. 2017. "Sequence, Structure and Function Relationships in Flaviviruses as Assessed by Evolutive Aspects of Its Conserved Non-Structural Protein Domains." *Biochemical and Biophysical Research Communications*. <https://doi.org/10.1016/j.bbrc.2017.01.041>.
- Fontenille, Didier, and Jean Claude Toto. 2001. "Aedes (Stegomyia) Albopictus (Skuse), a Potential New Dengue Vector in Southern Cameroon." *Emerging Infectious Diseases*. <https://doi.org/10.3201/eid0706.010631>.
- Forster, Michael, Silke Szymczak, David Ellinghaus, Georg Hemmrich, Malte Rühlemann, Lars Kraemer, Sören Mucha, Lars Wienbrandt, Martin Stanulla, and Andre Franke. 2015. "Vy-PER: Eliminating False Positive Detection of Virus Integration Events in next Generation Sequencing Data." *Scientific Reports*. <https://doi.org/10.1038/srep11534>.
- Fort, Philippe, Aurélie Albertini, Aurélie Van-Hua, Arnaud Berthomieu, Stéphane Roche, Frédéric Delsuc, Nicole Pasteur, Pierre Capy, Yves Gaudin, and Mylène Weill. 2012. "Fossil Rhabdoviral Sequences Integrated into Arthropod Genomes: Ontogeny, Evolution, and Potential Functionality." *Molecular Biology and Evolution* 29 (1): 381–90. <https://doi.org/10.1093/molbev/msr226>.
- Fragkoudis, Rennos, Ghassem Attarzadeh-Yazdi, Anthony A Nash, John K Fazakerley, and Alain Kohl. 2009. "Advances in Dissecting Mosquito Innate Immune Responses to Arbovirus Infection." *The Journal of General Virology* 90 (Pt 9): 2061–72. <https://doi.org/10.1099/vir.0.013201-0>.
- Frankel, a E, J H Gilbert, K J Porzig, E M Scolnick, and S a Aaronson. 1979. "Nature and Distribution of Feline Sarcoma Virus Nucleotide Sequences." *Journal of Virology*.
- Franz, A. W. E., I. Sanchez-Vargas, Z. N. Adelman, C. D. Blair, B. J. Beaty, A. A. James, and K. E. Olson. 2006. "Engineering RNA Interference-Based Resistance to Dengue Virus Type 2 in Genetically Modified Aedes Aegypti." *Proceedings of the National Academy of Sciences*. <https://doi.org/10.1073/pnas.0600479103>.

- Franz, Alexander W E, Asher M Kantor, A Lorena Passarelli, and Rollie J Clem. 2015. "Tissue Barriers to Arbovirus Infection in Mosquitoes." *Viruses* 7 (7): 3741–67. <https://doi.org/10.3390/v7072795>.
- Fujino, Kan, Masayuki Horie, Tomoyuki Honda, Dana K Merriman, and Keizo Tomonaga. 2014. "Inhibition of Borna Disease Virus Replication by an Endogenous Bornavirus-like Element in the Ground Squirrel Genome." *Proceedings of the National Academy of Sciences of the United States of America* 111 (36): 13175–80. <https://doi.org/10.1073/pnas.1407046111>.
- Fultz, P. N., J. A. Shaddock, C. Y. Kang, and J. W. Streilein. 1982. "Vesicular Stomatitis Virus Can Establish Persistent Infections in Syrian Hamsters." *Journal of General Virology*. <https://doi.org/10.1099/0022-1317-63-2-493>.
- Gaedigk-Nitschko, Kerstin, Mingxiao Ding, Marilyn Aach Levy, and Milton J. Schlesinger. 1990. "Site-Directed Mutations in the Sindbis Virus 6K Protein Reveal Sites for Fatty Acylation and the Underacylated Protein Affects Virus Release and Virion Structure." *Virology*. [https://doi.org/10.1016/0042-6822\(90\)90210-I](https://doi.org/10.1016/0042-6822(90)90210-I).
- Gaedigk-Nitschko, Kerstin, and Milton J. Schlesinger. 1991. "Site-Directed Mutations in Sindbis Virus E2 Glycoprotein's Cytoplasmic Domain and the 6K Protein Lead to Similar Defects in Virus Assembly and Budding." *Virology*. [https://doi.org/10.1016/0042-6822\(91\)90133-V](https://doi.org/10.1016/0042-6822(91)90133-V).
- Garcia, Melissa N., Rodrigo Hasbun, and Kristy O. Murray. 2015. "Persistence of West Nile Virus." *Microbes and Infection*. <https://doi.org/10.1016/j.micinf.2014.12.003>.
- Garmashova, N., R. Gorchakov, E. Volkova, S. Paessler, E. Frolova, and I. Frolov. 2007. "The Old World and New World Alphaviruses Use Different Virus-Specific Proteins for Induction of Transcriptional Shutoff." *Journal of Virology*. <https://doi.org/10.1128/jvi.02073-06>.
- Geisler, Christoph, and Donald L. Jarvis. 2016. "Rhabdovirus-like Endogenous Viral Elements in the Genome of Spodoptera Frugiperda Insect Cells Are Actively Transcribed: Implications for Adventitious Virus Detection." *Biologicals*. <https://doi.org/10.1016/j.biologicals.2016.04.004>.
- Geoghegan, Jemma L., Sebastián Duchêne, and Edward C. Holmes. 2017. "Comparative Analysis Estimates the Relative Frequencies of Co-Divergence and Cross-Species Transmission within Viral Families." *PLoS Pathogens*. <https://doi.org/10.1371/journal.ppat.1006215>.
- Geuking, Markus B, Jacqueline Weber, Marie Dewannieux, Elieser Gorelik, Thierry Heidmann, Hans Hengartner, Rolf M Zinkernagel, and Lars Hangartner. 2009. "Recombination of Retrotransposon and Exogenous RNA Virus Results in Nonretroviral CDNA Integration." *Science (New York, N.Y.)* 323 (5912): 393–96. <https://doi.org/10.1126/science.1167375>.
- Gifford, Robert J, Aris Katzourakis, Michael Tristem, Oliver G Pybus, Mark Winters, and Robert W Shafer. 2008. "A Transitional Endogenous Lentivirus from the Genome of a

- Basal Primate and Implications for Lentivirus Evolution.” *Proceedings of the National Academy of Sciences of the United States of America* 105 (51): 20362–67. <https://doi.org/10.1073/pnas.0807873105>.
- Gilbert and Feschotte. 2016. “Virus et Gènes Viraux Endogènes: Évolution et Impact Virologie” 20 (3): 158–73.
- Gilbert, Clément, and Cédric Feschotte. 2010. “Genomic Fossils Calibrate the Long-Term Evolution of Hepadnaviruses.” Edited by Michael Emerman. *PLoS Biology* 8 (9): e1000495. <https://doi.org/10.1371/journal.pbio.1000495>.
- Gillies, Stephen, and Victor Stollar. 1980. “Generation of Defective Interfering Particles of Vesicular Stomatitis Virus in *Aedes Albopictus* Cells.” *Virology*. [https://doi.org/10.1016/0042-6822\(80\)90316-5](https://doi.org/10.1016/0042-6822(80)90316-5).
- Goenaga, Silvina, Cintia M Fabbri, Jorge B García, Juan C Rondán, Noemí Gardenal, Gladys E Calderón, Delia A Enria, and Silvana M C Levis. 2014. “New Strains of *Culex* Flavivirus Isolated in Argentina.” *Journal of Medical Entomology* 51 (4): 900–906. <https://doi.org/10.1603/me13172>.
- Goenaga, Silvina, Joan L. Kenney, Nisha K. Duggal, Mark Delorey, Gregory D. Ebel, Bo Zhang, Silvana C. Levis, Delia A. Enria, and Aaron C. Brault. 2015. “Potential for Co-Infection of a Mosquito-Specific Flavivirus, Nhumirim Virus, to Block West Nile Virus Transmission in Mosquitoes.” *Viruses* 7 (11): 5801–12. <https://doi.org/10.3390/v7112911>.
- Goh, Wee Siong Sho, Ilaria Falciatori, Oliver H. Tam, Ralph Burgess, Oliver Meikar, Noora Kotaja, Molly Hammell, and Gregory J. Hannon. 2015. “PiRNA-Directed Cleavage of Meiotic Transcripts Regulates Spermatogenesis.” *Genes and Development*. <https://doi.org/10.1101/gad.260455.115>.
- Goic, Bertsy, Kenneth A Stapleford, Lionel Frangeul, Aurélien J Doucet, Valérie Gausson, Hervé Blanc, Nidia Schemmel-Jofre, et al. 2016. “Virus-Derived DNA Drives Mosquito Vector Tolerance to Arboviral Infection.” *Nature Communications* 7 (1): 12410. <https://doi.org/10.1038/ncomms12410>.
- Goic, Bertsy, Nicolas Vodovar, Juan A Mondotte, Clément Monot, Lionel Frangeul, Hervé Blanc, Valérie Gausson, Jorge Vera-Otarola, Gael Cristofari, and Maria-Carla Saleh. 2013a. “RNA-Mediated Interference and Reverse Transcription Control the Persistence of RNA Viruses in the Insect Model *Drosophila*.” *Nature Immunology* 14 (4): 396–403. <https://doi.org/10.1038/ni.2542>.
- Graham, R. R., M. Juffrie, R. Tan, C. G. Hayes, I. Laksono, C. Ma’roef, Erlin, Sutaryo, K. R. Porter, and S. B. Halstead. 1999. “A Prospective Seroepidemiologic Study on Dengue in Children Four to Nine Years of Age in Yogyakarta, Indonesia I. Studies in 1995–1996.” *American Journal of Tropical Medicine and Hygiene*. <https://doi.org/10.4269/ajtmh.1999.61.412>.
- Grandadam, Marc, Ségolène Brichtler, Yvan Souares, Gérard-antoine Denoyel, Jean-dominique Poveda, and Marc Gastellu-etchegorry. 2010. “Bulletin Épidémiologique

Hebdomadaire Importés En France Métropolitaine 2008-2009,” 2006–10.

- Gravina, Humberto Doriguêto, Andreia Akemi Suzukawa, Camila Zanluca, Fatima María Cardozo Segovia, Marcel Kruchelski Tschá, Allan Martins da Silva, Helisson Faoro, et al. 2019. “Identification of Insect-Specific Flaviviruses in Areas of Brazil and Paraguay Experiencing Endemic Arbovirus Transmission and the Description of a Novel Flavivirus Infecting Sabethes Belisarioi.” *Virology*. <https://doi.org/10.1016/j.virol.2018.11.008>.
- Grisenti, Michela, Ana Vázquez, Laura Herrero, Laureano Cuevas, Esperanza Perez-Pastrana, Daniele Arnoldi, Roberto Rosà, et al. 2015. “Wide Detection of Aedes Flavivirus in North-Eastern Italy – a European Hotspot of Emerging Mosquitoborne Diseases.” *Journal of General Virology*. <https://doi.org/10.1099/vir.0.069625-0>.
- Gritsun, T S, and E A Gould. 2006. “The 3’ Untranslated Regions of Kamiti River Virus and Cell Fusing Agent Virus Originated by Self-Duplication.” *The Journal of General Virology* 87 (Pt 9): 2615–19. <https://doi.org/10.1099/vir.0.81950-0>.
- Gubler, D J. 1998. “The Global Pandemic of Dengue/Dengue Haemorrhagic Fever: Current Status and Prospects for the Future.” *Annals of the Academy of Medicine, Singapore* 27 (2): 227–34. <http://www.ncbi.nlm.nih.gov/pubmed/9663316>.
- Gubler Daniel J. 2011. “Dengue, Urbanization, and Globalization: The Unholy Trinity of the 21st Century.” *Tropical Medicine and Health*. <https://doi.org/10.2149/tmh.2011-S05>.
- Gubler, Duane J. 1998. “Dengue and Dengue Hemorrhagic Fever.” *CLINICAL MICROBIOLOGY REVIEWS*. Vol. 11. <https://www.ncbi.nlm.nih.gov/pmc/articles/PMC88892/pdf/cm000480.pdf>.
- Guo, Juxin, Wenyun Ye, Xianmiao Liu, Xueli Sun, Qin Guo, Yun Huang, Lei Ma, et al. 2017. “PiRNA-3312: A Putative Role for Pyrethroid Resistance in Culex Pipiens Pallens (Diptera: Culicidae).” *Journal of Medical Entomology*. <https://doi.org/10.1093/jme/tjx043>.
- Guzman, Hilda, Maria Angelica Contreras-Gutierrez, Amelia P A Travassos da Rosa, Marcio R T Nunes, Jedson F Cardoso, Vsevolod L Popov, Katherine I Young, et al. 2018. “Characterization of Three New Insect-Specific Flaviviruses: Their Relationship to the Mosquito-Borne Flavivirus Pathogens.” *The American Journal of Tropical Medicine and Hygiene* 98 (2): 410–19. <https://doi.org/10.4269/ajtmh.17-0350>.
- Guzmán, M G, G Kourí, and S B Halstead. 2000. “Do Escape Mutants Explain Rapid Increases in Dengue Case-Fatality Rates within Epidemics?” *Lancet (London, England)* 355 (9218): 1902–3. [https://doi.org/10.1016/S0140-6736\(00\)02303-5](https://doi.org/10.1016/S0140-6736(00)02303-5).
- Haddow, Andrew D., Hilda Guzman, Vsevolod L. Popov, Thomas G. Wood, Steven G. Widen, Alastair D. Haddow, Robert B. Tesh, and Scott C. Weaver. 2013. “First Isolation of Aedes Flavivirus in the Western Hemisphere and Evidence of Vertical Transmission in the Mosquito Aedes (Stegomyia) Albopictus (Diptera: Culicidae).” *Virology*. <https://doi.org/10.1016/j.virol.2012.12.008>.

- Hall-Mendelin, Sonja, Breeanna J. McLean, Helle Bielefeldt-Ohmann, Jody Hobson-Peters, Roy A. Hall, and Andrew F. van den Hurk. 2016. "The Insect-Specific Palm Creek Virus Modulates West Nile Virus Infection in and Transmission by Australian Mosquitoes." *Parasites & Vectors* 9 (1): 414. <https://doi.org/10.1186/s13071-016-1683-2>.
- Halstead, S B, S Udomsakdi, P Singharaj, and A Nisalak. 1969. "Dengue Chikungunya Virus Infection in Man in Thailand, 1962-1964. 3. Clinical, Epidemiologic, and Virologic Observations on Disease in Non-Indigenous White Persons." *The American Journal of Tropical Medicine and Hygiene* 18 (6): 984-96. <https://doi.org/10.4269/ajtmh.1969.18.984>.
- Halstead, Scott B., Franz X. Heinz, A. D.T. Barrett, and John T. Roehrig. 2005. "Dengue Virus: Molecular Basis of Cell Entry and Pathogenesis, 25-27 June 2003, Vienna, Austria." In *Vaccine*. <https://doi.org/10.1016/j.vaccine.2004.03.069>.
- Halstead, Scott B. 2015. "Reappearance of Chikungunya, Formerly Called Dengue, in the Americas." *Emerging Infectious Diseases* 21 (4): 557-61. <https://doi.org/10.3201/eid2104.141723>.
- Hanada, Kousuke, Yoshiyuki Suzuki, and Takashi Gojobori. 2004. "A Large Variation in the Rates of Synonymous Substitution for RNA Viruses and Its Relationship to a Diversity of Viral Infection and Transmission Modes." *Molecular Biology and Evolution* 21 (6): 1074-80. <https://doi.org/10.1093/molbev/msh109>.
- Havecker, Ericka R., Xiang Gao, and Daniel F. Voytas. 2004. "The Diversity of LTR Retrotransposons." *Genome Biology*. <https://doi.org/10.1186/gb-2004-5-6-225>.
- Hawley, W A. 1988. "The Biology of Aedes Albopictus." *Journal of the American Mosquito Control Association. Supplement*.
- Hayward, A., M. Grabherr, and P. Jern. 2013. "Broad-Scale Phylogenomics Provides Insights into Retrovirus-Host Evolution." *Proceedings of the National Academy of Sciences*. <https://doi.org/10.1073/pnas.1315419110>.
- Hermanns, Kyra, Florian Zirkel, Anne Kopp, Marco Marklewitz, Innocent B Rwego, Alejandro Estrada, Thomas R Gillespie, Christian Drosten, and Sandra Junglen. 2017. "Discovery of a Novel Alphavirus Related to Eilat Virus." *The Journal of General Virology* 98 (1): 43-49. <https://doi.org/10.1099/jgv.0.000694>.
- Hess, Ann M, Abhishek N Prasad, Andrey Ptitsyn, Gregory D Ebel, Ken E Olson, Catalin Barbacioru, Cinna Monighetti, and Corey L Campbell. 2011. "Small RNA Profiling of Dengue Virus-Mosquito Interactions Implicates the PIWI RNA Pathway in Anti-Viral Defense." *BMC Microbiology* 11 (1): 45. <https://doi.org/10.1186/1471-2180-11-45>.
- Hillyer, Julián F., and Tania Y. Estévez-Lao. 2010. "Nitric Oxide Is an Essential Component of the Hemocyte-Mediated Mosquito Immune Response against Bacteria." *Developmental and Comparative Immunology*. <https://doi.org/10.1016/j.dci.2009.08.014>.
- Ho, N T, K M Keene, K E Olson, and L Zheng. 2003. "Characterization of RNA Interference in an Anopheles Gambiae Cell Line." *Insect Biochemistry and Molecular*

Biology 33 (9): 949–57. <http://www.ncbi.nlm.nih.gov/pubmed/12915186>.

- Hobson-Peters, Jody, Alice Wei Yee Yam, Jennifer Wei Fei Lu, Yin Xiang Setoh, Fiona J. May, Nina Kurucz, Susan Walsh, et al. 2013. “A New Insect-Specific Flavivirus from Northern Australia Suppresses Replication of West Nile Virus and Murray Valley Encephalitis Virus in Co-Infected Mosquito Cells.” *PLoS ONE* 8 (2): 1–12. <https://doi.org/10.1371/journal.pone.0056534>.
- Holden, Katherine Lynn, David A Stein, Theodore C Pierson, Asim A Ahmed, Karen Clyde, Patrick L Iversen, and Eva Harris. 2006. “Inhibition of Dengue Virus Translation and RNA Synthesis by a Morpholino Oligomer Targeted to the Top of the Terminal 3’ Stem-Loop Structure.” *Virology* 344 (2): 439–52. <https://doi.org/10.1016/j.virol.2005.08.034>.
- Holmes, Edward C. 2011. “The Evolution of Endogenous Viral Elements.” *Cell Host & Microbe* 10 (4): 368–77. <https://doi.org/10.1016/j.chom.2011.09.002>.
- Holt, Robert a, S Broder, G Mani Subramanian, Aaron L Halpern, Granger G Sutton, Rosane Charlab, Deborah R Nusskern, et al. 2002. “The Genome Sequence of the Malaria Mosquito *Anopheles Gambiae*.” *Science*. <https://doi.org/10.1126/science.1076181>.
- Holt, Robert A, G Mani Subramanian, Aaron Halpern, Granger G Sutton, Rosane Charlab, Deborah R Nusskern, Patrick Wincker, et al. 2002. “The Genome Sequence of the Malaria Mosquito *Anopheles Gambiae*.” *Science (New York, N.Y.)* 298 (5591): 129–49. <https://doi.org/10.1126/science.1076181>.
- Horie, Masayuki, Tomoyuki Honda, Yoshiyuki Suzuki, Yuki Kobayashi, Takuji Daito, Tatsuo Oshida, Kazuyoshi Ikuta, et al. 2010. “Endogenous Non-Retroviral RNA Virus Elements in Mammalian Genomes.” *Nature* 463 (7277): 84–87. <https://doi.org/10.1038/nature08695>.
- Horst, Anneliek M. ter, Jared C. Nigg, Fokke M. Dekker, and Bryce W. Falk. 2018. “Endogenous Viral Elements Are Widespread in Arthropod Genomes and Commonly Give Rise to PIWI-Interacting RNAs.” Edited by Julie K. Pfeiffer. *Journal of Virology* 93 (6). <https://doi.org/10.1128/JVI.02124-18>.
- Horwich, Michael D, Chengjian Li, Christian Matranga, Vasily Vagin, Gwen Farley, Peng Wang, and Phillip D Zamore. 2007. “The *Drosophila* RNA Methyltransferase, DmHen1, Modifies Germline PiRNAs and Single-Stranded siRNAs in RISC.” *Current Biology : CB* 17 (14): 1265–72. <https://doi.org/10.1016/j.cub.2007.06.030>.
- Hoshino, Keita, Haruhiko Isawa, Yoshio Tsuda, Kyoko Sawabe, and Mutsuo Kobayashi. 2009a. “Isolation and Characterization of a New Insect Flavivirus from *Aedes Albopictus* and *Aedes Flavopictus* Mosquitoes in Japan.” *Virology* 391 (1): 119–29. <https://doi.org/10.1016/j.virol.2009.06.025>.
- Hoshino, Keita, Haruhiko Isawa, Yoshio Tsuda, Kazuhiko Yano, Toshinori Sasaki, Masao Yuda, Tomohiko Takasaki, Mutsuo Kobayashi, and Kyoko Sawabe. 2007. “Genetic Characterization of a New Insect Flavivirus Isolated from *Culex Pipiens* Mosquito in Japan.” *Virology*. <https://doi.org/10.1016/j.virol.2006.09.039>.

- Hoshino, Keita, Azusa Takahashi-Nakaguchi, Haruhiko Isawa, Toshinori Sasaki, Yukiko Higa, Shinji Kasai, Yoshio Tsuda, Kyoko Sawabe, and Mutsuo Kobayashi. 2012. “Entomological Surveillance for Flaviviruses at Migratory Bird Stopover Sites in Hokkaido, Japan, and a New Insect Flavivirus Detected in *Aedes Galloisi* (Diptera: Culicidae).” *Journal of Medical Entomology*. <https://doi.org/10.1603/me11123>.
- Hotta, Susumu. 1952. “Experimental Studies on Dengue.” *Journal of Infectious Diseases*. <https://doi.org/10.1093/infdis/90.1.1>.
- Houé, Vincent, Mariangela Bonizzoni, and Anna-Bella Failloux. 2019. “Endogenous Non-Retroviral Elements in Genomes of *Aedes* Mosquitoes and Vector Competence.” *Emerging Microbes & Infections* 8 (1): 542–55. <https://doi.org/10.1080/22221751.2019.1599302>.
- Hron, Tomáš, Helena Farkašová, Robert J. Gifford, Petr Benda, Pavel Hulva, Tamás Görföl, Jan Pačes, and Daniel Elleder. 2018. “Remnants of an Ancient Deltaretrovirus in the Genomes of Horseshoe Bats (Rhinolophidae).” *Viruses*. <https://doi.org/10.3390/v10040185>.
- Huang, Xiao A., Hang Yin, Sarah Sweeney, Debasish Raha, Michael Snyder, and Haifan Lin. 2013. “A Major Epigenetic Programming Mechanism Guided by PiRNAs.” *Developmental Cell*. <https://doi.org/10.1016/j.devcel.2013.01.023>.
- Huang, Xiawei, Katalin Fejes Tóth, and Alexei A Aravin. 2017. “PiRNA Biogenesis in *Drosophila Melanogaster*.” *Trends in Genetics: TIG* 33 (11): 882–94. <https://doi.org/10.1016/j.tig.2017.09.002>.
- Huanyu, Wang, Wang Haiyan, Fu Shihong, Liu Guifang, Liu Hong, Gao Xiaoyan, Song Lizhi, Simon Rayner, Xu Aiqiang, and Liang Guodong. 2012. “Isolation and Identification of a Distinct Strain of *Culex* Flavivirus from Mosquitoes Collected in Mainland China.” *Virology Journal*. <https://doi.org/10.1186/1743-422x-9-73>.
- Hughes, Austin L., and Mary Ann K. Hughes. 2007. “More Effective Purifying Selection on RNA Viruses than in DNA Viruses.” *Gene*. <https://doi.org/10.1016/j.gene.2007.09.013>.
- Huhtamo, Eili, Shelley Cook, Gregory Moureau, Nathalie Y. Uzcátegui, Tarja Sironen, Suvi Kuivanen, Niina Putkuri, et al. 2014. “Novel Flaviviruses from Mosquitoes: Mosquito-Specific Evolutionary Lineages within the Phylogenetic Group of Mosquito-Borne Flaviviruses.” *Virology*. <https://doi.org/10.1016/j.virol.2014.07.015>.
- Huhtamo, Eili, Gregory Moureau, Shelley Cook, Ora Julkunen, Niina Putkuri, Satu Kurkela, Nathalie Y. Uzcátegui, et al. 2012. “Novel Insect-Specific Flavivirus Isolated from Northern Europe.” *Virology*. <https://doi.org/10.1016/j.virol.2012.08.038>.
- Huhtamo, Eili, Niina Putkuri, Satu Kurkela, Tytti Manni, Antti Vaheri, Olli Vapalahti, and Nathalie Y Uzcátegui. 2009. “Characterization of a Novel Flavivirus from Mosquitoes in Northern Europe That Is Related to Mosquito-Borne Flaviviruses of the Tropics.” *Journal of Virology* 83 (18): 9532–40. <https://doi.org/10.1128/JVI.00529-09>.

- Inaguma, Y., T. Yoshida, and H. Ikeda. 1992. "Scheme for the Generation of a Truncated Endogenous Murine Leukaemia Virus, the Fv-4 Resistance Gene." *Journal of General Virology*. <https://doi.org/10.1099/0022-1317-73-8-1925>.
- Ito, Jumpei, Takahiro Hiratsuka, Kyohei Kuse, Yuka Odahara, Haruyo Ochi, Kazuo Nishigaki, Shinya Watanabe, and Maki Kawamura. 2013. "Refrex-1, a Soluble Restriction Factor against Feline Endogenous and Exogenous Retroviruses." *Journal of Virology*. <https://doi.org/10.1128/JVI.01267-13>.
- Iturbe-Ormaetxe, Iñaki, Thomas Walker, and Scott L. O'Neill. 2011. "Wolbachia and the Biological Control of Mosquito-Borne Disease." *EMBO Reports*. <https://doi.org/10.1038/embor.2011.84>.
- J.L., Miller, DeWet B.J.M., Martinez-Pomares L., Radcliffe C.M., Dwek R.A., Rudd P.M., Joanna L Miller, et al. 2008. "The Mannose Receptor Mediates Dengue Virus Infection of Macrophages." *PLoS Pathogens*. <https://doi.org/http://dx.doi.org/10.1371/journal.ppat.0040017>.
- J, GUBLER, DUANE. 2001. "Human Arbovirus Infections Worldwide." *Annals of the New York Academy of Sciences*. <https://doi.org/10.1111/j.1749-6632.2001.tb02681.x>.
- Jenkins, Gareth M., Andrew Rambaut, Oliver G. Pybus, and Edward C. Holmes. 2002. "Rates of Molecular Evolution in RNA Viruses: A Quantitative Phylogenetic Analysis." *Journal of Molecular Evolution* 54 (2): 156–65. <https://doi.org/10.1007/s00239-001-0064-3>.
- Johnson, Welkin E. 2010. "Endless Forms Most Viral." Accessed March 5, 2018. <https://doi.org/10.1371/journal.pgen.1001210.t001>.
- Juárez-Martínez, Ariadna Berenice, Tania Olivia Vega-Almeida, Mariana Salas-Benito, Matilde García-Espitia, Mónica De Nova-Ocampo, Rosa María del Ángel, and Juan Santiago Salas-Benito. 2013. "Detection and Sequencing of Defective Viral Genomes in C6/36 Cells Persistently Infected with Dengue Virus 2." *Archives of Virology*. <https://doi.org/10.1007/s00705-012-1525-2>.
- Junglen, Sandra. 2016. "Evolutionary Origin of Pathogenic Arthropod-Borne Viruses - A Case Study in the Family Bunyaviridae." *Current Opinion in Insect Science*. <https://doi.org/10.1016/j.cois.2016.05.017>.
- Junglen, Sandra, Anne Kopp, Andreas Kurth, Georg Pauli, Heinz Ellerbrok, and Fabian H Leendertz. 2009. "A New Flavivirus and a New Vector: Characterization of a Novel Flavivirus Isolated from Uranotaenia Mosquitoes from a Tropical Rain Forest." *Journal of Virology* 83 (9): 4462–68. <https://doi.org/10.1128/JVI.00014-09>.
- Junglen, Sandra, Marvin Korries, Wolfgang Grasse, Janett Wieseler, Anne Kopp, Kyra Hermanns, Moises León-Juárez, Christian Drosten, and Beate Mareike Kümmerer. 2017. "Host Range Restriction of Insect-Specific Flaviviruses Occurs at Several Levels of the Viral Life Cycle." Edited by Glenn Randall. *MSphere* 2 (1): e00375-16. <https://doi.org/10.1128/mSphere.00375-16>.

- Jupatanakul, Natapong, Shuzhen Sim, and George Dimopoulos. 2014. "The Insect Microbiome Modulates Vector Competence for Arboviruses." *Viruses* 6 (11): 4294–4313. <https://doi.org/10.3390/v6114294>.
- Kakumani, P. K., S. S. Ponia, R. K. S, V. Sood, M. Chinnappan, A. C. Banerjea, G. R. Medigeshi, P. Malhotra, S. K. Mukherjee, and R. K. Bhatnagar. 2013. "Role of RNA Interference (RNAi) in Dengue Virus Replication and Identification of NS4B as an RNAi Suppressor." *Journal of Virology*. <https://doi.org/10.1128/jvi.02774-12>.
- Kamer, Gregory, and Patrick Argos. 1984. "Primary Structural Comparison of RNA-Dependent Polymerases from Plant, Animal and Bacterial Viruses." *Nucleic Acids Research*. <https://doi.org/10.1093/nar/12.18.7269>.
- Kammaing, Leonie M., Maartje J. Luteijn, Marjo J. Den Broeder, Stefan Redl, Lucas J.T. Kaaij, Elke F. Roovers, Peter Ladurner, Eugene Berezikov, and René F. Ketting. 2010. "Hen1 Is Required for Oocyte Development and PiRNA Stability in Zebrafish." *EMBO Journal*. <https://doi.org/10.1038/emboj.2010.233>.
- Kapitonov, V V, and J Jurka. 2001. "Rolling-Circle Transposons in Eukaryotes." *Proceedings of the National Academy of Sciences of the United States of America* 98 (15): 8714–19. <https://doi.org/10.1073/pnas.151269298>.
- Katzourakis, A., M. Tristem, O. G. Pybus, and R. J. Gifford. 2007. "Discovery and Analysis of the First Endogenous Lentivirus." *Proceedings of the National Academy of Sciences*. <https://doi.org/10.1073/pnas.0700471104>.
- Katzourakis, Aris. 2017. "Editorial Overview: Paleovirology: The Genomic Fossil Record, and Consequences of Ancient Viral Infections." *Current Opinion in Virology*, 2017. <https://doi.org/10.1016/j.coviro.2017.08.002>.
- Katzourakis, Aris, and Robert J Gifford. 2010. "Endogenous Viral Elements in Animal Genomes." Edited by Harmit S. Malik. *PLoS Genetics* 6 (11): e1001191. <https://doi.org/10.1371/journal.pgen.1001191>.
- Kawaoka, Shinpei, Natsuko Izumi, Susumu Katsuma, and Yukihide Tomari. 2011. "3' End Formation of PIWI-Interacting RNAs in Vitro." *Molecular Cell* 43 (6): 1015–22. <https://doi.org/10.1016/j.molcel.2011.07.029>.
- Kay, B H, W A Ives, P I Whelan, P Barker-Hudson, I D Fanning, and E N Marks. 1990. "Is Aedes Albopictus in Australia?" *The Medical Journal of Australia* 153 (1): 31–34. <http://www.ncbi.nlm.nih.gov/pubmed/2381357>.
- Keene, Kimberly M, Brian D Foy, Irma Sanchez-Vargas, Barry J Beaty, Carol D Blair, and Ken E Olson. 2004. "RNA Interference Acts as a Natural Antiviral Response to O'nyong-Nyong Virus (Alphavirus; Togaviridae) Infection of Anopheles Gambiae." *Proceedings of the National Academy of Sciences of the United States of America* 101 (49): 17240–45. <https://doi.org/10.1073/pnas.0406983101>.
- Kenney, Joan L, Owen D Solberg, Stanley A Langevin, and Aaron C Brault. 2014. "Characterization of a Novel Insect-Specific Flavivirus from Brazil: Potential for

- Inhibition of Infection of Arthropod Cells with Medically Important Flaviviruses.” *The Journal of General Virology* 95 (Pt 12): 2796–2808. <https://doi.org/10.1099/vir.0.068031-0>.
- Kent, Rebekah J, Mary B Crabtree, and Barry R Miller. 2010. “Transmission of West Nile Virus by *Culex Quinquefasciatus* Say Infected with *Culex Flavivirus* Izabal.” *PLoS Neglected Tropical Diseases* 4 (5): e671. <https://doi.org/10.1371/journal.pntd.0000671>.
- Ketkar, Harshada, Daniella Herman, and Penghua Wang. 2019. “Genetic Determinants of the Re-Emergence of Arboviral Diseases.” *Viruses* 11 (2). <https://doi.org/10.3390/v11020150>.
- Kidwell, M G. 1992. “Horizontal Transfer.” *Current Opinion in Genetics & Development* 2 (6): 868–73. <http://www.ncbi.nlm.nih.gov/pubmed/1335808>.
- Kim, A, C Terzian, P Santamaria, A Pélisson, N Purd’homme, and A Bucheton. 1994. “Retroviruses in Invertebrates: The Gypsy Retrotransposon Is Apparently an Infectious Retrovirus of *Drosophila Melanogaster*.” *Proceedings of the National Academy of Sciences of the United States of America* 91 (4): 1285–89. <https://doi.org/10.1073/pnas.91.4.1285>.
- Kim, Dal Y, Hilda Guzman, Rudy Bueno, James A Dennett, Albert J Auguste, Christine V F Carrington, Vsevolod L Popov, Scott C Weaver, David W C Beasley, and Robert B Tesh. 2009. “Characterization of *Culex Flavivirus* (Flaviviridae) Strains Isolated from Mosquitoes in the United States and Trinidad.” *Virology* 386 (1): 154–59. <https://doi.org/10.1016/j.virol.2008.12.034>.
- Kingsolver, Megan B, Zhijing Huang, and Richard W Hardy. 2013. “Insect Antiviral Innate Immunity: Pathways, Effectors, and Connections.” *Journal of Molecular Biology* 425 (24): 4921–36. <https://doi.org/10.1016/j.jmb.2013.10.006>.
- Kittigul, Leera, Piyamard Pitakarnjanakul, Dusit Sujirarat, and Kanokrat Siripanichgon. 2007. “The Differences of Clinical Manifestations and Laboratory Findings in Children and Adults with Dengue Virus Infection.” *Journal of Clinical Virology*. <https://doi.org/10.1016/j.jcv.2007.04.006>.
- Klaer, R, S Kühn, H J Fritz, E Tillmann, I Saint-Girons, P Habermann, D Pfeifer, and P Starlinger. 1981. “Studies on Transposition Mechanisms and Specificity of IS4.” *Cold Spring Harbor Symposia on Quantitative Biology* 45 Pt 1: 215–24. <http://www.ncbi.nlm.nih.gov/pubmed/6271469>.
- Klema, Valerie J., Mengyi Ye, Aditya Hindupur, Tadahisa Teramoto, Keerthi Gottipati, Radhakrishnan Padmanabhan, and Kyung H. Choi. 2016. “Dengue Virus Nonstructural Protein 5 (NS5) Assembles into a Dimer with a Unique Methyltransferase and Polymerase Interface.” *PLoS Pathogens*. <https://doi.org/10.1371/journal.ppat.1005451>.
- Klenerman, P, H Hengartner, and R M Zinkernagel. 1997. “A Non-Retroviral RNA Virus Persists in DNA Form.” *Nature* 390 (6657): 298–301. <https://doi.org/10.1038/36876>.

- Klobucar, Ana, Enrih Merdić, Nikola Benić, Zeljko Baklaić, and Stjepan Krcmar. 2006. "First Record of *Aedes Albopictus* in Croatia." *Journal of the American Mosquito Control Association* 22 (1): 147–48. [https://doi.org/10.2987/8756-971X\(2006\)22\[147:FROAAI\]2.0.CO;2](https://doi.org/10.2987/8756-971X(2006)22[147:FROAAI]2.0.CO;2).
- Kobayashi, Daisuke, Katsunori Murota, Ryosuke Fujita, Kentaro Itokawa, Akira Kotaki, Meng Ling Moi, Hiroko Ejiri, et al. 2018. "Dengue Virus Infection in *Aedes Albopictus* during the 2014 Autochthonous Dengue Outbreak in Tokyo Metropolis, Japan." *The American Journal of Tropical Medicine and Hygiene* 98 (5): 1460–68. <https://doi.org/10.4269/ajtmh.17-0954>.
- Kofler, Robert. 2019. "Dynamics of Transposable Element Invasions with PiRNA Clusters." *Molecular Biology and Evolution*. <https://doi.org/10.1093/molbev/msz079>.
- Kolodziejek, Jolanta, Karin Pachler, Hanna Bin, Ella Mendelson, Lester Shulman, Laor Orshan, and Norbert Nowotny. 2013. "Barkedji Virus, a Novel Mosquito-Borne Flavivirus Identified in *Culex Perexiguus* Mosquitoes, Israel, 2011." *The Journal of General Virology* 94 (Pt 11): 2449–57. <https://doi.org/10.1099/vir.0.056200-0>.
- Kondo, Hideki, Shuichi Hirano, Sotaro Chiba, Ida Bagus Andika, Makoto Hirai, Takanori Maeda, and Tetsuo Tamada. 2013. "Characterization of Burdock Mottle Virus, a Novel Member of the Genus Benyvirus, and the Identification of Benyvirus-Related Sequences in the Plant and Insect Genomes." *Virus Research*. <https://doi.org/10.1016/j.virusres.2013.07.015>.
- Koning, A P Jason de, Wanjun Gu, Todd A Castoe, Mark A Batzer, and David D Pollock. 2011. "Repetitive Elements May Comprise over Two-Thirds of the Human Genome." *PLoS Genetics* 7 (12): e1002384. <https://doi.org/10.1371/journal.pgen.1002384>.
- Konkel, Miriam K., and Mark A. Batzer. 2010. "A Mobile Threat to Genome Stability: The Impact of Non-LTR Retrotransposons upon the Human Genome." *Seminars in Cancer Biology* 20 (4): 211–21. <https://doi.org/10.1016/j.semcancer.2010.03.001>.
- Koonin, E. V. 1991. "The Phylogeny of RNA-Dependent RNA Polymerases of Positive-Strand RNA Viruses." *Journal of General Virology*. <https://doi.org/10.1099/0022-1317-72-9-2197>.
- Kotin, R M, R M Linden, and K I Berns. 1992. "Characterization of a Preferred Site on Human Chromosome 19q for Integration of Adeno-Associated Virus DNA by Non-Homologous Recombination." *The EMBO Journal* 11 (13): 5071–78. <http://www.ncbi.nlm.nih.gov/pubmed/1334463>.
- Kramer, Laura D, and Gregory D Ebel. 2003. "Dynamics of Flavivirus Infection in Mosquitoes." *Advances in Virus Research* 60: 187–232. <http://www.ncbi.nlm.nih.gov/pubmed/14689695>.
- Kuhn, Richard J, Wei Zhang, Michael G Rossmann, Sergei V Pletnev, Jeroen Corver, Edith Lenches, Christopher T Jones, et al. 2002. "Structure of Dengue Virus: Implications for Flavivirus Organization, Maturation, and Fusion." *Cell* 108 (5): 717–25. [https://doi.org/10.1016/s0092-8674\(02\)00660-8](https://doi.org/10.1016/s0092-8674(02)00660-8).

- Kumar, A, and K S Rai. 1990. "Intraspecific Variation in Nuclear DNA Content among World Populations of a Mosquito, *Aedes Albopictus* (Skuse)." *TAG. Theoretical and Applied Genetics. Theoretische Und Angewandte Genetik* 79 (6): 748–52. <https://doi.org/10.1007/BF00224239>.
- Kuno, G, G J Chang, K R Tsuchiya, N Karabatsos, and C B Cropp. 1998. "Phylogeny of the Genus *Flavivirus*." *Journal of Virology*.
- Kuno, Goro. 2015. "A Re-Examination of the History of Etiologic Confusion between Dengue and Chikungunya." *PLoS Neglected Tropical Diseases*. <https://doi.org/10.1371/journal.pntd.0004101>.
- Kuo, Szu Cheng, Ying Ju Chen, Yu Ming Wang, Pei Yi Tsui, Ming Der Kuo, Tzong Yuan Wu, and Szecheng J. Lo. 2012. "Cell-Based Analysis of Chikungunya Virus E1 Protein in Membrane Fusion." *Journal of Biomedical Science*. <https://doi.org/10.1186/1423-0127-19-44>.
- Kuwata, Ryusei, Hiroki Sugiyama, Kenzo Yonemitsu, Nguyen Van Dung, Yutaka Terada, Masayasu Taniguchi, Hiroshi Shimoda, Ai Takano, and Ken Maeda. 2015. "Isolation of Japanese Encephalitis Virus and a Novel Insect-Specific *Flavivirus* from Mosquitoes Collected in a Cowshed in Japan." *Archives of Virology* 160 (9): 2151–59. <https://doi.org/10.1007/s00705-015-2488-x>.
- Kyaw Kyaw, Aung, Mya Myat Ngwe Tun, Corazon C. Buerano, Takeshi Nabeshima, Miako Sakaguchi, Tsuyoshi Ando, Shingo Inoue, et al. 2018. "Isolation and Genomic Characterization of *Culex* *Flaviviruses* from Mosquitoes in Myanmar." *Virus Research*. <https://doi.org/10.1016/j.virusres.2018.01.007>.
- Lambrechts, Louis, Thomas W. Scott, and Duane J. Gubler. 2010a. "Consequences of the Expanding Global Distribution of *Aedes Albopictus* for Dengue Virus Transmission." Edited by Scott B. Halstead. *PLoS Neglected Tropical Diseases* 4 (5): e646. <https://doi.org/10.1371/journal.pntd.0000646>.
- Lambrechts, Louis, Thomas W Scott, and Duane J Gubler. 2010b. "Consequences of the Expanding Global Distribution of *Aedes Albopictus* for Dengue Virus Transmission." Edited by Scott B. Halstead. *PLoS Neglected Tropical Diseases* 4 (5): e646. <https://doi.org/10.1371/journal.pntd.0000646>.
- Laras, Kanti, Nono C. Sukri, Ria P. Larasati, Michael J. Bangs, Rizal Kosim, A. Djauzi, Tony Wandra, et al. 2005. "Tracking the Re-Emergence of Epidemic Chikungunya Virus in Indonesia." *Transactions of the Royal Society of Tropical Medicine and Hygiene*. <https://doi.org/10.1016/j.trstmh.2004.03.013>.
- Lavialle, Christian, Guillaume Cornelis, Anne Dupressoir, Cécile Esnault, Odile Heidmann, Cécile Vernochet, and Thierry Heidmann. 2013. "Paleovirology of 'Syncytins', Retroviral Env Genes Exapted for a Role in Placentation." *Philosophical Transactions of the Royal Society B: Biological Sciences*. <https://doi.org/10.1098/rstb.2012.0507>.
- Lazareva, Ekaterina, Alexander Lezzhov, Nikita Vassetzky, Andrey Solovyev, and Sergey Morozov. 2015. "Acquisition of Full-Length Viral Helicase Domains by Insect

- Retrotransposon-Encoded Polypeptides.” *Frontiers in Microbiology*.
<https://doi.org/10.3389/fmicb.2015.01447>.
- Lee, Regina Ching Hua, Hapuarachchige Chanditha Hapuarachchi, Karen Caiyun Chen, Khairunnisa’ Mohamed Hussain, Huixin Chen, Swee Ling Low, Lee Ching Ng, Raymond Lin, Mary Mah-Lee Ng, and Justin Jang Hann Chu. 2013. “Mosquito Cellular Factors and Functions in Mediating the Infectious Entry of Chikungunya Virus.” *PLoS Neglected Tropical Diseases* 7 (2): e2050. <https://doi.org/10.1371/journal.pntd.0002050>.
- Lee, Yoontae, Minju Kim, Jinju Han, Kyu-Hyun Yeom, Sanghyuk Lee, Sung Hee Baek, and V Narry Kim. 2004. “MicroRNA Genes Are Transcribed by RNA Polymerase II.” *The EMBO Journal* 23 (20): 4051–60. <https://doi.org/10.1038/sj.emboj.7600385>.
- Lefevre, Pierre, Gordon W. Harkins, Jean Michel Lett, Rob W. Briddon, Mark W. Chase, Benoit Moury, and Darren P. Martin. 2011. “Evolutionary Time-Scale of the Begomoviruses: Evidence from Integrated Sequences in the Nicotiana Genome.” *PLoS ONE*. <https://doi.org/10.1371/journal.pone.0019193>.
- Léger, P, E Lara, B Jagla, O Sismeiro, Z Mansuroglu, J Y Coppée, E Bonnefoy, and M Bouloy. 2013. “Dicer-2- and Piwi-Mediated RNA Interference in Rift Valley Fever Virus-Infected Mosquito Cells.” *Journal of Virology* 87 (3): 1631–48. <https://doi.org/10.1128/JVI.02795-12>.
- Lehmann, T, W A Hawley, and F H Collins. 1996. “An Evaluation of Evolutionary Constraints on Microsatellite Loci Using Null Alleles.” *Genetics* 144 (3): 1155–63. <http://www.ncbi.nlm.nih.gov/pubmed/8913757>.
- Lequime, Sebastian, and Louis Lambrechts. 2014. “Vertical Transmission of Arboviruses in Mosquitoes: A Historical Perspective.” *Infection, Genetics and Evolution*. <https://doi.org/10.1016/j.meegid.2014.07.025>.
- Lequime, Sebastian, and Louis Lambrechts. 2017. “Discovery of Flavivirus-Derived Endogenous Viral Elements in *Anopheles* Mosquito Genomes Supports the Existence of *Anopheles* -Associated Insect-Specific Flaviviruses.” *Virus Evolution* 3 (1): vew035. <https://doi.org/10.1093/ve/vew035>.
- Lequime, Sebastian, Richard E Paul, and Louis Lambrechts. 2016. “Determinants of Arbovirus Vertical Transmission in Mosquitoes.” *PLoS Pathogens* 12 (5): e1005548. <https://doi.org/10.1371/journal.ppat.1005548>.
- Leroy, Eric M., Alain Epelboin, Vital Mondonge, Xavier Pourrut, Jean-Paul Gonzalez, Jean-Jacques Muyembe-Tamfum, and Pierre Formenty. 2009. “Human Ebola Outbreak Resulting from Direct Exposure to Fruit Bats in Luebo, Democratic Republic of Congo, 2007.” *Vector-Borne and Zoonotic Diseases*. <https://doi.org/10.1089/vbz.2008.0167>.
- Leroy, Eric M., Brice Kumulungui, Xavier Pourrut, Pierre Rouquet, Alexandre Hassanin, Philippe Yaba, André Délicat, Janusz T. Paweska, Jean Paul Gonzalez, and Robert Swanepoel. 2005. “Fruit Bats as Reservoirs of Ebola Virus.” *Nature*. <https://doi.org/10.1038/438575a>.

- Leung, Jason Y, Gorben P Pijlman, Natasha Kondratieva, Jennifer Hyde, Jason M Mackenzie, and Alexander A Khromykh. 2008. "Role of Nonstructural Protein NS2A in Flavivirus Assembly †." *JOURNAL OF VIROLOGY* 82 (10): 4731–41. <https://doi.org/10.1128/JVI.00002-08>.
- Levinson, Gene, and George A Gutman. 1987. "Slipped-Strand Mispairing: A Major Mechanism for DNA Sequence Evolution." *Molecular Biology and Evolution* 4 (3): 203–21. <https://doi.org/10.1093/oxfordjournals.molbev.a040442>.
- Lewis, Samuel H, Kaycee A Quarles, Yujing Yang, Melanie Tanguy, Lise Frézal, Stephen A Smith, Prashant P Sharma, et al. 2018. "Pan-Arthropod Analysis Reveals Somatic PiRNAs as an Ancestral Defence against Transposable Elements." *Nature Ecology & Evolution* 2 (1): 174–81. <https://doi.org/10.1038/s41559-017-0403-4>.
- Li, Ci-Xiu, Mang Shi, Jun-Hua Tian, Xian-Dan Lin, Yan-Jun Kang, Liang-Jun Chen, Xin-Cheng Qin, Jianguo Xu, Edward C Holmes, and Yong-Zhen Zhang. 2015. "Unprecedented Genomic Diversity of RNA Viruses in Arthropods Reveals the Ancestry of Negative-Sense RNA Viruses." *ELife* 4 (January). <https://doi.org/10.7554/eLife.05378>.
- Li, Dongsheng, William B. Lott, Kym Lowry, Anita Jones, Hlaing Myat Thu, and John Aaskov. 2011. "Defective Interfering Viral Particles in Acute Dengue Infections." *PLoS ONE*. <https://doi.org/10.1371/journal.pone.0019447>.
- Li, W.-X., H. Li, R. Lu, F. Li, M. Dus, P. Atkinson, E. W. A. Brydon, et al. 2004. "Interferon Antagonist Proteins of Influenza and Vaccinia Viruses Are Suppressors of RNA Silencing." *Proceedings of the National Academy of Sciences*. <https://doi.org/10.1073/pnas.0308308100>.
- Lilley, Caroline E., Rachel A. Schwartz, and Matthew D. Weitzman. 2007. "Using or Abusing: Viruses and the Cellular DNA Damage Response." *Trends in Microbiology*. <https://doi.org/10.1016/j.tim.2007.01.003>.
- Lin, H, and A C Spradling. 1997. "A Novel Group of Pumilio Mutations Affects the Asymmetric Division of Germline Stem Cells in the Drosophila Ovary." *Development (Cambridge, England)*.
- Lobo, Francisco P, Bruno E F Mota, Sérgio D J Pena, Vasco Azevedo, Andréa M Macedo, Andreas Tauch, Carlos R Machado, and Glória R Franco. 2009. "Virus-Host Coevolution: Common Patterns of Nucleotide Motif Usage in Flaviviridae and Their Hosts." *PloS One* 4 (7): e6282. <https://doi.org/10.1371/journal.pone.0006282>.
- Löwer, Roswitha, Johannes Löwer, Reinhard Kurth, Roswitha Lwer, Johannes Lwer, and Reinhard Kurth. 1996. "The Virus in All of Us.Pdf." *Proceedings of the National Academy of Sciences*. <https://doi.org/10.1073/PNAS.93.11.5177>.
- Luo, Lei, Li-Yun Jiang, Xin-Cai Xiao, Biao Di, Qin-Long Jing, Sheng-Yong Wang, Jin-Ling Tang, Ming Wang, Xiao-Ping Tang, and Zhi-Cong Yang. 2017. "The Dengue Preface to Endemic in Mainland China: The Historical Largest Outbreak by Aedes Albopictus in Guangzhou, 2014." *Infectious Diseases of Poverty* 6 (1): 148. <https://doi.org/10.1186/s40249-017-0352-9>.

- Lynch, Michael, and John S. Conery. 2003. "The Origins of Genome Complexity." *Science*. <https://doi.org/10.1126/science.1089370>.
- M., Grandadam, Caro V., Plumet S., Thiberge J., Souarès Y., Failloux A., Tolou H.J., et al. 2011. "Chikungunya Virus, Southeastern France." *Emerging Infectious Diseases*. <https://doi.org/10.3201/eid1705.101873> LK - <http://resolver.ebscohost.com/openurl?sid=EMBASE&issn=10806040&id=doi:10.3201%2F1705.101873&atitle=Chikungunya+virus%2C+Southeastern+France&stitle=Emerg.+Infect.+Dis.&title=Emerging+Infectious+Diseases&volume=17&issue=5&spage=910&epage=913&aurlast=Grandadam&aurlfirst=Marc&aunit=M.&aufull=Grandadam+M.&coden=EIDIF&isbn=&pages=910-913&date=2011&aunit1=M&aunitm=>.
- Malfavon-Borja, Ray, and Cédric Feschotte. 2015. "Fighting Fire with Fire: Endogenous Retrovirus Envelopes as Restriction Factors." *Journal of Virology*. <https://doi.org/10.1128/jvi.03653-14>.
- Mani, Sneha Ramesh, and Celina E. Juliano. 2013. "Untangling the Web: The Diverse Functions of the PIWI/PiRNA Pathway." *Molecular Reproduction and Development*. <https://doi.org/10.1002/mrd.22195>.
- Manni, Mosè, Ludvik M Gomulski, Nidchaya Aketarawong, Gabriella Tait, Francesca Scolari, Pradya Somboon, Carmela R Guglielmino, Anna R Malacrida, and Giuliano Gasperi. 2015. "Molecular Markers for Analyses of Intraspecific Genetic Diversity in the Asian Tiger Mosquito, *Aedes Albopictus*." *Parasites & Vectors* 8 (March): 188. <https://doi.org/10.1186/s13071-015-0794-5>.
- Manni, Mosè, Carmela R. Guglielmino, Francesca Scolari, Anubis Vega-Rúa, Anna Bella Failloux, Pradya Somboon, Antonella Lisa, et al. 2017. "Genetic Evidence for a Worldwide Chaotic Dispersion Pattern of the Arbovirus Vector, *Aedes Albopictus*." *PLoS Neglected Tropical Diseases*. <https://doi.org/10.1371/journal.pntd.0005332>.
- Manokaran, Gayathri, Esteban Finol, Chunling Wang, Jayantha Gunaratne, Justin Bahl, Eugenia Z. Ong, Hwee Cheng Tan, et al. 2015. "Dengue Subgenomic RNA Binds TRIM25 to Inhibit Interferon Expression for Epidemiological Fitness." *Science*. <https://doi.org/10.1126/science.aab3369>.
- Maori, Eyal, Edna Tanne, and Ilan Sela. 2007. "Reciprocal Sequence Exchange between Non-Retro Viruses and Hosts Leading to the Appearance of New Host Phenotypes." *Virology* 362 (2): 342–49. <https://doi.org/10.1016/j.virol.2006.11.038>.
- Marklewitz, Marco, Florian Zirkel, Andreas Kurth, Christian Drosten, and Sandra Junglen. 2015. "Evolutionary and Phenotypic Analysis of Live Virus Isolates Suggests Arthropod Origin of a Pathogenic RNA Virus Family." *Proceedings of the National Academy of Sciences of the United States of America* 112 (24): 7536–41. <https://doi.org/10.1073/pnas.1502036112>.
- Marklewitz, Marco, Florian Zirkel, Innocent B. Rwego, Hanna Heidemann, Pascal Trippner, Andreas Kurth, René Kallies, et al. 2013. "Discovery of a Unique Novel Clade of Mosquito-Associated Bunyaviruses." *Journal of Virology*. <https://doi.org/10.1128/jvi.01862-13>.

- Markoff, Lewis. 2003. "5'- and 3'-Noncoding Regions in Flavivirus RNA." *Advances in Virus Research* 59: 177–228. <http://www.ncbi.nlm.nih.gov/pubmed/14696330>.
- Marques, João Trindade, Kevin Kim, Pei Hsuan Wu, Trevis M. Alleyne, Nadereh Jafari, and Richard W. Carthew. 2010. "Loqs and R2D2 Act Sequentially in the SiRNA Pathway in *Drosophila*." *Nature Structural and Molecular Biology*. <https://doi.org/10.1038/nsmb.1735>.
- Martins, Hugo, and Palle Villesen. 2011. "Improved Integration Time Estimation of Endogenous Retroviruses with Phylogenetic Data." *PLoS ONE*. <https://doi.org/10.1371/journal.pone.0014745>.
- Matranga, Christian, Yukihide Tomari, Chanseok Shin, David P Bartel, and Phillip D Zamore. 2005. "Passenger-Strand Cleavage Facilitates Assembly of SiRNA into Ago2-Containing RNAi Enzyme Complexes." *Cell* 123 (4): 607–20. <https://doi.org/10.1016/j.cell.2005.08.044>.
- Matthews, Benjamin J, Olga Dudchenko, Sarah B Kingan, Sergey Koren, Igor Antoshechkin, Jacob E Crawford, William J Glassford, et al. 2018. "Improved Reference Genome of *Aedes Aegypti* Informs Arbovirus Vector Control." *Nature* 563 (7732): 501–7. <https://doi.org/10.1038/s41586-018-0692-z>.
- Matusan, A E, M J Pryor, A D Davidson, and P J Wright. 2001. "Mutagenesis of the Dengue Virus Type 2 NS3 Protein within and Outside Helicase Motifs: Effects on Enzyme Activity and Virus Replication." *Journal of Virology* 75 (20): 9633–43. <https://doi.org/10.1128/JVI.75.20.9633-9643.2001>.
- Mavalankar, Dileep, Priya Shastri, Tathagata Bandyopadhyay, Jeram Parmar, and Karaikurichi V Ramani. 2008. "Increased Mortality Rate Associated with Chikungunya Epidemic, Ahmedabad, India." *Emerging Infectious Diseases* 14 (3): 412–15. <https://doi.org/10.3201/eid1403.070720>.
- MCCLINTOCK, B. 1956. "Intranuclear Systems Controlling Gene Action and Mutation." *Brookhaven Symposia in Biology*, no. 8 (February): 58–74. <http://www.ncbi.nlm.nih.gov/pubmed/13293421>.
- McLain, D K, K S Rai, and M J Fraser. 1987. "Intraspecific and Interspecific Variation in the Sequence and Abundance of Highly Repeated DNA among Mosquitoes of the *Aedes Albopictus* Subgroup." *Heredity* 58 (Pt 3) (June): 373–81. <http://www.ncbi.nlm.nih.gov/pubmed/3597124>.
- McLean, Breeanna J, Jody Hobson-Peters, Cameron E Webb, Daniel Watterson, Natalie A Prow, Hong Duyen Nguyen, Sonja Hall-Mendelin, et al. 2015. "A Novel Insect-Specific Flavivirus Replicates Only in *Aedes*-Derived Cells and Persists at High Prevalence in Wild *Aedes Vigilax* Populations in Sydney, Australia." *Virology* 486 (December): 272–83. <https://doi.org/10.1016/j.virol.2015.07.021>.
- Medstrand, Patrik, Louie N. Van De Lagemaat, and Dixie L. Mager. 2002. "Retroelement Distributions in the Human Genome: Variations Associated with Age and Proximity to Genes." *Genome Research*. <https://doi.org/10.1101/gr.388902>.

- Messier, W, S H Li, and C B Stewart. 1996. "The Birth of Microsatellites." *Nature* 381 (6582): 483. <https://doi.org/10.1038/381483a0>.
- Metselaar, D, C R Grainger, K G Oei, D G Reynolds, M Pudney, C J Leake, P M Tukei, R M D'Offay, and D I Simpson. 1980. "An Outbreak of Type 2 Dengue Fever in the Seychelles, Probably Transmitted by *Aedes Albopictus* (Skuse)." *Bulletin of the World Health Organization* 58 (6): 937–43. <http://www.ncbi.nlm.nih.gov/pubmed/6971192>.
- Mi, Shijun, Tao Cai, Yugang Hu, Yemiao Chen, Emily Hodges, Fangrui Ni, Liang Wu, et al. 2008. "Sorting of Small RNAs into Arabidopsis Argonaute Complexes Is Directed by the 5' Terminal Nucleotide." *Cell*. <https://doi.org/10.1016/j.cell.2008.02.034>.
- Miesen, Pascal, Erika Girardi, and Ronald P van Rij. 2015. "Distinct Sets of PIWI Proteins Produce Arbovirus and Transposon-Derived PiRNAs in *Aedes Aegypti* Mosquito Cells." *Nucleic Acids Research* 43 (13): 6545–56. <https://doi.org/10.1093/nar/gkv590>.
- Miesen, Pascal, Alasdair Ivens, Amy H. Buck, and Ronald P. van Rij. 2016. "Small RNA Profiling in Dengue Virus 2-Infected *Aedes* Mosquito Cells Reveals Viral PiRNAs and Novel Host MiRNAs." Edited by Gregory D Ebel. *PLOS Neglected Tropical Diseases* 10 (2): e0004452. <https://doi.org/10.1371/journal.pntd.0004452>.
- Miesen, Pascal, Joep Joosten, and Ronald P. van Rij. 2016. "PIWIs Go Viral: Arbovirus-Derived PiRNAs in Vector Mosquitoes." Edited by Tom C. Hobman. *PLOS Pathogens* 12 (12): e1006017. <https://doi.org/10.1371/journal.ppat.1006017>.
- Miller, Sven, Stefan Kastner, Jacomine Krijnse-Locker, Sandra Bühler, and Ralf Bartenschlager. 2007. "The Non-Structural Protein 4A of Dengue Virus Is an Integral Membrane Protein Inducing Membrane Alterations in a 2K-Regulated Manner." *The Journal of Biological Chemistry* 282 (12): 8873–82. <https://doi.org/10.1074/jbc.M609919200>.
- Miller, Sven, Sandra Sparacio, and Ralf Bartenschlager. 2006. "Subcellular Localization and Membrane Topology of the Dengue Virus Type 2 Non-Structural Protein 4B." *The Journal of Biological Chemistry* 281 (13): 8854–63. <https://doi.org/10.1074/jbc.M512697200>.
- Minard, Guillaume, Florence Hélène Tran, Fara Nantenaina Raharimalala, Eléonore Hellard, Pierre Ravelonandro, Patrick Mavingui, and Claire Valiente Moro. 2013. "Prevalence, Genomic and Metabolic Profiles of *Acinetobacter* and *Asaia* Associated with Field-Caught *Aedes Albopictus* from Madagascar." *FEMS Microbiology Ecology*. <https://doi.org/10.1111/j.1574-6941.2012.01455.x>.
- Misencik, Michael J., Nathan D. Grubaugh, Theodore G. Andreadis, Gregory D. Ebel, and Philip M. Armstrong. 2016. "Isolation of a Novel Insect-Specific Flavivirus from *Culiseta Melanura* in the Northeastern United States ." *Vector-Borne and Zoonotic Diseases*. <https://doi.org/10.1089/vbz.2015.1889>.
- Mishra, Priya, Colleen Furey, Velmurugan Balaraman, and Malcolm J. Fraser. 2016. "Antiviral Hammerhead Ribozymes Are Effective for Developing Transgenic Suppression of Chikungunya Virus in *Aedes Aegypti* Mosquitoes." *Viruses*.

<https://doi.org/10.3390/v8060163>.

- Mitchell, C J, and B R Miller. 1990. "Vertical Transmission of Dengue Viruses by Strains of *Aedes Albopictus* Recently Introduced into Brazil." *Journal of the American Mosquito Control Association*.
- MIYAKE, M. 1964. "THE PATHOLOGY OF JAPANESE ENCEPHALITIS. A REVIEW." *Bulletin of the World Health Organization* 30: 153–60. <http://www.ncbi.nlm.nih.gov/pubmed/14153404>.
- Mlera, Luwanika, Wessam Melik, and Marshall E. Bloom. 2014. "The Role of Viral Persistence in Flavivirus Biology." *Pathogens and Disease*. <https://doi.org/10.1111/2049-632X.12178>.
- Mogler, Mark A., and Kurt I. Kamrud. 2014. "RNA-Based Viral Vectors." *Expert Review of Vaccines*. <https://doi.org/10.1586/14760584.2015.979798>.
- Morales-Betoulle, M E, M L Monzón Pineda, S M Sosa, N Panella, M R B López, C Córdón-Rosales, N Komar, A Powers, and B W Johnson. 2008. "Culex Flavivirus Isolates from Mosquitoes in Guatemala." *Journal of Medical Entomology* 45 (6): 1187–90. [https://doi.org/10.1603/0022-2585\(2008\)45\[1187:cfifmi\]2.0.co;2](https://doi.org/10.1603/0022-2585(2008)45[1187:cfifmi]2.0.co;2).
- Morazzani, Elaine M, Michael R Wiley, Marta G Murreddu, Zach N Adelman, and Kevin M Myles. 2012. "Production of Virus-Derived Ping-Pong-Dependent PiRNA-like Small RNAs in the Mosquito Soma." Edited by Shou-Wei Ding. *PLoS Pathogens* 8 (1): e1002470. <https://doi.org/10.1371/journal.ppat.1002470>.
- Moreira, Luciano A., Iñaki Iturbe-Ormaetxe, Jason A. Jeffery, Guangjin Lu, Alyssa T. Pyke, Lauren M. Hedges, Bruno C. Rocha, et al. 2009. "A Wolbachia Symbiont in *Aedes Aegypti* Limits Infection with Dengue, Chikungunya, and Plasmodium." *Cell* 139 (7): 1268–78. <https://doi.org/10.1016/j.cell.2009.11.042>.
- Morissette, Guillaume, and Louis Flamand. 2010. "Herpesviruses and Chromosomal Integration." *Journal of Virology* 84 (23): 12100–109. <https://doi.org/10.1128/JVI.01169-10>.
- Moro, Maria Luisa, Carlo Gagliotti, Giuliano Silvi, Raffaella Angelini, Vittorio Sambri, Giovanni Rezza, Erika Massimiliani, et al. 2010. "Chikungunya Virus in North-Eastern Italy: A Seroprevalence Survey." *American Journal of Tropical Medicine and Hygiene*. <https://doi.org/10.4269/ajtmh.2010.09-0322>.
- Morozov, Sergey Y., Ekaterina A. Lazareva, and Andrey G. Solovyev. 2017. "RNA Helicase Domains of Viral Origin in Proteins of Insect Retrotransposons: Possible Source for Evolutionary Advantages." *PeerJ*. <https://doi.org/10.7717/peerj.3673>.
- Morozov, Sergey Y., and Andrey G. Solovyev. 2012. "Did Silencing Suppression Counter-Defensive Strategy Contribute to Origin and Evolution of the Triple Gene Block Coding for Plant Virus Movement Proteins?" *Frontiers in Plant Science*. <https://doi.org/10.3389/fpls.2012.00136>.

- Morozov, Sergey Y.. 2015. "Phylogenetic Relationship of Some 'Accessory' Helicases of Plant Positive-Stranded RNA Viruses: Toward Understanding the Evolution of Triple Gene Block." *Frontiers in Microbiology*. <https://doi.org/10.3389/fmicb.2015.00508>.
- Morrish, Tammy A., Nicolas Gilbert, Jeremy S. Myers, Bethaney J. Vincent, Thomas D. Stamato, Guillermo E. Taccioli, Mark A. Batzer, and John V. Moran. 2002. "DNA Repair Mediated by Endonuclease-Independent LINE-1 Retrotransposition." *Nature Genetics*. <https://doi.org/10.1038/ng898>.
- Moureaux, Gregory, Laetitia Ninove, Arezki Izri, Shelley Cook, Xavier De Lamballerie, and Remi N Charrel. 2010. "Flavivirus RNA in Phlebotomine Sandflies." *Vector Borne and Zoonotic Diseases (Larchmont, N.Y.)* 10 (2): 195–97. <https://doi.org/10.1089/vbz.2008.0216>.
- Muñoz-Jordán, Jorge L, Maudry Laurent-Rolle, Joseph Ashour, Luis Martínez-Sobrido, Mundrigi Ashok, W Ian Lipkin, and Adolfo García-Sastre. 2005. "Inhibition of Alpha/Beta Interferon Signaling by the NS4B Protein of Flaviviruses." *Journal of Virology* 79 (13): 8004–13. <https://doi.org/10.1128/JVI.79.13.8004-8013.2005>.
- Muñoz-Jordan, Jorge L, Gilma G Sánchez-Burgos, Maudry Laurent-Rolle, and Adolfo García-Sastre. 2003. "Inhibition of Interferon Signaling by Dengue Virus." *Proceedings of the National Academy of Sciences of the United States of America* 100 (24): 14333–38. <https://doi.org/10.1073/pnas.2335168100>.
- Mura, Manuela, Pablo Murcia, Marco Caporale, Thomas E Spencer, Kunio Nagashima, Alan Rein, and Massimo Palmarini. 2004. "Late Viral Interference Induced by Transdominant Gag of an Endogenous Retrovirus." *Proceedings of the National Academy of Sciences of the United States of America* 101 (30): 11117–22. <https://doi.org/10.1073/pnas.0402877101>.
- Murray, Kristy O., Steven Kolodziej, Shannon E. Ronca, Rodion Gorchakov, Patricia Navarro, Melissa S. Nolan, Amber Podoll, Kevin Finkel, and Sreedhar Mandayam. 2017. "Visualization of West Nile Virus in Urine Sediment Using Electron Microscopy and Immunogold up to Nine Years Postinfection." *American Journal of Tropical Medicine and Hygiene*. <https://doi.org/10.4269/ajtmh.17-0405>.
- Myles, K. M., M. R. Wiley, E. M. Morazzani, and Z. N. Adelman. 2008. "Alphavirus-Derived Small RNAs Modulate Pathogenesis in Disease Vector Mosquitoes." *Proceedings of the National Academy of Sciences*. <https://doi.org/10.1073/pnas.0803408105>.
- Nadir, E., H. Margalit, T. Gallily, and S. A. Ben-Sasson. 1996. "Microsatellite Spreading in the Human Genome: Evolutionary Mechanisms and Structural Implications." *Proceedings of the National Academy of Sciences*. <https://doi.org/10.1073/pnas.93.13.6470>.
- Nag, Dilip K., Matthew Brecher, and Laura D. Kramer. 2016. "DNA Forms of Arboviral RNA Genomes Are Generated Following Infection in Mosquito Cell Cultures." *Virology*. <https://doi.org/10.1016/j.virol.2016.08.022>.

- Nag, Dilip K., and Laura D. Kramer. 2017. "Patchy DNA Forms of the Zika Virus RNA Genome Are Generated Following Infection in Mosquito Cell Cultures and in Mosquitoes." *Journal of General Virology*. <https://doi.org/10.1099/jgv.0.000945>.
- Nasar, Farooq, Jesse H Erasmus, Andrew D Haddow, Robert B Tesh, and Scott C Weaver. 2015. "Eilat Virus Induces Both Homologous and Heterologous Interference." *Virology* 484 (October): 51–58. <https://doi.org/10.1016/j.virol.2015.05.009>.
- Nasar, Farooq, Gustavo Palacios, Rodion V Gorchakov, Hilda Guzman, Amelia P Travassos Da Rosa, Nazir Savji, Vsevolod L Popov, et al. 2012. "Eilat Virus, a Unique Alphavirus with Host Range Restricted to Insects by RNA Replication." *Proceedings of the National Academy of Sciences of the United States of America* 109 (36): 14622–27. <https://doi.org/10.1073/pnas.1204787109>.
- NELSON, E R. 1960. "Hemorrhagic Fever in Children in Thailand. Report of 69 Cases." *The Journal of Pediatrics* 56 (January): 101–8. [https://doi.org/10.1016/s0022-3476\(60\)80294-6](https://doi.org/10.1016/s0022-3476(60)80294-6).
- Nene, Vishvanath, Jennifer R Wortman, Daniel Lawson, Brian Haas, Chinnappa Kodira, Zhijian Jake Tu, Brendan Loftus, et al. 2007. "Genome Sequence of *Aedes Aegypti*, a Major Arbovirus Vector." *Science (New York, N.Y.)* 316 (5832): 1718–23. <https://doi.org/10.1126/science.1138878>.
- Nishimasu, Hiroshi, Hirotsugu Ishizu, Kuniaki Saito, Satoshi Fukuhara, Mihar K. Kamatani, Luc Bonnefond, Naoki Matsumoto, et al. 2012. "Structure and Function of Zucchini Endoribonuclease in PiRNA Biogenesis." *Nature*. <https://doi.org/10.1038/nature11509>.
- Ogino, Tomoaki. 2013. "In Vitro Capping and Transcription of Rhabdoviruses." *Methods*. <https://doi.org/10.1016/j.ymeth.2012.05.013>.
- Okamura, Katsutomo, Sudha Balla, Raquel Martin, Na Liu, and Eric C. Lai. 2008. "Two Distinct Mechanisms Generate Endogenous siRNAs from Bidirectional Transcription in *Drosophila Melanogaster*." *Nature Structural and Molecular Biology*. <https://doi.org/10.1038/nsmb.1438>.
- Olivieri, Daniel, Kirsten André Senti, Sailakshmi Subramanian, Ravi Sachidanandam, and Julius Brennecke. 2012. "The Cochaperone Shutdown Defines a Group of Biogenesis Factors Essential for All PiRNA Populations in *Drosophila*." *Molecular Cell*. <https://doi.org/10.1016/j.molcel.2012.07.021>.
- Olson, Ken E., and Mariangela Bonizzoni. 2017. "Nonretroviral Integrated RNA Viruses in Arthropod Vectors: An Occasional Event or Something More?" *Current Opinion in Insect Science*. <https://doi.org/10.1016/j.cois.2017.05.010>.
- Olson, Ken E, and Carol D Blair. 2015. "Arbovirus–Mosquito Interactions: RNAi Pathway." *Current Opinion in Virology* 15 (December): 119–26. <https://doi.org/10.1016/j.coviro.2015.10.001>.
- Orgel, L E, and F H Crick. 1980. "Selfish DNA: The Ultimate Parasite." *Nature* 284 (5757): 604–7. <http://www.ncbi.nlm.nih.gov/pubmed/7366731>.

- Ostertag, Eric M, John L Goodier, Yue Zhang, and Haig H Kazazian. 2003. "SVA Elements Are Nonautonomous Retrotransposons That Cause Disease in Humans." *American Journal of Human Genetics* 73 (6): 1444–51. <https://doi.org/10.1086/380207>.
- Palatini, Umberto, Pascal Miesen, Rebeca Carballar-Lejarazu, Lino Ometto, Ettore Rizzo, Zhijian Tu, Ronald P van Rij, and Mariangela Bonizzoni. 2017. "Comparative Genomics Shows That Viral Integrations Are Abundant and Express PiRNAs in the Arboviral Vectors *Aedes Aegypti* and *Aedes Albopictus*." *BMC Genomics* 18 (1): 512. <https://doi.org/10.1186/s12864-017-3903-3>.
- Pan, Ankita, Wuan Geok Saw, Malathy Sony Subramanian Manimekalai, Ardina Grüber, Shin Joon, Tsutomu Matsui, Thomas M Weiss, and Gerhard Grüber. 2017. "Structural Features of NS3 of Dengue Virus Serotypes 2 and 4 in Solution and Insight into RNA Binding and the Inhibitory Role of Quercetin." *Acta Crystallographica. Section D, Structural Biology* 73 (Pt 5): 402–19. <https://doi.org/10.1107/S2059798317003849>.
- Papa, Anna, Elpida Papadopoulou, Stella Kalaitzopoulou, Katerina Tsioka, and Spiros Mourelatos. 2014. "Detection of West Nile Virus and Insect-Specific Flavivirus RNA in *Culex* Mosquitoes, Central Macedonia, Greece." *Transactions of the Royal Society of Tropical Medicine and Hygiene*. <https://doi.org/10.1093/trstmh/tru100>.
- Parreira, Ricardo, Shelley Cook, Ângela Lopes, António Pedro de Matos, António Paulo Gouveia de Almeida, João Piedade, and Aida Esteves. 2012. "Genetic Characterization of an Insect-Specific Flavivirus Isolated from *Culex Theileri* Mosquitoes Collected in Southern Portugal." *Virus Research*. <https://doi.org/10.1016/j.virusres.2012.04.010>.
- Pauszek, Steven J., and Luis L. Rodriguez. 2012. "Full-Length Genome Analysis of Vesicular Stomatitis New Jersey Virus Strains Representing the Phylogenetic and Geographic Diversity of the Virus." *Archives of Virology*. <https://doi.org/10.1007/s00705-012-1420-x>.
- Pauvolid-Corrêa, Alex, Owen Solberg, Dinair Couto-Lima, Joan Kenney, Nicolau Serra-Freire, Aaron Brault, Rita Nogueira, Stanley Langevin, and Nicholas Komar. 2015. "Nhumirim Virus, a Novel Flavivirus Isolated from Mosquitoes from the Pantanal, Brazil." *Archives of Virology*. <https://doi.org/10.1007/s00705-014-2219-8>.
- Payne, Anne F., Iwona Binduga-Gajewska, Elizabeth B. Kauffman, and Laura D. Kramer. 2006. "Quantitation of Flaviviruses by Fluorescent Focus Assay." *Journal of Virological Methods*. <https://doi.org/10.1016/j.jviromet.2006.01.003>.
- Peterson, Townsend T., Darin S. Carroll, James N. Mills, and Karl M. Johnson. 2004. "Potential Mammalian Filovirus Reservoirs." *Emerging Infectious Diseases*. <https://doi.org/10.3201/eid1012.040346>.
- Petit, Marine, Vanesa Mongelli, Lionel Frangeul, Hervé Blanc, Francis Jiggins, and Maria-Carla Saleh. 2016. "PiRNA Pathway Is Not Required for Antiviral Defense in *Drosophila Melanogaster*." *Proceedings of the National Academy of Sciences* 113 (29): E4218–27. <https://doi.org/10.1073/pnas.1607952113>.

- PIERRE V., THIRIA J., RACHOU E., SISSOKO D., LASSALLE C. &, and RENAULT P. n.d. “Épidémie de Dengue-1 à La Réunion En 2004, Journées INVS, 2005,” http://www.invs.sante.fr/publications/2005/jvs_200.
- Pijlman, Gorben P., Anneke Funk, Natasha Kondratieva, Jason Leung, Shessy Torres, Lieke van der Aa, Wen Jun Liu, et al. 2008. “A Highly Structured, Nuclease-Resistant, Noncoding RNA Produced by Flaviviruses Is Required for Pathogenicity.” *Cell Host and Microbe*. <https://doi.org/10.1016/j.chom.2008.10.007>.
- Pischedda, Elisa, Francesca Scolari, Federica Valerio, Rebeca Carballar-Lejarazú, Paolo Luigi Catapano, Robert M Waterhouse, and Mariangela Bonizzoni. 2019. “Insights Into an Unexplored Component of the Mosquito Repeatome: Distribution and Variability of Viral Sequences Integrated Into the Genome of the Arboviral Vector *Aedes Albopictus*.” *Frontiers in Genetics* 10 (February): 93. <https://doi.org/10.3389/fgene.2019.00093>.
- Pluskota B, Storch V, Braunbeck T, Beck M, Becker N. n.d. “First Record of *Stegomyia Albopicta* (Skuse) (Diptera: Culicidae) in Germany.” *Eur Mosq Bull* 26: 1–5.
- Poirier, Enzo Z., Bertsy Goic, Lorena Tomé-Poderti, Lionel Frangeul, Jérémy Boussier, Valérie Gausson, Hervé Blanc, et al. 2018. “Dicer-2-Dependent Generation of Viral DNA from Defective Genomes of RNA Viruses Modulates Antiviral Immunity in Insects.” *Cell Host and Microbe*. <https://doi.org/10.1016/j.chom.2018.02.001>.
- Pompon, Julien, Menchie Manuel, Geok Kee Ng, Benjamin Wong, Chao Shan, Gayathri Manokaran, Ruben Soto-Acosta, et al. 2017. “Dengue Subgenomic Flaviviral RNA Disrupts Immunity in Mosquito Salivary Glands to Increase Virus Transmission.” *PLoS Pathogens*. <https://doi.org/10.1371/journal.ppat.1006535>.
- Post, Christina, Josef P. Clark, Yuliya A. Sytnikova, Gung Wei Chirn, and Nelson C. Lau. 2014. “The Capacity of Target Silencing by *Drosophila* PIWI and PiRNAs.” *RNA*. <https://doi.org/10.1261/rna.046300.114>.
- Powers, Ann M, and Christopher H Logue. 2007. “Changing Patterns of Chikungunya Virus: Re-Emergence of a Zoonotic Arbovirus.” *The Journal of General Virology* 88 (Pt 9): 2363–77. <https://doi.org/10.1099/vir.0.82858-0>.
- Pritham, Ellen J, Tasneem Putliwala, and Cédric Feschotte. 2007. “Mavericks, a Novel Class of Giant Transposable Elements Widespread in Eukaryotes and Related to DNA Viruses.” *Gene* 390 (1–2): 3–17. <https://doi.org/10.1016/j.gene.2006.08.008>.
- Qiu, F X, D J Gubler, J C Liu, and Q Q Chen. 1993. “Dengue in China: A Clinical Review.” *Bulletin of the World Health Organization* 71 (3–4): 349–59. <http://www.ncbi.nlm.nih.gov/pubmed/8324854>.
- Quintos FN, Lim LE, Juliano L, Reyes A and Lacson P. 1954. “Hemorrhagic Fever Observed among Children in the Philippines.” *Philippine J Pediat* 3:1-19.
- Raharimalala, Fara Nantenaina, Lala Harivelo Ravaomanarivo, Pierre Ravelonandro, Lala Sahondra Rafaraso, Karima Zouache, Van Tran-Van, Laurence Mousson, et al. 2012. “Biogeography of the Two Major Arbovirus Mosquito Vectors, *Aedes Aegypti* and

- Aedes Albopictus* (Diptera, Culicidae), in Madagascar.” *Parasites & Vectors* 5 (March): 56. <https://doi.org/10.1186/1756-3305-5-56>.
- Rao, P N, and K Rai. 1987. “Inter and Intraspecific Variation in Nuclear DNA Content in *Aedes* Mosquitoes.” *Heredity* 59 (Pt 2) (October): 253–58. <http://www.ncbi.nlm.nih.gov/pubmed/3679880>.
- Reuter, Michael, Philipp Berninger, Shinichiro Chuma, Hardik Shah, Mihoko Hosokawa, Charlotta Funaya, Claude Antony, Ravi Sachidanandam, and Ramesh S. Pillai. 2011. “Miwi Catalysis Is Required for PiRNA Amplification-Independent LINE1 Transposon Silencing.” *Nature*. <https://doi.org/10.1038/nature10672>.
- Rezza, G, L Nicoletti, R Angelini, R Romi, A C Finarelli, M Panning, P Cordioli, et al. 2007. “Infection with Chikungunya Virus in Italy: An Outbreak in a Temperate Region.” *Lancet (London, England)* 370 (9602): 1840–46. [https://doi.org/10.1016/S0140-6736\(07\)61779-6](https://doi.org/10.1016/S0140-6736(07)61779-6).
- Rezza, Giovanni. 2012. “*Aedes Albopictus* and the Reemergence of Dengue.” *BMC Public Health* 12 (1): 72. <https://doi.org/10.1186/1471-2458-12-72>.
- Riedel, B, and D T Brown. 1977. “Role of Extracellular Virus on the Maintenance of the Persistent Infection Induced in *Aedes Albopictus* (Mosquito) Cells by Sindbis Virus.” *Journal of Virology* 23 (3): 554–61. <http://www.ncbi.nlm.nih.gov/pubmed/561193>.
- Rima, Bertus K., and Neil V. McFerran. 1997. “Dinucleotide and Stop Codon Frequencies in Single-Stranded RNA Viruses.” *Journal of General Virology*. <https://doi.org/10.1099/0022-1317-78-11-2859>.
- Rizzo, Francesca, Francesco Cerutti, Marco Ballardini, Andrea Mosca, Nicoletta Vitale, Maria Cristina Radaelli, Rosanna Desiato, et al. 2014. “Molecular Characterization of Flaviviruses from Field-Collected Mosquitoes in Northwestern Italy, 2011-2012.” *Parasites and Vectors*. <https://doi.org/10.1186/1756-3305-7-395>.
- Robinson, H L, S M Astrin, A M Senior, and F H Salazar. 1981. “Host Susceptibility to Endogenous Viruses: Defective, Glycoprotein-Expressing Proviruses Interfere with Infections.” *Journal of Virology*.
- Robinson, Marion C. 1955. “An Epidemic of Virus Disease in Southern Province, Tanganyika Territory, in 1952–1953.” *Transactions of the Royal Society of Tropical Medicine and Hygiene* 49 (1): 28–32. [https://doi.org/10.1016/0035-9203\(55\)90080-8](https://doi.org/10.1016/0035-9203(55)90080-8).
- Roderick, George K. 1996. “Geographic Structure of Insect Populations: Gene Flow, Phylogeography, and Their Uses.” *Annual Review of Entomology* 41 (1): 325–52. <https://doi.org/10.1146/annurev.en.41.010196.001545>.
- Roiz, David, Ana Vázquez, Fausta Rosso, Daniele Arnoldi, Matteo Girardi, Laureano Cuevas, Esperanza Perez-Pastrana, Mari Paz Sánchez-Seco, Antonio Tenorio, and Annapaola Rizzoli. 2012. “Detection of a New Insect Flavivirus and Isolation of *Aedes* Flavivirus in Northern Italy.” *Parasites & Vectors* 5 (October): 223. <https://doi.org/10.1186/1756-3305-5-223>.

- Roiz, David, Ana Vázquez, Mari Paz Sánchez Seco, Antonio Tenorio, and Annapaola Rizzoli. 2009. "Detection of Novel Insect Flavivirus Sequences Integrated in *Aedes Albopictus* (Diptera: Culicidae) in Northern Italy." *Virology Journal* 6: 93. <https://doi.org/10.1186/1743-422X-6-93>.
- Roossinck, Marilyn J. 2015. "Plants, Viruses and the Environment: Ecology and Mutualism." *Virology*. <https://doi.org/10.1016/j.virol.2015.03.041>.
- Rosen, L, L E Roseboom, D J Gubler, J C Lien, and B N Chaniotis. 1985. "Comparative Susceptibility of Mosquito Species and Strains to Oral and Parenteral Infection with Dengue and Japanese Encephalitis Viruses." *The American Journal of Tropical Medicine and Hygiene* 34 (3): 603–15. <http://www.ncbi.nlm.nih.gov/pubmed/2860816>.
- Ross, R. W. 1956. "The Newala Epidemic: III. The Virus: Isolation, Pathogenic Properties and Relationship to the Epidemic." *Journal of Hygiene*. <https://doi.org/10.1017/S0022172400044442>.
- Ruche, G La, Y Souarès, A Armengaud, F Peloux-Petiot, P Delaunay, P Desprès, A Lenglet, et al. 2010. "First Two Autochthonous Dengue Virus Infections in Metropolitan France, September 2010." *Euro Surveillace: Bulletin Europeen Sur Les Maladies Transmissibles = European Communicable Disease Bulletin* 15 (39): 19676. <http://www.ncbi.nlm.nih.gov/pubmed/20929659>.
- Rust, R S, W H Thompson, C G Matthews, B J Beaty, and R W Chun. 1999. "La Crosse and Other Forms of California Encephalitis." *Journal of Child Neurology* 14 (1): 1–14. <https://doi.org/10.1177/088307389901400101>.
- Sahili, Abbas El, and Julien Lescar. 2017. "Dengue Virus Non-Structural Protein 5." *Viruses*. <https://doi.org/10.3390/v9040091>.
- Saiyasombat, Rungrat, Bethany G Bolling, Aaron C Brault, Lyric C Bartholomay, and Bradley J Blitvich. 2011. "Evidence of Efficient Transovarial Transmission of Culex Flavivirus by Culex Pipiens (Diptera: Culicidae)." *Journal of Medical Entomology* 48 (5): 1031–38. <http://www.ncbi.nlm.nih.gov/pubmed/21936322>.
- Saldaña, Miguel A., Kayvan Etebari, Charles E. Hart, Steven G. Widen, Thomas G. Wood, Saravanan Thangamani, Sassan Asgari, and Grant L. Hughes. 2017. "Zika Virus Alters the MicroRNA Expression Profile and Elicits an RNAi Response in *Aedes Aegypti* Mosquitoes." *PLoS Neglected Tropical Diseases*. <https://doi.org/10.1371/journal.pntd.0005760>.
- Salonen, A., L. Vasiljeva, A. Merits, J. Magden, E. Jokitalo, and L. Kaariainen. 2003. "Properly Folded Nonstructural Polyprotein Directs the Semliki Forest Virus Replication Complex to the Endosomal Compartment." *Journal of Virology*. <https://doi.org/10.1128/jvi.77.3.1691-1702.2003>.
- Sam, I-Ching, Shih-Keng Loong, Jasmine Chandramathi Michael, Chong-Long Chua, Wan Yusoff Wan Sulaiman, Indra Vythilingam, Shie-Yien Chan, et al. 2012. "Genotypic and Phenotypic Characterization of Chikungunya Virus of Different Genotypes from Malaysia." *PloS One* 7 (11): e50476. <https://doi.org/10.1371/journal.pone.0050476>.

- Samuel, Gladys Hazitha, Michael R. Wiley, Atif Badawi, Zach N. Adelman, and Kevin M. Myles. 2016. "Yellow Fever Virus Capsid Protein Is a Potent Suppressor of RNA Silencing That Binds Double-Stranded RNA." *Proceedings of the National Academy of Sciences*. <https://doi.org/10.1073/pnas.1600544113>.
- Sánchez-Vargas, Irma, Jaclyn C. Scott, B. Katherine Poole-Smith, Alexander W.E. Franz, Valérie Barbosa-Solomieu, Jeffrey Wilusz, Ken E. Olson, and Carol D. Blair. 2009. "Dengue Virus Type 2 Infections of *Aedes Aegypti* Are Modulated by the Mosquito's RNA Interference Pathway." *PLoS Pathogens*. <https://doi.org/10.1371/journal.ppat.1000299>.
- Sang, R. C., A. Gichogo, J. Gachoya, M. D. Dunster, V. Ofula, A. R. Hunt, Mary B. Crabtree, B. R. Miller, and L. M. Dunster. 2003. "Isolation of a New Flavivirus Related to Cell Fusing Agent Virus (CFAV) from Field-Collected Flood-Water *Aedes* Mosquitoes Sampled from a Dambo in Central Kenya." *Archives of Virology*. <https://doi.org/10.1007/s00705-003-0018-8>.
- Sanjuán, Rafael. 2012. "From Molecular Genetics to Phylodynamics: Evolutionary Relevance of Mutation Rates across Viruses." Edited by Barbara Sherry. *PLoS Pathogens* 8 (5): e1002685. <https://doi.org/10.1371/journal.ppat.1002685>.
- SanMiguel, P, A Tikhonov, Y K Jin, N Motchoulskaia, D Zakharov, A Melake-Berhan, P S Springer, et al. 1996. "Nested Retrotransposons in the Intergenic Regions of the Maize Genome." *Science (New York, N.Y.)* 274 (5288): 765–68. <https://doi.org/10.1126/science.274.5288.765>.
- Santos, Taissa Pereira dos, Oswaldo Gonsalvez Cruz, Keli Antunes Barbosa da Silva, Márcia Gonçalves de Castro, Anielly Ferreira de Brito, Renato Cesar Maspero, Rosilene de Alcântara, Flávia Barreto dos Santos, Nildimar A. Honorio, and Ricardo Lourenço-de-Oliveira. 2017. "Dengue Serotype Circulation in Natural Populations of *Aedes Aegypti*." *Acta Tropica*. <https://doi.org/10.1016/j.actatropica.2017.07.014>.
- Sanz, M A, and L Carrasco. 2001. "Sindbis Virus Variant with a Deletion in the 6K Gene Shows Defects in Glycoprotein Processing and Trafficking: Lack of Complementation by a Wild-Type 6K Gene in Trans." *Journal of Virology* 75 (16): 7778–84. <https://doi.org/10.1128/JVI.75.16.7778-7784.2001>.
- Savage, H M, V I Ezike, A C Nwankwo, R Spiegel, and B R Miller. 1992. "First Record of Breeding Populations of *Aedes Albopictus* in Continental Africa: Implications for Arboviral Transmission." *Journal of the American Mosquito Control Association* 8 (1): 101–3. <http://www.ncbi.nlm.nih.gov/pubmed/1583480>.
- Saxena, Vandana, Guorui Xie, Bei Li, Tierra Farris, Thomas Welte, Bin Gong, Paul Boor, et al. 2013. "A Hamster-Derived West Nile Virus Isolate Induces Persistent Renal Infection in Mice." *PLoS Neglected Tropical Diseases*. <https://doi.org/10.1371/journal.pntd.0002275>.
- Scaturro, Pietro, Mirko Cortese, Laurent Chatel-Chaix, Wolfgang Fischl, and Ralf Bartenschlager. 2015. "Dengue Virus Non-Structural Protein 1 Modulates Infectious Particle Production via Interaction with the Structural Proteins." *PLoS Pathogens* 11

(11): e1005277. <https://doi.org/10.1371/journal.ppat.1005277>.

- Schaffner, F, and S Karch. 2000. “[First Report of *Aedes Albopictus* (Skuse, 1984) in Metropolitan France].” *Comptes Rendus de l’Academie Des Sciences. Serie III, Sciences de La Vie* 323 (4): 373–75. <http://www.ncbi.nlm.nih.gov/pubmed/10803348>.
- Schaffner, Francis, Wim Van Bortel, and Marc Coosemans. 2004. “First Record of *Aedes* (*Stegomyia*) *Albopictus* in Belgium.” *Journal of the American Mosquito Control Association*.
- Schliessmann D.J and Calheiros L.B. 1974. “A Review of the Status of Yellow Fever and *Aedes Aegypti* Eradication Programs in the Americas.” *Mosqu News* 34 (1): 1–9.
- Schmidt, A, G Palumbo, M P Bozzetti, P Tritto, S Pimpinelli, and U Schäfer. 1999. “Genetic and Molecular Characterization of *Sting*, a Gene Involved in Crystal Formation and Meiotic Drive in the Male Germ Line of *Drosophila Melanogaster*.” *Genetics* 151 (2): 749–60. <http://www.ncbi.nlm.nih.gov/pubmed/9927466>.
- Schnettler, E., C. L. Donald, S. Human, M. Watson, R. W. C. Siu, M. McFarlane, J. K. Fazakerley, A. Kohl, and R. Fragkoudis. 2013. “Knockdown of PiRNA Pathway Proteins Results in Enhanced Semliki Forest Virus Production in Mosquito Cells.” *Journal of General Virology* 94 (Pt_7): 1680–89. <https://doi.org/10.1099/vir.0.053850-0>.
- Schnettler, E., J.Y. Leung, M.G. Sterken, S.W. Metz, C. Geertsema, R.W. Goldbach, J.M. Vlak, A. Kohl, A.a. Khromykh, and G.P. Pijlman. 2013. “Non-Coding Flavivirus RNA Displays RNAi Suppressor Activity in Insect and Mammalian Cells.” *Journal of Virology*. <https://doi.org/10.1128/JVI.01104-12>.
- Schuffenecker, Isabelle, Isabelle Iteman, Alain Michault, Séverine Murri, Lionel Frangeul, Marie-Christine Vaney, Rachel Lavenir, et al. 2006. “Genome Microevolution of Chikungunya Viruses Causing the Indian Ocean Outbreak.” Edited by Herbert Virgin IV. *PLoS Medicine* 3 (7): e263. <https://doi.org/10.1371/journal.pmed.0030263>.
- Schultz, Michaela J., Horacio M. Frydman, and John H. Connor. 2018. “Dual Insect Specific Virus Infection Limits Arbovirus Replication in *Aedes* Mosquito Cells.” *Virology* 518 (May): 406–13. <https://doi.org/10.1016/j.virol.2018.03.022>.
- Schüpbach, T, and E Wieschaus. 1991. “Female Sterile Mutations on the Second Chromosome of *Drosophila Melanogaster*. II. Mutations Blocking Oogenesis or Altering Egg Morphology.” *Genetics* 129 (4): 1119–36. <http://www.ncbi.nlm.nih.gov/pubmed/1783295>.
- Schwartz, Olivier, and Matthew L Albert. 2010. “Biology and Pathogenesis of Chikungunya Virus.” *Nature Reviews. Microbiology* 8 (7): 491–500. <https://doi.org/10.1038/nrmicro2368>.
- Scott, Jaclyn C., Doug E. Brackney, Corey L. Campbell, Virginie Bondu-Hawkins, Brian Hjelle, Greg D. Ebel, Ken E. Olson, and Carol D. Blair. 2010. “Comparison of Dengue Virus Type 2-Specific Small RNAs from RNA Interference-Competent and -Incompetent Mosquito Cells.” *PLoS Neglected Tropical Diseases* 4 (10).

<https://doi.org/10.1371/journal.pntd.0000848>.

- Sha, Mi, Xinhua Lee, Xiang ping Li, Geertrulda M. Veldman, Heather Finnerty, Lisa Racie, Edward LaVallie, et al. 2000. "Syncytin Is a Captive Retroviral Envelope Protein Involved in Human Placental Morphogenesis." *Nature*. <https://doi.org/10.1038/35001608>.
- Sharp, Tyler M, Nicole M Roth, Jomil Torres, Kyle R Ryff, Nicole M Pérez Rodríguez, Chanis Mercado, Maria Del Pilar Diaz Padró, et al. 2014. "Chikungunya Cases Identified through Passive Surveillance and Household Investigations--Puerto Rico, May 5-August 12, 2014." *MMWR. Morbidity and Mortality Weekly Report* 63 (48): 1121–28. <http://www.ncbi.nlm.nih.gov/pubmed/25474032>.
- Shepard, Donald S, Eduardo A Undurraga, Yara A Halasa, and Jeffrey D Stanaway. 2016. "The Global Economic Burden of Dengue: A Systematic Analysis." *The Lancet. Infectious Diseases* 16 (8): 935–41. [https://doi.org/10.1016/S1473-3099\(16\)00146-8](https://doi.org/10.1016/S1473-3099(16)00146-8).
- Shi, Mang, Xian Dan Lin, Jun Hua Tian, Liang Jun Chen, Xiao Chen, Ci Xiu Li, Xin Cheng Qin, et al. 2016. "Redefining the Invertebrate RNA Virophere." *Nature*. <https://doi.org/10.1038/nature20167>.
- Simmons, Gs, Pr Young, Jj Hanger, K. Jones, D. Clarke, Jj Mckee, and J. Meers. 2012. "Prevalence of Koala Retrovirus in Geographically Diverse Populations in Australia." *Australian Veterinary Journal*. <https://doi.org/10.1111/j.1751-0813.2012.00964.x>.
- Simon-Loriere, Etienne, Ren-Jye Lin, Sita Mint Kalayanarooj, Ampaiwan Chuansumrit, Isabelle Casademont, Shyr-Yi Lin, Han-Pang Yu, et al. 2015. "High Anti-Dengue Virus Activity of the OAS Gene Family Is Associated With Increased Severity of Dengue." *The Journal of Infectious Diseases* 212 (12): 2011–20. <https://doi.org/10.1093/infdis/jiv321>.
- Siomi, Mikiko C, Kaoru Sato, Dubravka Pezic, and Alexei A Aravin. 2011. "PIWI-Interacting Small RNAs: The Vanguard of Genome Defence." *Nature Reviews. Molecular Cell Biology* 12 (4): 246–58. <https://doi.org/10.1038/nrm3089>.
- Sissoko, Daouda, Amrat Moendandze, Denis Malvy, Claude Giry, Khaled Ezzedine, Jean Louis Solet, and Vincent Pierre. 2008. "Seroprevalence and Risk Factors of Chikungunya Virus Infection in Mayotte, Indian Ocean, 2005-2006: A Population-Based Survey." *PloS One* 3 (8): e3066. <https://doi.org/10.1371/journal.pone.0003066>.
- Smith, G P. 1976. "Evolution of Repeated DNA Sequences by Unequal Crossover." *Science (New York, N.Y.)* 191 (4227): 528–35. <https://doi.org/10.1126/science.1251186>.
- Smithburn, K. C., T. P. Hughes, A. W. Burke, and J. H. Paul. 1940. "A Neurotropic Virus Isolated from the Blood of a Native of Uganda 1." *The American Journal of Tropical Medicine and Hygiene* s1-20 (4): 471–92. <https://doi.org/10.4269/ajtmh.1940.s1-20.471>.
- Soldan, S. S., M. L. Plassmeyer, M. K. Matukonis, and F. Gonzalez-Scarano. 2005. "La Crosse Virus Nonstructural Protein NSs Counteracts the Effects of Short Interfering RNA." *Journal of Virology*. <https://doi.org/10.1128/jvi.79.1.234-244.2005>.

- Staginnus, Christina, and Katja R. Richert-Pöggeler. 2006. "Endogenous Pararetroviruses: Two-Faced Travelers in the Plant Genome." *Trends in Plant Science*. <https://doi.org/10.1016/j.tplants.2006.08.008>.
- Stanaway, Jeffrey D, Donald S Shepard, Eduardo A Undurraga, Yara A Halasa, Luc E Coffeng, Oliver J Brady, Simon I Hay, et al. 2016. "The Global Burden of Viral Hepatitis: An Analysis from the Global Burden of Disease Study 2013." *The Lancet Infectious Diseases*. [https://doi.org/10.1016/S1473-3099\(16\)00026-8](https://doi.org/10.1016/S1473-3099(16)00026-8).
- Staples, J Erin, Robert F Breiman, and Ann M Powers. 2009. "Chikungunya: Establishing a New Home in the Western Hemisphere." *Clinical Infectious Diseases: An Official Publication of the Infectious Diseases Society of America*. <https://doi.org/10.1086/605496>.
- Stiasny, K., S. Kiermayr, H. Holzmann, and F. X. Heinz. 2006. "Cryptic Properties of a Cluster of Dominant Flavivirus Cross-Reactive Antigenic Sites." *Journal of Virology*. <https://doi.org/10.1128/jvi.00080-06>.
- Stokes, a, J H Bauer, and N P Hudson. 2001. "The Transmission of Yellow Fever to Macacus Rhesus. 1928." *Reviews in Medical Virology*.
- Stollar, V, and V L Thomas. 1975. "An Agent in the Aedes Aegypti Cell Line (Peleg) Which Causes Fusion of Aedes Albopictus Cells." *Virology* 64 (2): 367–77. [https://doi.org/10.1016/0042-6822\(75\)90113-0](https://doi.org/10.1016/0042-6822(75)90113-0).
- Sudeep, A B, and D Parashar. 2008. "Chikungunya: An Overview." *Journal of Biosciences* 33 (4): 443–49. <http://www.ncbi.nlm.nih.gov/pubmed/19208970>.
- Suh, Alexander, Jürgen Brosius, Jürgen Schmitz, and Jan Ole Kriegs. 2013. "The Genome of a Mesozoic Paleovirus Reveals the Evolution of Hepatitis B Viruses." *Nature Communications*. <https://doi.org/10.1038/ncomms2798>.
- Sullivan, Christopher S, and Don Ganem. 2005. "A Virus-Encoded Inhibitor That Blocks RNA Interference in Mammalian Cells." *Journal of Virology* 79 (12): 7371–79. <https://doi.org/10.1128/JVI.79.12.7371-7379.2005>.
- Summers, Peter L., Wendy Houston Cohen, Maria M. Ruiz, Tatsuo Hase, and Kenneth H. Eckels. 1989. "Flaviviruses Can Mediate Fusion from without in Aedes Albopictus Mosquito Cell Cultures." *Virus Research* 12 (4): 383–92. [https://doi.org/10.1016/0168-1702\(89\)90095-6](https://doi.org/10.1016/0168-1702(89)90095-6).
- Sun, Chao, Helen Skaletsky, Steve Rozen, Jörg Gromol, Eberhard Nieschlag, Robert Oates, and David C. Page. 2000. "Deletion of Azoospermia Factor a (AZFa) Region of Human Y Chromosome Caused by Recombination between HERV15 Proviruses." *Human Molecular Genetics*. <https://doi.org/10.1093/oxfordjournals.hmg.a018920>.
- Suzuki, Yasutsugu, Lionel Frangeul, Laura B. Dickson, Hervé Blanc, Yann Verdier, Joelle Vinh, Louis Lambrechts, and Maria-Carla Saleh. 2017. "Uncovering the Repertoire of Endogenous Flaviviral Elements in Aedes Mosquito Genomes." Edited by Julie K. Pfeiffer. *Journal of Virology* 91 (15): e00571-17. <https://doi.org/10.1128/JVI.00571-17>.

- Taengchaiyaphum, Suparat, Jiraporn Srisala, Phimsucha Bunphimpapha, Premruethai Supungul, Anchalee Tassanakajon, Sage Chaiyapechara, Suparek Bowornpinyo, Kallaya Sritunyalucksana, and Timothy W. Flegel. 2019. "Mendelian Inheritance of Endogenous Viral Elements (EVE) of White Spot Syndrome Virus (WSSV) in Shrimp." *Developmental and Comparative Immunology*. <https://doi.org/10.1016/j.dci.2019.03.004>.
- Takata, Matthew A., Daniel Gonçalves-Carneiro, Trinity M. Zang, Steven J. Soll, Ashley York, Daniel Blanco-Melo, and Paul D. Bieniasz. 2017. "CG Dinucleotide Suppression Enables Antiviral Defence Targeting Non-Self RNA." *Nature*. <https://doi.org/10.1038/nature24039>.
- Talavera, Sandra, Lotty Birnberg, Ana I Nuñez, Francesc Muñoz-Muñoz, Ana Vázquez, and Núria Busquets. 2018. "Culex Flavivirus Infection in a Culex Pipiens Mosquito Colony and Its Effects on Vector Competence for Rift Valley Fever Phlebovirus." *Parasites & Vectors* 11 (1): 310. <https://doi.org/10.1186/s13071-018-2887-4>.
- Tanne, Edna, and Ilan Sela. 2005. "Occurrence of a DNA Sequence of a Non-Retro RNA Virus in a Host Plant Genome and Its Expression: Evidence for Recombination between Viral and Host RNAs." *Virology*. <https://doi.org/10.1016/j.virol.2004.11.007>.
- Tassaneetrithep, Boonrat, Timothy H. Burgess, Angela Granelli-Piperno, Christine Trumfpheller, Jennifer Finke, Wellington Sun, Michael A. Eller, et al. 2003. "DC-SIGN (CD209) Mediates Dengue Virus Infection of Human Dendritic Cells." *The Journal of Experimental Medicine*. <https://doi.org/10.1084/jem.20021840>.
- Taylor, Derek J., Robert W. Leach, and Jeremy Bruenn. 2010. "Filoviruses Are Ancient and Integrated into Mammalian Genomes." *BMC Evolutionary Biology*. <https://doi.org/10.1186/1471-2148-10-193>.
- Temin, Howard M. 1980. "Origin of Retroviruses from Cellular Moveable Genetic Elements." *Cell*. [https://doi.org/10.1016/0092-8674\(80\)90420-1](https://doi.org/10.1016/0092-8674(80)90420-1).
- Terasaki, Natsuko, John L. Goodier, Ling E. Cheung, Yue J. Wang, Masaki Kajikawa, Haig H. Kazazian, and Norihiro Okada. 2013. "In Vitro Screening for Compounds That Enhance Human L1 Mobilization." *PloS One*. <https://doi.org/10.1371/journal.pone.0074629>.
- Terzian, Christophe, Concepcion Ferraz, Jacques Demaille, and Alain Bucheton. 2000. "Evolution of the Gypsy Endogenous Retrovirus in the Drosophila Melanogaster Subgroup." *Molecular Biology and Evolution*. <https://doi.org/10.1093/oxfordjournals.molbev.a026371>.
- Thiberville, Simon Djamel, Veronique Boisson, Jean Gaudart, Fabrice Simon, Antoine Flahault, and Xavier de Lamballerie. 2013. "Chikungunya Fever: A Clinical and Virological Investigation of Outpatients on Reunion Island, South-West Indian Ocean." *PLoS Neglected Tropical Diseases*. <https://doi.org/10.1371/journal.pntd.0002004>.
- Tomari, Yukihide, Tingting Du, and Phillip D. Zamore. 2007. "Sorting of Drosophila Small Silencing RNAs." *Cell*. <https://doi.org/10.1016/j.cell.2007.05.057>.

- Tóth, Katalin Fejes, Dubravka Pezic, Evelyn Stuwe, and Alexandre Webster. 2016. “The Pirna Pathway Guards the Germline Genome against Transposable Elements.” In *Advances in Experimental Medicine and Biology*. https://doi.org/10.1007/978-94-017-7417-8_4.
- Tree, Maya O, Dexter R McKellar, Kristopher J Kieft, Alan M Watson, Kate D Ryman, and Michael J Conway. 2016. “Insect-Specific Flavivirus Infection Is Restricted by Innate Immunity in the Vertebrate Host.” *Virology* 497: 81–91. <https://doi.org/10.1016/j.virol.2016.07.005>.
- Tsai, Kuen Nan, Shih Fang Tsang, Chung Hao Huang, and Ruey Yi Chang. 2007. “Defective Interfering RNAs of Japanese Encephalitis Virus Found in Mosquito Cells and Correlation with Persistent Infection.” *Virus Research*. <https://doi.org/10.1016/j.virusres.2006.10.013>.
- Tsetsarkin, Konstantin A., Dana L. Vanlandingham, Charles E. McGee, and Stephen Higgs. 2007a. “A Single Mutation in Chikungunya Virus Affects Vector Specificity and Epidemic Potential.” *PLoS Pathogens* 3 (12): e201. <https://doi.org/10.1371/journal.ppat.0030201>.
- Tsetsarkin, Konstantin A, Charles E McGee, and Stephen Higgs. 2011. “Chikungunya Virus Adaptation to *Aedes Albopictus* Mosquitoes Does Not Correlate with Acquisition of Cholesterol Dependence or Decreased PH Threshold for Fusion Reaction.” *Virology Journal* 8 (July): 376. <https://doi.org/10.1186/1743-422X-8-376>.
- Tsetsarkin, Konstantin A, Dana L Vanlandingham, Charles E McGee, and Stephen Higgs. 2007b. “A Single Mutation in Chikungunya Virus Affects Vector Specificity and Epidemic Potential.” *PLoS Pathogens* 3 (12): e201. <https://doi.org/10.1371/journal.ppat.0030201>.
- Tyler, Shaun, Bethany G Bolling, Carol D Blair, Aaron C Brault, Kanti Pabbaraju, M Veronica Armijos, David C Clark, Charles H Calisher, and Michael A Drebot. 2011. “Distribution and Phylogenetic Comparisons of a Novel Mosquito Flavivirus Sequence Present in *Culex Tarsalis* Mosquitoes from Western Canada with Viruses Isolated in California and Colorado.” *The American Journal of Tropical Medicine and Hygiene* 85 (1): 162–68. <https://doi.org/10.4269/ajtmh.2011.10-0469>.
- Urcelay, E, P Ward, S M Wiener, B Safer, and R M Kotin. 1995. “Asymmetric Replication in Vitro from a Human Sequence Element Is Dependent on Adeno-Associated Virus Rep Protein.” *Journal of Virology* 69 (4): 2038–46. <http://www.ncbi.nlm.nih.gov/pubmed/7884849>.
- Varjak, Margus, Claire L. Donald, Timothy J. Mottram, Vattipally B. Sreenu, Andres Merits, Kevin Maringer, Esther Schnettler, and Alain Kohl. 2017a. “Characterization of the Zika Virus Induced Small RNA Response in *Aedes Aegypti* Cells.” *PLoS Neglected Tropical Diseases*. <https://doi.org/10.1371/journal.pntd.0006010>.
- Varjak, Margus, Claire L Donald, Timothy J Mottram, Vattipally B Sreenu, Andres Merits, Kevin Maringer, Esther Schnettler, and Alain Kohl. 2017b. “Characterization of the Zika Virus Induced Small RNA Response in *Aedes Aegypti* Cells.” *PLoS Neglected Tropical*

Diseases 11 (10): e0006010. <https://doi.org/10.1371/journal.pntd.0006010>.

- Varjak, Margus, Mayke Leggewie, and Esther Schnettler. 2018. "The Antiviral PiRNA Response in Mosquitoes?" *The Journal of General Virology* 99 (12): 1551–62. <https://doi.org/10.1099/jgv.0.001157>.
- Vazeille, Marie, Sara Moutailler, Daniel Coudrier, Claudine Rousseaux, Huot Khun, Michel Huerre, Julien Thiria, et al. 2007. "Two Chikungunya Isolates from the Outbreak of La Reunion (Indian Ocean) Exhibit Different Patterns of Infection in the Mosquito, *Aedes Albopictus*." Edited by Joel Montgomery. *PLoS ONE* 2 (11): e1168. <https://doi.org/10.1371/journal.pone.0001168>.
- Vazeille, Marie, Karima Zouache, Anubis Vega-Rúa, Jean Michel Thiberge, Valérie Caro, André Yébakima, Laurence Mousson, et al. 2016. "Importance of Mosquito 'Quasispecies' in Selecting an Epidemic Arthropod-Borne Virus." *Scientific Reports*. <https://doi.org/10.1038/srep29564>.
- Vázquez, Ana, María-Paz Sánchez-Seco, Gustavo Palacios, Francisca Molero, Noelia Reyes, Santiago Ruiz, Carles Aranda, et al. 2012. "Novel Flaviviruses Detected in Different Species of Mosquitoes in Spain." *Vector-Borne and Zoonotic Diseases*. <https://doi.org/10.1089/vbz.2011.0687>.
- Vega-Rúa, Anubis, Ricardo Lourenço-De-Oliveira, Laurence Mousson, Marie Vazeille, Sappho Fuchs, André Yébakima, Joel Gustave, et al. 2015. "Chikungunya Virus Transmission Potential by Local *Aedes* Mosquitoes in the Americas and Europe." *PLoS Neglected Tropical Diseases*. <https://doi.org/10.1371/journal.pntd.0003780>.
- Vijayakumar, K, B George, T S Anish, R S Rajasi, M J Teena, and C M Sujina. 2013. "Economic Impact of Chikungunya Epidemic: Out-of-Pocket Health Expenditures during the 2007 Outbreak in Kerala, India." *The Southeast Asian Journal of Tropical Medicine and Public Health* 44 (1): 54–61. <http://www.ncbi.nlm.nih.gov/pubmed/23682438>.
- Vodovar, Nicolas, Alfred W Bronkhorst, Koen W R van Cleef, Pascal Miesen, Hervé Blanc, Ronald P van Rij, and Maria-Carla Saleh. 2012. "Arbovirus-Derived PiRNAs Exhibit a Ping-Pong Signature in Mosquito Cells." Edited by Sebastien Pfeffer. *PloS One* 7 (1): e30861. <https://doi.org/10.1371/journal.pone.0030861>.
- Walbot, V, and C A Cullis. 2003. "Rapid Genomic Change in Higher Plants." *Annual Review of Plant Physiology* 36 (1): 367–96. <https://doi.org/10.1146/annurev.pp.36.060185.002055>.
- Walker, Peter J., Cadhla Firth, Steven G. Widen, Kim R. Blasdell, Hilda Guzman, Thomas G. Wood, Prasad N. Paradkar, Edward C. Holmes, Robert B. Tesh, and Nikos Vasilakis. 2015. "Evolution of Genome Size and Complexity in the Rhabdoviridae." *PLoS Pathogens*. <https://doi.org/10.1371/journal.ppat.1004664>.
- Walker, T., P. H. Johnson, L. A. Moreira, I. Iturbe-Ormaetxe, F. D. Frentiu, C. J. McMeniman, Y. S. Leong, et al. 2011. "The WMel *Wolbachia* Strain Blocks Dengue and Invades Caged *Aedes Aegypti* Populations." *Nature*.

<https://doi.org/10.1038/nature10355>.

- Wang-Johanning, Feng, Andra R. Frost, Bixi Jian, Ricardo Azuero, Danielle W. Lu, Dung Tsa Chen, and Gary L. Johanning. 2003. "Detecting the Expression of Human Endogenous Retrovirus E Envelope Transcripts in Human Prostate Adenocarcinoma." *Cancer*. <https://doi.org/10.1002/cncr.11451>.
- Wang, Z., A. An, Y. Wang, Y. Han, and J. Guo. 2009. "A New Virus of SSavivirus: Chaoyang Virus Isolated in Liaoning Province." *Chin. J. Public Health* 25: 769–72.
- Wang, Hui, Zaijun Ma, Kongyan Niu, Yi Xiao, Xiaofen Wu, Chenyu Pan, Yun Zhao, Kai Wang, Yaoyang Zhang, and Nan Liu. 2016. "Antagonistic Roles of Nibbler and Hen1 in Modulating PiRNA 3' Ends in *Drosophila* ." *Development*. <https://doi.org/10.1242/dev.128116>.
- Wang, Wei, and Ewen F Kirkness. 2005. "Short Interspersed Elements (SINEs) Are a Major Source of Canine Genomic Diversity." *Genome Research* 15 (12): 1798–1808. <https://doi.org/10.1101/gr.3765505>.
- Wang, Yanhai, Binbin Jin, Peiwen Liu, Jing Li, Xiaoguang Chen, and Jinbao Gu. 2018. "PiRNA Profiling of Dengue Virus Type 2-Infected Asian Tiger Mosquito and Midgut Tissues." *Viruses* 10 (4): 213. <https://doi.org/10.3390/v10040213>.
- Warning, J. C., S. A. McCracken, and J. M. Morris. 2011. "A Balancing Act: Mechanisms by Which the Fetus Avoids Rejection by the Maternal Immune System." *Reproduction*. <https://doi.org/10.1530/REP-10-0360>.
- Watts, D M, B A Harrison, S Pantuwatana, T A Klein, and D S Burke. 1985. "Failure to Detect Natural Transovarial Transmission of Dengue Viruses by *Aedes Aegypti* and *Aedes Albopictus* (Diptera: Culicidae)." *Journal of Medical Entomology* 22 (3): 261–65. <https://doi.org/10.1093/jmedent/22.3.261>.
- Webster and Granoff. 1999. *Encyclopedia of Virology*. Vol. 3.
- Weger-Lucarelli, James, Claudia Rückert, Nathan D. Grubaugh, Michael J. Misencik, Philip M. Armstrong, Mark D. Stenglein, Gregory D. Ebel, and Doug E. Brackney. 2018. "Adventitious Viruses Persistently Infect Three Commonly Used Mosquito Cell Lines." *Virology*. <https://doi.org/10.1016/j.virol.2018.06.007>.
- Wei, Yan, Chengfeng Qin, Tao Jiang, Xiaofeng Li, Hui Zhao, Zhongyu Liu, Yongqiang Deng, et al. 2009. "Translational Regulation by the 3' Untranslated Region of the Dengue Type 2 Virus Genome." *The American Journal of Tropical Medicine and Hygiene* 81 (5): 817–24. <https://doi.org/10.4269/ajtmh.2009.08-0595>.
- Weiner, Alan M. 2002. "SINEs and LINEs: The Art of Biting the Hand That Feeds You." *Current Opinion in Cell Biology* 14 (3): 343–50. <http://www.ncbi.nlm.nih.gov/pubmed/12067657>.
- Weiss, Robin A. 2006. "The Discovery of Endogenous Retroviruses." *Retrovirology* 3 (October): 67. <https://doi.org/10.1186/1742-4690-3-67>.

- Weitzman, Matthew D., Christian T. Carson, Rachel A. Schwartz, and Caroline E. Lilley. 2004. "Interactions of Viruses with the Cellular DNA Repair Machinery." *DNA Repair*. <https://doi.org/10.1016/j.dnarep.2004.03.018>.
- Welsch, Sonja, Sven Miller, Ines Romero-Brey, Andreas Merz, Christopher K.E. Bleck, Paul Walther, Stephen D. Fuller, Claude Antony, Jacomine Krijnse-Locker, and Ralf Bartenschlager. 2009. "Composition and Three-Dimensional Architecture of the Dengue Virus Replication and Assembly Sites." *Cell Host and Microbe*. <https://doi.org/10.1016/j.chom.2009.03.007>.
- Westby, Katie M, Charissa Fritzen, Dave Paulsen, Stephanie Poindexter, and Abelardo C Moncayo. 2015. "La Crosse Encephalitis Virus Infection in Field-Collected Aedes Albopictus, Aedes Japonicus, and Aedes Triseriatus in Tennessee." *Journal of the American Mosquito Control Association* 31 (3): 233–41. <https://doi.org/10.2987/moco-31-03-233-241.1>.
- Whitfield, Zachary J, Patrick T Dolan, Mark Kunitomi, Cheryl Heiner, Ellen Paxinos, Raul Andino Correspondence, Michel Tassetto, Matthew G Seetin, Steve Oh, and Raul Andino. 2017. "The Diversity, Structure, and Function of Heritable Adaptive Immunity Sequences in the Aedes Aegypti Genome." <https://doi.org/10.1016/j.cub.2017.09.067>.
- Whitfield, Zachary J, Patrick T Dolan, Mark Kunitomi, Michel Tassetto, Matthew G Seetin, Steve Oh, Cheryl Heiner, Ellen Paxinos, and Raul Andino. 2017. "The Diversity, Structure, and Function of Heritable Adaptive Immunity Sequences in the Aedes Aegypti Genome." *Current Biology: CB* 27 (22): 3511-3519.e7. <https://doi.org/10.1016/j.cub.2017.09.067>.
- Wright, S. 1978. "Evolution and the Genetics of Population, Variability Within and Among Natural Populations." Edited by University of Chicago Press.
- Wu, De, Jie Wu, Qiaoli Zhang, Haojie Zhong, Changwen Ke, Xiaoling Deng, Dawei Guan, et al. 2012. "Chikungunya Outbreak in Guangdong Province, China, 2010." *Emerging Infectious Diseases* 18 (3): 493–95. <https://doi.org/10.3201/eid1803.110034>.
- Wu, T., Y. Yan, and C. A. Kozak. 2005. "Rmcf2, a Xenotropic Provirus in the Asian Mouse Species *Mus Castaneus*, Blocks Infection by Polytropic Mouse Gammaretroviruses." *Journal of Virology*. <https://doi.org/10.1128/jvi.79.15.9677-9684.2005>.
- Xie, X., S. Gayen, C. Kang, Z. Yuan, and P.-Y. Shi. 2013. "Membrane Topology and Function of Dengue Virus NS2A Protein." *Journal of Virology*. <https://doi.org/10.1128/jvi.02424-12>.
- Yakub, Intiaz, Kristy M. Lillibridge, Ana Moran, Omar Y. Gonzalez, John Belmont, Richard A. Gibbs, and David J. Twardy. 2005. "Single Nucleotide Polymorphisms in Genes for 2'-5'-Oligoadenylate Synthetase and RNase L in Patients Hospitalized with West Nile Virus Infection." *The Journal of Infectious Diseases*. <https://doi.org/10.1086/497340>.
- Yamanaka, Atsushi, Supatra Thongrunkiat, Pongrama Ramasoota, and Eiji Konishi. 2013. "Genetic and Evolutionary Analysis of Cell-Fusing Agent Virus Based on Thai Strains

- Isolated in 2008 and 2012.” *Infection, Genetics and Evolution: Journal of Molecular Epidemiology and Evolutionary Genetics in Infectious Diseases* 19 (October): 188–94. <https://doi.org/10.1016/j.meegid.2013.07.012>.
- Yamshchikov, V F, and R W Compans. 1995. “Formation of the Flavivirus Envelope: Role of the Viral NS2B-NS3 Protease.” *Journal of Virology*.
- Ye, Wenyun, Xianmiao Liu, Juxin Guo, Xueli Sun, Yan Sun, Bo Shen, Dan Zhou, and Changliang Zhu. 2017. “PiRNA-3878 Targets P450 (CpCYP307B1) to Regulate Pyrethroid Resistance in *Culex Pipiens Pallens*.” *Parasitology Research*. <https://doi.org/10.1007/s00436-017-5554-3>.
- Youn, Soonjeon, Tuo Li, Broc T McCune, Melissa A Edeling, Daved H Fremont, Ileana M Cristea, and Michael S Diamond. 2012. “Evidence for a Genetic and Physical Interaction between Nonstructural Proteins NS1 and NS4B That Modulates Replication of West Nile Virus.” *Journal of Virology* 86 (13): 7360–71. <https://doi.org/10.1128/JVI.00157-12>.
- Young, S. M., and R. J. Samulski. 2001. “Adeno-Associated Virus (AAV) Site-Specific Recombination Does Not Require a Rep-Dependent Origin of Replication within the AAV Terminal Repeat.” *Proceedings of the National Academy of Sciences* 98 (24): 13525–30. <https://doi.org/10.1073/pnas.241508998>.
- Zawani, M. K.N., H. A. Abu, A. B. Sazaly, S. Y. Zary, and M. N. Darlina. 2014. “Population Genetic Structure of *Aedes Albopictus* in Penang, Malaysia.” *Genetics and Molecular Research*. <https://doi.org/10.4238/2014.October.7.13>.
- Zhang, Peng, Jun Yan Kang, Lan Tao Gou, Jiajia Wang, Yuanchao Xue, Geir Skogerboe, Peng Dai, et al. 2015. “MIWI and PiRNA-Mediated Cleavage of Messenger RNAs in Mouse Testes.” *Cell Research*. <https://doi.org/10.1038/cr.2015.4>.
- Zhang, Xianglilan, Xiaofang Guo, Hang Fan, Qiumin Zhao, Shuqing Zuo, Qiang Sun, Guangqian Pei, et al. 2017. “Complete Genome Sequence of Menghai Flavivirus, a Novel Insect-Specific Flavivirus from China.” *Archives of Virology* 162 (5): 1435–39. <https://doi.org/10.1007/s00705-017-3232-5>.
- Zhao, Wei, Bapi Pahar, Juan T. Borda, Xavier Alvarez, and Karol Sestak. 2007. “A Decline in CCL3-5 Chemokine Gene Expression during Primary Simian-Human Immunodeficiency Virus Infection.” *PLoS ONE*. <https://doi.org/10.1371/journal.pone.0000726>.
- Zhdanov, V M. 1975. “Integration of Viral Genomes.” *Nature* 256 (5517): 471–73. <http://www.ncbi.nlm.nih.gov/pubmed/51475>.
- Zhong, Daibin, Eugenia Lo, Renjie Hu, Marco E. Metzger, Robert Cummings, Mariangela Bonizzoni, Kenn K. Fujioka, et al. 2013. “Genetic Analysis of Invasive *Aedes Albopictus* Populations in Los Angeles County, California and Its Potential Public Health Impact.” *PLoS ONE*. <https://doi.org/10.1371/journal.pone.0068586>.

- Zhou, Yang, and Edward C. Holmes. 2007. "Bayesian Estimates of the Evolutionary Rate and Age of Hepatitis B Virus." *Journal of Molecular Evolution* 65 (2): 197–205. <https://doi.org/10.1007/s00239-007-0054-1>.
- Zhu, Y, J E Strassmann, and D C Queller. 2000. "Insertions, Substitutions, and the Origin of Microsatellites." *Genetical Research* 76 (3): 227–36. <http://www.ncbi.nlm.nih.gov/pubmed/11204970>.
- Zouache, Karima, Albin Fontaine, Anubis Vega-Rua, Laurence Mousson, Jean-Michel Thiberge, Ricardo Lourenco-De-Oliveira, Valérie Caro, Louis Lambrechts, and Anna-Bella Failloux. 2014. "Three-Way Interactions between Mosquito Population, Viral Strain and Temperature Underlying Chikungunya Virus Transmission Potential." *Proceedings. Biological Sciences* 281 (1792): 20141078–20141078. <https://doi.org/10.1098/rspb.2014.1078>.
- Zuo, Shuqing, Qiumin Zhao, Xiaofang Guo, Hongning Zhou, Wuchun Cao, and Jiusong Zhang. 2014. "Detection of Quang Binh Virus from Mosquitoes in China." *Virus Research* 180 (February): 31–38. <https://doi.org/10.1016/j.virusres.2013.12.005>.

Appendices

Appendix N°1

Results of sequence alignments between NIRVS-derived small RNAs and exogenous viruses found in *Aedes albopictus*. NIRVS used were those published in Palatini et al., 2017. Alignments were performed using bioinformatics software tool sRNA mapper. Most of the alignments resulted in match of a length inferior of the typical size distribution of piRNAs in *Aedes* mosquitoes (24-30 nt). NIRVS used in this thesis are in bold.

NIRVS	GenBank Accession number	Starting position on viral genome	Orientation	Alignment length	Nucleotide sequence
DENV-2					
AlbFlavi39	NC_001474.2	5779	F	16	GAGAGGGTGATAGACC
AlbRha10		6838	F	15	TTCCTAGAAAAAAT
AlbFlavi12_17		9692	F	22	TCTGTTCCCACCATTTCCATGA
CHIKV					
AlbFlavi39	NC_004162.2	2108	F	15	AAGAAGGAGGAAGAA
AlbRha1		2509	F	15	ACTTTGTGGTGAAC
AlbFlavi18		7371	F	15	CGGTATACCCTAGTC
AlbRha52		10584	F	15	AGGACAATTTGGTTG
AlbRha94		11384	R	16	GATAAGGGCTATATAA
CFAV					
AlbRha83	NC_001564.2	685	F	15	AACAGATTGAGGAGG
AlbFlavi4		2713	R	15	TTTCCCTTTCCAATT
AlbRha66		3756	R	15	CTCATTTCCTGTTCT
AlbRha66		5717	R	15	ATCATTGTGGATTCT
AlbFlavi1		9839	F	16	ACTGATGACATGCTGC
AeFV					

AlbRha10	NC_0129 32.1	189	F	15	AAGGGCCGCAGAATT
AlbFlavi2		1572	F	16	CACAACAGCAAATGCA
AlbFlavi2		1573	F	15	ACAACAGCAAATGCA
AlbRha38		2529	R	15	CTCCGTGACGCTGGA
AlbFlavi33		3440	F	15	TAAACCTCCTGTGCT
AlbFlavi40		8062	R	15	ACTGGCACGGCTGAA
AlbRha85		8720	R	16	CACATCTCGTTGGACA
KRV					
AlbFlavi4	NC_0050 64.1	1359	F	15	TATGGAAAATCATAG
AlbFlavi2		2617	R	15	AATGGAAGGCTTGAG
ALbFlavi37		3400	F	15	AACTACGGAAATGCT
ALbFlavi37		3472	F	27	TCCATTCTGAATCTCCTGTGCC TCGCG
ALbFlavi37		3472	F	19	TCCATTCTGAATCTCCTGT
ALbFlavi37		3937	F	21	TGGAAGACGTCCGTGGCCATA
ALbFlavi37		5023	R	16	GAGGACGATGCCACCA
AlbFlavi34		5317	F	27	ATGGATGAATGTCATTTTCATG GACCCA
AlbRha58		6109	F	15	TTCCAAGGAGAAATG
AlbFlavi18		6955	F	15	ATGTACGTGGTGAAG

AlbFlavi36		7130	F	24	AGAACAAGTGGAACGCAACG CCCA
AlbFlavi36		7135	F	19	AAGTGGAACGCAACGCCCA
AlbRha66		7427	R	15	CTCATTTCTGTCT
AlbFlavi39		8604	R	15	CCTCCAACATCTGGT
AlbFlavi6		9202	F	26	ATCGTTGCCATGTTCCCACGAT CCCA
AlbFlavi6		9205	F	28	GTTGCCATGTTCCCACGATCCC ATTCTA
AlbFlavi6		9206	F	27	TTGCCATGTTCCCACGATCCCA TTCTA
AlbRha44		9592	R	15	AGCTATCATTACCAT

Appendix N°2

Experimental protocol of an ongoing experiment assessing the expression of NIRVS-derived small RNAs in *Aedes albopictus* infected with CHIKV and DENV.

During this thesis, we designed and performed an experiment to better understand NIRVS formation and biological functions regarding arboviral infections in *Ae. albopictus*. Our objectives is divided in two aims that are further subdivided into several objectives:

- **Aim 1**
 - Address NIRVS formation during viral infection. Does new NIRVS formation occur in ovaries of infected *Ae. albopictus* individuals?
 - Assess the differences regarding NIRVS formation that are related to viral type (flavivirus vs. alphavirus)
- **Aim 2**
 - Are both newly formed and already present NIRVS involved in antiviral defense?
 - Assess differences in small RNA profiling: piRNAs vs. siRNA production from NIRVS loci

To that purposes, we used 3 different populations: Crema (Italy), Tapachula (Mexico) and La Réunion island as well as the Foshan colony (Figure A1). We infected them with DENV-1 (strain 1806; MG518567.1) and CHIKV (strain 06-021; AM258992.1) through an artificial blood meal of 10^7 ffu/mL and 10^7 PFU/mL respectively. At different time post-infection, mosquito salivas were collected to assess viral transmission, and individuals were dissected to extract the ovaries in order to assess NIRVS formation (Figure A1). All carcasses were kept to compare with the ovaries samples. Moreover, controls were performed by using individuals fed with sugar and non-infectious blood meal. Whole-genome sequencing (WGS) was performed so far on pools of ovaries and carcasses of the Foshan colony and preliminary results are expected soon.

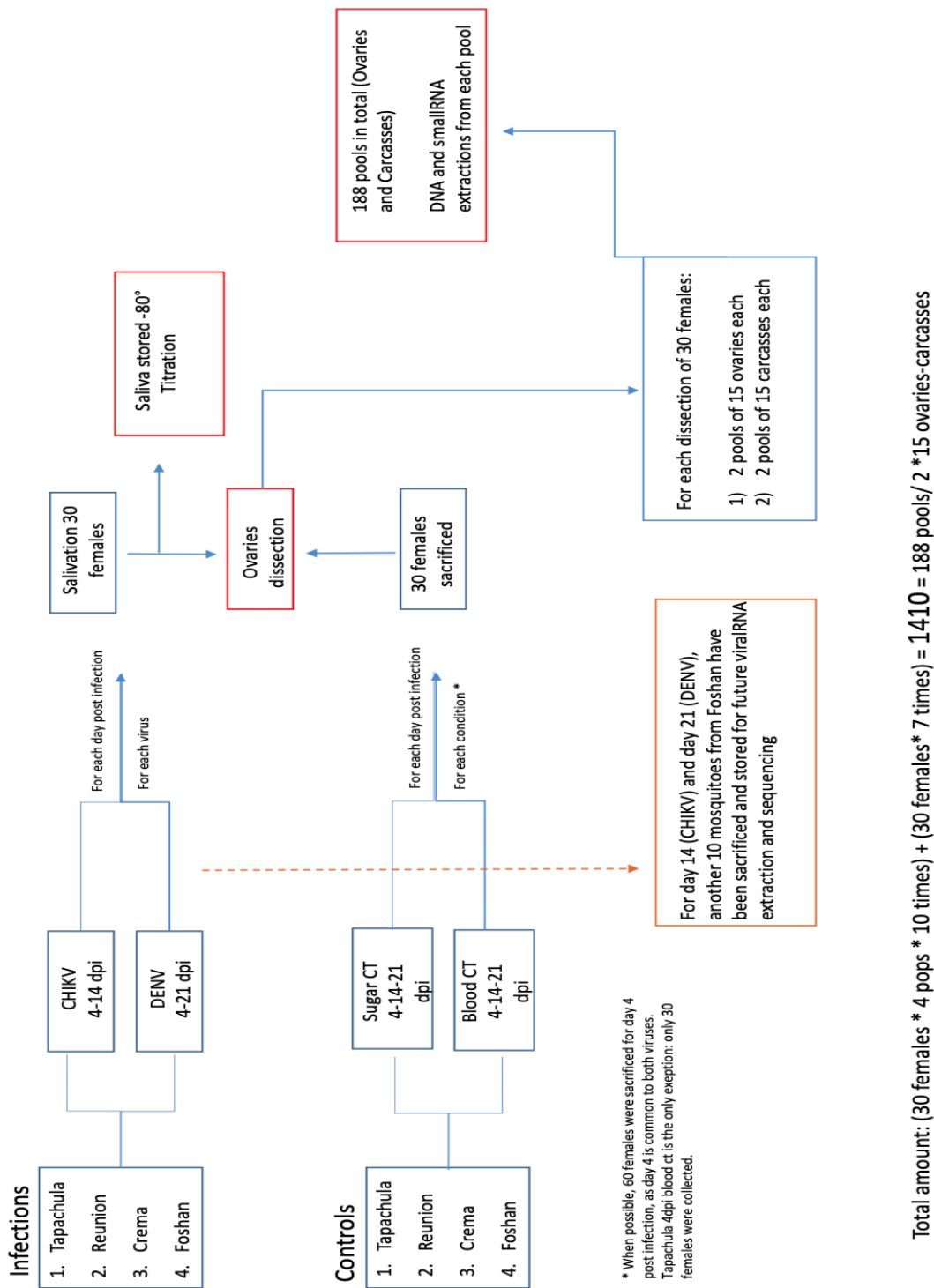

Figure A1 : Experimental protocol describing an ongoing experiment that aims to better understand NIRVS formation and biological functions.

Appendix N°3

Review article entitled "Endogenous non-retroviral elements in genomes of *Aedes* mosquitoes and vector competence" published in the journal *Emerging Microbes and Infections* in April 2019.

Endogenous non-retroviral elements in genomes of *Aedes* mosquitoes and vector competence

Vincent Houé^{a,b}, Mariangela Bonizzoni^c and Anna-Bella Failloux^a

^aDepartment of Virology, Arboviruses and Insect Vectors, Institut Pasteur, Paris, France; ^bCollège Doctoral, Sorbonne Université, Paris, France; ^cDepartment of Biology and Biotechnology, University of Pavia, Pavia, Italy

ABSTRACT

Recent extensive (re)emergences of arthropod-borne viruses (arboviruses) such as chikungunya (CHIKV), zika (ZIKV) and dengue (DENV) viruses highlight the role of the epidemic vectors, *Aedes aegypti* and *Aedes albopictus*, in their spreading. Differences of vector competence to arboviruses highlight different virus/vector interactions. While both are highly competent to transmit CHIKV (*Alphavirus, Togaviridae*), only *Ae. albopictus* is considered as a secondary vector for DENV (*Flavivirus, Flaviviridae*). Among other factors such as environmental temperature, mosquito antiviral immunity and microbiota, the presence of non-retroviral integrated RNA virus sequences (NIRVS) in both mosquito genomes may modulate the vector competence. Here we review the current knowledge on these elements, highlighting the mechanisms by which they are produced and endogenized into *Aedes* genomes. Additionally, we describe their involvement in antiviral immunity as a stimulator of the RNA interference pathways and in some rare cases, as producer of viral-interfering proteins. Finally, we mention NIRVS as a tool for understanding virus/vector co-evolution. The recent discovery of endogenized elements shows that virus/vector interactions are more dynamic than previously thought, and genetic markers such as NIRVS could be one of the potential targets to reduce arbovirus transmission.

ARTICLE HISTORY Received 26 December 2018; Revised 15 March 2019; Accepted 18 March 2019

KEYWORDS *Aedes albopictus*; arboviral diseases; vector competence; NIRVS

The main vectors of many medically important arboviruses, such as chikungunya (CHIKV), zika (ZIKV) and dengue (DENV) viruses, are the two mosquito species *Aedes aegypti* and *Aedes albopictus*. While their extensive distribution covering most tropical, subtropical and even, temperate countries, makes them a real threat for human health, *Ae. aegypti* and *Ae. albopictus* have different historical backgrounds and do not exhibit the same efficiency to transmit arboviruses. The objectives of this review are to point out critical features of both mosquito species that could explain their differences in vector competence. Vector competence is modulated by environmental, genetic, and epigenetic factors, the latter including mechanisms induced by mosquito microbiota [1]. Recently, non-retroviral integrated RNA virus sequences (NIRVS) have been proposed to be among the genetic factors influencing vector competence. The potential role of NIRVS in mosquitoes as vectors is discussed.

Aedes albopictus and *Aedes aegypti* have different histories (Figure 1)

Aedes albopictus (Skuse, 1894) is a mosquito species closely related to *Ae. aegypti*, both belonging to the

Culicidae family and vectors of several different arboviruses highly pathogenic for humans such as chikungunya virus (CHIKV) [2,3], yellow fever virus (YFV) [4] and dengue viruses (DENV) [5,6]. Contrary to many other mosquito vectors such as the malaria vector *Anopheles gambiae*, *Ae. albopictus* and *Ae. aegypti* eggs are capable of entering in diapause and quiescence respectively, ensuring survival during and after environmental stress [7–10]. In addition to survive under extreme conditions, this characteristic allows the two vectors to colonize new regions around the world [11].

However, in terms of evolution, the two species have a different history. *Aedes aegypti* (Linné, 1862) originates from a sub-Saharan African sylvan ancestor that migrated to West Africa late in the 8th century. It was introduced in the New World probably via the African slave trade between 15th and 17th centuries [12,13]. Around 1800, the species was introduced in the Mediterranean region where it was established in European harbours until about 1950 [14]. *Aedes aegypti* was introduced into Asia from Europe with the opening of the Suez Canal in 1869; it is abundantly found in Asia since late nineteenth century [15]. The species was later introduced in Australia (1887) and

CONTACT Anna-Bella Failloux  anna-bella.failloux@pasteur.fr 

 Supplemental data for this article can be accessed at [doi:10.1080/22221751.2019.1599302](https://doi.org/10.1080/22221751.2019.1599302)

© 2019 The Author(s). Published by Informa UK Limited, trading as Taylor & Francis Group, on behalf of Shanghai Shangyixun Cultural Communication Co., Ltd
This is an Open Access article distributed under the terms of the Creative Commons Attribution License (<http://creativecommons.org/licenses/by/4.0/>), which permits unrestricted use, distribution, and reproduction in any medium, provided the original work is properly cited.

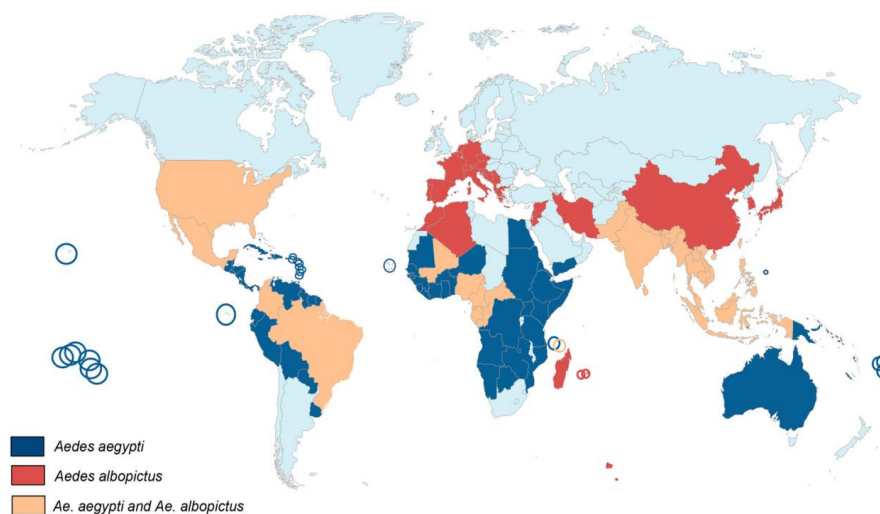

Figure 1. World distribution of *Aedes albopictus* and *Aedes aegypti*.

the South Pacific (1904) [14]. On the other hand, *Ae. albopictus* is native to tropical forests of South-East Asia. Until the late 70s, this species was restricted to

Table 1. List of arboviruses transmitted by *Aedes aegypti* and *Aedes albopictus*.

Virus	Family	Genus	Transmitted by	
			<i>Aedes aegypti</i>	<i>Aedes albopictus</i>
DENV-1,2,3,4	Flaviviridae	Flavivirus	+	+
Yellow Fever Virus			+	+
West Nile Virus			+	+
Japanese Encephalitis Virus			-	+
St Louis Encephalitis Virus			-	+
Zika Virus			+	+
Usutu Virus			-	+
Chikungunya	Togaviridae	Alphavirus	+	+
Eastern Equine Encephalitis Virus			+	+
Venezuelan Equine Encephalitis Virus			+	+
Western Equine Encephalitis Virus			+	+
Ross River Virus			+	+
Sindbis Virus			+	+
Mayaro Virus			+	+
Getah Virus			+	+
Rift Valley Fever Virus	Phenuiviridae	Phlebovirus	+	+
Potosi Virus				
Cache Valley Virus			-	+
Tensaw Virus			-	+
Keystone Virus			-	+
San Angelo Virus			+	+
La Crosse Virus			+	+
Jamestown Canyon Virus			-	+
Trivittatus Virus			-	+
Oropouche Virus			+	+
Orungo Virus	Reoviridae	Orbivirus	+	+
Nodamura virus	Picornaviridae	Nodaviridae	+	+

Asia, India and a few islands in the Pacific region such as La Reunion [16], the Seychelles [17] Mariana and Papua New Guinea islands [18]. However, in less than three decades, it has conquered all continents except Antarctica [19,20]. Contrary to *Ae. aegypti* which took hundreds of years to cover the tropical world, *Ae. albopictus* took only few decades to wide spread. This impressive fast colonization, promoted by increased human mobility and trade of goods including used tires and lucky bamboo as potential mosquito breeding sites, stresses its high ability to survive under both tropical and temperate regions. Moreover, *Ae. albopictus* is also a serious threat for human populations as it is a competent vector for at least 26 different arboviruses [21] and filarial nematodes of veterinary and zoonotic significance [22,23].

Both species are involved as vectors in major human diseases (Table 1)

After suspected outbreaks in America and Asia in the 18th and 19th centuries [24], CHIKV has been first identified in Tanzania in 1952 where it circulated between non-human primates and mosquito vectors. The virus escaped from a sylvatic cycle to cause urban outbreaks in South East Asia and Africa from the 1960s with *Ae. aegypti* as the main vector (reviewed by [25]). Lastly, CHIKV re-emerged in Thailand in 1991 [26], in the Democratic Republic of Congo in 1999–2000 [27], then in coastal Kenya in 2004 [28], and in the Union of Comoros, in 2005 [29,30], mainly associated to *Ae. aegypti*. More recently, the same species was involved in CHIKV outbreaks in 45 countries and territories in America, causing almost 3 million cases from 2013 to 2016 (<https://www.paho.org/hq/dmdocuments/2014/2014-jun-20-cha-CHIKV->

autoch-imported-cases-ew-25.pdf; <https://www.paho.org/hq/dmdocuments/2015/2015-sep-18-cha-CHIKV-cases-ew-37.pdf>). On the other hand, *Ae. albopictus* was also proved to be susceptible to CHIKV infection [31] and could involve as a CHIKV vector. In 2005, it became the primary vector on La Réunion Island where *Ae. aegypti* was present as remote populations [32–34]. On this island, CHIKV acquired a mutation in the glycoprotein E1 (E1-A226V) [35] that increases its infectivity in *Ae. albopictus* but not in *Ae. aegypti* [36,37]. From there, the virus spread to India and Southeast Asia between 2007 and 2014 causing 1.4 million cases [38].

Aedes aegypti and *Aedes albopictus* are also vectors of DENV, with the former being the major vector. *Aedes aegypti* has been responsible for severe outbreaks in America, Southeast Asia and Western Pacific regions in the late twentieth century [39,40]. On the other hand, even though it was also responsible for severe DENV outbreaks such as during the World War II in Japan [41] or recently in China [42], *Ae. albopictus* is considered as a less efficient vector of DENV. Indeed, no major epidemics were reported in regions like Taipei, Guam or Hawaii islands where *Ae. albopictus* is predominant, even when nearby places suffered from DENV outbreaks involving *Ae. aegypti* (reviewed by [43]). Additionally, even in presence of DENV outbreaks due to *Ae. albopictus*, like in the Seychelles Islands (1977), La Réunion Island (1977), southern China (1978), Macao (2001), Hawaii (2001) and lastly, in Europe [44,45], only mild symptoms are described [46].

***Aedes albopictus* and *Aedes aegypti* have different vector competences**

To be a vector, the arthropod species must be competent. The vector competence is the ability of an arthropod to acquire, support replication and dissemination of an infectious agent and successfully transmit it to another susceptible host [47,48]. Vector competence is a component of vectorial capacity and is determined by both genetic (depending on mosquito species/population, virus genotype/strain and their interactions) [49] and non-genetic factors (e.g. environmental components) [50]. *Aedes albopictus* and *Ae. aegypti* are highly susceptible to different CHIKV strains (Table S1) (reviewed by [51]). Although *Ae. albopictus* is considered as a secondary vector for DENV [21], its susceptibility to DENV infection compared to *Ae. aegypti* remains controversial [52–56]. *Aedes albopictus* mosquitoes generally show a higher midgut susceptibility to DENV infection but a lower rate of virus dissemination compared to *Ae. aegypti* (Table S2) [43].

Epigenetic factors which include mechanisms associated with the vector microbiota contribute to vector competence [1]. Insect microbiota comes

from the environment: the breeding sites where immature stages live [57] and the flower nectar where adults get the sugar nutrient as carbon source [58]. Insect microbiota influences various physiological processes that favour insect ecological adaptation such as growth, reproduction, survival and tolerance to external stresses [59–63]. Moreover, insect microbiota is capable of stimulating immune responses, described as immune priming, conferring antiviral protection [64,65]. As an example, infection with the bacterium *Wolbachia* induces an oxidative stress in *Ae. aegypti* causing an increased level of reactive oxygen species (ROS). The elevation of ROS activates immune pathways, inhibit DENV and then affect the vector competence [66].

Insect immunity: Toll, Imd, JAK-STAT pathways

The antiviral role of the microbiota has been ascribed to the activation of immune pathways [66,67]. So anti-viral immunity in mosquito vectors is critical to prevent virus replication and transmission. Mosquitoes lack adaptive immune responses, but they present innate immunity based on several strategies such as encapsulation and phagocytosis, melanization and production of physical barriers. Moreover, several molecular pathways have been described with antiviral immunity activities, including the RNA interference (RNAi) system, discussed further in the review, the Toll, Immune deficiency (Imd), Janus Kinase-Signal Transduction and Activators of Transcription (JAK-STAT) pathways [67–72]. The activation of these pathways leads to the expression of effector genes that have antiviral activities.

The Toll pathway of mosquitoes is very similar to the mammalian Toll-Like Receptor pathway (TLR). This pathway is activated by the interaction between either viral pathogen-associated molecular patterns (PAMPs) or the putative Toll ligand Spätzle, and host pattern recognition receptors (PRRs), that are present in several parts of the body (hemocoel and midgut). This interaction leads to the recruitment of Myd88 that triggers the phosphorylation and degradation of the negative regulator Cactus and the nuclear translocation of the NF- κ B-like transcription factor Rel1 that induces the transcription of antimicrobial peptides, such as cecropins and defensins [67].

The first (PRR activation) and the final step (synthesis of antimicrobial peptides) of the Imd pathway are processed in the same way as the Toll pathway, but different intermediate components are required in the cascade of the signalling pathway. The NF- κ B-like transcription factor Rel2 is activated by the caspase-mediated cleavage and is then translocated to the nucleus where it triggers the transcription of Imd-related genes [73].

The JAK-STAT pathway is activated through the interaction between the Unpaired ligand (Upd) and the receptor Dome. It first promotes the binding of Janus kinases to Dome and then the recruitment of STAT proteins. Once activated, STAT proteins are translocated into the nucleus and trigger the transcription of antimicrobial related genes, and specific antiviral genes such as *vir-1* (virus-induced RNA 1) [74–76].

Studies in *Ae. aegypti* revealed that the Toll and JAK-STAT pathways were both upregulated 10 days after DENV infection suggesting an anti-DENV activity [67,77]. Moreover, the JAK-STAT pathway has an antiviral activity against another flavivirus, WNV in *Culex* mosquito cells [71]. However, although suggested in *Drosophila* [69,78], antiviral properties of these signalling pathways are less obvious for the alphaviruses of the *Togaviridae* family. In both *in vitro* and *in vivo* experiments with *Ae. aegypti*, none of the 3 above-mentioned pathways showed anti-CHIKV properties [79]. Additionally, in *Ae. albopictus*-derived U4.4 cells, infections with the *Alphavirus* Semliki Forest virus did not trigger the JAK/STAT, Toll and Imd pathways [80]. Primed by the mosquito microbiota, the Imd pathway showed antiviral effects in *Ae. aegypti* following a blood meal containing the *Alphavirus* Sindbis virus (SINV) [81]. Ultimately, a microarray analysis on *Ae. aegypti* infected by SINV revealed a temporary up-regulation of Toll pathway which was later inhibited by the virus [82]. Collectively, these results suggest that antiviral immunity in mosquitoes is in part controlled by the Toll, Imd and JAK-STAT pathways which are efficient against flaviviruses, such as DENV and WNV, but their action on alphaviruses such as CHIKV and SINV is less obvious suggesting a virus-specific antiviral regulation.

Genome characteristics and evolution

Quantitative trait loci (QTL)

Because vector competence is under the control of multiple genes, quantitative genetics have been used to measure the contribution of mosquito genetic factors to viral infection and dissemination in mosquitoes. Quantitative Trait Loci (QTL) are defined as several genes grouped in the genome that affect the expression of quantitative traits and lead to important phenotypic variations. The species *Ae. aegypti* is described under two forms: *Ae. aegypti formosus* for the ancestral African type breeding in tree holes and *Ae. aegypti aegypti* for the domestic type colonizing man-made containers [83]. Using intercrosses of *Ae. aegypti aegypti* and *Ae. aegypti formosus* strains, respectively highly and weakly susceptible to DENV infection, two QTLs were identified: one affecting the midgut infection barrier on chromosomes 2 and 3, and one on chromosome 3

associated with a midgut escape barrier [84]. Moreover, an additional QTL found on the chromosome 2 along with a sex-linked QTL were associated with the ability to infect the midgut [85]. Moreover, QTLs were identified on the 3 chromosomes of *Ae. aegypti* associated with DENV-2 dissemination from midguts [86]. It appears that several different parts of the *Ae. aegypti* genome identified as QTL are independently capable of modulating the vector competence to DENV-2. However, no studies to date have been conducted to identify potential QTLs affecting the vector competence to DENV in *Ae. albopictus* genome.

Transposable elements (TE)

Last technical improvements in genome sequencing allowed bringing to light the complexity of mosquito genomes. *Aedes* mosquitoes have the biggest genome size among currently-sequenced mosquito genomes. For instance *Ae. aegypti* genome is 1,380 MB; [87], *Ae. albopictus* is 1,900 MB [88,89] while the *Anopheles gambiae* genome is 278 MB; [90] and *Culex quinquefasciatus* is 579 MB; [91].

Differences observed in the genome size of *Ae. albopictus* could be explained by the presence of Transposable Elements (TEs) [92,93]. First discovered in 1956 [94], TEs are considered as intragenomic parasites [95,96]. Ubiquitously found in both prokaryotic and eukaryotic genomes, TE are described as sequences integrated in the host genome capable of both independent replication and movement from one chromosomal location to another through a phenomenon called transposition. Transposition can occur in both somatic and germ line cells. However, some elements transpose in specific cell types, like the *P* elements in *Drosophila melanogaster* [97] or without any cells preference, such as the bacteriophage *Mu* [98,99]. Transposons are classified into two groups, depending on their DNA structure and transposition mechanism. The class I, also called retrotransposons, relies on RNA intermediates to transpose and is divided in two subgroups: LTR (Long Terminal Repeats) retrotransposons and non-LTR retrotransposons (reviewed by [100]). The class II TEs, also called DNA elements, contains terminal inverted repeats (TIRs). Three different groups of DNA elements have been described in eukaryotes: classic transposons [101], helitrons [102] and mavericks, also called politons [103]. Unlike retrotransposons, DNA elements do not rely on RNA intermediates for transposition [104].

Transposons are major drivers of host genome function and evolution. They can act as a source of mutational variations through their transposition producing multiple copies of the same element in the host genome. These copies can facilitate regulation of gene expression, recombination and unequal

crossing-overs between chromosomes and therefore, lead to chromosomal rearrangements by creating deletions, insertions, duplications, inversions and translocations. When a TE insertion occurs in an exon, the ORF can change and codes for a non-functional peptide or cause missense or nonsense mutations. A TE insertion can also create alternative splicing leading to the production of several protein isoforms or introduce a polyadenylation signal [105,106]. TE activity in a host genome contributes to introduce diversity. In *Ae. albopictus* genome, the differences of genome size are explained by the amount of TEs which represents 68% (1,967 Mb) of the total genome [89]. Additionally, variations of repetitive sequences were detected at the intra- and interspecific levels [88,92,107,108]. When comparing the TE composition between *Ae. albopictus* and *Ae. aegypti*, differences in the quantity and type of repeats are seen; TE amount reaches 1,343 and 988 Mb in the *Ae. albopictus* and *Ae. aegypti* genomes, respectively [89]. More than 20% of repetitive sequences present in *Ae. albopictus* are absent in *Ae. aegypti*. The two species have diverged 71 million years ago and most TE insertions occurred during the last 10 million years in the *Ae. albopictus* genome [89]. DNA transposons represent only 8% of TEs present in the *Ae. albopictus* genome, and 15% in the *Ae. aegypti* genome [89]. Non-LTR retrotransposons LINE represent one third of TEs in both genomes, followed by a high proportion of LTR retrotransposons, suggesting that retrotransposons and DNA transposons are suspected to cause genome size variations between *Ae. aegypti* and *Ae. albopictus*. Moreover, the activity of TEs can be controlled by the siRNA and piRNA immune pathways. piRNAs and siRNAs produced respectively by TEs from class I and class II transposons, can be up-regulated after an infectious blood feeding leading to modify the outcome of infection, and then the vector competence [109].

Endogenous viral elements (EVEs)

Due to strong and long-lasting interactions between the virus and the vector, the virus could integrate whole or parts of its genome into the genome of host cells, leading to the formation of Endogenous Viral Elements (EVEs) [110]. These elements are defined as viral sequences that integrate into the host germline as double-stranded DNA and are therefore maintained in the population through vertical transmission to the progeny. Considering that the genome of germline cells are strongly protected against any kind of intrusions, such as TE activity, notably by piRNAs [111], the odds of EVE introduction must be low. However, around 7%–8% of the human genome is made up by sequences of viral origins [112].

EVEs originated from retroviruses are called Endogenous Retroviruses (ERVs). It is well known

that ERVs formation occurs frequently in host cells since the integration into the genome host cell is mandatory to complete their viral life cycle. ERVs are easily detectable because of Long Terminal Repeats (LTR) present at each end of the segment. Other EVEs originated from other viral families have been recently discovered in many host genomes: single-stranded DNA viruses such as *Circoviridae* and *Parvoviridae* in diverse vertebrate genomes (dog, mouse and panda; [113]) and double-stranded DNA viruses such as hepadnaviruses in zebra finch genome [114].

Non-retroviral integrated RNA virus sequences (NIRVS) (Figure 2)

Main characteristics

Since non-retroviral RNA viruses do not encode for reverse transcriptase or integrase, endogenous enzymes or viruses infecting the cell at the same time must be involved in the endogenization of such viruses into host genome DNA. Three steps should be involved to achieve the integration of non-retroviral RNA viruses into the host genome: (i) first, the non-retroviral RNA needs to be reverse-transcribed into viral-derived double-stranded DNA (vDNA), (ii) be imported in the nucleus, and (iii) finally be integrated into the host genome.

The first mosquito NIRVS were identified in 2004 in *Aedes spp.* cell lines and mosquitoes [115]. Most of them were truncated or incorporated several stop codons, but one contained an intact ORF homologous to the NS1-NS4A region of insect-specific viruses (ISVs) in *Ae. albopictus* genome, i.e. Cell Fusing Agent Virus (CFAV) and Kamiti River Virus (KRV). This last fragment represents around one half of the flaviviral genome. These NIRVS (also called Cell Silent Agent (CSA) sequences) comprised two third of the flaviviral genome and contained enzymatic domains such as helicase and serine protease. The corresponding mRNA was detected in C6/36 *Ae. albopictus* cells suggesting the expression of the NIRVS and its potential functional role in the cell at the RNA level since no protein was detected [116]. Moreover, this NIRVS is present in 97%–98% of *Ae. albopictus* mosquitoes. Many NIRVS were found homologous to insect-specific flaviviruses (ISFs), such as CFAV, KRV and *Aedes* Flavivirus (AeFV) closely related to arboviruses [117,118]. The high prevalence of NIRVS in *Aedes spp.* genome as well as the high frequency of transposons might somehow be correlated to the mosquito genome size [87,89].

Most NIRVS described up to date were found in *Aedes spp.* genomes. Among 424 RNA viruses detected in 22 mosquito genomes, 81% (194/239) were identified as NIRVs in *Aedes* genomes and among them, 63% of NIRVS were located into the *Ae. aegypti*

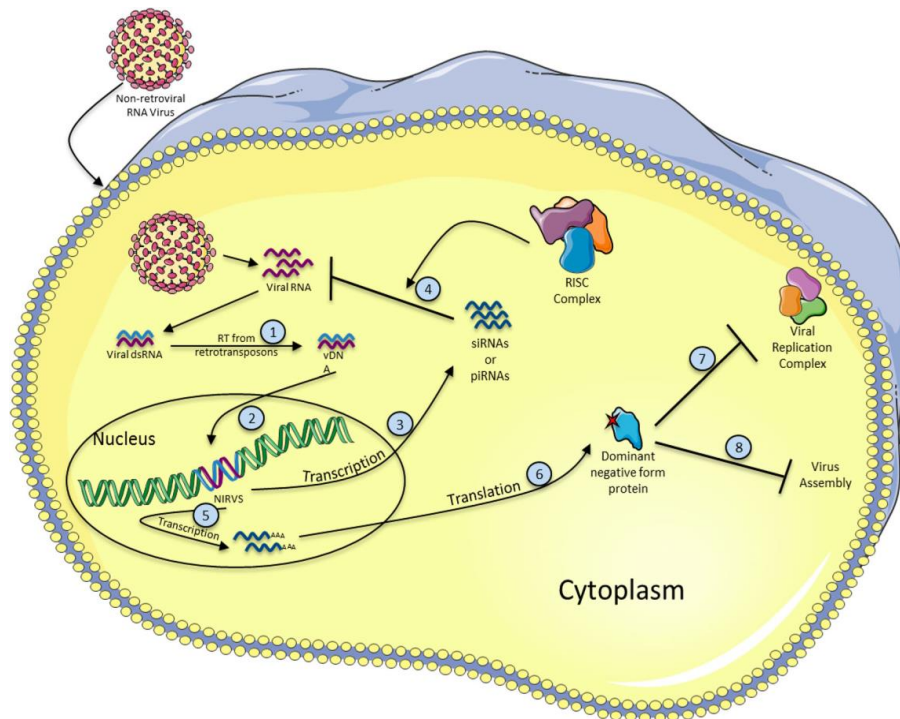

Figure 2. Formation and antiviral functions of NIRVS. When a non-retroviral virus infects a cell, the viral RNA is released and double stranded RNA (dsRNA) intermediates are produced. Viral dsRNA is then used as a template to produce viral DNA (vDNA) by the reverse transcriptase activity of retrotransposon elements (1). vDNA integrates into the host cell genome, probably by transposition activity of retrotransposons, becoming a NIRVS (2). NIRVS is then transcribed either into siRNAs or piRNAs (3) to inhibit the viral RNA after association with the RISC complex (4) or into mRNA (5), and translated into a dominant negative form protein (6), that can alter the viral replication by several ways. For example, by inhibiting the viral replication complex (7) or viral assembly (8).

genome, and the remaining 37% were identified in *Ae. albopictus* [119]. Additionally, 72% of the NIRVS were homologous to the Rhabdovirus family whereas 27% were close to the *Flavivirus* genus and 1% left belonging to *Bunyavirus* and *Reovirus* genera. These data are consistent with another study which compared the “EVEome” of both *Ae. aegypti* and *Ae. albopictus* [120]. Factors leading to endogenisation of viral genomes into host cells remain unclear. The mRNA abundance could be critical since ssRNA+ genomes are directly translated into proteins and ssRNA- genomes have first to be transcribed. Moreover, the transcripts of flaviviral genome are usually longer than those from ssRNA- viruses, and this could decrease their chance to be integrated into the host genome [121]. Most of the flaviviral NIRVS detected *in silico* are originated from non-structural protein coding sequences rather than structural ones. In *Ae. aegypti* and *Ae. albopictus* genomes, 30 and 25 flaviviral NIRVS were mapped to non-structural protein coding sequences, and respectively, only 2 and 3 NIRVS represented similarities with structural proteins coding sequences [119]. Half of the rhabdoviral NIRVS mapped to the *N* gene, which encode the nucleoprotein [110,122]. From 3' to 5', each gene (*N*, *P*, *M*, *G* and *L*) of the rhabdoviral

genome is transcribed in a progressive graduated manner due to the recognition of stop codons/polyadenylation signals by the polymerase [123], meaning that the transcripts at the 3' end (i.e. *N* gene) are in higher quantities than for those near the 5' end (i.e. *L* gene).

Production of viral DNA (vDNA) from non-retroviral viruses

As previously mentioned, to become integrated into the host genome, the non-retroviral RNA virus is first reverse transcribed to produce viral DNA (vDNA), imported into the cell nucleus and finally integrate into the chromosome [124–127]. Interestingly, only some parts of the viral genomes can be found in a DNA form. The reverse transcriptase probably switches from the original RNA template to a close viral RNA genome causing multiple independent reverse-transcription events [128,129]. These vDNA could also be the result of replication-slippage events caused by the reverse transcriptase. Whether the vDNA form belongs to the host genome or is present as extra-chromosomal DNA element such as episomes is still unknown. RNAi-deficient cells (C6/36) possess more vDNA forms than RNAi-proficient cells (Aag2

cells) suggesting that RNAi system could inhibit vDNA production. More importantly, after mosquito infection with CHIKV, vDNA has been found in legs and wings of infected *Aedes* mosquitoes suggesting that either vDNA is capable of dissemination from one tissue to another (possibly through cellular and tissue damages) in the mosquito or that all infected cells produce vDNA [125]. Moreover, FHV and Sindbis vDNA were found in infected flies after infection [130].

NIRVS reverse transcription and integration mediated by retrotransposons

vDNA from DNA viruses can integrate into host chromosomes by Non-Homologous (double-stranded) End Joining (NHEJ) [114,131], Non Homologous DNA recombination used by adeno-associated DNA virus [132–134] or Telomeric homologous recombination [135]. However, little is known about the mechanism used by the NIRVS to integrate into host chromosomes. Nevertheless, reverse transcription activity from endogenous retrotransposons has been associated with vDNA formation [130]. By adding a reverse transcriptase inhibitor, azidothymidine (AZT) in S2 and Kc167 *Drosophila* cell cultures, vDNA formation was inhibited after infection with several RNA viruses, namely Flock House Virus, Sindbis Virus and *Drosophila* C Virus (DCV) [130]. vDNA of CHIKV and DENV were detected after infections in *Ae. albopictus* and *Ae. aegypti* mosquitoes and cell cultures [125]. vDNA plays an important role in viral tolerance rather than viral resistance [125]. The early production of vDNA (6 hours and 2 days post-infection in cultured cells and mosquitoes respectively) is critical to establish efficient immune responses [125]. These regions were also enriched with LTR retrotransposons as it has been shown in *Drosophila*, especially retrotransposons of the Ty3_gypsy and Pao Bell families [119,120]. This suggests an important role of LTR retrotransposons in the reverse transcription of vDNA.

Biological function of NIRVS

The integration of NIRVS into host genomes has now been recognized to occur more frequently than previously thought. It has been suggested that NIRVS could be involved in antiviral immunity [128,136]. A non-retroviral RNAs segment encoding the capsid protein of the Israeli Acute Paralysis Virus (IAPV), a ssRNA+ dicistrovirus, was found in the genome of one third of the honeybee population (*Apis mellifera*); it was correlated with a virus-resistant phenotype [137]. Moreover, the presence of vDNA allowed the survival of FHV-infected flies [125,130]. More precisely, vDNA production detected at early stages of infection, promoted viral persistence, as it has been

seen in *in vivo* and *in vitro* experiments with mosquitoes challenged with CHIKV and S2 FHV-infected *Drosophila* cells [125,130].

The antiviral function of NIRVS has been linked to the innate immune system of RNAi which has been shown to be the main antiviral system in insects [125,138,139]. This system relies on small RNAs (sRNA) that when associated with a complex of proteins recognized by sequence-complementarity, led to the cleavage and degradation of incoming foreign nucleic acids [140]. Three different pathways have been described: the small interfering RNA (siRNA), the micro RNA (miRNA) and the PIWI-interacting RNA (piRNA). All three use the same mechanism to perform their antiviral action, but are distinguished by the sRNA biogenesis and the protein complex involved. Whereas the role of siRNA pathway in viral immunity in mosquitoes is largely accepted, little was known about the function of the piRNA pathway except its role in preserving genome stability in the germline by regulating the activity of transposable elements in *D. melanogaster* [141–145] and *Aedes* mosquitoes [146,147]. However, the piRNA pathway has been linked to antiviral immunity both *in vitro* and *in vivo* [148–153]. Indeed, deep-sequencing analysis of DENV-2 infected *Ae. aegypti* Aag2 cells revealed the production of specific viral piRNAs (vpiRNAs) along with viral siRNAs (vsiRNAs) [154]. Moreover, vpiRNAs have been detected in DENV-infected *Ae. aegypti* individuals as early as 2 days post-infection [151]. Nevertheless, the piRNA pathway has no antiviral property in the insect model *D. melanogaster* suggesting a different function depending on the host [155].

Interestingly, EVEs including NIRVS present in *Aedes* mosquitoes are frequently located in TE-derived piRNA clusters [119,120]. In *Ae. aegypti* and *Ae. albopictus*, half of NIRVS mapped to piRNA clusters in *Ae. aegypti* genome and only 12.5% of NIRVS mapped to piRNA clusters in *Ae. albopictus* genome [119], suggesting that the presence of NIRVS in these clusters was not a general feature. Moreover, bioinformatic predictions on Aag2 cell line showed that piRNA clusters containing EVEs produced more piRNA than those without EVEs, meaning that viruses may not integrate randomly in the host genome but target specific active piRNA clusters for endogenization [120]. Additionally, NIRVS produced both primary and secondary piRNAs; immunoprecipitation of Piwi proteins also detected NIRVS-derived sRNAs, and knockdown of Piwi proteins resulted in a decrease of NIRVS-derived sRNA expression [119]. However, NIRVS-derived siRNAs were not found indicating that NIRVS are involved in only one specific RNAi pathway. NIRVS originated from insect-specific viruses were proved to produce antisense orientation primary piRNA-like molecules and be located in active regions of both siRNA and

piRNA production in *Ae. aegypti* and *Ae. albopictus* mosquitoes [116]. In CHIKV-infected *Ae. aegypti* and *Ae. albopictus*, NIRVS produced viral small-interfering RNAs (vsiRNAs) and probably vpiRNAs after infection [125]. In FHV-infected *Drosophila* cells treated and non-treated with AZT (inhibitor of reverse transcriptase), vDNA are transcribed and processed by the RNAi machinery into vsiRNAs [130]. The knocking-down of RNAi machinery in *Drosophila* infected cells resulted in an acute infection leading to cell death [130].

In summary, NIRVS located in specific regions of the genome such as TE-derived areas called piRNA clusters in mosquitoes, are important for RNAi-based immunity [156]. Their transcripts are capable of producing vsiRNAs in *Drosophila* [130] and both vsiRNAs and vpiRNAs in *Aedes* mosquitoes [119,120,125]. The production of sRNAs is induced following arboviral infections (Togaviridae and Flaviviridae) and NIRVS are required for mosquito tolerance to control viral infection [125]. Since vDNA has been found in many mosquito tissues following viral infection, vDNA could serve as a danger signal to warn the uninfected cells and implement a solid immune response through sRNA production [125], even though the virus could also counteract by producing VSR (Viral Suppressor of RNAi), as it has been seen with insect-specific viruses [157,158].

NIRVS functional role at the protein level

Even though some NIRVS have accumulated several mutations including stop codons, some of them have conserved their open reading frames (ORFs) suggesting that they could be translated into proteins and have a function at the protein level. This scenario was first described for many Endogenous Retroviral elements (ERVs) found in different host genomes [159]. Produced proteins can confer viral interference and direct antiviral properties, leading to a resistance phenotype [160–162]. Up to now, no biological functions were found at the protein level for NIRVS in mosquitoes. However, many of them were proved to produce transcripts, mostly in *Aedes* and *Anopheles* mosquitoes [115,116,119,122,163] meaning that related proteins should be discovered shortly. Collectively, these results suggest that NIRVS have biological functions rather than being endogenized randomly into host genomes. Despite their low or even undetectable levels of RNA [119], NIRVS are suggested to be involved in the main antiviral defense mechanism in mosquitoes as being a source of sRNA production [116,119,120,125,130]. In some rare occasions, NIRVs produce a protein which blocks viral infection and replication by affecting viral polymerase activity [161].

NIRVS as ancient scars attesting virus/host coevolution

Understanding ancient viral cross-species transmission events and how viruses have evolved and interacted with their hosts in the past is important for anticipating future emerging diseases. However, reconstituting the history of viruses remains a challenge considering their rapid evolution. Indeed, viruses are considered as the fastest-evolving biological entity with an evolution rate of 10^{-3} substitutions/site/year (s/s/y) [164–167]. Once endogenized in the host, NIRVS are submitted to a slower evolution rate, around 10^{-9} s/s/y for mammals [165,168]. However the evolutionary reconstruction of the NIRVs remains tricky. EVEs are considered as « fossil records » of ancient infections [169]. Several different methods have been described to date EVEs [110,170]. The minimum insertion date of the EVE can be evaluated if the divergence time of the two species sharing the same taxonomic position is known [110]. Studies on EVE evolution revealed that many viral families are more ancient than previously thought. As an example, the lentivirus family classified as retroviruses dated to a hundred years by molecular clock dating techniques [171] appeared several million years ago since endogenous lentiviruses were discovered in the grey mouse lemur (*Microcebus murinus*) from Madagascar [172]. This can be extended to other viruses: *Hepadnaviridae* [114,173] and *Bornaviridae* [110].

Conclusion

Aedes albopictus and *Ae. aegypti* are two mosquito species that have different histories. They vector several major human arboviruses, including CHIKV and DENV, for which they exhibit different vector competence. Whereas both species highly transmit CHIKV, *Ae. albopictus* is considered as a less efficient vector for DENV [21]. Along with environmental factors such as the temperature, epigenetic factors like the mosquito microbiota [1,66,67], and genetic factors like Quantitative Trait Loci (QTLs) [86] are important to determine the vector competence. More importantly, the recent discovery of NIRVS highlights their potential role as modulator of vector competence to arboviruses. It has been suggested that their association with retrotransposons allowed them to be reverse transcribed into viral DNA (vDNA) and then be integrated into mosquito genomes. Moreover, NIRVS were found to produce vsiRNAs and vpiRNAs, which are important molecules in the RNAi-based immunity in *Aedes* mosquitoes [119,120,125]. In rare cases, NIRVS are translated into proteins that act as inhibitor of viral replication [161]. However, some questions remain unsolved, such as to which aim NIRVS are involved in the antiviral immunity. NIRVS could act as a

warning signal and prime the antiviral immunity for allowing the host to control viral replication before the infection becomes deleterious and harmful for the vector host. It reminds us the adaptive immunity mechanisms such as CRISPR-Cas systems in prokaryotic cells. Alternatively, NIRVS could also act as a keeper of persistent infection by maintaining a low level of viral replication, diminishing the negative impacts on the mosquito fitness. Nevertheless, analysis of natural mosquito populations revealed a high diversity of NIRVS at the intra- and inter-population levels (Houé et al. unpublished data; [174]), suggesting many DNA recombination in NIRVS-surrounding areas. While many NIRVS have been found homologous to insect-specific flavi- and rhabdovirus [119], which are genetically related to pathogenic viruses, none was found homologous to Togaviridae family that contains only two insect-specific viruses described so far [175,176]. This could explain why CHIKV is highly transmitted by both *Ae. aegypti* and *Ae. albopictus*, compared to the Flaviviridae family that harbours many insect-specific viruses [177].

Acknowledgments

The authors thank Pei-Shi Yen and Xavier de Lamballerie for critical discussion.

Disclosure statement

No potential conflict of interest was reported by the authors.

Funding

This study was supported by the Institut Pasteur, the French Government's Investissement d'Avenir programme, Laboratoire d'Excellence "Integrative Biology of Emerging Infectious Diseases" (<http://www.agence-nationale-recherche.fr/ProjetIA-10-LABX-0062>) [grant number ANR-10-LABX-62-IBED to A-BF], the European Union's Horizon 2020 research and innovation programme under ZIKAlliance (<https://cordis.europa.eu/project/rcn/207455/factsheet/en>) [grant agreement no. 734548 to A-BF], and the European Research Council (<https://cordis.europa.eu/project/rcn/203246/reporting/en>) [grant agreement no. 682394 - NIRV_HOST_INT to VH and MB].

ORCID

Mariangela Bonizzoni  <http://orcid.org/0000-0003-0568-8564>

Anna-Bella Failloux  <http://orcid.org/0000-0001-6890-0820>

References

- [1] Zhang G, Hussain M, O'Neill SL, et al. Wolbachia uses a host microRNA to regulate transcripts of a methyltransferase, contributing to dengue virus inhibition in *Aedes aegypti*. *Proc Natl Acad Sci U S A*. 2013; 110:10276–10281. doi:10.1073/pnas.1303603110.
- [2] Lepercq-Goffart I, Nougaiere A, Cassadou S, et al. Chikungunya in the Americas. *Lancet*. 2014;383: 514. doi:10.1016/S0140-6736(14)60185-9.
- [3] Solignat M, Gay B, Higgs S, et al. Replication cycle of chikungunya: a re-emerging arbovirus. *Virology*. 2009;393:183–197. doi:10.1016/j.virol.2009.07.024.
- [4] Gardner CL, Ryman KD. Yellow fever: a reemerging threat. *Clin Lab Med*. 2010;30:237–260. doi:10.1016/j.cll.2010.01.001.
- [5] Bhatt S, Gething PW, Brady OJ, et al. The global distribution and burden of dengue. *Nature*. 2013;496:504–507. doi:10.1038/nature12060.
- [6] Simmons CP, Farrar JJ, Nguyen v V, et al. Dengue. *N. Engl. J. Med*. 2012;366:1423–1432. doi:10.1056/NEJMra1110265.
- [7] Diniz DFA, de Albuquerque CMR, Oliva LO, et al. Diapause and quiescence: dormancy mechanisms that contribute to the geographical expansion of mosquitoes and their evolutionary success. *Parasit Vectors*. 2017;10:310. doi:10.1186/s13071-017-2235-0.
- [8] Rezende GL, Martins AJ, Gentile C, et al. Embryonic desiccation resistance in *Aedes aegypti*: presumptive role of the chitinized serosal cuticle. *BMC Dev Biol*. 2008;8:82. doi:10.1186/1471-213X-8-82.
- [9] Sota T, Mogi M. Interspecific variation in desiccation survival time of *Aedes* (*Stegomyia*) mosquito eggs is correlated with habitat and egg size. *Oecologia*. 1992;90:353–358. doi:10.1007/BF00317691.
- [10] Urbanski JM, Benoit JB, Michaud MR, et al. The molecular physiology of increased egg desiccation resistance during diapause in the invasive mosquito, *Aedes albopictus*. *Proc Biol Sci*. 2010;277:2683–2692. doi:10.1098/rspb.2010.0362.
- [11] Kraemer MU, Sinka ME, Duda KA, et al. The global distribution of the arbovirus vectors *Aedes aegypti* and *Ae. albopictus*. *Elife*. 2015;4:e08347. doi:10.7554/eLife.08347.
- [12] Christophers SR. *Aedes aegypti* (L.) the yellow fever mosquito: its life history, bionomics and structure. London (UK): Cambridge University Press; 1960; p. 750.
- [13] Murphy EJ. *History of African Civilization*. New York: Crowell; 1972.
- [14] Powell JR, Gloria-Soria A, Kotsakiozi P. Recent history of *Aedes aegypti*: vector Genomics and Epidemiology records. *Bioscience*. 2018;68:854–860. doi:10.1093/biosci/biy119.
- [15] Smith CE. The history of dengue in tropical Asia and its probable relationship to the mosquito *Aedes aegypti*. *J Trop Med Hyg*. 1956;59:243–251.
- [16] Mattingly PF. New records and a new species of the subgenus *Stegomyia* (Diptera, Culicidae) from the Ethiopian region. *Ann Trop Med Parasitol*. 1953; 47:294–298.
- [17] Metselaar D, Grainger CR, Oei KG, et al. An outbreak of type 2 dengue fever in the Seychelles, probably transmitted by *Aedes albopictus* (Skuse). *Bull. World Health Organ*. 1980;58:937–943.
- [18] Elliott SA. *Aedes albopictus* in the Solomon and Santa Cruz islands, South Pacific. *Trans. R. Soc. Trop. Med. Hyg.* 1980;74:747–748.
- [19] Caminade C, Medlock JM, Ducheyne E, et al. Suitability of European climate for the Asian tiger mosquito *Aedes albopictus*: recent trends and future scenarios. *J R Soc Interface*. 2012;9:2708–2717. doi:10.1098/rsif.2012.0138.

- [20] Benedict MQ, Levine RS, Hawley WA, et al. Spread of the tiger: global risk of invasion by the mosquito *Aedes albopictus*. *Vector Borne Zoonotic Dis.* 2007;7:76–85. doi:10.1089/vbz.2006.0562.
- [21] Paupy C, Delatte H, Bagny L, et al. *Aedes albopictus*, an arbovirus vector: from the darkness to the light. *Microbes Infect.* 2009;11:1177–1185. doi:10.1016/j.micinf.2009.05.005.
- [22] Cancrini G, Romi R, Gabrielli S, et al. First finding of *Dirofilaria repens* in a natural population of *Aedes albopictus*. *Med Vet Entomol.* 2003;17:448–451.
- [23] Pietrobelli M. Importance of *Aedes albopictus* in veterinary medicine. *Parassitologia.* 2008;50:113–115.
- [24] Christie J. On epidemics of dengue Fever; their Diffusion and Etiology. *Ind Med Gaz.* 1882;17:76–79.
- [25] Powers AM, Logue CH. Changing patterns of chikungunya virus: re-emergence of a zoonotic arbovirus. *J Gen Virol.* 2007;88:2363–2377. doi:10.1099/vir.0.82858-0.
- [26] Kittisirworapod S, Thammapalo S. Fever with rash outbreak investigation report, Chumpare District, Khon Kaen Province. (1991).
- [27] Muyembe-Tamfum JJ, Peyrefitte CN, Yogolelo R, et al. [Epidemic of chikungunya virus in 1999 and 2000 in the Democratic Republic of the Congo]. *Med Trop (Mars).* 2003;63:637–638.
- [28] Sergon K, Njuguna C, Kalani R, et al. Seroprevalence of chikungunya virus (CHIKV) infection on Lamu Island, Kenya, October 2004. *Am J Trop Med Hyg.* 2008;78:333–337.
- [29] Sergon K, Yahaya AA, Brown J, et al. Seroprevalence of chikungunya virus infection on Grande Comore Island, union of the Comoros, 2005. *Am J Trop Med Hyg.* 2007;76:1189–1193.
- [30] Sang RC, Ahmed O, Faye O, et al. Entomologic investigations of a chikungunya virus epidemic in the union of the Comoros, 2005. *Am J Trop Med Hyg.* 2008;78:77–82.
- [31] Singh KR, Pavri KM. Experimental studies with chikungunya virus in *Aedes aegypti* and *Aedes albopictus*. *Acta Virol.* 1967;11:517–526.
- [32] Delatte H, Paupy C, Dehecq JS, et al. [*Aedes albopictus*, vector of chikungunya and dengue viruses in Reunion Island: biology and control]. *Parasite.* 2008;15:3–13. doi:10.1051/parasite/2008151003.
- [33] Borgherini G, Poubeau P, Staikowsky F, et al. Outbreak of chikungunya on Reunion Island: early clinical and laboratory features in 157 adult patients. *Clin Infect Dis.* 2007;44:1401–1407. doi:10.1086/517537.
- [34] Bagny Beilhe L, Delatte H, Juliano SA, et al. Ecological interactions in *Aedes* species on Reunion Island. *Med Vet Entomol.* 2013;27:387–397. doi:10.1111/j.1365-2915.2012.01062.x.
- [35] Schuffenecker I, Iteman I, Michault A, et al. Genome microevolution of chikungunya viruses causing the Indian Ocean outbreak. *PLoS Med.* 2006;3:e263. doi:10.1371/journal.pmed.0030263.
- [36] Tsetsarkin KA, Vanlandingham DL, McGee CE, et al. A single mutation in chikungunya virus affects vector specificity and epidemic potential. *PLoS Pathog.* 2007;3:e201. doi:10.1371/journal.ppat.0030201.
- [37] Vazeille M, Moutailler S, Coudrier D, et al. Two chikungunya isolates from the outbreak of La Reunion (Indian Ocean) exhibit different patterns of infection in the mosquito, *Aedes albopictus*. *PLoS One.* 2007;2:e1168. doi:10.1371/journal.pone.0001168.
- [38] Powers AM. Risks to the Americas associated with the continued expansion of chikungunya virus. *J Gen Virol.* 2015;96:1–5. doi:10.1099/vir.0.070136-0.
- [39] Gubler DJ. The global pandemic of dengue/dengue haemorrhagic fever: current status and prospects for the future. *Ann Acad Med Singapore.* 1998;27:227–234.
- [40] Gubler DJ. Dengue and dengue hemorrhagic fever. *Clin Microbiol Rev.* 1998;11:480–496.
- [41] Hotta S. Dengue vector mosquitoes in Japan: the role of *Aedes albopictus* and *Aedes aegypti* in the 1942–1944 dengue epidemics of Japan main islands. *Med Entomol Zool.* 1998;49:267–274.
- [42] Luo L, Jiang L-Y, Xiao X-C, et al. The dengue preface to endemic in mainland China: the historical largest outbreak by *Aedes albopictus* in Guangzhou, 2014. *Infect Dis Poverty.* 2017;6:148. doi:10.1186/s40249-017-0352-9.
- [43] Lambrechts L, Scott TW, Gubler DJ. Consequences of the expanding global distribution of *Aedes albopictus* for dengue virus transmission. *PLoS Negl Trop Dis.* 2010;4:e646. doi:10.1371/journal.pntd.0000646.
- [44] La Ruche G, Souarès Y, Armengaud A, et al. First two autochthonous dengue virus infections in metropolitan France, September 2010. *Euro Surveillance : Bulletin Europeen sur les Maladies Transmissibles = European Communicable Disease Bulletin.* 2010;15:19676.
- [45] Gjenero-Margan I, Aleraj B, Krajcar D, et al. Autochthonous dengue fever in Croatia, August–September 2010. *Euro surveillance : bulletin Europeen sur les maladies transmissibles = European communicable disease bulletin.* 2011;16(9):pii: 19805.
- [46] Rezza G. *Aedes albopictus* and the reemergence of dengue. *BMC Public Health.* 2012;12:72. doi:10.1186/1471-2458-12-72.
- [47] Hardy JL. In: Monath TP, editor. *The arboviruses: Epidemiology and Ecology.* Boca Raton (FL): CRC Press; 1988. Vol. 2, p. 87–126.
- [48] Woodring JL, Higgs S, Beaty BJ. In: Marquardt WC, Beaty BJ, editors. *The Biology of Disease vectors.* Niwot: University Press of Colorado; 1996; p. 632.
- [49] Lambrechts L, Chevillon C, Albright RG, et al. Genetic specificity and potential for local adaptation between dengue viruses and mosquito vectors. *BMC Evol Biol.* 2009;9:160. doi:10.1186/1471-2148-9-160.
- [50] Zouache K, Fontaine A, Vega-Rúa A, et al. Three-way interactions between mosquito population, viral strain and temperature underlying chikungunya virus transmission potential. *Proc Biol Sci / R Soc.* 2014;281. doi:10.1098/rspb.2014.1078.
- [51] Coffey LL, Failloux AB, Weaver SC. Chikungunya virus-vector interactions. *Viruses.* 2014;6:4628–4663. doi:10.3390/v6114628.
- [52] Sunarto J, Gubler DJ, Nalim S, et al. Epidemic dengue hemorrhagic fever in rural Indonesia. III. Entomological studies. *Am J Trop Med Hyg* 1979; 28(4):717–724.
- [53] Rosen L, Roseboom LE, Gubler DJ, et al. Comparative susceptibility of mosquito species and strains to oral and parenteral infection with dengue and Japanese encephalitis viruses. *Am J Trop Med Hyg.* 1985;34:603–615.

- [54] Alto BW, Reiskind MH, Lounibos LP. Size alters susceptibility of vectors to dengue virus infection and dissemination. *Am J Trop Med Hyg.* 2008;79:688–695.
- [55] Vazeille M, Rosen L, Mousson L, et al. Low oral receptivity for dengue type 2 viruses of *Aedes albopictus* from Southeast Asia compared with that of *Aedes aegypti*. *Am J Trop Med Hyg.* 2003;68:203–208.
- [56] Whitehead RH, Yuill TM, Gould DJ, et al. Experimental infection of *Aedes aegypti* and *Aedes albopictus* with dengue viruses. *T Roy Soc Trop Med Hyg.* 1971;65:661–667.
- [57] Lindh JM, Borg-Karlson AK, Faye I. Transstadial and horizontal transfer of bacteria within a colony of *Anopheles gambiae* (Diptera: Culicidae) and oviposition response to bacteria-containing water. *Acta Trop.* 2008;107:242–250. doi:10.1016/j.actatropica.2008.06.008.
- [58] Alvarez-Perez S, Herrera CM, de Vega C. Zooming-in on floral nectar: a first exploration of nectar-associated bacteria in wild plant communities. *FEMS Microbiol Ecol.* 2012;80:591–602. doi:10.1111/j.1574-6941.2012.01329.x.
- [59] Douglas AE. Lessons from studying insect symbioses. *Cell Host Microbe.* 2011;359–367. doi:10.1016/j.chom.2011.09.001.
- [60] Douglas AE. The molecular basis of bacterial-insect symbiosis. *J Mol Biol.* 2014;426:3830–3837. doi:10.1016/j.jmb.2014.04.005.
- [61] Dillon RJ, Dillon VM. The gut bacteria of insects: nonpathogenic interactions. *Annu Rev Entomol.* 2004;49:71–92. doi:10.1146/annurev.ento.49.061802.123416.
- [62] Moran NA, McCutcheon JP, Nakabachi A. Genomics and evolution of heritable bacterial symbionts. *Annu Rev Genet.* 2008;42:165–190. doi:10.1146/annurev.genet.41.110306.130119.
- [63] Moya A, Pereto J, Gil R, et al. Learning how to live together: genomic insights into prokaryote-animal symbioses. *Nat Rev Genet.* 2008;9:218–229. doi:10.1038/nrg2319.
- [64] Berg RD. The indigenous gastrointestinal microflora. *Trends Microbiol.* 1996;4:430–435.
- [65] Charroux B, Royet J. *Drosophila* immune response: from systemic antimicrobial peptide production in fat body cells to local defense in the intestinal tract. *Fly (Austin).* 2010;4:40–47.
- [66] Pan X, Zhou G, Wu J, et al. Wolbachia induces reactive oxygen species (ROS)-dependent activation of the Toll pathway to control dengue virus in the mosquito *Aedes aegypti*. *Proc Natl Acad Sci U S A.* 2012;109:E23–E31. doi:10.1073/pnas.1116932108.
- [67] Xi Z, Ramirez JL, Dimopoulos G. The *Aedes aegypti* toll pathway controls dengue virus infection. *PLoS Pathog.* 2008;4:e1000098. doi:10.1371/journal.ppat.1000098.
- [68] Fragkoudis R, Attarzadeh-Yazdi G, Nash AA, et al. Advances in dissecting mosquito innate immune responses to arbovirus infection. *J Gen Virol.* 2009;90:2061–2072. doi:10.1099/vir.0.013201-0.
- [69] Avadhanula V, Weasner BP, Hardy GG, et al. A novel system for the launch of alphavirus RNA synthesis reveals a role for the Imd pathway in arthropod antiviral response. *PLoS Pathog.* 2009;5:e1000582. doi:10.1371/journal.ppat.1000582.
- [70] Costa A, Jan E, Sarnow P, et al. The Imd pathway is involved in antiviral immune responses in *Drosophila*. *PLoS One.* 2009;4:e7436. doi:10.1371/journal.pone.0007436.
- [71] Paradkar PN, Trinidad L, Voysey R, et al. Secreted Vago restricts West Nile virus infection in *Culex* mosquito cells by activating the Jak-STAT pathway. *Proc Natl Acad Sci U S A.* 2012;109:18915–18920. doi:10.1073/pnas.1205231109.
- [72] Zambon RA, Nandakumar M, Vakharia VN, et al. The Toll pathway is important for an antiviral response in *Drosophila*. *Proc Natl Acad Sci U S A.* 2005;102:7257–7262. doi:10.1073/pnas.0409181102.
- [73] Sim S, Jupatanakul N, Dimopoulos G. Mosquito immunity against arboviruses. *Viruses.* 2014;6:4479–4504. doi:10.3390/v6114479.
- [74] Arbouzova NI, Zeidler MP. JAK/STAT signalling in *Drosophila*: insights into conserved regulatory and cellular functions. *Development.* 2006;133:2605–2616. doi:10.1242/dev.02411.
- [75] Hombria JC, Brown S. The fertile field of *Drosophila* Jak/STAT signalling. *Curr Biol.* 2002;12:R569–R575.
- [76] Zhu F, Ding H, Zhu B. Transcriptional profiling of *Drosophila* S2 cells in early response to *Drosophila* C virus. *Virol J.* 2013;10:210. doi:10.1186/1743-422X-10-210.
- [77] Souza-Neto JA, Sim S, Dimopoulos G. An evolutionary conserved function of the JAK-STAT pathway in anti-dengue defense. *Proc Natl Acad Sci U S A.* 2009;106:17841–17846. doi:10.1073/pnas.0905006106.
- [78] Huang Z, Kingsolver MB, Avadhanula V, et al. An antiviral role for antimicrobial peptides during the arthropod response to alphavirus replication. *J Virol.* 2013;87:4272–4280. doi:10.1128/JVI.03360-12.
- [79] McFarlane M, Arias-Goeta C, Martin E, et al. Characterization of *Aedes aegypti* innate-immune pathways that limit chikungunya virus replication. *PLoS Negl Trop Dis.* 2014;8:e2994. doi:10.1371/journal.pntd.0002994.
- [80] Fragkoudis R, Chi Y, Siu RW, et al. Semliki Forest virus strongly reduces mosquito host defence signaling. *Insect Mol Biol.* 2008;17:647–656. doi:10.1111/j.1365-2583.2008.00834.x.
- [81] Barletta AB, Nascimento-Silva MC, Talyuli OA, et al. Microbiota activates IMD pathway and limits Sindbis infection in *Aedes aegypti*. *Parasit Vectors.* 2017;10:103. doi:10.1186/s13071-017-2040-9.
- [82] Sanders HR, Foy BD, Evans AM, et al. Sindbis virus induces transport processes and alters expression of innate immunity pathway genes in the midgut of the disease vector, *Aedes aegypti*. *Insect Biochem Molec.* 2005;35:1293–1307. doi:10.1016/j.ibmb.2005.07.006.
- [83] Failloux AB, Vazeille M, Rodhain F. Geographic genetic variation in populations of the dengue virus vector *Aedes aegypti*. *J Mol Evol.* 2002; 55(6):653–663.
- [84] Bosio CF, Fulton RE, Salasek ML, et al. Quantitative trait loci that control vector competence for dengue-2 virus in the mosquito *Aedes aegypti*. *Genetics.* 2000;156:687–698.
- [85] Gomez-Machorro C, Bennett KE, del Lourdes Munoz M, et al. Quantitative trait loci affecting dengue mid-gut infection barriers in an advanced intercross line of *Aedes aegypti*. *Insect Mol Biol.* 2004;13:637–648. doi:10.1111/j.0962-1075.2004.00522.x.

- [86] Bennett KE, Flick D, Fleming KH, et al. Quantitative trait loci that control dengue-2 virus dissemination in the mosquito *Aedes aegypti*. *Genetics*. 2005;170:185–194. doi:10.1534/genetics.104.035634.
- [87] Nene V, Wortman JR, Lawson D, et al. Genome sequence of *Aedes aegypti*, a major arbovirus vector. *Science* (New York, N.Y.). 2007;316:1718–1723. doi:10.1126/science.1138878.
- [88] Dritsou V, Topalis P, Windbichler N, et al. A draft genome sequence of an invasive mosquito: an Italian *Aedes albopictus*. *Pathog Glob Health*. 2015;109:207–220. doi:10.1179/2047773215Y.0000000031.
- [89] Chen XG, Jiang X, Gu J, et al. Genome sequence of the Asian Tiger mosquito, *Aedes albopictus*, reveals insights into its biology, genetics, and evolution. *Proc Natl Acad Sci U S A*. 2015;112:E5907–E5915. doi:10.1073/pnas.1516410112.
- [90] Holt RA, Subramanian GM, Halpern A, et al. The genome sequence of the malaria mosquito *Anopheles gambiae*. *Science* (New York, N.Y.). 2002;298:129–149. doi:10.1126/science.1076181.
- [91] Arensburger P, Megy K, Waterhouse RM, et al. Sequencing of *Culex quinquefasciatus* establishes a platform for mosquito comparative genomics. *Science* (New York, N.Y.). 2010;330:86–88. doi:10.1126/science.1191864.
- [92] McLain DK, Rai KS, Fraser MJ. Intraspecific and interspecific variation in the sequence and abundance of highly repeated DNA among mosquitoes of the *Aedes albopictus* subgroup. *Heredity* (Edinb). 1987;58(Pt 3):373–381.
- [93] Black WCt, Ferrari JA, Rai KS, et al. Breeding structure of a colonising species: *Aedes albopictus* (Skuse) in the United States. *Heredity* (Edinb). 1988;60(Pt 2):173–181.
- [94] McClintock B. Intracellular systems controlling gene action and mutation. *Brookhaven Symp Biol*. 1956; (8):58–74.
- [95] Doolittle WF, Sapienza C. Selfish genes, the phenotype paradigm and genome evolution. *Nature*. 1980; 284(5757):601–603.
- [96] Orgel LE, Crick FH. Selfish DNA: the ultimate parasite. *Nature*. 1980;284:604–607.
- [97] Klaer R, Kuhn S, Tillmann E, et al. The sequence of IS4. *Mol Gen Genet*. 1981;181:169–175.
- [98] Au TK, Agrawal P, Harshey RM. Chromosomal integration mechanism of infecting mu virion DNA. *J Bacteriol*. 2006;188:1829–1834. doi:10.1128/JB.188.5.1829-1834.2006.
- [99] Bukhari A, Zipser D. Random insertion of Mu-1 DNA within a single gene. *Nature* (London). 1972;236:240–243.
- [100] Finnegan DJ. Retrotransposons. *Curr Biol*. 2012;22: R432–R437. doi:10.1016/j.cub.2012.04.025.
- [101] Craig NL, Craigie R, Gellert M, et al. *Mobile DNA II*. (American Society for Microbiology Press, DC Washington, 2002).
- [102] Kapitonov VV, Jurka J. Rolling-circle transposons in eukaryotes. *Proc Natl Acad Sci U S A*. 2001;98:8714–8719. doi:10.1073/pnas.151269298.
- [103] Pritham EJ, Putliwala T, Feschotte C. Mavericks, a novel class of giant transposable elements widespread in eukaryotes and related to DNA viruses. *Gene*. 2007;390:3–17. doi:10.1016/j.gene.2006.08.008.
- [104] Kidwell MG. Horizontal transfer. *Curr Opin Genet Dev*. 1992;2:868–873.
- [105] Konkel MK, Batzer MA. A mobile threat to genome stability: The impact of non-LTR retrotransposons upon the human genome. *Semin Cancer Biol*. 2010; 20:211–221. doi:10.1016/j.semcancer.2010.03.001.
- [106] Batzer MA, Deininger PL. Alu repeats and human genomic diversity. *Nat Rev Genet*. 2002;3:370–379. doi:10.1038/nrg798.
- [107] Rao PN, Rai K. Inter and intraspecific variation in nuclear DNA content in *Aedes* mosquitoes. *Heredity* (Edinb). 1987;59(Pt 2):253–258.
- [108] Goubert C, Modolo L, Vieira C, et al. De novo assembly and annotation of the Asian tiger mosquito (*Aedes albopictus*) repeatome with dnaPipeTE from raw genomic reads and comparative analysis with the yellow fever mosquito (*Aedes aegypti*). *Genome Biol Evol*. 2015;7:1192–1205. doi:10.1093/gbe/evv050.
- [109] Biryukova I, Ye T. Endogenous siRNAs and piRNAs derived from transposable elements and genes in the malaria vector mosquito *Anopheles gambiae*. *BMC Genomics*. 2015;16:278. doi:10.1186/s12864-015-1436-1.
- [110] Katzourakis A, Gifford RJ. Endogenous viral elements in animal genomes. *PLoS Genet*. 2010;6:e1001191. doi:10.1371/journal.pgen.1001191.
- [111] Siomi MC, Sato K, Pezic D, et al. PIWI-interacting small RNAs: the vanguard of genome defence. *Nat Rev Mol Cell Biol*. 2011;12:246–258. doi:10.1038/nrm3089.
- [112] Bock M, Stoye JP. Endogenous retroviruses and the human germline. *Curr Opin Genet Dev*. 2000;10: 651–655.
- [113] Belyi VA, Levine AJ, Skalka AM. Unexpected inheritance: multiple integrations of ancient bornavirus and ebolavirus/marburgvirus sequences in vertebrate genomes. *PLoS Pathog*. 2010;6:e1001030. doi:10.1371/journal.ppat.1001030.
- [114] Gilbert C, Feschotte C. Genomic fossils calibrate the long-term evolution of hepadnaviruses. *PLoS Biol*. 2010;8. doi:10.1371/journal.pbio.1000495.
- [115] Crochu S, Cook S, Attoui H, et al. Sequences of flavivirus-related RNA viruses persist in DNA form integrated in the genome of *Aedes* spp. mosquitoes. *J Gen Virol*. 2004;85:1971–1980. doi:10.1099/vir.0.79850-0.
- [116] Suzuki Y, Frangeul L, Dickson LB, et al. Uncovering the Repertoire of endogenous flaviviral elements in *Aedes* mosquito genomes. *J Virol*. 2017;91. doi:10.1128/JVI.00571-17.
- [117] Bolling BG, Weaver SC, Tesh RB, et al. Insect-Specific Virus discovery: significance for the arbovirus Community. *Viruses*. 2015;7:4911–4928. doi:10.3390/v7092851.
- [118] Vasilakis N, Tesh RB. Insect-specific viruses and their potential impact on arbovirus transmission. *Curr Opin Virol*. 2015;15:69–74. doi:10.1016/j.coviro.2015.08.007.
- [119] Palatini U, Miesen P, Carballar-Lejarazu R, et al. Comparative genomics shows that viral integrations are abundant and express piRNAs in the arboviral vectors *Aedes aegypti* and *Aedes albopictus*. *BMC Genomics*. 2017;18:512. doi:10.1186/s12864-017-3903-3.
- [120] Whitfield ZJ, Dolan PT, Kunitomi M, et al. The diversity, structure, and function of Heritable adaptive immunity sequences in the *Aedes aegypti* genome. *Curr Biol*. 2017;27:3511–3519 e3517. doi:10.1016/j.cub.2017.09.067.

- [121] Holmes EC. The evolution of endogenous viral elements. *Cell Host Microbe*. 2011;10:368–377. doi:10.1016/j.chom.2011.09.002.
- [122] Fort P, Albertini A, Van-Hua A, et al. Fossil rhabdoviral sequences integrated into arthropod genomes: ontogeny, evolution, and potential functionality. *Mol Biol Evol*. 2012;29:381–390. doi:10.1093/molbev/msr226.
- [123] Conzelmann KK. Nonsegmented negative-strand RNA viruses: genetics and manipulation of viral genomes. *Annu Rev Genet*. 1998;32:123–162. doi:10.1146/annurev.genet.32.1.123.
- [124] Brackney DE, Scott JC, Sagawa F, et al. C6/36 *Aedes albopictus* cells have a dysfunctional antiviral RNA interference response. *PLoS Negl Trop Dis*. 2010;4:e856. doi:10.1371/journal.pntd.0000856.
- [125] Goic B, Stapleford KA, Frangeul L, et al. Virus-derived DNA drives mosquito vector tolerance to arboviral infection. *Nat Commun*. 2016;7:12410. doi:10.1038/ncomms12410.
- [126] Nag DK, Brecher M, Kramer LD. DNA forms of arboviral RNA genomes are generated following infection in mosquito cell cultures. *Virology*. 2016;498:164–171. doi:10.1016/j.virol.2016.08.022.
- [127] Nag DK, Kramer LD. Patchy DNA forms of the zika virus RNA genome are generated following infection in mosquito cell cultures and in mosquitoes. *J Gen Virol*. 2017;98:2731–2737. doi:10.1099/jgv.0.000945.
- [128] Geuking MB, Weber J, Dewannieux M, et al. Recombination of retrotransposon and exogenous RNA virus results in nonretroviral cDNA integration. *Science (New York, N.Y.)*. 2009;323:393–396. doi:10.1126/science.1167375.
- [129] Zhdanov VM. Integration of viral genomes. *Nature*. 1975;256:471–473.
- [130] Goic B, Vodovar N, Mondotte JA, et al. RNA-mediated interference and reverse transcription control the persistence of RNA viruses in the insect model *Drosophila*. *Nat Immunol*. 2013;14:396–403. doi:10.1038/ni.2542.
- [131] Bill CA, Summers J. Genomic DNA double-strand breaks are targets for hepadnaviral DNA integration. *Proc Natl Acad Sci U S A*. 2004;101:11135–11140. doi:10.1073/pnas.0403925101.
- [132] Kotin RM, Linden RM, Berns KI. Characterization of a preferred site on human chromosome 19q for integration of adeno-associated virus DNA by non-homologous recombination. *Embo J*. 1992;11:5071–5078.
- [133] Urceley E, Ward P, Wiener SM, et al. Asymmetric replication in vitro from a human sequence element is dependent on adeno-associated virus Rep protein. *J Virol*. 1995;69:2038–2046.
- [134] Young SM Jr., Samulski RJ. Adeno-associated virus (AAV) site-specific recombination does not require a Rep-dependent origin of replication within the AAV terminal repeat. *Proc Natl Acad Sci U S A*. 2001;98:13525–13530. doi:10.1073/pnas.241508998.
- [135] Morissette G, Flamand L. Herpesviruses and chromosomal integration. *J Virol*. 2010;84:12100–12109. doi:10.1128/JVI.01169-10.
- [136] Klenerman P, Hengartner H, Zinkernagel RM. A non-retroviral RNA virus persists in DNA form. *Nature*. 1997;390:298–301. doi:10.1038/36876.
- [137] Maori E, Tanne E, Sela I. Reciprocal sequence exchange between non-retro viruses and hosts leading to the appearance of new host phenotypes. *Virology*. 2007;362:342–349. doi:10.1016/j.virol.2006.11.038.
- [138] Bronkhorst AW, van Rij RP. The long and short of antiviral defense: small RNA-based immunity in insects. *Curr Opin Virol*. 2014;7:19–28. doi:10.1016/j.coviro.2014.03.010.
- [139] Olson KE, Blair CD. Arbovirus-mosquito interactions: RNAi pathway. *Curr Opin Virol*. 2015;15:119–126. doi:10.1016/j.coviro.2015.10.001.
- [140] Obbard DJ, Gordon KH, Buck AH, et al. The evolution of RNAi as a defence against viruses and transposable elements. *Philos Trans R Soc Lond B Biol Sci*. 2009;364:99–115. doi:10.1098/rstb.2008.0168.
- [141] Sarot E, Payen-Groschene G, Bucheton A, et al. Evidence for a piwi-dependent RNA silencing of the gypsy endogenous retrovirus by the *Drosophila melanogaster* flamenco gene. *Genetics*. 2004;166:1313–1321.
- [142] Saito K, Nishida KM, Mori T, et al. Specific association of Piwi with rasiRNAs derived from retrotransposon and heterochromatic regions in the *Drosophila* genome. *Genes Dev*. 2006;20:2214–2222. doi:10.1101/gad.1454806.
- [143] Brennecke J, Aravin AA, Stark A, et al. Discrete small RNA-generating loci as master regulators of transposon activity in *Drosophila*. *Cell*. 2007;128:1089–1103. doi:10.1016/j.cell.2007.01.043.
- [144] Vagin VV, Sigova A, Li C, et al. A distinct small RNA pathway silences selfish genetic elements in the germline. *Science (New York, N.Y.)*. 2006;313:320–324. doi:10.1126/science.1129333.
- [145] Pelisson A, Sarot E, Payen-Groschene G, et al. A novel repeat-associated small interfering RNA-mediated silencing pathway downregulates complementary sense gypsy transcripts in somatic cells of the *Drosophila* ovary. *J Virol*. 2007;81:1951–1960. doi:10.1128/JVI.01980-06.
- [146] Akbari OS, Antoshechkin I, Amrhein H, et al. The developmental transcriptome of the mosquito *Aedes aegypti*, an invasive species and major arbovirus vector. *G3 (Bethesda)*. 2013;3:1493–1509. doi:10.1534/g3.113.006742.
- [147] Arensburger P, Hice RH, Wright JA, et al. The mosquito *Aedes aegypti* has a large genome size and high transposable element load but contains a low proportion of transposon-specific piRNAs. *BMC Genomics*. 2011;12:606. doi:10.1186/1471-2164-12-606.
- [148] Morazzani EM, Wiley MR, Murreddu MG, et al. Production of virus-derived ping-pong-dependent piRNA-like small RNAs in the mosquito soma. *PLoS Pathog*. 2012;8:e1002470. doi:10.1371/journal.ppat.1002470.
- [149] Schnettler E, Donald CL, Human S, et al. Knockdown of piRNA pathway proteins results in enhanced Semliki Forest virus production in mosquito cells. *J Gen Virol*. 2013;94:1680–1689. doi:10.1099/vir.0.053850-0.
- [150] Vodovar N, Bronkhorst AW, van Cleef KW, et al. Arbovirus-derived piRNAs exhibit a ping-pong signature in mosquito cells. *PLoS One*. 2012;7:e30861. doi:10.1371/journal.pone.0030861.
- [151] Hess AM, Prasad AN, Ptitsyn A, et al. Small RNA profiling of dengue virus-mosquito interactions implicates the PIWI RNA pathway in anti-viral defense. *BMC Microbiol*. 2011;11:45. doi:10.1186/1471-2180-11-45.
- [152] Leger P, Lara E, Jagla B, et al. Dicer-2- and Piwi-mediated RNA interference in Rift Valley fever virus-infected mosquito cells. *J Virol*. 2013;87:1631–1648. doi:10.1128/JVI.02795-12.

- [153] Miesen P, Joosten J, van Rij RP. PIWI's Go viral: arbovirus-derived piRNAs in vector mosquitoes. *PLoS Pathog.* 2016;12:e1006017. doi:10.1371/journal.ppat.1006017.
- [154] Miesen P, Ivens A, Buck AH, et al. Small RNA Profiling in dengue Virus 2-infected Aedes mosquito cells Reveals viral piRNAs and Novel host miRNAs. *PLoS Negl Trop Dis.* 2016;10:e0004452. doi:10.1371/journal.pntd.0004452.
- [155] Petit M, Mongelli V, Frangeul L, et al. piRNA pathway is not required for antiviral defense in *Drosophila melanogaster*. *Proc Natl Acad Sci U S A.* 2016;113:E4218–E4227. doi:10.1073/pnas.1607952113.
- [156] Blair CD. Mosquito RNAi is the major innate immune pathway controlling arbovirus infection and transmission. *Future Microbiol.* 2011;6:265–277. doi:10.2217/fmb.11.11.
- [157] Kingsolver MB, Huang Z, Hardy RW. Insect antiviral innate immunity: pathways, effectors, and connections. *J Mol Biol.* 2013;425:4921–4936. doi:10.1016/j.jmb.2013.10.006.
- [158] van Cleef KW, van Mierlo JT, van den Beek M, et al. Identification of viral suppressors of RNAi by a reporter assay in *Drosophila* S2 cell culture. *Methods Mol Biol.* 2011;721:201–213. doi:10.1007/978-1-61779-037-9_12.
- [159] Aswad A, Katzourakis A. Paleovirology and virally derived immunity. *Trends Ecol Evol.* 2012;27:627–636. doi:10.1016/j.tree.2012.07.007.
- [160] Taylor GM, Gao Y, Sanders DA. Fv-4: identification of the defect in Env and the mechanism of resistance to ecotropic murine leukemia virus. *J Virol.* 2001;75:11244–11248. doi:10.1128/JVI.75.22.11244-11248.2001.
- [161] Fujino K, Horie M, Honda T, et al. Inhibition of Borna disease virus replication by an endogenous bornavirus-like element in the ground squirrel genome. *Proc Natl Acad Sci U S A.* 2014;111:13175–13180. doi:10.1073/pnas.1407046111.
- [162] Mura M, Murcia P, Caporale M, et al. Late viral interference induced by transdominant Gag of an endogenous retrovirus. *Proc Natl Acad Sci U S A.* 2004;101:11117–11122. doi:10.1073/pnas.0402877101.
- [163] Lequime S, Lambrechts L. Discovery of flavivirus-derived endogenous viral elements in *Anopheles* mosquito genomes supports the existence of *Anopheles*-associated insect-specific flaviviruses. *Virus Evol.* 2017;3, vew035. doi:10.1093/ve/vew035.
- [164] Hanada K, Suzuki Y, Gojobori T. A large variation in the rates of synonymous substitution for RNA viruses and its relationship to a diversity of viral infection and transmission modes. *Mol Biol Evol.* 2004;21:1074–1080. doi:10.1093/molbev/msh109.
- [165] Duffy S, Shackelton LA, Holmes EC. Rates of evolutionary change in viruses: patterns and determinants. *Nat Rev Genet.* 2008;9:267–276. doi:10.1038/nrg2323.
- [166] Jenkins GM, Rambaut A, Pybus OG, et al. Rates of molecular evolution in RNA viruses: a quantitative phylogenetic analysis. *J Mol Evol.* 2002;54:156–165. doi:10.1007/s00239-001-0064-3.
- [167] Sanjuan R. From molecular genetics to phylodynamics: evolutionary relevance of mutation rates across viruses. *PLoS Pathog.* 2012;8:e1002685. doi:10.1371/journal.ppat.1002685.
- [168] Kumar S, Subramanian S. Mutation rates in mammalian genomes. *Proc Natl Acad Sci U S A.* 2002;99:803–808. doi:10.1073/pnas.022629899.
- [169] Emerman M, Malik HS. Paleovirology—modern consequences of ancient viruses. *PLoS Biol.* 2010;8:e1000301. doi:10.1371/journal.pbio.1000301.
- [170] Aiewsakun P, Katzourakis A. Endogenous viruses: Connecting recent and ancient viral evolution. *Virology.* 2015;479–480:26–37. doi:10.1016/j.virol.2015.02.011.
- [171] Wertheim JO, Worobey M. Dating the age of the SIV lineages that gave rise to HIV-1 and HIV-2. *PLoS Comput Biol.* 2009;5:e1000377. doi:10.1371/journal.pcbi.1000377.
- [172] Gifford RJ, Katzourakis A, Tristem M, et al. A transitional endogenous lentivirus from the genome of a basal primate and implications for lentivirus evolution. *Proc Natl Acad Sci U S A.* 2008;105:20362–20367. doi:10.1073/pnas.0807873105.
- [173] Zhou Y, Holmes EC. Bayesian estimates of the evolutionary rate and age of hepatitis B virus. *J Mol Evol.* 2007;65:197–205. doi:10.1007/s00239-007-0054-1.
- [174] Pischedda E, Scolari F, Valerio F, et al. Evolutionary landscape of mosquito viral integrations. *BioRxiv.* 2018. doi:10.1101/385666.
- [175] Hermanns K, Zirkel F, Kopp A, et al. Discovery of a novel alphavirus related to Eilat virus. *J Gen Virol.* 2017;98:43–49. doi:10.1099/jgv.0.000694.
- [176] Nasar F, Palacios G, Gorchakov RV, et al. Eilat virus, a unique alphavirus with host range restricted to insects by RNA replication. *Proc Natl Acad Sci U S A.* 2012;109:14622–14627. doi:10.1073/pnas.1204787109.
- [177] Blitvich BJ, Firth AE. Insect-specific flaviviruses: a systematic review of their discovery, host range, mode of transmission, superinfection exclusion potential and genomic organization. *Viruses.* 2015;7:1927–1959. doi:10.3390/v7041927.

Appendix N°4

Research article entitled "Combining Wolbachia-induced sterility and virus protection to fight *Aedes albopictus*-borne viruses" published in the journal *PLoS Neglected Tropical Diseases* in July 2018.

RESEARCH ARTICLE

Combining *Wolbachia*-induced sterility and virus protection to fight *Aedes albopictus*-borne viruses

Riccardo Moretti^{1*}, Pei-Shi Yen², Vincent Houé², Elena Lampazzi¹, Angiola Desiderio¹, Anna-Bella Failloux², Maurizio Calvitti¹

1 Biotechnology and Agroindustry Division, ENEA (Italian National Agency for New Technologies, Energy and Sustainable Economic Development), Casaccia Research Center, Rome, Italy, **2** Department of Virology, Institut Pasteur, Arboviruses and Insect Vectors Unit, Paris, France

✉ These authors contributed equally to this work.

* riccardo.moretti@enea.it

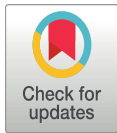

OPEN ACCESS

Citation: Moretti R, Yen P-S, Houé V, Lampazzi E, Desiderio A, Failloux A-B, et al. (2018) Combining *Wolbachia*-induced sterility and virus protection to fight *Aedes albopictus*-borne viruses. *PLoS Negl Trop Dis* 12(7): e0006626. <https://doi.org/10.1371/journal.pntd.0006626>

Editor: Cameron P. Simmons, Oxford University Clinical Research Unit, VIETNAM

Received: February 22, 2018

Accepted: June 21, 2018

Published: July 18, 2018

Copyright: © 2018 Moretti et al. This is an open access article distributed under the terms of the [Creative Commons Attribution License](https://creativecommons.org/licenses/by/4.0/), which permits unrestricted use, distribution, and reproduction in any medium, provided the original author and source are credited.

Data Availability Statement: All relevant data are within the paper and its Supporting Information files.

Funding: This project has received resources funded by the European Union's Horizon 2020 research and innovation programme under grant agreement No 731060 (Infravec2, Research Infrastructures for the control of vector-borne diseases; <http://infravec2.eu/>). Funding followed the positive evaluation of a formal request describing the research project which was

Abstract

Among the strategies targeting vector control, the exploitation of the endosymbiont *Wolbachia* to produce sterile males and/or invasive females with reduced vector competence seems to be promising. A new *Aedes albopictus* transinfection (ARwP-M) was generated by introducing wMel *Wolbachia* in the ARwP line which had been established previously by replacing wAlbA and wAlbB *Wolbachia* with the wPip strain. Various infection and fitness parameters were studied by comparing ARwP-M, ARwP and wild-type (S_{ANG} population) *Ae. albopictus* sharing the same genetic background. Moreover, the vector competence of ARwP-M related to chikungunya, dengue and zika viruses was evaluated in comparison with ARwP. ARwP-M showed a 100% rate of maternal inheritance of wMel and wPip *Wolbachia*. Survival, female fecundity and egg fertility did not show to differ between the three *Ae. albopictus* lines. Crosses between ARwP-M males and S_{ANG} females were fully infertile regardless of male age while egg hatch in reverse crosses increased from 0 to about 17% with S_{ANG} males aging from 3 to 17 days. When competing with S_{ANG} males for S_{ANG} females, ARwP-M males induced a level of sterility significantly higher than that expected for an equal mating competitiveness (mean Fried index of 1.71 instead of 1). The overall *Wolbachia* density in ARwP-M females was about 15 fold higher than in ARwP, mostly due to the wMel infection. This feature corresponded to a strongly reduced vector competence for chikungunya and dengue viruses (in both cases, 5 and 0% rates of transmission at 14 and 21 days post infection) with respect to ARwP females. Results regarding Zika virus did not highlight significant differences between ARwP-M and ARwP. However, none of the tested ARwP-M females was capable at transmitting ZIKV. These findings are expected to promote the exploitation of *Wolbachia* to suppress the wild-type *Ae. albopictus* populations.

prepared and submitted to Infravec2 by RM. The funders had no role in study design, data collection and analysis, decision to publish, or preparation of the manuscript.

Competing interests: The authors have declared that no competing interests exist.

Author summary

Aedes albopictus is one of the major human disease vectors and, despite substantial control efforts, it is rapidly spreading worldwide and increasing its epidemiological role. Thus, innovative approaches to fight this mosquito are urgently needed. Among the available control strategies, the exploitation of the endosymbiotic bacterium *Wolbachia* seems to be promising. In nature, the infection by *Wolbachia* is generally not detrimental, instead, it causes a series of modifications in host physiology promoting the spread of the infection in uninfected populations. Herein, we report on the artificial transinfection of specific *Wolbachia* strains in *Ae. albopictus* to replace its native *Wolbachia* infection type. This manipulation aimed at exploiting the expected modifications in the reproductive biology and vector competence of the species to contribute to reduce its epidemiological role. Specifically, we found that the new double *Wolbachia* infection did not affect *Ae. albopictus* fitness. The males belonging to the manipulated line, ARwP-M, induced full egg infertility in the wild-type females they mate with and showed increased male mating competitiveness. Remarkably, the ARwP-M females demonstrated significantly reduced competence for chikungunya and dengue viruses while both tested *Ae. albopictus* lines showed a very low susceptibility for Zika virus. These findings may encourage the use of ARwP-M *Ae. albopictus* as a highly efficient and safe biocide to suppress the wild-type populations.

Introduction

Despite control measures applied worldwide over decades, arthropod-borne diseases continue to pose a constant threat to human and domestic animal health [1]. Human-induced changes in the environment, climate change, passive transportation and acquisition of resistance to insecticides by the vectors are contributing to a dramatic re-emergence of harmful viruses such as dengue (DENV) and yellow fever (YFV) (both *Flavivirus*, *Flaviviridae*) transmitted by mosquitoes [2,3,4]. As well, further pathogens are rapidly spreading in areas where suitable vectors and environmental conditions are present and are showing a day by day increasing status of pathogenic relevance. These are the cases of chikungunya (CHIKV; *Alphavirus*, *Togaviridae*) and Zika (ZIKV; *Flavivirus*, *Flaviviridae*) viruses [5,6,7].

Aedes spp. (Diptera: Culicidae) are considered the key vectors of DENV, YFV, CHIKV and ZIKV [8,9]. At present, *Ae. aegypti* seems to play a leading role as vector among all of the *Aedes* species, mainly due to its high anthropophily and preference for the urban areas of the tropical regions [10]. However, though generally considered a secondary vector when *Ae. aegypti* is present, *Ae. albopictus*, the Asian tiger mosquito, demonstrated a key epidemiological role when abundant [11,12]. Moreover, the species may be responsible of increased risks of epidemics in temperate climate areas [13], as demonstrated by the DENV [14,15] and CHIKV [16] outbreaks occurred in Europe in recent years. In fact, even if less adapted to survive in dry conditions compared to *Ae. aegypti*, *Ae. albopictus* eggs display a remarkable cold hardiness in the diapausing form [17] which is highly contributing to the impressive extension of the geographic distribution of the species [18]. In addition, a recent mutation in an envelope glycoprotein led to a significant increase in CHIKV infectivity for *Ae. albopictus* and enhanced dissemination in mosquito organs and transmission [19,20]. *Ae. albopictus* was also found susceptible to ZIKV [21,22,23] even if vector competence can be considered low [24]. At the time of writing, CHIKV outbreaks occurred in Lazio (Rome Province) and Calabria regions [25] are still recent, with nearly 300 confirmed cases [26], endorsing the urgency of renewed control approaches.

Besides insecticide spraying, various alternative mosquito control methods are being developed and experimented [27,28,29]. In particular, theoretical and experimental studies are showing that certain strategies targeting mosquito reproduction biology have the potential to significantly affect mosquito populations, leading to a diminished risk that they may support diseases [30,31]. Basically, these methods rely on the release of functionally sterile males produced by three main techniques, namely, the irradiation of pupae by γ - or x-rays [32,33], the introduction of lethal factors through genetic modification [34,35] and the manipulation of the insect microbiome by the transinfection of the symbiotic bacterium *Wolbachia* (Rickettsiales) [36]. A further control strategy once again involves *Wolbachia* and it is not based on the suppression of the vector population but instead on the gradual replacement of the wild-types with conspecifics displaying desired biological traits [37] as more thoroughly described below.

Wolbachia is a vertically transmitted endosymbiotic bacterium, quite common in arthropods and a few other invertebrate taxa [38], which mainly infects the germ line of both sexes and manipulates host reproduction promoting the spread of the infected individuals in uninfected populations [39]. Among the various *Wolbachia*-induced effects on host biology, Cytoplasmic Incompatibility (CI) occurs at early stages of embryonic development and characterizes unfertile crosses between individuals with different *Wolbachia* infection types [40]. Introducing artificially a CI-inducing strain of *Wolbachia* in a vector species may provide a tool to produce functionally sterile males to be used to compromise the fertility of wild-type females not infected by the above *Wolbachia* strain.

Wolbachia-based strategies for vector control started to encounter a significant record of success in recent years. This is mainly due to the property shown by certain *Wolbachia* strains to reduce the vector competence of newly infected mosquito species [41,42,43,44]. This principle has been applied with *Ae. aegypti*, which is not infected by *Wolbachia* in the wild, through the artificial introduction of a *Wolbachia* strain (*wMel*) caught from *Drosophila melanogaster* (Diptera: Drosophilidae) [43]. This manipulation proved to suppress the DENV replication in the infected individuals and is responsible for a 70% reduction of the vector competence of this *Ae. aegypti* line [45]. A specific ongoing program aims at fighting dengue through the replacement of the wild-type *Ae. aegypti* population with this manipulated line [46]. The replacement is made feasible by the CI phenomenon which favors the *Wolbachia* infected over the uninfected *Ae. aegypti*. The *wMel* infected *Ae. aegypti* also displayed reduced vector competence for ZIKV [47] and CHIKV [48].

Ae. albopictus is a competent vector for the above mentioned viruses despite being naturally infected with two *Wolbachia* strains (*wAlbA* and *wAlbB*). However, the introduction of the *wMel* *Wolbachia* strain in a *Wolbachia*-cured line of *Aedes albopictus* induced resistance to DENV and CHIKV [49,50].

wMel *Wolbachia* had been previously introduced in wild-type *Ae. albopictus*, obtaining a triple infection which showed detrimental effects on female fitness leading to the early loss of the transinfected line [51]. Shortly after, ARwP *Ae. albopictus* was produced through the introduction of *wPip* *Wolbachia* belonging to the IV Incompatibility group [52] from *Culex pipiens* in a *Wolbachia*-cured population from Central Italy [53]. The obtained line showed a bidirectional incompatibility pattern with wild-type *Ae. albopictus* and was found highly efficient in suppressing this vector under laboratory [54,55] and semi-field settings [56]. Remarkably, compared to wild-type individuals belonging to the same genetic background, ARwP males displayed a significantly better male mating competitiveness under semi-field conditions in large enclosures [56]. Differently from *wMel*, *wPip* *Wolbachia* was proved to not significantly reduce *Ae. albopictus* capability to transmit CHIKV compared to wild-type females (Calvitti and Failloux, previously unpublished data, 2011; S1 Fig).

Herein, we report on the transinfection of *wMel Wolbachia* in ARwP to combine the remarkable suitability to the mass rearing protocols and male mating competitiveness, shown by this *Ae. albopictus* line over more than 100 generations, with a reduction in the vector competence, as expected by the introduction of *wMel Wolbachia*. This research aims to obtain an innovative and safe tool to suppress and/or replace *Ae. albopictus* wild-type populations based on considerations and conditions discussed below.

Materials and methods

Mosquito lines and rearing

Mosquito lines used in the experiments shared the same genetic background. S_{ANG} is a wild-type strain of *Ae. albopictus* colonized by using ovitraps in Anguillara Sabazia (Rome) in 2006 and since then reared under laboratory conditions at ENEA-Casaccia Research-Center (Rome). ARwP is a CI-inducing line, established at ENEA in 2008 through the transinfection of *Wolbachia*-cured S_{ANG} individuals with *wPip Wolbachia* from *Culex pipiens* [53] and reared for about 100 generations under rearing settings described below. Both the lines described above were periodically outcrossed with wild-type individuals from the same area to preserve the genetic variability according to methods reported previously [55]. Specifically, virgin ARwP and S_{ANG} females were crossed every five generations with the same number of two weeks old males obtained from Anguillara wild-caught females. ARwP-M has been obtained through the transinfection of ARwP with *wMel Wolbachia* from *D. melanogaster* as reported in a further paragraph.

Larvae were brought to adulthood inside 0.5 litre larval trays at the density of 1 larva/1 ml, augmented with a powder obtained by crushing dry cat food (Friskies Adults) at a fixed dose of 4 mg/larva of which 10% was given on day 1, 45% on day 2 and 45% on day 5. Adult mosquitoes were kept inside 40x40x40 cm cages at T = 28±1 C°, RH = 70±10%, L:D = 14:10 hours and were supplied with water and sucrose. Blood meals were provided through the use of anesthetized mice in agreement with the Bioethics Committee for Animal Experimentation in Biomedical Research and following procedures approved by the ENEA Bioethical Committee according to the EU directive 2010/63/EU. Used mice belonged to a colony housed at CR ENEA Casaccia and maintained for experimentation based on the authorization N. 80/2017-PR released on February the 2nd 2017 by Italian Ministry of Health.

wMel Wolbachia transinfection in ARwP *Aedes albopictus* and vertical transmission

ARwP *Ae. albopictus* embryos were transinfected according to techniques already used for mosquito transinfection [53,57,58]. *D. melanogaster* belonging to the *yw^{67C23}* genotype [59] was kindly furnished by Luis Teixeira (Instituto Gulbenkian de Ciência, Oeiras, Portugal) to be used as *wMel Wolbachia* donor. Cytoplasm was withdrawn from the posterior pole of donor eggs by borosilicate needles (Sutter Instrument; Novato, CA, USA) and then injected into the posterior of the recipient embryos using MN-151/MMO-202ND micromanipulators and an IM300 microinjector (Narishige Scientific; Tokyo, Japan).

After 5 days of development, the eggs were hatched by using a nutrient broth medium [60] and larvae were reared to the adult stage. G₀ females, isolated as pupae to assure virginity, were mated with ARwP males and then provided with a blood meal. After oviposition, the infection status of G₀ females and males was ascertained by PCR analysis using the *wMel-wsp* loci primers [61]. In the case of a positive result, the obtained amplicons were sequenced to confirm the *Wolbachia* infection type. The progeny produced by infected females were selected to establish

a new transinfected *Ae. albopictus* line, ARwP-M. To reduce the inbreeding effects, ARwP-M females were outcrossed with ARwP males for five generations. During the ARwP line establishment, the first 6 generations were monitored for transmission efficiency of *Wolbachia* infection. All the G₁ adults were PCR assayed for presence of wPip *Wolbachia* and infected offspring were chosen to start a new generation. Starting from G₂, the maternal inheritance rate was estimated by assaying 5 daughters and 5 sons for each of three isolated females (mothers), randomly chosen.

Fitness parameters

Adult survival, female fecundity and egg fertility of the ARwP-M line were measured in comparison with S_{ANG} and ARwP *Ae. albopictus*. Namely, each treatment consisted of 50:50 females:males in 40x40x40 cages furnished with 10% sugar solution and under climatic conditions reported above. Dead mosquitoes were counted and removed every four days to assess longevity until the test was stopped at 60 days.

At 1-week intervals and starting with 3±1 days-old females, a blood meal was provided and mosquito eggs were collected on wet germination paper until 7th day after feeding. The eggs produced by the 3±1 days old females were counted and then hatched to measure female fecundity and mean egg fertility in the three lines. Each treatment was replicated three times.

Cytoplasmic incompatibility and male mating competitiveness

Three different series of crossing experiments were set up to evaluate the CI pattern between ARwP-M and S_{ANG} and to measure the male mating competitiveness of the ARwP-M males in comparison with the S_{ANG} males in 100x50x50 cm cages. For this purpose, respectively, 2±1 and 3±1 days-old females and males were used: i) 20:20 S_{ANG} males:females were allowed to mate in control crosses; ii) CI crosses consisted of populations of 20:20 ARwP-M males:S_{ANG} females; iii) populations of 20:20 S_{ANG} males:ARwP-M females were used to measure CI in the reciprocal cross; iv) competition crosses involved 20:20:20 ARwP males:S_{ANG} males:S_{ANG} females respectively. After 24 h, males were retrieved and females were provided with a blood meal. On the day of oviposition, females were isolated into plastic tubes furnished with wet paper for individualized egg laying. Produced eggs were counted and then allowed to hatch to measure CI. In the case of no hatching egg, females were checked for the presence of spermatozoa to ascertain the occurrence of a mating and virgins were excluded from the counts. CI crosses (ii and iii) were also repeated with males aged 10±1 and 17±1 days to investigate age-dependant changes in the incompatibility level. The degree of CI was computed using the corrected index of cytoplasmic incompatibility (CI_{corr}) and the Fried competitiveness index, as described previously [55].

DNA purification and quantitative qPCR to evaluate wMel and wPip *Wolbachia* density

Ten male and ten female individuals belonging to the ARwP-M line were aged 5–10 days and then analyzed for wPip and wMel *Wolbachia* titer in comparison with the ARwP line.

Total DNA was extracted from whole body of individual mosquitoes, using the ZR Tissue & Insect DNA Kit MicroPrep (Zymo Research, Irvine, CA, USA), according to manufacturer instructions. Strain-specific primers were used to amplify the wPip-*wsp* and wMel-*wsp* loci (Zhou et al., 1998), using previously described oligonucleotides: wPF (CGACGTTAGTGGTGCAACATTTA) and wPR (AATAACGAGCACCAGCAAAGAGT) [54] to obtain a 272 bp fragment of the wPip-*wsp* gene; 308F (TTA AAG ATG TAA CAT TTG) [61] and QAreV2 (CAC CAG CTT TTA CTT GAC C) [62] leading to a 219 bp fragment of the wMel-*wsp* gene.

Aedes albopictus actin gene was used as a nuclear reference and amplified with the primers pair actAlbqPCRsense (CCCACACAGTCCCCATCTAC) and actAlbqPCRantisense (CGAGTAGCCAGTTCAGTCA), leading to a 119 bp amplification product.

Amplification reaction was prepared using the FluoCycle II SYBR Master Mix (Euroclone, Milano, Italy) in 20 µl final volume. Each mosquito extract was analyzed in triplicate using 2 µl total DNA extract as a reaction template. PCR was performed on ABI Prism 7100 (Applied Biosystems, Foster City, CA, USA) thermal cycler, optimizing the elongation temperature for each primer pair. Hence, the following amplification programs were applied: 5 min at 95°C, followed by 40 cycles of 15 sec at 95°C and 1 min at 60°C/52°C/62°C, for primer pair wPF-wPR/308F-QArev2/ actAlbqPCRsense-actAlbqPCRantisense, respectively. The presence of specific amplification products was verified with dissociation curves.

A plasmid (named pBS-M-P-act) containing single copy of wPip-wsp, wMel-wsp and actin was constructed to obtain a quantitative reference in qPCR amplifications. To this aim, specific DNA sequences encoding for wPip-wsp, wMel-wsp and actin, were cloned from total DNA extracts. The actin fragment (119 bp) was obtained by PCR using field-caught *Ae. albopictus* total DNA as a template and the primers pair actAlbqPCRsense/actAlbqPCRantisense. A 404 bp fragment of wPip-wsp locus was amplified using field-caught *Culex pipiens* total DNA extract as a template and the primers pair 183F/wPF [54,61], while a 405 bp fragment of wMel-wsp locus was amplified using *D. melanogaster* total DNA extract and primers pair 308F/691R [61]. All amplicons were then cloned in pCR 2.1 (TA Cloning Kit, Invitrogen, Carlsbad, CA) plasmid vector.

The amplified sequences were then assembled in a single plasmid, according to the following procedure. Actin gene fragment was transferred from pCR 2.1 into BamHI-NotI sites of pBluescript II SK (+) vector, resulting in pBS-act plasmid. Then, wPip-wsp fragment was cloned from pCR 2.1 into NotI-SacI sites of pBS-act, obtaining pBS-P-act plasmid. Finally, wMel-wsp fragment was cloned from pCR 2.1 into KpnI-XhoI sites of pBS-P-act, resulting in pBS-M-P-act plasmid. All obtained constructs were sequenced to assess the correct assembling and the absence of unwanted sequence variations.

For qPCR quantitation the pBS-M-P-act plasmid was serially diluted to build a standard curve with all three loci present at an equimolar concentration. The same standard dilutions were used in each qPCR, in order to standardize the signal with the nuclear actin reference. Quantitative PCR amplification was performed in triplicate for each mosquito extract and mean genome number of wPip-wsp and wMel-wsp was obtained per nuclear actin copy number.

Accession numbers for the genes mentioned in the paragraph are reported in S1 Table.

Vector competence tests for chikungunya, dengue and zika viruses

ARwP-M vector competence for CHIKV, DENV and ZIKV viruses was evaluated in comparison with ARwP *Ae. albopictus* to ascertain whether the introduction of the wMel *Wolbachia* infection may affect this biological trait.

Viruses. CHIKV (CHIKV 06.21; accession number AM258992) was isolated in 2005 from a newborn male from La Reunion presenting meningo-encephalitis symptoms [63]. This strain belongs to the East-Central-South African (ECSA) lineage known to be better adapted to *Ae. albopictus* due to the E1-A226V mutation [19,20] and this genotype was involved in the 2007 outbreak in Emilia-Romagna Region (Italy) [64]. We assumed that the widespread of this CHIKV strain was a valid argument to chose it over others as more suitable to be involved in severe epidemics. DENV (DENV-1 1806; accession number EU482591) was obtained in 2010 from an autochthonous case in Nice, France [14]. ZIKV (ZIKV PE243; accession number

KX197192) was isolated from a patient in Recife (Brazil) in 2015 [65]. Viral stocks were prepared after several passages of the isolate onto *Ae. albopictus* C6/36 cells for CHIKV and DENV, and Vero cells for ZIKV.

Experimental infections and viral titrations. One-week-old mosquitoes were isolated in boxes (60 females/box) and starved for 24 h before infection. The blood meal was composed of two parts of washed rabbit erythrocytes, one part of the viral suspension and a phagostimulant (ATP) at 5 mM. The infectious blood-meal at a viral titer of 10^7 FFU/mL for CHIKV and DENV-1 and, 10^7 PFU/mL for ZIKV was placed in capsules (Hemotek, Lancashire, UK) wrapped with a piece of pork intestine maintained at 37°C. After 15–20 min of feeding, engorged females were sorted on ice and incubated at 28°C, 80% RH and 16h:8h L:D cycle, with free access to 10% sucrose. Batches of 20–24 mosquitoes were examined at 7 and 14 days post-infection (dpi) for CHIKV, and 14 and 21 dpi for DENV-1 and ZIKV. Mosquitoes were processed as follows: abdomen and thorax (referred to as body) were examined to determine infection, head for dissemination and saliva for transmission. Infection rate (IR) corresponds to the proportion of mosquitoes with infected midgut, dissemination efficiency (DE) to the percentage of mosquitoes with virus detected in heads suggesting a successful viral dissemination from the midgut, and transmission efficiency (TE) to the proportion of mosquitoes with infectious saliva. IR, DE and TE were calculated by titrating body, head homogenates, and saliva, respectively.

To determine viral infection and dissemination rates, each mosquito body and head were ground in 300 µL of medium (Leibovitz L15 medium for CHIKV and DENV, and Dulbecco's Modified Eagle medium (DMEM) for ZIKV) supplemented with 2% fetal bovine serum (FBS), centrifuged at $10,000 \times g$ for 5 min at +4°C and inoculated onto monolayers of *Ae. albopictus* C6/36 cell culture (for CHIKV and DENV) or Vero cells (for ZIKV) in 96-well plates. Vero cells were incubated for 7 days at 37°C then stained with a solution of crystal violet (0.2% in 10% formaldehyde and 20% ethanol). Presence of viral particles was assessed by detection of CPE. C6/36 cells were incubated for 3 days (CHIKV) or 5 days (DENV) at 28°C and then were fixed with 10% formaldehyde, washed, and revealed using hyper-immune ascetic fluid as the primary antibody and Alexa Fluor 488 goat anti-mouse IgG as the second antibody (Life Technologies).

To estimate viral transmission, mosquito saliva was collected in individual pipette tips containing 5 µL FBS for 30 min as previously described [66]. FBS containing mosquito saliva was expelled into 45 µL of L15 medium, inoculated on C6/36 cell culture or Vero cells stained as described above.

Cell cultures. C6/36 (*Ae. albopictus*) cells used for CHIKV and DENV titrations were maintained at 28°C in L-15 medium supplemented with non-essential amino-acids (1X), 10% fetal bovine serum (FBS), 100 units/mL penicillin and 100 µg/mL streptomycin. Vero (green monkey kidney, ATCC CCL-81) cells used for ZIKV titrations were maintained at 37°C, 5% CO₂ in DMEM with 10% FBS, 100 units/mL penicillin and 100 µg/mL streptomycin.

Data analysis

Survival curves of the three different lines (ARwP, S_{ANG}, and ARwP-M) were compared using Kaplan-Meier method and log-rank (Mantel-Cox) test. One-way repeated-measures ANOVA and Bonferroni mean separation were used to compare fecundity and egg hatch data between lines. Percent data was transformed to arcsin square root of proportions before the analysis. Normality of the experimental data was determined by the Shapiro-Wilk test. ANOVA was also used to compare the mean level of observed and expected CI in the male competitiveness trials.

Difference between lines in infection rate (IR) dissemination efficiency (DE) and transmission efficiency (TE) were analyzed by the Fisher's exact test while Kruskal-Wallis test was used to compare the mean number of viral particles detected in bodies and saliva.

Statistical analysis was performed by PASW statistics (PASW Statistics for Windows, Version 18.0. SPSS Inc., Chicago, USA).

Results

Transinfection results and vertical transmission

More than 900 *Ae. albopictus* embryos were microinjected in total and 12 eggs were viable after the treatment and gave first instar larvae. Among obtained larvae, 8 emerged as adults, 4 of which were found infected with *wMel Wolbachia*. Two infected females were used to establish transinfected isofemale lines and one out of them transmitted the *wMel* infection to the progeny. All of the tested G₁ individuals were confirmed as positive for *wMel Wolbachia* and vertical transmission accuracy always approached 100% over the following generations with few exceptions only among male progeny (98.89±1.01% in mean) (Table 1). The obtained line was named ARwP-M. The confirmation of the transinfected *Wolbachia* strain was achieved by sequencing the *wsp* gene [61] to perform a comparison with published *wMel wsp* sequence (Accession Number: AF020064.1; S2 Fig).

Fitness parameters

Regardless of the sex, survival did not show to significantly differ between S_{ANG}, ARwP and ARwP-M *Ae. albopictus* (Fig 1). The average female life span was slightly higher than 38 days in all of the three *Ae. albopictus* lines under these experimental conditions (P = 0.984, log rank test). Average life expectancy for males was reduced to about 30 days in all of the tested lines (P = 0.984, log rank test).

At ARwP-M G₈, mean female fecundity did not significantly differ between tested *Ae. albopictus* lines (F_(2,6) = 0.005; P = 0.995; Fig 2). As well, the *wMel* infection did not significantly affect ARwP-M fertility compared to both S_{ANG} and ARwP lines (F_(2,6) = 1.395; P = 0.318).

CI and male mating competitiveness

Regardless of age, ARwP-M males compromised the hatchability of all of the eggs produced by the wild-type females they mated with (Table 2). Instead, the reverse crosses (S_{ANG} males × ARwP-M females) gave age-dependant results with egg fertility values gradually increasing from 0.09 ± 0.05 to 17.29 ± 2.32 when S_{ANG} males were, respectively, 3 and 17 days (±1) old. ARwP-M males demonstrated higher mating competitiveness compared to the wild-types presenting the same genetic background as shown by the measured level of CI_{corr} and by the Fried competitiveness index (Table 2) which was significantly higher than 1 (F_(1,4) = 11.24; P = 0.028).

Table 1. Maternal inheritance efficiency of the *wMel* infection in the ARwP-M *Ae. albopictus* line. The data sheet shows the number (N) of analyzed and the percentage of infected male and female individuals at each generation following the *wMel* transinfection.

		G ₁	G ₂	G ₃	G ₄	G ₅	G ₆	mean	SE
males	N	4	15	15	15	15	15		
	% infected	100	100	93.33	100	100	100	98.89	1.01
females	N	5	15	15	15	15	15		
	% infected	100	100	100	100	100	100	100	0

<https://doi.org/10.1371/journal.pntd.0006626.t001>

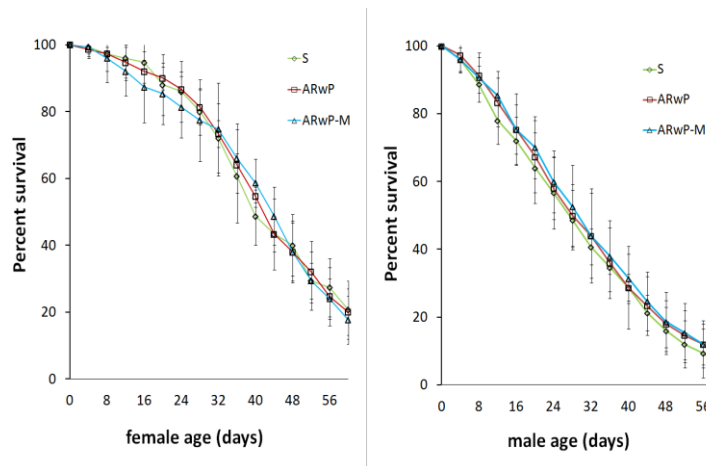

Fig 1. Survival of ARwP-M females (left) and males (right) in comparison with recipient ARwP and wild-type *Ae. albopictus*. S = *S*_{ANG} wild-type *Ae. albopictus*; ARwP = wPip infected *Ae. albopictus*; ARwP-M wPip + wMel infected *Ae. albopictus*. Error bars show the SEM of three biological replicates, each containing 50:50 females:males. In both cases, survival curves did not show to significantly differ by Kaplan-Meier method and log-rank (Mantel-Cox) test.

<https://doi.org/10.1371/journal.pntd.0006626.g001>

Wolbachia density in ARwP-M

Adding wMel *Wolbachia* to the ARwP line (wPip-only infected) led to a significant increase in the overall *Wolbachia* titer ($F_{(1,18)} = 51.346$; $P < 0.005$) which, specifically, was about 15 fold higher in the ARwP-M compared to the ARwP females (Fig 3). The increase in *Wolbachia*

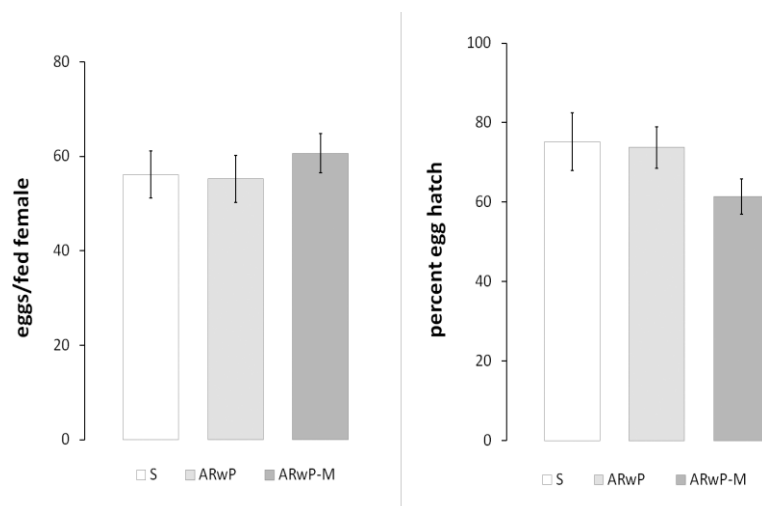

Fig 2. Female fecundity (left) and hatch rate (right) in ARwP-M *Ae. albopictus* in comparison with recipient ARwP and wild-type *Ae. albopictus*. S = *S*_{ANG} wild-type *Ae. albopictus*; ARwP = wPip infected *Ae. albopictus*; ARwP-M wPip + wMel infected *Ae. albopictus*. Error bars show the SEM of three biological replicates, each containing 17–20 fed females. In both cases, values are not significantly different by ANOVA-Bonferroni ($P > 0.05$).

<https://doi.org/10.1371/journal.pntd.0006626.g002>

Table 2. Crosses between ARwP-M and wild-type *Ae. albopictus* (*S_{ANG}*) to measure the level of induced cytoplasmic incompatibility and compare the male mating competitiveness. In all of the crosses, females were 2±1 days old. The *CI_{corr}* level in the CI crosses was measured at three different male ages. Competition crosses consisted of young (3 ±1 days old) ARwP-M and *S_{ANG}* males at 1:1 ratio.

crosses		N	percent egg hatch	<i>CI_{corr}</i>	Fried index
females	males (*)				
<i>S_{ANG}</i>	<i>S_{ANG}</i> (3)	2076	72.19 ± 3.12	0	
<i>S_{ANG}</i>	ARwP-M (3)	2152	0.00 ± 0.00	100	
<i>S_{ANG}</i>	ARwP-M (10)	2010	0.00 ± 0.00	100	
<i>S_{ANG}</i>	ARwP-M (17)	1962	0.00 ± 0.00	100	
ARwP-M	<i>S_{ANG}</i> (3)	2175	0.09 ± 0.05	99.87 ± 0.07	
ARwP-M	<i>S_{ANG}</i> (10)	1982	12.84 ± 1.50	82.22 ± 2.08	
ARwP-M	<i>S_{ANG}</i> (17)	1985	17.29 ± 2.32	76.06 ± 3.21	
<i>S_{ANG}</i>	1:1 <i>S_{ANG}</i> :ARwP-M	2253	26.32 ± 2.25	62.07 ± 3.60	1.71 ± 0.24**

*in brackets, male ages (days±1) are specified

N = total number of screened eggs; mean percent egg hatch and SE represent three biological replicates; *CI_{corr}* calculation derives from the equation: $CI_{corr}(\%) = [(CI_{obs} - CCM)/(100 - CCM)] \times 100$, where CCM represents the natural egg mortality in *S_{ANG}* control; the Fried index of male competitiveness is obtained from the equation: $(N/S)[(H_n - H_o)/(H_o - H_c)]$ where N/S stands for the ratio between the males belonging to the two lines (in this case 1), *H_n* the egg hatch in compatible crosses, *H_o* the egg hatch in competition trials and *H_c* the egg hatch in the CI crosses.

**The Fried index of competitiveness is significantly higher than that expected for an equal competitiveness between *S_{ANG}* and ARwP-M males ($P < 0.05$, ANOVA).

<https://doi.org/10.1371/journal.pntd.0006626.t002>

density in ARwP-M males was less evident but significant as well ($F_{(1,18)} = 12.673$; $P < 0.005$). The titer of wPip *Wolbachia* seemed to be not affected by the introduction of the additional *Wolbachia* strain (females: $F_{(1,18)} = 0.133$; $P = 0.720$; males: $F_{(1,18)} = 0.136$; $P = 0.716$).

Vector competence

We experimentally infected mosquitoes with the three viruses, CHIKV, DENV and ZIKV provided to mosquitoes at a titer of 10^7 FFU(PFU)/mL.

When analyzing mosquitoes infected with CHIKV, significant differences were detected between the two *Ae. albopictus* lines at each dpi (7, 14) and parameters examined (IR, DE, TE)

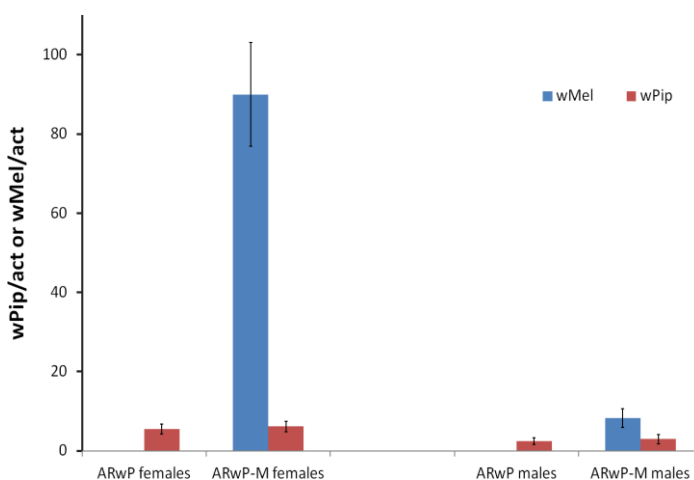

Fig 3. *wMel* and *wPip* *Wolbachia* density in ARwP and ARwP-M females and males measured by using *Ae. albopictus* actin gene as reference.

<https://doi.org/10.1371/journal.pntd.0006626.g003>

(Fig 4A). The ARwP line showed higher rates of infection, dissemination and transmission suggesting that ARwP was more susceptible to CHIKV than ARwP-M (Fisher exact test: $P < 0.05$). Previous results had shown that the vector competence for CHIKV was not significantly different comparing ARwP to S_{ANG} *Ae. albopictus* (Calvitti and Failloux, previously unpublished data, 2011; S1 Fig). Thus we can reasonably conclude that adding *wMel* to ARwP led to a reduced vector competence for CHIKV also compared to the wild-types. In fact, about 5 and 0% of the infected ARwP-M females were able to transmit the virus, respectively, at 14 and 21 dpi.

When examining mosquitoes infected with DENV-1, only IR and DE at 14 dpi were significantly different between the two mosquito lines (Fig 4B). Again, ARwP was better infected and better disseminated by DENV-1 at 14 dpi compared to ARwP-M (Fisher exact test: $P < 0.05$).

When comparing mosquitoes infected with ZIKV, no significant differences were detected between the two *Ae. albopictus* lines (Fig 4C) with very low rates at 14 and 21 dpi.

When examining the number of viral particles detected in bodies and saliva (Fig 5A–5C), no significant differences were found between ARwP and ARwP-M (Kruskal–Wallis test: $P > 0.05$). Regarding CHIKV, very low values of viral particles were found in ARwP-M saliva at 14 dpi and this value decreased to 0 at 21 dpi. Regarding DENV and ZIKV, viral particles were undetectable in the saliva of ARwP-M females at both dpi.

Discussion

The *Wolbachia*-based Incompatible Insect Technique (IIT) may offer a highly efficient approach to suppress mosquito vector populations because it can combine high efficacy with sustainable costs and negligible side-effects [67,68,69]. The efficiency of the approach has started to be demonstrated in the field with *Ae. albopictus* [70]. In this context, the introduction of different *Wolbachia* strains in a species may provide new resources among which to select the most suitable phenotypic effects for mosquito control purposes [71,72,73]. By introducing *wMel* *Wolbachia* in ARwP, we hoped to retain certain useful traits characterizing the line while adding further beneficial biological features to increase its potential as a control tool of *Ae. albopictus*-borne diseases. Based on the obtained results, these expectations were fulfilled.

As already reported for a *wMel*-only infected *Ae. albopictus* [49], the *wMel* infection was not found to affect *Ae. albopictus* fitness even in the case of coexistence with *wPip* *Wolbachia*. In addition, the CI trials demonstrated that ARwP-M maintained the notable male mating competitiveness already reported for ARwP in large enclosures under field conditions [56]. This advantage over the wild-types seemed to increase when moving from small cages to larger environments thus, we previously hypothesized that it could be due to ARwP male size [56,74]. However, this idea should be confirmed by more specific tests with regard to both ARwP and ARwP-M because changing environment could significantly affect the outcome of the trials. In any case, it is clear that releasing males with higher mating competitiveness compared to the wild-types may lead to induced infertility levels not reachable when using the same amount of irradiated males or males carrying dominant lethal mutations. This is because, using irradiation to obtain fully infertile *Ae. albopictus* males means reducing their mating competitiveness and survivorship, while preserving these latter traits by lowering the irradiation doses leads to a residual fertility which was found to increase with age [75]. Similarly, RIDL *Ae. aegypti* males showed reduced survivorship and mating competitiveness compared to the wild-types [76]. Furthermore, ARwP and, as confirmed herein, ARwP-M can be easily outcrossed, thanks to the partial fertility between the old wild-type males and the females belonging to these *Ae. albopictus* lines [77], allowing the preservation of the genetic variability

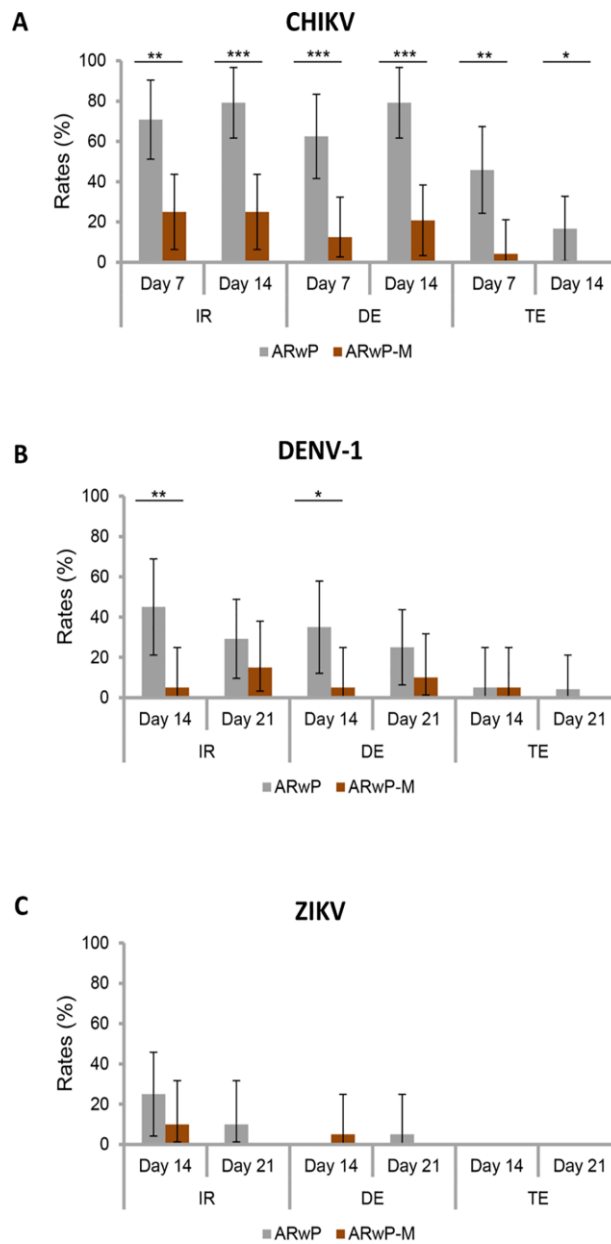

Fig 4. Rates of infection, dissemination efficiency and transmission efficiency for CHIKV, DENV and ZIKV in ARwP and ARwP-M *Ae. Albopictus*. IR = Infection rate; DE = Dissemination rate; TE = transmission rate; A: the differences between *Ae. albopictus* lines are significant with respect to all of the three parameters and at both time intervals (7, 14 dpi) post the infection (Fisher exact test, $P < 0.05$); B: ARwP and ARwP-M significantly differed with regard to IR and DE at 14 dpi (Fisher exact test, $P < 0.05$); C: ARwP and ARwP-M did not significantly differ with regard to any of the evaluated parameters.

<https://doi.org/10.1371/journal.pntd.0006626.g004>

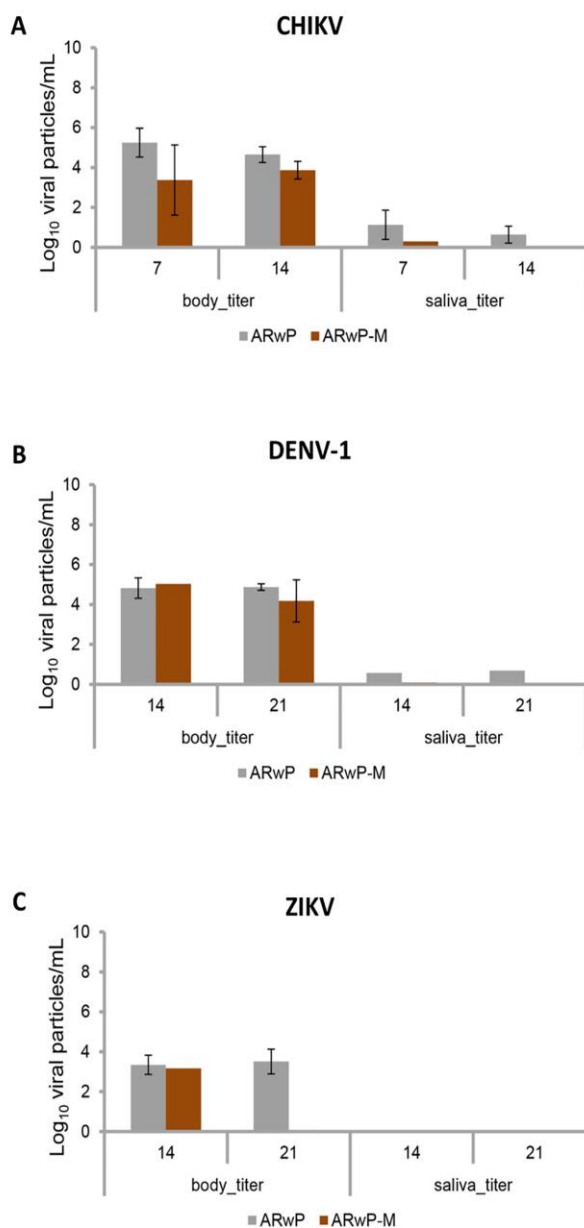

Fig 5. Titration of the viral particles of CHIKV, DENV and ZIKV in body and saliva of ARwP and ARwP-M *Ae. Albopictus*. The number of viral particles in the body and saliva of both mosquito lines were titrated for evaluating the viral load in each mosquito line. A: the number of CHIKV viral particles in the body and saliva of ARwP and ARwP-M at 7 and 14 dpi; B and C: the number of DENV-1 (B) and ZIKV (C) viral particles in the body and saliva of ARwP and ARwP-M at 14 and 21 dpi. Differences between *Ae. albopictus* lines were not statistically significant (Kruskal-Wallis test: $P > 0.05$).

<https://doi.org/10.1371/journal.pntd.0006626.g005>

and the transfer of the *wPip* *Wolbachia* infection into local *Ae. albopictus* genotypes by introgression. This possibility may consent ARwP/ARwP-M to be adapted to local environmental conditions and to acquire useful mutations from the wild-types of the target areas such as the ones responsible for the insecticide-resistance [29].

Compared to SIT, exploiting *Wolbachia* to produce functionally sterile males could also save costs (radiation sources would be not needed) and reduce logistic problems (it would not be necessary to manipulate and transport mosquito pupae as needed by the sterilization procedure).

Aside from these obvious advantages attributable to IIT, the opportunity to set up application protocols based on male-only releases or not is highly debated [77,78,79]. In fact, since 100% efficient sexing methods are not yet available for *Aedes* mosquitoes, applying the IIT would mean releasing in the wild fertile females harboring a new *Wolbachia* infection type. Due to bidirectional CI and immigration, small ARwP/ARwP-M populations are not expected to establish and invade much larger wild-type *Ae. albopictus* populations as the eventual replacement would not be self-sustaining [56,77,79]. However, it is certain that it would be preferable to avoid releasing vector females in areas subjected to epidemics.

As expected, the introduction of *wMel* in ARwP *Ae. albopictus* had a profound impact on the vector competence of this line. *wAlbA* and *wAlbB* *Wolbachia* were proved to not interfere with the transmission of CHIKV [80]. Also, we demonstrated previously (S1 Fig) that *wPip* *Wolbachia* was not capable of blocking this virus. Instead, when introducing *wMel* in ARwP *Ae. albopictus*, a blockade of CHIKV was detected lowering the potential of this mosquito to transmit the virus. This phenotype was shared with *Wolbachia*-cured *Ae. albopictus* transfected with *wMel* [49].

Mounting experimental evidence suggests that the low vector competence of wild-type *Ae. albopictus* for DENV is correlated with the presence of the natural of *wAlbA* and *wAlbB* *Wolbachia* strains [81,82]. While removing these strains canceled the inhibition exerted by *Wolbachia* on DENV [82], we demonstrated that adding *wMel* to *wPip* imposed a higher reduction of DENV-1 transmission by ARwP-M *Ae. albopictus* compared to ARwP. An even higher level of refractoriness to DENV transmission was previously obtained in a *wMel*-only infected *Ae. albopictus* [50], possibly due to a higher *wMel* *Wolbachia* titer compared to ARwP-M. However, the *Wolbachia* density data reported in the latter article is only expressed as a ratio compared to the wild-types thus, a direct comparison with the results reported herein is not feasible.

Lastly, the effect of exogenous *Wolbachia* strains in *Ae. albopictus* susceptibility to ZIKV is difficult to apprehend as the basic level of *Ae. albopictus* competence for ZIKV is already very low compared to CHIKV and DENV [83,84,85]. Our results confirmed the above results also in the *Ae. albopictus* lines infected with *wPip* alone or with *wPip* and *wMel* *Wolbachia*. However, the inhibition of ZIKV transmission seems to be significantly enhanced in both ARwP and ARwP-M *Ae. albopictus* compared to the wild-type *Ae. albopictus* from the same geographic area [83]. In fact, the above authors reported on ZIKV transmission rates of 29% in *Ae. albopictus* from Rome while, in this work, none of the tested ARwP-M females was capable of transmitting the virus.

Making available an *Ae. albopictus* line which couples high male mating competitiveness and suitability to the mass rearing protocols to a reduced vectorial competence would diminish the concerns associated with the possible escape of females among the released males in IIT programs. However, a series of issues will certainly need to be addressed before moving with ARwP-M to field testing. Further studies will have to evaluate ARwP-M vector competence in comparison with local wild-type populations and also testing other DENV and CHIKV serotypes. Moreover, the long-term stability of the new *Wolbachia* infection will be investigated

because natural selection might gradually lead to reduced symbiont density and the loss of antiviral protection [86]. In particular, the suitability of the line to the stressing mass production protocols will be studied together with its response to the environmental conditions of the open field. In fact, *wMel Wolbachia* is known to be quite susceptible to heat stress as *Ae. aegypti* eggs and larvae maintained at temperatures higher than 30°C showed a dramatic reduction of the *Wolbachia* titer [87,88]. Such temperatures are common at low latitudes as well as during the summer in the Mediterranean basin and they might lead to a reduced pathogen inhibition and to a progressive diminution or even loss of the infection.

Supporting information

S1 Fig. Transmission rate and CHIKV virus titer in saliva at 7 and 14 dpi in ARwP, *S*_{ANG} wild-type and *Wolbachia*-cured *Ae. albopictus*. *wPip* = ARwP *Ae. albopictus*; *wAlbA* & *wAlbB* = *S*_{ANG} wild-type *Ae. albopictus*; *w-* = *Wolbachia*-cured *S*_{ANG}; dpi = days post infection. Mosquitoes were infected with CHIKV at a titer of 10⁷ FFU(PFU)/mL. (A) Transmission rate was not significantly different between *Ae. albopictus* lines both at 7 and 14 dpi (Fisher exact test, *P* < 0.05). (B) Virus titer in female *Ae. albopictus* did not differ between lines at both 7 and 14 dpi (Kruskal–Wallis test: *P* < 0.05).

(PDF)

S2 Fig. Sequence of the *wsp* locus of *wMel Wolbachia* present in ARwP-M *Ae. albopictus*.

The *wsp* gene was initially amplified by PCR, using *wsp* generic primers 81F and 691R [61]. The obtained amplicon (ARwP Mel-amplicon) was then sequenced using the 308F and QAreV2 primers specific for *wMel*. The grey box indicates the regions of sequence homology. *wsp* sequence of *wPip Wolbachia* (*wsp wPip* AF301010) was also reported to highlight sequence differences with the *wMel wsp* locus (*wsp wMel* AF020064.1). The perfect alignment of the obtained amplicon with the *wMel wsp* gene demonstrated the presence of *wMel Wolbachia* in the transinfected ARwP-M *Ae. albopictus* line.

(PDF)

S1 Table. Assembling of plasmid pBS-M-P-act was performed by cloning fragments of the sequences of interest using field-caught insects total DNA extracts as PCR templates. The sequence analysis of the cloned sequences revealed a complete homology with the corresponding genes in database.

(PDF)

Acknowledgments

We thank Luis Teixeira (Instituto Gulbenkian de Ciência, Oeiras, Portugal) for gently furnishing the *D. melanogaster* strain used as *wMel Wolbachia* donor during the microinjections. We thank Marta Piscitelli (ENEA-Casaccia Research Centre, Division for Health Protection Technologies) as responsible of the facility for the housing and care of the mice used for blood feeding. We also thank Giuseppe Marzo (ENEA-Casaccia Research Centre, Division for Technologies and Facilities for Nuclear Fission and Nuclear Material Management) for statistical advice and Jason Cardone for his help with language editing.

Author Contributions

Conceptualization: Riccardo Moretti, Maurizio Calvitti.

Data curation: Riccardo Moretti, Pei-Shi Yen, Vincent Houé, Angiola Desiderio.

Formal analysis: Riccardo Moretti, Anna-Bella Failloux.

Funding acquisition: Riccardo Moretti, Maurizio Calvitti.

Investigation: Riccardo Moretti, Pei-Shi Yen, Vincent Houé, Elena Lampazzi, Angiola Desiderio.

Methodology: Riccardo Moretti, Angiola Desiderio, Anna-Bella Failloux.

Supervision: Anna-Bella Failloux, Maurizio Calvitti.

Writing – original draft: Riccardo Moretti.

Writing – review & editing: Riccardo Moretti, Angiola Desiderio, Anna-Bella Failloux, Maurizio Calvitti.

References

1. Marcondes CB, editor. *Arthropod Borne Diseases*. Cham: Springer International Publishing, Switzerland; 2017.
2. Gibbons R V. Dengue conundrums. *Int J Antimicrob Agents*. 2010; 36: S36–S39. <https://doi.org/10.1016/j.ijantimicag.2010.06.019> PMID: 20696556
3. Stanaway JD, Shepard DS, Undurraga EA, Halasa A, Coffeng LE, Brady OJ, et al. The global burden of dengue: an analysis from the global burden of disease study 2013. *Lancet Infect Dis*. 2016; 16: 712–723. [https://doi.org/10.1016/S1473-3099\(16\)00026-8](https://doi.org/10.1016/S1473-3099(16)00026-8) PMID: 26874619
4. Couto-lima D, Madec Y, Bersot MI, Campos SS, Motta DA, Barreto F, et al. Potential risk of re-emergence of urban transmission of Yellow Fever virus in Brazil facilitated by competent *Aedes* populations. *Sci Rep*. 2017; 7: 1–12. <https://doi.org/10.1038/s41598-016-0028-x>
5. Zeller H, Bortel W Van, Sudre B. Chikungunya: its history in Africa and Asia and its spread to new regions in 2013–2014, 2018; 214: 2014–2018. <https://doi.org/10.1093/infdis/jiw391>
6. Shragai T, Tesla B, Murdock C, Harrington LC. Zika and chikungunya: mosquito-borne viruses in a changing world. *Ann N Y Acad Sci*. 2017; 1399: 61–77. <https://doi.org/10.1111/nyas.13306> PMID: 28187236
7. Weaver SC, Costa F, Garcia-blanco MA, Ko AI, Ribeiro GS, Saade G, et al. Zika virus: history, emergence, biology, and prospects for control. *Antiviral Res*. 2016; 130: 69–80. <https://doi.org/10.1016/j.antiviral.2016.03.010> PMID: 26996139
8. Liu Z, Zhou T, Lai Z, Zhang Z, Jia Z, Zhou G, et al. Competence of *Aedes aegypti*, *Ae. albopictus*, and *Culex quinquefasciatus* mosquitoes as Zika virus vectors, China. *Emerg Infect Dis*. 2017; 23: 1085–1091. <https://doi.org/10.3201/eid2307.161528> PMID: 28430562
9. Vega-Rúa A, Zouache K, Girod R, Failloux A-B, Lourenço-de-Oliveira R. High Level of Vector Competence of *Aedes aegypti* and *Aedes albopictus* from Ten American Countries as a Crucial Factor in the Spread of Chikungunya Virus. *J Virol*. 2014; 88: 6294–6306. <https://doi.org/10.1128/JVI.00370-14> PMID: 24672026
10. Kraemer MUG, Sinka ME, Duda KA, Mylne AQN, Shearer FM, Barker CM, et al. The global distribution of the arbovirus vectors *Aedes aegypti* and *Ae. albopictus*. *Elife*. 2015; 4: 1–18. <https://doi.org/10.7554/eLife.08347> PMID: 26126267
11. Paupy C, Ollomo B, Kamgang B, Moutailler S, Rousset D, Demanou M, et al. Comparative role of *Aedes albopictus* and *Aedes aegypti* in the emergence of dengue and chikungunya in Central Africa. *Vector Borne Zoonotic Dis*. 2010; 10: 259–266. <https://doi.org/10.1089/vbz.2009.0005> PMID: 19725769
12. Whitehorn J, Thi D, Kien H, Nguyen NM, Nguyen HL, Kyrillos PP, et al. Comparative susceptibility of *Aedes albopictus* and *Aedes aegypti* to dengue virus infection after feeding on blood of viremic humans: implications for public health. *J Infect Dis*. 2015; 212: 1182–1190. <https://doi.org/10.1093/infdis/jiv173> PMID: 25784733
13. Brady OJ, Golding N, Pigott DM, Kraemer MUG, Messina JP, Reiner RC, et al. Global temperature constraints on *Aedes aegypti* and *Ae. albopictus* persistence and competence for dengue virus transmission. *Parasit Vectors*. 2014; 7: 338. <https://doi.org/10.1186/1756-3305-7-338> PMID: 25052008
14. La Ruche G, Souarès Y, Armengaud A, Peloux-Petiot F, Delaunay P, Desprès P, et al. First two autochthonous dengue virus infections in metropolitan France, September 2010. *Euro Surveill*. 2010; 15: 19676. PMID: 20929659

15. Gjenero-Margan I, Aleraj B, Krajcar D, Lesnikar V, Klobučar A. Autochthonous dengue fever in Croatia, August–September 2010. *Euro Surveill.* 2011; 16: 19805. PMID: [21392489](#)
16. Angelini R, Finarelli A, Angelini P, Po C, Petropulacos K, Macini P, et al. An outbreak of chikungunya fever in the province of Ravenna, Italy. *Euro Surveill.* 2007; 12: 3260.
17. Kreß A, Kuch U, Oehlmann J, Müller R. Effects of diapause and cold acclimation on egg ultrastructure: new insights into the cold hardiness mechanisms of the Asian tiger mosquito *Aedes (Stegomyia) albopictus*. *J Vector Ecol.* 2016; 41: 142–150. <https://doi.org/10.1111/jvec.12206> PMID: [27232137](#)
18. Benedict MQ, Levine RS, Hawley WA, Lounibos LP. Spread of the tiger: global risk of invasion by the mosquito *Aedes albopictus*. *Vector borne zoonotic Dis.* 2016; 7: 76–85.
19. Tsatsarkin KA, Vanlandingham DL, Mcgee CE, Higgs S. A single mutation in chikungunya virus affects vector specificity and epidemic potential. *PLoS Pathog.* 2007; 3: e201. <https://doi.org/10.1371/journal.ppat.0030201> PMID: [18069894](#)
20. Vazeille M, Moutailler S, Coudrier D, Rousseaux C, Khun H, Huerre M, et al. Two Chikungunya isolates from the outbreak of La Reunion (Indian Ocean) exhibit different patterns of infection in the mosquito, *Aedes albopictus*. *PLoS One.* 2007; 2: e1168. <https://doi.org/10.1371/journal.pone.0001168> PMID: [18000540](#)
21. Epelboin Y, Talaga S, Dusfour I. Zika virus: an updated review of competent or naturally infected mosquitoes. *PLoS Negl Trop Dis.* 2017; 11: e0005933. <https://doi.org/10.1371/journal.pntd.0005933> PMID: [29145400](#)
22. Tan CH, Wong PJ, Li MI, Yang H, Ng C, Neill SLO. wMel limits Zika and chikungunya virus infection in a Singapore *Wolbachia*—introgressed *Ae. aegypti* strain, wMel-Sg. *PLoS Negl Trop Dis.* 2017; 11: e0005496. <https://doi.org/10.1371/journal.pntd.0005496> PMID: [28542240](#)
23. Di Luca M, Severini F, Toma L, Boccolini D, Romi R, Remoli ME, et al. Experimental studies of susceptibility of Italian *Aedes albopictus* to Zika virus. *Eurosurveillance.* 2016; 21: 30223. <https://doi.org/10.2807/1560-7917.ES.2016.21.18.30223> PMID: [27171034](#)
24. Chouin-Carneiro T, Vega-Rua A, Vazeille M, Yebakima A. Differential susceptibilities of *Aedes aegypti* and *Aedes albopictus* from the Americas to Zika virus. *PLoS Negl Trop Dis.* 2016; 10: e0004543. <https://doi.org/10.1371/journal.pntd.0004543> PMID: [26938868](#)
25. Manica M, Guzzetta G, Poletti P, Filippini F, Solimini A, Caputo B, et al. Transmission dynamics of the ongoing chikungunya outbreak in Central Italy: from coastal areas to the metropolitan city of Rome, summer 2017. *Euro Surveill.* 2017; 22: 1–8.
26. European Centre for Disease Prevention and Control. Clusters of autochthonous chikungunya cases in Italy, first update—9 October 2017 [Internet]. 2017. Available: <https://ecdc.europa.eu/sites/portal/files/documents/RRA-chikungunya-Italy-update-9-Oct-2017.pdf>
27. Baldacchino F, Caputo B, Chandre F, Drago A, della Torre A, Montarsi F, et al. Control methods against invasive *Aedes* mosquitoes in Europe: a review. *Pest Manag Sci.* 2015; 71: 1471–1485. <https://doi.org/10.1002/ps.4044> PMID: [26037532](#)
28. Benelli G, Jeffries CL, Walker T. Biological control of mosquito vectors: past, present, and future. *Insects.* 2016; 7: 52. <https://doi.org/10.3390/insects7040052> PMID: [27706105](#)
29. Moyes CL, Vontas J, Martins AJ, Ng LC, Kouo SY, Dusfour I, et al. Contemporary status of insecticide resistance in the major *Aedes* vectors of arboviruses infecting humans. *PLoS Med.* 2017; 11: e0005625.
30. Alphey L, Benedict M, Bellini R, Clark GG, Dame DA, Service MW, et al. Sterile-insect methods for control of mosquito-borne diseases: an analysis. *Vector Borne Zoonotic Dis.* 2010; 10: 295–311. <https://doi.org/10.1089/vbz.2009.0014> PMID: [19725763](#)
31. Gould F, Schliekelman P. Population genetics of autocidal control and strain replacement. *Annu Rev Entomol.* 2004; 49: 193–217. <https://doi.org/10.1146/annurev.ento.49.061802.123344> PMID: [14651462](#)
32. Balestrino F, Medici A, Candini G, Carrieri M, Maccagnani B, Calvitti M, et al. γ ray dosimetry and mating capacity studies in the laboratory on *Aedes albopictus* males. *J Med Entomol.* 2010; 47: 581–591. <https://doi.org/10.1093/jmedent/47.4.581> PMID: [20695273](#)
33. Yamada H, Parker AG, Oliva CF, Balestrino F, Gilles JR. X-ray-induced sterility in *Aedes albopictus* (Diptera: Culicidae) and male longevity following irradiation. *J Med Entomol.* 2014; 51: 811–816. <https://doi.org/10.1603/ME13223> PMID: [25118413](#)
34. Phuc HK, Andreasen MH, Burton RS, Vass C, Epton MJ, Pape G, et al. Late-acting dominant lethal genetic systems and mosquito control. *BMC Biol.* 2007; 5: 11. <https://doi.org/10.1186/1741-7007-5-11> PMID: [17374148](#)

35. Wise de Valdez MR, Nimmo D, Betz J, Gong H-F, James AA, Alpey L, et al. Genetic elimination of dengue vector mosquitoes. *Proc Natl Acad Sci*. 2011; 108: 4772–4775. <https://doi.org/10.1073/pnas.1019295108> PMID: 21383140
36. Bourtzis K, Dobson SL, Xi Z, Rasgon JL, Calvitti M, Moreira LA, et al. Harnessing mosquito-Wolbachia symbiosis for vector and disease control. *Acta Trop*. 2014; 1325: 5150–5153. <https://doi.org/10.1016/j.actatropica.2013.11.004>
37. Sinkins SP, O'Neill SL. Wolbachia as a vehicle to modify insect populations. In: Handler AM, James AA, editors. *Insect Transgenesis: methods and applications*. Boca Raton (FL): CRC Press; 2000. pp. 271–287.
38. Zug R, Hammerstein P. Still a host of hosts for Wolbachia: Analysis of recent data suggests that 40% of terrestrial arthropod species are infected. *PLoS One*. 2012; 7: 7–9. <https://doi.org/10.1371/journal.pone.0038544> PMID: 22685581
39. Werren JH, Baldo L, Clark ME. Wolbachia: master manipulators of invertebrate biology. *Nat Rev Microbiol*. 2008; 6: 741–751. <https://doi.org/10.1038/nrmicro1969> PMID: 18794912
40. Sullivan W, O'Neill SL. Manipulation of the manipulators. *Nature*. 2017; 543: 182–183. <https://doi.org/10.1038/nature21509> PMID: 28241145
41. Hughes GL, Koga R, Xue P, Fukatsu T, Rasgon JL. Wolbachia infections are virulent and inhibit the human malaria parasite *Plasmodium falciparum* in *Anopheles gambiae*. *PLoS Pathog*. 2011; 7: 3–10. <https://doi.org/10.1371/journal.ppat.1002043> PMID: 21625582
42. Sinkins SP. Wolbachia and arbovirus inhibition in mosquitoes. *Future Microbiol*. 2013; 8: 1249–1256. <https://doi.org/10.2217/fmb.13.95> PMID: 24059916
43. Walker T, Johnson PH, Moreira LA, Iturbe-Ormaetxe I, Frentiu FD, McMeniman CJ, et al. The wMel Wolbachia strain blocks dengue and invades caged *Aedes aegypti* populations. *Nature Publishing Group*; 2011; 476: 450–453. <https://doi.org/10.1038/nature10355> PMID: 21866159
44. Rainey SM, Shah P, Kohl A, Dietrich I. Understanding the Wolbachia-mediated inhibition of arboviruses in mosquitoes: Progress and challenges. *J Gen Virol*. 2014; 95: 517–530. <https://doi.org/10.1099/vir.0.057422-0> PMID: 24343914
45. Ferguson NM, Kien DTH, Clapham H, Aguas R, Trung VT, Chau TNB, et al. Modeling the impact on virus transmission of Wolbachia-mediated blocking of dengue virus infection of *Aedes aegypti*. *Sci Transl Med*. 2015; 7: 279ra37. <https://doi.org/10.1126/scitranslmed.3010370> PMID: 25787763
46. Schmidt TL, Barton NH, Rasic G, Turley AP, Montgomery BL, Iturbe-ormaeetxe I, et al. Local introduction and heterogeneous spatial spread of dengue-suppressing Wolbachia through an urban population of *Aedes aegypti*. *PLoS Biol*. 2017; 15: e2001894. <https://doi.org/10.1371/journal.pbio.2001894> PMID: 28557993
47. Dutra HLC, Rocha MN, Dias FBS, Mansur SB, Caragata EP, Moreira LA. Wolbachia blocks currently circulating Zika virus isolates in Brazilian *Aedes aegypti* mosquitoes. *Cell Host Microbe*. The Author(s); 2016; 19: 771–774. <https://doi.org/10.1016/j.chom.2016.04.021> PMID: 27156023
48. Aliota MT, Walker EC, Yepes AU, Velez ID, Christensen M, Osorio JE. The wMel strain of Wolbachia reduces transmission of chikungunya virus in *Aedes aegypti*. *PLoS Negl Trop Dis*. 2016; 10: e0004677. <https://doi.org/10.1371/journal.pntd.0004677> PMID: 27124663
49. Blagrove MSC, Arias-Goeta C, Di Genua C, Failloux AB, Sinkins SP. A Wolbachia wMel Transinfection in *Aedes albopictus* Is Not Detrimental to Host Fitness and Inhibits Chikungunya Virus. *PLoS Negl Trop Dis*. 2013; 7. <https://doi.org/10.1371/journal.pntd.0002152> PMID: 23556030
50. Blagrove MSC, Arias-Goeta C, Failloux A, Sinkins SP. Wolbachia strain wMel induces cytoplasmic incompatibility and blocks dengue transmission in *Aedes albopictus*. *PNAS*. 2011; 109: 255–260. <https://doi.org/10.1073/pnas.1112021108> PMID: 22123944
51. Moretti R, Lampazzi E, Mastrobattista G, Calvitti M. Generazione di una nuova infezione di Wolbachia (ceppo "wMel") in *Aedes albopictus* (Skuse) attraverso trasferimento interspecifico. XXX Congresso Nazionale Italiano di Entomologia, Campobasso, 11–16 giugno 2007. 2007. p. 380. Available: <http://doczz.it/doc/623164/xxi-cnie—campobasso-2007—accademia-nazionale-italiana-di>
52. Atyame CM, Delsuc F, Pasteur N, Weill M, Duron O. Diversification of Wolbachia endosymbiont in the *Culex pipiens* mosquito. *Mol Biol Evol*. 2011; 28: 2761–2772. <https://doi.org/10.1093/molbev/msr083> PMID: 21515811
53. Calvitti M, Moretti R, Lampazzi E, Bellini R, Dobson SL. Characterization of a new *Aedes albopictus* (Diptera: Culicidae)-Wolbachia pipiens (Rickettsiales: Rickettsiaceae) symbiotic association generated by artificial transfer of the wPip strain from *Culex pipiens* (Diptera: Culicidae). *J Med Entomol*. 2010; 47: 179–187. <https://doi.org/10.1603/ME09140> PMID: 20380298
54. Calvitti M, Moretti R, Skidmore AR, Dobson SL. Wolbachia strain wPip yields a pattern of cytoplasmic incompatibility enhancing a Wolbachia-based suppression strategy against the disease vector *Aedes*

- albopictus. *Parasites and Vectors*. 2012; 5: 254. <https://doi.org/10.1186/1756-3305-5-254> PMID: 23146564
55. Moretti R, Calvitti M. Male mating performance and cytoplasmic incompatibility in a wPip *Wolbachia* trans-infected line of *Aedes albopictus* (*Stegomyia albopicta*). *Med Vet Entomol*. 2013; 27: 377–386. <https://doi.org/10.1111/j.1365-2915.2012.01061.x> PMID: 23171418
 56. Puggioli A, Calvitti M, Moretti R, Bellini R. wPip *Wolbachia* contribution to *Aedes albopictus* SIT performance: advantages under intensive rearing. *Acta Trop*. Elsevier B.V.; 2016; 164: 473–481. <https://doi.org/10.1016/j.actatropica.2016.10.014> PMID: 27784636
 57. Xi Z, Khoo CCH, Dobson SL. Interspecific transfer of *Wolbachia* into the mosquito disease vector *Aedes albopictus*. *Proc Biol Sci*. 2006; 273: 1317–22. <https://doi.org/10.1098/rspb.2005.3405> PMID: 16777718
 58. Xi Z, Dobson SL. Characterization of *Wolbachia* transfection efficiency by using microinjection of embryonic cytoplasm and embryo homogenate. *Appl Environ Microbiol*. 2006; 71: 3199–3204. <https://doi.org/10.1128/AEM.71.6.3199-3204.2005>
 59. Chrostek E, Marialva MSP, Esteves SS, Weinert LA, Martinez J, Jiggins FM, et al. *Wolbachia* variants induce differential protection to viruses in *Drosophila melanogaster*: a phenotypic and phylogenomic analysis. *PLoS Genet*. 2013; 9: e1003896. <https://doi.org/10.1371/journal.pgen.1003896> PMID: 24348259
 60. Bellini R, Calvitti M, Medici A, Carrieri M, Celli G, Maini S. Use of the sterile insect technique against *Aedes albopictus* in Italy: first results of a pilot trial. In: Vreysen MJB, Robinson AS, Hendrichs J, editors. *Area-Wide Control of Insect Pests*. Springer, Dordrecht, The Netherlands; 2007. pp. 505–515.
 61. Zhou W, Rousset F, O'Neill SL. Phylogeny and PCR-based classification of *Wolbachia* strains using wsp gene sequences. *Proc Biol Sci*. 1998; 265: 509–515. <https://doi.org/10.1098/rspb.1998.0324> PMID: 9569669
 62. Tortosa P, Courtiol A, Moutailler S, Failloux A-B, Weill M. Chikungunya-*Wolbachia* interplay in *Aedes albopictus*. *Insect Mol Biol*. 2008; 17: 677–684. <https://doi.org/10.1111/j.1365-2583.2008.00842.x> PMID: 19133077
 63. Schuffenecker I, Iteman I, Michault A, Murri S, Frangeul L, Vaney M-C, et al. Genome microevolution of chikungunya viruses causing the Indian Ocean outbreak. *PLoS Med*. 2006; 3: 1058–1070. <https://doi.org/10.1371/journal.pmed.0030263> PMID: 16700631
 64. Bordi L, Carletti F, Castillette C, Chiappini R, Sambri V, Cavrini F, et al. Presence of the A226V mutation in autochthonous and imported Italian chikungunya virus strains. *Clin Infect Dis*. 2008; 47: 428–429. <https://doi.org/10.1086/589925> PMID: 18605910
 65. Donald CL, Brennan B, Cumberworth SL, Rezelj V, Clark JJ, Cordeiro MT, et al. Full genome sequence and sfRNA interferon antagonist activity of Zika virus from Recife, Brazil. *PLoS Negl Trop Dis*. 2016; 10: e0005048. <https://doi.org/10.1371/journal.pntd.0005048> PMID: 27706161
 66. Dubrulle M, Mousson L, Moutailler S, Vazeille M, Failloux A. Chikungunya virus and *Aedes* mosquitoes: saliva is infectious as soon as two days after oral infection. *PLoS One*. 2009; 4: e5895. <https://doi.org/10.1371/journal.pone.0005895> PMID: 19521520
 67. Brelsfoard CL, Dobson SL. *Wolbachia*-based strategies to control insect pests and disease vectors. *Asia-Pacific J Mol Biol Biotechnol*. 2009; 17: 55–63.
 68. Hoffmann AA, Ross PA, Rašić G. *Wolbachia* strains for disease control: Ecological and evolutionary considerations. *Evol Appl*. 2015; 8: 751–768. <https://doi.org/10.1111/eva.12286> PMID: 26366194
 69. Jeffries CL, Walker T, Walker T. *Wolbachia* biocontrol strategies for arboviral diseases and the potential influence of resident *Wolbachia* strains in mosquitoes. *Curr Trop Med Reports*. 2016; 3: 20–25. <https://doi.org/10.1007/s40475-016-0066-2> PMID: 26925368
 70. Mains JW, Brelsfoard CL, Rose RI, Dobson SL. Female adult *Aedes albopictus* suppression by *Wolbachia*-infected male mosquitoes. *Sci Rep*. Nature Publishing Group; 2016; 6: 33846. <https://doi.org/10.1038/srep33846> PMID: 27659038
 71. Joubert DA, Walker T, Carrington LB, De Bruyne JT, Kien DHT, Hoang NLT, et al. Establishment of a *Wolbachia* superinfection in *Aedes aegypti* mosquitoes as a potential approach for future resistance management. *PLoS Pathog*. 2016; 12: e1005434. <https://doi.org/10.1371/journal.ppat.1005434> PMID: 26891349
 72. Ross PA, Endersby NM, Hoffmann AA. Costs of three *Wolbachia* infections on the survival of *Aedes aegypti* larvae under starvation conditions. *PLoS Negl Trop Dis*. 2016; 10: e0004320. <https://doi.org/10.1371/journal.pntd.0004320> PMID: 26745630
 73. Ant TH, Herd CS, Geoghegan V, Hoffmann AA, Sinkins SP. The *Wolbachia* strain wAu provides highly efficient virus transmission blocking in *Aedes aegypti*. *PLoS Pathog*. 2018; 14: e1006815. <https://doi.org/10.1371/journal.ppat.1006815> PMID: 29370307

74. Atyame CM, Labbé P, Lebon C, Weill M, Moretti R, Marini F, et al. Comparison of irradiation and *Wolbachia* based approaches for sterile-male strategies targeting *Aedes albopictus*. *PLoS One*. 2016; 11: e0146834. <https://doi.org/10.1371/journal.pone.0146834> PMID: 26765951
75. Bellini R, Balestrino F, Medici A, Gentile G, Veronesi R. Mating competitiveness of *Aedes albopictus* radio-sterilized males in large enclosures exposed to natural conditions. *J Med Entomol*. 2013; 50: 94–102. PMID: 23427657
76. Massonnet-Bruneel B, Corre-Catelin N, Lacroix R, Lees RS, Hoang KP, Nimmo D, et al. Fitness of transgenic mosquito *Aedes aegypti* males carrying a dominant lethal genetic system. *PLoS One*. 2013; 8: e62711. <https://doi.org/10.1371/journal.pone.0062711> PMID: 23690948
77. Calvitti M, Marini F, Desiderio A, Puggioli A, Moretti R. *Wolbachia* density and cytoplasmic incompatibility in *Aedes albopictus*: concerns with using artificial *Wolbachia* infection as a vector suppression tool. *PLoS One*. 2015; 10. <https://doi.org/10.1371/journal.pone.0121813> PMID: 25812130
78. Zhang D, Lees RS, Xi Z, Gilles JRL, Bourtzis K. Combining the sterile insect technique with *Wolbachia*-based approaches: II—A safer approach to *Aedes albopictus* population suppression programmes, designed to minimize the consequences of inadvertent female release. *PLoS One*. 2015; 10: e0135194. <https://doi.org/10.1371/journal.pone.0135194> PMID: 26252474
79. Dobson SL, Fox CW, Jiggins FM. The effect of *Wolbachia*-induced cytoplasmic incompatibility on host population size in natural and manipulated systems. *Proc Biol Sci*. 2002; 269: 437–45. <https://doi.org/10.1098/rspb.2001.1876> PMID: 11886634
80. Mousson L, Martin E, Zouache K, Madec Y, Mavingui P, Failloux AB. *Wolbachia* modulates Chikungunya replication in *Aedes albopictus*. *Mol Ecol*. 2010; 19: 1953–1964. <https://doi.org/10.1111/j.1365-294X.2010.04606.x> PMID: 20345686
81. Lu P, Bian G, Pan X, Xi Z. *Wolbachia* induces density-dependent inhibition to dengue virus in mosquito cells. *PLoS Negl Trop Dis*. 2012; 6: e1754. <https://doi.org/10.1371/journal.pntd.0001754> PMID: 22848774
82. Mousson L, Zouache K, Arias-goeta C, Raquin V, Mavingui P, Failloux A-B. The native *Wolbachia* symbionts limit transmission of dengue virus in *Aedes albopictus*. *PLoS Negl Trop Dis*. 2012; 6: e1989. <https://doi.org/10.1371/journal.pntd.0001989> PMID: 23301109
83. Di Luca M, Severini F, Toma L, Boccolini D, Romi R, Remoli ME, et al. Experimental studies of susceptibility of Italian *Aedes albopictus* to Zika virus. *Euro Surveill*. 2016; 21: pii = 30223.
84. Heitmann A, Jansen S, Luhken R, Leggewie M, Badusche M, Pluskota B, et al. Experimental transmission of Zika virus by mosquitoes from central Europe. *Euro Surveill*. 2018; 22: 30437. <https://doi.org/10.2807/1560-7917.ES.2017.22.2.30437> PMID: 28106528
85. Jupille H, Seixas G, Mousson L, Sousa CA. Zika virus, a new threat for Europe? *PLoS Negl Trop Dis*. 2016; 10: e0004901. <https://doi.org/10.1371/journal.pntd.0004901> PMID: 27505002
86. Martinez J, Ok S, Smith S, Snoeck K, Day JP, Jiggins FM. Should symbionts be nice or selfish? Antiviral effects of *Wolbachia* are costly but reproductive parasitism is not. *PLoS Pathog*. 2015; 11: e1005021. <https://doi.org/10.1371/journal.ppat.1005021> PMID: 26132467
87. Ulrich JN, Beier JC, Devine GJ, Hugo LE. Heat sensitivity of wMel *Wolbachia* during *Aedes aegypti* development. *PLoS Negl Trop Dis*. 2016; 10: e0004873. <https://doi.org/10.1371/journal.pntd.0004873> PMID: 27459519
88. Ross PA, Wiwatanaratnabutr I, Axford JK, White VL, Endersby-Harshman NM, Hoffmann AA. *Wolbachia* Infections in *Aedes aegypti* Differ Markedly in Their Response to Cyclical Heat Stress. *PLoS Pathog*. 2017; 13: e1006006. <https://doi.org/10.1371/journal.ppat.1006006> PMID: 28056065

Appendix N°5

Research article entitled "Evolution and biological significance of flaviviral elements in the genome of the arboviral vector *Aedes albopictus* " published in the journal *Emerging Microbes and Infections* in August 2019. This chapter corresponds to the Chapter 1 of this manuscript.

Evolution and biological significance of flaviviral elements in the genome of the arboviral vector *Aedes albopictus*

Vincent Houé^{a,b}, Gaëlle Gabiane^a, Catherine Dauga^c, Marie Suez^d, Yoann Madec^e, Laurence Mousson^a, Michele Marconcini^{b,f}, Pei-Shi Yen^a, Xavier de Lamballerie^{g,h}, Mariangela Bonizzoni^{b,f} and Anna-Bella Failloux^{b,a}

^aDepartment of Virology, Arboviruses and Insect Vectors, Institut Pasteur, Paris, France; ^bSorbonne Université, Collège Doctoral, Paris, France; ^cInstitut Pasteur, Center for Bioinformatics, BioStatistics and Integrative Biology (C3BI), Paris, France; ^dInstitut de Biologie Paris-Seine, Paris, France; ^eDepartment of Infection and Epidemiology, Institut Pasteur, Epidemiology of Emerging Diseases, Paris, France; ^fDepartment of Biology and Biotechnology, University of Pavia, Pavia, Italy; ^gAix Marseille Université, IRD French Institute of Research for Development, EHESP French School of Public Health, EPV UMR_D 190 'Emergence des Pathologies Virales', Marseille, France; ^hIHU Méditerranée Infection, APHM Public Hospitals of Marseille, Marseille, France

ABSTRACT

Since its genome details are publically available, the mosquito *Aedes albopictus* has become the central stage of attention for deciphering multiple biological and evolutionary aspects at the root of its success as an invasive species. Its genome of 1,967 Mb harbours an unusual high number of non-retroviral integrated RNA virus sequences (NIRVS). NIRVS are enriched in piRNA clusters and produce piRNAs, suggesting an antiviral effect. Here, we investigated the evolutionary history of NIRVS in geographically distant *Ae. albopictus* populations by comparing genetic variation as derived by neutral microsatellite loci and seven selected NIRVS. We found that the evolution of NIRVS was far to be neutral with variations both in their distribution and sequence polymorphism among *Ae. albopictus* populations. The Flaviviral elements AlbFlavi2 and AlbFlavi36 were more deeply investigated in their association with dissemination rates of dengue virus (DENV) and chikungunya virus (CHIKV) in *Ae. albopictus* at both population and individual levels. Our results show a complex association between NIRVS and DENV/CHIKV opening a new avenue for investigating the functional role of NIRVS as antiviral elements shaping vector competence of mosquitoes to arboviruses.

ARTICLE HISTORY Received 10 July 2019; Accepted 12 August 2019

KEYWORDS *Aedes albopictus*; arboviral diseases; genetic structure; vector competence; NIRVS

Introduction

In less than four decades, the Asian tiger mosquito *Aedes albopictus* (Skuse, 1894) has become a public health concern owing to its ability to transmit several human pathogenic viruses such as Chikungunya virus (CHIKV), Dengue viruses (DENV) and Zika virus (ZIKV) [1]. This vector is responsible of several recent arboviral outbreaks (reviewed by [2]) and astonished by the speed at which it has conquered all continents except Antarctica [3,4], thus becoming one of the world's 100-most invasive species according to the Global Invasive Species Database. Originally native to tropical forests of South-East Asia, *Ae. albopictus* was confined for centuries to few regions in Asia. Starting in the eighteenth or nineteenth centuries, *Ae. albopictus* was introduced in the islands of the Indian Ocean by Asian immigrants. From the late 1970s, this species took advantage of the increase in global trade to invade most tropical and sub-tropical regions of the world [5]. Additionally, the capacity of its eggs to undergo

photoperiodic diapause in winter, favoured *Ae. albopictus* colonization into temperate regions [6]. *Aedes albopictus* was first reported in Europe in 1979 [7], in North America in 1985 [8], in South America in 1986 [9] and in Africa in 1990 [10].

Migratory routes used by *Ae. albopictus* to expand from its Asian cradle can be defined using population genetic approaches [11–13]. Mosquito populations form groups of interbreeding individuals, which coexist in space and time. These genetic units are interconnected through gene flow. The current worldwide distribution of *Ae. albopictus* is a direct consequence of increasing human activities with rapid irradiation of populations [14–18]. Populations established locally presented a high genetic variability evidencing a mixture of individuals of distinct origins with disparate susceptibilities to arboviruses, which are reflected by different vector competences [17]. Vector competence refers to the ability of a mosquito population to become infected after an infectious blood meal, to support viral

CONTACT Anna-Bella Failloux  anna-bella.failloux@pasteur.fr  Department of Virology, Arboviruses and Insect Vectors, Paris F-75015, France

 Supplemental data for this article can be accessed at <https://doi.org/10.1080/22221751.2019.1657785>

© 2019 The Author(s). Published by Informa UK Limited, trading as Taylor & Francis Group, on behalf of Shanghai Shangyixun Cultural Communication Co., Ltd
This is an Open Access article distributed under the terms of the Creative Commons Attribution License (<http://creativecommons.org/licenses/by/4.0/>), which permits unrestricted use, distribution, and reproduction in any medium, provided the original work is properly cited.

replication, dissemination and transmission to a new host in a subsequent blood-meal [19]. The level of vector competence depends on the tripartite interactions among the mosquito genotype, the virus genotype and environmental factors under GxGxE interactions [20].

In the early 2000s, non-retroviral integrated RNA virus sequences (NIRVS) were discovered in different metazoans, including mosquitoes [21,22]. *Aedes* mosquitoes can host NIRVS originated from different viruses related to arboviruses: mainly insect-specific viruses (ISVs) including insect-specific flaviviruses (ISFs) and other viruses belonging to the *Mononegavirales* order (such as rhabdoviruses) [22–25]. Additionally, most NIRVS correspond to fragmented viral open-reading frames, are flanked by transposable elements (TEs), enriched in PIWI-interacting RNA (piRNA) clusters and produce piRNAs [29]. piRNA clusters are genomic regions composed of fragmented sequences of TEs which are expressed as long primary single-stranded RNAs and processed into fragments of 24–30 nucleotides called piRNAs. In the model organism *Drosophila melanogaster*, piRNAs are primarily produced in germline cells and target TE transcripts based on sequence complementarity to protect from heritable lesions [26–29]. The landscape of TE fragments within piRNA clusters defines the regulatory properties of *D. melanogaster* strains to TE invasion [30]. The analogy between TE fragments and viral sequences in piRNA supports the hypothesis that viral sequences may contribute to mosquito susceptibility to subsequent viral infections. If viral integrations contribute in controlling virus replication, with consequences on vector competence, positive selection should be expected [31]. On the contrary, if NIRVS stand for fossil records, these sequences should reach fixation and evolve at a neutral rate [32,33].

In this study, we selected 19 *Ae. albopictus* populations that cover the geographical distribution of the species, where CHIKV and DENV were circulating, to study the evolutionary dynamics of seven selected NIRVS [24]. The occurrence of NIRVS in populations was compared to processes driving population genetic differentiation observed on neutral loci (i.e. microsatellites). We showed that (i) based on microsatellite marker polymorphism, populations of *Ae. albopictus* are distributed into two different genetic clusters, one of them divided into four subclusters, without any correlation between genetic and geographical distances, (ii) the distribution of NIRVS in geographic populations and their polymorphism are not related to genetic divergences within and between populations as depicted by microsatellite markers, suggesting that NIRVS are not evolving neutrally, and (iii) all NIRVS studied, except AlbFlavi1 may have influence on vector competence to DENV and CHIKV, at the population level.

Materials and methods

Ethic statements

Mice were housed in the Institut Pasteur animal facilities accredited by the French Ministry of Agriculture for performing experiments on live rodents. Work on animals was performed in compliance with French and European regulations on care and protection of laboratory animals (EC Directive 2010/63, French Law 2013-118, February 6th, 2013). All experiments were approved by the Ethics Committee #89 and registered under the reference APAFIS#6573-2016061412077987 v2.

Mosquitoes

To assess genetic variation within and among *Ae. albopictus* populations, 19 samples from different geographic locations were studied (Table 1). These populations ranging from 10 to 30 mosquitoes were selected in the native range of *Ae. albopictus* where arboviral outbreaks and epidemics occurred [17,34,35]. Only the 13 populations of 19–20 mosquitoes and the Foshan colony used as control were selected to characterize NIRVS polymorphism [36].

Mosquitoes were collected in the field as immature stages (larvae, pupae, eggs). Frozen mosquitoes (<13th generation) were used for population genetic and NIRVS analyses. For the pilot experiments for DENV and CHIKV infections, F1 mosquitoes from Tibati population (Cameroon) and F18 mosquitoes from Foshan laboratory strain were used. Larvae obtained after immersion in dechlorinated tap water of field-collected eggs were distributed in pans of 200 individuals. Immature stages were fed every two days with a yeast tablet dissolved in 1 L of dechlorinated tap water and incubated at $26 \pm 1^\circ\text{C}$. Emerging adults were placed in cages and maintained at $28 \pm 1^\circ\text{C}$ with a light/dark cycle of 12/12 h at 80% relative humidity and supplied with a 10% sucrose solution. Females were exposed three times a week to anesthetized mice (OF1 mice; Charles River Laboratories, MA, USA) as a source of blood for producing eggs.

Microsatellite genotyping

Genomic DNA was extracted from individual mosquito using the Nucleospin Tissue kit (Macherey-Nagel, Hoerd, France) according to manufacturer's instructions. Briefly, mosquitoes were individually homogenized in 180 μL lysis buffer supplemented with 25 μL of Proteinase K. To bind total nucleic acids, homogenates were passed through columns. Silica membranes were further desalted and DNA was collected in 100 μL of elution buffer. Quality and quantity of DNA were then assessed using the

Table 1. Details on *Aedes albopictus* populations analyzed.

Population name	Continent	Country	City	Generation	Year of collection	Mosquitoes females	Males	
1	Alessandria	Europe	Italy	Alessandria	F2	2012	10	10
2	Ulcinj	Europe	Montenegro	Ulcinj	F1	2013	10	10
3	Cagnes-sur-mer	Europe	France	Cagnes-sur-mer	F13	2000	10	0
4	Montsecret	Europe	France	Montsecret	F4	2002	0	10
5	Bar-sur-Loup	Europe	France	Bar-sur-Loup	F1	2011	10	0
6	Tirana	Europe	Albania	Tirana	F6	2016	15	15
7	Franceville	Africa	Gabon	Franceville	F2	2015	10	10
8	Mfilou	Africa	Congo	Mfilou (Brazzaville)	F3	2012	10	10
9	Bertoua	Africa	Cameroon	Bertoua	F5	2008	10	4
10	Saint-Denis	Africa	La Réunion	Saint-Denis	F2	1998/2006	10	10
11	Rabat	Africa	Morocco	Rabat	F1	2017	15	15
12	Vero Beach	America	USA	VeroBeach	F5	2016	10	10
13	Rio	America	Brazil	Rio de Janeiro	F1	2001	10	9
14	Jurujuba	America	Brazil	Jurujuba	F1	2014	10	0
15	Manaus	America	Brazil	Manaus	F1	2015	15	15
16	PMNI	America	Brazil	PMNI (Nova Iguaçu)	F1	2015	15	15
17	Binh Duong	Asia	Vietnam	Binh Duong (Ben Cat) Phu Hoa	F9	2014	10	10
18	Sarba	Asia	Lebanon	Sarba	F0	2011	10	10
19	Foshan	Asia	China	Foshan	Lab colony	–	10	10
20	Oahu	America	Hawaii	Oahu	Lab colony	1999	10	10

Note: Except the colony Foshan, all 19 populations were genetically characterized using 10 microsatellite markers, and 13 populations (in bold) were selected for studying NIRS diversity.

Nanodrop 2000 Spectrophotometer (*Thermo Scientific*TM, MA, USA) and a PCR was performed using *histone h3* reference gene (NCBI: XM_019696438.1) as control. Eleven microsatellite loci were amplified using PCR specific primers flanking the repeated region [16]. PCR reaction mixtures in a final volume of 15 μ L contained 50 ng genomic DNA, 1X PCR buffer, 1.5 mM MgCl₂, 0.27 mM dNTPs (InvitrogenTM, CA, USA), 1U Taq polymerase (InvitrogenTM), and 10 μ M of each primer (one was 5' labelled with a fluorescent dye). PCR cycling conditions consisted in a step at 94°C for 5 min, followed by 29 cycles at 94°C for 30 s, 58°C for 30 s, and 72°C for 30 s with a final step at 72°C for 10 min. Aliquots of PCR products were visualized in 2% agarose gels stained with ethidium bromide under UV light. Each PCR product was then diluted 1:10 in ddH₂O water and 2 μ L of this dilution was added to 10 μ L of a mixture of deionized formamide and GeneScan-500 ROX size standard (Applied Biosystems, CA, USA). Genotyping was processed in an ABI3730XL sequence analyser (Applied Biosystems) and data analyzed using GeneScan and GeneMapper softwares.

Genetic diversity of populations

For statistical analyses, mosquitoes collected from each sampling site were assumed to represent local populations.

Amounts of heterozygosity at various levels of population structure were explored by using F_{IS} and F_{ST} values. The F_{IS} inbreeding coefficient indicates the level of heterozygosity within each population. The F_{ST} fixation index measures the reduction in heterozygosity due to random genetic drift between populations. The Wright's F -statistics were computed in Genetix v.4.05.2. software [37] and tested using 10⁴ iterations

according to Weir and Cockerham (1984). The number of alleles (N_A), allelic richness (A_R), expected (H_E), observed (H_O) heterozygosity, F_{IS} by locus and F_{ST} by populations were obtained. The significance of F_{IS} and F_{ST} were analyzed using FSTAT v.2.9.3.2 [38].

Departures from Hardy-Weinberg equilibrium, linkage disequilibrium between loci and molecular variance (AMOVA) over all populations were analyzed with Arlequin v3.5.2.2 to estimate intra- and inter-population variation [39]. The mean frequency of null alleles (a mutation in microsatellite flanking regions leading to an absence of amplification products) per population was also very low (i.e. 0.06) and ranged from 0.000 to 0.118, meaning that the selected microsatellite loci were successfully amplified and appropriate for population genetic analysis. Relationships between geographical and genetic F_{ST} distances were tested between populations using Mantel test implemented in GenAlEx v 6.5 [40].

Graphic representation of relatedness among populations

Genetic relationships between populations were estimated by using PHYLIP 3.69, as previously described [41]. Cavalli-Sforza & Edwards's (CSE) chord distance for each pair of populations was calculated (GENDIST module). The resulting distance matrix was used to create a phylogram based on Neighbour-Joining (NEIGHBOUR module). Node confidence was inferred via 100 bootstrap replicates (modules SEQ-BOOT, GENDIST, NEIGHBOUR and CONSENSE).

Test of isolation by distance

To test the hypothesis whether the geographical pattern of genetic differentiation is caused by isolation

by distance (IBD), we ran Mantel tests for pairwise matrices between geographical distances (kilometres) and genetic differentiation (measured as $F_{ST}/(1-F_{ST})$).

Genetic structure of populations

Genetic population structure was assessed with individual-based Bayesian clustering method implemented in the program STRUCTURE v.2.3.4 [42]. The likelihood of each possible number of genetic populations (K), ranging from 1 to 20, was calculated after 10 independent runs for each value of K, using a burn-in of 500,000 replications, 500,000 Markov Chain Monte Carlo steps, assuming an admixture model, with frequencies correlated between populations and without the use of sampling location as a prior. The most likely number of populations (K) was estimated by the ΔK method described by Evanno et al. [43] with Structure Harvester software (<http://taylor0.biology.ucla.edu/structureHarvester/>). The results were then graphically displayed with DISTRUCT 1.1 [44].

NIRVS in natural populations

Six NIRVS (AlbFlavi1, AlbFlavi2, AlbFlavi4, AlbFlavi10, AlbFlavi36, AlbFlavi41), plus CSA [21], were studied. They were chosen based on their unique occurrence in different regions of the Foshan genome, except for AlbFlavi41, known to be duplicated. Because of its length [21], CSA was characterized using two sets of primers (CSA-NS3 and CSA-JJL), and considered in analysis as two separated datasets (Supplementary Table 1). NIRVS were searched on the same mosquitoes as those used for microsatellite genotyping.

PCR primers flanking each NIRVS (Supplementary Table 1) were designed using PRIMER3 [45]. PCR reactions were performed in a final volume of 25 μ L using 5 ng of DNA, PCR buffer 1X, 2.9 mM $MgCl_2$, 0.25 mM dNTP mix, 0.25 μ M of each primer and 1.25 unit of *Taq* DNA polymerase (Invitrogen™). Amplifications were done using *T100™ Thermal Cycler* (Bio-Rad) according to the following cycle conditions: 95°C for 5 min, 35 cycles at 95°C for 15 s, 59–64°C for 90 s, 72°C for 90 s, and a final elongation step at 72°C for 10 min. PCR products were electrophoresed on 1.5% of agarose gels stained with ethidium bromide and visualized under UV light. All negative samples were confirmed with a second-round PCR.

The number of each NIRVS per population (frequency) was represented using Graph Pad Prism version 6 (Graph Pad Software, CA, USA).

NIRVS between populations

NIRVS composition of each population was expressed in terms of relative abundance corresponding to the percentage of each NIRVS relative to the total number

of tested mosquitoes. To assess variations of NIRVS abundance between populations, we calculated Bray Curtis dissimilarities, a metrics, widely used, including data standardization [46]. A dendrogram was generated by using this dissimilarity matrix and neighbour-joining method, to visualize NIRVS compositional differences across populations [46].

Mantel tests between NIRVS and microsatellites

Mantel tests implemented in GenAlEx v 6.5 [40], were used to evaluate the statistical significance of the correlation between two or more distance matrices, using permutation tests. The significance of associations between matrixes of φ' st distance among populations as derived by microsatellite markers or NIRVS distribution was tested using the Mantel test with 999 permutations.

NIRVS association with vector competence of *Ae. albopictus* at the population level

Vector competence is assessed using several parameters [47]. The dissemination efficiency (DE) refers to the proportion of mosquitoes able to disseminate the virus beyond the midgut barrier after ingestion of infectious blood meal and active viral replication in midgut epithelial cells. Published data on DEs to DENV and CHIKV were retrieved for mosquito populations with close or identical geographical proximity with the populations analyzed (Supplementary Table 2). DEs were described using median and inter-quartile range (IQR). Logistic linear regression models were used to test association between the presence of NIRVS and DEs at the *Ae. albopictus* population level. *P*-values <0.05 were considered significant.

Sequence polymorphism and evolutionary dynamics of AlbFlavi2 and AlbFlavi36

Sequence polymorphism of AlbFlavi2 and AlbFlavi36

Amplification products for AlbFlavi2 and AlbFlavi36 were purified by using NucleoSpin® Gel and PCR Clean-up kit (Macherey-Nagel) according to the manufacturer's instructions and sequenced by Eurofins Genomics (Cochin hospital platform, Paris, France). If the quality of chromatogram profiles assessed with Geneious® 10.1.3 did not meet the standard required, amplicons were subsequently cloned into pCR™IT-TOPO® vector using *TOPO® TA Cloning® Kit (Thermo Fisher Scientific) and transformed into One Shot® TOP10 Chemically Competent E. coli* (Invitrogen™). Sequences were aligned in Geneious® 10.1.3 using MUSCLE algorithm [48]. *p*-distance values, representing proportion of nucleotide sites at which two

sequences being compared are different, were calculated after alignments using MEGA 10.0.5.

Phylogeny based on AlbFlavi2 and AlbFlavi36

DNA sequences from AlbFlavi2 and AlbFlavi36 were aligned with MUSCLE algorithm [48]. Exogenous virus sequences were used as outgroup to determine the direction of character transformations. Phylogenetic trees were obtained by parsimony analysis implemented in the PAUP* software package (version 4.0), by using gap as 5th state or not (data not shown) and nearest neighbour interchange (NNI) for tree rearrangements [49].

Pilot experiment assessing the association between AlbFlavi2/Albflavi36 and vector competence of *Ae. albopictus* at the individual level

Logistic linear regression models were used to test association between the presence of AlbFlavi2 and AlbFlavi36 and viral dissemination in single mosquitoes from the Foshan colony and a field-collected African population (Tibati collected in Tibati, Cameroon in 2018). Foshan and Tibati mosquitoes were experimentally infected with DENV (DENV-2, Accession number: MK268692 [50]) and CHIKV (06.21, Accession number: AM258992 [51]) provided in blood meals as described in Amraoui et al. 2019 [52]. All surviving mosquitoes were examined individually at 14 days post-infection to define (i) the infectious status; presence of infectious particles in heads was estimated by focus fluorescent assay on C6/36 *Ae. albopictus* cells [52], and (ii) the presence of AlbFlavi2 and/or AlbFlavi36 by PCR on DNA extracted from bodies and thorax. Statistical analyses were conducted using the Stata software (StataCorp LP, Texas, and USA). *P*-values <0.05 were considered significant.

Results

Characterization of populations using microsatellite data

A total of 363 individuals (Table 1) were genotyped at 11 microsatellite markers. Ten of the 11 microsatellite loci, by showing a frequency upper to 0.95 for the most common allele, were considered polymorphic and as such, were included in the analysis. Only the A17 locus was monomorphic and then excluded from the analyses. No significant linkage disequilibrium between any pairs of loci was observed indicating that the 10 loci were statistically independent from each other. Each locus was tested for within-population deviations from HWE implementing Bonferroni correction for multiple testing: 20 deviations out of 190

Table 2. Genetic diversity at each microsatellite locus for all mosquito populations.

	N_A	N	Allelic richness	PIC	H_o	H_e	F_{IS}
A1	4	288		0.44	0.16	0.47	0.59
A2	10	360	2.43	0.55	0.63	0.62	-0.15
A3	18	341	3.14	0.74	0.62	0.78	0.08
A5	19	334	2.90	0.75	0.52	0.78	0.13
A6	11	330	2.59	0.68	0.54	0.68	-0.04
A9	9	326	2.73	0.65	0.59	0.70	0.01
A11	9	323	2.81	0.71	0.53	0.75	0.15
A14	9	351	1.71	0.41	0.17	0.40	0.38
A15	6	347	1.25	0.13	0.04	0.15	0.57
A16	14	279		0.83	0.66	0.84	0.04
Mean	10.9	327.9	2.44	0.59	0.45	0.62	0.17

Notes: N_A , number of alleles; N , number of individuals examined at a locus; PIC, polymorphism information content; H_o , observed heterozygosity; H_e , expected heterozygosity; F_{IS} , the inbreeding coefficient. Values in bold are significant at the 0.1% after Bonferroni correction.

combinations were found but did not cluster at any population or locus.

The loci displayed a mean PIC of 0.59 suggesting that they were sufficiently informative for assessing the degree of variability and structuring of mosquito populations (Table 2). The number of alleles, averaged over all loci, ranged from 4 to 19, with a mean value of 10.9 per locus, and a mean allelic richness at 2.44 (Table 2). Eight of the 10 loci presented a significant difference between observed and expected heterozygosity, with a mean F_{IS} of 0.17 (*p*-value <0.001; Table 2), supporting an excess of homozygotes in *Ae. albopictus* populations.

Population diversity

The overall mean number of alleles per population was 3.7 varying between 2.0 and 5.0. Private alleles were rarely found, their mean frequency per population ranged from 0.00 to 0.079 (Table 3). Mean F_{IS} value per population was -0.09, with values ranging from -0.0285 to 0.338 (Table 3). Estimation of the molecular variance within and among populations (AMOVA) revealed that most of the variation (89.6%) was detected within individuals whereas only 10.4% occurred among populations.

Population genetic structure

The overall differentiation across all 19 populations was high ($F_{ST} = 0.239$) with F_{ST} being highly significant (*p*-value <0.001), suggesting a significant genetic structure. To identify genetic clusters among tested individuals, we implemented 25 independent simulations in the software Structure according to the method of Evanno; the uppermost level of structuring in the model was observed at $K = 2$ ($\Delta K = 2293.4$; Supplementary Figure 1(A)). The best assignment of individuals made by Structure led to two clusters: (i) cluster 1, which includes populations from Brazil (i.e. PMNI and Manaus), Northern Africa (i.e. Rabat) and a population from Albania, and (ii) cluster 2, which includes the remaining populations (Figure 1 and

Table 3. Analysis of genetic variability of different geographical populations of *Aedes albopictus*.

Populations	Country	Continent	N	n_a	n_a/N	n_p	n_p/N	A_p	H_o	H_e	A_n	F_{IS}
Vero Beach	USA	America	20	4.4	0.22	2	0.10	0.07	0.48	0.53	0.08	0.12***
Oahu	Hawaii		20	2.6	0.13	0	0.00	0.00	0.25	0.34	0.08	0.30***
Manaus	Brazil		30	3.4	0.11	3	0.10	0.07	0.32	0.47	0.12	0.34***
PMNI			30	3.6	0.12	1	0.03	0.03	0.39	0.51	0.11	0.25***
Rio			19	3.4	0.18	0	0.00	0.00	0.42	0.50	0.08	0.18***
Jurujuba			10	3.3	0.33	0	0.00	0.00	0.47	0.42	0.00	-0.06
Montsecret	France	Europe	10	2.0	0.20	0	0.00	0.00	0.50	0.37	0.01	-0.29
Cagnes-sur-Mer			10	2.8	0.28	1	0.10	0.06	0.55	0.46	0.01	-0.14
Bar-sur-Loup			10	3.8	0.38	2	0.20	0.08	0.50	0.52	0.05	0.13*
Alessandria	Italy		20	4.1	0.21	2	0.10	0.05	0.43	0.50	0.06	0.18***
Ulcinj	Montenegro		20	3.1	0.16	0	0.00	0.00	0.40	0.39	0.03	0.02
Tirana	Albania		30	3.8	0.13	3	0.10	0.07	0.35	0.43	0.08	0.21***
Rabat	Morocco		30	3.2	0.11	0	0.00	0.00	0.42	0.47	0.06	0.11***
Bertoua	Cameroon		14	4.3	0.31	1	0.07	0.07	0.46	0.52	0.08	0.16***
Franceville	Gabon	Africa	20	4.8	0.24	1	0.05	0.03	0.44	0.56	0.08	0.25***
Mfilou	Congo		20	4.0	0.20	0	0.00	0.00	0.60	0.55	0.02	-0.06
Saint-Denis	La Réunion		20	5.1	0.26	6	0.30	0.05	0.52	0.55	0.07	0.08
Sarba	Lebanon	Asia	10	3.5	0.35	4	0.40	0.08	0.55	0.44	0.00	-0.18
Binh Duong	Vietnam		20	5.0	0.25	3	0.15	0.08	0.2	0.41	0.05	0.11**
Mean			19.1	3.7	0.022	1.5	0.09	0.04	0.45	0.47	0.06	-0.09

Notes: N , population size; n_a , mean number of alleles; n_a/N , mean number of alleles/individual; n_p , number of private alleles; n_p/N , mean number of private alleles/individual; A_p , mean frequency of private alleles; H_o , mean observed heterozygosity; H_e , mean expected heterozygosity; A_n , mean frequency of null alleles; F_{IS} , the inbreeding coefficient.

** p -value ≤ 0.01 ; *** p -value ≤ 0.001 .

Supplementary Figure 1(B)). Although Structure identified only two clusters, their genetic differentiation was significantly high ($F_{ST} = 0.12$, p -value ≤ 0.001). Additionally, these two genetic clusters were found to deviate significantly (p -value ≤ 0.01) from Hardy-Weinberg proportions, with F_{IS} values of 0.23 and 0.36, respectively after implementing 10^4 permutations on allele frequencies in the software GENETIX. This result suggested a Wahlund effect which indicated a genetic substructure. As a consequence, we re-analyzed the two clusters separately and detected substructures in Cluster 2 (Figure 1 and Supplementary Figure 1 (C)). Sub-structuring of Cluster 2 emphasized differentiation among populations from South America (Jurujuba and Rio), Europe (i.e. all French and Italian populations), Africa (Bertoua and Mfilou) and Asia. On the contrary, populations from Florida (Vero Beach), Middle East (Sarba), La Reunion Island (Saint Denis) and Gabon (Franceville) appeared genetically mixed suggesting that these sites may represent cross-roads in *Ae. albopictus* colonization out of Asia (Figure 1).

Spatial and genetic data

When considering the genetic differentiation according to geographical distances using Mantel test, only 21% of the genetic variability was explained by the geographical distance (p -value = 0.03).

NIRVS analysis

We further chose to study NIRVS distribution in 13 *Ae. albopictus* populations selected previously for assessing genetic diversity based on epidemiological data of arboviral outbreaks and *Ae. albopictus* widespread

out if its native range [17,34,35]; we analyzed 10 females and 10 males per population (Table 1). NIRVS distribution was not homogenous across populations (Figure 2, Supplementary Figure 2). AlbFlavi1 (Figure 2(A)) and CSA-JJL (Figure 2(H)) were the most widespread NIRVS, being detected in 85–100% of tested mosquitoes, respectively. On the opposite, AlbFlavi10 was the rarest NIRVS, being found in 17% of the tested mosquitoes. Despite displaying the highest presence of AlbFlavi2 and AlbFlavi4 (present in most populations), Brazilian populations showed the lowest number of NIRVS, with the absence of AlbFlavi36 and AlbFlavi10 and the lower frequency of AlbFlavi41 compared to the other *Ae. albopictus* populations (Figure 2).

Interestingly, when targeting the CSA locus, no amplification was obtained for Brazilian mosquitoes using the NS3-CSA primer set (Supplementary Table 1; Figure 2(G)), which was not consistent with the results obtained with the JJL-CSA primer set that amplified the same NIRVS but targeting a different region (Figure 2(H)). This suggests then that recombination events occurred at this genomic position for Manaus, Rio and PMNI mosquitoes.

Comparison between microsatellite data and NIRVS abundance profiles

To define whether NIRVS evolve under selective pressures or randomly, we compared (i) the relatedness between populations based on microsatellite polymorphism (Figure 3(A)) with (ii) the similarity between populations based on NIRVS abundance profiles (Figure 3(B)). At the population level, the Neighbour-Joining clustering analyses applied to genetic frequencies (Figures 1 and 3(A), Supplementary

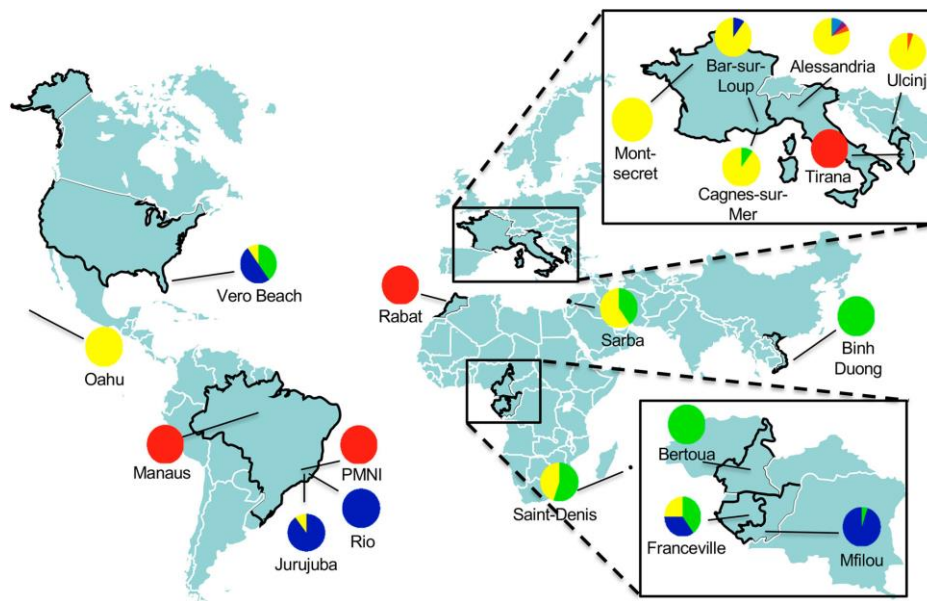

Figure 1. Estimated population structure of 363 individuals (19 populations) using 10 microsatellite markers. Map with sampling sites of populations with colour pie charts showing genotype frequencies, according to Cluster 1 (red) and Cluster 2, which the latest subdivided into 4 subclusters (blue, green, yellow and orange), deduced from the ΔK curve obtained (Supplementary Figure 1(A–C)).

Figure 1(B)) mainly revealed two clusters of populations: one with Tirana, Rabat, Manaus and PMNI populations, and the second with the remaining populations (i.e. Binh Duong, Oahu, Vero Beach, Rio, Franceville, Alessandria, Ulcinj and Mfilou). Regarding NIRVS contents, two major clusters distantly related from each other were also obtained (Figure 3 (B)), one including only Brazilian populations (i.e. Manaus, PMNI and Rio) sharing a low abundance of NIRVS, and the other including geographically distant populations. Therefore, populations from Vero Beach and Rio shared closely related genetic relationships and harboured clearly different abundance profiles of NIRVS (Figure 3(A,B)). Conversely, genetic distinct populations from Vero Beach, Rabat and Alessandria shared the same contents of NIRVS. In short, closely related populations can have different NIRVS contents and geographic and/or genetic distant populations can contain similar NIRVS abundance profiles. Thus, we observed significantly different relatedness between populations according to the marker used, that may indicate that random genetic drift was not the main force shaping these NIRVS distribution. In addition, no correlation was identified between the two matrices ($R^2 = 0.0006$), showing that NIRVS composition of populations was not related to the genetic structure caused by random genetic drift (Supplementary Figure 2).

Relationships between NIRVS landscape and vector competence (from published data)

Our results showed that NIRVS were not neutrally distributed across populations supporting the hypothesis of a biological function of NIRVS, such as antiviral functions, as it has been previously suggested. To analyze whether NIRVS contribute to the control of arboviral replication, we used logistic regression models to evaluate potential association between NIRVS distribution frequencies among populations and dissemination efficiencies (DEs) of DENV and CHIKV in corresponding or geographically close populations selected from the literature (Supplementary Table 2). On this basis, we classified our tested populations depending on their frequencies of each NIRVS using the median. Several associations between NIRVS and DENV DEs were found. Whereas high AlbFlavi2 and CSA-JJL frequencies were significantly associated with high DEs, high AlbFlavi10, AlbFlavi36, AlbFlavi41 and CSA-NS3 frequencies were however correlated to low DENV DEs (Table 4). Opposite associations to CHIKV DEs were also observed but with fewer NIRVS. Indeed, high frequencies of AlbFlavi4 were associated with high CHIKV DEs while high distribution of AlbFlavi36 and CSA-NS3 among populations was correlated to low CHIKV DEs. Together, these results indicated

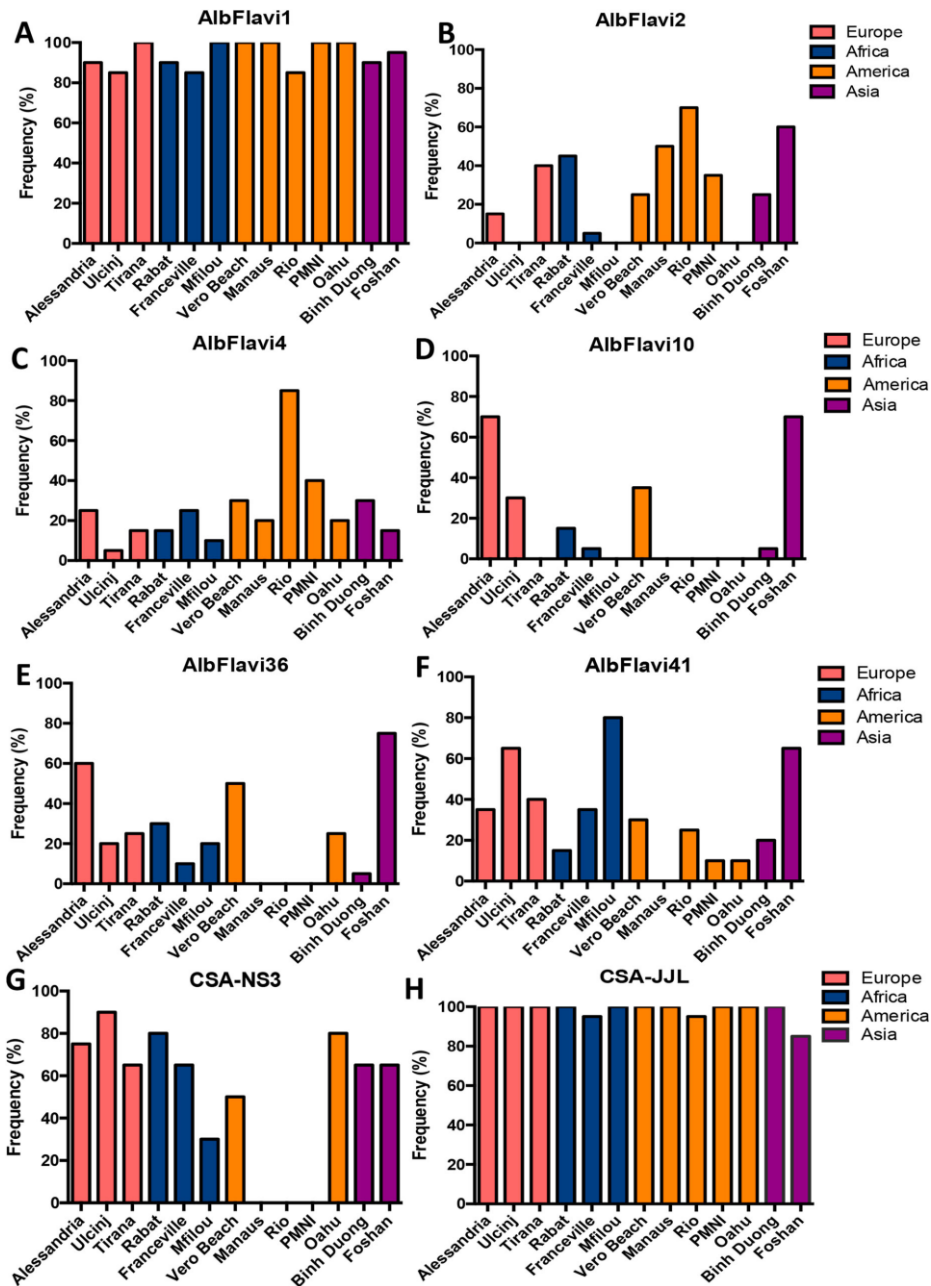

Figure 2. NIRVS variability among *Aedes albopictus* populations. The frequency of AlbFlavi1 (A), AlbFlavi2 (B), AlbFlavi4 (C), AlbFlavi10 (D), AlbFlavi36 (E), AlbFlavi41 (F) and CSA (G and H) was assessed for 20 individuals in each *Ae. albopictus* population (except the Rio population with 19 individuals). Populations were clustered according to their continent of origin. Oahu and Foshan correspond to laboratory colonies. The variability of CSA was assessed using two sets of primers: CSA-NS3 (G) and CSA-JJL (H).

that the presence of NIRVS was associated with changes in DEs of arboviruses in *Ae. albopictus* at the population level.

Focus on AlbFlavi2 and AlbFlavi36

Besides its association to high DENV DEs, we further focused on AlbFlavi2 located in a piRNA cluster and

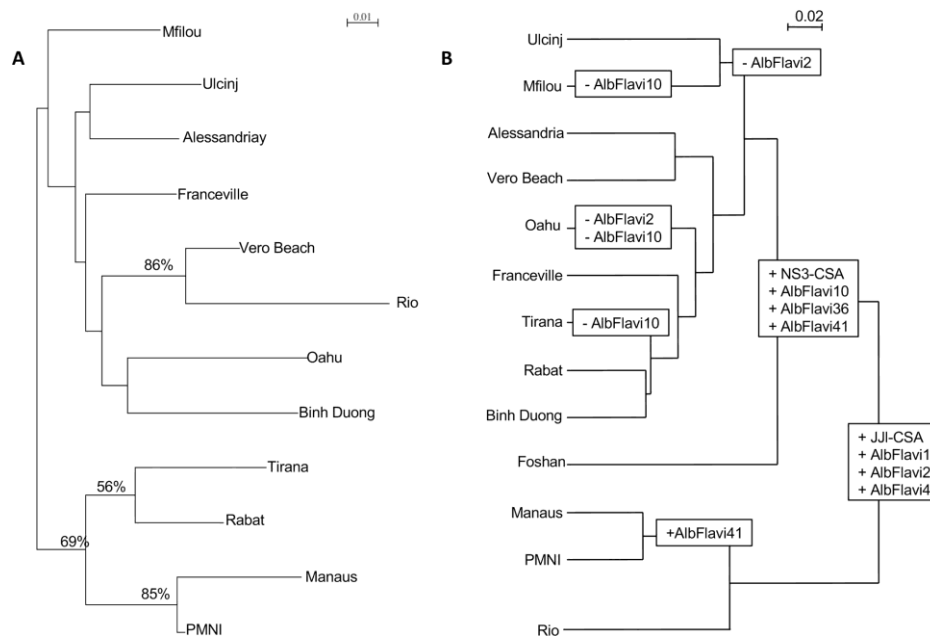

Figure 3. *Aedes albopictus* population clustering based on microsatellite and NIRVS loci. (A) Dendrogram of *Ae. albopictus* populations based on the analysis of 8 microsatellite loci of 12 *Aedes albopictus* populations using Cavalli-Sforza & Edwards's genetic distance and Neighbour-Joining method. Bootstrap values were indicated when >50%. (B) Dendrogram of *Ae. albopictus* populations based on Bray-Curtis distance representing dissimilarities between NIRVS composition and abundances.

Table 4. Association between NIRVS and arboviral dissemination efficiencies in *Aedes albopictus* populations (logistic regression models).

NIRVS	N	OR (95% CI)	p-value
<i>DENV</i>			
AlbFlavi1	707	0.82 (0.61–1.11)	NS
AlbFlavi2		3.07 (2.3–4.2)	***
AlbFlavi4		1.46 (1.0–2.1)	NS
AlbFlavi10		0.46 (0.3–0.6)	***
AlbFlavi36		0.46 (0.3–0.6)	***
AlbFlavi41		0.43 (0.29–0.62)	***
CSA-NS3		0.68 (0.5–0.9)	**
CSA-JJL		3.87 (1.0–14)	*
<i>CHIKV</i>			
AlbFlavi1	360	1.53 (0.9–2.6)	NS
AlbFlavi2		1.3 (0.7–2.1)	NS
AlbFlavi4		2.14 (1.2–3.6)	**
AlbFlavi10		0.60 (0.3–1.0)	NS
AlbFlavi36		0.36 (0.2–0.6)	***
AlbFlavi41		0.61 (0.4–1.0)	NS
CSA-NS3		0.56 (0.3–1.0)	*
CSA-JJL		0.68 (0.3–1.7)	NS

Notes: Dissemination efficiencies (DE) data were assessed from the same or geographically close *Ae. albopictus* populations (see Supplementary Table 2). Populations were characterized as high or low frequencies for each NIRVS by using the median and were analyzed with DE data by logistic regression models to find any association. Odds ratio (OR) >1 and <1 indicated positive and negative association respectively. 95% CI: 95% confidence intervals; N: sample size.

presenting a large geographical distribution encompassing all continents. Moreover, AlbFlavi36 located in an intergenic region was not found in populations from South America and presented an opposite pattern of association to DENV DEs; it was used for

comparison to AlbFlavi2. Therefore, sequence polymorphism, evolution and potential association to vector competence to arboviruses were assessed in *Ae. albopictus* at the individual level.

Sequence polymorphism and evolution of AlbFlavi2 and AlbFlavi36

AlbFlavi2 and AlbFlavi36 of individual mosquitoes were successfully amplified in 10 out of the 13 *Ae. albopictus* populations studied (Figure 2). Sequences of AlbFlavi2 and AlbFlavi36 amplified fragments were aligned with the closely related exogenous viral sequences: the Kamiti River virus (KRV) for AlbFlavi2 and the *Aedes Flavivirus* (AeFV) for AlbFlavi36.

The p-distance calculated between AlbFlavi2 sequences revealed a moderate diversity, with values ranging from 0% to 3.9% (data not shown). All AlbFlavi2 sequences underwent deletion events that were sometimes shared by several individuals from different populations or observed in a specific *Ae. albopictus* population (Figure 4; Supplementary AlbFlavi36).

The p-distance values calculated between AlbFlavi36 sequences were low and varied only from 0% to 0.9% (data not shown). Therefore, AlbFlavi36 sequences mapping to an intergenic region [24] appeared more similar between individuals than AlbFlavi2 sequences (which are integrated in piRNA cluster 27 [53]).

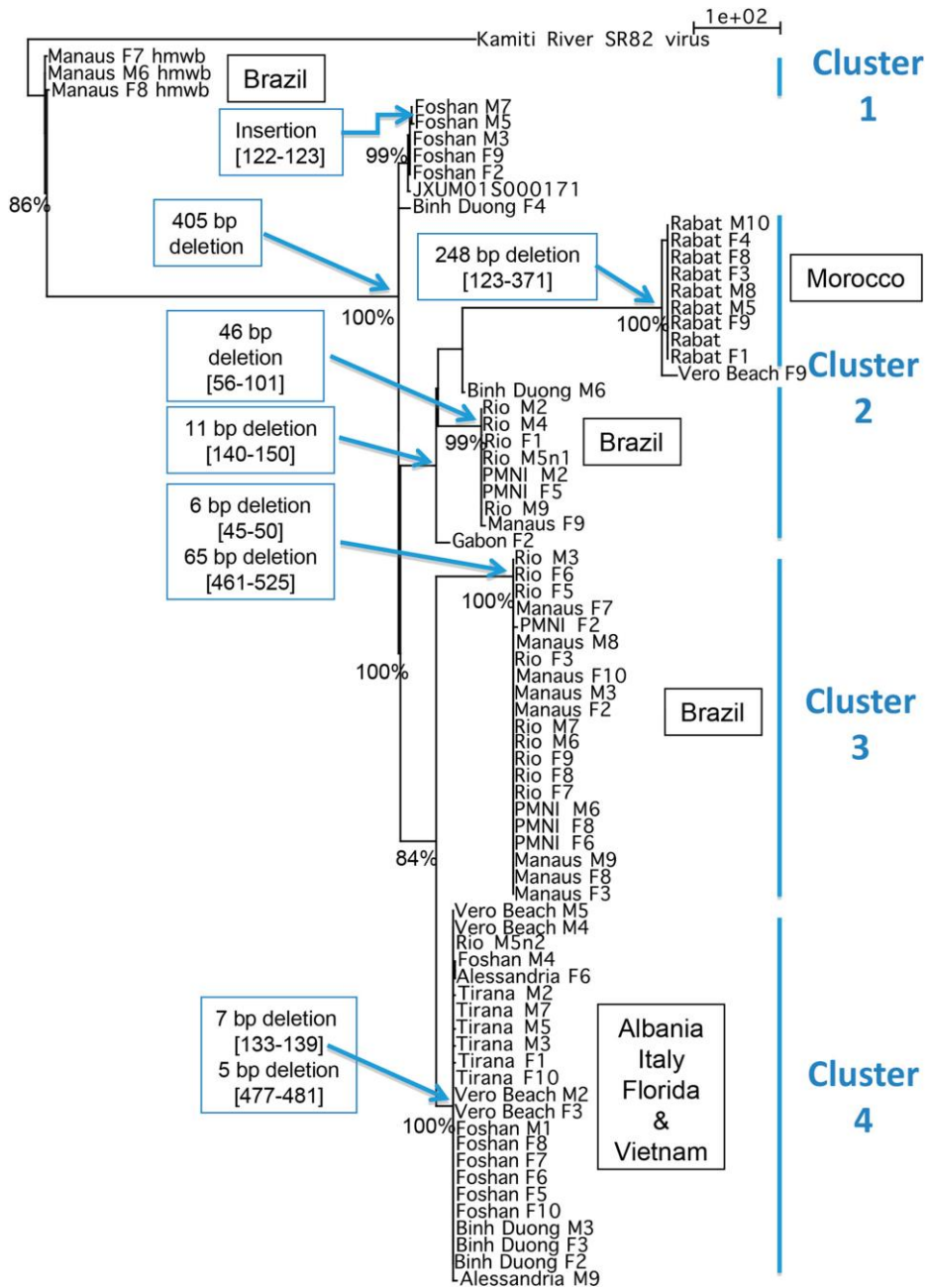

Figure 4. Divergence of AlbFlavi2 among *Aedes albopictus* individuals. Phylogram of AlbFlavi2 sequences based on parsimony with gaps considered as 5th nucleotides. Each node was found in 98–100% of the trees obtained through NNI rearrangements. Significant bootstrap values were indicated at nodes. hmwb: high molecular weight band Values; in brackets: alignment coordinates of deletion. The same result was obtained by parsimony without gap as 5th nucleotide, except for the sequence cluster of mosquitoes from Morocco.

We further performed phylogenetic analysis to describe the evolutionary history of AlbFlavi2 and AlbFlavi36 (Figure 4; Supplementary Figure 4). As

expected, AlbFlavi2 displayed higher divergence than AlbFlavi36. The resulted trees based on AlbFlavi2 supported four major clusters sharing sequences with the

same deletion events (Figure 4). One of them, defined by a 11 bp deletion was subdivided into two subclusters of sequences sharing respectively a 248 bp and a 46 bp deletion. Overall, these clusters did not show any strict relationship with geographical origin of populations.

AlbFlavi2 from Brazilian populations (PMNI, Manaus and Rio) appeared clearly polyphyletic. Three clusters represented only sequences from Brazil: an older cluster of sequences sharing a 405 bp insertion and two other clusters of sequences sharing respectively a 46 bp and a 6–65 bp deletions. Only AlbFlavi2 from Rabat population formed a monophyletic group, a unique cluster of sequences characterized by a 248 bp deletion.

One cluster contained most of the sequences from Tirana (Albania), Vero Beach (USA), Alessandria (Italy) and Binh Duong (Vietnam). However, some sequences from Binh Duong, Vero Beach and

Alessandria populations, were also isolated or found in other clusters. Moreover, half of the AlbFlavi2 sequences from Foshan formed a unique cluster whereas the other half shared the heterogeneous cluster of sequences described above.

The polymorphism of AlbFlavi36 was low in *Ae. albopictus* populations and all the sequences showed close relationships with each other, without any significant bootstrap values (Supplementary Figure 4). However, sequences from African mosquitoes (Congo, Gabon and Morocco) in branching deeply in the tree may be more ancient than sequences of Asian (Binh Duong, Foshan) and European mosquitoes.

Collectively, phylogenetic studies revealed different histories of NIRVS in mosquito populations and particularly, complex history of Albflavi2 evolving by both mutation and deletion events.

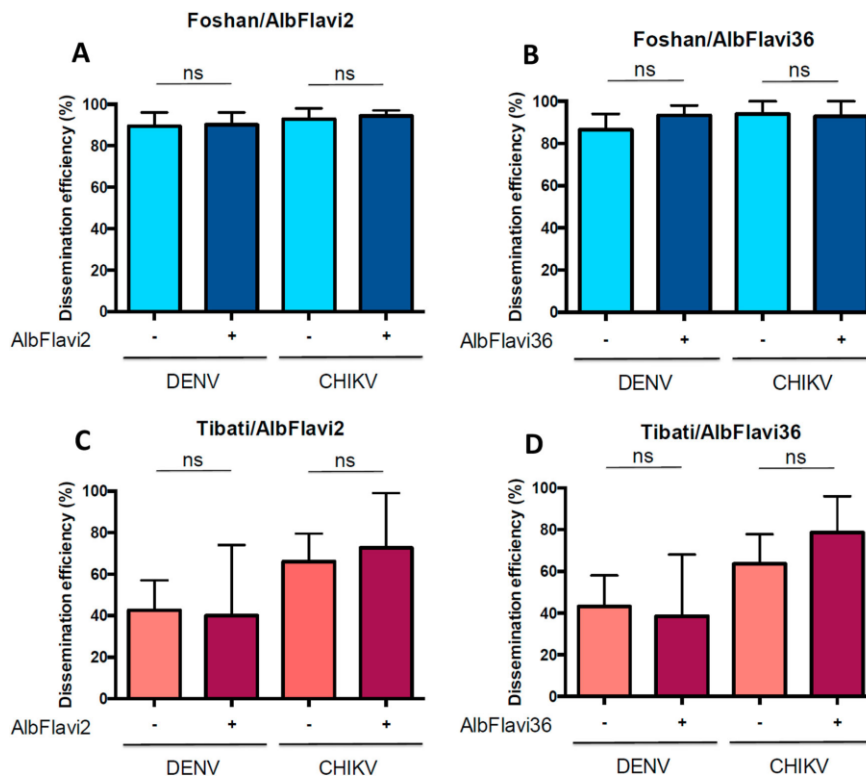

Figure 5. Pilot analysis showing the association between frequencies of AlbFlavi2/AlbFlavi36 and DENV/CHIKV dissemination efficiencies (DE) in *Aedes albopictus* populations. The Foshan colony and the Tibati population (Cameroon, generation F1) were used for the analysis. (A) Presence/absence of AlbFlavi2 and DEs to DENV and CHIKV obtained for the Foshan colony. (B) Presence/absence of AlbFlavi36 and DEs to DENV and CHIKV obtained for the Foshan colony. (C) Presence/absence of AlbFlavi2 and DEs to DENV and CHIKV obtained for the Tibati population. (D) Presence/absence of AlbFlavi36 and DEs to DENV and CHIKV obtained for the Tibati population. DEs were obtained for both viruses at 14 days post-infection. In total, 191 and 122 individuals were examined for presence of AlbFlavi2/AlbFlavi36 after infection DENV and CHIKV, respectively. Interactions of populations and frequencies of AlbFlavi2/AlbFlavi36 with DEs were tested using logistic regression models.

Association between AlbFlavi2/Albflavi36 and vector competence in *Ae. albopictus* at the individual level

To further investigate the biological role of AlbFlavi2 and AlbFlavi36, we extended our analyses of association between the presence of these two NIRVS and viral dissemination from a population level to an individual level. To do so, mosquitoes of the Foshan colony strain and the field-collected Tibati population (Cameroon) were infected with DENV-2 and CHIKV. At 14 days post-infection, mosquito dissemination status and the presence of both AlbFlavi2 and AlbFlavi36 were determined for 313 mosquitoes (Figure 5). When comparing DENV dissemination, Foshan better disseminated than Tibati (respectively 89.8% and 42.2%; p -value $<10^{-4}$; data not shown). However, the presence of AlbFlavi2 or AlbFlavi36 in mosquitoes from Foshan or Tibati was not significantly associated to DENV dissemination (p -values > 0.209 ; Figure 5(A–D)). Moreover, the same results were obtained regarding the association between AlbFlavi2/AlbFlavi36 presence and CHIKV dissemination (p -values > 0.3 ; Figure 5(A–D)). In all, using both laboratory colony and field-collected mosquitoes, no association was found between any of the two NIRVS (AlbFlavi2 and AlbFlavi36) and DENV/CHIKV dissemination.

Discussion

The presence of sequences with similarities to Flaviviruses in the genome of *Aedes* spp. mosquitoes and their enrichment in piRNA clusters support the hypothesis that viral integrations, at least some, are not simply viral fossils, but could have a biological role [24,25,54]. Here we demonstrated that the NIRVS studied are not neutrally distributed among *Ae. albopictus* populations and all of them (except AlbFlavi1) were significantly associated to vector competence to DENV and CHIKV.

NIRVS are not neutral markers

NIRVS are endogenous viral sequences located in protein-coding gene exons, intergenic regions, and PIWI-interacting RNA (piRNA) clusters [55]. Contrary to the other categories, piRNA genes are evolving rapidly under positive selection to generate a high diversity of piRNAs [56–63]. Approximately 30 sequences of flaviviral ORFs (primarily NS1 and NS5) were detected in the Foshan colony [24] including the early-detected Flavivirus-like sequences [21,64]. It has been suggested that the variable number and frequency of NIRVS across *Ae. albopictus* populations contribute to variations of genome size among mosquitoes [36]. Our study targeted seven NIRVS (AlbFlavi1, AlbFlavi2, AlbFlavi4, AlbFlavi10, AlbFlavi36, AlbFlavi41, CSA), for which their

evolution under selection pressures or simply by genetic drift remained unknown.

Contrary to NIRVS deriving from flaviviruses in *Ae. aegypti* (unpublished data), the presence of the tested NIRVS was highly variable among worldwide populations, with the lowest number being detected in mosquitoes from Brazil. This suggests that these NIRVS have not reached fixation in any of the *Ae. albopictus* populations tested (with potential exception for AlbFlavi1 and a fragment of CSA). Interestingly, Brazilian populations (Manaus, Rio, and PMNI) displayed the lowest number of NIRVS studied with a total absence of AlbFlavi10, AlbFlavi36 and CSA-NS3. Considering the ancient origin of NIRVS, estimated between 6.5 thousands to 2.5 million years ago [65], we hypothesized that they might have been less exposed to ISFs in the past, leading to fewer NIRVS in their genomes or that populations may have acquired NIRVS in the past which have been lost over time.

We showed that the microsatellite polymorphism of populations did not match with the NIRVS abundance profiles. Therefore, because microsatellites are sequences that neutrally evolve in the genome, we speculate that the evolution of NIRVS is far from neutral and NIRVS could provide benefits to the host. NIRVS may have been produced for specific purposes in the host rather than being the consequences of random endogenization of exogenous viral fragments.

The focus on NIRVS from piRNA cluster (AlbFlavi2) and intergenic region (AlbFlavi36) revealed different sequence polymorphism and evolutionary histories despite their relatively wide distribution among *Ae. albopictus* populations. Whereas AlbFlavi36 appeared monophyletic with highly conserved sequences among populations, the phylogenetic analyses showed a particularly complex history for Albflavi2 evolving by both mutation and deletion events. We postulate that owing to its high variability, AlbFlavi2 may act similarly to TE fragments and piRNA genes, and evolve according to exposures to related exogenous virus burden.

Association between NIRVS and vector competence to arboviruses

Similar to some endogenous retroviruses (ERVs) that have an effect on viruses from different subfamilies and genera [66], we questioned whether NIRVS deriving from ISF sequences affect the dissemination of different arboviruses and contribute to the regulation of vector competence of *Ae. albopictus* mosquitoes. Because NIRVS located in piRNA clusters, such as AlbFlavi2, produce piRNAs, are differentially distributed among populations and appeared older integrations than NIRVS located in codons [65], they were proposed to function as novel mosquito antiviral immune factors. However, contradictory results were obtained using both population- and individual-level analysis.

At the population level, many NIRVS were present in *Ae. albopictus* populations. The frequency of some of them appears correlated (positively or negatively) to DENV dissemination. Whereas some NIRVS were associated with high viral dissemination (i.e. AlbFlavi2 and CSA-JJL), others were significantly related to low viral dissemination (AlbFlavi10, AlbFlavi36, AlbFlavi41 and CSA-NS3), suggesting different functions of NIRVS deriving from ISFs. Moreover, fewer NIRVS were positively (i.e. AlbFlavi4) and negatively (i.e. AlbFlavi36 and CSA-NS3) correlated to CHIKV dissemination. These results are consistent with the contradictory results obtained in studies assessing the impact of exogenous ISFs on arbovirus fitness in mosquitoes. Indeed, whereas some ISFs have shown to repress arboviral replication [67], others have been proved to facilitate infection [68]. Further experiments should be performed to confirm these results, as only 20 mosquitoes per population were tested for NIRVS distribution.

At the level of individuals, our pilot experiment based on mosquitoes from both laboratory colony and field did not show any significant association between dissemination of DENV and CHIKV, and NIRVS, AlbFlavi2 or AlbFlavi36. While this does not seem surprising for the alphavirus CHIKV considering that NIRVS examined are homologous to flavivirus sequences, it is still questionable for DENV. Since it appears that they do not evolve neutrally and were preserved from purifying selection, NIRVS such as CSA has demonstrated to produce a transcript of 4671 nt long [21,69]; its functional role should be investigated. Lastly, other components should be considered such as the virome [70] in addition to the anatomical barriers in the mosquito such as the salivary glands for viral transmission [19].

To conclude, our results clearly show that NIRVS in *Ae. albopictus* follow processes different from that of neutral genes such as microsatellites and most NIRVS are far from reaching fixation. Flaviviral integrations are differentially distributed among *Ae. albopictus* populations and are here suggested to be associated with the vector competence to arboviruses by mechanisms that remain to be elucidated. Finally, this study opens the way to new perspectives on evolution and biological functions of NIRVS, in part on vector competence.

Acknowledgements

We are grateful to Basile Kamgang for providing mosquito samples, and Dominique Higuët, Anna Malacrida, Giuliano Gasperi for discussions. We also thank Charlotte Balière, Valérie Caro and Aurélie Kwasiborski for help in genotyping mosquitoes.

Author contributions

ABF and XDL designed the experiments; VH performed the research; GG did the microsatellite genotyping; CD did the phylogenetic reconstruction; MS

and MM did the analysis of genetic structure; YD did the statistical analysis; LM and PSY provided a technical help; MB edited the paper; VH, CD, ABF wrote the paper.

Disclosure statement

No potential conflict of interest was reported by the authors.

Funding

This study was supported by the Institut Pasteur, the French Government's Investissement d'Avenir program, Laboratoire d'Excellence "Integrative Biology of Emerging Infectious Diseases" (grant number ANR-10-LABX-62-IBEID to A-BF), the European Union's Horizon 2020 research and innovation program, ZIKAlliance program under ZIKAlliance grant agreement no. 734548 to A-BF, and the European Research Council, NIRV_HOST_INT Council (grant agreement number 682394 – NIRV_HOST_INT to VH and MB).

ORCID

Michele Marconcini  <http://orcid.org/0000-0002-6785-9106>

Mariangela Bonizzoni  <http://orcid.org/0000-0003-0568-8564>

Anna-Bella Failloux  <http://orcid.org/0000-0001-6890-0820>

References

- Paupy C, Delatte H, Bagny L, et al. *Aedes albopictus*, an arbovirus vector: from the darkness to the light. *Microbes Infect.* 2009;11:1177–1185. doi:10.1016/j.micinf.2009.05.005.
- Bonizzoni M, Gasperi G, Chen X, et al. The invasive mosquito species *Aedes albopictus*: current knowledge and future perspectives. *Trends Parasitol.* 2013;29:460–468. doi:10.1016/j.pt.2013.07.003.
- Caminade C, Medlock JM, Ducheyne E, et al. Suitability of European climate for the Asian tiger mosquito *Aedes albopictus*: recent trends and future scenarios. *J R Soc Interface.* 2012;9:2708–2717. doi:10.1098/rsif.2012.0138.
- Benedict MQ, Levine RS, Hawley WA, et al. Spread of the tiger: global risk of invasion by the mosquito *Aedes albopictus*. *Vector Borne Zoonotic Dis.* 2007;7:76–85. doi:10.1089/vbz.2006.0562.
- Lounibos LP. Invasions by insect vectors of human disease. *Annu Rev Entomol.* 2002;47:233–266. doi:10.1146/annurev.ento.47.091201.145206.
- Hawley WA. The biology of *Aedes albopictus*. *J Am Mosq Control Assoc Suppl.* 1988;1:1–39.
- Adhami J, Reiter P. Introduction and establishment of *Aedes (Stegomyia) albopictus* skuse (Diptera: Culicidae) in Albania. *J Am Mosq Control Assoc.* 1998;14:340–343.
- Sprenger D, Wuithiranyagool T. The discovery and distribution of *Aedes albopictus* in Harris County, Texas. *J Am Mosq Control Assoc.* 1986;2:217–219.
- Consoli RAGB OR. Principais mosquitos de importância sanitária no Brasil. Rio de Janeiro. Editora FIOCRUZ. 1994;228.

- [10] Cornel AJ, Hunt RH. *Aedes albopictus* in Africa? First records of live specimens in imported tires in Cape Town. *J Am Mosq Control Assoc.* 1991;7:107–108.
- [11] Goubert C, Minard G, Vieira C, et al. Population genetics of the Asian tiger mosquito *Aedes albopictus*, an invasive vector of human diseases. *Heredity (Edinb).* 2016;117:125–134. doi:10.1038/hdy.2016.35.
- [12] Jackson H, Strubbe D, Tollington S, et al. Ancestral origins and invasion pathways in a globally invasive bird correlate with climate and influences from bird trade. *Mol Ecol.* 2015;24:4269–4285. doi:10.1111/mec.13307.
- [13] Powell JR, Tabachnick WJ. History of domestication and spread of *Aedes aegypti*—a review. *Mem Inst Oswaldo Cruz.* 2013;108(Suppl 1):11–17. doi:10.1590/0074-0276130395.
- [14] Maynard AJ, Ambrose L, Cooper RD, et al. Tiger on the prowl: invasion history and spatio-temporal genetic structure of the Asian tiger mosquito *Aedes albopictus* (Skuse 1894) in the Indo-Pacific. *PLoS Negl Trop Dis.* 2017;11:e0005546. doi:10.1371/journal.pntd.0005546.
- [15] Kotsakiozi P, Richardson JB, Pichler V, et al. Population genomics of the Asian tiger mosquito, *Aedes albopictus*: insights into the recent worldwide invasion. *Ecol Evol.* 2017;7:10143–10157. doi:10.1002/ece3.3514.
- [16] Manni M, Gomulski LM, Aketarawong N, et al. Molecular markers for analyses of intraspecific genetic diversity in the Asian tiger mosquito, *Aedes albopictus*. *Parasit Vectors.* 2015;8:188. doi:10.1186/s13071-015-0794-5.
- [17] Manni M, Guglielmino CR, Scolari F, et al. Genetic evidence for a worldwide chaotic dispersion pattern of the arbovirus vector, *Aedes albopictus*. *PLoS Negl Trop Dis.* 2017;11:e0005332. doi:10.1371/journal.pntd.0005332.
- [18] Mousson L, Dauga C, Garrigues T, et al. Phylogeography of *Aedes* (Stegomyia) *aegypti* (L.) and *Aedes* (Stegomyia) *albopictus* (Skuse) (Diptera: Culicidae) based on mitochondrial DNA variations. *Genet Res.* 2005;86:1–11. doi:10.1017/S0016672305007627.
- [19] Kramer LD, Ebel GD. Advances in virus research. *Adv Virus Res.* 2003;60:187–232.
- [20] Zouache K, Fontaine A, Vega-Rúa A, et al. Three-way interactions between mosquito population, viral strain and temperature underlying chikungunya virus transmission potential. *Proc Biol Sci.* 2014;281. doi:10.1098/rspb.2014.1078.
- [21] Crochu S, et al. Sequences of flavivirus-related RNA viruses persist in DNA form integrated in the genome of *Aedes* spp. mosquitoes. *J Gen Virol.* 2004;85:1971–1980. doi:10.1099/vir.0.79850-0.
- [22] Katzourakis A, Gifford RJ. Endogenous viral elements in animal genomes. *PLoS Genet.* 2010;6:e1001191. doi:10.1371/journal.pgen.1001191.
- [23] Fort P, Albertini A, Van-Hua A, et al. Fossil rhabdoviral sequences integrated into arthropod genomes: ontology, evolution, and potential functionality. *Mol Biol Evol.* 2012;29:381–390. doi:10.1093/molbev/msr226.
- [24] Palatini U, Miesen P, Carballar-Lejarazu R, et al. Comparative genomics shows that viral integrations are abundant and express piRNAs in the arboviral vectors *Aedes aegypti* and *Aedes albopictus*. *BMC Genomics.* 2017;18:512. doi:10.1186/s12864-017-3903-3.
- [25] Whitfield ZJ, Dolan PT, Kunitomi M, et al. The diversity, structure, and function of heritable adaptive immunity sequences in the *Aedes aegypti* genome. *Curr Biol.* 2017;27:3511–3519. doi:10.1016/j.cub.2017.09.067. e3517.
- [26] Brennecke J, Aravin AA, Stark A, et al. Discrete small RNA-generating loci as master regulators of transposon activity in *Drosophila*. *Cell.* 2007;128:1089–1103. doi:10.1016/j.cell.2007.01.043.
- [27] Pelisson A, Sarot E, Payen-Groschene G, et al. A novel repeat-associated small interfering RNA-mediated silencing pathway downregulates complementary sense gypsy transcripts in somatic cells of the *Drosophila* ovary. *J Virol.* 2007;81:1951–1960. doi:10.1128/JVI.01980-06.
- [28] Saito K, Nishida KM, Mori T, et al. Specific association of Piwi with rasiRNAs derived from retrotransposon and heterochromatic regions in the *Drosophila* genome. *Genes Dev.* 2006;20:2214–2222. doi:10.1101/gad.1454806.
- [29] Vagin VV, Sigova A, Li C, et al. A distinct small RNA pathway silences selfish genetic elements in the germline. *Science.* 2006;313:320–324. doi:10.1126/science.1129333.
- [30] Zanni V, Eymery A, Coiffet M, et al. Distribution, evolution, and diversity of retrotransposons at the flamenco locus reflect the regulatory properties of piRNA clusters. *Proc Natl Acad Sci U S A.* 2013;110:19842–19847. doi:10.1073/pnas.1313677110.
- [31] Frank JA, Feschotte C. Co-option of endogenous viral sequences for host cell function. *Curr Opin Virol.* 2017;25:81–89. doi:10.1016/j.coviro.2017.07.021.
- [32] Aswad A, Katzourakis A. Paleovirology and virally derived immunity. *Trends Ecol Evol.* 2012;27:627–636. doi:10.1016/j.tree.2012.07.007.
- [33] Katzourakis A. Paleovirology: inferring viral evolution from host genome sequence data. *Philos Trans R Soc Lond B Biol Sci.* 2013;368:20120493. doi:10.1098/rstb.2012.0493.
- [34] Musso D, Rodriguez-Morales AJ, Levi JE, et al. Unexpected outbreaks of arbovirus infections: lessons learned from the Pacific and tropical America. *Lancet Infect Dis.* 2018;18:e355–e361. doi:10.1016/S1473-3099(18)30269-X.
- [35] Fritzell C, Rousset D, Adde A, et al. Current challenges and implications for dengue, chikungunya and Zika seroprevalence studies worldwide: A scoping review. *PLoS Negl Trop Dis.* 2018;12:e0006533. doi:10.1371/journal.pntd.0006533.
- [36] Chen XG, Jiang X, Gu J, et al. Genome sequence of the Asian tiger mosquito, *Aedes albopictus*, reveals insights into its biology, genetics, and evolution. *Proc Natl Acad Sci U S A.* 2015;112:E5907–E5915. doi:10.1073/pnas.1516410112.
- [37] GENETIX 4.05 Logiciel Sous Windows TM Pour la Génétique des Populations. 1996–2004.
- [38] FSTAT, a program to estimate and test gene diversities and fixation indices (version 2.9.3). 2001.
- [39] Excoffier L, Lischer HE. Arlequin suite ver 3.5: a new series of programs to perform population genetics analyses under Linux and Windows. *Mol Ecol Resour.* 2010;10:564–567. doi:10.1111/j.1755-0998.2010.02847.x.
- [40] Peakall R, Smouse PE. Genalex 6.5: genetic analysis in Excel. Population genetic software for teaching and research—an update. *Bioinformatics.* 2012;28:2537–2539. doi:10.1093/bioinformatics/bts460.
- [41] Vazeille M, Zouache K, Vega-Rúa A, et al. Importance of mosquito “quasispecies” in selecting an epidemic arthropod-borne virus. *Sci Rep.* 2016;6:29564. doi:10.1038/srep29564.

- [42] Pritchard JK, Stephens M, Donnelly P. Inference of population structure using multilocus genotype data. *Genetics*. 2000;155:945–959.
- [43] Evanno G, Regnaut S, Goudet J. Detecting the number of clusters of individuals using the software STRUCTURE: a simulation study. *Mol Ecol*. 2005;14:2611–2620. doi:10.1111/j.1365-294X.2005.02553.x.
- [44] Rosenberg N. DISTRUCT: a program for the graphical display of population structure. *Mol Ecol Notes*. 2004;4:137–138. doi:10.1046/j.1471-8286.2003.00566.x.
- [45] Rozen S, Skaletsky H. Primer3 on the WWW for general users and for biologist programmers. *Methods Mol Biol*. 2000;132:365–386.
- [46] Ricotta C, Podani J. On some properties of the Bray-Curtis dissimilarity and their ecological meaning. *Ecol Complex*. 2017;31:201–205.
- [47] Vega-Rua A, Zouache K, Girod R, et al. High level of vector competence of *Aedes aegypti* and *Aedes albopictus* from ten American countries as a crucial factor in the spread of chikungunya virus. *J Virol*. 2014;88:6294–6306. doi:10.1128/JVI.00370-14.
- [48] Edgar RC. MUSCLE: a multiple sequence alignment method with reduced time and space complexity. *BMC Bioinformatics*. 2004;5:113. doi:10.1186/1471-2105-5-113.
- [49] PAUP*. Phylogenetic analysis using parsimony (*and other methods). Version 4. Sunderland (MA), 1998.
- [50] Vazeille-Falcoz M, Mousson L, Rodhain F, et al. Variation in oral susceptibility to dengue type 2 virus of populations of *Aedes aegypti* from the islands of Tahiti and Moorea, French Polynesia. *Am J Trop Med Hyg*. 1999;60:292–299.
- [51] Schuffenecker I, Iteman I, Michault A, et al. Genome microevolution of chikungunya viruses causing the Indian Ocean outbreak. *PLoS Med*. 2006;3:e263. doi:10.1371/journal.pmed.0030263.
- [52] Amraoui F, Ben Ayed W, Madec Y, et al. Potential of *Aedes albopictus* to cause the emergence of arboviruses in Morocco. *PLoS Negl Trop Dis*. 2019;13:e0006997. doi:10.1371/journal.pntd.0006997.
- [53] Liu P, Dong Y, Gu J, et al. Developmental piRNA profiles of the invasive vector mosquito *Aedes albopictus*. *Parasit Vectors*. 2016;9:524. doi:10.1186/s13071-016-1815-8.
- [54] Olson KE, Bonizzoni M. Nonretroviral integrated RNA viruses in arthropod vectors: an occasional event or something more? *Curr Opin Insect Sci*. 2017;22:45–53. doi:10.1016/j.cois.2017.05.010.
- [55] Houe V, Bonizzoni M, Failloux AB. Endogenous non-retroviral elements in genomes of *Aedes* mosquitoes and vector competence. *Emerg Microbes Infect*. 2019;8:542–555. doi:10.1080/22221751.2019.1599302.
- [56] Lee YC, Langley CH. Long-term and short-term evolutionary impacts of transposable elements on *Drosophila*. *Genetics*. 2012;192:1411–1432. doi:10.1534/genetics.112.145714.
- [57] Vermaak D, Henikoff S, Malik HS. Positive selection drives the evolution of rhino, a member of the heterochromatin protein 1 family in *Drosophila*. *PLoS Genet*. 2005;1:96–108. doi:10.1371/journal.pgen.0010009.
- [58] Lewis SH, Quarles KA, Yang Y, et al. Pan-arthropod analysis reveals somatic piRNAs as an ancestral defence against transposable elements. *Nat Ecol Evol*. 2018;2:174–181. doi:10.1038/s41559-017-0403-4.
- [59] Heger A, Ponting CP. Evolutionary rate analyses of orthologs and paralogs from 12 *Drosophila* genomes. *Genome Res*. 2007;17:1837–1849. doi:10.1101/gr.6249707.
- [60] Obbard DJ, Gordon KH, Buck AH, et al. The evolution of RNAi as a defence against viruses and transposable elements. *Philos Trans R Soc Lond B Biol Sci*. 2009;364:99–115. doi:10.1098/rstb.2008.0168.
- [61] Kolaczowski B, Hupalo DN, Kern AD. Recurrent adaptation in RNA interference genes across the *Drosophila* phylogeny. *Mol Biol Evol*. 2011;28:1033–1042. doi:10.1093/molbev/msq284.
- [62] Yi M, Chen F, Luo M, et al. Rapid evolution of piRNA pathway in the teleost fish: implication for an adaptation to transposon diversity. *Genome Biol Evol*. 2014;6:1393–1407. doi:10.1093/gbe/evu105.
- [63] Simkin A, Wong A, Poh YP, et al. Recurrent and recent selective sweeps in the piRNA pathway. *Evolution*. 2013;67:1081–1090. doi:10.1111/evo.12011.
- [64] Roiz D, Vazquez A, Seco MP, et al. Detection of novel insect flavivirus sequences integrated in *Aedes albopictus* (Diptera: Culicidae) in Northern Italy. *Virol J*. 2009;6:93. doi:10.1186/1743-422X-6-93.
- [65] Pischedda E, Scolari F, Valerio F, et al. Insights into an unexplored component of the mosquito repeatome: distribution and variability of viral sequences integrated into the genome of the arboviral vector *Aedes albopictus*. *Front Genet*. 2019;10:93. doi:10.3389/fgene.2019.00093.
- [66] Yap MW, Colbeck E, Ellis SA, et al. Evolution of the retroviral restriction gene Fv1: inhibition of non-MLV retroviruses. *PLoS Pathog*. 2014;10:e1003968. doi:10.1371/journal.ppat.1003968.
- [67] Hobson-Peters J, Yam AWY, Lu JWF, et al. A new insect-specific flavivirus from northern Australia suppresses replication of West Nile virus and Murray Valley encephalitis virus in co-infected mosquito cells. *PLoS One*. 2013;8:e56534. doi:10.1371/journal.pone.0056534.
- [68] Kuwata R, Isawa H, Hoshino K, et al. Analysis of mosquito-borne flavivirus superinfection in *Culex tritaeniorhynchus* (Diptera: Culicidae) cells persistently infected with Culex Flavivirus (Flaviviridae). *J Med Entomol*. 2015;52:222–229. doi:10.1093/jme/tju059.
- [69] Suzuki Y, Frangeul L, Dickson LB, et al. Uncovering the repertoire of endogenous flaviviral elements in *Aedes* mosquito genomes. *J Virol*. 2017;91. doi:10.1128/JVI.00571-17.
- [70] Bolling BG, Weaver SC, Tesh RB, et al. Insect-specific virus discovery: significance for the arbovirus community. *Viruses*. 2015;7:4911–4928. doi:10.3390/v7092851.

Caractérisation de séquences intégrées de virus à ARN non-rétroviral dans les populations d'*Aedes albopictus* et relation avec la compétence vectorielle

Résumé:

Aedes albopictus est un moustique vecteur d'arbovirus, et ceci fait de lui une menace sérieuse pour la santé humaine. Durant la dernière décennie, les NIRVS (séquences intégrées de virus à ARN non-rétroviraux) issues de Flavivirus spécifiques d'insectes (FSIs) ont été découverts intégrées dans le génome du moustique *Aedes albopictus*. De plus, il a été montré que ces éléments pourraient avoir un rôle antiviral chez le vecteur par la production de piARNs qui réduirait la réplication virale. Nous avons caractérisé 8 NIRVS chez 12 populations d'*Ae. albopictus*. Nous montrons qu'il y a une forte diversité inter- et intra-population, suggérant une évolution complexe de ces NIRVS dans le génome, différemment des marqueurs à évolution neutre tels les microsatellites, suggérant une fonction potentielle des NIRVS. Nous montrons que cette fonction pourrait être liée à la compétence vectorielle d'*Ae. albopictus* pour les arbovirus. Enfin, En utilisant des lignées cellulaires infectées de manière persistante par des arbovirus, nous montrons que la formation des NIRVS est un évènement qui se produit rarement dans le génome des moustiques *Aedes*, et que les arbovirus ainsi que les FSIs, sont capable d'endogénéisation chez les moustiques.

Mots clés : [*Aedes albopictus* ; NIRVS ; Compétence Vectorielle ; Arbovirus]

Characterization of non-retroviral integrated RNA virus sequences (NIRVS) in *Aedes albopictus* populations and relation with vector competence

Abstract :

Aedes albopictus is a vector for transmitting arboviruses and this makes it a serious threat for human health. In the last decade, NIRVS (non-retroviral integrated RNA virus sequences) from insect-specific flaviviruses (ISFs) have been found integrated in *Ae. albopictus* mosquito genome. Moreover, it has been shown that these elements may have an antiviral role in vectors by producing piRNAs that would reduce viral replication. Here we characterized 7 NIRVS in 12 *Ae. albopictus* populations. We show that there is a high inter- and intra-population diversity, suggesting a complex evolution of these NIRVS in *Ae. albopictus* genome. Moreover, those NIRVS evolved differently from neutral genes such as microsatellites, suggesting a potential function of these elements. We show that this function can be the vector competence of *Ae. albopictus* to arboviruses. Finally, we show by establishing persistently-infected cells that NIRVS formation is an event that occurs rarely in *Aedes* mosquito genome however arboviruses, along with ISFs, are also capable of endogenization in mosquitoes.

Keywords: [*Aedes albopictus*; NIRVS; Vector competence; Arbovirus]