



HAL
open science

Cubic realizations of some combinatorial partial orders

Camille Combe

► **To cite this version:**

Camille Combe. Cubic realizations of some combinatorial partial orders. *Combinatorics [math.CO]*.
Université de Strasbourg, 2020. English. NNT : 2020STRAD028 . tel-02994460v4

HAL Id: tel-02994460

<https://theses.hal.science/tel-02994460v4>

Submitted on 16 Nov 2022 (v4), last revised 29 Dec 2022 (v5)

HAL is a multi-disciplinary open access archive for the deposit and dissemination of scientific research documents, whether they are published or not. The documents may come from teaching and research institutions in France or abroad, or from public or private research centers.

L'archive ouverte pluridisciplinaire **HAL**, est destinée au dépôt et à la diffusion de documents scientifiques de niveau recherche, publiés ou non, émanant des établissements d'enseignement et de recherche français ou étrangers, des laboratoires publics ou privés.

THÈSE DE DOCTORAT

Spécialité Mathématiques

Présentée le 20 novembre 2020 par

Camille Combe

Université de Strasbourg

Réalisations cubiques d'ordres partiels combinatoires

Cubic realizations of some combinatorial partial orders

Devant le jury composé par

Frédéric Chapoton	Directeur de Thèse
Dominique Manchon	Rapporteur
Christophe Reutenauer	Rapporteur
Claudia Malvenuto	Examinatrice
Jean-Christophe Novelli	Examineur
Viviane Pons	Examinatrice

Remerciements

Je remercie mon directeur de thèse, Frédéric Chapoton, pour m'avoir transmis sa passion et pour m'avoir initiée à de nombreux sujets. Merci pour l'investissement personnel, les innombrables heures à relire mes écrits, à discuter de concepts, d'idées, de démonstrations, et surtout pour m'avoir encouragée dans mes propres idées. Merci aux membres du jury, les rapporteurs, Dominique Manchon et Christophe Reutenauer, et les examinateurs, Claudia Malvenuto, Jean-Christophe Novelli et Viviane Pons, pour avoir répondu présent sans hésitation et pour leur temps. Je n'aurais pu imaginer meilleure composition pour mon jury de thèse.

Dans le domaine de la combinatoire algébrique, je remercie Jean-Christophe Aval, François Bergeron, Nicolas Bonichon, Olivier Bouillot, Grégory Châtel, Bérénice Delcroix-Oger, Sophia Elia, Justine Falque, Wenjie Fang, Loïc Foissy, Florent Hivert, Matthieu Josuat-Vergès, Jean-Philippe Labbé, Dominique Manchon, Henry Mülhe, Philippe Nadeau, Jean-Christophe Novelli, Arthur Nunge, Vincent Pilaud, Viviane Pons, Baptiste Rognerud, Jean-Yves Thibon, Xavier Gérard Viennot, Marc Zipstein pour leur aide, conseils et/ou soutien durant ma thèse, ou simplement pour leur amitié. Merci à toute la communauté de la combinatoire algébrique, qui forme une grande famille que j'apprécie beaucoup. Je remercie mon co-auteur Samuele Giraudo pour son enthousiasme pour mes idées, et pour m'avoir beaucoup appris. J'ai également une pensée pour Clément Dupont et Emeric Gioan qui m'ont encadrée en master, et sans qui je n'aurais pas connu mon domaine de recherche, merci à vous deux.

Je remercie le personnel administratif de l'IRMA dont les secrétaires ont toujours été très efficaces, les enseignant-chercheurs et chercheurs, les directeurs du laboratoire Yann Bugeaud et Philippe Helluy, et les doctorants que j'ai côtoyés pendant ces trois années. Merci à mon comité de suivi de thèse, Thomas Dreyfus et Nicolas Juillet. Mes anciens co-bureaux, Arthur Soulié, Viet-Cuong Pham et Alexander Semenov (dont deux sont docteurs maintenant). Merci aussi à l'équipe algèbre, topologie, groupes quantiques, représentations : Pierre Baumann, Vladimir Fock, Dragos Fratila, Pierre Guillot, Christian Kassel, Sofiane Souaifi, Christine Vespa, Vladimir Dotsenko et tous les autres. Merci également à Florence Lecomte. Je peux également citer chez les doctorants/ex-doctorants : Frédéric, Alexander, Pierre-Alexandre, Francisco, Hao, Laura, Nicolas, Philippe², Claire, Valdo, Gatien, Martin, Djibril, Alix et beaucoup d'autres !

Enfin mes remerciements dans un cadre plus personnel sont dédiés à toute ma famille, mes parents Claudine, Marc et ma sœur Julie, mais aussi à Clément, Assunta, Luigi, Carlo, Davide et Chiara. Merci surtout à celui qui partage ma vie depuis plus de trois ans, qui

m'a tant soutenu et encouragé sur tous les plans. Merci Samuele, je n' imagine plus ma vie sans toi.

Résumé

Cette thèse s'inscrit dans le domaine de la combinatoire algébrique et porte sur l'étude d'ordres partiels admettant une réalisation géométrique particulière, appelée réalisation cubique.

Après avoir introduit les coordonnées cubiques, nous munissons l'ensemble de ces objets de l'ordre de comparaison composante par composante, formant des treillis. Nous établissons ensuite un isomorphisme d'ordres partiels entre les treillis des coordonnées cubiques et les ordres partiels des intervalles des treillis de Tamari. La réalisation cubique des coordonnées cubiques permet une étude géométrique de ces treillis et également de montrer qu'ils sont épluchables.

Par ailleurs, nous considérons les treillis de Hochschild qui sont des intervalles particuliers de l'ensemble des chemins de Dyck munis de l'ordre dextre. Ces treillis admettent également une réalisation cubique que nous construisons. Nous montrons entre autres que ces treillis sont épluchables, constructibles par doublement d'intervalles et plusieurs propriétés combinatoires dont le dénombrement des k -chaînes.

Finalement, nous construisons trois familles d'ordres partiels dont les ensembles sous-jacents sont dénombrés par les nombres de Fuss-Catalan. Parmi elles, nous obtenons une généralisation des treillis de Stanley et une généralisation des treillis de Tamari. Ces trois familles d'ordres partiels sont liées par une relation d'extension d'ordre et partagent plusieurs propriétés. Deux algèbres associatives sont ensuite construites comme quotients de généralisations de l'algèbre de Malvenuto-Reutenauer. Leurs produits ont pour support les intervalles de nos analogues des treillis de Stanley et des treillis de Tamari. En particulier, un de ces quotients est une généralisation de l'algèbre de Loday-Ronco.

Mots clés. Ordres partiels, treillis de Tamari, objets Fuss-Catalan, algèbres associatives, réalisations géométriques.

* *
*

Abstract

This thesis is in the field of algebraic combinatorics and deals with the study of partial orders admitting a particular geometric realization, called cubic realization.

After having introduced the cubic coordinates, we endow the set of these objects with the componentwise order, forming lattices. Then we establish an isomorphism of partial orders between the lattices of the cubic coordinates and the partial orders of the intervals of the Tamari lattices. The cubic realization of the cubic coordinates allows a geometrical study of these lattices and also to show that they are shellable.

Moreover, we consider the Hochschild lattices, which are particular intervals of the set of Dyck paths endowed with the dexter order. These lattices also admit a cubic realization that we construct. Among other things, we show that these lattices are shellable, constructible by interval doubling, and several combinatorial properties such as the enumeration of k -chains.

Finally, we build three families of partial orders which underlying sets are enumerated by the Fuss-Catalan numbers. Among these, one is a generalization of Stanley lattices and another one is a generalization of Tamari lattices. These three families of partial orders fit into a chain for the order extension relation and they share some properties. Two associative algebras are then constructed as quotients of generalizations of the Malvenuto-Reutenauer algebra. Their products describe intervals of our analogues of Stanley lattices and Tamari lattices. In particular, one of these quotients is a generalization of the Loday-Ronco algebra.

Key words. Partial orders, Tamari lattices, Fuss-Catalan objects, associative algebras, geometric realizations.

Articles

This thesis consists of three articles written over the last three years. Two of the three papers have a short version.

Publications in international conferences.

- (1) C. Combe and S. Giraudo. *Three interacting families of Fuss-Catalan posets*, to appear in Formal Power Series and Algebraic Combinatorics (short version), 2020.
- (2) C. Combe. *Cubic realizations of Tamari interval lattices*, Formal Power Series and Algebraic Combinatorics (short version), 2019.

Prepublications.

- (1) C. Combe et S. Giraudo. Three Fuss-Catalan posets in interaction and their associative algebras, [arXiv:2007.02378](https://arxiv.org/abs/2007.02378), 2020.
- (2) C. Combe. A geometric and combinatorial exploration of Hochschild lattices, [arXiv:2007.00048](https://arxiv.org/abs/2007.00048), 2020.
- (3) C. Combe. Geometric realizations of Tamari interval lattices via cubic coordinates, [arXiv:1904.00658](https://arxiv.org/abs/1904.00658), 2020.

Contents

List of Figures	xi
Introduction	1
Chapter 1. Elements of algebraic combinatorics and partial orders	11
1. Algebraic and combinatorics objects	11
1.1. Graded sets, words, and Catalan objects	11
1.2. Trees and algorithms	18
1.3. Posets and lattices	22
1.4. Poset morphisms and poset embeddings	28
2. Combinatorial and geometric properties	29
2.1. Distributive and semidistributive lattices	30
2.2. Posets of k -chains	31
2.3. EL-shellability	33
2.4. Construction by interval doubling	35
3. Combinatorial Hopf algebras and posets	37
3.1. Combinatorial Hopf algebras	37
3.2. Examples of combinatorial Hopf algebras	42
3.3. Products, coproducts, and partial orders	44
Chapter 2. Cubic coordinate lattices	47
1. Cubic coordinates and Tamari intervals	48
1.1. Tamari interval diagrams	48
1.2. Cubic coordinates	55
1.3. Order structure and poset isomorphism	58
2. Geometric properties	62
2.1. Cubic realizations	62
2.2. Cells and volumes	67
2.3. EL-shellability	72
Chapter 3. Hochschild lattices	75
1. Definitions and first properties	76

1.1. Hochschild polytopes and triwords	76
1.2. Order structure and poset isomorphism	78
2. Geometric properties	80
2.1. Cubic realizations	80
2.2. EL-shellability	80
2.3. Construction by interval doubling	82
3. Combinatorial properties	83
3.1. Maximal chains and degree polynomial	84
3.2. Intervals and k -chains	89
3.3. Subposets of the Hochschild posets	94
Chapter 4. Fuss-Catalan posets and algebras	97
1. δ -cliff posets and general properties	99
1.1. δ -cliffs	99
1.2. δ -cliff posets	101
1.3. Subposets of δ -cliff posets	104
2. Some Fuss-Catalan posets	114
2.1. δ -avalanche posets	114
2.2. δ -hill posets	119
2.3. δ -canyon posets	124
2.4. Poset morphisms and other interactions	133
3. Associative algebras of δ -cliffs	136
3.1. Coalgebras and algebras	136
3.2. E and H-bases	139
3.3. Quotient algebras	141
Perspectives	147
Bibliography	151

List of Figures

1.1 A Tamari diagram 9021043100 (on the left) and a dual Tamari diagram 0010040002 (on the right) of size 10.	17
1.2 A rooted tree of size 8.	19
1.3 A binary tree of size 8 and the numbering of its nodes following the infix order.	20
1.4 Right rotation of edge (k, l) in t (on the left), where a, b , and c are any subtrees.	20
1.5 A binary tree and the associated Tamari diagram of the same size.	22
1.6 A binary tree and the associated Dyck path of the same size.	22
1.7 The Hasse diagrams of a lattice (on the left) and of a poset (on the right).	24
1.8 Hasse diagrams of $\mathfrak{S}(4)$ for \preceq_{we} .	25
1.9 Hasse diagrams of $T_2(2)$ and $T_2(3)$.	26
1.10 Tamari order on 132-avoiding permutations of size 4.	27
1.11 From left to right, Hasse diagrams of the Stanley order, the dexter order, and the Kreweras order on $Dy(3)$.	27
1.12 A Dyck path 1100101100 with two movable paths, in blue (dark).	27
1.13 The three Dyck paths covering the Dyck path 1100101100 for the dexter order.	28
1.14 Hasse diagrams of $BT(3)$, the Tamari order on $Dy(3)$, and the componentwise order on Tamari diagrams of size 3.	29
1.15 Hasse diagrams of $\mathfrak{S}(3)$ and of the Lehmer code lattice of size 3.	29
1.16 From left to right, Kreweras lattice, Tamari lattice, and Stanley lattice on $Dy(3)$.	29
2.1 Hasse diagram of an interval-poset of size 8.	33
2.2 Construction of a Tamari interval from an interval-poset by ρ .	34
2.3 Counterexample of a lattice not EL-shellable.	35
2.4 Operation of doubling in an interval in blue (dark).	35
2.5 Graph of first posets generated by interval doubling.	36
2.6 Counterexample of a lattice not constructible by interval doubling.	36
1.1 Different representations of an interval-poset of size 8.	49
1.2 Right rotation of the edge (i, j) in the binary tree s (resp. t), where a, b and c are subtrees.	49

1.3	Interval-poset of the decreasing forest before (without dotted line) and after (with dotted line) the right rotation of the edge (i, j) , where a , b and c may be empty.	50
1.4	Interval-poset of the increasing forest before (with dotted lines) and after (without dotted lines) the right rotation of the edge (i, j) , where a , b and c may be empty.	50
1.5	A Tamari diagram 9021043100 (on the left) and a dual Tamari diagram 0010040002 (on the right) of size 10.	51
1.6	Two incompatible diagrams (on the left) and two compatible diagrams (on the right).	52
1.7	A Tamari interval diagram of size 10 (on the left) and its associated interval-poset (on the right).	52
2.1	$\mathfrak{C}(\mathbb{C}\mathbb{C}(3))$.	62
2.2	$\mathfrak{C}(\mathbb{C}\mathbb{C}(4))$.	68
1.1	Hasse diagrams of the dexter meet-semilattice of size 4.	76
2.1	Cubic realizations of some Hochschild posets.	81
2.2	A sequence of interval doublings from $\text{Tr}(2)$ to $\text{Tr}(3)$.	84
3.1	Cubic realizations of some spines of Hochschild posets.	86
3.2	Construction of $\mathbb{J}(\mathbb{J}(\mathbb{S}(\text{Tr}(3))))$ from the poset $\mathbb{J}(\mathbb{S}(\text{Tr}(3)))$.	86
3.3	Shape of the poset $\mathbb{J}(\mathbb{S}(\text{Tr}(n)))$.	87
1.1	Hasse diagrams of some δ -cliff posets.	102
1.2	The Hasse diagram of the poset $(\text{Cl}_{0112^{\omega}}(4), \preceq')$.	103
1.3	Some cubic realizations of straight subposets of posets of δ -cliffs for certain range maps δ .	112
2.1	Hasse diagrams of some δ -avalanche posets.	115
2.2	From the top to bottom and left to right, here are the posets $\text{Av}_2(3)$, $\text{Av}_3(3)$, $\text{Av}_3(3)$, and $\text{Av}_4(3)$. All these posets contain $\text{Av}_2(3)$ as subposet by restricting on input-wings, output-wings, or butterflies.	117
2.3	Hasse diagrams of some δ -hill posets.	121
2.4	From the top to bottom and left to right, here are the posets $\text{Hi}_2(3)$, $\text{Hi}_3(3)$, $\text{Hi}_3(3)$, and $\text{Hi}_4(3)$. All these posets contain $\text{Hi}_2(3)$ as subposet by restricting on input-wings, output-wings, or butterflies.	123
2.5	Hasse diagrams of some δ -canyon posets.	127
2.6	A sequence of interval contractions from $\text{Ca}_2(4)$ to a poset isomorphic to $\text{Ca}_2(3)$. These interval contractions are poset derivations as introduced in Section 1.3.3. The marked intervals are the ones involved in the interval doubling operations.	129
2.7	The poset $\text{Ca}_3(3)$ wherein output-wings are marked. The arrows connect these elements to their images by the bijection ρ .	131

- 2.8 From the top to bottom and left to right, here are the posets $\text{Ca}_2(3)$, $\text{Ca}_2(3)$, and $\text{Ca}_3(3)$. The two last posets contain $\mathcal{F}(\text{Hi}_1(3))$ as subposets. There is a poset morphism between the output-wings of the first one and the input-wings of the second one. 132
- 2.9 From the left to the right, here are the posets $\text{Av}_3(3)$, $\text{Ca}_3(3)$, and $\text{Hi}_3(3)$. The poset on the right is an order extension of the one at middle, which is itself an order extension of the one at the left. 134
- 2.10 The subposet of $\text{Ca}_2(4)$ formed by its input-wings is isomorphic to $\text{Hi}_1(4)$. 135

Introduction

Avant-propos

La combinatoire est un domaine fondamental à l'intersection des mathématiques et de l'informatique. Elle se décline en plusieurs branches très différentes [FS09, Sta12]. Un objectif commun à toutes ces branches est d'avoir la compréhension la plus précise possible sur des familles d'objets, tels que des cartes, des arbres ou des permutations. En particulier, dénombrer et établir des bijections entre différentes familles d'objets peut mener à cet objectif. Une de ces branches est la combinatoire algébrique, domaine propice aux interactions fortes entre la combinatoire et l'algèbre. Un exemple bien connu est l'utilisation de structures arborescentes pour représenter et manipuler des éléments dans des structures algébriques libres. C'est dans ce domaine où se mélangent combinatoire et algèbre que se situe cette thèse.

Plus précisément, ce travail se focalise sur l'étude d'ensembles partiellement ordonnés (appelés aussi posets). Ces structures apportent un formalisme qui permet de comparer des objets combinatoires. L'étude de posets sur des familles d'objets combinatoires est motivée entre autres pour les deux raisons suivantes. La première est que, selon le poset étudié, de belles suites de nombres peuvent émerger, en considérant par exemple le nombre d'intervalles [Cha06, BMFPR12] ou le nombre de chaînes saturées. Un autre intérêt de définir des posets sur des objets combinatoires est qu'ils permettent de définir des changements de bases dans certains espaces vectoriels [LR02, HNT05]. Pour reprendre l'exemple des structures arborescentes, il existe dans la littérature différentes structures d'ordres mettant en jeu les arbres binaires, comme par exemple l'ordre phagocyte [BP06], l'ordre coupe-greffe [BP08] ou encore l'ordre de Tamari [Tam62]. De même, il existe plusieurs ordres partiels définis sur les permutations, objets très classiques de la combinatoire. On peut citer par exemple l'ordre faible droit et l'ordre de Bruhat. Munir des familles d'objets combinatoires d'une structure d'ordre nous permet de les étudier algébriquement.

Certains de ces posets admettent une propriété bien particulière, à savoir que pour toute paire d'éléments comparables, il existe une borne supérieure et une borne inférieure pour l'ordre associé. Ces posets sont appelés des treillis. C'est le cas par exemple de l'ordre de Tamari. Il s'agit d'un exemple très important et connu dans la théorie des ordres du fait de sa richesse combinatoire et algébrique. Cet ordre, défini sur l'ensemble des arbres binaires, est donné par la clôture réflexive et transitive de l'opération de rotation droite [HT72]. Cette opération fondamentale apparaît aussi dans l'algorithmique des arbres binaires de recherche [AVL62].

Comme beaucoup d'objets combinatoires, les arbres binaires ont la propriété d'être dénombrés par les nombres de Catalan. Chaque ensemble regroupant les objets de taille $n \geq 0$ a ainsi pour cardinal

$$\text{cat}_1(n) := \frac{1}{n+1} \binom{2n}{n}.$$

Les premiers nombres décrits par cette formule sont

$$1, 1, 2, 5, 14, 42, 132, 429.$$

Ces nombres se retrouvent fréquemment en combinatoire, et possèdent plusieurs généralisations, dont la plus connue est donnée par les nombres de Fuss-Catalan

$$\text{cat}_m(n) := \frac{1}{mn+1} \binom{mn+n}{n}.$$

Cette formule compte par exemple les arbres $(m+1)$ -aires ou encore les m -chemins de Dyck.

Les diagrammes de Hasse sont des outils pratiques et classiques pour dessiner les ordres partiels. Il s'agit de graphes orientés reliant les éléments du poset en relation de couverture, orientés de l'élément couvert vers l'élément couvrant pour l'ordre. Par convention, les arcs sont orientés implicitement du haut vers le bas. Par exemple, le cube, qui est le treillis défini sur les sous-ensembles de l'ensemble $A := \{a, b, c\}$ ordonnés pour l'inclusion, a pour diagramme de Hasse

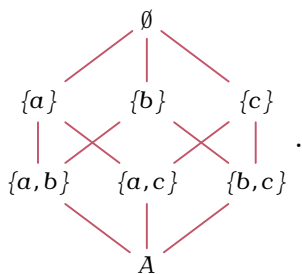

Cette réalisation des posets permet de mettre en évidence les relations entre les éléments. Par exemple, les éléments $\{a\}$, $\{b\}$ et $\{c\}$ ne sont pas comparables car il n'existe aucune chemin respectant l'ordre qui les relie. À l'inverse, A est comparable avec tous les éléments du cube. De même, le treillis de Tamari pour les arbres de taille 3 a pour diagramme de

Hasse

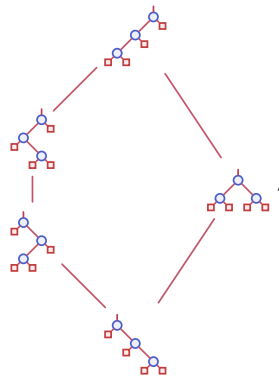

où les nœuds des arbres sont dessinés par \circ et les feuilles par \square .

Contexte et motivations

Il est toujours possible de dessiner le diagramme de Hasse d'un poset fini. Cependant, nous nous intéressons dans ce travail à des posets dont le diagramme de Hasse possède une propriété spéciale, qui n'est pas toujours garantie. Cette propriété consiste à assimiler les diagrammes de Hasse à un assemblage d'hypercubes, en plongeant la réalisation dans l'espace. Par exemple, le diagramme de Hasse du treillis de Tamari pour les arbres de taille 4 et sa réalisation cubique sont dessinés ci-dessous respectivement à gauche et à droite :

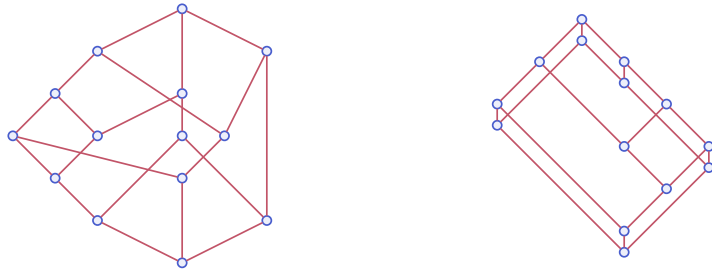

Les posets que nous allons considérer ont la particularité d'être tous définis sur un ensemble de mots et d'être munis d'une relation de comparaison composante par composante. Cette particularité figure comme un des pré-requis pour que ces posets admettent une réalisation cubique.

Chercher la réalisation cubique de posets présente divers avantages. D'une part, elle permet d'avoir un nouveau point de vue sur des posets déjà connus, et d'autre part, elle apporte une nouvelle dimension géométrique, amenant de nouvelles questions sur le volume de la réalisation ou encore sur l'arrangement des complexes cellulaires formant cette réalisation.

Cette thèse explore trois thèmes dont l'intersection est le concept de réalisation cubique. Un autre point commun, plus indirect, vient du fait que les familles de posets étudiées sont liées au treillis de Tamari, que ce soit par l'introduction d'une généralisation avec des objets appelés canyons, ou par l'étude d'une autre généralisation avec les intervalles du

treillis de Tamari et d'intervalles particuliers d'un sous-poset du treillis des intervalles de Tamari.

L'objectif de ce travail est d'apporter, avec un point de vue qui se veut original offert par la réalisation cubique, une étude de ces familles de posets particulières. Un autre but est aussi d'introduire de nouvelles familles de posets dénombrées par les nombres de Fuss-Catalan, et généralisant le poset de Tamari et le poset de Stanley [Sta75, Knu04]. Ces résultats ont également des conséquences algébriques puisque nous apportons des généralisations des algèbres de Malvenuto-Reutenauer [MR95] et de Loday-Ronco [LR98], dont les produits sont liés respectivement aux intervalles de l'ordre faible droit et aux intervalles du treillis de Tamari.

Organisation et résultats

Quatre chapitres composent cette thèse. Le chapitre 1 forme le tronc commun des trois derniers, en apportant toutes les définitions et propriétés utilisées par la suite. On y trouve ainsi des notions classiques du domaine de la combinatoire et de l'algèbre liées à l'étude des ordres partiels. Ces notions sont illustrées par plusieurs exemples. Notamment, dans la première partie sont présentés des treillis définis sur des arbres binaires, des chemins de Dyck, ou encore des partitions non croisées. Plusieurs propriétés combinatoires et géométriques sont ensuite données dans la partie suivante. Par exemple, nous verrons la notion de distributivité et de semidistributivité pour un treillis et quelques propriétés connexes, ou encore la construction d'un poset par doublement d'intervalles, en partant du poset trivial [Day92]. Nous finirons ce chapitre avec des notions d'algèbre liées aux algèbres de Hopf combinatoires. Puis nous présenterons deux importants exemples de ces objets : l'algèbre de Malvenuto-Reutenauer [MR95] définie sur les permutations, et l'algèbre de Loday-Ronco [LR98, HNT05] définie sur les arbres binaires.

Dans le chapitre 2, nous introduisons dans un premier temps les coordonnées cubiques, qui sont des mots d'entiers codant les intervalles du treillis de Tamari. Puis, nous montrerons que les coordonnées cubiques sont en bijection avec les intervalle-posets, eux même connus pour être en bijection avec les intervalles de Tamari [CP15]. Plus qu'une bijection, nous montrons que pour chaque degré, l'ensemble des coordonnées cubiques muni de l'ordre de comparaison composante par composante forme un treillis et est isomorphe au treillis des intervalles de Tamari. Nous donnons ensuite une réalisation géométrique naturelle du treillis des coordonnées cubiques, appelée réalisation cubique. Cette réalisation est obtenue en plaçant dans l'espace \mathbb{R}^k , avec $k \geq 0$, toutes les coordonnées cubiques de même taille et en reliant les éléments qui sont en relation de couverture. Par exemple, pour $k = 2$, la réalisation cubique du treillis des coordonnées cubiques de taille 3, et donc du treillis des intervalles de Tamari pour la même taille, se dessine dans le plan comme

suit :

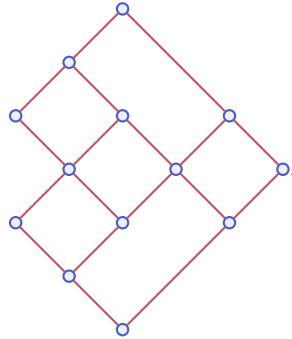

La réalisation cubique permet de mettre en évidence plusieurs propriétés des coordonnées cubiques et de leur treillis. Notamment, cette réalisation fait apparaître une structure cellulaire, nous permettant d'établir une bijection entre ces cellules et des coordonnées cubiques spéciales, appelées synchrones, et ainsi d'obtenir une formule pour calculer le volume de cette réalisation via ces éléments particuliers. Dans une dernière partie, nous montrons que le treillis des coordonnées cubiques est épluchable, ce qui nous permet de généraliser le résultat de Björner et Wachs [BW96, BW97] sur l'épluchabilité du treillis de Tamari.

Le chapitre 3 est dédié à l'étude d'un autre treillis, appelé treillis de Hochschild. Les treillis de Hochschild sont des intervalles particuliers des semitreillis pour la borne inférieure définis sur l'ensemble des chemins de Dyck muni de l'ordre dextre. L'ordre dextre et les treillis de Hochschild ont tous deux été récemment introduits par Chapoton [Cha20]. Dans un premier temps, nous rappellerons la bijection établie dans l'article de Chapoton entre les chemins de Dyck de ces intervalles particuliers et un ensemble de mots définis sur l'alphabet $\{0, 1, 2\}$, appelés trimots. Sur l'ensemble des trimots, l'ordre dextre se traduit par cette bijection comme l'ordre de comparaison composante par composante. L'ensemble des trimots muni de cet ordre forme alors un treillis, appelé treillis de Hochschild en référence au polytope de Hochschild dont le treillis de Hochschild est le 1-squelette [San09, San11]. Comme pour le treillis des coordonnées cubiques étudié dans le chapitre 2, nous pouvons donner la réalisation cubique du treillis de Hochschild. L'étude de cette réalisation nous permet de montrer que le treillis de Hochschild est épluchable et constructible par doublement d'intervalles. Parallèlement à cette étude géométrique, nous montrons plusieurs propriétés combinatoires des ces treillis, comme par exemple le dénombrement de ses k -chaînes.

Dans le chapitre 4, nous introduisons les δ -cliffs, une généralisation des permutations et des arbres croissants dépendant d'une application de variation δ . En munissant l'ensemble de ces objets de l'ordre de comparaison composante par composante, nous définissons un premier treillis. Puis, nous établissons plusieurs résultats généraux sur ses sous-posets. Parmi ces résultats, nous donnons les conditions suffisantes pour que les posets soient épluchables, soient des treillis avec un algorithme pour calculer la borne inférieure et supérieure entre deux éléments, et soient constructibles par doublement d'intervalles. Certains de ces sous-posets admettent des réalisations cubiques, et nous introduisons trois familles

de ces sous-posets qui, pour une certaine application de variation δ , ont des ensembles sous-jacents dénombrés par les nombres de Fuss-Catalan. Un de ces sous-posets est une généralisation des treillis de Stanley et un autre est une généralisation des treillis de Tamari. Ces trois familles de posets sont reliées par une relation d'extension d'ordre et elles partagent plusieurs propriétés. Finalement, de la même façon que le produit de l'algèbre de Malvenuto-Reutenauer forme les intervalles de l'ordre faible droit des permutations, nous construisons dans une dernière partie des algèbres dont les produits forment les intervalles des treillis de δ -cliff. Nous donnons alors les conditions nécessaires et suffisantes sur δ pour avoir une algèbre associative, ou libre. En utilisant les posets Fuss-Catalan précédents, nous définissons des quotients de nos algèbres de δ -cliffs. En particulier, un quotient donne l'algèbre de Loday-Ronco et on obtient de nouvelles généralisations de cette structure.

* *
*
*

Foreword

Combinatorics is a fundamental area at the intersection of mathematics and computer science. It is divided into several very different branches [FS09, Sta12]. A common objective for all these branches is to reach the most precise understanding on families of objects, such as maps, trees, or permutations. In particular, counting and establishing bijections between different families of objects can lead to this objective. One of these branches is algebraic combinatorics, a field that leads to strong interactions between combinatorics and algebra. A well-known example is the use of tree structures to represent and manipulate elements in free algebraic structures. It is in this field where combinatorics and algebra are mixed together that this thesis is situated.

More specifically, this work focuses on the study of partially ordered sets (also called posets). These structures provide a formalism that allows the comparison of combinatorial objects. The study of posets on families of combinatorial objects is motivated among others by the following two reasons. The first is that, depending on the studied poset, beautiful sequences of numbers can emerge, by considering for example the number of intervals [Cha06, BMFPR12] or the number of saturated chains. Another interest of defining posets on combinatorial objects is that they allow to define base changes in certain vector spaces [LR02, HNT05]. To take the example of tree structures, in the literature there are different order structures involving binary trees, such as the phagocyte order [BP06], the pruning-grafting order [BP08], or the Tamari order [Tam62]. In the same way, there are several partial orders defined on permutations, very classical objects

in combinatorics. We can mention for example the right weak order and the Bruhat order. Endowing families of combinatorial objects with an order structure allows us to study them algebraically.

Some of these posets admit a very particular property, namely that for any pair of comparable elements, there is a supremum and an infimum for the associated order. These posets are called lattices. This is the case, for example, with the Tamari order. This is a very important and well-known example in the order theory because of its combinatorial and algebraic richness. This order, defined on the set of binary trees, is given by the reflexive and transitive closure of the operation of right rotation [HT72]. This fundamental operation also appears in the algorithmic of the binary search trees [AVL62].

Like many combinatorial objects, binary trees have the property of being enumerated by Catalan numbers. Each set of objects of size $n \geq 0$ has thus for cardinality

$$\text{cat}_1(n) := \frac{1}{n+1} \binom{2n}{n}.$$

The first numbers described by this formula are

$$1, 1, 2, 5, 14, 42, 132, 429.$$

These numbers are frequently found in combinatorics, and have several generalisations, the most well-known of which is given by the Fuss-Catalan numbers

$$\text{cat}_m(n) := \frac{1}{mn+1} \binom{mn+n}{n}.$$

This formula computes for example the $(m+1)$ -ary trees or the m -Dyck paths.

Hasse diagrams are practical and classical tools for drawing partial orders. They are oriented graphs linking the elements of the poset in covering relation, oriented from the covered element to the covering element for the order. By convention, the arrows are implicitly oriented from top to bottom. For instance, the cube, which is the lattice defined on the subsets of the set $A := \{a, b, c\}$ ordered for inclusion, has as Hasse diagram

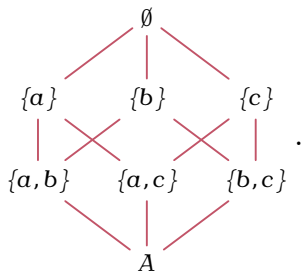

This realization of the posets allows to highlight the relations between the elements. For instance, the elements $\{a\}$, $\{b\}$ and $\{c\}$ are not comparable because there is no path respecting the order that connects them. Conversely, A is comparable with all the elements

of the cube. Likewise, the Tamari lattice for trees of size 3 has as Hasse diagram

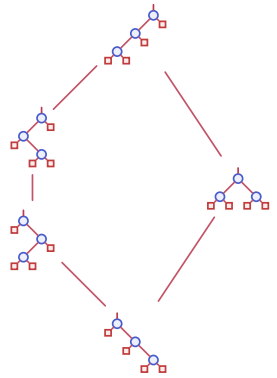

where the nodes of the trees are drawn by \circ and leaves by \square .

Context and motivations

It is always possible to draw the Hasse diagram of a finite poset. However, in this work we are interested in posets whose Hasse diagram has a special property, which is not always guaranteed. This property consists in assimilating the Hasse diagrams to an assembly of hypercubes, by embedding the realization in the space. For instance, the Hasse diagram of the Tamari lattice for trees of size 4 and its cubic realization are drawn below on the left and right respectively:

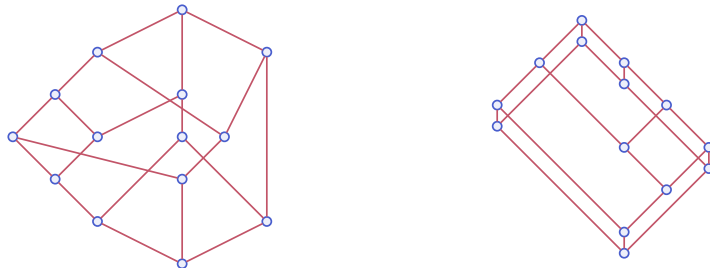

The posets we are going to consider have the particularity of being all defined on a set of words and of being endowed with a componentwise order. This particularity appears as one of the prerequisites for these posets to admit a cubic realization.

Looking for the cubic realization of posets has various advantages. On the one hand, it gives a new point of view on already known posets, and on the other hand, it brings a new geometrical dimension, raising new questions about the volume of the realization or about the arrangement of the cell complexes forming this realization.

This thesis explores three topics whose intersection is the concept of cubic realization. Another common point, more indirect, comes from the fact that the families of posets studied are related to the Tamari lattice, either by introducing a generalisation with objects called canyons, or by studying another generalisation with the intervals of the Tamari lattice and particular intervals of a subset of the Tamari interval lattice.

The aim of this work is to bring, with an original point of view offered by the cubic realization, a study of these particular families of posets. Another goal is also to introduce new families of posets enumerated by Fuss-Catalan numbers, and generalizing the Tamari posets and the Stanley posets [Sta75, Knu04]. These results also have algebraic consequences since we bring generalizations of the Malvenuto-Reutenauer [MR95] and Loday-Ronco [LR98] algebras, whose products are respectively related to the intervals of the right weak order and to the intervals of the Tamari lattice.

Organization and results

This thesis consists of four chapters. Chapter 1 forms the common core of the last three, providing all the definitions and properties used thereafter. It contains classical notions of combinatorics and algebra related to the study of partial orders. These notions are illustrated by several examples. Notably, in the first part, lattices defined on binary trees, Dyck paths, or non-crossing partitions are presented. Several combinatorial and geometrical properties are then given in the following section. For instance, we will see the notion of distributivity and semidistributivity for a lattice and some related properties, or the construction of a poset by interval doubling, starting from the trivial poset [Day92]. We will end this chapter with notions of algebra related to combinatorial Hopf algebras. Then we will present two important examples of these objects: the Malvenuto-Reutenauer algebra [MR95] defined on permutations, and the Loday-Ronco algebra [LR98, HNT05] defined on binary trees.

In Chapter 2, we first introduce cubic coordinates, which are integer words encoding the intervals of Tamari lattices. Then, we will show that the cubic coordinates are in bijection with the interval-posets, themselves known to be in bijection with Tamari intervals [CP15]. More than a bijection, we show that for each degree, the set of cubic coordinates endowed with the componentwise order forms a lattice and is isomorphic to the lattice of Tamari intervals. We then give a natural geometric realization of the lattice of cubic coordinates, called cubic realization. This realization is obtained by placing in the space \mathbb{R}^k , with $k \geq 0$, all the cubic coordinates of the same size and connecting the elements which are in covering relation. For instance, for $k = 2$, the cubic realization of the lattice of cubic coordinates of size 3, and therefore of the lattice of Tamari intervals for the same size, is shown in the plane as follows:

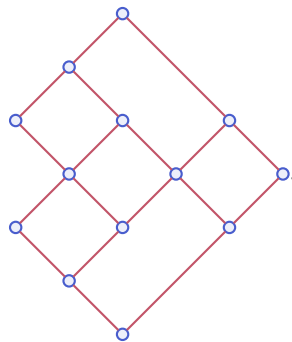

The cubic realization allows to highlight several properties of the cubic coordinates and their lattice. In particular, this realization reveals a cellular structure, allowing us to establish a bijection between these cells and special cubic coordinates, called synchronous, and thus to obtain a formula to compute the volume of this realization via these particular elements. In a final section, we show that the lattice of cubic coordinates is shellable, which allows us to generalise the result of Björner and Wachs [BW96, BW97] on the shellability of the Tamari lattice.

Chapter 3 is dedicated to the study of another lattice, called Hochschild lattice. The Hochschild lattices are particular intervals of the meet-semilattice defined on the set of Dyck paths endowed with the dexter order. The dexter order and the Hochschild lattice were both recently introduced by Chapoton [Cha20]. First of all, we will recall the bijection established in the article of Chapoton between the Dyck paths of these particular intervals and a set of words defined on the alphabet $\{0, 1, 2\}$, called triwords. For all the triwords, the dexter order is translated by this bijection as the componentwise order. The set of triwords endowed with this order then forms a lattice, called the Hochschild lattice in reference to the Hochschild polytope, of which the Hochschild lattice is the 1-skeleton [San09, San11]. As for the lattice of cubic coordinates studied in Chapter 2, we can give the cubic realization of the Hochschild lattice. The study of this realization allows us to show that the Hochschild lattice can be shellable and constructible by interval doubling. Alongside this geometrical study, we show several combinatorial properties of these lattices, such as for instance the enumeration of its k -chains.

In Chapter 4, we introduce δ -cliffs, a generalization of permutations and increasing trees depending on a range map δ . By endowing the set of these objects with the componentwise order, we define a first lattice. Then, we establish several general results on its subposets. Among these results, we give sufficient conditions for the posets to be shellable, to be lattices with an algorithm to compute the meet and join between two elements, and to be constructible by interval doubling. Some of these subposets admit cubic realizations, and we introduce three families of these subposets which, for some range map δ , have underlying sets enumerated by Fuss-Catalan numbers. One of these subposets is a generalization of the Stanley lattices and another is a generalization of the Tamari lattices. These three families of posets fit into a chain for the order extension relation and they share several properties. Finally, in the same way that the product of Malvenuto-Reutenauer algebra forms the intervals of the right weak order of permutations, we construct, in a last part, algebras whose products form the intervals of the δ -cliff lattices. We then provide necessary and sufficient conditions on δ to have associative or free algebras. Using the previous Fuss-Catalan posets, we define quotients of our algebras of δ -cliffs. In particular, a quotient gives the Loday-Ronco algebra and we get new generalizations of this structure.

Elements of algebraic combinatorics and partial orders

In the three last chapters, we deal with several combinatorial objects and partial orders. Chapter 2 and Chapter 3 each give a study of a specific lattice, and Chapter 4 provide a study of a family of posets enumerated by Fuss-Catalan numbers. The aim of this first chapter is to connect the last three chapters of this thesis with common definitions and notions.

This chapter is organized as follows.

Section 1 sets the groundwork by recalling through examples several combinatorial objects, partial orders, and links between them.

The concepts discussed in Section 2 are less classical than those seen in Section 1. We recall several constructions on posets and lattices, such as the shellability on non-graded posets [BW96] and the construction by interval doubling [Day92].

Section 3 is related to Chapter 4, and provides a better understanding of the motivations for the latter chapter. Elementary definitions related to Hopf algebras are recalled, and two important examples are presented: The Malvenuto-Reutenauer Hopf algebra [MR95], and the Loday-Ronco Hopf algebra [LR98].

1. Algebraic and combinatorics objects

The aim of this section is to give the main definitions used in this thesis. Thus, we start by presenting several combinatorial objects. We recall for example the definitions of Dyck paths, binary trees, and permutations. All the sets of these objects are graded by their size, and we can endow these sets with partial orders.

We continue by giving elementary definitions and properties related to posets and lattices. Then, we shall see several examples of order extensions and poset isomorphisms.

1.1. Graded sets, words, and Catalan objects.

1.1.1. *General notations and conventions.* We begin by giving some notations and basic definitions on words, which we shall use in all this thesis.

For all words u , we denote by u_i the i -th letter of u . The *size* of a word is its number of letters. For any word a and integer k , a^k is the word a repeated k times. For all integers i and j , $[i, j]$ denotes the set $\{i, i + 1, \dots, j\}$. For any integer i , $[i]$ denotes the set $[1, i]$. Unless otherwise stated, all words are defined on the alphabet $\mathbb{N} = \{0, 1, 2, \dots\}$. The empty word is denoted by ϵ .

If P is a statement, we denote by $\mathbf{1}_P$ the indicator function (equals to 1 if P holds and 0 otherwise).

Let $n \geq 0$ and $w = a_1 a_2 \dots a_n$ be a word of size n . The *prefixes* of w are the $n + 1$ words $\epsilon, a_1 \dots a_i$, and the *suffixes* of w are the $n + 1$ words $\epsilon, a_i \dots a_n$, with $i \in [n]$. A word x is a *factor* of w if there is a prefix p and a suffix s such that $w = pxs$. A word y is a *subword* of w if y can be obtained by deleting letters in w . For instance, *radar* is a subword of *abracadabra*.

1.1.2. *Graded sets.* In this section, one may refer to [FS09].

A *graded set* (or *combinatorial set*) is a set S endowed with a map $|\cdot| : S \rightarrow \mathbb{N}$ such that for all $n \in \mathbb{N}$, the set $\{x \in S : |x| = n\}$ is finite.

A *combinatorial object* is an element of a graded set, and its *size* is its image by the map $|\cdot|$. The set of combinatorial objects of S of size $n \geq 0$ is denoted by $S(n)$. Thus, a graded set S decomposes as a disjoint union

$$S = \bigsqcup_{n \geq 0} S(n). \quad (1.1.1)$$

A *graded subset* of S is a graded set S' such that for all $n \geq 0$, $S'(n) \subseteq S(n)$.

Any graded set S is associated to its *generating series* $\mathcal{G}(t)$, which is a series with nonnegative integer coefficients, defined by

$$\mathcal{G}_S(t) := \sum_{n \geq 0} \#S(n)t^n = \sum_{x \in S} t^{|x|}, \quad (1.1.2)$$

where $\#E$ means the cardinality of the set E .

Let us see some classic examples of graded sets. The first example is the *empty graded set* \emptyset which has no object. Its generating series satisfies $\mathcal{G}_\emptyset(t) = 0$. Then one has two graded sets with a unique object: the *elementary graded set* \mathcal{E} which has one object ϵ of size 0, and the *atomic graded set* \mathcal{X} which has one object of size 1. The generating series of these two sets satisfy respectively $\mathcal{G}_\mathcal{E}(t) = 1$ and $\mathcal{G}_\mathcal{X}(t) = t$.

Another example of graded set is provided by the set of integers \mathbb{N} , where the size of an object is its value. The generating series of this set is

$$\mathcal{G}_\mathbb{N}(t) = \frac{1}{1-t} = 1 + t + t^2 + t^3 + \dots \quad (1.1.3)$$

The graded set of words A^* on the alphabet $A := \{a, b\}$ contains all finite sequences of elements of A . For instance, the elements of A^* of size less or equal to 3 are

$$\epsilon, a, b, aa, ab, bb, aaa, aab, aba, baa, abb, bab, bba, bbb, \quad (1.1.4)$$

and its generating series is

$$\mathcal{G}_{A^*}(t) = \frac{1}{1-2t} = 1 + 2t + 4t^2 + 8t^3 + \dots \quad (1.1.5)$$

The graded set of graphs contains all finite *graphs* $G := (V, E)$, where V is a finite set of elements called *vertices*, and E is a finite set of pairs of vertices called *edges*. Likewise, the graded set of oriented graphs contains all finite *oriented graphs* $G := (V, A)$, where V

is a finite set of vertices and A is a finite set of oriented edges from a *source* vertex to a *target* vertex, called *arrows*. The *size* of a graph (resp. oriented graph) is the cardinality of V .

Let $n \in \mathbb{N}$ and S_1 and S_2 be two graded sets. The sum of graded sets is defined by

$$(S_1 + S_2)(n) := S_1(n) \sqcup S_2(n), \tag{1.1.6}$$

and the product is defined by

$$(S_1 \times S_2)(n) := \{(x_1, x_2) : x_1 \in S_1, x_2 \in S_2, |x_1| + |x_2| = n\}. \tag{1.1.7}$$

For the generating series of $S_1 + S_2$ and $S_1 \times S_2$, one has

$$\mathcal{G}_{S_1+S_2}(t) := \mathcal{G}_{S_1}(t) + \mathcal{G}_{S_2}(t), \tag{1.1.8}$$

and

$$\mathcal{G}_{S_1 \times S_2}(t) := \mathcal{G}_{S_1}(t)\mathcal{G}_{S_2}(t). \tag{1.1.9}$$

For the next two examples, we can refer respectively to 1.1.4 and 1.2.2. The graded set of *Dyck paths* Dy is defined by induction by

$$Dy := \mathcal{E} + \{1\} \times Dy \times \{0\} \times Dy, \tag{1.1.10}$$

where $\{1\}$ is a graded set with one element of size 1, and $\{0\}$ is a graded set with one element of size 0. Expression (1.1.10) means that a Dyck path is either the empty word ϵ or a binary sequence such that there are as many 1 as 0, and in all prefixes the number of 0 is not greater than the number of 1. The *size* of a Dyck path is its number of letter 1. For instance, the elements of Dy of size not greater than 3 are

$$\epsilon, 10, 1010, 1100, 101010, 110100, 110010, 101100, 111000, \tag{1.1.11}$$

or in an equivalent way (see 1.1.4),

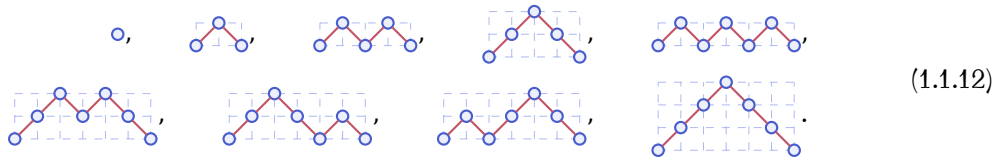

Similarly, the graded set of *binary trees* T_2 is defined by induction by

$$T_2 := \mathcal{E} + T_2 \times \{O\} \times T_2, \tag{1.1.13}$$

where $\{O\}$ is a graded set with one element of size 1, called *node*. Expression (1.1.13) means that a binary tree is either empty or two binary trees connected by a node. The *size* of a binary tree is its number of nodes. For instance, the elements of T_2 of size not

greater than 3 are

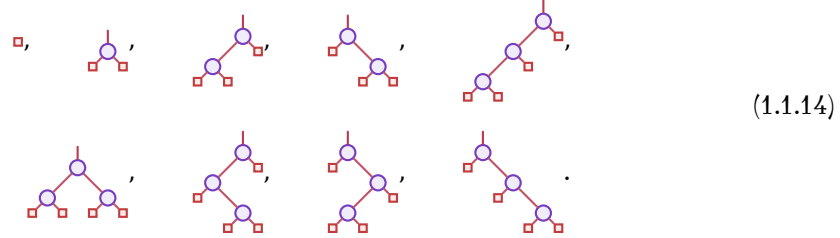

(1.1.14)

Dyck paths and binary trees are two important examples of this thesis, which is why we will recall the definitions of these objects more accurately in the following section.

1.1.3. *Regular expressions and algebraic grammars.* In order to describe and to enumerate certain sets, we are led to use the *regular expression* notation [Sak09]. An *atomic regular expression* can be either \emptyset which denotes the empty set of words, or a where a is a letter which denotes the singleton $\{a\}$. To produce regular expressions, for r and s two (atomic or not) regular expressions, one has three operations: rs is the set of words that can be obtained by concatenating a word of r and a word of s , $r + s$ is the union of the two sets r and s , and r^* denote the set of words r^k for any $k \in \mathbb{N}$. The star used for the last operation is known as the Kleene star. Besides, we use the notation r^+ to denote the set of words rr^* . Note that the expression ϵ which denotes the set $\{\epsilon\}$ is obtained with \emptyset^* .

For instance, to describe the set of words S_1 on the alphabet $\{a, b, c\}$ such that either the first letter is a or there is no letter a , only one letter b , and the first letter is c , then

$$S_1 = \{u \in \{a, b, c\}^{\mathbb{N}} : u \in a(a + b + c)^* + c^+bc^*\}. \quad (1.1.15)$$

From the formal language theory, we also use *algebraic grammars* (or formal context-free grammars), which allows us to rewrite a description of a certain set through a set of rules, when the regular expression is less obvious. An algebraic grammar G is a 4-tuple (V, A, S, P) , where V is a finite set of elements called *variables*, A is a finite set of letters such that $A \cap V = \emptyset$, S is a element of V called *axiom*, and P is a finite set of pair $(X, \chi) \in V \times (V \sqcup A)^*$ called *productions* of the grammar.

For instance, to describe the set of words S_2 on the alphabet $\{a, b, c\}$ such that the subword ab is prohibited, then S_2 is specified by the algebraic grammar

$$S'_2 = \epsilon + aS'_2 + cS'_2, \quad (1.1.16)$$

$$S_2 = \epsilon + bS_2 + cS_2 + aS'_2, \quad (1.1.17)$$

where S'_2 is the set of words on $\{a, c\}$. The sets S'_2 and S_2 are the variables, the set $\{a, b, c\}$ is the set A , and S_2 is the axiom.

We obtain the generating series from an expression, then the generating function, with the linear map $u \mapsto z^{|u|}$ for all words u of the expression.

For instance, we can deduce from the regular expression (1.1.15) that the generating function of S_1 is

$$\mathcal{G}_{S_1}(t) = \frac{t}{1-3t} + \frac{t^2}{(1-t)^2}. \tag{1.1.18}$$

Likewise, the generating series deduced from (1.1.16) and (1.1.17) are

$$\mathcal{G}_{S_2}(t) = 1 + 2t\mathcal{G}_{S_2}(t), \tag{1.1.19}$$

$$\mathcal{G}_{S_2}(t) = 1 + 2t\mathcal{G}_{S_2}(t) + t\mathcal{G}_{S_2}(t). \tag{1.1.20}$$

Then, the generating function of S_2 is

$$\mathcal{G}_{S_2}(t) = \frac{1-t}{1-4t+4t^2}. \tag{1.1.21}$$

1.1.4. *m-Dyck paths.* An important example of combinatorial objects defined on the alphabet $\{0, 1\}$ is provided by *m-Dyck paths*. We will encounter these objects in Chapter 3 and in Chapter 4.

For any $n \geq 0$ and $m \geq 0$, an *m-Dyck path* of size n is a path from $(0, 0)$ to $((m+1)n, 0)$ in \mathbb{N}^2 staying above the x -axis, and consisting only in steps of the form $(1, -1)$, called *down steps*, or steps of the form $(1, m)$, called *up steps*, with an up step as the first step. The *size* of an *m-Dyck path* is its number of up steps. We denote by $Dy_m(n)$ the set of all *m-Dyck paths* of size n .

As for Dyck paths defined in Section 1.1.2, an *m-Dyck path* of size n can be seen as a binary sequence of length $n(1+m)$, where the letter 1 encodes an up step and the letter 0 encodes a down step. Generally speaking, we shall use this convention instead.

For instance,

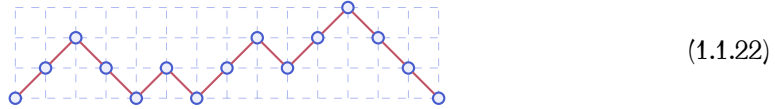

is the 1-Dyck path (or Dyck path for short) 11001011011000 of size 7, and

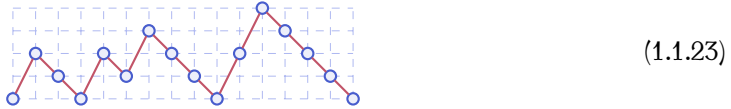

is the 2-Dyck path 100101000110000 of size 5.

Let us see further definitions about *m-Dyck paths*. Let $d \in Dy_m(n)$. A factor x is a *subpath* of d if x is a *m-Dyck path*. The Dyck path d is *primitive* if for all Dyck paths x and y such that $d = xy$, one has $x = \epsilon$ or $y = \epsilon$. A factor 01 is called a *valley*, and the *height* of a valley is the ordinate of its corresponding middle point in the path. More generally, the height of a step is the ordinate of its lowest point.

It is a known fact that *m-Dyck paths* of size n are enumerated by *m-Fuss-Catalan numbers* [DM47]

$$\text{cat}_m(n) := \frac{1}{mn+1} \binom{mn+n}{n}. \tag{1.1.24}$$

The first numbers by sizes are

$$1, 1, 1, 1, 1, 1, 1, 1, \quad m = 0, \quad (1.1.25a)$$

$$1, 1, 2, 5, 14, 42, 132, 429, \quad m = 1, \quad (1.1.25b)$$

$$1, 1, 3, 12, 55, 273, 1428, 7752, \quad m = 2, \quad (1.1.25c)$$

$$1, 1, 4, 22, 140, 969, 7084, 53820, \quad m = 3. \quad (1.1.25d)$$

The second, third, and fourth sequences are respectively Sequences **A000108**, **A001764**, and **A002293** of [Slo].

These numbers are important in the field of algebraic combinatorics, and they are often encountered. In particular, in Chapter 4 we define three sets of objects enumerated by these numbers.

1.1.5. *Tamari diagrams.* In Chapter 2 and Chapter 4, we deal with another important object called Tamari diagram [HT72, Pal86]. Let us give the definition of a Tamari diagram, as formulated in [BW97].

For any $n \geq 0$, a *Tamari diagram* is a word u of length n on the alphabet \mathbb{N} which satisfies the two following conditions:

- (i) $0 \leq u_i \leq n - i$ for all $i \in [n]$,
- (ii) $u_{i+j} \leq u_i - j$ for all $i \in [n]$ and $j \in [0, u_i]$.

The *size* of a Tamari diagram is its number of letters. For instance, the sets of Tamari diagrams of size 2, 3 and 4 are

$$\{00, 10\}, \quad \{000, 100, 010, 200, 210\}, \quad (1.1.26)$$

$$\{0000, 0010, 0100, 0200, 0210, 1000, 1010, 2000, 2100, 3000, 3010, 3100, 3200, 3210\}.$$

In the literature, Tamari diagrams are also known as bracket vectors, objects inspired by the right parenthesesage introduced in [HT72] by Huang and Tamari. Furthermore, Tamari diagrams are known to be enumerated by Catalan numbers

$$\text{cat}_1(n) := \frac{1}{n+1} \binom{2n}{n}. \quad (1.1.27)$$

Note that Catalan numbers are the 1-Fuss-Catalan numbers (1.1.25b). Thus, the m -Fuss-Catalan numbers are a natural generalisation of Catalan numbers.

A dual version of Tamari diagrams can be defined by considering the opposite of the conditions (i) and (ii).

For any $n \geq 0$, a *dual Tamari diagram* is a word v of length n on the alphabet \mathbb{N} which satisfies the two following conditions:

- (i) $0 \leq v_i \leq i - 1$ for all $i \in [n]$,
- (ii) $v_{i-j} \leq v_i - j$ for all $i \in [n]$ and $j \in [0, v_i]$.

The *size* of a dual Tamari diagram is its number of letters. In other words, $v = v_1 \dots v_n$ is a dual Tamari diagram if and only if $v_n \dots v_1$ is a Tamari diagram.

Note that the first condition of a Tamari diagram u and of a dual Tamari diagram v of size n implies that $u_n = 0$ and $v_1 = 0$.

A graphical representation of a Tamari diagram u of size n by needles and diagonals provides a simple way to check the condition (ii) of a Tamari diagram. For each position $i \in [n]$, we draw a needle from the point $(i - 1, 0)$ to the point $(i - 1, u_i)$ in the Cartesian plane. The condition (ii) says that one can draw lines of slope -1 passing through the x -axis and the top of each needle without crossing any other needle. For instance, the Tamari diagram 9021043100 is drawn by Figure 1.1. One can observe that none of its diagonals, drawn as dotted lines, crosses a needle.

Likewise, a graphical representation can be given for the dual Tamari diagram v of size n . One draws v in the same way as Tamari diagram, and the condition (ii) says that one can draw lines of slope 1 passing through the x -axis and the top of each needle without crossing any other needle. Figure 1.1 also depicts the dual Tamari diagram 0010040002.

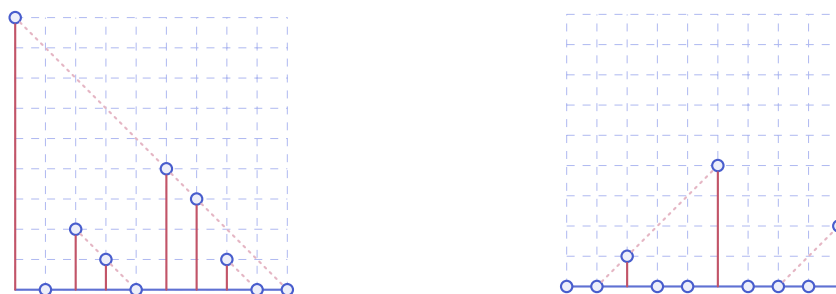

FIGURE 1.1. A Tamari diagram 9021043100 (on the left) and a dual Tamari diagram 0010040002 (on the right) of size 10.

We will deal with both notions in Chapter 2. A generalisation of Tamari diagrams is provided in Chapter 4, where by agreement we will use the definition of dual Tamari diagrams.

1.1.6. *Permutations and Lehmer codes.* Permutations are the departure point of the Chapter 4, since this all work starts by giving a generalisation of the Lehmer codes of permutations.

For any $n \geq 0$, a *permutation* σ is a bijection from a finite set of cardinality n onto itself. The *size* of a permutation is the cardinality of the underlying set. The set of permutations of size n is denoted by $\mathfrak{S}(n)$, and is enumerated by the factorial numbers $n!$. We use the word notation to specify a permutation, which is the word u of size n such that $u_i = \sigma(i)$ for all $i \in [n]$.

For instance, let σ be a permutation on 12345 such that $\sigma(1) = 5$, $\sigma(2) = 1$, $\sigma(3) = 3$, $\sigma(4) = 2$ and $\sigma(5) = 4$, namely σ is the word 51324.

Let us recall some classical operations on permutations. Let $\sigma \in \mathfrak{S}(n)$ and $\nu \in \mathfrak{S}(m)$. The *over* operation $/$ is defined by

$$\sigma / \nu := \sigma_1 \dots \sigma_n (\nu_1 + n) \dots (\nu_m + n), \quad (1.1.28)$$

and the *under* operation \setminus is defined by

$$\sigma \setminus \nu := (\nu_1 + n) \dots (\nu_m + n) \sigma_1 \dots \sigma_n. \quad (1.1.29)$$

For instance, $2413 / 312 = 2413756$ and $2413 \setminus 312 = 7562413$.

The *shifted shuffle product* $\bar{\sqcup}$ is defined by

$$\sigma \bar{\sqcup} \nu := \sigma \sqcup ((\nu_1 + n) \dots (\nu_m + n)), \quad (1.1.30)$$

where \sqcup is the shuffle of letters.

The *standardization* is the map std from the set of words to the set of permutations that sends a word u to the unique permutation $\text{std}(u) \in \mathfrak{S}_{|u|}$ obtained by numbering the letters of u from the smallest to the greatest from 1 to $|u|$, and such that if there is more than one then we consider the leftmost as the smaller. For instance, $\text{std}(643827685) = 532817694$.

For any $n \geq 0$, a *Lehmer code* (or *Lehmer code of permutations*) is a word u such that $0 \leq u_i \leq i - 1$ for all $i \in [n]$ [Leh60]. The *size* of a Lehmer code is its size as a word. Note that the condition on Lehmer code is the same as for (dual) Tamari diagrams, namely condition (i) seen in Section 1.1.5.

There is classical correspondence between permutations and Lehmer codes. Here, we consider a slight variation of Lehmer codes, establishing a bijection between the set of Lehmer codes of size n and the set of permutations of the same size. Given a permutation σ of size n , let u be the Lehmer code such that for any $i \in [n]$, u_i is the number of indices $j > \sigma^{-1}(i)$ such that $\sigma(j) < i$. We denote by $\text{leh}(\sigma)$ the Lehmer code thus associated with the permutation σ . For instance, $\text{leh}(436512) = 002323$.

1.1.7. Non-crossing partitions and Dyck paths. For any $n \geq 0$, a partition of $\{1, \dots, n\}$ is *non-crossing* if whenever four elements $1 \leq i < j < k < l \leq n$ are such that i, k are in the same class and j, l are in the same class, then the two classes coincide. The *size* of a non-crossing partition is the cardinality of the underlying set. The set of non-crossing partitions of size n is denoted by $\text{NC}(n)$, and his cardinality is $\text{cat}_1(n)$.

A well know bijection between non-crossing partitions and Dyck paths of same size consists in associating to a non-crossing partition the Dyck path $10^{\alpha_1}10^{\alpha_2} \dots 10^{\alpha_n}$ where α_i is the size of the class containing i if i is the maximal index in its class and $\alpha_i = 0$ otherwise. For instance, the non-crossing partition $\{\{1, 2\}, \{3\}, \{4, 6, 7\}, \{5\}\}$ corresponds to the Dyck path 11001011011000 of size 7.

1.2. Trees and algorithms.

1.2.1. Trees and forests. Trees are intrinsically linked to the notion of recursion. This is why they can be found in many scientific fields. We use the definition from graph theory, namely a rooted tree is an oriented acyclic graph with a unique root, and such that any node, except the root, is a child of a single node.

A *tree* consists in *nodes* (or *internal nodes*) which are elements with at least one child, and *leaves* which are elements with no child, where a *child* is either a node or a leaf. The elements are connected by edges. The *size* of a tree is its number of nodes.

If it exists, a *root* is the only node which is not a child. A *rooted tree* is a tree with a root. Unless otherwise specified, all the trees we consider in this thesis are rooted trees. Let x be a node, a *subtree* of x is a rooted tree admitting a child of x as root. A *descendant* of x is a node in a subtree of x . An *ordered tree* (or *plane tree*) is a rooted tree such that an ordering from left to right is specified for the children of each node.

We draw rooted trees with the root at the top and the leaves at the bottom, where a node is depicted by \circ and a leaf is depicted by \square . Figure 1.2 shows a rooted tree of size 8.

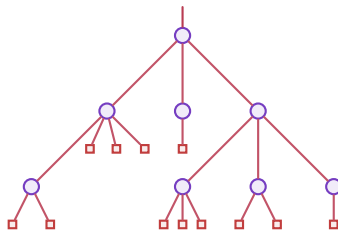

FIGURE 1.2. A rooted tree of size 8.

A *forest* is a sequence of trees. From a forest f of n trees, it is always possible to build a rooted tree t by choosing a root for each element of f and by linking all these roots to an artificial node, such that this artificial node become the root of t . The size of the obtained tree is the sum of all sizes in f plus 1.

Let $m \geq 0$. A *m-tree* is either a leaf or a node attached through m edges to m m -trees. The set of m -trees T_m is known to be enumerated by $(m - 1)$ -Fuss-Catalan numbers.

1.2.2. *Binary trees.* A *binary tree* (or *2-tree*) t is either a leaf or a node attached through two edges to two binary trees called respectively *left subtree* and *right subtree* of t [Sta12]. Recall that the *size* of a binary tree is its number of nodes. We denote by $T_2(n)$ the set of binary trees of size n . The set of binary trees is enumerated by Catalan number. In all this thesis, we consider all binary trees as ordered and rooted binary trees.

Let $t \in T_2(n)$. Each node of t is numbered recursively, starting with the left subtree, then the root, and ending with the right subtree. An example is given in Figure 1.3. This numbering then establishes a total order on the nodes of a binary tree called *infix order*. Afterwards, this numbering is used to refer to the nodes. The path following this numbering is called *infix traversal*.

The *canopy* of t is the word of size $n - 1$ on the alphabet $\{0, 1\}$ built by assigning to each leaf of t a letter as follows. Any leaf oriented to the left (resp. right) is labeled by 0 (resp. 1). The canopy of t is the word obtained by reading from left to right the labels thus established, forgetting the first and the last one. For instance, the binary tree in Figure 1.3 has for canopy the word 0110100.

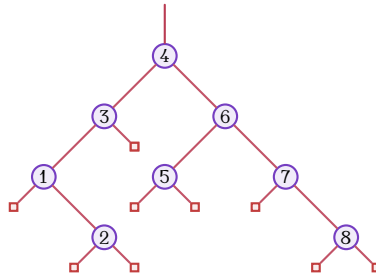

FIGURE 1.3. A binary tree of size 8 and the numbering of its nodes following the infix order.

A fundamental operation in binary trees is the *right rotation* [Tam62]. Let k and l be the indices in infix order of two nodes of a binary tree t , such that the node k is left child of the node l . Right rotation locally changes the tree t so that l becomes the right child of k (see Figure 1.4). Equivalently, this means that $((a, b), c)$ becomes $(a, (b, c))$, where a, b and c are the subtrees shown in Figure 1.4.

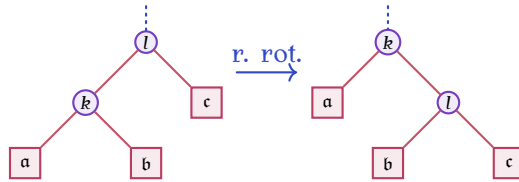

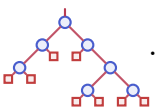

FIGURE 1.4. Right rotation of edge (k, l) in t (on the left), where a, b , and c are any subtrees.

As for permutations, there is an under operation and a over operation for binary trees due to Loday and Ronco [LR02]. Let $t \in T_2(n)$ and $s \in T_2(m)$. The *over* operation $/$ between t and s gives the binary tree t/s by replacing the leftmost leaf of s by the root of t . Likewise, the *under* operation \setminus between t and s gives the binary tree $t \setminus s$ by replacing the right most leaf of t by the root of s .

For instance, for $t :=$  and $s :=$ , one has

$$t/s = \text{} \tag{1.2.1}$$

$$t \setminus s = \text{} \tag{1.2.2}$$

1.2.3. *Binary trees and permutations.* A *binary search tree* is a binary tree where nodes are labelled by integers, such that for each node x of label a , any node in the left

subtree of x has a label smaller than or equal as a , and any node in the right subtree of x has a label greater than a .

Let t be a binary search tree of size n , and a be a letter. The *algorithm of insertion*, denoted by bst , of the letter a in t consists in adding a node a such that, for each node x of t , starting by the root, a is placed in the left subtree of x if $a \leq x$ and in the right subtree of x otherwise. Therefore, the size of the obtained tree is $n + 1$.

With the algorithm of insertion, one can build a binary search tree from a word of same size as follows. Let u be a word of size n . The root is the letter u_n , then we build recursively the left subtree and the right subtree of u_n by placing for each letter u_i with $i \in [n]$, the letter u_{i-1} on the left of u_i if $u_{i-1} \leq u_i$ and on the right of u_i otherwise. For instance, the binary tree see in Figure 1.3 is obtained by $\text{bst}(52871634)$, which is a permutation.

For any $n \geq 0$, the algorithm of insertion bst provides a surjection from the set of permutations $\mathfrak{S}(n)$ to the set of binary trees $T_2(n)$.

For instance, for $n = 3$,

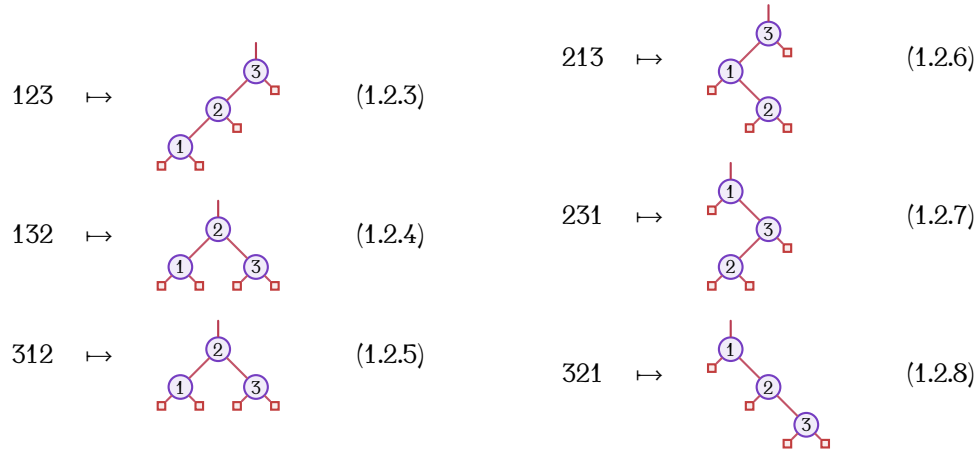

Note that when we consider permutations, we can forget the labelling of nodes since the only way to label binary search trees is an infix traversal. For instance, (1.2.4) and (1.2.5) are the same binary tree.

1.2.4. *Binary trees and Tamari diagrams.* For any $n \geq 0$, the set of Tamari diagrams of size n is in bijection with $T_2(n)$. Indeed, one builds from a Tamari diagram u of size n a binary tree \mathfrak{s} recursively as follows. If $n = 0$, \mathfrak{s} is defined as the leaf. Otherwise, let i be the smallest position in u such that u_i is the maximum allowed value, namely $n - i$. Then $\mathfrak{s}_1 := u_1 \dots u_{i-1}$ and $\mathfrak{s}_2 := u_{i+1} \dots u_n$ are also Tamari diagrams. One forms \mathfrak{s} by grafting the binary trees obtained recursively by this process applied on \mathfrak{s}_1 and on \mathfrak{s}_2 to a new node. Reciprocally, for each node of index i of the tree \mathfrak{s} , labeled with an infix transversal, the value of the i -th letter of the corresponding Tamari diagram is given by the number of nodes in the right subtree of the node i . The complete demonstration is given in [Pal86].



FIGURE 1.5. A binary tree and the associated Tamari diagram of the same size.

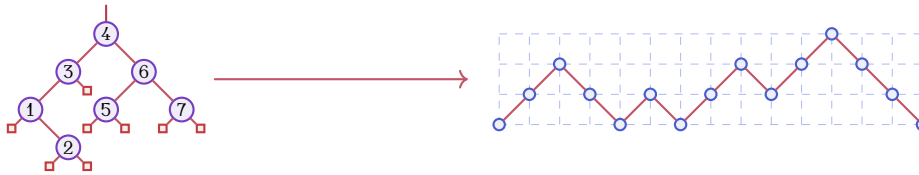

FIGURE 1.6. A binary tree and the associated Dyck path of the same size.

In the case of dual Tamari diagrams, the construction of the binary tree t is also recursive, except that it is the maximum position i in the dual Tamari diagram whose value is the highest allowed on that section of the word that should be chosen first. Similarly for the reciprocal, the procedure is identical, except that the value of the i -th letter in the dual Tamari diagram is given by the number of nodes in the left subtree of the node i in the tree t .

For instance, in Figure 1.3, the Tamari diagram is 10040210 and the dual Tamari diagram is 00230100. Figure 1.5 depicts the corresponding binary tree of the Tamari diagram 1003010.

1.2.5. Binary trees and Dyck paths. There are several bijections between binary trees and Dyck paths of the same size. Let us describe one of them. We know that a binary tree t is either a leaf or a node related to a left subtree t_1 and a right subtree t_2 , that is $t = (t_1, t_2)$. The bijection, denoted by ϕ , is then defined as follows. If t is a leaf, then $\phi(t)$ is the empty word ϵ , otherwise $\phi(t) = \phi(t_1)1\phi(t_2)0$. An example is given in Figure 1.6.

Reciprocally, for any $n \geq 0$, one can build the Tamari diagram, and so the binary tree, from a Dyck path d of size n as follows. For all $i \in [n]$, the letter u_i in u is the number of up steps between the i -th up step and the first down step of same height at its right in d . The word u is then a Tamari diagram, and the binary tree is obtained as seen in 1.2.4. For instance, the Dyck path in Figure 1.6 corresponds to the Tamari diagram 1003010, which corresponds to the tree on its left.

1.3. Posets and lattices.

1.3.1. *Elementary definitions.* A *partial order* $\preceq_{\mathcal{P}}$ on a set \mathcal{P} is a binary relation $\preceq_{\mathcal{P}}$ such that, for all $x, y, z \in \mathcal{P}$, this relation is

- (i) *reflexive*: $x \preceq_{\mathcal{P}} x$,
- (ii) *antisymmetric*: if $x \preceq_{\mathcal{P}} y$ and $y \preceq_{\mathcal{P}} x$, then $x = y$,
- (iii) *transitive*: if $x \preceq_{\mathcal{P}} y$ and $y \preceq_{\mathcal{P}} z$, then $x \preceq_{\mathcal{P}} z$.

A *partially ordered set*, commonly called *poset*, is a pair $(\mathcal{P}, \preceq_{\mathcal{P}})$. When the context is clear, we simply denote this pair by \mathcal{P} .

When two elements x and y of \mathcal{P} satisfy $x \preceq_{\mathcal{P}} y$, then we say that x and y are *comparable*. Otherwise they are *incomparable*. A *subposet* of a poset \mathcal{P} is a subset of \mathcal{P} endowed with the induced partial order.

Let $x, y \in \mathcal{P}$ such that $x \preceq_{\mathcal{P}} y$ and $x \neq y$. The element y *covers* x , denoted by $x \triangleleft_{\mathcal{P}} y$, for the partial order $\preceq_{\mathcal{P}}$ if, for all $z \in \mathcal{P}$ such that $x \preceq_{\mathcal{P}} z \preceq_{\mathcal{P}} y$, either $z = x$ or $z = y$. The binary relation $\triangleleft_{\mathcal{P}}$ is called the *covering relation* of the poset \mathcal{P} . By a slight abuse of notation, the set of elements (x, y) such that $x \triangleleft_{\mathcal{P}} y$ is also denoted by $\triangleleft_{\mathcal{P}}$.

A *maximal element* of \mathcal{P} is an element x such that if there is $y \in \mathcal{P}$ such that $x \preceq_{\mathcal{P}} y$ then $y = x$. Likewise, a *minimal element* of \mathcal{P} is an element y such that if there is $x \in \mathcal{P}$ such that $x \preceq_{\mathcal{P}} y$ then $x = y$. A poset \mathcal{P} is *bounded* if it has a unique maximal element and a unique minimal element for $\preceq_{\mathcal{P}}$.

Since a partial order is transitive, one can realize posets or lattices by knowing only covering relations. The natural way to realize posets is to draw their *Hasse diagrams*, by drawing a edge between all x and y in \mathcal{P} such that $(x, y) \in \triangleleft_{\mathcal{P}}$. For any $(x, y) \in \triangleleft_{\mathcal{P}}$, we choose the convention to represent x at the top and y at the bottom in the Hasse diagrams. We will keep this convention for all realizations.

The *dual* of \mathcal{P} is the set \mathcal{P} endowed with $\preceq_{\mathcal{P}}^*$ defined, for all $x, y \in \mathcal{P}$ such that $x \preceq_{\mathcal{P}} y$, by $y \preceq_{\mathcal{P}}^* x$. We say that \mathcal{P} is *self-dual* if there is a poset isomorphism between \mathcal{P} and its dual (see Section 1.4 for the definition of poset isomorphism).

Let $x, y \in \mathcal{P}$, the *join* between x and y , denoted by $\vee_{\mathcal{P}}(x, y)$ (or $x \vee_{\mathcal{P}} y$), is defined by

$$\vee_{\mathcal{P}}(x, y) := \min_{\preceq_{\mathcal{P}}} \{z \in \mathcal{P} : x \preceq_{\mathcal{P}} z \text{ and } y \preceq_{\mathcal{P}} z\}. \quad (1.3.1)$$

The *meet* between x and y , denoted by $\wedge_{\mathcal{P}}(x, y)$ (or $x \wedge_{\mathcal{P}} y$), is defined by

$$\wedge_{\mathcal{P}}(x, y) := \max_{\preceq_{\mathcal{P}}} \{z \in \mathcal{P} : z \preceq_{\mathcal{P}} x \text{ and } z \preceq_{\mathcal{P}} y\}. \quad (1.3.2)$$

A poset \mathcal{P} is a *join-semilattice* if for all $x, y \in \mathcal{P}$, $\vee_{\mathcal{P}}(x, y)$ exists. Likewise, a poset \mathcal{P} is a *meet-semilattice* if for all $x, y \in \mathcal{P}$, $\wedge_{\mathcal{P}}(x, y)$ exists.

A poset $(\mathcal{L}, \preceq_{\mathcal{L}})$ is a *lattice* if \mathcal{L} is a join-semilattice and a meet-semilattice. A *sublattice* of a lattice \mathcal{L} is a subset of \mathcal{L} that is a lattice for the meet and join operations of \mathcal{L} .

Our first example is the *hypercube* (or *Boolean lattice*) of dimension $n \geq 0$, which is the lattice \mathcal{H}_n on the set of the subsets of $[n]$ ordered by set inclusion. Figure 1.7 depicts on the left the lattice \mathcal{H}_3 on $A := \{a, b, c\}$. On the right one has a poset \mathcal{P} which is not

a lattice, since there are two non comparable elements d and e such that $b \preceq_{\mathcal{P}} d$ and $c \preceq_{\mathcal{P}} d$, and $b \preceq_{\mathcal{P}} e$ and $c \preceq_{\mathcal{P}} e$.

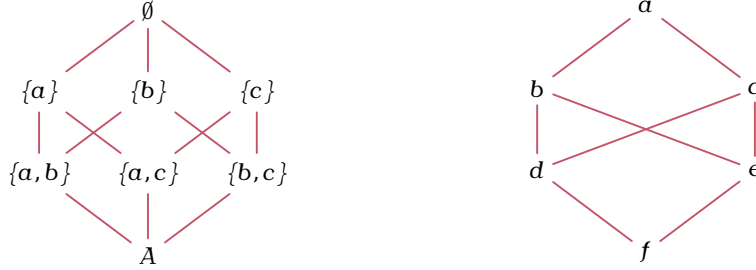

FIGURE 1.7. The Hasse diagrams of a lattice (on the left) and of a poset (on the right).

An element x of a lattice \mathcal{L} is *join-irreducible* (resp. *meet-irreducible*) if x covers (resp. is covered by) exactly one element in \mathcal{L} . We denote by $\mathbf{J}(\mathcal{L})$ (resp. $\mathbf{M}(\mathcal{L})$) the set of join-irreducible (resp. meet-irreducible) elements of \mathcal{L} . These notions are usually considered specially for lattices but we can take the same definitions even when \mathcal{L} is just a poset.

For instance, in Figure 1.7 one has for the lattice \mathcal{L} ,

$$\mathbf{J}(\mathcal{L}) = \{\{a\}, \{b\}, \{c\}\}, \quad (1.3.3)$$

$$\mathbf{M}(\mathcal{L}) = \{\{a, b\}, \{a, c\}, \{b, c\}\}. \quad (1.3.4)$$

1.3.2. Rank functions. Let \mathcal{P} be a poset. A *rank function* rk is a function from \mathcal{P} to \mathbb{N} such that $\text{rk}(x) = 0$ if and only if x is a minimal element of \mathcal{P} , and $\text{rk}(y) = \text{rk}(x) + 1$ if and only if $x \prec_{\mathcal{P}} y$ for all $x, y \in \mathcal{P}$. For all $x \in \mathcal{P}$, the value $\text{rk}(x)$ is the *rank* of x . If \mathcal{P} admits a rank function then \mathcal{P} is *graded*.

1.3.3. Order dimension. The *order dimension* [Tro92] of a poset \mathcal{P} is the smallest nonnegative integer k such that there exists a poset embedding of \mathcal{P} into (\mathbb{N}^k, \preceq) where \preceq is the componentwise partial order (see Section 1.4 for the definition of embedding). For example, it can be shown that the order dimension of \mathcal{H}_n is n .

1.3.4. Degree polynomial. For any poset \mathcal{P} , the *degree polynomial* of \mathcal{P} is the polynomial $d_{\mathcal{P}}(x, y) \in \mathbb{K}[x, y]$ defined by

$$d_{\mathcal{P}}(x, y) := \sum_{u \in \mathcal{P}} x^{\text{in}_{\mathcal{P}}(u)} y^{\text{out}_{\mathcal{P}}(u)}, \quad (1.3.5)$$

where for any $u \in \mathcal{P}$, $\text{in}_{\mathcal{P}}(u)$ (resp. $\text{out}_{\mathcal{P}}(u)$) is the number of elements covered by (resp. covering) u in \mathcal{P} . We define the specialization $d_{\mathcal{P}}(1, y)$ as the *h -polynomial* of \mathcal{P} .

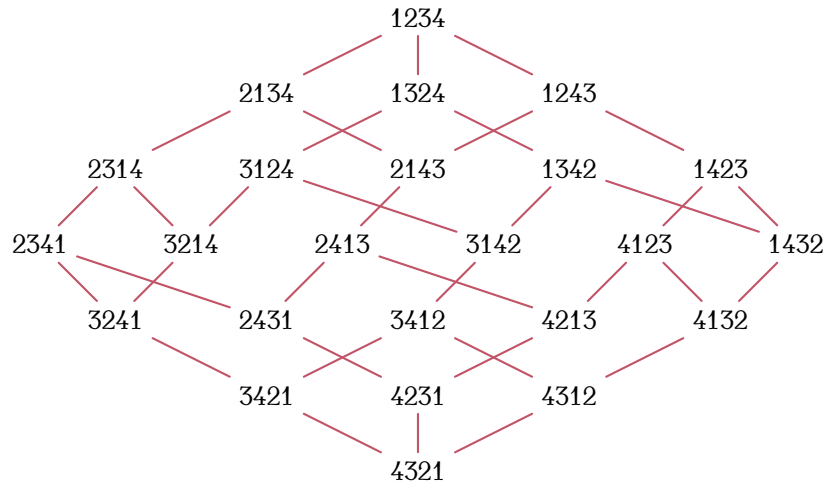
FIGURE 1.8. Hasse diagrams of $\mathfrak{S}(4)$ for \preceq_{we} .

1.3.5. *Right weak order on permutations.* For any $n \geq 0$, let $\sigma, \nu \in \mathfrak{S}(n)$. We set $\sigma \prec_{\text{we}} \nu$ if ν is obtained from σ by replacing one factor ab by ba with $a < b$. The *right weak order* (or *weak Bruhat order*) \preceq_{we} is the reflexive and transitive closure of \prec_{we} , which is the covering relation. The right weak order on permutations forms a lattice, also known as the *permutohedron*. Figure 1.8 depicts the right weak order on permutations for $n = 4$.

1.3.6. *Lehmer code lattices.* For any $n \geq 0$, let u and v be two Lehmer codes of the same size n . We set $u \preceq v$ if $u_i \leq v_i$ for all $i \in [n]$. The relation \preceq is a partial order called the *componentwise order*, and the set of Lehmer codes endowed with \preceq is the *Lehmer code lattice* [Leh60]. Moreover, u is covered by v , denoted $u \prec v$, if there is a unique $i \in [n]$ such that $u_i < v_i$, and for all Lehmer codes w such that $u \preceq w \preceq v$, either $w = u$ or $w = v$. A study of these posets appears in [Den13].

The componentwise order is a natural order on words, and plays a very important role in all the next chapters.

1.3.7. *Tamari lattices.* For any $n \geq 0$, let $s, t \in T_2(n)$. We set $s \preceq_{\text{ta}} t$ if t is obtained by successively applying one or more right rotations in s . The set $T_2(n)$ endowed with \preceq_{ta} is the *Tamari lattice* of order n [HT72]. Moreover, s is covered by t , denoted by $s \prec_{\text{ta}} t$, if t is obtained from s by performing one right rotation. Figure 1.9 shows the Tamari lattice for $n = 2$ and for $n = 3$.

In the literature, the Tamari lattice is also called the *associahedron*, or the *Stasheff polytope* after the work of Stasheff. More precisely, the Hasse diagram of the Tamari lattice is the 1-skeleton of the associahedron.

As seen previously, the algorithm of insertion bst provides a surjection from $\mathfrak{S}(n)$ to $T_2(n)$ for $n \geq 0$. This implies that the Tamari lattice can be obtained from the right weak order on permutations [HNT05]. More precisely, the Tamari order is the right weak

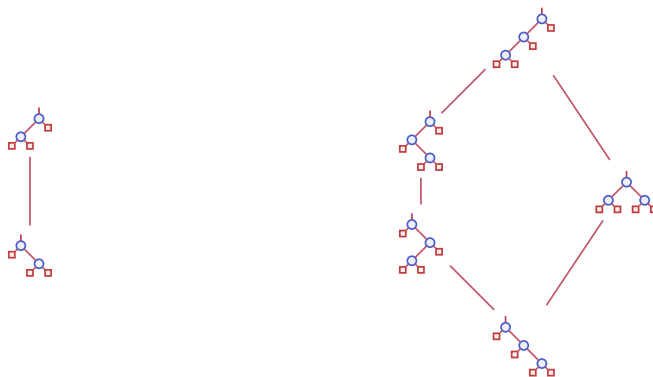
FIGURE 1.9. Hasse diagrams of $T_2(2)$ and $T_2(3)$.

order on 132-avoiding permutations, where 132-avoiding means that we have to remove all permutations u such that $u_i < u_j > u_k$ for some $i < j < k$. Figure 1.10 depicts the Tamari lattice of order 4, obtained from Figure 1.8.

A natural translation of the Tamari order is given by the bijection between binary trees and Tamari diagrams seen in 1.2.4. With this bijection, the Tamari order can be translated as the componentwise order on Tamari diagrams [Pal86].

Likewise, through the bijection between binary trees and Dyck paths seen in 1.2.5, the Tamari order can also be defined on Dyck paths as follows. For any $n \geq 0$, let $d, d' \in \text{Dy}(n)$ such that $d := p0xs$ where p is a prefix, s is a suffix, and x is primitive. We set $d \prec_{\text{ta}} d'$ if $d' = px0s$. The Tamari order on $\text{Dy}(n)$ is then the reflexive and transitive closure of \prec_{ta} .

The Tamari posets admit a lot of generalizations, for instance through the so-called m -Tamari posets [BPR12] defined on m -Dyck paths, where $m \geq 0$, and through the ν -Tamari posets [PRV17] where ν is a binary word. In Chapter 4, we define another generalisation of the Tamari lattice, based on a generalisation of Tamari diagrams.

1.3.8. *Kreweras lattices.* There is a natural order \prec_{kr} on non-crossing partitions due to Kreweras [Kre72]. For any $n \geq 0$, let $p, q \in \text{NC}(n)$. We set $p \prec_{\text{kr}} q$ if q is obtained from p by merging two parts such that the condition to be a non-crossing partition is satisfied. The Kreweras order \prec_{kr} on $\text{NC}(n)$ is then the reflexive and transitive closure of \prec_{kr} .

The translation of the Kreweras order on Dyck paths given by the bijection seen in 1.1.7 is also natural. For any $n \geq 0$, let $d, d' \in \text{Dy}(n)$ such that $d := p10^m x s$ where p is a prefix, s is a suffix, x is a subpath, and $m \geq 1$. We set $d \prec_{\text{kr}} d'$ if $d' = p1x0^m s$. The Kreweras order on $\text{Dy}(n)$ is then the reflexive and transitive closure of \prec_{kr} . See Figure 1.11 for the Kreweras order on $\text{Dy}(3)$.

1.3.9. *Stanley lattices.* For any $n \geq 0$, let $d, d' \in \text{Dy}(n)$. We set $d \prec_{\text{st}} d'$ if d stays below d' . The set $\text{Dy}(n)$ endowed with the partial order \prec_{st} is the *Stanley lattice* [Sta75, Knu04]. Moreover, d is covered by d' if d' is obtained from d by replacing a factor 01 by a factor 10. See Figure 1.11 for the Stanley lattice on $\text{Dy}(3)$.

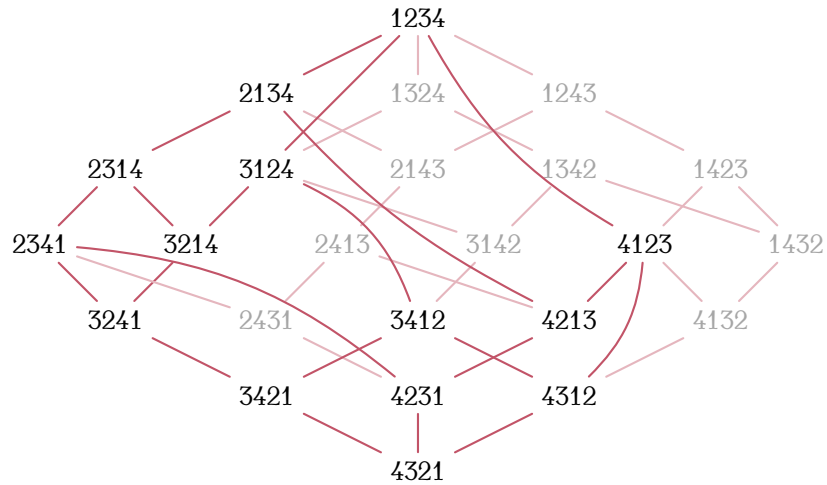

FIGURE 1.10. Tamari order on 132-avoiding permutations of size 4.

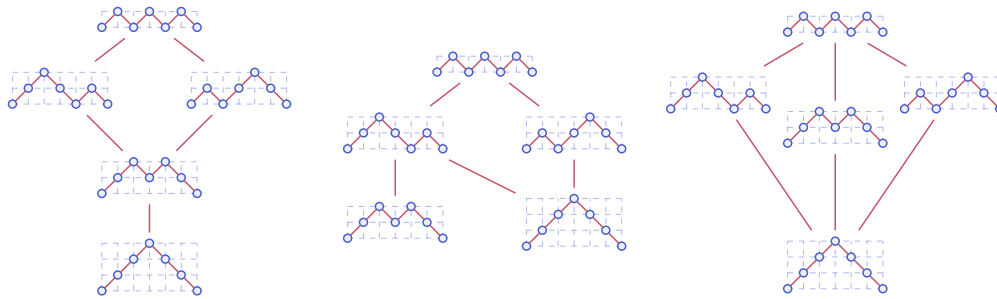

FIGURE 1.11. From left to right, Hasse diagrams of the Stanley order, the dexter order, and the Kreweras order on $Dy(3)$.

1.3.10. *Dexter order.* The dexter order, introduced in [Cha20], is the natural order obtained on special elements of the Tamari interval lattices (see Section 2.2.3 for the definition of Tamari interval lattice). In Chapter 3, we shall work on a particular interval of the dexter order, called the Hochschild lattice.

A subpath x of d is *movable* if x is primitive and if there is a prefix p and a suffix s such that $d = p10^m xs$, where $m > 0$, and either $s = \epsilon$ or the first letter of s is 1. Figure 1.12 gives two examples of movable subpaths.

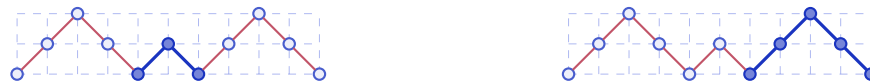

FIGURE 1.12. A Dyck path 1100101100 with two movable paths, in blue (dark).

For any $n \geq 0$, let $d := p10^m xs$ be a Dyck path of size n , where x is movable. Let $d_{\alpha,\beta}$ be the Dyck path of size n such that $d_{\alpha,\beta} := p10^\alpha x0^\beta s$, where $\alpha + \beta = m$ and $\beta > 0$.

We set $d \prec_{\text{de}} d'$ if $d' = d_{\alpha,\beta}$, for any x movable subpath of d . The *dexter order* \preceq_{de} is the reflexive and transitive closure of \prec_{de} , which is the covering relation. Figure 1.13 depicts the three covering Dyck paths of the Dyck path 1100101100 seen in Figure 1.12 for the dexter order. Note that the chosen movable subpath x is no longer movable in $d_{\alpha,\beta}$.

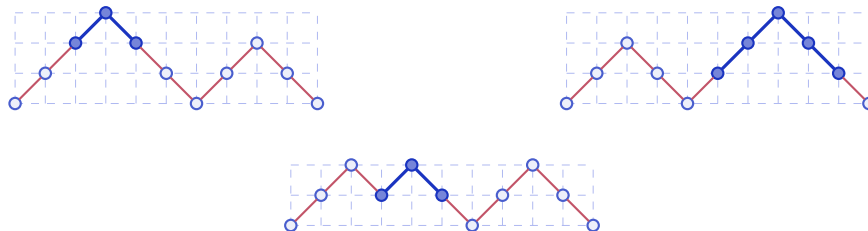

FIGURE 1.13. The three Dyck paths covering the Dyck path 1100101100 for the dexter order.

The set $\text{Dy}(n)$ endowed with the dexter order is a meet-semilattice with many properties highlighted in the article of Chapoton [Cha20]. See Figure 1.11 for the dexter order on $\text{Dy}(3)$.

1.4. Poset morphisms and poset embeddings.

1.4.1. *Definitions.* Let $(\mathcal{P}_1, \preceq_1)$ and $(\mathcal{P}_2, \preceq_2)$ be two posets. A map $\phi : \mathcal{P}_1 \rightarrow \mathcal{P}_2$ is a *poset morphism* if for any $x, y \in \mathcal{P}_1$, $x \preceq_1 y$ implies $\phi(x) \preceq_2 \phi(y)$. We say that \mathcal{P}_2 is an *order extension* of a poset \mathcal{P}_1 if there is a map $\phi : \mathcal{P}_1 \rightarrow \mathcal{P}_2$ which is both a bijection and a poset morphism.

A map $\phi : \mathcal{P}_1 \rightarrow \mathcal{P}_2$ is a *poset embedding* if for any $x, y \in \mathcal{P}_1$, $x \preceq_1 y$ if and only if $\phi(x) \preceq_2 \phi(y)$. Observe that a poset embedding is necessarily injective. A map $\phi : \mathcal{P}_1 \rightarrow \mathcal{P}_2$ is a *poset isomorphism* if ϕ is both a bijection and a poset embedding.

1.4.2. *Examples.* In 1.3.7, we see that a natural translation of the Tamari order on binary trees is given by the componentwise order on Tamari diagrams. The bijection described in 1.2.4 is in fact a poset isomorphism between the two lattices. Likewise, one has a poset isomorphism between the Tamari order on binary trees and the Tamari order on Dyck paths described in 1.3.7. Figure 1.14 shows the three lattices, which are finally the same lattice.

Another example of poset isomorphism is given by the bijection seen in 1.1.7 between non-crossing partitions and Dyck paths. Therefore, the Kreweras order on non-crossing partitions and the Kreweras order on Dyck paths are the same lattice.

In 1.1.6, we give a bijection between permutations and Lehmer codes. This bijection provides our first example of order extension. Thus, the componentwise order on Lehmer codes is a order extension of the right weak order on permutations (see Section 1.2.3 of Chapter 4). Figure 1.15 depicts the lattice of permutations for $n = 3$, and the lattice on Lehmer codes for $n = 3$.

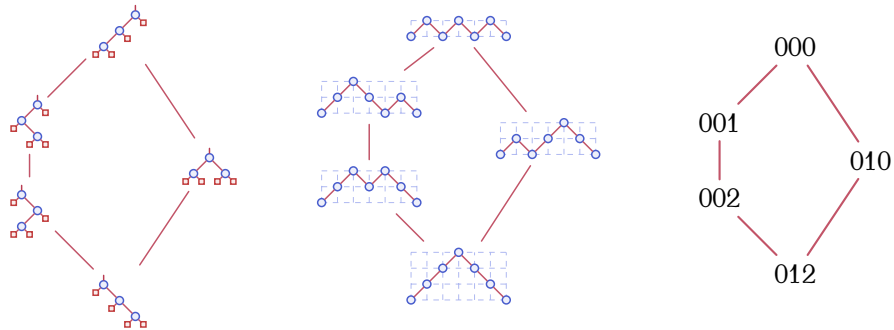

FIGURE 1.14. Hasse diagrams of $BT(3)$, the Tamari order on $Dy(3)$, and the componentwise order on Tamari diagrams of size 3.



FIGURE 1.15. Hasse diagrams of $S(3)$ and of the Lehmer code lattice of size 3.

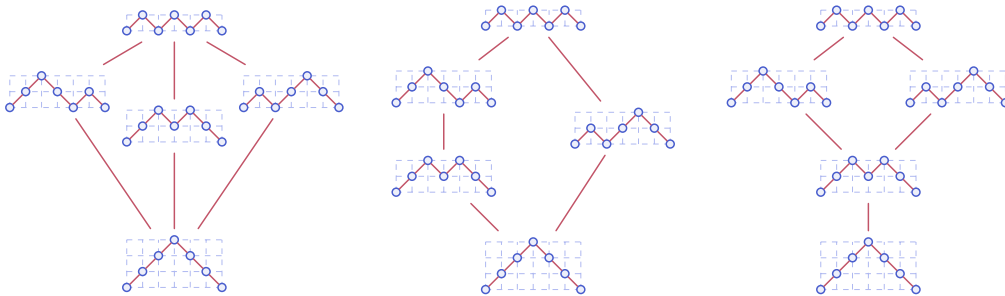

FIGURE 1.16. From left to right, Kreweras lattice, Tamari lattice, and Stanley lattice on $Dy(3)$.

Another example of order extension relates the Stanley order, the Tamari order, and the Kreweras order. Indeed, ordered by inclusion, the Stanley lattice is an extension of the Tamari lattice which is an extension of the Kreweras lattice [Knu06, BB09]. Figure 1.16 shows the three orders on $Dy(3)$.

2. Combinatorial and geometric properties

There are several constructions on posets, as the posets of k -chains or the order ideals ordered by inclusion. We start this section by recalling some definitions and properties on lattices, such as the distributivity. Then, we shall see some poset constructions as the

posets of intervals or the edge labelling on non-graded posets. We will end this section with the properties of some posets to be constructible by doubling specific intervals.

This section will be useful for all next chapters.

2.1. Distributive and semidistributive lattices.

2.1.1. *Elementary definitions.* A lattice \mathcal{L} is *join-semidistributive* if for all $x, y, z \in \mathcal{L}$,

$$x \vee y = x \vee z \text{ implies } x \vee y = x \vee (y \wedge z). \quad (2.1.1)$$

Likewise, a lattice \mathcal{L} is *meet-semidistributive* if for all $x, y, z \in \mathcal{L}$,

$$x \wedge y = x \wedge z \text{ implies } x \wedge y = x \wedge (y \vee z). \quad (2.1.2)$$

A lattice \mathcal{L} is *semidistributive* if \mathcal{L} is both join-semidistributive and meet-semidistributive.

A lattice \mathcal{L} is *distributive* if

$$x \wedge (y \vee z) = (x \wedge y) \vee (x \wedge z), \quad (2.1.3)$$

or in an equivalent way

$$x \vee (y \wedge z) = (x \vee y) \wedge (x \vee z). \quad (2.1.4)$$

For instance, the Boolean lattices are distributive lattices. The Tamari lattices are non-distributive lattices, as the Kreweras lattices.

It is known [Bir79] that all sublattices of distributive lattices are distributive.

2.1.2. *Chains and maximal chains.* A *chain* of a poset \mathcal{P} is a tuple

$$\left(x^{(1)}, x^{(2)}, \dots, x^{(r-1)}, x^{(r)} \right), \quad (2.1.5)$$

where $x^{(1)}, x^{(2)}, \dots, x^{(r-1)}, x^{(r)}$ are r elements of \mathcal{P} such that

$$x^{(1)} \preceq_{\mathcal{P}} x^{(2)} \preceq_{\mathcal{P}} \dots \preceq_{\mathcal{P}} x^{(r-1)} \preceq_{\mathcal{P}} x^{(r)}. \quad (2.1.6)$$

Let $\preceq_{\mathcal{P}}$ be the covering relation of \mathcal{P} . If $x^{(i)} \preceq_{\mathcal{P}} x^{(i+1)}$ for all $i \in [r-1]$, then the chain (2.1.5) is *saturated*.

Let \mathcal{L} be a lattice and let

$$\left(x^{(1)}, x^{(2)}, \dots, x^{(r-1)}, x^{(r)} \right) \quad (2.1.7)$$

be a saturated chain of \mathcal{L} . The *length* of the saturated chain (2.1.7) is $r-1$.

Note that in Section 2.2, we deal with k -chains, where k refers not to the length of the chain but to the number of elements forming that chain.

A longest saturated chain between the minimal element and the maximal element of \mathcal{L} is a *maximal saturated chain*. The union of maximal saturated chains of \mathcal{L} is known as the *spine* of \mathcal{L} . The spine of \mathcal{L} is denoted by $\mathbb{S}(\mathcal{L})$.

2.1.3. *Extremal and trim lattices.* Let \mathcal{L} be a lattice such that the length of a maximal saturated chain is k . If $\#\mathbf{J}(\mathcal{L}) = \#\mathbf{M}(\mathcal{L}) = k$ then \mathcal{L} is an *extremal lattice* [Mar92].

An element x of a lattice \mathcal{L} is *left modular* [BS97] if for any $y \preceq_{\mathcal{L}} z$,

$$(y \vee x) \wedge z = y \vee (x \wedge z). \quad (2.1.8)$$

A lattice is *left modular* if there is a maximal saturated chain of left modular elements.

A lattice is *trim* [Tho06] if it is an extremal left modular lattice.

It is shown in [TW19] that if a lattice is extremal and semidistributive, then it is also left modular, and therefore trim.

Let \mathcal{L} be an extremal lattice. It is known from [Tho06] that the spine of an extremal lattice is a distributive sublattice of \mathcal{L} .

2.1.4. *The Fundamental theorem for finite distributive lattices.* Let \mathcal{P} be a poset. An *order ideal* in \mathcal{P} is a subset S of \mathcal{P} such that if $x \in S$ and $y \preceq_{\mathcal{P}} x$ then $y \in S$.

The Fundamental theorem for finite distributive lattices (FTFDL for short) due to Birkhoff [Bir37] states that any finite distributive lattice \mathcal{L} is isomorphic to the lattice $\mathbb{J}(\mathcal{P})$ of the order ideals of the subposet \mathcal{P} of \mathcal{L} restricted to its join-irreducible elements, ordered by inclusion [Sta11].

More recently, a general version of the FTFDL has been given by Reading, Speyer, and Thomas for finite semidistributive lattices [RST19].

2.2. Posets of k -chains.

2.2.1. *Definitions.* A *k -chain* of a poset \mathcal{P} is a chain of \mathcal{P} which is, as a tuple, of length k .

For any poset \mathcal{P} , we can always consider the poset of k -chains \mathcal{P}^k of \mathcal{P} where elements are k -chains and the order relation is defined, for all $\gamma, \delta \in \mathcal{P}^k$ such that $\gamma := (u^{(1)}, u^{(2)}, \dots, u^{(k)})$ and $\delta := (v^{(1)}, v^{(2)}, \dots, v^{(k)})$, by

$$\gamma \preceq_{\mathcal{P}^k} \delta \text{ if } u^{(i)} \preceq_{\mathcal{P}} v^{(i)} \text{ for all } i \in [k]. \quad (2.2.1)$$

2.2.2. *Posets of intervals.* Let \mathcal{P} be a poset and $u^{(1)}, u^{(2)} \in \mathcal{P}$ such that $u^{(1)} \preceq_{\mathcal{P}} u^{(2)}$. An *interval* $[u^{(1)}, u^{(2)}]$ is the set of all elements between $u^{(1)}$ and $u^{(2)}$. The set of intervals of \mathcal{P} is denoted by $\text{int}(\mathcal{P})$. Since the 2-chain $(u^{(1)}, u^{(2)})$ characterizes the interval $[u^{(1)}, u^{(2)}]$ and reciprocally, we use the same notation for intervals as for 2-chains.

The *poset of intervals* of a poset \mathcal{P} is the poset on the set $\text{int}(\mathcal{P})$ endowed with the partial order $\preceq_{\text{int}(\mathcal{P})}$ defined, for all $(u^{(1)}, u^{(2)}), (v^{(1)}, v^{(2)}) \in \text{int}(\mathcal{P})$, by

$$(u^{(1)}, u^{(2)}) \preceq_{\text{int}(\mathcal{P})} (v^{(1)}, v^{(2)}) \text{ if } u^{(1)} \preceq_{\mathcal{P}} v^{(1)} \text{ and } u^{(2)} \preceq_{\mathcal{P}} v^{(2)}. \quad (2.2.2)$$

The property of being a lattice is preserved under this construction.

PROPOSITION 2.2.1. *If $(\mathcal{L}, \preceq_{\mathcal{L}})$ is a lattice then $(\text{int}(\mathcal{L}), \preceq_{\text{int}(\mathcal{L})})$ is a lattice.*

PROOF. Let $(u^{(1)}, u^{(2)}), (v^{(1)}, v^{(2)}) \in \text{int}(\mathcal{L})$. First, we have to show that $\vee_{\mathcal{L}}(u^{(1)}, v^{(1)}) \preceq_{\mathcal{L}} \vee_{\mathcal{L}}(u^{(2)}, v^{(2)})$. By definition of the join, one has $u^{(2)} \preceq_{\mathcal{L}} \vee_{\mathcal{L}}(u^{(2)}, v^{(2)})$ and $v^{(2)} \preceq_{\mathcal{L}} \vee_{\mathcal{L}}(u^{(2)}, v^{(2)})$. Furthermore, since $u^{(1)} \preceq_{\mathcal{L}} u^{(2)}$ and $v^{(1)} \preceq_{\mathcal{L}} v^{(2)}$, one has $u^{(1)} \preceq_{\mathcal{L}} \vee_{\mathcal{L}}(u^{(2)}, v^{(2)})$ and $v^{(1)} \preceq_{\mathcal{L}} \vee_{\mathcal{L}}(u^{(2)}, v^{(2)})$. In addition, $\vee_{\mathcal{L}}(u^{(1)}, v^{(1)})$ is the minimal element of \mathcal{L} satisfying $u^{(1)} \preceq_{\mathcal{L}} \vee_{\mathcal{L}}(u^{(1)}, v^{(1)})$ and $v^{(1)} \preceq_{\mathcal{L}} \vee_{\mathcal{L}}(u^{(1)}, v^{(1)})$. Thus $\vee_{\mathcal{L}}(u^{(1)}, v^{(1)}) \preceq_{\mathcal{L}} \vee_{\mathcal{L}}(u^{(2)}, v^{(2)})$.

From the equation (2.2.2), one has

$$\begin{aligned}
& \vee_{\text{int}(\mathcal{L})}((u^{(1)}, u^{(2)}), (v^{(1)}, v^{(2)})) \\
&= \min_{\preceq_{\text{int}(\mathcal{L})}} \{ (w^{(1)}, w^{(2)}) \in \text{int}(\mathcal{L}) : (u^{(1)}, u^{(2)}) \preceq_{\text{int}(\mathcal{L})} (w^{(1)}, w^{(2)}), (v^{(1)}, v^{(2)}) \preceq_{\text{int}(\mathcal{L})} (w^{(1)}, w^{(2)}) \} \\
&= \min_{\preceq_{\text{int}(\mathcal{L})}} \{ (w^{(1)}, w^{(2)}) \in \text{int}(\mathcal{L}) : u^{(1)} \preceq_{\mathcal{L}} w^{(1)}, u^{(2)} \preceq_{\mathcal{L}} w^{(2)}, v^{(1)} \preceq_{\mathcal{L}} w^{(1)}, v^{(2)} \preceq_{\mathcal{L}} w^{(2)} \} \\
&= (\vee_{\mathcal{L}}(u^{(1)}, v^{(1)}), \vee_{\mathcal{L}}(u^{(2)}, v^{(2)})).
\end{aligned} \tag{2.2.3}$$

The case of the meet $\wedge_{\text{int}(\mathcal{L})}((u^{(1)}, u^{(2)}), (v^{(1)}, v^{(2)})) = (\wedge_{\mathcal{L}}(u^{(1)}, v^{(1)}), \wedge_{\mathcal{L}}(u^{(2)}, v^{(2)}))$ is symmetrical. \square

In the same way for $(u^{(1)}, u^{(2)}), (v^{(1)}, v^{(2)}) \in \text{int}(\mathcal{L})$ such that $(u^{(1)}, u^{(2)}) \preceq_{\text{int}(\mathcal{L})} (v^{(1)}, v^{(2)})$, a covering relation for the partial order $\preceq_{\text{int}(\mathcal{L})}$ is defined.

2.2.3. Tamari intervals and interval-posets. Let $s, t \in T_2(n)$. A *Tamari interval of size n* is an interval (s, t) for the Tamari order \preceq_{ta} . The set of Tamari intervals of size n is denoted by $\text{int}(T_2(n))$.

The Tamari interval lattice is the set $\text{int}(T_2(n))$ endowed with the partial order $\preceq_{\text{int}(\text{ta})}$. Let $n \geq 0$ and $(s, t), (s', t') \in \text{int}(T_2(n))$, following (2.2.2), we have that $(s, t) \preceq_{\text{int}(\text{ta})} (s', t')$ if $s \preceq_{\text{ta}} s'$ and $t \preceq_{\text{ta}} t'$. According to Lemma 2.2.1, the poset so defined is a lattice. Moreover, it follows from the definition of $\preceq_{\text{int}(\text{ta})}$ that (s', t') covers (s, t) if

- ★ either s' is obtained by a single right rotation of an edge in s and $t' = t$,
- ★ or t' is obtained by a single right rotation of an edge in t and $s' = s$.

It is known from [Cha06] that Tamari intervals of size n are enumerated by

$$\frac{2(4n+1)!}{(n+1)!(3n+2)!}. \tag{2.2.4}$$

The first numbers are

$$1, 1, 3, 13, 68, 399, 2530, 16965. \tag{2.2.5}$$

This sequence is Sequence **A000260** of [Slo].

Interval-posets are posets introduced by Châtel and Pons in [CP15] in order to study the Tamari interval posets. Indeed, there is a poset isomorphism between the Tamari interval lattices and the set of interval-posets endowed with a certain partial order. We shall use the one-to-one correspondence between the two sets in Chapter 2. This is why we shall recall here a part of the bijection in the broad outline.

Let $n \geq 0$ and $\{\pi_1, \dots, \pi_n\}$ be a set of n symbols numbered from 1 to n . An *interval-poset* π is a partial order \triangleleft on the set $\{\pi_1, \dots, \pi_n\}$ such that

- (i) if $i < k$ and $\pi_k \triangleleft \pi_i$ then for all π_j such that $i < j < k$, one has $\pi_j \triangleleft \pi_i$,
- (ii) if $i < k$ and $\pi_i \triangleleft \pi_k$ then for all π_j such that $i < j < k$, one has $\pi_j \triangleleft \pi_k$.

The *size* of an interval-poset is the cardinality of its underlying set. The set of interval-posets of size n is denoted by $IP(n)$, and the elements of interval-poset are called *vertices*.

The two conditions (i) and (ii) of interval-posets are referred to as *interval-poset properties*. For any $i < j$, the relations $\pi_j \triangleleft \pi_i$ are known as *decreasing relations* and the relations $\pi_i \triangleleft \pi_j$ are known as *increasing relations*.

As it is shown in Figure 2.1, the Hasse diagram of interval-posets can be drawn as an oriented graph where two vertices π_i and π_j are related by an arrow from π_i to π_j (resp. π_j to π_i) if $\pi_i \triangleleft \pi_j$ (resp. $\pi_j \triangleleft \pi_i$) where $i < j$.

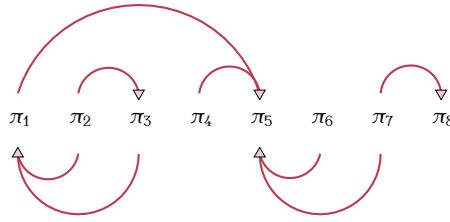
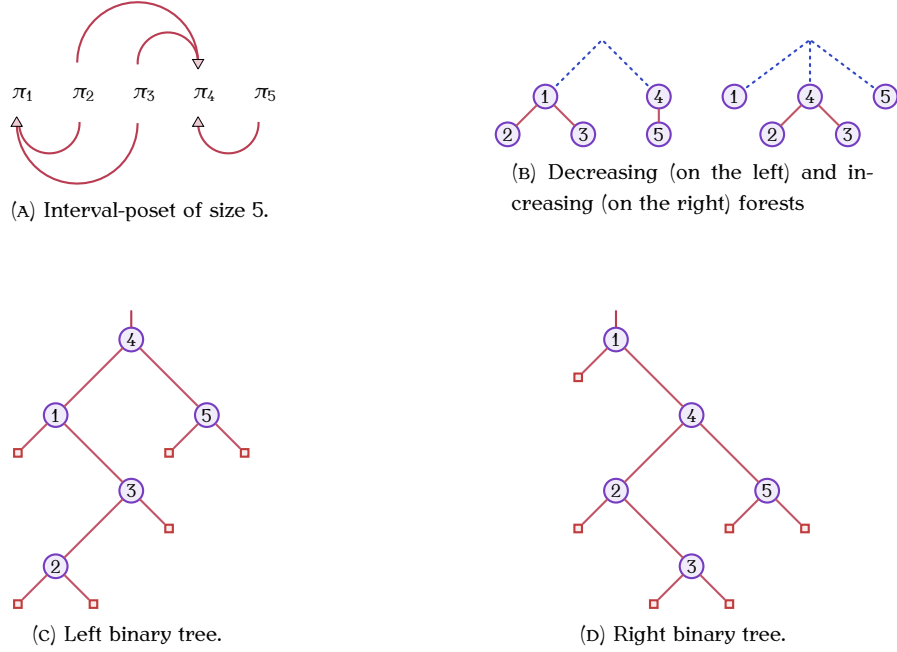

FIGURE 2.1. Hasse diagram of an interval-poset of size 8.

Let $n \geq 0$ and $(s, t) \in \text{int}(T_2(n))$ and $\pi \in IP(n)$. The bijection ρ relates on the one hand the restriction of π to its decreasing relations with the binary tree s , and on the other hand the restriction of π to its increasing relations with the binary tree t .

Thus the restriction of π to its decreasing (resp. increasing) relations has a decreasing (resp. increasing) forest as Hasse diagram, where if $\pi_j \triangleleft \pi_i$ with $i < j$ (resp. $j < i$), then the node j is a descendant of the node i . Otherwise, it is placed to the right (resp. left) of the node i . To form the binary tree s (resp. t), then read the decreasing (resp. increasing) forest for the prefix transversal from right to left (resp. from left to right). If a node j is a descendant of a node i in the decreasing (resp. increasing) forest, then the node j becomes a right (resp. left) descendant of the node i in s (resp. t). Otherwise, it becomes the left (resp. right) descendant of the node i . The numbering of the binary trees thus obtained is exactly the infix order. Figure 2.2 gives an example of construction by the bijection ρ of a Tamari interval from an interval-poset of size 5.

2.3. EL-shellability.

FIGURE 2.2. Construction of a Tamari interval from an interval-poset by ρ .

2.3.1. *Edge labelling and shellability of non-graded posets.* In [BW96] and [BW97], Björner and Wachs generalized the method of labellings of the cover relations of graded posets to the case of non-graded posets. In particular, they showed the EL-shellability of the Tamari poset [BW97].

Let \mathcal{P} be a bounded poset and Λ be a poset, and $\lambda : \prec_{\mathcal{P}} \rightarrow \Lambda$ be a map. For any saturated chain $(x^{(1)}, \dots, x^{(k)})$ of \mathcal{P} , we set

$$\lambda(x^{(1)}, \dots, x^{(k)}) := (\lambda(x^{(1)}, x^{(2)}), \dots, \lambda(x^{(k-1)}, x^{(k)})). \quad (2.3.1)$$

We say that a saturated chain of \mathcal{P} is λ -increasing (resp. λ -weakly decreasing) if its image by λ is an increasing (resp. weakly decreasing) word for the order relation \preceq_{Λ} . We say also that a saturated chain $(x^{(1)}, \dots, x^{(k)})$ of \mathcal{P} is λ -smaller than a saturated chain $(y^{(1)}, \dots, y^{(k)})$ of \mathcal{P} if $\lambda(x^{(1)}, \dots, x^{(k)})$ is smaller than $\lambda(y^{(1)}, \dots, y^{(k)})$ for the lexicographic order induced by \preceq_{Λ} . The map λ is called *EL-labeling* (edge lexicographic labeling) of \mathcal{P} if for any $x, y \in \mathcal{P}$ satisfying $x \preceq_{\mathcal{P}} y$, there is exactly one λ -increasing saturated chain from x to y , and this chain is λ -minimal among all saturated chains from x to y . Any bounded poset that admits an EL-labeling is *EL-shellable* [BW96, BW97].

The EL-shellability of a poset \mathcal{P} implies several topological and order theoretical properties of the associated order complex $\Delta(\mathcal{P})$ built from \mathcal{P} . Recall that the faces of this simplicial complex are all the chains of \mathcal{P} . Moreover, if \mathcal{P} has at most one λ -weakly decreasing chain between any pair of elements then the Möbius function of \mathcal{P} takes values

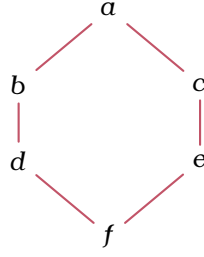

FIGURE 2.3. Counterexample of a lattice not EL-shellable.



FIGURE 2.4. Operation of doubling in an interval in blue (dark).

in $\{-1, 0, 1\}$. In this case, the simplicial complex associated with each open interval of \mathcal{P} is either contractible or has the homotopy type of a sphere [BW97].

2.3.2. Example and counterexample. Figure 2.3 gives an example of a lattice \mathcal{L} which is not EL-shellable. Indeed, suppose that there is a poset Λ and a map $\lambda : \leq_{\mathcal{L}} \rightarrow \Lambda$ such that between a and f there is a unique λ -increasing saturated chain passing through c and e . Then, the saturated chain (a, b, d, f) cannot be λ -increasing. Therefore, either the map λ cannot be increasing between a and d or between b and f . Thus, there is no way to find for all interval one λ -increasing saturated chain.

The Tamari lattice is an example of an EL-shellable lattice [BW97].

2.4. Construction by interval doubling.

2.4.1. Interval doubling and construction. Let $\mathbf{2}$ be the poset $\{0, 1\}$ where $0 \preceq 1$. Let \mathcal{P} be a poset and I one of its intervals. The *interval doubling* of I in \mathcal{P} is the poset

$$\mathcal{P}[I] := (\mathcal{P} \setminus I) \cup (I \times \mathbf{2}), \quad (2.4.1)$$

having $\preceq'_{\mathcal{P}}$ as order relation, which is defined as follows. For any $x, y \in \mathcal{P}[I]$, one has $x \preceq'_{\mathcal{P}} y$ if one of the following assertions is satisfied:

- (i) $x \in \mathcal{P} \setminus I, y \in \mathcal{P} \setminus I$, and $x \preceq_{\mathcal{P}} y$,
- (ii) $x \in \mathcal{P} \setminus I, y = (y', b) \in I \times \mathbf{2}$, and $x \preceq_{\mathcal{P}} y'$,
- (iii) $x = (x', a) \in I \times \mathbf{2}, y \in \mathcal{P} \setminus I$, and $x' \preceq_{\mathcal{P}} y$,
- (iv) $x = (x', a) \in I \times \mathbf{2}, y = (y', b) \in I \times \mathbf{2}$, and $x' \preceq_{\mathcal{P}} y'$ and $a \preceq_{\mathcal{P}} b$.

Figure 2.4 give an example of interval doubling.

This operation has been introduced in [Day92] as an operation on posets preserving the property of being a lattice. On the other way round, we say that \mathcal{P} is obtained by

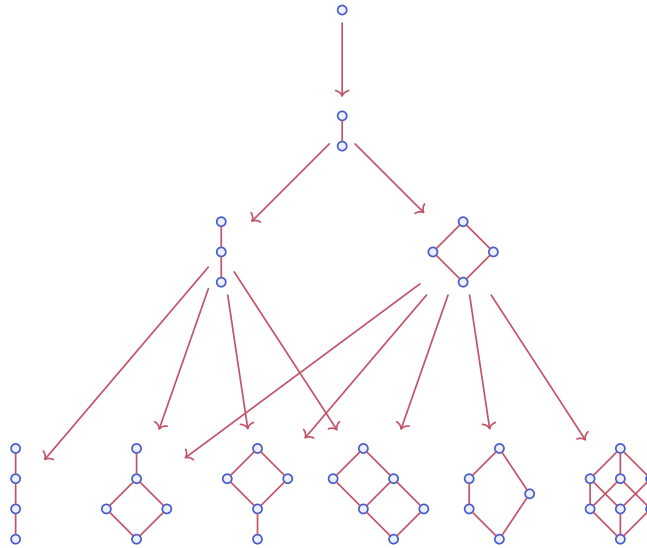

FIGURE 2.5. Graph of first posets generated by interval doubling.

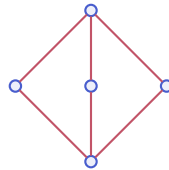

FIGURE 2.6. Counterexample of a lattice not constructible by interval doubling.

an *interval contraction* from a poset \mathcal{P}' if there is an interval I of \mathcal{P} such that $\mathcal{P}[I]$ is isomorphic as a poset to \mathcal{P}' [CLCdPBM04].

A lattice \mathcal{L} is *constructible by interval doubling* (called “*bounded*” in the original article [Day92]) if \mathcal{L} is isomorphic as a poset to a poset obtained by performing a sequence of interval doubling from the singleton lattice. It is known from [Day79] that such lattices are semidistributive. Recall that a finite lattice \mathcal{L} is constructible by interval doubling if and only if it is *congruence uniform*, and then in particular, the number of join-irreducible elements of \mathcal{L} determines the number of interval doubling steps needed to create \mathcal{L} (see [Day79] and [Müh19]).

2.4.2. Example and counterexample. Starting from the trivial poset (one element), one can give the first posets generated by interval doubling. Figure 2.5 shows all the posets obtained for three steps of interval doubling.

Figure 2.6 is the Kreweras order for $n = 3$. Considering Figure 2.5, the only way to obtain another lattice with 5 elements is to doubling one element of the lattice at the bottom left. However, it is clear that the Kreweras lattice cannot be obtained from the latter. Therefore, the Kreweras lattice is not constructible by interval doubling.

3. Combinatorial Hopf algebras and posets

In Section 3 of Chapter 4, we deal with algebraic structures such as graded algebras and graded coalgebras. More precisely, we shall define a graded associative algebra linked with a poset introduced in Chapter 4.

This section provides several definitions and properties related to combinatorial Hopf algebras, and introduce two important examples of combinatorial Hopf algebras: the Hopf algebra FQSym and the Hopf algebra PBT, defined respectively on permutations and on binary trees. Due to their link with the right weak order and the Tamari order, these two combinatorial Hopf algebras are one of the most important motivations for our work in Chapter 4. We will see how their product and coproduct are related to both partial orders at the end of this section.

The classical references for the elementary notions are [Swe69, Abe80].

3.1. Combinatorial Hopf algebras.

3.1.1. *Combinatorial vector spaces.* Throughout the rest of this thesis, \mathbb{K} is a field of characteristic zero. The identity element of \mathbb{K} is denoted by $1_{\mathbb{K}}$ for the product, and $0_{\mathbb{K}}$ for the addition. The *Kronecker delta* is denoted $\delta_{x,y}$. Let us recall that $\delta_{x,y} = 1_{\mathbb{K}}$ if $x = y$, and $\delta_{x,y} = 0_{\mathbb{K}}$ else.

Let E be a set and $f : E \rightarrow \mathbb{K}$ be a map. The *support* of f is the set

$$\text{Supp}(f) := \{x \in E : f(x) \neq 0\}. \quad (3.1.1)$$

The *free vector space* associated with the set E is

$$\text{Vect}(E) := \{f : E \rightarrow \mathbb{K} : \text{Supp}(f) \text{ is finite}\}. \quad (3.1.2)$$

The set $F := \{F_x := y \mapsto \delta_{x,y} : x \in E\}$ is a basis of $\text{Vect}(E)$, called the *fundamental basis*. Therefore, all elements f of $\text{Vect}(E)$ are expressed as

$$f = \sum_{x \in \text{Supp}(f)} f(x)F_x, \quad (3.1.3)$$

and $\text{Vect}(E)$ can be seen as the vector space of finite formal sums of elements of E with coefficients in \mathbb{K} .

Let S be a graded set such that $\#S(0) = 1$. The *combinatorial vector space* generated by S is the free vector space $\text{Vect}(S)$.

All combinatorial vector spaces are graded, namely they decompose as a direct sum

$$\text{Vect}(S) = \bigoplus_{n \geq 0} \text{Vect}(S(n)), \quad (3.1.4)$$

where the vector spaces $\text{Vect}(S(n))$, called *homogeneous components of degree n* of $\text{Vect}(S)$, are of finite dimension.

If V is a combinatorial vector space then we will denote by $V^{(n)}$ its homogeneous component of degree n .

The *Hilbert series* of a combinatorial vector space V is the series

$$\mathcal{H}_V(t) := \sum_{n \geq 0} \dim V^{(n)} t^n. \quad (3.1.5)$$

In other words, this series is the generating series of the underlying graded set of V .

3.1.2. Combinatorial algebras. An *unital associative algebra* is a vector space \mathcal{A} endowed with a linear map $\cdot : \mathcal{A} \otimes \mathcal{A} \rightarrow \mathcal{A}$ called *product*, and a linear map $u : \mathbb{K} \rightarrow \mathcal{A}$ called *unit* such that, for all $x, y, z \in \mathcal{A}$ and $\lambda \in \mathbb{K}$,

$$(x \cdot y) \cdot z = x \cdot (y \cdot z), \quad (3.1.6)$$

$$u(\lambda) \cdot x = \lambda x = x \cdot u(\lambda). \quad (3.1.7)$$

When the context is clear, we simply say algebra. It will be specified if the algebra is not associative.

The condition (3.1.6) means that the product \cdot is associative. Equivalently, by denoting the product \cdot by p , and the identity map by I , this means that the diagram (3.1.8) is commutative.

$$\begin{array}{ccc} \mathcal{A} \otimes \mathcal{A} \otimes \mathcal{A} & \xrightarrow{I \otimes p} & \mathcal{A} \otimes \mathcal{A} \\ \downarrow p \otimes I & & \downarrow p \\ \mathcal{A} \otimes \mathcal{A} & \xrightarrow{p} & \mathcal{A} \end{array} \quad (3.1.8)$$

Likewise, the condition (3.1.7) means that $u(1_{\mathbb{K}})$ is the identity element for the product \cdot , that is the diagram (3.1.9) is commutative.

$$\begin{array}{ccccc} \mathcal{A} \otimes \mathbb{K} & \xrightarrow{I \otimes u} & \mathcal{A} \otimes \mathcal{A} & \xleftarrow{u \otimes I} & \mathbb{K} \otimes \mathcal{A} \\ & \searrow \simeq & \downarrow p & \swarrow \simeq & \\ & & \mathcal{A} & & \end{array} \quad (3.1.9)$$

Note that since we can deduce the unit map u from the identity element $1_{\mathcal{A}}$ for the product by setting $u(\lambda) := \lambda 1_{\mathcal{A}}$ for all $\lambda \in \mathbb{K}$, and reciprocally $1_{\mathcal{A}}$ from u by setting $1_{\mathcal{A}} := u(1_{\mathbb{K}})$, one has that the two notations are equivalent.

Let (\mathcal{A}, \cdot, u) be an algebra. A vector subspace \mathcal{A}' is a *subalgebra* of \mathcal{A} if for all $x, y \in \mathcal{A}'$, $x \cdot y \in \mathcal{A}'$, and if for any $\lambda \in \mathbb{K}$, $u(\lambda) \in \mathcal{A}'$.

An algebra \mathcal{A} is *graded* if the vector space \mathcal{A} is graded, and if $x \in \mathcal{A}^{(n)}$ and $y \in \mathcal{A}^{(m)}$ then $x \cdot y \in \mathcal{A}^{(n+m)}$. Moreover, if \mathcal{A} is graded and $\dim \mathcal{A}^{(0)} = 1$ then \mathcal{A} is *connected*. An algebra \mathcal{A} is *commutative* if for all $x, y \in \mathcal{A}$, $x \cdot y = y \cdot x$.

Let $(\mathcal{A}, \cdot_{\mathcal{A}}, u_{\mathcal{A}})$ and $(\mathcal{B}, \cdot_{\mathcal{B}}, u_{\mathcal{B}})$ be two algebras. An *algebra morphism* is a linear map $\phi : \mathcal{A} \rightarrow \mathcal{B}$ such that, for all $x, y \in \mathcal{A}$ and $\lambda \in \mathbb{K}$,

$$\phi(x \cdot_{\mathcal{A}} y) = \phi(x) \cdot_{\mathcal{B}} \phi(y), \quad (3.1.10)$$

$$\phi(u_{\mathcal{A}}(\lambda)) = u_{\mathcal{B}}(\lambda). \quad (3.1.11)$$

An *algebra isomorphism* is a bijective algebra morphism. If there is an algebra isomorphism from \mathcal{A} to \mathcal{B} , then we write $\mathcal{A} \simeq \mathcal{B}$.

The *tensor product* of \mathcal{A} and \mathcal{B} is the algebra $\mathcal{A} \otimes \mathcal{B}$ with the product \cdot defined for all $x \otimes y, x' \otimes y' \in \mathcal{A} \otimes \mathcal{B}$ by

$$(x \otimes y) \cdot (x' \otimes y') := (x \cdot_{\mathcal{A}} x') \otimes (y \cdot_{\mathcal{B}} y'), \quad (3.1.12)$$

and the unit u defined by $u := u_{\mathcal{A}} \otimes u_{\mathcal{B}}$. An *ideal* of \mathcal{A} is a vector subspace I of \mathcal{A} such that, for all $x \in I$ and $y \in \mathcal{A}$, $x \cdot_{\mathcal{A}} y \in I$ and $y \cdot_{\mathcal{A}} x \in I$. The *quotient* of \mathcal{A} by the ideal I is the algebra \mathcal{A}/I with the product \cdot defined for all $\dot{x}, \dot{y} \in \mathcal{A}/I$ by

$$\dot{x} \cdot \dot{y} := \tau(x \cdot_{\mathcal{A}} y), \quad (3.1.13)$$

where $\tau : \mathcal{A} \rightarrow \mathcal{A}/I$ is the canonical projection, and x and y are elements of \mathcal{A} such that $\tau(x) = \dot{x}$ and $\tau(y) = \dot{y}$, and the unit u defined by $u := \tau \circ u_{\mathcal{A}}$.

Let A be a set and A^* be the set of words on A . Let $\mathbb{K}\langle A^* \rangle := \text{Vect}(A^*)$ be an algebra endowed with the product $\cdot : \mathbb{K}\langle A^* \rangle \otimes \mathbb{K}\langle A^* \rangle \rightarrow \mathbb{K}\langle A^* \rangle$ such that $u \cdot v := uv$. An algebra \mathcal{A} is *free* if there is a set A such that $\mathcal{A} \simeq \mathbb{K}\langle A^* \rangle$.

A *combinatorial algebra* is an algebra whose vector space is combinatorial. In particular, a combinatorial algebra is graded, connected, and its homogeneous components are of finite dimension.

3.1.3. Combinatorial coalgebras. A *counital coassociative coalgebra* is a vector space \mathcal{C} endowed with a linear map $\Delta : \mathcal{C} \rightarrow \mathcal{C} \otimes \mathcal{C}$ called *coproduct*, and a linear map $c : \mathcal{C} \rightarrow \mathbb{K}$ called *counit* such that

$$(\Delta \otimes I)\Delta(x) = (I \otimes \Delta)\Delta(x), \quad (3.1.14)$$

$$(c \otimes I)\Delta(x) = 1_{\mathbb{K}} \otimes x \text{ and } (I \otimes c)\Delta(x) = x \otimes 1_{\mathbb{K}}, \quad (3.1.15)$$

where $I : \mathcal{C} \rightarrow \mathcal{C}$ is the identity map.

The condition (3.1.14) means that the coproduct is coassociative, which is equivalent to saying that the diagram (3.1.16) is commutative.

$$\begin{array}{ccc} \mathcal{C} & \xrightarrow{\Delta} & \mathcal{C} \otimes \mathcal{C} \\ \downarrow \Delta & & \downarrow I \otimes \Delta \\ \mathcal{C} \otimes \mathcal{C} & \xrightarrow{\Delta \otimes I} & \mathcal{C} \otimes \mathcal{C} \otimes \mathcal{C} \end{array} \quad (3.1.16)$$

The commutative diagram (3.1.17) corresponds to the condition (3.1.15).

$$\begin{array}{ccccc}
\mathcal{G} \otimes \mathbb{K} & \xleftarrow{I \otimes c} & \mathcal{G} \otimes \mathcal{G} & \xrightarrow{c \otimes I} & \mathbb{K} \otimes \mathcal{G} \\
& \searrow \cong & \uparrow \Delta & \swarrow \cong & \\
& & \mathcal{G} & &
\end{array} \tag{3.1.17}$$

For $x \in \mathcal{G}$, the coproduct $\Delta(x)$ is a finite sum of tensors in the form

$$\Delta(x) = \sum_i x_i^L \otimes x_i^R. \tag{3.1.18}$$

Let (\mathcal{G}, Δ, c) be a coalgebra. A vector subspace \mathcal{G}' is a *subcoalgebra* of \mathcal{G} if for any $x \in \mathcal{G}'$, $\Delta(x) \in \mathcal{G}' \otimes \mathcal{G}'$.

A coalgebra \mathcal{G} is *graded* if the vector space \mathcal{G} is graded, and if $x \in \mathcal{G}^{(n)}$ then $\Delta(x) \in \bigoplus_{i+j=n} \mathcal{G}^{(i)} \otimes \mathcal{G}^{(j)}$. Moreover, if \mathcal{G} is graded and $\dim \mathcal{G}^{(0)} = 1$ then \mathcal{G} is *connected*. Let $\omega : \mathcal{G} \otimes \mathcal{G} \rightarrow \mathcal{G} \otimes \mathcal{G}$ be the linear map defined for any $x \otimes y \in \mathcal{G} \otimes \mathcal{G}$ by $\omega(x \otimes y) := y \otimes x$. A coalgebra \mathcal{G} is *cocommutative* if for any $x \in \mathcal{G}$, $\Delta(x) = \omega(\Delta(x))$.

Let $(\mathcal{G}, \Delta_{\mathcal{G}}, c_{\mathcal{G}})$ and $(\mathcal{D}, \Delta_{\mathcal{D}}, c_{\mathcal{D}})$ be two coalgebras. A *coalgebra morphism* is a linear map $\phi : \mathcal{G} \rightarrow \mathcal{D}$ such that, for any $x \in \mathcal{G}$,

$$(\phi \otimes \phi)\Delta_{\mathcal{G}}(x) = \Delta_{\mathcal{D}}(\phi(x)), \tag{3.1.19}$$

$$c_{\mathcal{G}}(x) = c_{\mathcal{D}}(\phi(x)). \tag{3.1.20}$$

A *coalgebra isomorphism* is a bijective coalgebra morphism. If there is a coalgebra isomorphism from \mathcal{G} to \mathcal{D} , then we write $\mathcal{G} \simeq \mathcal{D}$.

The *tensor product* of \mathcal{G} and \mathcal{D} is the coalgebra $\mathcal{G} \otimes \mathcal{D}$ with the coproduct Δ defined for any $x \otimes y \in \mathcal{G} \otimes \mathcal{D}$ by

$$\Delta(x \otimes y) := \sum (x^L \otimes y^L) \otimes (x^R \otimes y^R) \tag{3.1.21}$$

where $\Delta_{\mathcal{G}}(x) = \sum x^L \otimes x^R$ and $\Delta_{\mathcal{D}}(y) = \sum y^L \otimes y^R$, and the counit c defined by $c := c_{\mathcal{G}} \otimes c_{\mathcal{D}}$. An *coideal* of \mathcal{G} is a vector subspace I of \mathcal{G} such that, for any $x \in I$, $\Delta_{\mathcal{G}}(x) \in I \otimes \mathcal{G} + \mathcal{G} \otimes I$ and $I \subseteq \ker(c)$. The *quotient* of \mathcal{G} by the coideal I is the coalgebra \mathcal{G}/I with the product Δ defined for any $\dot{x} \in \mathcal{G}/I$ by

$$\Delta(\dot{x}) := (\tau \otimes \tau)\Delta_{\mathcal{G}}(x), \tag{3.1.22}$$

where $\tau : \mathcal{G} \rightarrow \mathcal{G}/I$ is the canonical projection, and x is an element of \mathcal{G} such that $\tau(x) = \dot{x}$, and the counit c defined by $c(\dot{x}) := c_{\mathcal{G}}(x)$.

Let A be a set and A^* be the set of words on A . Let $\mathbb{K}\langle A^* \rangle := \text{Vect}(A^*)$ be a coalgebra endowed with the coproduct $\Delta : \mathbb{K}\langle A^* \rangle \rightarrow \mathbb{K}\langle A^* \rangle \otimes \mathbb{K}\langle A^* \rangle$ such that $\Delta(u) := \sum_{u=vw} v \otimes w$. An algebra \mathcal{G} is *cofree* if there is a set A such that $\mathcal{G} \simeq \mathbb{K}\langle A^* \rangle$.

A *combinatorial coalgebra* is a coalgebra whose vector space is combinatorial. Like for combinatorial algebras, one has in particular that a combinatorial coalgebra is graded, connected, and its homogeneous components are of finite dimension.

3.1.4. *Bialgebras and combinatorial Hopf algebras.* A **bialgebra** is a vector space \mathfrak{B} which is both an algebra (\mathfrak{B}, \cdot, u) and a coalgebra $(\mathfrak{B}, \Delta, c)$ such that Δ and c are algebra morphisms, or in an equivalent way, \cdot and u are coalgebra morphisms.

The fact that Δ and c are algebra morphisms, and that \cdot and u are coalgebra morphisms, means that the following relations hold for all $x, y \in \mathfrak{B}$.

$$\Delta(x \cdot y) = (\cdot \otimes \cdot)(I \otimes \omega \otimes I)(\Delta(x) \otimes \Delta(y)), \quad (3.1.23)$$

$$c(x \cdot y) = c(x)c(y), \quad (3.1.24)$$

$$\Delta(u(1_{\mathbb{K}})) = u(1_{\mathbb{K}}) \otimes u(1_{\mathbb{K}}), \quad (3.1.25)$$

$$c(u(1_{\mathbb{K}})) = 1_{\mathbb{K}}, \quad (3.1.26)$$

where $I : \mathfrak{B} \rightarrow \mathfrak{B}$ is the identity map. This conditions can be translated with the following commutative diagrams.

$$\begin{array}{ccccc} \mathfrak{B} \otimes \mathfrak{B} & \xrightarrow{p} & \mathfrak{B} & \xrightarrow{\Delta} & \mathfrak{B} \otimes \mathfrak{B} \\ \downarrow \Delta \otimes \Delta & & & & \uparrow p \otimes p \\ \mathfrak{B} \otimes \mathfrak{B} \otimes \mathfrak{B} \otimes \mathfrak{B} & \xrightarrow{I \otimes \omega \otimes I} & \mathfrak{B} \otimes \mathfrak{B} \otimes \mathfrak{B} \otimes \mathfrak{B} & & \end{array} \quad (3.1.27)$$

$$\begin{array}{ccc} & \mathfrak{B} & \\ p \nearrow & & \searrow c \\ \mathfrak{B} \otimes \mathfrak{B} & \xrightarrow{c \otimes c} & \mathbb{K} \otimes \mathbb{K} \simeq \mathbb{K} \end{array} \quad (3.1.28)$$

$$\begin{array}{ccc} & \mathfrak{B} & \\ \Delta \searrow & & \nearrow u \\ \mathfrak{B} \otimes \mathfrak{B} & \xleftarrow{u \otimes u} & \mathbb{K} \otimes \mathbb{K} \simeq \mathbb{K} \end{array} \quad (3.1.29)$$

$$\begin{array}{ccc} & \mathfrak{B} & \\ u \nearrow & & \searrow c \\ \mathbb{K} & \xrightarrow{I} & \mathbb{K} \end{array} \quad (3.1.30)$$

Let $(\mathfrak{B}, \cdot, u, \Delta, c)$ be a bialgebra. A vector subspace \mathfrak{B}' is a **subbialgebra** of \mathfrak{B} if \mathfrak{B}' is both a subalgebra and a subcoalgebra of \mathfrak{B} . If \mathfrak{B} is a graded algebra and a graded coalgebra, then \mathfrak{B} is graded. Moreover, if \mathfrak{B} is graded, and both a connected algebra and a connected coalgebra, then \mathfrak{B} is connected.

Let $(\mathfrak{B}, \cdot_{\mathfrak{B}}, u_{\mathfrak{B}}, \Delta_{\mathfrak{B}}, c_{\mathfrak{B}})$ and $(\mathfrak{C}, \cdot_{\mathfrak{C}}, u_{\mathfrak{C}}, \Delta_{\mathfrak{C}}, c_{\mathfrak{C}})$ be two bialgebras. A **bialgebra morphism** is a linear map $\phi : \mathfrak{B} \rightarrow \mathfrak{C}$ which is both an algebra morphism and a coalgebra morphism. Furthermore, ϕ is a **bialgebra isomorphism** if ϕ is an algebra isomorphism and a coalgebra isomorphism.

An **ideal** I of \mathfrak{B} is both an ideal of \mathfrak{B} as an algebra, and a coideal of \mathfrak{B} as a coalgebra. Likewise, the quotient of \mathfrak{B} by the ideal I is the bialgebra \mathfrak{B}/I which is both the quotient of the algebra \mathfrak{B} as an algebra, and the quotient of the bialgebra \mathfrak{B} as a coalgebra.

A *combinatorial bialgebra* is a bialgebra whose vector space is combinatorial. A combinatorial bialgebra is graded, connected, and its homogeneous components are of finite dimension.

3.1.5. *Combinatorial Hopf algebras.* Let $(\mathcal{B}, \cdot, u, \Delta, c)$ be a bialgebra and \mathcal{E} be the vector space of linear map from \mathcal{B} to \mathcal{B} . The vector space \mathcal{E} can be endowed with the *convolution product* $*$ defined for all $f, g \in \mathcal{E}$ by

$$f * g := \cdot \circ (f \otimes g) \circ \Delta. \quad (3.1.31)$$

A *Hopf algebra* \mathcal{H} is a bialgebra $(\mathcal{H}, \cdot, u, \Delta, c)$ endowed with a linear map $S : \mathcal{H} \rightarrow \mathcal{H}$ called antipode. The antipode is the inverse of the identity map $I : \mathcal{H} \rightarrow \mathcal{H}$ for the convolution product. In other words, the antipode S satisfies

$$S * I = I * S = u \circ c, \quad (3.1.32)$$

which means that the diagram (3.1.33) is commutative.

$$\begin{array}{ccccc}
 & & \mathcal{H} \otimes \mathcal{H} & \xrightarrow{I \otimes S} & \mathcal{H} \otimes \mathcal{H} & & \\
 & \nearrow \Delta & & & & \searrow p & \\
 \mathcal{H} & \xrightarrow{c} & \mathbb{K} & \xrightarrow{u} & \mathcal{H} & & \\
 & \searrow \Delta & & & & \nearrow p & \\
 & & \mathcal{H} \otimes \mathcal{H} & \xrightarrow{S \otimes I} & \mathcal{H} \otimes \mathcal{H} & &
 \end{array} \quad (3.1.33)$$

Since any combinatorial bialgebra is graded and connected, it is always possible to compute an antipode S . Therefore, any combinatorial bialgebra admits a unique antipode satisfying (3.1.32). This leads us to the following conclusion: a *combinatorial Hopf algebra* is a combinatorial bialgebra.

3.2. Examples of combinatorial Hopf algebras.

3.2.1. *Malvenuto-Reutenauer Hopf algebra.* Our first example is a combinatorial Hopf algebra on permutations, called the *Malvenuto-Reutenauer Hopf algebra* [MR95], or *FQSym* for free quasi-symmetric functions. We denote by F_σ the elements of the fundamental basis F , where σ is a permutation.

On the linear span of $\{F_\sigma : \sigma \in \mathfrak{S}\}$, endowed with the shifted shuffle product, the FQSym product is defined, for all $\sigma \in \mathfrak{S}(n)$ and $\nu \in \mathfrak{S}(m)$, by

$$F_\sigma \cdot F_\nu := \sum_{\pi \in \sigma \boxplus \nu} F_\pi. \quad (3.2.1)$$

For instance,

$$\begin{aligned}
 F_{312} \cdot F_{21} &= F_{31254} + F_{31524} + F_{31542} + F_{35124} + F_{35142} + F_{35412} + F_{53124} \\
 &\quad + F_{53142} + F_{53412} + F_{54312}.
 \end{aligned} \quad (3.2.2)$$

Thus, (FQSym, \cdot) is a combinatorial algebra.

Likewise, FQSym can be endowed with a coproduct Δ , defined, for all $\sigma \in \mathfrak{S}(n)$, by

$$\Delta(F_\sigma) := \sum_{\sigma=uv} F_{\text{std}(u)} \otimes F_{\text{std}(v)}, \quad (3.2.3)$$

where $\text{std}(w)$ is the standardization of w . For instance,

$$\begin{aligned} \Delta(F_{41532}) &= 1 \otimes F_{41532} + F_1 \otimes F_{1432} + F_{21} \otimes F_{321} \\ &\quad + F_{213} \otimes F_{21} + F_{3142} \otimes F_1 + F_{41532} \otimes 1. \end{aligned} \quad (3.2.4)$$

The space FQSym endowed with Δ is a combinatorial coalgebra.

Endowed with the product \cdot and the coproduct Δ , FQSym is a combinatorial bialgebra, and therefore a combinatorial Hopf algebra.

There are several other interesting bases of FQSym [DHT02, HNT05], related to the fundamental basis, such as the *elementary basis* of FQSym , which is defined for any permutation σ by

$$E_\sigma := \sum_{\sigma \preceq_{\text{we}} \nu} F_\nu. \quad (3.2.5)$$

Similarly, the *homogeneous basis* of FQSym is defined by

$$H_\sigma := \sum_{\nu \preceq_{\text{we}} \sigma} F_\nu. \quad (3.2.6)$$

These two bases have the property to be multiplicative, that is the FQSym product on these bases is one element. Indeed, for all permutations σ and ν ,

$$E_\sigma \cdot E_\nu = E_{\sigma / \nu}, \quad (3.2.7)$$

and

$$H_\sigma \cdot H_\nu = H_{\sigma \setminus \nu}, \quad (3.2.8)$$

where the operations $/$ and \setminus are defined in 1.1.6.

Since the elements of these bases depend on the right weak order, these two bases are closely related to the combinatorial properties of permutohedron [DHNT11]. In the following, we will see that the product of FQSym and its coproduct are also linked to the right weak order, and thus to the permutohedron.

3.2.2. Loday-Ronco Hopf algebra. There are several Hopf subalgebras of FQSym , such as the Poirier-Reutenauer Hopf algebra on Young tableaux [PR95]. The *Loday-Ronco Hopf algebra* [LR98], or *PBT* for planar binary trees, is one of them. The algebra PBT, defined on planar binary trees, can be thus defined as the subalgebra of FQSym spanned by the elements

$$P_t := \sum_{\substack{\sigma \in \mathfrak{S} \\ \text{bst}(\sigma) = t}} F_\sigma, \quad (3.2.9)$$

where bst is the algorithm of insertion. For instance,

$$P_{\text{P}} = F_{2143} + F_{2413} + F_{4213}. \quad (3.2.10)$$



Instead of the algorithm of insertion, another way to see PBT as Hopf subalgebra of FQSym is to use congruence classes called the *sylvester classes* [HNT05].

Thus, the PBT product is deduced from the FQSym product, via the algorithm of insertion. For example,

$$\begin{array}{c}
 \mathbb{P} \cdot \mathbb{P} = \mathbb{P} + \mathbb{P} + \mathbb{P} \\
 \begin{array}{c}
 \begin{array}{c} \circ \\ \swarrow \searrow \\ \square \square \end{array} \cdot \begin{array}{c} \circ \\ \swarrow \searrow \\ \square \square \end{array} = \begin{array}{c} \circ \\ \swarrow \searrow \\ \begin{array}{c} \circ \\ \swarrow \searrow \\ \square \square \end{array} \begin{array}{c} \circ \\ \swarrow \searrow \\ \square \square \end{array} \\ \square \square \end{array} + \begin{array}{c} \circ \\ \swarrow \searrow \\ \begin{array}{c} \circ \\ \swarrow \searrow \\ \square \square \end{array} \begin{array}{c} \circ \\ \swarrow \searrow \\ \square \square \end{array} \\ \square \square \end{array} + \begin{array}{c} \circ \\ \swarrow \searrow \\ \begin{array}{c} \circ \\ \swarrow \searrow \\ \square \square \end{array} \begin{array}{c} \circ \\ \swarrow \searrow \\ \square \square \end{array} \\ \square \square \end{array} \\
 + \mathbb{P} + \mathbb{P} + \mathbb{P} \cdot
 \end{array}
 \end{array} \tag{3.2.11}$$

Likewise, for the PBT coproduct, we compute the coproduct in the basis F of FQSym and then we group the elements via the algorithm of insertion, or equivalently, via the sylvester classes.

Endowed with this product and coproduct thus defined, PBT is a combinatorial Hopf algebra.

3.3. Products, coproducts, and partial orders.

3.3.1. *FQSym and the right weak order.* The Malvenuto-Reutenauer Hopf algebra and the permutohedron are intrinsically linked, and this connection comes from the fact that the product of FQSym can be rephrased, for all permutations F_σ and F_ν , as

$$F_\sigma \cdot F_\nu = \sum_{\pi \in [\sigma / \nu, \sigma \setminus \nu]_{\prec_{we}}} F_\pi. \tag{3.3.1}$$

Thus rephrased, the product is seen as a sum with intervals for the right weak order as support. For instance, using the example (3.2.2), we obtain that the product $F_{312} \cdot F_{21}$ is the sum of elements of the interval $[31254, 54312]_{\prec_{we}}$.

In the same way, the FQSym coproduct can also be rephrased as a sum of elements of an interval of the permutohedron. Thus, we get a combinatorial interpretation of this coproduct.

3.3.2. *PBT and the Tamari order.* A similar property holds for PBT relative to the Tamari order \prec_{ta} . Therefore, the PBT product can be rephrased, for all binary trees P_t and P_s , as

$$P_t \cdot P_s = \sum_{r \in [t / s, t \setminus s]_{\prec_{ta}}} P_r, \tag{3.3.2}$$

where $/$ and \setminus are the grafting operations on binary trees defined in 1.2.2.

For instance, by considering the example (3.2.11), the product

$$\begin{array}{c}
 \mathbb{P} \cdot \mathbb{P} \\
 \begin{array}{c} \circ \\ \swarrow \searrow \\ \square \square \end{array} \cdot \begin{array}{c} \circ \\ \swarrow \searrow \\ \square \square \end{array}
 \end{array} \tag{3.3.3}$$

is the sum of elements of the interval

$$\left[\begin{array}{c} \text{Diagram 1} \\ \text{Diagram 2} \end{array} \right]_{\preceq_{\text{ta}}} \cdot \quad (3.3.4)$$

The PBT coproduct can also be rephrased in the same way.

In 1.3.7, it is explained that the Tamari order can be seen on the 132-avoiding permutations through the algorithm of insertion 1.10. Therefore, as the Tamari order is a sublattice of the right weak order, PBT is a Hopf subalgebra of FQSym.

Cubic coordinate lattices

Tamari lattices are partial orders having extremely rich combinatorial and algebraic properties. These partial orders are defined on the set of binary trees and rely on the right rotation operation [Tam62] defined in Section 1.2.2 of Chapter 1. We are interested in the intervals of these lattices, meaning the pairs of comparable binary trees. As seen in Section 2.2.3 of Chapter 1, Tamari intervals form also a lattice. The number of these objects is given by a formula that was proved by Chapoton [Cha06]:

$$\frac{2(4n+1)!}{(n+1)!(3n+2)!} \tag{0.0.1}$$

Strongly linked with associahedra, Tamari lattices have been recently generalized in many ways [BPR12, PRV17]. In this process, the number of intervals of these generalized lattices have also been enumerated through beautiful formulas [BMFPR12, FPR17]. Many bijections between Tamari intervals and other combinatorial objects are known. For instance, a bijection with planar triangulations is presented by Bernardi and Bonichon in [BB09]. It has been proved by Châtel and Pons that Tamari intervals are in bijection with interval-posets of the same size [CP15] (see Section 2.2.3 of Chapter 1).

We provide in this chapter a new bijection with Tamari intervals, which is inspired by interval-posets. More precisely, we first build two words of size n from the Tamari diagrams [Pal86] of a binary tree. If they satisfy a certain property of compatibility, we build a Tamari interval diagram from these two words. We show that Tamari interval diagrams and interval-posets are in bijection. Then we propose a new encoding of Tamari intervals, by building $(n-1)$ -tuples of numbers from Tamari interval diagrams. We call these tuples cubic coordinates. This new encoding has two obvious virtues: it is very compact and it gives a way of comparing in a simple manner two Tamari intervals, through a fast algorithm. On the other hand, some properties of Tamari intervals translate nicely in the setting of cubic coordinates. For instance, synchronized Tamari intervals [FPR17] become cubic coordinates with no zero entry. Besides, cubic coordinates provide naturally a geometric realization of the lattice of Tamari intervals, by seeing them as space coordinates. Indeed, all cubic coordinates of size n can be placed in the space \mathbb{R}^{n-1} . By drawing their covering relations, we obtain an oriented graph. This gives us a realization of cubic coordinate lattices, which we call cubic realization. This realization leads us to many questions, in particular about the cells it contains. We characterize these cells in a combinatorial way, and we deduce a formula to compute a volume of the cubic realization in the geometrical sense. Another direction, more topological, involves the shellability of partial order (see Section 2.3 of Chapter 1). We show, drawing inspiration from the work

of Björner and Wachs [BW96, BW97], that the cubic coordinates poset is EL-shellable, and as a consequence its associated complex is shellable.

This chapter is organized in two sections.

In Section 1, we define Tamari interval diagrams and show that they are in bijection, size by size, with interval-posets. We then define cubic coordinates and show that they are in bijection, size by size, with Tamari interval diagrams. Using these two bijections, and after having provided the set of cubic coordinates with a partial order, we show that there is a poset isomorphism between the poset of cubic coordinates and the poset of Tamari intervals.

As pointed out above, the poset of cubic coordinates can then be realized geometrically. This cubic realization and the cells that compose it are the object of Section 2. For each cell, we then associate a synchronous cubic coordinate. By relying upon this particular cubic coordinate, we give a formula to compute the volume of the cubic realization. Finally, we extend the result of Björner and Wachs on the Tamari posets to the Tamari interval posets, by showing that the cubic coordinate posets are EL-shellable.

1. Cubic coordinates and Tamari intervals

The aim of this section is to build the poset of the cubic coordinates, then to establish the poset isomorphism between this poset and the poset of the Tamari intervals. To achieve this aim, we first define the Tamari interval diagrams based on the interval-posets. The cubic coordinates are then obtained from the Tamari interval diagrams.

1.1. Tamari interval diagrams.

1.1.1. *Interval-posets.* In Section 2.2.3 of Chapter 1 we saw a way of drawing an interval-poset. In this chapter, we shall draw interval-posets as follows. For any $i < j$, if $\pi_j \triangleleft \pi_i$ and there is no vertex π_k such that $\pi_k \triangleleft \pi_i$ and $j < k$, then we draw an arrow with source π_j and target π_i from below as shown in the example in Figure 1.1. Symmetrically, if $\pi_j \triangleleft \pi_k$ and $j < k$ and if there is no π_i such that $\pi_i \triangleleft \pi_k$ and $i < j$, then we draw an arrow with source π_j and target π_k from above. We refer to this oriented graph with two types of arrows as the *minimalist representation*.

The closure for the interval-poset properties is given by adding the decreasing relations $\pi_j \triangleleft \pi_i$ for any relation $\pi_k \triangleleft \pi_i$ and by adding the increasing relations $\pi_j \triangleleft \pi_k$ for any relation $\pi_i \triangleleft \pi_k$, for any $i < j < k$. By taking the reflective closure and the closure for the interval-poset properties, an interval-poset is obtained from such a representation. The interest of the minimalist representation is later justified, in particular with Theorem 1.1.3. It is important to represent the decreasing relations and the increasing relations independently.

Let $n \geq 0$ and $\pi, \pi' \in \text{IP}(n)$ and $(s, t) := \rho(\pi)$, $(s', t') := \rho(\pi')$. Let (\star) (resp. (\diamond)) the following condition: π' is obtained by adding (resp. removing) only decreasing (resp. increasing) relations of target a vertex π_k in π , such that if only one of these decreasing

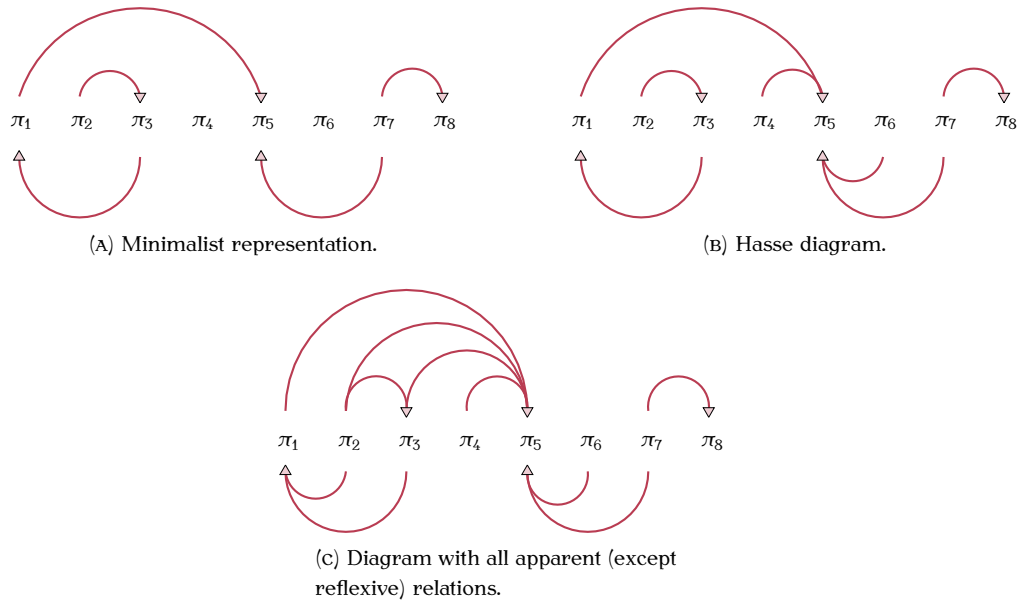

FIGURE 1.1. Different representations of an interval-poset of size 8.

(resp. increasing) relations is removed (resp. added), then either π is obtained or the object obtained is not an interval-poset.

For the sequel, we need to recall that (s', t') covers (s, t) if and only if π and π' satisfy either (\star) or (\diamond) .

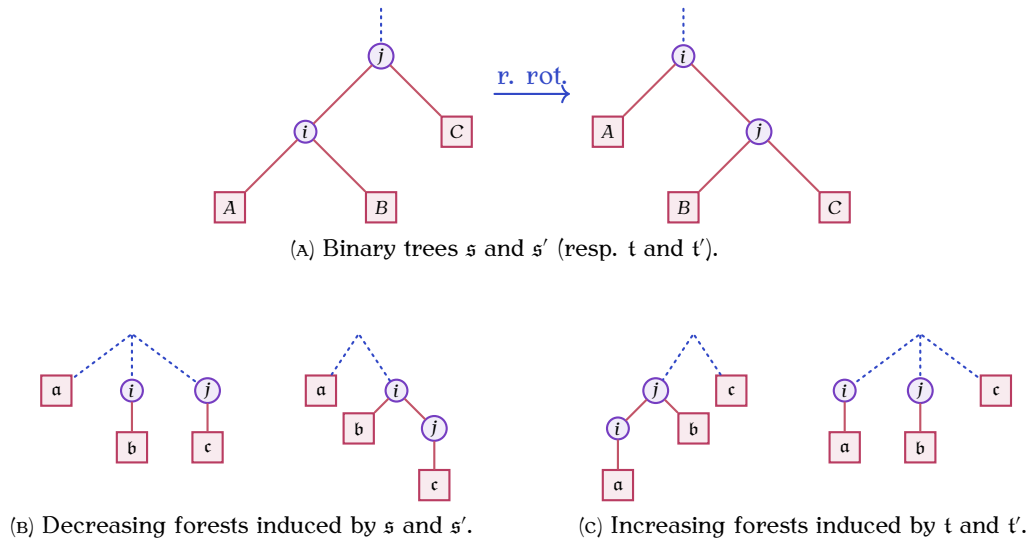

FIGURE 1.2. Right rotation of the edge (i, j) in the binary tree s (resp. t), where a, b and c are subtrees.

LEMMA 1.1.1. *The interval-posets π and π' satisfy (\star) (resp. (\diamond)) for the vertex π_i (resp. π_j) if and only if s' (resp. t') is obtained by a unique right rotation of the edge (i, j) in s (resp. t) and $t' = t$ (resp. $s' = s$).*

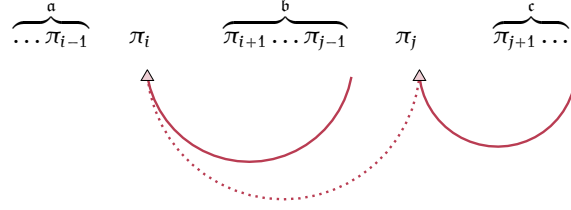

FIGURE 1.3. Interval-poset of the decreasing forest before (without dotted line) and after (with dotted line) the right rotation of the edge (i, j) , where a , b and c may be empty.

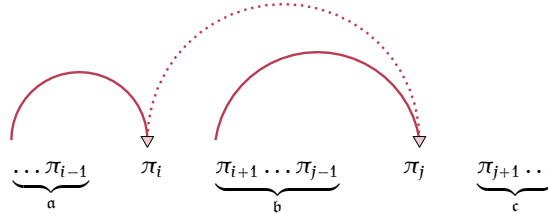

FIGURE 1.4. Interval-poset of the increasing forest before (with dotted lines) and after (without dotted lines) the right rotation of the edge (i, j) , where a , b and c may be empty.

PROOF. Suppose π and π' satisfy (\star) for the vertex π_i . Therefore, π' has more decreasing relations of target π'_i than the vertex π_i in π . Suppose that the vertices π_j and π_i are not related in π , and that π'_j and π'_i are related in π' , with $k < l$. Then, by the interval-poset property (i), for any π'_k such that $i < k < j$, $\pi'_k \triangleleft \pi'_i$. Moreover, if we remove only one of these decreasing relations, we obtain either π or an object that is no longer an interval-poset. This means that the number of descending relations added in π' is minimal, or equivalently, that the vertex π_j is closest to the vertex π_i such that π_j and π_i are not related in π and $i < j$. This case is depicted in Figure 1.3. By the bijection ρ , add these decreasing relations of target π_i in π leads to the decreasing forest induced by s' represented by Figure 1.2b. A unique right rotation is then made between the trees s and s' (see Figure 1.2a). Furthermore, since the increasing relations are unchanged between π and π' , the increasing forests induced by t and t' are the same, and thus $t' = t$.

Reciprocally, suppose that s' is obtained by a unique right rotation of the edge (i, j) in s and that $t' = t$. The case is depicted by Figure 1.2a, and the two decreasing forests induced by s and s' are depicted by Figure 1.2b. By the bijection ρ , we then obtain the interval-poset whose restriction to decreasing relations is shown by Figure 1.3. Since $t' = t$, the increasing relations of the interval-posets associated with (s, t) and (s', t') are the same. Finally, π' is obtained by adding only decreasing relations of target π_i in π . Furthermore, if only one of these relations is removed, then either π is obtained, or the object obtained is not an interval-poset. This means that π and π' satisfy (\star) .

Symmetrically, we show that π and π' satisfy (\diamond) for π_j if and only if t' is obtained by a unique right rotation of the edge (i, j) in t and $s' = s$. Figure 1.2c and Figure 1.4 depicts this case. \square

1.1.2. *The compatibility condition.* Our aim is to encode a pair of binary trees of n nodes by two words of size n . The first binary tree of the pair is encoded by a Tamari diagram and the second is encoded by a dual Tamari diagram, associated by the bijection seen in 1.2.4 of Chapter 1. Then, by checking a certain compatibility condition, we build the Tamari interval diagrams.

Let us recall the definition of Tamari diagrams and dual Tamari diagrams seen in Section 1.1.5 of Chapter 1. For any $n \geq 0$, a Tamari diagram is a word u of length n on the alphabet \mathbb{N} which satisfies the two following conditions

- (i) $0 \leq u_i \leq n - i$ for all $i \in [n]$,
- (ii) $u_{i+j} \leq u_i - j$ for all $i \in [n]$ and $j \in [0, u_i]$.

Likewise, a dual Tamari diagram is a word v of length n on the alphabet \mathbb{N} which satisfies the two following conditions

- (i) $0 \leq v_i \leq i - 1$ for all $i \in [n]$,
- (ii) $v_{i-j} \leq v_i - j$ for all $i \in [n]$ et $j \in [0, v_i]$.

The size of a dual Tamari diagram is its number of letters.

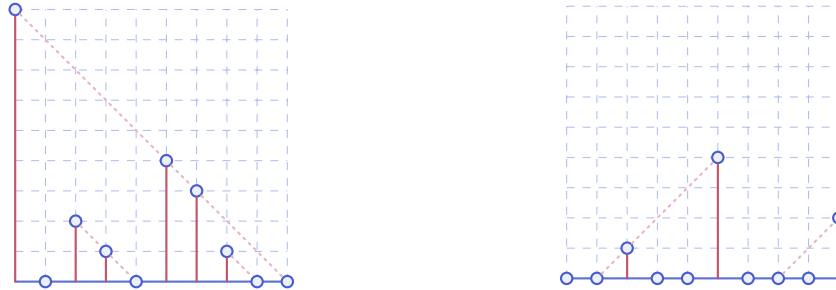

FIGURE 1.5. A Tamari diagram 9021043100 (on the left) and a dual Tamari diagram 0010040002 (on the right) of size 10.

Let $n \geq 0$ and u be a Tamari diagram, and v be a dual Tamari diagram, both of size n . The diagrams u and v are *compatible* if for all $1 \leq i < j \leq n$ such that $u_i \geq j - i$ then $v_j < j - i$. If u and v are compatible, then the pair (u, v) is called *Tamari interval diagram*. The set of Tamari interval diagrams of size n is denoted by $\text{TID}(n)$.

In other words, a Tamari diagram u of size n and a dual Tamari diagram v of size n are compatible if for any needle of position i and height $v_i \neq 0$ in v (resp. $u_i \neq 0$ in u), there is no needle of position j and height greater than or equal to $i - j$ in u (resp. $j - i$ in v) with $i - v_i \leq j \leq i - 1$ (resp. $i + 1 \leq j \leq i + u_i$) and $i \in [n]$.

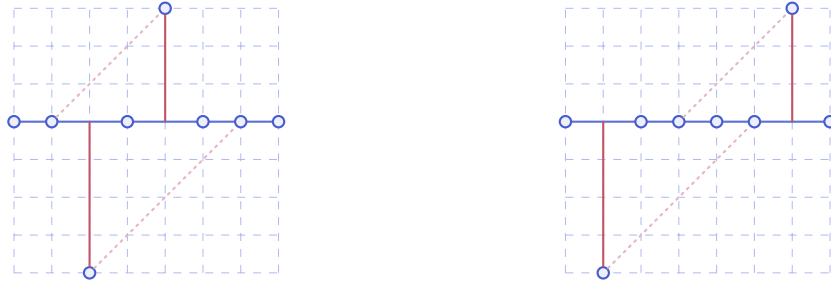

FIGURE 1.6. Two incompatible diagrams (on the left) and two compatible diagrams (on the right).

For example, the two diagrams in Figure 1.5 are compatible. Figure 1.6 gives two other examples of two incompatible diagrams 00400000 and 00003000, and two compatible diagrams 04000000 and 00000030. Thereafter, if u and v are compatible, we can also say that u and v satisfy the compatibility condition.

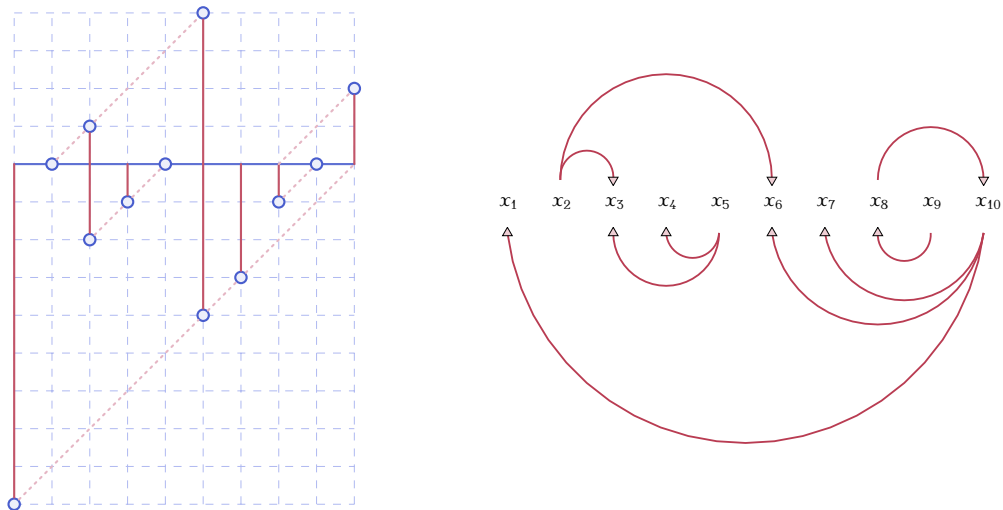

FIGURE 1.7. A Tamari interval diagram of size 10 (on the left) and its associated interval-poset (on the right).

As for Tamari diagrams and dual Tamari diagrams, a graphical representation of the Tamari interval diagram is also possible, as shown in Figure 1.6. Figure 1.7 gives this representation of the Tamari interval diagram $(9021043100, 0010040002)$ from the two diagrams seen in Figure 1.5, where we have simply considered the symmetry relative to the abscissa axis of the Tamari diagram, and placed it under its dual. Thus, Tamari diagram u is drawn below and its dual Tamari diagram v is drawn above. With such a representation, it is then easy to verify that u and v are compatible. Indeed, any needle of u that is below the diagonal linking the top of the needle in position j in v to the abscissa point $j - v_j$, has a diagonal that intersects the x -axis strictly before the position j . Symmetrically, any needles of v that is above a diagonal linking the top of the needle in

position i in u to the abscissa point $i + u_i$, has a diagonal that intersects the x -axis strictly after the position i .

One consequence of the compatibility condition is that each needle of non-zero height in the dual Tamari diagram v is always preceded by a needle of u of zero height. Symmetrically, each non-zero height needle in the Tamari diagram u is always followed by a needle of v of zero height. In other words, for any $i \in [n]$, u_i and v_{i+1} can both be zero, but cannot both be non-zero.

1.1.3. *Tamari interval diagrams and interval-posets.* In this part, we use these definitions, conventions, and Lemma 1.1.1 seen in Section 2.2.3 of Chapter 1

Let us show that there is a bijection between the set of Tamari interval diagrams and the set of interval-posets of the same size.

Let $n \geq 0$ and χ be the map sending a Tamari interval diagram (u, v) of size n to the relation

$$(\{\pi_1, \dots, \pi_n\}, \triangleleft) \quad (1.1.1)$$

where $\pi_{i+l} \triangleleft \pi_i$ for all $i \in [n]$ and $0 \leq l \leq u_i$, and $\pi_{i-k} \triangleleft \pi_i$ for all $i \in [n]$ and $0 \leq k \leq v_i$.

PROPOSITION 1.1.2. *For any $n \geq 0$, the map χ has values in $\text{IP}(n)$.*

PROOF. Let $(u, v) \in \text{TID}(n)$ and $\pi := \chi(u, v)$. First, we show that \triangleleft is a partial order, then that interval-poset properties are satisfied.

- (1) By definition of χ one has $\pi_{i+l} \triangleleft \pi_i$ and $\pi_{i-k} \triangleleft \pi_i$ with $0 \leq l \leq u_i$ and $0 \leq k \leq v_i$ for all $\pi_i \in \pi$. Specifically, $\pi_i \triangleleft \pi_i$. This shows that π is reflexive.
- (2) Let π_i, π_j and π_k be vertices of π with $i < j < k$.
 - (a) Suppose that $\pi_j \triangleleft \pi_i$ and that $\pi_k \triangleleft \pi_j$. Then $\pi_j \triangleleft \pi_i$ implies that there is an integer $0 \leq i' \leq u_i$ such that $j = i + i'$. Therefore, by the condition (ii) of a Tamari diagram, $u_j = u_{i+i'} \leq u_i - i'$. Likewise, $\pi_k \triangleleft \pi_j$ implies that there is an integer $0 \leq j' \leq v_j$ such that $k = j + j'$. Still by the same condition, one has $u_k = u_{j+j'} \leq u_j - j'$. By using these two inequalities, we obtain that $u_i \geq u_k + i' + j'$. Since $i' + j' = k - i$, then we have $u_i \geq k - i$, which implies by definition of χ that $\pi_k \triangleleft \pi_i$ in π .
 - (b) Suppose that $\pi_j \triangleleft \pi_i$ and that $\pi_i \triangleleft \pi_k$. Therefore, $\pi_j \triangleleft \pi_k$ because $\pi_i \triangleleft \pi_k$ implies that for each vertex between π_i and π_k is in relation with π_k .
 - (c) Suppose that $\pi_i \triangleleft \pi_j$ and that $\pi_j \triangleleft \pi_k$. Then $\pi_i \triangleleft \pi_j$ implies that there is an integer $0 \leq i' \leq v_i$ such that $i = j - i'$. By the condition (ii) of a dual Tamari diagram, $v_i = v_{j-i'} \leq v_j - i'$. Likewise, $\pi_j \triangleleft \pi_k$ implies that there is an integer $0 \leq j' \leq v_j$ such that $j = k - j'$. By the same condition (ii), $v_j = v_{k-j'} \leq v_k - j'$. By these two inequalities, one has $v_k \geq v_i + i' + j'$. Since $i' + j' = k - i$, one has $v_k \geq k - i$, which implies by definition of χ that $\pi_i \triangleleft \pi_k$ in π .
 - (d) Suppose that $\pi_j \triangleleft \pi_k$ and that $\pi_k \triangleleft \pi_i$. Then $\pi_j \triangleleft \pi_i$ because $\pi_k \triangleleft \pi_i$ implies that all vertex between π_i and π_k is in relation with π_i .

This shows that π is transitive. Note that it is impossible to have the case $\pi_i \triangleleft \pi_k$ and $\pi_k \triangleleft \pi_j$ since π is the image of a Tamari interval diagram. Getting this case would contradict the fact that u and v are compatible. Similarly, the case $\pi_i \triangleleft \pi_j$ and $\pi_k \triangleleft \pi_i$ is impossible.

- (3) Let $i < j$ and π_i, π_j be vertices of π . Suppose that $\pi_j \triangleleft \pi_i$ and that $\pi_i \triangleleft \pi_j$. By definition of χ , $\pi_j \triangleleft \pi_i$ if and only if $u_i \geq j - i$. Likewise, $\pi_i \triangleleft \pi_j$ if and only if $v_j \geq j - i$. However, since u and v are compatible, this case is impossible. This shows that π is antisymmetric.
- (4) The definition of χ implies directly that π satisfies the interval-poset properties, namely that for all π_i, π_j and π_k vertices of π with $i < j < k$, if $\pi_k \triangleleft \pi_i$ then $\pi_j \triangleleft \pi_i$, and if $\pi_i \triangleleft \pi_k$ then $\pi_j \triangleleft \pi_k$.

□

THEOREM 1.1.3. *For any $n \geq 0$, the map $\chi : \text{TID}(n) \rightarrow \text{IP}(n)$ is bijective.*

PROOF. Let $\pi \in \text{IP}(n)$ and let $(u, v) \in \mathbb{N}^n \times \mathbb{N}^n$ be a pair of words, such that for all $i \in [n]$,

$$u_i := \#\{\pi_j \in \pi : \pi_j \triangleleft \pi_i \text{ and } i < j\}; \quad (1.1.2)$$

$$v_j := \#\{\pi_i \in \pi : \pi_i \triangleleft \pi_j \text{ and } i < j\}. \quad (1.1.3)$$

Let us show that this pair of words (u, v) is a Tamari interval diagram and that its image by χ gives π .

- (1) Since π is an interval-poset, there are at most $n - i$ vertices of π in decreasing relation to π_i and at most $i - 1$ vertices of π in increasing relation to π_i for all $i \in [n]$. Therefore, the condition (i) of a Tamari diagram and (i) of a dual Tamari diagram are satisfied.
- (2) Let π_i and π_{i+j} be vertices of π such that $i \in [n]$ and $j \in [0, u_i]$. The fact that $u_i \geq j$ means according to the equation (1.1.2) that there are at least j vertices in decreasing relation to the vertex π_i , that is $\pi_{i+j} \triangleleft \pi_i$. Thus by transitivity of interval-posets, one has that for any $i + j \leq k \leq n$, if $\pi_k \triangleleft \pi_{i+j}$ then $\pi_k \triangleleft \pi_i$. Thus $u_{i+j} + j \leq u_i$, which implies the condition (ii) of a Tamari diagram. Symmetrically, the condition (ii) of a dual Tamari diagram is checked by considering π_i and π_{i-j} vertices of π such that $i \in [n]$ and $j \in [0, v_i]$.
- (3) Let $1 \leq i < j \leq n$ such that $u_i \geq j - i$. Suppose that $v_j \geq j - i$. The relation $u_i \geq j - i$ means that there are $j - i$ vertices of π in decreasing relation to π_i , meaning $\pi_j \triangleleft \pi_i$. Likewise, the relation $v_j \geq j - i$ means that $\pi_i \triangleleft \pi_j$. Both of these implications lead to a contradiction with the antisymmetric nature of interval-posets. Necessarily, we have $v_j < j - i$, namely u and v are compatible.

The pair (u, v) is a Tamari interval diagram of size n . Finally, it is clear that $\chi(u, v) = \pi$ by construction. The map χ is therefore surjective.

Let (u, v) and (u', v') be two Tamari interval diagrams of size n , such that $(u, v) \neq (u', v')$ and such that $\chi(u, v) := \pi$ and $\chi(u', v') := \pi'$. So there is at least one letter of (u, v) and (u', v') such that $u_i \neq u'_i$ or $v_i \neq v'_i$, for $i \in [n]$. Therefore the number of vertices of π in

relation to the vertex π_i associated with the component u_i and v_i by χ is different from the number of vertices of π' in relation to the vertex π'_i associated with the component u'_i and v'_i by χ , that is $\pi \neq \pi'$. This shows that the map χ is injective. \square

The minimalist representation of the interval-posets defined in Section 2.2.3 of Chapter 1 allows a direct construction of the corresponding Tamari interval diagram. Indeed, let us consider the minimalist representation of an interval-poset π of size n . For any relation $\pi_j \triangleleft \pi_i$ (resp. $\pi_i \triangleleft \pi_j$) drawn, with $1 \leq i < j \leq n$, we set $u_i := j - i$ (resp. $v_j := j - i$). This forms a pair of words (u, v) which is the inverse image of π by χ .

An example is given by Figure 1.7, where a Tamari interval diagram and its interval-poset which is its image by χ are shown.

1.2. Cubic coordinates. We describe in this part the set of cubic coordinates, and we show that there is a bijection between this set and the set of Tamari interval diagrams. We end this part with some properties of the cubic coordinates.

1.2.1. Definition. Let $n \geq 0$ and (u, v) be a Tamari interval diagram of size n . We build a $(n - 1)$ -tuple $(u_1 - v_2, u_2 - v_3, \dots, u_{n-1} - v_n)$ from the letters of (u, v) , by subtracting v_{i+1} from u_i for any $i \in [n]$. The resulting $(n - 1)$ -tuples can be characterized using Tamari interval diagram definition.

Let $n \geq 0$ and c be a $(n - 1)$ -tuple of components with value in \mathbb{Z} . The $(n - 1)$ -tuple c is a **cubic coordinate** if the pair (u, v) , where u is the word defined by $u_n := 0$ and for any $i \in [n - 1]$ by

$$u_i := \max(c_i, 0), \quad (1.2.1)$$

and v is the word defined by $v_1 := 0$ and for any $2 \leq i \leq n$ by

$$v_i := |\min(c_{i-1}, 0)|, \quad (1.2.2)$$

is a Tamari interval diagram. The size of a cubic coordinate is its number of components plus one. The set of cubic coordinates of size n is denoted by $\text{CC}(n)$.

For instance, the cubic coordinate of the Tamari interval diagram in Figure 1.7 is $(9, -1, 2, 1, -4, 4, 3, 1, -2)$.

1.2.2. Cubic coordinates and Tamari interval diagrams. Let us denote by ϕ the map which sends a cubic coordinate c to a Tamari interval diagram (u, v) .

THEOREM 1.2.1. *For any $n \geq 0$, the map $\phi : \text{CC}(n) \rightarrow \text{TID}(n)$ is bijective.*

PROOF. Let c and c' be two cubic coordinates of size n such that $c \neq c'$. Then there is a component c_i such that $c_i \neq c'_i$, with $i \in [n - 1]$. By the map ϕ , one has then $u_i \neq u'_i$ or $v_{i+1} \neq v'_{i+1}$, namely $(u, v) \neq (u', v')$. Which shows that the map ϕ is injective.

Let $(u, v) \in \text{TID}(n)$. Let $c := (u_1 - v_2, u_2 - v_3, \dots, u_{n-1} - v_n)$, the $(n - 1)$ -tuple whose components are given by the difference between u_i and v_{i+1} for any $i \in [n - 1]$. Now if $u_i \neq 0$ then $v_{i+1} = 0$ for any $i \in [n - 1]$. Therefore $\phi(c) = (u, v)$, where (u, v) is indeed a Tamari interval diagram by hypothesis. By definition of a cubic coordinate, one can conclude that $c \in \text{CC}(n)$. Which shows that the map ϕ is surjective. \square

Therefore, by the map ϕ it is possible to build a cubic coordinate from its Tamari interval diagram and reciprocally. Graphically, by simply shifting the dual Tamari diagram to the left by one position and collect the height of the needles from left to right, putting a positive sign for the needles of the Tamari diagram and a negative sign for its dual, and forgetting the last needle of zero height. Reconstruct the needles of the Tamari diagram and its dual from the components of the cubic coordinate in the same way, and then shift the Tamari dual diagram to the right by one position.

Using the map χ we can then directly give the cubic coordinate of an interval-poset π . In the same way that we shift the dual Tamari diagram one position to the left, we shift all the increasing relations of the interval-poset to the left by one vertex. Then, for each vertex π_i , we count the number of elements in increasing or decreasing relation of target π_i , out of reflexive relation, for all $i \in [n - 1]$. These numbers become the components of positive sign if it is a decreasing relation, negative otherwise, of the cubic coordinate. As the increasing relations have been shifted, the number associated with the vertex π_n is always zero. This vertex is therefore forgotten for the cubic coordinate. In the same way, with each component of a cubic coordinate, we rebuild the increasing and decreasing relations on $n - 1$ vertices, then we shift the increasing relations to the right, in order to form the vertex π_n .

1.2.3. Cubic coordinates properties.

LEMMA 1.2.2. *Let $n \geq 0$ and $c \in \text{CC}(n)$ such that there is a component $c_i \neq 0$, for $i \in [n - 1]$. Let c' the $(n - 1)$ -tuple such that $c'_i = 0$ and $c'_j = c_j$ for any $j \neq i$, with $j \in [n - 1]$. Then c' is a cubic coordinate.*

PROOF. Let $(u', v') := \phi(c')$ and (u'_i, v'_{i+1}) be the pair of letters corresponding to c'_i by the map ϕ . Since $c'_i = 0$ then $(u'_i, v'_{i+1}) = (0, 0)$. In order to show that c' is a cubic coordinate, we have to show that (u', v') is a Tamari interval diagram. This is equivalent to satisfying the conditions of a Tamari diagram, a dual Tamari diagram, and compatibility. Replace in (ii) of a Tamari diagram u_i with 0. The condition $u_{i+j} \leq u_i - j$ for any $i \in [n]$ and $j \in [0, u_i]$ becomes $0 \leq 0$ because j equals 0. Similarly, if we replace in (ii) of a dual Tamari diagram v_i by 0 then the condition $v_{i-j} \leq v_i - j$ for any $i \in [n]$ and $j \in [0, v_i]$ becomes $0 \leq 0$ for the same reason. Finally, we have to check the condition of compatibility: for all $1 \leq i < j \leq n$, if $u_i \leq j - i$ then $v_j < j - i$. This condition is always true for $u_i = 0$ or for $v_j = 0$ because $j - i > 0$. Therefore, the $(n - 1)$ -tuple c' is a cubic coordinate. \square

Depending on the case, either the definition of cubic coordinates or the definition of Tamari interval diagrams is used, as it is done for the proof of Lemma 1.2.2. For example, the following results are stated for Tamari interval diagrams.

Let $n \geq 0$. A Tamari interval diagram (u, v) of size n is *synchronized* if either $u_i \neq 0$ or $v_{i+1} \neq 0$ for any $i \in [n - 1]$.

Likewise a cubic coordinate c of size n is synchronized if $c_i \neq 0$ for any $i \in [n - 1]$. The set of synchronized cubic coordinates of size n is denoted by $\text{SCC}(n)$.

A Tamari interval (s, t) is synchronized if and only if the binary trees s and t have the same canopy [FPR17]. The definition of the canopy is recalled in Section 1.2.2 of Chapter 1.

PROPOSITION 1.2.3. *Let $n \geq 0$ and $(u, v) \in \text{TID}(n)$. The Tamari interval diagram (u, v) is synchronized if and only if $\rho(\chi(u, v))$ is a synchronized Tamari interval.*

PROOF. Suppose that (u, v) is not synchronized, then there is an index $i \in [n - 1]$ such that $u_i = 0$ and $v_{i+1} = 0$. Let $\pi := \chi(u, v)$ be the interval-poset associated to (u, v) , and $(s, t) := \rho(\chi(u, v))$.

The letter u_i is equal to 0 if and only if there is no descending relation of target π_i in π , namely if and only if the node i has no right child in the tree s (see Section 2.2.3 of Chapter 1). Furthermore, since i cannot be equal to n , the node i cannot be the rightmost node in S . Therefore, it is a left child of the node $i + 1$. Then the right subtree of the node i is a leaf oriented to the right.

Symmetrically, $v_{i+1} = 0$ if and only if there is no increasing relation of target π_{i+1} in π , namely if and only if the node $i + 1$ has no left child in the tree t . Since $i + 1$ is always different from 1, the node $i + 1$ cannot be the leftmost node in t , so the node $i + 1$ must be a right child of the node i . Therefore, the right subtree of the node i has a leaf oriented to the left as left subtree.

Finally, there is at least one letter of index i in the canopy of the tree s different from the canopy of the tree t , for the same index. However, two binary trees s and t are not synchronized if there is at least one letter of index i in the canopy of the tree s that is different from the letter of index i in the canopy of t . Therefore, the binary trees s and t are not synchronized if and only if (u, v) is not synchronized. \square

An interval-poset π of size $n \geq 3$ is *new* if

- (1) there is no decreasing relation of source π_n ,
- (2) there is no increasing relation of source π_1 ,
- (3) there is no relation $\pi_{i+1} \triangleleft \pi_{j+1}$ and $\pi_j \triangleleft \pi_i$ with $i < j$.

The definition of a new interval-poset is given in [Rog20].

For any $n \geq 3$, a Tamari interval diagram (u, v) of size n is *new* if the following conditions are satisfied

- (i) $0 \leq u_i \leq n - i - 1$ for all $i \in [n - 1]$,
- (ii) $0 \leq v_j \leq j - 2$ for all $j \in [2, n]$,
- (iii) $u_k < l - k - 1$ or $v_l < l - k - 1$ for all $k, l \in [n]$ such that $k + 1 < l$.

PROPOSITION 1.2.4. *Let $n \geq 3$ and $(u, v) \in \text{TID}(n)$. The Tamari interval diagram (u, v) is new if and only if $\chi(u, v)$ is a new interval-poset.*

PROOF. Let us show that $\pi := \chi(u, v)$ is not new if and only if (u, v) is not new.

- ★ Suppose there is $\pi_n \triangleleft \pi_i$ with $i \in [n-1]$. By Theorem 1.1.3, one has $u_i = \#\{\pi_j \in \pi : \pi_j \triangleleft \pi_i \text{ and } i < j\}$. Therefore for $\chi^{-1}(\pi)$ one has $u_i = n - i$. This is the negation of (i) of a new Tamari interval diagram.
- ★ Suppose there is $\pi_1 \triangleleft \pi_j$ with $j \in [2, n]$. Then for $\chi^{-1}(\pi)$ one has $v_j = j - 1$ because $v_j = \#\{\pi_i \in \pi : \pi_i \triangleleft \pi_j \text{ and } i < j\}$. This is the negation of (ii) of a new Tamari interval diagram.
- ★ Suppose there is one relation $\pi_{i+1} \triangleleft \pi_{j+1}$ and $\pi_j \triangleleft \pi_i$ with $i < j$. For $\chi^{-1}(\pi)$, it implies on the one hand $v_{j+1} \geq j - i$ and on the other hand $u_i \geq j - i$. Specifically, by setting $l := j + 1$ and $k := i$ one has $k + 1 < l$. This is the negation of (iii) of a new Tamari interval diagram.

□

In [Rog20] it is shown that a Tamari interval is new if and only if the associated interval-poset is new. With Proposition 1.2.4 we get the following result.

PROPOSITION 1.2.5. *Let $n \geq 3$ and $(u, v) \in \text{TID}(n)$. The Tamari interval diagram (u, v) is new if and only if $\rho(\chi(u, v))$ is a new Tamari interval.*

PROPOSITION 1.2.6. *Let $n \geq 3$ and $(u, v) \in \text{TID}(n)$. If (u, v) is synchronized then (u, v) is not new.*

PROOF. If (u, v) is new, then $u_i < n - i$ for $i \in [n-1]$, and $v_j < j - 1$ for $j \in [2, n]$. In particular, $u_{n-1} = 0$ and $v_2 = 0$. This implies, since (u, v) is synchronized, that $u_1 \neq 0$ and $v_n \neq 0$. Furthermore, (u, v) is new if the condition (iii) of a Tamari interval diagram is satisfied. Specifically, for any $k \in [n-2]$, either $u_k < 1$ or $v_{k+2} < 1$. Note (*) this condition. Assuming that $u_1 \neq 0$ one has either $u_2 \neq 0$ or $v_3 \neq 0$. By (*), the second choice is impossible, thus $u_2 \neq 0$. By the same reasoning, for every $k \in [n-2]$, $u_k \neq 0$. However, also by assumption one has $v_n \neq 0$. Therefore, $u_{n-2} \neq 0$ and $v_n \neq 0$ which is a contradiction with (*). □

1.3. Order structure and poset isomorphism. Firstly, we endow the set of cubic coordinates with an order relation. Then we show that there is an isomorphism between this poset and the poset of Tamari intervals. The two bijections constructed in the first two parts of Section 1 allow us to establish this poset isomorphism.

1.3.1. *Componentwise order.* Let $n \geq 0$ and $c, c' \in \text{CC}(n)$. We set that $c \preceq c'$ if and only if $c_i \leq c'_i$ for all $i \in [n-1]$. Endowed with \preceq , the set $\text{CC}(n)$ is a poset called the *cubic coordinate poset*.

Let $(s, t), (s', t') \in \text{int}(\text{T}_2(n))$. For the next results in all this section, let us denote by $c := \psi((s, t))$, $c' := \psi((s', t'))$ and $(u, v) := \phi(c)$, $(u', v') := \phi(c')$, and $\pi := \chi(u, v)$, $\pi' := \chi(u', v')$.

LEMMA 1.3.1. *If (s', t') covers (s, t) then there is a unique different component c_i between c and c' such that $c_i < c'_i$ and there is no cubic coordinate c'' different from c and c' such that $c \preceq c'' \preceq c'$.*

PROOF. By Lemma 1.1.1 we know that (s', t') covers (s, t) if and only if π and π' satisfy either (\star) or (\diamond) . Let us assume that π and π' satisfy either (\star) or (\diamond) for the vertex π_i . Two cases are possible.

- ★ Suppose that π and π' satisfy (\star) , then since only decreasing relations are added in π' relative to π , only u' is modified in (u', v') relative to (u, v) . Furthermore, since π' is obtained by adding decreasing relations of target π_i in π , then only the letter u'_i in u' is increased relative to u . Moreover, since the number of descending relations added in π is minimal, there cannot be any Tamari interval diagram between (u, v) and (u', v') , and thus no cubic coordinate between c and c' . In the end, the image by ϕ^{-1} of (u', v') is the cubic coordinate c' with $c'_i = u'_i$ and $c'_j = c_j$ for any $j \neq i$.
- ★ Suppose that π and π' satisfy (\diamond) , then since only increasing relations are removed in π' relative to π , only v' is changed in (u', v') relative to (u, v) . Furthermore, since π' is obtained by removing increasing relations of target π_i in π , then only the letter v'_i in v' is decreased relative to v . Adding the fact that the number of increasing relations removed in π is minimal, then only the component $c'_{i-1} = -v'_i$ of c' has increased relative to c .

In both cases, the implication is true. \square

Note that if there is a unique different component c_i between c and c' such that $c_i < c'_i$ and there is no cubic coordinate c'' different from c and c' such that $c \preceq c'' \preceq c'$, then in particular c' covers c . Thus, Lemma 1.3.1 has the consequence that if (s', t') covers (s, t) then c' covers c .

Let us go back to the composition of bijections $\phi^{-1} \circ \chi^{-1}$. This composition associates to a pair of comparable binary trees (s, t) a pair of words (u, v) such that u encodes the binary tree s and v encodes the binary tree t . Indeed, by this composition u (resp. v) is obtained by counting in s (resp. t) the number of left (resp. right) descendants of each node for the infix order. Now, if $(s, t) \preceq_{\text{int}(ta)} (s', t')$, then the interval (s, t') is a Tamari interval because we always have $s \preceq_{ta} s' \preceq_{ta} t'$. This implies that the pair (u, v') is always a compatible pair of words. A direct consequence is the following lemma.

LEMMA 1.3.2. *Let $n \geq 0$ and $c, c' \in \text{CC}(n)$. If $c \preceq c'$ then there is a cubic coordinate c'' such that $u'' = u$ and $v'' = v'$, where $(u'', v'') := \phi(c'')$.*

For any $c, c' \in \text{CC}(n)$, let

$$D^-(c, c') := \{d : c_d \neq c'_d \text{ and } c'_d \leq 0\}, \quad (1.3.1)$$

and

$$D^+(c, c') := \{d : c_d \neq c'_d \text{ and } c_d \geq 0\}, \quad (1.3.2)$$

and

$$D(c, c') := D^-(c, c') \cup D^+(c, c'). \quad (1.3.3)$$

Now consider the case where c and c' share either their Tamari diagrams or their associated dual Tamari diagrams, then we have the two following lemmas.

LEMMA 1.3.3. *Let $n \geq 0$ and $c, c' \in \text{CC}(n)$. If $c \preceq c'$ such that $u = u'$ and $D^-(c, c') \neq \emptyset$ then there is a cubic coordinate c'' different from c and c' such that $c \preceq c'' \preceq c'$.*

PROOF. Let c'' be a $(n-1)$ -tuple such that this image (u'', v'') by ϕ is defined as follows: $u'' = u$ and for v'' we set $v''_i = v'_i$ and $v''_j = v_j$ for any $i \in [s]$ and $j \in [s+1, n]$ with $s \in D^-(c, c')$. Since $u'' = u$, the word u'' is a Tamari diagram. Furthermore, since c and c' are cubic coordinates, u and v are compatible and u' and v' are compatible. Therefore, the only thing to check is that v'' is a dual Tamari diagram. The condition (i) is naturally satisfied. Since $c \leq c'$, the condition (ii) is satisfied because $v_k \geq v'_k$ for all $k \in [n]$. The $(n-1)$ -tuple c'' is a cubic coordinate. \square

LEMMA 1.3.4. *Let $n \geq 0$ and $c, c' \in \text{CC}(n)$. If $c \preceq c'$ such that $v = v'$ and $D^+(c, c') \neq \emptyset$ then there is a cubic coordinate c'' different from c and c' such that $c \preceq c'' \preceq c'$.*

PROOF. The proof is similar to the demonstration of Lemma 1.3.3 by choosing for the image (u'', v'') of c'' to set $v'' = v$ and $u''_i = u'_i$ and $u''_j = u_j$ for any $i \in [r]$ and $j \in [r+1, n]$ with $r \in D^+(c, c')$. \square

LEMMA 1.3.5. *Let $n \geq 0$ and $c, c' \in \text{CC}(n)$. If $c \preceq c'$ with $\#D(c, c') = s$, then there is a saturated chain*

$$(c = c^{(0)}, c^{(1)}, \dots, c^{(s-1)}, c^{(s)} = c'), \quad (1.3.4)$$

such that $\#D(c^{(i-1)}, c^{(i)}) = 1$ for all $i \in [s]$.

PROOF. Suppose that $c \preceq c'$, it means that for all $i \in [n-1]$ one has $c_i \leq c'_i$. Let

$$D^-(c, c') = \{d_1, d_2, \dots, d_r\} \quad (1.3.5)$$

and

$$D^+(c, c') = \{d_{r+1}, d_{r+2}, \dots, d_s\}, \quad (1.3.6)$$

with $d_{k-1} < d_k$ for all $k \in [s]$. According to Lemma 1.3.2 there is a cubic coordinate $c^{(r)}$ such that $u^{(r)} = u$ and $v^{(r)} = v'$. Since between c and $c^{(r)}$ the positive components are the same, we can build from Lemma 1.3.3 a chain

$$(c = c^{(0)}, c^{(1)}, \dots, c^{(r-1)}, c^{(r)}) \quad (1.3.7)$$

where $c^{(k)}$ is obtained by replacing successively in c all the components $c_{d_1}, c_{d_2}, \dots, c_{d_k}$ by the components $c_{d_1}^{(r)}, c_{d_2}^{(r)}, \dots, c_{d_k}^{(r)}$, for all $k \in [r]$. Thus, we build a chain between c and $c^{(r)}$ by changing only one component from left to right between each $c^{(k-1)}$ and $c^{(k)}$ for all $k \in [r]$.

Note that the letters in the dual Tamari diagrams associated with $c^{(r)}$ and c' are the same, and the letters in the Tamari diagrams associated with $c^{(r)}$ and c are the same. In other words, $D^+(c, c') = D^+(c^{(r)}, c')$. Therefore, we build from Lemma 1.3.4 a chain

$$(c^{(r)}, c^{(r+1)}, \dots, c^{(s-1)}, c^{(s)} = c') \quad (1.3.8)$$

where $c^{(k)}$ is obtained by replacing successively in $c^{(r)}$ all the components $c_{d_{r+1}}, c_{d_{r+2}}, \dots, c_{d_k}$ by the components $c'_{d_{r+1}}, c'_{d_{r+2}}, \dots, c'_{d_k}$, for all $k \in [r+1, s]$. As before, we then obtain a chain between $c^{(r)}$ and c' by changing only one component from left to right between each $c^{(k-1)}$ and $c^{(k)}$ for all $k \in [r+1, s]$. \square

1.3.2. *Poset isomorphism.* Let $\psi := \phi^{-1} \circ \chi^{-1} \circ \rho^{-1}$ be the map from the Tamari interval poset to the cubic coordinate poset $\text{CC}(n)$.

THEOREM 1.3.6. *For any $n \geq 0$, the map ψ is a poset isomorphism.*

PROOF. The map ψ is an isomorphism of posets if ψ and its inverse preserves the partial order. As these relations are transitive, Lemma 1.3.1 gives the direct implication. Suppose that $c \preceq c'$. According to Lemma 1.3.5 there is always a chain between c and c' such that the components are independently increasing one by one. So we can see what happens when we change only one component c_i by c'_i at any step between c and c' .

Obviously, if $c_i = c'_i$ then $u_i = u'_i$ and $v_{i+1} = v'_{i+1}$ and no changes are made between the corresponding binary tree pairs. Suppose that $c_i < c'_i$, then two cases are possible.

- ★ Suppose that c'_i is positive and c_i is positive or null. The image by ϕ of c and c' differ for the letter u_i , namely $c'_i = u'_i$ and $c_i = u_i$, and $v_{i+1} = v'_{i+1} = 0$. The difference of a letter u_i between (u, v) and (u', v') is directly translated by the map χ : the interval-poset π' has more decreasing relations of target π_i than the vertex π_i in π . By the map ρ , it means that to go from the tree s to the tree s' at least one right rotation of the edge (i, j) is made, where j is the father of the node i in s .
- ★ Symmetrically, assume that c'_i is negative or null, then $c'_i = -v'_{i+1}$, $c_i = -v_{i+1}$ and $u_i = u'_i = 0$. By the map χ , the interval-poset π' has less decreasing relations of target π_{i+1} than the vertex π_{i+1} in π . This implies by ρ that to pass from the tree t to the tree t' at least one right rotation of the edge $(k, i+1)$ is made, where k is the right child of the node $i+1$ in t .

In both cases $c \preceq c'$ implies that to get (s', t') only right rotations in the tree s and in the tree t can be made. Therefore $(s, t) \preceq_{\text{int}(ta)} (s', t')$.

The map ψ is an isomorphism of posets. □

Let us denote by \triangleleft the covering relation of the poset $\text{CC}(n)$.

PROPOSITION 1.3.7. *Let $n \geq 0$ and $c, c' \in \text{CC}(n)$ such that $c \triangleleft c'$. Then, there is a unique different component between c and c' .*

PROOF. It is a consequence of Theorem 1.3.6 and Lemma 1.3.1. □

The following diagram provides a summary of the applications used in Section 1. Recall that $\psi = \phi^{-1} \circ \chi^{-1} \circ \rho^{-1}$, therefore this diagram of poset isomorphisms is commutative.

$$\begin{array}{ccc}
 \text{TID}(n) & \xrightarrow{\chi} & \text{IP}(n) \\
 \uparrow \phi & & \downarrow \rho \\
 \text{CC}(n) & \xleftarrow{\psi} & \text{int}(\text{T}_2(n))
 \end{array} \tag{1.3.9}$$

A consequence of the poset isomorphism ψ is that the order dimension of the poset of Tamari intervals is at most $n - 1$ (see Section 1.3.3 of Chapter 1).

2. Geometric properties

In this section, we give a very natural geometrical realization for the lattices of cubic coordinates. After defining the cells of this realization, we give some properties related to them. Finally, we show that the lattice of the cubic coordinates is EL-shellable.

2.1. Cubic realizations. Theorem 1.3.6 provides a simpler translation of the order relation between two Tamari intervals. We provide the geometrical realization induced by this order relation which is natural for cubic coordinates. In a combinatorial way we study the cells formed by this realization.

2.1.1. *Space embedding.* For any $n \geq 0$, the *cubic realization* of $CC(n)$ is the geometric object $\mathcal{C}(CC(n))$ defined in the space \mathbb{R}^{n-1} and obtained by placing for each $c \in CC(n)$ a vertex of coordinates (c_1, \dots, c_{n-1}) , and by forming for each $c, c' \in CC(n)$ such that $c \leq c'$ an edge between c and c' . Every edge of $\mathcal{C}(CC(n))$ is parallel to a line passing by the origin and a cubic coordinate of the form $(0, \dots, 0, 1, 0, \dots, 0)$ or $(0, \dots, 0, -1, 0, \dots, 0)$.

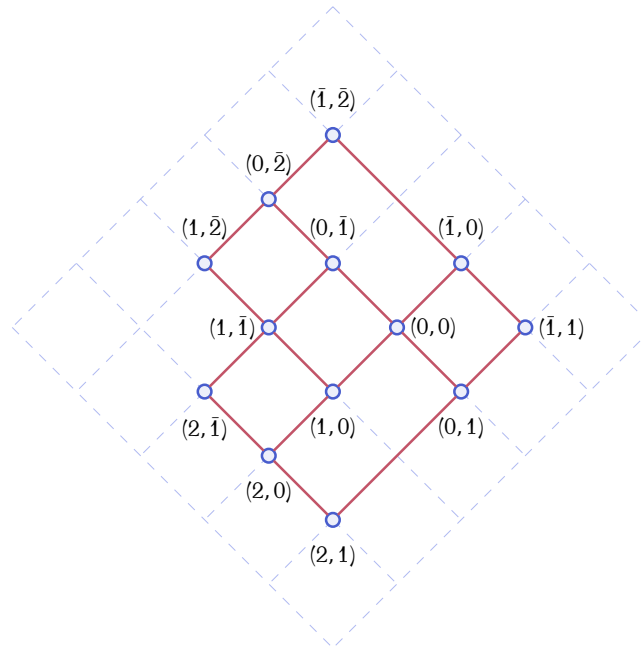

FIGURE 2.1. $\mathcal{C}(CC(3))$.

Figure 2.1 is the cubic realization of $CC(3)$, where the elements are the vertices and the edges are the covering relations. Figure 2.2 is the cubic realization of $CC(4)$. In these drawings the negative sign components are denoted with a bar.

In algebraic topology, to define the tensor products of A_∞ -algebras, one can use a cell complex called the *diagonal of the associahedron*. This complex has notably been studied by Loday [Lod11], by Saneblidze and Umble [SU04] or by Markl and Shnider [MS06].

More recently, there is a description of this object in [MTTV19]. The realization of this complex seems to be identical to the cubic realization, up to continuous deformation.

2.1.2. *Minimal increasing map.* Let $n \geq 0$ and $c, c' \in \text{CC}(n)$ such that $c < c'$. Knowing that between c and c' only one component is different, one may define the set of

- * *input-wings* as the set $\mathcal{F}(\text{CC}(n))$ containing any $c \in \text{CC}(n)$ which covers exactly $n - 1$ elements,
- * *output-wings* as the set $\mathcal{O}(\text{CC}(n))$ containing any $c \in \text{CC}(n)$ which is covered by exactly $n - 1$ elements.

Note that both notions of input-wings and output-wings will be used in Chapter 4, where elements both input-wings and output-wings will also be considered.

Let $n \geq 0$ and $c \in \text{CC}(n)$. Suppose there is $c' \in \text{CC}(n)$ such that $c'_i > c_i$ and $c'_j = c_j$ for all $j \neq i$ with $i, j \in [n - 1]$. The *minimal increasing map* of \uparrow_i is defined by

$$\uparrow_i(c) := (c_1, \dots, c_{i-1}, \uparrow c_i, c_{i+1}, \dots, c_{n-1}), \quad (2.1.1)$$

such that $c < \uparrow_i(c)$ and $c_i < \uparrow c_i \leq c'_i$. This map \uparrow_i allows us to select one covering cubic coordinate of c in particular. In the following, it is said that $\uparrow_i(c)$ is the *minimal increasing* of c for the component c_i .

In particular, for $n \geq 0$, a cubic coordinate c of size n is an output-wing if for any $i \in [n - 1]$, $\uparrow_i(c)$ is well-defined.

Let $n \geq 0$ and $c \in \text{CC}(n)$, and $(u, v) := \phi(c)$. If $\uparrow c_i$ is positive then the letter u_i increases and becomes equal to $\uparrow c_i$ and v_{i+1} is equal to 0. Then, we set $\uparrow u_i := \uparrow c_i$. If $\uparrow c_i$ is negative or null then v_{i+1} decreases and becomes equal to $|\uparrow c_i|$ and u_i is equal to 0. Then, we set $\downarrow v_{i+1} := \uparrow c_i$.

LEMMA 2.1.1. *Let $n \geq 0$ and $c \in \text{CC}(n)$, and $i \in [n - 1]$ such that $\uparrow_i(c)$ is well-defined. Then,*

- (i) *if $c_i < 0$ then $\uparrow c_i \leq 0$,*
- (ii) *if $c_i \geq 0$ then $\uparrow c_i > 0$.*

PROOF. Let us show the first implication, the second being obvious because the minimal increasing map always strictly increases a component. Let $c_i < 0$. Suppose by contradiction that $\uparrow c_i > 0$. Let us then note c' the $(n - 1)$ -tuple such that $c'_i = 0$ and $c'_j = c_j$ for any $j \neq i$, with $j \in [n - 1]$. By Lemma 1.2.2 c' is a cubic coordinate. Clearly, $c \preceq c' \preceq \uparrow_i(c)$, with the three distinct elements. Which is impossible by definition of the minimal increasing map. \square

LEMMA 2.1.2. *Let $n \geq 0$ and $c \in \mathcal{O}(\text{CC}(n))$ and $i \in [n - 1]$. If*

$$c' = \uparrow_{i+1}(\uparrow_{i+2}(\dots(\uparrow_{n-1}(c))\dots)), \quad (2.1.2)$$

is well-defined then $\uparrow_i(c')$ is well-defined.

PROOF. Suppose that (2.1.2) is satisfied for $i + 1$. Let us show that $\uparrow_i(c')$ is also well-defined. Then two cases are possible for c_i .

Suppose that $c_i < 0$. In this case, consider c'' the $(n - 1)$ -tuple obtained from c' by replacing the c_i component by 0. This $(n - 1)$ -tuple c'' is a cubic coordinate by Lemma 1.2.2. Since $c_i < 0$ one has $c' \preceq c''$. If c'' is a cover for c' then $c'' = \uparrow_i(c')$. Otherwise, it is always possible to find another cubic coordinate c''' between c' and c'' such that $c'' = \uparrow_i(c')$. In both cases, $\uparrow_i(c')$ is well-defined.

Suppose that $c_i \geq 0$. Let $(u, v) := \phi(c)$, then $c_i = u_i$. The minimal increasing of c' for u_i can lead to three different cases due to the two conditions of a Tamari diagram and the compatibility condition.

- (i) If there is an index j such that $1 \leq i < j \leq n$ and $\downarrow v_j \geq j - i$ then $v_j \geq j - i$ because $\downarrow v_j < v_j$. By the compatibility condition that implies $u_i < j - i$. Moreover, since c is assumed output-wing, $u_i < j - i - 1$, so that u_i can be increased in c . This inequality remains true for c' .
- (ii) If there is an index h such that $1 \leq i - h \leq u_h$ then $u_i \leq u_h - i + h$ by the condition (ii) of a Tamari diagram. This remains true in c' because components with index smaller than i remain unchanged between c and c' . Furthermore, since c is an output-wing then $u_i < u_h - i + h$. This property remains true for c' .
- (iii) If there is an index k such that $1 \leq i < k \leq n$ then by (i) of a Tamari diagram, $\uparrow u_k \leq n - k$.

Let us build a $(n - 1)$ -tuple c'' different from c' only for component c_i and let us see what choices are available for u_i .

- (a) Suppose there is a j satisfying (i) and there is no h satisfying (ii) in c' . In this case, we set $u_i := j - i - 1$. The compatibility condition is satisfied because $u_i < j - i$. Furthermore, since c' is assumed to be well-defined, all conditions in a Tamari diagram and a dual Tamari diagram are satisfied for c'' . Our candidate c'' is therefore a cubic coordinate.
- (b) Suppose there is a h satisfying (ii) and there is no j satisfying (i) in c' . Then we set $u_i := u_h - i + h$. The condition (ii) of a Tamari diagram is thus satisfied for u_i . Also, by the condition (i) of a Tamari diagram, $u_h \leq n - h$ which implies $u_i \leq n - i$. Finally, the compatibility condition is also satisfied because it was assumed that there was no j satisfying (i). The tuple c'' is thus a cubic coordinate.
- (c) Suppose there is a j and a h satisfying (i) and (ii) in c' . In this case, we set $u_i := \min\{u_h - i + h, j - i - 1\}$. The tuple c'' is then a cubic coordinate by the two previous cases.
- (d) Otherwise, we set $u_i := n - i$. The tuple c'' is a cubic coordinate.

In all four cases, the existence of a k satisfying (iii) has no influence. Indeed, in (a) $\uparrow u_k$ is increased by $\downarrow v_j$ and is thus lower than $u_i = j - i - 1$ in c'' . In (b) $\uparrow u_k$ is increased by u_h and is thus lower than $u_i = u_h - i + h$ in c'' . In (c) $\uparrow u_k$ is increased by either $\downarrow v_j$ or u_h . Finally in (d) since $\uparrow u_k \leq n - k$ and $n - k < n - i$ one has $\uparrow u_k < n - i$.

In any case, for u_i fixed in c'' , either there is a $\uparrow u_i$ such that $0 < \uparrow u_i < u_i$ and $\uparrow_i(c')$ is well-defined, otherwise $\uparrow_i(c') = c''$. \square

Let $n \geq 0$ and $c \in \mathcal{O}(\text{CC}(n))$ and $c' \in \text{CC}(n)$. The cubic coordinate c' is the *corresponding input-wing* of c if

$$c' = \uparrow_1 (\uparrow_2 (\dots (\uparrow_{n-1} (c)) \dots)). \quad (2.1.3)$$

For instance $c = (0, -1, 1, -1, -5, 0, 1, -1, -3)$ is an output-wing, and its corresponding input-wing is $c' = (1, 0, 2, 0, -4, 3, 2, 0, -2)$. By Lemma 2.1.2 such an element does exist. Note that performing the minimal increasing of c in a different order does not always result in the corresponding input-wing. This observation can already be made on the two pentagons of Figure 2.1.

2.1.3. *Cubic cells.* In Figure 2.1 and Figure 2.2, we notice that a "cellular" organization appears. Thanks to the cubic coordinates, a combinatorial definition of these cells is provided. The aim is to have a better understanding of the realization of the cubic coordinate posets, as a geometrical object.

For any $n \geq 0$, let $c, c' \in \text{CC}(n)$ such that $c \preceq c'$. A *cell* is the set of points

$$\langle c, c' \rangle := \{x \in \mathbb{R}^{n-1} : c_i \leq x_i \leq c'_i \text{ for all } i \in [n-1]\}. \quad (2.1.4)$$

By definition, a cell is an orthotope, that is a parallelotope whose edges are all mutually orthogonal or parallel. The *dimension* $\dim \langle c, c' \rangle$ of a cell $\langle c, c' \rangle$ is its dimension as an orthotope and it satisfies $\dim \langle c, c' \rangle = \#D(c, c')$, where $D(c, c') := D^-(c, c') \sqcup D^+(c, c')$. The size of the cell $\langle c, c' \rangle$ is $\dim \langle c, c' \rangle + 1$.

From now on, we denote by c^{out} any output-wing and by c^{in} its corresponding input-wing.

A consequence of Lemma 2.1.1 is that for any cell $\langle c^{\text{out}}, c^{\text{in}} \rangle$ of size n , for all $i \in [n-1]$,

- (i) if $c_i^{\text{out}} < 0$ then $c_i^{\text{in}} \leq 0$,
- (ii) if $c_i^{\text{out}} \geq 0$ then $c_i^{\text{in}} > 0$.

THEOREM 2.1.3. *Let $n \geq 0$ and $\langle c^{\text{out}}, c^{\text{in}} \rangle$ be a cell of size n , and c be a $(n-1)$ -tuple such that all component c_i is equal either to c_i^{out} or to c_i^{in} , for all $i \in [n-1]$. Then c is a cubic coordinate.*

PROOF. If all the components of c are equal to those of c^{out} (resp. to those of c^{in}), then c is a cubic coordinate. Suppose this is not the case, meaning that c has components of c^{out} and c^{in} .

Let us note $(u_i^{\text{out}}, v_{i+1}^{\text{out}})$ (resp. $(u_i^{\text{in}}, v_{i+1}^{\text{in}})$) the pair of letters corresponding to c_i^{out} (resp. c_i^{in}) and (u_i, v_{i+1}) the one corresponding to c_i for any $i \in [n-1]$. By hypothesis on c^{out} and c^{in} the letter u_i which is equal to u_i^{out} or u_i^{in} satisfies $0 \leq u_i \leq n-i$ for any $i \in [n]$. Similarly, the letter v_i which is equal to v_i^{out} or v_i^{in} satisfies $0 \leq v_i \leq i-1$ for any $i \in [n]$. Let us show that c satisfies the condition (ii) of a Tamari diagram, the condition (ii) of a dual Tamari diagram and the compatibility condition.

- (i) Let us show that for any choice of letters u_i and u_{i+j} with $i \in [n]$ and $j \in [0, u_i]$ one has $u_{i+j} \leq u_i - j$.

- ★ If u_i and u_{i+j} are equal respectively to u_i^{out} and to u_{i+j}^{out} (resp. to u_i^{in} and to u_{i+j}^{in}) then the condition (ii) of a Tamari diagram is satisfied because c^{out} (resp. c^{in}) is a cubic coordinate.
 - ★ Suppose that $u_i = u_i^{\text{in}}$ and $u_{i+j} = u_{i+j}^{\text{out}}$. By definition of c^{in} one has $u_{i+j}^{\text{out}} < u_{i+j}^{\text{in}}$. However $u_{i+j}^{\text{in}} \leq u_i^{\text{in}} - j$ because c^{in} is a cubic coordinate. Therefore the condition (ii) of a Tamari diagram is satisfied.
 - ★ Suppose that $u_i = u_i^{\text{out}}$ and $u_{i+j} = u_{i+j}^{\text{in}}$. Let $c' = \uparrow_{i+j} (\uparrow_{i+j+1} (\dots (\uparrow_{n-1} (c^{\text{out}})) \dots))$. According to Lemma 2.1.2 c' is a cubic coordinate such that $c'_i = u_i^{\text{out}}$ and $c'_{i+j} = u_{i+j}^{\text{in}}$. Since the condition (ii) of a Tamari diagram is satisfied for c' , it must also be satisfied for c .
- (ii) The condition (ii) of a dual Tamari diagram is satisfied with the same arguments given for the three previous cases, applied to the dual Tamari diagram v .
- (iii) Rather than showing the compatibility condition as it is stated, let us show the contrapositive. That is, for every $1 \leq i < j \leq n$ such that $v_j \geq j - i$, let us show that $u_i < j - i$.
- ★ Clearly, if u_i and v_j are equal to u_i^{out} and v_j^{out} (resp. to u_i^{in} and v_j^{in}) then the compatibility condition is satisfied.
 - ★ Suppose that $u_i = u_i^{\text{out}}$ and $v_j = v_j^{\text{in}}$. If $v_j^{\text{in}} \geq j - i$ then for c^{out} one has $v_j^{\text{out}} \geq j - i$ because $v_j^{\text{in}} < v_j^{\text{out}}$. Since c^{out} is a cubic coordinate, this implies that $u_i^{\text{out}} < j - i$.
 - ★ Suppose that $u_i = u_i^{\text{in}}$ and $v_j = v_j^{\text{out}}$. If $v_j^{\text{out}} \geq j - i$ then for all $k \in [i, j - 1]$, $u_k^{\text{out}} < j - k$ because c^{out} is a cubic coordinate and then satisfies the compatibility condition. Moreover, since $c^{\text{out}} \in \mathcal{O}(\text{CC}(n))$ each component can be minimally increased independently of the others, thus $u_k^{\text{out}} < j - k - 1$ for all $k \in [i, j - 1]$. For the same reason $u_{i+h} < u_i - h$ for all $h \in [0, u_i]$. These two reasons imply that if one builds the cubic coordinate $c' = \uparrow_i (\uparrow_{i+1} (\dots (\uparrow_{n-1} (c^{\text{out}})) \dots))$ then by definition of the minimal increasing map one has $c'_i = u'_i < j - i$, because at worst, the minimal increasing map sends u_i^{out} to $j - i - 1$. However, by definition of c^{in} one has $u_i^{\text{in}} = u'_i$, that is $u_i^{\text{in}} < j - i$. Therefore the compatibility condition between u^{in} and v_j^{out} is satisfied for c .

Thus, for all choices of letters of u and v one has that c is a cubic coordinate. \square

One of the direct consequences of Theorem 2.1.3 is that for every cell $\langle c^{\text{out}}, c^{\text{in}} \rangle$, at least 2^{n-1} cubic coordinates belong to this cell.

This theorem also implies that a corresponding input-wing covers $n - 1$ cubic coordinates, and so is in particular an input-wing.

Moreover, due to the fact the Tamari interval lattice is self-dual, the number of output-wings is equal to the number of input-wings. Therefore, by Theorem 1.3.6, an input-wing is a corresponding input-wing.

Let $n \geq 0$ and $\epsilon \in \{-1, 1\}^{n-1}$, and $c \in \text{CC}(n)$. A *region* of c is the set

$$\mathcal{R}_\epsilon(c) := \{(x_1, \dots, x_{n-1}) \in \mathbb{R}^{n-1} : x_i < c_i \text{ if } \epsilon_i = -1, x_i > c_i \text{ otherwise}\}. \quad (2.1.5)$$

The cubic coordinate c is *external* if there is $\epsilon \in \{-1, 1\}^{n-1}$ such that $\text{CC}(n) \cap \mathcal{R}_\epsilon(c) = \emptyset$. The region $\mathcal{R}_\epsilon(c)$ is then *empty*. Otherwise c is *internal*.

PROPOSITION 2.1.4. *Let $n \geq 0$ and $c \in \text{CC}(n)$. If c is internal then $\phi(c)$ is a new Tamari interval diagram.*

PROOF. Instead, let us show that if $\phi(c)$ is not new, then c is external. Let us note (u_i, v_{i+1}) the pair of letters corresponding to c_i by the map ϕ for $i \in [n-1]$.

Tamari interval diagram $\phi(c)$ is not new if there is

- (1) either $i \in [n-1]$ such that $u_i = n-i$,
- (2) or $j \in [2, n]$ such that $v_j = j-1$,
- (3) or $k, l \in [n]$ such that $u_k = l-k-1$ and $v_l = l-k-1$ with $k+1 < l$.

Suppose there is i satisfying (1) then there cannot be a cubic coordinate c' such that $c'_i > c_i$ because by definition of a Tamari diagram $c'_i \leq n-i$. Similarly, if we assume that there is j satisfying (2) then there cannot be a cubic coordinate c' such that $c'_{j-1} < c_{j-1}$ because by definition of a dual Tamari diagram, $c'_{j-1} \geq 1-j$. If (3) is satisfied, then there cannot be a cubic coordinate c' such that $c'_k > c_k$ and $c'_{l-1} < c_{l-1}$. Indeed, if the letters u_k and v_l are increased in c then the compatibility condition is contradicted, so the result cannot be a cubic coordinate. Since in each case at least one region is empty, c is external. \square

PROPOSITION 2.1.5. *Let $n \geq 0$ and $c \in \text{SCC}(n)$. Then c is external.*

PROOF. By Proposition 1.2.6 we know that if c is synchronized then $\phi(c)$ is not new. Now, we just saw from Proposition 2.1.4 that if $\phi(c)$ is not new, then c is external. \square

2.2. Cells and volumes. We now have a definition of cells. In addition, we know that each cell contains at least 2^{n-1} cubic coordinates on the edges. In this section, we show that it is possible to associate bijectively each cell to a synchronized cubic coordinate. Finally, we deduce a formula to compute the volume of the cubic realization.

2.2.1. Cells and synchronized cubic coordinates. Let $n \geq 0$ and $\langle c^{\text{out}}, c^{\text{in}} \rangle$ be a cell of size n and γ be the map defined by

$$\gamma(c_i^{\text{out}}, c_i^{\text{in}}) := \begin{cases} c_i^{\text{out}} & \text{if } c_i^{\text{out}} < 0, \\ c_i^{\text{in}} & \text{if } c_i^{\text{out}} \geq 0, \end{cases} \quad (2.2.1)$$

for all $i \in [n-1]$. Note that the components returned by the map γ are never zero. Let denote by $(u_i^{\text{out}}, v_{i+1}^{\text{out}})$ (resp. $(u_i^{\text{in}}, v_{i+1}^{\text{in}})$) the pair of letters corresponding to c_i^{out} (resp. c_i^{in}) by the map ϕ , for any $i \in [n-1]$. Then the map γ becomes

$$\gamma(c_i^{\text{out}}, c_i^{\text{in}}) := \begin{cases} -v_{i+1}^{\text{out}} & \text{if } c_i^{\text{out}} < 0, \\ u_i^{\text{in}} & \text{if } c_i^{\text{out}} \geq 0. \end{cases} \quad (2.2.2)$$

Let Γ be the map defined by

$$\Gamma\langle c^{\text{out}}, c^{\text{in}} \rangle := (\gamma(c_1^{\text{out}}, c_1^{\text{in}}), \gamma(c_2^{\text{out}}, c_2^{\text{in}}), \dots, \gamma(c_{n-1}^{\text{out}}, c_{n-1}^{\text{in}})). \quad (2.2.3)$$

For instance, the cell $\langle (0, -1, 1, -1, -5, 0, 1, -1, -3), (1, 0, 2, 0, -4, 3, 2, 0, -2) \rangle$ is sent by Γ to $(1, -1, 2, -1, -5, 3, 2, -1, -3)$.

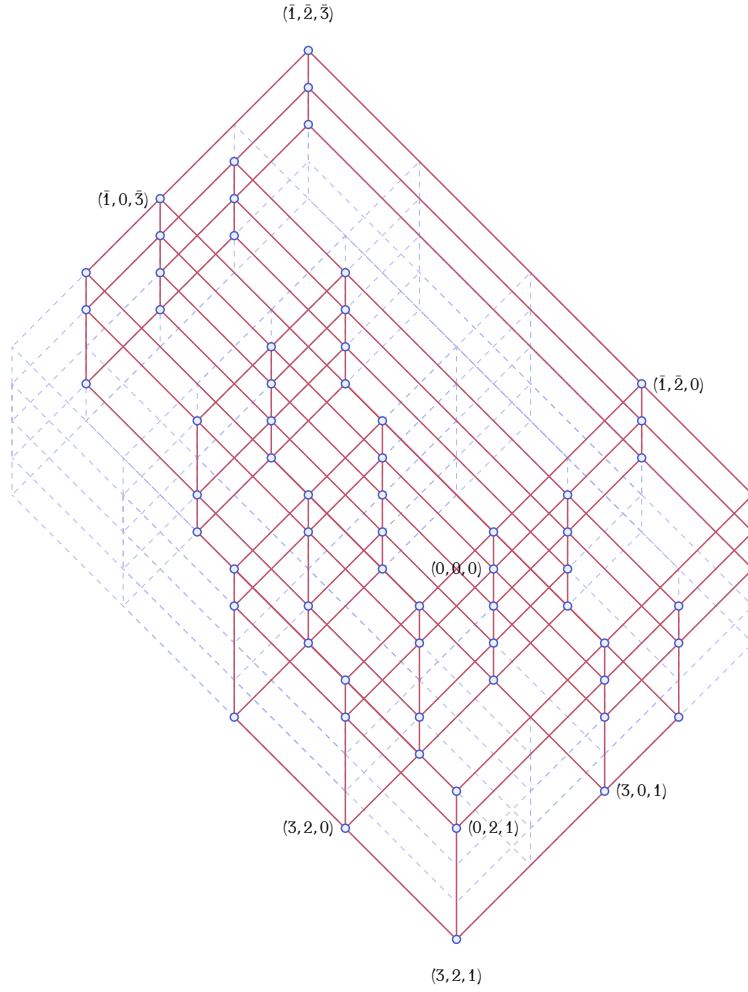
FIGURE 2.2. $\mathcal{C}(\text{CC}(4))$.

THEOREM 2.2.1. *For any $n \geq 0$, the map Γ is a bijection from the set of cells of size n to $\text{SCC}(n)$.*

PROOF. The components of $\Gamma\langle c^{\text{out}}, c^{\text{in}} \rangle$ belong to either c^{out} or c^{in} . In both cases, it is a non-zero component. According to Theorem 2.1.3, $\Gamma\langle c^{\text{out}}, c^{\text{in}} \rangle$ is therefore a cubic coordinate of size n . Moreover, this cubic coordinate is synchronized because none of its components is null.

Let $\langle c^{\text{out}}, c^{\text{in}} \rangle$ and $\langle e^{\text{out}}, e^{\text{in}} \rangle$ be two cells of size n such that $\Gamma\langle c^{\text{out}}, c^{\text{in}} \rangle = \Gamma\langle e^{\text{out}}, e^{\text{in}} \rangle$. Let us note $(u_i^{\text{out}}, v_{i+1}^{\text{out}})$ (resp. $(u_i^{\text{in}}, v_{i+1}^{\text{in}})$) the pair of letters corresponding to c_i^{out} (resp. c_i^{in}) and $(x_i^{\text{out}}, y_{i+1}^{\text{out}})$ (resp. $(x_i^{\text{in}}, y_{i+1}^{\text{in}})$) the pair of letters corresponding to e_i^{out} (resp. e_i^{in}) by the map ϕ , for all $i \in [n-1]$.

The map Γ is injective if $c_i^{\text{out}} = e_i^{\text{out}}$ (resp. $c_i^{\text{in}} = e_i^{\text{in}}$) for any $i \in [n-1]$. To suppose that $\Gamma\langle c^{\text{out}}, c^{\text{in}} \rangle = \Gamma\langle e^{\text{out}}, e^{\text{in}} \rangle$ is equivalent to suppose that for all $i \in [n-1]$, $\gamma(c_i^{\text{out}}, c_i^{\text{in}}) =$

$\gamma(e_i^{\text{out}}, e_i^{\text{in}})$. Two cases are then to be considered, either $\gamma(c_i^{\text{out}}, c_i^{\text{in}}) = u_i^{\text{in}}$ or $\gamma(c_i^{\text{out}}, c_i^{\text{in}}) = -v_{i+1}^{\text{out}}$. By definition of the map γ , no other case is possible.

(1) Suppose that $\gamma(c_i^{\text{out}}, c_i^{\text{in}}) = u_i^{\text{in}}$ with $i \in [n-1]$.

- ★ In this case, $\gamma(e_i^{\text{out}}, e_i^{\text{in}}) = x_i^{\text{in}}$ and $u_i^{\text{in}} = x_i^{\text{in}}$. Moreover, since $u_i^{\text{in}} \neq 0$ (resp. $x_i^{\text{in}} \neq 0$), then necessarily $v_{i+1}^{\text{in}} = 0$ (resp. $y_{i+1}^{\text{in}} = 0$). Therefore $c_i^{\text{in}} = e_i^{\text{in}}$.
- ★ Let us show that $c_i^{\text{out}} = e_i^{\text{out}}$. The fact that $u_i^{\text{in}} > 0$ (resp. $x_i^{\text{in}} > 0$) implies by Lemma 1.2.2 that $0 \leq u_i^{\text{out}} < u_i^{\text{in}}$ and $v_{i+1}^{\text{out}} = 0$ (resp. $0 \leq x_i^{\text{out}} < x_i^{\text{in}}$ and $y_{i+1}^{\text{out}} = 0$). Thus one has $v_{i+1}^{\text{out}} = y_{i+1}^{\text{out}}$. So it remains to be shown that $u_i^{\text{out}} = x_i^{\text{out}}$. Suppose by contradiction that $u_i^{\text{out}} < x_i^{\text{out}}$. By definition of the minimal increasing map, one has $x_i^{\text{out}} < x_i^{\text{in}}$. This implies, in addition to the hypothesis that $x_i^{\text{in}} = u_i^{\text{in}}$, that $u_i^{\text{out}} < x_i^{\text{out}} < u_i^{\text{in}}$. Let $c = \uparrow_{i+1}(\dots(\uparrow_{n-1}(c^{\text{out}}))\dots)$ and $e = \uparrow_{i+1}(\dots(\uparrow_{n-1}(e^{\text{out}}))\dots)$. By Lemma 2.1.2 c and e are both cubic coordinates. By construction $c_j = u_j^{\text{out}}$ (resp. $e_j = x_j^{\text{out}}$) for all $j \in [i]$ and $c_k = c_k^{\text{in}}$ (resp. $e_k = e_k^{\text{in}}$) for all $k \in [i+1, n-1]$. Now let c' be a tuple such that $c'_i = x_i^{\text{out}}$ and $c'_j = c_j$ for all $j \neq i$. Let us show that c' is a cubic coordinate. Let (u, v) and (u', v') be the two pairs of words corresponding respectively to c and c' . Since only one positive letter changes between c and c' , the words v and v' are the same. Furthermore, since c is a cubic coordinate, the word v is in particular a dual Tamari diagram. Therefore v' is also a dual Tamari diagram. On the other hand, for any $k \in [i+1, n-1]$ one has $u'_k = u_k^{\text{in}}$ by definition of an input-wing. However, by hypothesis $u_k^{\text{in}} = x_k^{\text{in}}$. Since the cubic coordinate e is in particular a Tamari diagram, the fact that $u'_k = x_k^{\text{in}}$ for any $k \in [i+1, n-1]$ means that u' is also a Tamari diagram. Finally, since $\uparrow_i(c)$ is a cubic coordinate by Lemma 2.1.2, it satisfies in particular the compatibility condition, with $\uparrow c_i = u_i^{\text{in}}$ by definition of an input-wing. This condition remains satisfied if the letter u_i^{in} is decreased to the letter x_i^{out} . Therefore, c' satisfies the compatibility condition and is a cubic coordinate. We have built a cubic coordinate c' distinct from c and $\uparrow_i(c)$ such that $c \preceq c' \preceq \uparrow_i(c)$, which is impossible according to the definition of the minimal increasing map.

(2) Suppose that $\gamma(c_i^{\text{out}}, c_i^{\text{in}}) = -v_{i+1}^{\text{out}}$. In this case $\gamma(e_i^{\text{out}}, e_i^{\text{in}}) = -y_{i+1}^{\text{out}}$ and $v_{i+1}^{\text{out}} = y_{i+1}^{\text{out}}$. By rephrasing the arguments of the case (1) for the dual, we show that $c_i^{\text{out}} = e_i^{\text{out}}$ and $c_i^{\text{in}} = e_i^{\text{in}}$.

This shows that the map Γ is injective.

Now let us show that the cardinal of the set of cells of size n is equal to the cardinal of $\text{SCC}(n)$. Recall that the set of cells of size n is exactly $\mathcal{O}(\text{CC}(n))$. Furthermore, by the poset isomorphism ψ we know that these elements are the Tamari intervals having $n-1$ elements covering in the Tamari interval lattices. In [Cha18] Chapoton shows that the set of these Tamari intervals has the same cardinal as the set of synchronized Tamari intervals (see Theorem 2.1 and Theorem 2.3 from [Cha18]). Finally, Proposition 1.2.3 allows us to conclude that the cardinal of $\text{SCC}(n)$ and the cardinal of the set of cells of size n are equal. Thus, the map Γ is bijective. \square

Let us also defined the map $\bar{\gamma}$ by

$$\bar{\gamma}(c_i^{\text{out}}, c_i^{\text{in}}) := \begin{cases} c_i^{\text{in}} & \text{if } c_i^{\text{out}} < 0, \\ c_i^{\text{out}} & \text{if } c_i^{\text{out}} \geq 0, \end{cases} \quad (2.2.4)$$

for all $i \in [n - 1]$. Then $\bar{\Gamma}$ is defined by

$$\bar{\Gamma}(c^{\text{out}}, c^{\text{in}}) := (\bar{\gamma}(c_1^{\text{out}}, c_1^{\text{in}}), \bar{\gamma}(c_2^{\text{out}}, c_2^{\text{in}}), \dots, \bar{\gamma}(c_{n-1}^{\text{out}}, c_{n-1}^{\text{in}})). \quad (2.2.5)$$

By Theorem 2.1.3, $\bar{\Gamma}(c^{\text{out}}, c^{\text{in}})$ is a cubic coordinate belonging to $\langle c^{\text{out}}, c^{\text{in}} \rangle$, called *opposite cubic coordinate*. For the synchronized cubic coordinate c associated with $\langle c^{\text{out}}, c^{\text{in}} \rangle$ by Γ , note c^{op} the opposite cubic coordinate. All the components of c^{op} are different from those of c , and these differences are the greatest possible. For any synchronized cubic coordinate c , such a cubic coordinate c^{op} always exists and is unique.

Note that the map Γ only returns the positive components of c^{in} and the negative components of c^{out} . Conversely, the map $\bar{\Gamma}$ returns the positive components of c^{out} and the negative components of c^{in} . We already know that the latter combination is always possible for any comparable cubic coordinates according to Lemma 1.3.2. On the other hand this is not the case for the first mentioned combination.

2.2.2. *Volume of $\mathcal{C}(\text{CC})$.* Now let us take a closer look at the geometry of the cubic realization. We already know that there are at least 2^{n-1} cubic coordinates forming an outline of each cell. The following notions will allow us to say more.

A point x of \mathbb{R}^{n-1} is *inside* a cell $\langle c, c' \rangle$ if for any $i \in [n - 1]$, $c_i \neq c'_i$ implies $c_i < x_i < c'_i$. A cell $\langle c, c' \rangle$ is *pure* if there is no cubic coordinate inside $\langle c, c' \rangle$. In other terms, this says that for all $c'' \in [c, c']$, there exists $i \in [n - 1]$ such that $c_i \neq c''_i$ and $c''_i \in \{c_i, c'_i\}$. The *volume* $\text{vol}(c, c')$ of $\langle c, c' \rangle$ is its volume as an orthotope and it satisfies

$$\text{vol}(c, c') = \prod_{i \in D(c, c')} c'_i - c_i. \quad (2.2.6)$$

LEMMA 2.2.2. *Let $n \geq 0$ and $\langle c^{\text{out}}, c^{\text{in}} \rangle$ be a cell of size n . The cell $\langle c^{\text{out}}, c^{\text{in}} \rangle$ is pure.*

PROOF. Suppose there is a cubic coordinate c such that $c_i^{\text{out}} < c_i < c_i^{\text{in}}$ for all $i \in [n - 1]$. By Lemma 2.1.1 we know that if $c_i^{\text{out}} < 0$ then $c_i^{\text{in}} \geq 0$ and if $c_i^{\text{out}} \geq 0$ then $c_i^{\text{in}} > 0$. However, since $c_i^{\text{out}} < c_i < c_i^{\text{in}}$ then c_i is different from 0. In the end, if such a cubic coordinate c exists, it would be synchronized. But then, there would be a cubic coordinate both synchronized and internal by hypothesis. This is impossible according to Proposition 2.1.5. \square

We showed with Theorem 2.1.3 that each cell contains at least 2^{n-1} cubic coordinates. By Lemma 2.2.2, we know that each cell $\langle c^{\text{out}}, c^{\text{in}} \rangle$ is pure, and then has only cubic coordinates on its border.

Let $n \geq 0$ and $\langle c^{\text{out}}, c^{\text{in}} \rangle$ be a cell of size n . Since between c^{out} and c^{in} all components are different, one has $D(c^{\text{out}}, c^{\text{in}}) = n - 1$, and so the volume of $\langle c^{\text{out}}, c^{\text{in}} \rangle$ satisfies

$$\text{vol}(c^{\text{out}}, c^{\text{in}}) = \prod_{i=1}^{n-1} c_i^{\text{in}} - c_i^{\text{out}}. \quad (2.2.7)$$

Let us denote by c^0 the cubic coordinate such that $c_i^0 = 0$ for any $i \in [n - 1]$. To compute $\text{vol}\langle c^{\text{out}}, c^{\text{in}} \rangle$ from the synchronized cubic coordinate c associated by Γ , we must first compute the volume of the pseudo-cell formed by c^0 and c . Let us summarize the data we have so far.

By Lemma 2.1.1, any cell is included in a region of the c^0 cubic coordinate. This means that no cell can be cut by a line passing by the origin c^0 and a cubic coordinate of the form $(0, \dots, 0, 1, 0, \dots, 0)$ or $(0, \dots, 0, -1, 0, \dots, 0)$.

According to Lemma 1.2.2, for any cubic coordinate, replacing any component by 0 gives a cubic coordinate. In other words, for any cubic coordinate c , there are $n - 1$ cubic coordinates related to c which are its projections on the lines passing by c^0 and a cubic coordinate of the form $(0, \dots, 0, 1, 0, \dots, 0)$ or $(0, \dots, 0, -1, 0, \dots, 0)$. Therefore, even if c^0 and c are not comparable, we can define a *pseudo-cell*, denoted by $\langle c \rangle$, between c^0 and c , such that the volume of this pseudo-cell satisfies

$$\text{vol}\langle c \rangle = \prod_{i \in D(c, c^0)} |c_i|. \quad (2.2.8)$$

Note that the dimension of a pseudo-cell is less than or equal to $n - 1$. Moreover, $\langle c \rangle$ can be no pure, and may even contain other pseudo-cells of the same dimension.

By the map Γ the components of the synchronized cubic coordinate c of cell $\langle c^{\text{out}}, c^{\text{in}} \rangle$ are the greatest in absolute value between c^{out} and c^{in} . Therefore, in the cell $\langle c^{\text{out}}, c^{\text{in}} \rangle$, c is the furthest cubic coordinate from c^0 . In particular, $\langle c \rangle$ contains the cell $\langle c^{\text{out}}, c^{\text{in}} \rangle$. Therefore of dimension of $\langle c \rangle$ is $n - 1$.

Let $n \geq 0$ and $c \in \text{SCC}(n)$. Since by definition, all components of c are different from 0, one has $D(c, c^0) = n - 1$. Therefore,

$$\text{vol}\langle c \rangle = \prod_{i=1}^{n-1} |c_i|. \quad (2.2.9)$$

Let us endow the set $\text{SCC}(n)$ with the partial order \preceq_s such that for $c, c' \in \text{SCC}(n)$ one has $c' \preceq_s c$ if c'_i and c_i have the same sign and $|c'_i| \leq |c_i|$ for any $i \in [n - 1]$.

LEMMA 2.2.3. *For any $n \geq 0$, let $\langle c^{\text{out}}, c^{\text{in}} \rangle$ be a cell of size n , and $c := \Gamma^{-1}\langle c^{\text{out}}, c^{\text{in}} \rangle$. For any $x \in \mathbb{R}^{n-1}$ such that $x \in \langle c \rangle$, if $x \notin \langle c^{\text{out}}, c^{\text{in}} \rangle$ then there is $c' \in \text{SCC}(n)$ different from c such that $c' \preceq_s c$ and $x \in \langle c' \rangle$.*

PROOF. Let c^{op} be the opposite cubic coordinate of c . Since $x \notin \langle c^{\text{out}}, c^{\text{in}} \rangle$ and $x \in \langle c \rangle$, then necessarily $c^{\text{op}} \neq c^0$. For the same reasons, there is an index i such that $|x_i| < |c_i^{\text{op}}|$ where $c_i^{\text{op}} \neq 0$. Let us build $\nabla_i c$ the $(n - 1)$ -tuple such that $\nabla_i c_i = c_i^{\text{op}}$ and $\nabla_i c_j = c_j$ for all $j \neq i$. According to Theorem 2.1.3, $\nabla_i c$ is a cubic coordinate and belongs to the cell $\langle c^{\text{out}}, c^{\text{in}} \rangle$. Also, $\nabla_i c$ is a synchronized cubic coordinate which satisfies $\nabla_i c \preceq_s c$ and which is different from c . We can then associate to $\nabla_i c$ a cell, which is strictly included in $\langle c \rangle$. Then $x \in \langle \nabla_i c \rangle$. \square

Since by Lemma 2.2.2 all cells are pure, Lemma 2.2.3 implies that $\langle c \rangle \subseteq \coprod_{c' \preceq_s c} \Gamma^{-1}\langle c' \rangle$, and since the reciprocal inclusion is obvious, one has the following result.

LEMMA 2.2.4. Let $n \geq 0$ and $c \in \text{SCC}(n)$. Then

$$\langle c \rangle = \bigsqcup_{c' \preccurlyeq_s c} \Gamma^{-1}(c'). \quad (2.2.10)$$

Let $n \geq 0$ and $c \in \text{SCC}(n)$. The *synchronized volume* of c is defined by

$$\text{sv}(c) := \text{vol} \langle c \rangle - \sum_{\substack{c' \preccurlyeq_s c \\ c' \neq c}} \text{sv}(c'). \quad (2.2.11)$$

Note that Expression (2.2.11) is a Möbius inversion [Sta12].

PROPOSITION 2.2.5. Let $n \geq 0$ and $\langle c^{\text{out}}, c^{\text{in}} \rangle$ be a cell of size n , be the synchronized cubic coordinate associated with it by Γ . Then

$$\text{vol} \langle c^{\text{out}}, c^{\text{in}} \rangle = \text{sv}(c). \quad (2.2.12)$$

PROOF. This is a consequence of Lemma 2.2.4 and of (2.2.11). \square

With Proposition 2.2.5 we are able to compute, for any $n \geq 0$, the volume of $\mathfrak{C}(\text{CC}(n))$ depending on synchronized cubic coordinates,

$$\text{vol}(\mathfrak{C}(\text{CC}(n))) = \sum_{c \in \text{SCC}(n)} \text{sv}(c). \quad (2.2.13)$$

2.3. EL-shellability. For this section, we refer for definitions and conventions to Section 2.3 of Chapter 1.

For the sequel, we set Λ as the poset \mathbb{Z}^3 wherein elements are ordered lexicographically. Let $(c, c') \in \prec$ such that $c_i < c'_i$ for $i \in [n-1]$ and let $\lambda : \prec \rightarrow \mathbb{Z}^3$ be the map defined by

$$\lambda(c, c') := (\varepsilon, i, c_i), \quad (2.3.1)$$

$$\text{where } \varepsilon := \begin{cases} -1 & \text{if } c_i < 0, \\ 1 & \text{else.} \end{cases}$$

THEOREM 2.3.1. For any $n \geq 0$, the map λ is an EL-labeling of $\text{CC}(n)$. Moreover, there is at most one λ -weakly decreasing chain between any pair of elements of $\text{CC}(n)$.

PROOF. Let $c, c' \in \text{CC}(n)$ such that $c \preccurlyeq c'$. By Lemma 1.3.5, there is a saturated chain

$$(c = c^{(0)}, c^{(1)}, \dots, c^{(s-1)}, c^{(s)} = c'). \quad (2.3.2)$$

Recall that the chain (2.3.2) is obtained by considering

$$D^-(c, c') := \{d : c_d \neq c'_d \text{ and } c'_d \leq 0\} = \{d_1, d_2, \dots, d_r\} \quad (2.3.3)$$

and

$$D^+(c, c') := \{d : c_d \neq c'_d \text{ and } c_d \geq 0\} = \{d_{r+1}, d_{r+2}, \dots, d_s\}, \quad (2.3.4)$$

with $d_{k-1} < d_k$ for all $k \in [s]$. the chain (2.3.2) is then the concatenation of two saturated chains, the first one between c and $c^{(r)}$

$$(c = c^{(0)}, c^{(1)}, \dots, c^{(r-1)}, c^{(r)}), \quad (2.3.5)$$

where $c^{(k)}$ is obtained by replacing successively in c all the components $c_{d_1}, c_{d_2}, \dots, c_{d_k}$ by the components $c_{d_1}^{(r)}, c_{d_2}^{(r)}, \dots, c_{d_k}^{(r)}$, for all $k \in [r]$, and the second saturated chain between $c^{(r)}$ and c'

$$\left(c^{(r)}, c^{(r+1)}, \dots, c^{(s-1)}, c^{(s)} = c' \right), \quad (2.3.6)$$

where $c^{(k)}$ is obtained by replacing successively in $c^{(r)}$ all the components $c_{d_{r+1}}, c_{d_{r+2}}, \dots, c_{d_k}$ by the components $c'_{d_{r+1}}, c'_{d_{r+2}}, \dots, c'_{d_k}$, for all $k \in [r+1, s]$, with the observation that $D^+(c, c') = D^+(c^{(r)}, c')$.

Since in this chain only one component differs between two cubic coordinates $c^{(k-1)}$ and $c^{(k)}$ for all $k \in [s]$, the saturated chain can be constructed by considering all the cubic coordinates between them. Besides, since the chain between c and c' is obtained by changing only one component from left to right between each cubic coordinates, then this saturated chain is λ -increasing for the lexicographic order induced by (2.3.1). Let us note this chain μ .

Moreover, any other choice of saturated chain between c and c' implies choosing, at a certain step k , a greater label for the lexicographical order than the label (ε, k, c_k) of μ , and then having to choose the label (ε, k, c''_k) afterwards. Thus, the saturated chain μ is unique and is λ -smaller.

If there is a saturated chain λ -weakly decreasing between c and c' , then it is obtained by first replacing successively in c the components $c_{d_s}, c_{d_{s-1}}, \dots, c_{d_k}$ by the components $c'_{d_s}, c'_{d_{s-1}}, \dots, c'_{d_k}$ for any $k \in [r+1, s]$, with $D^+(c, c') := \{d_{r+1}, d_{r+2}, \dots, d_s\}$. Then, by replacing successively in the cubic coordinate thus obtained the components $c_{d_r}, c_{d_{r-1}}, \dots, c_{d_k}$ by $c_{d_r}^{(r)}, c_{d_{r-1}}^{(r)}, \dots, c_{d_k}^{(r)}$ for any $k \in [r]$, with $D^-(c, c') := \{d_1, d_2, \dots, d_r\}$. To summarize, if a saturated chain λ -weakly decreasing exists between c and c' , it is built by first changing the different and positive components between c and c' from right to left, and then changing the different and negative components between c and c' from right to left. For the same reason that any saturated λ -increasing chain is unique for any interval, if it exists, the λ -weakly decreasing chain is also unique. \square

For instance, in Figure 2.1, the λ -increasing saturated chain between $(-1, -2)$ and $(2, 1)$ is the chain

$$\left((-1, -2), (0, -2), (0, -1), (0, 0), (1, 0), (2, 0), (2, 1) \right), \quad (2.3.7)$$

and

$$\lambda((-1, -2), \dots, (2, 1)) = \left((-1, 1, -1), (-1, 2, -2), (-1, 2, -1), (1, 1, 0), (1, 1, 1), (1, 2, 0) \right). \quad (2.3.8)$$

Hochschild lattices

In [Cha20], Chapoton introduces new meet-semilattices called dexter posets, defined on the set of Dyck paths, endowed with the dexter order (see Section 1.3.10 of Chapter 1). An interesting and surprising link is found in this article: a connection between some specific intervals of dexter posets and cell complexes introduced by Saneblidze [San09, San11] in the area of algebraic topology. These cell complexes are called Hochschild polytopes by Saneblidze. They provide, in the context of algebraic topology, combinatorial cellular models of free loops spaces. There are several ways to build Hochschild polytopes. For instance, they can be obtained by a sequence of truncations of the n -simplex, where n is the dimension of the polytopes [RS18].

It is shown in [Cha20] that the set of Dyck paths in these specific intervals in dexter posets is in bijection with a set of words defined on the alphabet $\{0, 1, 2\}$ satisfying some conditions. Better than that, by considering the poset on this set of words endowed with the componentwise order, Chapoton shows that a covering relation on Dyck paths for the dexter order implies by this bijection a covering relation on the corresponding words.

As a first contribution of the present work, we show the reverse implication. This implies that the two posets are isomorphic. Moreover, we show that these posets are lattices. Because of their links with cell complexes of Saneblidze, we call these lattices Hochschild lattices. Our goal is to present a geometric and combinatorial exploration of Hochschild lattices, revealing several interesting features. To this aim, we shall mainly work with the word version of the lattice previously mentioned, whose elements are called triwords.

This chapter is organised as follows.

In Section 1, we shall define triwords and see the bijection between Dyck paths of the specific intervals and triwords.

Then, we divide our study of the posets into two strands: a geometric one and a combinatorial one. Thus, Section 2 is devoted to the geometric properties. First, we provide a natural geometric realization for Hochschild lattices, by placing triwords of size n in the space \mathbb{R}^n and by linking by an edge triwords which are in a covering relation. Thanks to this realization, called cubic realization, we are able to show that Hochschild lattices are EL-shellable and constructible by interval doubling (see Section 2.3 and Section 2.4 of Chapter 1).

Section 3 is about enumerative and combinatorial results. We give here for instance the degree polynomial of the Hochschild lattices that enumerates the triwords with respect

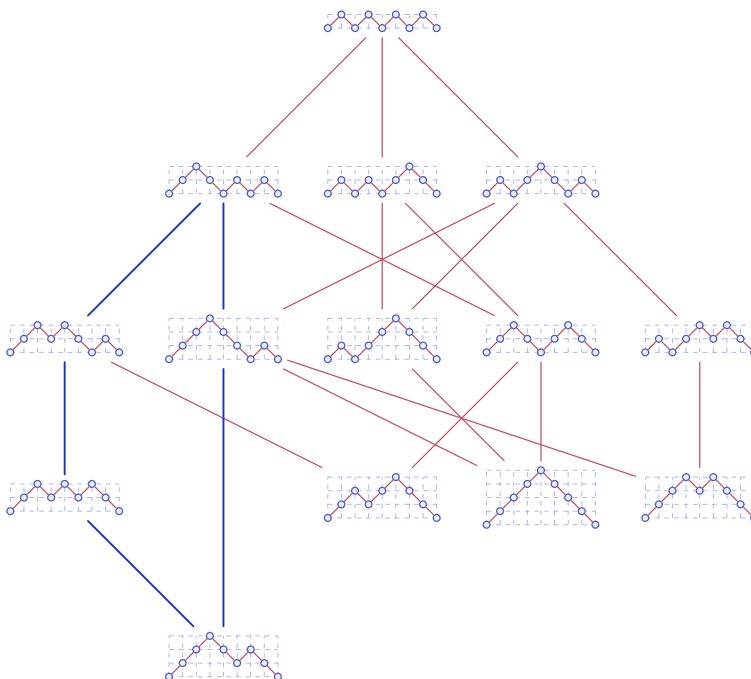

FIGURE 1.1. Hasse diagrams of the dexter meet-semilattice of size 4.

to their coverings and the elements they cover. We also provide a formula to compute the number of intervals of these lattices, as well as a method to compute the number of k -chains (see Section 2.2 of Chapter 1). Section 3 ends with the introduction of an interesting subposet of the Hochschild poset, which seems to have similar nice properties.

1. Definitions and first properties

1.1. Hochschild polytopes and triwords.

1.1.1. *A particular interval of the dexter order.* The definition of the dexter order is given in Section 1.3.10 of Chapter 1.

The set $\text{Dy}(n)$ endowed with the dexter order is a meet-semilattice with many properties highlighted in [Cha20]. In this chapter, we restrict ourselves to a particular interval of this meet-semilattice.

For any $n \geq 1$, let $F(n)$ be the interval in $\text{Dy}(n+2)$ between $1100(10)^n$ and 11^n0^n100 . In particular, any d in the interval $F(n)$ satisfies the three following assertions:

- ★ the sequence of heights of the valleys in d is weakly decreasing from left to right,
- ★ the Dyck path d ends either with 010 or 0100 ,
- ★ the Dyck path d starts with 11 and has only valleys of height 0 or 1.

Figure 1.1 show the Hasse diagram of this poset for $n = 2$, with the interval $F(n)$ in blue.

For any $n \geq 1$, let us recall the bijection ρ between $F(n)$ and the set of words of length n in the alphabet $\{0, 1, 2\}$ satisfying some conditions. Let $d \in F(n)$ and N_2 be an integer initially set to 0. By reading from left to right the word d , let us build the word u , initially the empty word, by following the two conditions,

- (i) when two consecutive 1 are read in d , except the first two letters of d , then 1 is added to N_2 ,
- (ii) when a valley of height h is read in d , the word $h2^{N_2}$ is added at the end of the building word u , and N_2 is then set back to 0.

The result $\rho(d)$ is the word u obtained after reading all d . The length of u is n because, except the two initial letters 1, every letter 1 in d contributes a letter in u .

For instance, the image by ρ of the two Dyck paths 1101001010 and 1110010010, both in $F(3)$, are respectively 100 and 120.

Since we are going to work in this chapter on the set $\rho(F(n))$, we need to give a description of this set which is independent of the construction induced by ρ .

1.1.2. *Triwords.* For any $n \geq 1$, a word u of size n is a *triword* of the same size if u satisfies, for all $i \in [n]$,

- (i) $u_i \in \{0, 1, 2\}$,
- (ii) $u_1 \neq 2$,
- (iii) if $u_i = 0$ then $u_j \neq 1$ for all $j > i$.

The graded set of triwords is denoted by Tr , where the size of a triword is its number of letters.

For instance,

$$\begin{aligned} \text{Tr}(1) &= \{0, 1\}, & \text{Tr}(2) &= \{00, 02, 10, 11, 12\}, \\ \text{Tr}(3) &= \{000, 020, 002, 100, 022, 110, 102, 120, 111, 121, 112, 122\}. \end{aligned} \tag{1.1.1}$$

Note that the condition (iii) means that there is no subword 01 in any triword.

LEMMA 1.1.1. *The set of triwords is specified by the formal grammar*

$$A = \epsilon + 0A + 2A, \tag{1.1.2}$$

$$B = \epsilon + 0A + 1B + 2B, \tag{1.1.3}$$

$$\text{Tr} = \epsilon + 0A + 1B. \tag{1.1.4}$$

PROOF. First, A is the set of all words on 0, 2. By induction on the length of the words, one can prove that B is the set of all words on $\{0, 1, 2\}$ avoiding the subword 01. Finally, since a triword beginning by 0 has no occurrences of 1, and a triword beginning by 1 writes as $1u'$ where $u' \in B$, (1.1.4) holds. \square

From Lemma 1.1.1 one obtains the generating series

$$\mathcal{G}_A(t) = 1 + 2t\mathcal{G}_A(t), \tag{1.1.5}$$

$$\mathcal{G}_B(t) = 1 + t\mathcal{G}_A(t) + 2t\mathcal{G}_B(t), \tag{1.1.6}$$

$$\mathcal{G}_{\text{Tr}}(t) = 1 + t\mathcal{G}_A(t) + t\mathcal{G}_B(t) \tag{1.1.7}$$

of A , B , and Tr . We deduce that Tr admits

$$\mathcal{G}_{\text{Tr}}(t) = \frac{(1-t)^2}{(1-2t)^2} \quad (1.1.8)$$

as generating function. Therefore, for any $n \geq 1$, the number of triwords is

$$\#\text{Tr}(n) = 2^{n-2}(n+3). \quad (1.1.9)$$

LEMMA 1.1.2. *For any $n \geq 1$, the image $\rho(F(n))$ coincides with $\text{Tr}(n)$.*

PROOF. Let $d \in F(n)$ such that $\rho(d) := u$. Then the first letter of u is either 0 or 1. Besides, a letter 0 cannot be followed by a letter 1 because the height of the valleys in d is weakly decreasing from left to right. Thus, one has $u \in \text{Tr}(n)$.

Moreover, we know from [Cha20] that the number of elements in $F(n)$ is (1.1.9). \square

1.2. Order structure and poset isomorphism. We endow the set of triwords with the componentwise order and show that the bijection ρ is a poset isomorphism. Then, we describe the meet and join of the poset so defined.

1.2.1. *Componentwise order.* For any $n \geq 1$, let \preceq be the partial order on $\text{Tr}(n)$ satisfying $u \preceq v$ for any $u, v \in \text{Tr}(n)$ such that $u_i \leq v_i$ for all $i \in [n]$. The set $\text{Tr}(n)$ endowed with \preceq is the *Hochschild poset* of order n .

We set that $u \triangleleft v$ if and only if $u \preceq v$ and there is only one index i such that $u_i < v_i$, and if there is $w \in \text{Tr}(n)$ such that $u \preceq w \preceq v$, then either $w = u$ or $w = v$. Obviously, the binary relation \triangleleft is contained in the covering relation of $\text{Tr}(n)$.

Note that the minimal element of $\text{Tr}(n)$ is 0^n and the maximal element is 12^{n-1} .

PROPOSITION 1.2.1. *For any $n \geq 1$, the binary relation \triangleleft is the covering relation of the Hochschild poset $\text{Tr}(n)$.*

PROOF. Let $u, v \in \text{Tr}(n)$ such that v covers u . The case $n = 1$ is clear. Let $n > 1$ and let i be the minimal index such that $u_i \neq v_i$, and let $w := u_1 \dots u_{i-1} v_i u_{i+1} \dots u_n$ be the word with the same letters as u , except for the i -th letter. Since $v_i > u_i$, either w is obtained by replacing in u the i -th letter 0 by 1 or by 2, or by replacing in u the i -th letter 1 by 2. In both cases, v_i is not 0. Moreover, since i is the minimal index such that $u_i \neq v_i$, if there is a letter 0 before u_i in u , then this letter exists also in v , and so v_i cannot be 1. Therefore, the subword 01 cannot be generated in w . Thus, the word w is a triword. It follows that there is a triword $w' \preceq w$ such that u is covered by w' . One can conclude that between two triwords in covering relation, there is exactly one different letter. \square

1.2.2. *Poset isomorphism.* For any Dyck path $d = p10^m x s$ with $m > 0$, p a prefix, s a suffix, and x a movable subpath, let $N(d, x)$ be the number of consecutive 0 letters that appear before x in d .

PROPOSITION 1.2.2. *For any $n \geq 1$, the map ρ is an isomorphism of posets from $F(n)$ to $\text{Tr}(n)$.*

PROOF. Let $d, b \in F(n)$. We know (Lemma 9.9 from [Cha20]) that if d covers b in $F(n)$ then the words $\rho(b)$ and $\rho(d)$ differ by exactly one letter, which increases. This implies that $\rho(b) \preceq \rho(d)$.

Let $u, v \in \text{Tr}(n)$ such that $u < v$, and let b and d be the respective images of u and v by ρ^{-1} . Since $u < v$, there is only one index i such that $u_i < v_i$. Then, there are three cases: either 0 becomes 1 or 0 becomes 2, or 1 becomes 2.

- ★ Suppose that $u_i = 0$ and $v_i = 1$. Then, in the path b , there is a movable subpath x (in blue (dark) in (1.2.1)) starting at the height 0 such that $N(b, x) \geq 2$. The height of the starting point of x gives the value of u_i in u by the map ρ . In the path d , since only one letter changes between u and v , the same subpath x starts at the height 1 and $N(d, x) = N(b, x) - 1$. Because of this move, we have to add one 0 after x .

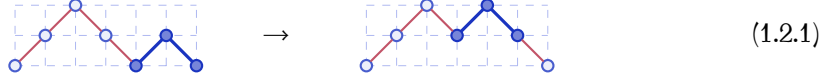

- ★ Suppose that $u_i = 0$ and $v_i = 2$. Then, in the path b , there is a movable subpath x (in blue (dark) in (1.2.2)) starting at the height 0, followed by an other subpath y also starting at the height 0. This is the height of the starting point of y which gives u_i in u by the map ρ . In the path d , there is a subpath z starting at the height 0 followed by the subpath y which is unchanged, such that $N(d, x) = 0$ and $N(d, y) = N(b, x) + N(b, y)$.

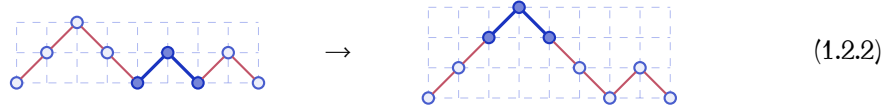

- ★ Suppose that $u_i = 1$ and $v_i = 2$. This case is very similar to the previous case, by changing the height of the starting point 0 of x , y and z by 1.

In all cases, one has $b \preceq_{\text{de}} d$. □

1.2.3. *Meet and join operations.* Let us describe the meet and join operations between two triwords u and v .

Let $u, v \in \text{Tr}(n)$, and let $r := \max(u_1, v_1) \dots \max(u_n, v_n)$. Since u_1 and v_1 are both none 2, $r_1 \neq 2$. Besides, if $r_i = 0$ for $i \in [n]$, then necessarily u_i and v_i have to be equal to 0. In this case, for all $j > i$, neither u_j nor v_j can take the value 1. Therefore, if there is an index $i \in [n]$ such that $r_i = 0$, then $r_j \neq 1$ for all $j > i$. Thus r is a triword.

The triword r is the join between u and v . Indeed, r is by definition the smallest element such that for all $i \in [n]$, $r_i \geq u_i$ and $r_i \geq v_i$. Moreover, since the join between u and v is unique, by Proposition 1.2.2, the Hochschild poset is a join-semilattice. One can conclude that Hochschild poset is a lattice since there is a unique minimal triword [Sta11]. Note that this fact is already known since the Hochschild poset is an interval of the dexter meet-semilattice [Cha20].

Let $s := \min(u_1, v_1) \dots \min(u_n, v_n)$. The word s is not necessarily a triword. For instance, if we consider $u = 11112$ and $v = 10022$, two triwords of size 5, then $s = 10012$ which contains a subword 01.

Let $t := u \wedge v$ be the word obtained from s by changing all subwords 01 by 00 in s .

PROPOSITION 1.2.3. *Let $n \geq 1$ and $u, v \in \text{Tr}(n)$, then $t := u \wedge v$ is the meet between u and v .*

PROOF. If $s := \min(u_1, v_1) \dots \min(u_n, v_n)$ is a triword, then $t = s$. Suppose that s is not a triword. Since we replace in s all subwords 01 by 00, t is a triword. Moreover, if there is a subword 01 in s , then either u or v has a letter 0 following by letters 0 or 2. Necessary, the word s inherits this letter 0, and then t is a triword if all letters after this letter 0 are 0 or 2. Therefore, the triword t is the greatest element such that $t \leq u$ and $t \leq v$. \square

For example, in order to compute $11112 \wedge 10222$, first we compute $s = 10112$, which is not a triword. We replace the subword s_2s_3 and s_2s_4 by the subword 00. One has $11112 \wedge 10222 = 10002$.

2. Geometric properties

Through triwords, it is possible to give a cubic realization of the Hochschild lattice by placing in the space \mathbb{R}^n all triwords of size n . As for the cubic coordinate lattice seen in Chapter 2, this lattice thus joins the family of posets having a cubic realisation. This realization allows us to show two geometrical results: on the one hand that the Hochschild lattice is EL-shellable and on the other hand that this lattice is constructible by interval doubling.

2.1. Cubic realizations. The Hochschild poset $\text{Tr}(n)$ can be seen as a geometric object in the space \mathbb{R}^n by placing for each $u \in \text{Tr}(n)$ a vertex of coordinates (u_1, \dots, u_n) , and by forming for each $u, v \in \text{Tr}(n)$ such that $u < v$ an edge between u and v . In other words, as it is done in Chapter 2 for the cubic coordinate poset, we just describe the cubic realization $\mathcal{C}(\text{Tr}(n))$ of $\text{Tr}(n)$. Figure 2.1 shows the cubic realizations of $\text{Tr}(2)$ and $\text{Tr}(3)$.

The first thought that comes to mind, is that for any $n \geq 1$, any k -face of the realization $\mathcal{C}(\text{Tr}(n))$ is contained in a $n - 1$ -face of the hypercube of dimension n , for $k \in [0, n - 1]$. Indeed, between the minimal triword $0^n := u$ and the maximal triword $12^{n-1} := v$, there is no triword w of size n such that $u_i < w_i < v_i$ for all $i \in [n]$ since $u_1 = 0$ and $v_1 = 1$.

Therefore, we can see this realization as one empty cell of dimension n . Thus, it is clear that the volume of $\mathcal{C}(\text{Tr}(n))$ is 2^{n-1} .

2.2. EL-shellability. We refer to Section 2.3 of Chapter 1 in the sequel.

In order to show the EL-shellability of $\text{Tr}(n)$ for $n \geq 1$, we set Λ as the poset \mathbb{Z}^2 ordered lexicographically. Then we introduce the map $\lambda : \prec \rightarrow \mathbb{Z}^2$ defined for any u, v such that $u < v$ by

$$\lambda(u, v) := (i, u_i) \tag{2.2.1}$$

where i is the unique index such that $u_i \neq v_i$. Observe that because of the covering relation \prec defined in Proposition 1.2.1, the image by λ of any saturated chain in $\text{Tr}(n)$ is well-defined.

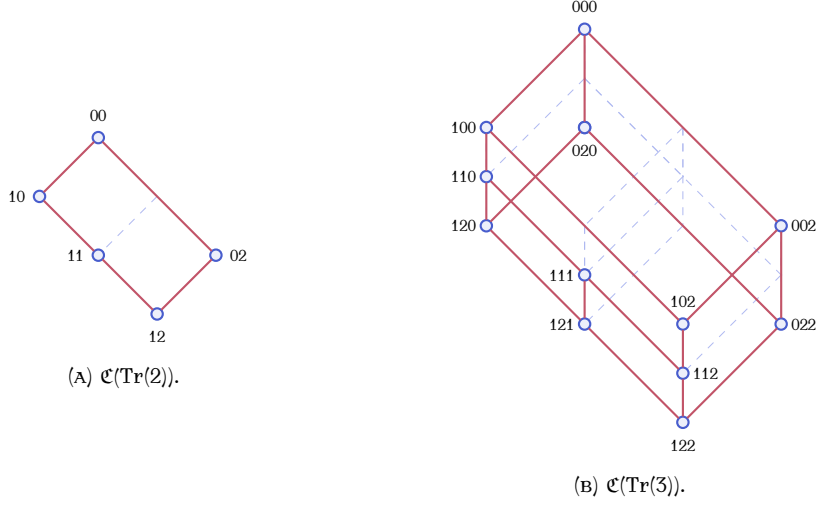

FIGURE 2.4. Cubic realizations of some Hochschild posets.

For any $u, v \in \text{Tr}(n)$, let

$$D(u, v) := \{d : u_d \neq v_d\} \quad (2.2.2)$$

be the set of all indices of different letters between u and v .

THEOREM 2.2.1. *For any $n \geq 1$, the map λ is an EL-labelling of the Hochschild lattice $\text{Tr}(n)$. Moreover, there is at most one λ -weakly decreasing chain between any pair of comparable elements of $\text{Tr}(n)$.*

PROOF. Let $u, v \in \text{Tr}(n)$ such that $u \preceq v$ and

$$D(u, v) := \{d_1, d_2, \dots, d_s\}, \quad (2.2.3)$$

with $d_1 < d_2 < \dots < d_s$. For $k \in [s]$, let $u^{(k)}$ be the word of size n defined by replacing the k letters $u_{d_1}, u_{d_2}, \dots, u_{d_k}$ in u by the k letters $v_{d_1}, v_{d_2}, \dots, v_{d_k}$ of v .

Thus, for any $k \in [s]$, either $u_i^{(k)} = u_i$ or $u_i^{(k)} = v_i$ for all $i \in [n]$. Since the letters are increased from the triword u from left to right, the word $u^{(k)}$ is not a triword if and only if there is a letter $u_i^{(k)} = 0$ and a letter $u_j^{(k)} = 1$ with $i \leq d_k$ and $j > i$. However, if there is a letter $u_i^{(k)} = 0$ in $u^{(k)}$ with $i \leq d_k$, then $v_i = 0$ since $u_i^{(k)} = v_i$ by construction of $u^{(k)}$. And so $u_i = 0$ since by hypothesis $u_i \leq v_i$. Thus, $u_i = 0$ and $v_i = 0$ imply respectively that $u_j \neq 1$ and $v_j \neq 1$ in the triwords u and v for all $j > i$. In particular, one has $u_j^{(k)} \neq 1$ for all $j > i$. It follows that the subword 01 cannot occur in $u^{(k)}$, and then $u^{(k)}$ is a triword. Let us consider the chain

$$\left(u, u^{(1)}, u^{(2)}, \dots, u^{(s-1)}, u^{(s)} = v \right) \quad (2.2.4)$$

which is not necessarily saturated. Then, by concatenating the unique saturated chain in each interval $[u^{(k-1)}, u^{(k)}]$ for all $k \in [s]$, we obtain a saturated chain between u and v . Since each word $u^{(k)}$ of this saturated chain is obtained from u by replacing letters from left to right, this chain is clearly weakly increasing for the partial order \preceq . Furthermore, between

two consecutive triwords $u^{(k-1)}$ and $u^{(k)}$ in this saturated chain, $u^{(k-1)} < u^{(k)}$. Therefore, the image of the chain by λ is increasing for \preceq . Thus this chain is λ -increasing.

Moreover, since between any two consecutive triwords of this chain only one letter is different, if we consider another saturated chain from u to v , then at some point, this chain passes through a word obtained by increasing a letter which has not the smallest possible index. It lead us to choose later in this chain the letter with a smallest index to increase it. For this reason, the saturated chain obtained is not λ -increasing.

If a λ -weakly decreasing chain exists in $[u, v]$, then it must have the sequence of edge-labels

$$((d_s, u_{d_s}), (d_{s-1}, u_{d_{s-1}}), \dots, (d_2, u_{d_2}), (d_1, u_{d_1})). \quad (2.2.5)$$

Indeed, suppose that between u and v , there is an index $d \in D(u, v)$ such that $u_d = 0$ and $v_d = 2$, and there is a triword w such that $u \preceq w \preceq v$ with $w_d = 1$. Then for this index d , the sequence of edge-labels passing through w is $((d, 0), (d, 1))$, and so the saturated chain passing through w in $[u, v]$ cannot be λ -weakly decreasing. Therefore, to obtain a λ -weakly decreasing chain in $[u, v]$, each index d of $D(u, v)$ can only appear once in the sequence of edge-labels.

Assume that there is a λ -weakly decreasing chain. For the same reason as previously, this chain is unique. \square

For instance, for $\text{Tr}(3)$, the λ -increasing chain between 000 and 122 is

$$(000, 100, 110, 120, 121, 122), \quad (2.2.6)$$

and

$$\lambda(000, \dots, 122) = ((1, 0), (2, 0), (2, 1), (3, 0), (3, 1)). \quad (2.2.7)$$

For the same interval, the λ -weakly decreasing chain is

$$(000, 002, 022, 122), \quad (2.2.8)$$

and

$$\lambda(000, \dots, 122) = ((3, 0), (2, 0), (1, 0)). \quad (2.2.9)$$

2.3. Construction by interval doubling. One may refer to Section 2.4 of Chapter 1.

For all $n \geq 1$, let us build $\text{Tr}(n+1)$ from $\text{Tr}(n)$ by following these three steps.

- (i) Let $T_0(n+1)$ be the poset on the set of all words $u0$ such that $u \in \text{Tr}(n)$.
- (ii) We build the set $T_2(n+1)$ from $T_0(n+1)$ by changing for all $u \in T_0(n+1)$ the letter u_{n+1} to 2. Let $T_{0,2}(n+1)$ be the union $T_0(n+1) \cup T_2(n+1)$.
- (iii) Let I_0 be the set of words of shape $1(1+2)^*0$. We build the set I_1 from I_0 by changing for all $u \in I_0$ the letter 0 to 1. Let $T(n+1)$ be the union $T_{0,2}(n+1) \cup I_1$.

LEMMA 2.3.1. *For any $n \geq 1$, the Hochschild poset $\text{Tr}(n+1)$ is the poset $(T(n+1), \preceq)$ built from $\text{Tr}(n)$.*

PROOF. Let $u \in T(n+1)$, u is written either $v0$, or $v2$ with $v \in \text{Tr}$, or is a word of form $1(1+2)^*1$. It is clear that, for any $v \in \text{Tr}(n)$, adding a letter 0 or a letter 2 at the end of v give a triword of size $n+1$. Likewise, a word of form $1(1+2)^*1$ is also a triword.

Now, let $u \in \text{Tr}(n+1)$. Suppose that $u_{n+1} = 1$. Since the subword 01 is forbidden, one has $u_i \in \{1, 2\}$ for all $i \in [n]$. Therefore, u belongs to $T(n+1)$. Suppose that $u_{n+1} = 0$ or that $u_{n+1} = 2$. Since u belongs to $\text{Tr}(n+1)$, the conditions of triwords remain on the prefix v of size n of u . Thus, one has $v \in \text{Tr}(n)$. \square

THEOREM 2.3.2. *For any $n \geq 1$, the Hochschild poset $\text{Tr}(n)$ is constructible by interval doubling.*

PROOF. We proceed by induction on $n \geq 1$. If $n = 1$, we have the poset $\mathbf{2}$, namely the poset with two elements, which is a lattice constructible by interval doubling. Assume now that $n \geq 2$. We have to show that $\text{Tr}(n+1)$ can be obtained from $\text{Tr}(n)$ by a sequence of interval doublings. By Lemma 2.3.1, one has that $\text{Tr}(n+1)$ is the poset $T(n+1)$. Since $T(n+1)$ is obtain from $\text{Tr}(n)$ by performing the three steps (i), (ii), and (iii), by showing that these two last steps are two operations of interval doubling, the intended result will follow.

Let us consider $T_0(n+1)$. By changing for all $u \in T_0(n+1)$ the last letter 0 to 2 , a copy $T_2(n+1)$ of $T_0(n+1)$ is obtained. Since any $u \in T_0(n+1)$ have a copy $v \in T_2(n+1)$ such that $u_i = v_i$ for all $i \in [n]$ and $u_{n+1} \leq v_{n+1}$, one has that $u \preceq v$. Therefore, the step (ii) is the doubling of the interval $T_0(n+1)$.

In the step (iii) one builds I_1 from I_0 by changing for all $u \in I_0$ the letter 0 to 1 . Since for all $u, v \in I_0$ such that $u \preceq v$, any word w such that $u \preceq w \preceq v$ is by definition of \preceq a word of shape $1(1+2)^*0$, one has that I_0 is the interval $[1^n 0, 12^{n-1} 0]$. For the same reason, I_1 is the interval $[1^{n+1}, 12^{n-1} 1]$.

Since any $u \in I_0$ has a copy $v \in I_1$ such that $u_i = v_i$ for all $i \in [n]$ and $u_{n+1} \leq v_{n+1}$, one has that $u \preceq v$. Meanwhile, any $u \in I_0$ has a copy $w \in T_2(n+1)$, included in the interval $[1^n 2, 12^n]$, such that $u_i = w_i$ for all $i \in [n]$ and $u_{n+1} \leq w_{n+1}$. However, by construction, one has $u_{n+1} = 0$, $v_{n+1} = 1$, and $w_{n+1} = 2$, for all $u \in I_0$, $v \in I_1$ and $w \in [1^n 2, 12^n]$. It follows that $u \preceq v \preceq w$ for all $u \in I_0$, $v \in I_1$ and $w \in [1^n 2, 12^n]$ such that $u_i = v_i = w_i$ for $i \in [n]$. Therefore, the step (iii) is the doubling of the interval I_0 . \square

Note that for $n = 0$, $\text{Tr}(0) = \{\epsilon\}$ is constructible by interval doubling. Note also that, for any $n \geq 1$, only two steps are necessary to built $\text{Tr}(n+1)$ from $\text{Tr}(n)$, by starting with the doubling of $T_0(n+1)$ built from $\text{Tr}(n)$,

$$\text{Tr}(n) \simeq T_0(n+1) \rightarrow T_0(n+1) \times 2 \rightarrow \text{Tr}(n+1). \quad (2.3.1)$$

For instance, Figure 2.2 depicts the sequence of interval doublings from $\text{Tr}(2)$ to $\text{Tr}(3)$. To obtain $\text{Tr}(3)$ from $T_0(3)$, we have first to double the interval $T_0(3)$, then we have to double the interval $[110, 120]$.

3. Combinatorial properties

In this section, several combinatorial and enumerative properties of the Hochschild lattice are proved. We obtain results such as the enumeration of intervals, the enumeration of k -chains, and the description of the degree polynomial of the Hochschild lattice.

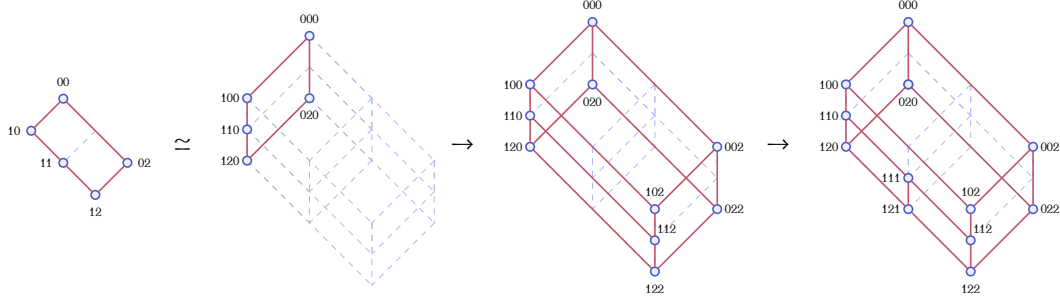
FIGURE 2.2. A sequence of interval doublings from $\text{Tr}(2)$ to $\text{Tr}(3)$.

3.1. Maximal chains and degree polynomial.

3.1.1. *Irreducible elements.* Let us describe the set of join-irreducible and meet-irreducible elements of $\text{Tr}(n)$ by using the regular expression notation [Sak09] recalled in Section 1.1.

The two possibilities of having a join-irreducible triword are either to change a letter $u_i = 1$ to 0 such that all letters on the left of u_i are letters 1 and letters on the right of u_i are 0, or to change a letter $u_i = 2$ to 0 such that all other letters are 0. Indeed, suppose that we change in a triword u a letter $u_i = 2$ to 1. Since u should cover just one triword, all other letters in u have to be 0. However, since the first letter in u is different from 2, there is a letter u_{i-1} such that $u_{i-1} \neq 0$. Thus, u_{i-1} can be also decreased. This implies that u covers more than just one triword. Since the subword 01 is not allowed, the set of triwords which covers a unique triword is described by

$$\mathbf{J}(\text{Tr}(n)) = \{u \in \text{Tr}(n) : u \in 1^+0^* + 0^+20^*\}. \quad (3.1.1)$$

Likewise, the three possibilities of having a meet-irreducible triword are either to change a letter 1 to 2 or to change a letter 0 to 1, or to change a letter 0 to 2. Moreover, for all cases, the other letters which are unchanged should be as large as possible. Thus, the set of triwords covered by a unique triword is described by

$$\mathbf{M}(\text{Tr}(n)) = \{u \in \text{Tr}(n) : u \in 12^*12^* + 12^*02^* + 02^*\}. \quad (3.1.2)$$

Note that both regular expressions (3.1.1) and (3.1.2) have as generating function

$$\mathcal{G}_{\mathbf{J}(\text{Tr})}(t) = \mathcal{G}_{\mathbf{M}(\text{Tr})}(t) = \frac{t + t^2}{(1 - t)^2}. \quad (3.1.3)$$

From (3.1.3), one can deduce that, for $n \geq 1$,

$$\#\mathbf{J}(\text{Tr}(n)) = \#\mathbf{M}(\text{Tr}(n)) = 2n - 1. \quad (3.1.4)$$

In Section 2, we have shown that the Hochschild lattice is constructible by interval doubling. However, it is known from [Day79] that lattices constructible by interval doubling are in particular semidistributive. Moreover, a finite lattice \mathcal{L} is constructible by interval doubling if and only if it is congruence uniform [Day79]. In particular, the number of

join-irreducible elements $\mathbb{J}(\mathcal{L})$ is equal to the number of doubling steps needed to build \mathcal{L} [Müh19].

Therefore, there are two consequences of Theorem 2.3.2. The first one is that for any $n \geq 1$, the Hochschild poset $\text{Tr}(n)$ is semidistributive. Another consequence is that the difference of numbers of join-irreducible elements between $\text{Tr}(n-1)$ and $\text{Tr}(n)$ is always 2. Indeed, $\text{Tr}(n)$ is constructible by interval doubling from $\text{Tr}(n-1)$ with only two steps.

3.1.2. Maximal chains.

LEMMA 3.1.1. *For any $n \geq 1$, the length of any maximal saturated chain in the Hochschild poset $\text{Tr}(n)$ is $2n - 1$. Moreover, a triword belongs to a maximal saturated chain if and only if all letters following a letter 0 are also 0.*

PROOF. If $n = 1$, then the length of the saturated chain $[0, 1]$ is 1. Suppose that $n > 1$. Since all letters 0, except the first one, can be increased to 1, then to 2, the length of a maximal saturated chain in $\text{Tr}(n)$ between 0^n and 12^{n-1} is at most $2n - 1$. Therefore, to obtain a maximal saturated chain between 0^n and 12^{n-1} , all letters 0 in 0^n must become 1 before becoming 2, except for the first 0. Considering that, the letters have to be increased from left to right, in order to avoid the forbidden subword 01. This way, each letter of 0^n , except the first one, contributes 2 in the length of the saturated chain between the minimal triword and the maximal triword. Since the first 0 contributes 1, the length of such a saturated chain is $2n - 1$.

Furthermore, since the letters have to be increased from left to right, this implies that a triword u belongs to a maximal saturated chain if and only if for any letter $u_i = 0$ then $u_j = 0$ for all $j \geq i$. \square

By Lemma 3.1.1 and by (3.1.4), one has the following result.

PROPOSITION 3.1.2. *For any $n \geq 1$, the Hochschild lattice $\text{Tr}(n)$ is extremal.*

Recall that if a lattice is extremal and semidistributive, then it is also left modular, and therefore trim (see Section 2.1.3 of Chapter 1). Therefore, since Theorem 2.3.2 implies that $\text{Tr}(n)$ is semidistributive, $\text{Tr}(n)$ is trim.

3.1.3. *Spine.* Let us consider the subposet $\mathbb{J}(\mathbb{S}(\text{Tr}(n)))$ of $\mathbb{S}(\text{Tr}(n))$, where $\mathbb{S}(\text{Tr}(n))$ is the spine of $\text{Tr}(n)$ (see Section 2.1.3 of Chapter 1). Figure 3.1 shows the spine of $\mathbb{S}(\text{Tr}(2))$ and $\mathbb{S}(\text{Tr}(3))$.

Since the spine of $\text{Tr}(n)$ is a distributive sublattice of $\text{Tr}(n)$, then by the FTFDL one has that $\mathbb{S}(\text{Tr}(n))$ is isomorphic to $\mathbb{J}(\mathbb{J}(\mathbb{S}(\text{Tr}(n))))$.

For instance, Figure 3.2 depicts the construction of $\mathbb{J}(\mathbb{J}(\mathbb{S}(\text{Tr}(3))))$, which is a distributive lattice isomorphic to $\mathbb{S}(\text{Tr}(3))$ (see Figure 3.1).

Our aim is to give a description of triwords belonging to the spine of the Hochschild lattice. Then, in this set, we give a description of join-irreducible triwords.

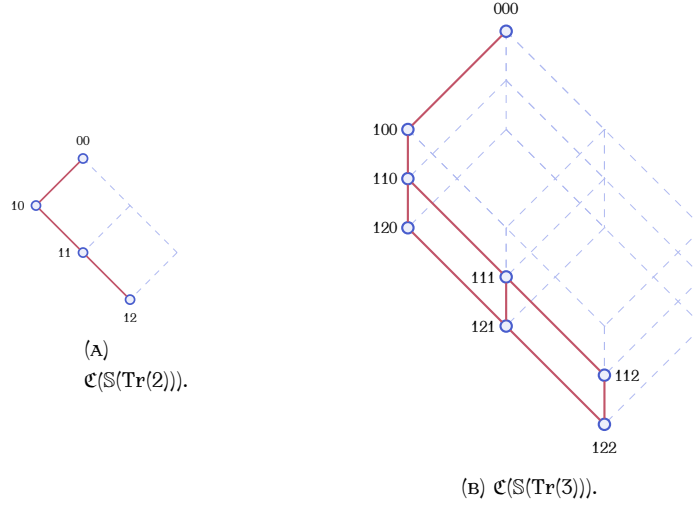

FIGURE 3.4. Cubic realizations of some spines of Hochschild posets.

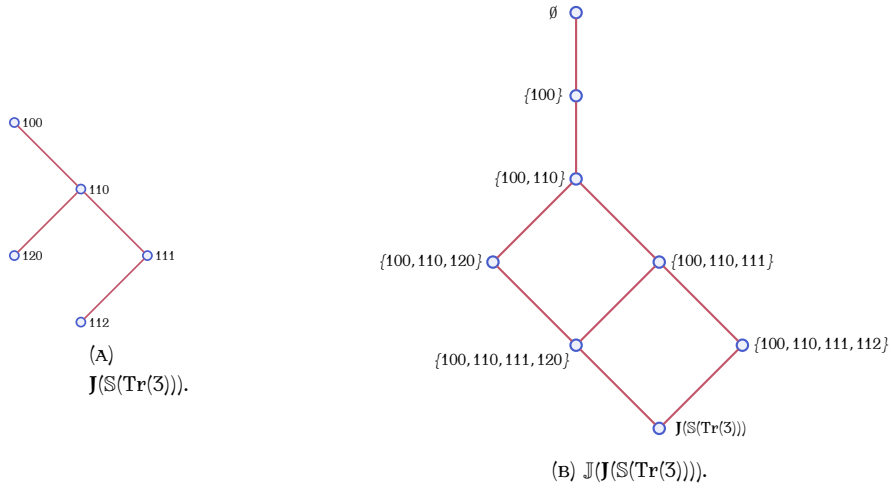

FIGURE 3.2. Construction of $\mathbb{J}(\mathbb{J}(\mathbb{S}(\text{Tr}(3))))$ from the poset $\mathbb{J}(\mathbb{S}(\text{Tr}(3)))$.

By Lemma 3.1.1 we know that a triword u belongs to a maximal saturated chain if and only if for any letter $u_i = 0$ then $u_j = 0$ for all $j \geq i$. Therefore, the regular expression of these triwords is

$$\mathbb{S}(\text{Tr}(n)) = \{u \in \text{Tr}(n) : u \in 0^* + 1(1 + 2)^*0^*\}. \tag{3.1.5}$$

Therefore, the generating function is

$$\mathcal{G}_{\mathbb{S}(\text{Tr})}(t) = \frac{1}{1 - 2t}, \tag{3.1.6}$$

and thus

$$\#\mathbb{S}(\text{Tr}(n)) = 2^n. \tag{3.1.7}$$

Let $u \in \mathbb{S}(\text{Tr}(n))$. The two possibilities for u to be a join-irreducible triword are either to have one unique letter 1 which can be changed to 0 or to have one unique letter 2 which can be changed to 1. To summarize,

$$\mathbf{J}(\mathbb{S}(\text{Tr}(n))) = \{u \in \mathbb{S}(\text{Tr}(n)) : u \in 1^+0^* + 1^+20^*\}. \quad (3.1.8)$$

One can deduce the generating function

$$\mathcal{G}_{\mathbf{J}(\mathbb{S}(\text{Tr}))}(t) = \frac{t + t^2}{(1 - t)^2}, \quad (3.1.9)$$

and thus

$$\#\mathbf{J}(\mathbb{S}(\text{Tr}(n))) = 2n - 1. \quad (3.1.10)$$

From (3.1.8) one can also deduce that the shape of $\mathbf{J}(\mathbb{S}(\text{Tr}(n)))$ is as depicted in Figure 3.3.

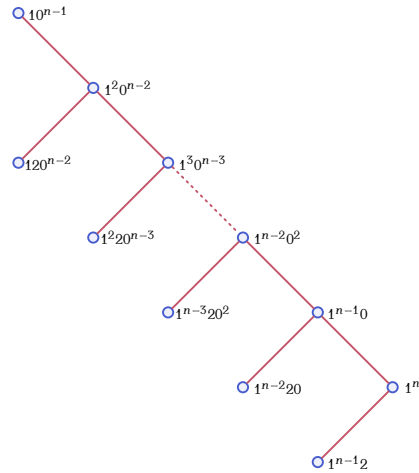

FIGURE 3.3. Shape of the poset $\mathbf{J}(\mathbb{S}(\text{Tr}(n)))$.

3.1.4. *Degree polynomial.* For this section, we can refer to 1.3.4 of Chapter 1

Let us start by computing the specialization $d_{\text{Tr}}(1, y)$ of the degree polynomial of Tr .

PROPOSITION 3.1.3. *For any $n \geq 1$, the h -polynomial of $\text{Tr}(n)$ is*

$$d_{\text{Tr}(n)}(1, y) = (y + 1)^{n-2}(y^2 + (n + 1)y + 1). \quad (3.1.11)$$

PROOF. Let us compute the generating series

$$P_{\text{Tr}}(y, z) := \sum_{n \geq 0} d_{\text{Tr}(n)}(1, y)z^n \quad (3.1.12)$$

of all degree polynomials of $\text{Tr}(n)$ for all $n \geq 0$.

Let us consider the grammar of Tr given by Lemma 1.1.1. By the map $u \mapsto z^{|u|}y^{\text{out}_{\text{Tr}}(u)}$ one obtains the system of formal series

$$\begin{aligned} P_A(y, z) &= 1 + yzP_A(y, z) + zP_A(y, z), \\ P_B(y, z) &= 1 + yzP_A(y, z) + yzP_B(y, z) + zP_B(y, z), \\ P_{\text{Tr}}(y, z) &= 1 + yzP_A(y, z) + zP_B(y, z). \end{aligned} \tag{3.1.13}$$

Indeed, in (1.1.2) of the grammar, $0A$ becomes $yzP_A(y, z)$ because the letter 0 can always be increased to 2. Note that the letter 0 in $0A$ cannot be increased to 1 because in (1.1.4), this expression $0A$ comes after a first letter 0, and the subword 01 is prohibited by definition of triwords. However, $2A$ becomes $zP_A(y, z)$ since the letter 2 cannot be increased. Likewise, in (1.1.3), $0A$ becomes $yzP_A(y, z)$ because the letter 0 can be increased to 1, and $1B$ becomes $yzP_B(y, z)$ because the letter 1 can be increased to 2, unlike the letter 2 in $2B$ which becomes $zP_B(y, z)$.

Thus,

$$\begin{aligned} P_A(y, z) &= \frac{1}{1 - z - yz}, \\ P_B(y, z) &= \frac{1 - z}{(1 - z - yz)^2}, \\ P_{\text{Tr}}(y, z) &= \frac{1 - z}{1 - (z + yz)} + \frac{z - z^2}{(1 - (z + yz))^2}. \end{aligned} \tag{3.1.14}$$

From this expression of $P_{\text{Tr}}(y, z)$ in partial fraction decomposition, we deduce by a straightforward computation the given expression for $d_{\text{Tr}(n)}(1, y)$. \square

Let $n \geq 1$ and $u \in \text{Tr}(n)$. For any letter u_i of u with $i \in [n]$, the number of letters u'_i such that the word u' defined by $u'_j := u_j$ for all $j \neq i$ is in covering relation with u is the *degree* of the letter u_i . The sum of the degrees of all letters of u is the number of elements covered by u or covering u , namely $\text{in}_{\mathcal{C}}(u) + \text{out}_{\mathcal{C}}(u)$.

LEMMA 3.1.4. *For any $n \geq 1$ and $u \in \text{Tr}(n)$, $\text{in}_{\text{Tr}}(u) + \text{out}_{\text{Tr}}(u) = n$.*

PROOF. Suppose that the first letter of u is 0, then all letters of u are either 0 or 2. The letter u_1 can be increased to 1, but since we cannot have a letter 0 followed by 1, all other letters 0 can only be increased to 2, and all letters 2 can only be decreased to 0. And so for the case where $u_1 = 0$, all letters of u have degree 1.

Suppose now that the first letter of u is 1. Either u_1 is the only letter 1 in u or there is another letter $u_i = 1$ such that all letters after u_i are not 1. In the first case, u_1 can be decreased to 0, thus all letters of u have degree 1. In the second case, since there is at least one other letter 1 in u , u_1 cannot be decreased to 0. Then the degree of u_1 is 0. However, this degree is compensated by the degree of the letter u_i . Indeed, the last letter 1 is the only one which can be decreased to 0 or increased to 2. Hence the degree of u_i is 2, and since all other letters of u have degree 1, the sum is equal to n . \square

By Proposition 3.1.3 and Lemma 3.1.4, one can deduce the degree polynomial of $\text{Tr}(n)$ by replacing y^k in the h -polynomial by $x^{n-k}y^k$, with $k \in [0, n]$. Thus, the degree polynomial of $\text{Tr}(n)$ is

$$d_{\text{Tr}(n)}(x, y) = (x + y)^{n-2}(x^2 + (n + 1)xy + y^2). \quad (3.1.15)$$

For instance,

$$\begin{aligned} d_{\text{Tr}(1)}(x, y) &= x + y, \\ d_{\text{Tr}(2)}(x, y) &= x^2 + 3xy + y^2, \\ d_{\text{Tr}(3)}(x, y) &= x^3 + 5x^2y + 5xy^2 + y^3, \\ d_{\text{Tr}(4)}(x, y) &= x^4 + 7x^3y + 12x^2y^2 + 7xy^3 + y^4. \end{aligned} \quad (3.1.16)$$

3.2. Intervals and k -chains. This section also provides enumerative results about the Hochschild lattice. We have already computed the length of any maximal chain for this lattice in Section 2. Here we give a method to find formulas for the number of k -chains of this lattice. We can refer to Section 2.2 of Chapter 1.

3.2.1. \mathcal{L} -classifications. Firstly, we need to define a classification for all k -chains of size n .

For a letter a and a word u , we use the notation $a \in u$ if there is a letter $u_i = a$. Conversely, $a \notin u$ if all letters u_i of u are different from a .

For any $n \geq 1$ and $k \geq 1$, let $(u^{(1)}, u^{(2)}, \dots, u^{(k-1)}, u^{(k)})$ be a k -chain of triwords of size n . It is always possible to classify k -chains according to the presence or absence of the letter 0 in $u^{(j)}$ with $j \in [k]$ by setting, for all $i \in [0, k]$,

$$\mathcal{L}_i(n, k) := \{(u^{(1)}, u^{(2)}, \dots, u^{(k)}) : 0 \in u^{(r)}, 0 \notin u^{(s)} \text{ for all } r \in [k-i], s \in [k-i+1, k]\}. \quad (3.2.1)$$

This classification is called the \mathcal{L} -classification for k -chains. Note that the union of all these sets is disjoint and give a description of all k -chains. Note also that for $n = 1$, $\#\mathcal{L}_i(1, k) = 1$ for all $i \in [0, k]$.

For any $n \geq 2$, $k \geq 1$, $i \in [0, k]$, and $j \geq i$, let

$$\phi_i^{(n,k)} : \mathcal{L}_i(n, k) \rightarrow \mathbb{N} \times \mathcal{L}_j(n-1, k) \quad (3.2.2)$$

such that, for γ a k -chain in $\mathcal{L}_i(n, k)$,

$$\phi_i^{(n,k)}(\gamma) := (t, \gamma') \quad (3.2.3)$$

where γ' is the k -chain obtained by forgetting the last letter of each word of γ , and t is the number of words ending by 2 in γ .

Let $\gamma \in \mathcal{L}_i(n, k)$. Clearly, $\phi_i^{(n,k)}(\gamma)$ is a k -chain γ' which belongs to $\mathcal{L}_j(n-1, k)$ with $j \in [i, k]$, since the k -chain γ' has at the most the same number of triwords with a letter 0 than the k -chain γ .

Therefore, by setting $\gamma := (v^{(1)}a^{(1)}, v^{(2)}a^{(2)}, \dots, v^{(k)}a^{(k)})$ with $v^{(r)} \in \text{Tr}(n-1)$ and $a^{(r)} \in [0, 2]$ for all $r \in [k]$, and $(t, \gamma') := \phi_i^{(n,k)}(\gamma)$, there are two cases.

- ★ Suppose that γ' belongs to $\mathcal{L}_i(n-1, k)$. Then one has $k+1$ possibilities to place or not the letter 2. Indeed, for $r \in [k-i]$, $a^{(r)} = 0$ or $a^{(r)} = 2$ because by hypothesis $0 \in v^{(r)}$. For $s \in [k-i+1, k]$, because γ' is already in $\mathcal{L}_i(n-1, k)$, one has $a^{(s)} = 1$ or $a^{(s)} = 2$. To summarize, one has $k+1$ possibilities to place the letter 2, knowing that all letters before the first ending letter 2 have to be smaller than 2, and all letters after have to be 2.
- ★ Suppose now that γ' belongs to $\mathcal{L}_j(n-1, k)$ with $j \in [i+1, k]$. Then one has $i+1$ possibilities to place or not the letter 2. Indeed, in this case we must set $a^{(s)} = 0$ for all $s \in [k-j, k-i]$ in order to obtain a k -chain in $\mathcal{L}_i(n, k)$. This implies that all ending letters before $a^{(k-j)}$ have to be also 0. It follows that for all $r \in [k-i+1, k]$, $a^{(r)} = 1$ or $a^{(r)} = 2$.

In the two cases, the position of the first letter 2 depends on the integer t .

Thus, for γ a k -chain in $\mathcal{L}_i(n, k)$, it follows that

$$\phi_i^{(n,k)}(\gamma) \in [k+1] \times \mathcal{L}_i(n-1, k) \bigsqcup [i+1] \times \bigsqcup_{j \in [i+1, k]} \mathcal{L}_j(n-1, k). \quad (3.2.4)$$

For instance, by setting

$$\gamma := (00200, 02200, 02202, 12222) \quad (3.2.5)$$

a 4-chain of $\mathcal{L}_1(5, 4)$, one has $\phi_1^{(5,4)}(\gamma) = (t, \gamma')$ with

$$\gamma' = (0020, 0220, 0220, 1222), \quad (3.2.6)$$

and $t = 2$.

LEMMA 3.2.1. *For any $n \geq 2$, $k \geq 1$, and $i \in [0, k]$, the map $\phi_i^{(n,k)}$ is a bijection.*

PROOF. Let $\delta' := (v^{(1)}, v^{(2)}, \dots, v^{(k)})$ be a k -chain of $\text{Tr}(n-1)$, and $t \in [0, k]$.

- ★ Suppose that $\delta' \in \mathcal{L}_i(n-1, k)$. Let $\delta := (v^{(1)}a^{(1)}, v^{(2)}a^{(2)}, \dots, v^{(k)}a^{(k)})$ such that for all $r \in [k-t]$ we set $a^{(r)} = 0$ if $0 \in v^{(r)}$, and $a^{(r)} = 1$ otherwise, and $a^{(s)} = 2$ for all $s \in [k-t+1, k]$. The resulting k -chain is a k -chain of $\text{Tr}(n)$ because $a^{(1)} \leq a^{(2)} \leq \dots \leq a^{(k)}$ by construction. Furthermore, since no 0 is added at the end of a word that does not contain a letter 0 in δ' , the k -chain δ belongs to $\mathcal{L}_i(n, k)$.
- ★ Suppose that $\delta' \in \mathcal{L}_j(n-1, k)$, with $j \in [i+1, k]$. Let $\delta := (v^{(1)}a^{(1)}, v^{(2)}a^{(2)}, \dots, v^{(k)}a^{(k)})$ such that $a^{(r)} = 0$ for all $r \in [k-i]$, $a^{(s)} = 1$ for all $s \in [k-i+1, k-t]$, and $a^{(q)} = 2$ for all $q \in [k-t+1, k]$. By construction, one has $a^{(1)} \leq a^{(2)} \leq \dots \leq a^{(k)}$. This implies that this k -chain is a k -chain of $\text{Tr}(n)$. Moreover, since the letter 0 is added at the end of $v^{(r)}$ for $r \in [k-i]$, the k -chain δ belongs to $\mathcal{L}_i(n, k)$.

In both cases, since δ belongs to $\mathcal{L}_i(n, k)$, this implies that the map $\phi_i^{(n,k)}$ is surjective.

Let (t_1, γ') and (t_2, δ') be two pairs with $t_1, t_2 \in [0, k]$, and $\gamma' \in \mathcal{L}_{j_1}(n-1, k)$ and $\delta' \in \mathcal{L}_{j_2}(n-1, k)$ with $j_1, j_2 \in [i, k]$. Let γ be the image of (t_1, γ') and δ be the image of (t_2, δ') by $\phi_i^{(n,k)}$. Suppose that $(t_1, \gamma') \neq (t_2, \delta')$. This implies that either $t_1 \neq t_2$ or $\gamma' \neq \delta'$. In the first case, if $t_1 > t_2$ then there are more words ending by 2 in γ than in δ . Thus one has $\gamma \neq \delta$. In the second case, there is at least one word in γ such that the prefix of this word

is different from the word with the same index in δ . Here again, one has $\gamma \neq \delta$. Hence, the map $\phi_i^{(n,k)}$ is injective. \square

For instance, for the 4-chain (3.2.5), γ' belongs to $\mathcal{L}_1(4, 4)$ and t is 2. We can rebuild γ by adding the letter 2 on the two last words of γ' , since by definition of triwords, the greater triwords of a k -chain must have greater or equal letters compare to smaller triwords. Besides, since the two first words of γ' have the letter 0, we can only add the letter 0 at its end.

Let us consider another example with

$$\gamma := (00000, 00200, 12210, 12211, 12212) \quad (3.2.7)$$

a 5-chain of $\mathcal{L}_2(5, 5)$. One has $\phi_2^{(5,5)}(\gamma) = (t, \gamma')$ with $t = 1$ and

$$\gamma' = (0000, 0020, 1221, 1221, 1221). \quad (3.2.8)$$

Here γ' belongs to $\mathcal{L}_3(4, 5)$. Since $\gamma \in \mathcal{L}_2(5, 5)$, to rebuild γ from γ' , we have to add 0 at the end of the third word of γ' . Moreover, since $t = 1$, the letter 2 is added to the last word and the letter 1 is added to the penultimate word of γ' .

3.2.2. Enumeration of k -chains. For all matrices M , we denote in the following by $M(i, j)$ the entry at the i -th line and the j -th column.

For any $\mathcal{L}_i(n, k)$ of this classification, one obtains by denoting by $\mathfrak{z}_i(n, k)$ the cardinality of $\mathcal{L}_i(n, k)$ with $i \in [0, k]$, the following result.

PROPOSITION 3.2.2. *Let $n \geq 2$ and $k \geq 1$. For all $i \in [0, k]$, each $\mathfrak{z}_i(n, k)$ satisfies*

$$\mathfrak{z}_i(n, k) = (k + 1)\mathfrak{z}_i(n - 1, k) + (i + 1) \sum_{j=i+1}^k \mathfrak{z}_j(n - 1, k). \quad (3.2.9)$$

PROOF. This is a direct consequence of Lemma 3.2.1. \square

For example, for

$$\begin{aligned} \mathcal{L}_1(2, 3) = \{ & (00, 00, 11), (00, 00, 12), (00, 02, 12), (02, 02, 12), \\ & (00, 10, 11), (00, 10, 12), (10, 10, 11), (10, 10, 12) \}, \end{aligned} \quad (3.2.10)$$

the first four 3-chains came from $\mathcal{L}_1(1, 3) = \{(0, 0, 1)\}$, the next two came from $\mathcal{L}_2(1, 3) = \{(0, 1, 1)\}$, and the last two came from $\mathcal{L}_3(1, 3) = \{(1, 1, 1)\}$.

The system

$$\begin{aligned} \mathfrak{z}_0(n, k) &= (k + 1)\mathfrak{z}_0(n - 1, k) + \mathfrak{z}_1(n - 1, k) + \cdots + \mathfrak{z}_{k-1}(n - 1, k) + \mathfrak{z}_k(n - 1, k), \\ \mathfrak{z}_1(n, k) &= (k + 1)\mathfrak{z}_1(n - 1, k) + 2\mathfrak{z}_2(n - 1, k) + \cdots + 2\mathfrak{z}_{k-1}(n - 1, k) + 2\mathfrak{z}_k(n - 1, k), \\ &\vdots \\ \mathfrak{z}_{k-1}(n, k) &= (k + 1)\mathfrak{z}_{k-1}(n - 1, k) + k\mathfrak{z}_k(n - 1, k), \\ \mathfrak{z}_k(n, k) &= (k + 1)\mathfrak{z}_k(n - 1, k), \end{aligned} \quad (3.2.11)$$

is called \mathfrak{z} -system.

PROPOSITION 3.2.3. *For any $n \geq 2$ and $k \geq 1$, the k -chains of the Hochschild poset $\text{Tr}(n)$ are enumerated by*

$$\sum_{i=0}^k \mathfrak{z}_i(n, k) = (k+1)^{n-(k+1)} P_k(n), \quad (3.2.12)$$

where $P_k(n)$ is a monic polynomial of degree k determined by the \mathfrak{z} -system.

PROOF. Since for $n = 1$, all $\mathfrak{z}_i(1, k) = 1$ with $i \in [0, k]$, one can rewrite the \mathfrak{z} -system with matrices

$$\begin{pmatrix} \mathfrak{z}_0(n, k) \\ \mathfrak{z}_1(n, k) \\ \vdots \\ \mathfrak{z}_{k-1}(n, k) \\ \mathfrak{z}_k(n, k) \end{pmatrix} = \begin{pmatrix} k+1 & 1 & 1 & \dots & 1 \\ 0 & k+1 & 2 & \dots & 2 \\ \vdots & & \ddots & & \vdots \\ 0 & \dots & 0 & k+1 & k \\ 0 & \dots & 0 & 0 & k+1 \end{pmatrix}^{n-1} \begin{pmatrix} 1 \\ 1 \\ \vdots \\ 1 \\ 1 \end{pmatrix}. \quad (3.2.13)$$

Let us denote by M this upper triangular matrix, I the identity matrix of dimension $k+1$, and $N := M - (k+1)I$. Since I and N commute, one has

$$\begin{aligned} M^{n-1} &= ((k+1)I + N)^{n-1} \\ &= \sum_{i=0}^k \binom{n-1}{i} (k+1)^{n-1-i} N^i \\ &= (k+1)^{n-(k+1)} \left((k+1)^k I + (n-1)(k+1)^{k-1} N + \dots + \frac{(n-1)!}{(n-k-1)!k!} N^k \right) \\ &= (k+1)^{n-(k+1)} Q_k(n), \end{aligned} \quad (3.2.14)$$

where $Q_k(n)$ is clearly polynomial in n . It only remains to deduce the polynomial $P_k(n)$ from the matrix $Q_k(n)$, as the sum of all entries of $Q_k(n)$.

Furthermore, $P_k(n)$ is a polynomial of degree k since n^k appears in $\frac{(n-1)!}{(n-k-1)!k!}$.

Moreover, a particular case from Lemma 3.2.4 gives that $N^k(1, k+1) = k!$. Since N is a strictly upper triangular matrix, $N^k(1, k+1)$ is the only nonzero entry of N^k . This implies that $P_k(n)$ is a monic polynomial. \square

LEMMA 3.2.4. *For any $n \geq 2$ and $k \geq 1$, let M be the upper triangular matrix in (3.2.13), I be the identity matrix of dimension $k+1$, and $N := M - (k+1)I$. For any $l \in [k]$ and $i \in [k+1]$ such that $i+l \leq k+1$, one has*

$$N^l(i, i+l) = \frac{(i+l-1)!}{(i-1)!}. \quad (3.2.15)$$

PROOF. We proceed by induction on l . Since $N(i, i+1) = i$ for all $i \in [k+1]$, one has that (3.2.15) follows for $l = 1$. Suppose that (3.2.15) is true for $l-1$ and let us consider N^l . For any $i \in [k+1]$, one obtains $N^l(i, i+l)$ with the i -th line of N^{l-1} and the $(i+l)$ -th column

of N . Since N is a strictly upper triangular matrix, all left entries before $N^{l-1}(i, i + l - 1)$ are zeros, and all below entries after $N(i + l - 1, i + l)$ are also zeros. Therefore,

$$N^l(i, i + l) = N^{l-1}(i, i + l - 1) N(i + l - 1, i + l) = \frac{(i + l - 2)!}{(i - 1)!} (i + l - 1) = \frac{(i + l - 1)!}{(i - 1)!}, \quad (3.2.16)$$

and then (3.2.15) holds for all $l \in [k]$. \square

Note that since for $n = 1$, all $\mathfrak{z}_i(1, k) = 1$ with $i \in [0, k]$, the number of k -chains is $k + 1$ for all $k \geq 1$. Using Proposition 3.2.3, one can therefore deduce that $P_k(1) = (k + 1)^{k+1}$.

Recall that the triwords of size n are enumerated by

$$2^{n-2}(n + 3). \quad (3.2.17)$$

A demonstration of this result is given in Section 1.1, involving generating series. By Proposition 3.2.3, one has

$$\begin{pmatrix} \mathfrak{z}_0(n, 1) \\ \mathfrak{z}_1(n, 1) \end{pmatrix} = \begin{pmatrix} 2 & 1 \\ 0 & 2 \end{pmatrix}^{n-1} \begin{pmatrix} 1 \\ 1 \end{pmatrix} = \begin{pmatrix} 2^{n-1} & (n-1)2^{n-2} \\ 0 & 2^{n-1} \end{pmatrix} \begin{pmatrix} 1 \\ 1 \end{pmatrix}, \quad (3.2.18)$$

which leads to the formula already known, for $n \geq 1$,

$$\mathfrak{z}_0(n, 1) + \mathfrak{z}_1(n, 1) = 2^{n-2}(n + 3). \quad (3.2.19)$$

Likewise, to enumerate the intervals of the Hochschild lattice, or in other words their 2-chains, one has

$$\begin{aligned} \begin{pmatrix} \mathfrak{z}_0(n, 2) \\ \mathfrak{z}_1(n, 2) \\ \mathfrak{z}_2(n, 2) \end{pmatrix} &= \begin{pmatrix} 3 & 1 & 1 \\ 0 & 3 & 2 \\ 0 & 0 & 3 \end{pmatrix}^{n-1} \begin{pmatrix} 1 \\ 1 \\ 1 \end{pmatrix} \\ &= \begin{pmatrix} 3^{n-1} & 3^{n-2}(n-1) & 3^{n-2}(n-3) + 3^{n-3}(n^2 - 3n + 8) \\ 0 & 3^{n-1} & 3^{n-2}(2n-2) \\ 0 & 0 & 3^{n-1} \end{pmatrix} \begin{pmatrix} 1 \\ 1 \\ 1 \end{pmatrix}. \end{aligned} \quad (3.2.20)$$

The number of intervals of $\text{Tr}(n)$ is therefore given by

$$\mathfrak{z}_0(n, 2) + \mathfrak{z}_1(n, 2) + \mathfrak{z}_2(n, 2) = 3^{n-3}(n^2 + 9n + 17). \quad (3.2.21)$$

In the same way, the number of 3-chains is

$$4^{n-4}(n^3 + 20n^2 + 93n + 142), \quad (3.2.22)$$

the number of 4-chains is

$$5^{n-5} \left(n^4 + \frac{110}{3}n^3 + 355n^2 + \frac{3490}{3}n + 1569 \right), \quad (3.2.23)$$

and the number of 5-chains is

$$6^{n-6} \left(n^5 + \frac{119}{2}n^4 + 1026n^3 + \frac{13261}{2}n^2 + 17363n + 21576 \right). \quad (3.2.24)$$

It seems that the sequence of constant terms of the polynomials $P_k(n)$

$$3, 17, 142, 1569, 21576, \dots \quad (3.2.25)$$

is the sequence of numbers of *connected functions* on n labeled nodes **A001865** of [Slo]. Recall that a connected function is a function $f : [n] \rightarrow [n]$ such that the graph $G := (V, E)$ is connected, where $V := [n]$ is the set of vertices and $E := \{(i, f(i))\}$ with $i \in [n]$ is the set of edges.

3.3. Subposets of the Hochschild posets. An interesting subposet of the poset $\text{Tr}(n)$ appears by considering the set of triwords restricted to words beginning by the letter 1. Here, some results are given for this subposet.

3.3.1. Mini-Hochschild posets. Let $u \in \text{Tr}(n)$ such that $u_1 = 1$, then u is called a μ -triword, and the graded set of μ -triwords is denoted by Tr_μ .

From Lemma 1.1.1, one has

$$\text{Tr}_\mu = \epsilon + 1B, \quad (3.3.1)$$

where B is the set of all words on $\{0, 1, 2\}$ avoiding the subword 01.

It follows that the generating series of Tr_μ is

$$\mathcal{G}_{\text{Tr}_\mu}(t) = 1 + t\mathcal{G}_B(t). \quad (3.3.2)$$

By reminding the two generating series (1.1.5) and (1.1.6), one can deduce, for any $n \geq 1$,

$$\#\text{Tr}_\mu(n) = 2^{n-2}(n+1). \quad (3.3.3)$$

The subposet $(\text{Tr}_\mu(n), \preceq)$ is called *mini-Hochschild poset*.

3.3.2. k -chains. As for Hochschild posets, we can give the \mathcal{L} -classification for k -chains of mini-Hochschild posets. This classification is identical to the classification (3.2.1). For any $n \geq 2$, $k \geq 1$, and $i \in [0, k]$, let us show that the map $\phi_i^{(n,k)}$ defined by (3.2.3) is also a bijection for the set of μ -triwords.

First, the reverse image of the map $\phi_i^{(n,k)}$ adds one letter on the end of each triwords of the k -chains. It means that if all triwords of a k -chain γ in $\mathcal{L}_j(n-1, k)$ for $j \in [i, k]$ are μ -triwords, then the reverse image of γ is also a k -chain of μ -triwords. Likewise, for a k -chain of μ -triwords such that $\gamma \in \mathcal{L}_i(n, k)$, $\phi_i^{(n,k)}(\gamma)$ remains a k -chain of μ -triwords since the first letter of each μ -triword remains 1. Second, all arguments in the proof of Lemma 3.2.1 hold in the case of μ -triwords because at no point the first letter of triwords which constitutes k -chains intervenes.

The \mathfrak{z} -system for the mini-Hochschild poset holds, and one has for any $n \geq 2$, $k \geq 1$, and for all $i \in [0, k]$,

$$\mathfrak{z}_i(n, k) = (k+1)\mathfrak{z}_i(n-1, k) + (i+1) \sum_{j=i+1}^k \mathfrak{z}_j(n-1, k). \quad (3.3.4)$$

Since $\mathfrak{z}_k(1, k) = 1$ and $\mathfrak{z}_j(1, k) = 0$ for all $j \in [0, k - 1]$, it follows that the \mathfrak{z} -system for the mini-Hochschild poset can be rewritten

$$\begin{pmatrix} \mathfrak{z}_0(n, k) \\ \mathfrak{z}_1(n, k) \\ \vdots \\ \mathfrak{z}_{k-1}(n, k) \\ \mathfrak{z}_k(n, k) \end{pmatrix} = \begin{pmatrix} k+1 & 1 & 1 & \dots & 1 \\ 0 & k+1 & 2 & \dots & 2 \\ \vdots & & \ddots & & \vdots \\ 0 & \dots & 0 & k+1 & k \\ 0 & \dots & 0 & 0 & k+1 \end{pmatrix}^{n-1} \begin{pmatrix} 0 \\ 0 \\ \vdots \\ 0 \\ 1 \end{pmatrix}. \quad (3.3.5)$$

Thus, for any $n \geq 2$ and $k \geq 1$, the number of k -chains in the poset $\text{Tr}_\mu(n)$ is given by the sum of the last column of M^{n-1} , where M is the upper triangular matrix. One can conclude that Proposition 3.2.3 holds for the mini-Hochschild poset.

For instance, one deduce from (3.2.18) that the number of μ -triwords of size n is

$$2^{n-1} + (n-1)2^{n-2} = 2^{n-2}(n+1), \quad (3.3.6)$$

as shown through generating series (3.3.3).

In the same way, from (3.2.20) one deduce that the number of intervals of $\text{Tr}_\mu(n)$ is

$$3^{n-3}(n^2 + 6n + 2), \quad (3.3.7)$$

the number of 3-chains is

$$4^{n-4}(n^3 + 16n^2 + 41n + 6), \quad (3.3.8)$$

the number of 4-chains is

$$5^{n-5} \left(n^4 + \frac{95}{3}n^3 + \frac{445}{2}n^2 + \frac{2075}{2}n + 24 \right), \quad (3.3.9)$$

and the number of 5-chains is

$$6^{n-6} \left(n^5 + \frac{107}{2}n^4 + 750n^3 + \frac{6505}{2}n^2 + 3599n + 120 \right). \quad (3.3.10)$$

Similarly to the remark on the sequence of constant terms (3.2.25), it seems that the sequence of constant terms of these polynomials

$$1, 2, 6, 24, 120, \dots \quad (3.3.11)$$

is the sequence of factorial numbers.

Several other properties verified by the Hochschild poset seem to hold for the mini-Hochschild poset. It may be interesting to proceed to a complete study of this subposet as well.

Fuss-Catalan posets and algebras

The theory of combinatorial Hopf algebras takes a prominent place in algebraic combinatorics. The Malvenuto-Reutenauer algebra FQSym [MR95, DHT02] is a central object in this theory. This structure is defined on the linear span of all permutations and the product of two permutations has the notable property to form an interval of the right weak order. Moreover, FQSym admits a lot of substructures, like the Loday-Ronco algebra of binary trees PBT [LR98, HNT05] and the algebra of noncommutative symmetric functions Sym [GKL⁺95]. Each of these structures brings out in a beautiful and somewhat unexpected way the combinatorics of some partial orders, respectively the Tamari order [Tam62] and the Boolean lattice, playing the same role as the one played by the right weak order for FQSym . To be slightly more precise, all these algebraic structures have, as common point, a product \cdot which expresses, on their so-called fundamental bases $\{F_x\}_x$, as

$$F_x \cdot F_y = \sum_{x/y \preceq z \preceq x \setminus y} F_z, \quad (0.0.1)$$

where \preceq is a partial order on basis elements, and $/$ and \setminus are some binary operations on basis elements (in most cases, some sorts of concatenation operations).

The point of departure of this work consists in considering a different partial order relation on permutations and ask to what extent analogues of FQSym and a similar hierarchy of algebras arise in this context. We consider here first a very natural order on permutations: the componentwise ordering \preceq on Lehmer codes of permutations [Leh60] seen in Section 1.3.6 of Chapter 1. A study of these posets $\text{Cl}_1(n)$ appears in [Den13]. Each poset $\text{Cl}_1(n)$ is an order extension of the right weak order of order n . To give a concrete point of comparison, the Hasse diagrams of the right weak order of order 3 and of $\text{Cl}_1(3)$ are respectively

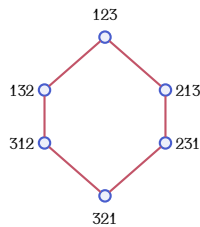

(0.0.2)

and

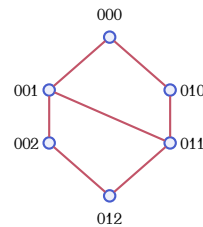

(0.0.3)

As we can observe, the right weak order relation of permutations of size 3 is included into the order relation of $\text{Cl}_1(3)$.

In this work, we consider a more general version of Lehmer codes, called δ -cliffs, leading to distributive lattices Cl_δ . Here δ is a parameter which is a map $\mathbb{N} \setminus \{0\} \rightarrow \mathbb{N}$,

called range map, assigning to each position of the words a maximal allowed value. The linear spans \mathbf{Cl}_δ of these sets are endowed with a very natural product related to the intervals of \mathbf{Cl}_δ . Some properties of this product are implied by the general shape of δ . For instance, when δ is so-called valley-free, \mathbf{Cl}_δ is an associative algebra, and when δ is weakly increasing, \mathbf{Cl}_δ is free as a unital associative algebra. The particular algebra \mathbf{Cl}_1 is in fact isomorphic to FQSym , so that for any range map δ , \mathbf{Cl}_δ is a generalization of this latter. For instance, when δ is the map \mathbf{m} satisfying $\mathbf{m}(i) = m(i - 1)$ with $m \in \mathbb{N}$, then all \mathbf{Cl}_m are free associative algebras whose bases are indexed by increasing trees wherein all nodes have $m + 1$ children.

In the same way as the Tamari order can be defined by restricting the right weak order to some permutations, one builds three subposets of \mathbf{Cl}_δ by restricting \preceq to particular δ -cliffs. This leads to three families of posets: Av_δ , Hi_δ , and Ca_δ . When δ is the particular map \mathbf{m} defined above with $m \geq 0$, the underlying sets of all these posets of order $n \geq 0$ are enumerated by the n -th m -Fuss-Catalan number [DM47]

$$\text{cat}_m(n) := \frac{1}{mn + 1} \binom{mn + n}{n}. \quad (0.0.4)$$

These posets have some close interactions: when δ is an increasing map, Hi_δ is an order extension of Ca_δ , which is itself an order extension of Av_δ . Besides, Hi_1 (resp. Ca_1) is the Stanley lattice [Sta75, Knu04] (resp. the Tamari lattice), so that Hi_m (resp. Ca_m), $m \geq 0$, are new generalizations of Stanley lattices (resp. Tamari lattices —see [BPR12] for the classical one). Besides, from these posets Hi_m and Ca_m , one defines respectively two quotients \mathbf{Hi}_m and \mathbf{Ca}_m of \mathbf{Cl}_m . Notably, the algebra \mathbf{Ca}_1 is isomorphic to PBT, and the other ones \mathbf{Ca}_m , $m \geq 2$, are not free as associative algebras.

This chapter is organized as follows.

Section 1 is intended to introduce δ -cliffs and the lattices \mathbf{Cl}_δ . Even if the posets $\mathbf{Cl}_\delta(n)$ have a very simple structure, these posets contain interesting subposets $\mathcal{S}(n)$. To study these substructures, we establish a series of sufficient conditions on $\mathcal{S}(n)$ for the fact that these posets are EL-shellable [BW96, BW97], are lattices (and give algorithms to compute the meet and the join of two elements), and are constructible by interval doubling [Day79]. Moreover, under some precise conditions, each subposet $\mathcal{S}(n)$ can be seen as a geometric object in \mathbb{R}^n . We call this the geometric realization of $\mathcal{S}(n)$. We introduce here the notion of cell and expose a way to compute the volume of the geometrical object.

Next, in Section 2, we study the posets Av_δ , Hi_δ , and Ca_δ . For each of these, we provide some general properties (EL-shellability, lattice property, constructibility by interval doubling), and describe its input-wings, output-wings, and butterflies elements, that are elements having respectively a maximal number of covered elements, covering elements, or both properties at the same time. We observe a surprising phenomenon: some posets Av_δ , Hi_δ , or Ca_δ are isomorphic to their subposets restrained on input-wings, output-wings, or butterflies elements. Moreover, a notable link among other ones is that the subposet of $\text{Ca}_m(n)$ is isomorphic to the subposet of $\text{Hi}_{m-1}(n)$ restrained to its input-wings. We also study further interactions between our three families of Fuss-Catalan posets. There are

for instance bijective posets morphisms (but not poset isomorphisms) between Av_δ and Ca_δ , and between Ca_δ and Hi_δ , when δ is increasing.

Finally, Section 3 presents a study of the algebra \mathbf{Cl}_δ . We start by introducing a natural coproduct on \mathbf{Cl}_δ in order to obtain by duality a product, associative in some cases. Three alternative bases of \mathbf{Cl}_δ are introduced, including two that are multiplicative and are defined from the order on δ -cliffs. When δ is weakly increasing, \mathbf{Cl}_δ is free as an associative algebra. We end this work by constructing, given a subfamily S of \mathbf{Cl}_δ , a quotient space \mathbf{Cl}_S of \mathbf{Cl}_δ isomorphic to the linear span of S . A sufficient condition on S to have moreover a quotient algebra of \mathbf{Cl}_δ is introduced. We also describe a sufficient condition on S for the fact that the product of two basis elements of \mathbf{Cl}_S is an interval of a poset $S(n)$. These results are applied to construct and study the two quotients $\mathbf{Hi}_m := \mathbf{Cl}_{\text{Hi}_m}$ and $\mathbf{Ca}_m := \mathbf{Cl}_{\text{Ca}_m}$ of \mathbf{Cl}_m . The algebra \mathbf{Ca}_1 is isomorphic to the Loday-Ronco algebra and the other algebras \mathbf{Ca}_m , $m \geq 2$, provide generalizations of this later which are not free. On the other hand, for any $m \geq 1$, all \mathbf{Hi}_m are other associative algebras whose dimensions are also Fuss-Catalan numbers and are not free.

1. δ -cliff posets and general properties

This section is devoted to introduce the lattices of δ -cliffs and their combinatorial and order theoretic properties. Then, we will review some properties of its subsets, like EL-shellability, constructibility by interval doubling, and geometric realizations.

1.1. δ -cliffs. We introduce here δ -cliffs, their links with Lehmer codes, permutations, and particular increasing trees.

1.1.1. First definitions. A *range map* is a map $\delta : \mathbb{N} \setminus \{0\} \rightarrow \mathbb{N}$. We shall specify range maps as infinite words $\delta = \delta(1)\delta(2)\dots$. For this purpose, for any $a \in \mathbb{N}$, we shall denote by a^ω the infinite word having all its letters equal to a . We say that δ

- ★ is *rooted* if $\delta(1) = 0$,
- ★ is *weakly increasing* if for all $i \geq 1$, $\delta(i) \leq \delta(i+1)$,
- ★ is *increasing* if for all $i \geq 1$, $\delta(i) < \delta(i+1)$,
- ★ has an *ascent* if there are $1 \leq i_1 < i_2$ such that $\delta(i_1) < \delta(i_2)$,
- ★ has a *descent* if there are $1 \leq i_1 < i_2$ such that $\delta(i_1) > \delta(i_2)$,
- ★ has a *valley* if there are $1 \leq i_1 < i_2 < i_3$ such that $\delta(i_1) > \delta(i_2) < \delta(i_3)$,
- ★ is *valley-free* (or *unimodal*) if δ has no valley,
- ★ is *j-dominated* for a $j \geq 1$ if there is $k \geq 1$ such that for all $k' \geq k$, $\delta(j) \geq \delta(k')$.

For any $n \geq 0$, the *n-th dimension* of δ is the integer $\dim_n(\delta) := \#\{i \in [n] : \delta(i) \neq 0\}$.

Given a range map δ , a word u of integers of length n is a *δ -cliff* if for any $i \in [n]$, $0 \leq u_i \leq \delta(i)$. The *size* $|u|$ of a δ -cliff u is its length as a word, and the *weight* $\omega(u)$ of u is the sum of its letters. The graded set of all δ -cliffs where the degree of a δ -cliff is its size, is denoted by \mathbf{Cl}_δ . In the sequel, for any $m \geq 0$, we shall denote by \mathbf{m} the range map satisfying $\mathbf{m} := 0\ m\ (2m)\ (3m)\ \dots$. For instance,

$$\mathbf{Cl}_1(3) = \{000, 001, 002, 010, 011, 012\}, \quad (1.1.1a)$$

$$\text{Cl}_2(3) = \{000, 001, 002, 003, 004, 010, 011, 012, 013, 014, 020, 021, 022, 023, 024\}. \quad (1.1.1b)$$

In particular, the **1**-cliffs are the Lehmer codes seen in Section 1.1.6 of Chapter 1. As seen this section, there is classical correspondence between permutations and Lehmer codes, and the **1**-cliff thus associated with the permutation σ is denoted by $\text{leh}(\sigma)$.

It follows immediately from the definition of δ -cliffs that the cardinality of $\text{Cl}_\delta(n)$ satisfies

$$\#\text{Cl}_\delta(n) = \prod_{i \in [n]} (\delta(i) + 1). \quad (1.1.2)$$

The first numbers of **m**-cliffs are

$$1, 1, 1, 1, 1, 1, 1, 1, \quad m = 0, \quad (1.1.3a)$$

$$1, 1, 2, 6, 24, 120, 720, 5040, \quad m = 1, \quad (1.1.3b)$$

$$1, 1, 3, 15, 105, 945, 10395, 135135, \quad m = 2, \quad (1.1.3c)$$

$$1, 1, 4, 28, 280, 3640, 58240, 1106560, \quad m = 3, \quad (1.1.3d)$$

$$1, 1, 5, 45, 585, 9945, 208845, 5221125, \quad m = 4, \quad (1.1.3e)$$

and form, respectively from the third one, Sequences **A001147**, **A007559**, and **A007696** of [Slo].

1.1.2. *Weakly increasing range maps and increasing trees.* Given a rooted weakly increasing range map δ , let $\Delta_\delta : \mathbb{N} \setminus \{0\} \rightarrow \mathbb{N}$ be the map defined by $\Delta_\delta(i) := \delta(i + 1) - \delta(i)$. A δ -*increasing tree* is a planar rooted tree where nodes are bijectively labeled from 1 to n , any node labeled by $i \in [n]$ has arity $\Delta_\delta(i) + 1$, and every child of any node labeled by $i \in [n]$ is a leaf or is a node labeled by $j \in [n]$ such that $j > i$. The *size* of such a tree is its number of nodes. The leaves of a δ -increasing tree are implicitly numbered from 1 to its total number of leaves from left to right.

Observe that, regardless of any particular condition on δ , any δ -cliff u of size $n \geq 1$ recursively decomposes as $u = u'a$ where $a \in [0, \delta(n)]$ and u' is a δ -cliff of size $n - 1$. Relying on this observation, when δ is rooted and weakly increasing, let tree_δ be the map sending any δ -cliff u of size n to the δ -increasing tree of size n recursively defined as follows. If $n = 0$, $\text{tree}_\delta(u)$ is the leaf. Otherwise, by using the above decomposition of u , $\text{tree}_\delta(u)$ is the tree obtained by grafting on the $a + 1$ -st leaf of the tree $\text{tree}_\delta(u')$ a node of arity $\Delta_\delta(n) + 1$ labeled by n . For instance,

$$\text{tree}_2(0230228) = \begin{array}{c} \textcircled{1} \\ \swarrow \quad \searrow \\ \textcircled{4} \quad \textcircled{2} \\ \swarrow \quad \searrow \quad \swarrow \quad \searrow \\ \textcircled{5} \quad \square \quad \textcircled{7} \quad \textcircled{3} \\ \swarrow \quad \searrow \quad \swarrow \quad \searrow \\ \textcircled{6} \quad \square \quad \square \quad \square \quad \square \quad \square \quad \square \quad \square \end{array} \quad (1.1.4)$$

and for $\delta := 0233579^\omega$, one has $\Delta_\delta = 2102220^\omega$, and

$$\text{tree}_\delta(021042) = \begin{array}{c} \textcircled{1} \\ \swarrow \quad \searrow \\ \textcircled{4} \quad \textcircled{3} \quad \textcircled{2} \\ \swarrow \quad \searrow \quad \swarrow \quad \searrow \\ \square \quad \square \quad \textcircled{5} \quad \square \end{array} \quad (1.1.5)$$

PROPOSITION 1.1.1. *For any rooted weakly increasing range map δ , tree_δ is a one-to-one correspondence from the set of all δ -cliffs of size $n \geq 0$ and the set of all δ -increasing trees of size n .*

PROOF. Let us first prove that tree_δ is a well-defined map. This can be done by induction on n and arises from the fact that, for any $u \in \text{Cl}_\delta(n)$, the total number of leaves of $\text{tree}(u)$ is

$$\begin{aligned} 1 - n + \left(\sum_{i \in [n]} \Delta_\delta(i) + 1 \right) &= 1 + \left(\sum_{i \in [n]} \delta(i+1) - \delta(i) \right) \\ &= 1 + \delta(2) - \delta(1) + \delta(3) - \delta(2) + \cdots + \delta(n+1) - \delta(n) \\ &= 1 + \delta(n+1). \end{aligned} \tag{1.1.6}$$

Therefore, there is in $\text{tree}(u)$ a leaf of index $a+1$ for any value $a \in [0, \delta(n+1)]$. Therefore, $\text{tree}(ua)$ is well-defined.

Now, let ϕ be the map from the set of all δ -increasing trees of size n to $\text{Cl}_\delta(n)$ defined recursively as follows. If t is the leaf, set $\phi(t) := \epsilon$. Otherwise, consider the node with the maximal label in t . Since t is increasing, this node has no children. Set t' as the δ -increasing tree obtained by replacing this node by a leaf in t , and set a as the index of the leaf of t' on which this maximal node of t is attached (this index is 1 if t' is the leaf). Then, set $\phi(t) := \phi(t')(a-1)$. The statement of the proposition follows by showing by induction on n that ϕ is the inverse of the map tree_δ . \square

In [CP19], s -decreasing trees are considered, where s is a sequence of length $n \geq 0$ of nonnegative integers. These trees are labeled decreasingly and any node labeled by $i \in [n]$ has arity s_i . As a consequence of Proposition 1.1.1, any s -decreasing tree can be encoded by a δ -increasing tree where δ is a rooted weakly increasing range map satisfying $\delta(i) = \sum_{1 \leq j \leq i-1} s_{n-j+1}$ for all $i \in [n+1]$. The correspondence between such s -decreasing trees and δ -increasing trees consists in relabeling by $n+1-i$ each node labeled by $i \in [n]$. A consequence of all this is that δ -cliffs can be seen as generalizations of s -decreasing trees by relaxing the considered conditions on δ .

1.2. δ -cliff posets. We endow now the set of all δ -cliffs of a given size with an order relation and give some of the properties of the obtained posets.

1.2.1. First definitions. For any $n \geq 0$, let δ be a range map and \preceq be the partial order relation on $\text{Cl}_\delta(n)$ defined by $u \preceq v$ for any $u, v \in \text{Cl}_\delta(n)$ such that $u_i \leq v_i$ for all $i \in [n]$. The poset $(\text{Cl}_\delta(n), \preceq)$ is the δ -cliff poset of order n . Figure 1.1 shows the Hasse diagrams of some δ -cliff posets.

Let us introduce some notation about δ -cliffs. For any $u \in \text{Cl}_\delta(n)$ and $i \in [n]$, let $\downarrow_i(u)$ (resp. $\uparrow_i(u)$) be the word on \mathbb{Z} of length n obtained by decrementing (resp. incrementing) by 1 the i -th letter of u . Let also, for any $u, v \in \text{Cl}_\delta(n)$,

$$D(u, v) := \{i \in [n] : u_i \neq v_i\} \tag{1.2.1}$$

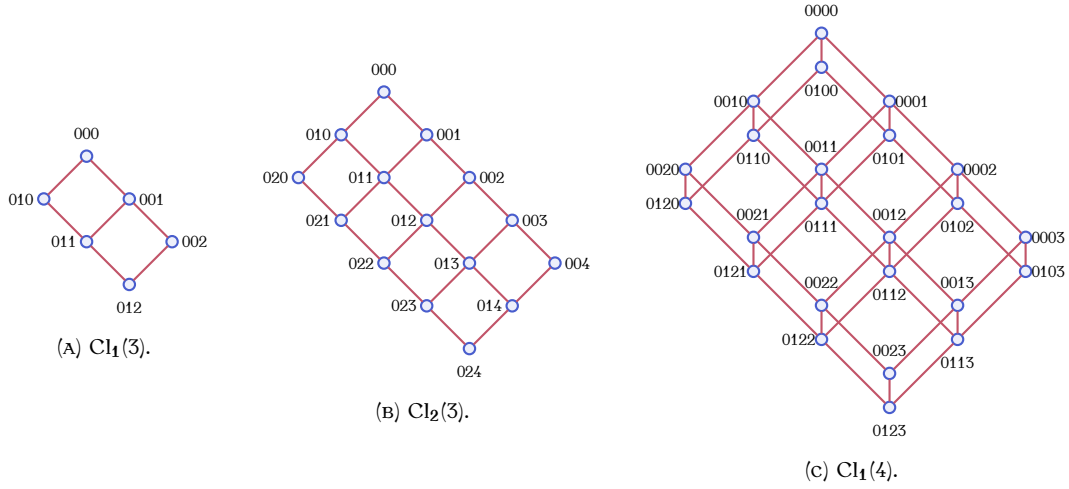
FIGURE 4.1. Hasse diagrams of some δ -cliff posets.

be the set of all indices of different letters between u and v . Let us denote respectively by $\bar{0}_\delta(n)$ and by $\bar{1}_\delta(n)$ the δ -cliffs 0^n and $\delta(1)\dots\delta(n)$. For any $u, v \in Cl_\delta(n)$, let $u \wedge v$ be the δ -cliff of size n defined for any $i \in [n]$ by

$$(u \wedge v)_i := \min\{u_i, v_i\}. \quad (1.2.2)$$

We also define $u \vee v$ similarly by replacing the min operation by max in (1.2.2). For any $u, v \in Cl_\delta(n)$, the *difference* between v and u is the word $v - u$ on \mathbb{Z} of length n defined for any $i \in [n]$ by

$$(v - u)_i := v_i - u_i. \quad (1.2.3)$$

Observe that when $u \preceq v$, $v - u$ is a δ -cliff. The *δ -complementary* $c_\delta(u)$ of $u \in Cl_\delta(n)$ is the δ -cliff $\bar{1}_\delta(n) - u$. For instance, by setting $u := 0010$, if u is seen as a **1**-cliff, $c_\delta(u) = 0113$, and if u is seen as a **2**-cliff, $c_\delta(u) = 0236$. This map c_δ is an involution.

1.2.2. First properties. A study of the **1**-cliff posets appears in [Den13]. Our definition stated here depending on δ is therefore a generalization of these posets. The structure of the δ -cliff posets is very simple since each of these posets of order n is isomorphic to the Cartesian product $[0, \delta(1)] \times \dots \times [0, \delta(n)]$, where $[k]$ is the total order on k elements. It follows from this observation that each δ -cliff poset is a lattice admitting respectively \wedge and \vee as meet and join operations. The lattice $Cl_\delta(n)$ can be seen as a sublattice of the Cartesian product \mathbb{N}^n of copies of total orders \mathbb{N} , which is a distributive lattice. Since all sublattices of distributive lattices are distributive [Bir79], $Cl_\delta(n)$ is distributive.

It follows immediately from the definition of \preceq that the covering relation \prec of $Cl_\delta(n)$ satisfies $u \prec v$ if and only if there is an index $i \in [n]$ such that $v = \uparrow_i(u)$. Moreover, these posets $Cl_\delta(n)$ are graded, and the rank of a δ -cliff u is $\omega(u)$. The least element of the poset is $\bar{0}_\delta(n)$ while the greatest element $\bar{1}_\delta(n)$.

1.2.3. *Links with the right weak order.* We refer to Section 1.1.6, and to Section 1.3.5 of Chapter 1 for this part.

When δ is a rooted weakly increasing range map, let us consider the binary relation \prec' on $\text{Cl}_\delta(n)$ wherein $u \prec' v$ if there is an index $i \in [n]$ such that $v = \uparrow_i(u)$ and, by setting $t := \text{tree}_\delta(u)$, all the children of the node labeled by i of t are leaves, except possibly the first of its brotherhood. For instance, for $\delta := 0233579^\omega$ and the δ -cliff $u := 021042$, since

$$\text{tree}_\delta(u) = \begin{array}{c} \textcircled{1} \\ \swarrow \quad \searrow \\ \textcircled{4} \quad \textcircled{3} \quad \textcircled{2} \\ \swarrow \quad \searrow \quad \swarrow \quad \searrow \\ \square \quad \textcircled{6} \quad \square \quad \textcircled{5} \quad \square \\ \swarrow \quad \searrow \quad \swarrow \quad \searrow \\ \square \quad \square \quad \square \quad \square \end{array}, \tag{1.2.4}$$

we observe that all the children of the nodes labeled by 2, 3, and 6 are leaves, except possibly the first ones. For this reason, u is covered by $\uparrow_3(u) = 022042$ and by $\uparrow_6(u) = 021043$, but not by $\uparrow_2(u) = 031042$ since this word is not a δ -cliff.

The reflexive and transitive closure \preceq' of this relation is an order relation. By Proposition 1.1.1, this endows the set of all δ -increasing trees with a poset structure. It follows immediately from the description of the covering relation \prec of $\text{Cl}_\delta(n)$ provided in Section 1.2.2 that \prec' is a refinement of \prec . For this reason $(\text{Cl}_\delta(n), \preceq')$ is an order extension of $(\text{Cl}_\delta(n), \prec)$. Figure 1.2 shows an example of a Hasse diagram of such a poset.

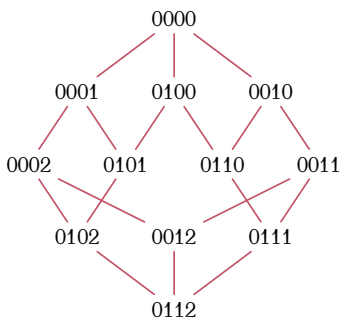

FIGURE 1.2. The Hasse diagram of the poset $(\text{Cl}_{0112^\omega}(4), \preceq')$.

PROPOSITION 1.2.1. *For any $n \geq 0$, the poset $(\text{Cl}_1(n), \preceq')$ is isomorphic to the right weak order on permutations of size n .*

PROOF. Let ϕ be the map from the set of all words u of size n of integers without repeated letters to the set of increasing binary trees of size n where nodes are bijectively labeled by the letters of u , defined recursively as follows. If σ is the empty word, then $\phi(\sigma)$ is the leaf. Otherwise, σ decomposes as $\sigma = waw'$ where a is the least letter of σ , and w and w' are words of integers. In this case, $\phi(\sigma)$ is the binary tree consisting in a root labeled by a and having as left subtree $\phi(w')$ and as right subtree $\phi(w)$ —observe the reversal of the order between w and w' . Now, by induction on n , one can prove that for any permutation σ of size n , the binary trees $\phi(\sigma)$ and $\text{tree}_1(\text{leh}(\sigma))$ are the same.

Assume that σ and ν are two permutations such that $\sigma \prec_{\text{we}} \nu$. Thus, by definition of \prec_{we} , σ decomposes as $\sigma = wabw'$ and ν as $\nu = wba'w'$ where a and b are letters such that $a < b$, and w and w' are words of integers. By definition of ϕ , since a and b are adjacent in σ , the right subtree of the node labeled by b of $\phi(\sigma)$ is empty. Therefore, due to the property stated in the first part of the proof, and by definition of the map tree_1 and of the covering relation \prec' , one has $\text{leh}(\sigma) \prec' \text{leh}(\nu)$. Conversely, assume that u and ν are two $\mathbf{1}$ -cliffs such that $u \prec' \nu$. Thus, by definition of \prec' , ν is obtained by changing a letter u_i , $i \geq 2$, in u by $u_i + 1$, and in $\text{tree}_1(u)$, the right subtree of the node labeled by i is empty. Let $\sigma := \text{leh}^{-1}(u)$ and $\nu := \text{leh}^{-1}(\nu)$. Since $\phi(\sigma)$ and $\text{tree}_1(u)$ are the same increasing binary trees, we have, from the definition of the map ϕ , that $u_{i-1} < u_i$. Finally, by definition of \prec_{we} , one obtains $\sigma \prec_{\text{we}} \nu$.

We have shown that the bijection leh between $\mathfrak{S}(n)$ and $\text{Cl}_1(n)$ is such that, for any $\sigma, \nu \in \mathfrak{S}(n)$, $\sigma \prec_{\text{we}} \nu$ if and only if $\text{leh}(\sigma) \prec' \text{leh}(\nu)$. For this reason, leh is a poset isomorphism. \square

Therefore, Proposition 1.2.1 says in particular that the $\mathbf{1}$ -cliff poset is an extension of the right weak order, as mentioned in Section 1.4 of Chapter 1. Besides, for all rooted weakly increasing range maps δ , one can see $(\text{Cl}_\delta(n), \prec')$ as generalizations of the right weak order. After some computer experiments, we conjecture that for any rooted weakly increasing range map δ and any $n \geq 0$, $(\text{Cl}_\delta(n), \prec')$ is a lattice.

1.3. Subposets of δ -cliff posets. Despite their simplicity, the δ -cliff posets contain subposets having a lot of combinatorial and algebraic properties. If \mathcal{S} is a graded subset of Cl_δ , each $\mathcal{S}(n)$, $n \geq 0$, is a subposet of $\text{Cl}_\delta(n)$ for the order relation \preceq . We denote by $\prec_{\mathcal{S}}$ the covering relation of each $\mathcal{S}(n)$, $n \geq 0$.

We say that \mathcal{S} is

- * *spread* if for any $n \geq 0$, $\bar{0}_\delta(n) \in \mathcal{S}$ and $\bar{1}_\delta(n) \in \mathcal{S}$,
- * *straight* if for any $u, v \in \mathcal{S}$ such that $u \prec_{\mathcal{S}} v$, $\#D(u, v) = 1$,
- * *coated* if for any $n \geq 0$, any $u, v \in \mathcal{S}(n)$ such that $u \preceq v$, and any $i \in [n - 1]$, $u_1 \dots u_i v_{i+1} \dots v_n \in \mathcal{S}$,
- * *closed by prefix* if for any $u \in \mathcal{S}$, all prefixes of u belong to \mathcal{S} ,
- * *minimally extendable* if $\epsilon \in \mathcal{S}$ and for any $u \in \mathcal{S}$, $u\epsilon \in \mathcal{S}$,
- * *maximally extendable* if $\epsilon \in \mathcal{S}$ and for any $u \in \mathcal{S}$, $u\delta(|u| + 1) \in \mathcal{S}$.

Observe that when \mathcal{S} is spread, each poset $\mathcal{S}(n)$, $n \geq 0$, is *bounded*, that is it admits a least and a greatest element. Observe also that if \mathcal{S} is both minimally and maximally extendable, then \mathcal{S} is spread.

LEMMA 1.3.1. *Let δ be a range map and \mathcal{S} be a coated graded subset of Cl_δ . Then, \mathcal{S} is straight.*

PROOF. Let $n \geq 0$ and $u, v \in \mathcal{S}(n)$ such that $u \preceq v$ and $\#D(u, v) \geq 2$. Set $j := \max D(u, v)$ and $w := u_1 \dots u_{j-1} v_j v_{j+1} \dots v_n$. Since \mathcal{S} is coated, w belongs to \mathcal{S} , and moreover, since j is maximal, $w := u_1 \dots u_{j-1} v_j u_{j+1} \dots u_n$. Therefore, $\#D(u, w) = 1$. This

proves that there exists a $w' \in S(n)$ such that $u \prec_S w' \preceq w$ and $\#D(u, w') = 1$. Thus, S is straight. \square

Let us defined more generally the three following graded sets seen in Section 2.1.2 of Chapter 2. In the case where S is straight, we define the graded set of

- ★ *input-wings* as the set $\mathcal{F}(S)$ containing any $u \in S$ which covers exactly $\dim_{|u|}(\delta)$ elements,
- ★ *output-wings* as the set $\mathcal{O}(S)$ containing any $u \in S$ which is covered by exactly $\dim_{|u|}(\delta)$ elements,
- ★ *butterflies* as the set $\mathcal{B}(S)$ being the intersection $\mathcal{F}(S) \cap \mathcal{O}(S)$.

By definition, the number of input-wings (resp. output-wings) of size $n \geq 0$ is the coefficient of the leading monomial of the degree polynomial $d_{S(n)}(x, 1)$ (resp. $d_{S(n)}(1, y)$). Observe also that if there is an $i \geq 1$ such that $\delta(i) = 1$, there are no butterfly in $S(n)$ for all $n \geq i$.

We present now general results about subposets $S(n)$, $n \geq 0$, of δ -cliff posets.

1.3.1. *EL-shellability.* For this part, we refer to Section 2.3 of Chapter 1.

For the sequel, we set Λ as the poset \mathbb{Z}^2 wherein elements are ordered lexicographically. For any straight graded subset S of Cl_δ , let us introduce the map $\lambda_S : \prec_S \rightarrow \mathbb{Z}^2$ defined for any $(u, v) \in \prec_S$ by

$$\lambda_S(u, v) := (-i, u_i) \quad (1.3.1)$$

where i is the unique index $i \in [|u|]$ such that $D(u, v) = \{i\}$. Observe that the fact that S is straight ensures that λ_S is well-defined.

THEOREM 1.3.2. *Let δ be a range map and S be a coated graded subset of Cl_δ . For any $n \geq 0$, the map λ_S is an EL-labeling of $S(n)$. Moreover, there is at most one λ_S -weakly decreasing chain between any pair of elements of $S(n)$.*

PROOF. By Lemma 1.3.1, the fact that S is coated implies that S is also straight. Let $u, v \in S(n)$ such that $u \preceq v$. Since S is straight, the image by λ_S of any saturated chain from u to v is well-defined.

Now, let

$$\left(u = w^{(0)}, w^{(1)}, \dots, w^{(k-1)}, w^{(k)} = v \right) \quad (1.3.2)$$

be the sequence of elements of $S(n)$ defined in the following way. For any $i \in [0, k-1]$, the word $w^{(i+1)}$ is obtained from $w^{(i)}$ by increasing by the minimal possible value $a \geq 1$ the letter $w_j^{(i)}$ such that j is the greatest index satisfying $w_j^{(i)} < v_j$. By construction, for any $i \in [0, k-1]$, each $w^{(i+1)}$ writes as $w^{(i+1)} = u_1 \dots u_{j-1} (u_j + a) v_{j+1} \dots v_n$, where a is some positive integer. There is at least one value a such that $w^{(i)}$ belongs to $S(n)$ since by hypothesis, S is coated. For this reason, (1.3.2) is a well-defined saturated chain in $S(n)$. This saturated chain is also λ_S -increasing by construction. Moreover, since S is straight, if one consider another saturated chain from u to v , this chain passes through a word obtained by incrementing a letter which has not a greatest index, and one has to choose later in the chain the letter of the smallest index to increment it. For this reason, this saturated chain would not be λ_S -increasing.

Assume now that there is a λ_S -weakly decreasing saturated chain

$$\left(u = w^{(0)}, w^{(1)}, \dots, w^{(k-1)}, w^{(k)} = v \right) \quad (1.3.3)$$

between u and v . By definition of λ_S and of the poset Λ , for any $i \in [0, k-1]$, the word $w^{(i+1)}$ is obtained from $w^{(i)}$ by increasing by the minimal possible value the letter $w_j^{(i)}$ such that j is the smallest index satisfying $w_j^{(i)} < v_j$. If it exists, this saturated chain is by construction the unique λ_S -weakly decreasing saturated chain from u to v . \square

1.3.2. Meet and join operations, sublattices, and lattices. Here we give some sufficient conditions on S for the fact that each $S(n)$, $n \geq 0$, is a lattice.

PROPOSITION 1.3.3. *Let δ be a range map and S be a spread graded subset of Cl_δ . We have the following properties:*

- (i) *if for any $n \geq 0$ and any $u, v \in S(n)$, $u \wedge v \in S$, then $S(n)$ is a lattice and is a meet semi-sublattice of $\text{Cl}_\delta(n)$,*
- (ii) *if for any $n \geq 0$ and any $u, v \in S(n)$, $u \vee v \in S$, then $S(n)$ is a lattice and is a join semi-sublattice of $\text{Cl}_\delta(n)$,*
- (iii) *if for any $n \geq 0$, $S(n)$ is a sublattice of $\text{Cl}_\delta(n)$, then $S(n)$ is distributive and graded.*

PROOF. Let $u, v \in S(n)$. When $u \wedge v \in S$, $u \wedge v$ is the greatest lower bound of u and v in $\text{Cl}_\delta(n)$ and also in $S(n)$. For this reason, $S(n)$ is a meet semi-sublattice of $\text{Cl}_\delta(n)$. Moreover, since $S(n)$ is finite and admits $\hat{1}_\delta(n)$ as greatest element, by [Sta11], u and v have a least upper bound $u \vee' v$ in $S(n)$ for a certain join operation \vee' . Whence (i) and also (ii) by symmetry. Point (iii) is a consequence of the fact that any sublattice of a distributive lattice is distributive, and the fact that any distributive lattice is graded [Sta11]. \square

Let S be a minimally extendable graded subset of Cl_δ . For any $n \geq 0$, the *S -decrementation map* is the map

$$\Downarrow_S : \text{Cl}_\delta(n) \rightarrow S(n) \quad (1.3.4)$$

defined recursively by $\Downarrow_S(\epsilon) := \epsilon$ and, for any $ua \in \text{Cl}_\delta(n)$ where $u \in \text{Cl}_\delta$ and $a \in \mathbb{N}$, by

$$\Downarrow_S(ua) := \Downarrow_S(u) b \quad (1.3.5)$$

where

$$b := \max\{b \leq a : \Downarrow_S(u) b \in S\}. \quad (1.3.6)$$

Observe that the fact that S is minimally extendable ensures that \Downarrow_S is a well-defined map. Let also, for any $n \geq 0$ and $u, v \in S(n)$,

$$u \wedge_S v := \Downarrow_S(u \wedge v). \quad (1.3.7)$$

When S is maximally extendable, we denote by \Uparrow_S the *S -incrementation map* defined in the same way as the S -decrementation map with the difference that in (1.3.6), the operation \max is replaced by the operation \min and the relation \leq is replaced by the relation \geq . Here, the fact that S is maximally extendable ensure that \Uparrow_S is well-defined. We also define the operation \vee_S in the same way as \wedge_S with the difference that in (1.3.7), the map \Downarrow_S is replaced by \Uparrow_S and the operation \wedge is replaced by the operation \vee .

THEOREM 1.3.4. *Let δ be a range map and S be a closed by prefix and minimally (resp. maximally) extendable graded subset of Cl_δ . The operation \wedge_S (resp. \vee_S) is, for any $n \geq 0$, the meet (resp. join) operation of the poset $S(n)$.*

PROOF. Let us show the property of the statement of the theorem in the case where S is minimally extendable. The other case is symmetric. We proceed by induction on $n \geq 0$. When $n = 0$, the property is trivially satisfied. Let $n \geq 1$ and $u, v \in S(n)$. Since S is closed by prefix, one has $u = u'a$ and $v = v'b$ with $u', v' \in S(n-1)$ and $a, b \in \mathbb{N}$. Since S is minimally extendable,

$$\begin{aligned} u \wedge_S v &= u'a \wedge_S v'b \\ &= \Downarrow_S(u'a \wedge v'b) \\ &= \Downarrow_S((u' \wedge v') \min\{a, b\}) \\ &= \Downarrow_S(u' \wedge v') c \end{aligned} \tag{1.3.8}$$

where $c := \max\{c \leq \min\{a, b\} : \Downarrow_S(u' \wedge v') c \in S\}$. Now, by induction hypothesis, we obtain

$$\Downarrow_S(u' \wedge v') c = (u' \wedge_S v') c \tag{1.3.9}$$

where \wedge_S is the meet operation of the poset $S(n-1)$. First, we deduce from the above computation that for any $i \in [n]$, the i -th letter of $u \wedge_S v$ is nongreater than $\min\{u_i, v_i\}$, and that $u \wedge_S v$ belongs to $S(n)$. Therefore, $u \wedge_S v$ is a lower bound of $\{u, v\}$. Second, by induction hypothesis, $w' := u' \wedge_S v'$ is the greatest lower bound of $\{u', v'\}$. By construction, since c is the greatest letter such that $c \leq a$, $c \leq b$, and $w'c \in S$ holds, any other lower bound of $\{u, v\}$ is smaller than $w'c$. This prove that $w'c$ is the greatest lower bound of $\{u, v\}$ and implies the statement of the theorem. \square

Together with Proposition 1.3.3, Theorem 1.3.4 provides the following sufficient conditions on the graded subset S of Cl_δ for the fact that for all $n \geq 0$, the posets $S(n)$ are lattices:

- (i) S is spread and each $S(n)$, $n \geq 0$, is a meet semi-sublattice of $\text{Cl}_\delta(n)$,
- (ii) S is spread and each $S(n)$, $n \geq 0$, is a join semi-sublattice of $\text{Cl}_\delta(n)$,
- (iii) S is minimally and maximally extendable, and closed by prefix.

1.3.3. Constructibility by interval doubling. For this section, we can refer to Section 2.4 of Chapter 1.

The aim of this section is to introduce a sufficient condition on a graded subset S of Cl_δ for the fact that each $S(n)$, $n \geq 0$, is constructible by interval doubling. We shall moreover describe explicitly the sequence of interval doubling operations involved in the construction of $S(n)$ from the trivial lattice.

Let \mathcal{P} be a nonempty subposet of $\text{Cl}_\delta(n)$ for a given fixed size $n \geq 1$. Let us denote by $m(\mathcal{P})$ the letter $\max\{u_n : u \in \mathcal{P}\}$. For any $a, b \in [0, \delta(n)]$, let $\mathcal{P}_a := \{u \in \mathcal{P} : u_n = a\}$ and $\mathcal{P}_{a,b} := \{ub : ua \in \mathcal{P}_a\}$. Observe that \mathcal{P}_a is a subposet of \mathcal{P} while $\mathcal{P}_{a,b}$ may contain δ -cliffs that do not belong to \mathcal{P} . The *derivation* of \mathcal{P} is the set

$$\mathcal{D}(\mathcal{P}) := \mathcal{P}_0 \cup \mathcal{P}_1 \cup \dots \cup \mathcal{P}_{m(\mathcal{P})-1} \cup \mathcal{P}_{m(\mathcal{P}), m(\mathcal{P})-1}. \tag{1.3.10}$$

In other words, $\mathcal{D}(\mathcal{P})$ is the set of all the cliffs obtained from \mathcal{P} by decrementing their last letters if they are equal to $m(\mathcal{P})$ or by keeping them as they are otherwise. Observe that $\mathcal{D}(\mathcal{P})$ is not necessarily a subposet of \mathcal{P} . Nevertheless, $\mathcal{D}(\mathcal{P})$ is still a subposet of $\text{Cl}_\delta(n)$. Observe also that $m(\mathcal{D}(\mathcal{P})) \leq m(\mathcal{P}) - 1$. For instance, by considering the subposet

$$\mathcal{P} := \{0000, 0111, 0002, 0112, 0103, 0104, 0004\} \quad (1.3.11)$$

of $\text{Cl}_2(4)$, we have

$$\mathcal{P}_{2, m(\mathcal{P})} = \{0004, 0114\} \quad (1.3.12)$$

and

$$\mathcal{D}(\mathcal{P}) = \{0000, 0111, 0002, 0112, 0103, 0003\}. \quad (1.3.13)$$

The subposet \mathcal{P} is *nested* if it is nonempty and

(N1) for any $a \in [0, m(\mathcal{P})]$, the δ -cliff $0^{n-1}a$ belongs to \mathcal{P} ,

(N2) for any $a \in [0, m(\mathcal{P})]$, $\mathcal{P}_{a, m(\mathcal{P})}$ is both a subset and an interval of \mathcal{P} .

This definition still holds when $m(\mathcal{P}) = 0$. Observe that any δ -cliff $0^{n-1}a$, $a \geq 1$, of \mathcal{P} covers exactly the single element $0^{n-1}(a-1)$ of \mathcal{P} . This element exists by (N1). Therefore, when \mathcal{P} is a lattice, these δ -cliffs are join-irreducible.

LEMMA 1.3.5. *Let δ be a range map and \mathcal{P} be a nonempty subposet of $\text{Cl}_\delta(n)$ for an $n \geq 1$. If \mathcal{P} is nested, then for any $a \in [0, m(\mathcal{P})]$, \mathcal{P}_a is an interval of \mathcal{P} .*

PROOF. First, by (N1), \mathcal{P}_a admits $0^{n-1}a$ as unique least element. It remains to prove that \mathcal{P}_a has at most one greatest element. By contradiction, assume that there are in \mathcal{P}_a two different greatest elements ua and va , where $u, v \in \text{Cl}_\delta(n-1)$. Then, by setting $b := m(\mathcal{P})$, in $\mathcal{P}_{a,b}$ the δ -cliffs ub and vb are still incomparable. Since these two elements are also greatest elements of $\mathcal{P}_{a,b}$, this implies that $\mathcal{P}_{a,b}$ is not an interval in \mathcal{P} . This contradicts (N2). \square

LEMMA 1.3.6. *Let δ be a range map and \mathcal{P} be a nonempty subposet of $\text{Cl}_\delta(n)$ for an $n \geq 1$. If $m(\mathcal{P}) \geq 1$ and \mathcal{P} is nested, then $\mathcal{D}(\mathcal{P})_{m(\mathcal{D}(\mathcal{P}))} = \mathcal{P}_{m(\mathcal{P}), m(\mathcal{P})-1}$.*

PROOF. Let $b := m(\mathcal{P})$, $\mathcal{P}' := \mathcal{D}(\mathcal{P})$, and $b' := m(\mathcal{P}')$. First, since \mathcal{P} satisfies (N1), $b' = b - 1$. Moreover, directly from the definition of the derivation operation \mathcal{D} , we have $\mathcal{P}'_{b'} = \mathcal{P}_{b,b'} \cup \mathcal{P}_{b'}$. By (N2), $\mathcal{P}_{b',b}$ is a subset of \mathcal{P}_b , so that $\mathcal{P}_{b'}$ is a subset of $\mathcal{P}_{b,b'}$. Therefore, $\mathcal{P}'_{b'} = \mathcal{P}_{b,b'}$. \square

LEMMA 1.3.7. *Let δ be a range map and \mathcal{P} be a nonempty subposet of $\text{Cl}_\delta(n)$ for an $n \geq 1$. If $m(\mathcal{P}) \geq 1$ and \mathcal{P} is nested, then $\mathcal{D}(\mathcal{P})$ is nested.*

PROOF. Let $b := m(\mathcal{P})$, $\mathcal{P}' := \mathcal{D}(\mathcal{P})$, and $b' := m(\mathcal{P}')$. First, since \mathcal{P} satisfies (N1), $b' = b - 1$. Moreover, in particular, for any $a \in [0, b']$, $0^{n-1}a \in \mathcal{P}$. Hence, $0^{n-1}a \in \mathcal{P}'$, so that \mathcal{P}' satisfies (N1). Let $a \in [0, b' - 1]$. By (N2), $\mathcal{P}_{a,b}$ is an interval of \mathcal{P}_b . Due to the fact $a \leq b' - 1$, one has $\mathcal{P}_a = \mathcal{P}'_a$, so that $\mathcal{P}'_{a,b}$ is an interval of \mathcal{P}_b . This is equivalent to the fact that $\mathcal{P}'_{a,b'}$ is an interval of $\mathcal{P}_{b,b'}$. By Lemma 1.3.6, the relation $\mathcal{P}'_{b'} = \mathcal{P}_{b,b'}$ holds and leads to the fact that $\mathcal{P}'_{a,b'}$ is an interval of $\mathcal{P}'_{b'}$. Therefore, \mathcal{P}' satisfies (N2). \square

LEMMA 1.3.8. *Let δ be a range map and \mathcal{P} be a nonempty subset of $\text{Cl}_\delta(n)$ for an $n \geq 1$. If $m(\mathcal{P}) \geq 1$ and \mathcal{P} is nested, then \mathcal{P} is isomorphic as a poset to $\mathcal{D}(\mathcal{P})[I]$ where I is the interval $\mathcal{P}_{m(\mathcal{P})-1}$ of $\mathcal{D}(\mathcal{P})$.*

PROOF. Let $b := m(\mathcal{P})$, $\mathcal{P}' := \mathcal{D}(\mathcal{P})$, and $b' := m(\mathcal{P}')$. By (N1), $b' = b - 1$. Let us first prove that $I = \mathcal{P}_{b'}$ is an interval of \mathcal{P}' . Let $u, v \in \mathcal{P}_{b'}$ such that $u \preceq v$. Assume that there exists $w \in \mathcal{P}'_{b'}$ such that $u \preceq w \preceq v$. Let us denote by u' (resp. v' , w') the prefix of size $n - 1$ of u (resp. v , w). By (N2), $u'b$ and $v'b$ belong to \mathcal{P}_b . Moreover, by Lemma 1.3.6, since $\mathcal{P}'_{b'} = \mathcal{P}_{b,b'}$, $w \in \mathcal{P}_{b,b'}$. Therefore, $w'b$ belongs to \mathcal{P}_b . Again by (N2), this leads to the fact that $w \in \mathcal{P}_{b'}$. This shows that the set $\mathcal{P}_{b'}$ is closed by interval in $\mathcal{P}'_{b'}$. Since finally, by Lemma 1.3.5, $\mathcal{P}_{b'}$ is an interval of \mathcal{P} , $\mathcal{P}_{b'}$ has a unique least and a unique greatest element. This implies that $\mathcal{P}_{b'}$ is an interval of \mathcal{P}' .

Since I is an interval of \mathcal{P}' , we can now consider the poset $\mathcal{P}'[I]$. By definition of the interval doubling operation, $\mathcal{P}'[I] = (\mathcal{P}' \setminus \mathcal{P}_{b'}) \sqcup (\mathcal{P}_{b'} \times 2)$. Let $\phi : \mathcal{P}'[I] \rightarrow \mathcal{P}$ be the map defined by

$$\phi(ua) := ua, \quad \text{if } ua \in \mathcal{P}' \setminus \mathcal{P}_{b'} \text{ and } a \neq b', \quad (1.3.14a)$$

$$\phi(ub') := ub, \quad \text{if } ub' \in \mathcal{P}' \setminus \mathcal{P}_{b'}, \quad (1.3.14b)$$

$$\phi((ub', 1)) := ub', \quad \text{if } (ub', 1) \in \mathcal{P}_{b'} \times 2, \quad (1.3.14c)$$

$$\phi((ub', 2)) := ub, \quad \text{if } (ub', 2) \in \mathcal{P}_{b'} \times 2. \quad (1.3.14d)$$

This map ϕ is well-defined because, respectively, one has $\mathcal{P}'_a = \mathcal{P}_a$ for any $a \in [0, b' - 1]$, Lemma 1.3.6 holds, I is in particular a subset of \mathcal{P} , and \mathcal{P} satisfies (N2). Let now $\psi : \mathcal{P} \rightarrow \mathcal{P}'[I]$ be the map satisfying

$$\psi(ua) = ua, \quad \text{if } ua \in \mathcal{P} \text{ and } a \in [0, b' - 1], \quad (1.3.15a)$$

$$\psi(ub) = ub', \quad \text{if } ub' \in \mathcal{P}' \setminus \mathcal{P}_{b'}, \quad (1.3.15b)$$

$$\psi(ub) = (ub', 2), \quad \text{if } ub' \in \mathcal{P}_{b'}, \quad (1.3.15c)$$

$$\psi(ub') = (ub', 1), \quad \text{if } ub' \in \mathcal{P}_{b'}. \quad (1.3.15d)$$

By similar arguments as before, this map ψ is well-defined. Moreover, by construction, ψ is the inverse of ϕ . Therefore, ϕ is a bijection. The fact that ϕ is a poset embedding comes by definition of ϕ and from the fact that, due to the property of \mathcal{P} to be nested, for any $ub' \in \mathcal{P}' \setminus \mathcal{P}_{b'}$, all elements greater than ub' in \mathcal{P}' do not belong to $\mathcal{P}_{b'}$. Thus, $\mathcal{P}'[I]$ is isomorphic as a poset to \mathcal{P} . \square

By assuming that \mathcal{P} is nested, the *sequence of derivations* from \mathcal{P} is the sequence

$$\left(\mathcal{P}, \mathcal{D}(\mathcal{P}), \mathcal{D}^2(\mathcal{P}), \dots, \mathcal{D}^{m(\mathcal{P})}(\mathcal{P}) \right) \quad (1.3.16)$$

of subsets of $\text{Cl}_\delta(n)$. Observe that due to (N1), for any $k \in [m(\mathcal{P}) - 1]$, $m(\mathcal{D}^k(\mathcal{P})) \geq 1$, so that $\mathcal{D}^{k+1}(\mathcal{P})$ is well-defined.

Given a graded subset \mathcal{S} of Cl_δ , we say by extension that \mathcal{S} is *nested* if for all $n \geq 0$, the posets $\mathcal{S}(n)$ are nested.

THEOREM 1.3.9. *Let δ be a rooted range map and S be a nested and closed by prefix graded subset of Cl_δ . For any $n \geq 1$, $S(n)$ is constructible by interval doubling. Moreover,*

$$\begin{aligned} S(n) &\rightarrow \mathcal{D}(S(n)) \rightarrow \cdots \rightarrow \mathcal{D}^{\text{m}(S(n))}(S(n)) \simeq S(n-1) \\ &\rightarrow \mathcal{D}(S(n-1)) \rightarrow \cdots \rightarrow \mathcal{D}^{\text{m}(S(n-1))}(S(n-1)) \simeq S(n-2) \\ &\rightarrow \cdots \rightarrow S(0) \simeq \{\epsilon\} \end{aligned} \quad (1.3.17)$$

is a sequence of interval contractions from $S(n)$ to the trivial lattice $\{\epsilon\}$.

PROOF. We proceed by induction on $n \geq 0$. If $n = 0$, since δ is rooted, we necessarily have $S(0) \simeq \{\epsilon\}$, and this poset is by constructible by interval doubling. Assume now that $n \geq 1$ and set $\mathcal{P} := S(n)$. Since S is nested, the sequence of reductions from \mathcal{P} is well-defined. By Lemmas 1.3.7 and 1.3.8, by setting $\mathcal{P}' := \mathcal{D}^{\text{m}(\mathcal{P})}(\mathcal{P})$, \mathcal{P} is obtained by performing a sequence of interval doubling from the poset \mathcal{P}' . Now, due to the definition of the derivation algorithm \mathcal{D} , \mathcal{P}' is made of the δ -cliffs of \mathcal{P} wherein the last letters have been replaced by 0. This poset \mathcal{P}' is therefore isomorphic to the poset \mathcal{P}'' formed by the prefixes of length $n-1$ of \mathcal{P} . Since S is closed by prefix, \mathcal{P}'' is thus the poset $S(n-1)$. By induction hypothesis, this last poset is constructible by interval doubling. Therefore, $S(n)$ also is. All this produces the sequence (1.3.17) of interval contractions. \square

1.3.4. Elevation maps. We introduce here a combinatorial tool intervening in the study of the three Fuss-Catalan posets introduced in the sequel.

Let S be a closed by prefix graded subset of Cl_δ . For any $u \in S$, let

$$F_S(u) := \{a \in [0, \delta(|u| + 1)] : ua \in S\}. \quad (1.3.18)$$

By definition, $F_S(u)$ is the set of all the letters a that can follow u to form an element of S . For any $n \geq 0$, the *S-elevation map* is the map

$$\mathbf{e}_S : S(n) \rightarrow \text{Cl}_\delta(n) \quad (1.3.19)$$

defined, for any $u \in S(n)$ and $i \in [n]$ by

$$\mathbf{e}_S(u)_i := \#(F_S(u_1 \dots u_{i-1}) \cap [0, u_i - 1]) \quad (1.3.20)$$

for any $i \in [n]$. From an intuitive point of view, the value of the i -th letter of $\mathbf{e}_S(u)$ is the number of cliffs of S obtained by considering the prefix of u ending at the letter u_i and by replacing this letter by a smaller one. Remark in particular that $\mathbf{e}_{\text{Cl}_\delta}$ is the identity map. Besides, we say that any $u \in S$ is an *exuvia* if $\mathbf{e}_S(u) = u$.

Let \mathcal{E}_S be the graded set wherein for any $n \geq 0$, $\mathcal{E}_S(n)$ is the image of $S(n)$ by the S -elevation map. We call this set the *S-elevation image*. Observe that \mathcal{E}_S is a graded subset of Cl_δ . Note also that for any $u \in S$, $\mathbf{e}_S(u) \preceq u$.

PROPOSITION 1.3.10. *Let δ be a range map and S be a closed by prefix graded subset of Cl_δ . For any $n \geq 0$, the S -elevation map is injective on the domain $S(n)$.*

PROOF. We proceed by induction on n . When $n = 0$, the property is trivially satisfied. Let $u, v \in \mathcal{S}(n)$ such that $n \geq 1$ and $\mathbf{e}_S(u) = \mathbf{e}_S(v)$. Since \mathcal{S} is closed by prefix, we have $u = u'a$ and $v = v'b$ where $u', v' \in \mathcal{S}(n-1)$ and $a, b \in \mathbb{N}$. By definition of \mathbf{e}_S , we have $\mathbf{e}_S(u'a) = \mathbf{e}_S(u')c$ and $\mathbf{e}_S(v'b) = \mathbf{e}_S(v')c$ where $c \in \mathbb{N}$. Hence, $\mathbf{e}_S(u') = \mathbf{e}_S(v')$ which leads, by induction hypothesis, to the fact that $u' = v'$. Moreover, we deduce from this and from the definition of the \mathcal{S} -elevation map that there are exactly c letters a' smaller than a such that $u'a' \in \mathcal{S}$ and that there are exactly c letters b' smaller than b such that $v'b' \in \mathcal{S}$. Therefore, we have $a = b$ and thus $u = v$, establishing the injectivity of \mathbf{e}_S . \square

LEMMA 1.3.11. *Let δ be a range map and \mathcal{S} be a closed by prefix graded subset of Cl_δ . The \mathcal{S} -elevation image is closed by prefix.*

PROOF. Let $n \geq 0$ and $v \in \mathcal{E}_S(n)$. Then, there exists $u \in \mathcal{S}(n)$ such that $\mathbf{e}_S(u) = v$. Let v' be a prefix of v . Since \mathcal{S} is closed by prefix, the prefix u' of u of length $n' := |v'|$ belongs to $\mathcal{S}(n')$. Moreover, by definition of \mathbf{e}_S , we have $\mathbf{e}_S(u') = v'$. Therefore, $v' \in \mathcal{E}_S$, implying the statement of the lemma. \square

PROPOSITION 1.3.12. *Let δ be a range map and \mathcal{S} be a closed by prefix graded subset of Cl_δ such that for any $u, v \in \mathcal{S}$, $u \preccurlyeq v$ implies $F_S(v) \subseteq F_S(u)$. For any $n \geq 0$, the map \mathbf{e}_S^{-1} is a poset morphism from $\mathcal{E}_S(n)$ to $\mathcal{S}(n)$.*

PROOF. First, by Proposition 1.3.10, the map \mathbf{e}_S^{-1} is well-defined. We now proceed by induction on n . When $n = 0$, the property is trivially satisfied. Let u and v be elements of $\mathcal{E}_S(n)$ such that $n \geq 1$ and $u \preccurlyeq v$. By Lemma 1.3.11, we have $u = u'a$ and $v = v'b$ where $u', v' \in \mathcal{E}_S(n-1)$ and $a, b \in \mathbb{N}$. By definition of \mathbf{e}_S^{-1} , we have $\mathbf{e}_S^{-1}(u'a) = \mathbf{e}_S^{-1}(u')c$ and $\mathbf{e}_S^{-1}(v'b) = \mathbf{e}_S^{-1}(v')d$ where $c, d \in \mathbb{N}$. Since $u \preccurlyeq v$, one has $u' \preccurlyeq v'$ so that, by induction hypothesis, $\mathbf{e}_S^{-1}(u') \preccurlyeq \mathbf{e}_S^{-1}(v')$. Moreover, $u \preccurlyeq v$ implies that $a \leq b$. Due to the fact that $F_S(v') \subseteq F_S(u')$, one has by definition of \mathbf{e}_S^{-1} that $c \leq d$. Therefore, $\mathbf{e}_S^{-1}(u')c \leq \mathbf{e}_S^{-1}(v')d$, which implies the statement of the proposition. \square

Proposition 1.3.12 says that when \mathcal{S} is closed by prefix, for any $n \geq 0$, the poset $\mathcal{S}(n)$ is an order extension of $\mathcal{E}_S(n)$.

1.3.5. *Cubic realizations.* As for the cubic coordinate lattices in Chapter 2 and for the Hochschild lattices in Chapter 3, the poset Cl_δ and these graded subsets admit a cubic realization. Let us recall and generalize some definitions seen in Section 2.1 of Chapter 2.

Let \mathcal{S} be a graded subset of Cl_δ . For any $n \geq 0$, the *realization* of $\mathcal{S}(n)$ is the geometric object $\mathcal{C}(\mathcal{S}(n))$ defined in the space \mathbb{R}^n and obtained by placing for each $u \in \mathcal{S}(n)$ a vertex of coordinates (u_1, \dots, u_n) , and by forming for each $u, v \in \mathcal{S}(n)$ such that $u \prec_S v$ an edge between u and v . Remark that the posets of Figure 1.1 represent actually the realizations of δ -cliff posets. We will follow this drawing convention for all the next figures of posets in all the sequel. When \mathcal{S} is straight, every edge of $\mathcal{C}(\mathcal{S}(n))$ is parallel to a line passing by the origin and a point of the form $(0, \dots, 0, 1, 0, \dots, 0)$. In this case, we say that $\mathcal{C}(\mathcal{S}(n))$ is *cubic*.

Let us assume from now that \mathcal{S} is straight. Let $u, v \in \mathcal{S}(n)$ such that $u \preccurlyeq v$. The word u is *cell-compatible* with v if for any word w of length n such that for any $i \in [n]$,

$w_i \in \{u_i, v_i\}$, then $w \in \mathcal{S}$. In this case, we call **cell** the set of points

$$\langle u, v \rangle := \{x \in \mathbb{R}^n : u_i \leq x_i \leq v_i \text{ for all } i \in [n]\}. \tag{1.3.21}$$

By definition, a cell is an orthotope, that is a parallelotope whose edges are all mutually orthogonal or parallel. A point x of \mathbb{R}^n is **inside** a cell $\langle u, v \rangle$ if for any $i \in [n]$, $u_i \neq v_i$ implies $u_i < x_i < v_i$. A cell $\langle u, v \rangle$ is **pure** if there is no point of $\mathcal{S}(n)$ inside $\langle u, v \rangle$. In other terms, this says that for all $w \in [u, v]$, there exists $i \in [n]$ such that $u_i \neq v_i$ and $w_i \in \{u_i, v_i\}$. Two cells $\langle u, v \rangle$ and $\langle u', v' \rangle$ of $\mathcal{C}(\mathcal{S}(n))$ are **disjoint** if there is no point of \mathbb{R}^n which is both inside $\langle u, v \rangle$ and $\langle u', v' \rangle$. The **dimension** $\dim \langle u, v \rangle$ of a cell $\langle u, v \rangle$ is its dimension as an orthotope and it satisfies $\dim \langle u, v \rangle = \#D(u, v)$. The **volume** $\text{vol} \langle u, v \rangle$ of $\langle u, v \rangle$ is its volume as an orthotope and it satisfies

$$\text{vol} \langle u, v \rangle = \prod_{i \in D(u, v)} v_i - u_i. \tag{1.3.22}$$

For any $k \geq 0$, the **k -volume** $\text{vol}_k(\mathcal{C}(\mathcal{S}(n)))$ of $\mathcal{C}(\mathcal{S}(n))$ is the volume obtained by summing the volumes of all its all its cells of dimension k , computed by not counting several times potential intersecting orthotopes. The **volume** $\text{vol}(\mathcal{C}(\mathcal{S}(n)))$ of $\mathcal{C}(\mathcal{S}(n))$ is defined as $\text{vol}_k(\mathcal{C}(\mathcal{S}(n)))$ where k is the largest integer such that $\mathcal{C}(\mathcal{S}(n))$ has at least one cell of dimension k .

Figure 1.3 shows examples of these notions. Figure 1.3a shows a cubic realization

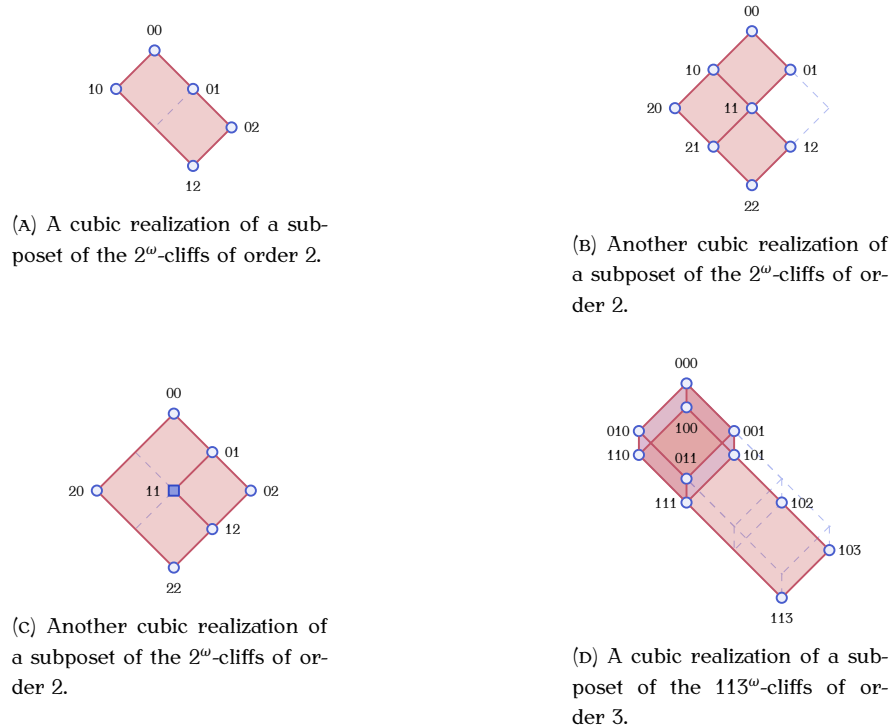

FIGURE 1.3. Some cubic realizations of straight subsets of posets of δ -cliffs for certain range maps δ .

wherein 00 is cell-compatible with 12. Hence, $\langle 00, 12 \rangle$ is a cell. The point $(\frac{1}{2}, \frac{3}{2}) \in \mathbb{R}^2$ is inside $\langle 00, 12 \rangle$, and since there are no elements of the poset inside the cell, this cell is pure. Figure 1.3b shows a cubic realization wherein 00 is not cell-compatible with 22 because 02 does not belong to the poset. Nevertheless, $\langle 00, 11 \rangle$, $\langle 10, 21 \rangle$, and $\langle 11, 22 \rangle$ are pure cells of dimension 2. Figure 1.3c shows a cubic realization wherein $\langle 00, 22 \rangle$ is a non-pure cell. Indeed, the δ -cliff 11 is an element of the poset and is inside this cell. Finally, Figure 1.3d shows a cubic realization having 1 as volume since there is exactly one cell $\langle 000, 111 \rangle$ of maximal dimension (which is 3) and of volume 1. Its 2-volume is 8 since this cubic realization decomposes as the seven disjoint cells $\langle 000, 011 \rangle$, $\langle 000, 101 \rangle$, $\langle 000, 110 \rangle$, $\langle 001, 111 \rangle$, $\langle 010, 111 \rangle$, $\langle 100, 111 \rangle$, and $\langle 101, 113 \rangle$ of respective volumes 1, 1, 1, 1, 1, 1, and 2.

There is a close connection between output-wings (resp. input-wings) of $\mathcal{S}(n)$, $n \geq 0$, and the computation of the volume of $\mathfrak{C}(\mathcal{S}(n))$: if $\langle u, v \rangle$ is a cell of maximal dimension of $\mathfrak{C}(\mathcal{S}(n))$, then due to the fact that \mathcal{S} is straight, u (resp. v) is an output-wing (resp. input-wing) of $\mathcal{S}(n)$. When for any $n \geq 0$,

- (i) there is a map $\rho : \mathcal{O}(\mathcal{S})(n) \rightarrow \mathcal{F}(\mathcal{S})(n)$,
- (ii) all cells of maximal dimension of $\mathfrak{C}(\mathcal{S}(n))$ express as $\langle u, \rho(u) \rangle$ with $u \in \mathcal{O}(\mathcal{S})(n)$,
- (iii) all cells of $\{\langle u, \rho(u) \rangle : u \in \mathcal{O}(\mathcal{S})(n)\}$ are pairwise disjoint,

then the volume of $\mathfrak{C}(\mathcal{S}(n))$, $n \geq 0$, writes as

$$\text{vol}(\mathfrak{C}(\mathcal{S}(n))) = \sum_{u \in \mathcal{O}(\mathcal{S})(n)} \text{vol} \langle u, \rho(u) \rangle. \quad (1.3.23)$$

When some cells of $\{\langle u, \rho(u) \rangle : u \in \mathcal{O}(\mathcal{S})(n)\}$ intersect each other, the expression for the volume would not be as simple as (1.3.23) and can be written instead as an inclusion-exclusion formula. Of course, the same property holds when ρ is instead a map from $\mathcal{F}(\mathcal{S})(n)$ to $\mathcal{O}(\mathcal{S})(n)$ by changing accordingly the previous text.

PROPOSITION 1.3.13. *Let δ be a range map and \mathcal{S} be a straight graded subset of Cl_δ . If, for an $n \geq 0$, $\mathfrak{C}(\mathcal{S}(n))$ has a cell of dimension $\dim_n(\delta)$, then the order dimension of the poset $\mathcal{S}(n)$ is $\dim_n(\delta)$.*

PROOF. First, since $\mathcal{S}(n)$ is a subposet of $\text{Cl}_\delta(n)$, $\mathcal{S}(n)$ is a subposet of the Cartesian product

$$\prod_{\substack{i \in [n] \\ \delta(i) \neq 0}} \mathbb{N}. \quad (1.3.24)$$

This poset has order dimension $\dim_n(\delta)$, so that the order dimension of $\mathcal{S}(n)$ is at most $\dim_n(\delta)$. Besides, since \mathcal{S} is straight, the notion of cell is well-defined in the cubic realization of $\mathcal{S}(n)$. By hypothesis, $\mathcal{S}(n)$ contains a cell $\langle u, v \rangle$ of dimension $\dim_n(\delta)$. Thus, there is a poset embedding of $\mathcal{H}_{\dim_n(\delta)}$ into the interval $[u, v]$ of $\mathcal{S}(n)$. Therefore, the order dimension of $\mathcal{S}(n)$ is at least $\dim_n(\delta)$. \square

As a particular case of Proposition 1.3.13, the order dimension of $\text{Cl}_\delta(n)$ is $\dim_n(\delta)$. This explains the terminology of “ n -th dimension of δ ” for the notation $\dim_n(\delta)$ introduced in Section 1.1.1.

2. Some Fuss-Catalan posets

We present here some examples of subsets of δ -cliff posets. We focus in this work on three posets whose elements are enumerated by m -Fuss-Catalan numbers for the case $\delta = \mathbf{m}$, $m \geq 0$. We provide some combinatorial properties of these posets like among others, a description of their input-wings, output-wings, and butterflies, a study of their order theoretic properties, and a study of their cubic realizations. We end this section by establishing links between these three families of posets in terms of poset morphisms, poset embeddings, and poset isomorphisms. We shall omit some straightforward proofs (for instance, in the case of the descriptions of input-wings, output-wings, butterflies, meet-irreducible and join-irreducible elements of the posets).

We use the following notation conventions. Poset morphisms are denoted by letters ϕ and through arrows \rightarrow , poset embeddings by letters ζ and through arrows \succ , and poset isomorphisms by letters θ and through arrows \Rightarrow .

2.1. δ -avalanche posets. We begin by introducing a first Fuss-Catalan family of posets. As we shall see, these posets are not lattices but they form an important tool to study the two next two families of Fuss-Catalan posets.

2.1.1. *Objects.* For any range map δ , let Av_δ be the graded subset of Cl_δ containing all δ -cliffs u such that for all nonempty prefixes u' of u , then $\omega(u') \leq \delta(|u'|)$. Any element of Av_δ is a *δ -avalanche*. For instance,

$$\text{Av}_2(3) = \{000, 001, 002, 003, 004, 010, 011, 012, 013, 020, 021, 022\}. \quad (2.1.1)$$

PROPOSITION 2.1.1. *For any weakly increasing range map δ , the graded set Av_δ is*

- (i) *closed by prefix,*
- (ii) *is minimally extendable,*
- (iii) *is maximally extendable if and only if $\delta = 0^\omega$.*

PROOF. Point (i) is an immediate consequence of the definition of δ -avalanches. Let $n \geq 0$ and $u \in \text{Av}_\delta(n)$. Since $\delta(n+1) \geq \delta(n)$, $u0$ is a δ -avalanche. This establishes (ii). Finally, we have immediately that Av_{0^ω} is maximally extendable. Moreover, when $\delta \neq 0^\omega$, there is an $n \geq 1$ such that $\delta(n) \geq 1$ and $\delta(n') = 0$ for all $1 \leq n' < n$. Therefore, $0^{n-1} \delta(n)$ is a δ -avalanche but $0^{n-1} \delta(n) \delta(n+1)$ is not. Therefore, (iii) holds. \square

PROPOSITION 2.1.2. *For any $m \geq 0$ and $n \geq 0$,*

$$\#\text{Av}_m(n) = \text{cat}_m(n). \quad (2.1.2)$$

PROOF. This is a consequence of Proposition 2.2.2 coming next. Indeed, by this result, $\text{Av}_m(n)$ is the image by the elevation map of a graded set of objects enumerated by m -Fuss-Catalan numbers. Since this set of objects satisfies all the requirements of Proposition 1.3.10, the elevation map is injective, implying that it is a bijection. \square

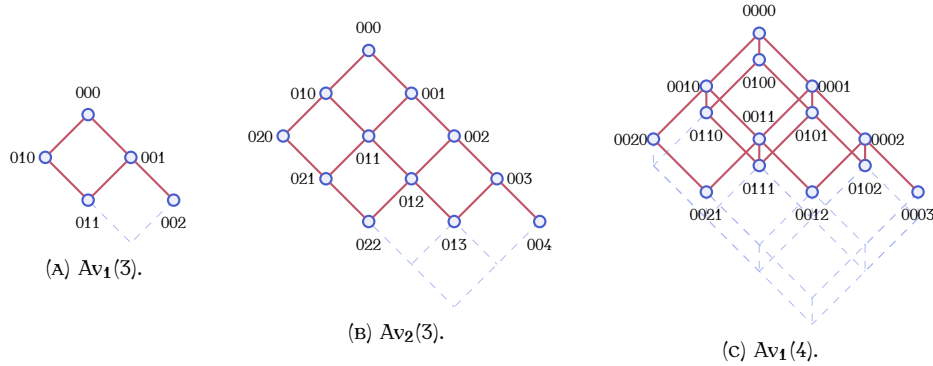

FIGURE 2.1. Hasse diagrams of some δ -avalanche posets.

2.1.2. *Posets.* For any $n \geq 0$, the subposet $\text{Av}_\delta(n)$ of $\text{Cl}_\delta(n)$ is the δ -avalanche poset of order n . Figure 2.1 shows the Hasse diagrams of some \mathbf{m} -avalanche posets.

Let δ be a weakly increasing range map. Notice that in general, $\text{Av}_\delta(n)$ is not bounded. Since for all $u \in \text{Av}_\delta(n)$, $\omega(u) \leq \delta(n)$, we have $u \in \max_{\preceq} \text{Av}_\delta(n)$ if and only if $\omega(u) = \delta(n)$. Moreover, due to the fact that any δ -cliff obtained by decreasing a letter in a δ -avalanche is also a δ -avalanche, the poset $\text{Av}_\delta(n)$ is the order ideal of $\text{Cl}_\delta(n)$ generated by $\max_{\preceq} \text{Av}_\delta(n)$. Finally, as a particular case, we shall show as a consequence of upcoming Proposition 2.2.10 that for any $m \geq 0$ and $n \geq 1$, $\#\max_{\preceq} \text{Av}_m(n) = \text{cat}_m(n - 1)$.

PROPOSITION 2.1.3. *For any weakly increasing range map δ and $n \geq 0$, the poset $\text{Av}_\delta(n)$*

- (i) *is straight, where $u \in \text{Av}_\delta(n)$ is covered by $v \in \text{Av}_\delta(n)$ if and only if there is an $i \in [n]$ such that $\uparrow_i(u) = v$,*
- (ii) *is coated,*
- (iii) *is graded, where the rank of an avalanche is its weight,*
- (iv) *admits an EL-labeling,*
- (v) *is a meet semi-sublattice of $\text{Cl}_\delta(n)$,*
- (vi) *is a lattice if and only if $\delta = 0^\omega$.*

PROOF. Points (i), (iii), (v), and (vi) are immediate. If u and v are two δ -avalanches of size n such that $u \preceq v$, then for any $i \in [n - 1]$, $\omega(u_1 \dots u_i) \leq \omega(v_1 \dots v_i)$. Therefore, the δ -cliff $u_1 \dots u_i v_{i+1} \dots v_n$ is a δ -avalanche. For this reason, (ii) checks out. Point (iv) follows from (ii), and Theorem 1.3.2. \square

PROPOSITION 2.1.4. *For any $m \geq 1$,*

- (i) *the graded set $\mathcal{I}(\text{Av}_m)$ contains all the \mathbf{m} -avalanches u satisfying $u_i \neq 0$ for all $i \in [2, |u|]$,*
- (ii) *the graded set $\mathcal{O}(\text{Av}_m)$ contains all the \mathbf{m} -avalanches u satisfying $\omega(u') < \mathbf{m}(|u'|)$ for all prefixes u' of u of length 2 or more,*

(iii) the graded set $\mathcal{B}(\text{Av}_m)$ contains all the \mathbf{m} -avalanches u satisfying $u_i \neq 0$ for all $i \in [2, |u|]$, and $\omega(u') < \mathbf{m}(|u'|)$ for all prefixes u' of u of length 2 or more.

PROPOSITION 2.1.5. For any $m \geq 0$ and $n \geq 0$, the map $\theta : \text{Av}_m(n) \rightarrow \mathcal{F}(\text{Av}_{m+1})(n)$ defined for any $u \in \text{Av}_m(n)$ and $i \in [n]$ by

$$\theta(u)_i := \mathbf{1}_{i \neq 1}(u_i + 1) \quad (2.1.3)$$

is a poset isomorphism.

PROOF. It follows from Proposition 2.1.4 and its description of the input-wings of $\text{Av}_{m+1}(n)$ that θ is a well-defined map. Let $\theta' : \mathcal{F}(\text{Av}_{m+1})(n) \rightarrow \text{Av}_m(n)$ be the map defined for any $u \in \mathcal{F}(\text{Av}_{m+1})(n)$ and $i \in [n]$ by $\theta'(u)_i := \mathbf{1}_{i \neq 1}(u_i - 1)$. It follows also from Proposition 2.1.4 and the definition of \mathbf{m} -avalanches that θ' is a well-defined map. Now, since by definition of θ' , both $\theta \circ \theta'$ and $\theta' \circ \theta$ are identity maps, θ is a bijection. Finally, the fact that θ is a translation implies that θ is a poset embedding. \square

As a consequence of Proposition 2.1.5, for any $m \geq 1$ and $n \geq 0$, the number of input-wings in $\text{Av}_m(n)$ is $\text{cat}_{m-1}(n)$.

PROPOSITION 2.1.6. For any $m \geq 1$ and $n \geq 0$, the map $\zeta : \mathcal{F}(\text{Av}_m) \rightarrow \mathcal{O}(\text{Av}_m)$ defined for any $u \in \mathcal{F}(\text{Av}_m)(n)$ and $i \in [n]$ by

$$\zeta(u)_i := \mathbf{1}_{i \neq 1}(u_i - 1) \quad (2.1.4)$$

is a poset embedding.

PROOF. It follows from Proposition 2.1.4 and its descriptions of the input-wings and output-wings of $\text{Av}_m(n)$ that ζ is a well-defined map. The fact that ζ is a translation implies the statement of the proposition. \square

PROPOSITION 2.1.7. For any $m \geq 1$ and $n \geq 0$, the map $\theta : \mathcal{O}(\text{Av}_m) \rightarrow \mathcal{B}(\text{Av}_{m+1})$ defined for any $u \in \mathcal{O}(\text{Av}_m)(n)$ and $i \in [n]$ by

$$\theta(u)_i := \mathbf{1}_{i \neq 1}(u_i + 1) \quad (2.1.5)$$

is a poset isomorphism.

PROOF. The proof uses Proposition 2.1.4 and is very similar to the one of Proposition 2.1.5. \square

To summarize, the three previous propositions lead to the following diagram of posets wherein appear avalanche posets and their subsets of input-wings, output-wings, and butterflies.

THEOREM 2.1.8. For any $m \geq 1$ and $n \geq 0$,

$$\begin{array}{ccc} \text{Av}_{m-1}(n) & \xrightarrow{\theta \text{ (Pr. 2.1.5)}} & \mathcal{F}(\text{Av}_m)(n) \\ & & \downarrow \zeta \text{ (Pr. 2.1.6)} \\ & & \mathcal{O}(\text{Av}_m)(n) \xrightarrow{\theta \text{ (Pr. 2.1.7)}} \mathcal{B}(\text{Av}_{m+1})(n) \end{array} \quad (2.1.6)$$

is a diagram of poset embeddings or isomorphisms.

Figure 2.2 gives an example of the poset isomorphisms or embeddings described by the statement of Theorem 2.1.8.

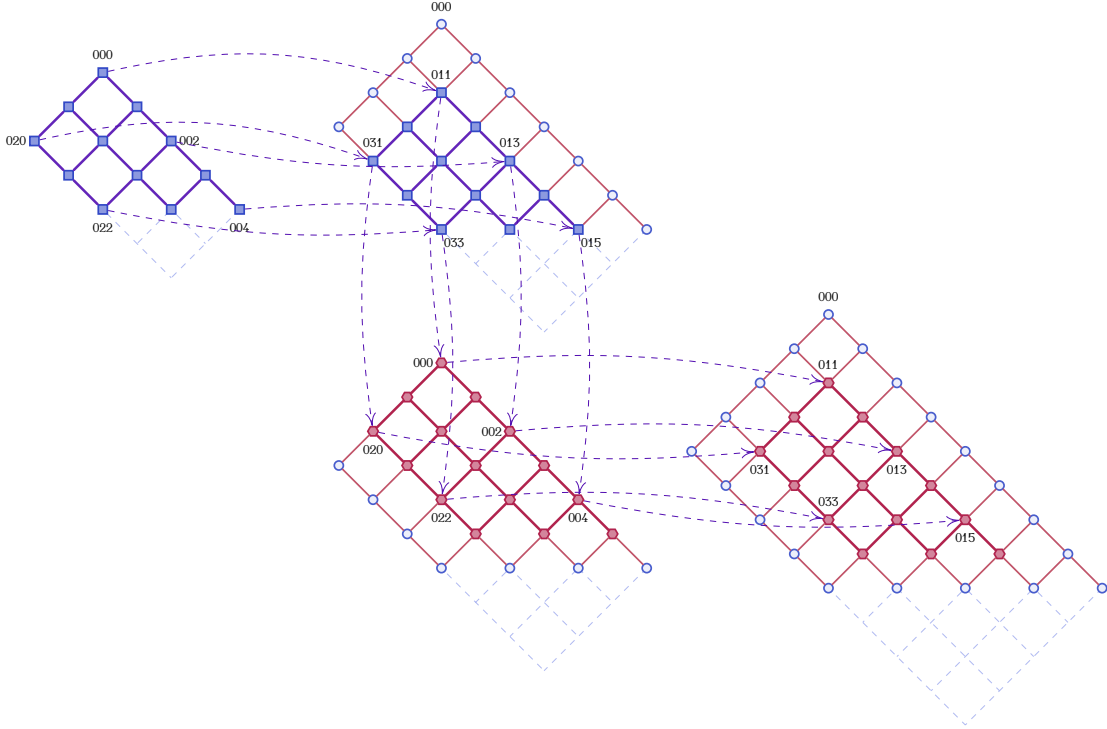

FIGURE 2.2. From the top to bottom and left to right, here are the posets $Av_2(3)$, $Av_3(3)$, $Av_3(3)$, and $Av_4(3)$. All these posets contain $Av_2(3)$ as subposet by restricting on input-wings, output-wings, or butterflies.

Let us define for any $m \geq 0$ and $n \geq 1$ the n -th *twisted m -Fuss-Catalan number* by

$$tcat_m(n) := \frac{1}{n} \binom{n(m+1)-2}{n-1}. \tag{2.1.7}$$

PROPOSITION 2.1.9. For any $m \geq 1$, $\#\mathcal{O}(Av_m)(0) = 1$ and, for any $n \geq 1$,

$$\#\mathcal{O}(Av_m)(n) = tcat_m(n). \tag{2.1.8}$$

PROOF. By Proposition 2.1.4, the set $\mathcal{O}(Av_m)(n)$ is in one-to-one correspondence with the set of all \mathbf{m} -cliffs v of size n such that for any $i \in [2, n]$, $v_{i-1} \leq v_i < \mathbf{m}(i)$. A possible bijection between these two sets sends any $u \in \mathcal{O}(Av_m)(n)$ to the \mathbf{m} -cliff v of the same size such that for any $i \in [n]$, $v_i := u_1 + \dots + u_i$. These words are moreover in one-to-one correspondence with indecomposable m -Dyck paths with $n \geq 1$ up steps, that are m -Dyck paths which cannot be written as a nontrivial concatenation of two m -Dyck paths. A possible bijection is the one described in upcoming Section 2.2.1. Let us denote by $\mathcal{S}(t)$ (resp. $\mathcal{S}'(t)$) the generating series of m -Dyck paths (resp. indecomposable m -Dyck

paths) enumerated with respect to their numbers of up steps. By convention, $\mathcal{G}'(t)$ has no constant term. Since any m -Dyck path decomposes in a unique way as a concatenation of indecomposable m -Dyck paths, one has $\mathcal{G}(t) = (1 - \mathcal{G}'(t))^{-1}$. Now, by using the fact that $\mathcal{G}(t)$ satisfies $\mathcal{G}(t) = 1 + t\mathcal{G}(t)^{m+1}$, we have

$$\mathcal{G}'(t) = \frac{\mathcal{G}(t) - 1}{\mathcal{G}(t)} = t\mathcal{G}(t)^m = t \left(\frac{1}{1 - \mathcal{G}'(t)} \right)^m \quad (2.1.9)$$

This relation satisfied by $\mathcal{G}'(t)$ between the first and last members of (2.1.9) is known to be the one of the generating series of twisted m -Fuss-Catalan numbers (see [Slo] for instance). \square

By Proposition 2.1.9, the first numbers of output-wings of $\text{Av}_m(n)$ by sizes are

$$1, 1, 1, 1, 1, 1, 1, 1, \quad m = 0, \quad (2.1.10a)$$

$$1, 1, 1, 2, 5, 14, 42, 132, \quad m = 1, \quad (2.1.10b)$$

$$1, 1, 2, 7, 30, 143, 728, 3876, \quad m = 2, \quad (2.1.10c)$$

$$1, 1, 3, 15, 91, 612, 4389, 32890, \quad m = 3. \quad (2.1.10d)$$

The third and fourth sequences are respectively Sequences **A006013** and **A006632** of [Slo]. As a side remark, for any $m \geq 1$, the generating series of the graded set $\mathcal{O}(\text{Av}_m)$ is 1 plus the inverse, for the functional composition of series, of the polynomial $t(1 - t)^m$.

PROPOSITION 2.1.10. *For any $m \geq 1$ and $n \geq 1$,*

- (i) *the set $\mathbf{M}(\text{Av}_m(n))$ contains all \mathbf{m} -avalanches u such that $u = u'a$ where $u' \in \max_{\preceq} \text{Av}_m(n - 1)$ and $a \in [0, m - 1]$,*
- (ii) *the set $\mathbf{J}(\text{Av}_m(n))$ contains all \mathbf{m} -avalanches having exactly one letter different from 0.*

By Proposition 2.1.10 and by upcoming Proposition 2.2.10, the number of meet-irreducible elements of $\text{Av}_m(n)$ satisfies, for any $m \geq 1$ and $n \geq 2$,

$$\mathbf{M}(\text{Av}_m(n)) = \text{mcat}_m(n - 2) \quad (2.1.11)$$

and the number of join-irreducibles elements of $\text{Av}_m(n)$ satisfies, for any $m \geq 1$ and $n \geq 1$,

$$\#\mathbf{J}(\text{Av}_m(n)) = m \binom{n}{2}. \quad (2.1.12)$$

2.1.3. *Cubic realization.* The map ζ introduced by Proposition 2.1.6 is used here to describe the cells of maximal dimension of the cubic realization of $\text{Av}_m(n)$, $m \geq 1$, $n \geq 0$.

PROPOSITION 2.1.11. *For any $m \geq 1$, $n \geq 0$, and $u \in \mathcal{F}(\text{Av}_m)(n)$,*

- (i) *the \mathbf{m} -avalanche $\zeta(u)$ is cell-compatible with the \mathbf{m} -avalanche u ,*
- (ii) *the cell $(\zeta(u), u)$ is pure,*
- (iii) *all cells of $\{(\zeta(u), u) : u \in \mathcal{F}(\text{Av}_m)(n)\}$ are pairwise disjoint.*

PROOF. Let v be an \mathbf{m} -cliff of size n satisfying $v_i \in \{\zeta(u)_i, u_i\}$ for all $i \in [n]$. By definition of ζ , $v_1 = 0$ and $v_i \in \{u_i - 1, u_i\}$ for all $i \in [2, n]$. Since u is an input-wing of Av_m , $\zeta(u)$ is an \mathbf{m} -avalanche, and due to the definition of \mathbf{m} -avalanches, any \mathbf{m} -cliff obtained by decrementing some letters of u is still an \mathbf{m} -avalanche. Thus, $v \in \text{Av}_m$ and (i) holds. Points (ii) and (iii) are consequences of the fact that there is no element of $\text{Av}_m(n)$ inside a cell $\langle \zeta(u), u \rangle$. Indeed, since for any $i \in [n]$, $|\zeta(u)_i - u_i| \leq 1$, we have $v_i \in \{\zeta(u)_i, u_i\}$ for all $v \in \langle \zeta(u), u \rangle \cap \text{Av}_m(n)$. \square

As shown by Proposition 2.1.11, the cells of maximal dimension of the cubic realization of $\text{Av}_m(n)$ are all of the form $\langle \zeta(u), u \rangle$ where the u are input-wings of $\text{Av}_m(n)$.

PROPOSITION 2.1.12. For any $m \geq 1$ and $n \geq 0$,

$$\text{vol}(\mathcal{C}(\text{Av}_m(n))) = \text{cat}_{m-1}(n). \quad (2.1.13)$$

PROOF. Proposition 2.1.11 describes all the cells of maximal dimension of $\mathcal{C}(\text{Av}_m(n))$ as cells $\langle \zeta(u), u \rangle$ where u is an input-wing of $\text{Av}_m(n)$. Since all these cells are pairwise disjoint, the volume of $\mathcal{C}(\text{Av}_m(n))$ expresses as (1.3.23). Moreover, observe that the volume of each cell $\langle \zeta(u), u \rangle$ where u in an input-wing is by definition of ζ equal to 1. Therefore, $\text{vol}(\mathcal{C}(\text{Av}_m(n)))$ is equal to the number of input-wings of $\text{Av}_m(n)$. The statement of the proposition follows now from Proposition 2.1.5. \square

2.2. δ -hill posets. We now introduce δ -hills and δ -hill posets as subposets of δ -cliff posets. As we shall see, some of these posets are sublattices of \mathbf{m} -cliff lattices.

2.2.1. *Objects.* For any range map δ , let Hi_δ be the graded subset of Cl_δ containing all δ -cliffs such that that for any $i \in [u] - 1$, $u_i \leq u_{i+1}$. Any element of Hi_δ is a δ -hill. For instance,

$$\text{Hi}_2(3) = \{000, 001, 011, 002, 012, 022, 003, 013, 023, 004, 014, 024\}. \quad (2.2.1)$$

PROPOSITION 2.2.1. For any weakly increasing range map δ , the graded set Hi_δ is

- (i) closed by prefix,
- (ii) is minimally extendable if and only if $\delta = 0^\omega$,
- (iii) is maximally extendable.

PROOF. Point (i) is an immediate consequence of the definition of δ -hills. We have immediately that Hi_{0^ω} is minimally extendable. Moreover, when $\delta \neq 0^\omega$, there is an $n \geq 1$ such that $\delta(n) \geq 1$. Therefore, $\bar{1}_\delta(n)$ is a δ -hill but $\bar{1}_\delta(n)0$ is not. This establishes (ii). Finally, since for any $n \geq 0$, $\delta(n+1) \geq \delta(n)$, one has $\delta(n+1) \geq u_n$ for any $u \in \text{Hi}_\delta(n)$. This shows that $u\delta(n+1)$ is a δ -hill. Therefore, (iii) holds. \square

There is a one-to-one correspondence between $\text{Hi}_m(n)$ and the set of m -Dyck paths $\text{Dy}_m(n)$ seen in Section 1.1.4 of Chapter 1. This bijection sends an m -Dyck path w of size n to the \mathbf{m} -hill u of size n such that for any $i \in [n]$, u_i is the number of down steps to the

left of the i -th up step of w . For instance, the 2-Dyck path

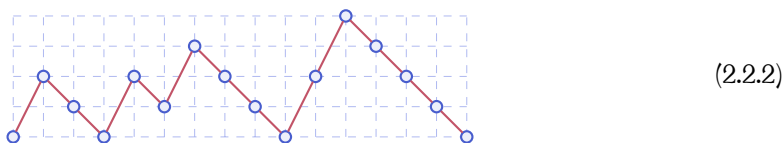

(2.2.2)

is sent to the 2-hill 02366. Since m -Dyck paths of size n are known to be enumerated by m -Fuss-Catalan numbers, one has

$$\#\text{Hi}_m(n) = \text{cat}_m(n). \quad (2.2.3)$$

PROPOSITION 2.2.2. For any range map δ and any $n \geq 0$,

$$\mathcal{E}_{\text{Hi}_\delta}(n) = \text{Av}_\delta(n). \quad (2.2.4)$$

PROOF. First, since Hi_m is by Proposition 2.2.1 closed by prefix, the Hi_m -elevation map and the Hi_m -elevation image are well-defined. Let $u \in \text{Hi}_\delta(n)$ and $v := \mathbf{e}_{\text{Hi}_\delta}(u)$. By definition of δ -hills and of the Hi_δ -elevation map, we have $v_1 = u_1$ and, for any $i \in [2, n]$, $v_i = u_i - u_{i-1}$. Therefore, for any prefix $v' := v_1 \dots v_j$, $j \in [n]$, of v , we have

$$\omega(v') = u_1 + (u_2 - u_1) + (u_3 - u_2) + \dots + (u_j - u_{j-1}) = u_j. \quad (2.2.5)$$

Since u is in particular a δ -cliff of size n , then $u_j \leq \delta(j)$, so that $v \in \text{Av}_\delta(n)$. This shows that $\mathcal{E}_{\text{Hi}_\delta}(n)$ is a subset of $\text{Av}_\delta(n)$.

Now, let u be an δ -avalanche of size n . Let us show by induction on $n \geq 0$ that there exists $v \in \text{Hi}_\delta(n)$ such that $\mathbf{e}_{\text{Hi}_\delta}(v) = u$. When $n = 0$, the property is trivially satisfied. When $n \geq 1$, since Av_δ is, by Proposition 2.1.1, closed by prefix, one has $u = u'a$ for a $u' \in \text{Av}_\delta(n-1)$ and an $a \in \mathbb{N}$. By induction hypothesis, there exists $v' \in \text{Hi}_\delta(n-1)$ such that $\mathbf{e}_{\text{Hi}_\delta}(v') = u'$. Now, let $b := a + v'_{n-1}$ and set $v := v'b$. By using what we have proven in the first paragraph, $\omega(u') = v'_{n-1}$. Since $\omega(u') + a = \omega(u) \leq \delta(n)$, we have that $b \leq \delta(n)$. Therefore, since moreover $b \geq v'_{n-1}$, v is a δ -hill and it satisfies $\mathbf{e}_{\text{Hi}_\delta}(v) = u$. \square

2.2.2. Posets. For any $n \geq 0$, the subposet $\text{Hi}_\delta(n)$ of $\text{Cl}_\delta(n)$ is the δ -hill poset of order n . Figure 2.3 shows the Hasse diagrams of some \mathbf{m} -hill posets. The 1-hill posets are the Stanley lattices seen in Section 1.3.9 of Chapter 1. Therefore, the δ -hill posets can be seen as generalizations of these structures.

PROPOSITION 2.2.3. For any weakly increasing range map δ and $n \geq 0$, the poset $\text{Hi}_\delta(n)$ is

- (i) straight, where $u \in \text{Hi}_\delta(n)$ is covered by $v \in \text{Hi}_\delta(n)$ if and only if there is an $i \in [n]$ such that $\uparrow_i(u) = v$,
- (ii) coated,
- (iii) nested,
- (iv) graded, where the rank of a hill is its weight,
- (v) EL-shellable,
- (vi) a sublattice of $\text{Cl}_\delta(n)$,
- (vii) constructible by interval doubling.

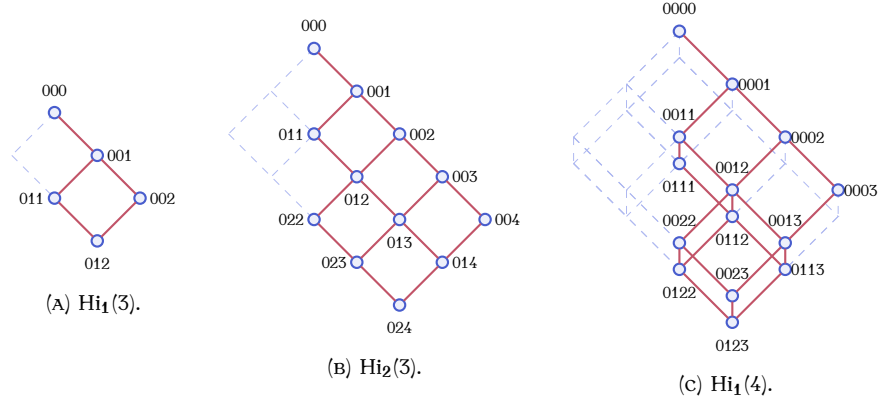
FIGURE 2.3. Hasse diagrams of some δ -hill posets.

PROOF. Points (i), (ii), (iii), (iv), and (vi) are immediate. Point (v) follows from (ii) and Theorem 1.3.2. Point (vii) is a consequence of Theorem 1.3.9 since (iii) holds and, from Proposition 2.2.1, of the fact that Hi_δ is closed by prefix. Alternatively, (vii) is implied by (vi) and the fact that any sublattice of a lattice constructible by interval doubling is constructible by interval doubling [Day79], which is indeed the case for $\text{Cl}_\delta(n)$. \square

PROPOSITION 2.2.4. For any $m \geq 0$,

- (i) the graded set $\mathcal{F}(\text{Hi}_m)$ contains all the \mathbf{m} -cliffs u satisfying $u_1 < \dots < u_{|u|}$,
- (ii) the graded set $\mathcal{O}(\text{Hi}_m)$ contains all the \mathbf{m} -cliffs u satisfying $u_1 \leq u_2 < \dots < u_{|u|}$ and for all $i \in [2, |u|]$, $u_i < \mathbf{m}(i)$,
- (iii) the graded set $\mathcal{B}(\text{Hi}_m)$ contains all the \mathbf{m} -cliffs u satisfying $u_1 < \dots < u_{|u|}$ and for all $i \in [2, |u|]$, $u_i < \mathbf{m}(i)$.

PROPOSITION 2.2.5. For any $m \geq 0$ and $n \geq 0$, the map $\theta : \text{Hi}_m(n) \rightarrow \mathcal{F}(\text{Hi}_{m+1})(n)$ defined for any $u \in \text{Hi}_m(n)$ and $i \in [n]$ by

$$\theta(u)_i := u_i + i - 1 \quad (2.2.6)$$

is a poset isomorphism.

PROOF. It follows from Proposition 2.2.4 and its description of the output-wings of $\text{Hi}_{m+1}(n)$ that θ is a well-defined map. Let $\theta' : \mathcal{F}(\text{Hi}_{m+1})(n) \rightarrow \text{Hi}_m(n)$ be the map defined for any $u \in \mathcal{F}(\text{Hi}_{m+1})(n)$ and $i \in [n]$ by $\theta'(u)_i := u_i - i + 1$. It follows also from Proposition 2.2.4 that θ' is a well-defined map. Now, since by definition of θ' , both $\theta \circ \theta'$ and $\theta' \circ \theta$ are identity maps, θ is a bijection. Finally, the fact that θ is a translation implies that θ is a poset embedding. \square

As a consequence Proposition 2.2.5, for any $m \geq 1$ and $n \geq 0$, the number of input-wings in $\text{Hi}_m(n)$ is $\text{cat}_{m-1}(n)$.

PROPOSITION 2.2.6. *For any $m \geq 1$ and $n \geq 0$, the map $\theta : \mathcal{F}(\text{Hi}_m)(n) \rightarrow \mathcal{O}(\text{Hi}_m)(n)$ defined for any $u \in \mathcal{F}(\text{Hi}_m)(n)$ and $i \in [n]$ by*

$$\theta(u)_i := \mathbf{1}_{i \neq 1}(u_i - 1) \quad (2.2.7)$$

is a poset isomorphism.

PROOF. This proof uses Proposition 2.2.4 and is very similar to the one of Proposition 2.2.5. \square

PROPOSITION 2.2.7. *For any $m \geq 1$ and $n \geq 0$, the map $\zeta : \mathcal{F}(\text{Hi}_m)(n) \rightarrow \mathcal{B}(\text{Hi}_{m+1})(n)$ defined for any $u \in \mathcal{F}(\text{Hi}_m)(n)$ by $\zeta(u) := u$ is a poset embedding.*

PROOF. It follows directly from Proposition 2.2.4 that any input-wing of $\text{Hi}_m(n)$ is also a butterfly of $\text{Hi}_{m+1}(n)$. The fact the identity map is a poset embedding implies the statement of the proposition. \square

To summarize, the three previous propositions lead to the following diagram of posets wherein appear hill posets and their subsets of input-wings, output-wings, and butterflies.

THEOREM 2.2.8. *For any $m \geq 1$ and $n \geq 0$,*

$$\begin{array}{ccc} \text{Hi}_{m-1}(n) & \xrightarrow{\theta \text{ (Pr. 2.2.5)}} & \mathcal{F}(\text{Hi}_m)(n) & \xrightarrow{\theta \text{ (Pr. 2.2.6)}} & \mathcal{O}(\text{Hi}_m)(n) \\ & & \downarrow \zeta \text{ (Pr. 2.2.7)} & & \\ & & \mathcal{B}(\text{Hi}_{m+1})(n) & & \end{array} \quad (2.2.8)$$

is a diagram of poset embeddings or isomorphisms.

Figure 2.4 gives an example of the poset isomorphisms or embeddings described by the statement of Theorem 2.2.8.

PROPOSITION 2.2.9. *For any $m \geq 1$, $\#\mathcal{B}(\text{Hi}_m)(0) = 1$ and, for any $n \geq 1$,*

$$\#\mathcal{B}(\text{Hi}_m)(n) = \text{tcat}_{m-1}(n). \quad (2.2.9)$$

PROOF. By Proposition 2.2.4, the set $\mathcal{B}(\text{Hi}_m)(n)$ contains all \mathbf{m} -cliffs u of size n satisfying $u_1 < \dots < u_n$ and for any $i \in [2, n]$, $u_i < \mathbf{m}(i)$. By setting $\mathbf{m}' := \mathbf{m} - 1$, this set is in one-to-one correspondence with the set of all \mathbf{m}' -cliffs v of size n satisfying $v_{i-1} \leq v_i < \mathbf{m}'(i)$. A possible bijection between these two sets sends any $u \in \mathcal{B}(\text{Hi}_m)(n)$ to the \mathbf{m}' -cliff v of the same size such that for any $i \in [n]$, $v_i = u_i - i + 1$. We have already seen in the proof of Proposition 2.1.9 that these sets are in one-to-one correspondence with $(m - 1)$ -Dyck paths which cannot be written as a nontrivial concatenation of two $(m - 1)$ -Dyck paths. Therefore, the statement of the proposition follows. \square

PROPOSITION 2.2.10. *For any $m \geq 0$ and $n \geq 1$, the map $\rho : \max_{\preceq} \text{Av}_m(n) \rightarrow \text{Hi}_m(n - 1)$ such that any $u \in \max_{\preceq} \text{Av}_m(n)$, $\rho(u)$ is the prefix of size $n - 1$ of $\mathbf{e}_{\text{Hi}_m}^{-1}(u)$, is a bijection.*

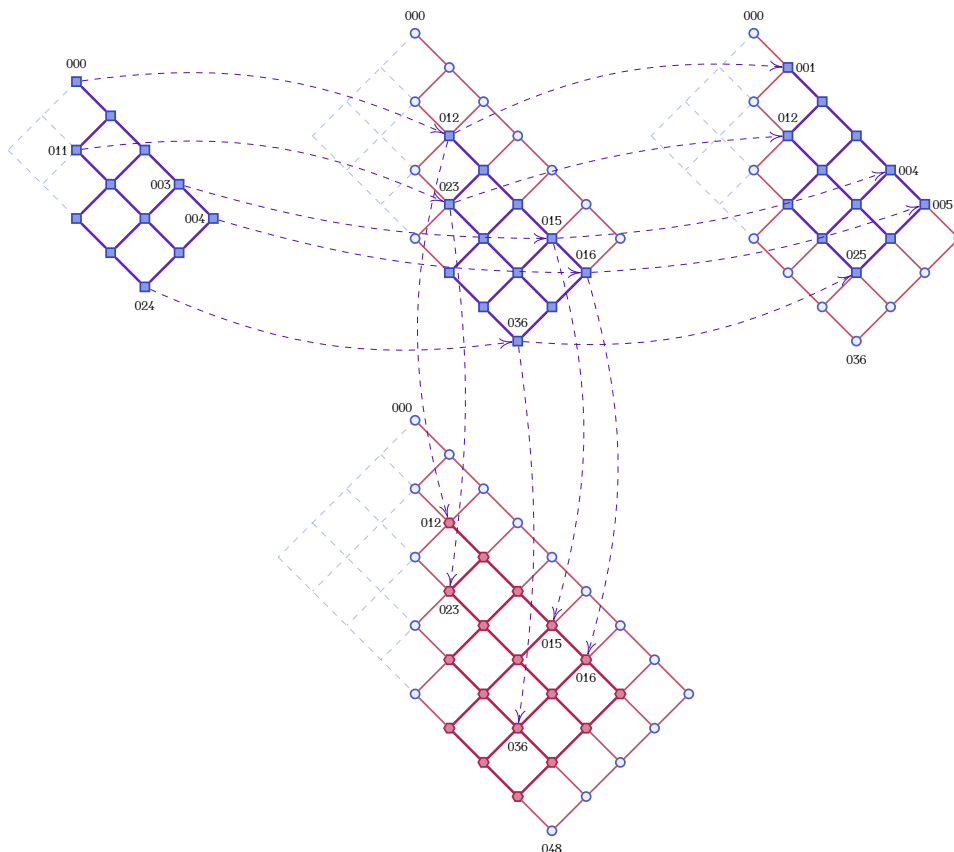

FIGURE 2.4. From the top to bottom and left to right, here are the posets $Hi_2(3)$, $Hi_3(3)$, $Hi_3(3)$, and $Hi_4(3)$. All these posets contain $Hi_2(3)$ as subposet by restricting on input-wings, output-wings, or butterflies.

PROOF. First, since Hi_m is by Proposition 2.2.1 closed by prefix, by Proposition 1.3.10, e_{Hi_m} is an injective map. This implies that the map ρ , defined by considering the inverse of e_{Hi_m} is a well-defined map. Let $\rho' : Hi_m(n - 1) \rightarrow \max_{\preceq} Av_m(n)$ be the map defined for any $v \in Hi_m(n - 1)$ by $\rho'(v) := e_{Hi_m}(va)$ where $a := m(n - 1)$. As pointed out before, $u \in \max_{\preceq} Av_m(n)$ if and only if $\omega(u) = m(n - 1)$. This implies that $\rho'(v)$ belongs to $\max_{\preceq} Av_m(n)$. Moreover, due to the respective definitions of ρ and ρ' , both $\rho \circ \rho'$ and $\rho' \circ \rho$ are identity maps. Therefore, ρ is a bijection. \square

PROPOSITION 2.2.11. For any $m \geq 1$ and $n \geq 1$, the set $J(Hi_m(n))$ contains all m -hills u such that $u = 0^k a^{n-k}$ such that $k \in [n - 1]$ and $a \in [km]$.

PROPOSITION 2.2.12. For any $m \geq 0$ and $n \geq 0$, the map e_{Hi_m} is a bijection between $J(Hi_m(n))$ and $J(Av_m(n))$.

PROOF. This is a straightforward verification using the descriptions of join-irreducible elements of $Hi_m(n)$ and $Av_m(n)$ brought by Propositions 2.2.11 and 2.1.10. \square

By Proposition 2.2.11 (or also by Propositions 2.1.10 and 2.2.12), the number of join-irreducibles elements of $\text{Hi}_m(n)$ satisfies, for any $m \geq 1$ and $n \geq 1$,

$$\#\mathbf{J}(\text{Hi}_m(n)) = m \binom{n}{2}. \quad (2.2.10)$$

Since by Proposition 2.2.3, $\text{Hi}_m(n)$ is constructible by interval doubling, this is also the number of its meet-irreducible elements [GW16].

2.2.3. *Cubic realization.* The map θ introduced by Proposition 2.2.6 is used here to describe the cells of maximal dimension of the cubic realization of $\text{Hi}_m(n)$, $m \geq 1$, $n \geq 0$.

PROPOSITION 2.2.13. *For any $m \geq 1$, $n \geq 0$, and $u \in \mathcal{F}(\text{Hi}_m)(n)$,*

- (i) *the \mathbf{m} -hill $\theta(u)$ is cell-compatible with the \mathbf{m} -hill u ,*
- (ii) *the cell $\langle \theta(u), u \rangle$ is pure,*
- (iii) *all cells of $\{\langle \theta(u), u \rangle : u \in \mathcal{F}(\text{Hi}_m)(n)\}$ are pairwise disjoint.*

PROOF. Due to the similarity between the maps θ and the map ζ introduced in the statement of Proposition 2.1.6, the proof here is very similar to the one of Proposition 2.1.11. \square

As shown by Proposition 2.2.13, the cells of maximal dimension of the cubic realization of $\text{Hi}_m(n)$ are all of the form $\langle \theta(u), u \rangle$ where the u are input-wings of $\text{Hi}_m(n)$.

PROPOSITION 2.2.14. *For any $m \geq 1$ and $n \geq 0$,*

$$\text{vol}(\mathcal{C}(\text{Hi}_m(n))) = \text{cat}_{m-1}(n). \quad (2.2.11)$$

PROOF. Proposition 2.2.13 describes all the cells of maximal dimension of $\mathcal{C}(\text{Hi}_m(n))$ as cells $\langle \theta(u), u \rangle$, where u is an input-wing of $\text{Hi}_m(n)$. Since all these cells are pairwise disjoint, the volume of $\mathcal{C}(\text{Hi}_m(n))$ expresses as (1.3.23). Moreover, observe that the volume of each cell $\langle \theta(u), u \rangle$ where u in an input-wing, is by definition of θ equal to 1. Therefore, $\text{vol}(\mathcal{C}(\text{Hi}_m(n)))$ is equal to the number of input-wings of $\text{Hi}_m(n)$. The statement of the proposition follows now from Proposition 2.2.5. \square

2.3. **δ -canyon posets.** We introduce here our last family of posets. They are defined on particular δ -cliffs called δ -canyons. As we shall see, under some conditions these posets are lattices but not sublattices of δ -cliff lattices.

2.3.1. *Objects.* For any range map δ , let Ca_δ be the graded subset of Cl_δ containing all δ -cliffs such that $u_{i-j} \leq u_i - j$, for all $i \in [|\mathbf{u}|]$ and $j \in [u_i]$ satisfying $i - j \geq 1$. Any element of Ca_δ is a δ -canyon. For instance

$$\text{Ca}_2(3) = \{000, 010, 020, 001, 002, 012, 003, 013, 023, 004, 014, 024\}. \quad (2.3.1)$$

In particular, the **1-canyons** are the (dual) Tamari diagrams seen in Section 1.1.5 of Chapter 1.

As a larger example, the 2-cliff $u := 020100459002301$ is a 2-canyon. Indeed, by picturing an \mathbf{m} -canyon in the exact same way as Tamari diagrams, we can check the previous condition. For instance, the previous u is drawn as

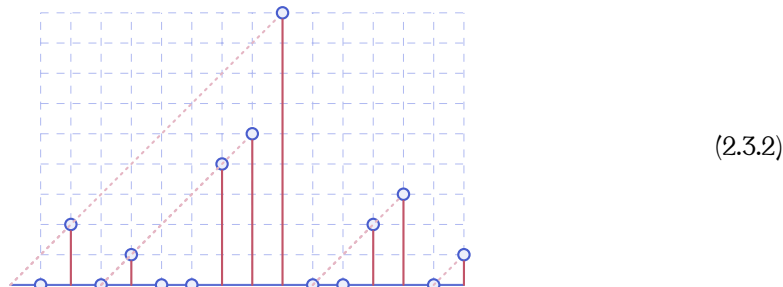

and one can observe that none of the dotted lines crosses a needle. Besides, if u is a δ -cliff of size n and $i, j \in [n]$ are two indices such that $i < j$, one has the three following possible configurations depending on the value $\alpha := u_j - (j - i)$:

- ★ If $\alpha < 0$, then we say that i and j are *independent* in u (graphically, the diagonal of u_j falls under the x -axis before reaching the segment of u_i),
- ★ If $\alpha \in [0, u_i - 1]$, then we say that j is *hinded* by i in u (graphically, the diagonal of u_j hits the segment of u_i),
- ★ If $\alpha \geq u_i$, then we say that j *dominates* i in u (graphically, the segment of u_i is below or on the diagonal of u_j).

By definition, a δ -cliff u is a δ -canyon if no index of u is hinded by another one.

PROPOSITION 2.3.1. *For any range map δ , the graded set Ca_δ is*

- (i) *closed by prefix,*
- (ii) *is minimally extendable,*
- (iii) *is maximally extendable if δ is increasing.*

PROOF. Let u be a δ -canyon of size $n \geq 0$. Immediately from the definition of the δ -canyons, it follows that $u0$ is a δ -canyon of size $n + 1$, and that for any prefix u' of u , u' is a δ -canyon. Therefore, Points (i) and (ii) check out. Let us now consider the δ -cliff $u' := u\delta(n + 1)$. If δ is increasing, for all $j \in [n]$, $u_{n+1-j} \leq u_{n+1} - j$. Therefore, u' is a δ -canyon. Therefore, (iii) holds. \square

Let us now introduce a series of definitions and lemmas in order to show that the sets $\text{Ca}_\delta(n)$ and $\text{Hi}_\delta(n)$ are in one-to-one correspondence when δ is an increasing range map.

For any δ -canyon u of size n , let $d(u)$ be the δ -canyon obtained by changing for each index $i \in [n]$ the letter u_i into 0 if i is dominated by another index $j \in [i + 1, n]$. For instance, when $\delta = \mathbf{m}$ with $m = 2$, $d(020050012) = 000050002$. Observe that $u \in \text{Ca}_\delta$ is an exuvia (see Section 1.3.4) if and only if $d(u) = u$.

LEMMA 2.3.2. *For any range map δ and any δ -canyon u , $F_{\text{Ca}_\delta}(u) = F_{\text{Ca}_\delta}(d(u))$.*

PROOF. Assume that u is of size n and set $w := d(u)$. Assume that ua is a δ -canyon for a letter $a \in \mathbb{N}$. Then, the index $n + 1$ is hinded by no other index in ua . Since w

is obtained by changing to 0 some letters of u , the index $n + 1$ remains hinded by no other index in wa . Therefore, wa is also a δ -canyon. Conversely, assume that wa is a δ -canyon for a letter $a \in \mathbb{N}$. Then, the index $n + 1$ is hinded by no other index in wa . By contradiction, assume that ua is not a δ -canyon. This implies that the index $n + 1$ is hinded by an index i in ua . Let us take i maximal among all indices satisfying this property. Due to the maximality of i , i is dominated by no other index in u so that we have $u_i = w_i$. This implies that $n + 1$ is hinded by i in wa , which contradicts our hypothesis. Therefore, ua is a δ -canyon. \square

LEMMA 2.3.3. *Let δ be a range map and u be a δ -canyon of size $n \geq 0$. Then,*

$$F_{\text{Ca}_\delta}(u) = [0, \delta(n + 1)] \setminus \bigsqcup_{\substack{i \in [n] \\ d(u)_i \neq 0}} [n + 1 - i, n + d(u)_i - i]. \quad (2.3.3)$$

PROOF. Let w be a δ -canyon of size n and let $w := d(u)$. For any letter $a \in [0, \delta(n + 1)]$, the δ -cliff wa is a δ -canyon if and only if the index $n + 1$ is hinded by no index in wa . Now, for any $i \in [n]$ such that $w_i \neq 0$, the index i hinds the index $n + 1$ in wa if and only if $a \in [n + 1 - i, n + w_i - i]$. By definition of d , all indices of w are pairwise independent. Therefore, for any $i, i' \in [n]$ such that $i \neq i'$ and $w_i \neq 0 \neq w_{i'}$, the sets $[n + 1 - i, n + w_i - i]$ and $[n + 1 - i', n + w_{i'} - i']$ are disjoint. Lemma 2.3.2 and the fact that d is an idempotent map imply the stated formula. \square

LEMMA 2.3.4. *Let δ be a range map and u be a δ -canyon. Then,*

$$\omega(\mathbf{e}_{\text{Ca}_\delta}(u)) = \omega(d(u)). \quad (2.3.4)$$

PROOF. This follows by induction on the size of u , by using the relation $d(u) = \mathbf{e}_{\text{Ca}_\delta}(d(u))$, and by using Lemma 2.3.2. \square

PROPOSITION 2.3.5. *For any increasing range map δ and any $n \geq 0$,*

$$\mathcal{E}_{\text{Ca}_\delta}(n) = \text{Av}_\delta(n). \quad (2.3.5)$$

PROOF. First, since Ca_δ is by Proposition 2.3.1 closed by prefix, the Ca_δ -elevation map and so the Ca_δ -elevation image are well-defined.

By Lemmas 2.3.3 and 2.3.4, and since δ is increasing, for any δ -canyon u of size $n \geq 0$, one has

$$\#F_{\text{Ca}_\delta}(u) = 1 + \delta(n + 1) - \omega(\mathbf{e}_{\text{Ca}_\delta}(u)). \quad (2.3.6)$$

Let us proceed by induction on n to prove that for any $u \in \text{Ca}_\delta(n)$, $\mathbf{e}_{\text{Ca}_\delta}(u)$ is a δ -avalanche. If $n = 0$, the property holds immediately. Let $u = u'a$ be a δ -canyon of size $n + 1$ where $u' \in \text{Ca}_\delta(n)$ and $a \in \mathbb{N}$. By induction hypothesis, $\mathbf{e}_{\text{Ca}_\delta}(u')$ is a δ -avalanche. Therefore, in particular, $\omega(\mathbf{e}_{\text{Ca}_\delta}(u')) \leq \delta(n)$. Moreover, by (2.3.6), we have

$$\begin{aligned} \omega(\mathbf{e}_{\text{Ca}_\delta}(u'a)) &= \omega(\mathbf{e}_{\text{Ca}_\delta}(u')) + \#(F_{\text{Ca}_\delta}(u') \cap [0, a - 1]) \\ &\leq \omega(\mathbf{e}_{\text{Ca}_\delta}(u')) + 1 + \delta(n + 1) - \omega(\mathbf{e}_{\text{Ca}_\delta}(u')) - 1 \\ &= \delta(n + 1), \end{aligned} \quad (2.3.7)$$

showing that $u'a$ is a δ -canyon.

Conversely, let us prove by induction on n that for any $v \in Av_\delta(n)$, there exists a δ -canyon u such that $\mathbf{e}_{Ca_\delta}(u) = v$. If $n = 0$, the property holds immediately. Let $v = v'b$ be a δ -avalanche of size $n + 1$ where $v' \in Av_\delta(n)$ and $b \in \mathbb{N}$. By induction hypothesis, there is $u' \in Ca_\delta(n)$ such that $\mathbf{e}_{Ca_\delta}(u') = v'$. Since v is a δ -avalanche, $b \leq \delta(n + 1) - \omega(v')$. Now, by (2.3.6), since there are $1 + \delta(n + 1) - \omega(v')$ different letters a such that $u'a$ is a δ -canyon, there is in particular a δ -canyon $u = u'a$ such that $\mathbf{e}_{Ca_\delta}(u) = v$. \square

PROPOSITION 2.3.6. For any increasing range map δ and any $n \geq 0$, the map $\phi : Ca_\delta(n) \rightarrow Hi_\delta(n)$ defined by

$$\phi := \mathbf{e}_{Hi_\delta}^{-1} \circ \mathbf{e}_{Ca_\delta} \tag{2.3.8}$$

is a bijection.

PROOF. First, since δ is increasing, by Propositions 2.2.1 and 2.3.1, both Hi_δ and Ca_δ are closed by prefix. Therefore, the maps \mathbf{e}_{Hi_δ} and \mathbf{e}_{Ca_δ} are well-defined. By Proposition 1.3.10, the maps \mathbf{e}_{Cam} and \mathbf{e}_{Him} are injective, and by Propositions 2.2.2 and 2.3.5, they both share the same image $Av_m(n)$. This implies that \mathbf{e}_{Cam} is a bijection from Ca_m to $Av_m(n)$, and that \mathbf{e}_{Him}^{-1} is a well-defined map and is a bijection from $Av_m(n)$ to $Hi_m(n)$. Therefore, the statement of the proposition follows. \square

As a consequence of Proposition 2.3.6, for any $m \geq 0$, \mathbf{m} -canyons are enumerated by \mathbf{m} -Fuss-Catalan numbers.

2.3.2. Posets. For any $n \geq 0$, the subset $Ca_\delta(n)$ is the δ -canyon poset of order n . Figure 2.5 shows the Hasse diagrams of some \mathbf{m} -canyon posets. We have already seen

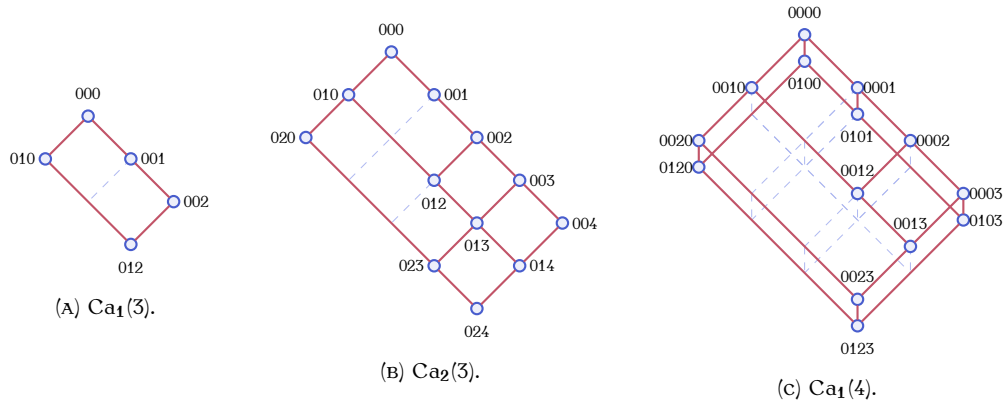

FIGURE 2.5. Hasse diagrams of some δ -canyon posets.

that the $\mathbf{1}$ -canyons are the Tamari diagrams. Moreover, as we have seen in Section 1.2.4 of Chapter 1, the set of these objects of size n is in one-to-one correspondence with the set of binary trees with n nodes. It is also known that the componentwise comparison of Tamari diagrams is the Tamari order (see Section 1.3.7 of Chapter 1). As for the several generalizations of the Tamari posets evoked in Section 1.3.7 of Chapter 1, our δ -canyon posets can be seen as different generalizations of Tamari posets. For any $m \geq 2$, the

\mathbf{m} -canyon posets are not isomorphic to the m -Tamari posets. Moreover, we shall prove in the sequel that for any increasing map δ , Ca_δ is a lattice. As already mentioned, Tamari posets have the nice property to be lattices [HT72], are also EL-shellable [BW97], and constructible by interval doubling [Gey94]. The same properties hold for m -Tamari lattices, see respectively [BMFPR11] and [Müh15] for the first two ones. The last one is a consequence of the fact that m -Tamari lattices are intervals of the Tamari lattices [BMFPR12] and the fact that the property to be constructible by interval doubling is preserved for all sublattices of a lattice [Day79]. As we shall see here, the δ -canyon posets have the same three properties.

PROPOSITION 2.3.7. *For any increasing range map δ and $n \geq 0$, the poset $\text{Ca}_\delta(n)$ is*

- (i) *straight,*
- (ii) *coated,*
- (iii) *nested,*
- (iv) *EL-shellable,*
- (v) *a meet semi-sublattice of $\text{Cl}_\delta(n)$,*
- (vi) *a lattice,*
- (vii) *constructible by interval doubling.*

PROOF. Point (iii) is immediate. Assume that u and v are two δ -canyons of size n such that $u \preceq v$. Let $k \in [n-1]$ and consider the δ -cliff $w := u_1 \dots u_k v_{k+1} \dots v_n$. Now, since for any $i \in [k]$, $w_i = u_i \leq v_i$, and for any $i \in [k+1, n]$, $w_i = v_i \geq u_i$, the fact that u and v are δ -canyons implies that for any $i \in [n]$ and $j \in [w_i]$ such that $i-j \geq 1$, the inequality $w_j \geq w_{i-j} + j$ holds. Thus, w is an δ -canyon, so that (ii) holds. Now, by Lemma 1.3.1, (i) checks out, and by Theorem 1.3.2, (iv) also. Let u and v be two δ -canyons of size n and set w as the δ -cliff $u \wedge v$. For all $j \in [w_i]$ such that $i-j \geq 1$, $w_{i-j} \leq w_i - j$. Indeed, either $w_{i-j} = u_{i-j}$ or $w_{i-j} = v_{i-j}$, and in the two cases $w_{i-j} \leq (u \wedge v)_{i-j}$. For this reason, w is a δ -canyon. This shows (v). Besides, due to the fact that by Proposition 2.3.1, Ca_δ is closed by prefix and is maximally extendable, Theorem 1.3.4 implies (vi). Point (vii) is a consequence of Theorem 1.3.9 since (iii) holds and Ca_δ is closed by prefix. \square

One can observe that $\text{Ca}_m(n)$ is not a join semi-sublattice of the lattice of δ -cliffs. Indeed, by setting $u := 0124$ and $v := 0205$, even if u and v are 2-canyons, $u \vee v = 0225$ is not. By Proposition 2.3.7, the posets $\text{Ca}_m(n)$ are lattices and Theorem 1.3.4 provides a way to compute the join of two of their elements. For instance, in Ca_1 , one has

$$00120 \vee_{\text{Ca}_1} 00201 = \uparrow_{\text{Ca}_1}(00120 \vee 00201) = \uparrow_{\text{Ca}_1}(00221) = 00234, \quad (2.3.9)$$

and, in Ca_2 , one has

$$0124 \vee_{\text{Ca}_2} 0205 = \uparrow_{\text{Ca}_2}(0124 \vee 0205) = \uparrow_{\text{Ca}_2}(0225) = 0235. \quad (2.3.10)$$

These computations of the join of two elements are similar to the ones described in [Mar92] (see also [Gey94]) for Tamari lattices.

Besides, as pointed out by Proposition 2.3.7, when δ is an increasing range map, each $\text{Ca}_\delta(n)$ is constructible by interval doubling. Figure 2.6 shows a sequence of interval contractions performed from $\text{Ca}_2(4)$ in order to obtain $\text{Ca}_2(3)$.

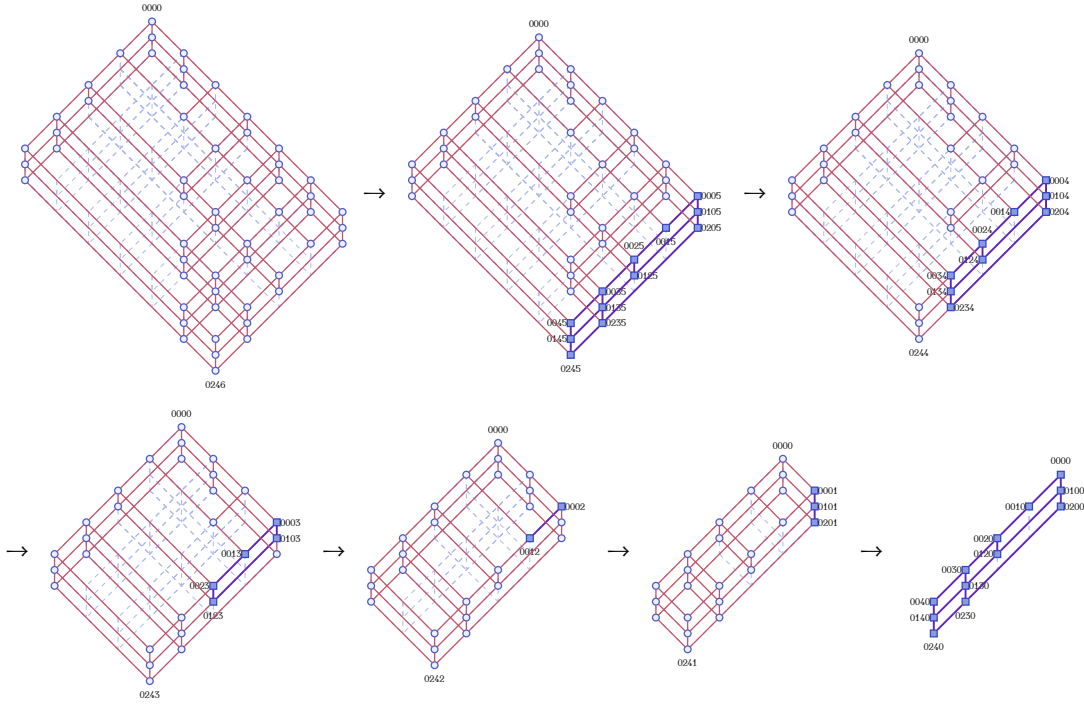

FIGURE 2.6. A sequence of interval contractions from $\text{Ca}_2(4)$ to a poset isomorphic to $\text{Ca}_2(3)$. These interval contractions are poset derivations as introduced in Section 1.3.3. The marked intervals are the ones involved in the interval doubling operations.

PROPOSITION 2.3.8. For any $m \geq 0$,

- (i) the graded set $\mathcal{F}(\text{Ca}_m)$ contains all the \mathbf{m} -cliffs u satisfying $u_i < u_{i+1}$ for all $i \in [|u| - 1]$,
- (ii) the graded set $\mathcal{O}(\text{Ca}_m)$ contains all the \mathbf{m} -cliffs u satisfying, for all $i \in [2, |u|]$, $u_i < \mathbf{m}(i)$, and, for all $i \in [|u|]$, if $u_i \neq 0$, then for all $j \in [i - 2]$, $u_{i-j} < u_i - j$,
- (iii) the graded set $\mathcal{B}(\text{Ca}_m)$ contains all the \mathbf{m} -cliffs u satisfying $1 \leq u_i < \mathbf{m}(i)$ for all $i \in [2, |u|]$, and $u_i - u_{i-1} \geq 2$ for all $i \in [3, |u|]$.

Remark that, from the definition of \mathbf{m} -canyons and the the description of $\mathcal{F}(\text{Ca}_m)$ brought by Proposition 2.3.8, for any $u \in \mathcal{F}(\text{Ca}_m)$, all \mathbf{m} -canyons v such that $u \preceq v$ are also input-wings of Ca_m . For this reason, for any $n \geq 0$, $\mathcal{F}(\text{Ca}_m)(n)$ is an order filter of $\text{Ca}_m(n)$.

PROPOSITION 2.3.9. For any $m \geq 1$ and $n \geq 0$, the map $\theta : \mathcal{F}(\text{Ca}_m)(n) \rightarrow \mathcal{B}(\text{Ca}_{m+1})(n)$ defined for any $u \in \mathcal{F}(\text{Ca}_m)(n)$ and $i \in [n]$ by

$$\theta(u)_i := \mathbf{1}_{i \neq 1}(u_i + i - 2) \tag{2.3.11}$$

is a poset isomorphism.

PROOF. It follows from Proposition 2.3.8 and its descriptions of the input-wings and butterflies of $\text{Ca}_m(n)$ and $\text{Ca}_{m+1}(n)$ that θ is a well-defined map. Let $\theta' : \mathcal{B}(\text{Ca}_{m+1})(n) \rightarrow \mathcal{F}(\text{Ca}_m)(n)$ be the map defined for any $u \in \mathcal{B}(\text{Ca}_{m+1})(n)$ and $i \in [n]$ by $\theta'(u)_i := \mathbf{1}_{i \neq 1}(u_i - i + 2)$. It follows also from Proposition 2.3.8 that θ' is a well-defined map. Now, since by definition of θ' , both $\theta \circ \theta'$ and $\theta' \circ \theta$ are identity maps, θ is a bijection. Finally, the fact that θ is a translation implies that θ is a poset embedding. \square

PROPOSITION 2.3.10. *For any $m \geq 1$ and $n \geq 1$, the set $\mathbf{J}(\text{Ca}_m(n))$ contains all \mathbf{m} -canyons having exactly one letter different from 0.*

By Proposition 2.3.10, the number of join-irreducibles elements of $\text{Ca}_m(n)$ satisfies, for any $m \geq 1$ and $n \geq 1$,

$$\#\mathbf{J}(\text{Ca}_m(n)) = m \binom{n}{2}. \quad (2.3.12)$$

Since by Proposition 2.3.7, $\text{Ca}_m(n)$ is constructible by interval doubling, (2.3.12) is also the number of its meet-irreducible elements [GW16].

2.3.3. *Cubic realization.* Let $m \geq 1$ and $n \geq 0$. For any output-wing u of $\text{Ca}_m(n)$, we define $\rho(u)$ as the \mathbf{m} -canyon $\uparrow_{\text{Ca}_m}(u')$, where u' is the \mathbf{m} -cliff obtained by incrementing by 1 all letters of u except the first one. For instance, the output-wing 01007 of $\text{Ca}_2(5)$ is sent by ρ to the 2-canyon $\uparrow_{\text{Ca}_2}(02118) = 02348$. We call $\rho(u)$ the *left-to-right increasing* of u . This map is not a poset embedding because, for $\mathbf{m} := 2$ and $n := 3$, $\rho(010) = 023 \preceq 013 = \rho(002)$ but 010 and 002 are incomparable.

PROPOSITION 2.3.11. *For any $m \geq 1$, $n \geq 0$, and $u \in \mathcal{O}(\text{Ca}_m)(n)$,*

- (i) *the map ρ is a poset morphism and a bijection between $\mathcal{O}(\text{Ca}_m)(n)$ and $\mathcal{F}(\text{Ca}_m)(n)$,*
- (ii) *the \mathbf{m} -canyon u is cell-compatible with the \mathbf{m} -canyon $\rho(u)$,*
- (iii) *the cell $\langle u, \rho(u) \rangle$ is pure,*
- (iv) *all cells of $\{\langle u, \rho(u) \rangle : u \in \mathcal{O}(\text{Ca}_m)(n)\}$ are pairwise disjoint.*

PROOF. Let us first prove that ρ is a well-defined map. By Proposition 2.3.8, since for all $i \in [2, n]$, $u_i < \mathbf{m}(i)$, the word u' obtained by incrementing by 1 all its letters except the first one is an \mathbf{m} -cliff. Moreover, since by Proposition 2.3.1, Ca_m is maximally extendable, $v := \uparrow_{\text{Ca}_m}(u')$ is a well-defined \mathbf{m} -canyon. Since by construction, for all $i \in [2, n]$, $v_i \neq 0$, each word obtained by replacing by 0 a letter v_i in v is an \mathbf{m} -canyon. Therefore, v covers $n - 1$ elements of $\text{Ca}_m(n)$. These elements are obtained by decreasing v_i by some value, due to the fact that by Proposition 2.3.7, Ca_m is straight. For this reason, v is an input-wing, showing that ρ is a well-defined map from $\mathcal{O}(\text{Ca}_m)(n)$ to $\mathcal{F}(\text{Ca}_m)(n)$. Let us now define the map $\rho' : \mathcal{F}(\text{Ca}_m)(n) \rightarrow \mathcal{O}(\text{Ca}_m)(n)$ as follows. For any $v \in \mathcal{F}(\text{Ca}_m)(n)$, $u := \rho'(v)$ is the \mathbf{m} -cliff satisfying $u_i = \mathbf{1}_{i \neq 1} \mathbf{1}_{u_{i-1} \leq u_{i-2}}(u_i - 1)$ for any $i \in [n]$. It is straightforward to prove that ρ' is a well-defined map. Moreover, by induction on $n \geq 0$, one can prove that both $\rho \circ \rho'$ and $\rho' \circ \rho$ are identity maps. This establishes (i).

Let v be an \mathbf{m} -cliff satisfying $v_i \in \{u_i, \rho(u)_i\}$ for any $i \in [n]$. Since ρ' is the inverse map of ρ , this is equivalent to the fact that $v_i \in \{\rho'(w)_i, w_i\}$ for all $i \in [n]$, where w is the input-wing $\rho(u)$ of $\text{Ca}_m(n)$. Therefore, by definition of ρ' , $v_1 = 0$ and $v_i \in \{0, w_i - 1\}$ for

any $i \in [2, n]$. The fact that w is an input-wing implies, by Proposition 2.3.8, that $u_i < u_{i+1}$ for all $i \in [n - 1]$. This implies that v is an \mathbf{m} -canyon, so that (ii) checks out.

Point (iii) follows directly from the definition of ρ : since $\rho(u)$ is obtained by incrementing all the letters of u , except the first, in a minimal way so that the obtained \mathbf{m} -cliff is an \mathbf{m} -canyon, there cannot be any \mathbf{m} -canyon inside the cell $\langle u, \rho(u) \rangle$.

Finally, assume that there are two input-wings v and w of $\text{Ca}_{\mathbf{m}}(n)$ such that there is a point $x := (x_1, \dots, x_n) \in \mathbb{R}^n$ such that x is inside both the cells $\langle \rho'(v), v \rangle$ and $\langle \rho'(w), w \rangle$. By contradiction, let us assume that $v \neq w$ and let us set $i \in [2, n]$ as the smallest position such that $v_i \neq w_i$. Therefore, we have in particular

$$\rho'(v)_i < x_i < v_i \quad \text{and} \quad \rho'(w)_i < x_i < w_i. \tag{2.3.13}$$

Without loss of generality, we assume that $v_i < w_i$. Now, if $v_i - 2 \geq v_{i-1}$, then $\rho'(v)_i = v_i - 1$ and $\rho'(w)_i = w_i - 1$. It follows from (2.3.13) that $v_i = w_i$. Otherwise, when $v_i - 2 < v_{i-1}$, we have $\rho'(v)_i = 0$ and $\rho'(w)_i = w_i - 1$. It follows again, from (2.3.13), that $v_i = w_i$. This contradicts our hypothesis and shows that $v = w$. Therefore, (iv) holds. \square

This algorithm ρ brought by Proposition 2.3.11 describes the cells of maximal dimension of the cubic realization of $\text{Ca}_{\mathbf{m}}(n)$. Figure 2.7 shows some examples of images of output-wings of $\text{Ca}_{\mathbf{m}}(n)$ by ρ .

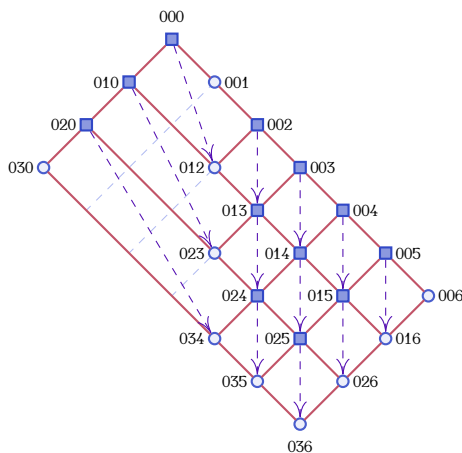

FIGURE 2.7. The poset $\text{Ca}_3(3)$ wherein output-wings are marked. The arrows connect these elements to their images by the bijection ρ .

Propositions 2.3.9 and 2.3.11 lead to the following diagram of posets wherein appear input-wings, output-wings, and butterflies of canyon posets.

THEOREM 2.3.12. For any $m \geq 1$ and $n \geq 0$,

$$\begin{array}{ccc}
 \mathcal{O}(\text{Ca}_m)(n) & & \\
 \downarrow \rho \text{ (Pr. 2.3.11)} & & \\
 \mathcal{F}(\text{Ca}_m)(n) & \xrightarrow{\theta \text{ (Pr. 2.3.9)}} & \mathcal{B}(\text{Ca}_{m+1})(n)
 \end{array} \tag{2.3.14}$$

is a diagram of poset morphisms or isomorphisms.

Figure 2.8 gives an example of the poset morphisms or isomorphisms described by the statement of Theorem 2.3.12.

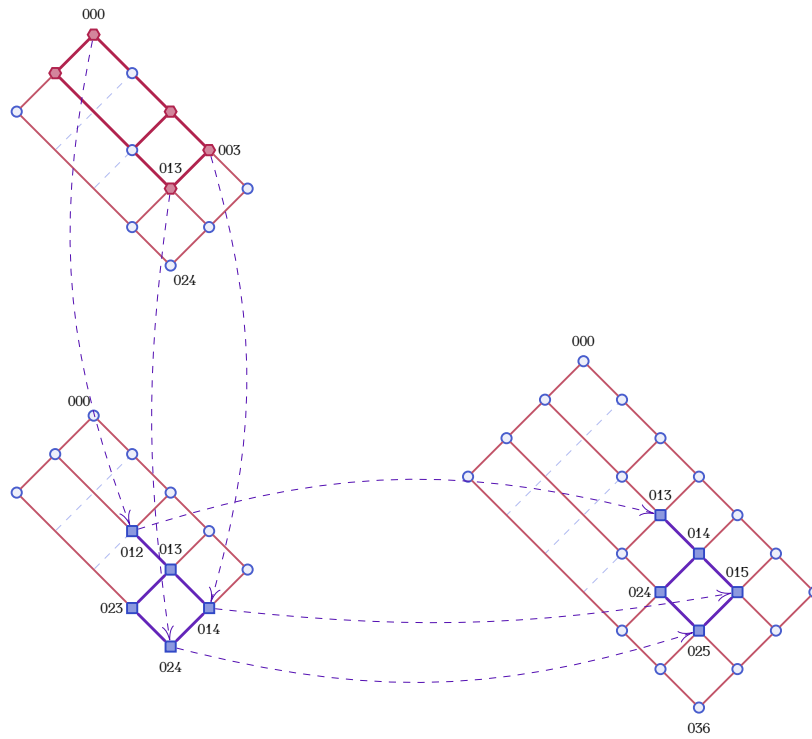

FIGURE 2.8. From the top to bottom and left to right, here are the posets $\text{Ca}_2(3)$, $\text{Ca}_2(3)$, and $\text{Ca}_3(3)$. The two last posets contain $\mathcal{F}(\text{Hi}_1)(3)$ as subposets. There is a poset morphism between the output-wings of the first one and the input-wings of the second one.

PROPOSITION 2.3.13. For any $m \geq 1$ and $n \geq 1$,

$$\text{vol}(\mathcal{C}(\text{Ca}_m(n))) = \text{vol}(\mathcal{C}(\text{Cl}_m(n))) = m^{n-1}(n-1)! \tag{2.3.15}$$

PROOF. Directly from the definition of \mathbf{m} -canyons, one has that the \mathbf{m} -canyon $\bar{0}_m(n)$ is cell-compatible with $\bar{1}_m(n)$. Therefore, $\langle \bar{0}_m(n), \bar{1}_m(n) \rangle$ is a cell of $\mathcal{C}(\text{Ca}_m(n))$. Since all others cells of this cubic realization are contained in this one, one obtains that $\mathcal{C}(\text{Ca}_m(n))$

is an orthotope. This leads to the stated expression for the volume of the cubic realization of $\text{Ca}_m(n)$. \square

2.4. Poset morphisms and other interactions. The purpose of this part is to state the main links between the three posets Av_δ , Hi_δ , and Ca_δ when δ is an increasing range map. We shall also consider their subposets formed by their input-wings, output-wings, and butterflies elements in the particular case where $\delta = \mathbf{m}$ for an $m \geq 0$.

2.4.1. Order extensions. Observe that the map $\mathbf{e}_{\text{Ca}_\delta}$ is not a poset morphism. Indeed, for instance in Ca_1 one has $002 \preceq 012$ but $\mathbf{e}_{\text{Ca}_1}(002) = 002 \not\preceq 011 = \mathbf{e}_{\text{Ca}_1}(012)$. Nevertheless, by composing this map on the left with the inverse of the Hi_δ -elevation map, we obtain a poset morphism, as stated by the next theorem.

LEMMA 2.4.1. *Let δ be a range map, and u and v be two δ -canyons of size n . If $u \preceq v$, then $\omega(\mathbf{e}_{\text{Ca}_\delta}(u)) \leq \omega(\mathbf{e}_{\text{Ca}_\delta}(v))$.*

PROOF. First, since by Proposition 2.3.1, Ca_δ is closed by prefix, $\mathbf{e}_{\text{Ca}_\delta}$ is well-defined. By considering the contrapositive of the statement of the lemma and by Lemma 2.3.4, we have to show that for any δ -canyons u and v of size n , $\omega(d(u)) > \omega(d(v))$ implies that there exists $i \in [n]$ such that $u_i > v_i$. We proceed by induction on n . If $n = 0$, the property holds immediately. Assume now that $u = u'a$ and $v = v'b$ are two δ -canyons of size $n + 1$ such that $\omega(d(u'a)) > \omega(d(v'b))$ where u' and v' are δ -canyons of size n and $a, b \in \mathbb{N}$. If $\omega(d(u')) > \omega(d(v'))$, then by induction hypothesis, there is $i \in [n]$ such that $u'_i > v'_i$. Since $u_i = u'_i$ and $v_i = v'_i$, the property holds. Otherwise, $\omega(d(u')) \leq \omega(d(v'))$. Since $\omega(d(u)) > \omega(d(v))$ and by definition of the map d , we necessarily have $a > b$. Therefore one has $u_{n+1} > v_{n+1}$, showing that the property holds. \square

THEOREM 2.4.2. *For any increasing range map δ and any $n \geq 0$, the map $\mathbf{e}_{\text{Hi}_\delta}^{-1} \circ \mathbf{e}_{\text{Ca}_\delta}$ from $\text{Ca}_\delta(n)$ to $\text{Hi}_\delta(n)$ is a poset morphism.*

PROOF. First of all, by Proposition 2.3.6, the map $\phi := \mathbf{e}_{\text{Hi}_\delta}^{-1} \circ \mathbf{e}_{\text{Ca}_\delta}$ is well-defined. By definition of the maps $\mathbf{e}_{\text{Hi}_\delta}$ and $\mathbf{e}_{\text{Ca}_\delta}$, for any δ -canyon w of size n and any $i \in [n]$, $\phi(w)_i = \omega(\mathbf{e}_{\text{Ca}_\delta}(w_1 \dots w_i))$. Assume now that u and v are two δ -canyons of size n such that $u \preceq v$. Then, for any $i \in [n]$, $u_1 \dots u_i \preceq v_1 \dots v_i$. By Lemma 2.4.1, this implies $\omega(\mathbf{e}_{\text{Ca}_\delta}(u_1 \dots u_i)) \leq \omega(\mathbf{e}_{\text{Ca}_\delta}(v_1 \dots v_i))$. Moreover, by the above remark, this implies $\phi(u)_i \leq \phi(v)_i$. Therefore, we have $\phi(u) \preceq \phi(v)$, establishing the statement of the theorem. \square

Even if, by Proposition 2.3.6, $\mathbf{e}_{\text{Hi}_\delta}^{-1} \circ \mathbf{e}_{\text{Ca}_\delta} : \text{Ca}_\delta(n) \rightarrow \text{Hi}_\delta(n)$ is a bijection, this map is not a poset isomorphism. This is the case since there does not exist for instance a poset isomorphism between $\text{Ca}_1(3)$ and $\text{Hi}_1(3)$ —their Hasse diagrams are not superimposable. Moreover, as a consequence of Theorem 2.4.2, for any $n \geq 0$, $\text{Hi}_\delta(n)$ is an order extension of $\text{Ca}_\delta(n)$. Furthermore, it is possible to show by induction on the length of the δ -canyons and by using Lemma 2.3.3 that Ca_δ satisfies the prerequisites of Proposition 1.3.12. Therefore, $\text{Ca}_\delta(n)$ is an order extension of $\text{Av}_\delta(n)$.

To summarize the whole situation, the three families of Fuss-Catalan posets fit into the chain

$$\begin{array}{ccc}
 \text{Av}_\delta(n) & \xrightarrow{e_{\text{Ca}_\delta}^{-1}} & \text{Ca}_\delta(n) & \xrightarrow{e_{\text{Hi}_\delta}^{-1} \circ e_{\text{Ca}_\delta}} & \text{Hi}_\delta(n) \\
 & \searrow & & \nearrow & \\
 & & & & e_{\text{Hi}_\delta}^{-1}
 \end{array}
 \tag{2.4.1}$$

of posets for the order extension relation. This phenomenon is analogous to the one stating that Stanley lattices are order extensions of Tamari lattices, which in turn are order extension of Kreweras lattices [Kre72] (see for instance [BB09]). Figure 2.9 gives an example of an instance of (2.4.1).

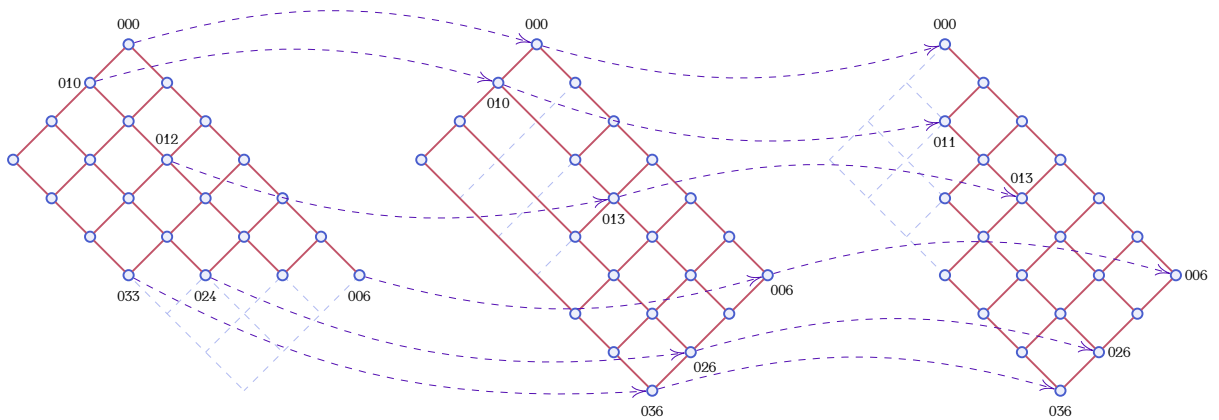

FIGURE 2.9. From the left to the right, here are the posets $\text{Av}_3(3)$, $\text{Ca}_3(3)$, and $\text{Hi}_3(3)$. The poset on the right is an order extension of the one at middle, which is itself an order extension of the one at the left.

2.4.2. Isomorphisms between subposets.

PROPOSITION 2.4.3. For any $m \geq 1$ and $n \geq 0$, the map $\theta : \text{Hi}_{m-1}(n) \rightarrow \mathcal{F}(\text{Ca}_m)(n)$ defined for any $u \in \mathcal{F}(\text{Ca}_m)(n)$ and $i \in [n]$ by

$$\theta(u)_i := u_i + i - 1
 \tag{2.4.2}$$

is an isomorphism of posets.

PROOF. It follows from Proposition 2.3.8 and its description of the input-wings of $\text{Ca}_m(n)$ that θ is a well-defined map. Let $\theta' : \mathcal{F}(\text{Ca}_m)(n) \rightarrow \text{Hi}_{m-1}(n)$ be the map defined for any $u \in \mathcal{F}(\text{Ca}_m)(n)$ and $i \in [n]$ by $\theta'(u)_i := (u_i - i + 1)$. It follows also from Proposition 2.3.8 that θ' is a well-defined map. Now, since by definition of θ' , both $\theta \circ \theta'$ and $\theta' \circ \theta$ are identity maps, θ is a bijection. Finally, the fact that θ is a translation implies that θ is a poset embedding. \square

Figure 2.10 gives an example of the poset isomorphism described by the statement of Proposition 2.4.3. A consequence of Proposition 2.4.3 is that, for any $m \geq 2$ and $n \geq 0$, the

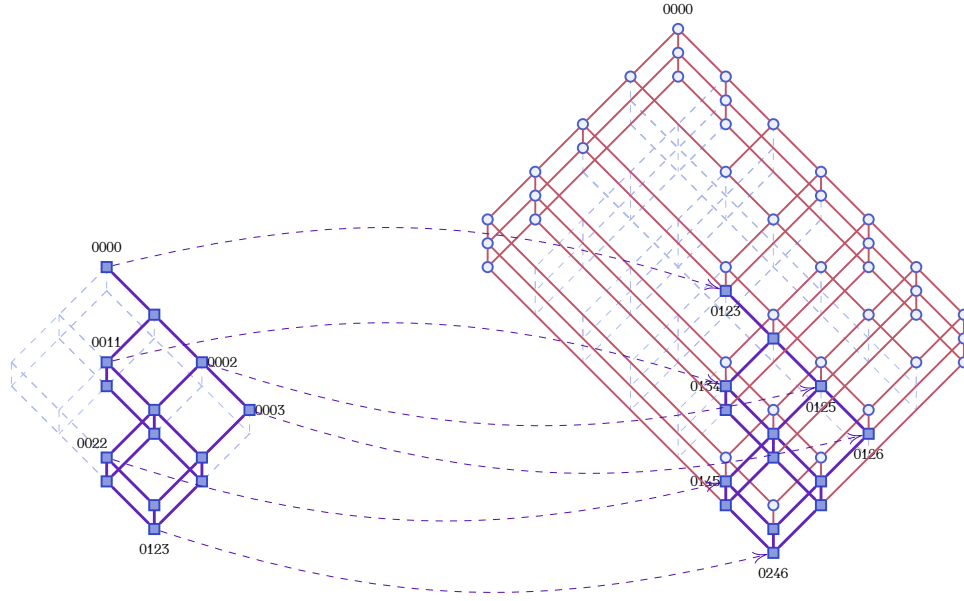

FIGURE 2.4.0. The subset of $\text{Ca}_2(4)$ formed by its input-wings is isomorphic to $\text{Hi}_1(4)$.

image by θ^{-1} of $\text{Ca}_{m-1}(n) \cap \mathcal{F}(\text{Ca}_m)(n)$ is $\text{Hi}_{m-2}(n)$. Indeed, the set $\text{Ca}_{m-1}(n) \cap \mathcal{F}(\text{Ca}_m)(n)$ is nothing but the set $\mathcal{F}(\text{Ca}_{m-1})(n)$.

THEOREM 2.4.4. *For any $m \geq 1$ and $n \geq 0$,*

$$\begin{array}{ccccc}
 & & \text{Av}_{m-1}(n) & \xrightarrow{\theta \text{ (Pr. 2.1.5)}} & \mathcal{F}(\text{Av}_m)(n) \\
 & & \downarrow \text{e}_{\text{Ca}_{m-1}}^{-1} & & \downarrow \zeta \text{ (Pr. 2.1.6)} \\
 & \mathcal{O}(\text{Ca}_m)(n) & \text{Ca}_{m-1}(n) & & \mathcal{O}(\text{Av}_m)(n) \xrightarrow[\theta \text{ (Pr. 2.1.7)}]{\longrightarrow} \mathcal{B}(\text{Av}_{m+1})(n) \\
 & \downarrow \rho \text{ (Pr. 2.3.11)} & \downarrow \text{e}_{\text{Hi}_{m-1}}^{-1} \circ \text{e}_{\text{Ca}_{m-1}} & & \\
 \mathcal{B}(\text{Ca}_{m+1})(n) & \xleftarrow[\theta \text{ (Pr. 2.3.9)}]{\longleftarrow} \mathcal{F}(\text{Ca}_m)(n) & \xleftarrow[\theta \text{ (Pr. 2.4.3)}]{\longleftarrow} \text{Hi}_{m-1}(n) & \xrightarrow[\theta \text{ (Pr. 2.2.5)}]{\longrightarrow} \mathcal{F}(\text{Hi}_m)(n) & \xrightarrow[\theta \text{ (Pr. 2.2.6)}]{\longrightarrow} \mathcal{O}(\text{Hi}_m)(n) \\
 & & & \downarrow \zeta \text{ (Pr. 2.2.7)} & \\
 & & & \mathcal{B}(\text{Hi}_{m+1})(n) & \\
 & & & & \text{(2.4.3)}
 \end{array}$$

is a diagram of poset morphisms, embeddings, or isomorphisms.

PROOF. This is a consequence of Theorems 2.1.8, 2.2.8, 2.3.12, and 2.4.2, and Proposition 1.3.12. \square

3. Associative algebras of δ -cliffs

This section is devoted to endow the sets of δ -cliffs with algebraic structures, and we can refer to Section 3 of Chapter 1 for the classical notions. We describe a graded associative algebra on δ -cliffs motivated by a connection with the δ -cliff posets. Indeed, the product of two δ -cliffs is a sum of δ -cliffs forming an interval of a δ -cliff poset. This property is shared by a lot of combinatorial and algebraic structures. For instance, the algebra FQSym of permutations is related to the weak order [DHT02, AS05], the algebra PBT of binary trees is related to the Tamari order [LR02, HNT05], and the algebra Sym of integer compositions is related to the hypercube [GKL+95].

3.1. Coalgebras and algebras. We introduce here a graded coalgebra structure on the linear span of all δ -cliffs and then, by considering the dual structure, we obtain a graded algebra. When δ satisfies some properties, this gives an associative algebra.

From now, \mathbb{K} is any field of characteristic zero and all the next algebraic structures in the category of vector spaces have \mathbb{K} as ground field. For any graded vector space \mathcal{V} , we denote by $\mathcal{H}_{\mathcal{V}}(t)$ the Hilbert series of \mathcal{V} .

3.1.1. Coalgebras of δ -cliffs. For any range map δ , let \mathbf{Cl}_{δ} be the linear span of all δ -cliffs. This space is graded and decomposes as

$$\mathbf{Cl}_{\delta} = \bigoplus_{n \geq 0} \mathbf{Cl}_{\delta}(n), \quad (3.1.1)$$

where $\mathbf{Cl}_{\delta}(n)$, $n \geq 0$, is the linear span of all δ -cliffs of size n . By definition, the set $\{F_u : u \in \mathbf{Cl}_{\delta}\}$ is a basis of \mathbf{Cl}_{δ} , and we shall refer to it as the *fundamental basis* or as the *F-basis*. Let also $c : \mathbf{Cl}_{\delta} \rightarrow \mathbb{K}$ be the linear map defined by $c(F_{\epsilon}) := 1$ and by $c(F_u) := 0$ for any $u \in \mathbf{Cl}_{\delta} \setminus \{\epsilon\}$.

For any $n \geq 0$, the *δ -reduction map* is the map $r_{\delta} : \mathbb{N}^n \rightarrow \mathbf{Cl}_{\delta}(n)$ defined for any word $u \in \mathbb{N}^n$ and any $i \in [n]$ by $(r_{\delta}(u))_i := \min\{u_i, \delta(i)\}$. For instance, $r_1(212066) = 012045$ and $r_2(212066) = 012066$.

Let $\Delta : \mathbf{Cl}_{\delta} \rightarrow \mathbf{Cl}_{\delta} \otimes \mathbf{Cl}_{\delta}$ be the cobinary coproduct defined, for any $w \in \mathbf{Cl}_{\delta}$, by

$$\Delta(F_w) := \sum_{\substack{u, v \in \mathbb{N}^* \\ w=uv}} F_u \otimes F_{r_{\delta}(v)}, \quad (3.1.2)$$

where \mathbb{N}^* denotes the set of all words on \mathbb{N} . This coproduct is well-defined since any prefix of a δ -cliff is a δ -cliff and the image of a word on \mathbb{N} by the δ -reduction map is by definition a δ -cliff. For instance, for $\delta := 1221013^{\omega}$, we have in \mathbf{Cl}_{δ} ,

$$\Delta(F_{1021}) = F_{\epsilon} \otimes F_{1021} + F_1 \otimes F_{021} + F_{10} \otimes F_{11} + F_{102} \otimes F_1 + F_{1021} \otimes F_{\epsilon}, \quad (3.1.3)$$

and

$$\begin{aligned} \Delta(F_{1211010}) &= F_{\epsilon} \otimes F_{1211010} + F_1 \otimes F_{111000} + F_{12} \otimes F_{11010} + F_{121} \otimes F_{1010} \\ &\quad + F_{1211} \otimes F_{010} + F_{12110} \otimes F_{10} + F_{121101} \otimes F_0 + F_{1211010} \otimes F_{\epsilon}. \end{aligned} \quad (3.1.4)$$

THEOREM 3.1.1. *Let δ be a range map. The space \mathbf{Cl}_δ endowed with the coproduct Δ and the counit c is a counital graded coalgebra. Moreover, Δ is coassociative if and only if δ is valley-free.*

PROOF. The first part of the statement is a direct consequence of the definition of Δ .

To establish the second part, let us compute the two ways to apply twice the coproduct Δ on a basis element of \mathbf{Cl}_δ . For any $w \in \mathbf{Cl}_\delta$, we have

$$(\Delta \otimes I)\Delta(F_w) = \sum_{\substack{x,y,z \in \mathbb{N}^* \\ w=xyz}} F_x \otimes F_{r_\delta(y)} \otimes F_{r_\delta(z)} \quad (3.1.5)$$

and

$$\begin{aligned} (I \otimes \Delta)\Delta(F_w) &= \sum_{\substack{u,v \in \mathbb{N}^* \\ w=uv}} \sum_{\substack{y',z' \in \mathbb{N}^* \\ r_\delta(v)=y'z'}} F_u \otimes F_{y'} \otimes F_{r_\delta(z')} \\ &= \sum_{\substack{x,y,z \in \mathbb{N}^* \\ w=xyz}} F_x \otimes F_{r_\delta(y)} \otimes F_{r_{\delta_{|y|}}(z)}, \end{aligned} \quad (3.1.6)$$

where for any $k \geq 0$, δ_k is the range map satisfying $\delta_k(i) = \min\{\delta(i), \delta(k+i)\}$ for any $i \geq 1$. The second equality of (3.1.6) comes from the two following facts. First, for any $i \in [|y'|]$, $y'_i = r_\delta(v)_i = r_\delta(y)_i$ where y is the factor $w_{|u|+1} \dots w_{|u|+|y'|}$ of w . Second, we have for any $j \in [|z'|]$, $z'_j = r_\delta(v)_{|y'|+j} = \min\{v_{|y'|+j}, \delta(|y'|+j)\}$, so that for any $i \in [|z'|]$, $r_\delta(z')_i = \min\{z'_i, \delta(i)\} = \min\{v_{|y'|+i}, \delta(|y'|+i), \delta(i)\} = r_{\delta_{|y|}}(z)_i$, where z is the suffix of length $|z'|$ of w .

Let us now prove that (3.1.5) and (3.1.6) are different if and only if δ has a valley. These two elements are different if and only if there exists a factorization $w = xyz$ with $x, y, z \in \mathbb{N}^*$ such that $r_\delta(z) \neq r_{\delta_{|y|}}(z)$. This is equivalent to the fact there exists an index $i \in [|z|]$ such that $r_\delta(z)_i \neq r_{\delta_{|y|}}(z)_i$. Since z is a suffix of w , there exists a $j \in [|x|+|y|+1, |w|]$ such that $z = w_j w_{j+1} \dots w_{|w|}$. Now, we have

$$r_\delta(z)_i = \min\{w_{j+i-1}, \delta(i)\} \neq \min\{w_{j+i-1}, \delta(|y|+i), \delta(i)\} = r_{\delta_{|y|}}(z)_i. \quad (3.1.7)$$

To have this difference, we necessarily have $\delta(|y|+i) < z_i$ and $\delta(|y|+i) < \delta(i)$. Now, since w is in particular a δ -cliff, we have $z_i = w_{j+i-1} \leq \delta(j+i-1)$. Therefore, we obtain

$$\delta(i) > \delta(|y|+i) < \delta(j+i-1). \quad (3.1.8)$$

Since $j \geq |y|+1$, this leads to the fact that δ has a valley. This establishes that Δ is coassociative if and only if δ is valley-free. \square

3.1.2. Algebras of δ -cliffs. Let $\cdot : \mathbf{Cl}_\delta \otimes \mathbf{Cl}_\delta \rightarrow \mathbf{Cl}_\delta$ be the binary product defined as the dual of the coproduct Δ introduced in Section 3.1.1, where the graded dual space \mathbf{Cl}_δ^* is identified with \mathbf{Cl}_δ . By duality, this product \cdot satisfies, for any $u, v \in \mathbf{Cl}_\delta$,

$$F_u \cdot F_v = \sum_{w \in \mathbf{Cl}_\delta} \langle F_u \otimes F_v, \Delta(F_w) \rangle F_w, \quad (3.1.9)$$

where, for any $w \in \mathbf{Cl}_\delta$, $\langle F_u \otimes F_v, \Delta(F_w) \rangle$ is the coefficient of $F_u \otimes F_v$ in $\Delta(F_w)$. Therefore,

$$F_u \cdot F_v = \sum_{\substack{v' \in r_\delta^{-1}(v) \\ uv' \in \mathbf{Cl}_\delta}} F_{uv'}, \quad (3.1.10)$$

where $r_\delta^{-1}(v)$ is the fiber of v under the map r_δ . For instance, in \mathbf{Cl}_1 ,

$$F_{00} \cdot F_{011} = F_{00011} + F_{00021} + F_{00031} + F_{00111} + F_{00121} + F_{00131} + F_{00211} + F_{00221} + F_{00231}, \quad (3.1.11)$$

in \mathbf{Cl}_2 ,

$$F_{00} \cdot F_{011} = F_{00011} + F_{00111} + F_{00211} + F_{00311} + F_{00411}, \quad (3.1.12)$$

and in \mathbf{Cl}_δ , where $\delta = 01312^\omega$, we have both

$$F_{00} \cdot F_{011} = F_{00011} + F_{00111} + F_{00211} + F_{00311} \quad (3.1.13)$$

and

$$F_{00} \cdot F_{013} = 0. \quad (3.1.14)$$

By Theorem 3.1.1, the product \cdot admits the linear map $\mathbb{1} : \mathbb{K} \rightarrow \mathbf{Cl}_\delta$ satisfying $\mathbb{1}(1) = F_\epsilon$ as unit, and is graded. Moreover, again by this last theorem, \cdot is associative if and only if δ is valley-free. For instance, for $\delta := 101^\omega$, δ has a valley and since

$$(F_0 \cdot F_0) \cdot F_0 - F_0 \cdot (F_0 \cdot F_0) = F_{000} - (F_{000} + F_{001}) = -F_{001} \neq 0, \quad (3.1.15)$$

the product \cdot of \mathbf{Cl}_δ is not associative.

We now establish a link between this product \cdot on the F -basis of \mathbf{Cl}_δ and the posets $\mathbf{Cl}_\delta(n)$, $n \geq 0$, introduced and studied in the previous sections. For this, let for any $n_1, n_2 \geq 0$ the two binary operations

$$/, \setminus : \mathbf{Cl}_\delta(n_1) \times \mathbf{Cl}_\delta(n_2) \rightarrow \mathbb{N}^{n_1+n_2} \quad (3.1.16)$$

defined, for any $u, v \in \mathbf{Cl}_\delta$, by $u / v := uv$ and $u \setminus v := uv'$ where v' is the word on \mathbb{N} of length $|v|$ satisfying, for any $i \in [|v|]$,

$$v'_i = \begin{cases} \delta(|u| + i) & \text{if } v_i = \delta(i), \\ v_i & \text{otherwise.} \end{cases} \quad (3.1.17)$$

For instance, for $\delta = 112334^\omega$, $010 / 1021 = 0101021$ and $010 \setminus 1021 = 0103041$. For $\delta = 210^\omega$, $21 \setminus 11 = 2110$. Observe that this last word is not a δ -cliff.

LEMMA 3.1.2. *Let δ be a range map and $u, v \in \mathbf{Cl}_\delta$. If the word u / v is a δ -cliff, then $u \setminus v$ also is.*

PROOF. Assume that $w := u / v \in \mathbf{Cl}_\delta$. Hence, for any $i \in [|w|]$, $w_i \leq \delta(i)$. In particular, this implies that for any $i \in [|v|]$, $v_i = w_{|u|+i} \leq \delta(|u| + i)$. By definition of the operation \setminus , the word $w' := u \setminus v$ satisfies $w'_{|u|+i} \in \{v_i, \delta(|u| + i)\}$. Moreover, the fact that u is a δ -cliff implies that for any $i \in [|u|]$, $u_i = w'_i \leq \delta(i)$. Therefore, w' is a δ -cliff. \square

LEMMA 3.1.3. *A range map δ is weakly increasing if and only if for any $u, v \in \mathbf{Cl}_\delta$, u / v is a δ -cliff.*

PROOF. Assume that δ is weakly increasing and let $w := u / v$ where $u, v \in \mathbf{Cl}_\delta$. Hence, since v is a δ -cliff, for any $i \in [|v|]$, $w_{|u|+i} = v_i \leq \delta(i)$. Since δ is weakly increasing, we have $\delta(i) \leq \delta(|u| + i)$. This implies that $w_{|u|+i} \leq \delta(|u| + i)$. Moreover, the fact that u is δ -cliff implies that, for any $i \in [|u|]$, $w_i = u_i \leq \delta(i)$. Therefore, u / v is a δ -cliff.

Conversely, assume that all $w := u / v$ are δ -cliffs for all $u, v \in \mathbf{Cl}_\delta$. Hence, since v is a δ -cliff, for any $i \in [|v|]$, $v_i \leq \delta(i)$. Moreover, since w is a δ -cliff, $v_i = w_{|u|+i} \leq \delta(|u| + i)$. This implies that $\delta(i) \leq \delta(|u| + i)$. Since this last relation holds for all δ -cliffs u and v , and that there is at least one δ -cliff of any size, this leads to the fact that δ weakly increasing. \square

Let $\chi_\delta : \mathbb{N}^* \rightarrow \mathbb{K}$ be the map defined for any $u \in \mathbb{N}^*$ by $\chi_\delta(u) := \mathbf{1}_{u/v \in \mathbf{Cl}_\delta}$.

THEOREM 3.1.4. For any range map δ , the product \cdot of \mathbf{Cl}_δ satisfies, for any $u, v \in \mathbf{Cl}_\delta$,

$$F_u \cdot F_v = \chi_\delta(u / v) \sum_{w \in [u / v, u \setminus v]} F_w \quad (3.1.18)$$

where $[u / v, u \setminus v]$ is an interval of the poset $\mathbf{Cl}_\delta(|u| + |v|)$.

PROOF. Assume first that $w := u / v \in \mathbf{Cl}_\delta$. By Lemma 3.1.2, $u \setminus v \in \mathbf{Cl}_\delta$. By (3.1.10), for any $w' \in \mathbf{Cl}_\delta$, $F_{w'}$ appears in $F_u \cdot F_v$ if and only if there is $v' \in r_\delta^{-1}(v)$ such that $uv' = w'$. This implies that $r_\delta(v') = v$ and, by definition of the δ -reduction map, for any $i \in [|v|]$, $v'_i \geq v_i$. Moreover, since w' is a δ -cliff, we have for any $i \in [|v|]$, $v'_i = w'_{|u|+i} \leq \delta(|u| + i)$. Therefore, for all $i \in [|v|]$, $v_i \leq v'_i \leq \delta(|u| + i)$. This is equivalent to the fact that $u / v \preceq w' \preceq u \setminus v$ and leads to the expression of the statement of theorem.

Assume finally that $w := u / v \notin \mathbf{Cl}_\delta$. Since u and v are δ -cliffs, there exists an index $i \in [|v|]$ such that $w_{|u|+i} > \delta(|u| + i)$. Since $w_{|u|+i} = v_i$, this implies that $v_i > \delta(|u| + i)$. Observe that by definition of the δ -reduction map, for all $v' \in r_\delta^{-1}(v)$ and $j \in [|v|]$, $v'_j \geq v_j$. Therefore, no uv' can be a δ -cliff. By inspecting Formula (3.1.10) for the product \cdot , we obtain that the sum is empty, so that $F_u \cdot F_v = 0$. \square

For instance, for $\delta := 01120^\omega$,

$$F_{01} \cdot F_{010} = F_{01010} + F_{01020} + F_{01110} + F_{01120},$$

and, since $01 / 011 = 01011 \notin \mathbf{Cl}_\delta$,

$$F_{01} \cdot F_{011} = 0.$$

In particular when δ is weakly increasing, Lemma 3.1.3 and Theorem 3.1.4 state that any product of two elements of the F-basis of \mathbf{Cl}_δ is a sum of elements of the F-basis ranging in an interval of a δ -cliff poset.

3.2. E and H-bases. By mimicking the construction of bases of several combinatorial spaces by using a particular partial order on their basis element (see for instance [DHT02, HNT05]), let for any $u \in \mathbf{Cl}_\delta$,

$$E_u := \sum_{\substack{v \in \mathbf{Cl}_\delta \\ u \preceq v}} F_v \quad (3.2.1)$$

and

$$H_u := \sum_{\substack{v \in \text{Cl}_\delta \\ v \preccurlyeq u}} F_v. \quad (3.2.2)$$

By triangularity, the sets $\{E_u : u \in \text{Cl}_\delta\}$ and $\{H_u : u \in \text{Cl}_\delta\}$ are bases of Cl_δ , called respectively *elementary basis* and *homogeneous basis*, or respectively *E-basis* and *H-basis*. For instance, for $\delta := 1021^\omega$,

$$E_{10010} = F_{10010} + F_{10011} + F_{10110} + F_{10111} + F_{10210} + F_{10211}, \quad (3.2.3)$$

and

$$H_{10010} = F_{10010} + F_{10000} + F_{00010} + F_{00000}. \quad (3.2.4)$$

PROPOSITION 3.2.1. *For any range map δ , the product \cdot of Cl_δ satisfies, for any $u, v \in \text{Cl}_\delta$,*

$$E_u \cdot E_v = \chi_\delta(u/v) E_{u/v} \quad (3.2.5)$$

PROOF. By (3.1.10), we have

$$\begin{aligned} E_u \cdot E_v &= \sum_{\substack{u', v' \in \text{Cl}_\delta \\ u \preccurlyeq u' \\ v \preccurlyeq v'}} \sum_{\substack{v'' \in r_\delta^{-1}(v') \\ u'v'' \in \text{Cl}_\delta}} F_{u'v''} \\ &= \sum_{\substack{u' \in \text{Cl}_\delta \\ u \preccurlyeq u'}} \sum_{\substack{v'' \in \mathbb{N}^* \\ v \preccurlyeq r_\delta(v'') \\ u'v'' \in \text{Cl}_\delta}} F_{u'v''} \\ &= \sum_{\substack{u' \in \text{Cl}_\delta \\ u \preccurlyeq u'}} \sum_{\substack{v'' \in \mathbb{N}^{|v|} \\ \forall i \in [|v|], v_i \leq v''_i \\ u'v'' \in \text{Cl}_\delta}} F_{u'v''}. \end{aligned} \quad (3.2.6)$$

The equality between the third and the last member of (3.2.6) is a consequence of the fact that for any $v'' \in \mathbb{N}^*$, one has $v \preccurlyeq r_\delta(v'')$ if and only if $v_i \leq v''_i$ for all $i \in [|v|]$. By definition of the E-basis provided by (3.2.1), the last member of (3.2.6) is equal to the stated formula. \square

PROPOSITION 3.2.2. *For any range map δ , the product \cdot of Cl_δ satisfies, for any $u, v \in \text{Cl}_\delta$,*

$$H_u \cdot H_v = H_{r_\delta(u \setminus v)}. \quad (3.2.7)$$

PROOF. By (3.1.10), we have

$$\begin{aligned} H_u \cdot H_v &= \sum_{\substack{u', v' \in \text{Cl}_\delta \\ u \preccurlyeq u' \\ v' \preccurlyeq v}} \sum_{\substack{v'' \in r_\delta^{-1}(v') \\ u'v'' \in \text{Cl}_\delta}} F_{u'v''} \\ &= \sum_{\substack{u' \in \text{Cl}_\delta \\ u \preccurlyeq u'}} \sum_{\substack{v'' \in \mathbb{N}^* \\ r_\delta(v'') \preccurlyeq v \\ u'v'' \in \text{Cl}_\delta}} F_{u'v''} \\ &= \sum_{\substack{u' \in \text{Cl}_\delta \\ u \preccurlyeq u'}} \sum_{\substack{v'' \in \mathbb{N}^{|v|} \\ \forall i \in [|v|], v_i < \delta(i) \Rightarrow v''_i \leq v_i \\ u'v'' \in \text{Cl}_\delta}} F_{u'v''}. \end{aligned} \quad (3.2.8)$$

The equality between the third and the last member of (3.2.8) is a consequence of the fact that for any $v'' \in \mathbb{N}^*$, one has $r_\delta(v'') \preceq v$ if and only if for all $i \in [|\nu|]$, $v_i < \delta(i)$ implies $v''_i \leq v_i$. By definition of the H-basis provided by (3.2.2), and since $F_{r_\delta(u \setminus v)}$ is the element with the greatest index appearing in the last member of (3.2.8), this expression is equal to the stated formula. \square

It can be shown that \mathbf{Cl}_1 is free by reasoning on the E-basis. A consequence of the freeness of \mathbf{Cl}_1 is that \mathbf{Cl}_1 is isomorphic as a unital associative algebra to FQSym [MR95, DHT02], an associative algebra on the linear span of all permutations. This follows from the fact that FQSym is also free as a unital associative algebra and that its Hilbert series is the same as the one of \mathbf{Cl}_1 . Moreover, in [NT14], the authors construct some associative algebras ${}^m\text{FQSym}$ as generalizations of FQSym whose bases are indexed by objects being generalizations of permutations. The algebras \mathbf{Cl}_m , $m \geq 0$, can therefore be seen as other generalizations of FQSym , not isomorphic to ${}^m\text{FQSym}$ when $m \geq 2$.

3.3. Quotient algebras. This last section of this work provides an answer to the problem set out in the introduction. This question concerns the possibility of constructing a hierarchy of substructures of \mathbf{Cl}_δ similar to that of FQSym . For this, we consider quotients of \mathbf{Cl}_δ obtained by considering a graded subset \mathcal{S} of \mathbf{Cl}_δ and by equating the basis elements F_u with 0 whenever $u \notin \mathcal{S}$. As we shall see, this is possible only under some combinatorial conditions on \mathcal{S} . We describe the products of these quotient algebras and give a sufficient condition for the fact that it can be expressed by interval of the poset $\mathcal{S}(n)$ for a certain $n \geq 0$. We end this part by studying the quotients of \mathbf{Cl}_m obtained from \mathbf{m} -hills and \mathbf{m} -canyons.

3.3.1. Quotient space. Let δ be a range map. Given a graded subset \mathcal{S} of \mathbf{Cl}_δ , let $\mathbf{Cl}_\mathcal{S}$ be the quotient space of \mathbf{Cl}_δ defined by

$$\mathbf{Cl}_\mathcal{S} := \mathbf{Cl}_\delta / \mathcal{V}_\mathcal{S} \quad (3.3.1)$$

such that $\mathcal{V}_\mathcal{S}$ is the linear span of the set

$$\{F_u : u \in \mathbf{Cl}_\delta \setminus \mathcal{S}\}. \quad (3.3.2)$$

By definition, the set $\{F_u : u \in \mathcal{S}\}$ is a basis of $\mathbf{Cl}_\mathcal{S}$.

Let us introduce here an important combinatorial condition for the sequel on \mathcal{S} . We say that \mathcal{S} is *closed by suffix reduction* if for any $u \in \mathcal{S}$, for all suffixes u' of u , $r_\delta(u') \in \mathcal{S}$.

PROPOSITION 3.3.1. *Let δ be a valley-free range map and \mathcal{S} be a graded subset of \mathbf{Cl}_δ . If \mathcal{S} is closed by prefix and is closed by suffix reduction, then $\mathbf{Cl}_\mathcal{S}$ is a quotient algebra of the unital associative algebra $(\mathbf{Cl}_\delta, \cdot, \mathbb{1})$.*

PROOF. Notice first that, since δ is valley-free, \mathbf{Cl}_δ is by Theorem 3.1.1 a well-defined unital associative algebra. We have to prove that $\mathcal{V}_\mathcal{S}$ is an associative algebra ideal of \mathbf{Cl}_δ . For this, let $F_u \in \mathcal{V}_\mathcal{S}$ and $F_v \in \mathbf{Cl}_\mathcal{S}$. Let us look at Expression (3.1.10) for computing the product of \mathbf{Cl}_δ . Assume that there is a cliff $uv' \in \mathcal{S}$ such that $F_{uv'}$ appears in $F_u \cdot F_v$. Then, since \mathcal{S} is closed by prefix, $u \in \mathcal{S}$, which contradicts our hypothesis. For this reason,

$F_u \cdot F_v$ belongs to \mathcal{V}_S . Moreover, let $F_u \in \mathbf{Cl}_S$ and $F_v \in \mathcal{V}_S$. Assume that there is a cliff $uv' \in S$ such that $F_{uv'}$ appears in $F_u \cdot F_v$. Then, since S is closed by suffix reduction, one has $r_\delta(v') \in S$. By (3.1.10), $r_\delta(v') = v$, leading to the fact that $v \in S$ holds, and which contradicts our hypothesis. Therefore, $F_u \cdot F_v$ belongs to \mathcal{V}_S . This establishes the statement of the proposition. \square

Notice that the graded subset Av_δ is not closed by suffix reduction. For instance, even if 00112 is an $\mathbf{1}$ -avalanche, the $\mathbf{1}$ -reduction of its suffix 112 is 012, which is not an $\mathbf{1}$ -avalanche.

Let us denote by $\theta_S : \mathbf{Cl}_\delta \rightarrow \mathbf{Cl}_S$ the canonical projection map. By definition, this map satisfies, for any $u \in \mathbf{Cl}_\delta$,

$$\theta_S(F_u) = \mathbf{1}_{u \in S} F_u. \quad (3.3.3)$$

3.3.2. Product. We show here that under some conditions of S , the product in \mathbf{Cl}_S can be described by using the poset structure of S . More precisely, we say that \mathbf{Cl}_S has the *interval condition* if the support of any product $F_u \cdot F_v$, $u, v \in S$, is empty or is an interval of a poset $S(n)$, $n \geq 0$.

LEMMA 3.3.2. *Let δ be a range map and S be a graded subset of \mathbf{Cl}_δ such that for any $n \geq 0$, $S(n)$ is a meet (resp. join) semi-sublattice of $\mathbf{Cl}_\delta(n)$. For any $u, v \in S$, if u/v is a δ -cliff, then the set*

$$[u/v, u \setminus v] \cap S \quad (3.3.4)$$

admits at most one minimal (resp. maximal) element.

PROOF. Assume that $S(n)$ is a meet semi-sublattice of $\mathbf{Cl}_\delta(n)$ and that $u/v \in \mathbf{Cl}_\delta$. By Lemma 3.1.2, $u \setminus v \in \mathbf{Cl}_\delta$ so that $I := [u/v, u \setminus v]$ is a well-defined interval of $\mathbf{Cl}_\delta(n)$. Assume that there exist two δ -cliffs w and w' belonging to $I \cap S$. Since $S(n)$ is a meet semi-sublattice of $\mathbf{Cl}_\delta(n)$, by setting $w'' := w \wedge w'$, one has $w'' \in S$. Since u/v is a lower bound of both w and w' , we necessarily have $u/v \preceq w''$ and $w'' \in I$. This shows that when $I \cap S$ is nonempty, this set admits exactly one minimal element. The proof is analogous for the respective part of the statement of the proposition. \square

When for any $n \geq 0$, $S(n)$ is a lattice, we denote by \wedge_S (resp. \vee_S) its meet (resp. join) operation. In this case, S is *meet-stable* (resp. *join-stable*) if, for any $n \geq 0$ and any $u, v \in S(n)$, the relation $u_i = v_i$ for an $i \in [n]$ implies that the i -th letter of $u \wedge_S v$ (resp. $u \vee_S v$) is equal to u_i .

LEMMA 3.3.3. *Let δ be a range map and S be a closed by prefix, maximally extendable, and join-stable graded subset of \mathbf{Cl}_δ . For any $u, v \in S$ such u/v is a δ -cliff, the set*

$$[u/v, u \setminus v] \cap S \quad (3.3.5)$$

admits at most one maximal element.

PROOF. Assume that $u/v \in \mathbf{Cl}_\delta$. By Lemma 3.1.2, $u \setminus v \in \mathbf{Cl}_\delta$ so that $I := [u/v, u \setminus v]$ is a well-defined interval of δ -cliff poset. Assume that there exist two δ -cliffs w and w' belonging to $I \cap S$. It follows from the hypotheses on S of the statement that, by Theorem 1.3.4, the operation \vee_S is the join operation of the posets $S(n)$, $n \geq 0$ (see Section 1.3.2). First,

since $w \preceq u \setminus v$ and $w' \preceq u \setminus v$, we have $w \vee w' \preceq u \setminus v$. Moreover, by definition of the \vee_S operation, $w'' := w \vee_S w'$ is obtained by incrementing by some values some letters of $w \vee w'$. Now, observe that due to the definitions of the operations $/$ and \setminus , w and w' write respectively as $w = ur$ and $w' = ur'$ where r and r' are some words on \mathbb{N} . Moreover, if there is an index $i \in [|r|]$ such that $r_i \neq r'_i$, then $v_i = \delta(i)$ and $(u \setminus v)_{|u|+i} = \delta(|u| + i)$. This, the definition of the \vee_S operation, and the fact that S is join-stable imply that $w'' \preceq u \setminus v$. Therefore, $w'' \in I \cap S$. This shows that when $I \cap S$ is nonempty, this set admits exactly one maximal element. \square

THEOREM 3.3.4. *Let δ be a valley-free range map and S be a graded subset of Cl_δ closed by prefix and by suffix reduction. If at least one the following conditions is satisfied:*

- (i) *for any $n \geq 0$, all posets $S(n)$ are sublattices of $\text{Cl}_\delta(n)$,*
- (ii) *for any $n \geq 0$, all posets $S(n)$ are meet semi-sublattices of $\text{Cl}_\delta(n)$, maximally extendable, and join-stable,*

then \mathbf{Cl}_S has the interval condition.

PROOF. First, by Proposition 3.3.1, \mathbf{Cl}_S is a well-defined unital associative algebra quotient of \mathbf{Cl}_δ . Now, the product $F_u \cdot F_v$ in \mathbf{Cl}_S can be computed as the image by θ_S of the product of the same inputs in \mathbf{Cl}_δ . By Theorem 3.1.4, this product is equal to zero or its support I is an interval of a δ -cliff poset. By construction of \mathbf{Cl}_S , the support of the product $F_u \cdot F_v$ in \mathbf{Cl}_S is equal to $I' := I \cap S$. If (i) holds, then by Lemma 3.3.2, I' admits both a minimal and a maximal element. If (ii) holds, then by Lemma 3.3.2, I' admits a minimal element, and by Lemma 3.3.3, S' admits a maximal element. In both cases, I' is an interval of a poset $S(n)$, $n \geq 0$. \square

3.3.3. Examples: two Fuss-Catalan associative algebras. We define and study the associative algebras related to the \mathbf{m} -hill posets and to the \mathbf{m} -canyon posets.

Hill associative algebras. For any $m \geq 0$, let \mathbf{Hi}_m be the quotient $\mathbf{Cl}_{\text{Hi}_m}$. This quotient is well-defined due to the fact that Hi_m satisfies the conditions of Proposition 3.3.1. Moreover, by Proposition 2.2.1 and Point (i) of Theorem 3.3.4, \mathbf{Hi}_m has the interval condition. For instance, one has in \mathbf{Hi}_1 ,

$$F_{01} \cdot F_{01} = F_{0111} + F_{0112} + F_{0113} + F_{0122} + F_{0123}, \quad (3.3.6a)$$

$$F_{01} \cdot F_{00} = 0, \quad (3.3.6b)$$

$$F_{001} \cdot F_{0122} = F_{0011122} + F_{0011222} + F_{0012222}. \quad (3.3.6c)$$

In \mathbf{Hi}_2 , one has

$$F_{02} \cdot F_{023} = F_{02223} + F_{02233} + F_{02333}, \quad (3.3.7a)$$

$$F_{011} \cdot F_{01} = F_{01111}, \quad (3.3.7b)$$

$$F_{0015} \cdot F_{014} = 0. \quad (3.3.7c)$$

By computer exploration, minimal generating families of \mathbf{Hi}_1 and \mathbf{Hi}_2 , respectively up to degree 5 and 4, are

$$\begin{aligned} F_0, F_{00}, F_{001}, F_{011}, F_{0002}, F_{0011}, F_{0012}, F_{0022}, F_{0112}, F_{0122}, \\ F_{00003}, F_{00013}, F_{00023}, F_{00033}, F_{00112}, F_{00113}, F_{00122}, F_{00123}, F_{00133}, F_{00222}, \\ F_{00223}, F_{00233}, F_{01113}, F_{01122}, F_{01123}, F_{01133}, F_{01223}, F_{01233}, \end{aligned} \quad (3.3.8)$$

and

$$\begin{aligned} F_0, F_{00}, F_{01}, F_{001}, F_{002}, F_{003}, F_{012}, F_{013}, F_{022}, F_{023}, \\ F_{0004}, F_{0005}, F_{0012}, F_{0013}, F_{0014}, F_{0015}, F_{0022}, F_{0023}, F_{0024}, F_{0025}, F_{0033}, F_{0034}, F_{0035}, \\ F_{0044}, F_{0045}, F_{0114}, F_{0115}, F_{0122}, F_{0123}, F_{0124}, F_{0125}, F_{0133}, F_{0134}, F_{0135}, F_{0144}, F_{0145}, \\ F_{0223}, F_{0224}, F_{0225}, F_{0234}, F_{0235}, F_{0244}, F_{0245}. \end{aligned} \quad (3.3.9)$$

Moreover, the sequences for the numbers of generators of \mathbf{Hi}_1 and \mathbf{Hi}_2 , degree by degree begin respectively by

$$0, 1, 1, 2, 6, 18, 59, 196, 669, \quad (3.3.10)$$

and

$$0, 1, 2, 7, 33, 168, 900, 4980. \quad (3.3.11)$$

We can observe that for any $m \geq 1$, \mathbf{Hi}_m is not free as unital associative algebra. Indeed, the quasi-inverse of the respective generating series of these elements is not the Hilbert series of \mathbf{Hi}_m , which is expected when this algebra is free.

Canyon associative algebras. For any $m \geq 0$, let \mathbf{Ca}_m be the quotient $\mathbf{Cl}_{\mathbf{Ca}_m}$. This quotient is well-defined due to the fact that \mathbf{Ca}_m satisfies the conditions of Proposition 3.3.1. Moreover, by Proposition 2.3.1, the fact that for any $m \geq 0$ and $n \geq 0$, $\mathbf{Ca}_m(n)$ is join-stable, and by Point (ii) of Theorem 3.3.4, \mathbf{Ca}_m has the interval condition. For instance, one has in \mathbf{Ca}_1 ,

$$F_0 \cdot F_{01} = F_{001} + F_{002} + F_{012}, \quad (3.3.12a)$$

$$F_0 \cdot F_{002} = F_{0002} + F_{0003} + F_{0103}, \quad (3.3.12b)$$

$$\begin{aligned} F_{0012} \cdot F_{0103} = F_{00120103} + F_{00120106} + F_{00120107} + F_{00120406} + F_{00120407} \\ + F_{00120507} + F_{00123406} + F_{00123407} + F_{00123507} + F_{00124507}. \end{aligned} \quad (3.3.12c)$$

In \mathbf{Ca}_2 , one has

$$F_{01} \cdot F_{0014} = 0, \quad (3.3.13a)$$

$$F_{01} \cdot F_{0013} = F_{010013}. \quad (3.3.13b)$$

$$\begin{aligned} F_{020} \cdot F_{02} = F_{02002} + F_{02005} + F_{02006} + F_{02007} + F_{02008} + F_{02012} + F_{02015} + F_{02016} \\ + F_{02017} + F_{02018} + F_{02045} + F_{02046} + F_{02047} + F_{02048} + F_{02056} + F_{02057} \\ + F_{02058} + F_{02067} + F_{02068}. \end{aligned} \quad (3.3.13c)$$

By computer exploration, minimal generating families of \mathbf{Ca}_1 and \mathbf{Ca}_2 , respectively up to respectively up to degree 5 and 4, are

$$\begin{aligned} F_0, F_{00}, F_{000}, F_{001}, F_{0000}, F_{0001}, F_{0002}, F_{0010}, F_{0012}, \\ F_{00000}, F_{00001}, F_{00002}, F_{00003}, F_{00010}, F_{00012}, F_{00013}, F_{00020}, F_{00023}, F_{00100}, \\ F_{00101}, F_{00103}, F_{00120}, F_{00123}, \end{aligned} \quad (3.3.14)$$

and

$$\begin{aligned} F_0, F_{00}, F_{01}, F_{000}, F_{002}, F_{003}, F_{010}, F_{012}, F_{013}, F_{023}, \\ F_{0000}, F_{0003}, F_{0004}, F_{0005}, F_{0014}, F_{0015}, F_{0020}, F_{0023}, F_{0024}, F_{0025}, F_{0030}, F_{0034}, F_{0035}, F_{0045}, F_{0100}, \\ F_{0104}, F_{0105}, F_{0120}, F_{0124}, F_{0125}, F_{0130}, F_{0134}, F_{0135}, F_{0145}, F_{0204}, F_{0205}, F_{0230}, F_{0234}, F_{0235}, F_{0245}. \end{aligned} \quad (3.3.15)$$

The associative algebra \mathbf{Ca}_1 is the Loday-Ronco algebra [LR98], also known as PBT [HNT05]. It is known that this associative algebra is free and that the dimension of its generators are a shifted version of Catalan numbers:

$$0, 1, 1, 2, 5, 14, 42, 132, 429. \quad (3.3.16)$$

The sequence for the numbers of generators of \mathbf{Ca}_2 degree by degree begins by

$$0, 1, 2, 7, 30, 149, 788, 4332. \quad (3.3.17)$$

We can observe that for any $m \geq 2$, \mathbf{Ca}_m is not free as unital associative algebra. It follows, from the same argument as the previous section, that \mathbf{Ca}_m is not free.

Perspectives

To conclude this thesis, we propose several possible directions of research, in the continuity of the presented work. Except for the last axis of research, the first three concern cubical lattices, meaning lattices admitting a cubical realization, notion introduced in this thesis.

Cubical lattices and polytopes

Tamari lattices are known to be the 1-skeletons of the associahedra, also called the Stasheff polytopes. More precisely, the Hasse diagrams of the Tamari lattices are the edges and vertices of the associahedra.

Among the lattices presented in this work, two are, up to continuous deformation, the 1-skeletons of known cell complexes. Thus, we saw in Chapter 2 that the posets of cubic coordinates seem to be the 1-skeletons of the diagonal of the associahedra [Lod11, SU04, MS06]. Likewise, in Chapter 3, the Hochschild lattices seem to be the 1-skeletons of the Hochschild polytopes, also called the freehedron.

Study the links between cubical lattices and polytopes is the first axis of research proposed. More precisely, it seems that if a lattice admits a cubical realization, it is possible to build, under some rules to find, a cell complex. The reversal question can be also addressed: for any polytope, can we find a cubical lattice which is this 1-skeleton?

In Chapter 4, we study several family of cubical lattices. A first approach consists in finding geometric realizations of these posets, giving cell complexes. Then, knowing that these lattices are related to each other, we can look for links between these realizations. For instance, by finding a certain truncations process to build the cell complexes associated to the canyon lattices from the cell complexes associated to the cliff lattices.

The core label order of cubical lattices

Lattices which are constructible by interval doubling, or congruence uniform lattices, admit an alternative way to order their elements. This order is called the *core label order* [Müh19] and was first considered under the term of *shard intersection order* by Reading in the context of posets of regions of hyperplane arrangements [Rea11]. In this quoted article, Reading proves that the core label order of the Tamari lattice is isomorphic to the lattice of noncrossing partitions. Recently, Mühle shows in [Müh20] that the Hochschild poset admits also a lattice as core label order. More than that, he shows that

the core label order of the Hochschild lattice is isomorphic to a certain shuffle lattice introduced by Greene [Gre88].

A first idea is to show that the poset of cubic coordinates $CC(n)$, meaning the poset of Tamari intervals, is a congruence uniform lattice. A way to prove that is to find a sequence of interval contractions from the lattice $CC(n)$ to the Tamari lattice $T_2(n)$, with $n \geq 0$, as it is done to prove that subposets of the cliff posets are constructible by interval doubling in Chapter 4. For instance, a sequence of interval contractions from $CC(3)$ to a poset isomorphic to the Tamari lattice $T_2(3)$ could be

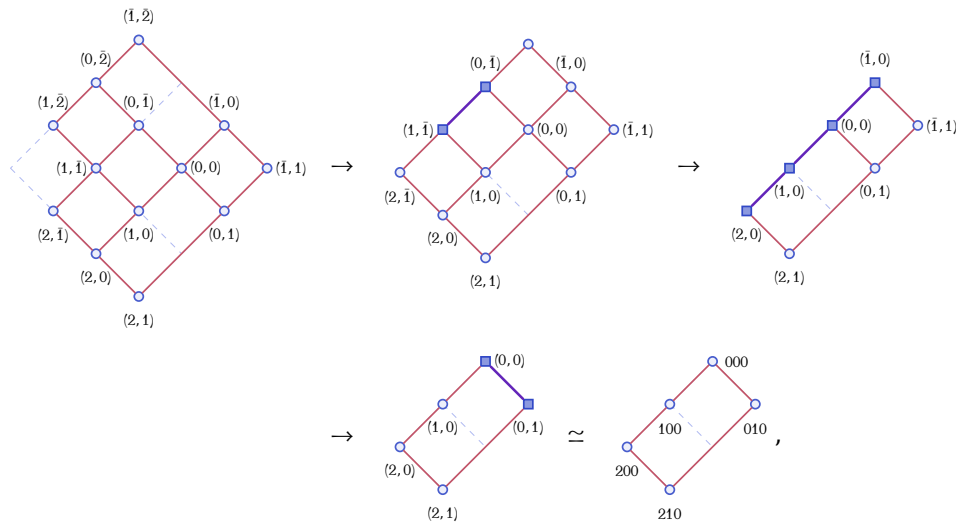

where the marked intervals are the ones involved in the presumed interval doubling operations.

If the posets of Tamari intervals are congruence uniform, we can then ask ourselves what is the core label order of this lattice, and see if there is a link with the lattice of noncrossing partitions.

Likewise, a study of the core label order of the canyon poset and hill poset introduced in Chapter 4 can be done.

Finally, we saw in Chapter 4 that under certain conditions, cubical lattices are constructible by interval doubling. A natural question is to ask if any congruence uniform lattice is a cubical lattice.

Inherited properties for the k -chain lattices

It is known that if a poset \mathcal{L} is a lattice, then the poset of intervals $\text{int}(\mathcal{L})$ of this lattice is also a lattice. We recall this fact in Section 2.2 of Chapter 1. Another more recent example of inherited properties for intervals is the trimness of the lattice [TW19]. Conversely, intervals of extremal lattices are not usually again extremal lattices [Mar92].

At the end of Chapter 2 we show that the Tamari interval lattices are EL-shellable, extending the result of Björner and Wachs [BW97] on the EL-shellability of the Tamari lattices. Likewise, in the previous perspective, we assume that the property of being constructible by interval doubling of the Tamari lattices is inherited by the Tamari interval lattices.

The idea of this proposed axis of research is to see what are the properties which remain valid for the lattices of intervals of lattices satisfying these same properties. More generally, we can consider this question for the lattices of k -chains. We can thus ask for instance about the shellability, the constructibility by interval doubling, and the existence of a cubical realization.

The question about the inherited of the cubical lattice property can be rephrased as follows: given a cubical lattice, can we find a way to encode its intervals such that the obtained lattice is cubical? We give the answer for Tamari lattices in Chapter 2 with cubic coordinates, but it seems to be complicated to generalize cubic coordinates for generalizations of Tamari lattices. The question remains for the canyon lattices and the hill lattices, or for the k -chains of the Hochschild lattices.

Cliffs operads and generalizations of the Dendriform operad

In Chapter 4 we have seen that for $m = 1$, the canyon posets coincide with the Tamari posets. For $m > 1$, we obtain a generalization of the Tamari lattices, which is different from those already known, as the m -Tamari lattices [BPR12] or the μ -Tamari lattices [PRV17].

One of our main motivations for this work is the definition of an associative algebra on the set of cliffs, where the product between two cliffs is the sum of cliffs forming an interval in the cliff posets. This property is true for many other algebraic structures, such as the Malvenuto-Reutenauer algebra for the weak order [DHT02, AS05], or the Loday-Ronco algebra for the Tamari order [HNT05]. Considering a certain quotient of cliffs algebra, we define the algebra of canyons, which then becomes to the algebra of cliffs what the algebra PBT is to the algebra FQSym. The pair of algebras thus obtained is a generalization of the pair of algebras PBT and FQSym.

The driving idea of this axis is to ask similar questions at the level of operads and not only at the level of associative algebras. Indeed, the space of permutations (and thus the space underlying FQSym) is equipped with an operad structure known as the associative operad [AL07]. In the work quoted, it is shown that under an appropriate changing of basis, the partial composition of this operad is described by a sum over an interval of the weak order. The dendriform operad has a similar property related to the Tamari order [Lod10].

A first objective is to endow the space of cliffs with an operad structure which would play a role similar to the associative operad, but where the cliff poset is used. Then, in the same way as previously presented, the idea is to build a quotient operad of the cliff operad restricted to canyons. This would lead to an operad whose dimensions are given by Fuss-Catalan number and which would offer a new generalisation of the dendriform

operad. The comparison between this generalization and those already existing [**Gir16**, **Ler07**, **Nov14**] would then be possible.

Bibliography

- [Abe80] E. Abe. *Hopf algebras*, volume 74 of *Cambridge Tracts in Mathematics*. Cambridge University Press, Cambridge-New York, 1980. 37
- [AL07] M. Aguiar and M. Livernet. The associative operad and the weak order on the symmetric groups. *J. Homotopy Relat. Struct.*, 2(1):57–84, 2007. 149
- [AS05] M. Aguiar and F. Sottile. Structure of the Malvenuto-Reutenauer Hopf algebra of permutations. *Adv. Math.*, 191(2):225–275, 2005. 136, 149
- [AVL62] G. M. Adelson-Velsky and E. M. Landis. An algorithm for organization of information. *Soviet Mathematics Doklady*, 3:1259–1263, 1962. 1, 7
- [BB09] O. Bernardi and N. Bonichon. Intervals in Catalan lattices and realizers of triangulations. *J. Combin. Theory Ser. A*, 116(1):55–75, 2009. 29, 47, 134
- [Bir37] G. Birkhoff. Rings of sets. *Duke Math. J.*, 3(3):443–454, 1937. 31
- [Bir79] G. Birkhoff. *Lattice theory*, volume 25 of *American Mathematical Society Colloquium Publications*. American Mathematical Society, Providence, R.I., third edition, 1979. 30, 102
- [BMFPR11] M. Bousquet-Mélou, É. Fusy, and L-F. Préville-Ratelle. The number of intervals in the m -Tamari lattices. *Electron. J. Comb.*, 18(2), 2011. Paper 31. 128
- [BMFPR12] M. Bousquet-Mélou, É. Fusy, and L-F. Préville-Ratelle. The number of intervals in the m -Tamari lattices. *Electronic J. Combin.*, 18(2), 2012. 1, 6, 47, 128
- [BP06] J. L. Baril and J. M. Pallo. The phagocyte lattice of Dyck words. *Order*, 23(2-3):97–107, 2006. 1, 6
- [BP08] J. L. Baril and J. M. Pallo. The pruning-grafting lattice of binary trees. *Theoret. Comput. Sci.*, 409(3):382–393, 2008. 1, 6
- [BPR12] F. Bergeron and L-F. Préville-Ratelle. Higher trivariate diagonal harmonics via generalized Tamari posets. *J. Combin.*, (3):317–341, 2012. 26, 47, 98, 149
- [BS97] A. Blass and B. Sagan. Möbius functions of lattices. *Adv. in Math.*, 127:94–123, 1997. 31
- [BW96] A. Björner and M. L. Wachs. Shellable nonpure complexes and posets. I. *Trans. Amer. Math. Soc.*, 348(4):1299–1327, 1996. 5, 10, 11, 34, 48, 98
- [BW97] A. Björner and M. L. Wachs. Shellable nonpure complexes and posets. II. *Trans. Amer. Math. Soc.*, 349(10):3945–3975, 1997. 5, 10, 16, 34, 35, 48, 98, 128, 149
- [Cha06] F. Chapoton. Sur le nombre d’intervalles dans les treillis de Tamari. *Sém. Lothar. Combin.*, 55:Art. B55f, 18, 2006. 1, 6, 32, 47
- [Cha18] F. Chapoton. Une note sur les intervalles de Tamari. *Ann. Math. Blaise Pascal*, 25(2):299–314, 2018. 69
- [Cha20] F. Chapoton. Some properties of a new partial order on Dyck paths. *Algebraic Combinatorics*, 3:433–463, 2020. 5, 10, 27, 28, 75, 76, 78, 79
- [CLCdPBM04] N. Caspard, C. Le Conte de Poly-Barbut, and M. Morvan. Cayley lattices of finite Coxeter groups are bounded. *Adv. Appl. Math.*, 33(1):71–94, 2004. 36
- [CP15] G. Châtel and V. Pons. Counting smaller elements in the Tamari and m -Tamari lattices. *J. Combin. Theory Ser. A*, 134: 58–97, 2015. 4, 9, 32, 47
- [CP19] C. Ceballos and V. Pons. The s -weak order and s -permutahedra. *Sém. Lothar. Combin.*, 82B:Article #76, 2019. 101
- [Day79] A. Day. Characterizations of finite lattices that are bounded-homomorphic images of sublattices of free lattices. *Canadian J. Math.*, 31(1):69–78, 1979. 36, 84, 98, 121, 128

- [Day92] A. Day. Doubling constructions in lattice theory. *Canad. J. Math.*, 44(2):252–269, 1992. [4](#), [9](#), [11](#), [35](#), [36](#)
- [Den13] H. Denoncourt. A refinement of weak order intervals into distributive lattices. *Ann. Comb.*, 17(4):655–670, 2013. [25](#), [97](#), [102](#)
- [DHNT11] G. H. E. Duchamp, F. Hivert, J.-C. Novelli, and J.-Y. Thibon. Noncommutative symmetric functions VII: free quasi-symmetric functions revisited. *Ann. Comb.*, 15(4):655–673, 2011. [43](#)
- [DHT02] G. Duchamp, F. Hivert, and J.-Y. Thibon. Noncommutative Symmetric Functions VI: Free Quasi-Symmetric Functions and Related Algebras. *Int. J. of Algebr. Comput.*, 12:671–717, 2002. [43](#), [97](#), [136](#), [139](#), [141](#), [149](#)
- [DM47] A. Dvoretzky and Th. Motzkin. A problem of arrangements. *Duke Math. J.*, 14(2):305–313, 1947. [15](#), [98](#)
- [FPR17] W. Fang and L-F. Préville-Ratelle. The enumeration of generalized Tamari intervals. *European J. Combin.*, 61:69–84, 2017. [47](#), [57](#)
- [FS09] P. Flajolet and R. Sedgewick. *Analytic combinatorics*. Cambridge University Press, Cambridge, 2009. [1](#), [6](#), [12](#)
- [Gey94] W. Geyer. On Tamari lattices. *Discrete Math.*, 133(1):99–122, 1994. [128](#)
- [Gir16] S. Giraud. Pluriassociative algebras II: The polydendriform operad and related operads. *Adv. in Appl. Math.*, 77:43–85, 2016. [150](#)
- [GKL⁺95] I. M. Gelfand, D. Krob, A. Lascoux, B. Leclerc, V. S. Retakh, and J.-Y. Thibon. Noncommutative symmetric functions I. *Adv. Math.*, 112:218–348, 1995. [97](#), [136](#)
- [Gre88] C. Greene. Posets of shuffles. *J. Combin. Theory Ser. A*, 47(2):191–206, 1988. [148](#)
- [GW16] G. Grätzer and F. Wehrung, editors. *Lattice Theory: Special Topics and Applications*, volume 2. Birkhäuser/Springer, Cham, 2016. [124](#), [130](#)
- [HNT05] F. Hivert, J.-C. Novelli, and J.-Y. Thibon. The algebra of binary search trees. *Theoret. Comput. Sci.*, 339(1):129–165, 2005. [1](#), [4](#), [6](#), [9](#), [25](#), [43](#), [44](#), [97](#), [136](#), [139](#), [145](#), [149](#)
- [HT72] S. Huang and D. Tamari. Problems of associativity: A simple proof for the lattice property of systems ordered by a semi-associative law. *J. Combinatorial Theory Ser. A*, 13:7–13, 1972. [1](#), [7](#), [16](#), [25](#), [128](#)
- [Knu04] D. Knuth. *The Art of Computer Programming. Volume 4, Fascicle 4. Generating all trees — History of combinatorial generation*. Addison Wesley Longman, 2004. [4](#), [9](#), [26](#), [98](#)
- [Knu06] D. E. Knuth. *The art of computer programming. Vol. 4, Fasc. 4*. Addison-Wesley, Upper Saddle River, NJ, 2006. Generating all trees—history of combinatorial generation. [29](#)
- [Kre72] G. Kreweras. Sur les partitions non croisées d’un cycle. *Discrete Math.*, 1(4):333–350, 1972. [26](#), [134](#)
- [Leh60] D. H. Lehmer. Teaching combinatorial tricks to a computer. In *Proc. Sympos. Appl. Math., Vol. 10*, pages 179–193. American Mathematical Society, Providence, R.I., 1960. [18](#), [25](#), [97](#)
- [Ler07] P. Leroux. A simple symmetry generating operads related to rooted planar m -ary trees and polygonal numbers. *J. Integer Seq.*, 10(4):Article 07.4.7, 23, 2007. [150](#)
- [Lod10] J.-L. Loday. On the operad of associative algebras with derivation. *Georgian Math. J.*, 17(2):347–372, 2010. [149](#)
- [Lod11] J.-L. Loday. The diagonal of the Stasheff polytope. In *Higher structures in geometry and physics*, volume 287 of *Progr. Math.*, pages 269–292. Birkhäuser/Springer, New York, 2011. [62](#), [147](#)
- [LR98] J.-L. Loday and M. Ronco. Hopf Algebra of the Planar Binary Trees. *Adv. Math.*, 139:293–309, 1998. [4](#), [9](#), [11](#), [43](#), [97](#), [145](#)
- [LR02] J.-L. Loday and M. O. Ronco. Order structure on the algebra of permutations and of planar binary trees. *J. Algebr. Comb.*, 15(3):253–270, 2002. [1](#), [6](#), [20](#), [136](#)
- [Mar92] G. Markowsky. Primes, irreducibles and extremal lattices. *Order*, 9(3):265–290, 1992. [31](#), [128](#), [148](#)
- [MR95] C. Malvenuto and C. Reutenauer. Duality between quasi-symmetric functions and the Solomon descent algebra. *J. Algebra*, 177(3):967–982, 1995. [4](#), [9](#), [11](#), [42](#), [97](#), [141](#)
- [MS06] M. Markl and S. Shnider. Associahedra, cellular W -construction and products of A_∞ -algebras. *Trans. Amer. Math. Soc.*, 358(6):2353–2372, 2006. [62](#), [147](#)

- [MTTV19] N. Masuda, H. Thomas, A. Tonks, and B. Vallette. The diagonal of the associahedra. [arXiv:1902.08059](https://arxiv.org/abs/1902.08059), 2019. 63
- [Müh15] H. Mühle. The topology of the m -Tamari lattices. [arXiv:1201.2020](https://arxiv.org/abs/1201.2020), 2015. 128
- [Müh19] H. Mühle. The core label order of a congruence-uniform lattice. *Algebr. Univ.*, 80(1):Art. 10, 22, 2019. 36, 85, 147
- [Müh20] H. Mühle. Hochschild lattices and shuffle lattices. [arXiv:2008.13247](https://arxiv.org/abs/2008.13247), 2020. 147
- [Nov14] J.-C. Novelli. m -dendriform algebras. [arXiv:1406.1616v1](https://arxiv.org/abs/1406.1616v1), 2014. 150
- [NT14] J.-C. Novelli and J.-Y. Thibon. Hopf Algebras of m -permutations, $(m + 1)$ -ary trees, and m -parking functions. [arXiv:1403.5962v2](https://arxiv.org/abs/1403.5962v2), 2014. 141
- [Pal86] J. M. Pallo. Enumerating, ranking and unranking binary trees. *Comput. J.* 29, no. 2, 171–175, 1986. 16, 21, 26, 47
- [PR95] S. Poirier and C. Reutenauer. Algèbres de Hopf de tableaux. *Ann. Sci. Math. Québec*, 19(1):79–90, 1995. 43
- [PRV17] L-F. Préville-Ratelle and X. Viennot. The enumeration of generalized Tamari intervals. *Trans. Amer. Math. Soc.*, 369(7):5219–5239, 2017. 26, 47, 149
- [Rea11] N. Reading. Noncrossing partitions and the shard intersection order. *J. Algebraic Combin.*, 33(4):483–530, 2011. 147
- [Rog20] B. Rognerud. Exceptional and modern intervals of the Tamari lattice. *Sém. Lothar. Combin.*, 79:Art. B79d, 23, 2018-2020. 57, 58
- [RS18] M. Rivera and S. Saneblidze. A combinatorial model for the free loop fibration. *Bull. Lond. Math. Soc.*, 50(6):1085–1101, 2018. 75
- [RST19] N. Reading, D. E. Speyer, and H. Thomas. The fundamental theorem of finite semidistributive lattices. [arXiv:1907.08050](https://arxiv.org/abs/1907.08050), 2019. 31
- [Sak09] J. Sakarovitch. *Elements of automata theory*. Cambridge University Press, Cambridge, 2009. Translated from the 2003 French original by Reuben Thomas. 14, 84
- [San09] S. Saneblidze. The bitwisted Cartesian model for the free loop fibration. *Topology Appl.*, 156(5):897–910, 2009. 5, 10, 75
- [San11] S. Saneblidze. On the homology theory of the closed geodesic problem. *Rep. Enlarged Sess. Semin. I. Vekua Appl. Math.*, 25:113–116, 2011. 5, 10, 75
- [Slo] N. J. A. Sloane. The On-Line Encyclopedia of Integer Sequences. <https://oeis.org/>. 16, 32, 94, 100, 118
- [Sta75] R. P. Stanley. The Fibonacci lattice. *Fibonacci Quart.*, 13(3):215–232, 1975. 4, 9, 26, 98
- [Sta11] R. P. Stanley. *Enumerative Combinatorics*, volume 1. Cambridge University Press, second edition, 2011. 31, 79, 106
- [Sta12] R. P. Stanley. *Enumerative combinatorics. Volume 1*, volume 49 of *Cambridge Studies in Advanced Mathematics*. Cambridge University Press, Cambridge, second edition, 2012. 1, 6, 19, 72
- [SU04] S. Saneblidze and R. Umble. Diagonals on the permutahedra, multiplihedra and associahedra. *Homology Homotopy Appl.*, 6(1):363–411, 2004. 62, 147
- [Swe69] M. E. Sweedler. *Hopf algebras*. Mathematics Lecture Note Series. W. A. Benjamin, Inc., New York, 1969. 37
- [Tam62] D. Tamari. The algebra of bracketings and their enumeration. *Nieuw Arch. Wisk.* (3), 10:131–146, 1962. 1, 6, 20, 47, 97
- [Tho06] H. Thomas. An analogue of distributivity for ungraded lattices. *Order*, 23(2-3):249–269, 2006. 31
- [Tro92] W. T. Trotter. *Combinatorics and partially ordered sets: Dimension theory*. Johns Hopkins Series in the Mathematical Sciences. The Johns Hopkins University Press, 1992. 24
- [TW19] H. Thomas and N. Williams. Rowmotion in slow motion. *Proc. Lond. Math. Soc.* (3), 119(5):1149–1178, 2019. 31, 148

Cette thèse s'inscrit dans le domaine de la combinatoire algébrique et porte sur l'étude d'ordres partiels admettant une réalisation géométrique particulière, appelée réalisation cubique.

Après avoir introduit les coordonnées cubiques, nous munissons l'ensemble de ces objets de l'ordre de comparaison composante par composante, formant des treillis. Nous établissons ensuite un isomorphisme d'ordres partiels entre les treillis des coordonnées cubiques et les ordres partiels des intervalles des treillis de Tamari. La réalisation cubique des coordonnées cubiques permet une étude géométrique de ces treillis et également de montrer qu'ils sont épluchables.

Par ailleurs, nous considérons les treillis de Hochschild qui sont des intervalles particuliers de l'ensemble des chemins de Dyck munis de l'ordre dextre. Ces treillis admettent également une réalisation cubique que nous construisons. Nous montrons entre autres que ces treillis sont épluchables, constructibles par doublement d'intervalles et plusieurs propriétés combinatoires dont le dénombrement des k -chaînes.

Finalement, nous construisons trois familles d'ordres partiels dont les ensembles sous-jacents sont dénombrés par les nombres de Fuss-Catalan. Parmi elles, nous obtenons une généralisation des treillis de Stanley et une généralisation des treillis de Tamari. Ces trois familles d'ordres partiels sont liées par une relation d'extension d'ordre et partagent plusieurs propriétés. Deux algèbres associatives sont ensuite construites comme quotients de généralisations de l'algèbre de Malvenuto-Reutenauer. Leurs produits ont pour support les intervalles de nos analogues des treillis de Stanley et des treillis de Tamari. En particulier, un de ces quotients est une généralisation de l'algèbre de Loday-Ronco.

Mots clés. Ordres partiels, treillis de Tamari, objets Fuss-Catalan, algèbres associatives, réalisations géométriques.

INSTITUT DE RECHERCHE MATHÉMATIQUE AVANCÉE
UMR 7501
Université de Strasbourg
CNRS
IRMA, UMR 7501
7 rue René Descartes
F-67000 STRASBOURG
Tél. 03 68 85 01 29
irma.math.unistra.fr
irma@math.unistra.fr

IRMA
Institut de Recherche
Mathématique Avancée

cnrs

Université
de Strasbourg

IRMA 2020/008
<http://tel.archives-ouvertes.fr/tel-02994460>