



HAL
open science

The adrenal cortex exhibits sexually dimorphic tissue renewal and disease development

Anaëlle Grabek

► **To cite this version:**

Anaëlle Grabek. The adrenal cortex exhibits sexually dimorphic tissue renewal and disease development. Cellular Biology. COMUE Université Côte d'Azur (2015 - 2019), 2019. English. NNT : 2019AZUR4018 . tel-03000459

HAL Id: tel-03000459

<https://theses.hal.science/tel-03000459v1>

Submitted on 11 Nov 2020

HAL is a multi-disciplinary open access archive for the deposit and dissemination of scientific research documents, whether they are published or not. The documents may come from teaching and research institutions in France or abroad, or from public or private research centers.

L'archive ouverte pluridisciplinaire **HAL**, est destinée au dépôt et à la diffusion de documents scientifiques de niveau recherche, publiés ou non, émanant des établissements d'enseignement et de recherche français ou étrangers, des laboratoires publics ou privés.

THÈSE DE DOCTORAT

Dimorphisme sexuel du cortex
surrénalien dans le renouvellement
cellulaire et les pathologies

Anaëlle GRABEK

Institut de Biologie Valrose

**Présentée en vue de l'obtention
du grade de docteur en Sciences
d'Université Côte d'Azur**

Dirigée par : Andreas Schedl / Marie-
Christine Chaboissier

Soutenue le : 16/04/2019

Devant le jury, composé de :

Marie-Christine Chaboissier, Directeur de
recherche, Université Côte d'Azur

Nick Hastie, Professeur, Université
d'Edimbourg

Thomas Lamonerie, Professeur, Université
Côte d'Azur

Serge Nef, Professeur, Université de
Genève

Andreas Schedl, Directeur de recherche,
Université Côte d'Azur

Amanda Swain, Directeur de recherche,
Université de Londres

Dimorphisme sexuel du cortex surrénalien dans le renouvellement cellulaire et les pathologies

Jury

Président du jury

Thomas Lamonerie, Professeur, Université Côte d'Azur

Rapporteurs

Nick Hastie, Professeur, Université d'Edimbourg

Amanda Swain, Directeur de recherche, Université de Londres

Examineur

Serge Nef, Professeur, Université de Genève

Invité

Antoine Martinez, Directeur de recherche, Université Clermont Auvergne

En français

Titre

Dimorphisme sexuel du cortex surrénalien dans le renouvellement cellulaire et les pathologies.

Résumé

Des différences importantes sont observées dans la prévalence des maladies du cortex surrénalien entre hommes et femmes. En particulier les femmes ont jusqu'à 6 fois plus de probabilités de développer un cancer de la corticosurrénale que les hommes. Malgré cela, les différences et similitudes du renouvellement cellulaire dans le cortex surrénalien ont jusqu'à présent été peu étudiées. La glande surrénale est un organe essentiel au maintien de l'homéostasie corporelle qu'elle régule grâce à la sécrétion d'hormones stéroïdiennes. Elle est composée d'une médulla et d'un cortex qui est sous-divisé en plusieurs couches concentriques, de la plus externe à la plus interne : la zone glomérulée, la zone fasciculée et enfin la zone X chez la souris. Le cortex surrénalien est de plus enrobé d'une capsule et d'un mésenchyme. Tout au long du stade adulte, il subit un renouvellement cellulaire important avec des cellules progénitrices localisées au sein de la zone glomérulée qui sont capables de se renouveler et de générer de nouvelles cellules stéroïdogéniques qui vont ensuite migrer de façon centripète puis entrer en apoptose lorsqu'elles atteignent la médulla. Au cours de mes travaux de thèse, j'ai pu mettre en évidence la présence d'un renouvellement cellulaire important du cortex surrénalien et sexuellement dimorphe avec un cortex renouvelé en 3 mois chez la femelle et environ 9 mois chez le male. De plus, alors que le renouvellement cellulaire du male repose sur les cellules progénitrices présentes dans la zone glomérulée, chez les femelles, le cortex recrute également des cellules de la capsule. Enfin, des expériences avec des modèles d'inversion de sexe, des gonadectomies et des traitements à la dihydrotestostérone ont pu identifier un effet inhibiteur des androgènes sur le recrutement et la prolifération des cellules progénitrices de la capsule. En parallèle, j'ai étudié un modèle murin exprimant *Rspo1* de façon ectopique dans les cellules stéroïdogéniques. L'analyse de ce modèle a permis de mettre en évidence le développement, chez ces souris, d'hyperplasie précoce du cortex surrénalien et le développement de tumeurs corticosurrénaliennes avec l'âge, phénotype qui s'est avéré être nettement plus prononcé chez les femelles à partir de la puberté. De plus, les males présentent

des signes de dégénération cellulaire dès 6 semaines d'âge avec l'apparition de cellules vacuolisées. Ensemble, ces résultats mettent en avant de profondes différences entre mâles et femelles dans l'homéostasie cellulaire du cortex surrénalien et le développement de phénotypes, différences qui pourraient être à l'origine des prévalences plus importantes chez les femmes du développement des maladies de la corticosurrénale.

Mots-clés : Glande surrénale, renouvellement cellulaire, hormones sexuelles, cellules progénitrices

In English

Title

The adrenal cortex exhibits sexually dimorphic tissue renewal and disease development.

Abstract

Significant differences between men and women are observed in terms of prevalence to adrenal cortical diseases. In particular, women are up to 6 times more likely than men to develop tumors of the adrenal cortex. Despite those striking disparity, differences and similarities in adrenal cortex renewal between sexes have yet to be investigated. The adrenal gland is a vital organ maintaining body homeostasis through the secretion of steroid hormones. It is composed of two endocrine glands, the medulla and the cortex, that is further divided into concentric zones, from the outer to the inner: the zona glomerulosa, the zona fasciculata and a zona reticularis in human or an X-zone in mice. The cortex is surrounded by a capsule that is further enveloped by a layer of mesothelial cells. In the adult stage, the adrenal cortex undergoes constant cellular renewal. Progenitor cells, located in the outer cortex, proliferate and give rise to new steroidogenic cells that centripetally migrate within the cortex, transdifferentiating along the way until they reach the border with the medulla and enter into apoptosis. During my thesis, I have shown that cell renewal in the adrenal cortex is highly sexually dimorphic with the female cortex being fully replaced in less than 3 months, while in males tissue renewal takes about 9 months. In addition, while male cortical renewal relies on progenitors located in the zona glomerulosa, the female cortex also recruits cells from the capsule to replenish the steroidogenic cell population. Finally, using sex reversal mouse models, gonadectomy and dihydrotestosterone treatments, I have identified an inhibitory role of male androgens on the proliferation and recruitment of capsular cells. In parallel, I have also studied a mouse model ectopically expressing *Rspo1* in steroidogenic cells. Careful analysis of this model has evidenced the development of cortical hyperplasia and tumors in aging mice, a phenotype that was found to be significantly more pronounced in female than male. In addition, while male adrenals show signs of cellular degeneration in the adrenal cortex as early as 6 weeks of age, this histology is only observed in females of 12 months of age. Together, these results highlight profound differences between

male and female in tissue homeostasis and phenotype development. These differences could offer an explanation to the unequal prevalence to adrenal diseases in men and women.

Keywords: Adrenal gland, tissue homeostasis, sex hormones, progenitor cells

Dedicated to my grand-father, Pierre GRABEK.

Table of content

Dimorphisme sexuel du cortex surrénalien dans le renouvellement cellulaire et les pathologies	0
En français	3
Titre	3
Résumé	3
In English	5
Title	5
Abstract	5
Table of content	9
- INTRODUCTION -	11
The adrenal gland	13
The developing adrenal gonadal primordium	15
Development of the adrenal cortex	15
Gonadal development and sex determination	17
Factors involved in adrenal gonadal development	18
WT1	18
GATA 4/6	19
PBX1	19
SF1	20
DAX1	22
The adult adrenal cortex	24
Hormonal production	24
The HPA axis	24
The renin-angiotensin-aldosterone system	25
Steroid synthesis	26
Disease of the adrenal cortex	27
Congenital adrenal hyperplasia	27
Addison's disease	28
Cushing's syndrome	28
Adrenocortical tumors	28

Homeostasis of the adrenal cortex	29
Adrenal cortex homeostasis model	29
Signaling pathways involved in formation and renewal of the adult cortex.....	30
Sonic Hedgehog signaling	30
Canonical WNT signaling	33
Canonical WNT signaling.....	33
The R-spondin protein family.....	35
WNT/ β -catenin signaling in the adrenal cortex	37
cAMP/PKA signaling.....	39
Hippo signaling	40
Scientific context	42
Experimental models.....	44
CRE-LoxP system	44
Lineage tracing	45
Sex reversal	46
RSPO1 Gain of function	48
Aim of the study	51
- RESULTS -	53
Part1: Paper 1 “Androgens regulate sex-specific stem cell activity of the adrenal cortex”	55
Part2: Paper 2 “ <i>Rspo1</i> over expression induces sex-specific hyperplasia and tissue degeneration in the adrenal cortex”	81
- DISCUSSION -	109
Conclusions.....	111
Perspectives	113
Abbreviations	117
Nomenclature.....	119
Bibliography.....	121
Acknowledgements.....	137

- INTRODUCTION -

The adrenal gland

The adrenal gland is responsible of maintaining body homeostasis through regulation of various processes such as blood pressure, inflammation, stress and metabolism. Despite this important role, the adrenal gland is one of the least studied organs of the human body, it is nevertheless one of the most important one as the absence of adrenals is lethal. The very first description of adrenal tissue was made in the XVI century by Bartholomeus Eustachius (Hiatt & Hiatt, 1997). In 1656, Wharton published "a description of the glands of the entire body," in which he describes a nerve connecting to the adrenal and so suggests a neuroendocrine role for the adrenal gland (Leoutsakos & Leoutsakos, 2008). Almost two hundred years later, a French naturalist and zoologist, Baron George Cuvier, describes two morphologically distinct zones within the gland that will later be known as the cortex and the medulla. However, we had to wait until 1855 to start understanding the vital role of the adrenal glands when Addison first identified patients with severe symptoms resulting from degenerating adrenals. His name was later given to the adrenal insufficiency pathology known as Addison's disease (Leoutsakos & Leoutsakos, 2008). Another adrenal malfunction, featuring hypercortisolism, was described by Harvey Cushing from whom the disease inherited the name: Cushing's Syndrome. In 1866, Julius Arnold further described the adrenal cortex and its cellular organization in the different concentric zones (Walczak & Hammer, 2015). Finally, the *in vitro* synthesis of adrenal hormones was first achieved by Edward Calvin Kendall, Tadeus Reichstein and Philip Showalter Hench, who were awarded with the Nobel Prize in Physiology or Medicine in 1950 (Welbourn, 1991).

The adrenal gland maintains its homeostatic role on the entire body by secretion of steroid hormones (and catecholamines). Such a tissue has so far been found exclusively in vertebrates highlighted by the specific expression of adrenal and gonad specific steroid receptors, the most ancient being the estradiol-receptor (ER) (Baker, 2003).

We are born with two adrenals, one on each side located above the kidney. They are part of the Hypothalamus-Pituitary-Adrenal (HPA) axis and are highly vascularized to receive stimulating hormones from and release secreted hormones to the whole organism. The adrenal gland is composed of two distinct endocrine glands, the medulla in the center and the cortex surrounding the medulla (Figure 1. Left). Each gland is characterized by its developmental origin as well as the specific set of hormones they are producing. The medulla is derived from the neural crest (ectodermal origin) during development and is composed of chromaffin cells. When exposed

to stress, these cells secrete catecholamines (such as adrenaline and noradrenaline) to induce the “flight or fight” response. The adrenal cortex is derived from the intermediate mesoderm (mesodermal origin) from which the kidneys and gonads also originate. The adrenal cortex is surrounded by a capsule, itself covered by a mesothelial cell layer, and is subdivided into three concentric layers, from the capsule to the medulla: the zona Glomerulosa (zG), the zona Fasciculata (zF) and either the zona Reticularis (zR) in human or the X-zone in mice (Figure 1. Right).

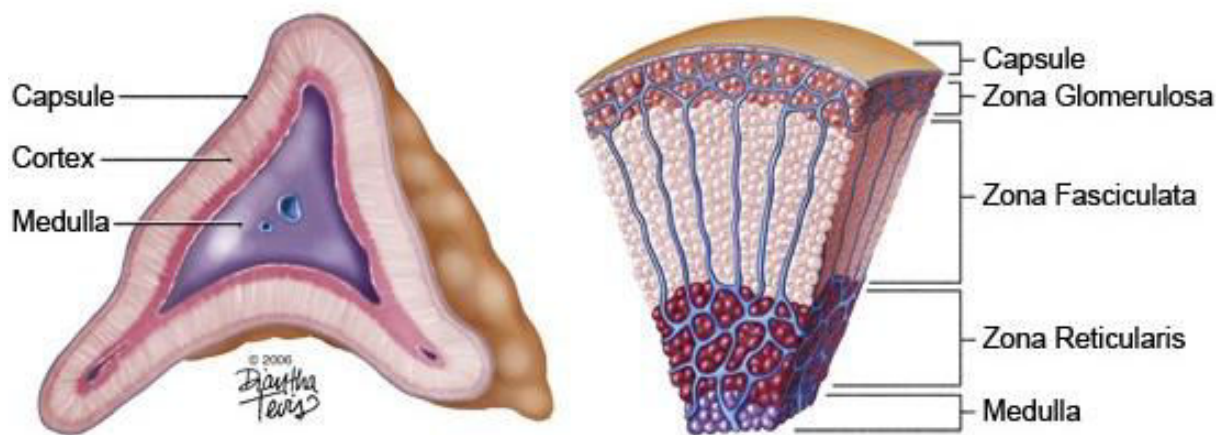

Figure 1 Schematic drawing of the adrenal gland and the adrenal cortex. Left : Schematic transection of an adrenal gland showing the inner medulla, the surrounding cortex and the enveloping capsule. Right : Detailed schematic of a section of the human adrenal cortex highlighting the different concentric zones.

The developing adrenal gonadal primordium

Development of the adrenal cortex

The adrenal cortex and the gonads share a common precursor during embryogenesis. An adrenal-gonadal primordium (AGP) arises from the thickening of the coelomic epithelium of the urogenital ridge at E9.0 in the mouse embryo and is recognized by the expression of the Steroidogenic Factor-1 (*Sfl/Ad4bp/Nr5a1*), Wilms' tumor suppressor (*Wt1*) and *Gata4* (Figure 2) (Bandiera et al., 2013; Hatano, Takakusu, Nomura, & Morohashi, 1996; Stallings et al., 2002). Around E10.5, the adrenal-gonadal primordium separates and gives rise to the gonadal primordium and the adrenocortical primordium. By E11, the two organs are fully distinct and the adrenal primordium becomes the fetal adrenal cortex highlighted by the expression of the Fetal Adrenal Enhancer (FAde) (Figure 2). SF1 has been shown to be strictly required for adrenal cortex and gonad development and *Sfl* knockout mice display in agenesis of the two organs (Majdic et al., 2002). Furthermore, the dose of *Sfl* has been proven to be important for normal adrenal development. In *Sfl*^{+/-} animals, the adrenal anlagen were dramatically reduced in size while the gonads were not affected (Bland, Fowkes, & Ingraham, 2004). Consequently, it is thought that the cells expressing higher levels of *Sfl* give rise to the adrenal anlagen while the other SF1+ cells, expressing lower *Sfl* level, will form the gonads. In addition to SF1, WT1 as well as CITED2 are two transcription factors that have been shown to be crucial for adrenal development and to precede *Sfl* expression. Indeed, it is thought that CITED2 acts as a co-factor of WT1 in order to increase *Sfl* levels in the AGP and drives the specific differentiation of the adrenal tissue (P. Val, Martinez-Barbera, & Swain, 2007). SF1 is also self-enhancing its expression by binding to the fetal adrenal enhancer located on its intron 4 (FAde). DAX-1 has been identified as a repressor of *Fade*, increasing the difference in *Sfl* expression between the gonadal and adrenal primordium (Hoivik et al., 2011). As SF1 is maintained throughout the embryonic and adult life, *Wt1* expression in the adrenal anlagen is no longer required for its expression and in fact gets quickly abolished after AGP separation (Bandiera et al., 2013). At E12.5, neural crest cells invade the fetal adrenal cortex, migrate to the inner part of the organ and differentiate into chromaffin cells that establish the medulla (Figure 2). Invasion of the chromaffin-to-be cells is followed by encapsulation of the fetal adrenal cortex by WT1+ mesenchymal cells at E14.5 (Bandiera et al., 2013). E14.5 also marks the limit at which fetal cortical cells can become precursors of the adult cortex cell and switch off *FAdE* expression (Morohashi 2011). By E17.5, only a small proportion of cells are still expressing *FAdE* and are

exclusively located at the border with the medulla suggesting that as the adult cortex grows, it takes over the fetal adrenal cortex that becomes restricted to a zone next to the medulla and form the X-zone (Morohashi & Zubair, 2011). However, complete zonation (differentiated zonae glomerulosa and fasciculata) of the adrenal cortex is only fully acquired after birth (Bandiera et al., 2013; Freedman et al., 2013).

The final maturation step of the adrenal cortex occurs at puberty. While females maintain an X-zone throughout adulthood until the first pregnancy or aging, the X-zone in males regresses at puberty in response to the rise in androgen secretions (Figure 3) (Hershkovitz, Beuschlein, Klammer, Krup, & Weinstein, 2007; Xing, Lerario, Rainey, & Hammer, 2015).

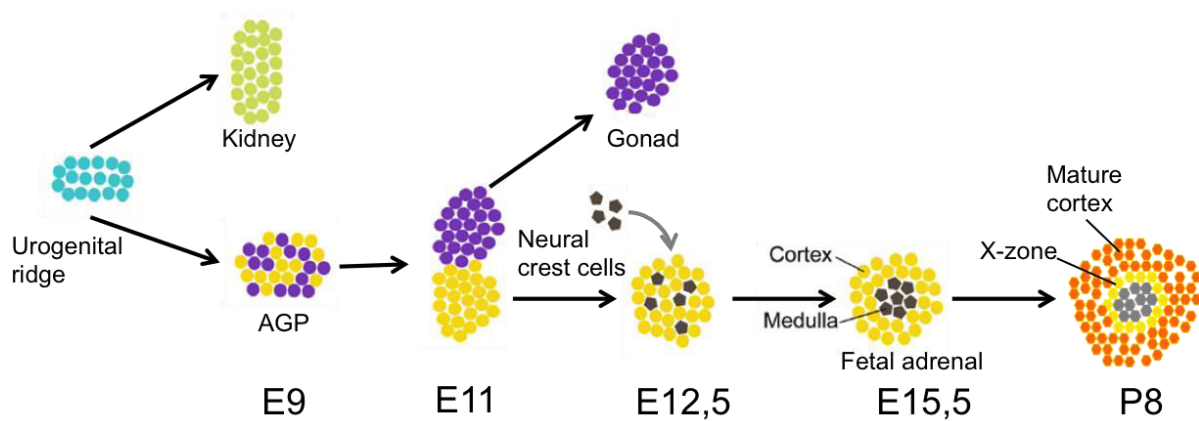

Figure 2 Schematic representation of adrenal development from the urogenital ridge in the mouse. E=Embryonic day ; P= Postnatal day. Modified from Pihlajoki et al. 2015 (Pihlajoki, Dörner, Cochran, Heikinheimo, & Wilson, 2015).

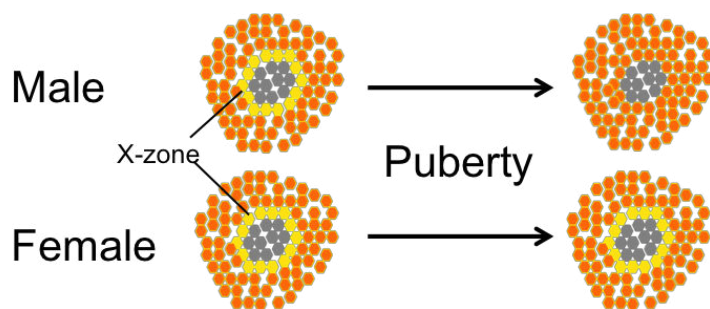

Figure 3 Schematic representation of the X-zone regression at puberty in the male while it is maintained in female.

Gonadal development and sex determination

As its name suggests, the Adrenal-Gonadal Primordium also gives rise to the gonadal anlagen. From the AGP, the cells expressing lower level of *Sfl* separate from the adrenal primordium and give rise to the bipotential gonadal primordium. The primordium is composed of precursor cells that can either become steroid-producing cells or supportive cells (Sertoli cells in male or granulosa cells in female). In addition, primordial germ cells that maintain an undifferentiated state, but do not derive from the intermediate mesoderm, migrate into the developing gonad (Dagmar Wilhelm, Yang, & Thomas, 2013).

Two antagonistic pathways in male and female orchestrate sex determination (Figure 4). In females (XX), *Wnt4* and *Rspo1* expression triggers the level of active β -catenin to increase. β -catenin inhibits *Sox9* and male differentiation allowing the development of the ovaries. In males (XY), SRY (sex determining region of the Y chromosome) is transcribed from the *Sry* gene located on the Y chromosome. Along with SF1, SRY drives the expression of *Sox9* inducing PGD and FGF signaling to induce testis differentiation and inhibits β -catenin and ovarian differentiation (Figure 4). The timing at which *Sox9* is expressed is crucial for testis development, as a delay causes β -catenin to take over, inhibiting testicular differentiation and driving ovarian differentiation instead (Sekido & Lovell-Badge, 2008).

In my research, I have made use of genetic sex-reversal models to investigate the role of the sex chromosomes in the adrenal cortex. The absence of SOX9 in an XY animal (*Sfl:Cre*(Tg/+); *Sox9(flox/flox)*) causes gonadal differentiation of the gonads and genitalia towards a female phenotype (Lavery et al., 2011). Reversely, ectopic expression of *Sox9* in an XX animal (*Wt1:Sox9*) triggers male phenotype development (Gregoire et al., 2011; V. P. I. Vidal, Chaboissier, & Schedl, 2002).

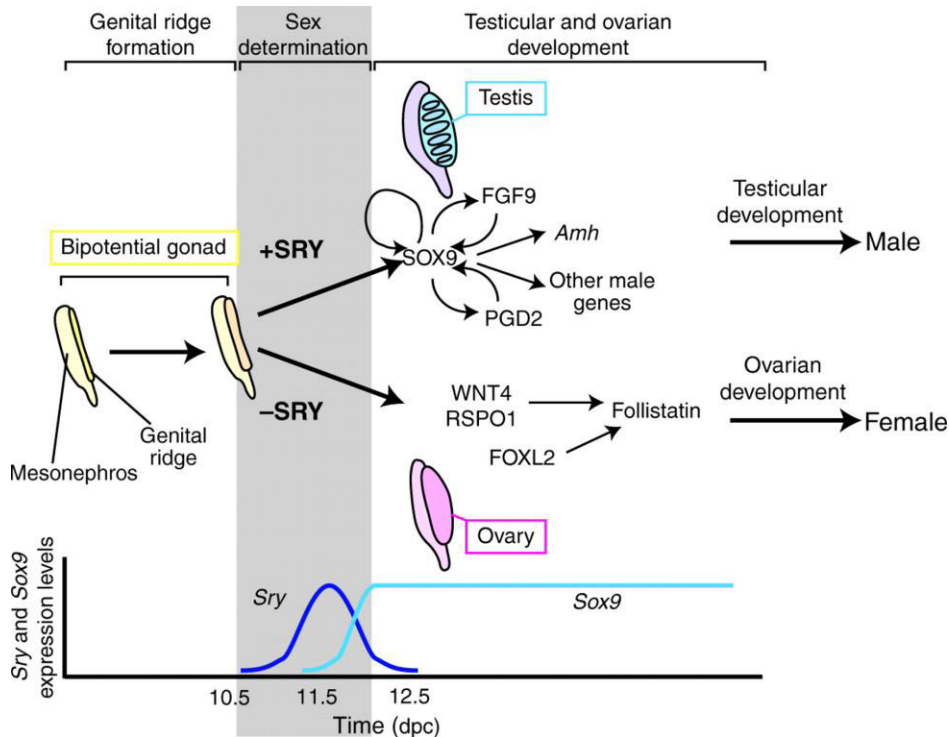

Figure 4 Schematic representation of sex determination and factors involved in the mouse (Kashimada & Koopman, 2010).

Factors involved in adrenal gonadal development

WT1

The Wilms' tumor suppressor 1 (WT1) is a zinc finger transcription factor acting upstream of *Sfl* and *Dax1* in adrenal-gonadal differentiation. *Wt1* knockout mice do not only fail to develop the adrenal gland and the gonad but also lack kidneys demonstrating a role in early differentiation and survival of the uro-genital ridge (Hastie, 2017). Two splicing variants of *Wt1* have been shown to be important in the urogenital ridge development: One of the variant contains the lysine-threonine-serine amino acids (+KTS), the other one lacks those (-KTS). In the gonad, the two isoforms have specific roles. For example, the -KTS variant protein seems to be essential to prevent apoptosis in the gonad while the +KTS variant control *Sry* expression level (Bradford et al., 2009; Hammes et al., 2001). In the adrenal cortex, *Wt1* in parallel to *Gata4* expression are switched off soon after the separation of the AGP into the adrenal primordium and the gonadal primordium. Forced expression of a *Wt1-KTS* isoform in the developing adrenal resulted in two distinct cell population in the fetal adrenal cortex at E12,5 including a low *Wt1*, high *Sfl* cell population and a high *Wt1*, low *Sfl*, *Gata4+* second

population, suggesting that WT1-KTS prevents differentiation of the early adrenal progenitor into steroidogenic lineages (Bandiera et al., 2013). In the adult, a small subset of cells surrounding the capsule displays low levels of *Wt1* expression and these cells maintain a progenitor state to steroidogenic lineages. Upon gonadectomy, those cells have been identified to give rise to gonadal-like cells expressing *Wt1* and *Gata4* as well as low level of *Sfl* (Bandiera et al., 2013).

GATA 4 / 6

GATA binding protein (GATA) 4 and 6 are two transcription factors that have been identified to have important roles in adrenal gonadal development and maintenance. While GATA4 has been shown to be dispensable for adrenal development and adult adrenal maintenance, it is required for initial gonadal differentiation and maturation (Hu, Okumura, & Page, 2013; Kiiveri et al., 2002; Tevosian et al., 2002). Hu et al., highlighted an important role of GATA4 in initiating thickening of the coelomic epithelium at early developmental stages of the genital ridge as well as activation of the early gonadal markers *Sfl* and *Lhx9* (Baker, 2003; Hu et al., 2013). GATA6 plays a role in the development and maintenance of the adrenal cortex, as deletion of *Gata6* resulted in significantly smaller adrenals (Hu et al., 2013; Kiiveri et al., 2002; Tevosian et al., 2002). In addition homozygous double knockout for *Gata4* and *Gata6* mutant showed complete adrenal agenesis (Tevosian et al., 2002).

PBX1

Pre-B-cells transcription factor 1 (PBX1) is a TALE class homeodomain transcription factor (Lichtenauer et al., 2007; Schnabel, Selleri, & Cleary, 2003). PBX1 can act as a co-activator or co-repressor by binding to other TALE homeodomain proteins including MEIS and PREP to form heterodimers (Lichtenauer et al., 2007). These complexes further interact with HOX proteins, forming heterotrimers and allowing for region-specific DNA binding. Ubiquitous deletion of *Pbx1* resulted in embryonic lethality at E15/16 and adrenal agenesis associated with low levels of *Sfl* expression demonstrating an important role of PBX1 in the development of the adrenal cortex (Schnabel et al., 2003). In addition, gonads failed to differentiate, yet SF1+ cells were observed in the defective gonads in the *Pbx1*^{-/-} mutant. According to these results, it was suggested that PBX1 plays an important role in the fate of the adrenal cortex, promoting expansion of the adrenal gonadal primordium through cell proliferation, as well as enhancing *Sfl* expression (Schnabel et al., 2003).

SF1

Steroidogenic factor 1 (SF1/Ad4BP/NR5A1) is the master regulator of steroidogenesis encoded by the nuclear receptor subfamily 5 group A member 1 (*NR5A1*) gene. SF1 is a transcription factor highly expressed in all steroidogenic tissues including the adrenal cortex, gonads, and the pituitary (Ozisik, Achermann, Meeks, & Jameson, 2003; Parker & Schimmer, 1997). In the embryo, SF1 expression is observed in the uro-genital ridge as early as E9.75 in the mouse and is the earliest marker of the adrenal-gonadal primordium. It is also seen during embryogenesis in the fetal spleen and the hypothalamic primordium (Schimmer & White, 2010). In the adult, *Sf1* is expressed in the entire adrenal cortex, the Leydig and Sertoli cells of the testis, the theca and cells in the ovary and the gonadotrope cells (secreting LH and FSH) in the pituitary. *Sf1* expression is also observed in the ventromedial part of the hypothalamus, some restricted epithelial structures of the spleen and a few neurons in the hippocampus (Schimmer & White, 2010).

In the absence of SF1, mice die perinatally from adrenal insufficiency (Luo, Ikeda, & Parker, 1994). They also lack gonads and develop a male-to-female sex reversal of the external genitalia and of the internal urogenital tracts. This phenotype highlights the essential role of SF1 in adrenal and gonadal development (Buaas, Gardiner, Clayton, Val, & Swain, 2012; Ferraz-de-Souza, Lin, & Achermann, 2011; Luo et al., 1994; Schimmer & White, 2010).

SF1 is a 461 amino acids proteins of 7 exons that contains a DNA-binding domain (DBD) including two Cys2-Cys2 zinc fingers and a FTZ-F1 box that cooperates to specifically bind with strong specificity, affinity and stability to DNA as a monomer (Figure 5) (Hoivik, Lewis, Aumo, & Bakke, 2010). The FTZ-F1 box is followed by a hinge domain harboring an Activation Function 1 (AF-1), a phosphorylation site and sumoylation sites, essential for the transcriptional activity of SF1. Finally, a Ligand Binding Domain (LBD) harbors an AF-2 domain on its C-terminal that is required for co-factor interactions and transcriptional activity (Figure 5) (Hoivik et al., 2010).

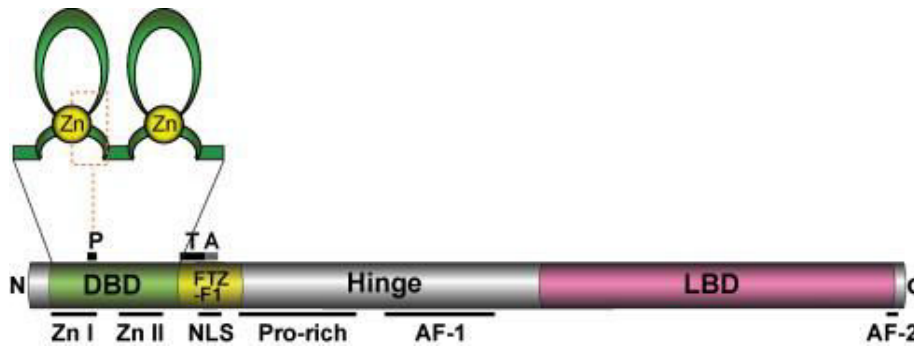

Figure 5 Schematic drawing of the SF1 protein domains. DBD: DNA Binding Domain; AF: Activation Function; LBD: Ligand Binding Domain; Zn: zinc fingers; NLS: Nuclear Localization Signal; Pro-rich: Proline rich region; FTZ-F1: Fushi-tarazu factor-1 box, P/T/A; DNA binding boxes (Hoivik et al., 2010).

SF1 activates genes required for cholesterol metabolism and steroidogenesis but also has an important role in inducing genes involved in sex determination and differentiation (Hoivik et al., 2010). More specifically, SF1 binds to the promoters of genes encoding cholesterol transport factors such as the steroidogenic acute regulatory protein (StAR) and the sterol carrier protein 2 (SCP2), but also cholesterol metabolizing enzymes for P450 steroidogenic enzymes CYP11A, CYP11B, CYP21 as well as 3β steroid dehydrogenase (3β HSD) and Akr1-b7 (Aigueperse et al., 2001; Caron, Clark, Ikeda, & Parker, 1997; Hoivik et al., 2010; Mclean et al., 2001; Parker & Schimmer, 1997; Sugawara, Holt, Kiriakidou, & Strauss, 1996; Pierre Val, Lefrançois-Martinez, Veyssière, & Martinez, 2003; M. Zubair, Ishihara, Oka, Okumura, & Morohashi, 2006). In line with the importance of SF1 in sex determination and gonad development, *Sox9* has been shown to be a direct transcriptional target of SF1 and so have *Amh*, the FSH receptor and *Inha*, genes specifically necessary in testis differentiation (Buaas et al., 2012; Schimmer & White, 2010). In addition, the regulation of *Dax1* and *Sfl* is tightly intertwined. Indeed, *Dax1* is activated by SF1 and, in the adrenal, has been shown to have a negative feedback regulation on SF1 transcriptional activity of genes encoding glucocorticoids synthesis enzymes in presence of increased glucocorticoid levels and suggested to have a crucial role in maintaining progenitor capacities through inhibition of steroidogenesis (Hoivik et al., 2010; Kim et al., 2009).

Several factors have been identified to bind to the *Sfl* promoter and regulate its expression (Figure 6). *Sfl* presents an E-box binding domain located in its basal promoter that has been shown to be essential for its regulation. It is the binding site for the nuclear transcription factor Y (CBF), ubiquitous transcription factors, stimulatory protein 1 and 3 (SP1 and SP3) and upstream stimulatory factors (USF) (Figure 6) (Hoivik et al., 2010). POD1 (Capsulin/TCF21)

has also been identified to interact with the basal promoter with a repressive action on the promoter activity (Figure 6) (Hoivik et al., 2010; Pierre Val et al., 2003; M. Zubair et al., 2006). In addition, upstream and downstream regulatory regions have been evidenced to have additional roles in *Sfl* regulation. In the fetal adrenal, the Fetal Adrenal Enhancer (FADE) has been discovered in intron 4 to serve as a positive self-regulator for *Sfl* expression and ensures continuous *Sfl* expression. However, the *Fade* activity only starts after *Sfl* expression has been initiated and additional factors must initially activate *Sfl* expression before it becomes self-regulated (M. Zubair et al., 2006; Mohamad Zubair, Oka, Parker, & Morohashi, 2009). At early developmental stages, HOX proteins are described to interact with PBX1 to bind the *Fade* binding site for the PBX1-HOX complex located right next to a PREP-PBX1 binding site allowing enhanced transcription. HOX proteins have been shown to specify anterior/posterior identity in the mesoderm and *Pbx1* knockout mice failed to develop adrenal glands and differentiated gonads highlighting important roles for those proteins in initiating early differentiation steps of the adrenal-gonadal primordium (M. Zubair et al., 2006). In the AGP, *Sfl* expression is also thought to be regulated by WT1 binding to the E-box site and further enhanced by interaction of CITED2 with WT1 with a binding site located upstream of the basal promoter and to initiate adrenal specific differentiation (Figure 6) (P. Val et al., 2007; D. Wilhelm & Englert, 2002). With regards to the gonads, tissue specific activators such as GATA4 and LHX9 (essential factor in germ cell proliferation) have also been described to induce *Sfl* expression albeit at a moderate level for GATA4 (Figure 6). Finally, *in vitro* analysis evidenced SOX9 to have a potential regulatory action on *Sfl* expression (Birk et al., 2000; Hoivik et al., 2010; Pierre Val et al., 2003).

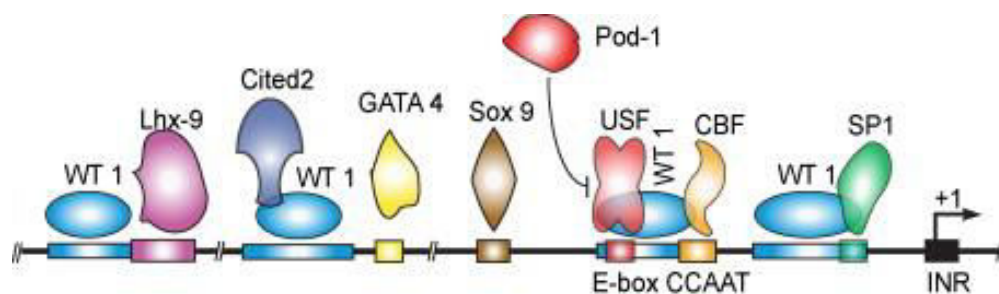

Figure 6 Transcription factors binding to the *Sfl* basal promoter (Hoivik et al., 2010)

DAX1

DAX1, dosage sensitive sex reversal, adrenal hypoplasia congenital, critical region of the X chromosome, gene 1, is another protein encoded by an orphan nuclear receptor family gene:

NROB1 (Niakan & McCabe, 2005). *NROB1* is encoded by two exons. The encoded protein of 470 amino acids contains a DNA binding domain and a Ligand Binding Domain (Li et al., 2010; Niakan & McCabe, 2005). Three structures are highly conserved within the nuclear receptor superfamily and include the region I that encompasses the DNA binding domain (DBD) and the region II and III that are found on the ligand binding domain (LBD) (Niakan & McCabe, 2005). In comparison to other nuclear receptors, DAX1 has the particularity to harbor on its C-terminal three repeats of a 70 amino acid cysteine-rich sequences that include a LXXLL motif instead of the zing-finger DNA-binding domain traditionally found in nuclear receptors. This specificity is thought to confer to DAX1 its transcriptional regulation properties (Lalli, 2014; Niakan & McCabe, 2005). *Dax1* has been shown to be expressed as early as E9 in the AGP as well as in the developing gonad, adrenal cortex, anterior pituitary and hypothalamus during embryogenesis. In the adult, its expression is restricted to the adrenal cortex, the gonadotropes (anterior pituitary), the ventro-medial hypothalamus, Leydig and Sertoli cells in the testis and the granulosa and theca cells of the ovary (Li et al., 2010). Interestingly, *Dax1* and *Sfl* have similar expression patterns. DAX1 has been shown to principally have a negative transcriptional activity and in particular to repress genes that are activated by SF1, including the steroidogenic enzymes and *StAR* (Lalli, 2014; Niakan & McCabe, 2005). In addition, SF1 induces *Dax1* expression that in a feedback loop negatively regulates steroidogenesis. It has been suggested that DAX1 can repress *FAdE* to transition into the adult adrenal cortex (Lalli, 2014). This was further confirmed in *Dax1* knockout mice in which the X-zone fails to regress (Iyer & McCabe, 2004). Even though the specific implications are not known to date, WT1 has been suggested to regulate *Dax1* during early developmental stages (Lalli, 2014). In the adult, *Dax1* is further enhanced by WNT signaling and glucocorticoids, but repressed by ACTH and its localization in the adrenal cortex is restricted to the subcapsular zone. Finally, DAX1 has been suggested as an essential component to maintain progenitor properties within the zG as it is repressing steroidogenesis and preventing differentiation (Kim et al., 2009). In human, *DAX1* mutations have been associated with the cytomegalic form of adrenal hypoplasia congenital (AHG). In the affected patients, adult adrenals lack the mature cortex and the residual adrenal cortex is composed of large vacuolated cells. To this date, it has not been possible to recreate the disease in a mouse model (Iyer & McCabe, 2004; Scheys, Heaton, & Hammer, 2011).

The adult adrenal cortex

Hormonal production

The HPA axis

The adrenal cortex is communicating with the body via the secretion of steroid hormones. Steroid hormones are only produced by the gonads and the adrenal cortex and encompass the sex hormones (androgens, estrogens, progestins) that regulate the reproductive functions and the adrenal corticosteroids (glucocorticoids and mineralocorticoids) maintaining body homeostasis (Morohashi, 1997). The hormonal production in the adrenal cortex is under the control of two distinct systems: the Hypothalamus-Pituitary-Adrenal (HPA) axis and the Renin-Angiotensin axis. Under stress conditions, the hypothalamus produces corticotropin-releasing hormone (CRH) that is sensed by the pituitary and induces adrenocorticotrophic hormone (ACTH) release by the corticotropes. ACTH is transported through the bloodstream and induces production of glucocorticoids in the zona fasciculata (Figure 7). Glucocorticoids act on many organs and participate in the regulation of major homeostatic processes such as metabolism and immune response to inflammation. As glucocorticoids are released, they negatively (feedback loop) affect the hypothalamus and pituitary to decrease the secretion of CRH and ACTH respectively (Figure 7) (Hiller-Sturmhöfel & Bartke, 1998).

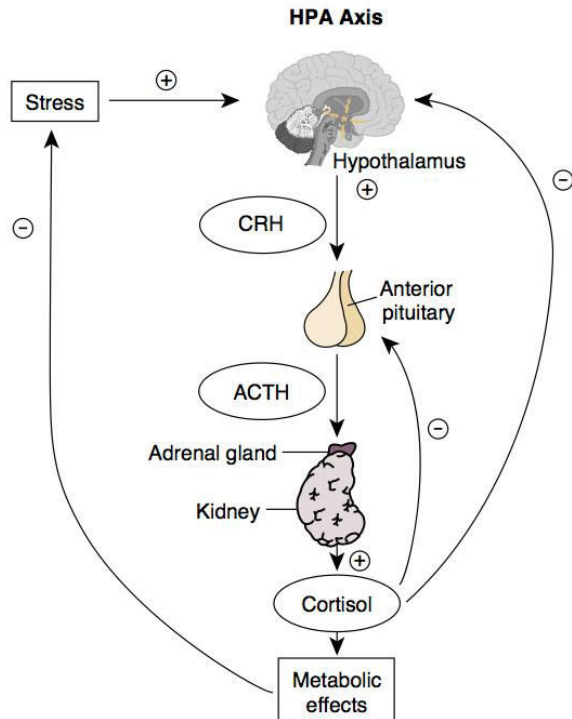

Figure 7 Schematic representation of the hypothalamus-pituitary-adrenal axis. Upon stress condition, the hypothalamus secretes corticotrophin-releasing hormone that induces the pituitary to release adrenocorticotrophic hormone. ACTH is then sense by the adrenal which in turn synthesize cortisol to cope with stress and negatively feedback to the hypothalamus and pituitary. CRH: corticotropin releasing hormones; ACTH: adrenocorticotrophic hormone. (Hiller-Sturmhöfel & Bartke, 1998).

The renin-angiotensin-aldosterone system

The Renin-Angiotensin-Aldosterone system (RAAS) is an essential system maintaining fluid and blood pressure homeostasis that is activated upon low sodium conditions. In response, the kidney releases renin that cleaves its substrate angiotensinogen to form Angiotensin I (ANGI) (Figure 8). Highest expression of Angiotensin Converting Enzyme (ACE) is found in the lung and this enzyme further catalyzes ANGI into its active form: Angiotension II (ANGII). In the final step of the RAAS, ANGI acts on the adrenal zona glomerulosa to stimulate aldosterone production. Aldosterone then binds to the mineralocorticoids receptor in the kidney and increases sodium retention and water reabsorption as well as potassium secretion resulting in an increase in blood volume and subsequently blood pressure (Figure 8) (Xanthakis & Vasan, 2013).

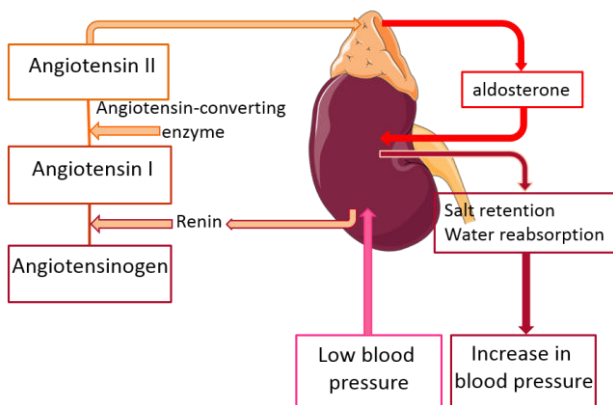

Figure 8 Scheme of the Renin-Angiotensin-Aldosterone system. In case of low blood pressure, the kidney releases Renin that convert angiotensinogen into Angiotensin I that is further transformed into Angiotensin II, its active form. Angiotensin II travels through the blood and signal to the adrenal cortex to synthesize aldosterone inducing water reabsorption and salt retention that create an increase in blood pressure.

Steroid synthesis

All steroids are derived from cholesterol. Cholesterol is transported by low-density lipoprotein from the bloodstream to the Outer Mitochondrial Membrane (OMM) and is stored in the OMM until the Steroidogenic acute protein STaR transfers the cholesterol from the outer membrane to the inner membrane of the mitochondria, making the substrate accessible to the required enzyme, CYP11A1, for catalysis (Figure 9) (Miller, 2007; Turcu & Auchus, 2015). SF1 (NR5A1) is known as the master regulator of steroidogenesis in the adrenal gland. SF1 is activating transcription of the cholesterol side chain cleavage enzyme CYP11A1 that initiates the first step of steroid synthesis, the conversion of cholesterol to pregnenolone, and maintains the differentiated state of the steroidogenic cells (Turcu & Auchus, 2015; Yamazaki, 2014). In order to synthesize aldosterone from pregnenolone, the zG requires the consecutive action of HSD3 β 2, CYP21A2 and CYP11B2 (Aldosterone Synthase, AS) (Figure 9). In contrast to the zG, the zF needs CYP17A1 to catalyze 17OH-hydroxylation of pregnenolone and progesterone that respectively serve as substrate to HSD3 β 2 and CYP21A2 before CYP11B1 catalyzes the last reaction leading to cortisol synthesis. CYP17A1 also further cleaves 17-OH-pregnenolone into dehydroepiandrosterone (DHEA) (Figure 9). As mouse zF lacks the CYP17A1 enzyme, they consequently do not produce cortisol, but instead display high levels of corticosterone that is produced from deoxycorticosterone by the 11 β -hydroxylase (CYP11B1) (Bremer & Miller, 2014; Miller, 2007; Mullins et al., 2009; Turcu & Auchus, 2015). In the human zona Reticularis,

adrenal androgens are synthesized by the CYP17 enzyme (Figure 9). In the murine X-zone, *Cyp17* is not expressed and the murine adrenal does not produce any androgens. However, the X-zone possesses the 20 α HSD enzyme, a progesterone-metabolizing enzyme (Hershkovitz et al., 2007). The functional relevance of this expression is unknown.

Disease of the adrenal cortex

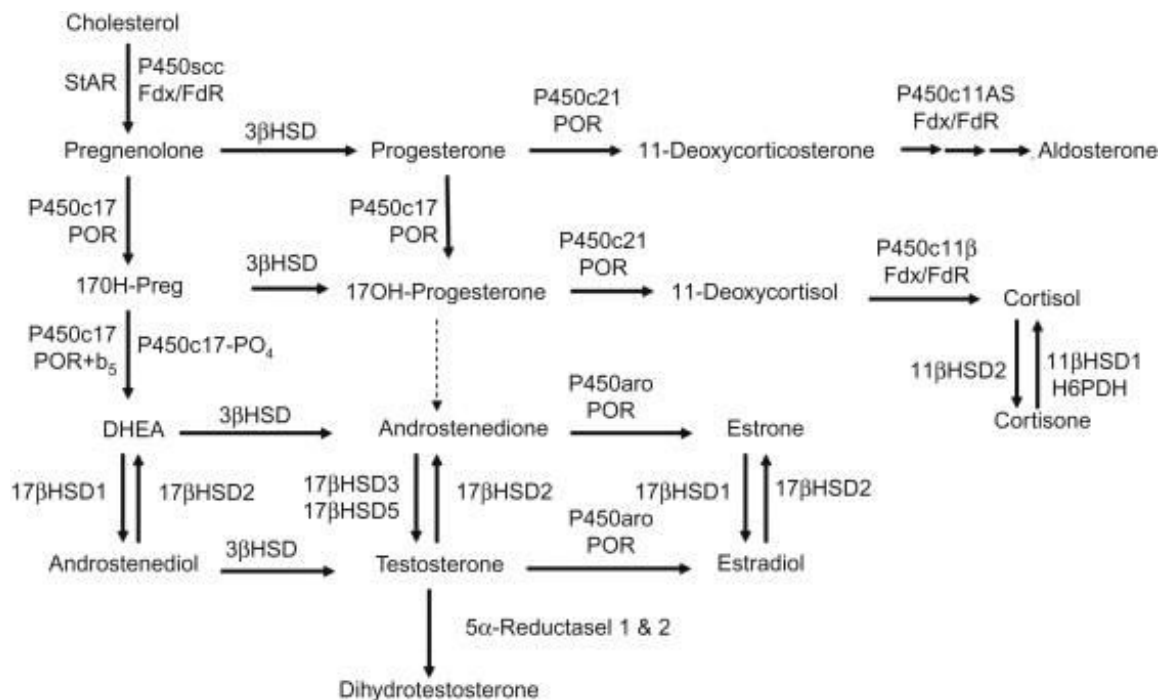

Figure 9 Enzymatic reactions involved in steroid hormone synthesis from cholesterol in human. From cholesterol, StAR initiates cholesterol metabolism by transferring cholesterol from the outer membrane to the inner membrane of the mitochondria where enzymes can access it for catalysis. In the zona glomerulosa, cholesterol is then metabolized into aldosterone, or in the zona fasciculata into corticosterone or cortisol. In human, conversion into androgens occurs in the zona reticularis. Further catalysis is occurring in the gonads, where different enzymes are expressed to produce sex hormones (Bremer & Miller, 2014).

Congenital adrenal hyperplasia

As is the case for any tissue, many dysfunctions and deregulations of the adrenal cortex can lead to disease development. Congenital adrenal hyperplasia (CAH) is one of them and is the result of mutation(s) in genes coding for steroidogenic enzyme, such as *CYP21A2* encoding for the 21-hydroxylase enzyme in 90% of cases. In about 8% of the cases, the mutation is found in the *CYP11B1* gene. In both cases, glucocorticoid synthesis is altered and results in high levels of ACTH and CRH, uncontrolled by the glucocorticoid negative feedback on the hypothalamus-pituitary axis, as well as a hyperplasia of the adrenal cortex (Mullins et al., 2009; Turcu &

Auchus, 2015). This increase in ACTH leads to an over-synthesis of pregnenolone and subsequently progesterone and adrenal androgens in human resulting in early puberty in boys and ambiguous genitalia in girls. Additional symptoms include facial hair growth, infertility, irregular period in girls and women. CAH are classified in two different forms, the most severe form is affecting about 1:15000 births worldwide while the milder form affects 1:1000 births (Merke & Kabbani, 2001).

Addison's disease

Addison's disease, also called adrenal insufficiency or hypoadrenocorticism, is a condition in which the adrenal cortex does not produce enough of the mineralocorticoids and glucocorticoids. In Europe, Addison's disease affects 1 in 10,000 people and patients show sign of fatigue, nausea, weight lost, increased pigmentation, vitiligo and more. The most predominant cause of Addison's disease is tuberculosis though, in developed countries, autoimmune diseases represent the commonest underlying reason (Burton, Cottrell, & Edwards, 2015; Vaidya, Chakera, & Dick, 2009).

Cushing's syndrome

Cushing's syndrome is another disease of the adrenal cortex. It results from overexposure to circulating glucocorticoids, either endogenous (pituitary or adrenal tumor) or exogenous (from steroid medication), for an extended period of time leading to adrenal hyperplasia, as well as metabolic disorders, cardiovascular diseases, osteoporosis, psychiatric disorders and overall, a shorter lifespan (Buliman, Tataranu, Paun, Mirica, & Dumitrache, 2016; Newell-Price, Bertagna, Grossman, & Nieman, 2006). Cushing's diseases are a subtype of Cushing's syndromes and represent up to 80% of Cushing's syndromes. They are fairly rare with 40:1,000,000 people being affected. They are the result of an over secretion of ACTH caused by an ACTH-producing tumors (often benign) in the pituitary, increasing glucocorticoid secretion by the adrenal cortex (Buliman et al., 2016; Lonser, Nieman, & Oldfield, 2017).

Adrenocortical tumors

While adrenocortical adenoma - benign tumors of the adrenal cortex - are commonly found in the population (1% to 10%), adrenocortical carcinoma (ACC) are rare, but severe, malignancies affecting between 0.7 and 2 millions patients per year (Libé, 2015). Patients generally present with excessive steroid hormones (40-60%) or secondary effects resulting from the pressure of the growing mass on surrounding tissues (30%), but about 15-20% of patients are accidentally

diagnosed. No effective drugs are currently available on the market and the primary treatment remains surgical removal of the tumor, resulting in a 5-year survival rate lower than 35% (Assié et al., 2014). Surgery can be followed with Mitotane treatment to prevent recurrence of the cancer in cases of metastatic diseases. ACC development is attributed to germline or somatic mutations. 3% to 7% of adult ACCs and 50% to 80% of pediatric ACCs are attributed to Li-Fraumeni Syndrome, patients presenting with germline mutation of the *TP53* gene (Libé, 2015). In addition, mutation in the *IGF2* gene leading to its overexpression is encountered in 85% of the adrenal carcinomas (De Fraipont et al., 2005). Exome sequencing further identified altered genes in somatic cells. *ZNRF3*, a negative regulator of the WNT signaling pathway, was mutated in 21% of ACCs while *CTNNB1*, a downstream effector of the same pathway was found to be mutated in 16% of ACC with *ZNRF3* and *CTNNB1* mutations being mutually exclusive. *TP53* and *CDKN2A*, both part of the P53/RB signaling were respectively inactivated in 16% and 11% of the ACC analyzed in the study. Finally, with a lesser occurrence, genes involved in chromatin remodeling were also found to be altered (Assié et al., 2014; Zheng et al., 2016).

Homeostasis of the adrenal cortex

Adrenal cortex homeostasis model

The different cell types corresponding to each zone are easily identified by their shape and secrete specific hormones as described in “Hormonal secretions”. Surrounding the capsule, a single cell layer expresses *Wt1* as well as *Rspo1* that is continuous with the mesothelial lining of the abdominal cavity. The capsular cells are spindle shaped and organized in 2 to 3 layers around the cortex. Just below the capsule, the zG cells are clustered in rosette-like structures characterized by a central focal point where all cells are in contact. The zG specifically expresses *Cyp11b2* (aldosterone synthase) required for aldosterone production as well as *Disabled2* (*Dab2*), a protein involved in aldosterone secretion, *Axin2* and *Wnt4*, both downstream of the WNT/ β -catenin signaling pathway and *Shh* (Romero et al., 2007). The zF cells are organized in columns and express *Cyp11b1* that catalysis the final step of glucocorticoids synthesis. In human, the zR produces androgens but mice lack the zR and present instead an X-zone that is a remnant of the fetal adrenal (see “Adrenal Development”). The X-zone lacks the 17 α -hydroxylase (CYP17) enzyme and consequently does not produce androgens. Its physiological function is so far unknown, but the X-zone can be identified by

the expression of *20 α -Hsd*, encoding an enzyme catalyzing the reduction of progesterone and 11- deoxycorticosterone (Hershkovitz et al., 2007).

The adult adrenal cortex undergoes constant cellular renewal. Several studies have now shown the existence of progenitor-like cells in the outer adrenal cortex that maintain a certain degree of undifferentiated state and are proliferating to give rise to steroidogenic cells of the zG (Figure 10)(Kim et al., 2009). As they centripetally migrate, the steroidogenic cells transdifferentiate into zF cells and start to produce zF specific enzymes such as CYP11B1 and AKR (Figure 10). As they reach the X-zone (nulliparous females) or the medulla (males and parous females), the cortical cells undergo apoptosis and are cleared from the adrenal cortex (Figure 10). Although this has never been evaluated in detail, proliferation and apoptosis appear to be in perfect equilibrium maintaining a constant adrenal cortex size during the adult stage. Specific signaling pathways tightly regulate the homeostasis of the adrenal cortex. In particular, SHH, WNT and PKA signaling are the most important pathways involved in maintaining a functioning adrenal cortex (Walczak & Hammer, 2015).

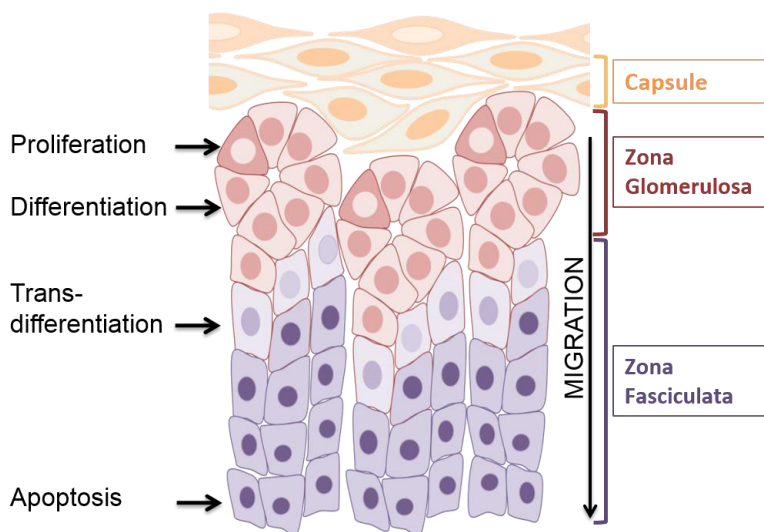

Figure 10 Model of the adrenal cortex homeostasis. A progenitor population resides in the zG and proliferates to give rise to new steroidogenic cells that convert into zona glomerulosa steroid producing cells. As the cells migrate centripetally, they transdifferentiate into zona fasciculata cells. Finally, once they reach the medulla, the steroidogenic cells undergo apoptosis. Balance between the proliferation in the outer cortex and apoptosis in the inner cortex maintains the steroidogenic cortex.

Signaling pathways involved in formation and renewal of the adult cortex

Sonic Hedgehog signaling

Hedgehog proteins are a family of highly conserved secreted proteins including Sonic (SHH), Desert (DHH) and Indian (IHH) Hedgehog. They are essential signaling molecules for embryonic development, cell proliferation, differentiation and polarization as well as adult stem cell maintenance. Considering their important role in stem cell and proliferation, it is not surprising that alterations of the hedgehog pathway are linked to tumorigenesis. Upon binding of SHH to the Patched1 (PTCH1) receptor and co-receptor CDO at the plasma membrane, Smoothened (SMO) is released from the inhibitory effect of PTCH1 and activates downstream effectors, the transcription factors of the GLI family (Figure 11A)(Choudhry et al., 2014; Huang et al., 2010).

Shh expression is restricted to steroidogenic cells of the outer adrenal cortex in the adult. Its expression is first observed at E11,5 in a subset of steroidogenic cells in the fetal adrenal (Figure 11B). *Ptch1*, *Smo* and *Gli1* are specifically expressed in the non-steroidogenic capsular cells during development as well as in adult, suggesting that the outer cortex signals to the capsule (Figure 11B). In absence of *Shh* (*Sf1-Cre;Shh^{flox/-}*), the adrenal cortex fails to develop normally and is of a dramatically decreased thickness (Figure 11C) (Huang et al., 2010; King, Paul, & Laufer, 2009). Further experiments showed a decrease in proliferation in the non-steroidogenic capsule that also resulted in a thinning of the capsule at the two time- points analyzed: E16,5 and P5. Lineage tracing experiments in embryos of *Gli1-CreEERT2* mice additionally identified the GLI1+ as progenitors of the steroidogenic lineages as during development they self-renew and are recruited to the steroidogenic cortex (Huang et al., 2010; King et al., 2009). While GLI1+ cells give rise to the steroidogenic lineages that form the mature cortex during development, their recruitment is thought to be limited postnatally. Instead, lineage-tracing experiments using the *Shh-CreERT2* evidenced the presence of a SHH+ progenitor population active in the adult that self-renew and constantly replenish the steroidogenic compartment. Renewal of the adult adrenal cortex is thus thought to rely on SHH+ progenitors located within the zG that are able to self-replicate and give rise to new steroidogenic cells of the zG and the zF (King et al., 2009).

Sonic hedgehog signaling plays a major role in the adrenal cortex during development to ensure the formation of the mature cortex containing SHH+ progenitors that maintain constant cellular renewal of the adult steroidogenic cortex.

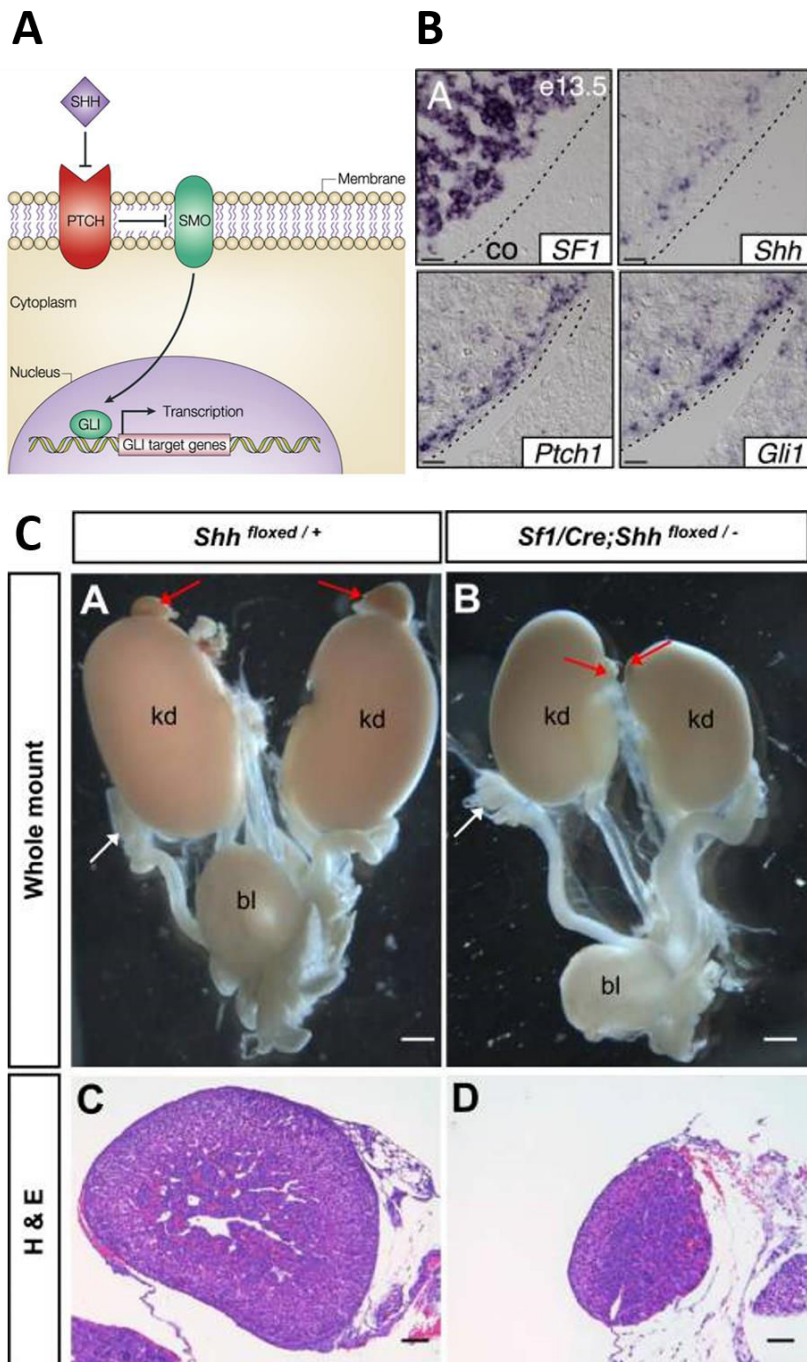

Figure 11 Sonic Hedgehog signaling in the adrenal gland. **A**) Binding of SHH to the Patched receptor represses its inhibitory action on Smoothened and activates GLI proteins transcriptional activity. (Owens & Watt, 2003) **B**) In situ hybridization of *Sf1* (Top left), *Shh* (Top right), *Ptch1* (bottom left) and *Gli1* (King et al., 2009) **C**) whole mount (top) and H&E staining of adrenal section (bottom) of P5 control and *Shh* conditional KO animals show significant decrease in adrenal size (Huang et al., 2010). SHH: Sonic Hedgehog, PTCH: Patched, SMO: Smoothened, H&E: Hematoxylin and Eosin coloration.

Canonical WNT signaling

Canonical WNT signaling

The WNT signaling pathway has been studied for more than 37 years and has been shown to play essential roles in developmental and adult organ maintenance processes. Consequently, deregulation of WNT signaling is also associated with many diseases. WNT signaling can act through distinct intracellular signaling pathways including the canonical or WNT/ β -catenin signaling pathway, the planar cell polarity pathways and the WNT/ Ca^{2+} pathway, the two latest being β -catenin independent. In this section, I will focus on canonical WNT signaling (Komiya & Habas, 2008).

In human, 19 *WNT* genes have been identified and encode WNT proteins of about 40 kDa (Clevers & Nusse, 2012; Tanaka, Kitagawa, & Kadowaki, 2002). Highly conserved, they are secreted proteins containing a lipid chain and several conserved cysteines. WNT proteins bind to heterodimers of Frizzled receptors (FZD) and the low-density lipoprotein related protein 5/6 (LRP5/6) cofactor. The frizzled receptors are composed of 7 transmembrane domains and the WNT proteins have high affinity for their extracellular cysteine rich domain (Clevers & Nusse, 2012).

In the absence of WNT ligand, the destruction complex, located in the cytoplasm, is targeting β -catenin for proteasomal degradation (Figure 12 Right). The destruction complex is formed by APC (adenomatous polyposis coli, a tumor suppressor), AXIN (a scaffolding protein), and the two kinases casein kinase 1 (CK1) and glycogen synthase kinase 3 (GSK3) (Clevers & Nusse, 2012; Komiya & Habas, 2008; MacDonald, Tamai, & He, 2009; Nusse & Clevers, 2017). GSK3 and CK1 both phosphorylate β -catenin that is then targeted by the E3 ubiquitin-ligase β -TRCP for ubiquitination and subsequent proteasomal degradation (MacDonald et al., 2009). Because it is phosphorylated and degraded, β -catenin is prevented from translocating into the nucleus and from activating target genes. Indeed, in the absence of β -catenin, the T-cell factor (TCF) and the lymphoid enhancer factor (LEF) repress downstream targets (Figure 12 Right). Upon binding of a WNT ligand to the FZD/LRP5-6 heterodimer, the receptors undergo conformational changes (Figure 12 Left). AXIN then interacts with the cytoplasmic tail of the LRP receptor that is then phosphorylated by the CK1 and GSK3 kinases (Figure 12 Left) (Clevers & Nusse, 2012). In addition, the co-receptor FZD interacts with Dishevelled (DSH) through its cytoplasmic part and DSH then helps to stabilize the interaction of AXIN to LRP5-6 (Figure 12 Left). The complete role of DSH in canonical WNT signaling is not yet fully resolved, but DSH phosphorylation in the “On” pathway has been suggested to inhibit β -

catenin phosphorylation by the GSK3 kinase to prevent its degradation. The recruitment of the destruction complex to the membrane results in inhibition of its phosphorylating action on β -catenin, blocking β -catenin degradation and inducing its accumulation in the cytoplasm. Translocation of β -catenin into the nucleus permits interaction with TCF/LEF proteins, which converts this proteins into activators thus inducing transcription of downstream targets (Figure 12 Left) (Clevers & Nusse, 2012; Komiya & Habas, 2008; MacDonald et al., 2009; Nusse & Clevers, 2017).

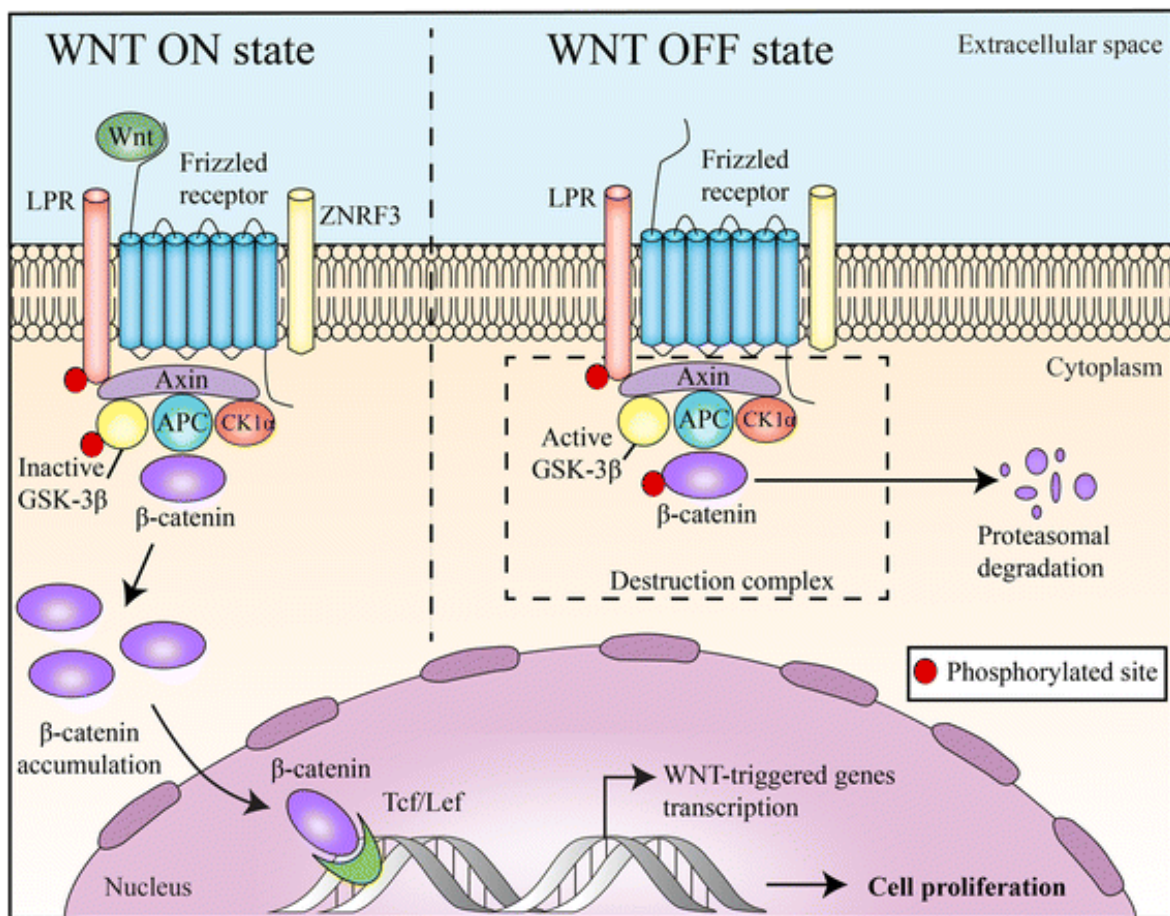

Figure 12 “On” and “Off” state of the WNT signaling pathway. In the “On” state, the WNT ligand bind to the LPR/Frizzled receptor and recruit the destruction complex composed of AXIN, APX, CK1 and GSK3 β inactivating the destruction complex and inhibiting phosphorylation of β -catenin, allowing for cytoplasmic accumulation of β -catenin and its translocation into the nucleus to activate TCF/LEF transcription factors and trigger WNT-target genes transcription. In the “Off” state, the destruction complex is active and binds to cytoplasmic β -catenin that is phosphorylated by GSK3 β and CK1, further ubiquitinated and targeted for proteasomal degradation inhibiting its translocation into the nucleus and the targeted genes transcription. (Pai et al., 2017).

The R-spondin protein family

The R-spondin (roof plate-specific spondin, from the original identification of *Rspo1* expression in the neural tube roof plate during embryogenesis) proteins are a family of secreted proteins that can potentiate WNT signaling (Jin & Yoon, 2012; Lebensohn & Rohatgi, 2018). R-spondins (RSPO) homologs have been identified in all vertebrates and four different R-spondins from RSPO1-4 have been found in mice and human. In human, the four RSPOs are approximately 35 kDa and share between 40 and 60% amino acid sequence identity (Figure 13) (de Lau, Snel, & Clevers, 2012; Jin & Yoon, 2012). The R-spondins are between 234 and 272 amino acids long and contain on the N-terminal an hydrophobic signal peptide (SP) required for secretion, two cysteine-rich furin-like domains (FU1 and FU2), a thrombospondin type 1 repeat domain (TSR) and a basic amino acid rich region (BR) domain of varying length on the C-terminal (Figure 13) (de Lau et al., 2012; Jin & Yoon, 2012). The Furin-like motifs have been found to be essential for activation of the WNT pathway and the TSR and BR domains help to increase the activation efficiency of the WNT/ β -catenin signaling through binding to heparan sulfate proteoglycans (HSPGs) (Lebensohn & Rohatgi, 2018).

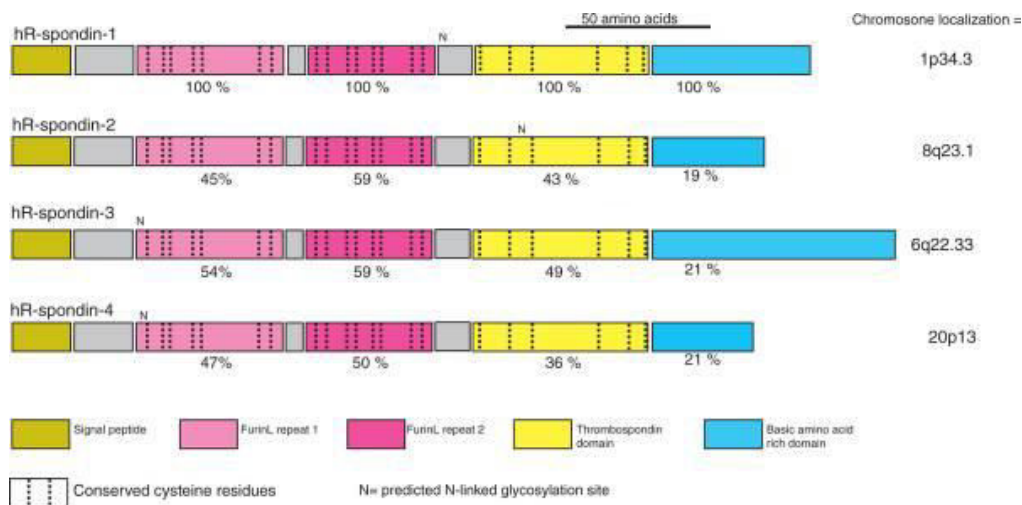

Figure 13 Scheme of the four R-spondin proteins found in human. The four proteins are composed of a signal peptide essential for secretion, two cysteine-rich furin-like repeats including 15 highly conserved cysteines, a thrombospondin domain with 6 highly conserved cysteines and a basic amino acid rich domain (de Lau et al., 2012).

The leucine-rich repeat-containing G-protein-coupled receptors (LGRs) 4 to 6 have been identified as receptors for the RSPO proteins. In vitro, all four RSPOs can bind to all three LGRs through their FU2 domain (de Lau et al., 2012; Lebensohn & Rohatgi, 2018). In addition, LGR5 and LGR6 have both been identified as adult stem cell markers in the intestine, hair follicle and stomach and skin and sebaceous gland (Leushacke & Barker, 2012). As RSPOs

bind with the LGRs located at the plasma membrane, they can simultaneously interact through their FU1 domain with the two homologous transmembrane E3 ubiquitin ligases, the zinc and ring finger 3 (ZNRF3) and the ring finger 43 (RNF43) (Jin & Yoon, 2012; Lebensohn & Rohatgi, 2018). ZNRF3 and RNF43 are two target genes of β -catenin that act as negative regulators of canonical WNT signaling through ubiquitination, internalization and degradation of the FZD and LRP6 receptors (Figure 14 Left) (Hao, Jiang, & Cong, 2016; Hao et al., 2012; Koo et al., 2012). When RSPO binds to the LGR and ZNRF3/RNF43 together, it induces auto-ubiquitination of ZNRF3 and RN43 and subsequent membrane clearance of the two E3 ubiquitin ligases, which increases the FZD receptor availability at the plasma membrane enhancing the ability of WNT ligands to bind to their receptor to induce WNT signaling (Figure 14 Right) (Hao et al., 2016).

In a recent study, R-spondins 3 and 2, but not R-spondins 1 and 4, have been shown to be able

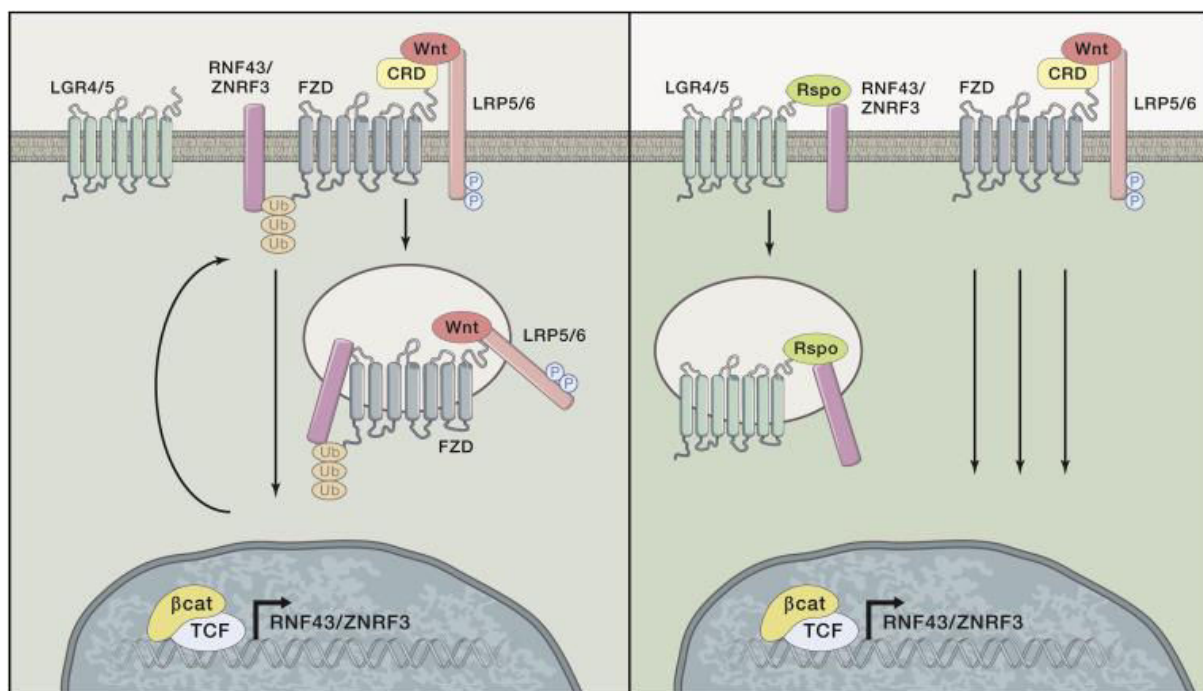

Figure 14 Role of R-spondin in potentiating WNT signaling. In absence of RSPO (Left panel), ZNRF3/RNF43, two E3 ubiquitin ligase transmembrane proteins induce turn over of the frizzled receptor, down regulating WNT signaling. R-spondins can bind to their receptor LGR and to ZNRF3/ZNRF3 (Right panel) inducing their auto-ubiquitination and subsequent membrane clearance, increasing FZD availability and WNT signaling (Nusse & Clevers, 2017).

to potentiate WNT/ β -catenin without binding to LGRs (Lebensohn & Rohatgi, 2018). More specifically, this study highlights that in R-spondins 3 and 2, the FU2 domain is not required to inactivate ZNRF3/RNF43, but the FU1 is strictly necessary (Figure 15). Additionally, when the

FU1 domain of RSPO3 was transplanted to RSPO1, this was enough to enable WNT potentiation without LGR interaction. However, the BR and TSP domains, that were previously thought to be non-essential for ZNRF3/RN43 membrane clearance, seem, in the case of LGR-independent potentiation, to be strictly required to enhance WNT/ β -catenin signaling (Lebensohn & Rohatgi, 2018).

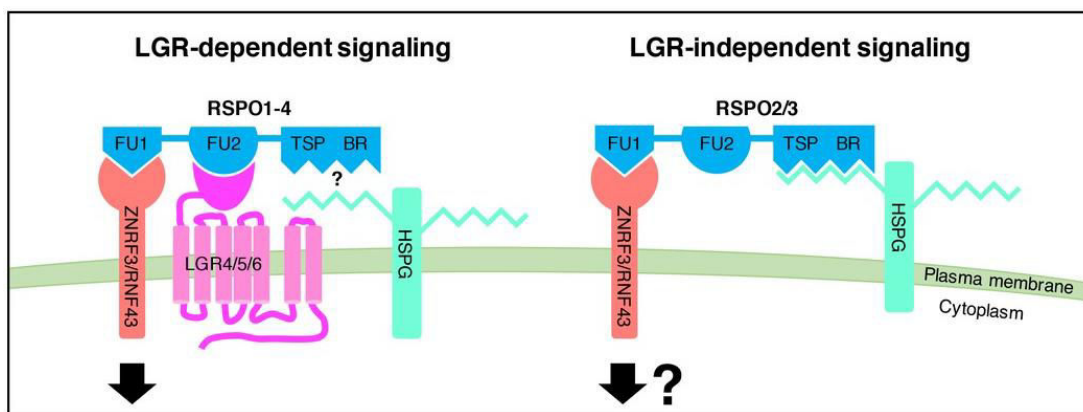

Figure 15 LGR-dependent and independent signalings of RSPOs. RSPO1 to 4 can potentiate WNT signaling by binding to their receptors, LGR4/5/6, in order to induce membrane clearance of ZNRF3/RNF43. In addition, RSPO2 and 3 only can inactivate ZNRF3/RNF43 without the need to bind to the LGR receptors, but the TSP/BR binding to HSPG is required. (Lebensohn & WNT/ β -catenin signaling in the adrenal cortex

In the adrenal cortex, different factors of the WNT/ β -catenin signaling pathway have been identified. RSPO1 is an essential component of the female gonadal differentiation and mutation in its gene result in a female-to-male sex reversal phenotype (Takase, Kanai-Azuma, & Kanai, 2018). In the adrenal, *Rspo1* is exclusively expressed in the WT1+ mesothelial cells but its role in the adrenal is not known yet as *Rspo1* knock out mice survived and did not show any significant abnormalities in adrenal development, zonation or tissue renewal (Vidal et al., 2016). The other RSPO found in the adrenal is *Rspo3* and is expressed specifically in GLI1+ capsular cells. They are both expressed during development and maintained expression into adulthood. In contrast, the expression of *Axin2*, *Lgr4* and *Lgr5* has been observed in the zG suggesting that the capsular cells signal to the zG cells (de Lau et al., 2012; Vidal et al., 2016; our data not shown). In addition, *Wnt4*, encoding a WNT ligand, is expressed in the zG from development to adulthood (Heikkilä et al., 2002; our data). *Wnt4*^{-/-} mice show decreased expression of zG specific enzymes (such as *Cyp11b2*) and as a consequence exhibit decreased production of aldosterone (Heikkilä et al., 2002). The role of RSPO3 in development and adult

tissue maintenance has previously been evidenced exposed by our lab using an inducible deletion of *Rspo3* in mice (*cCAG-CreERT;Rspo3^{Floxed/Floxed}* or *Gli1-CreERT2;Rspo3^{Floxed/Floxed}*) (Vidal et al., 2016). *Rspo3* deletion during development resulted in smaller adrenals with a thinning of the cortex and a decreased number of steroidogenic cells at E16.5. This was accompanied by a decrease in canonical WNT signaling as highlighted by reduced *Axin2* and *Wnt4* expression (two direct downstream targets), but also by a decrease in *Shh* expression in the zG and in *Gli1* expression in the capsule (Vidal et al., 2016). In addition, the adrenal cortex lacking RSPO3 showed an almost complete loss of proliferation and a disappearance of the zG, as marked by absence of DAB2 labeling and the expression of the zF marker AKR1B7+ reaching to the capsule. Deletion of *Rspo3* in adults also showed a decrease in adrenal cortex thickness, cellular proliferation, and loss of zonation with a decrease in zG markers including *Shh*, *Dab2*, *Wnt4* and *Cyp11b2*, yet no changes in apoptosis were detected. As well as an important role during development, this study also showed the importance of RSPO3 in adult adrenal cortex maintenance, as loss of *Rspo3* resulted in decrease progenitor proliferation and loss of the zG. In addition, it also brought a new model of double paracrine signaling between the capsule and the zG with the capsule signaling RSPO3 to activate WNT signaling within the zG, essential for proliferation and zonation. In turn, the zG secretes SHH that acts on the capsular cells to activate GLI1 co-transcriptional activity (Figure 16) (Vidal et al., 2016).

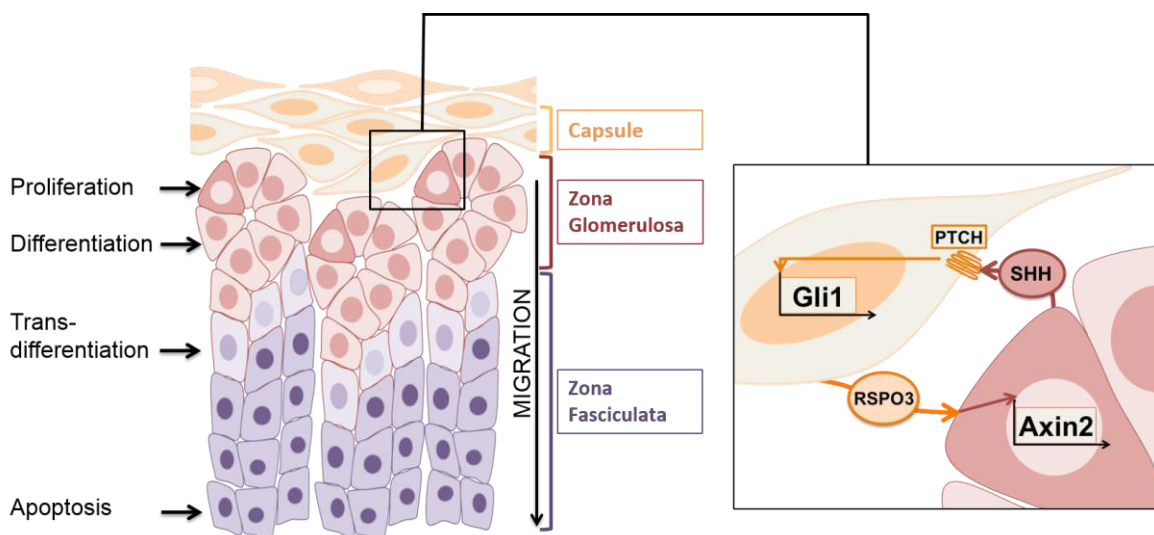

Figure 16 Paracrine signaling in adult adrenal cortex homeostasis. The capsular cells secrete RSPO3 that activate WNT signaling in the cells of the outer cortex inducing zona glomerulosa specification and proliferation. The cells of the zona glomerulosa secrete SHH that is received by the capsular cells and activate the downstream transcription factor GLI1.

Finally, as previously mentioned, WNT/ β -catenin signaling has been associated to adrenal carcinomas. A conditional mouse mutant carrying a mutation in Exon3 of *Ctnnb1*, where the phosphorylation sites by the destruction complex are located, prevents degradation of β -catenin and results in constitutive activation of β -catenin. Activation of this mutant within steroidogenic cells (*Sfl+*) caused an extension of the zG that resulted in over production of aldosterone and evidenced the inhibitory action of WNT/ β -catenin signaling on the zF. These mice also developed cortical hyperplasia through increased proliferation and at later stages, adrenocortical carcinoma (Berthon et al., 2010). These results confirmed the important role of WNT/ β -catenin in maintaining adult adrenal cortex homeostasis in term of proliferation and zonation. The data also showed that under hyperactive canonical WNT/ β -catenin signaling mice were prone to develop malignant tumors, as has been observed in the human pathology (Assié et al., 2014; Berthon et al., 2010) .

cAMP/PKA signaling

In the adrenal, binding of ACTH to its receptor the melanocortin receptor 2 (MC2R), a G protein-coupled transmembrane receptor induces adenylate synthase to synthesize cyclic adenosine monophosphate (cAMP). Increase of cytoplasmic cAMP activates the cAMP-dependent protein kinase (PKA). PKA is formed by two regulatory subunits, including PRKAR1A, and two inactive catalytic subunits forming a tetramer. Upon binding of cAMP to the regulatory subunits, the catalytic subunits are released from the tetramer and phosphorylate the downstream effectors including the transcription factor cAMP response element binding protein (CREB) (Zilbermint & Stratakis, 2015). As WNT signaling has been shown to trigger zG differentiation, PKA signaling has a major role in the specification and function of the zF. PKA has been evidenced to trigger expression of *StAR* and *Akr1b7*, the later being a specific marker of the zF. Overactivation of the PKA pathway can be achieved by ACTH treatment or in a transgenic mouse model with loss of function of the regulatory subunit *Prkar1a*. In both cases, the zF was found to be extended which was accompanied with excess glucocorticoids production and, in the case of the transgenic model, in the development of ACTH-independent Cushing's syndrome (Dumontet et al., 2018). In addition, the zG lost its specific markers such as CYP11B2 and a significant decrease in the canonical WNT target genes *Axin2* and *Lef1* was observed suggesting a repressive action of PKA on WNT signaling and on the zG (Drelon et al., 2016). Furthermore, complementary experiments suggested a mechanism through which PKA signaling downregulates *Wnt4*, the principal WNT ligand in the zG, which in turn inactivates the canonical WNT pathway and leads to β -catenin phosphorylation, targeting it for

degradation and preventing it to translocate into the nucleus to activate expression of downstream genes (Drelon et al., 2016). In conclusion, WNT and PKA signaling are required for zonation of the zG and zF, respectively. In addition, their antagonistic actions are essential to maintain the proper adrenal homeostasis and deregulation of one or the other pathway results in loss of the zG or the zF and development of a hypoplastic or hyperplastic adrenal cortex

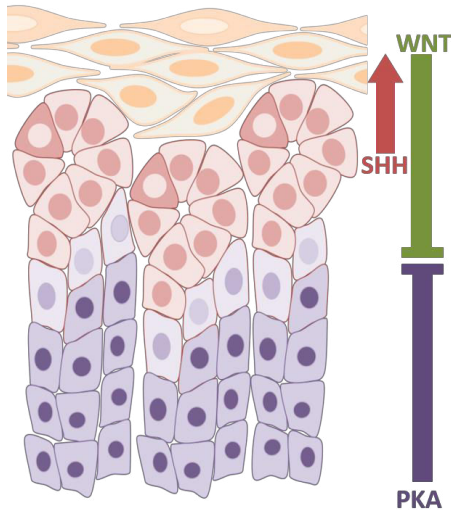

Figure 17 Signaling pathways in the adult adrenal cortex. SHH signaling acts from the zona glomerulosa to the capsule. In the reverse direction, WNT signaling is activated in the zona glomerulosa through RSPO3 secretion by the capsule and is further enhanced locally by WNT4, secreted by the zona glomerulosa. While WNT signaling is strictly required for the zonation of the zona glomerulosa, so is PKA signaling for the zona fasciculata. WNT and PKA signalings have inhibitory effect on each other and maintain proper zonation and hormonal secretion of the adrenal cortex.

(Figure 17).

Hippo signaling

The Hippo signaling pathway, as for WNT and SHH signaling, has important functions in development, tissue homeostasis and diseases, but is particularly known for its important role in regulating organ growth and size. Yes-associated protein and transcriptional co-activator with a PDZ-binding domain (YAP and TAZ) are two downstream effectors of the Hippo pathway. When the pathway is “OFF”, YAP and TAZ are unphosphorylated and translocate to the nucleus where they activate gene transcription through binding to TEAD-family transcription factors. When the pathway is “ON”, a cascade of kinase phosphorylation induces YAP/TAZ phosphorylation that results in YAP/TAZ inhibition through sequestration in the cytoplasm and degradation. (Meng, Moroishi, & Guan, 2016; Piccolo, Dupont, & Cordenosi, 2014).

Little has been published with regards to Hippo signaling in the adrenal cortex. In fact, to this date only one paper studied the role of YAP/TAZ using a double knock out strategy in steroidogenic cells (*Sfl-Cre*). YAP is expressed in the nucleus and cytoplasm of the zG as well as in the nucleus of the zF. TAZ is only found in the nuclei of the zG and zF but is also observed in the cytoplasm in the female X-zone. After homozygous deletion of *Yap* and *Taz* (as well as in homozygous deletion of *Yap* and heterozygous deletion of *Taz* together), degeneration of the adrenal was observed from 10 weeks of age onwards, featuring hypertrophy and presence of vacuolated multinucleated cells in the zF. At a later stage, the adrenal cortex looked highly abnormal with accumulation of vacuolated cells and disturbed zG as highlighted by uneven β -catenin labeling in the zG and unexpected β -catenin labeling in hypertrophic cells, suggesting a generalized degeneration of the cortex affecting all the zones by 30 weeks of age (Figure 18). Further analysis identified apoptosis within the zF, but no decrease in proliferation, to initiate the degenerative phenotype (Levasseur, St-Jean, Paquet, Boerboom, & Boyer, 2017).

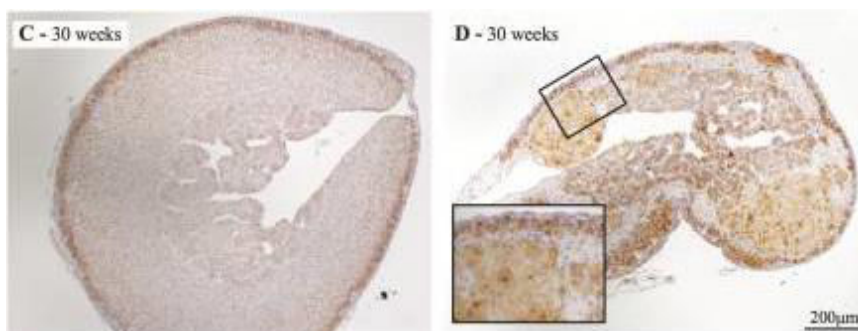

Figure 18 Effect of *Yap/Taz* knockout on the adrenal cortex. β -catenin immunohistochemistry in adrenal section of 30 weeks of age control mouse (Left) or *Sf1^{Cre+};Yap^{flox/flox};Taz^{flox/flox}* (Right). The mutant cortex is hypertrophic and presents vacuolated cells as well as multinucleated structures in the zona fasciculata accompanied with a disrupted distribution of β -catenin (Levasseur et al., 2017).

Scientific context

In 2001, a report from the Government accounting office showed that 8 out of 10 drugs withdrawn from the US markets between 1997 and 2000 posed a greater risk to women than to men (U.S. Government Accountability Office, 2001). Men and women do not react the same way to drugs and in addition, many diseases, including conditions affecting non-reproductive organs, are unequally affecting men and women. For example, women are twice more likely to develop depression (Martin, Neighbors, & Griffith, 2013), 78% of patients with autoimmune diseases are women (Fairweather, Frisancho-Kiss, & Rose, 2008), men are 4 times more often affected by autism (Halladay et al., 2015), etc. In endocrinology, women are more likely to develop Cushing's syndrome and Addison's diseases (respectively 4:1 (Sharma, Nieman, & Feelders, 2015) and 4:1 (Margulies & Mullen, 1997)) as well as adrenal carcinomas that are up to 6 times more frequent for some subtypes of malignant tumors in women than in men (Audenet, Yates, Cussenot, & Rouprêt, 2013; Ayala-Ramirez et al., 2013; Scollo et al., 2016). However, most scientific fields do not study females, as much as they do males and this is particularly the case in endocrinology where almost 70% of the research articles (published in 2009 in the top 4 journals) were exclusively studying male individuals (Beery & Zucker, 2011). In the adrenal, disease prevalence is not the only difference between the two sexes. Histologically, the adult female adrenals of the mouse maintain an X-zone, a remnant of the fetal adrenal cortex, which is lost at puberty in the male (Hershkovitz et al., 2007). In addition, starting from 3 weeks of age, the mouse female adrenal cortex is significantly thicker than that of males. Further analysis showed that the X-zone was not the only contributor to this difference, but that in addition, the zF of female mice was also thicker due to an increased number of cells (Bielohuby et al., 2007). Hormonal concentrations are also different between male and female mice with females having higher plasma ACTH, corticosterone and aldosterone than males (El Wakil, Mari, Barhanin, & Lalli, 2013).

On the transcriptomic level, analysis in mice and rats have shown higher expression levels of *Nr5a1* and *Nr0b1* and a subset of steroidogenic genes such as *Cyp11a1*, *Cyp11b1* and *StAR* that were upregulated in the zF (El Wakil et al., 2013; Trejter et al., 2015).

Finally, several studies using transgenic animals presented striking differences in phenotype development between male and female. In 2010, the constitutive activation of β -catenin restricted to the adrenal cortex resulted in the development of adrenal cortex hyperplasia, dysplasia and tumors in the later stage. Strikingly, males presented with a slower progression

of the phenotype (Berthon et al., 2010). In addition, double knock out of *Yap* and *Taz*, two downstream effectors of the Hippo signaling pathway, were studied. While the expression of the two proteins was mostly similar between male and female, male mutants showed a degeneration of the adrenal cortex accompanied with increased apoptosis and decreased steroidogenesis, phenotype that was not observed in female mutants at the exception of a reduced steroidogenesis (Levasseur et al., 2017). More recently, a murine transgenic model for ACTH-independent Cushing's syndrome (Overactivation of PKA signaling through ablation of *Prkar1a*) has been analyzed. In this model, while females developed a Cushing's syndrome phenotype at 3 months, males only started to show phenotypic features around 7 month with a disorganization of the zF similar to the one of female at 3 months only developing at 12 months in males (Dumontet et al., 2018).

Considering the above differences between male and female in the adrenal, it is of importance to study the differences and similitudes in control condition regulating the adult adrenal cortex tissue maintenance.

Experimental models

CRE-LoxP system

With the exception of the zona reticularis, mice have an adrenal gland similar to those of humans, making it an adequate model to study the adrenal cortex (Niakan & McCabe, 2005). In addition to a similar physiology and tissue organization, mice offer possibilities of genetic manipulation leading to transgenic line allowing for genetic manipulation of interesting signaling pathways and specific labeling of a subtype of cells. In particular, the CRE-loxP system allows for cell type and time specific genetic targeting, offering a versatile tool. The CRE is a recombinase enzyme binding to *loxP* sites and inducing recombination between two sites. When the two *loxP* sequences are facing the same orientation, recombination results in excision of the intervening (also called floxed) DNA sequence. Combination of the CRE with a tissue-specific promoter allows for cell-type targeting, since only cells expressing this promoter will undergo recombination. In addition, the CRE-recombinase has been further engineered by fusing it with the ligand binding domain of the human estrogen receptor (ER) making CRE active only upon ligand binding to the receptor and so giving it a temporal dimension. The unbound ligand binding domain (LBD) retains the CRE within the cell cytoplasm. Upon ligand binding, the CRE protein is translocated to the nucleus where it can have access to the *loxP* sites (Figure 19). Since the ligand binding domain of the ER can recognize endogenous estrogen naturally present in mice, the original CREER is not selective. A second and more specific fusion protein called CREER^T has been created with a G521R mutation in the ligand-binding domain of the ER making it more specific to Tamoxifen (synthetic analog of Estrogen) so that it binds with reduced leakiness. Finally a second version of the mutated ER-LBD has been created with the three G400V/M543A/L544A mutations to increase affinity of Tamoxifen to the LBD so that lower doses are required for CRE activation as well as an even reduced leakiness giving it a high specificity to Tamoxifen (Feil, Valtcheva, & Feil, 2009; Metzger & Chambon, 2001; Ray, Fagan, Charles, Michael, & Debakey, 2000; Sauer, 1998).

Time specific induction of the CRE can be of great advantage when knocking out genes that are strictly required during development or, as we will further develop, cell lineage tracing.

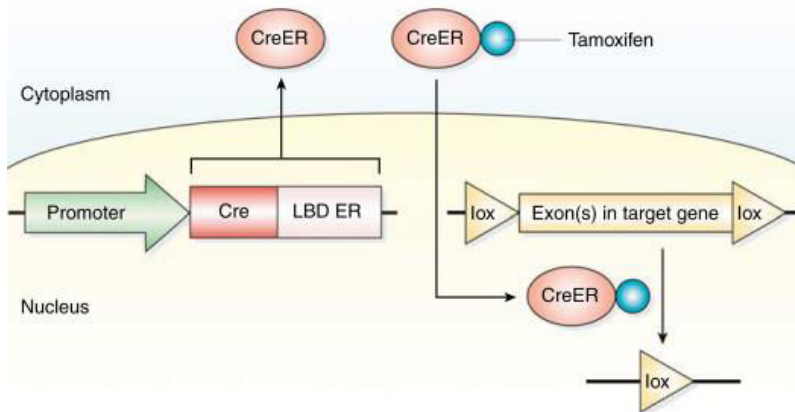

Figure 19 Schematic representation of CRE recombination. The *Cre* recombinase is fused to the ligand-binding domain of the estrogen receptor and encodes the CerER located in the cytoplasm. Upon Tamoxifen administration, CerER translocates to the nucleus where it recombinates DNA between two loxP sites (Kohan, 2008).

Lineage tracing

Cell lineage tracing experiments have been designed in order to trace a specific cell population and its progeny. Time and cell specificity of the labeling is acquired thanks to an inducible CRE (CREERT2) while the fluorescent labeling is obtained by crossing the CRE with a reporter gene, in my case the mTmG (Membrane-targeted tandem dimer tomato, membrane-targeted green fluorescent protein) transgene (Figure 20A) (Muzumdar, Tasic, Miyamichi, Li, & Luo, 2007). The mTmG construct is driven by a ubiquitous promoter and expresses under normal condition a membranous red fluorescent protein, labeling all the cells of the organism (Figure 20B). Upon Tamoxifen treatment, the cells expressing the specific promoter undergo CRE recombination that excises the mT along with the stop codon preceding the mG, encoding a membranous green fluorescent protein (GFP) (Figure 20C) (Kretzschmar & Watt, 2012; Snyder et al., 2013). The cells are subsequently labeled by a membranous green fluorescence while all the cells that do not express the promoter driving the *Cre* expression will remain red. In addition, if a green fluorescent cell divides, both daughter cells will retain the expression of the green fluorescence (Figure 20D). GFP can be observed approximately 24hours after Tamoxifen injection, the timing between Tamoxifen induction and mouse sacrifice will determine the time of the chase. Lineage tracing is a very powerful tool to follow cell fate and

cell contribution to other lineages with the labeling specificity relying on the specificity of the promoter employed for *Cre* expression.

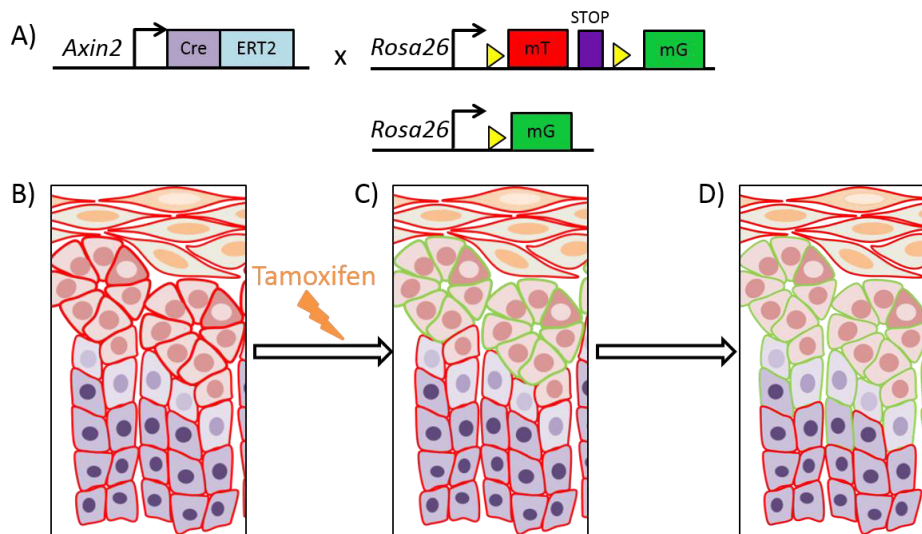

Figure 20 Lineage tracing schematic overview. A) Genetic construct for lineage tracing experiment requires a *Cre* recombinase. The specific promoter will determine the cell population to be initially labeled and presence of the ligand-binding domain of the estrogen receptor offers timing choice of the labeling. Lineage tracing experiments also require a reporter, such as the mTmG transgene that encodes fluorescent proteins. B) Before induction, all the cells express the membrane red fluorescence. C) Upon tamoxifen administration, the *Cre* recombines in the cells expressing the promoter allowing for the membrane GFP to be expressed instead of the Tomato. D) All descendant cells of the originally GFP labeled cells will also be GFP labeled allowing the movement of the labeled cells to be followed and their progeny to be identified.

Sex reversal

As already mentioned, SOX9 plays a major role in sex determination and in particular in testis differentiation. In this research project, I made use of two distinct sex reversal models that have been previously described. The first is a conditional knockout of *Sox9* driven by the *Sfl-Cre* line (*Sfl-Cre; Sox9^{lox/lox}*) (Lavery et al., 2011). In human, heterozygote mutations of *Sox9* results in XY patients to develop a male-to-female sex reversal phenotype. *Sox9* is expressed in XX and XY genital ridge independently of SRY, but upon *Sry* activation becomes up regulated in pre-Sertoli and Sertoli cells. Mice carrying a heterozygous mutation of *Sox9* do not exhibit sex-reversal and full knockout animals die around E9.5 with severe defects in multiple organs. To allow homozygous deletion within Sertoli precursor cells, the *Sfl-Cre* line has been used in combination with the floxed allele for *Sox9*. XY mice with the CRE and homozygous for the *Sox9* floxed allele develop female external genitalia, ovaries and female reproductive

tracts and are fertile, but produce reduced litters in comparison to the XX females (Figure 21) (Lavery et al., 2011).

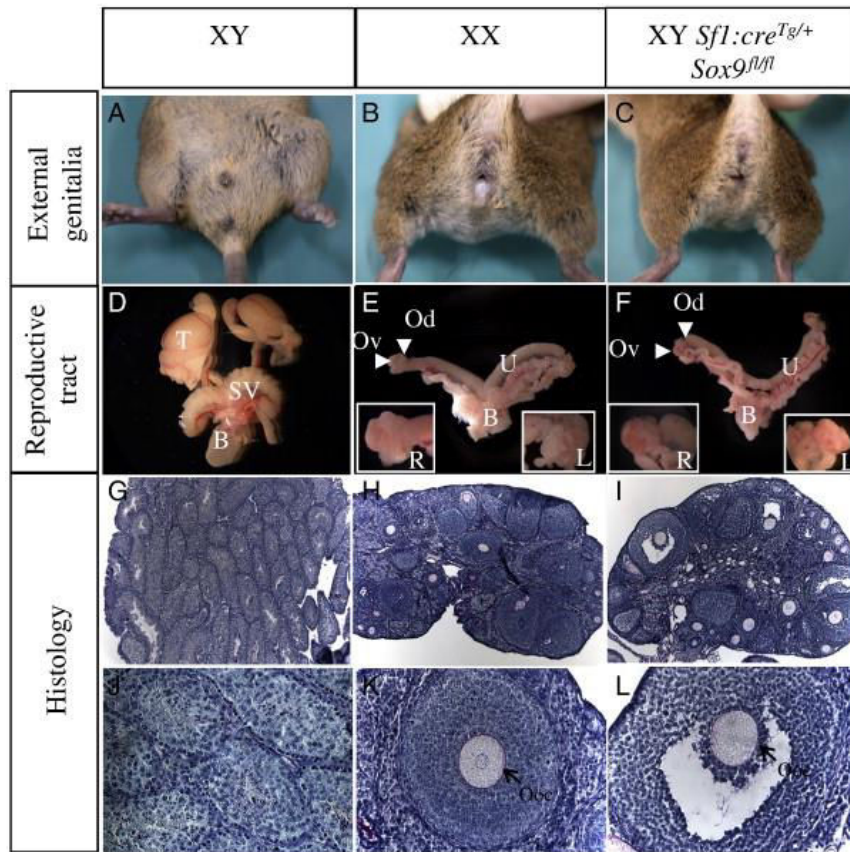

Figure 21 *Sox9* knock out sex reversal model. Adult XY *Sfl-Cre;Sox9^{fl/fl}* present with external genitalia, internal reproductive tracts and gonad histology that resemble the ones of female control, as opposed to male control. T: Testis; SV: Seminal vesicle; B: Bowel; Ov: Ovary; Od Oviduct; U: Uterus; R: Right ovary; L: Left ovary. (Lavery et al., 2011).

SOX9 duplication has been found to induce female-to-male sex reversal in a patient suggesting that *SOX9* is enough to induce male gonadal differentiation. In the second sex reversal mouse model used in this study, *Sox9* is ectopically expressed under the control of regulatory regions of the Wilms' tumor suppressor gene (*Wt1*) in undifferentiated gonads. This early ectopic *Sox9* expression results in a female-to-male sex reversal with XX male phenotypically reassembling XY control male accompanied by the development of ovotestes in the XX *Wt1:Sox9* male including testis cord formation (Figure 22) (Gregoire et al., 2011; V. P. I. Vidal et al., 2002).

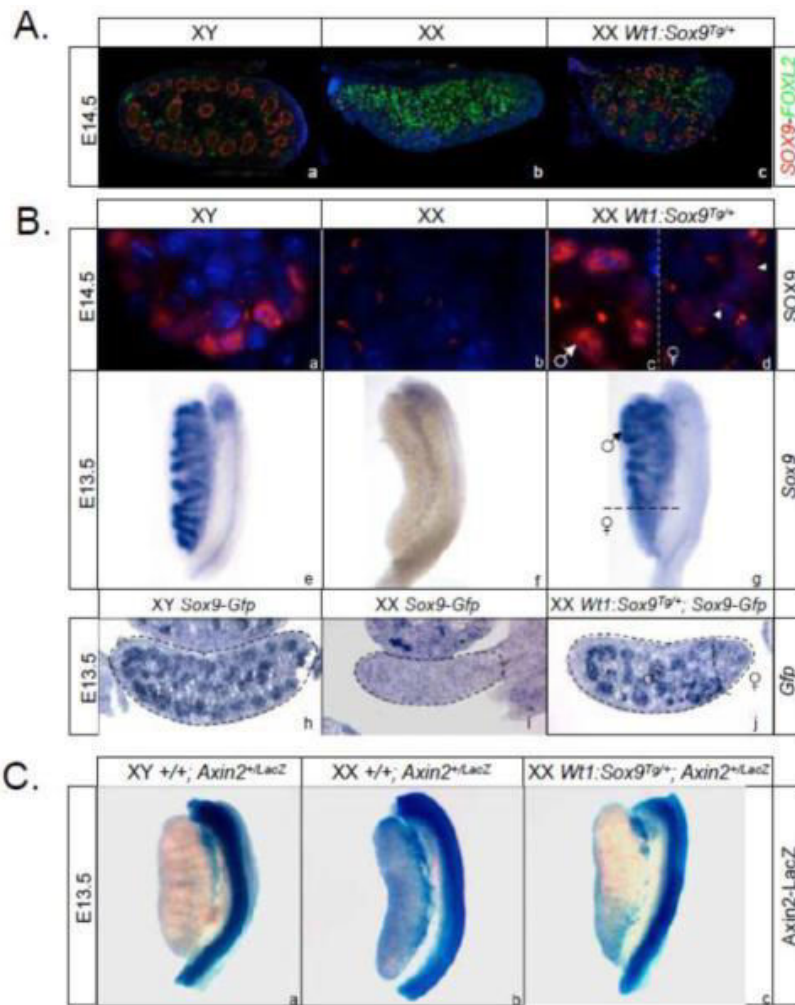

Figure 22 *Sox9* overexpression sex reversal model. XX *Wt1:Sox9* mice present with ovotestes as shown by A) the presence of both SOX9⁺ and FOXL2⁺ cells in the mutant gonad at E14,5; B) High level of *Sox9* in the testicular region and low level of *Sox9* in the ovarian part as opposed to C) low level of WNT signaling activity in the testicular part and high level of WNT signaling activity in the ovarian part. Gregoire et al. 2012.

RSP01 Gain of function

In the second part, the *Sfl-Cre^{High}* (Bingham, Verma-Kurvari, Parada, & Parker, 2006) line was combined with an *Rspo1* transgene homologously recombined into the *Rosa26* locus. *Rspo1* ectopic expression is driven by the strong *Cag* (chicken β -actin gene) promoter. A floxed stop codon upstream of the *Rspo1* transgene ensures quiescence of the construct in the absence of CRE recombinase, but allows for specific expression of the transgene upon recombination within SF1 expressing cells. This model has previously been described by De Cian et al. (2017) in a study analyzing the over expression of *Rspo1* in the ovary (De Cian et al., 2017). RSP01 is an important factor in sex determination and ovarian differentiation, but is down regulated

postnatally in the ovary suggesting that it is not required for adult ovarian function. *Rspo1* has also been identified to be amplified in 8% of ovarian epithelial cancers. Ectopic expression of *Rspo1* in the adult ovary and subsequently increased activation of the WNT/ β -catenin signaling induced a decrease in fertility in mice heterozygote for the transgene and a complete infertility by 6 months of age in homozygote mice. In addition, over expression of *Rspo1* also resulted in various abnormalities of the ovary including hyperplasia and development of tumors (De Cian et al., 2017).

Aim of the study

In view of the importance of organ homeostasis and its regulation in the development of disease, it is of great interest to investigate further the cellular renewal and its regulation in the adrenal cortex.

In this thesis, the first part aimed at investigating the dynamics and cell populations involved in the process of tissue maintenance of the adrenal cortex using different mouse Cre lines for lineage tracing experiments. In an effort to fully understand the cellular renewal, this project also aimed at identifying similarities and differences in adult males and females. Since previous research has reported differences in adrenal disease prevalence in human and in phenotype development in various mouse models, investigating the sex-specific aspect of adrenal cortex tissue homeostasis is an important part of its in depth analysis. Finally, this part also intend to understand the source of the sex-specific differences using different mouse models and approaches including sex-reversal mouse models, gonadectomy and hormonal treatment.

In a second part, a mouse model presenting with development of sex-specific pathologies of the adrenal cortex is investigated. Using the *Rspo1* Gain of function mice, this project aims to complete the previous study by further analyzing sex differences in adrenal cortex cell renewal and more specifically in its regulation in case of abnormal signaling. In addition, careful analysis of the phenotype in male and female, its timing and causes are expected to allow for the establishment of a link between sex-specific tissue homeostasis and disease development.

Overall, this thesis intends to evaluate the profound differences between male and female in adrenal cortex homeostasis in order to understand the origin of the sex-specific phenotypes and disease prevalence of the adrenal cortex. In addition, this in depth analysis of tissue homeostasis in the adrenal cortex can serve as a model of stem cell sex specificity in other non-reproductive organ that can pave the way to personalized treatment depending on the individual's sex.

- RESULTS -

Part1: Paper 1 “Androgens regulate sex-specific stem cell activity of the adrenal cortex”

Androgens Regulate Sex-Specific Proliferation and Capsular Stem Cell Recruitment in the Adrenal Cortex

Anaëlle Grabek¹, Bastien Dolfi¹, Bryan Klein¹, Fariba Jian-Motamedi¹, Marie-Christine Chaboissier¹
and Andreas Schedl^{1,2*}

¹ Université Côte d'Azur, Inserm, CNRS, iBV, France

² Equipe Labellisée Ligue Contre le Cancer

***Corresponding author:**

Andreas Schedl
iBV, Institut de Biologie Valrose,
Université Cote d'Azur
Centre de Biochimie
UFR Sciences
Parc Valrose
06108 Nice Cedex 2, France
Tel.: ++33492076401
FAX: ++33492076402
Email: schedl@unice.fr

SUMMARY

Evolution has resulted in profound differences between males and females that extend to non-reproductive organs and are reflected in the susceptibility and progression of diseases. The cellular and molecular basis for these differences remain however largely unknown. Here we report that tissue renewal in adrenals is highly active and sexually dimorphic with female mice showing a 3-fold higher turnover than males. Moreover, while in males, homeostasis relies on the proliferation of cells within the steroidogenic zone, females employ an additional stem/progenitor compartment situated in the adrenal capsule. Using sex reversal models, gonadectomy and dihydrotestosterone treatments, we further show that sex-specific stem cell activity is driven by male hormones that repress recruitment of *Gli1*⁺ stem cells from the capsule and cell proliferation. Taken together our findings provide a molecular and cellular basis for adrenal sex dimorphism that may contribute to the increased incidence of adrenal diseases in females.

INTRODUCTION

Tissue renewal is an essential process that ensures continued organ function in the aging organism. Dramatic progress towards an understanding of tissue homeostasis in many tissues has been made. By contrast, little is known about the extent to which the adrenal cortex renews, despite the fact that it represents one of the main sites of steroid synthesis in the mammalian organism.

Adrenals are composed of a neural crest derived medulla and the adrenal cortex that originates from the intermediate mesoderm. The development of the adrenal cortex commences with an adrenal primordium around E9.5 (embryonic day) in mice (for review see (Bandiera et al., 2015)). SHH, released from this primordium, induces recruitment of surrounding *Gli1*⁺ mesenchymal cells to the steroidogenic lineage (King et al., 2009; Lerario et al., 2017). Once formed, the adult cortex adopts its zonated organization with the zona glomerulosa (zG), zona fasciculata (zF) and zona reticularis (zR) producing mineralocorticoids, glucocorticoids and androgens, respectively. Mice lack the zR, but instead have an X-zone that represents a developmental remnant disappearing at puberty in males and during first pregnancy in females. Recent studies have demonstrated that zonation depends on the antagonistic action of β -catenin and PKA signaling (Drelon et al., 2016). RSPO3, a signalling molecule released from the mesenchymal adrenal capsule, activates β -catenin in sub-capsular steroidogenic cells thus conferring the zG fate (Vidal et al., 2016). Steroidogenic cells situated closer to the medullary position do not receive R-spondin/WNT signals and thus adopt the zF fate (Figure 1A).

Several reports suggested continuous turnover of the adrenal cortex with steroidogenic cells being born in the outer cortex, followed by centripetal migration and stereotypic apoptosis when they reach the cortico-medullary boundary (Chang et al., 2013; Finco et al., 2018; Freedman et al., 2013; Penny et al., 2017; Vidal et al., 2016). However, the vast majority of studies have been restricted to males and differences/similarities in adult tissue turnover between the two sexes remain unknown. This is surprising given the well-established sexual dimorphism in the adrenal gland. Indeed, female adrenals in mice are larger, which has been attributed to an increased zF resulting from differential growth after puberty (Bielohuby et al., 2007). Sexual dimorphism has also been observed on the phenotypic level with several genetic models showing a sex-dependent phenotype (Berthon et al., 2014; Dumontet et al., 2018; Levasseur et al., 2017) and transcriptomic studies revealing sex-specific differences (El Wakil et al., 2013; Jopek et al., 2017). Most importantly, adrenal pathologies including Cushing syndrome

(Steffensen et al., 2010), Addison's disease (Ten et al., 2001) and certain adrenal cortical cancers are up to 6 times more frequent in women than in men (Audenet et al., 2013; Ayala-Ramirez et al., 2013; Scollo et al., 2016). Despite these striking differences, the cellular basis of these sex bias remains largely unknown.

Here, we addressed the cellular dynamics of adrenal tissue homeostasis in both sexes. We show that the adult adrenal cortex is subject to rapid and sex-specific turnover that results in a complete replacement of the steroidogenic tissue every 3 months in females. We further show that while renewal in male adrenals is primarily driven through proliferation of cells situated in the zG, female adrenals also recruit mesenchymal cells from the capsule. Both, proliferation and stem cell recruitment are suppressed by male hormones, thus providing a molecular explanation for the sex-specific activity.

RESULTS

To address whether adrenal sex differences may be reflected in tissue renewal, we first used BrdU labelling (2 days pulse) (Figure 1B) in fully matured (12 weeks of age) mice and quantified proliferation rates in different adrenal compartments. BrdU labelled steroidogenic cells were predominantly observed in the zG and the outer zone of the zF, whereas deeper zones were devoid of proliferation (FigureS1A), consistent with a previous report (Chang et al., 2013). Overall, females showed a 6.3-fold ($p=0.007$) higher proliferation rate in steroidogenic cells, when compared to males (Figure 1B, Figure S1A). Differences were particularly striking in the outer zF, where we observed a 15-fold higher number of proliferating cells in females ($p<0.0001$; Figure 1B). The much higher proliferation rate in females was surprising, as organ size is maintained throughout adult life in both sexes. We therefore speculated that the high level of proliferation in females maybe counter-balanced by increased apoptosis. Indeed, quantification revealed a 2.0-fold ($p\text{-value}=0.038$) higher number of Caspase 3 positive cells at the juxtamedullary boundary (Figure1C, FigureS1B), thus ensuring maintenance of tissue size.

To gain insights into the cellular dynamics of adrenal cortex homeostasis, we next performed lineage-tracing experiments using tamoxifen-inducible Cre lines to activate GFP expression (*mTmG*) (Muzumdar et al., 2007) in different cellular compartments. *Axin2* and *Wnt4* are two β -catenin (CTNNB1) downstream targets and tamoxifen activation with *Axin2-CreERT2* (Wang et al., 2015) or *Wnt4-CreERT2* driver lines (Kobayashi et al., 2008) resulted in GFP-labelling of zG cells in both sexes two days after induction (Figure 1D; Figure S1C, D). Over

time the number of GFP-labelled cells increased and in females the entire cortex was replaced by 3 months after induction (Figure 1D). Quantification of GFP-labelled cells using the *Wnt4-CreERT2* line revealed that renewal was considerably slower in males (Figure 1E, Figure S1E) and only 41,8% and 74,6% of cells were replaced after 3 and 6 months, respectively, despite the fact that males exhibit a significantly thinner cortex when compared to females (Bielohuby et al., 2007).

A higher index of proliferation in females was not limited to steroidogenic cells, but was also detected in NR2F2⁺ capsular cells (4-fold, p-value=0.0016, Figure 2A; Figure S2A). Since capsular cells are essential for the initial formation of the adult adrenal cortex (King et al., 2009), we wondered whether this population may also contribute to sex-specific adrenal cell renewal. Lineage-tracing experiments using the *Gli1-CreERT2* strain (Ahn and Joyner, 2004) in 3-weeks-old animals (1-month chase) revealed recruitment of capsular cells to the steroidogenic lineage in both sexes (Figure S2B, C). By 6 weeks after birth, however, this contribution had almost entirely ceased in males (Figure S2B) and only occasional GFP⁺ steroidogenic cells were detected in adults even after long-term labelling (Figure 2B). In contrast, induction in adult females (12 weeks) resulted in recruitment of GFP-labelled steroidogenic (zG and zF) cells as early as 1 week after induction (Figure 2B, Figure S2D). After 1 month, the number of capsule-derived steroidogenic cells was 16.1-fold higher in females than in males (Figure 2C, Figure S2B, p-value=0,013). Upon reaching the zF, a proportion of GFP⁺ cells further proliferated (Figure 2D; Figure S2E). Taken together these data show that while cell turnover in adult males relies on progenitors located within the zG, in females, capsular stem cells continuously proliferate and contribute significantly to tissue renewal. GFP-label was maintained in the capsule over the entire period analyzed (6 months) indicating continuous self-renewal of this compartment (Figure S2F).

To assess whether the observed sexual dimorphism is sex-chromosome dependent, we employed *Sfl-Cre; Sox9^{fl/fl}* XY (Lavery et al., 2012) and *Tg(Wt1:Sox9)* XX (Vidal et al., 2001) mice, two genetic models that present sex reversal phenotypes and develop as XY females and XX males, respectively (Figure 3A and Figure 3B). Morphological and histological analysis revealed that *Tg(Wt1-Sox9)* XX males developed adrenals that lacked the X-zone and resembled wildtype male organs in both weight and histology (Figure S3A and Figure S3B). Analogously, XY females (*Sfl-Cre; Sox9^{fl/fl}* XY) had significantly larger adrenals than male controls and displayed the X-zone, thus resembling control females (Figure S3C and Figure S3D). Quantification of BrdU incorporation in the capsular compartment revealed a significant

increase in proliferation in XY females (Figure 3A; p-value=0.0024) and a decrease in XX males (Figure 3B; p-value=0.0006), when compared to control males and females, respectively. Strikingly, lineage-tracing analysis of *Gli1*⁺ cells on a *Tg(Wt1-Sox9)* transgenic background (induction at 12 weeks, 1 month chase) showed that GFP⁺ cells in XX males remained restricted to the capsule, a pattern resembling XY males rather than XX females (Figure 3C, D; p-value=0.0051).

The above sex reversal analysis suggested that sex-specific proliferation and recruitment does not depend on sex chromosomes, but is rather controlled by hormones. To confirm this hypothesis, we gonadectomized 10-week old *Gli1-CreERT2;mTmG* males and females, induced GFP expression by tamoxifen treatments 2 weeks later and analyzed adrenal glands after 4 weeks chase (Figure 4A). Consistent with a previous report (HersHKovitz et al., 2007), bilateral orchiectomy induced a secondary X-zone (20 α HSD⁺) at the juxta-medullary boundary (Figure S4A). Proliferation and cell recruitment of capsular cells was unaffected in adrenals in females that had undergone ovariectomy (Figure 4A-C) suggesting that ovarian hormones, such as estrogens and progesterone, do not significantly influence adrenal cell renewal. By contrast, orchiectomized males showed a 3.5-fold increase of the proliferative index when compared to sham males (Figure 4A; p-value<0.0001). Similarly, recruitment of capsular cells to the steroidogenic lineage was 3 times higher after testis removal than in sham males (Figure 4B, C; p-value=0.0012) suggesting that the reduction of androgens permitted activation of this stem cell compartment.

To further assess the contribution of androgens to sex-specific differences in adrenal homeostasis, we performed ovariectomy of *Gli1-CreERT2;mTmG* females at 10 weeks of age and treated them for 6 consecutive weeks with dihydrotestosterone (DHT), the primary androgen produced by testes (Figure 4D). As reported previously (HersHKovitz et al., 2007), DHT administration induced X-zone regression (Figure S4B), demonstrating successful treatment. BrdU labeling revealed a significant reduction of capsular cell proliferation 3.2 fold compared to controls (Figure 4D; p-value<0.0001). Importantly, the recruitment of *Gli1*⁺ capsular cells was almost entirely suppressed (81-fold decrease, Figure 4E and Figure S4C; p-value=0.0002). Moreover, DHT treatment of pregnant females (E14.5 onwards) also strongly inhibited capsular cell recruitment during adrenal development (26.7-fold; p-value<0.0001; Figure S4 D-F). We conclude that androgens negatively impact proliferation and capsular cell recruitment.

Discussion

Studying tissue homeostasis is an important objective when considering aging, responses to tissue damage and its links to cancer. Previous studies have suggested that the adrenal cortex is undergoing active cell replacement, but the degree of tissue turnover and a potential influence of sex on this process remained poorly characterized. Here we have performed an in-depth analysis of tissue dynamics in the adult adrenal cortex and demonstrate that this tissue is subject to an unexpectedly high level of cell renewal that leads to a complete replacement of the steroidogenic compartment every few months. The directed proliferation in the outer cortex, centripetal migration of cells and stereotypic apoptosis at the cortico-medullary boundary suggest an organ-intrinsic requirement for this rapid turnover. As steroid hormone synthesis generates reactive oxygen substrates (ROS) as byproducts (Prasad et al., 2014; Zangar et al., 2004), we can speculate that the active tissue renewal has been adopted to avoid an accumulation of damage in steroid producing cells. Future experiments are needed to address this hypothesis.

Even more surprising than the rapid turnover of the adrenal cortex are the dramatic differences observed in stem cell dynamics between males and females. A recent paper by Dumontet et al. (2018) reported sex differences in the migration of adrenal steroidogenic cells in the postnatal period, but their experimental setup (constitutive Cre-line) did not allow them to analyze tissue turnover in adults. Our study now demonstrates that a striking sex-difference in tissue renewal persists throughout life. Although we did not perform lineage tracing beyond 6 months, by extrapolating from our data we estimate that the male adrenal cortex appears to be replaced every 9 months, which is in stark contrast to the rapid turnover of 3 months in females. In addition to the differences in proliferation, our study demonstrates that females, but not males, continuously recruit capsular stem cells to the steroidogenic cell lineage. Why females require this high level of tissue turnover and the need for continuous recruitment of capsular cells is presently unknown, but we can assume a physiological reason for this dimorphism. In this respect, it will be interesting to determine whether the recruited cells are distinct in terms of transcriptional signature and/or hormone production.

Apart from organs involved in the reproduction (including the mammary gland), stem cell activity is usually not considered to be sex-specific. However, a recent study in *Drosophila* reported differences in gut stem cell proliferation that appears to be under control of the chromosomal sex determination system (Hudry et al., 2016). By contrast, the here reported stem cell dimorphism involves hormonal control. The fact that orchietomy rather than ovariectomy

influenced proliferation and stem cell recruitment, suggested that androgens rather than female hormones regulate adrenal cortex turnover. In line with this hypothesis, hormone treatment with dihydrotestosterone suppressed proliferation and capsular stem cell recruitment in ovariectomised females. Testosterone has been shown previously to impact proliferation of human mesenchymal stem and endothelial progenitor cells at least *in vitro*, although this study described a pro-proliferative action (Corotchi et al., 2016). That androgens can influence adrenal gene expression and the phenotype in a mouse model for Cushing syndrome has been recently reported (Dumontet et al., 2018) and it will now be important to determine how transcriptional changes translate into altered stem cell activity.

It is tempting to speculate that the dramatic differences in adrenal stem cell activity of opposite sex are linked to the much higher prevalence of adrenal diseases in women. Indeed, the significantly higher proliferation rate observed in females is expected to cause an accumulation of mutations and thus increase the risk of developing cancer. Future research will need to focus on how these differences translate into sex-specific diseases, which in the long run may pave the way to the development of sex-specific treatment options.

As sexual dimorphism on the histological, molecular and phenotypic level is not restricted to the adrenal gland (Karp et al., 2017), it is likely that sex-specific stem cell activity may also occur in other organ systems. Surprisingly, research in many fields, but in particular in endocrinology, is often limited to one sex (often male) to avoid the recurring physiological changes due to changes of hormones in the menstrual cycle (Beery and Zucker, 2011; Yoon et al., 2014). Our data highlight the profound differences sex hormones have on tissues and underline the importance of analyzing phenotypes and basic molecular processes in both sexes.

Acknowledgements

We would like to thank the staff of the animal facility and Samah Rekima (histology platform) for their dedication, Ioannis Oikonomakos and Filippo Massa for initial experimental help. We are indebted to Andy P. McMahon (Eli and Edythe Broad Center for Regenerative Medicine and Stem Cell Research) for providing the *Wnt4-CreERT2* mice. This work was supported by La Ligue Contre le Cancer (Equipe Labelisée), the ANR (ANR-14-CE12-0007, ANR-11-LABX-0028-01, ANR-18-CE14-0012) and the WWCR (18-0437).

Declaration of Interests

The authors declare no competing interests.

References

- Ahn, S., and Joyner, A.L. (2004). Dynamic changes in the response of cells to positive hedgehog signaling during mouse limb patterning. *Cell* 118, 505-516.
- Audenet, F., Mejean, A., Chartier-Kastler, E., and Roupret, M. (2013). Adrenal tumours are more predominant in females regardless of their histological subtype: a review. *World J Urol* 31, 1037-1043.
- Ayala-Ramirez, M., Jasim, S., Feng, L., Ejaz, S., Deniz, F., Busaidy, N., Waguespack, S.G., Naing, A., Sircar, K., Wood, C.G., *et al.* (2013). Adrenocortical carcinoma: clinical outcomes and prognosis of 330 patients at a tertiary care center. *Eur J Endocrinol* 169, 891-899.
- Bandiera, R., Sacco, S., Vidal, V.P., Chaboissier, M.C., and Schedl, A. (2015). Steroidogenic organ development and homeostasis: A WT1-centric view. *Mol Cell Endocrinol* 408, 145-155.
- Beery, A.K., and Zucker, I. (2011). Sex bias in neuroscience and biomedical research. *Neurosci Biobehav Rev* 35, 565-572.
- Berthon, A., Drelon, C., Ragazzon, B., Boulkroun, S., Tissier, F., Amar, L., Samson-Couterie, B., Zennaro, M.C., Plouin, P.F., Skah, S., *et al.* (2014). WNT/beta-catenin signalling is activated in aldosterone-producing adenomas and controls aldosterone production. *Hum Mol Genet* 23, 889-905.
- Bielohuby, M., Herbach, N., Wanke, R., Maser-Gluth, C., Beuschlein, F., Wolf, E., and Hoeflich, A. (2007). Growth analysis of the mouse adrenal gland from weaning to adulthood: time- and gender-dependent alterations of cell size and number in the cortical compartment. *American journal of physiology Endocrinology and metabolism* 293, E139-146.
- Bingham, N.C., Verma-Kurvari, S., Parada, L.F., and Parker, K.L. (2006). Development of a steroidogenic factor 1/Cre transgenic mouse line. *Genesis* 44, 419-424.
- Chang, S.P., Morrison, H.D., Nilsson, F., Kenyon, C.J., West, J.D., and Morley, S.D. (2013). Cell proliferation, movement and differentiation during maintenance of the adult mouse adrenal cortex. *PLoS One* 8, e81865.
- Corotchi, M.C., Popa, M.A., and Simionescu, M. (2016). Testosterone stimulates proliferation and preserves stemness of human adult mesenchymal stem cells and endothelial progenitor cells. *Rom J Morphol Embryol* 57, 75-80.
- Drelon, C., Berthon, A., Sahut-Barnola, I., Mathieu, M., Dumontet, T., Rodriguez, S., Batisse-Lignier, M., Tabbal, H., Tauveron, I., Lefrancois-Martinez, A.M., *et al.* (2016). PKA inhibits WNT signalling in adrenal cortex zonation and prevents malignant tumour development. *Nat Commun* 7, 12751.
- Dumontet, T., Sahut-Barnola, I., Septier, A., Montanier, N., Plotton, I., Roucher-Boulez, F., Ducros, V., Lefrancois-Martinez, A.M., Pointud, J.C., Zubair, M., *et al.* (2018). PKA signaling drives reticularis differentiation and sexually dimorphic adrenal cortex renewal. *JCI Insight* 3.
- Finco, I., Lerario, A.M., and Hammer, G.D. (2018). Sonic Hedgehog and WNT Signaling Promote Adrenal Gland Regeneration in Male Mice. *Endocrinology* 159, 579-596.
- Freedman, B.D., Kempna, P.B., Carlone, D.L., Shah, M.S., Guagliardo, N.A., Barrett, P.Q., Gomez-Sanchez, C.E., Majzoub, J.A., and Breault, D.T. (2013). Adrenocortical zonation results from lineage conversion of differentiated zona glomerulosa cells. *Dev Cell* 26, 666-673.
- HersHKovitz, L., Beuschlein, F., Klammer, S., Krup, M., and Weinstein, Y. (2007). Adrenal 20alpha-hydroxysteroid dehydrogenase in the mouse catabolizes progesterone and 11-deoxycorticosterone and is restricted to the X-zone. *Endocrinology* 148, 976-988.
- Hudry, B., Khadayate, S., and Miguel-Aliaga, I. (2016). The sexual identity of adult intestinal stem cells controls organ size and plasticity. *Nature* 530, 344-348.

Karp, N.A., Mason, J., Beaudet, A.L., Benjamini, Y., Bower, L., Braun, R.E., Brown, S.D.M., Chesler, E.J., Dickinson, M.E., Flenniken, A.M., *et al.* (2017). Prevalence of sexual dimorphism in mammalian phenotypic traits. *Nat Commun* 8, 15475.

King, P., Paul, A., and Laufer, E. (2009). Shh signaling regulates adrenocortical development and identifies progenitors of steroidogenic lineages. *Proc Natl Acad Sci U S A* 106, 21185-21190.

Kobayashi, A., Valerius, M.T., Mugford, J.W., Carroll, T.J., Self, M., Oliver, G., and McMahon, A.P. (2008). Six2 defines and regulates a multipotent self-renewing nephron progenitor population throughout mammalian kidney development. *Cell Stem Cell* 3, 169-181.

Lavery, R., Chassot, A.A., Pauper, E., Gregoire, E.P., Klopfenstein, M., de Rooij, D.G., Mark, M., Schedl, A., Ghyselinck, N.B., and Chaboissier, M.C. (2012). Testicular differentiation occurs in absence of R-spondin1 and Sox9 in mouse sex reversals. *PLoS Genet* 8, e1003170.

Lavery, R., Lardenois, A., Ranc-Jianmotamedi, F., Pauper, E., Gregoire, E.P., Vigier, C., Moreilhon, C., Primig, M., and Chaboissier, M.C. (2011). XY Sox9 embryonic loss-of-function mouse mutants show complete sex reversal and produce partially fertile XY oocytes. *Dev Biol* 354, 111-122.

Lerario, A.M., Finco, I., LaPensee, C., and Hammer, G.D. (2017). Molecular Mechanisms of Stem/Progenitor Cell Maintenance in the Adrenal Cortex. *Front Endocrinol (Lausanne)* 8, 52.

Levasseur, A., St-Jean, G., Paquet, M., Boerboom, D., and Boyer, A. (2017). Targeted Disruption of YAP and TAZ Impairs the Maintenance of the Adrenal Cortex. *Endocrinology* 158, 3738-3753.

Muzumdar, M.D., Tasic, B., Miyamichi, K., Li, L., and Luo, L. (2007). A global double-fluorescent Cre reporter mouse. *Genesis* 45, 593-605.

Penny, M.K., Finco, I., and Hammer, G.D. (2017). Cell signaling pathways in the adrenal cortex: Links to stem/progenitor biology and neoplasia. *Mol Cell Endocrinol* 445, 42-54.

Scollo, C., Russo, M., Trovato, M.A., Sambataro, D., Giuffrida, D., Manusia, M., Sapuppo, G., Malandrino, P., Vigneri, R., and Pellegriti, G. (2016). Prognostic Factors for Adrenocortical Carcinoma Outcomes. *Front Endocrinol (Lausanne)* 7, 99.

Steffensen, C., Bak, A.M., Rubeck, K.Z., and Jorgensen, J.O. (2010). Epidemiology of Cushing's syndrome. *Neuroendocrinology* 92 Suppl 1, 1-5.

Ten, S., New, M., and Maclaren, N. (2001). Clinical review 130: Addison's disease 2001. *The Journal of clinical endocrinology and metabolism* 86, 2909-2922.

Vidal, V., Sacco, S., Rocha, A.S., da Silva, F., Panzolini, C., Dumontet, T., Doan, T.M., Shan, J., Rak-Raszewska, A., Bird, T., *et al.* (2016). The adrenal capsule is a signaling center controlling cell renewal and zonation through Rspo3. *Genes Dev* 30, 1389-1394.

Vidal, V.P., Chaboissier, M.C., de Rooij, D.G., and Schedl, A. (2001). Sox9 induces testis development in XX transgenic mice. *Nat Genet* 28, 216-217.

Wang, B., Zhao, L., Fish, M., Logan, C.Y., and Nusse, R. (2015). Self-renewing diploid Axin2(+) cells fuel homeostatic renewal of the liver. *Nature* 524, 180-185.

Yoon, D.Y., Mansukhani, N.A., Stubbs, V.C., Helenowski, I.B., Woodruff, T.K., and Kibbe, M.R. (2014). Sex bias exists in basic science and translational surgical research. *Surgery* 156, 508-516.

Figure Legends

Figure 1. Adrenal cortex renewal is sex-dependent. **A)** Schematic drawing of the adrenal cortex with *Gli1*⁺ and *Axin2*⁺/*Wnt4*⁺ stem/progenitor cells residing within the capsule and zG, respectively. **B)** BrdU analysis (treated for 2 days) in 12 weeks old animals demonstrated increased proliferation rates in the female zG (5-fold; p=0.0038), outer zF (15-fold; p<0.0001) and the overall adrenal cortex (6.3-fold; p=0.007), when compared to males. **C)** Similarly, apoptosis (active Caspase3⁺ cells) in female adrenals was also higher than in males (2-fold; p<0.05). **D)** Cell lineage-analysis (*Axin2-CreERT2*) confirmed the more rapid turnover in females. Scale bar 100 μm. **E)** Quantification using *Wnt4-CreERT2* mice shows complete replacement of the female, but not the male adrenal cortex in 3 months. Lineage analysis with the *Axin2-CreERT2* line gave similar results (not shown). See also Figure S1.

Figure 2. Female-specific recruitment of capsular stem cells. **A)** Capsular (NR2F2⁺) cells show a higher proliferation rate in females than in males (3.7-fold; p=0.0016; 12 weeks old animals treated for 1 week with BrdU). **B)** Lineage tracing revealed continuous recruitment of capsular cells to the adrenal cortex in females. Inset: *Gli1*⁺ cells give rise to both zF and zG (DAB2⁺) cells. Scale bar 100 μm. **C)** The number of cortical cells derived from the capsule is significantly higher in females (zG: 18.1-fold, p-value=0.0003; zF: 15.9-fold, p-value=0.0044; total cortex: 16.1-fold, p-value=0.0026). **D)** Once in the outer zF, proliferation of recruited female capsular cells is increased in females (11.5-fold; p=0.013; For all statistical analysis: two-tailed t-test). See also Figure S2

Figure 3. Adrenal cortex homeostasis depends on gonadal rather than chromosomal sex. **(A)** Proliferation of capsular cells in a genetic model for male to female sex reversal (*SflCre*⁺/*Sox9flox/flox* XY) was increased when compared to XY males (3.1-fold, p-value=0.0024), but remained lower than in XX females (1.8-fold, p-value=0.0003). and **B)** Proliferation of capsular cells was decreased in sex reversed XX males (*Tg(Wt1:Sox9)* XX) when compared to XX females (4.7-fold; p-value=0.0006). **C)** *Gli1-CreERT2* lineage tracing demonstrates absence of capsular cell recruitment in adult XX males. Scale bar 100 μm. **D)** Quantification of the lineage tracing experiment. XX males show a decreased recruitment compared to XX females (55-fold; p-value=0.0051; For all statistical analysis: two-tailed t-test). See also Figure S3.

Figure 4. Capsular stem cell activity is inhibited by dihydrotestosterone (DHT). **A)** Orchiectomized males exhibit increased proliferation of capsular cells (3.5-fold, p-value<0.0001), albeit slightly lower than control females (1.4fold; p-value=0.0041). **B, C)** Recruitment of capsular cells is significantly increased in orchiectomized males (3-fold; p-value=0.0012), but unaffected in oophorectomized females. Scale bar 50 μ m. **D)** DHT-treatment of adult ovariectomised females results in a dramatic decrease of cortical proliferation (3.2-fold; p-value<0.0001) and **(E)** the number of GFP⁺ cells derived from the capsule (81-fold; p-value=0,0002). See also Figure S4.

STAR Methods

Lead contact details:

Andreas Schedl
iBV, Université Côte d'Azur
Centre de Biochimie, UFR Sciences
Parc Valrose
06108 Nice Cedex 2, France
Tel.: ++33492076401
FAX: ++33492076402
Email: schedl@unice.fr

Experimental models

In vivo animal studies

All animal work was conducted according to national and international guidelines and approved by the local ethic committee (CIEPAL: PEA-NCE/335) and the French ministry for agriculture. *Axin2-CreERT2* (Wang et al., 2015), *Wnt4-CreERT2* (Kobayashi et al., 2008), *Gli1-CreERT2* (Ahn and Joyner, 2004), *Wt1:Sox9* (Vidal et al., 2001), *Sfl-Cre;Sox9flox* (Lavery et al., 2012) and *mTmG* (Muzumdar et al., 2007) lines were previously reported. If not otherwise stated, all lines were maintained and bred on mixed genetic background. Male and female mice were equally used and littermates were preferentially chosen for experimental group. Unless specifically stated, all experiments were conducted at 12 weeks of age.

Method details

Proliferation quantification

For proliferation quantification in the adrenal capsule and cortex, 1mg/ml of BrdU (Sigma) was dissolved in autoclaved water with 5% sugar and given as drinking water to 12weeks of age C57Bl/6J (Charles River, Europe) mice. The solution was changed every other day and mice were sacrificed after 48hours (cortex) or 7 days of treatment (capsule). Tissues were processed as described for Immunofluorescence analysis. Every 5th section was stained for NR2F2 and BrdU (capsule) or DAB2 and BrdU (cortex).

Cell lineage tracing

Axin2-CreERT, *Wnt4-CreERT2*, and *Gli1-CreERT2* were activated by a single intraperitoneal injection on two consecutive days of Tamoxifen (Sigma). 100µl/20g of mouse weight from a solution of 20mg/ml of Tamoxifen in corn oil was administrated per mouse. For adult experiments, animals were induced at 12 weeks of age (unless stated otherwise). For experiments during embryogenesis, the CRE recombinase was activated at E15.5 by intraperitoneally injecting 100µl/20g of mouse weight (pregnant female) from a solution of 20mg/ml of Tamoxifen (made up in corn oil).

Hormonal treatment

Beginning two weeks after surgery, oophorectomized females were injected twice daily subcutaneously with 5 α -androstan-17 β -ol-3-one (75 µg in 5% ethanol and corn oil) or oil only for a period of 6 weeks. For developmental studies, pregnant females were injected twice daily subcutaneously with 5 α -androstan-17 β -ol-3-one (75 µg in 5% ethanol and corn oil) from E14.5 onwards.

Immunofluorescence analysis

For immunofluorescence analysis of paraffin-embedded samples, adrenal tissues were fixed overnight at 4°C with 4% paraformaldehyde, progressively dehydrated and paraffin embedded. Sections of 5µm were cut and unmasked with PT Link (Dako Agilent Pathology Solutions) at pH6. Sections were blocked for 1h with 10% Normal Donkey Serum (Jackson ImmunoResearch), 3% BSA (Sigma) and 0,1% Tween-20 (Sigma). Primary antibodies were applied overnight at 4 degrees diluted in 3% NDS, 3% BSA, 0,1% Tween-20 as follows: anti-NR2F2, anti-DAB2, anti-3 β -HSD, anti-AR and anti- α 20-HSD at 1:200; anti-BrdU (NB500-169) at 1:100; anti-BrdU (3D4) at 1:250; anti-GFP at 1:500. The next day, sections were incubated at room temperature with secondary antibodies diluted 1:400 in PBS-0.1%Tween-20 and mounted in antifade mounting medium with DAPI (Vectashield). For immunofluorescence analysis of thick sections, freshly dissected adrenals were fixed for 1hour in 4% paraformaldehyde at 4°C, embedded in low melting point agarose and cut with a vibratome at a thickness of 50µm per section. Sections were mounted in antifade mounting medium with DAPI.

Quantification and statistical analysis

Proliferation analysis

Counting results were processed using Graph Pad Prism 7.00 for Windows (GraphPad Software). Statistical significance was determined with a two-tailed unpaired Students t-test. For the quantification of the proliferation in the capsule, 5 sections of whole adrenals were counted per animal (n=5 males, n=6 females). The number of

double positive cells for NR2F2 and BrdU was normalized on the total number of NR2F2 positive cells. In the cortex, 3 sections were counted per animal (n=4 males and females). The number of double positive cells for BrdU and DAB2 was normalized on the total number of DAB2 positive cells for the *zona glomerulosa*. For the *zona fasciculata*, the number of BrdU positive cells was normalized on the total number of cells. The quantification of the cell turnover was used by measuring the distance from the capsule to the innermost GFP positive cell normalized on the total thickness of the cortex (excluding the X-zone) in 3 regions of 3 nonconsecutive sections per animal (n≥3). For proliferation analysis of the recruited capsular cells, the number of BrdU/GFP double positive cells in the cortex was normalized on the total number of GFP positive cells in the cortex (n=4 for males and females). For the sex reverse models, both adrenals were weighed for each animal. Mean adrenal weights were normalized on body weight (n≥5). Gonadectomized animals were compared to age matched animals undergoing the surgical procedure without removal of the gonads. DHT-treated females after oophorectomy were compared to oil-treated females after oophorectomy.

For all graphs, error bars represent the standard error of mean and asterisks represent the p-values as follows: p < 0.05 (*), p < 0.01 (**), p < 0.001 (***) and p < 0.0001 (****).

Key resources table

REAGENT or RESOURCE	SOURCE	IDENTIFIER	RRID
Antibodies			
Anti-CouPTFII (NR2F2)	R&D systems	PP-H7147-00	AB_1964214
Anti-BrdU	Novus Bio	NB500-169	AB_10002608
Anti-DAB2 (E11)	Santa Cruz	sc-136964	AB_2245763
Anti-BrdU (3D4)	Pharmingen™	555627	AB_10015222
Anti-GFP	Abcam	ab13970	AB_300798
Anti-3β-HSD (P-18)	Santa Cruz	sc-30820	AB_2279878
Anti-α20-HSD	from Yacob Weinstein	n/a	n/a
Anti-AR	Santa Cruz	sc-816	AB_1563391
Chemicals, Peptides, and Recombinant Proteins			
BrdU	Sigma	B9285	n/a
Tamoxifen	Sigma	T5648	n/a
5α-androstan-17β-ol-3-one	Sigma	A8380	n/a
Anti-fade mounting medium with DAPI	Vectashield	H-1200	n/a
Experimental Models: Organisms/Strains			
Mouse: C57Bl/6J	Charles River	n/a	IMSR_JAX:000664
Mouse: mTmG	(Muzumdar et al., 2007)	n/a	IMSR_JAX:007576
Mouse: Axin2-CreERT2	(Wang et al., 2015)	n/a	IMSR_JAX:018867
Mouse: Wnt4-CreERT2	(Kobayashi et al., 2008)	n/a	IMSR_JAX:032489
Mouse: Gli1-CreERT2	(Ahn and Joyner, 2004)	n/a	IMSR_JAX:007913
Mouse: Wt1:Sox9	(Vidal et al., 2001)	n/a	n/a
Mouse: Sox9flox	(Lavery et al., 2011)	n/a	IMSR_JAX:013106
Mouse: Sf1-Cre (high)	(Bingham et al., 2006)	n/a	n/a
Software and Algorithms			
Graph Pad Prism 7.00 for Windows	GraphPad Software	n/a	n/a

Figure 1 Adrenal cortex renewal is sex-dependent.

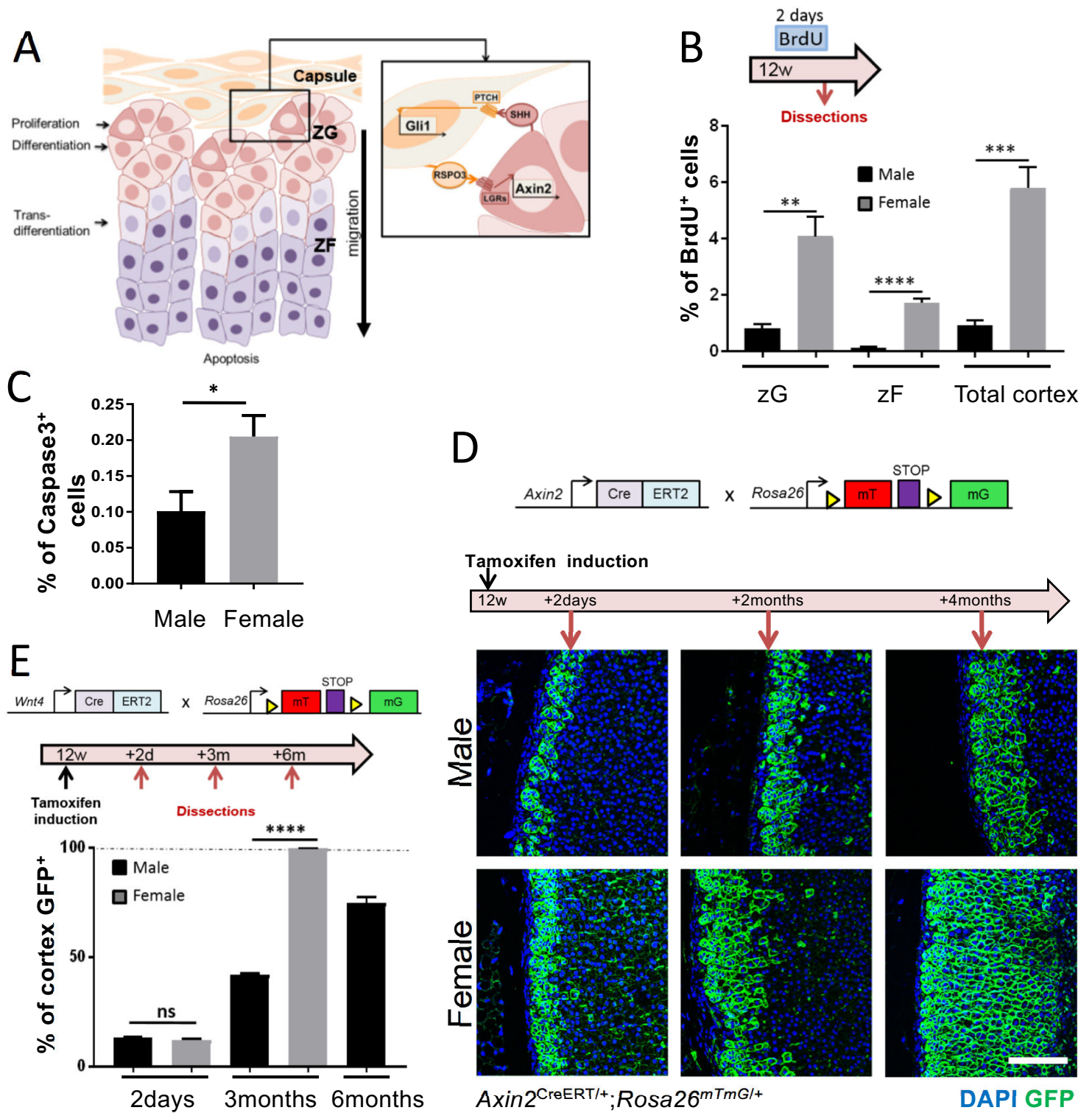

Figure 2. Female-specific recruitment of capsular stem cells.

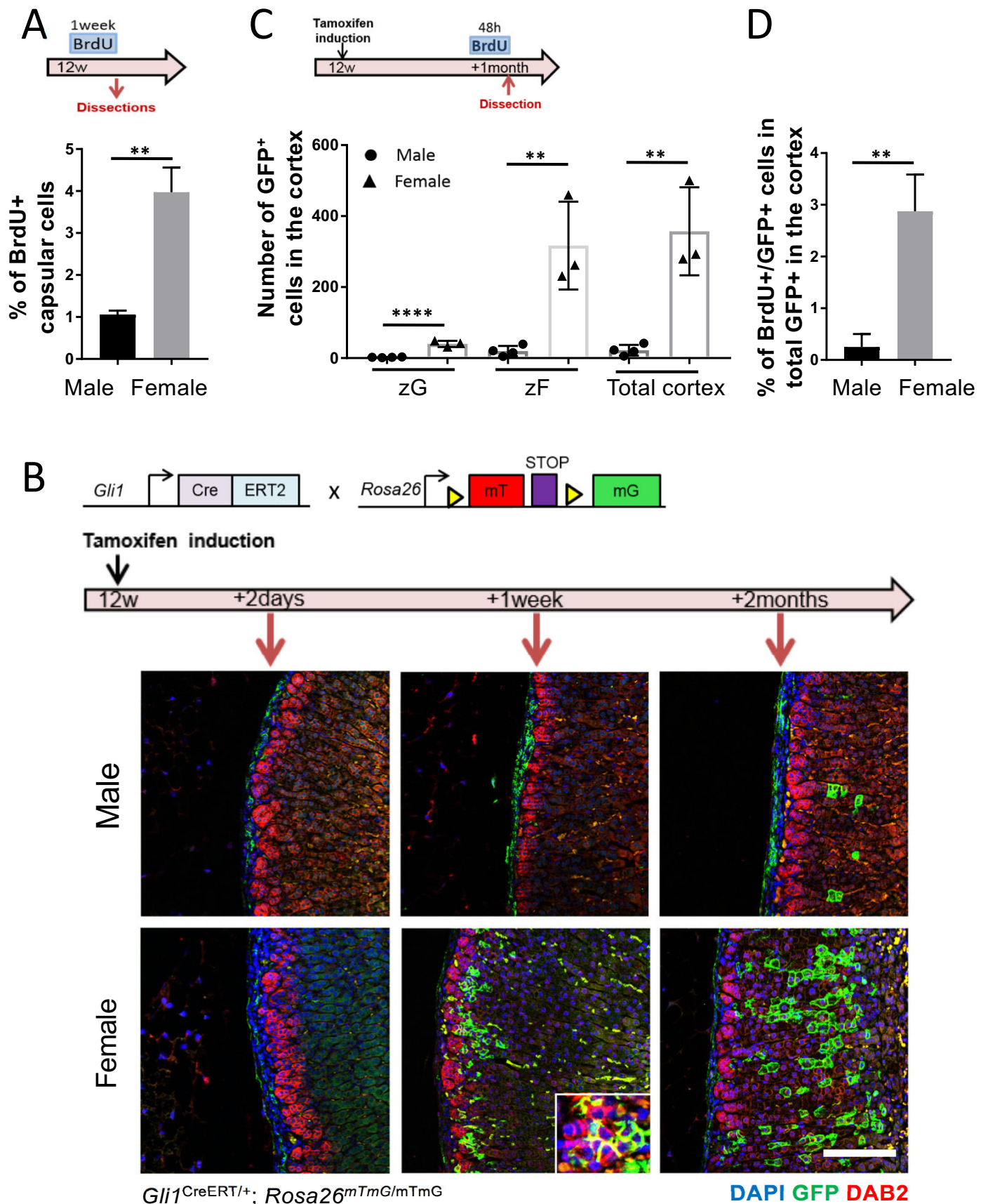

Figure 3. Adrenal cortex homeostasis depends on gonadal rather than chromosomal sex.

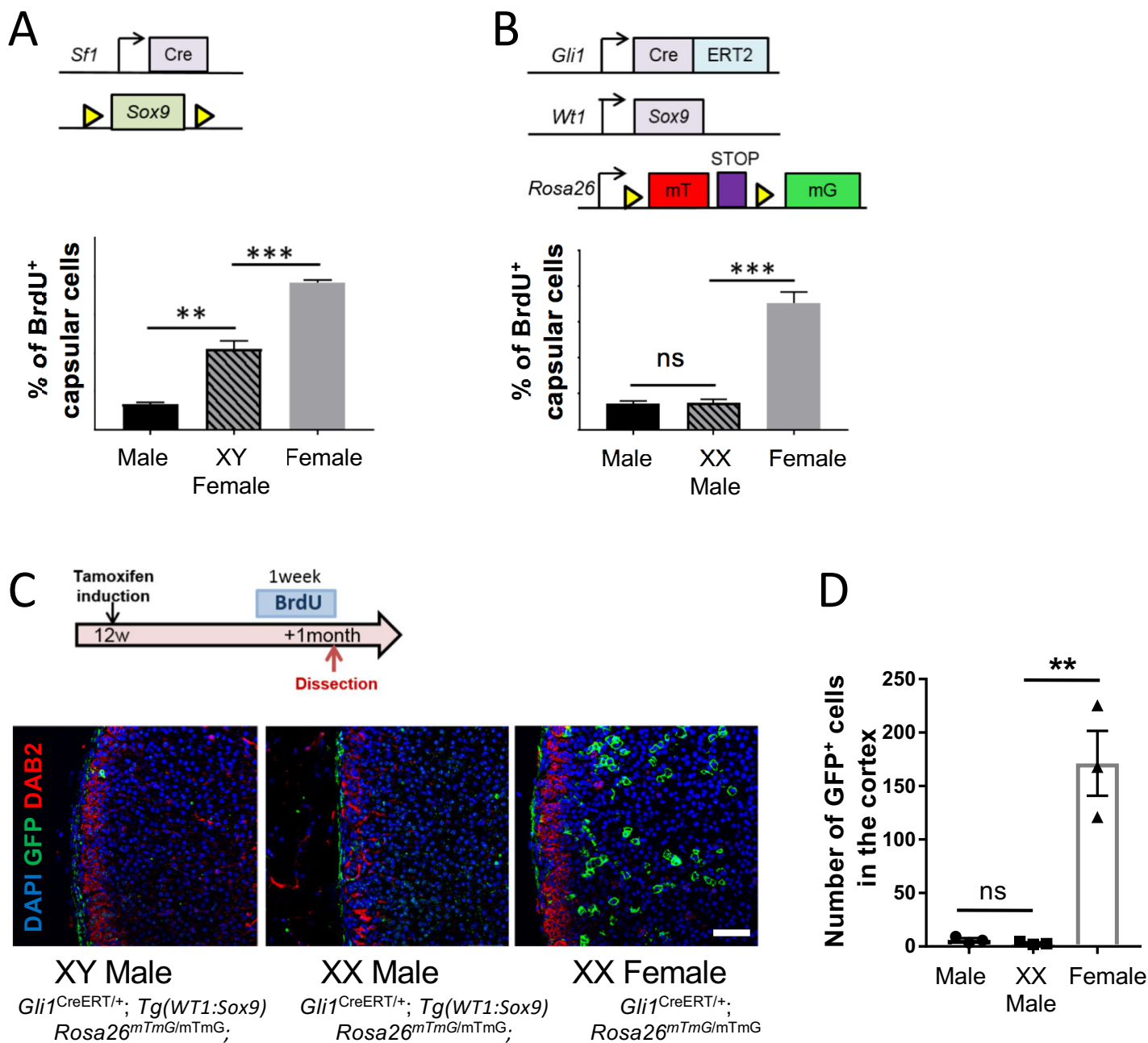
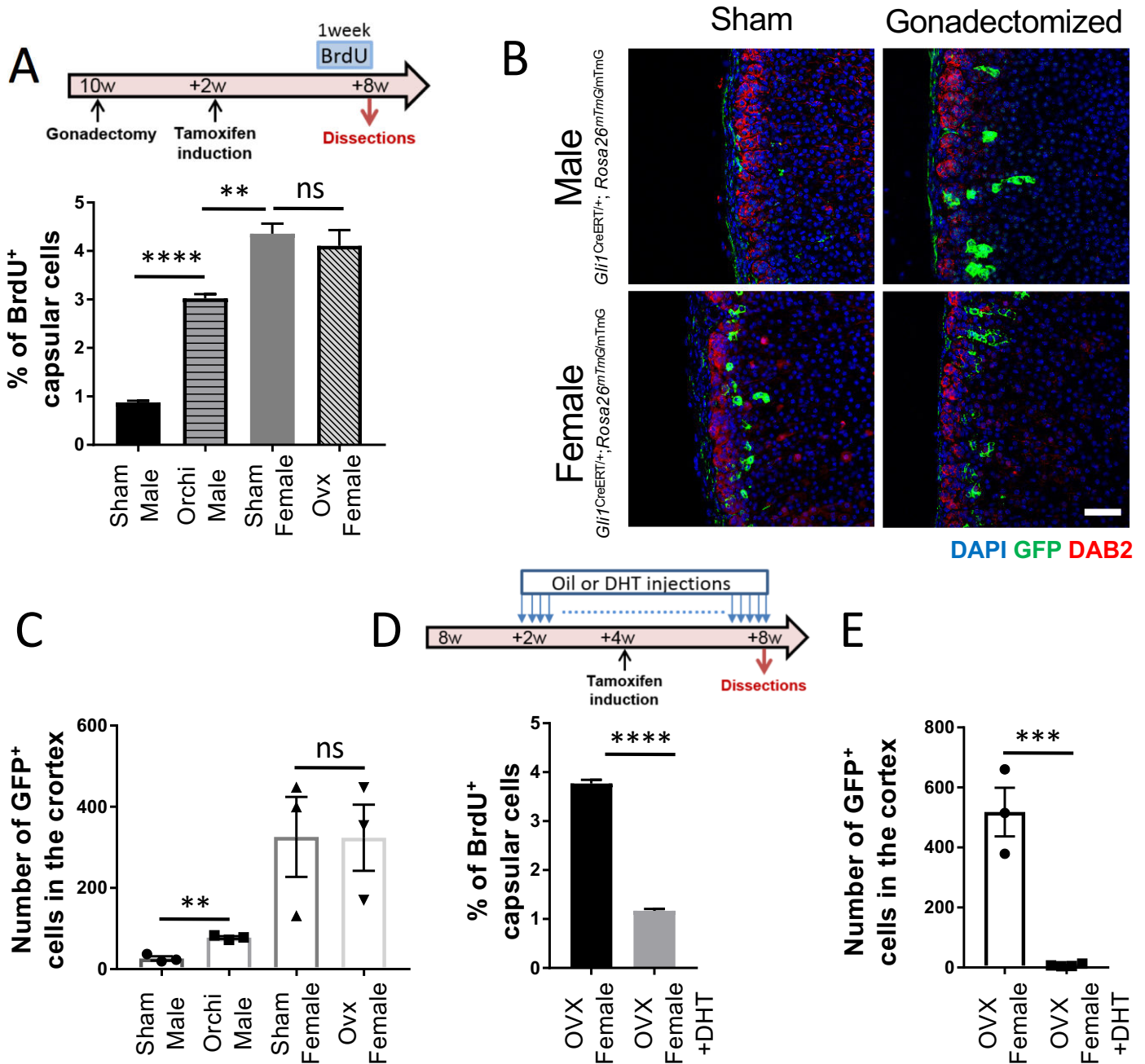

Figure 4. Capsular stem cell activity is inhibited by dihydrotestosterone



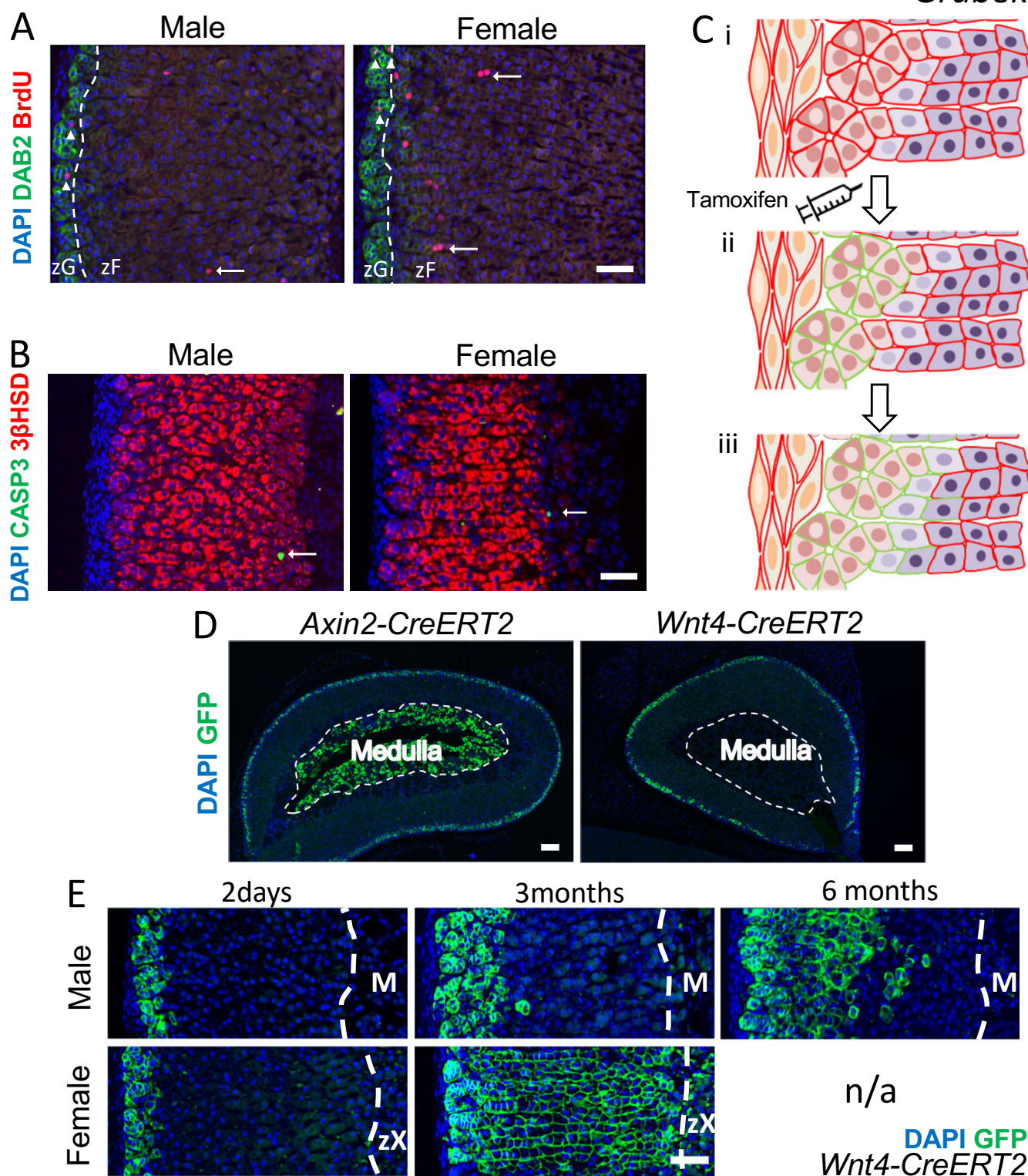

Figure S1. Related to Figure 1: **A)** Representative images of BrdU staining in the adrenal cortex of 12 weeks old mice (2-days pulse). BrdU labelling is observed in the zG and the outer zF. Scale bar 50µm. **B)** Representative image of active Caspase3 analysis in the adult adrenal cortex. Active Caspase3 positive steroidogenic cells are specifically observed at the boundary of cortex and medulla. Scale bar 50 µm **C)** Schematic drawing of lineage tracing experiments (i). Tamoxifen injection induces activation of GFP within the zG (ii). Proliferation and centripetal migration of cells lead to labelling of deeper zones of the cortex (iii). **D)** *Axin2-CreERT2* induction results in GFP labelling of the zG and medulla, while *Wnt4-CreERT2* induction specifically labels the zG 48hours after induction. Scale bar 200 µm. **E)** Cell lineage tracing experiments in adult animals using the *Wnt4-CreERT2* line. Scale bar 50 µm.

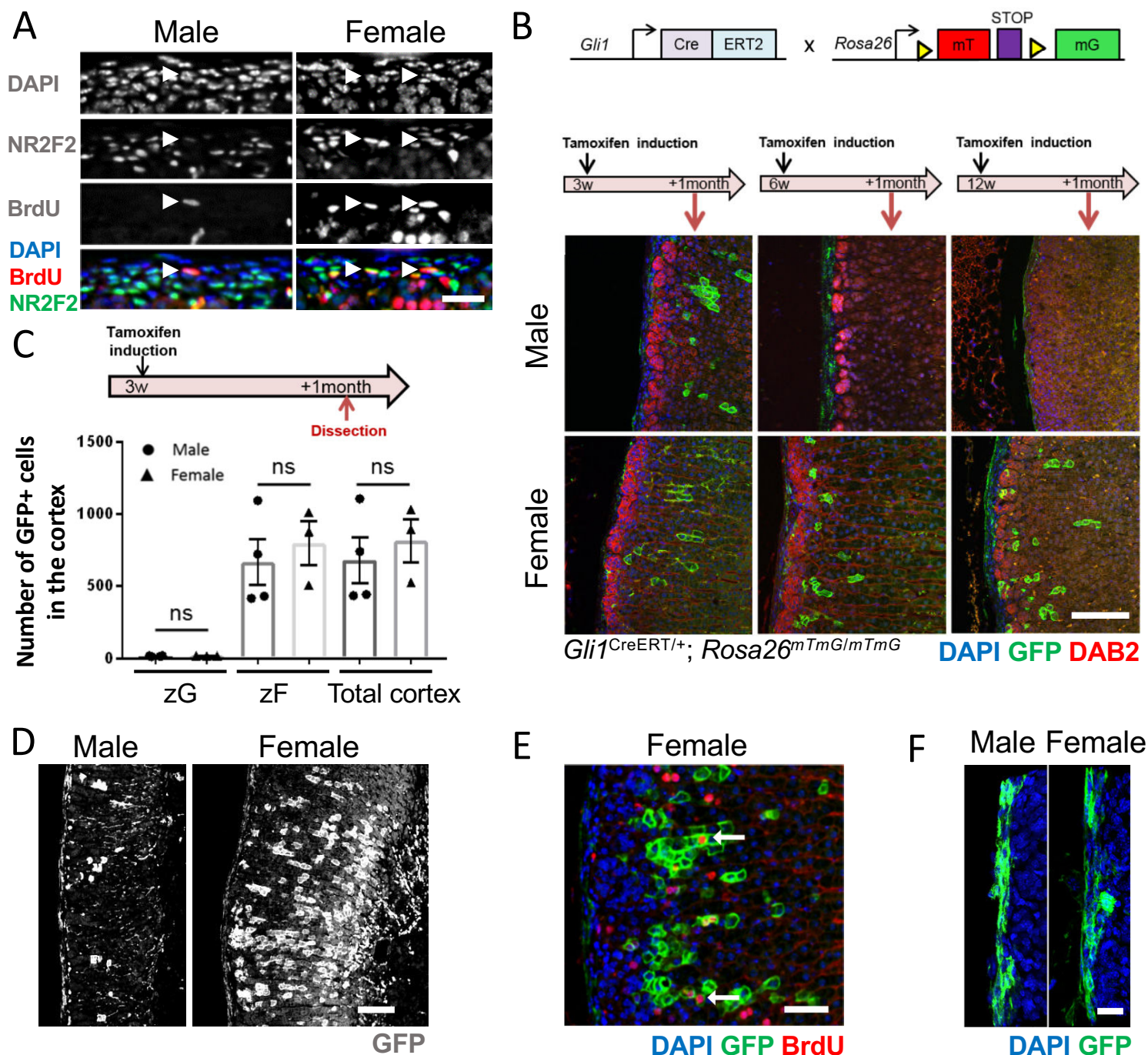

Figure S2. Related to Figure 2: A) Representative images of BrdU-analysis (1-week pulse) in the adrenal capsule of 12-weeks old mice. Capsular cells were identified by the expression of NR2F2. Scale bar 30 μ m. **B)** Contribution of *Gli1*⁺ cells towards the steroidogenic lineage at different ages. Recruitment of capsular cells ceases at puberty in males, but is maintained in adult females. Scale bar 100 μ m. **C)** Quantification of recruited cells shows no sex-specific difference before puberty (induction at 3 weeks of age). **D)** Low-power view of adrenal glands (induction at 12 weeks, chase of 4 months) reveals significant contribution of *Gli1*⁺-derived cells in females, but not in males. Scale bar 20 μ m. **E)** Representative image of capsule-derived cells that undergo proliferation (BrdU⁺) upon reaching the zF. Scale bar 100 μ m. **F)** 3D-projection of thick sections (50 μ m) reveal comparable labelling efficiency of capsular cells in males and females. Scale bar 200 μ m.

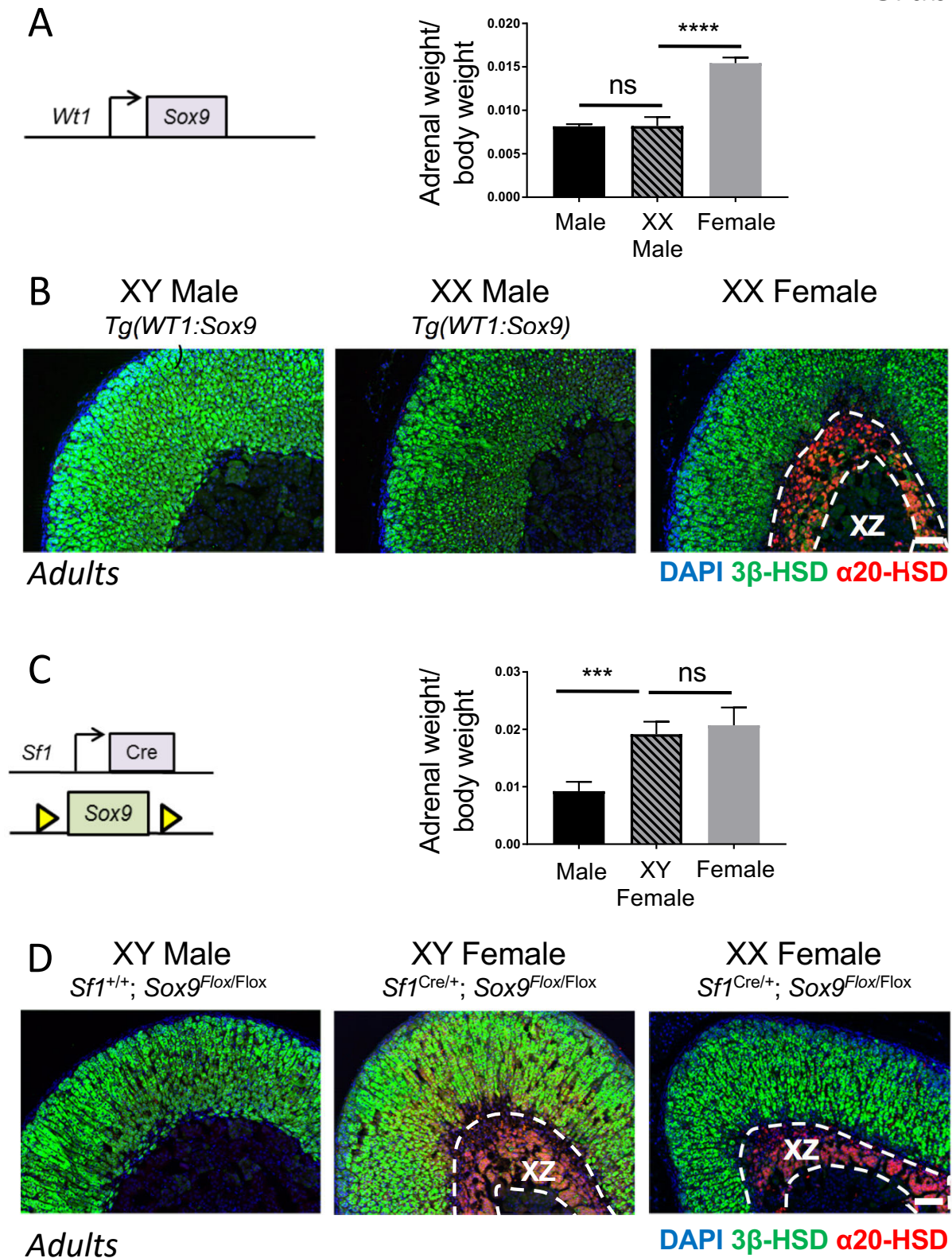

Figure S3. related to Figure 3: **A)** Adrenal weights in *Tg(Wt1:Sox9)* XX males (12weeks) were comparable to those of male controls (2.1-fold; $p < 0.0001$; two tailed t-test). **B)** Adrenals of *tg(Wt1:Sox9)* XX animals lack an a X-zone and resemble in histology that of control males. **C)** Accordingly, adrenal weights in *Sf1-Cre^{+/+}; Sox9^{flox/flox}* XY females equaled those of female controls. (1.9-fold; $p < 0.0001$; two tailed t-test). **D)** Adrenal histology in *Sf1-Cre^{+/+}; Sox9^{flox/flox}* XY females resembled that of female controls highlighted by the presence of an X-zone (20- α -HSD).

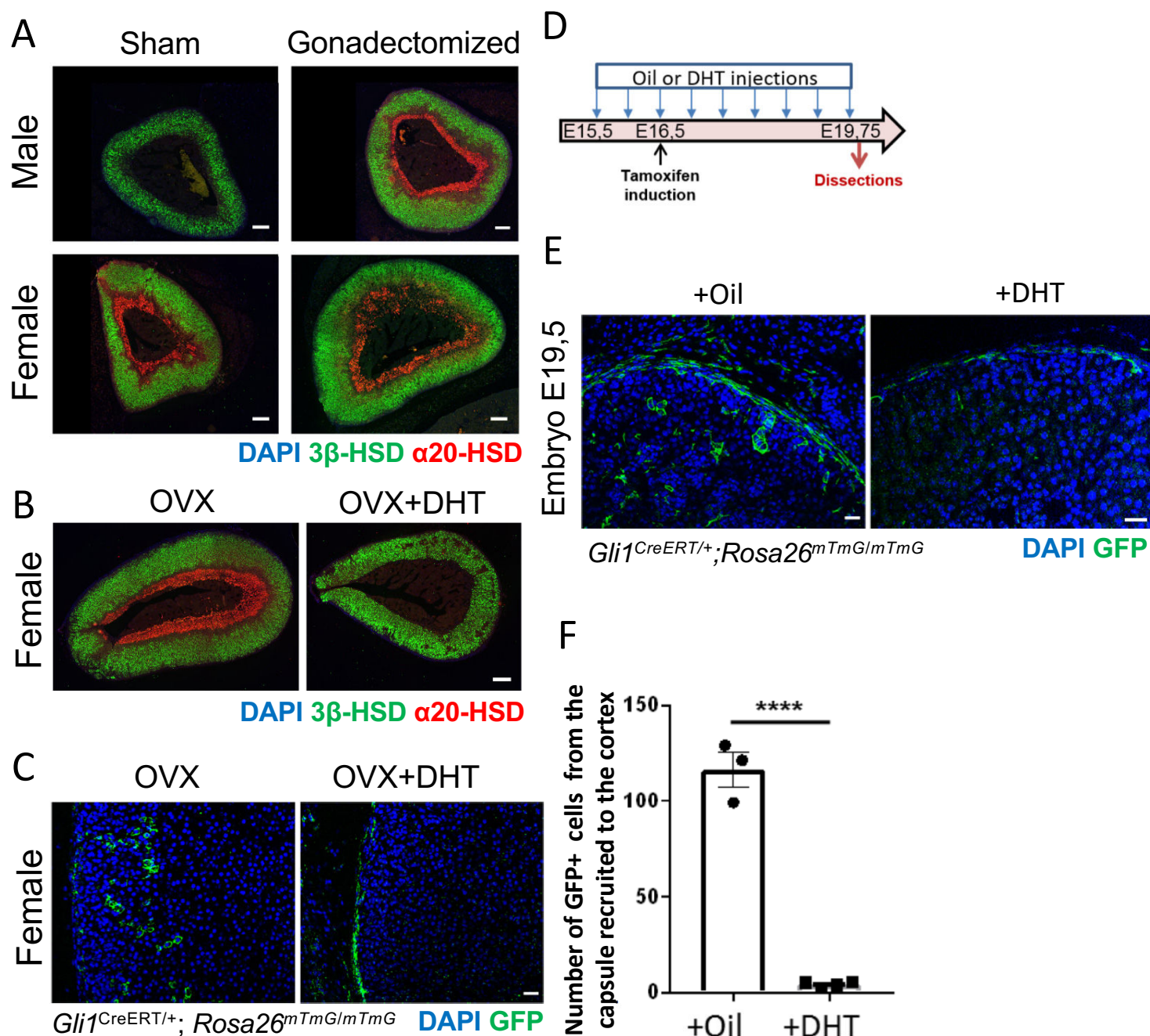

Figure S4. Related to Figure 4: **A)** Adrenal histology of gonadectomized animals shows the emergence of a secondary X-zone (*20- α -HSD*) in orchietomized males. Scale bar 200 μ m. **B)** Adrenal histology of DHT treated oophorectomized females show the absence of an X-zone (*20- α -HSD*). Scale bar 200 μ m. **C)** Representative image of the inhibition of capsular cell recruitment under DHT treatment of oophorectomized females. Scale bar 50 μ m. **D)** Experimental setup for DHT treatment in embryos. **E)** DHT-treated embryos show a decreased recruitment of capsular cells to the cortex. Scale bar 50 μ m. **F)** Quantification shows a 26.7-fold reduction of recruited cells (p-value<0.0001; two tailed t-test).

Part2: Paper 2 “*Rspo1* over expression induces sex-specific hyperplasia and tissue degeneration in the adrenal cortex”

Rspo1 overexpression induces sex specific hyperplasia and tissue degeneration in the adrenal cortex

Grabek Anaëlle^{1*}, Lyraki Rodanthi^{1*}, Bandiera Roberto², Vidal Valérie¹, Youssef Sameh³, De Bruin Alain³, Chaboissier Marie-Christine¹, Schedl Andreas¹.

¹ Université Côte d'Azur, Inserm, CNRS, iBV, France

² Wellcome Trust-Medical Research Council Cambridge Stem Cell Institute, Department of Genetics, University of Cambridge

³ Utrecht University, Faculty of Veterinary Medicine, department of Pathobiology.

*These authors contributed equally to this work

Abstract

Sex differences in non-reproductive organs and diseases have been poorly investigated to this date. Yet, the adrenal cortex is subject to striking sex specific differences in cellular renewal and adrenal diseases are systematically more frequent in women. WNT signaling is an essential pathway involved in adult adrenal cortex proliferation and zonation which has also been identified as the primary pathway mutated in adrenal cortex carcinomas, a rare but severe tumor of the adrenal cortex. In this study, over expression of *Rspo1* in steroidogenic cells resulted in over activation of canonical WNT signaling that led to adrenal cortex hyperplasia of similar severity in male and female from embryonic stages to puberty. However, from 6 weeks of age, while female continued to display cortical diffuse hyperplasia of increasing severity that later evolved in adrenal tumor, males showed signs of cortical degeneration which was associated with the presence of vacuolated cells and the thinning of the cortex. These results suggest different mechanisms to be implicated in regulation of the adrenal cortex homeostasis in male and female and could provide an explanation for the sex-specific adrenal disease prevalence.

Introduction

The adrenal glands consist of two endocrine tissues of different developmental origins, the cortex and the medulla, which produce essential hormones that control body homeostasis. The

adult adrenal cortex is surrounded by a capsule and is composed of concentric zones: the subcapsular zona glomerulosa (ZG), the zona fasciculata (ZF) and the zona reticularis (ZR) in human or the X-zone, remnant of the fetal cortex, in mice. It is now clear that the adult adrenal cortex undergoes an important cellular renewal that has been shown to rely on SHH+ progenitors in the ZG, which give rise to new SF1+ steroidogenic cells that change their fate along their centripetal migration until reaching the border with the medulla where they undergo apoptosis (Kim et al., 2009; Walczak & Hammer, 2015). More recently, adrenal cortex tissue homeostasis has been shown to be sexually dimorphic with the rate of renewal being increased in female and the capsular cells contributing to the female adult cortex renewal. In addition, an inhibitory action of male androgens was observed on the proliferation and recruitment of the capsular cells to the cortex suggesting a crucial role for sex hormones in cortical maintenance (Grabek et al., submitted). However, the molecular mechanisms that control sexual dimorphism in the adrenal cortex remain unknown.

Notably, human adrenocortical disease is also characterized by sex bias as adrenocortical adenomas (ACAs) and carcinomas (ACCs) are consistently more frequent in women than in men, reaching as much as a 6 fold difference in the case of ACCs depending on the age at diagnosis and the study (Audenet, Yates, Cussenot, & Rouprêt, 2013; Ayala-Ramirez et al., 2013; Scollo et al., 2016). While ACAs are frequent benign tumors occurring in 1% to 10% of the population, ACCs are rare and severe tumors affecting between 0,7 to 2 persons per million every year with a 5-year surviving rate inferior to 35% (Assié et al., 2014; Libé, 2015). To this date, few choices have been available in managing the disease with surgery being the primary treatment. In depth sequencing analysis have identified components of the WNT signaling pathways to be frequently mutated. Among others, *ZNRF3*, a negative regulator of the canonical Wnt pathway is found in 21% of ACC with an inactivating mutation. In addition, *CNNTB1*, a downstream effector of canonical WNT signaling is mutated in 16% of ACCs, with *CNNTB1* and *ZNRF3* mutations being mutually excluded, highlighting WNT signaling as the primary pathway to be altered in ACCs with somatic cell mutations (Assié et al., 2014).

Canonical WNT signaling has major functions in embryonic development and adult tissue maintenance including cell proliferation. It is activated in target cells upon binding of WNT ligand to their receptors, LRP5 and 6 and frizzled (FZ), which then undergo conformational changes and interact with the β -catenin destruction complex, composed of AXIN, a

scaffolding protein, the adenomatous polyposis coli (APC) tumor suppressor and GSK3 and CDK1, two kinases that phosphorylate cytoplasmic β -catenin, targeting it for ubiquitination and proteasomal degradation. The receptor-destruction complex interaction inhibits β -catenin phosphorylation leading to β -catenin accumulation in the cytoplasm and subsequent translocation to the nucleus where it co-activates target genes transcription through interaction with the transcription factors TCF and LEF (Clevers & Nusse, 2012; MacDonald, Tamai, & He, 2009; Nusse & Clevers, 2017). In addition, four conserved secreted proteins, the R-spondin 1-4, have been identified to enhance WNT signaling through their interaction with the ZNRF3 and RNF43 E3 ubiquitin ligases, transmembrane repressors of WNT signaling which induce endocytosis of LRP5-6 and FZ. When RSPOs simultaneously bind to ZNRF3/RNF43 and their receptors, the LGR4-6, they induce membrane clearance of ZNRF3/RNF43, increasing the availability of the WNT ligand receptor at the membrane (Hao, Jiang, & Cong, 2016; Hao et al., 2012; Koo et al., 2012).

Canonical WNT signaling is active within the adrenal cortex and has a major role in development and tissue homeostasis. Wnt4 ligand is expressed by the zona glomerulosa and locally enhances WNT signaling. In addition, RSPO3, one of the R-spondin family secreted proteins, is released by capsular cells and potentiate WNT signaling within the zona glomerulosa. Therefore, canonical WNT signaling is selectively active in the outer cortex where it is required both for progenitor proliferation and zona glomerulosa specification. Indeed, partial or complete inactivation of β -catenin leads to adrenal aplasia and degeneration of the adult cortex, respectively (Kim et al., 2018). Moreover, within a few weeks of *Rspo3* deletion in the adult adrenal cortex the cortex was significantly thinner, with loss of proliferation and of the zona glomerulosa markers (Vidal et al., 2016). On the other hand, strong over-activation of WNT signaling due to a constitutively active β -catenin leads to adrenal hyperplasia and tumour development (Berthon et al., 2010). However, the differences between male and female in phenotype development were not investigated in any of those previous publications. In this paper, we describe a mouse model of moderate ectopic over activation of WNT/ β -catenin signaling in the adrenal cortex due to RSPO1 overexpression, which leads to ectopic proliferation and hyperplasia. We identify a strong sexual dimorphism in phenotype development between male and female mice which manifests during puberty and progressively leads to a higher incidence of tumours in the female cortex, in contrast to cortical loss and degeneration in males. Our study will help to better understand the control of

tissue homeostasis in both sexes and to elucidate the link between sexually dimorphic tissue renewal and sex-specific disease development.

Main

Model of canonical WNT signaling activation in the adrenal cortex.

In order to investigate the role of a moderate over activation of the WNT signaling pathway, we made use of the *Sfl-Cre; Rosa26^{Rspo1/+}* mouse line in which *Rspo1* is ectopically expressed in SF1+ cells which includes the cortical cells of the adrenal (Figure 1A) (De Cian et al., 2017). In wild type adrenals, RNA-ScopeTM confirmed the restricted expression of *Rspo1* in the capsule/ surrounding mesenchyme of male and female (Figure 1B). In *Rspo1* gain of function mice (GOF), *Rspo1* was maintained in the outer cell layers but was in addition found in deeper tissue of the adrenal cortex (Figure 1B). Quantification with qPCR confirmed the RNA-ScopeTM observations with a low expression of *Rspo1* in wild type males and females that was 60-fold higher in the GOF mice with no differences between the two sexes (Figure 1C). Further RNA-ScopeTM analysis confirmed the expression of *Axin2*, a direct target of canonical WNT signaling, in the outer cortex in control animals. By contrast in GOF mice, *Axin2* expression was observed throughout the cortex suggesting that ectopic expression of *Rspo1* in steroidogenic cells induces activation of canonical WNT signaling in deeper layers of the adrenal cortex (Figure 1D). Further, immunostaining for β -catenin at 3 weeks of age reveals accumulation of the protein at the membrane of all cortical cells in GOF adrenals, contrary to the wild-type pattern of β -catenin staining which is restricted to the zG. Interestingly, β -catenin immunostaining at 6 weeks of age shows a different pattern, with accumulation of the protein in the nucleus of cortical cells in female GOF adrenals only (Supplementary Figure 1). Further work will be required to explain this difference in β -catenin distribution across different ages.

Rspo1 GOF animals develop a hyperplastic adrenal cortex in a sexually dimorphic fashion.

Analysis of the *Rspo1* GOF adrenals showed hyperplastic features starting during development and maintained until adulthood (Figure 2A). Before puberty (P21), adrenals of GOF mice were significantly bigger than control mice, exhibiting a 5-fold increase in the ratio

of adrenal weight to body weight, while no differences were observed between males and females (Figure 2B). However, while at 6 weeks of age female GOF were 14 times bigger than controls, the GOF adrenals in males were only 6 times bigger than control males and male GOF adrenals were still 3,5 times smaller than female GOF (Figure 2C). Because Sf1-Cre is expressed during embryonic development, we analysed cell proliferation using BrdU incorporation (3 days treatment in drinking water) in E18.5 embryonic adrenals which already macroscopically show signs of hyperplasia (Figure 2D). This experiment showed a significant increase in proliferation of about 2,6 times higher at E18,5 in GOF adrenals in comparison to control (Fig 2E; Fig. Supp 2A). However, no differences were observed between male and female at this stage in term of cell proliferation. At later time points, while proliferation was similar between GOF and control mice in the outer cortex of both sexes as well as the inner cortex of males, GOF females showed a 5,1-folds increased proliferation in the inner cortex in comparison to controls (Fig.2F; Fig. Supp. 2B). To complete the proliferation study, we also analyzed apoptosis in the adrenal cortex of GOF mice but no differences could be observed in the number of apoptotic cells in comparison to controls (Fig. Supp. 3A,B). These results suggest that the hyperplasia of the adrenal cortex observed in GOF mice is the result of an increase in cell proliferation in the inner cortex, where proliferation is low in wild type condition, which is not balanced by increased apoptosis. In addition, the absence of increased proliferation in the GOF male inner cortex at 6 weeks of age is consistent with the stagnation in the GOF male adrenal weight between 3 and 6 weeks of age.

Adrenal zonation is disturbed in GOF animals.

Histological analysis further identified sex-specific features in adrenal cortex histology of GOF animals. At 6 weeks of age, GOF female cortex systematically presented with atypical diffuse hyperplasia that was not observed in control mice and this phenotype was 100% penetrant at 6 weeks of age with a severity score of 3 out of 5 (Fig. 3A, Fig. Supp. 4A). On the contrary, GOF male cortex displayed degenerative lesions in the form of vacuolated cells at 6 weeks of age with a severity score of 2,5 out of 5 (Fig. 3A, Fig. Supp. 4A). These lesions expanded with age leading to cortical loss, to the point that the hyperplasia phenotype was fully abolished by 6 months of age in GOF males, as confirmed by a decrease in adrenal weight of male GOF between 6 weeks of age and 6 months of age, which was not statistically different from control mice anymore (Fig. Supp. 4B). Notably, vacuolated cells were not present in the male GOF adrenal cortex at 3 weeks of age, suggesting an important role of

puberty in the development of sex-specific differences in the phenotype (Figure 3A). In order to trace the identity of the vacuolated cells, we performed a lineage tracing experiment in *Sf1^{Cre/+}; Rosa26^{Rspo1/mTmG}* which resulted, as expected, in complete recombination within the adrenal cortex as observed by membrane GFP staining in all steroidogenic cells (3 β HSD+). However, vacuolated cells did not show a positive staining for GFP suggesting they these cells do not derive from cortical steroidogenic cells (Fig. 3B). Surprisingly, while lipid droplets could be observed with an oil red O staining in the cortex of wild type males and droplets size was increased in some cortical areas of the GOF male as 6 months of age, other areas of degeneration were strikingly negative for the staining suggesting that these cells do not results from lipid retention (Fig. Supp. 4B). To further analyse the histology of the GOF adrenals, we conducted IF staining for zonation markers of the cortex and the medulla. In both sexes, GOF adrenals presented with a dispersed medulla and cortical cells could be observed surrounding medullary cells in the center of the organ (Figure 3B). In the GOF animals, the ZG was not expanded in comparison to control as was previously been reported in β -catenin constitutive activation in the adrenal cortex (Berthon et al., 2010) and the two zones could clearly be distinguished (Figure 3B). In conclusion, while until puberty male and female show similar hyperplastic phenotype in the adrenal cortex, striking differences in adrenal size and histology were observed between male and female carrying the *Rspo1* transgene after 6 weeks of age.

Aging GOF mice present with adrenal pathologies.

With aging (1 year and beyond), mice carrying the *Rspo1* transgene developed different types of sex-specific adrenal pathologies. Vacuolar degeneration in GOF male adrenals further progressed in severity and led to dramatic cortical thinning, while it was also accompanied by nodular hyperplasia (Fig. 4A and Supp. Fig. 5A). We noticed that these pathologies often occur in wild type male adrenals although in a milder form and later occurrence, suggesting early aging/degeneration of the male adrenal cortex in the GOF mutant (Supp. Fig. 5A). In female, 50% of the mice carrying one allele of the *Rspo1* transgene developed tumors of the adrenal cortex of which half were adenomas (Benign tumors) and half were carcinomas (Malignant tumors) (Fig. 4B; Fig. sup. 5B). In adrenal carcinoma, the neoplastic cells observed are highly invasive to the capsule as well as to the pre-existing tissue and include areas of necrosis. *Rspo1* GOF females of 1 year of age or more also developed vacuolar degeneration and nodular hyperplasia that was not observed in control females suggesting that

Rspo1 GOF adrenal cortex are more prone to degeneration and aging processes than wild types. In conclusion, while in aged females *Rspo1* ectopic expression in the steroidogenic cells of the adrenal leads to neoplasia and proliferative lesions, in males, it induces aging and degeneration processes such as vacuolar degeneration of the adrenal cortex, cortical thinning as well as nodular hyperplasia.

Discussion

In the present study, we describe a mouse model of moderate ectopic activation of canonical WNT signaling in the mouse adrenal cortex due to overexpression of *Rspo1* by steroidogenic (SF1+) cells. This genetic manipulation disrupts the normal gradient of WNT signaling activity and consequently leads to ectopic proliferation in the inner cortex and pronounced hyperplasia of the gland. Histologically, we found normal tissue organization to be disrupted and the medulla to be dispersed among cortical cells, while we identified the hyperplastic tissue to consist mostly of DAB2-negative steroidogenic cells, suggesting that the zG is not expanding in our model. Moreover, we are currently working to expand our findings by analyzing levels of circulating adrenal hormones in *RSPO1* GOF mice. A recent study describing moderately enhanced WNT signaling in the adrenal cortex via a *ZNRF3* knockout corroborates our findings, as it describes a proliferative expansion of the inner cortex only (Basham et al., 2019). On the contrary, a mouse model of strong WNT signaling activation due to a constitutively active β -catenin allele develops an ectopic zG to the expense of the zF and suffers from hypersecretion of the zG hormone aldosterone (Berthon et al., 2010). The discrepancies between this earlier study and ours are probably due to the different levels of WNT signaling activation in the two models.

Previous studies about canonical WNT signaling in the adrenal cortex were conducted on female mice only and did not take potential sex differences of the phenotype into account. Thus, our work constitutes the first documentation of sexual dimorphism in phenotype development after abnormal activation of WNT signaling. While male adrenals grow larger than controls from embryonic life until puberty, they subsequently develop degenerative lesions consisting mainly of vacuolated cells that progressively expand to the whole organ and lead to cortical loss. Although this vacuolar degeneration is reminiscent of lipid accumulation in the cytoplasm of steroidogenic cells in *StAR* knockout mice, lineage tracing analysis in our model showed that vacuolated cells do not appear to originate from the steroidogenic lineage (Mizuno, Ishii, & Hasegawa, 2019). Further experiments will be required to identify the exact

identity of the abnormal cells. On the other hand, female GOF mice present with diffuse hyperplasia of the cortex that progressively becomes more pronounced and in some cases evolves in tumors in aged mice. Consistently with our findings, WNT signaling hyperactivation is the driving force behind many forms of cancer in humans and R-spondin gene fusions which drive higher or ectopic expression are relatively frequent mutagenic events in colorectal, prostate cancer and non-small cell lung cancer (Hao et al., 2016). In addition, ZNRF3, a negative regulator of WNT signaling and a binding partner of RSPOs, has been identified as the primary gene mutated in somatic mutations of adrenocortical carcinomas in human (Assié et al., 2014)

Recently, sexual dimorphism in diverse areas, from invertebrate biology (Hudry, Khadayate, & Miguel-Aliaga, 2016) to human disease (Clocchiatti, Cora, Zhang, & Dotto, 2016), has been gaining increasingly more attention. Regarding adrenal gland physiology, in particular, female bias in adrenal diseases is well documented: not only ACCs (Audenet et al., 2013; Ayala-Ramirez et al., 2013; Scollo et al., 2016) but also hormone-producing adenomas are 4-8 times more frequent in women, depending on the study (Lacroix, Feelders, Stratakis, & Nieman, 2015), while autoimmune Addison's disease is about 3 times more frequent (Laureti, Vecchi, Santeusano, & Falorni, 1999). Rodent studies mention similar observations about sexual dimorphism in adrenal physiology. We have recently reported that capsular stem cell-fuelled renewal of the cortex is sexually dimorphic and dependent on sex hormones rather than chromosomal sex (Grabek et al., submitted). Moreover, two central pathways have recently been shown to affect homeostasis of the adrenal cortex in a sex-dependent manner. In a recent report, double knockout of YAP and TAZ, effectors of the Hippo pathway, causes age-dependent degeneration only in male mice (Levasseur, St-Jean, Paquet, Boerboom, & Boyer, 2017). In another study, hyperactivation of the PKA pathway affects female and male mice disproportionately, and male androgens play an important role in the phenotypic outcome (Dumontet et al., 2018). Our study complements these analyses by focusing on another major pathway for adrenal gland homeostasis and will contribute further to understanding female bias in adrenal diseases. As WNT signaling ultimately affects gene expression patterns, our efforts are currently focused on high-throughput transcriptional analyses that will help us acquire a mechanistic understanding of the pathways that underlie sexual dimorphism in the *Rspo1* GOF adrenal cortex.

Finally, because canonical WNT signaling over- and under-activation is implicated in many health conditions, from cancer to neurodegenerative diseases, components of the pathway are candidate targets for novel therapies (Nusse & Clevers, 2017). Our study highlights the

importance of taking sex into account when developing novel therapies, and avoiding the bias for male-only studies in biomedical research.

Acknowledgements

We would like to thank the staff of the animal facility. This work was supported by La Ligue (Equipe Labelisée), the ANR (ANR-14-CE12-0007, ANR-11-LABX-0028-01, ANR-18-CE14-0012) and the WWCR (18-0437).

References

- Assié, G., Letouzé, E., Fassnacht, M., Jouinot, A., Luscap, W., Barreau, O., ... Bertherat, J. (2014). Integrated genomic characterization of adrenocortical carcinoma. *Nature Genetics*, *46*(6), 607–612. <https://doi.org/10.1038/ng.2953>
- Audenet, F., Yates, D. R., Cussenot, O., & Rouprêt, M. (2013). The role of chemotherapy in the treatment of urothelial cell carcinoma of the upper urinary tract (UUT-UCC). *Urologic Oncology: Seminars and Original Investigations*, *31*(4), 407–413. <https://doi.org/10.1016/j.urolonc.2010.07.016>
- Ayala-Ramirez, M., Jasim, S., Feng, L., Ejaz, S., Deniz, F., Busaidy, N., ... Habra, M. A. (2013). Adrenocortical carcinoma: clinical outcomes and prognosis of 330 patients at a tertiary care center. *European Journal of Endocrinology*, *169*(6), 891–899. <https://doi.org/10.1530/EJE-13-0519>
- Basham, K. J., Rodriguez, S., Turcu, A. F., Lerario, A. M., Logan, C. Y., Rysztak, M. R., ... Hammer, G. D. (2019). A ZNRF3-dependent Wnt/ β -catenin signaling gradient is required for adrenal homeostasis. *Genes & Development*, *33*(3–4), 209–220. <https://doi.org/10.1101/gad.317412.118>
- Berthon, A., Sahut-Barnola, I., Lambert-Langlais, S., de Jossineau, C., Damon-Soubeyrand, C., Louiset, E., ... Val, P. (2010). Constitutive β -catenin activation induces adrenal hyperplasia and promotes adrenal cancer development. *Human Molecular Genetics*, *19*(8), 1561–1576. <https://doi.org/10.1093/hmg/ddq029>
- Bingham, N. C., Verma-Kurvari, S., Parada, L. F., & Parker, K. L. (2006). Development of a steroidogenic factor 1/Cre transgenic mouse line. *Genesis*, *44*(9), 419–424. <https://doi.org/10.1002/dvg.20231>
- Clevers, H., & Nusse, R. (2012). Wnt/ β -Catenin Signaling and Disease. *Cell*, *149*(6), 1192–

1205. <https://doi.org/10.1016/j.cell.2012.05.012>

- Clocchiatti, A., Cora, E., Zhang, Y., & Dotto, G. P. (2016). Sexual dimorphism in cancer. *Nature Reviews Cancer*, *16*(5), 330–339. <https://doi.org/10.1038/nrc.2016.30>
- De Cian, M.-C., Pauper, E., Bandiera, R., Vidal, V. P. I., Sacco, S., Gregoire, E. P., ... Chaboissier, M.-C. (2017). Amplification of R-spondin1 signaling induces granulosa cell fate defects and cancers in mouse adult ovary. *Oncogene*, *36*(2), 208–218. <https://doi.org/10.1038/onc.2016.191>
- Dumontet, T., Sahut-Barnola, I., Septier, A., Montanier, N., Plotton, I., Roucher-Boulez, F., ... Martinez, A. (2018). PKA signaling drives reticularis differentiation and sexually dimorphic adrenal cortex renewal. *JCI Insight*, *3*(2). <https://doi.org/10.1172/jci.insight.98394>
- Hao, H.-X., Jiang, X., & Cong, F. (2016). Control of Wnt Receptor Turnover by R-spondin-ZNRF3/RNF43 Signaling Module and Its Dysregulation in Cancer. *Cancers*, *8*(6), 54. <https://doi.org/10.3390/cancers8060054>
- Hao, H.-X., Xie, Y., Zhang, Y., Charlat, O., Oster, E., Avello, M., ... Cong, F. (2012). ZNRF3 promotes Wnt receptor turnover in an R-spondin-sensitive manner. *Nature*, *485*(7397), 195–200. <https://doi.org/10.1038/nature11019>
- Hudry, B., Khadayate, S., & Miguel-Aliaga, I. (2016). The sexual identity of adult intestinal stem cells controls organ size and plasticity. *Nature*, *530*(7590), 344–348. <https://doi.org/10.1038/nature16953>
- Kim, A. C., Barlaskar, F. M., Heaton, J. H., Else, T., Kelly, V. R., Krill, K. T., ... Hammer, G. D. (2009). In Search of Adrenocortical Stem and Progenitor Cells. *Endocrine Reviews*, *30*(3), 241–263. <https://doi.org/10.1210/er.2008-0039>
- Koo, B.-K., Spit, M., Jordens, I., Low, T. Y., Stange, D. E., van de Wetering, M., ... Clevers, H. (2012). Tumour suppressor RNF43 is a stem-cell E3 ligase that induces endocytosis of Wnt receptors. *Nature*, *488*(7413), 665–669. <https://doi.org/10.1038/nature11308>
- Lacroix, A., Feelders, R. A., Stratakis, C. A., & Nieman, L. K. (2015). Cushing's syndrome. *The Lancet*, *386*(9996), 913–927. [https://doi.org/10.1016/S0140-6736\(14\)61375-1](https://doi.org/10.1016/S0140-6736(14)61375-1)
- Lauretì, S., Vecchi, L., Santeusano, F., & Falorni, A. (1999). Is the Prevalence of Addison's Disease Underestimated? *The Journal of Clinical Endocrinology & Metabolism*, *84*(5), 1762–1762. <https://doi.org/10.1210/jcem.84.5.5677-7>
- Levasseur, A., St-Jean, G., Paquet, M., Boerboom, D., & Boyer, A. (2017). Targeted Disruption of YAP and TAZ Impairs the Maintenance of the Adrenal Cortex. *Endocrinology*, *158*(11), 3738–3753. <https://doi.org/10.1210/en.2017-00098>

- Libé, R. (2015). Adrenocortical carcinoma (ACC): diagnosis, prognosis, and treatment. *Frontiers in Cell and Developmental Biology*, 3, 45.
<https://doi.org/10.3389/fcell.2015.00045>
- MacDonald, B. T., Tamai, K., & He, X. (2009). Wnt/ β -Catenin Signaling: Components, Mechanisms, and Diseases. *Developmental Cell*, 17(1), 9–26.
<https://doi.org/10.1016/j.devcel.2009.06.016>
- Mizuno, Y., Ishii, T., & Hasegawa, T. (2019). *In Vivo* Verification of the Pathophysiology of Lipoid Congenital Adrenal Hyperplasia in the Adrenal Cortex. *Endocrinology*, 160(2), 331–338. <https://doi.org/10.1210/en.2018-00777>
- Muzumdar, M. D., Tasic, B., Miyamichi, K., Li, L., & Luo, L. (2007). A global double-fluorescent Cre reporter mouse. *Genesis*, 45(9), 593–605.
<https://doi.org/10.1002/dvg.20335>
- Nusse, R., & Clevers, H. (2017). Wnt/ β -Catenin Signaling, Disease, and Emerging Therapeutic Modalities. *Cell*, 169(6), 985–999.
<https://doi.org/10.1016/j.cell.2017.05.016>
- Scollo, C., Russo, M., Trovato, M. A., Sambataro, D., Giuffrida, D., Manusia, M., ... Pellegriti, G. (2016). Prognostic Factors for Adrenocortical Carcinoma Outcomes. *Frontiers in Endocrinology*, 7, 99. <https://doi.org/10.3389/fendo.2016.00099>
- Vidal, V., Sacco, S., Rocha, A. S., da Silva, F., Panzolini, C., Dumontet, T., ... Schedl, A. (2016). The adrenal capsule is a signaling center controlling cell renewal and zonation through *Rspo3*. *Genes & Development*, 30(12), 1389–1394.
<https://doi.org/10.1101/gad.277756.116>
- Walczak, E. M., & Hammer, G. D. (2015). Regulation of the adrenocortical stem cell niche: implications for disease. *Nature Reviews Endocrinology*, 11(1), 14–28.
<https://doi.org/10.1038/nrendo.2014.166>

Figure legends

Figure 1: Ectopic activation of canonical WNT signaling in the adrenal cortex. A) Schematic representation of the mouse model genetic construct. *Sfl-Cre* was crossed with the *Rspo1* transgene on the Rosa26 locus preceded by the CAG promoter and a floxed stop codon. Upon CRE recombination, the stop codon is excised which allows for transcription of the *Rspo1* transgenic sequence. SA: Splicing acceptor; Neo: neomycin. B) *Rspo1* RNA-

ScopeTM on adrenal sections of 3 months old animals. Scale bars 50µm, capsule close up 25µm. C) Relative expression of *Rspo1* in the adrenal cortex of 6 weeks of age animals normalized on the housekeeping gene *Psmc4* expression. Ctl: *Sfl^{Cre/+};Rosa26^{+/+}* or *Sfl^{+/+};Rosa26^{Rspo1/+}*; GOF: Gain of function, *Sfl^{Cre/+};Rosa26^{Rspo1/+}*. D) *Axin2* RNA-ScopeTM on adrenal sections of 3 months old animals. Scale bar 50µm.

Figure 2: *Rspo1* Gain of function animals show sex-specific adrenal cortex hyperplasia.

A) Macroscopic images of adult adrenal glands (6 weeks of age). Scale bars = 500µm. B) Adrenal weight normalized on body weight from animals of 3 weeks of age. C) Adrenal weight normalized on body weight from animals of 6 weeks of age. D) Microscopic view of E18,5 embryonic adrenals of control and GOF embryos. Adr: adrenal gland; Kid: kidney. Scale bar: 500 µm. E, F) Proliferation analysis in the adrenal cortex using BrdU labeling for three days in animal drinking water (or pregnant mother) and normalized on the number of cells in the cortex at E18, 5 (E) or at 6 weeks in either the outer (left) or the inner (right) cortex (F).

Figure 3: Histopathologic examination of the *Rspo1* GOF adrenal phenotype.

A) H&E-stained sections of adrenal glands from 6 weeks old and 3 weeks old *Rspo1* GOF and control mice. The most prominent morphological changes of the adrenal cortex include atypical diffuse hyperplasia in the females and vacuolar degeneration in the males (black arrows). Scale bars: 1 mm (top panel), 100 µm (bottom panel). B) Immunofluorescence of lineage tracing experiment in adrenal cortex of 3 months old control and *Rspo1* GOF males. C: Cortex; D: Degenerative zone. White square: area presented in the bottom panel with higher magnification. Scale bar= 200 µm (top), 50 µm (bottom). C) Immunofluorescence staining for adrenocortical zonation markers – 3β-HSD, CYP21A1 and DAB2 – and the medulla – TH – on sections from 6 weeks old *Rspo1* GOF and control mice. White squares in the top panel indicate the areas that are shown in higher magnification below. C: cortex, X: X-zone, M: medulla, D: degenerative lesions, zG: zona glomerulosa, zF: zona fasciculata. Scale bars: 400 µm (top panel), 50 µm (bottom panels).

Figure 4: Development of adrenal cortex pathologies in *Rspo1* gain of function mice.

A) Macroscopic images (top panel) and hematoxylin-eosin staining (bottom panel) of adrenal cortex section of 1 year old control male (i) & iii)) and *Rspo1* GOF males presenting with nodular hyperplasia (ii) & iv)) and extended vacuolopathy (v)). Scale bar: i) 200µm; ii)

250µm; iii)/iv) 500µm; v) 1mm. B) Adrenal tumors in female *Sfl^{Cre/+};Rosa26^{Rspo1/+}* mice. i) ii) iii) microscopic images of control (i), adrenocortical adenoma (ii) and adrenocortical carcinoma presenting with neoplastic cells invading the capsule and the pre-existing cortex (blue arrow) and areas of necrosis (black arrow) (iii). iv)-ix) Hematoxylin and eosin staining of adrenal paraffin section of control (iv/vii), adrenocortical adenoma (v/viii) and adrenocortical carcinoma (vi/ix). Scale bars: i) 200µm, ii) 250µm, iii)/iv) 500µm, v)/vi) 2500µm, vii) 250µm, viii) 250µm, ix) 500µm. A=Adenoma; C=Cortex; M=Medulla.

Supplementary figure 1: β-catenin immunofluorescence in adrenal sections of control and GOF animals of both sexes at 3 and 6 weeks of age. Scale bar: 50 µm.

Supplementary figure 2: Immunofluorescence images used for proliferation analysis in embryonic (A) or adult (B) adrenal cortex of control and *Rspo1* GOF mice. Scale bar: A) B) 50 µm.

Supplementary figure 3: Apoptosis analysis. A) Immunofluorescence for cleaved Caspase3 and 3β-HSD on adult adrenal section. Scale bar: 50 µm. B) Percentage of apoptotic cells (CASPASE3+) on overall steroidogenic cells in the adult adrenal cortex.

Supplementary figure 4: A) Non-neoplastic lesions were semi-quantitatively assessed by 2 board-certified pathologists according to frequency and severity. The severity of the phenotype was scored based on the following scale: 0 (absent), 1 (subtle), 3 (moderate), 4 (severe) and 5 (massive). No: number of examined animals, VD: vacuolar degeneration, ADH: atypical diffuse hyperplasia. B) Adrenal weight normalized on body weight of 6 months old control and *Rspo1* GOF animals. Ctl: control *Sfl^{Cre/+};Rosa26^{+/+}* or *Sfl^{+/+};Rosa26^{Rspo1/+}*; GOF: Gain of function, *Sfl^{Cre/+};Rosa26^{Rspo1/+}*. C) Oil red O staining of 6 months of age control and *Rspo1* GOF males. Black squares: zones presented in bottom panel with a higher magnification. Scale bar: 200 µm (Top) and 50 µm (Bottom).

Supplementary figure 5: A) Average severity scores of adrenal pathologies in 1 year of age males. VD: vacuolar degeneration; NH: nodular hyperplasia; CTh: cortical thinning. B) Frequencies of adrenal pathologies observed in 1 year of age female controls and *Rspo1* GOF. VD: vacuolar degeneration; NH: nodular hyperplasia; CTh: nodular thinning.

Material and methods

Experimental models

In vivo animal studies

All animal work was conducted according to national and international guidelines and approved by the local ethic committee (CIEPAL: PEA-NCE/335) and the French ministry for agriculture. *Sfl-Cre;Rosa26-CagRspo1 (1)*, and *mTmG (4)* lines were previously reported. All lines were maintained and bred on mixed genetic background. Male and female mice were equally used and littermates were preferentially chosen for experimental groups.

Method details

Immunofluorescence analysis

For immunofluorescence analysis of paraffin-embedded samples, adrenal tissues were fixed overnight at 4°C with 4% paraformaldehyde, progressively dehydrated and paraffin embedded. Sections of 5µm were cut and unmasked with PT Link (Dako Agilent Pathology Solutions) at pH6 or pH9 depending on antibodies. Sections were blocked for 1h with 10% Normal Donkey Serum (Jackson Immunoresearch), 3% BSA (Sigma) and 0,1% Tween-20 (Sigma). Primary antibodies were applied overnight at 4 degrees diluted in 3% NDS, 3% BSA, 0,1% Tween-20 as follows: anti-CYP21A2, anti-DAB2, anti-3β-HSD, anti-TH, anti-CASPASE3 at 1:200; anti-BrdU (3D4) at 1:250; anti-SF1 at 1:300; anti-GFP at 1:500. The next day, sections were incubated at room temperature with secondary antibodies diluted 1:400 in PBS-0.1%Tween-20 and mounted in antifade mounting medium with DAPI (Vectashield).

Histological analysis

For Hematoxylin-eosin staining, 5µm paraffin embedded sections were incubated with xylene for 2x 5 min and rehydrated in successive ethanol solutions from 40 to 100%. Slides were then incubated for 3 min in hematoxylin solution, thoroughly rinsed in water and incubated in eosin solution for 3 min before dehydration in ethanol solutions and mounting. For Oil Red O staining, 5µm frozen sections from tissue previously snap-frozen in OCT compound were fixed in 10% formalin for 2 minutes, washed under running tap water and placed in 60% isopropanol for 1 min. The sections were then stained in Oil Red O solution for 10 minutes

and differentiated in 60% isopropanol for 30 seconds. After washing with running water, the sections were counterstained in Harris hematoxylin for 10 seconds followed by 1 minute in bluing solution (0.1% sodium bicarbonate) and washed with running tap water.

RNA-ScopeTM

RNA-ScopeTM (ACD Biotechnie) analysis for *Rspo1* and *Axin2* was performed according to the manufacturer's instructions on 5 µm paraffin-embedded sections from tissue previously fixed in 10% formalin overnight at 4°C.

Proliferation quantification

For proliferation quantification in the adrenal cortex, 1mg/ml of BrdU (Sigma) was dissolved in autoclaved water with 5% sugar and given as drinking water. The solution was changed every other day and mice were sacrificed after 72 hours. Tissues were processed as described for Immunofluorescence analysis. Every 5th section was counted and at least 3 different sections were counted per animal.

Quantification and statistical analysis

All counting data were processed using Graph Pad Prism 7.00 for Windows (GraphPad Software). For all graphs, statistical analysis was assessed using unpaired student T-test. Error bars represent the standard error of mean and asterisks represent the p- values as follows: p < 0.05 (*), p < 0.01 (**), p < 0.001 (***) and p < 0.0001 (****).

RNA extraction/qPCR

RNA was isolated from whole adrenal glands using the Qiagen RNeasy kit according to the manufacturer's instructions. cDNA synthesis was performed using 0.4 µg of the purified RNA as template and a random primer-based approach with reagents from Thermo Fisher Scientific. Quantitative real-time PCR was performed using the SYBR Green mastermix (Roche) in a LightCycler 480 II instrument (Roche). The following primers were used: for *Rspo1* and for *Psmc4*, the reference gene to which reactions were normalized. For primer sequences see "Key resources table".

Key resources table

REAGEN or RESOURCE	SOURCE	IDENTIFIER
Antibodies		
Anti-BrdU (3D4)	Pharmingen	555627
Anti-DAB2 (E11)	Santa Cruz	Sc-136964
Anti-CYP21A2	Sigma	HPA048979
Anti-TH	Millipore	AB152
Anti- β -catenin	Sigma-Aldrich	C2206
Anti-3 β HSD (P-18)	Santa Cruz	Sc-30820
Anti-SF1	Transgenic Inc	#KAL-KO611
Anti-GFP	Abcam	Ab13970
Anti-Caspase3	R&D Systems	AF835
Primers		
RSPO1	Sigma	5'-GGATCAAGGGCAAGAGACAG-3' 5'-GCGAGCACTTGAGGCAAC-3'
PSMC4	Sigma	5'-TTCTTGAAGCTGTGGATCA-3' 5'-TCAGGATGCGCACATAATAGTT-3'
Chemicals		
BrdU	Sigma	B9285
Anti-fade mounting medium with DAPI	Vectashield	H-1200
Experimental model		
Mouse: Sf1-Cre	(Bingham, Verma-Kurvari, Parada, & Parker, 2006)	
Mouse: Rspo1 GOF	(De Cian et al., 2017)	
Mouse: mTmG	(Muzumdar et al., 2007)	

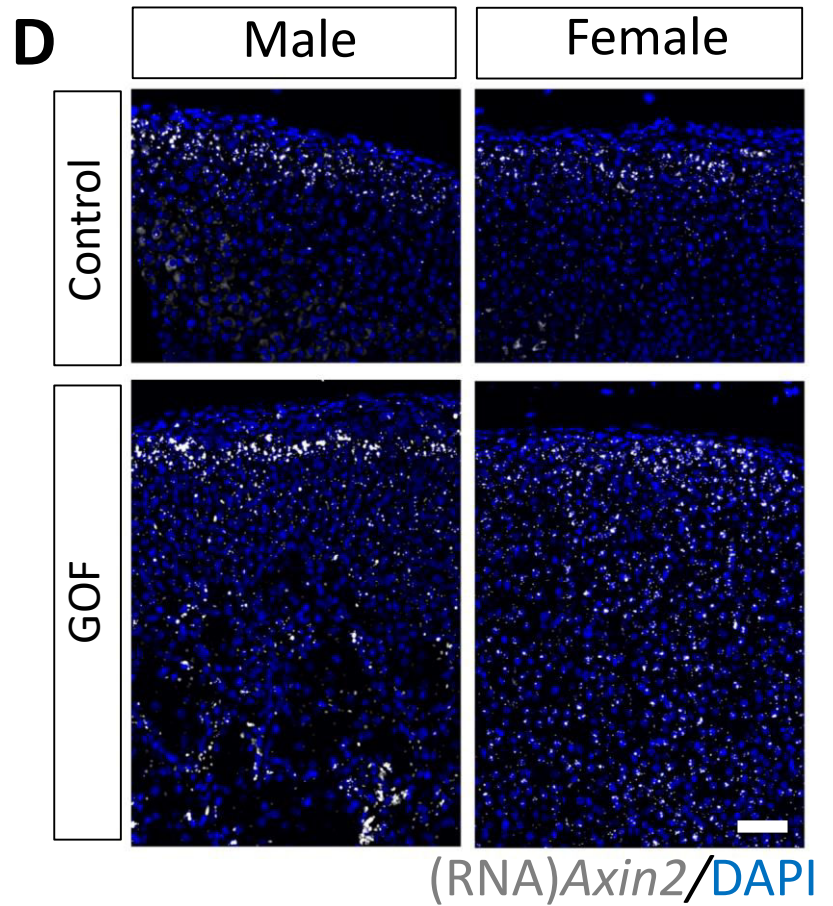
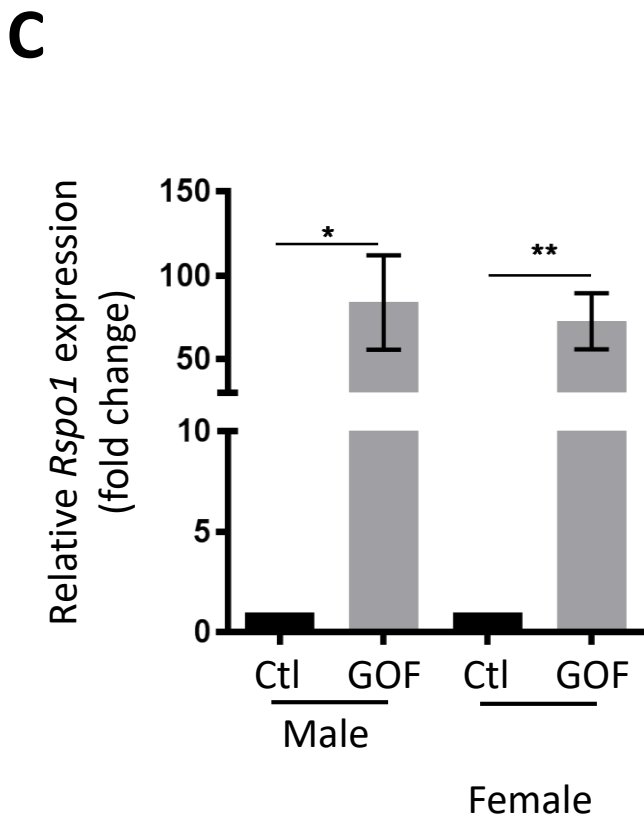
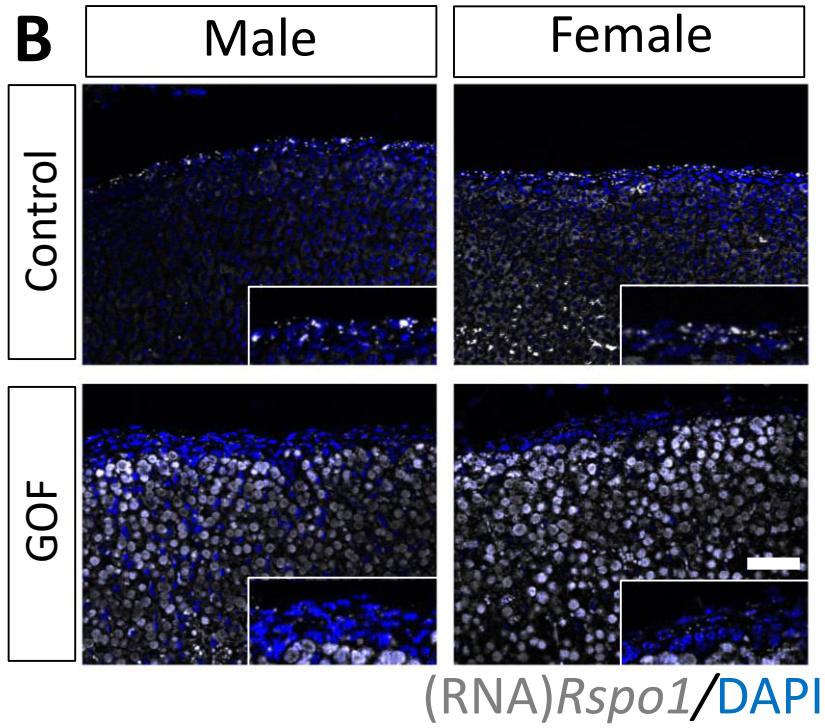
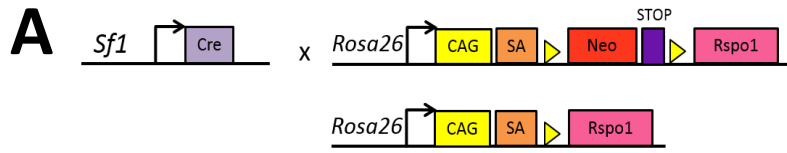

Figure1

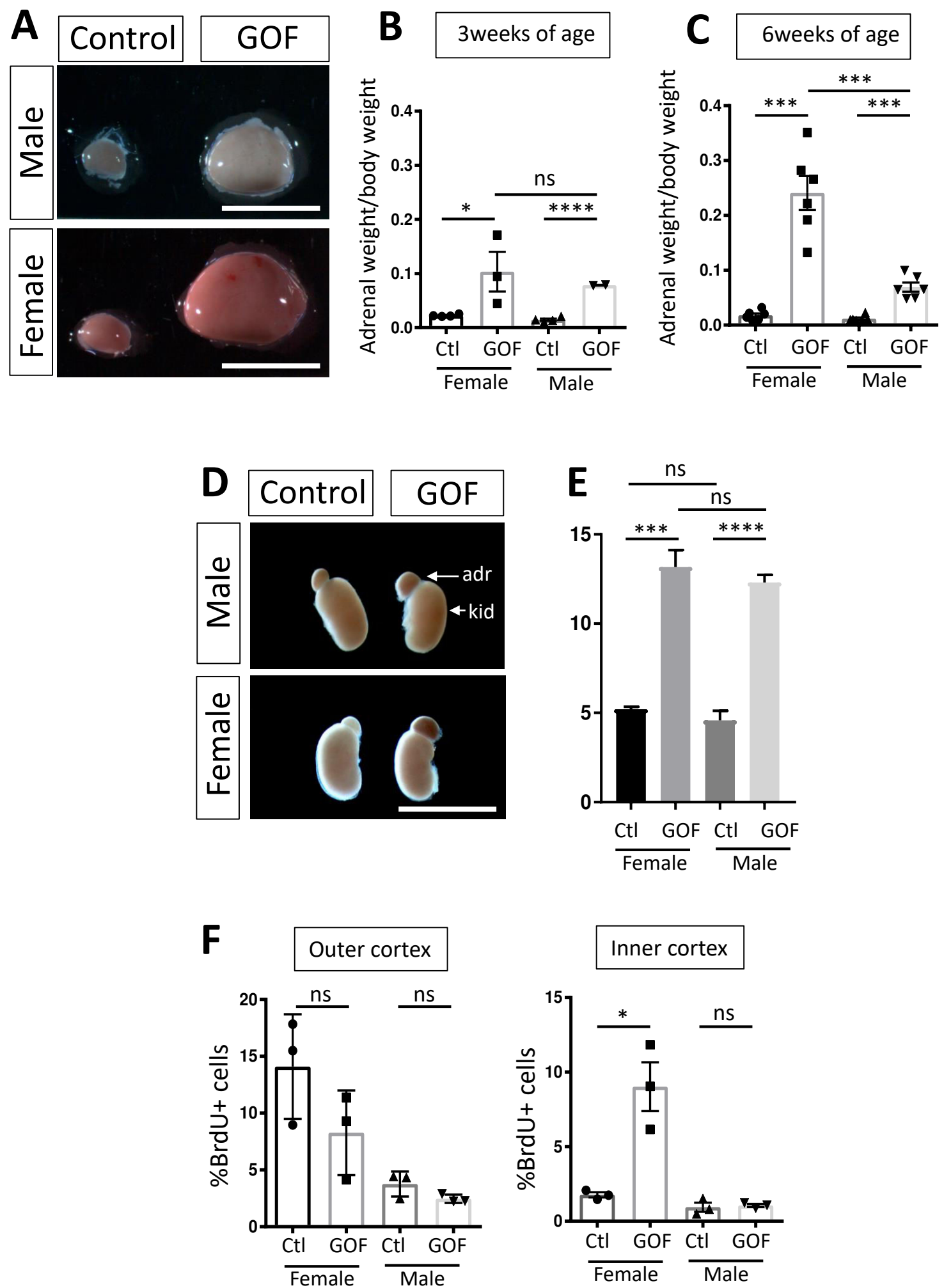

Figure 2

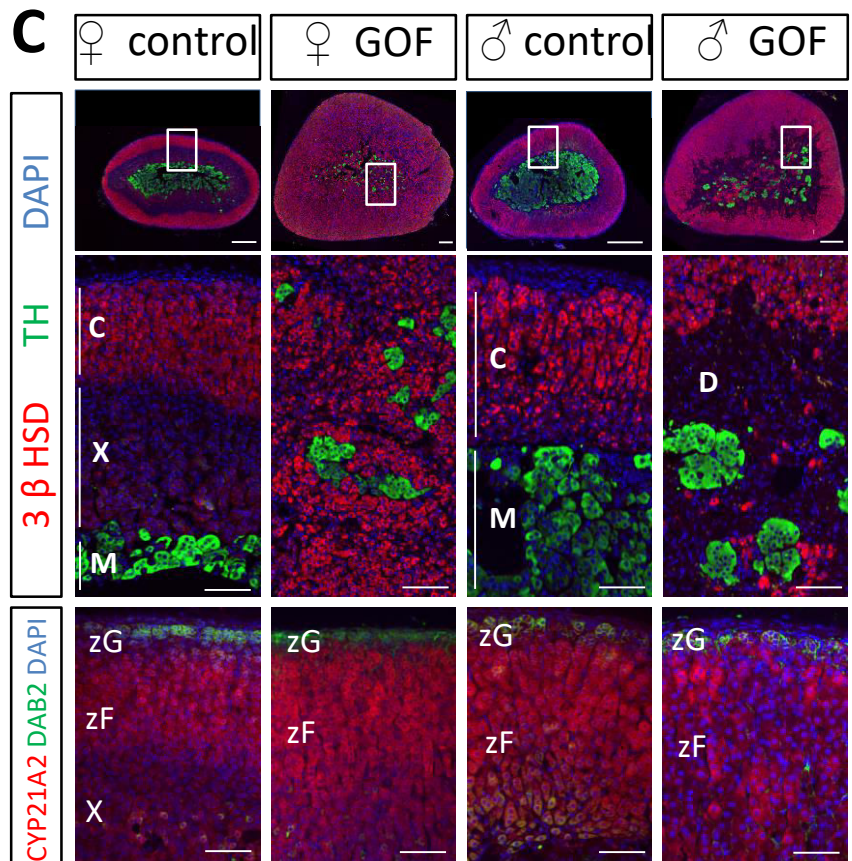
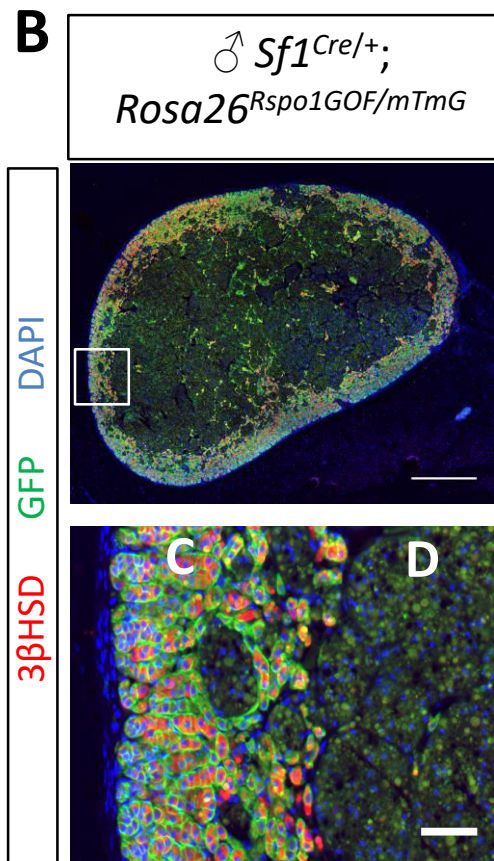
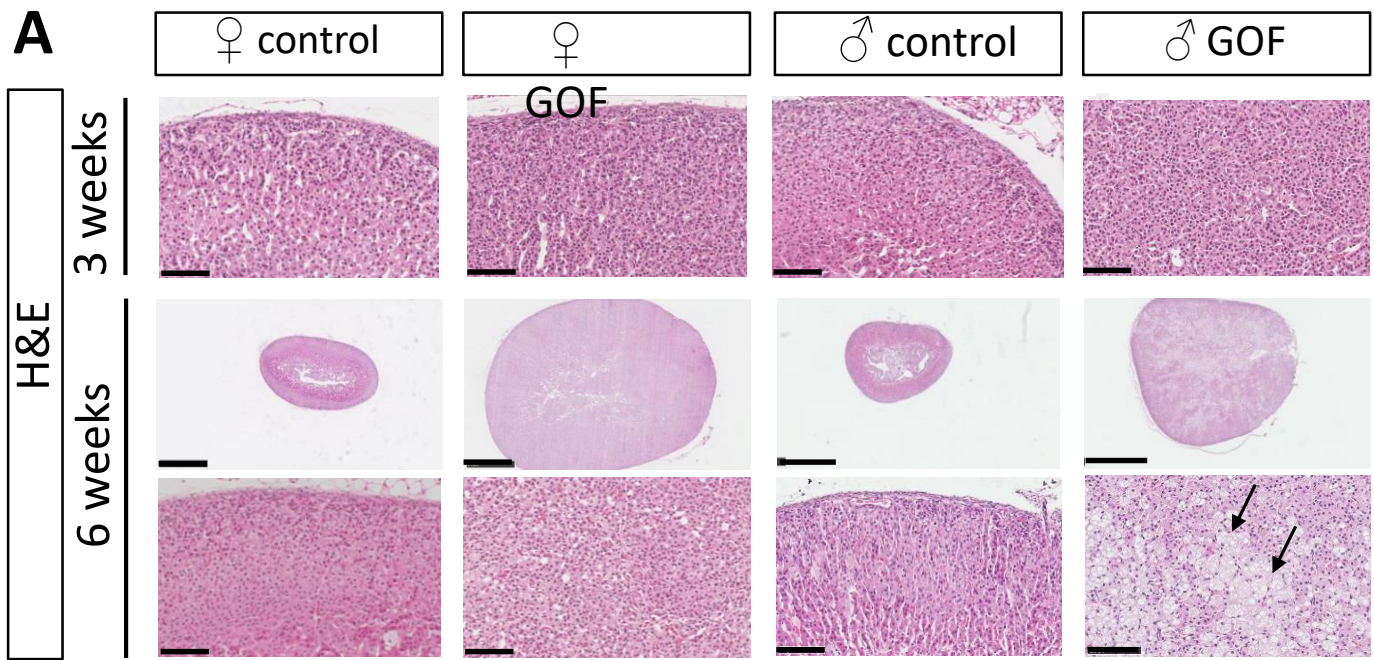

Figure 3

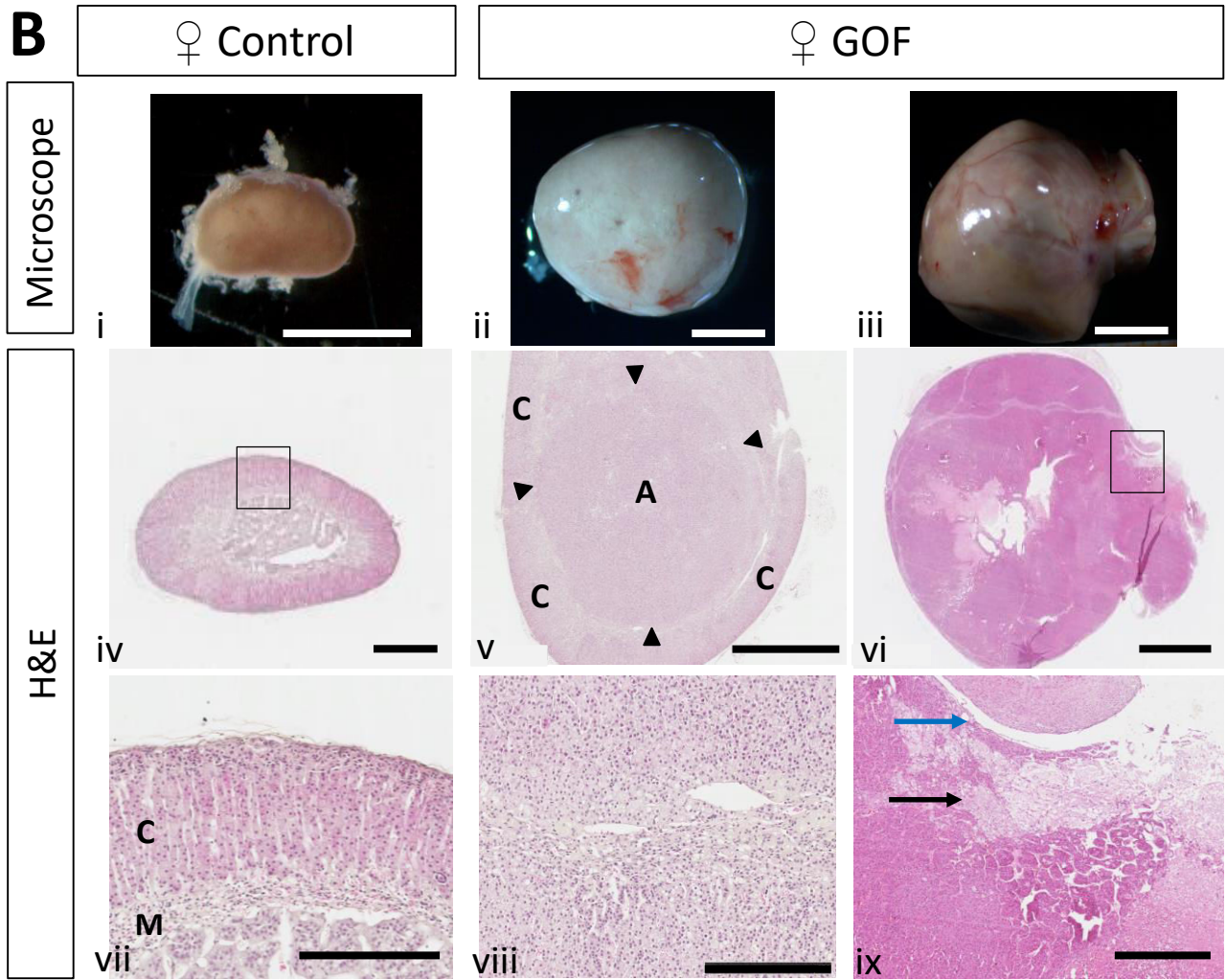
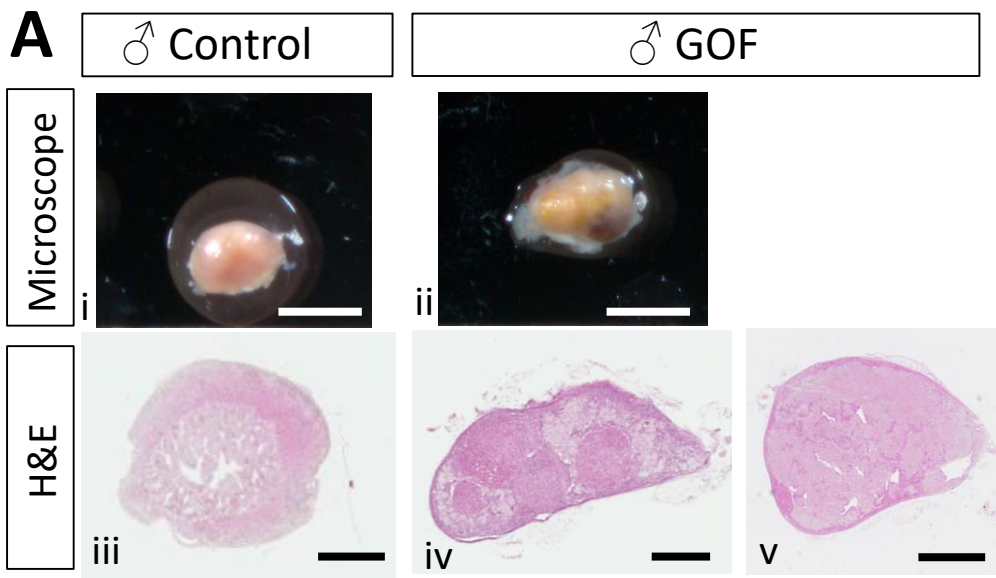
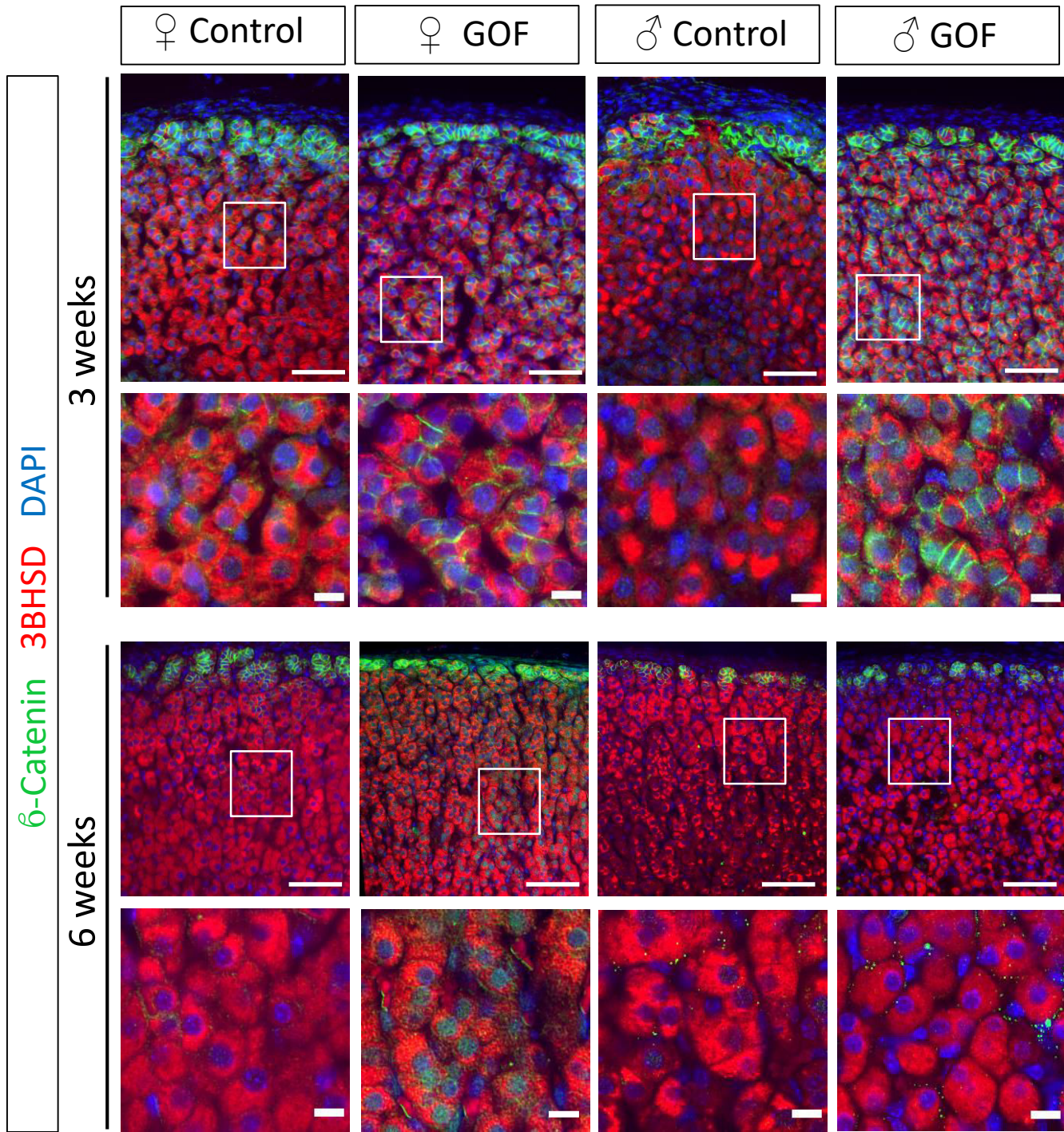
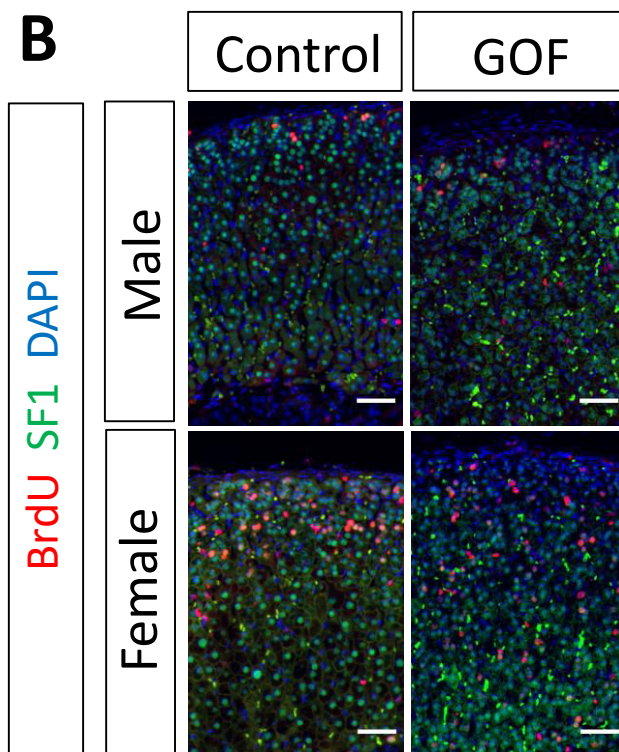
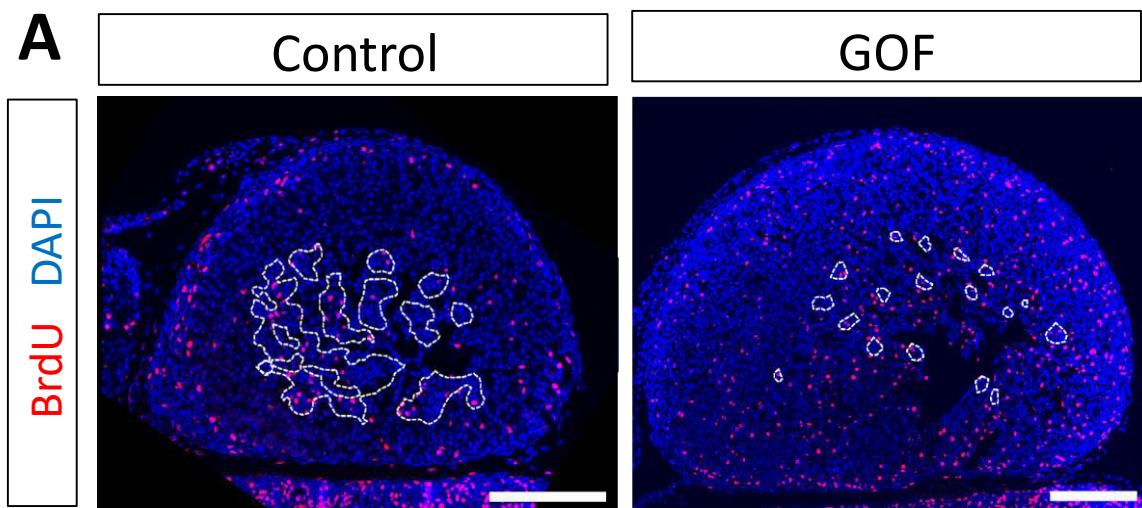
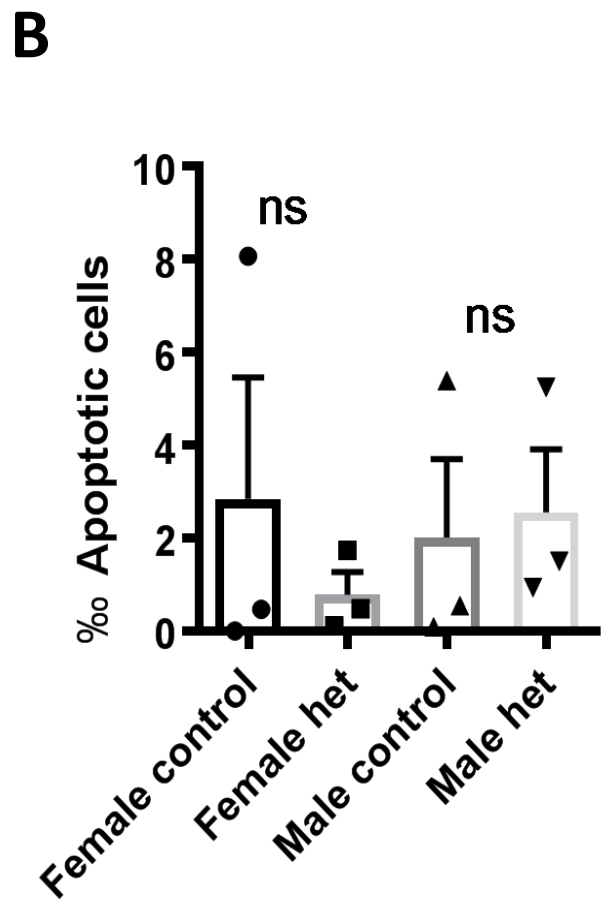
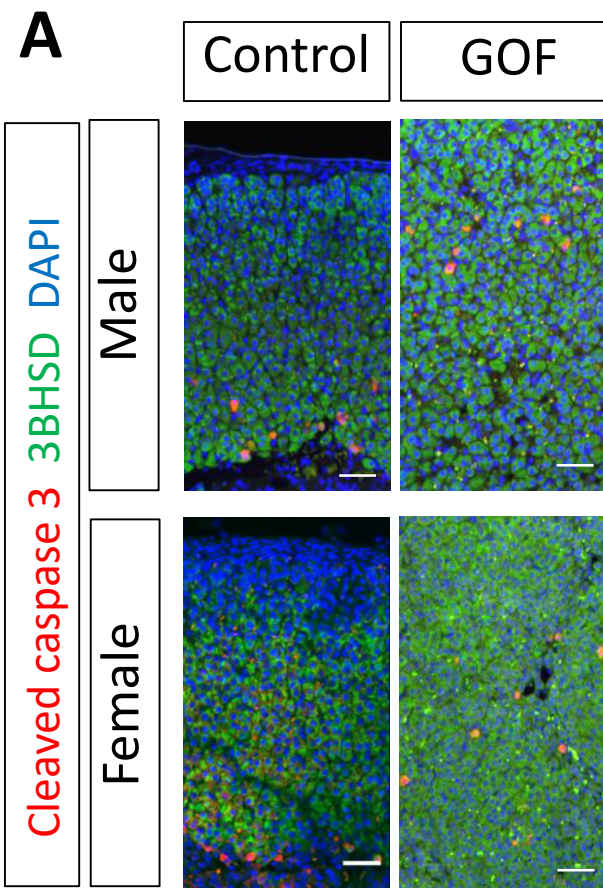

Figure 4



Supplementary figure 1





A

	No	Severity		Frequency	
		VD	ADH	VD	ADH
♀ control	3	0	0	0%	0%
♀ GOF	4	0	3	0%	100%
♂ control	3	0	0	0%	0%
♂ GOF	4	2,5	0	100%	0%

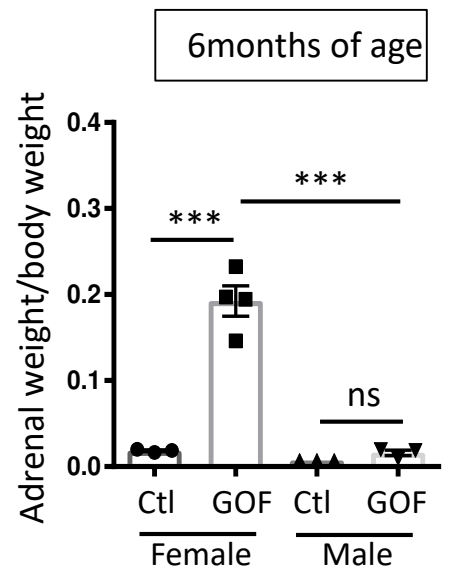
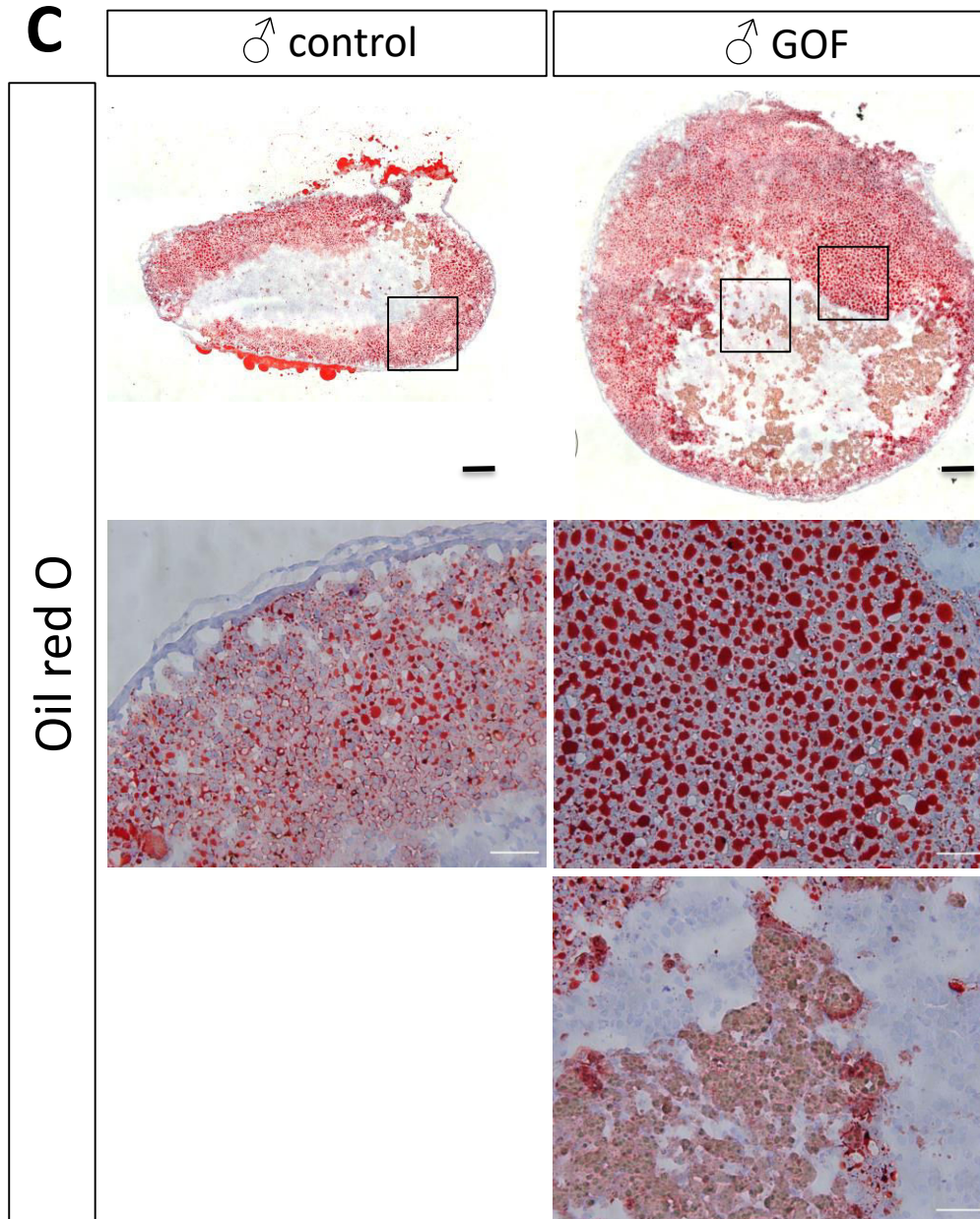
B**C**

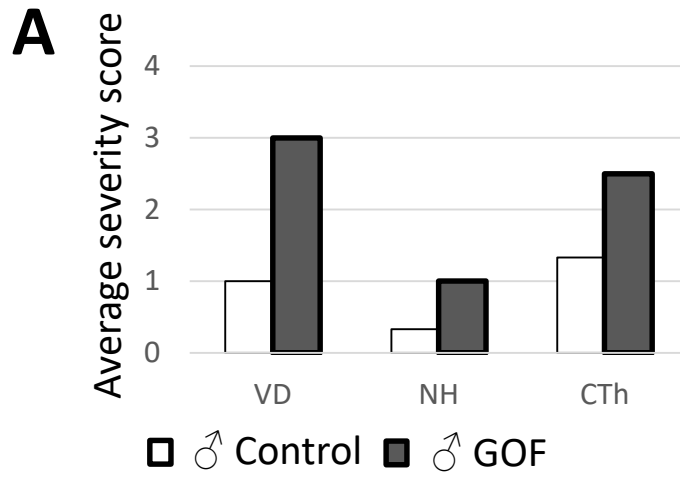

B

	No	% Frequency			
		VD	NH	CTh	Tumours
♀ Control	3	0	0	100	0
♀ GOF	4	75	25	33	50

- DISCUSSION -

Conclusions

In this thesis, I aimed at investigating the differences between male and female in adrenal cortex homeostasis and disease development.

In the first part of the thesis, I have evidenced surprisingly rapid cell renewal as well as dramatic differences in the cellular process of male and female tissue homeostasis in the adrenal cortex. First of all, the rate of replacement is up to 3-fold higher in females with the entire cortex being replaced in less than three months. Higher tissue turnover was further linked to increased proliferation in the female cortex in the capsule, zona glomerulosa and zona fasciculata. In contrast to males, in which capsular stem cells cease to contribute to the cortex from puberty onwards, GLI1+ cells are continuously recruited in females, suggesting the contribution of an additional progenitor cell population to adrenal renewal in this sex. Use of sex-reversal models excluded the role of sex chromosomes on the activity of the capsular cells in relation to the adrenal cortex renewal, as shown by the capsular cell proliferation and recruitment in concordance with the gonadal sex rather than the chromosomal sex in the two employed models. In addition, gonadectomy experiments in males and females suggested a role for male hormones suppression of capsular cell recruitment that was confirmed in females treated with the androgen dihydrotestosterone (DHT). The inhibitory action of male androgen on progenitor cells has been evidenced for the first time in this study and can explain the dramatic differences observed in adrenal cortex homeostasis between male and female. In addition, these differences and the fact that the female cortex relies on different progenitor cell populations as well as an increased proliferation rate may explain the fact that female mice are often less affected in loss-of-function experiments (knockout), such as in the *Yap/Taz* double knock out (Levasseur et al., 2017), yet more affected by pathway over activation such as in WNT over activation (constitutive β -catenin activation model (Berthon et al., 2010)) or in case of PKA over activation (through *Prkar1a* mutation (Dumontet et al., 2018)). The adrenal cortex is a non-reproductive organ, but exhibits sex hormone related features. It may serve as an example for studying sex-specific renewal in other non-reproductive organs that have so far been considered equal between the two sexes and contribute to male and female individuals being equally studied in research.

In the second part of the thesis, I have made use of a mouse model ectopically expressing *Rspo1* in the steroidogenic lineage of mice. In this model, mice developed, in a sexually dimorphic manner, pathophysiologies of the adrenal cortex. Indeed, while until puberty male and female both showed similar severities in hyperplasia of the adrenal cortex, after puberty females

presented with adrenals 2,5 folds bigger than the males. This was accompanied by a significant increase in proliferation at 6 weeks of age in the mutant female inner adrenal cortex, while no change in proliferation could be observed in the male mutant in comparison to the control. Indeed, transgenic male adrenals did not further increased in size after puberty and was even decreased at 6 months of age resulting in control and mutant adrenals being not significantly different in size at this time stage. These observations suggest different mechanisms to regulate adrenal cortex size and proliferation in case of abnormal signaling in male and female. From 4 weeks of age, male adrenals also started to present with unusual structures of large vacuolated cells in the inner part of the cortex. With age, this histological feature expanded and took over most of the normal cortex, leaving only a very thin functional cortex adjacent to the capsule that was accompanied with a higher frequency of development of nodular hyperplasia in mutant males in comparison to control. Finally, several pathologies were found to develop in older *Rspo1*^{GOF} females including adrenal adenoma and carcinoma. This mouse model is therefore not only a tool to further understand the molecular mechanisms involved in adrenal cortex homeostasis and its regulation in the context of abnormal signaling, but also represents an excellent model for sex bias in adrenal tumors. In summary, this model of moderate over activation of WNT-signaling in the steroidogenic cells represent a powerful tool to address the regulation of adrenal cortex homeostasis in male and female and to analyze how differences in tissue homeostasis translate into different prevalence of adrenal diseases between the two sexes. In the long term, these results could help us to better understand human adrenal pathologies and their occurrence rate.

Taken together, these results have helped us to understand the fundamental differences between male and female in adult adrenal tissue homeostasis and evidenced a major role of male androgens on the activity of adrenal progenitors. Translation of these results to human could be a precious help in finding novel diagnosis and treatment for adrenal pathologies.

Perspectives

The presented research reveals striking differences between male and female in term of homeostasis and disease development. But these results also raise many scientific questions to be answered.

In the first part of the thesis, capsular cells were shown to be recruited to the female adrenal cortex and to play an important role in tissue renewal. However, further experiments are needed to understand in detail the circumstances under which their proliferation and recruitment occur. A first part would focus on characterizing the stemness capacities of the female capsular cells using the Gli1-CreERT2 crossed with the confetti transgene in order to trace individual clones. This study could be completed with an in-depth analysis of the route employed by capsular cells to incorporate the steroidogenic compartment. It is indeed unclear whether capsular cells first incorporate into the ZG before transdifferentiating into ZF cells or if a proportion of them can bypass the ZG and directly enter the ZF. These hypotheses raise from two separate results: the fact that it is possible to observe GFP+ cells coming from the capsule within rosette structures and positive for DAB2, a ZG marker, but, at later chase time, the proportion of GFP+/DAB+ cells is much lower than of GFP+ in the ZF. The later can, at least partly, be explained by the observation that GFP+ coming from the capsule that have differentiated into ZF steroidogenic cells are able to re-enter the cell cycle and proliferate, generating an increased number of GFP+ within the ZF. Proliferation in this area has been previously reported in the ZNRF3 knock out mutant (Basham et al., 2019) but it has also been observed in this thesis in control female adrenal. Yet, the role of this additional proliferation and the signaling pathway initiating it in control female are not known to date.

Secondly, dihydrotestosterone was identified to have an inhibitory effect on capsular cell proliferation and recruitment. In order to further dissect the mechanism of action through which male androgens can regulate progenitor cell activity, RNA sequencing of the capsular cells and ZG compared between male and female could provide relevant information regarding the signaling pathways and factors involved in mediating cellular activity. To this end, the Gli1-CreERT2 and Wnt4-CreERT2 lines combined with the mTmG transgene and a short tracing (24-48h) allow specific GFP labeling of the capsular or ZG cells respectively. To this date, technical issues have prevented us to dissociate cells without compromising cellular survival and we were unable to perform FACS sorting and subsequent RNA isolation and sequencing. Similar difficulties will have to be addressed for adult adrenal single cell RNA sequencing that

would allow us to map and compare cell populations in male and female. Yet, these two techniques could offer great advances in the field by providing cellular profiling of the male and female adrenal cortex as well as mechanistic insight in such dramatic cellular renewal differences between the two sexes. Factors and signaling pathways of interest could then be investigated in mouse models, but more importantly could be applied to human samples that would give insight in rather these sex differences are also observed in human.

Finally, the first part of the thesis also offered a possible explanation to differences observed in phenotype development in various mouse models. In the currently available literature, females have been reported to be less severely impacted by down regulation of signaling pathway such as in the *Yap/Taz* double knock (Levasseur et al., 2017) but to present with a significantly increased phenotype in pathway over activation as observed in the β -catenin gain of function model (Berthon et al., 2010) and the PKA-over activation model (Dumontet et al., 2018). Hypothesis would suggest that the multiple cell populations proliferating in females may compensate for the decrease in signaling and may be more sensitive to increased proliferation through pathway over activation. However, the results obtained in the second part of the thesis suggest more profound differences to be at play in adrenal tissue homeostasis and physiology.

The analysis of the *Rspo1*^{GOF} mice identified this model as an adequate tool to study the link between the sex-specific homeostasis and sex-specific disease development, but further analyses are needed. First of all, further validation of the model can be done. As mentioned in the introduction, *Sfl* is also expressed in the gonads and this mouse model has been described to developed ovarian tumors. In order to confirm that the phenotype observed is not a secondary phenotype resulting from the ovarian abnormalities or changes in the pituitary, an adrenal-specific Cre line, such as the AS-Cre (Aldosterone Synthase – Cre) (Freedman et al., 2013), could be used. In addition, *Rspo1* expression in wild type adrenals is restricted to the mesothelium (Bandiera et al., 2013), whereas *Rspo3* is the main factor involved in zonation and proliferation (V. Vidal et al., 2016). *Rspo1* overexpression should therefore be compared with ectopic expression of *Rspo3* within the adrenal cortex. Contrarily to RSPO1, RSPO3 has been shown to potentiate WNT signaling independently of LGRs through binding to the heparan sulfate proteoglycans (Lebensohn & Rohatgi, 2018). Studying the *Rspo3* gain of function could provide with additional information on LGRs-dependent and independent WNT signaling within the adrenal cortex.

The male phenotype is also yet to be fully understood and so are the driving mechanisms behind the sex-specific phenotypes observed. Indeed, while initially males present with hyperplastic adrenal cortex similarly to females, from puberty and onward the apparition of vacuolopathy with age-increasing severity is noticeable and accompanied with increased frequency of nodular hyperplasia, both of which are signs of aging/degeneration of the cortex. Yet, the origin of these vacuoles is not clear. Our data from lineage tracing experiments and oil-red-O staining refute the hypothesis that the vacuoles are derived from steroidogenic cells that have accumulated lipids. Alternative hypotheses are presently under investigation including a potential role of the immune system. In addition, RNA sequencing of 4 weeks of age adrenals will provide mechanistic insights into the origin of the male phenotype and more generally how the adrenal cortex reacts to increased β -catenin signaling in a sexually dimorphic manner. This analysis could broaden our understanding of how cellular turnover of the adrenal cortex is controlled and evidence more profound differences between male and female.

Taken together, my results provide important insights into the cellular renewal of the adrenal cortex and its regulation and suggest dramatic differences in adrenal cortex homeostasis and disease development between male and female. However, the physiological reasons for this dimorphism are unknown. Differences between male and female individuals go beyond the physical appearance, sex organs, sex chromosomes and sex hormones and can affect every cells and process of the body. Of note, female adrenals produce higher levels of steroid hormones than males (Goel, Workman, Lee, Innala, & Viau, 2014). To date, the cause for this differential secretion is not well understood, but we can speculate that females may need to adapt to increased homeostatic stress throughout their lifespan and in particular during pregnancy. Increased hormonal production could also justify the requirement for a higher cellular turnover in female in order to replace steroidogenic cells that may be damaged faster. Little literature is currently available on this subject, but it has been suggested that steroid production may induce oxidative stress in cells increasing the risk of DNA damage and disease development. Increased cellular renewal may be an adaptive feature to cope with increased cellular stress and prevent, through replacement, cells to become cancerous. Yet increased proliferation and susceptibility to cell signaling may as well provide a rational for increased tumor development in females.

The adrenal is an under-studied organ when considering its major role in maintaining body homeostasis through its wide spectrum of actions. Collaborations between clinicians and researchers will be important to apply the observations made in mice to human in order to develop new treatments, but also in adapting diagnosis and treatment to each patient. In

addition, the adrenal may serve as a model system for sex-specific differences in non-reproductive organs. Finally, the findings presented in this thesis further highlight the importance of performing scientific studies in both sexes.

Abbreviations

3 β -HSD	3 β steroid hydrogenase
ACC	Adrenocortical carcinoma
ACE	Angiotensin-converting enzyme
ACTH	Adrenocorticotropic hormone
AGP	Adrenal-gonadal primordium
ANG	Angiotensin
APC	Adenomatous polyposis coli
AS	Aldosterone synthase
BR	Basic amino acid rich region
CAH	Congenital adrenal hyperplasia
cAMP	Cyclic adenosine monophosphate
CBF	Nuclear transcription factor Y
CDK	Casein kinase
CREB	cAMP response element binding protein
CRH	Coricotropin-releasing hormone
CYP11B1	11- β -hydroxylase
CYP17	17- α -hydroxylase
DAB2	Disabled 2
DHEA	Dehydroepiandrosterone
DHH	Desert hedgehog
E	Embryonic day
ER	Estrogen receptor
FadE	Fetal adrenal enhancer
FU	Furin-like domain
FZD	Frizzled
GFP	Green fluorescent protein
GSK	Glycogen synthase kinase
HPA	Hypothalamus-Pituitary-Adrenal
HSPG	Heparan sulfate proteoglycan
IHH	Indian hedgehog
LBD	Ligand binding domain

LEF	Lymphoid enhancer facto
LGR	Leucine-rich repeat-containing G-protein-coupled receptor
LRP	Low-density lipoprotein related protein
MC2R	Melanocortin receptor 2
mG	Membrane-targeted green fluorescent protein
mT	Membrane-targeted tandem dimer tomato
OMM	Outer mitochondria membrane
P	Postnatal day
PBX	Pre B-cells transcription factor
PKA	cAMP-dependent protein kinase
PTCH	Patched
RAAS	Renin-Angiotensin-Aldosterone system
RNF	Ring finger
RSPO	Roof plate-specific spondin
SCP	Sterol carrier protein
SF1	Steroidogenic factor 1
SMO	Smothered
SHH	Sonic hedgehog
SP	Signal peptide
SRY	Sex-determining region of Y chromosome
TAZ	Transcriptional co-activator with a PDZ-binding domain
TCF	T-cell factor
TSR	Thrombospondin type 1 repeat domain
USF	Upstream stimulatory factor
WT1	Wilm's tumor 1
YAP	Yes-associated protein
ZF	Zona fasciculata
ZG	Zona glomerulosa
ZNRF	Zinc and ring finger
ZR	Zona reticularis

Nomenclature

Proteins and signaling pathway are written with all uppercase for both human and mouse (ex: SF1 protein/ WNT signaling). Genes are italicized and written in all capital letters for human (ex: *SFI*) and with only the first letter in uppercase and the rest in lowercase for mouse genes (ex: *Sf1*).

Bibliography

- Aigueperse, C., Val, P., Pacot, C., Darne, C., Lalli, E., Sassone-Corsi, P., ... Martinez, A. (2001). SF-1 (Steroidogenic Factor-1), C/EBP β (CCAAT/Enhancer Binding Protein), and Ubiquitous Transcription Factors NF1 (Nuclear Factor 1) and Sp1 (Selective Promoter Factor 1) Are Required for Regulation of the Mouse Aldose Reductase-Like Gene (AKR1B7) Expression in Adrenocortical Cells. *Molecular Endocrinology*, *15*(1), 93–111. <https://doi.org/10.1210/mend.15.1.0577>
- Assié, G., Letouzé, E., Fassnacht, M., Jouinot, A., Luscap, W., Barreau, O., ... Bertherat, J. (2014). Integrated genomic characterization of adrenocortical carcinoma. *Nature Genetics*, *46*(6), 607–612. <https://doi.org/10.1038/ng.2953>
- Audenet, F., Yates, D. R., Cussenot, O., & Rouprêt, M. (2013). The role of chemotherapy in the treatment of urothelial cell carcinoma of the upper urinary tract (UUT-UCC). *Urologic Oncology: Seminars and Original Investigations*, *31*(4), 407–413. <https://doi.org/10.1016/j.urolonc.2010.07.016>
- Ayala-Ramirez, M., Jasim, S., Feng, L., Ejaz, S., Deniz, F., Busaidy, N., ... Habra, M. A. (2013). Adrenocortical carcinoma: clinical outcomes and prognosis of 330 patients at a tertiary care center. *European Journal of Endocrinology*, *169*(6), 891–899. <https://doi.org/10.1530/EJE-13-0519>
- Baker, M. E. (2003). *Evolution of adrenal and sex steroid action in vertebrates: a ligand-based mechanism for complexity*. *BioEssays* (Vol. 25). Wiley Periodicals, Inc. Retrieved from <https://escholarship.org/content/qt2mp575b7/qt2mp575b7.pdf>
- Bandiera, R., Vidal, V. P. I., Motamedi, F. J., Clarkson, M., Sahut-Barnola, I., von Gise, A., ... Schedl, A. (2013). WT1 maintains adrenal-gonadal primordium identity and marks a population of AGP-like progenitors within the adrenal gland. *Developmental Cell*, *27*(1), 5–18. <https://doi.org/10.1016/j.devcel.2013.09.003>
- Basham, K. J., Rodriguez, S., Turcu, A. F., Lerario, A. M., Logan, C. Y., Rysztak, M. R., ... Hammer, G. D. (2019). A ZNRF3-dependent Wnt/ β -catenin signaling gradient is

- required for adrenal homeostasis. *Genes & Development*, 33(3–4), 209–220.
<https://doi.org/10.1101/gad.317412.118>
- Beery, A. K., & Zucker, I. (2011). Sex bias in neuroscience and biomedical research. *Neuroscience & Biobehavioral Reviews*, 35(3), 565–572.
<https://doi.org/10.1016/j.neubiorev.2010.07.002>
- Berthon, A., Sahut-Barnola, I., Lambert-Langlais, S., de Joussineau, C., Damon-Soubeyrand, C., Louiset, E., ... Val, P. (2010). Constitutive β -catenin activation induces adrenal hyperplasia and promotes adrenal cancer development. *Human Molecular Genetics*, 19(8), 1561–1576. <https://doi.org/10.1093/hmg/ddq029>
- Bielohuby, M., Herbach, N., Wanke, R., Maser-Gluth, C., Beuschlein, F., Wolf, E., & Hoeflich, A. (2007). Growth analysis of the mouse adrenal gland from weaning to adulthood: time- and gender-dependent alterations of cell size and number in the cortical compartment. *American Journal of Physiology-Endocrinology and Metabolism*, 293(1), E139–E146. <https://doi.org/10.1152/ajpendo.00705.2006>
- Bingham, N. C., Verma-Kurvari, S., Parada, L. F., & Parker, K. L. (2006). Development of a steroidogenic factor 1/Cre transgenic mouse line. *Genesis*, 44(9), 419–424.
<https://doi.org/10.1002/dvg.20231>
- Birk, O. S., Casiano, D. E., Wassif, C. A., Cogliati, T., Zhao, L., Zhao, Y., ... Westphal, H. (2000). The LIM homeobox gene *Lhx9* is essential for mouse gonad formation. *Nature*, 403(6772), 909–913. <https://doi.org/10.1038/35002622>
- Bland, M. L., Fowkes, R. C., & Ingraham, H. A. (2004). Differential Requirement for Steroidogenic Factor-1 Gene Dosage in Adrenal Development Versus Endocrine Function. *Molecular Endocrinology*, 18(4), 941–952. <https://doi.org/10.1210/me.2003-0333>
- Bradford, S. T., Wilhelm, D., Bandiera, R., Vidal, V., Schedl, A., & Koopman, P. (2009). A cell-autonomous role for WT1 in regulating *Sry* in vivo. *Human Molecular Genetics*, 18(18), 3429–3438. <https://doi.org/10.1093/hmg/ddp283>

- Bremer, A. A., & Miller, W. L. (2014). Regulation of Steroidogenesis. *Cellular Endocrinology in Health and Disease*, 207–227. <https://doi.org/10.1016/B978-0-12-408134-5.00013-5>
- Buaas, F. W., Gardiner, J. R., Clayton, S., Val, P., & Swain, A. (2012). In vivo evidence for the crucial role of SF1 in steroid-producing cells of the testis, ovary and adrenal gland. *Development*, 139(24), 4561–4570. <https://doi.org/10.1242/dev.087247>
- Buliman, A., Tataranu, L. G., Paun, D. L., Mirica, A., & Dumitrache, C. (2016). Cushing's disease: a multidisciplinary overview of the clinical features, diagnosis, and treatment. *Journal of Medicine and Life*, 9(1), 12–18. Retrieved from <http://www.ncbi.nlm.nih.gov/pubmed/27974908>
- Burton, C., Cottrell, E., & Edwards, J. (2015). Addison's disease: identification and management in primary care. *The British Journal of General Practice : The Journal of the Royal College of General Practitioners*, 65(638), 488–490. <https://doi.org/10.3399/bjgp15X686713>
- Caron, K. M., Clark, B. J., Ikeda, Y., & Parker, K. L. (1997). Steroidogenic factor 1 acts at all levels of the reproductive axis. *Steroids*, 62(1), 53–56. [https://doi.org/10.1016/S0039-128X\(96\)00159-6](https://doi.org/10.1016/S0039-128X(96)00159-6)
- Choudhry, Z., Rikani, A. A., Choudhry, A. M., Tariq, S., Zakaria, F., Asghar, M. W., ... Mobassarrah, N. J. (2014). Sonic hedgehog signalling pathway: a complex network. *Annals of Neurosciences*, 21(1), 28–31. <https://doi.org/10.5214/ans.0972.7531.210109>
- Clevers, H., & Nusse, R. (2012). Wnt/ β -Catenin Signaling and Disease. *Cell*, 149(6), 1192–1205. <https://doi.org/10.1016/j.cell.2012.05.012>
- De Cian, M.-C., Pauper, E., Bandiera, R., Vidal, V. P. I., Sacco, S., Gregoire, E. P., ... Chaboissier, M.-C. (2017). Amplification of R-spondin1 signaling induces granulosa cell fate defects and cancers in mouse adult ovary. *Oncogene*, 36(2), 208–218. <https://doi.org/10.1038/onc.2016.191>
- De Fraipont, F., El Atifi, M., Cherradi, N., Le Moigne, G., Defaye, G., Houlgatte, R., ...

- Gene, al. (2005). Gene expression profiling of human adrenocortical tumors using complementary deoxyribonucleic Acid microarrays identifies several candidate genes as markers of malignancy. *Journal of Clinical Endocrinology and Metabolism*, *90*(3), 1819–1848. <https://doi.org/10.1210/jc.2004-1075>
- de Lau, W. B., Snel, B., & Clevers, H. C. (2012). The R-spondin protein family. *Genome Biology*, *13*(3), 242. <https://doi.org/10.1186/gb-2012-13-3-242>
- Drelon, C., Berthon, A., Sahut-Barnola, I., Mathieu, M., Dumontet, T., Rodriguez, S., ... Val, P. (2016). PKA inhibits WNT signalling in adrenal cortex zonation and prevents malignant tumour development. *Nature Communications*, *7*, 12751. <https://doi.org/10.1038/ncomms12751>
- Dumontet, T., Sahut-Barnola, I., Septier, A., Montanier, N., Plotton, I., Roucher-Boulez, F., ... Martinez, A. (2018). PKA signaling drives reticularis differentiation and sexually dimorphic adrenal cortex renewal. *JCI Insight*, *3*(2). <https://doi.org/10.1172/jci.insight.98394>
- El Wakil, A., Mari, B., Barhanin, J., & Lalli, E. (2013). Genomic Analysis of Sexual Dimorphism of Gene Expression in the Mouse Adrenal Gland. *Hormone and Metabolic Research*, *45*(12), 870–873. <https://doi.org/10.1055/s-0033-1349881>
- Fairweather, D., Frisancho-Kiss, S., & Rose, N. R. (2008). Sex differences in autoimmune disease from a pathological perspective. *The American Journal of Pathology*, *173*(3), 600–609. <https://doi.org/10.2353/ajpath.2008.071008>
- Feil, S., Valtcheva, N., & Feil, R. (2009). Inducible Cre Mice (pp. 343–363). Humana Press. https://doi.org/10.1007/978-1-59745-471-1_18
- Ferraz-de-Souza, B., Lin, L., & Achermann, J. C. (2011). Steroidogenic factor-1 (SF-1, NR5A1) and human disease. *Molecular and Cellular Endocrinology*, *336*(1–2), 198–205. <https://doi.org/10.1016/j.mce.2010.11.006>
- Freedman, B. D., Kempna, P. B., Carlone, D. L., Shah, M., Guagliardo, N. A., Barrett, P. Q., ... Breault, D. T. (2013). Adrenocortical zonation results from lineage conversion of

- differentiated zona glomerulosa cells. *Developmental Cell*, 26(6), 666–673.
<https://doi.org/10.1016/j.devcel.2013.07.016>
- Goel, N., Workman, J. L., Lee, T. T., Innala, L., & Viau, V. (2014). Sex Differences in the HPA Axis. In *Comprehensive Physiology* (Vol. 4, pp. 1121–1155). Hoboken, NJ, USA: John Wiley & Sons, Inc. <https://doi.org/10.1002/cphy.c130054>
- Gregoire, E. P., Lavery, R., Chassot, A.-A., Akiyama, H., Treier, M., Behringer, R. R., & Chaboissier, M.-C. (2011). Transient development of ovotestes in XX Sox9 transgenic mice. *Developmental Biology*, 349(1), 65–77.
<https://doi.org/10.1016/j.ydbio.2010.10.006>
- Halladay, A. K., Bishop, S., Constantino, J. N., Daniels, A. M., Koenig, K., Palmer, K., ... Szatmari, P. (2015). Sex and gender differences in autism spectrum disorder: summarizing evidence gaps and identifying emerging areas of priority. *Molecular Autism*, 6, 36. <https://doi.org/10.1186/s13229-015-0019-y>
- Hammes, A., Guo, J. K., Lutsch, G., Leheste, J. R., Landrock, D., Ziegler, U., ... Schedl, A. (2001). Two splice variants of the Wilms' tumor 1 gene have distinct functions during sex determination and nephron formation. *Cell*, 106(3), 319–329. Retrieved from <http://www.ncbi.nlm.nih.gov/pubmed/11509181>
- Hao, H.-X., Jiang, X., & Cong, F. (2016). Control of Wnt Receptor Turnover by R-spondin-ZNRF3/RNF43 Signaling Module and Its Dysregulation in Cancer. *Cancers*, 8(6), 54. <https://doi.org/10.3390/cancers8060054>
- Hao, H.-X., Xie, Y., Zhang, Y., Charlat, O., Oster, E., Avello, M., ... Cong, F. (2012). ZNRF3 promotes Wnt receptor turnover in an R-spondin-sensitive manner. *Nature*, 485(7397), 195–200. <https://doi.org/10.1038/nature11019>
- Hastie, N. D. (2017). Wilms' tumour 1 (WT1) in development, homeostasis and disease. *Development*, 144(16), 2862–2872. <https://doi.org/10.1242/dev.153163>
- Hatano, O., Takakusu, A., Nomura, M., & Morohashi, K. (1996). Identical origin of adrenal cortex and gonad revealed by expression profiles of Ad4BP/SF-1. *Genes to Cells* :

Devoted to Molecular & Cellular Mechanisms, 1(7), 663–671. Retrieved from <http://www.ncbi.nlm.nih.gov/pubmed/9078392>

Heikkilä, M., Peltoketo, H., Leppäluoto, J., Ilves, M., Vuolteenaho, O., & Vainio, S. (2002). Wnt-4 Deficiency Alters Mouse Adrenal Cortex Function, Reducing Aldosterone Production. *Endocrinology*, 143(11), 4358–4365. <https://doi.org/10.1210/en.2002-220275>

Hershkovitz, L., Beuschlein, F., Klammer, S., Krup, M., & Weinstein, Y. (2007). Adrenal 20 α -Hydroxysteroid Dehydrogenase in the Mouse Catabolizes Progesterone and 11-Deoxycorticosterone and Is Restricted to the X-Zone. *Endocrinology*, 148(3), 976–988. <https://doi.org/10.1210/en.2006-1100>

Hiatt, J. R., & Hiatt, N. (1997). The conquest of Addison's disease. *The American Journal of Surgery*, 174(3), 280–283. [https://doi.org/10.1016/S0002-9610\(97\)00136-0](https://doi.org/10.1016/S0002-9610(97)00136-0)

Hiller-Sturmhöfel, S., & Bartke, A. (1998). The endocrine system: an overview. *Alcohol Health and Research World*, 22(3), 153–164. Retrieved from <http://www.ncbi.nlm.nih.gov/pubmed/15706790>

Hoivik, E. A., Bjanesoy, T. E., Mai, O., Okamoto, S., Minokoshi, Y., Shima, Y., ... Bakke, M. (2011). DNA Methylation of Intronic Enhancers Directs Tissue-Specific Expression of Steroidogenic Factor 1/Adrenal 4 Binding Protein (SF-1/Ad4BP). *Endocrinology*, 152(5), 2100–2112. <https://doi.org/10.1210/en.2010-1305>

Hoivik, E. A., Lewis, A. E., Aumo, L., & Bakke, M. (2010). Molecular aspects of steroidogenic factor 1 (SF-1). *Molecular and Cellular Endocrinology*, 315(1–2), 27–39. <https://doi.org/10.1016/j.mce.2009.07.003>

Hu, Y.-C., Okumura, L. M., & Page, D. C. (2013). Gata4 Is Required for Formation of the Genital Ridge in Mice. *PLoS Genetics*, 9(7), e1003629. <https://doi.org/10.1371/journal.pgen.1003629>

Huang, X., Liu, J., Ketova, T., Fleming, J. T., Grover, V. K., Cooper, M. K., ... Chiang, C. (2010). Transventricular delivery of Sonic hedgehog is essential to cerebellar ventricular

- zone development. *Proceedings of the National Academy of Sciences of the United States of America*, *107*(18), 8422–8427. <https://doi.org/10.1073/pnas.0911838107>
- Iyer, A. K., & McCabe, E. R. B. (2004). Molecular mechanisms of DAX1 action. *Molecular Genetics and Metabolism*, *83*(1–2), 60–73.
<https://doi.org/10.1016/J.YMGME.2004.07.018>
- Jin, Y.-R., & Yoon, J. K. (2012). The R-spondin family of proteins: emerging regulators of WNT signaling. *The International Journal of Biochemistry & Cell Biology*, *44*(12), 2278–2287. <https://doi.org/10.1016/j.biocel.2012.09.006>
- Kashimada, K., & Koopman, P. (2010). Sry: the master switch in mammalian sex determination. *Development*, *137*(23), 3921–3930. <https://doi.org/10.1242/dev.048983>
- Kiiveri, S., Liu, J., Westerholm-Ormio, M., Narita, N., Wilson, D. B., Voutilainen, R., & Heikinheimo, M. (2002). *Differential Expression of GATA-4 and GATA-6 in Fetal and Adult Mouse and Human Adrenal Tissue*. Retrieved from <https://academic.oup.com/endo/article-abstract/143/8/3136/2989737>
- Kim, A. C., Barlaskar, F. M., Heaton, J. H., Else, T., Kelly, V. R., Krill, K. T., ... Hammer, G. D. (2009). In Search of Adrenocortical Stem and Progenitor Cells. *Endocrine Reviews*, *30*(3), 241–263. <https://doi.org/10.1210/er.2008-0039>
- King, P., Paul, A., & Laufer, E. (2009). Shh signaling regulates adrenocortical development and identifies progenitors of steroidogenic lineages. *Proceedings of the National Academy of Sciences of the United States of America*, *106*(50), 21185–21190.
<https://doi.org/10.1073/pnas.0909471106>
- Komiya, Y., & Habas, R. (2008). Wnt signal transduction pathways. *Organogenesis*, *4*(2), 68–75. Retrieved from <http://www.ncbi.nlm.nih.gov/pubmed/19279717>
- Koo, B.-K., Spit, M., Jordens, I., Low, T. Y., Stange, D. E., van de Wetering, M., ... Clevers, H. (2012). Tumour suppressor RNF43 is a stem-cell E3 ligase that induces endocytosis of Wnt receptors. *Nature*, *488*(7413), 665–669. <https://doi.org/10.1038/nature11308>
- Kretzschmar, K., & Watt, F. M. (2012). Lineage Tracing.

<https://doi.org/10.1016/j.cell.2012.01.002>

Lalli, E. (2014). Role of Orphan Nuclear Receptor DAX-1/NR0B1 in Development, Physiology, and Disease. *Advances in Biology*, 2014, 1–19.
<https://doi.org/10.1155/2014/582749>

Lavery, R., Lardenois, A., Ranc-Jianmotamedi, F., Pauper, E., Gregoire, E. P., Vigier, C., ... Chaboissier, M.-C. (2011). XY Sox9 embryonic loss-of-function mouse mutants show complete sex reversal and produce partially fertile XY oocytes. *Developmental Biology*, 354(1), 111–122. <https://doi.org/10.1016/j.ydbio.2011.03.029>

Lebensohn, A. M., & Rohatgi, R. (2018). R-spondins can potentiate WNT signaling without LGRs. *ELife*, 7. <https://doi.org/10.7554/eLife.33126>

Leoutsakos, B., & Leoutsakos, A. (2008). The adrenal glands: a brief historical perspective. *HORMONES*, 7(4), 334–336. <https://doi.org/10.14310/horm.2002.1216>

Leushacke, M., & Barker, N. (2012). Lgr5 and Lgr6 as markers to study adult stem cell roles in self-renewal and cancer. *Oncogene*, 31(25), 3009–3022.
<https://doi.org/10.1038/onc.2011.479>

Levasseur, A., St-Jean, G., Paquet, M., Boerboom, D., & Boyer, A. (2017). Targeted Disruption of YAP and TAZ Impairs the Maintenance of the Adrenal Cortex. *Endocrinology*, 158(11), 3738–3753. <https://doi.org/10.1210/en.2017-00098>

Li, N., Liu, R., Zhang, H., Yang, J., Sun, S., Zhang, M., ... Li, X. (2010). Seven Novel DAX1 Mutations with Loss of Function Identified in Chinese Patients with Congenital Adrenal Hypoplasia. *The Journal of Clinical Endocrinology & Metabolism*, 95(9), E104–E111.
<https://doi.org/10.1210/jc.2009-2408>

Libé, R. (2015). Adrenocortical carcinoma (ACC): diagnosis, prognosis, and treatment. *Frontiers in Cell and Developmental Biology*, 3, 45.
<https://doi.org/10.3389/fcell.2015.00045>

Lichtenauer, U. D., Duchniewicz, M., Kolanczyk, M., Hoeflich, A., Hahner, S., Else, T., ... Beuschlein, F. (2007). Pre-B-Cell Transcription Factor 1 and Steroidogenic Factor 1

- Synergistically Regulate Adrenocortical Growth and Steroidogenesis. *Endocrinology*, 148(2), 693–704. <https://doi.org/10.1210/en.2006-0681>
- Lonser, R. R., Nieman, L., & Oldfield, E. H. (2017). Cushing's disease: pathobiology, diagnosis, and management. *Journal of Neurosurgery*, 126(2), 404–417. <https://doi.org/10.3171/2016.1.JNS152119>
- Luo, X., Ikeda, Y., & Parker, K. L. (1994). A cell-specific nuclear receptor is essential for adrenal and gonadal development and sexual differentiation. *Cell*, 77(4), 481–490. Retrieved from <http://www.ncbi.nlm.nih.gov/pubmed/8187173>
- MacDonald, B. T., Tamai, K., & He, X. (2009). Wnt/ β -Catenin Signaling: Components, Mechanisms, and Diseases. *Developmental Cell*, 17(1), 9–26. <https://doi.org/10.1016/j.devcel.2009.06.016>
- Majdic, G., Young, M., Gomez-Sanchez, E., Anderson, P., Szczepaniak, L. S., Dobbins, R. L., ... Parker, K. L. (2002). Knockout Mice Lacking Steroidogenic Factor 1 Are a Novel Genetic Model of Hypothalamic Obesity. *Endocrinology*, 143(2), 607–614. <https://doi.org/10.1210/endo.143.2.8652>
- Margulies, P., & Mullen, M. D. J. (1997). *North American Survey*. Retrieved from <https://www.nadf.us/downloads/survey1997.pdf>
- Martin, L. A., Neighbors, H. W., & Griffith, D. M. (2013). The Experience of Symptoms of Depression in Men vs Women. *JAMA Psychiatry*, 70(10), 1100. <https://doi.org/10.1001/jamapsychiatry.2013.1985>
- Mclean, M. P., Lopez, D., Nackley, A. C., Shea-Eaton, W., Xue, J., & Schimmer, B. P. (2001). *Effects of Mutating Different Steroidogenic Factor-1 Protein Regions on Gene Regulation The involvement of cyclic adenosine monophosphate cAMP-dependent protein kinase A (PKA) in the*. *Endocrine* (Vol. 14). Retrieved from <https://link.springer.com/content/pdf/10.1385/ENDO:14:3:353.pdf>
- Meng, Z., Moroishi, T., & Guan, K.-L. (2016). Mechanisms of Hippo pathway regulation. *Genes & Development*, 30(1), 1–17. <https://doi.org/10.1101/gad.274027.115>

- Merke, D., & Kabbani, M. (2001). Congenital Adrenal Hyperplasia. *Paediatric Drugs*, 3(8), 599–611. <https://doi.org/10.2165/00128072-200103080-00005>
- Metzger, D., & Chambon, P. (2001). Site- and Time-Specific Gene Targeting in the Mouse. *Methods*, 24(1), 71–80. <https://doi.org/10.1006/METH.2001.1159>
- Miller, W. L. (2007). Steroidogenic acute regulatory protein (StAR), a novel mitochondrial cholesterol transporter. *Biochimica et Biophysica Acta (BBA) - Molecular and Cell Biology of Lipids*, 1771(6), 663–676. <https://doi.org/10.1016/J.BBALIP.2007.02.012>
- Morohashi, K. (1997). The ontogenesis of the steroidogenic tissues. *Genes to Cells*, 2(2), 95–106. <https://doi.org/10.1046/j.1365-2443.1997.1060304.x>
- Morohashi, K., & Zubair, M. (2011). The fetal and adult adrenal cortex. *Molecular and Cellular Endocrinology*, 336(1–2), 193–197. <https://doi.org/10.1016/j.mce.2010.11.026>
- Mullins, L. J., Peter, A., Wrobel, N., McNeilly, J. R., McNeilly, A. S., Al-Dujaili, E. A. S., ... Kenyon, C. J. (2009). Cyp11b1 Null Mouse, a Model of Congenital Adrenal Hyperplasia. *Journal of Biological Chemistry*, 284(6), 3925–3934. <https://doi.org/10.1074/jbc.M805081200>
- Muzumdar, M. D., Tasic, B., Miyamichi, K., Li, L., & Luo, L. (2007). A global double-fluorescent Cre reporter mouse. *Genesis*, 45(9), 593–605. <https://doi.org/10.1002/dvg.20335>
- Newell-Price, J., Bertagna, X., Grossman, A. B., & Nieman, L. K. (2006). Cushing's syndrome. *The Lancet*, 367(9522), 1605–1617. [https://doi.org/10.1016/S0140-6736\(06\)68699-6](https://doi.org/10.1016/S0140-6736(06)68699-6)
- Niakan, K. K., & McCabe, E. R. B. (2005). DAX1 origin, function, and novel role. *Molecular Genetics and Metabolism*, 86(1–2), 70–83. <https://doi.org/10.1016/J.YMGME.2005.07.019>
- Nusse, R., & Clevers, H. (2017). Wnt/ β -Catenin Signaling, Disease, and Emerging Therapeutic Modalities. *Cell*, 169(6), 985–999. <https://doi.org/10.1016/j.cell.2017.05.016>

- Owens, D. M., & Watt, F. M. (2003). Contribution of stem cells and differentiated cells to epidermal tumours. *Nature Reviews Cancer*, 3(6), 444–451.
<https://doi.org/10.1038/nrc1096>
- Ozisik, G., Achermann, J. C., Meeks, J. J., & Jameson, J. L. (2003). SF1 in the development of the adrenal gland and gonads. *Hormone Research*, 59 Suppl 1(Suppl. 1), 94–98.
<https://doi.org/10.1159/000067831>
- Park, S. Y., & Jameson, J. L. (2005). Minireview: Transcriptional Regulation of Gonadal Development and Differentiation. *Endocrinology*, 146(3), 1035–1042.
<https://doi.org/10.1210/en.2004-1454>
- Parker, K. L., & Schimmer, B. P. (1997). Steroidogenic Factor 1: A Key Determinant of Endocrine Development and Function. *Endocrine Reviews*, 18(3), 361–377.
<https://doi.org/10.1210/edrv.18.3.0301>
- Piccolo, S., Dupont, S., & Cordenonsi, M. (2014). The Biology of YAP/TAZ: Hippo Signaling and Beyond. *Physiological Reviews*, 94(4), 1287–1312.
<https://doi.org/10.1152/physrev.00005.2014>
- Pihlajoki, M., Dörner, J., Cochran, R. S., Heikinheimo, M., & Wilson, D. B. (2015). Adrenocortical zonation, renewal, and remodeling. *Frontiers in Endocrinology*, 6, 27.
<https://doi.org/10.3389/fendo.2015.00027>
- Ray, M. K., Fagan, S. P., Charles, F., Michael, B., & Debakey, E. (2000). *The Cre-loxP System: A Versatile Tool for Targeting Genes in a Cell-and Stage-Specific Manner*. *Cell Transplantation* (Vol. 9). Retrieved from www.cognizantcommunication.com
- Romero, D. G., Zhou, M. Y., Yanes, L. L., Plonczynski, M. W., Washington, T. R., Gomez-Sanchez, C. E., & Gomez-Sanchez, E. P. (2007). Regulators of G-protein signaling 4 in adrenal gland: localization, regulation, and role in aldosterone secretion. *Journal of Endocrinology*, 194(2), 429–440. <https://doi.org/10.1677/JOE-07-0153>
- Sauer, B. (1998). Inducible Gene Targeting in Mice Using the Cre/loxSystem. *Methods*, 14(4), 381–392. <https://doi.org/10.1006/METH.1998.0593>

- Scheys, J. O., Heaton, J. H., & Hammer, G. D. (2011). Evidence of adrenal failure in aging Dax1-deficient mice. *Endocrinology*, *152*(9), 3430–3439.
<https://doi.org/10.1210/en.2010-0986>
- Schimmer, B. P., & White, P. C. (2010). Minireview: steroidogenic factor 1: its roles in differentiation, development, and disease. *Molecular Endocrinology (Baltimore, Md.)*, *24*(7), 1322–1337. <https://doi.org/10.1210/me.2009-0519>
- Schnabel, C. A., Selleri, L., & Cleary, M. L. (2003). Pbx1 is essential for adrenal development and urogenital differentiation. *Genesis*, *37*(3), 123–130.
<https://doi.org/10.1002/gene.10235>
- Scollo, C., Russo, M., Trovato, M. A., Sambataro, D., Giuffrida, D., Manusia, M., ... Pellegriti, G. (2016). Prognostic Factors for Adrenocortical Carcinoma Outcomes. *Frontiers in Endocrinology*, *7*, 99. <https://doi.org/10.3389/fendo.2016.00099>
- Sekido, R., & Lovell-Badge, R. (2008). Sex determination involves synergistic action of SRY and SF1 on a specific Sox9 enhancer. *Nature*, *453*(7197), 930–934.
<https://doi.org/10.1038/nature06944>
- Sharma, S. T., Nieman, L. K., & Feelders, R. A. (2015). Cushing's syndrome: epidemiology and developments in disease management. *Clinical Epidemiology*, *7*, 281–293.
<https://doi.org/10.2147/CLEP.S44336>
- Snyder, C. S., Harrington, A. R., Kaushal, S., Mose, E., Lowy, A. M., Hoffman, R. M., & Bouvet, M. (2013). A dual-color genetically engineered mouse model for multispectral imaging of the pancreatic microenvironment. *Pancreas*, *42*(6), 952–958.
<https://doi.org/10.1097/MPA.0b013e31828643df>
- Stallings, N. R., Hanley, N. A., Majdic, G., Zhao, L., Bakke, M., & Parker, K. L. (2002). Development of a Transgenic Green Fluorescent Protein Lineage Marker for Steroidogenic Factor 1. *Molecular Endocrinology*, *16*(10), 2360–2370.
<https://doi.org/10.1210/me.2002-0003>
- Sugawara, T., Holt, J. A., Kiriakidou, M., & Strauss, J. F. (1996). Steroidogenic Factor 1-

Dependent Promoter Activity of the Human Steroidogenic Acute Regulatory Protein (StAR) Gene †. *Biochemistry*, 35(28), 9052–9059. <https://doi.org/10.1021/bi960057r>

Takase, H. M., Kanai-Azuma, M., & Kanai, Y. (2018). Differentiation of Ovaries. *Reference Module in Biomedical Sciences*. <https://doi.org/10.1016/B978-0-12-801238-3.65395-3>

Tanaka, K., Kitagawa, Y., & Kadowaki, T. (2002). Drosophila Segment Polarity Gene Product Porcupine Stimulates the Posttranslational N-Glycosylation of Wingless in the Endoplasmic Reticulum. *Journal of Biological Chemistry*, 277(15), 12816–12823. <https://doi.org/10.1074/jbc.M200187200>

Tevosian, S. G., Albrecht, K. H., Crispino, J. D., Fujiwara, Y., Eicher, E. M., & Orkin, S. H. (2002). Gonadal differentiation, sex determination and normal Sry expression in mice require direct interaction between transcription partners GATA4 and FOG2. *Development (Cambridge, England)*, 129(19), 4627–4634. Retrieved from <http://www.ncbi.nlm.nih.gov/pubmed/12223418>

Trejter, M., Hochol, A., Tyczewska, M., Ziolkowska, A., Jopek, K., Szyszka, M., ... Rucinski, M. (2015). Sex-related gene expression profiles in the adrenal cortex in the mature rat: microarray analysis with emphasis on genes involved in steroidogenesis. *International Journal of Molecular Medicine*, 35(3), 702–714. <https://doi.org/10.3892/ijmm.2015.2064>

Turcu, A. F., & Auchus, R. J. (2015). Adrenal Steroidogenesis and Congenital Adrenal Hyperplasia. *Endocrinology and Metabolism Clinics of North America*, 44(2), 275–296. <https://doi.org/10.1016/j.ecl.2015.02.002>

U.S. Government Accountability Office. (2001, February 9). Drug Safety: Most Drugs Withdrawn in Recent Years Had Greater Health Risks for Women. Retrieved from <https://www.gao.gov/products/GAO-01-286R>

Vaidya, B., Chakera, A. J., & Dick, C. (2009). Addison's disease. *BMJ (Clinical Research Ed.)*, 339, b2385. <https://doi.org/10.1136/bmj.b2385>

Val, P., Lefrançois-Martinez, A.-M., Veyssi re, G., & Martinez, A. (2003). SF-1 a key player

- in the development and differentiation of steroidogenic tissues. *Nuclear Receptor*, *1*(1), 8. <https://doi.org/10.1186/1478-1336-1-8>
- Val, P., Martinez-Barbera, J.-P., & Swain, A. (2007). Adrenal development is initiated by Cited2 and Wt1 through modulation of Sf-1 dosage. *Development*, *134*(12), 2349–2358. <https://doi.org/10.1242/dev.004390>
- Vidal, V. P. I., Chaboissier, M.-C., & Schedl, A. (2002). Le gène sox9 induit la formation de testicules chez des souris transgéniques de génotype XX. *Médecine/Sciences*, *18*(2), 149–151. <https://doi.org/10.1051/medsci/2002182149>
- Vidal, V., Sacco, S., Rocha, A. S., da Silva, F., Panzolini, C., Dumontet, T., ... Schedl, A. (2016). The adrenal capsule is a signaling center controlling cell renewal and zonation through Rspo3. *Genes & Development*, *30*(12), 1389–1394. <https://doi.org/10.1101/gad.277756.116>
- Walczak, E. M., & Hammer, G. D. (2015). Regulation of the adrenocortical stem cell niche: implications for disease. *Nature Reviews Endocrinology*, *11*(1), 14–28. <https://doi.org/10.1038/nrendo.2014.166>
- Welbourn, R. B. (1991). *The history of endocrine surgery*. *Medical History* (Vol. 35). Cambridge University Press. <https://doi.org/10.1017/S0025727300054454>
- Wilhelm, D., & Englert, C. (2002). The Wilms tumor suppressor WT1 regulates early gonad development by activation of Sf1. *Genes & Development*, *16*(14), 1839–1851. <https://doi.org/10.1101/gad.220102>
- Wilhelm, D., Yang, J. X., & Thomas, P. (2013). Mammalian Sex Determination and Gonad Development. In *Current topics in developmental biology* (Vol. 106, pp. 89–121). <https://doi.org/10.1016/B978-0-12-416021-7.00003-1>
- Xanthakis, V., & Vasan, R. S. (2013). Aldosterone and the risk of hypertension. *Current Hypertension Reports*, *15*(2), 102–107. <https://doi.org/10.1007/s11906-013-0330-y>
- Xing, Y., Lerario, A. M., Rainey, W., & Hammer, G. D. (2015). Development of adrenal cortex zonation. *Endocrinology and Metabolism Clinics of North America*, *44*(2), 243–

274. <https://doi.org/10.1016/j.ecl.2015.02.001>

Yamazaki, H. (2014). *Fifty years of cytochrome P450 research*.

Zheng, S., Cherniack, A. D., Dewal, N., Moffitt, R. A., Danilova, L., Murray, B. A., ... Verhaak, R. G. W. (2016). Comprehensive Pan-Genomic Characterization of Adrenocortical Carcinoma. *Cancer Cell*, 29(5), 723–736.
<https://doi.org/10.1016/j.ccell.2016.04.002>

Zilbermint, M., & Stratakis, C. A. (2015). Protein kinase A defects and cortisol-producing adrenal tumors. *Current Opinion in Endocrinology, Diabetes, and Obesity*, 22(3), 157–162. <https://doi.org/10.1097/MED.0000000000000149>

Zubair, M., Ishihara, S., Oka, S., Okumura, K., & Morohashi, K. -i. (2006). Two-Step Regulation of Ad4BP/SF-1 Gene Transcription during Fetal Adrenal Development: Initiation by a Hox-Pbx1-Prep1 Complex and Maintenance via Autoregulation by Ad4BP/SF-1. *Molecular and Cellular Biology*, 26(11), 4111–4121.
<https://doi.org/10.1128/MCB.00222-06>

Zubair, M., Oka, S., Parker, K. L., & Morohashi, K. (2009). Transgenic Expression of *Ad4BP/SF-1* in Fetal Adrenal Progenitor Cells Leads to Ectopic Adrenal Formation. *Molecular Endocrinology*, 23(10), 1657–1667. <https://doi.org/10.1210/me.2009-0055>

Acknowledgements

My very first acknowledgement goes to Andreas Schedl, my supervisor and mentor during the past three years. Andreas gave me the space to grow as a researcher and involved me in many aspect of the team, always giving me new opportunities to expand my knowledge and area of expertise and constantly getting me out of my comfort zone. Thank you for caring so much about your team, to push us to give the most of ourselves and to always involve us within the team and network. Your passion and enthusiasm for science are a great inspiration to all of us within your team and beyond.

To the Schedl team, thank you for your constant supports rather it has been technical, scientific or personal. More personally, Fariba and Valerie, your passion and dedication to science are such an example for any member of the lab to follow. You are never counting your time and effort and are always ready to help everyone around. Thank you for great scientific and non-scientific discussion throughout the years. Filippo, your generosity is limitless. Thank you for your constant help, your curiosity and thinking outside of the box always finding crazy new ideas for my project as well as for challenging me and questioning everything. Rodanthi, thank you for joining the adrenal team and making me feel less lonely around all the kidney people and thank you for your scientific and moral support. Fabio, thank you for showing me the way to follow and for your challenging scientific questions. To Bastien and Bryan, thank you for your energy and enthusiasm to learn science and without forgetting your very precious help in the experiments. You both made student supervision an enjoyable experience and gave me the opportunity to share my knowledge, which has been a really valuable part of my PhD.

I would like to greatly thank my co-supervisor, Marie-Christine Chaboissier, for always being available for advices on my projects, for your involvement, feedbacks and giving me new sexy perspectives.

I am really grateful for the support of Marie-Christine's team, for their encouragement, help and feedback, having a second team to work with has been a privilege.

I would like to deeply acknowledge Antoine Martinez for his support during my thesis, for showing interest and sharing his valuable knowledge with us as well as Kay Wagner for his insightful suggestions.

I would also like to thank all the jury members for accepting my invitation and taking the time to review my thesis.

To the Collombat and Studer team, thank you for all the enjoyable time in between science, for the lunch discussion, beer sessions and scientific help. I would like to more personally thank Serena for welcoming me to the lab since my very first day and for becoming a great friend as we went through the PhD together, as well as for moral support especially as we attended all the fascinating classes. I am also very grateful to Josipa for becoming one of my closest friends and for the unconditional support you have shown me the past two years. Your friendship means a lot and has definitely made a difference in my daily life.

Merci à Marjorie et Aurélie ainsi qu'au reste de l'équipe animalerie, pour avoir pris soin de mes souris au quotidien et d'avoir été des personnes de confiance avec qui travailler et sur qui s'appuyer. Merci à Agnes, Samah, Simon et Magali, pour leur soutien technique ainsi que leur investissement dans nos projets.

A ma famille et mes amis, merci pour votre soutien et votre amour, pour m'avoir toujours laissé la possibilité de suivre la voie que je voulais et pour m'avoir données les opportunités de suivre le parcours qui m'a amené ici aujourd'hui. Une petite note pour Aurélie pour m'avoir montré la voie du doctorat.

Jean, whatever I write will be an understatement. You have been my strongest support for the past three years. Thank you for believing in me more than I could, at times, believe in myself and for providing me with the healthiest environment to grow and evolve. You make everything easier and doing this life with you is more than I could have ever hope for. I cannot wait to share with you every bit of what the future is holding for us.

This thesis is dedicated to my beloved grandfather, education had a very strong meaning to him and I can only start to imagine how proud he would be today. He was the bravest, most tolerant and determined person I know and always set up a great example of determination for us to follow. This thesis is for him, the amount of work, effort and determination; I would not have had it if it weren't in my genes and education.