



HAL
open science

Non Thermal Plasmas interacting with surfaces at elevated pressures

Olivier Guaitella

► **To cite this version:**

Olivier Guaitella. Non Thermal Plasmas interacting with surfaces at elevated pressures. Plasma Physics [physics.plasm-ph]. Sorbonne Université, 2018. tel-03016746

HAL Id: tel-03016746

<https://theses.hal.science/tel-03016746>

Submitted on 20 Nov 2020

HAL is a multi-disciplinary open access archive for the deposit and dissemination of scientific research documents, whether they are published or not. The documents may come from teaching and research institutions in France or abroad, or from public or private research centers.

L'archive ouverte pluridisciplinaire **HAL**, est destinée au dépôt et à la diffusion de documents scientifiques de niveau recherche, publiés ou non, émanant des établissements d'enseignement et de recherche français ou étrangers, des laboratoires publics ou privés.



HABILITATION A DIRIGER DES RECHERCHES

Spécialité: Physique
Mention: Physique des Plasmas

Non Thermal Plasmas interacting with surfaces at elevated pressures

Olivier GUAITELLA

*Laboratoire de Physique des Plasmas
présentée le 4 Juillet 2018 à l'Ecole Polytechnique*

Pr Gilles CARTRY	Rapporteur
Pr Timo GANS	Rapporteur
Pr Bill GRAHAM	Examineur
Pr Gérard HENRION	Rapporteur
Pr Dominique VERNHET	Présidente



Contents

1. Introduction: the Non Thermal Plasma boundaries	1
2. Research strategy	2
2.1. General orientations	2
2.2. Indoor air treatment	6
2.2.1. Context of indoor air treatment with plasma/catalysis	6
2.2.2. Methodology and summary of the work done on air treatment	8
2.3. Atmospheric pressure plasma jets (APPJ)	10
2.4. Plasma conversion of CO ₂	13
2.4.1. CO ₂ recycling: a major societal challenge	13
2.4.2. Motivations for using mid-range pressure non thermal plasmas (MP-NTP) to dissociate CO ₂	15
3. Main scientific results	18
3.1. Investigating atoms reactivity on surfaces	18
3.1.1. Usual description of radical reactions on surfaces	18
3.1.2. Experimental approach	21
3.1.3. Molecule formation with chemisorbed O atoms	22
3.1.4. Role of chemisorbed atoms in O atom recombination	24
3.1.5. Role of weakly bonded atoms in molecule formation on complex surfaces	25
3.1.6. Recombination into O ₂ with weakly bonded atoms	27
3.2. Vibrational kinetic and surfaces	29
3.2.1. Vibrational de-excitation at the wall: example of N ₂ ^{v*}	30
3.2.2. CO ₂ vibrational kinetic	31
3.2.3. first measurements with specific materials	37
3.3. Ionization waves interaction with surfaces	38
3.3.1. Characterization of the APPJ freely expanding	39
3.3.2. APPJ above surfaces	43
3.3.3. Measures on dielectric surfaces with Mueller polarimetry	44
4. Conclusions and perspectives	48
References	51
A. Supervision, teaching and curriculum vitae	63

1. Introduction: the Non Thermal Plasma boundaries

In 1927 Irving Langmuir introduced for the first time the term "*plasma*" to describe the way an electrified fluid carries electrons and ions. As such one can consider him as the first "*plasma physicist*". Langmuir became a pioneer of plasma physics together with his colleague Lewi Tonks while investigating how to increase the life time of tungsten-filaments light bulbs. While doing so, they established the first description of *plasma sheath* which later on will have huge development for plasma processing technique especially for manufacturing integrated circuits. This is a good illustration that from its very early age, the physics of Non Thermal Plasmas (NTP) develops in close connection with industrial applications. It also shows that studying NTP almost always requires to take into account the surfaces in contact with the plasma (the sheath forming on the tungsten filament in the case of Langmuir).

Non Thermal Plasmas (NTP) are versatile energy converters, transforming electrical energy into either radiation, heating or chemical energy. The non equilibrium nature of NTP is the key for tuning the way the energy is transformed by adjusting simple parameters such as the reactor design, the gas mixture or the power source for instance. Based on this property many industrial applications have taken advantage of the production of highly reactive species with a limited energetic cost thanks to the minimization of gas heating. As a result, the field of NTP physics is strongly driven by applications and it is very common to define the research activity of plasma physicists through their industrial objectives. However the physics underlying their work is often transverse to many different technologies.

Furthermore the fundamental questions addressed while studying NTP are often essentially multidisciplinary, involving atomic and molecular physics, condensed matter, spectroscopy, quantum mechanics, chemistry, statistical physics, thermodynamics, fluid dynamics, etc... The richness of Non Thermal Plasma Physics lies in the coupling of numerous phenomena. The flexibility of NTP for various industrial processes comes from the combined effect of strong electric field, temperature, photons, charged particles, radicals and excited molecules, most of the time in interactions with surfaces. This strong multi-physic/chemistry coupling is a gift and a curse, that opens many opportunities but makes the understanding of fundamental mechanisms very challenging in a "real" system. Most of the time an accurate description of such complex multi physics system is still beyond our current computing and experimental capabilities. Therefore the plasma physicist always needs to find a delicate balance: investigating fundamental mechanisms with simplified system while keeping the horizon of engineering. In turn the development of "real" systems often reveals new fields of research.

Besides the variety of possible industrial processes based on NTP technologies, the diversity of mechanisms induced by NTP is also leading many different scientific communities such as biologist, chemists, solid state physicists or planetologists to use NTP in their field of research. This is a chance to expand the science of plasma physics but the risk is that plasma is used only as a tool, more or less treated as

a black box without any real understanding. To prevent the pitfall of NTP physics disappearing in other scientific fields, as well as for learning good practice of other fields for which plasmas are useful, close collaborations with other communities is an absolute necessity. As a researcher in experimental plasma physics, I therefore try to combine three component in my research strategy:

- seek for innovative industrial processes based on NTP technologies and be aware of the engineering constraints associated to them
- be curious of other fields of science where NTP can be of interest
- Always focus on fundamentals of plasma physics even through the two first items

Since my PhD defense in november 2006, these three goals are underlying my whole research.

2. Research strategy

2.1. General orientations

The common thread of all my work is the plasma/surface interaction at medium and high pressure (from 1 to 1000 mbar). Most of the studies carried out on plasma/surface interaction have been done at pressure below 0.1 mbar with the motivation of material processing. Our work on the contrary has initially been motivated by atmospheric pressure plasmas. In keeping with my PhD work, our motivation was at first plasma/catalyst coupling for indoor air treatment.

About 20 years ago, it was commonly believed that surfaces had only minor influence on plasma development at atmospheric pressure because of the very short life time of ions and radicals. However plasma/catalyst coupling implies the use filamentary discharges developing in direct contact with high specific surface materials. It is now clear that plasma is capable not only to induce chemistry on the catalyst, but also modifies the surface properties. The other way around, the catalyst can strongly affect the plasma dynamics. The work on indoor air treatment has been initiated at LPP by Antoine Rousseau in 2003 at the beginning of my PhD. Our work together on indoor air treatment has contributed to evidence some of the plasma/catalyst interaction mechanisms. The general principles of indoor air treatment by plasma are now well established in the community and reported in several review papers [59–64] including our own one [45]. This has allowed the development of devices for indoor air cleaning already on the market. If one would draw a "hype curve" [65] for applied research topic, indoor air cleaning by plasma would therefore be currently on the second rising slope. In spite of this level of technological maturity, the understanding of plasma/catalyst coupling is still very little predictive. For every new pollutant, or new surrounding atmosphere composition, new trial and error studies are needed to assess the appropriate catalyst combination and reactor design. The

field is therefore still progressing a lot with empirical approach because of the lack of deep understanding of fundamental mechanisms at stake. The gathering of large amount of data with various pollutant/catalyst/reactors can of course lead to the emergence of interesting processes. It is one path that we are also following in collaboration with a spin-off company, Air-Serenity funded by a former PhD student of the group (Joseph Youssef). However it is also clear that no real breakthrough can be achieved in plasma/catalysis without addressing several fundamental scientific questions separately.

In the first place, **the role of radicals in surface reaction**, especially on complex material surfaces has to be understood. This is a very challenging task and the originality of our approach consists in the utilization of a low pressure (1 mbar) dc discharge (a Pulsed Glow Discharge PGD) used in contact with "real" complex catalytic materials that are also studied in atmospheric pressure DBDs. The PGDs make it possible to use numerous diagnostics to obtain a detailed characterization of the gas phase kinetics in contact or not with catalytic surfaces, during the plasma or in the post discharge. The data obtained are particularly interesting for the validation of 0D kinetic models, which in turn allow a better understanding of modifications induced by complex surfaces. We have initially applied this fruitful approach for the study of N_2/O_2 plasmas with Daniil Marinov (PhD 2009-2012) who is the first PhD I have formally co-supervised together with Antoine Rousseau. Our investigation were primarily devoted to the surface reactivity of N and O atoms. Later I have chosen to adapt this approach for investigating CO_2 conversion by plasma, and concomitantly pure O_2 plasmas in collaboration with Jean-Paul Booth (see below).

Obviously surface reactivity under plasma exposure can not be understood without a good understanding of **the gas phase kinetics interacting with the surface**. A significant part of our work is therefore dedicated to gas phase plasma kinetics. I have developed a strong collaboration since 2009 with Pr Carlos Pintassilgo and Pr Vasco Guerra from IST in Portugal to model both gas phase and surface kinetics and compare these models to our measurements. The gas temperature (T_g) is a crucial parameter for gas phase kinetics because of its direct influence on rate coefficient of chemical reactions, but also because of its consequences on the value of reduced electric field (E/N) via the change of gas density. **The development of various techniques to accurately measure T_g in molecular gases plasmas in different pressure range has become a constant concern of my work.**

For reasons that will be explained in section 2.2, in the case of indoor air treatment, the reactivity of radicals on surfaces is certainly more relevant to investigate than ions or excited molecules reactivity. However over the last 5 years, a new possible application of NTP has emerged with the recycling of CO_2 . NTP could be the most efficient way to convert CO_2 molecules in other added value molecules by taking advantage of vibrational excitation. Plasma/catalyst coupling has still a key

role to play in this field but with a completely different challenge since the molecules to be converted are not any more very diluted. It becomes therefore essential to understand **the role of vibrationally excited molecules on surface reactions**.

A very large part of the energy deposited in a NTP ignited in a molecular gas is transferred to vibrational excitation. Indeed the typical energy threshold of vibrational excitation often matches the average electron energy. Despite this well-known fact, the vibrational kinetics of many molecules in plasma is still poorly understood, and the interaction of these excited molecules with surfaces is even less so. This is especially true for CO₂ despite all the work done for CO₂ lasers because of the complexity of energy transfer mechanisms between the three vibrational modes of this molecule. A very large research plan is now opened on this topic, starting from a **detailed description of vibrational kinetic of CO₂ containing plasma, their interaction with surfaces, and the possible use of excited molecule in catalytic reactions**.

Another unexplored question in plasma/Catalysis is the impact on catalytic reactions of surface electric field and charge deposited by plasma. The adsorption energy of reactive species could be strongly affected by the intense electric field (several tens of kV/cm) induced by ionization waves, and therefore their reactivity could be considerably modified. In a broader perspective, the interaction of ionization waves with surfaces is the key for many applications such as surface treatment or biomedical applications but it remains poorly understood. In spite of the experimental work from Allen in the 70s [66, 67] or more recently the modelling work from Babaeva or Pechereau et al [68, 69], direct measurements on targets under filamentary plasma exposure are too scarce. Therefore we have initiated a long term project dedicated to the interaction of ionization waves and dielectric surfaces with a special focus on surface electric field and deposited charge determination. This research has started during the post-doc of Ana Sobota at LPP in 2013 which turned now into a collaboration since her nomination as associate professor at TU/e. The measurement of electric field in atmospheric pressure filamentary plasma is very challenging. Atmospheric pressure plasma jets (APPJ) in noble gases excited with kHz range power supply are the most reproducible source of ionization waves. Therefore as a first step, we are developing **advanced diagnostic techniques to study APPJ impacting surfaces** as a model of filamentary discharge interaction with targets.

The development of advanced diagnostics, for ionizations waves development, gas temperature determination or *in situ* time resolved kinetic studies is a recurrent part of my work as an experimentalist. A summary of different diagnostic techniques I have been using with their main characteristics is given in appendix ??.

To summarize, my research activity was at first dedicated to plasma/catalyst coupling for indoor air treatment. It has now evolved in two main axes: (i) the propagation mechanisms of atmospheric pressure plasma jet on surfaces, and (ii) the

conversion of CO₂ by plasma. These two main themes can be subdivided into the following topics:

1. fundamentals of plasma/catalyst interaction (5 articles)
2. ionization waves interaction with targets (13 articles)
3. molecule formation and atom recombination on dielectric (9 articles)
4. gas phase kinetic and gas heating mechanisms (10 articles)
5. kinetics of vibrationally excited molecules and interaction with surfaces (3 articles)

the number of article corresponds to the papers I am one of the co-author published for each topic after my PhD defense (after 2006). A very complex case of plasma/surface interaction is that of plasma in contact with liquids. Even if this has not been the core of my research, this is a side topic on which I have also been working (6 articles since 2010) and that could have future development for CO₂ conversion (see section 2.4)

My list of publication can be found in the first 55 references of the bibliography. After my PhD, I have been strongly involved in the work of 5 PhD without being official supervisor (2 of them during my one year secondment at TU/e in 2014). I have been formally co-supervisor of 2 PhD who already graduated, and I am currently co-supervisor of 4 PhD students. I have been also working with 4 post-docs and I supervised more than 20 master students.

In sections 2.2, 2.3 and 2.4, the context of the three main fields of application of my research (indoor air treatment, APPJ and CO₂ conversion) is briefly described. The general strategy chosen for each topic, as well as quantitative data concerning the funding obtained, the related published work, and the students with whom I have been working are presented. However, the main scientific results will only be presented in section 3, articulating them around 3 axes: the surface reactivity of O atoms (section 3.1), the influence of surfaces on vibrational excitation of N₂ and CO₂ (section 3.2), and finally the development of a helium plasma jet above, and on surfaces (section 3.3).

2.2. Indoor air treatment

"The smallest alteration in atmospheric constitution, in which we are condemned to live, leads to a disorder in our functions and can become the seed of our diseases."

François-Vincent Raspail, Health Manual Directory, 1894

recent fundings as PI:

AirClean project: ASTRE financial support from Essonnes (2013-2016), 80k€

co-supervisor of PhD students:

Daniil Marinov (PhD, 2009-2012), Christelle Barakat (PhD, 2011-2014)

other co-workers PhD students and post-docs:

Joseph Youssef (PhD, 2007-2010), Binjie Dong (Post-doc 2011-2012), Paul Gravejat (Post-doc 2012), Eugenio Fasci (Post-doc 2012)

2.2.1. Context of indoor air treatment with plasma/catalysis

New energy-saving standards promote the construction of buildings that are better thermally insulated. The renewal of indoor air is then limited. As a result various toxic compounds are accumulating in the indoor air. In particular the concentration of Volatile Organic Compound (VOCs) released by various sources, paintings, furnitures, carpets, etc... is increasing in our new living spaces. We spend on average 80% of our time being exposed to this pollution in confined spaces. The typical concentration of indoor air pollutants (most of the time below ppm range) could seem very low and benign. However as we are exposed to these pollutants everyday, it is now undeniable that the effect of these pollutants on long term is harmful to our health. The technological challenge is therefore to invent a way to remove very diluted molecules from air with a low energy cost.

Non thermal plasmas allow to achieve significant abatement of VOCs without loosing energy in gas heating. In addition NTP offer the possibility to switch on and off the treatment instantaneously depending on the level of pollution to treat. Plasma technologies are not only trapping the VOCs but they are converting them into CO₂ and H₂O by oxidative mechanisms. However the oxidation of VOCs by NTP in air leads to the production of undesired by-products that are difficult to control. The selectivity of VOC oxidation into CO₂ and H₂O has therefore been the first motivation for coupling plasma with catalytic materials already back to the 1990's [70–74]. Dielectric Barrier Discharges (DBD) quickly became the most used plasma source for indoor air treatment because of their simplicity, low cost, safety, and also because they offer the easiest way to place a catalyst in direct contact with the plasma with the so called "packed bed" reactor configuration.

The coupling between a plasma and a catalyst can be achieved in different ways: the catalyst can be placed inside the plasma (*in situ* coupling IP) or after the plasma zone (post-discharge coupling PC). In PC only stable molecules, meaning mostly O₃

can reach the surface of the catalyst while in IC configuration, the short life species can also interact with the catalytic surface. Therefore the IC seems *a priori* to provide more reaction pathways to remove VOC's but the overall energy efficiency of the system is not necessarily higher than with PC. Moreover when using a DBD in air at atmospheric pressure, considerable amount of O_3 are produced (ozone production is the first use of DBD by Siemens already in 1857 [75]) and can not be released in the breathable air. Therefore even an efficient IC configuration requires a catalyst downstream the reactor to convert the left over of O_3 back to O_2 . Instead of being a problem, the surface dissociation of O_3 can be beneficial for oxidizing further the VOCs coming out of the plasma reactor.

The catalytic material for indoor air treatment by plasma has therefore multiple utilities: it promotes the oxidation of the VOCs activated by the plasma and it removes the O_3 from the exhaust, but its main purpose is in fact to increase the probability for the VOCs molecules to encounter an oxidizing specie.

Indeed the low concentration of the molecules to be treated makes very improbable the dissociation of VOCs by direct electron impact, or even by reactions with ions. Radicals such as O atoms or OH have a longer life time and a very high reactivity that makes their interaction with the VOCs more feasible. However even these radicals have a much higher chance to recombine into O_3 or H_2O than reacting with the targeted VOCs. A decisive advantage of using a catalyst is therefore, above all, to achieve surface densities of pollutants that are sufficiently high inside the plasma region in order to increase the likelihood of reactions with the radicals produced by plasma. With appropriate materials, the radicals themselves can be adsorbed and their life time on the surface increased, promoting also a higher reactivity towards VOCs. The material in contact with the plasma for air treatment must then be a good adsorbent of VOCs in the first place, but also preferably of O and OH radicals. Until now only the catalytic material used in regular thermal catalysis are used with plasmas but these catalysts are designed to reduce the energy barrier of a given reaction by producing a reactive specie on the surface. A plasma is already producing very reactive species, making the main action of usual catalyst at best redundant, or completely useless. Catalytic materials really dedicated to the synergy with a plasma still need to be invented.

Moreover a catalyst aims at reducing the activation energy of a reaction which partly depends on the adsorption energy of the reactant. However the adsorption energy as well as the surface mobility of adsorbed species could be significantly affected by the surface electric field induced under plasma exposure. Surface electric field might therefore significantly change the surface reaction pathways. The possible effect of charge deposition and surface electric field in adsorption processes and reactivity is completely unknown and only very recent work starts considering it in modelling [64,76]. On one hand the work we have done on air treatment aimed at investigating the best approach to achieve high energy efficiency in realistic conditions of air treatment from a process point of view. On the other hand several experiments far from air treatment conditions are still currently being developed to start clearing

the complex plasma/catalyst interaction mechanisms and the possible role of surface electric field.

2.2.2. Methodology and summary of the work done on air treatment

The lack of fundamental understanding of plasma/catalyst interaction is still too great to clearly define the characteristics of a material that would be truly optimized to use the reactive species produced in a plasma. Nevertheless very promising results can already be obtained with commercially available catalysts. From an application point of view, in addition to the energy cost of the treatment, the diversity of pollutants to be treated is an important issue to take into account. Since 2007, these two observations have led us to follow two complementary approaches in parallel: a) a more application oriented strategy in collaboration with two companies ([Al-Ko Therm](#) in Germany and [Air Serenity](#) which is a spin off funded by a previous PhD student of the group, Joseph Youssef), and b) the study of surface reactivity of radicals and the measurement of surface electric field induced on dielectric.

Towards an optimal process for VOC abatement with plasma

From a process point of view, The PhD work of Christelle Barakat (that I have co-supervised with Antoine Rousseau) in collaboration with Al-Ko therm has completely changed our approach for air treatment. This work has evidenced the gain of energy efficiency when using a "sequential method". The idea is to have a two steps process with first the trapping of the pollutant on an adsorbent material like in a normal filter, and then a regeneration phase of the surface by plasma. Filters have usually a limited efficiency due to the saturation of the surface for a given compounds, and the competitive adsorption of several molecules that results in release of pollutants in the gas phase. These problems can be avoided if the surface coverage by the pollutants is always kept significantly lower than the saturation level, letting enough free adsorption sites for capturing completely the flow of pollutants. This can be done by adjusting the frequency of regeneration phases according to the pollution level. The energy consumption is then optimal because the plasma is switched on only when the surface coverage requires it, and the filter keeps the efficiency of a new one at any time.

We have initially validated the concept of plasma regeneration of adsorbent materials on simple test molecules (isopropanol, acetone [39, 45]). The sequential method has been transferred to Al-Ko Therm and the air treatment unit from Air Serenity are also based on this idea.

Most of the publications devoted to air treatment by plasma are using relatively high pollutant concentration (typically 10-1000ppm). This is due to the difficulties related to control and measurement of very low concentrations (1-100 ppb) which would be more realistic for indoor air pollution conditions. An important part of our work has focussed on lowering down the detection limit of pollutants and products measurements to assess the efficiency of our plasma reactor in realistic conditions

to remains below toxicity threshold. As an example the careful design of gas lines installed with Paul Gravejat during his post-doc allowed us to go down to a detection limit of 10 ppb of CO₂ by FTIR with a 10m gas cell. Along the same line, an ANR project Apolin'R ended in 2013 was dedicated to the detection of formaldehyde and formic acid (two markers of the degradation of numerous VOCs in air) with a detection limit at 100 ppt! This has been done with a platform of optical feed back cavity enhanced spectroscopy (OF-CEAS) running with a diode at 1769 cm⁻¹ developed by Daniele Romanini in Grenoble and that we have used at LPP during the post-doc of Eugenio Fasci [77].

The variety of pollutants depending on the pollution sources imposes the use of different adsorbing materials. An efficient treatment unit combine several catalysts/adsorbents. The efficiency of surface regeneration for systems mixing several catalysts exposed to a mixture VOCs become quickly impossible to predict. Therefore the collaboration with Air Serenity is still ongoing to adapt the composition of each plasma/catalyst cartridge to the typical pollutant mixtures targeted (motivation of the funding obtained from Essonnes, ASTRE project "Air-clean"). This project is still using commercial catalysts which are not necessarily the most adapted for a synergistic effect with plasma.

Until now there are no catalytic material specially designed for being used in plasma, simply because no one knows what should really do an efficient catalyst under plasma exposure. This is why in parallel to the "Air-Clean" project, we have pursued a more fundamental method to investigate what happens directly on the catalytic surface.

Investigating surface mechanisms under plasma exposure

the sequential approach described above (pollutants adsorption on the catalyst followed by plasma regeneration of the surface) is very beneficial from a process point of view, but it is also convenient for fundamental studies. Indeed the adsorption phase allows to determine quantitatively the amount of molecules adsorbed on the surface before following their oxidation under plasma by simply measuring a breakthrough curve. The oxidation products generated during the plasma regeneration phase can then be quantified in the exhaust. The originality of the work we carried out (Christelle Barakat's thesis and post-doc by Paul Gravejat) consisted in measuring directly on the surface the species adsorbed by infrared spectroscopy. As an example of this experimental method, the oxidation of isopropanol (IPA) has been monitored on a surface of TiO₂ [39]. The use of infrared absorption through surfaces directly under plasma exposure gives valuable information but one should never forget that species detected are mostly the ones accumulating on the surface. Therefore they are often species poisoning the surface and not the most reactive intermediary species. Nevertheless one of the key result obtained in [39] has confirmed the key role of O atoms in VOCs abatement on catalytic surfaces, as we had already suggested in previous works [12,14]. A detailed investigation of recombination mechanisms and surface reactivity of radicals on complex surfaces was therefore an obvious necessity, however

difficult to perform at atmospheric pressure. This motivated a series of successful experiments in a pulsed DC discharge at reduced pressure (few mbar), the main results of which will be described in section 3. As interesting as these results obtained at lower pressure are, they do not allow a direct understanding of the development filamentary discharges interacting with surfaces. I chose to address this topic by studying the simplest source of ionization wave: the atmospheric pressure plasma jets.

2.3. Atmospheric pressure plasma jets (APPJ)

In the midst of the rushing waters it happened that, when there was a hurricane, suddenly a divine lantern was seen shining at the masthead, and as soon as that miraculous light appeared the danger was appeased.

About St Elmo's fires, Admiral Zheng He in 15th-century Ming China

recent fundings as PI:

PhD grant from "Chaire Energie Durable from EDF-Ecole Polytechnique, 120 k€
ETINCELLES: equipment project Plas@par LabeX 40k€

PhD students and post-docs:

Elmar Slikboer (PhD, 2015-2018), Ana Sobota (Post-doc 2013)

A major trend in our community over the last 20 years has been the considerable increase in applications of cold plasma at atmospheric pressure (see figure 1).

The air treatment described above is just one example of the many ideas that have been explored. Although microwave, glidarc, RF discharges are studied, in the vast majority of cases, cold plasmas generated at atmospheric pressure are corona or Dielectric Barrier Discharges (DBD) because of their simplicity of use.

A DBD ignited in air, CO₂ or any molecular gases will most of the time develop into a filamentary regime corresponding to the ignition of multiple discharges growing through "streamer" breakdown mechanism (or "ionization waves").

These streamers are occurring randomly in time and space, lasting only a few nanoseconds, and having a typical diameter of few hundreds microns. Their interaction with complex surfaces is therefore extremely challenging to study and papers addressing this issue

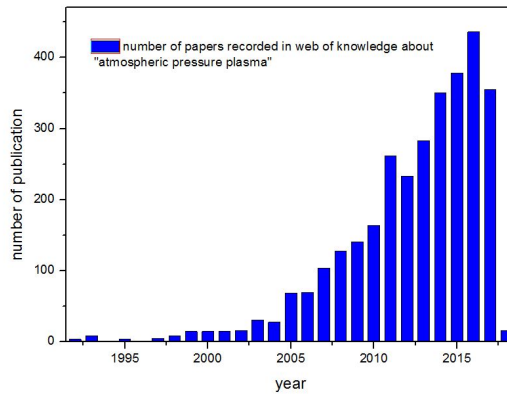

Fig. 1 – number of publication recorded per year on *Isi* web of knowledge about the topic "atmospheric pressure plasma"

are rare as it can be seen from the recent and extensive review on DBDs from R. Brandenburg [78]. The plasma filaments are often used to modify material surfaces but it is evident that in turn, the properties of material to be treated are strongly affecting the plasma dynamic as well. However beyond this general statement, the mechanisms at stake in the interaction between an ionization wave and surfaces are still poorly understood. The best fluid models describing streamer development often treat the surface only with a dielectric constant and an effective secondary electron emission coefficient. **The nature, the life time and the mobility of charge adsorbed on dielectric material, the modification of gas dynamic above a target, the potential re-distribution induced above a floating conductive target, the role of micro and nano-porosity of the material are just a few examples of the many questions that remain unanswered to date.**

Obviously, the study of plasma/surface interaction requires not only characterizing the effects induced in the treated material with surface diagnostics, but also simultaneously the properties of the plasma in contact with the surface. In order to investigate fundamental properties of ionization waves and obtain basic parameters such as electric field (E_{field}), electron density (n_e), electron temperature (T_e) or gas temperature (T_g), compromises need to be done.

It is possible to force the ignition of a streamer at a given time and a given place by using a pin to pin geometry with a fast rise time of the applied voltage. This approach provides very reproducible streamers that allow for signal accumulation as it is necessary for cross correlation spectroscopy for instance [78–80]. This method is very interesting and provides with a very high time resolution (tens of *ps*) the evolution of electric field and charge density. It is a technique based on emission of excited states and therefore the absolute values obtained rely on the accuracy of the kinetic model used for describing the population of excited states considered. However the pin to pin configuration is a strong constraint that do not allow for studying the interaction between streamers, or the development over complex surfaces.

Another possibility to generate reproducible ionization waves is to use atmospheric pressure plasma jets (APPJ). These plasma sources have become the subject of intense research activity over the last 10 years due to their potential for biomedical applications [81] or the treatment of surfaces, such as polymers, which are temperature sensitive [82, 83]. The name "APPJ" correspond in the literature to many different types of plasmas from corona to microwave, or radiofrequency discharges [84]. However one of the most common source of APPJ are DBDs powered with sinusoidal or pulsed voltage in the kHz frequency range, with the feed gas flowing inside a capillary tube (in the following APPJ will refer only to this configuration). Using this configuration with a flow of noble gas, very reproducible ionization waves can be generated over several *cm* or even tens of *cm* in a tube of few *mm* in diameter. The role of the capillary tube is to keep a charge density high enough for developing the discharge through a streamer mechanism over long distance away from the electrodes. These APPJ are cheap and their reproducibility allow to implement feedback loop to control their effect on a target [85]. As a consequence an abundant literature

is dealing with their application in various fields but our interest for these sources has not been focus on applications.

We have started to use these APPJ in 2013 in collaboration with Ana Sobota (TU/e), as a model for detailed study of ionization waves and their interaction with various surfaces. APPJ generate ionization waves with longer time scale, larger dimension, and much higher stability than any streamer in molecular gas. They can easily be applied on any targets, dielectric, metallic, liquid etc... They are reproducible even when ignited with a low frequency sinusoidal voltage, meaning that no over-voltage is required to study them in a stable regime. Our approach is therefore to take advantage of these APPJ to perform complementary diagnostic techniques providing E_{field}, n_e, T_e, T_g to compare these data with results of fluid models describing the growth of ionization waves. The necessary use of noble gases however implies that gas mixing at the output of the capillary tube plays a major role in the discharge development, and this additional difficulty needs to be addressed.

During the first years of this project we have been developing diagnostic techniques that are now giving interesting results as it will be shown in section 3.3. In addition to the commonly used iCCD fast imaging and Schlieren imaging, we have been measuring the maximum of E_{field} along the plasma jet propagation with Stark polarization spectroscopy [51, 53] and in the surrounding with a commercial probe based on pockels effect. The n_e and T_e are obtained by Thomson scattering and the gas temperature with optical probe. All these methods are applied in the jet expanding freely in surrounding atmosphere but also above dielectric, metallic or liquid targets. The effect induced on target is also monitored directly with Mueller polarimetry which allow the measurement of E_{field} induced in the target by deposited charge by using the Pockels effect [38, 50, 52] but also other effect such as surface temperature (T_{surf}) [56] or etching depth. We are entering the most exciting part of the project since all these complementary measurements can now be performed in various gas mixture and above complex surfaces (polymers, dielectric with controlled patterns, biological tissues, etc...) and finally be compared with fluid models as it will be discussed in section 3.3.

The electric field in the front of an ionization wave is usually very high (up to several tens of kV/cm) which can be beneficial when seeking to promote the dissociation of molecules by direct electronic impact. However for some applications in molecular gases it is more interesting to keep lower electron energy and take advantage of the natural tendency of NTP to store energy in vibrational excitation of molecules. This has motivated a completely different project devoted to the recycling of CO_2 by plasma, and more specifically the vibrational kinetic of CO_2 , and the plasma/catalyst coupling at reduced pressure.

2.4. Plasma conversion of CO₂

A great deal has been written on the influence of the absorption of the atmosphere upon the climate. Fourier maintained that the atmosphere acts like the glass of a hothouse, because it lets through the light rays of the sun but retains the dark rays from the ground. The selective absorption of the atmosphere is according to the researches of Tyndall, Lecher and Pernter, Röntgen, Heine, Langley, Ångström, Paschen, and others, of a wholly different kind. It is not exerted by the chief mass of the air, but in a high degree by aqueous vapour and carbonic acid, which are present in the air in small quantities.

Arrhenius, philosophical magazine and journal of science, 1896

recent fundings as PI:

SYCAMORE: ANR Jeune Chercheur (2016-2020), équipement 130 k€ and 1 PhD grant 120 k€

ValCO₂Plas: ANR Blanc lead by JM Tatibouet from IC2MP, PI for LPP, 38 k€ and 1 post-doc grant 18 months

SYCAMORE: Plas@par PhD grant 120 k€

OILSEED: équipement projects Plas@par LabeX 38k€ + 27k€

co-supervisor of PhD students

Ana-Sofia Morillo-Candas (PhD, 2016-2019), Marlous Hofmans (PhD 2017-2020), Polina Oglobina (PhDat IST Lisbon,2016-2020)

other co-workers PhD students and post-docs:

David Yap (Post-doc 2016-2017)

2.4.1. CO₂ recycling: a major societal challenge

Our society is currently relying mainly on fossil fuels that are responsible for a dramatic increase in carbon dioxide (CO₂) emissions. The link is undeniable between the increasing concentration of CO₂ in the atmosphere (which recently reached the historical mark of 400 ppm) and growing environmental problems, particularly climate change and ocean acidification. There is a consensus, illustrated by the agreement of the COP21 held in Paris in 2015, to admit the urgency to find sustainable solutions to either reduce the emission sources by developing alternative renewable energy sources, and to recycle the CO₂ that will still inevitably

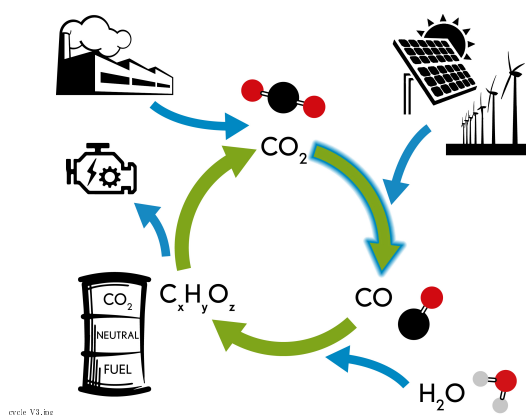

Fig. 2 – The ideal carbon cycle

be emitted. The European Commission, for instance, explicitly recognizes this mission in the 2020 Climate and Energy Package and in the EU2050 Roadmap [86]

The challenge is at an inconceivable scale: the values can change depending on the model but CO₂ emission are expected to increase from 34 GT/y nowadays to 50 GT/y in 2040 [87]. Not one single solution will solve this problem. The priority is to reduce the emissions by means of carbon-free energy sources. CO₂ capture is then the most advanced technology in terms of tons of CO₂ removed from the atmosphere. Even combining the performance of all CO₂ recycling technologies currently implemented, only about 0.4% of the CO₂ emitted is recycled. A full panel of sustainable solutions need then to be developed (only 4% of CO₂ recycling project are already at a commercial stage) to be able to choose the most suitable recycling technology for each CO₂ emission source. It also means that CO₂ emission is an almost infinite reservoir of carbon to be functionalized to build platform molecules for the chemical industry. The common issue to any recycling technique is the source of energy to be transferred to activate the CO₂ molecule.

Renewable energies powered by the sun including photovoltaic, concentrated solar or wind driven sources provides a partial solution to this challenge. However, the geographically and temporally ill-matched supply and demand characteristics as well as the absence of useful storage solutions cause significant problems. The energy storage into chemical energy is very efficient thanks to the high energy density of hydrocarbon-based chemical fuels (HBF) that could be methanol or ethanol. An attractive course of action is therefore the “power-to-gas” represented on figure 2, where the excess electrical power produced by solar or wind generators is used to convert CO₂ into hydrocarbon fuels, thus replacing fossil HBF by renewable HBF also called “solar-fuels”.

One significant advantage of this scheme is that, as the technology remains rooted on hydrocarbon fuel, it is possible to use the existing infrastructure for gas and oil storage, transport and distribution.

In the energy storage chain covering capture, conversion, separation and production of fuel, the weakest link is the conversion. CO₂ dissociation is the most difficult step. Indeed splitting CO₂ into CO and O is a strongly endothermic process, which makes it hardly efficient with conventional thermal and catalytic reaction techniques. Many technologies are currently investigated to circumvent the major obstacle of CO₂ dissociation (Bio-reforming, electrolysis, thermo-chemistry, catalysis...) [88]. Worldwide a lot of research focuses on photoelectro catalytic processes. Classic electrolysis reaches an energy efficiency of 70-80% [89], but makes use of precious metals as a catalyst, such as Platinum, which drives up cost. Avoiding scarce materials in alternative photo- and electro-catalytic schemes presents a challenge [90]. Solid Oxygen Electrolysis Cells based on layers of rare earth metal composites operate at high pressure and high temperature that remains an engineering challenge. Thermal dissociation based on heat generated with concentrated solar power by means of nano-structured metal oxides reaches an energy efficiency of less than 5%. Most

efficient metal oxides are based on rare earth metals such as Cerium.

Compared to other techniques, Non Thermal Plasmas are still studied very little for CO₂ dissociation. Yet NTP provide a unique way to break CO₂ molecule with the minimal energy of 5.5 eV corresponding to the bond energy C=O because of their non equilibrium nature. NTP are therefore very promising as the first step towards solar-fuels and/or platform molecules synthesis.

Having this context in mind, in 2014 I have spent one year in Eindhoven in the group of R. Engeln (TU/e) to work on CO₂ conversion in atmospheric pressure discharges. After this initial approach I have decided to develop a different but complementary strategy at LPP by using reduced pressure discharges coupled with catalyst. I obtained a funding from ANR on this topic and this project is now the core of a strong collaboration with TU/e (R. Engeln and A. Sobota) and IST Lisbon (V. Guerra).

2.4.2. Motivations for using mid-range pressure non thermal plasmas (MP-NTP) to dissociate CO₂

Non Thermal Plasma are a non equilibrium medium meaning that temperature of the electron (T_e), vibrational temperature of molecule (T_v) and temperature of the gas (T_g) can be very different. Depending on the plasma source used, the energy transferred to the gas can be concentrated mainly on CO₂ excitation processes while keeping T_g as low as possible. Hence, NTP provide an entirely different environment for chemical reactions as compared with the typical processes occurring under thermal equilibrium conditions.

CO₂ dissociation in a non-thermal plasma can proceed mainly through three mechanisms: direct electron impact dissociation (reaction 1), vibrational pumping (reaction 2) or reaction between excited CO₂ molecule and O atoms (reaction 3)

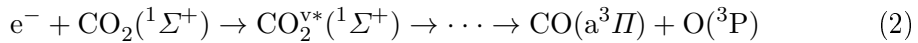
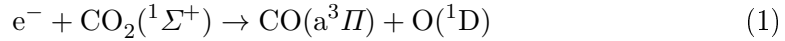

The direct electron impact (mechanism 1) is the result of few electrons having the highest energy. It is not the most energy efficient process because it produces an atomic oxygen in an excited state.

The vibrational pumping of CO₂ (mechanism 2) is the most efficient mechanism. It occurs when low energy electrons (T_e around 1 eV) excite the asymmetric stretching mode of the CO₂ molecule [91]. If the density of vibrationally excited molecules is high enough, the vibrational quanta can be pumped up to the dissociation limit during the relaxation process, due to non-resonant vibration-vibration energy exchanges similarly to what has been described in nitrogen [92]. In addition, the third mechanism 3 with O atoms could improve the efficiency of the dissociation

by reacting with CO₂^{v*}. It must be stressed here that vibrational excitation can also lower the energy threshold of direct electron impact dissociation as it has been shown for N₂ [93].

The contribution of O atoms can however also reduce the dissociation rate if the gas temperature is too high, because of the back reaction from CO to CO₂. **The control of O atoms recombination into O₂ or O₃ at low gas temperature is one of the key for an efficient CO₂ dissociation.**

The energy efficiency η for splitting CO₂ into CO and O is defined as the ratio of dissociation enthalpy and energy spent in the plasma per CO molecule produced.

$$\eta = \frac{\Delta H_{diss}}{E_{CO}} \quad (4)$$

The dissociation enthalpy $\Delta H_{diss} = 2.9eV$ correspond to the average of the dissociation enthalpy with reaction 2 ($\Delta H_2 = 5.5eV$) and the enthalpy of reaction 3 ($\Delta H_3 = 0.3eV$).

The feasibility of efficient plasma decomposition of CO₂ was first reported in the former USSR [91], with energy efficiencies of about 90% reported for non-equilibrium microwave plasmas at pressures in the range 50-200 Torr in supersonic flows [94]. Similar experiments recently performed at DIFFER institute in The Netherland attempt to reproduce these energy efficiency but until now they have reached 60% in the best case [95]. Few more results become available from recent experiments [96,97] and a first modelling attempts have been done [98].

Using appropriate non-thermal plasma sources with a low mean electron energy (1-2 eV), typically RF and MW discharge at medium pressure range, very high energy efficiency η can be reached but at the cost of a low dissociation rate α (defined as the ratio of CO molecules produced and initial CO₂ molecules). **The challenge is to find a way to improve the dissociation rate α while keeping high energy efficiency η .** However an efficient CO₂ conversion is not necessarily obtained in pure CO₂: a vibrationally excited CO₂ molecule could become more reactive with other molecules (CH₄, H₂O, H₂, etc...) in the gas phase or on surfaces. The main goal of the plasma would then be to "activate" chemically CO₂, without needing to fully dissociate it via electron processes.

To summarize, in order to develop an effective process for the conversion of CO₂ by plasma, several key points need to be well managed:

- optimization of the vibrational excitation of CO₂ in various gas mixture
- control of the recombination of O atoms to prevent back reaction with CO
- minimization of the gas heating

Surfaces in contact with the plasma could be very beneficial. First of all, plasma/catalyst coupling could help promoting O atom recombination into O₂. It could also promote reactivity of excited CO₂ with other adsorbed reactant (such as H₂ on Nickel surface

for instance). In addition the interaction of vibrationally excited molecules with surfaces can be much more complex than a simple loss of one vibrational quanta as it is often considered in kinetic models. A lot of work has been done in chemical physics to show how a molecule excited in different vibrational modes can have an enhanced reactivity with other molecules in the gas phase [?], but also on solid [99–101] and even liquid surfaces [102]. These results are usually obtained from pump/probe experiments with a population of molecule excited in one single vibrational mode. In more realistic conditions for plasma exposure, the surface mechanisms involving vibrationally excited molecules are rarely considered except for vibrational de-excitation with more or less unknown accommodation coefficients. A few papers mainly dealing with re-entry plasma are considering the recombination of atoms leading to vibrationally excited molecules, especially N_2 and O_2 [103]. Even in the gas phase, the reactivity of M^{v*} is rarely known. For instance the production of NO from N_2^{v*} and O is sometime considered to have two different rates, for $v < 13$ or $v > 13$ because above $v = 13$ the reaction becomes exothermal [104]. The modification of the vibrational distribution function of molecules excited in a MP-NTP due to the interaction with a complex surface like a catalyst has never been reported.

The work on CO_2 plasmas that I initiated at LPP in 2015 is organised around three main lines:

- provide experimental data to establish a detailed description of CO_2 vibrational kinetic
- investigate the reactivity of CO_2^{v*} with other molecule (in particular CH_4) and on porous surfaces (first of all silica, and then more complex catalysts)
- design pulsed plasma sources with higher density (pulsed RF-discharges for instance) and use various duty cycle ratio to optimize vibrational excitation while keeping minimum gas temperature

The first studies dedicated to CO_2 vibrational kinetic and the influence of porous material are performed in a pulsed glow discharge which is also used for studies of atoms recombination and molecule formation at the wall as it will be described in the following sections.

3. Main scientific results

The scientific results presented in this habilitation thesis are articulated around three main themes: 3.1 the surface reactivity of oxygen atoms which is essential to the three fields of application described in the section 2, 3.2 the first investigations on the effect of surfaces on vibrational excitation of N₂ and CO₂, and 3.3 the first measurements characterizing both a plasma jet and its effects inside a dielectric target.

3.1. Investigating atoms reactivity on surfaces

Any laboratory plasma is interacting with walls. This interaction is often the key for industrial applications of NTP and this has motivated a lot of studies mostly at very low pressure (below 10 Pa, 0.1 mbar). At higher pressure the increase of collision frequency makes *a priori* the gas phase processes become dominant over surface processes. However reaction rates on surfaces, especially on complex materials with high specific surface, often unknown, can be orders of magnitude higher than in gas phase. Consequently the relative importance of surface and gas phase processes is not necessarily clear. This is especially true for radicals such as O or N atoms produced from dissociation of molecular gases because of their relatively long life time compared to ions, and their high reactivity. The chemistry induced by NTP at medium and high pressure (from 1 mbar to atmospheric pressure) can therefore be strongly influenced by surface recombination and reactivity of atoms. Surprisingly there is still a lack of data for adsorption, recombination probability or reactivity of atoms on dielectric surfaces as simple as silica or Pyrex, not to say about real high specific surface catalyst. Yet, oxygen containing plasmas are crucial for many applications, from re-entry plasmas, surface processing, assisted combustion to indoor air cleaning and CO₂ conversion for instance. A better understanding of surface mechanisms under direct plasma exposure involving radicals and in particular O atoms is thus essential. This has motivated an important part of my work during the last ten years and that work is still ongoing. Before presenting our main results, the next subsection present a brief summary of what was known in the literature before we start working on the topic.

3.1.1. Usual description of radical reactions on surfaces

This section provides some of the basic concepts of surface mechanisms description mostly to illustrate how the relevant parameters crucial for this description are most of the time unknown.

The general picture of gas/surface interaction is described in many textbooks [105]. A "surface mechanism" correspond to a succession of elementary steps including (i) adsorption, (ii) surface reaction and (iii) desorption of the products. The adsorption step is generally described by considering two sub cases: physisorption and chemisorption.

The physisorption corresponds to Van der Waals collective interaction with the atoms of the surface with typical desorption energy $E_d = 0.01 - 0.2eV$. It is characterized by the surface density of physisorption sites $[F]$, the fractional coverage of physisorption sites θ_F , the energy of desorption E_d and diffusion E_D (typically $E_d/E_D = 0.5$ [106]), and the characteristic frequencies of desorption ν_d and diffusion ν_D , as well as the sticking coefficient $s = s_0(1 - \theta_F)$ where s_0 is the sticking coefficient on clean surface. A good illustration of this interaction is to consider a periodic potential wells both in perpendicular and parallel direction to the surface, in which the particle is moving with characteristic residence time of desorption and surface diffusion depending on ν_d and ν_D with an exponential dependence with the wall temperature T_{wall} .

$$\tau_{d(D)} = 1/\nu_{d(D)} \exp(E_{d(D)}/kT_{wall}) \quad (5)$$

$[F]$ coincides typically with the number of atoms on the surface (typically $\sim 10^{15} \text{ cm}^{-2}$). In the models s_0 is often considered equal to 1 even though this assumption is probably getting wrong for high energy impinging particles [107]

The chemisorption corresponds to the formation of a chemical bond (with typical binding energy $E_d^{chem} \sim 0.4 - 8 \text{ eV}$) which therefore can occur only at specific sites on the surface. In the case of O atoms on silica surface, the unpaired electrons of O may efficiently form a chemical bond but the chemisorption sites have not been directly identified and are only supposed to be either non-saturated Si atoms, or impurities, or surface defects. This lack of available data explains that reported ratio of chemisorption $[S]$ over physisorption $[F]$ sites densities on silica is scattered from 10^{-3} to 10^{-1} [107–111]. As the nature of chemisorption site is not known, the fractional coverage of chemisorption sites θ_S and the desorption energy E_d^{chem} are generally also unknown. In models atoms chemisorption sites are usually considered to be trapped with high E_d^{chem} (for instance 3 eV in [108]) and therefore no thermal desorption or diffusion are considered.

the coexistence of "mobile" physisorbed atoms and "trapped" chemisorbed atoms implies the possibility of two surface reaction mechanisms: i) Eley-Rideal (E-R) involving a gas phase specie impacting on an adsorbed specie, and ii) Langmuir-Hinshelwood (L-H) requiring diffusion of specie on the surface, therefore needing physisorbed specie. L-H becomes more important at lower wall temperature when the physisorbed specie spend more time on the surface. The recombination of atoms at the wall require to provide an activation energy E_{rec} to break the bond with the surface. O and N atoms on silica are strongly bound and therefore E_{rec} is estimated to be relatively high ($E_{rec} \sim 0.2 \text{ eV}$ according to [108]). In models E_{rec} is usually supposed to be the same for both L-H and E-R and E_{rec} determines the temperature dependence of the reaction rate. From a thermodynamic point of view one can understand that for a reaction to happen, the adsorption energy of O_{ads} should be lower than the bond energy in the product molecule.

Plasma/surface interaction can be modelled with different levels of complexity. A description at *macroscopic* level rely on effective probabilities γ for surface processes

that are usually unknown and serve as fitting parameters to account for experimental measurements [112–114]. On the other hand, a *microscopic* description at atomic level can be obtained with molecular dynamics calculations using interaction potential obtained from density functional theory (DFT) [115–118]. This very interesting approach provides calculated values of recombination probabilities or accommodation energy but they are obtained on a limited number of atoms simulating a well ordered surface and the extrapolation to "real" disordered surfaces is questionable. In addition, surface processes in plasmas correspond to characteristic time scales that can range from microseconds to several seconds, incompatible with MD calculations even if methods exist to extend MD simulation timescales [119, 120]. An intermediary approach is the description at a *mesoscopic level* based on the parameters introduced above. These models describe the kinetics of surface reactions with the fractional coverage of active sites given by a set of differential equations, and the elementary steps (adsorption, desorption, diffusion, reaction) with given rate coefficients [107–111]. It is also possible to have a more microscopic description at mesoscopic level with Monte-Carlo [121] especially with the Kinetic Monte Carlo model algorithms in which the individual surface processes are treated as discrete jumps between system states avoiding the time loss of simulating exact trajectories of atoms [122, 123].

The *mesoscopic* approach seems to be a good compromise to describe and predict reliably surface reactivity in plasma. However the exact values of parameters such as $[S]$, E_D , E_d , E_{rec} , ν_D , ν_d are usually not known. Even when data are available, large discrepancies can be found in literature. As an example the values reported for recombination probabilities of O (γ_O) and N (γ_N) on silica materials may vary of several order of magnitude [124, 125]. This is due to the fact that recombination process depends on the surface pretreatment history, the surface temperature, obviously the material but also the morphology of the surface, and the conditions of plasma exposure. The pressure and gas mixture certainly influence γ but values are also very different if the measurements are done in *spatial post discharge* (profile of atom density in the gas flow after the plasma zone [108, 112, 126–129]), in *temporal post discharge* (decay of atom density right after plasma exposure [110, 111, 130, 131]), in *stationary discharge* (deduced from gradient of atom density in front of the studied surface [109, 115, 132–135]) or with the original *spinning wall* technique [136, 137]. The different values of γ are sometimes attributed to the "cleaning" of active site by ions bombardment leading to higher values under direct plasma exposure than in the post discharge. It illustrates that even for simple heterogeneous atomic recombination, there is a lack of deep understanding about surface elementary processes. This is even worse concerning molecule production at the wall such as N_xO_y from N and O, O_3 from O and O_2 or CO_2 from CO and O that could significantly contribute to the loss of atoms on surfaces but are still poorly documented. The difficulty to have reliable data is due to the multiplicity of reactions paths in mixtures of gases, both in gas and adsorbed phase. The reported rates of surface reaction are then obtained from the best agreement between gas phase products measurements

and kinetic models with precision limited by the accuracy of the gas phase model itself [112, 138–140].

The lack of data available in the literature even for systems as simple as pure O_2 plasma interacting with silica surfaces motivated the work we started more than 10 years ago and which is still ongoing today. Our goal was at first to answer questions such as *Can atoms be chemisorbed on SiO_2 ? What is the surface coverage of chemisorbed atoms? What is their role in recombination processes and molecule formation?* Our goal was then to design simple experiments to isolate as much as possible each elementary processes on non-ideal surfaces.

3.1.2. Experimental approach

The aim of this document is not to describe thoroughly the experimental setup we have used for studying plasma/surface interaction. Details can be found in already published works [21, 31] and only the important characteristics needed to explain the results shown in the following sections are given here. The originality of our approach is to use a low pressure pulsed DC discharge to study elementary surface processes on SiO_2 but also complex catalytic materials.

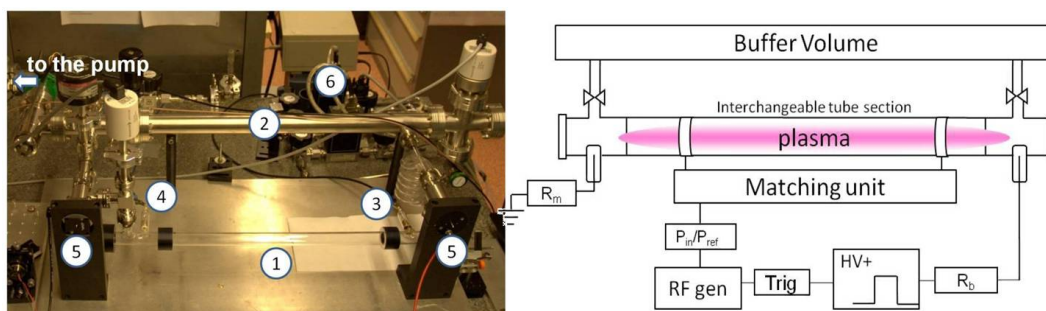

Fig. 3 – picture and schematic of the low pressure experiment that can be powered both with pulsed DC or with RF power supply. (1) interchangeable discharge tube section, (2) buffer volume, (3) high voltage electrode, (4) grounded electrode, (5) pneumatic valves, (6) mass flow controllers

The setup shown on fig. 3 has several important advantages:

- it provides a well controlled homogeneous plasma in contact with various surfaces
- the pulsed dc power supply in combination with time resolved *in situ* diagnostics gives strong constraints for comparison with kinetic models developed in collaboration with IST Lisbon
- the high vacuum connections insure very low leak rate make possible the measurements in closed reactor for several tens of minutes

- the interchangeable straight section of the discharge tube gives the opportunity to make coatings of complex materials on the inner wall of the tube
- the possibility to ignite the discharge in the same tube with RF power supply connected to two ring electrodes outside the discharge tube gives the possibility to expose the same materials to higher power density plasma and without any contact with metal electrode that could exhibit catalytic activity for N_xO_y for instance

Thanks to the simplicity and flexibility of this device, it is possible to carry out experiments separating a pre-treatment of the surface from the phase during which the adsorbed species are probed and monitored. The pre-treatment phase can be done with plasma ignited in different gases with a gas flow or in "static conditions" meaning in a closed reactor, to remove and/or graft atoms on the wall. The reactor is then pumped down and only strongly bonded species are left on the surface. These chemisorbed atoms can then be probed by chemical reaction, UV or thermal desorption, or under plasma exposure and the species released in the gas phase are monitored with various diagnostics. These type of multi-steps experiments inspired by work reported in [139, 141], required a long development done by Daniil Marinov during his thesis [142] to achieve reproducible results mostly because of the difficulty to make sure the surface is back to a similar state between each experiment. In particular an Argon plasma is always ran for at least 15 min before starting any pre-treatment phase, and the pumping phase is always kept 10 min long at the base pressure of 0.1 Pa. Some of the results obtained on this topic since 2009 and until now are shown in the following. Even though we have reported a lot of work dedicated to N atoms, we will focus here on results obtained on O atoms because of their importance for air treatment and CO₂ conversion.

3.1.3. Molecule formation with chemisorbed O atoms

The experimental sequence with pre-treatment, pumping and then probing is giving results only on atoms strongly adsorbed on the wall. If we consider a desorption frequency around $\nu_d \sim 10^{15} s^{-1}$ [143] an estimate of the adsorption energy of the atoms capable of staying on the surface longer than the 10 min of pumping is about 1 eV. The existence of chemisorbed O atoms on silica or Pyrex surface was not clearly proven. We have performed a simple experiment to evidence them by using the surface reaction $NO + O_{ads} \rightarrow NO_2$. As the bond energy $D(O-NO) = 3.1 eV$ in the NO_2 molecule, one can estimate that the only adsorbed O atoms that could be probed with this reaction have binding energy $1eV \leq E_d(O_{ads}) \leq 3.1eV$.

The experimental procedure is shown on fig.4. A pre-treatment with a pure O₂ plasma is performed with the RF discharge at 0.5 mbar during 60 min insuring to reach a saturation of the grafted O atoms. The reactor is then filled with a known amount of NO molecules by using a 1% NO mixture diluted in Ar at controlled pressure between 0.03 and 5.3 mbar. The conversion of NO into NO₂ is monitored with IR absorption spectroscopy in the closed reactor as it can be seen on fig.4.b

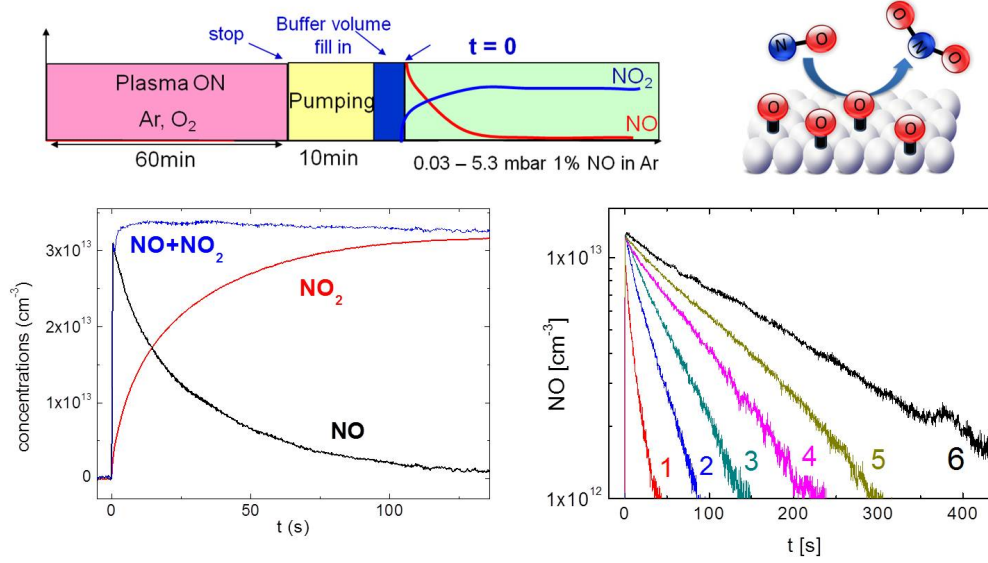

Fig. 4 – probing strongly bounded O atoms with the conversion of NO into NO₂. a) Schematic of the experimental procedure, b) bottom left: time evolution of NO and NO₂ during the probing phase at $p = 0.13$ mbar, c) bottom right: decay of NO during 6 successive fillings at $p = 0.045$ mbar after one single O₂ pre-treatment

The production of NO₂ starts immediately after the introduction of NO corresponding to Eley-Rideal mechanism. For high filling pressure the production of NO₂ reaches a saturation around $3 \cdot 10^{14} \text{cm}^{-3}$ requiring a surface coverage with O_{ads} around $2.5 \cdot 10^{14} \text{cm}^{-2}$ ie less than 10% of a monolayer. The most interesting result is shown on fig.4c. After the same O₂ pre-treatment as for fig.4b, 6 successive fillings of the tube with the same amount of NO molecules (introduced with 1%NO in Ar at $p = 0.045$) are made with pumping between each filling. The decay time of NO reduces with each filling of the reactor. Yet the total amount of NO introduced during the 6 injections corresponds only to $\sim 4 \cdot 10^{13} \text{cm}^{-2}$ ie less than 15% of the total estimated coverage of O_{ads} . Therefore the reduction of NO decay rate is not due to a lack of O_{ads} but most probably to the existence of several types of chemisorbed atoms with different binding energy resulting in a distribution of reactivity. A simple surface kinetic model has been used in [40] to explain these experimental data and a distribution of not less than 7 different adsorption sites is necessary to reproduce the measurements in all the conditions. Our results are in agreement with the data from [137] showing similarly that strongly bonded O atoms exhibit a distribution in binding energy and are not efficient for Langmuir-Hinshelwood recombination. The traditional description with one binding energy for physisorbed atom and one for chemisorbed atom seems already significantly wrong. Strongly adsorbed O atoms are capable of oxidizing NO but the question remains of their role in the O atom recombination in O₂.

3.1.4. Role of chemisorbed atoms in O atom recombination

A similar pre-treatment/probing procedures as described in previous section can be used to investigate O atoms recombination by using isotopic exchange $^{16}\text{O} \leftrightarrow ^{18}\text{O}$. All the results of this section are obtained for gas pressure low enough ($P = 0.53\text{mbar}$) to have negligible recombination in the gas phase and all the reasoning can be done considering O atoms loss only at the wall. A schematic of the experimental procedure is shown on fig.5a.

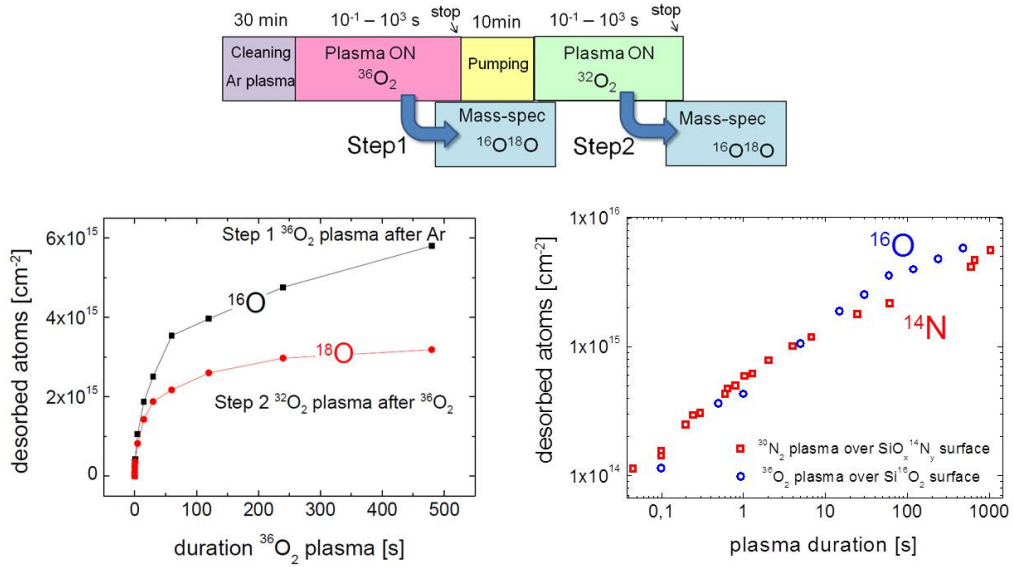

Fig. 5 – Isotopic exchange on the wall: a) experimental procedure, b) Evolution of the coverage of ^{16}O desorbed from the surface of silica discharge tube under $^{36}\text{O}_2$ plasma exposure (Step 1, "pre-treatment"). On the second step ^{18}O was desorbed from the surface by a discharge in $^{32}\text{O}_2$ during 240s, c) Comparison of the kinetics of desorption of atoms from the surface under plasma exposure, either desorption of ^{14}N under $^{30}\text{N}_2$ plasma exposure from silica surface pretreated by $^{28}\text{N}_2$ discharge or desorption of ^{16}O from silica under $^{36}\text{O}_2$ plasma

The same RF discharge is used as in section 3.1.3. After 30 min of argon plasma cleaning, pre-treatment of the Pyrex tube is made in closed reactor with a pure $^{36}\text{O}_2$ plasma in order to graft ^{18}O on the wall. This pre-treatment can be done with different durations from 0.1 to 1000s. The probing phase consists in a pure $^{32}\text{O}_2$ plasma of variable duration. The proportion of $^{32}\text{O}_2$, $^{34}\text{O}_2$ and $^{36}\text{O}_2$ are then analysed by mass spectrometry. A statistical distribution of the three isotopologues is quickly established in the gas phase but the proportion of atoms desorbed from the surface can still be deduced from the signals of the three masses. The surface density of atoms is deduced from the known gas pressure in the closed reactor and the surface/volume ratio. However the difficulty is that Pyrex or silica surfaces already contains ^{16}O . The black curve on fig.5b shows the amount of ^{16}O extracted from

the surface under $^{36}\text{O}_2$ plasma exposure. These ^{16}O atoms show the reactivity of atoms from the silica crystalline network of the tube itself. Additional measurements comparing the amount of ^{16}O detected after only the Ar cleaning (like on fig.5b) and after argon cleaning followed by 20 minutes of $^{32}\text{O}_2$ plasma exposure (not shown on fig.5) have indicated that approximately $5 \cdot 10^{14} \text{cm}^{-2}$ additional ^{16}O can be grafted on the wall by the $^{32}\text{O}_2$. This value is remarkably similar to the amount of chemisorbed O atoms probed with NO conversion into NO_2 (see section 3.1.3)

The red curve on fig.5b shows the amount of ^{18}O extracted from the surface during 240s of exposition to $^{36}\text{O}_2$ plasma. The maximum amount of ^{18}O extracted is 5 to 10 times larger than the amount of chemisorbed atoms added onto the surface by O_2 plasma. Nevertheless these atoms were strongly bond to the surface since they remained on the surface in spite of the pumping. This can be explained by exchange of lattice oxygen atoms from the silica network. In view of these results, the image of SiO_2 surface under plasma exposure is that of an essentially dynamic object. The plasma is not only adsorbing atoms with more or less strong binding energy, it fully reshuffle the atoms from the material surface itself. This process continues over very long time scale as can be seen from fig.5c. showing the amount of atoms extracted from the surface as a function of plasma exposure duration. Similar isotopic exchange experiments have been performed also in nitrogen plasma. Surprisingly the exchange of atoms with the material appears to be done with similar rate under O_2 or N_2 plasma exposure with the same power. One would expect the N atoms density to be lower than O atoms density because of the energy cost of N_2 dissociation [144]. Therefore fig.5c suggests that ions bombardment is responsible for the observed atoms exchange with the surface.

The distribution of reactivity of chemisorbed atoms shown in section 3.1.3 could then be a consequence of constant reorganization of surface structure under ion bombardment. Another important observation is that the rate of atoms from the surface released in the gas phase is too slow to account for the recombination of all the atoms produced during the plasma. We have measured with short discharge pulses that flux of atoms reaching the surface is about 10 times larger than the amount of strongly bonded atoms extracted from the surface shown on fig.5c (these results are published for N atoms in [41]). This suggests that physisorbed atoms play a key role in surface reactivity and especially in atoms recombination. However the multi-steps experimental method described so far do not allow to investigate physisorbed atoms. Other strategies are described in the next sections.

3.1.5. Role of weakly bonded atoms in molecule formation on complex surfaces

In order to follow the recombination of weakly adsorbed atoms *in situ* diagnostics with good time resolution are required. In this first example we are using two photons laser induced fluorescence to measure the O atoms density during the post-discharge of short plasma pulses and time resolved UV absorption spectroscopy to measure the corresponding ozone formation from the Hartley band between 220 and 300 nm.

The recombination of O atoms is not necessarily leading to O_2 . The production of O_3 can also be a significant sink of O atoms depending on the conditions. At low pressure O_3 is often neglected because its formation requires a three body reaction $O + O_2 + M \rightarrow O_3 + M$ where M is a molecule absorbing the excess of energy. However the rate of this reaction with O_2 acting as a third body ($k_{O_3} = 6.3 \cdot 10^{-34} \cdot (300/T_g)^2 cm^6 s^{-1}$) shows that already at 5 mbar ozone production in the gas phase is significant. The possibility that surface plays the role of third body and enhances ozone production is still little investigated. However a few papers mention that surface ozone production could even be the main O atoms loss mechanisms at pressure from 1 to 50 mbar [134, 145]. The increase of ozone production with high specific surface materials has also been reported in DBD discharges at atmospheric pressure [12, 146, 147].

The fig.7 shows the decay time of O atoms and the O_3 production after a 1ms plasma pulse at $p = 6.7mbar$. The black curves are obtained with the bare silica tube already used in the previous sections. The red curves are obtained with porous silica material placed on the inner surface of the discharge tube. This material (called fibers in the following) is described in [12] and is made of silica fibers of $\sim 10\mu m$ in diameter partly covered of SiO_2 nanoparticles. This material has a large specific area (BET) and the amount placed on the inner wall of the reactor corresponds to roughly $100m^2$ added in the reactor.

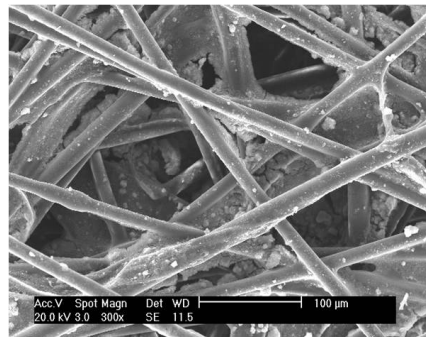

Fig. 6 – MEB picture of the silica fibers material used to increase the specific surface

The O_3 production with the bare tube has very similar characteristic time as the O atoms loss τ_0 . The lifetime of O atoms due to ozone formation estimated from the gas phase production of O_3 (k_{O_3} given above) is about $\sim 60ms$ at 300K, matching very well the measured τ_0 . The characteristic time of O atom loss is much shorter with the fibers ($\tau_0 = 5.5ms$) than without ($\tau_0 = 65ms$). Considering the O atoms diffusion coefficient given in [134], the diffusion time in these conditions is estimated to be $\sim 4ms$. It means that all the O atoms diffusing to the wall are lost on the fibers. Production of O_3 is much faster and higher than with the bare tube in the early post-discharge with a characteristic time of 9ms that can not be explained with any volume processes.

This result gives a direct evidence for surface production of ozone. We have estimated that production of ozone on the fibers account for $\sim 25\%$ of the O atoms loss (see details in [29]). However on the bare tube surface *vs* gas phase relative contribution to ozone formation is more difficult to determine. A kinetic model described in [35] allowed us to show that gas phase production is dominating in our conditions but that O_3 production can not be explained without considering an intermediary

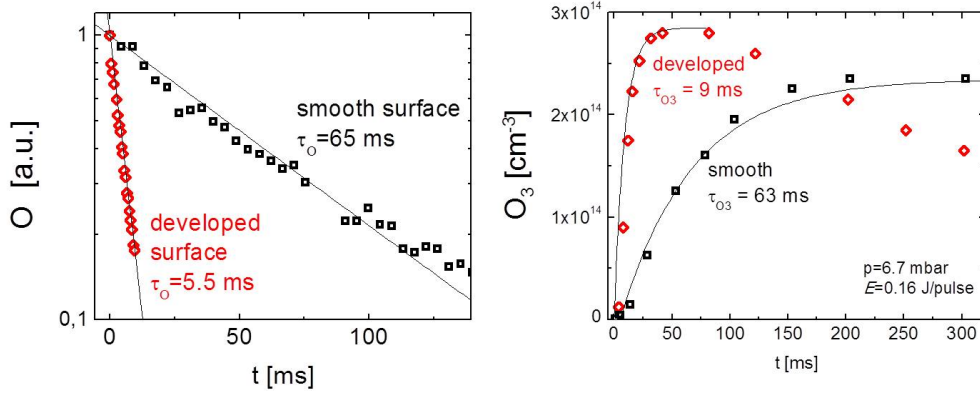

Fig. 7 – *O* atoms conversion after a short plasma pulse of 1 ms at 6.7 mbar: a) decay of *O* atoms in temporal post-discharge, b) corresponding ozone formation with and without SiO_2 fibers material on the inner wall of the reactor

step producing vibrationally excited ozone (the importance of vibrational kinetic in molecular plasmas will be developed in section 3.2). Measurements *in situ* during plasma exposure compared with detailed kinetic model of O_2 plasma are the only possibility to get insight on the main mechanism of *O* atoms recombination on bare silica tube.

3.1.6. Recombination into O_2 with weakly bonded atoms

Time-resolved measurements always provide much better constraints for comparisons with kinetic models than measurements made in a stationary state. However in order to reach reproducible conditions for surface processes, long exposure time are needed.

This has motivated our current work on "modulated" plasmas and not only pulsed plasma. These measurements are only part of an

ongoing project in collaboration with JP Booth (LPP) dedicated to the kinetic of O_2 plasma but it is also of primary importance for the understanding of CO_2 plasma (see section 3.2.2). The principle of these measurements is to use a continuous plasma with small square modulation of the current around an average value ($\sim 15\%$). As a result the surface of the reactor is under an almost constant ions bombardment and atoms flux but the time variation of *O* atoms density can be measured to deduce

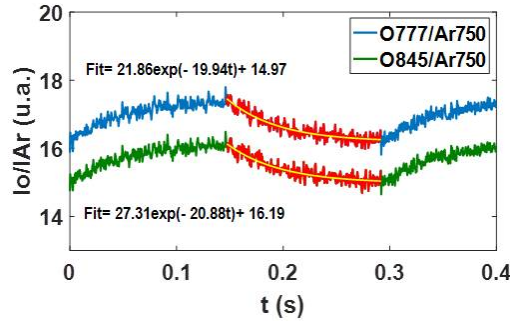

Fig. 8 – principle of modulated discharge

their life time (see fig.8).

Actinometry is a convenient technique to perform quickly a parametric study with the modulated discharge but the absolute O atoms density has also been confirmed with TALIF. The laser used for these TALIF measurements has been developed by Cyril Drag recently arrived at LPP and is described in [46, 49]. The special feature of this laser is that it achieves much higher spectral resolution than a conventional dye laser and therefore allows the gas temperature to be obtained from the Doppler broadening of the O atoms TALIF signal. This temperature is used as an input of actinometry together with the measured E_{field} to determine the excitation coefficients of O and Ar lines. We have applied this technique with the DC discharge in a tube with a controlled wall temperature in the range $T_w = 240 - 320K$.

Fig.9 shows the loss frequency of O atoms obtained in pure O₂ and in pure CO₂ plasma for various pressure and current (central value of the modulation).

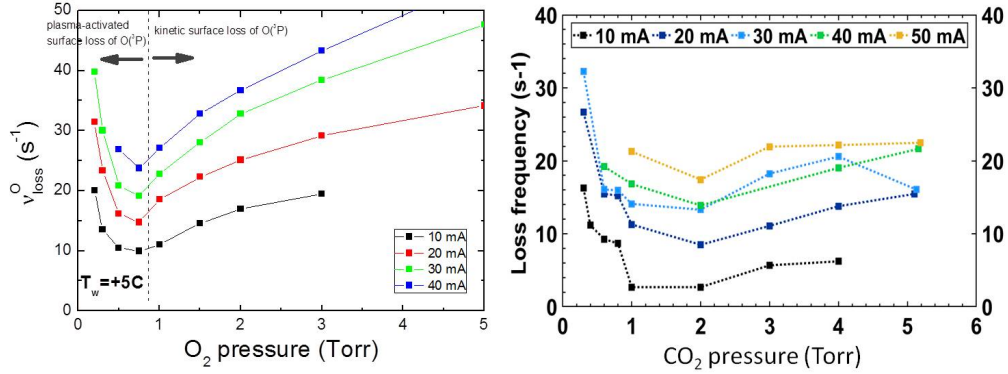

Fig. 9 – Loss frequency of O atoms as a function of pressure for different average currents in a) pure O₂ plasma and b) pure CO₂ plasma

Two different regimes clearly appears as a function of gas pressure, both in pure O₂ and in pure CO₂: i) above 1 Torr the loss frequency is slowly increasing with the increase of gas phase recombination, ii) below 1 Torr becomes quickly higher as the pressure is reduced. The loss frequencies were almost not modified by the imposed wall temperature. When loss are dominated by gas phase recombination rough estimate of reaction rates suggests that $O + O + M \rightarrow O_2 + M$ with rate coefficient $k_{O_2} = 1.27 \cdot 10^{-32} \cdot (300/T_g) \cdot e^{-70/T_g} cm^6 s^{-1}$ is always the dominant loss process but $O + O + M \rightarrow O_3 + M$ becomes significant at low gas temperature and $O + CO + M \rightarrow CO_2 + M$ (with rate $k_{CO_2} = 8.2 \cdot 10^{-34} \cdot e^{-1510/T_g} cm^6 s^{-1}$) becomes important at high dissociation rate in CO₂ plasma. However even in this "high pressure" regime, the importance of surface recombination could easily reach 10 or 20% and a detailed kinetic model of the gas phase is necessary to give accurate values.

In the low pressure regime, the recombination is dominated by surface mechanisms. According to [111], in the range of surface temperature reached in our conditions the recombination occurs probably with E-R mechanism. The loss probability with E-R mechanisms depends on the flux of O atoms to the wall and the surface coverage of O atoms that can be either on physisorption or chemisorption sites. The absolute density of atoms in the gas phase is lower at lower gas pressure. Weakly bonded atoms have probably a fast sorption balance (equilibrium between atoms flux and desorption rate) and therefore their surface coverage should reduce at lower pressure. The increase of loss frequency seems to point towards an increase of the amount of strongly bonded atoms. The number of adsorption sites with strong chemical bonds could increase because of stronger ions bombardment. However even at the lowest pressure considered here ($p = 0.2\text{Torr}$) the sheath of dc discharge is still collisional and the population of ions having enough energy to break bonds in the SiO_2 network might not be high enough to explain such a strong increase of O atoms loss. Moreover strongly bonded O atoms were shown in section 3.1.4 to not be the main specie for O atoms recombination... The role of energetic neutral species should also be investigated.

We are still working on the analysis of these results. Other measurements are currently being done to obtain densities of other species of importance both in O_2 and CO_2 plasmas. Measurements campaign on the VUV line of synchrotron SOLEIL are being done to investigate in particular $O_2(a^1\Delta_g)$ and $O_2(b^1\Sigma_g^+)$ metastables. Vibrationally excited O_2^v can also be measured with broadband UV absorption like in [148]. However all these data will provide more understanding only when compared to detailed kinetic models of the gas phase and description of the surface mechanisms. In spite of the fact that we are working on this topic for more than 10 years, first with A. Rousseau and D. Marinov, then with JP Booth, Abhyuday Chatterjee and Ana-Sofia Morillo-Candas, and from the beginning with models developed by V. Guerra and C. Pintassilgo, a lot still need to be done and this work will be continued in the coming years. Among other things it includes a need for a more accurate description of the energy stored in vibrations of molecules.

3.2. Vibrational kinetic and surfaces

It has already been mentioned in section 3.1.5 that vibrationally excited ozone plays a key role in O_3 formation. In general vibrationally excited molecules act as a large energy reservoir in NTP and vibrational kinetic description often suffer of a lack of experimental data. The interaction of vibrationally excited molecules with surfaces is even less studied. Accurate measurement of vibrational temperature is especially important for CO_2 conversion by plasma as explained in section 2.4. In the following subsections the work started on CO_2 vibrational kinetic in 2015 will be described but vibrational de-excitation of N_2^v is first used to illustrate the influence of various surfaces on vibrational kinetics.

3.2.1. Vibrational de-excitation at the wall: example of N_2^{v*}

For many molecules the cross section of excitation of the first vibrational levels by electron impact have low energy threshold. As a result the electron energy distribution function is strongly affected by vibrational excitation. At reduced pressure the main de-excitation channel for vibrationally excited molecules (M_v^*) is often the de-excitation on the walls. Therefore the probability of relaxation of a vibrational quanta on the surface γ_v is an important parameter driving the energy balance in molecular NTP. Nevertheless only few papers report about N_2^{v*} relaxation on surfaces and they are usually providing data in the flowing post-discharge [149–151]. The reported values of γ_{N_2} lies in the range $10^{-4} - 10^{-2}$. These low values are attributed to the fact that relaxation mechanism would proceed in two steps with first physisorption of N_2 and then transfer of vibrational energy to phonons of the surface. However the values of γ_{N_2} on surface under direct plasma exposure could be very different.

The difficulty to obtain values of γ_{N_2} is the detection of N_2^{v*} . A simple and original technique first used in [150] is to take advantage of the resonance between the vibrational levels of CO_2 and N_2 . The first level of the asymmetric CO_2 mode is very close in energy to the first vibration level of N_2 (2349 cm^{-1} and 2331 cm^{-1} respectively). By adding small amounts of CO_2 to a N_2 plasma, the vibration temperature of CO_2 will quickly equilibrate with that of N_2 , giving a chance to make a titration of N_2^v by measuring CO_2 with infrared absorption spectroscopy. Similar resonance exists also with vibrational levels of CO and N_2O . Three different Quantum Cascade Lasers (QCL) have been used to perform this titration of N_2^{v*} *in situ*, as a function of time in the afterglow of a single plasma pulse. The details of this method have been published in [42].

Similarly to previous sections, a pulsed dc discharge is used with a pre-treatment phase and then measurement during and after a 5ms single plasma pulse in N_2 with small admixture of the titrating molecules. The measured absorbance follows the Beer Lambert law and is proportional to the difference of population of the lower and the upper state of the transition (see equation 6)

$$\int \ln\left(\frac{I_\nu(L)}{I_\nu(0)}\right) d\nu = -\alpha (N_0 - \beta N_1) \quad (6)$$

where N_0 and N_1 are the densities of lower and upper vibrational levels, α is obtained from a calibration, β depends on the chosen transition (the difference of rotational energy of the levels) and the gas temperature. An example of measured absorption signal obtained with CO_2 admixture in N_2 is given on fig.10a.

The difference of absorption signal before the plasma pulse and 200ms after is due to the dissociation of the titration molecule in the plasma. The observed relaxation time during the post-discharge could be due either to variation of the rotational distribution induced by gas heating, or to vibrational excitation. The characteristic time of heating and cooling down in the same N_2 plasma is in the range of few ms only [43, 152] and therefore can not explain the observed relaxation time. The

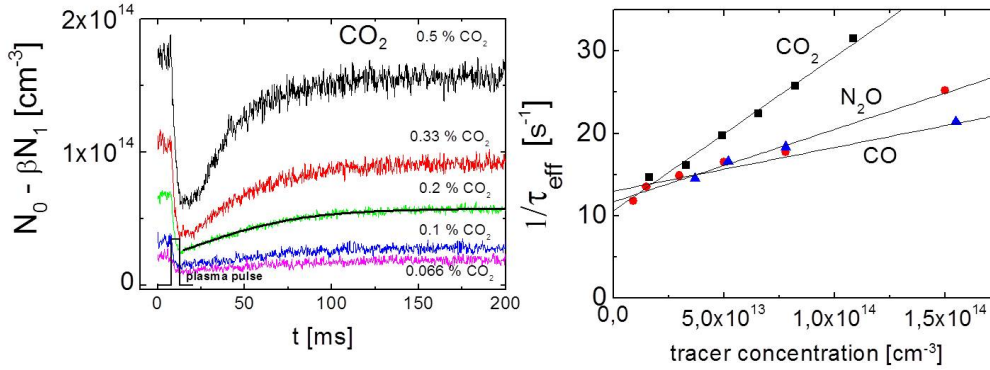

Fig. 10 – titration with CO_2 , CO and N_2O of $\text{N}_2^* b$ during and after a 5ms and 50mA plasma pulse at $p=1.33\text{mbar}$: a) example of absorption signal for different admixture of CO_2 , b) inverse of the relaxation time obtained with the 3 titrating molecules.

fig.10b shows that for each titration molecule the inverse of the relaxation time τ_{eff} is proportional to the admixture of CO_2 , CO or N_2O but the extrapolation for zero admixture gives similar values for the extrapolation in pure N_2 . A simple vibrational kinetic model is required to obtain γ_{N_2} from τ_{eff} as described in details in [42]. This method has allowed us to obtain values of γ_{N_2} in the range $5 \cdot 10^{-4} - 30 \cdot 10^{-4}$ depending on the material of the surface (Silica, Pyrex, TiO_2 ...), but also on the pretreatment of the surface. For instance γ_{N_2} on silica surface is measured to be twice larger after a pure N_2 pre-treatment than after a pure O_2 pre-treatment, which could be due to a better accommodation of the excited molecule with an adsorbed one as suggested for CO_2 in [153]. The material of the walls, their roughness, but also the molecules adsorbed on the surface can significantly affect the vibrational excitation of the molecules in the gas phase. This could have important consequences for the use of plasma for CO_2 conversion, where it is critical to optimize the vibrational excitation.

3.2.2. CO_2 vibrational kinetic

The exact pathways of CO_2 plasma dissociation are far from being understood. A lot of work has been done on CO_2 plasma in the 70's for the development of CO_2 lasers, atmospheric re-entry plasmas, and the early stage of plasma-chemistry mostly led by russian and italian groups [91, 154, 155]. In spite of the available literature there is no predictive model capable of evaluating the dissociation rate of CO_2 , mainly because V-V and V-T transfers are not well captured and because the electron kinetic is strongly influenced by vibrational superelastic and electronically excited collisions [156]. In fact, even dissociation through direct electron impact on the ground state could lead to the production of an excited O atoms (around 7eV) or a excited CO (around 10.5 eV) and cross sections from the literature can have a factor

10 difference in magnitude [157–159]. It is even worse for the other dissociation mechanisms. Depending on the number of vibrational levels considered, on how the climbing along the vibrational ladder is treated [160], or how the superelastic collision are estimated, very different results are obtained [98, 161]. Until now the uncertainty on data for elementary processes is too large to build a predictive model from the theory.

In order to obtain efficient CO₂ conversion by plasma one should manage either to dissociate it directly into CO, or at least to make CO₂ reactive with other species (CH₄, H₂O, H₂, etc...) which is *a priori* achieved with efficient vibrational excitation. In both cases, the recombination of O atoms must be controlled to prevent oxidation back to CO₂. Appropriate materials coupled with the plasma could be beneficial both for reaction of CO₂ with other molecules, and for recombination of O into O₂. However the primary requirement remains: CO₂ must be efficiently activated to initiate chemical conversion. Before studying the influence of any surface it is necessary to get a deeper understanding of CO₂ vibrational kinetic.

Our approach is therefore to measure as many parameters as possible, *in situ* and time resolved in a pulsed glow discharge to provide constraints to self consistent 0D kinetic model developed at IST which couple electron, vibrational and chemical kinetic as well as calculation of the gas heating. Only low energy excitation regime will be reached with a pulsed glow discharge (PGD) in CO₂ but this initial validation step is necessary before being able to have similar approach with RF or microwave discharges. It is also necessary to have a detailed and accurate description of the gas phase before being able to understand the role of surfaces as it will be illustrated by the first measurements done with catalysts in section 3.2.3. The first results of the work on CO₂ are providing T_v , T_g , O, CO₂^{v*}, CO^{v*}, O₂^{v*}, CO, CO₂, O₃ in a pure CO₂ PGD. The most challenging measurement is to obtain the population of the vibrational levels of CO₂ and CO.

In the following quantum numbers ν_1 , ν_2 and ν_3 designate respectively the symmetric stretch, doubly degenerate bending and the asymmetric stretch of CO₂. In order to get insight on energy transfers between these three modes, it is necessary to use a measurement technique capable of detecting the population of levels from all three modes. Only the symmetric stretch mode of CO₂ is Raman active which invalidate Raman scattering and coherent anti-Stokes Raman scattering methods used in [162–165]. On the other hand the three modes are strongly infrared active. Infrared emission spectroscopy requires taking into account the optical thickness of the plasma to determine accurate densities [166, 167]. IR absorption spectroscopy had already been used by mean of tuneable laser diodes to determine densities in CO₂ laser [168, 169] but the narrow spectral width of IR lasers makes it inconvenient to get information of ro-vibrational absorption structures spread over several hundreds of wavenumbers. FTIR spectrometers on the contrary allow to obtain spectra over a very broad spectral range. The method we have developed is based on the use of FTIR with the IR beam going through the plasma reactor where the PGD is ignited. The homogeneity of the positive column of a glow discharge is an advantage

to determine accurate densities from a line of sight measurement like IR absorption. Details of the experiment can be found in [55]. Fig.11 gives example of transmittance spectra obtained at different time during and after the plasma pulse for a pure CO₂ plasma at 6.7 mar and 50mA.

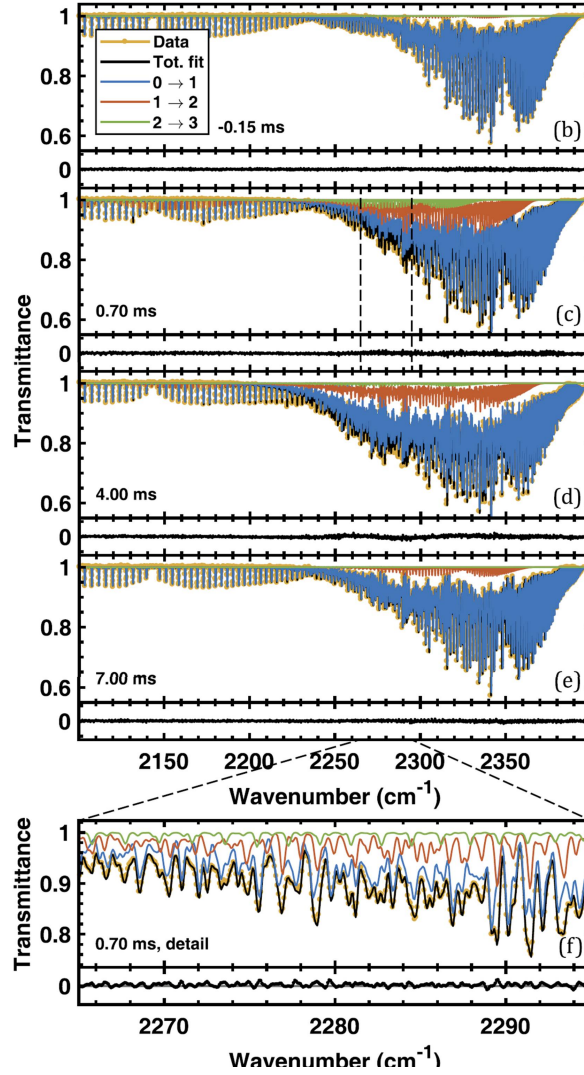

Fig. 11 – Example of measured and fitted transmittance spectra obtained at different time during a 5ms plasma pulse and during the 10ms post-discharge in pure CO₂ with 50 mA

Obtaining the time resolved spectra is relatively simple but the data treatment is challenging. The CO₂ absorption band around 2349cm^{-1} corresponds to the transition of one quanta in the asymmetric mode but this transition can occur for any combination of the bending and symmetric mode. The absorption band mea-

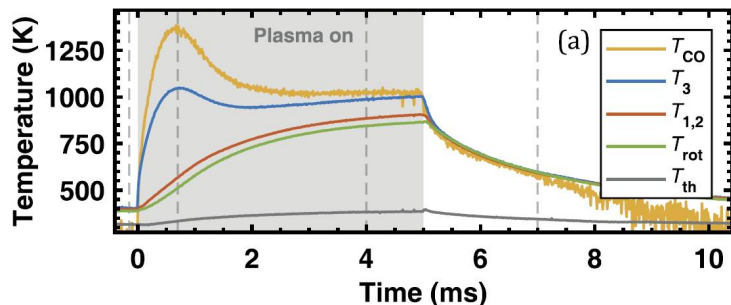

Fig. 12 – Time evolution of vibrational temperature of asymmetric (T_3), and symmetric/bending ($T_{1,2}$) modes of CO_2 , vibrational temperature of CO (T_{CO}) and rotational temperature (T_{rot}) during a 5 ms plasma pulse at 5 Torr and during the post-discharge of 10 ms

sured is therefore a convolution of any transition with the form $(\nu_1, \nu_2^{l_2}, \nu_3) \rightarrow (\nu_1, \nu_2^{l_2}, (\nu_3 + 1))$ where l_2 is the angular momentum of ν_2 . It makes the fitting of absolute densities of each level more complex but it also gives a chance to obtain information about the population of the three vibrational modes of CO_2 (and also the vibrational excitation of CO) simply by measuring the wavenumber range $1975 - 2400\text{cm}^{-1}$.

In order to fit the data, we have developed an algorithm in collaboration with B. Klarenaar (PhD student at TU/e under supervision of R. Engeln, and my own co-supervision) and Ana-Sofia Morillo-Candas capable of calculating absorption spectra without thermal equilibrium. The details of this algorithm are given in [55]. It makes use of the HITEMP-2010 database [170] that includes transitions for asymmetric mode up to $\nu_3 = 6 \rightarrow 7$. It calculates rovibrational state distributions assuming the same rotational temperature for all vibrational levels, line strengths of all transitions, temperature and pressure broadening, and finally a transmittance spectrum including the profile of instrumental broadening. This spectrum calculation algorithm is included in a loop to fit the experimental spectra using 7 fitting parameters: the rotational temperature (T_{rot}), the bending and symmetric mode temperature that are in Fermi resonance ($T_{1,2}$), the asymmetric mode temperature (T_3), CO vibrational temperature (T_{CO}), the rotational temperature in the part of the gas along the line of sight that is at thermal equilibrium (T_{th}) (about 26% of the full line of sight), the dissociation rate of CO_2 into CO (α), and the pressure (p). The coloured spectra on fig. 11 correspond to the transmittance spectra of each individual transition of one quanta in the ν_3 mode for all other states of the ν_1 and ν_2 .

The fitting parameters presented above are temperatures. It should be mentioned that the calculation of the transmittance spectra can be done letting each single vibrational level independent, without assuming any distribution. A Treanor distribution is assumed (using $T_{1,2}, T_3, T_{\text{CO}}$ for scaling the harmonic part and T_{rot} for scaling the anharmonic part) only to speed up the fitting algorithm, especially for time resolved measurement series.

Fig.10 gives an example of time evolution of vibrational temperature obtained with this method. During the first *ms* of the plasma pulse, T_3 and T_{CO} increases very fast while T_{rot} and $T_{1,2}$ are still low. $T_{1,2}$ remains always nearly thermalized with T_{rot} . When T_{rot} and $T_{1,2}$ increase, T_3 and T_{CO} are pulled back to lower values probably because of more efficient V-T transfers at elevated gas temperature. In the post discharge the gas thermalize very quickly and all the temperatures are following the same relaxation. The vibrational levels population densities are then too low, and the pressure already too high to keep a non equilibrium during the post-discharge. In order to promote the excitation of $\nu - 3$ that is supposed to be beneficial for CO_2 conversion, it seems particularly important to maintain a low gas temperature. This has been confirmed by modelling in collaboration with the group of Pr Guerra [54].

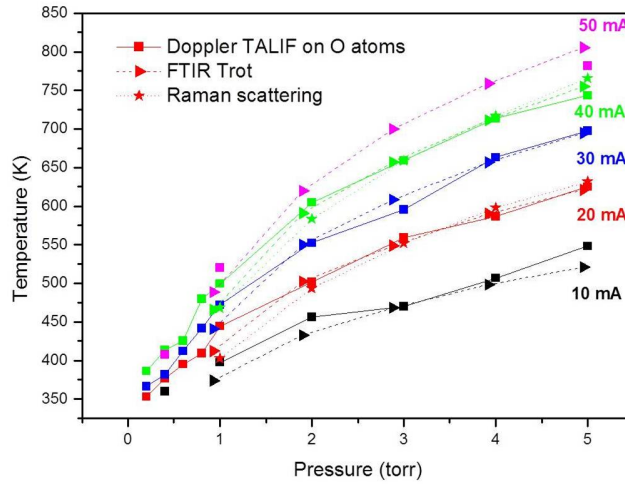

Fig. 13 – Gas temperature measured with Raman scattering, Doppler broadening of O atoms TALIF signal, and FTIR absorption in the same plasma conditions in pure CO_2

Gas temperature is generally a very important parameter in plasma because of the dependence of reaction rates with T_g and because it affects also the E/N . Various techniques have been developed to measure the gas temperature (emission spectroscopy, Doppler broadening of absorption line, etc...), but all have significant disadvantages. In our case, determining accurately T_g appears to be critical because of the consequences on vibrational kinetic and chemistry, but also because we wanted to confirm the accuracy of the fitting procedure of IR spectra described above. Indeed the number of fitting parameters and the convolution of several tens of transitions on the same spectral band could make the results questionable. Therefore we have compared three different measurements techniques of T_g in the same glow discharge reactor: 1) T_{rot} from FTIR data as described above, 2) T_{rot} from Raman scattering measured at TU/e in the same reactor, 3) T_g deduced from Doppler broadening of TALIF signal of O atoms as described in [46, 49] and in section 3.1.6. Fig.13 shows the comparison of measured temperature with these three methods.

Raman scattering and TALIF are both measuring at one particular point of the reactor while FTIR is a line of sight measurement. TALIF is probing the temperature of the ground state of O atoms, while Raman scattering gives the rotational temperature of the ground state of molecules. Nevertheless, all three techniques are perfectly matched for the whole pressure and current range investigated. It gives us confidence in the validity of the fitting of FTIR data.

parametric studies are then possible for many different plasma conditions (duty cycle ratio, pressure, current, etc...), different gas mixtures, with and without catalytic materials and of course with other plasma sources expected to induce higher densities of high vibrational levels. This work is currently being done in close collaboration with Pr. Engeln's group in Eindhoven and Pr. Guerra's group in Lisbon and is the core of the PhD of Ana-Sofia Morillo-Candas. Already fig.14 shows the evolution of T_3 , $T_{1,2}$ and T_{rot} at $t = 1.5ms$ during a $5ms$ plasma pulse for different discharge currents and gas pressures.

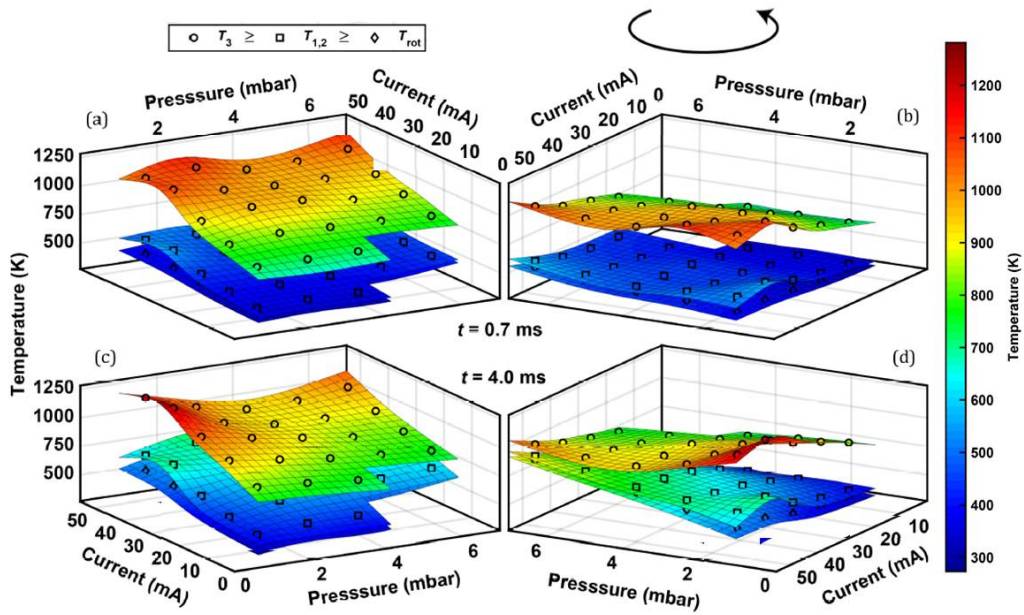

Fig. 14 – Values of T_3 , $T_{1,2}$ and T_{rot} at $t = 1.5ms$ during a $5ms$ plasma pulse for different discharge currents and gas pressures. The top row is taken at $0.7ms$ and the bottom row at $4ms$ during the pulse. Left and right graphs are showing the same data from different angle for visibility

The temperature of the asymmetric mode T_3 is always higher than $T_{1,2}$ and T_{rot} . However in order to maximize T_3 it is clear from fig. 14 that T_{rot} must be kept as low as possible: at $0.7ms$ the gas temperature has not yet raised and T_3 is higher

than other temperatures for all conditions, however at $4ms$ at high pressure the gas temperature is already high and T_3 is almost thermalized with $T_{1,2}$ and T_{rot} . Low pressure and high current are the most favourable conditions in a dc discharge and pulsing the plasma could be interesting to excite vibrational states while keeping low gas temperature. These conclusions were already known from CO₂ laser literature however it is the first time that measurements of the different temperature are performed time resolved in a pulsed plasma.

As it will be discussed in section 4, the advantage of low gas temperature and low pressure could even make plasma technologies a viable solution for production of O₂ from Mars atmosphere for fuel production or human mission to the red planet [54]. However industrial applications on Earth would not be viable with too low pressure. The use of CO₂/N₂ mixtures to keep non equilibrium at higher pressure is one of the promising routes since the exhausts of industrial plants requiring CO₂ recycling are often containing N₂. Moreover, as discussed in section 3.2.1, first vibrational level of N₂ is resonant with asymmetric stretch of CO₂ and could enhance T_3 . The coupling with catalytic materials is another path of investigations.

3.2.3. first measurements with specific materials

In section 3.2.1 we have shown that surfaces are playing an important role on vibrational de-excitation of N₂^{v*} and that different surface states can change the de-excitation probability. The material introduced in section 3.1.5 made of silica fibers can be placed on the inner surface of the discharge tube to increase significantly the specific surface area without changing the chemical nature of the walls. One would expect that using this material in a pure CO₂ plasma would increase the vibrational de-excitation and lower the vibrational temperatures. Fig 15 is showing the first measurements of vibrational temperature by infra-red absorption as described previously, performed in a continuous CO₂ glow discharge for various pressures.

The vibrational temperatures are not decreased with the fibers. On the contrary $T_{1,2}$ and T_{CO} are significantly higher with the SiO₂ fibers while T_3 is slightly increased and T_{rot} remains unchanged. This effect is more pronounced at low pressure when surface processes becomes dominant. The introduction of the silica fibers is affecting the whole plasma dynamics and one should certainly not conclude from this preliminary data that vibrational de-excitation at the wall is lower with this material. First of all the increase of charge loss at the wall results in an enhancement of the electric field for the same plasma current. However the small E_{field} increase is probably not sufficient to account for the observed vibrational temperature change. We have already shown in a pure CO₂ plasma that SiO₂ fibers are drastically reducing the O atoms density, similarly to what is shown in pure O₂ on fig 7a. Thus we suppose the increase of vibrational temperature observed is a consequence of a lower quenching by O atoms.

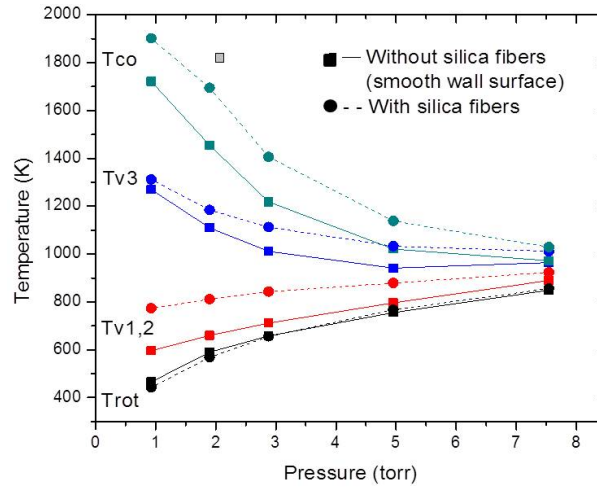

Fig. 15 – comparison of vibrational temperatures of CO_2 and CO T_3 , $T_{1,2}$ and T_{CO} as well as T_{rot} as a function of pressure with and without glass fibers material in a continuous glow discharge at $40mA$ measured by infrared absorption

The role of porous materials, catalysts and membranes on CO_2 conversion will be an important part of our investigations in the near future, especially during the thesis of Ana-Sofia Morillo-Candas.

3.3. Ionization waves interaction with surfaces

The interaction of filamentary discharges with surfaces is studied for decades and yet, no clear description is made of it. From the early theory of flashover [171], to the numerous studies on plasma actuators [172], or theoretical and experimental work on corona discharge interacting with targets [173–175], an extensive literature exists on this topic. Nevertheless the nature of the charge deposited or induced on/in a target, the influence of the roughness on the discharge propagation depending on the orientation of the field with respect to the surface, the role of the surface in the pre-breakdown phase are among the questions remaining un-answered. As explained in section 2.3 filamentary plasmas are now the focus of many research groups because of the development of numerous emerging applications dealing most of the time with treatment of targets. More and more complex reactor configurations are investigated in order to fulfil applications requirements with electrodes deposited on flexible polymers for biomedical applications [176], arrays of microplasmas for air treatment [177], cascaded DBD or roll to roll configuration for polymer and textile treatment for instance [178, 179]. Among the atmospheric pressure plasma sources, the plasma jets (APPJ) have motivated a lot of studies mostly because of their high reproducibility. Like for any other atmospheric plasma, the design of sources is very diverse and tend to increase in complexity with industrial motivations like in [180].

However, just as we chose the simplest possible plasma discharge to study the surface reactivity of excited atoms and molecules (PGD in previous sections), we chose one of the simplest plasma jet configuration to study the interaction of an ionization front with complex surfaces.

Since 2013, in collaboration with the group of Ana Sobota in Eindhoven, we are investigating a coaxial APPJ powered with kHz pulsed or sinusoidal voltage. The interaction of this APPJ with various surfaces can not be understood if the jet itself is not well characterized first.

3.3.1. Characterization of the APPJ freely expanding

The APPJ used throughout our work is described in several papers [38,44,47,51]. A metal tube acts simultaneously as high voltage electrode and gas inlet inside a Pyrex capillary tube. A ring shape ground electrode is placed outside the tube forming a coaxial DBD configuration. The gap distance between the electrodes, the width of the ground and the length of the tube after the ground can all be varied but what is called in the following our "reference configuration" corresponds to a gap of 5mm, a ground of 3 mm thickness and a tube length after the ground of 20 mm with a glass tube of 4 mm outer diameter and 2.5 mm inner diameter. With this geometry and a helium gas flow of 700 sccm, the plasma is expanding of a few *mm* outside the capillary in the surrounding air as can be seen on part A of fig.16. Three parts of the setup are distinguished in the following discussion: the "source" (space between the two electrodes), the "tube" (segment of tube after the ground), and the "plume" or "jet" (the part of plasma outside the tube). With this configuration and a sinusoidal applied voltage with 2 to 3 kV amplitude, an ionization wave is developing only during the positive half period of the voltage.

The growth of the ionization front can be seen on the iCCD images on fig.16 taken with 100 ns exposure time. A plasma is first ignited in the source in a glow like regime (image (B.a) on fig.16). When the charge deposition in front of the ground electrode is large enough to induce a field higher than the breakdown field, an ionization front develops beyond the ground electrode inside the capillary tube (images (B.b),(B.c) and (B.d)).

When the front reaches the nozzle, it starts propagating in the surrounding air with a conical shape imposed by the gas mixing between helium and air (iCCD images (B.e), (B.f), and colour picture of gas mixing simulation E). The development of the discharge in the tube and the plume corresponds to the propagation of a streamer connected to the high voltage electrode by a conductive channel (the influence of the ground is mostly shielded by the deposited charge). It could be compared to a streamer in a corona discharge but this particular streamer is first confined by the capillary tube, and then strongly influence by the proportion of air entrained in the helium flow (lower than 1%). The plasma jets can therefore be called "guided ionization waves". The plume gives a good illustration of the necessity to include the surrounding in the study of a non thermal plasma.

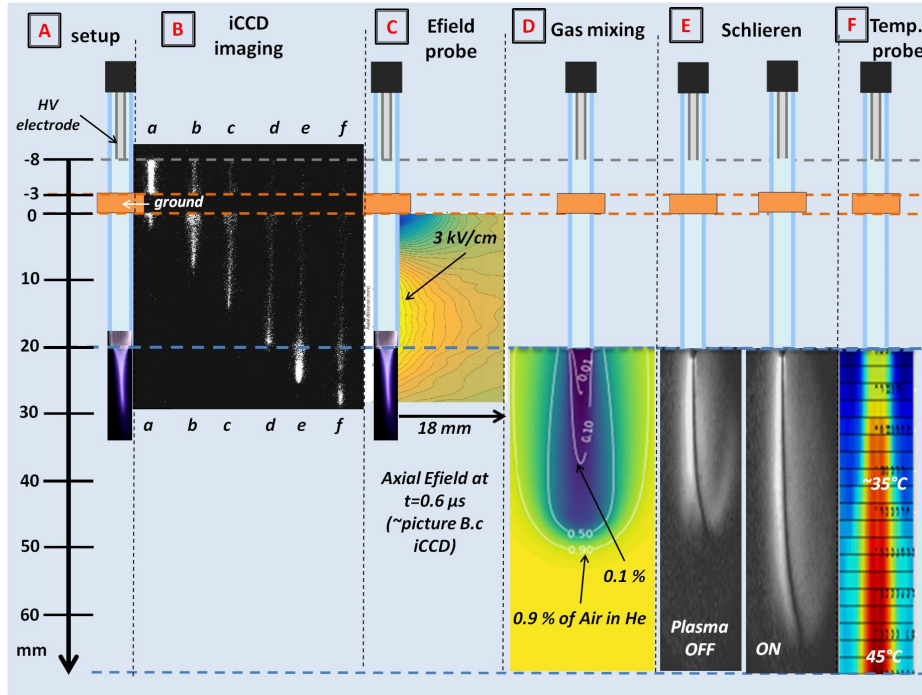

Fig. 16 – comparison of measurements performed on the same APPJ positioned on the figure with the same spatial scale: A. setup and long exposure image, B. fast iCCD imaging (a to f) with 100 ns exposure time, C. surrounding field obtained with commercial probe (scale [0-3kV/cm] from blue to yellow), D. simulation of gas mixing without plasma (pure He in blue, 0.9% Air in He in yellow), E. Schlieren imaging without and with plasma, and F. gas temperature measurement obtained with GaAs optical fiber probe (scale [18 - 45°C from blue to red])

Picture A on Fig.16 shows that the dimensions of the plasma plume visible with emitted light ($\sim 10\text{mm}$) is very small compared to the characteristic size of phenomena driving this APPJ (more than 70mm length). This is clear from parts C to F on Fig.16 all shown with the same scale as the iCCD imaging on part B. On part C the axial field measured with a commercial probe at time $t = 0.6\mu\text{s}$ corresponding to image (B.c) shows strong field values about 3 kV.cm^{-1} few cm around the tube and the plume which could be important for applications. On parts E the Schlieren imaging of the gas flow mixing (700 sccm He) shows that buoyancy force is limiting the vertical extension of the He flow at a position where gas flow simulation (part D) estimates only 0.9% of air is mixed into He. However when the plasma is ignited, the laminar flow region is extended further down up to $\sim 70\text{mm}$ which is also the distance at which the maximum gas temperature of 45°C is measured (see temperature map on part F). The reason why the plasma is expanding the laminar flow on loonger distance is still controversial in litterature and could either be a consequence of ionic wind (or Electro-Hydro Dynamic force EHD) or due to gas heating [181–184]. Attempt were done to calculate the relative contribution of gas heating and EHD

but the gas heating mechanism itself is not yet understood. For instance in [185] the maximum temperature is considered right at the exit of the nozzle which is not corresponding to measurements of part F in our case. Exothermic chemical reactions could be responsible for this heating away from the nozzle. It is in any case clear that the proportion of air entrained in the gas flow determine the length of the plasma plume [51, 186]. Therefore understanding the 10mm of plasma plume require to describe accurately the 100mm of gas dynamic around!

Until now fluid models reproducing the development of ionization waves are not solving simultaneously the fluid dynamic and the chemistry induced [187] even if recent works are addressing this challenge [188]. Besides the complexity of the coupled phenomena, the validity of the models is often difficult to assess since the experimental data available on APPJ are most of the time focused on the chemistry induced which is not the main output of fluid models due to the limited kinetic schemes included in these models. In [187] in order to bridge the gap between models output and experimental data, a calculation of electronic excited states of He and N₂ is included for comparison with emission spectroscopy. In the same paper a comparison is made with the electric field measured with a commercial probe placed aside the capillary tube. This type of probe can be used to map the electric field in the surrounding of the APPJ setup as it is done in Fig.16 but the dimension are too large to insert it inside the plasma. Moreover these probes are calibrated for an homogeneous field which is very different from the situation of an APPJ. There is an obvious lack of experimental data on parameters that are direct output of fluid models such as Electric field E_{field} , electron density n_e and electron temperature (T_e). **Our approach is therefore to develop and apply experimental methods capable of providing basic parameters of the plasma (E_{field} , n_e , T_e) in a reproducible APPJ source applicable later on various targets.** Fig.17 gives example of measurements obtained with Stark Polarization spectroscopy (SP) and Thomson Scattering (TS) with the jet vertical pointing downward.

SP is based on the detection of the emission of $He(2^1P-4^1D)$ allowed line at 492.19 nm and the forbidden $He(2^1P-4^1F)$ line nearest to it as described in [44, 189]. Since the signal detected comes from the light emission of the plasma, the E_{field} measured is dominated by the peak value in the ionization front. The E_{field} as a function of position shown on Fig.17 is therefore an image of the time evolution of the maximum field along the propagation of the discharge. The results obtained for a sinusoidal power source with 2 kV amplitude and a pulsed power source with 6 kV amplitude are shown on Fig.17. Inside the tube, E_{field} is decreasing for both power supply probably because of the charge losses on the wall of the capillary tube (in [52] we have estimated this loss to $\sim 7.5pC \cdot mm^{-1}$). The field is stronger with the pulsed power supply which could be simply a consequence of a higher voltage amplitude (6kV instead of 2kV). However it could also results from a weaker "memory effect" due to remaining charge and/or metastable states density from one ignition to the next one since the pulsed jet is ran at 5kHz instead of 30kHz. The gas flow has little influence on the field inside the capillary tube (which seems contradictory with

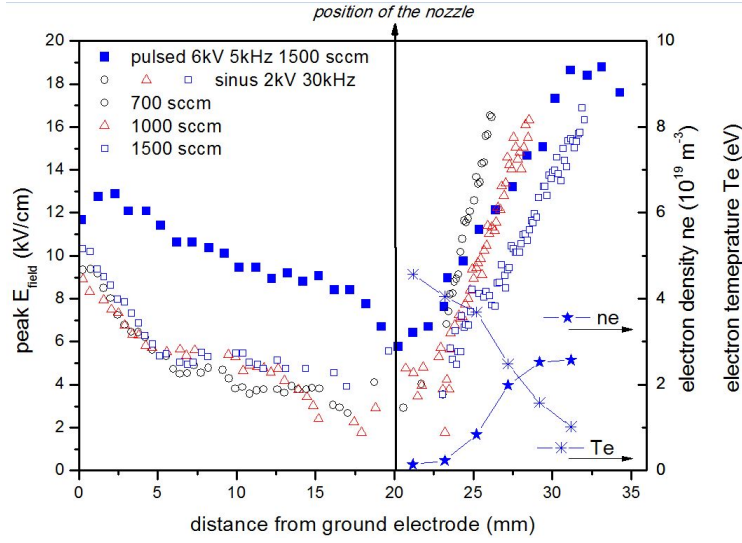

Fig. 17 – Electric field measured along plasma propagation inside the capillary tube and in the plume for both sinusoidal (opened symbols) and pulsed (solid symbols) power supply and different gas flows (700, 1000, 1500 sccm). The electron density and electron temperature measured by Thomson scattering is shown on the right axis for the case at 1500 sccm and pulsed power supply

the possible role of "memory effect" on the comparison pulsed/sinusoidal jet). On the contrary, after the nozzle the influence of the gas mixing, and therefore the gas flow, on E_{field} is evident. A linear increase of E_{field} is observed after the nozzle for all flows. The conical shape of the plume imposed by the structure of the helium flow expanding in air that is more dense, increase the charge density by reducing the volume of the ionization front [44]. This is confirmed by the measurement of n_e by TS which showing indeed an increase along the plume axis. As far as we know only one paper [190] reports n_e measured with TS in a helium APPJ giving similar values as in our case with n_e around few $10^{19}cm^{-3}$. Fluid models are often giving lower values of electron density which might be a consequence of cumulative effect over several period of the power supply in experiments.

When the gas flow is increased, the slope of the E_{field} reduces simply because of the extension of the length of the pure helium region as shown by Schlieren imaging (see part E fig 16). It is worth noticing that in spite of a higher field amplitude with the pulsed power supply, the slope of the peak E_{field} in the plume is the same as with the sinusoidal voltage for a given gas flow (1500 sccm in this case), showing that the gas mixing is the dominant parameter structuring the plume of the APPJ.

The description of the APPJ development is still phenomenological but to the best of our knowledge, it is the first time that measurements of peak E_{field} , n_e and (T_e) are successfully performed in the same plasma source. It opens the door to detailed comparison with fluid models but it also gives us an excellent tool for checking the

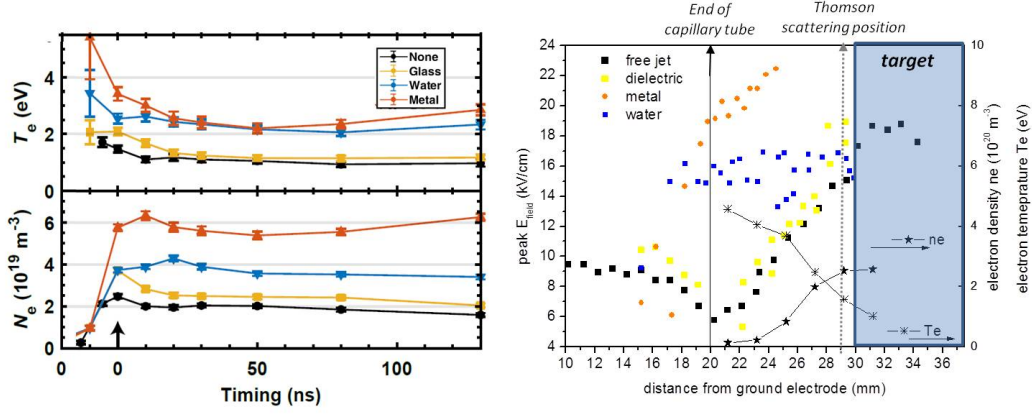

Fig. 18 – measurements performed with the same APPJ as in fig. 16 and fig. 17 in freely expanding jet and above glass, metal and water targets placed at 10 mm. a) Results of electron density and temperature obtained from Thomson scattering, b) Electric field values from Stark polarisation spectroscopy

influence of targets on the APPJ propagation.

3.3.2. APPJ above surfaces

We are only starting to investigate the influence of targets on the development of our APPJ source in the frame of the PhD of Marlous Hofmans (cosupervision with Ana Sobota TU/e). As a first step to identify the main influence of a surface on the APPJ, very different targets are compared: a metal (copper plate), an insulator (glass or PVC plate) and a liquid (water). We have performed SP and TS in the jet impacting the surface at 90° vertically (see fig.18). The target is placed at 10mm from the nozzle and the jet is powered with a pulsed voltage of 6 kV amplitude.

The left graph shows TS results obtained with the laser focus 1mm above the surfaces as a function of time. In this case $t = 0$ corresponds to the time at which the ionization front monitored with iCCD camera passes at the focal point of the laser. A small decay of T_e is obtained after the ionization front arrival but the n_e remains almost constant over 120ns as expected in the conductive channel left behind a streamer. Surprisingly a dielectric target do not seem to affect E_{field} nor n_e , T_e . From Schlieren imaging it is clear that at least the gas mixing is modified when any target, including dielectric target, is facing the gas flow. The results of fig.18 probably means a gas flow of 1500 sccm is large enough to have an almost pure helium gas reaching the surface at 10mm distance in spite of flow modifications induced by the target. However water surface and copper plate, both not grounded, enhance E_{field} , n_e and T_e for the same distance. After the impact of the ionization front on the surface, a channel with high charge density is established from the high voltage electrode to the conductive target and higher current can be pulled in the

plume. The electric field is enhanced not only in the vicinity of the target surface but all over the gap between the nozzle and the target, and even inside the capillary tube. As the field detected with SP is only the maximum field in the ionization front, it is not yet clear how the field enhancement occurs before the ionization front reaches the target. When water or copper surface are used, several "re-strike" of the discharge are observed after impact like in [191, 192]. More measurements will be necessary with different gas flows, distances, targets conductivity in order to fully understand the influence of targets on the APPJ. In any case it is clear from these measurements that no industrial application of APPJ can be developed without considering how the substrate that need to be treated will modify the properties of the plasma. In biomedical applications it is sometimes claimed that electric field induced by the plasma on tissues can influence electroporation of cell membrane. As the target itself modifies the field in the plasma, a good control of the process would require a better understanding of the interaction depending on the nature of tissues treated.

There are very few method measuring directly under plasma exposure quantitative data of the effect induced by plasma in/on a target. Most of the time material processing studies make use of diagnostics to characterize modification of materials after plasma exposure. These measurements gives information only on the material structure without direct connection with the plasma properties. It is however possible to measure the electric field, the temperature gradient and possibly other modification induced in a dielectric target by using polarimetry techniques.

3.3.3. Measures on dielectric surfaces with Mueller polarimetry

APPJs can modify the surface of a material in different ways, especially chemically, but we have decided to focus our work primarily on determining fundamental parameters of the plasma spreading over the surface, similarly to what we have done for the propagation in the gas phase. Determining the electric field induced on a surface E_{surf} and in the bulk of a target E_{bulk} as well as the surface charge deposited (Q_{surf}) by the plasma have been our first goals before investigating possible chemical etching or other surface processes.

There are not many options to measure surface field under plasma at atmospheric pressure [193]. It is possible to use capacitive probes to determine surface charges but the spatial resolution is limited by the deconvolution of the signal coming from different location on the surface, and an image of the distribution of charge require to scan step by step the whole surface [194]. Instead we have chosen to use optical method based on electro-optic effects (and in particular the Pockels effect) induced in specific birefringent crystals.

The Pockels effect corresponds to a variation of refractive index of a material when an electric field is applied. When a polarized light is shined through a crystal sensitive to Pockels effect, a retardance is induced that can be measured to deduce the E_{surf} . Measurements of electric field induced by various plasma sources based on Pockels effect were first used with corona discharges for flashover studies [195]. In [196] we

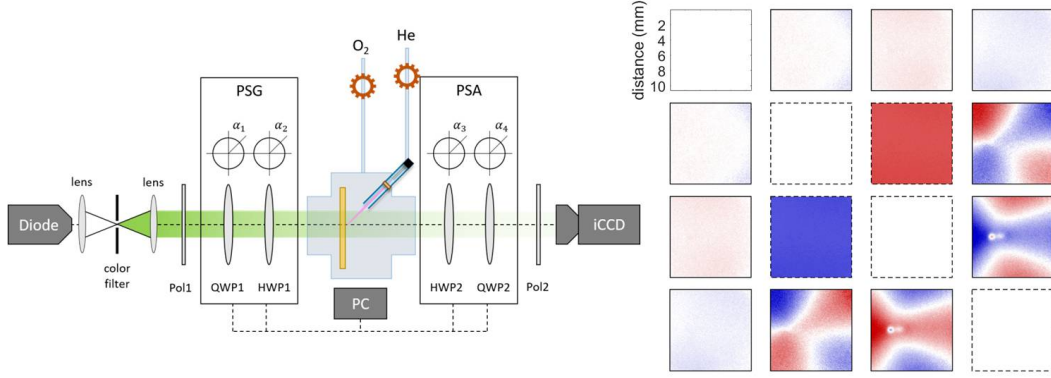

Fig. 19 – optical setup developed to obtain the sixteen components of the Mueller matrix M of the crystal under plasma exposure, and the corresponding non-depolarization matrix L_M deduced from M after impact of the APPJ on a BSO crystal

were reporting for the first time E_{bulk} measurements induced in a BSO ($Bi_{12}SiO_{20}$) crystal by the APPJ source described in section 3.3.1 using a Sénarmont setup. This type of configuration measures solely the retardance in one optical coordinate system which has some limitation as it will be discussed later. Nevertheless with this first approach a parametric study on the E_{surf} induced Q_{surf} deposited with our APPJ source was done at the beginning of the thesis of Elmar Slikboer (co-supervision with A. Sobota, TU/e and E. Garcia-Caurel, LPICM, Ecole polytechnique) [52]. It is important to note here that it is not straight forward to relate the measured value of electric field E_{bulk} to the amount of charge deposited Q_{surf} and surface field E_{surf} . Indeed the retardance detected is directly related to the field across the thickness of the crystal. The typical thickness of BSO crystals used is $500\mu m$. If the field applied on the crystal is homogeneous over dimensions much larger than the crystal thickness, then a simple approximation of a parallel plate capacitor would give a good value of Q_{surf} . Unfortunately the spreading of the plasma jet over the surface has characteristic dimensions in the mm range and a correction procedure taking into account the penetration of the field inside the crystal need to be done, as proposed in [52].

In the frame of the PhD of Elmar Slikboer the diagnostic has been extended further by developing an **imaging Mueller polarimeter** shown on fig.19

The Mueller matrix M is a general tool to describe the optical properties of a material as described in [197]. A Mueller matrix is a 4×4 matrix that describes both the behaviour of polarized light (like Jones matrices) and depolarized light which will be useful in future work with complex surfaces. The new polarimeter developed in collaboration with E. Garcia-Caurel from LPICM, consists of two polarizers (polarization state generator PSG, and polarization state analyser PSA) each composed of two ferroelectric liquid crystals. By varying the voltage applied on the four liquid

crystals, 16 different polarization states of the light passing through the crystal can be imposed and detected on an iCCD camera. Knowing the Mueller matrix of the PSA and PSG, the matrix M of the crystal can be deduced. This matrix contains all the optical properties but the informations are entangled. The procedure to analyse M is given in [56]. The final result is the non-depolarization matrix L_m containing diattenuation and birefringence (see eqn. 7)

$$L_m = \begin{bmatrix} 0 & \beta & \gamma & \delta \\ \beta & 0 & \mu & \nu \\ \gamma & -\mu & 0 & \eta \\ \delta & -\nu & -\eta & 0 \end{bmatrix} \longrightarrow \begin{bmatrix} \text{Depolarization} = 0 \\ \text{Diattenuation} = \beta \ \gamma \ \delta \\ \text{Retardance} = \eta \ \nu \ \mu \end{bmatrix} \quad (7)$$

The elements η and $-\eta$ gives the linear birefringence in the $(0/90^\circ)$ coordinate system, while ν and $-\nu$ show the linear birefringence in the diagonal system $(45/135^\circ)$. The right part of fig.19 shows an example of experimental matrix L_m obtained after impact of the plasma jet on a BSO crystal. By expanding the light source beam and detecting on the chip of an iCCD camera, each element of the matrix L_m is an image of the crystal. Therefore all the optical properties can be deduced at every point of the image.

The elements η , $-\eta$, ν and $-\nu$ on fig.19 exhibit a background structure as well as a white "circle with a tail" in the middle of η and $-\eta$. This small white structure appears only after impact of the ionization front and is due to the charge deposited by the plasma on the crystal. The background structure visible on the four elements is on the contrary much more stable in time. When the plasma is ignited it takes a few minutes to stabilize and then remains constant. This structure is the result of surface temperature gradient. We have been able to use this background structure to determine the pattern of the temperature gradient at the same time as the field measurement. A maximum of surface heating about 11° has been deduced from this background signal demonstrating high sensitivity of the detected signal to small temperature variations [56].

As the background structure induced by temperature is stable in time, it can easily be subtracted to analyse properly the field induced by the plasma jet. The first row of Fig.20 shows an example of the element η and ν from matrix L_m on BSO crystal after subtraction of the temperature background.

Only the element ν in the diagonal system $(45/135^\circ)$ shows the field induced by the plasma. The signal on this element is proportional to the electric field strength along the z direction (ie perpendicular to the crystal surface). The maximum field strength obtained is about $6kV/cm$ averaged throughout the $500\mu m$ thickness of the crystal which corresponds roughly to $\sim 10kV/cm$ on the surface exposed to the plasma.

The second row of Fig.20 is measured in the same way but with another crystal ($Fe : LiNbO_3$ "Felinbo"). The symetry point group of Felinbo is different from BSO and as a result its optical response on the linear birefringent part is sensitive to the radial component of the field E_x and E_y instead of E_z for BSO. Both crystals have

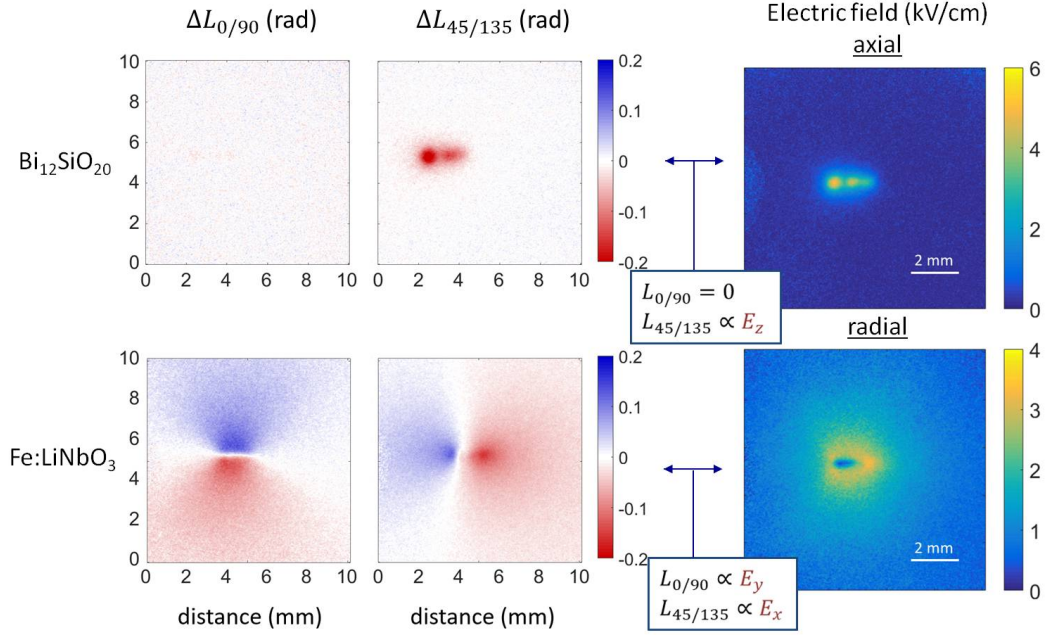

Fig. 20 – axial and radial field component on surfaces of two different crystals of $\text{Bi}_{12}\text{SiO}_{20}$ and $\text{Fe}:\text{LiNbO}_3$ exposed to the same APPJ source

high permittivity so that the plasma is behaving similarly when spreading on them. The profile of radial field obtained from the Felinbo is therefore matching the pattern of perpendicular field obtained with BSO.

The depolarization part is not discussed here because measurement done with only a BSO or Felinbo crystal do not exhibit any depolarization. However the separation of the depolarization contribution obtained with our polarimeter becomes a very important source of information when the technique is applied to more complex samples. Preliminary studies are currently being performed for two different applications: the use of plasma jet on biological tissues, and the effect of ionization waves on catalytic materials.

The first step on biological tissue will be to detect electric field through the sample thanks to the separation of the depolarization signal from the retardance signal possible with Mueller polarimetry. Later the use of the depolarization signal could be beneficial to obtain more information on the modification of the sample.

Catalytic materials are usually porous in order to promote exchanges with the gas phase. Even a thin coating of catalytic material induce a strong depolarization of the transmitted light. Studying with Mueller polarimetry a thin catalyst coating deposited on BSO could allow us to determine the ageing of catalyst observed from the modification of depolarization. In addition BSO crystals are mostly transparent in the infrared, which allow us to study the same sample with infrared absorption.

The coupling of Mueller imaging with FTIR in transmission will give us for the first time a possibility to correlate the electric field induced at the surface of a catalyst with the chemical species adsorbed on the surface and the corresponding surface reactivity.

These two applications are only examples of the variety of information that can be obtained on plasma surface interaction with Mueller polarimetry. This instrument will therefore be a corner stone of our research in the coming years.

4. Conclusions and perspectives

Plasma/surface interaction at atmospheric or medium range pressure (1-1000 mbar) is the common thread running through my research. The use of energy stored in the form of vibrational excitation of molecules, or the study of ionization waves on surfaces are in fact two aspects of the same quest: to highlight how cold plasmas can offer new way of molecule synthesis and even reinvent catalysis with the use of short life species. This general idea naturally finds its application in CO₂ recycling.

Optimizing CO₂ conversion by using vibrational excitation and catalytic materials is at the same time a case study of molecule conversion in plasma at mid-range pressure, and a major societal challenge. I have started working on this topic in 2015 at LPP and it will be the core of my work in the near future. The research on plasma/catalysis for CO₂ conversion at pressure 10-100 mbar has been supported by an ANR JCJC SYCAMORE running until 2020. In order to develop further the field of plasma catalysis for molecule synthesis, I am the scientific coordinator of an ITN-EJD named PIONEER submitted in january 2019 for the second time. This project is dedicated to plasma/catalyst coupling for CO₂ recycling. This project aims at educating 15 PhD student all across Europe to form a new generation of inter-disciplinary experts in both plasma physics and catalysis to invent technologies of CO₂ recycling.

In a broader view, the role of vibrational excitation and surface catalytic reactions can go far beyond the single CO₂ conversion. Ammonia formation in N₂/H₂ plasmas for fertilizing industry is another example of potential field of investigation. Interestingly, both CO₂ and N₂/H₂ plasmas have relevance in planetology in addition to their industrial potential.

It has been mentioned in section 3.2.2 that Mars atmosphere present the ideal conditions to promote vibrational excitation. This is a great opportunity to use plasma for oxygen production from in situ ressources. The CO₂ vibrational kinetic is also pertinent for studying consequences of lightning in Mars atmosphere [198].

Concerning N₂/H₂, Audrey Chatain has started a PhD in 2017 (co-supervision with Nathalie Carrasco LATMOS) to simulate the ageing of aerosols from Titan atmosphere. The complex chemistry happening in Titan leads to the formation of complex organic molecules in a partially ionized atmosphere in a large range of pressure. Good analogues of dust particles detected in Saturn's moon atmosphere, called "Tholins" can be synthesized with CH₄/N₂/H₂ plasmas [199]. Studying tholins with

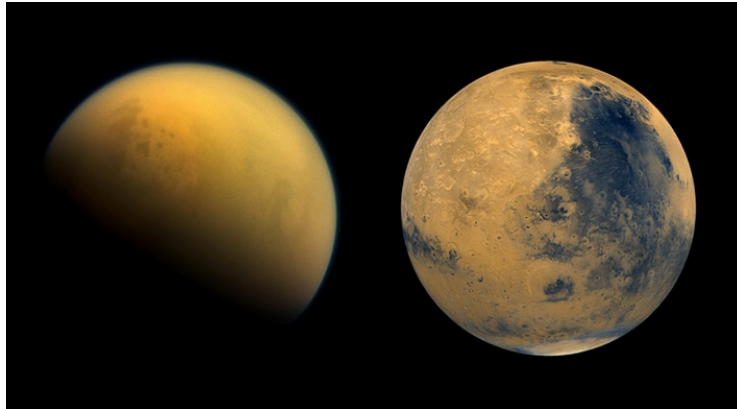

Fig. 21 – *Titan the satellite of Saturn (to the left) and Mars (to the right) gives two examples of the interest of non thermal plasma for studying planetary atmosphere evolution, or for space missions*

infra-red absorption under direct N_2/H_2 plasma exposure is helping to understand the evolution of the particles in Titan. The very long time scale of chemical kinetics taking place in planetary atmosphere can be well reproduced in some cases by using plasma as a model system speeding up the chemistry. This project just starting demonstrates how the techniques developed for studying plasma/catalysis can open the door for very different fields.

The development of ionization waves over surfaces is another strong line of my research for the coming years. As discussed in section 3.3 we have now a well characterized source and powerful diagnostic tools to obtain in the same setup a full characterization of the main plasma parameters and the resulting effects induced in targets. Mueller polarimetry gives us a chance in the near future to investigate more complex surfaces than only birefringent crystals. We intend to use infrared absorption through catalysts or other targets in addition to the Mueller polarimetry to study the link between the surface field and the chemical reactivity.

Plasma/surface interaction at elevated pressure remains poorly understood and it still offers many opportunities for fundamental investigations. The great success of cold plasmas in the industry have not been achieved because plasma technologies are less expensive or easier to implement. Each time fundamental scientific arguments have proved that no other alternative technologies could replace plasmas (low temperature atomic oxygen production to stabilize ozone molecule, unidirectionality of ions for etching processes, intense UV emission for lighting, etc...). Plasmas at atmospheric or slightly reduced pressure certainly have a future for the synthesis of molecules, surface treatment or biomedical applications but the demonstration must be made by understanding the fundamental mechanisms at stake. In this respect plasma physicists have a bright future on condition to not give into a race to blind tests in systems that are too complex for understanding.

In this context, the education of young plasma physicists, and also of users of plasma from other fields is very important. I am honoured to contribute to this necessary effort through my participation as lecturer and as co-chair with Anna Bourdon since 2017 to the International School on Low Temperature Plasma Physics: Basics and Applications, held in Bad Honnef for more than 20 years.

I also believe important to develop joint tools across the plasma community for a more efficient use of data produced. the round-robin exercise presented during last GEC conference in Pittsburgh is an example of the need for harmonisation of data in plasma physics and chemistry. The measurements we are performing in a pulsed glow discharge can hopefully contribute to establish a set of validated data on plasma chemistry. From an experimental point of view, the COST jet [200] is a very interesting example of atmospheric plasma source aiming at joining efficiently the measurements done in different plasma laboratories. Until now there is no equivalent for comparison of ionization waves sources and the literature is full of data hardly comparable with each other. The definition of a configuration suitable both for experiments and fluid models would be an interesting goal to pursue.

As a final word, I wish to warmly thank all the PhD students I had the chance to work with. Both those who have already defended their thesis (Daniil Marinov, Christelle Barakat, Bart Klarenaar), as well as those I currently co-supervise (Elmar Slikboer, Ana-Sofia Morillo-Candas, Marlous Hofmans, Audrey Chatain, Polina Ogloblina), I have the chance to work with competent, enthusiastic and motivated students who make my work even more interesting. Without them, a lot of the results presented throughout this "habilitation" thesis would not have been obtained.

Patents

- [1] Guaitella Olivier, Rousseau Antoine, Youssef Joseph. Système de traitement d'air / Air treatment system. (WO 2012127169) (2012) publication date: 27th september 2012
- [2] Allegraud Katia, Guaitella Olivier, Rousseau Antoine. Traitement de gaz par plasma de surface / Surface plasma gas processing. (WO 2009007588) (2009) publication date: 15th january 2009

References

- [1] A Rousseau, O Guaitella, J Röpcke, LV Gatilova, and YA Tolmachev. Combination of a pulsed microwave plasma with a catalyst for acetylene oxidation. *Applied physics letters*, 85(12):2199–2201, 2004. 1
- [2] O Guaitella, L Gatilova, and A Rousseau. Plasma-photocatalyst interaction: Production of oxygen atoms in a low pressure discharge. *Applied Physics Letters*, 86(15):151502, 2005. 1
- [3] F Thevenet, O Guaitella, JM Herrmann, A Rousseau, and C Guillard. Photocatalytic degradation of acetylene over various titanium dioxide-based photocatalysts. *Applied Catalysis B: Environmental*, 61(1):58–68, 2005. 1
- [4] A Rousseau, O Guaitella, L Gatilova, F Thevenet, C Guillard, J Röpcke, and GD Stancu. Photocatalyst activation in a pulsed low pressure discharge. *Applied Physics Letters*, 87(22):221501, 2005. 1
- [5] O Guaitella, F Thevenet, C Guillard, and A Rousseau. Dynamic of the plasma current amplitude in a barrier discharge: influence of photocatalytic material. *Journal of Physics D: Applied Physics*, 39(14):2964, 2006. 1
- [6] K Allegraud, O Guaitella, and A Rousseau. Spatio-temporal breakdown in surface dbds: evidence of collective effect. *Journal of Physics D: Applied Physics*, 40(24):7698, 2007. 1
- [7] A Rousseau, O Guaitella, L Gatilova, M Hannemann, and J Röpcke. Measurement of the c2h2 destruction kinetics by infrared laser absorption spectroscopy in a pulsed low pressure dc discharge. *Journal of Physics D: Applied Physics*, 40(7):2018, 2007. 1
- [8] F Thevenet, O Guaitella, E Puzenat, J-M Herrmann, A Rousseau, and C Guillard. Oxidation of acetylene by photocatalysis coupled with dielectric barrier discharge. *Catalysis Today*, 122(1):186–194, 2007. 1
- [9] F Thevenet, O Guaitella, C Guillard, E Puzenat, G Stancu, J Roepcke, and A Rousseau. Comparison of the plasma-photocatalyst synergy at low and atmospheric pressure. *Int. J. Plasma Environ. Sci. Technol*, 1(1):52–56, 2007. 1
- [10] Sébastien Célestin, G Canes-Boussard, Olivier Guaitella, Anne Bourdon, and Antoine Rousseau. Influence of the charges deposition on the spatio-temporal self-organization of streamers in a dbd. *Journal of Physics D: Applied Physics*, 41(20):205214, 2008. 1
- [11] Sebastien Celestin, Katia Allegraud, Gregoire Canes-Boussard, Noemi Leick, Olivier Guaitella, and Antoine Rousseau. Patterns of plasma filaments propagating on a dielectric surface. *IEEE Transactions on Plasma Science*, 36(4):1326–1327, 2008. 1
- [12] O Guaitella, F Thevenet, E Puzenat, C Guillard, and A Rousseau. C 2 h 2 oxidation by plasma/tio 2 combination: influence of the porosity, and photocatalytic mechanisms under plasma exposure. *Applied Catalysis B: Environmental*, 80(3):296–305, 2008. 1, 9, 26
- [13] J Röpcke, S Welzel, N Lang, F Hempel, L Gatilova, O Guaitella, A Rousseau, and PB Davies. Diagnostic studies of molecular plasmas using mid-infrared semiconductor lasers. *Applied Physics B: Lasers and Optics*, 92(3):335–341, 2008. 1

-
- [14] F Thevenet, O Guaitella, E Puzenat, C Guillard, and A Rousseau. Influence of water vapour on plasma/photocatalytic oxidation efficiency of acetylene. *Applied Catalysis B: Environmental*, 84(3):813–820, 2008. 1, 9
- [15] C Lazzaroni, X Aubert, D Marinov, O Guaitella, G Stancu, S Welzel, A Pipa, J Röpcke, N Sadeghi, and A Rousseau. Microplasmas and micro-jets. *Publ Astron Obs Belgrade*, 84:248–249, 2008. 1
- [16] Sébastien Célestin, Zdenek Bonaventura, Olivier Guaitella, Antoine Rousseau, and Anne Bourdon. Influence of surface charges on the structure of a dielectric barrier discharge in air at atmospheric pressure: experiment and modeling. *The European Physical Journal-Applied Physics*, 47(2), 2009. 1
- [17] CD Pintassilgo, Olivier Guaitella, and Antoine Rousseau. Heavy species kinetics in low-pressure dc pulsed discharges in air. *Plasma Sources Science and Technology*, 18(2):025005, 2009. 1
- [18] PH Ceccato, O Guaitella, M Rabec Le Gloahec, and A Rousseau. Time-resolved nanosecond imaging of the propagation of a corona-like plasma discharge in water at positive applied voltage polarity. *Journal of Physics D: Applied Physics*, 43(17):175202, 2010. 1
- [19] Olivier Guaitella, Claudia Lazzaroni, Daniil Marinov, and Antoine Rousseau. Evidence of atomic adsorption on TiO_2 under plasma exposure and related C_2H_2 surface reactivity. *Applied Physics Letters*, 97(1):011502, 2010. 1
- [20] O Guaitella, M Hübner, S Welzel, D Marinov, J Röpcke, and A Rousseau. Evidence for surface oxidation on pyrex of NO into NO_2 by adsorbed O atoms. *Plasma Sources Science and Technology*, 19(4):045026, 2010. 1
- [21] Daniil Marinov, Olivier Guaitella, Antoine Rousseau, and Yuri Ionikh. Production of molecules on a surface under plasma exposure: example of NO on pyrex. *Journal of Physics D: Applied Physics*, 43(11):115203, 2010. 1, 21
- [22] CD Pintassilgo, V Guerra, O Guaitella, and A Rousseau. Modelling of an afterglow plasma in air produced by a pulsed discharge. *Plasma Sources Science and Technology*, 19(5):055001, 2010. 1
- [23] SM Starikovskaia, K Allegraud, O Guaitella, and A Rousseau. On electric field measurements in surface dielectric barrier discharge. *Journal of Physics D: Applied Physics*, 43(12):124007, 2010. 1
- [24] Olivier Guaitella, M Hübner, Daniil Marinov, V Guerra, CD Pintassilgo, S Welzel, J Röpcke, and Antoine Rousseau. Oxidation of NO into NO_2 by surface adsorbed O atoms. *Contributions to Plasma Physics*, 51(2-3):176–181, 2011. 1
- [25] Olivier Guaitella, Ilya Marinov, and Antoine Rousseau. Role of charge photodesorption in self-synchronized breakdown of surface streamers in air at atmospheric pressure. *Applied Physics Letters*, 98(7):071502, 2011. 1
- [26] M Hübner, S Welzel, Daniil Marinov, Olivier Guaitella, S Glitsch, Antoine Rousseau, and J Röpcke. Triple Q: a three channel quantum cascade laser absorption spectrometer for fast multiple species concentration measurements. *Review of Scientific Instruments*, 82(9):093102, 2011. 1
- [27] Ilya L Marinov, Olivier Guaitella, Antoine Rousseau, and Svetlana M Starikovskaia. Successive nanosecond discharges in water. *IEEE Transactions on Plasma Science*, 39(11):2672–2673, 2011. 1
- [28] S Welzel, O Guaitella, C Lazzaroni, CD Pintassilgo, A Rousseau, and J Röpcke. No kinetics in pulsed low-pressure plasmas studied by time-resolved quantum cascade laser absorption spectroscopy. *Plasma Sources Science and Technology*, 20(1):015020, 2011. 1
- [29] D Marinov, O Guaitella, JP Booth, and A Rousseau. Direct observation of ozone formation on SiO_2 surfaces in O_2 discharges. *Journal of Physics D: Applied Physics*, 46(3):032001, 2012. 1, 26
- [30] M Hübner, D Marinov, O Guaitella, A Rousseau, and J Röpcke. On time resolved gas temperature measurements in a pulsed dc plasma using quantum cascade laser absorption spectroscopy. *Measurement Science and Technology*, 23(11):115602, 2012. 1

- [31] D Marinov, D Lopatik, O Guaitella, M Hübner, Y Ionikh, J Röpcke, and A Rousseau. Surface vibrational relaxation of n₂ studied by co₂ titration with time-resolved quantum cascade laser absorption spectroscopy. *Journal of Physics D: Applied Physics*, 45(17):175201, 2012. 1, 21
- [32] M Dang Van Sung Mussard, O Guaitella, and A Rousseau. Propagation of plasma bullets in helium within a dielectric capillary: influence of the interaction with surfaces. *Journal of Physics D: Applied Physics*, 46(30):302001, 2013. 1
- [33] Marko Huebner, Olivier Guaitella, Antoine Rousseau, and Juergen Roepcke. A spectroscopic study of ethylene destruction and by-product generation using a three-stage atmospheric packed-bed plasma reactor. *Journal of Applied Physics*, 114(3):033301, 2013. 1
- [34] D Lopatik, D Marinov, O Guaitella, A Rousseau, and J Röpcke. On the reactivity of plasma-treated photo-catalytic tio₂ surfaces for oxidation of c₂h₂ and co. *Journal of Physics D: Applied Physics*, 46(25):255203, 2013. 1
- [35] Daniil Marinov, Vasco Guerra, Olivier Guaitella, Jean-Paul Booth, and Antoine Rousseau. Ozone kinetics in low-pressure discharges: vibrationally excited ozone and molecule formation on surfaces. *Plasma Sources Science and Technology*, 22(5):055018, 2013. 1, 26
- [36] I Marinov, O Guaitella, A Rousseau, and SM Starikovskaia. Modes of underwater discharge propagation in a series of nanosecond successive pulses. *Journal of Physics D: Applied Physics*, 46(46):464013, 2013. 1
- [37] I Marinov, O Guaitella, A Rousseau, and SM Starikovskaia. Cavitation in the vicinity of the high-voltage electrode as a key step of nanosecond breakdown in liquids. *Plasma Sources Science and Technology*, 22(4):042001, 2013. 1
- [38] A Sobota, Olivier Guaitella, and Enric Garcia-Caurel. Experimentally obtained values of electric field of an atmospheric pressure plasma jet impinging on a dielectric surface. *Journal of Physics D: Applied Physics*, 46(37):372001, 2013. 1, 12, 39
- [39] Christelle Barakat, Paul Gravejat, Olivier Guaitella, Frédéric Thévenet, and Antoine Rousseau. Oxidation of isopropanol and acetone adsorbed on tio₂ under plasma generated ozone flow: Gas phase and adsorbed species monitoring. *Applied Catalysis B: Environmental*, 147:302–313, 2014. 1, 8, 9
- [40] Vasco Guerra, Daniil Marinov, Olivier Guaitella, and Antoine Rousseau. No oxidation on plasma pretreated pyrex: the case for a distribution of reactivity of adsorbed o atoms. *Journal of Physics D: Applied Physics*, 47(22):224012, 2014. 1, 23
- [41] D Marinov, O Guaitella, T de los Arcos, A von Keudell, and A Rousseau. Adsorption and reactivity of nitrogen atoms on silica surface under plasma exposure. *Journal of Physics D: Applied Physics*, 47(47):475204, 2014. 1, 25
- [42] D Marinov, D Lopatik, O Guaitella, Y Ionikh, J Röpcke, and A Rousseau. Surface deactivation of vibrationally excited n₂ studied using infrared titration combined with quantum cascade laser absorption spectroscopy. *Journal of Physics D: Applied Physics*, 47(1):015203, 2013. 1, 30, 31
- [43] CD Pintassilgo, V Guerra, O Guaitella, and A Rousseau. Study of gas heating mechanisms in millisecond pulsed discharges and afterglows in air at low pressures. *Plasma Sources Science and Technology*, 23(2):025006, 2014. 1, 30
- [44] A Sobota, O Guaitella, and A Rousseau. The influence of the geometry and electrical characteristics on the formation of the atmospheric pressure plasma jet. *Plasma Sources Science and Technology*, 23(2):025016, 2014. 1, 39, 41, 42
- [45] F Thevenet, L Sivachandiran, O Guaitella, C Barakat, and A Rousseau. Plasma–catalyst coupling for volatile organic compound removal and indoor air treatment: a review. *Journal of Physics D: Applied Physics*, 47(22):224011, 2014. 1, 2, 8
- [46] JP Booth, D Marinov, M Foucher, O Guaitella, D Breteau, L Cabaret, and C Drag. Gas temperature measurements in oxygen plasmas by high-resolution two-photon absorption laser-induced fluorescence. *Journal of Instrumentation*, 10(11):C11003, 2015. 1, 28, 35

-
- [47] O Guaitella and A Sobota. The impingement of a khz helium atmospheric pressure plasma jet on a dielectric surface. *Journal of Physics D: Applied Physics*, 48(25):255202, 2015. 1, 39
- [48] M Hübner, S Gortschakow, O Guaitella, D Marinov, A Rousseau, J Röpcke, and D Loffhagen. Kinetic studies of no formation in pulsed air-like low-pressure dc plasmas. *Plasma Sources Science and Technology*, 25(3):035005, 2016. 1
- [49] Daniil Marinov, Cyril Drag, Christophe Blondel, Olivier Guaitella, Judith Golda, Bart Klarenaar, Richard Engeln, Volker Schulz-von der Gathen, and Jean-Paul Booth. Pressure broadening of atomic oxygen two-photon absorption laser induced fluorescence. *Plasma Sources Science and Technology*, 25(6):06LT03, 2016. 1, 28, 35
- [50] Elmar Slikboer, Olivier Guaitella, and Ana Sobota. Time-resolved electric field measurements during and after the initialization of a khz plasma jet: from streamers to guided streamers. *Plasma Sources Science and Technology*, 25(3):03LT04, 2016. 1, 12
- [51] A Sobota, O Guaitella, GB Sretenović, IB Krstić, VV Kovačević, Adam Obrusnik, Yen Nhi Nguyen, L Zajíčková, BM Obradović, and MM Kuraica. Electric field measurements in a khz-driven he jet: the influence of the gas flow speed. *Plasma Sources Science and Technology*, 25(6):065026, 2016. 1, 12, 39, 41
- [52] Elmar Slikboer, Enric Garcia-Caurel, Olivier Guaitella, and Ana Sobota. Charge transfer to a dielectric target by guided ionization waves using electric field measurements. *Plasma Sources Science and Technology*, 26(3):035002, 2017. 1, 12, 41, 45
- [53] Goran B Sretenović, Olivier Guaitella, Ana Sobota, Ivan B Krstić, Vesna V Kovačević, Bratislav M Obradović, and Milorad M Kuraica. Electric field measurement in the dielectric tube of helium atmospheric pressure plasma jet. *Journal of Applied Physics*, 121(12):123304, 2017. 1, 12
- [54] Vasco Guerra, Tiago Silva, Polina Ogloblina, Marija Grofulović, Loann Terraz, Mário Lino da Silva, Carlos D Pintassilgo, Luís L Alves, and Olivier Guaitella. The case for in situ resource utilisation for oxygen production on mars by non-equilibrium plasmas. *Plasma Sources Science and Technology*, 26(11):11LT01, 2017. 1, 35, 37
- [55] BLM Klarenaar, R Engeln, DCM van den Bekerom, MCM van de Sanden, AS Morillo-Candas, and O Guaitella. Time evolution of vibrational temperatures in a co2 glow discharge measured with infrared absorption spectroscopy. *Plasma Sources Science and Technology*, 26(11):115008, 2017. 1, 33, 34
- [56] Elmar Slikboer, Ana Sobota, Olivier Guaitella, and Enric Garcia-Caurel. Electric field and temperature in a target induced by a plasma jet imaged using mueller polarimetry. *Journal of Physics D: Applied Physics*, 51(2):025204, 2017. 1, 12, 46
- [57] Elmar Slikboer, Ana Sobota, Olivier Guaitella, and Enric Garcia-Caurel. Imaging axial and radial electric field components in dielectric targets under plasma exposure. *Journal of Physics D: Applied Physics*, 51(11):115203, 2018. 1
- [58] Bart Leonardus Mándy Klarenaar, Marija Grofulović, Ana Sofia Morillo-Candas, Dirk Cornelis Maria van den Bekerom, Mark Damen, Richard Van de Sanden, Olivier Guaitella, and Richard Engeln. A rotational raman study under non-thermal conditions in a pulsed co2 glow discharge. *Plasma Sources Science and Technology*, 27:045009, 2018. 1
- [59] Jim Van Durme, Jo Dewulf, Christophe Leys, and Herman Van Langenhove. Combining non-thermal plasma with heterogeneous catalysis in waste gas treatment: a review. *Applied Catalysis B: Environmental*, 78(3):324–333, 2008. 2
- [60] Hyun-Ha Kim. Nonthermal plasma processing for air-pollution control: a historical review, current issues, and future prospects. *Plasma Processes and Polymers*, 1(2):91–110, 2004. 2
- [61] EC Neyts and A Bogaerts. Understanding plasma catalysis through modelling and simulation—a review. *Journal of Physics D: Applied Physics*, 47(22):224010, 2014. 2

- [62] J Christopher Whitehead. Plasma catalysis: a solution for environmental problems. *Pure and Applied Chemistry*, 82(6):1329–1336, 2010. 2
- [63] J Christopher Whitehead. Plasma-catalysis: the known knowns, the known unknowns and the unknown unknowns. *Journal of Physics D: Applied Physics*, 49(24):243001, 2016. 2
- [64] Erik C Neyts. Plasma-surface interactions in plasma catalysis. *Plasma Chemistry and Plasma Processing*, 36(1):185–212, 2016. 2, 7
- [65] Jackie Fenn and Mark Raskino. *Mastering the hype cycle: how to choose the right innovation at the right time*. Harvard Business Press, 2008. 2
- [66] NL Allen and PN Mikropoulos. Streamer propagation along insulating surfaces. *IEEE transactions on dielectrics and electrical insulation*, 6(3):357–362, 1999. 4
- [67] NL Allen and DC Faircloth. Corona propagation and charge deposition on a ptfе surface. *IEEE transactions on dielectrics and electrical insulation*, 10(2):295–304, 2003. 4
- [68] Natalia Yu Babaeva and Mark J Kushner. Ion energy and angular distributions onto polymer surfaces delivered by dielectric barrier discharge filaments in air: I. flat surfaces. *Plasma Sources Science and Technology*, 20(3):035017, 2011. 4
- [69] François Pechereau, Zdeněk Bonaventura, and Anne Bourdon. Influence of surface emission processes on a fast-pulsed dielectric barrier discharge in air at atmospheric pressure. *Plasma Sources Science and Technology*, 25(4):044004, 2016. 4
- [70] Karen LL Vercammen, Alexander A Berezin, Frans Lox, and Jen-Shih Chang. Non-thermal plasma techniques for the reduction of volatile organic compounds in air streams: A critical review. *Journal of Advanced Oxidation Technologies*, 2(2):312–329, 1997. 6
- [71] Akira Mizuno, Yoshiyuki Kisanuki, Masanobu Noguchi, Shinji Katsura, Sung Hwa Lee, Young Ki Hong, Soo Yeon Shin, and Jung Hoon Kang. Indoor air cleaning using a pulsed discharge plasma. *IEEE Transactions on Industry Applications*, 35(6):1284–1288, 1999. 6
- [72] T. Yamamoto. Methods and apparatus for controlling toxic compounds using catalysis-assisted non-thermal plasma, March 11 1997. US Patent 5,609,736. 6
- [73] Bernie M Penetrante, J Norman Bardsley, and Mark C Hsiao. Kinetic analysis of non-thermal plasmas used for pollution control. *Japanese journal of applied physics*, 36(7S):5007, 1997. 6
- [74] Atsushi Ogata, Kazushi Yamanouchi, Koichi Mizuno, Satoshi Kushiya, and Toshiaki Yamamoto. Decomposition of benzene using alumina-hybrid and catalyst-hybrid plasma reactors. *IEEE Transactions on Industry Applications*, 35(6):1289–1295, 1999. 6
- [75] Werner Siemens. Ueber die elektrostatische induction und die verzögerung des stroms in flaschen-drähten. *Annalen der Physik*, 178(9):66–122, 1857. 7
- [76] Erik C Neyts and Kristof M Bal. Effect of electric fields on plasma catalytic hydrocarbon oxidation from atomistic simulations. *Plasma Processes and Polymers*, 14(6), 2017. 7
- [77] E Fasci, O Guaitella, P Gorrotxategi Carbajo, I Ventrillard, M Carras, G Maisons, D Romanini, and A Rousseau. Optical-feedback cavity-enhanced absorption spectroscopy detects ppt traces of formaldehyde for the validation of air plasma treatment system. In *Proc. ESCAMPIG XXI, Viana do Castelo, Portugal, July 10-14 2012*. 9
- [78] Ronny Brandenburg. Dielectric barrier discharges: progress on plasma sources and on the understanding of regimes and single filaments. *Plasma Sources Science and Technology*, 26(5):053001, 2017. 11
- [79] KV Kozlov, R Brandenburg, HE Wagner, AM Morozov, and P Michel. Investigation of the filamentary and diffuse mode of barrier discharges in n₂/o₂ mixtures at atmospheric pressure by cross-correlation spectroscopy. *Journal of Physics D: Applied Physics*, 38(4):518, 2005. 11

-
- [80] H Höft, M Kettlitz, MM Becker, T Hoder, D Loffhagen, R Brandenburg, and KD Weltmann. Break-down characteristics in pulsed-driven dielectric barrier discharges: influence of the pre-breakdown phase due to volume memory effects. *Journal of Physics D: Applied Physics*, 47(46):465206, 2014. 11
- [81] GY Park, SJ Park, MY Choi, IG Koo, JH Byun, JW Hong, JY Sim, GJ Collins, and JK Lee. Atmospheric-pressure plasma sources for biomedical applications. *Plasma Sources Science and Technology*, 21(4):043001, 2012. 11
- [82] Oleksiy V Penkov, Mahdi Khadem, Won-Suk Lim, and Dae-Eun Kim. A review of recent applications of atmospheric pressure plasma jets for materials processing. *Journal of Coatings Technology and Research*, 12(2):225–235, 2015. 11
- [83] Björn Surowsky, Oliver Schlüter, and Dietrich Knorr. Interactions of non-thermal atmospheric pressure plasma with solid and liquid food systems: a review. *Food Engineering Reviews*, 7(2):82–108, 2015. 11
- [84] J Winter, R Brandenburg, and KD Weltmann. Atmospheric pressure plasma jets: an overview of devices and new directions. *Plasma Sources Science and Technology*, 24(6):064001, 2015. 11
- [85] Dogan Gidon, Brandon Curtis, Joel A Paulson, David B Graves, and Ali Mesbah. Model-based feedback control of a khz-excited atmospheric pressure plasma jet. *IEEE Transactions on Radiation and Plasma Medical Sciences*, 2017. 11
- [86] the European economic Communication from the commission to the European parliament, the council, social committee, and the committee of the regions. A roadmap for moving to a competitive low carbon economy in 2050. 14
- [87] Organisation for Economic Co-operation and Development. <http://www.oecd.org/statistics/>. 14
- [88] ENEA Consulting. Valorisation chimique du co2 : état des lieux. quantification des bénéfices énergétiques et environnementaux et évaluation économique de trois voies chimiques. Etude, rapport, ADEME, <http://www.ademe.fr/>, 2014. 14
- [89] Chena Zuofeng, Concepciona Javier J., M. Kyle Brennamana, Kanga Peng, Norrisa Michael R., Hoertz Paul G., and Meyer Thomas J. Splitting co2 into co and o2 by a single catalyst. *Proc. Nat. Ac. of Sci. of USA*, 109(39):15606, 2012. 14
- [90] Lewis N.S. and Nocera D.G. Powering the planet: Chemical challenges in solar energy utilization. *PNAS*, 103(43):15729, 2006. 14
- [91] A. Friedman. *Plasma chemistry*. Cambridge University Press, New York, 2008. 15, 16, 31
- [92] Guerra V., Sá P.A., and Loureiro J. Kinetic modeling of nitrogen discharges and post-discharges. *Eur. Phys. J. Appl. Phys.*, pages 125–152, 2004. 15
- [93] Mario Capitelli, Gianpiero Colonna, Giuliano D’Ammando, Vincenzo Laporta, and Annarita Laricchiuta. The role of electron scattering with vibrationally excited nitrogen molecules on non-equilibrium plasma kinetics. *Physics of Plasmas (1994-present)*, 20(10):101609, 2013. 16
- [94] Asisov R.I., Givotov V.K., Krashennnikov E.G., Potapkin B.V., Rusanov V.D., and Fridman A. title. *Sov. Phys.*, 27:567, 1983. 16
- [95] Goedel A.P.H., Bongers W.A., Graswinckel M.F., van de Sanden R.M.C.M, Leins M., Kopecki J., Schulz A., and Walker M. Production of solar fuels by co2 plasmolysis. In *E2C 2013 – 3rd European Energy Conference, EPJ Web Conf.*, volume 79, page 01005, 2014. 16
- [96] F Brehmer, S Welzel, MCM van de Sanden, and R Engeln. Co and byproduct formation during co2 reduction in dielectric barrier discharges. *Journal of Applied Physics*, 116(12):123303, 2014. 16
- [97] Tiago Silva, Nikolay Britun, Thomas Godfroid, and Rony Snyders. Optical characterization of a microwave pulsed discharge used for dissociation of co2. *Plasma Sources Science and Technology*, 23(2):025009, 2014. 16

- [98] Tomáš Kozák and Annemie Bogaerts. Splitting of CO_2 by vibrational excitation in non-equilibrium plasmas: a reaction kinetics model. *Plasma Sources Science and Technology*, 23(4):045004, 2014. 16, 32
- [99] H Hou, Y Huang, SJ Gulding, CT Rettner, DJ Auerbach, and AM Wodtke. Enhanced reactivity of highly vibrationally excited molecules on metal surfaces. *Science*, 284(5420):1647–1650, 1999. 17
- [100] F Fleming Crim. Chemical dynamics of vibrationally excited molecules: Controlling reactions in gases and on surfaces. *Proceedings of the National Academy of Sciences*, 105(35):12654–12661, 2008. 17
- [101] Paul L Houston and Robert P Merrill. Gas-surface interactions with vibrationally excited molecules. *Chemical Reviews*, 88(4):657–671, 1988. 17
- [102] Gilbert M Nathanson. Molecular beam studies of gas-liquid interfaces. *Annu. Rev. Phys. Chem.*, 55:231–255, 2004. 17
- [103] I Armenise and M Capitelli. State to state vibrational kinetics in the boundary layer of an entering body in earth atmosphere: particle distributions and chemical kinetics. *Plasma Sources Science and Technology*, 14(2):S9, 2005. 17
- [104] V Guerra and JMAH Loureiro. Non-equilibrium coupled kinetics in stationary $\text{N}_2\text{-O}_2$ discharges. *Journal of Physics D: Applied Physics*, 28(9):1903, 1995. 17
- [105] Geoffrey Colin Bond. Heterogeneous catalysis. 1987. 18
- [106] RM Barrer. The measurement of surface area of finely divided solids by the flow of gases through them. *British Journal of Applied Physics*, 5(S3):S41, 1954. 19
- [107] Vasco Guerra. Analytical model of heterogeneous atomic recombination on silicalike surfaces. *IEEE Transactions on plasma science*, 35(5):1397–1412, 2007. 19, 20
- [108] Young C Kim and Michel Boudart. Recombination of oxygen, nitrogen, and hydrogen atoms on silica: kinetics and mechanism. *Langmuir*, 7(12):2999–3005, 1991. 19, 20
- [109] B Gordiets, CM Ferreira, J Nahorny, D Pagnon, M Touzeau, and M Vialle. Surface kinetics of n and o atoms in discharges. *Journal of Physics D: Applied Physics*, 29(4):1021, 1996. 19, 20
- [110] G Cartry, L Magne, and G Cernogora. Atomic oxygen recombination on fused silica: modelling and comparison to low-temperature experiments (300 k). *Journal of Physics D: Applied Physics*, 33(11):1303, 2000. 19, 20
- [111] P Macko, P Veis, and G Cernogora. Study of oxygen atom recombination on a pyrex surface at different wall temperatures by means of time-resolved actinometry in a double pulse discharge technique. *Plasma Sources Science and Technology*, 13(2):251, 2004. 19, 20, 29
- [112] Dušan A Pejaković, Jochen Marschall, Lian Duan, and Maria P Martin. Nitric oxide production from surface recombination of oxygen and nitrogen atoms. *Journal of Thermophysics and Heat Transfer*, 22(2):178–186, 2008. 20, 21
- [113] M Castillo, VJ Herrero, and I Tanarro. Characterization and modelling of the steady state and transients of modulated hollow cathode discharges of nitric oxide. *Plasma Sources Science and Technology*, 11(4):368, 2002. 20
- [114] M Castillo, VJ Herrero, I Méndez, and I Tanarro. Spectrometric and kinetic study of a modulated glow air discharge. *Plasma Sources Science and Technology*, 13(2):343, 2004. 20
- [115] L Bedra, M Rutigliano, M Balat-Pichelin, and M Cacciatore. Atomic oxygen recombination on quartz at high temperature: experiments and molecular dynamics simulation. *Langmuir*, 22(17):7208–7216, 2006. 20
- [116] M Rutigliano, A Pieretti, M Cacciatore, N Sanna, and Vincenzo Barone. N atoms recombination on a silica surface: A global theoretical approach. *Surface science*, 600(18):4239–4246, 2006. 20

-
- [117] M Rutigliano, C Zazza, N Sanna, A Pieretti, G Mancini, Vincenzo Barone, and M Cacciatore. Oxygen adsorption on β -cristobalite polymorph: ab initio modeling and semiclassical time-dependent dynamics. *The Journal of Physical Chemistry A*, 113(52):15366–15375, 2009. 20
- [118] C Arasa, P Gamallo, and R Sayós. Adsorption of atomic oxygen and nitrogen at β -cristobalite (100): a density functional theory study. *The Journal of Physical Chemistry B*, 109(31):14954–14964, 2005. 20
- [119] Erik C Neyts and Pascal Braut. Molecular dynamics simulations for plasma-surface interactions. *Plasma Processes and Polymers*, 14(1-2), 2017. 20
- [120] Kristof M Bal and Erik C Neyts. Direct observation of realistic-temperature fuel combustion mechanisms in atomistic simulations. *Chemical Science*, 7(8):5280–5286, 2016. 20
- [121] V Guerra and J Loureiro. Dynamical monte carlo simulation of surface atomic recombination. *Plasma Sources Science and Technology*, 13(1):85, 2003. 20
- [122] Daniil Marinov, Carlos Teixeira, and Vasco Guerra. Deterministic and monte carlo methods for simulation of plasma-surface interactions. *Plasma Processes and Polymers*, 14(1-2), 2017. 20
- [123] Vasco Guerra and Daniil Marinov. Dynamical monte carlo methods for plasma-surface reactions. *Plasma Sources Science and Technology*, 25(4):045001, 2016. 20
- [124] A-M Diamy, J-C Legrand, and J Al Andari. Atomic oxygen titration in a dioxygen microwave plasma. part 1: recombination on silica walls. *New journal of chemistry*, 21(2):177–185, 1997. 20
- [125] NEVTRALNIH ATOMOV. Heterogeneous surface recombination of neutral nitrogen atoms. *Materiali in tehnologije*, 46(1):7–12, 2012. 20
- [126] Sunil Wickramanayaka, Naokithi Hosokawa, and Yoshinori Hatanaka. Variation of the recombination coefficient of atomic oxygen on pyrex glass with applied rf power. *Japanese journal of applied physics*, 30(11R):2897, 1991. 20
- [127] JC Greaves and JW Linnett. Recombination of atoms at surfaces. part 6.—recombination of oxygen atoms on silica from 20° c to 600° c. *Transactions of the Faraday Society*, 55:1355–1361, 1959. 20
- [128] T Belmonte, L Lefèvre, T Czerwiec, H Michel, and A Ricard. Measurements of the loss probability of nitrogen atoms versus temperature on various surfaces. *Thin Solid Films*, 341(1):27–30, 1999. 20
- [129] L Lefevre, T Belmonte, and H Michel. Modeling of nitrogen atom recombination on pyrex: Influence of the vibrationally excited n 2 molecules on the loss probability of n. *Journal of Applied Physics*, 87(10):7497–7507, 2000.
- [130] Gilles Cartry, Xavier Duten, and Antoine Rousseau. Atomic oxygen surface loss probability on silica in microwave plasmas studied by a pulsed induced fluorescence technique. *Plasma Sources Science and Technology*, 15(3):479, 2006. 20
- [131] L Magne, H Coitout, G Cernogora, and G Gousset. Atomic oxygen recombination at the wall in a time afterglow. *Journal de Physique III*, 3(9):1871–1889, 1993. 20
- [132] M Balat-Pichelin, JM Badie, R Berjoan, and P Boubert. Recombination coefficient of atomic oxygen on ceramic materials under earth re-entry conditions by optical emission spectroscopy. *Chemical Physics*, 291(2):181–194, 2003. 20
- [133] Larbi Bedra and Marianne JH Balat-Pichelin. Comparative modeling study and experimental results of atomic oxygen recombination on silica-based surfaces at high temperature. *Aerospace Science and Technology*, 9(4):318–328, 2005. 20
- [134] DV Lopaev, EM Malykhin, and SM Zyryanov. Surface recombination of oxygen atoms in o2 plasma at increased pressure: I. the recombination probability and phenomenological model of surface processes. *Journal of Physics D: Applied Physics*, 44(1):015201, 2010. 20, 26

- [135] D Pagnon, J Amorim, J Nahorny, M Touzeau, and M Vialle. On the use of actinometry to measure the dissociation in o₂ dc glow discharges: determination of the wall recombination probability. *Journal of Physics D: Applied Physics*, 28(9):1856, 1995. 20
- [136] VM Donnelly, J Guha, and L Stafford. Critical review: Plasma-surface reactions and the spinning wall method. *Journal of Vacuum Science & Technology A: Vacuum, Surfaces, and Films*, 29(1):010801, 2011. 20
- [137] Joydeep Guha, Rohit Khare, Luc Stafford, Vincent M Donnelly, Stephen Sirard, and Eric A Hudson. Effect of cu contamination on recombination of o atoms on a plasma-oxidized silicon surface. *Journal of Applied Physics*, 105(11):113309, 2009. 20, 23
- [138] Dusan A Pejakovic, Jochen Marschall, Lian Duan, and Maria P Martin. Direct detection of n₂ produced by high-temperature surface-catalyzed atom recombination. *Journal of thermophysics and heat transfer*, 24(3):603–611, 2010. 21
- [139] Rens Andreas Bartholomeus Zijlmans. *Molecule conversion in recombining plasmas*. PhD thesis, PhD thesis, Technical University Eindhoven, The Netherlands, 2008 Search PubMed, 2008. 21, 22
- [140] M Balat-Pichelin, J Iacono, and P Boubert. Recombination coefficient of atomic oxygen on ceramic materials in a co₂ plasma flow for the simulation of a martian entry. *Ceramics International*, 42(2):2761–2769, 2016. 21
- [141] Gilles Cartry. *Etude par spectroscopie de la cinétique des décharges électriques dans les mélanges n₂-o₂*. PhD thesis, Paris 11, 1999. 22
- [142] Daniil Marinov. *Reactive adsorption of molecules and radicals on surfaces under plasma exposure*. PhD thesis, Ecole Polytechnique X, 2012. 22
- [143] VP Zhdanov, J Pavlíček, and Z Knor. Preexponential factors for elementary surface processes. *Catalysis Reviews Science and Engineering*, 30(4):501–517, 1988. 22
- [144] AV Eletskii and BM Smirnov. Dissociation of molecules in plasma and gas: the energy. *Pure and Applied Chemistry*, 57(9):1235–1244, 1985. 25
- [145] Christof Janssen and Béla Tuzson. Isotope evidence for ozone formation on surfaces. *The Journal of Physical Chemistry A*, 114(36):9709–9719, 2010. 26
- [146] Sławomir Jodzis. Effect of silica packing on ozone synthesis from oxygen-nitrogen mixtures. *Ozone: science & engineering*, 25(1):63–72, 2003. 26
- [147] Sławomir Jodzis, Tomasz Smolinski, and Piotr Sowka. Ozone synthesis under surface discharges in oxygen: application of a concentric actuator. *IEEE Transactions on Plasma Science*, 39(4):1055–1060, 2011. 26
- [148] Mickaël Foucher, Daniil Marinov, Emile Carbone, Pascal Chabert, and Jean-Paul Booth. Highly vibrationally excited o₂ molecules in low-pressure inductively-coupled plasmas detected by high sensitivity ultra-broad-band optical absorption spectroscopy. *Plasma Sources Science and Technology*, 24(4):042001, 2015. 29
- [149] Perry P Yaney and John W Parish. Studies of surface deactivation of vibrationally-excited homonuclear molecules in gaseous discharge media using coherent anti-stokes raman spectroscopy (cars). Technical report, DAYTON UNIV OH, 1999. 30
- [150] VI Egorov, Yu M Gershenzon, VB Rozenshtein, and S Ya Umanskii. On the mechanism of heterogeneous relaxation of vibrationally excited nitrogen molecules. *Chemical Physics Letters*, 20(1):77–80, 1973. 30
- [151] Graham Black, Henry Wise, Samuel Schechter, and Robert L Sharpless. Measurements of vibrationally excited molecules by raman scattering. ii. surface deactivation of vibrationally excited n₂. *The Journal of Chemical Physics*, 60(9):3526–3536, 1974. 30

-
- [152] Carlos D Pintassilgo and Vasco Guerra. Modelling of the temporal evolution of the gas temperature in n₂ discharges. *Plasma Sources Science and Technology*, 26(5):055001, 2017. 30
- [153] M Kovacs, D Ramachandra Rao, and A Javan. Study of diffusion and wall de-excitation probability of 00⁺ 1 state in co₂. *The Journal of Chemical Physics*, 48(7):3339–3341, 1968. 31
- [154] PA Sergeev and DI Slovetsky. Vibrationally excited molecules and mechanisms of chemical and physical processes in non-equilibrium plasmas. *Chemical Physics*, 75(2):231–241, 1983. 31
- [155] Pio Capezzuto, Francesco Cramarossa, Riccardo D’Agostino, and Ettore Molinari. Contribution of vibrational excitation to the rate of carbon dioxide dissociation in electrical discharges. *The Journal of Physical Chemistry*, 80(8):882–888, 1976. 31
- [156] Mario Capitelli, Gianpiero Colonna, and Antonio D’Angola. *Fundamental aspects of plasma chemical physics: thermodynamics*, volume 66. Springer Science & Business Media, 2011. 31
- [157] LS Polak and DI Slovetsky. Electron impact induced electronic excitation and molecular dissociation. *International Journal for Radiation Physics and Chemistry*, 8(1):257–282, 1976. 32
- [158] Yukikazu Itikawa et al. Cross sections for electron collisions with carbon dioxide. *Journal of Physical and Chemical Reference Data*, 31(3):749–768, 2002. 32
- [159] Marija Grofulović, Luís L Alves, and Vasco Guerra. Electron-neutral scattering cross sections for co₂: a complete and consistent set and an assessment of dissociation. *Journal of Physics D: Applied Physics*, 49(39):395207, 2016. 32
- [160] I Armenise and EV Kustova. State-to-state models for co₂ molecules: from the theory to an application to hypersonic boundary layers. *Chemical Physics*, 415:269–281, 2013. 32
- [161] Arnaud Bultel and Julien Annaloro. Elaboration of collisional–radiative models for flows related to planetary entries into the earth and mars atmospheres. *Plasma Sources Science and Technology*, 22(2):025008, 2013. 32
- [162] T Kishimoto, N Wenzel, H Grosse-Wilde, G Lüpke, and G Marowsky. Experimental study of a co₂ laser plasma by coherent anti-stokes raman scattering (cars). *Spectrochimica Acta Part B: Atomic Spectroscopy*, 47(1):51–60, 1992. 32
- [163] T Doerk, J Ehlbeck, P Jauernik, J Stańco, J Uhlenbusch, and T Wottka. Narrow-band boxcars applied to co₂ laser discharges. *Il Nuovo Cimento D*, 14(10):1051–1063, 1992. 32
- [164] Wonchul Lee, Igor V Adamovich, and Walter R Lempert. Optical pumping studies of vibrational energy transfer in high-pressure diatomic gases. *The Journal of Chemical Physics*, 114(3):1178–1186, 2001. 32
- [165] Elke Plönjes, Peter Palm, Wonchul Lee, Matthew D Chidley, Igor V Adamovich, Walter R Lempert, and J William Rich. Vibrational energy storage in high pressure mixtures of diatomic molecules. *Chemical Physics*, 260(3):353–366, 2000. 32
- [166] Sébastien Depraz, Marie-Yvonne Perrin, and Anouar Soufiani. Infrared emission spectroscopy of co₂ at high temperature. part i: Experimental setup and source characterization. *Journal of Quantitative Spectroscopy and Radiative Transfer*, 113(1):1–13, 2012. 32
- [167] Sébastien Depraz, Marie-Yvonne Perrin, Ph Rivière, and Anouar Soufiani. Infrared emission spectroscopy of co₂ at high temperature. part ii: Experimental results and comparisons with spectroscopic databases. *Journal of Quantitative Spectroscopy and Radiative Transfer*, 113(1):14–25, 2012. 32
- [168] C Dang, J Reid, and BK Garside. Detailed vibrational population distributions in a co₂ laser discharge as measured with a tunable diode laser. *Applied Physics B: Lasers and Optics*, 27(3):145–151, 1982. 32
- [169] SN Andreev, VV Zakharov, VN Ochkin, and S Yu Savinov. Plasma-chemical co₂ decomposition in a non-self-sustained discharge with a controlled electronic component of plasma. *Spectrochimica Acta Part A: Molecular and Biomolecular Spectroscopy*, 60(14):3361–3369, 2004. 32

- [170] LS Rothman, IE Gordon, RJ Barber, H Dothe, RR Gamache, A Goldman, VI Perevalov, SA Tashkun, and J Tennyson. Hitemp, the high-temperature molecular spectroscopic database. *Journal of Quantitative Spectroscopy and Radiative Transfer*, 111(15):2139–2150, 2010. 34
- [171] Alan Watson. Pulsed flashover in vacuum. *Journal of Applied Physics*, 38(5):2019–2023, 1967. 38
- [172] Thomas C Corke, C Lon Enloe, and Stephen P Wilkinson. Dielectric barrier discharge plasma actuators for flow control. *Annual review of fluid mechanics*, 42:505–529, 2010. 38
- [173] NL Allen and DC Faircloth. Corona propagation and charge deposition on a ptfе surface. *IEEE transactions on dielectrics and electrical insulation*, 10(2):295–304, 2003. 38
- [174] M Abdel-Salam and P Weiss. Discharges in air from point electrodes in the presence of dielectric plates-theoretical analysis. *IEEE transactions on electrical insulation*, 27(2):320–333, 1992. 38
- [175] M Abdel-Salam, P Weiss, and B Lieske. Discharges in air from point electrodes in the presence of dielectric plates-experimental results. *IEEE transactions on electrical insulation*, 27(2):309–319, 1992. 38
- [176] BKHL Boekema, M Vlig, D Guijt, K Hijnen, S Hofmann, P Smits, A Sobota, EM van Veldhuizen, Peter Bruggeman, and E Middelkoop. A new flexible dbd device for treating infected wounds: in vitro and ex vivo evaluation and comparison with a rf argon plasma jet. *Journal of Physics D: Applied Physics*, 49(4):044001, 2015. 38
- [177] Kunihide Tachibana. Current status of microplasma research. *IEEE Transactions on Electrical and Electronic Engineering*, 1(2):145–155, 2006. 38
- [178] M Heise, W Neff, O Franken, P Muranyi, and J Wunderlich. Sterilization of polymer foils with dielectric barrier discharges at atmospheric pressure. *Plasmas and polymers*, 9(1):23–33, 2004. 38
- [179] Mirko Černák, D Kováčik, P St’ahel, A Zahoranová, J Kubincová, A Tóth, et al. Generation of a high-density highly non-equilibrium air plasma for high-speed large-area flat surface processing. *Plasma Physics and Controlled Fusion*, 53(12):124031, 2011. 38
- [180] FJJ Peeters and MCM Van de Sanden. The influence of partial surface discharging on the electrical characterization of dbds. *Plasma Sources Science and Technology*, 24(1):015016, 2014. 38
- [181] S Zhang, A Sobota, EM Van Veldhuizen, and PJ Bruggeman. Gas flow characteristics of a time modulated appj: the effect of gas heating on flow dynamics. *Journal of Physics D: Applied Physics*, 48(1):015203, 2014. 40
- [182] Eric Robert, Vanessa Sarron, Thibault Darny, Delphine Riès, Sébastien Dozias, Jérôme Fontane, Laurent Joly, and Jean Michel Pouvesle. Rare gas flow structuration in plasma jet experiments. *Plasma Sources Science and Technology*, 23(1):012003, 2014. 40
- [183] Jun-Seok Oh, Olumuyiwa T Olabanji, Craig Hale, Raffaello Mariani, Konstantinos Kontis, and James W Bradley. Imaging gas and plasma interactions in the surface-chemical modification of polymers using micro-plasma jets. *Journal of Physics D: Applied Physics*, 44(15):155206, 2011. 40
- [184] M Ghasemi, P Olszewski, JW Bradley, and JL Walsh. Interaction of multiple plasma plumes in an atmospheric pressure plasma jet array. *Journal of Physics D: Applied Physics*, 46(5):052001, 2013. 40
- [185] PK Papadopoulos, P Vafeas, P Svarnas, K Gazeli, PM Hatzikonstantinou, A Gkelios, and Franck Clément. Interpretation of the gas flow field modification induced by guided streamer (‘plasma bullet’) propagation. *Journal of Physics D: Applied Physics*, 47(42):425203, 2014. 41
- [186] E Karakas, M Koklu, and M Laroussi. Correlation between helium mole fraction and plasma bullet propagation in low temperature plasma jets. *Journal of Physics D: Applied Physics*, 43(15):155202, 2010. 41
- [187] Anne Bourdon, Thibault Darny, François Pechereau, Jean-Michel Pouvesle, Pedro Viegas, Sylvain Iséni, and Eric Robert. Numerical and experimental study of the dynamics of a μs helium plasma gun discharge with various amounts of n2 admixture. *Plasma Sources Science and Technology*, 25(3):035002, 2016. 41

-
- [188] Amanda M Lietz, Eric Johnsen, and Mark J Kushner. Plasma-induced flow instabilities in atmospheric pressure plasma jets. *Applied Physics Letters*, 111(11):114101, 2017. 41
- [189] N Cvetanović, MM Martinović, BM Obradović, and MM Kuraica. Electric field measurement in gas discharges using stark shifts of he i lines and their forbidden counterparts. *Journal of Physics D: Applied Physics*, 48(20):205201, 2015. 41
- [190] S Hübner, J Santos Sousa, V Puech, GMW Kroesen, and N Sadeghi. Electron properties in an atmospheric helium plasma jet determined by thomson scattering. *Journal of Physics D: Applied Physics*, 47(43):432001, 2014. 42
- [191] Thibault Darny, Jean Michel Pouvesle, Vincent Puech, Claire Douat, Sebastien Dozias, and Eric Robert. Analysis of conductive target influence in plasma jet experiments through helium metastable and electric field measurements. *Plasma Sources Science and Technology*, 26(4):045008, 2017. 44
- [192] Seth A Norberg, Eric Johnsen, and Mark J Kushner. Helium atmospheric pressure plasma jets touching dielectric and metal surfaces. *Journal of Applied Physics*, 118(1):013301, 2015. 44
- [193] NA Othman, MAM Piah, and Z Adzis. Charge distribution measurement of solid insulator materials: A review and new approach. *Renewable and Sustainable Energy Reviews*, 70:413–426, 2017. 44
- [194] Han Wang, Jian-Yi Xue, Yi-Bo Wang, Guo-Qiang Su, Jun-Bo Deng, Hai-Bao Mu, and Guan-Jun Zhang. Improved algorithm of surface charge density distribution and electric field distribution on insulating materials. In *Electrical Materials and Power Equipment (ICEMPE), 2017 1st International Conference on*, pages 332–335. IEEE, 2017. 44
- [195] Kunihiko Hidaka and Hiroyuki Fujita. A new method of electric field measurements in corona discharge using pockels device. *Journal of Applied Physics*, 53(9):5999–6003, 1982. 44
- [196] Ana Sobota, Olivier Guaitella, and Enric Garcia-Caurel. Experimentally obtained values of electric field of an atmospheric pressure plasma jet impinging on a dielectric surface. *Journal of Physics D: Applied Physics*, 46(37):372001, 2013. 44
- [197] José Jorge Gil Pérez and Razvigor Ossikovski. *Polarized Light and the Mueller Matrix Approach*. CRC Press, 2016. 45
- [198] Carlos I Calle, Paul J Mackey, Michael R Johansen, Michael D Hogue, James Phillips III, and Rachel E Cox. The electrostatic environments of mars: Atmospheric discharges. 2016. 48
- [199] Nathalie Carrasco, François Jomard, Jackie Vigneron, Arnaud Etcheberry, and Guy Cernogora. Laboratory analogues simulating titan’s atmospheric aerosols: Compared chemical compositions of grains and thin films. *Planetary and Space Science*, 128:52–57, 2016. 48
- [200] Judith Golda, J Held, B Redeker, M Konkowski, P Beijer, A Sobota, G Kroesen, N St J Braithwaite, S Reuter, MM Turner, et al. Concepts and characteristics of the ‘cost reference microplasma jet’. *Journal of Physics D: Applied Physics*, 49(8):084003, 2016. 50

A. Supervision, teaching and curriculum vitae

Supervision

After my PhD, I have been involved in the work of 3 PhD without being official supervisor. Later I have been formally co-supervisor of 2 PhDs who have already graduated (Daniil Marinov and Christelle Brakat). I am currently co-supervisor of 4 PhD students. I am also co-supervisor of 1 PhD from IST Lisbon (Polina Oglobina who is supervised by Vasco Guerra) and 1 PhD from Technical University of Eindhoven (Bart Klarenaar whose main supervisor is Richard Engeln). I have been also working with 5 post-docs and I supervised roughly 20 master students. I have been jury member of 4 PhD defenses, referee for 2 of them. The summary of people I have been working with is given in the table below.

First name	Family name	defense year	broad topic	(Co-)Supervisor	my own involvement in the PhD
Katia	Allegraud	2008	ionization waves	A. Rousseau	daily help
Joseph	Youssef	2010	plasma/cata air treatment	A. Rousseau	daily help
Paul	Ceccato	2009	plasma dans l'eau	A. Rousseau	daily help
Christelle	Barakat	2015	plasma/cata air treatment	A. Rousseau	Co-Supervisor
Daniil	Marinov	2012	plasma/surface interaction	A. Rousseau	Co-Supervisor
Bart	Klarenaar	2018	CO2 recycling	R. Engeln (TU/e)	co-promotor at TU/e
Elmar	Slikboer	2018	ionization waves	A. Sobota (TU/e), E. Garcia-Caurel (X)	Co-Supervisor
Ana-Sofia	Morillo-Candas	2019	CO2 recycling	V. Guerra (IST)	Co-Supervisor
Audrey	Chatain	2020	Titan aerosols	N. Carrasco (UVSQ)	Co-Supervisor
Marlous	Hofmans	2020	CO2 recycling	Ana Sobota (TU/e)	Co-Supervisor
Polina	Oglobina	2020	CO2 recycling	Vasco Guerra (IST)	Co-Supervisor, 1 year at LPP

Post-doc collaborators				legend	
Paul	Gravejat	2012	plasma/cata air treatment	PhD/Post-Doc for whom I was not official co-supervisor	
Binjie	Dong	2012	plasma/cata air treatment	PhD successfully defended, Post-Doc ended	
Eugenio	Fasci	2012	plasma/cata air treatment	PhD ongoing with international collaboration	
Ana	Sobota	2013	ionization waves	PhD ongoing	
David	Yap	2017	CO2 recycling		

Teaching and research networking

As a research engineer from Ecole polytechnique, I don't have any teaching duties. However I have chosen to get involved in two yearly summer schools. Since 2013 I am lecturer and I organized practicals during the [summer school organized by LabeX plas@par](#) every august. Since 2014 I am also lecturer of the ["international summer school on low temperature plasma"](#) that is organized for more than 20 years by the university of Bochum in Bad Honnef (Germany). In 2017 Bochum university asked me to be the international chair of this summer school together with Anne Bourdon and I will still be chair for 2018.

I am also member of the steering committee of the ["réseau plasma froids"](#) for 5 years now. The goal of this network is to bring together the french community of plasma physicists, but also all users of plasmas such as researcher from material science for instance.

Curriculum vitae

olivier.guaitella@polytechnique.edu

Olivier Guaitella, PhD

39 years old
Tel : + 33 1 69 33 59 48
Laboratoire de Physique des Plasmas (LPP)
Ecole Polytechnique
91128 Palaiseau cedex
FRANCE

Education

- 2006 : PhD from Ecole Polytechnique in Plasmas Physics
- 2003 : Master of fundamental physic – Orsay University (Paris)
- 2000 : Preparation School for High School competitive exams – Lycée du Parc (Lyon)

Experience and current projects

Since 2007 : Researcher at Plasma Physics Laboratory (LPP) from Ecole Polytechnique

- 2016-2020: PI ANR Jeune Chercheur SYCAMORE: surface kinetics of CO₂ containing plasmas
- 2015-2019: Partner of ANR Project ValCO₂Plas (gas reforming by plasma)
- 2014: 1 year mobility convention from Ecole Polytechnique: promoting collaboration with TUE Eindhoven
- 2013-2016: PI of AIRCLEAN, Essonne Region ASTRE, Air treatment by plasma/catalyst coupling
- currently co-supervisor of 5 PhD students

Scientific expertise

- **Plasma physics:** filamentary discharges physic, surface reactivity, plasma-catalyst coupling for air treatment and molecule synthesis, guided streamers for biomedical applications, plasma in liquid phase
- **Diagnostic skills:** IR absorption spectroscopy (FTIR, TDLAS, QCL and OFCEAS), fast imaging, mass spectrometry, emission spectroscopy

Collaborations and networking

- since 2015: Expert adviser of PREMIERE project led by Pr V; Guerra, IST Lisboa (Portugal)
- since 2014: Collaboration with Pr. R. Engeln, 1 year visiting position in PMP group from TUE Eindhoven
- since 2013: Collaboration with Pr. A. Sobota from TUE Eindhoven (currently co-supervision of a PhD)
- 2013-2019: member steering committee of French Non Thermal Plasma Network ([//plasmasfroids.cnrs.fr](http://plasmasfroids.cnrs.fr))
- 2015-17: PI french side of PHC Van Gogh bilateral project with R. Van De Sanden (DIFFER, Eindhoven)

Communications

- 58 peer reviewed international publications
- 2 patents
- > 20 invited talks in international conferences and more than 200 other communications

Teaching

- Since 2014: lecturer at International Plasma Summer School, Bad Honnef, Germany, Co-chair in 2017-18
- Since 2013: lecturer at International Summer School of Plas@Par in Banyuls
- 2013 : Jury member for 4 PhD defenses
- Since 2003 : 7 formal co-supervision of PhDs, involved in 6 other PhDs, > 25 master students

Conferences organisation

- 2013 Co-founder of the Workshop Cloud Manager, online system (<https://www.erudicio.com/wcm/>)
- 2012 LOC Secretary of 5th International workshop on Plasma Spectroscopy (IPS 2012)
- 2010 LOC member of 63rd Gaseous Electronic Conference from American Physical Society (63rd GEC)

Miscellaneous

- English (fluent), German (basics)
- Associate in ERUDICIO company, e-learning and web solutions
- Final diploma of classical guitar and chamber music from National Conservatory of Lyon
- Basket Ball (10 years in national championship)