



**HAL**  
open science

# Résilience des écosystèmes prairiaux aux stress climatiques selon l'intensité de gestion. Une approche par le concept de trait fonctionnel microbien

Gabin Piton

► **To cite this version:**

Gabin Piton. Résilience des écosystèmes prairiaux aux stress climatiques selon l'intensité de gestion. Une approche par le concept de trait fonctionnel microbien. Biodiversité. Université Grenoble Alpes, 2019. Français. NNT : 2019GREAV070 . tel-03052283

**HAL Id: tel-03052283**

**<https://theses.hal.science/tel-03052283>**

Submitted on 10 Dec 2020

**HAL** is a multi-disciplinary open access archive for the deposit and dissemination of scientific research documents, whether they are published or not. The documents may come from teaching and research institutions in France or abroad, or from public or private research centers.

L'archive ouverte pluridisciplinaire **HAL**, est destinée au dépôt et à la diffusion de documents scientifiques de niveau recherche, publiés ou non, émanant des établissements d'enseignement et de recherche français ou étrangers, des laboratoires publics ou privés.

## THÈSE

Pour obtenir le grade de

### **DOCTEUR DE LA COMMUNAUTE UNIVERSITE GRENOBLE ALPES**

Spécialité : **BIODIVERSITE ECOLOGIE ENVIRONNEMENT**

Arrêté ministériel : 25 mai 2016

Présentée par

**Gabin PITON**

Thèse dirigée par **Jean-Christophe CLEMENT, Professeur, Université de Savoie Mont Blanc**, et  
co-encadrée par **Arnaud FOULQUIER, Maître de conférence, Université Grenoble Alpes**

préparée au sein du **Laboratoire D'Écologie Alpine**  
dans **l'École Doctorale Chimie et Sciences du Vivant**

### **Résilience des écosystèmes prairiaux aux stress climatiques selon l'intensité de gestion. Une approche par le concept de trait fonctionnel microbien.**

Thèse soutenue publiquement le « **19 décembre 2019** »,  
devant le jury composé de :

**M<sup>me</sup>, Aurélie, CEBRON**

Chargé de recherche au CNRS, Nancy, France (Rapporteur)

**M, Stephan, HÄTTENSCHWILER**

Directeur de recherche au CNRS, Montpellier, France (Rapporteur)

**M, Robert, GRIFFITHS**

Researcher at CEH, Bangor, Royaume-Uni (Examineur)

**M, Nicolas, FANIN**

Chargé de recherche à l'INRA, Bordeaux, France (Examineur)

**M, Thomas, SPIEGELBERGER**

Directeur de recherche à l'IRSTEA, Grenoble, France (Président)

**M, Jean-Christophe, CLEMENT**

Professeur à l'Université Savoie Mont-Blanc, Le Bourget du Lac, France  
(Directeur de Thèse)

**M, Arnaud, FOULQUIER**

Maître de conférence à l'Université Grenoble-Alpes, Grenoble, France  
(Co-encadrant de Thèse, invité)





"A mon père,  
parti trop tôt,  
qui fait maintenant parti des arbres.

A ma mère,  
qui prend soin de leurs racines.

A ce qu'ils m'ont transmis,  
entre terre et nuages. "



## Résumé

Dans le contexte actuel du changement climatique et de l'augmentation de la fréquence et de l'intensité des épisodes climatiques extrêmes, une question centrale pour l'écologie scientifique est de comprendre les répercussions de ces changements sur le fonctionnement des écosystèmes. Les communautés microbiennes du sol contrôlent une grande partie des processus écosystémiques déterminant la circulation de l'énergie et des nutriments. Dans le cadre des agroécosystèmes se pose donc la question de l'influence des pratiques agricoles sur les communautés microbiennes du sol et sur leur aptitude à maintenir le fonctionnement des écosystèmes face au changement climatique. L'intensification écologique de l'agriculture a récemment été proposée comme une approche intégrant les processus écologiques dans la stratégie de gestion des agroécosystèmes, dans l'objectif d'optimiser leur fonctionnement et leur résilience. L'écologie fonctionnelle pourrait répondre à certains des enjeux posés par le changement climatique et l'intensification écologique de l'agriculture.

Dans cette thèse, j'ai cherché à mobiliser le cadre conceptuel des traits fonctionnels pour apporter de nouveaux éléments de compréhension de l'influence de différentes modalités d'intensité de gestion d'agroécosystèmes prairiaux (gestion extensive, conventionnelle-intensive et écologiquement-intensive) : 1) sur les caractéristiques fonctionnelles des communautés microbiennes du sol; 2) sur la capacité de ces communautés microbiennes à maintenir le fonctionnement de l'écosystème face à des périodes de stress climatiques (résilience). Dans le cadre de ma thèse, trois expérimentations ont été réalisées en faisant varier le degré de contrôle des facteurs de gestion, le type de stress climatique et la durée de ces stress. S'appuyant sur des agroécosystèmes prairiaux répartis dans trois pays Européens (France, Suisse, Portugal), les résultats des deux premières expérimentations de cette thèse montrent que les communautés microbiennes des sols des prairies écologiquement-intensives disposent d'une plus faible capacité à maintenir les propriétés écosystémiques microbiennes durant les stress (faible résistance) mais disposent d'une meilleure capacité de récupération comparée aux communautés microbiennes des sols en gestion conventionnelle-intensive. Une autre étude montre que la gestion éco-intensive favorise des communautés microbiennes protéolytiques bénéfiques à l'assimilation de l'azote pour les plantes en conditions perturbées. L'étude des traits végétaux suggère que ces effets de la gestion sur la composition des communautés microbiennes et sur leur résilience passe par certains traits, notamment une augmentation de la richesse en phosphore des litières en gestion écologiquement-intensive. En effet ces traits fonctionnels des plantes semblent influencer les traits microbiens, favorisant des communautés microbiennes copiotrophes, caractérisées par un ratio azote:phosphore faible de leur biomasse et un faible investissement dans la production d'enzymes extracellulaires, deux traits négatifs pour la résistance au stress mais favorisant une récupération rapide. Ainsi, ces deux expérimentations soulignent l'importance de la gestion des traits des plantes dans le contrôle des traits microbiens et de la résilience des écosystèmes au changement climatique. La troisième expérimentation a cherché à tester spécifiquement les effets d'un épisode de fertilisation minérale sur la résilience des communautés microbiennes à différents stress climatiques. Les résultats montrent que la fertilisation modifie la composition et les traits microbiens avec des répercussions négatives sur la stabilité de l'écosystème face à la sécheresse et à l'inondation.

Mobilisant une approche par le concept de trait fonctionnel microbien, ce travail de thèse apporte de nouveaux éléments de compréhension des effets de l'intensité de gestion sur la résilience des écosystèmes prairiaux face aux stress climatiques.

## Abstract

In the current context of climate change, associated with increases of climate extremes frequency and intensity, understanding the ecosystem response to climate variability is a central challenge in ecology. Soil microbial communities control most ecosystem processes driving energy and nutrients fluxes. In the context of agriculture management, an important question is to understand the influence of farming practices on soil microbial communities and their capacity to maintain ecosystem functioning under climate change. Ecological-intensive agriculture has been recently proposed as an approach integrating ecological processes in management strategies to optimise agroecosystems functioning and resilience to climate change. Functional ecology might be relevant to address these challenges associated with climate change and ecological-intensification of agriculture.

In this PhD thesis, I used the functional trait framework to grassland ecosystems to address how different modalities of management intensity (extensive, conventional-intensive, ecological-intensive management) influence: 1) functional parameters of soil microbial communities; 2) the capacity of these soil microbial communities to maintain ecosystem functioning during and after climatic stresses (Resilience). During my PhD, three experiments have been conducted using different degrees of control of management factors and simulating different kind of climatic stresses, with different durations. Based on grassland agroecosystems in three countries across Europe (France, Switzerland, Portugal), results from the first two experiments of this PhD showed that ecological-intensive management select soil microbial communities with a lower capacity to maintain microbial ecosystem properties during stresses (resistance) but with higher capacity to recover compared with soil microbial communities of soils under conventional-intensive management. Moreover, another study showed that ecological-intensive management promotes beneficial proteolytic soil microbial communities for plant nitrogen uptake under climate change-induced rain regimes. Plant functional traits assessment suggest this management effect on microbial communities composition and resilience to be explained by higher litter phosphorous content in ecological-intensive systems. Indeed, this plant functional trait affect microbial traits, favouring copiotrophic microbial community characterized by a lower nitrogen:phosphorous ratio of their biomass and a lower investment in extracellular enzymes production, two traits decreasing stress resistance but increasing recovery capacities. Thereby, these two experiments stress the relevance of plant traits management to control soil microbial traits and the resilience of soil microbial communities to climate changes. A third experiment tested specifically the impact of a mineral fertilisation event on the resilience of soil microbial communities to different climatic stresses. Results clearly demonstrated that fertilization modify soil microbial community composition and soil microbial traits and decrease ecosystem stability under climatic stresses.

Implementing an approach based on the microbial functional trait concept, this thesis brings new insights on the effects of management intensity on grassland ecosystem resilience to climatic stress.

Merci...

---

... à mes parents

Un peu des racines de cette aventure se trouvent peut-être, déjà, dans la génétique.

Mon père ne m'a **pas** transmis le gène qui permet d'arrêter de réfléchir, faisant de moi, comme lui, un éternel étourdi, toujours sur son nuage, cherchant à comprendre le monde... Tu m'as aussi transmis ta passion pour le travail, ton amour de la connaissance et des hommes. Où que tu sois, merci.

Merci à ma mère également, dont les ancêtres, sans aucun doute, sont des Jacinthes du bois de Halle. Tu m'as appris à m'émerveiller de tous les êtres qui nous entoure, et tant, tant d'autres choses encore... Merci Maman.

---

... à mes professeurs/mentors

Cette aventure n'aurait peut-être pas été possible sans certaines personnes qui ont joué un rôle à des moments clés de mon parcours. D'abord, M<sup>r</sup> BELLEAU, professeur de SVT en terminal, vous m'avez encouragé à aller à la fac si je voulais faire une carrière universitaire, j'y ai trouvé ma voie. Merci ensuite à Etienne DAMBRINE, professeur d'écologie et pédologie à l'Université de Savoie, c'est sûrement toi qui m'as passionné pour l'étude des sols et du fonctionnement des écosystèmes. Merci Etienne et aussi Florent ARTHAUD, de m'avoir ensuite pris en stage sur les lacs d'altitudes, me permettant ainsi de mettre un premier pied dans la recherche. Je tiens aussi à remercier chaleureusement André EVETTE et Grégory LOUCOUGARAY de l'IRSTEA Grenoble avec qui j'ai fait mes stages de L3 et de M1. C'est vous qui m'avez vraiment fait découvrir ce que veut dire « faire de la recherche », merci pour votre confiance et pour vos encouragements à poursuivre dans cette voie.

---

... à mes directeurs de thèse

Cette aventure a vraiment commencé grâce à Jean-Christophe CLEMENT et Arnaud FOULQUIER. Merci à tous les deux. Vous avez su canaliser mon enthousiasme pour la recherche et mes rélexions souvent toufues, tout en me laissant une grande liberté dans la mise en œuvre de mes recherches. Merci pour les échanges que l'on a pû avoir, toujours très riches, que ce soit sur des questions scientifiques, sémentiques, d'organisations ou plus personnelles. Merci pour votre capacité à être sérieux sans vous prendre trop au sérieux, pour votre humour et votre amitié. Merci également de m'avoir permis de m'impliquer dans le projet Eco-serve qui m'a ouvert à de nombreuses collaborations dans un cadre scientifique international d'une grande richesse.

---

... aux différents membre de mes comités de thèse

Annette BERARD, Roberto GEREMIA, Sandra LAVOREL, Isabelle BERTRAND et Nicolas FANIN pour les échanges très riches que l'on a pû avoir.

---

...aux différents membre de mon jury de thèse

Aurélie CEBRON, Stefan HÄTTENSCHWILLER, Robert GRIFFITHS, Nicolas FANIN et Thomas SPIEGELBERGER d'avoir accepté d'évaluer ce travail de thèse.

---

....à mes collègues du 1<sup>er</sup> étage

Tout d'abord Merci Cindy, pour ton aide précieuse sur la plateforme et cette belle première année en co-bureau avec toi. Merci Lio également, pour tes talents de bricoleur et ton aide inconditionnelle sur ma dernière manip (Et Merci à Laurence de me l'avoir prêté certains samedi...) et pour tous les bons moments partagés, on a fait une belle équipe. Merci Nico (Legay) pour m'avoir formé et fait confiance sur la manip "Legacy Effect". Merci Sandra, pour les échanges toujours très positifs avec toi et pour m'avoir poussé à valoriser mon travail dans un journal comme *Journal of Ecology*, ça valait le coup ! Merci ensuite à tous les collègues du bureau 111 : Océane pour ton énergie, Enora pour tes fabuleux gateaux, et tous les autres : Rémy, Emilie, Coline, Marine, Julia, Nico, Marie, Babette, Pierre-Louis ! Pour cette bonne ambiance et pour tous les moments partagés en dehors du labo. Merci également à mes stagiaires Bastien et Dana qui m'ont donné de sacrés coups de main ! Merci Stéphane (Bec) pour m'avoir confié de nombreux enseignements.

Et tous les autres du du LECA !

Merci en particulier à tous ceux qui m'ont impliqué dans des collaborations sur d'autres projets que celui de ma thèse (ce qui faisait du bien de temps en temps ! ) : Wilfried, Tamara, Camille, Sarah, Amélie, Baptiste, Jean-Marc, Seb Ibanez.

Et la SAJF pour le prêt de la serre alpine toute neuve et également Jérôme Couston pour son aide précieuse quand ça déconnaît...

Merci aussi à Mathieu Loubiat de m'avoir fait confiance pour monter des cours et TP pour les LPRO Agroécologie.

---

....to all the colleagues from Eco-serve project

Lijbert, Gerlinde, Laura, Pablo, Rubén, Paulo, Filipa, Eduardo, Pedro, Paul, Andreas, Sarah, Martina, Tina Katarina, Helene, thank you very much for all these good times shared during the meetings and for the very interesting collaborations! A special thanks for the Portuguese team who carried out the Eco-serve Joint experiment from wich several of my thesis chapters come. And a special thanks also for Martina, with who I shared the first authorship of my chapter 2.3. We made a great team, I think this was a very fruitful collaboration!

---

...à tous mes amis

Et spécialement à Jim, Lucas, Gaspard, Coco et toute l'équipe de notre coloc' à Meylan Pierro, Ju', Oriane, Romain, Nico, Louise, Fany, Rémy pour votre amitié qui m'est si précieuse. Avec un merci particulier à Lucas (Cultivateur de légumes et de savoirs sur notre belle montagne de Chartreuse), de m'avoir donné accès à ton sol pour mes expérimentations.

---

....à ma famille et belle-famille

Guillaume, merci d'avoir toujours sû me conseiller avec le regard à la fois du grand frère et du chercheur, tu m'as été d'une grande aide. Milena, merci d'avoir toujours pris soin de ton petit frère préféré, merci pour tous ces moments partagés avec toi à S<sup>t</sup> Bé, qui ont été de vrais bouffées d'oxygène... Maman, encore merci, de m'avoir bichonné à chaque fois que je montais travailler dans notre montagne. Merci aussi à tout le reste de ma famille : Olivia, Gaël mais aussi Ed, Cyrielle, Alex, Emeline et mes neveux et nièces Noémie, Pauline, Hugo, Marius, Sam, Siobàn et Léon. Avec un merci tout spécial à Léon qui m'a permis de m'évader le week-end dans les univers fantastiques de mon enfance ; maintenant que ma thèse est finie, comme promis, on aura plus de temps tous les deux ! Merci à ma belle-famille : Marylaure, Patrice, Robin et Esther pour votre soutien.

---

....à Madame Piton-Ducroz,

Romane,

Merci pour ton amour, pour toutes tes attentions quotidiennes.

Merci pour ta patience, ta force.

Merci pour ton sourire, ton sourire, qui fait tout oublier...



## PUBLICATIONS ET COMMUNICATIONS SCIENTIFIQUES

### ARTICLES EN TANT QUE 1<sup>ER</sup> AUTEUR :

ARTICLE 1: **Piton G.**, Legay N., Arnoldi C., Lavorel S., Clément JC. & A. Foulquier 2019. *Using proxies of microbial community-weighted means traits to explain cascading effect of management intensity, soil and plant traits on ecosystem resilience in mountain grasslands. Journal of Ecology. DOI 10.1111/1365-2745.13327*

#### Publié dans *Journal of Ecology*

ARTICLE 2: **Piton G.**, Martinez L., Foulquier A., Legay N., Brussaard L., Hedlund K., Nascimento E., Reis F., Sousa P., Clement JC. & G. De Deyn. *The resilience of soil microbial communities to climate change-induced rain regimes differs between conventional and ecological-intensive managed soils across European agroecosystems*

#### Article en préparation

ARTICLE 3: **Piton G.**, Foulquier A., Martinez L., Legay N., Brussaard L., Hedlund K., Nascimento E., Reis F., Sousa P., De Deyn G. & J.C. Clement. *Implementing ecoenzymes in the trait framework bring new insights on the microbial community composition control on ecosystem functioning.*

#### Article en préparation

ARTICLE 4 : Lori M.\*, **Piton G.\***, Symanczik S., Legay N., Brussard L., Jaenicke S., Nascimento E., Reis F., Sousa P., Mäder P., Gattinger A. & Clément JC., A. Foulquier. *Compared to conventional, ecological intensive management promotes beneficial proteolytic soil microbial communities for agro-ecosystem functioning under climate change-induced rain regimes*

\* Shared first co-authorship

#### En revision dans le journal *Scientific report.*

ARTICLE 5 : **Piton G.**, Foulquier A., Bernard L., Arnoldi C., Audemard B., Bonin A., Gervais J., Miquel C. Pommier T., Tran-Khac V., Geremia R., J.C. Clément. *Mineral fertilization affects soil microbial community composition and traits and decrease microbial ecosystem properties resistance to climatic stresses, with and without plants.*

#### Article en préparation

### ARTICLE EN TANT QUE CO-AUTEUR :

Legay N., **Piton G.**, Arnoldi C., Bernard L., Binet M.N., Mouhamadou B., Pommier T., Lavorel S., Foulquier A. & J.C. Clément. 2018. *Soil legacy effects of climatic stress, management and plant functional composition on microbial communities influence the response of Lolium perenne to a new drought event. Plant & Soil. 424:233-254. DOI 10.1007/s11104-017-3403-x.*

#### Publié dans le journal *Plant & Soil*

Bien que nous ayons écrit cet article durant ma thèse, **il n'a pas été intégré dans mon manuscrit principal.** Seul les articles dont je suis le 1<sup>er</sup> auteur sont présentés dans ce manuscrit.

## COMMUNICATIONS SCIENTIFIQUES EN TANT QUE 1<sup>ER</sup> AUTEUR EN FRANCE ET A L'ETRANGER

COMMUNICATION 1 : **Piton G.**, Clément JC. & A. Foulquier. *Understanding grassland response to land use intensity and climate change: moving forward microbial trait based approach*. International Mountain Conference 2019, Septembre 2019, Innsbruck (Autriche). **Flashtalk + Poster + workshop**

COMMUNICATION 2 : **Piton G.**, Lori M., Symanczik S., Legay N., Jaenicke S., Nascimento E., Martins da Silva P., Reis F., Sousa P., Brussard L., Mäder P., Gattinger A., Clement JC. & A. Foulquier. *Eco-intensive agriculture, soil microbial community and ecosystem functions under altered rain regimes: a cross country experiment*. conférence internationale SFE 2018, Octobre 2018, Rennes (France). **Communication orale**

COMMUNICATION 3 : **Piton G.**, Clément JC. & A. Foulquier. *Rôle de la disponibilité en ressource sur la réponse des communautés microbiennes du sol aux variations climatiques*. Journée des doctorants FREE-Alpes, Juin 2018, Barraux (France). **Communication orale**

COMMUNICATION 4 : **Piton G.**, Clément JC. & A. Foulquier. *How agricultural models influence soil microbial communities responses to climate changes ?* Journée annuelle des doctorants, Juin 2018, Grenoble (France). **Flash communication**

COMMUNICATION 5 : **Piton G.**, Martinez L., de Deyn G., Clément JC. & A. Foulquier. *Structural and functional resistance and resilience of microbial communities to climate perturbations across land use systems*. Meeting annuel du Projet Ecoserve, Janvier 2018, Ghent (Belgique). **Communication orale**

COMMUNICATION 6 : **Piton G.**, Legay N., Lavorel S., Arnoldi C., Clément JC. & A. Foulquier. *Gestion des prairies et réponses biogéochimiques à la sécheresse : quels liens avec les traits éco-enzymatiques microbiens ?* VI<sup>èmes</sup> journées TEBIS, colloque annuel organisé par le réseau TEBIS, Octobre 2017, Metz (France). **Communication orale**

COMMUNICATION 7 : **Piton G.**, Legay N., Lavorel S., Arnoldi C., Clément JC. & A. Foulquier. *Mountain grasslands management, trophic resources and microbial response to drought*. Meeting annuel du Projet Ecoserve, Janvier 2017, Frick (Suisse). **Communication orale**

COMMUNICATION 8 : **Piton G.**, Legay N., Lavorel S., Clément JC. & A. Foulquier. *Pratiques agricoles en prairies de montagne et résistance des communautés microbiennes du sol à un épisode climatique extrême*. 13<sup>èmes</sup> Journées d'étude des Sols 2016, colloque annuel organisé par l'AFES (Association Française de l'Etude des Sols), Juillet 2016, Louvain-la-Neuve (Belgique) **Communication orale**

## COMMUNICATIONS SCIENTIFIQUES EN TANT QUE CO-AUTEUR EN FRANCE ET A L'ETRANGER

Lori M., Symanczik S., **Piton G.**, Mäder P. & A. Gattinger. *Enhancing microbial community performance via ecological intensive management with a focus on N-related ecosystem processes under altering water regimes*. Symposium on Above- and belowground Biodiversity for Sustainable Ecosystems, Novembre 2019, Agroscope, Zurich (Suisse). **Communication orale**

Lori M., Symanczik S., **Piton G.**, Mäder P. & A. Gattinger. *Nitrogen transformations and its underlying microbial communities in differently managed soils under future projected rainfall variability*. International Workshop, Comparing organic and conventional agricultural cropping systems - What can be learned from the DOK and other long-term trials? Octobre 2019, Monte Verità (Suisse). **Communication orale**

Legay N., **Piton G.**, Arnoldi A., Bernard L., Binet M.N., Mouhamadou B., Pommier T., Lavorel S., Foulquier A. & J.C. Clément. *Soil legacy effects of climatic stress, management and plant functional composition on microbial communities influence the response of Lolium perenne to a new drought event*. Sfécologie-2018, International Conference of Ecological Sciences, Rennes, FR. Octobre 2018. **Poster**

Legay A., Foulquier A., Piton G., Arnoldi C., Bernard L., Lavorel S. & J.C. Clément. *Resistance of soil microbial communities and Lolium perenne to drought: Is there a legacy effect of previous hydric stresses?* ECOSUMMIT 2016, Août 2016, Montpellier (France). **Communication orale**





## TABLE DES MATIERES

AVANT PROPOS.....	16
Glossaire (glossary).....	17
CHAPITRE 0.....	20
INTRODUCTION.....	20
L'écologie fonctionnelle, une discipline répondant aux enjeux des changements globaux.....	20
1 Développement de l'approche fonctionnelle en écologie.....	21
2 Réponse fonctionnelle des organismes à l'environnement : stratégie et traits fonctionnels.....	24
3 Effet des traits fonctionnels sur le fonctionnement des écosystèmes.....	27
4 Niveau versus résilience des propriétés des écosystèmes.....	29
5 Cadre des traits fonctionnels et changements globaux.....	31
6 hypothèse et structure de la thèse.....	35
7 Sites d'études.....	36
8 Expérimentations.....	37
9 Organisation du document.....	41
Références.....	43
CHAPITRE 1 (Article 1).....	52
Using proxies of microbial community-weighted means traits to explain cascading effect of management intensity, soil and plant traits on ecosystem resilience in mountain grasslands.....	52
Abstract.....	53
1 Introduction.....	54
2 Materials and methods.....	56
3 Results.....	62
4 discussion.....	67
5 Conclusion.....	70
REFERENCES.....	71
Supplementary materials.....	77
contribution personnelle au chapitre 1.....	78
conclusion et perspectives du chapitre 1.....	79
CHAPITRE 2.1 (Article 2).....	81
The resilience of soil microbial communities to climate change-induced rain regimes differs between conventional and ecological-intensive managed soils across European agroecosystems.....	81
Abstract.....	82
1 Introduction.....	82

2	Materials and methods .....	84
3	Results.....	90
4	Discussion .....	94
5	Conclusion.....	95
	References.....	96
	Supplementary materials.....	100
	contribution personnelle au chapitre 2.1 .....	103
	conclusion et perspectives du chapitre 2.1 .....	104
	CHAPITRE 2.2 (Article 3) .....	106
	Implementing ecoenzymes in the trait framework bring new insights on the microbial control on ecosystem functioning. .....	106
	Abstract .....	107
1	Introduction .....	107
2	Materials and methods.....	110
3	Results.....	113
4	Discussion .....	117
5	Conclusion.....	120
	References.....	120
	Contribution personnelle au chapitre 2.2.....	124
	conclusion et perspectives du chapitre 2.2 .....	124
	CHAPITRE 2.3 (Article 4) .....	126
	Compared to conventional, ecological intensive management promotes beneficial proteolytic soil microbial communities for agro-ecosystem functioning under climate change-induced rain regimes.....	126
	Abstract .....	127
1	Introduction .....	127
2	Material and Methods .....	130
3	Results.....	132
4	Discussion .....	138
	Acknowledgements .....	141
	Author contributions .....	141
	Additional information.....	142
	References.....	142
	Supplementary materials.....	146
	Contribution personnelle au chapitre 2.3.....	150

conclusion et perspectives du chapitre 2.3 .....	151
CHAPITRE 3 (Article 5) .....	153
Mineral fertilization affects soil microbial community composition and traits and decrease microbial ecosystem properties resistance to climatic stresses, with and without plants. ....	153
Abstract .....	154
1 Introduction .....	154
2 Materials and methods .....	156
3 Results.....	161
4 Discussion .....	170
5 Conclusion.....	174
References .....	175
Supplementary materials.....	180
Contribution personnelle au chapitre 3.....	184
Conclusion et perspectives du chapitre 3.....	185
CHAPITRE 4 .....	187
DISCUSSION : Approche de la résilience des écosystèmes prairiaux par le concept de trait fonctionnel microbien : Synthèse, discussion et perspectives .....	187
1 Synthèse des résultats .....	188
2 Discussion de la signification fonctionnelle des proxys de CWM microbiens .....	189
3 Evaluation transversale de l'hypothèse générale : variation fonctionnelle des communautés microbiennes et résilience.....	193
4 Développement de l'approche par les traits microbiens : perspectives .....	199
5 Conclusion générale.....	201
Références.....	201

## AVANT PROPOS

Cette thèse a été financée par une bourse de l'école doctorale Chimie Science de la Vie de l'université de Grenoble.

Elle s'intègre également au projet Européen **ECO-Serve** (site web : [ecoserve-project.eu](http://ecoserve-project.eu)) : "Sustainable provisioning of multiple ecosystem services in agricultural landscapes". Ce projet, financé par BiodivERsA/FACCE-JPI sur la période de 2014-2018 et dirigé par Lijbert Brussard (Wageningen University), a fait collaborer 6 partenaires répartis sur 6 pays Européens : l'Université de Wageningen (Pays-Bas), L'Université de Lund (Suède), L'institut FIBL de recherche sur l'agriculture biologique (Suisse), L'université de Coimbra (Portugal), l'Université Rey Juan Carlos (Espagne) et l'Université Grenoble Alpes-CNRS (France).

L'objectif général du projet était d'évaluer des systèmes agricoles écologiquement intensifs, pouvant être plus adaptés au changement climatique que les systèmes conventionnels. L'hypothèse générale de ce projet était qu'une approche par les traits fonctionnels appliquée aux communautés végétales et aux communautés du sol (microorganismes, faune) pourrait permettre une meilleure compréhension des processus écologiques déterminant l'efficacité d'utilisation des ressources et de l'eau des agroécosystèmes dans un contexte de changement climatique. L'objectif final était que cette meilleure compréhension des effets des traits des plantes et des organismes du sol sur le fonctionnement de l'écosystème puisse apporter des clés pour les agriculteurs en vue d'une gestion des services écosystémiques et finalement, d'une adaptation au changement climatique.

Ce projet s'organisait en 5 « work packages » (WP) dont les objectifs étaient :

WP1-3 : évaluer l'effet des traits des litières des espèces utilisées dans les agroécosystèmes conventionnels-intensifs et écologiquement-intensifs sur les propriétés de la teneur en matière organique du sol (WP1), **les traits des microorganismes du sol (WP2)** et les traits de la faune du sol (WP3), et les répercussions sur le fonctionnement de l'écosystème et sa réponse aux variations du régime de précipitation.

WP4 : croiser les résultats des WP 1, 2 et 3 pour évaluer les compromis entre services écosystémiques dans un contexte de changements des régimes de précipitations.

WP5 : transférer les résultats aux agriculteurs et politiques.

Cette thèse s'intégrait plus spécifiquement dans le WP2 portant sur les traits des microorganismes du sol.

## GLOSSAIRE (GLOSSARY)

Term	Definition
<b>Community composition</b>	<b>Proportion of different organisms relative to the total in a given habitat</b> (Bender et al. 2016).
<b>Community weighted mean (CWM) trait</b>	<b>Average trait value per unit of biomass within a community</b> (Lavorel and Grigulis, 2012), representing the expected functional trait value of a random community sample, often understood as the dominant trait value in a community (Diaz et al., 2007).
<b>Ecological intensification</b>	<b>The attempt to integrate ecosystem services provided by biodiversity into crop production systems</b> (Bender et al. 2016).
<b>Ecosystem properties</b>	<b>Sizes of ecosystem compartments (e.g. pools of Nitrogen in microbial biomass) and fluxes of materials and energy among compartments (e.g. fluxes of Nitrogen between microbial biomass and soil)</b> (Hooper et al. 2005). Thus, ecosystem properties represent properties at the ecosystem level, expressed per unit of weight, volume or surface of the ecosystem under investigation (e.g. microbial biomass-N (pools) or N-mineralization (fluxe) per gram of soil (weight), soil m <sup>3</sup> (volume) or soil m <sup>2</sup> (surface)), with fluxes also expressed per unit of time (e.g. g-N m <sup>2</sup> min <sup>-1</sup> ). Ecosystem properties can be split depending on the associated compartment (e.g. <b>microbial ecosystem properties</b> such as microbial biomass-N or <b>plant ecosystem properties</b> such as plant biomass-N).
<b>Ecosystem Recovery</b>	<b>Capacity to recover ecosystem properties to its initial or normal state following the stress period</b> (Ingrisch and Bahn 2018).
<b>Ecosystem Resistance</b>	<b>Capacity to maintain ecosystem properties (pools sizes or fluxes levels) during disturbance</b> (Ingrisch and Bahn 2018).
<b>Effect trait</b>	<b>Any trait which reflects the effects of an organism on ecosystem properties</b> (Violle et al. 2007).
<b>Functional trait</b>	<b>Any morphological, physiological, phenological feature measurable at the individual level, which impacts fitness indirectly via its effects on growth, reproduction and survival</b> (Violle et al. 2007).
<b>Response trait</b>	<b>Any trait which varies in response to changes in environmental conditions</b> (Violle et al. 2007).
<b>Stress</b>	<b>Something that creates physiological challenges that threaten organisms function or survival</b> (Schimel et al. 2007).

*“Our descriptions of microbial communities are littered with question marks just as maps of continents were once littered with labels of ‘terra incognita’ by European explorers.”*

Noah Fierer, Albert Barberán & Daniel C. Laughlin. (2014). *Frontiers in microbiology*.

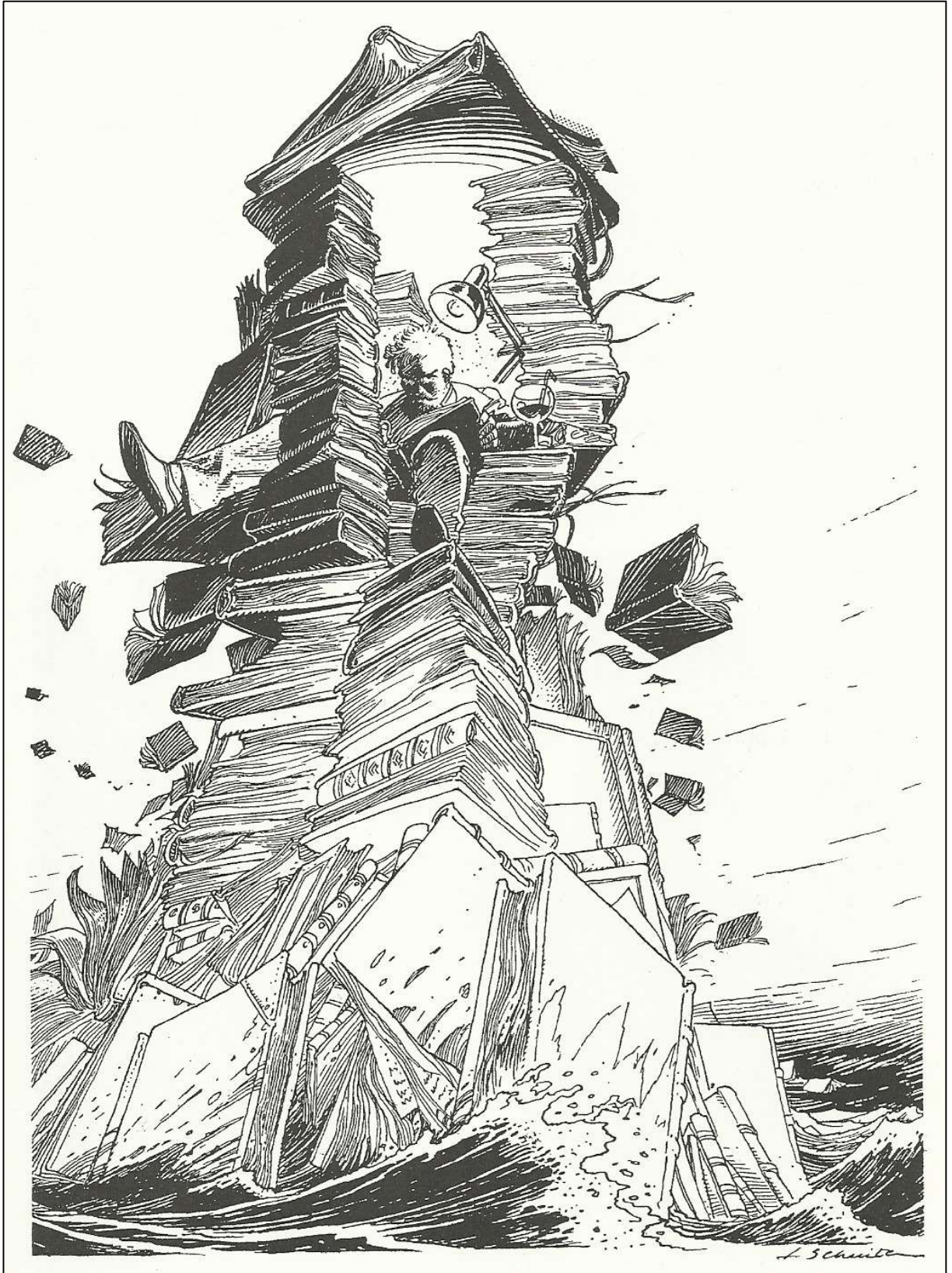

Le devoir de transmission selon François Schuiten



---

# CHAPITRE 0

## INTRODUCTION

L'ÉCOLOGIE FONCTIONNELLE, UNE DISCIPLINE REpondANT AUX  
ENJEUX DES CHANGEMENTS GLOBAUX

---

Ce chapitre introduit dans une première partie les bases conceptuelles d'une approche d'écologie fonctionnelle basée sur les traits fonctionnels. La deuxième partie de ce chapitre fait un état de l'art de nos connaissances des stratégies des plantes et des microorganismes du sol et de leur association avec les traits fonctionnels. La troisième partie présente notre compréhension actuelle des relations entre traits des plantes, des microorganismes du sol et le fonctionnement des écosystèmes. La quatrième partie de ce chapitre introduit le concept de résilience et son lien avec les traits fonctionnels. La cinquième partie présente finalement l'utilité de l'approche fonctionnelle dans le contexte des changements globaux pour ensuite présenter les problématiques et les objectifs de cette thèse.

## 1 DEVELOPPEMENT DE L'APPROCHE FONCTIONNELLE EN ECOLOGIE

L'écologie fonctionnelle représente une discipline de l'écologie scientifique, spécifique de par son étude des caractéristiques phénotypiques (traits) des organismes plutôt que de leur identité taxonomique (espèce, genre, classe...) (Calow 1987, Keddy 1992a). Les premières traces d'une telle approche remontent au philosophe grec Théophraste (372-282 av. J.C.) qui proposait une classification des plantes en arbres, arbrisseaux, sous-arbrisseaux et plantes herbacées (Amigues 2010). Cependant, cette discipline a réellement pris son essor au XX<sup>ème</sup> siècle suite à la reconnaissance de la difficulté d'émettre des principes généraux et prédictifs sur la seule base de l'approche taxonomique (Keddy 1992a). Ainsi, l'objectif de l'écologie fonctionnelle est d'élaborer des principes et modèles généraux concernant le fonctionnement des systèmes écologiques (Calow 1987, Keddy 1992a). Remplir cet objectif revient à répondre à deux questions fondamentales : 1) comment les conditions environnementales contrôlent les caractéristiques des organismes ? 2) Comment les organismes contrôlent le fonctionnement de l'écosystème, c'est-à-dire la circulation de l'énergie et des nutriments dans l'écosystème (Lavorel and Garnier 2002, Garnier and Navas 2013) ?

Ces questions ont dans un premier temps été adressées *via* une approche cherchant à classifier les organismes en groupes fonctionnels (Gitay and Noble 1997, Lavorel et al. 1997). Alexander von Humboldt (1806) est notamment reconnu comme un des fondateurs de l'écologie fonctionnelle de par ses travaux proposant une classification fonctionnelle des plantes basée sur leurs formes de croissance (Duckworth et al. 2000). La classification de Raunkiaer, dite des types biologiques, basée sur la position des bourgeons, proposée en 1904 a également été très influente et reste encore largement utilisée (Garnier and Navas 2013). Cependant, l'écologie fonctionnelle a progressivement évolué vers l'utilisation des traits des organismes. Cette évolution s'est opérée face à la difficulté à définir des groupes fonctionnels pertinents pour de multiples fonctions. De plus, la reconnaissance de la nature non pas discrète et qualitative de certaines variations fonctionnelles (comme supposée par une approche par groupes fonctionnels), mais continue et quantitative, pouvant ainsi être capturée par des traits, a motivé cette transition vers des approches basées sur les traits (Lavorel and Garnier 2001). Le concept de trait a eu des significations diverses jusqu'au formalisme par Violle et al. (2007) du concept de "**trait fonctionnel**" dont la définition est aujourd'hui largement acceptée en écologie. Dans cet article, Violle et al. (2007) définissent un trait fonctionnel comme : « une caractéristique morphologique, physiologique ou phénologique mesurable à l'échelle de l'individu impactant indirectement sa fitness *via* son effet sur la croissance, la reproduction ou la survie » (Glossaire).

Le concept de trait fonctionnel est intimement lié au concept de stratégie adaptative (ou simplement « stratégie » ci-dessous). Une stratégie peut être définie comme « un ensemble d'adaptations imbriquées qui résultent du processus de sélection naturelle et qui favorisent la croissance et le succès reproducteur dans un milieu donné » (Craine 2009). Une stratégie est donc un ensemble de traits permettant aux organismes d'être adaptés à un environnement donné (maximisation de leur fitness). Southwood (1977) décrivait les habitats dans lesquels évoluent les organismes comme des "gabarits" (templates) contraignant leurs stratégies (Southwood 1977). Ainsi dans des conditions environnementales exerçant des forces sélectives similaires, une évolution convergente des traits peut amener des

espèces éloignées d'un point de vue phylogénétique à développer la même stratégie et donc les mêmes traits fonctionnels (Garnier and Navas 2013). L'existence d'une diversité de stratégies, résultant chacune d'une adaptation à des conditions environnementales particulières, est possible car l'évolution des espèces est soumise à des compromis ou « trade-offs » qui empêchent les organismes d'être adaptés à la fois à toutes les conditions environnementales. Ces compromis sont associés au fait que les organismes disposent d'une quantité limitée de ressources, ce qui les empêche de maximiser leur investissement énergétique dans toutes les fonctions (croissance, survie, maintenance, reproduction...) à la fois (Southwood 1977).

De par leurs effets sur la croissance, la reproduction et la survie des organismes, les traits fonctionnels peuvent également avoir un impact sur les flux d'énergie et de nutriments et donc le fonctionnement de l'écosystème. Cette propriété a amené à une discrimination entre deux types de traits : les **traits de réponse**, représentant ceux qui changent en réponse à des variations de l'environnement et les **traits d'effet** qui influencent le fonctionnement de l'écosystème (Glossaire, Lavorel and Garnier 2002). Traits de réponse et traits d'effet ne sont pas exclusifs l'un de l'autre et de nombreux traits peuvent à la fois répondre aux variations environnementales et influencer le fonctionnement de l'écosystème. Ces concepts de traits de réponse-effet ont permis de proposer un modèle reliant de manière mécaniste l'effet de l'environnement sur le fonctionnement de l'écosystème à travers la réponse de la biodiversité (Lavorel and Garnier (2002), Figure 1).

A l'échelle de la communauté, les traits fonctionnels jouent un rôle central dans l'assemblage des communautés (constitution des communautés sur la base d'un sous échantillonnage du pool d'espèces régionales) en étant les caractéristiques des organismes à partir desquels les filtre trient les espèces qui composeront la communauté (Figure 2) (Diamond 1975, Keddy 1992b, Diaz et al. 1998, Lavorel and Garnier 2002, Laughlin and Messier 2015).

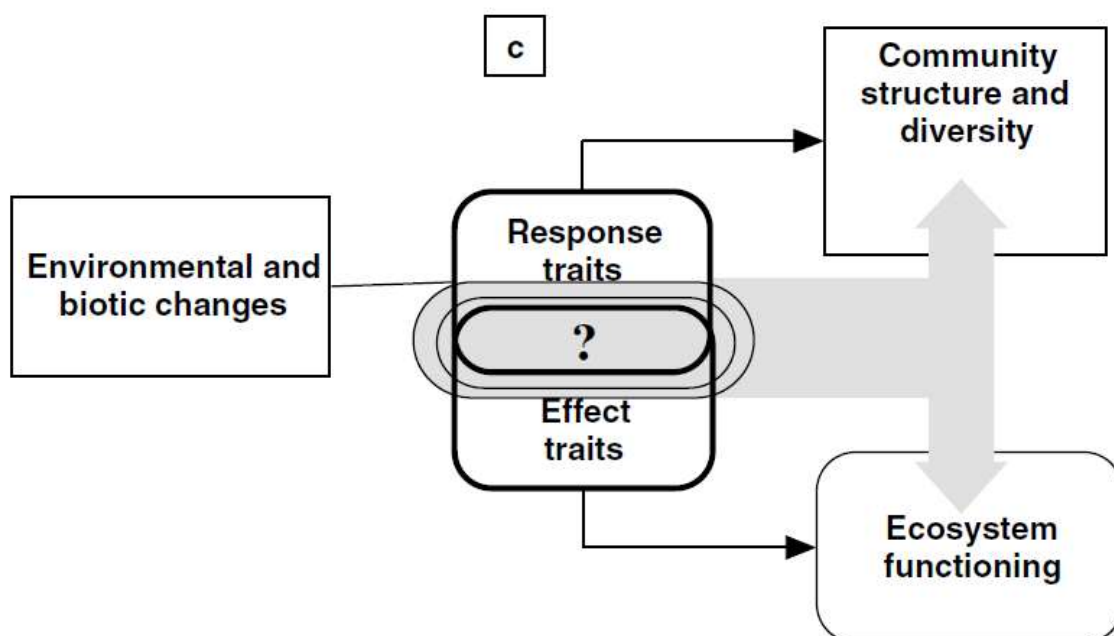

Figure 1. Modèle des traits de réponse-effet représentant le lien mécaniste entre environnement et composition/diversité des communautés à travers les traits de réponse et entre environnement et fonctionnement de l'écosystème à travers les traits de réponse-effet. Figure tirée de Lavorel et Garnier 2002.

Ainsi, en sélectionnant certains traits, les filtres environnementaux vont influencer leur distribution au sein des communautés (structure fonctionnelle). Cette structure fonctionnelle peut être caractérisée par deux types de propriétés : celles caractérisant la valeur moyenne du trait dans la communauté et celles caractérisant sa variation (ou diversité) (Diaz et al. 2007, Violle et al. 2007). La valeur moyenne d'un trait dans la communauté est couramment évaluée par la méthode du trait moyen pondéré à la communauté (ou **CWM** pour **Community Weighted Mean**, Figure 2, Glossaire) qui consiste à faire la somme pour l'ensemble (ou au moins 80%) des espèces de la communauté des valeurs de traits des espèces multipliées par la proportion de la biomasse totale qu'elles représentent :

$$CWM = \sum_{i=1}^n p_i \times trait_i \text{ (Garnier et al. 2004)}$$

Avec  $n$  le nombre d'espèces dans la communauté,  $trait_i$  la valeur de trait de l'espèce  $i$  et  $p_i$  la proportion de la biomasse totale que représente l'espèce  $i$ . D'un autre côté, un grand nombre d'indices ont été proposés pour caractériser la diversité fonctionnelle (Figure 2) mais ne seront pas détaillés ici car non utilisés dans ce travail de thèse (voir par exemple la revue de Mouchet et al. (2010) pour plus de détails).

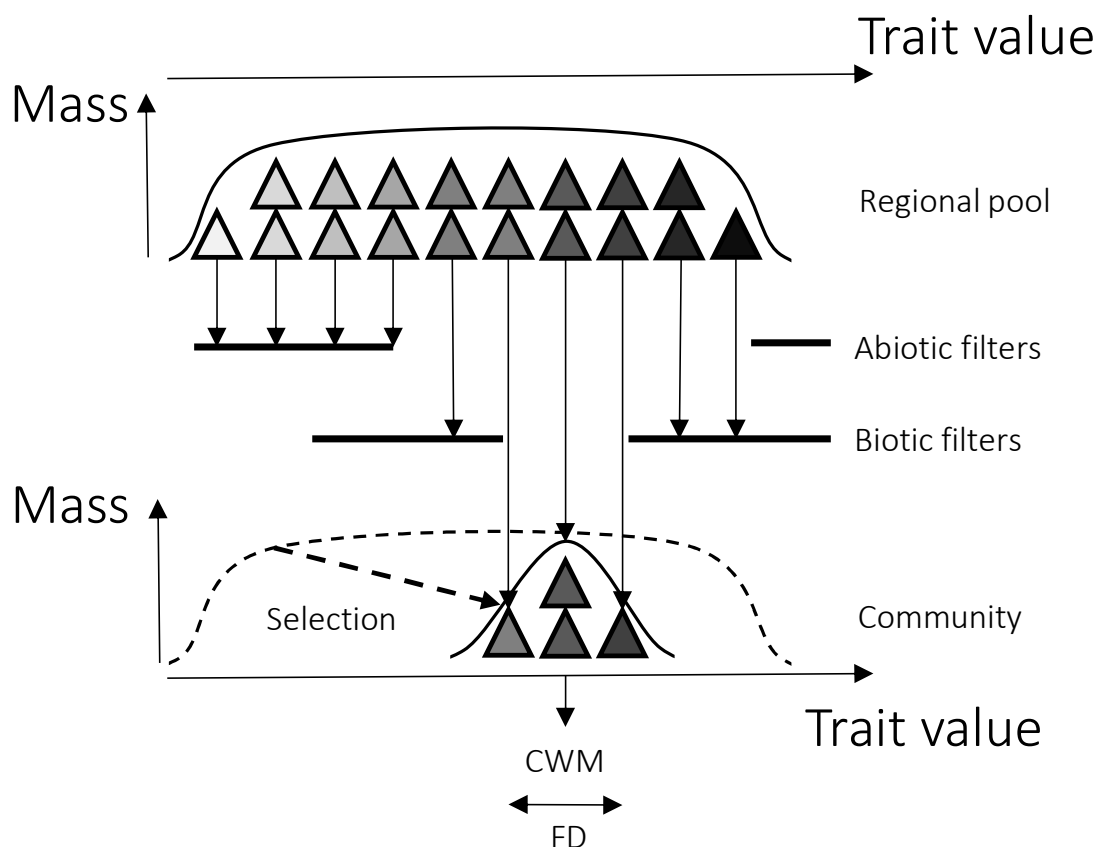

Figure 2. Règle d'assemblage des communautés selon la théorie des filtres (Diamond 1975, Keddy 1992b). Chaque triangle représente un individu et chaque couleur une espèce associée à une valeur de trait. Les espèces du pool régional sont filtrées selon leur valeur de trait, dans un premier temps par des filtres abiotiques (ex : climat) puis dans un deuxième temps par des filtres biotiques (ex : compétition pour les ressources) pour finalement constituer la communauté observée. La structure fonctionnelle de cette communauté peut être caractérisée par la valeur de trait moyen pondérée à la communauté (CWM) ou par la diversité de valeurs de trait présente dans la communauté (FD). Figure adaptée (Diaz et al. 1999).

Ces propriétés (valeur moyenne et diversité d'un trait) sont au cœur de deux hypothèses concernant l'effet de la structure fonctionnelle de la communauté sur le fonctionnement de l'écosystème. La première, proposée par Grime (1998), sous les termes de « mass ratio hypothesis » stipule que c'est la valeur de trait des espèces dominantes qui détermine le fonctionnement de l'écosystème (Grime 1998). En accordant un poids à la valeur de trait proportionnel à la biomasse de chaque espèce dans la communauté, l'indice de CWM permet de tester cette hypothèse (Garnier et al. 2004). La seconde hypothèse, dite de complémentarité (Loreau 2000, Petchey and Gaston 2006), stipule qu'une large diversité de valeurs de trait favorisera le fonctionnement de l'écosystème en permettant une complémentarité entre espèces dans l'utilisation des ressources.

## 2 REPONSE FONCTIONNELLE DES ORGANISMES A L'ENVIRONNEMENT : STRATEGIE ET TRAITS FONCTIONNELS

Le développement de cadres conceptuels visant à définir les stratégies au sein du vivant a fait l'objet d'importantes réflexions en écologie (MacArthur and Wilson 1967, Grime 1977). Ces cadres conceptuels sont essentiels à la compréhension des mécanismes d'assemblage des communautés le long de gradients environnementaux ainsi que leurs effets sur le fonctionnement de l'écosystème (Lavorel and Garnier 2002, Fierer et al. 2007). Le modèle r/K de MacArthur et Wilson (1967) est probablement le plus célèbre et le plus influent avec le modèle C-S-R de Grime (1977, voir (Grime 2006) pour plus de détails sur ce dernier). Le modèle r/K s'appuie sur un compromis entre investissement dans la croissance et investissement dans une utilisation efficace des ressources. La stratégie r est une stratégie sélectionnée dans les environnements non limités en ressources avec de fortes fluctuations environnementales, favorisant des traits associés à un taux de croissance et une reproduction rapide au détriment de la longévité et de la capacité à utiliser de manière efficace les ressources. A l'opposé, la stratégie K sera plus compétitive dans des conditions limitantes en ressources grâce à son efficacité d'utilisation des ressources plus élevée, mais disposera d'un taux de croissance et de reproduction plus faible. Bien que reconnu comme simpliste, ce modèle r/K reste encore largement utilisé en écologie de par son intérêt pour comparer différentes stratégies (Fierer et al. 2007).

### 2.1 STRATEGIE ET TRAITS FONCTIONNELS CHEZ LES PLANTES

Le développement récent des approches par les traits fonctionnels chez les plantes a permis des avancées majeures dans la compréhension des axes fonctionnels de variations au sein du monde végétal (Westoby 1998, Westoby et al. 2002, Reich 2014, Diaz et al. 2016). Parmi les axes fonctionnels majeurs, l'axe de gestion des ressources associé au spectre économique foliaire (Wright et al. 2004) discrimine deux types de stratégies (exploitatives et conservatives), analogues aux stratégies r et K de Mac Arthur et Wilson (1967). La stratégie exploitative se caractérise par une photosynthèse, une vitesse d'acquisition de l'azote et une croissance rapide, impliquant un temps de recyclage court des nutriments. Les traits fonctionnels associés à cette stratégie sont une faible teneur en matière sèche foliaire, mais une teneur en azote et une surface spécifique foliaire élevée. D'un autre côté, les plantes à stratégie conservative se caractérisent par des caractéristiques et des valeurs de traits opposées (Wright et al. 2004, Reich 2014).

### 2.2 STRATEGIE ET TRAITS FONCTIONNELS CHEZ LES MICROORGANISMES

Plusieurs modèles conceptuels ont été proposés pour caractériser les stratégies au sein du monde microbien (Fierer et al. 2007, Ho et al. 2013, 2017, Malik et al. 2018). Le modèle du continuum copiotrophe-oligotrophe (Fierer et al. 2007) est sûrement le plus couramment utilisé et le plus influent en écologie microbienne (Ho et al. 2017), en particulier pour les bactéries. Analogue aux continuums des stratégies r et K des macroorganismes (MacArthur and Wilson 1967) et exploitative-conservative décrit chez les plantes (Wright et al. 2004), le continuum copiotrophe-oligotrophe adapté aux microorganismes se base sur les variations de traits physiologiques associés à l'acquisition et l'utilisation des ressources (Ho et al. 2017). Les stratégies copiotrophe et oligotrophe ont dans un premier temps été

associées à des différences d'utilisation du carbone (C) (Fierer et al. 2007). Une préférence pour l'utilisation de C labile caractérise les microorganismes copiotrophes alors que les oligotrophes dominent dans des conditions de faible disponibilité de cet élément (Fierer et al. 2007). Cette dominance reposerait sur une meilleure capacité à utiliser les formes de C complexes via un investissement plus important dans la production d'enzymes extracellulaires, dépolymérisant la matière organique (Fontaine et al. 2003). Une forte disponibilité en azote a également été définie comme favorisant les copiotrophes au détriment des oligotrophes (Ramirez et al. 2010, 2012, Fierer et al. 2012, Leff et al. 2015, Ho et al. 2017).

Bien que de nombreux traits aient été proposés comme éléments définissant les stratégies copiotrophes et oligotrophes (Fierer et al. 2007), la difficulté de mesure des traits microbiens a amené les écologues microbiens à utiliser des indicateurs basés sur la **composition des communautés** microbiennes (Glossaire), théoriquement reliée avec certains traits fonctionnels, comme proxys de la stratégie dominante des communautés microbiennes (De Vries and Shade 2014). L'indicateur le plus répandu est probablement le ratio champignon / bactérie, basé sur l'idée que champignons et bactéries diffèrent au niveau d'un grand nombre de traits fonctionnels (morphologie, membrane, matériel génétique, machinerie enzymatique). De manière générale, les champignons sont considérés comme étant généralement plus oligotrophes que les bactéries, du fait d'une meilleure efficacité d'utilisation des ressources (De Vries and Shade 2014, Ho et al. 2017). Le ratio entre l'abondance des bactéries Gram positive et Gram négative est également couramment utilisé, basé sur des études démontrant que les bactéries Gram négatives sont fortement associées à l'utilisation du C labile dérivé des plantes alors que les Gram positives présenteraient une stratégie oligotrophe associée à une meilleure capacité à utiliser le C complexe de la matière organique (Kramer and Gleixner 2008, Fanin et al. 2018, Naylor and Coleman-Derr 2018). Les études à l'échelle du phylum au sein des bactéries montrent également une stratégie généralement oligotrophe chez les *Acidobacteria* et les *Verrucomicrobia* alors que la stratégie copiotrophe semble difficilement prédictible à l'échelle du phylum, bien que plusieurs études aient identifié les *Actinobacteria* et les *Betaproteobacteria* (subphylum) (Ho et al. 2017) comme de potentiels représentants de cette stratégie. Ces résultats peuvent s'expliquer par la présence de ces deux stratégies au sein d'un même phylum (Fierer et al. 2007) comme récemment démontré dans différentes études (Sauvadet et al. 2019), invitant à une caractérisation des stratégies à une échelle taxonomique plus fine (Ho et al. 2017, Sauvadet et al. 2019).

Les études mesurant directement des traits fonctionnels sont bien plus rares en écologie microbienne en comparaison à l'écologie des macroorganismes. L'essor récent de la biologie moléculaire appliquée à l'environnement a largement stimulé l'approche taxonomique en écologie microbienne. Ces études ont permis de larges avancées dans la caractérisation de l'impressionnante diversité taxonomique des microorganismes dans divers environnements (Baldrian 2019). Cependant, l'absence de données concernant les traits fonctionnels de la majorité des taxons microbiens limite notre capacité à prédire la diversité fonctionnelle de ces communautés sur la seule base d'une identification taxonomique. Cette difficulté a stimulé d'intenses réflexions ces dernières années sur l'utilisation d'approches par les traits en écologie microbienne (Green et al. 2008, Wallenstein and Hall 2012, Crowther et al. 2014, Fierer et al. 2014, Krause et al. 2014, Litchman et al. 2015, Martiny et al. 2015, Treseder and Lennon 2015, Hall et al. 2018, Malik et al. 2018, Baldrian 2019), comme cela avait été le cas en écologie végétale il y a plus de 20 ans (Keddy 1992a). Ce retard de l'écologie microbienne peut être également expliqué par les contraintes méthodologiques de l'étude des microorganismes que sont la difficulté à faire des mesures à l'échelle individuelle, l'incapacité à isoler et cultiver certaines espèces et la très grande diversité taxonomique et métabolique à caractériser (Green et al. 2008, Martiny et al. 2015). Une déconnexion entre la littérature de l'écologie microbienne et celle de l'écologie des macroorganismes peut aussi être avancée pour expliquer les rares liens établis avec l'approche fonctionnelle développée chez les macroorganismes dans les journaux d'écologie microbienne.

Cependant, certaines approches de biologie moléculaire comme l'étude ciblée de certains gènes fonctionnels, la métagénomique, la métatranscriptomique, la métaprotéomique ou encore plus récemment les méthodes de "stable isotope probing" ont permis d'appliquer une approche fonctionnelle en écologie microbienne.

Les approches moléculaires ciblant spécifiquement certains gènes fonctionnels sont déjà utilisées en routine depuis le début des années 2000 grâce à l'optimisation des méthodes de PCR quantitative (qPCR) et le développement de marqueurs ciblant ces gènes fonctionnels. Ces approches permettent ainsi de caractériser l'abondance et la diversité génétique de certains groupes fonctionnels de microorganismes (Rocca et al. 2015), comme les organismes protéolytiques (Bach et al. 2001, Lori et al. 2018), les bactéries nitrifiantes et dénitrifiantes ou encore les bactéries méthanogènes et méthanotrophes (Rocca et al. 2015). Bien que ces études soient très utiles pour comprendre la distribution de certains groupes fonctionnels et donc de certains traits (par ex : Alves et al. (2013)), l'utilisation des mesures d'abondance de ces gènes fonctionnels comme proxy de l'intensité du processus dans lequel ces gènes sont impliqués reste discutée (Rocca et al. 2015). En effet de nombreux facteurs peuvent induire un découplage entre l'abondance de gènes et le processus associé, qu'ils soient biologiques (régulation de la transcription du gène et de la traduction de l'ARNm associé, complexité de la chaîne métabolique associée au processus, turnover des nucléotides), abiotiques (effets directs des caractéristiques abiotiques du sol sur le processus) ou méthodologiques (efficacité d'extraction, biais PCR et qualité des primers) (Rocca et al. 2015).

Les approches de métagénomique, de métatranscriptomique, de métaprotéomique et de "stable isotope probing" développées plus récemment offrent également une opportunité de mieux caractériser les traits des microorganismes du sol (Fierer 2017, Morrissey et al. 2019). N'étant pas utilisées dans cette thèse, les perspectives de ces méthodes seront développées dans la discussion générale (Chapitre 4).

Bien que rarement définies comme telles, d'autres caractéristiques mesurées à l'échelle de la communauté microbienne peuvent être considérées comme des proxys du trait moyen pondéré à la communauté (voir chapitre 1 pour une démonstration de leur intérêt). Les traits reliés aux taux de croissance ou aux stratégies d'acquisition et d'utilisation des ressources semblent particulièrement prometteurs dans cette perspective. C'est le cas par exemple des traits stœchiométriques (Meunier et al. 2017). D'après la "growth rate hypothesis" (Elser et al. 2003), une teneur élevée en P relativement au C et au N (faible ratio C:P et N:P de la biomasse microbienne), indiquerait une forte concentration en matériel impliqué dans la division cellulaire (ARNr, ATP) associée à un taux de croissance élevé. D'un autre côté, une forte concentration en N relativement au C et P, serait reliée à un plus grand investissement dans la machinerie enzymatique (Arrigo 2004). En utilisant des données expérimentales, Karpinets et al. (2006) confirment cette hypothèse. En condition de contrainte nutritionnelle, une diminution du taux de croissance et une réorientation des ressources vers le maintien cellulaire induit une augmentation du ratio protéine:ARN et donc du ratio N:P de la biomasse (Karpinets et al. 2006). Ces résultats confirment un compromis dans l'allocation des ressources entre les fonctions de croissance et de maintien cellulaire reflété par des variations du ratio N:P de la biomasse microbienne. Les structures de résistances aux stress, notamment pour la résistance à la dessiccation, sont quant à elle riches en C et N (Delgado-Baquerizo et al. 2018). L'investissement dans ces structures au détriment de la machinerie de croissance sera donc associé à une augmentation des ratio C:P et N:P de la biomasse. **Ainsi, la stœchiométrie de la biomasse microbienne pourrait être utilisée comme indicateur de la stratégie des organismes.**

Le modèle d'allocation des ressources proposé par Sinsabaugh (1993) prédit une allocation dans la production d'enzymes extracellulaires optimisée en fonction de la disponibilité des différents éléments (C, N et P). Suivant ce modèle, les microorganismes augmenteraient leur investissement dans les enzymes extracellulaires permettant la dégradation des substrats contenant les éléments les plus limitants (disponibles en faible quantité assimilable) et diminueraient leur investissement dans la production d'enzymes ciblant des éléments non-limitants. Ce mécanisme

peut être appréhendé à travers la stœchiométrie enzymatique (ratio entre les enzymes d'acquisition du C, N et P) qui retranscrit l'investissement relatif dans la production d'enzymes extracellulaires pour l'acquisition du C, de l'N ou du P (Sinsabaugh et al. 2009). Le coût élevé en C et en N de la production d'enzymes extracellulaires (Frankena et al. 1988, Allison et al. 2010) pourrait aussi impliquer un compromis entre investissements dans la production d'enzymes extracellulaires de manière générale (ciblant tous les éléments confondus) et l'investissement dans les voies métaboliques associées à la croissance ou la résistance au stress (Malik et al. 2018). Cet investissement dans la production d'enzymes extracellulaires peut être évalué par la mesure de l'activité enzymatique pondérée par la biomasse microbienne ou **activité masse-spécifique** (Moorhead et al. 2013, Lashermes et al. 2016, Malik et al. 2019). L'utilisation des ratios enzymatiques comme indicateur non biaisé de la limitation nutritionnelle des microorganismes fait l'objet d'un débat (Rosinger et al. 2019) et mérite de plus amples investigations. Néanmoins, les éléments empiriques accumulés ces dernières années indiquent des variations de ratios enzymatiques et d'activités masse-spécifiques le long de gradients environnementaux (Sinsabaugh et al. 1993, 2008, 2009, Allison et al. 2007, Waring et al. 2014, Fanin et al. 2016, Xu et al. 2017, Malik et al. 2019) en accord avec le modèle d'acquisition des ressources (Sinsabaugh et al. 1993). Cela suggère que les variations de production des enzymes extracellulaires ont une position centrale dans la stratégie d'acquisition des ressources des microorganismes du sol et dans l'assemblage des communautés microbiennes (Mooshammer et al. 2014).

Les éléments développés dans cette partie mettent en avant l'intérêt de certains traits microbiens (activité masse-spécifique, stœchiométrie enzymatique et stœchiométrie de la biomasse microbienne) pour inférer la stratégie de gestion des ressources des microorganismes. Ainsi, ces indicateurs peuvent être utiles pour faire avancer notre compréhension de la réponse des communautés microbiennes aux changements globaux (Allison 2012, Litchman et al. 2015, Meunier et al. 2017, Malik et al. 2018).

### 3 EFFET DES TRAITS FONCTIONNELS SUR LE FONCTIONNEMENT DES ECOSYSTEMES

#### 3.1 TRAITS DES PLANTES, COMPOSITION DES COMMUNAUTES MICROBIENNES DU SOL ET FONCTIONNEMENT DE L'ECOSYSTEME

L'étude du fonctionnement des écosystèmes s'appuie sur le concept de **propriétés des écosystèmes** définies comme les quantités de carbone et de nutriments dans les compartiments de l'écosystème ainsi que les flux entre ces compartiments (Glossaire, Hooper et al. 2005). Ces dernières années, les travaux basés sur les traits fonctionnels des plantes ont permis une meilleure compréhension de l'effet de la biodiversité végétale sur le fonctionnement des écosystèmes (Wardle et al. 2004, Bardgett et al. 2014, Bardgett 2018) ainsi que sur les services écosystémiques (services fournis par les écosystèmes aux sociétés humaines (Millennium Ecosystem Assessment 2005)) qui en découlent (Lavorel et al. 2011, Lavorel and Grigulis 2012, Lavorel 2013). Un consensus tend à s'établir sur le fait que la structure fonctionnelle des communautés végétales serait plus déterminante pour le fonctionnement de l'écosystème que la diversité taxonomique (Garnier and Navas 2013). La compréhension la plus poussée est sûrement celle du fonctionnement des écosystèmes prairiaux (Garnier and Navas 2013). Au sein de ces systèmes, de fortes associations ont été mises en évidence entre disponibilité en N, structure fonctionnelle des communautés végétales, composition des communautés microbiennes et fonctionnement de l'écosystème (De Vries and Bardgett 2012, Bardgett 2018). Dans les prairies plus riches en N, se retrouvent des communautés végétales avec une stratégie exploitative produisant une litière facilement dégradable (Garnier et al. 2004, Quedsted et al. 2007, Fortunel et al. 2009). Elles sont liées à des communautés microbiennes dominées par des bactéries et un recyclage rapide des nutriments (Orwin et al. 2010, Laughlin 2011, De Vries et al. 2012b, Grigulis et al. 2013, Legay et al. 2014, 2016). D'autre part, les prairies pauvres en N sont dominées par des communautés végétales conservatives qui produisent des litières



plus récalcitrantes (Garnier et al. 2004, Quested et al. 2007, Fortunel et al. 2009). Ces conditions favorisent des communautés microbiennes dominées par des champignons avec un recyclage des nutriments plus lent (Orwin et al. 2010, Laughlin 2011, De Vries et al. 2012b, Grigulis et al. 2013, Legay et al. 2014, 2016) se traduisant par une meilleure aptitude du système à séquestrer du C et à conserver l'N (De Vries and Bardgett 2012, Lavorel and Grigulis 2012, Grigulis et al. 2013, Legay et al. 2014, 2016). De plus, de nombreuses études expérimentales démontrent que les associations entre traits des plantes, composition et activité des communautés microbiennes observées *in situ* peuvent être expliquées par des effets directs des plantes (Bardgett 2018) *via* des différences de qualité de leur litière (Fanin et al. 2014, Bernard et al. 2019) et/ou de rhizodéposition (Philippot et al. 2013) et de traits racinaires (Bardgett et al. 2014, Legay et al. 2016, 2017), et par des effets indirects *via* les effets des traits des plantes sur la disponibilité en nutriments et la compétition pour leur acquisition avec les microbes (Moreau et al. 2015, Bardgett 2018).

### 3.2 TRAITS MICROBIENS ET FONCTIONNEMENT DE L'ÉCOSYSTEME

Les communautés microbiennes du sol sont reconnues comme étant particulièrement importantes dans le fonctionnement de l'écosystème, catalysant 80 à 90 % des processus biogéochimiques du sol (Coleman and Crossley 1996, Nannipieri et al. 2003, Falkowski et al. 2008). Parmi les processus biogéochimiques catalysés, au moins en partie par les microorganismes, on peut citer : la dépolymérisation de la matière organique par les enzymes extracellulaires, considérée comme l'étape limitante de la décomposition de la matière organique (Schimel and Bennett 2004); la minéralisation du C (respiration), de l'N (ammonification) et du P (action des phosphatases extracellulaires) ; la nitrification et la dénitrification (Falkowski et al. 2008). L'importance des caractéristiques de la communauté microbienne (biomasse, composition, activité) dans le fonctionnement des écosystèmes est aujourd'hui reconnue par la majorité des écologues microbiens (Kuzyakov et al. 2009). La biomasse microbienne est généralement considérée comme le principal facteur influençant les processus généralistes (conduits par la majorité des espèces microbiennes) comme la minéralisation du C et du N ou la production d'enzymes extracellulaires (Kivlin and Treseder 2014, Li et al. 2019). Cependant, la composition de la communauté microbienne montre une capacité à expliquer une part de la variation des processus non expliquée par la biomasse microbienne (Graham et al. 2016) suggérant que des variations de traits (activité masse-spécifique) entre espèces influencent l'intensité des processus à l'échelle de l'écosystème.

Cependant, comme mentionné précédemment, peu d'études en écologie microbienne ont mobilisé le cadre des traits fonctionnels, se limitant généralement à la caractérisation de la diversité et la composition taxonomique des communautés microbiennes, limitant ainsi notre compréhension des mécanismes sous-jacents à l'effet de la diversité microbienne sur le fonctionnement de l'écosystème (Fierer et al. 2014). Les traits éco-enzymatiques et stœchiométriques détaillés dans la partie précédente pourraient être particulièrement intéressants à mobiliser pour comprendre la réponse des communautés microbiennes aux changements globaux et leurs effets sur le fonctionnement biogéochimique de l'écosystème car ils représentent à la fois des traits de réponse et des traits d'effet (Allison 2012).

### 3.3 APPROCHE PAR LES TRAITS ET COMPREHENSION DES EFFETS EN CASCADE

Un autre intérêt majeur des approches par les traits est la possibilité de mieux comprendre les mécanismes sous-jacents aux effets en cascade impliquant à la fois des composantes abiotiques et/ou biotiques de l'écosystème. Par exemple la modification de la disponibilité des nutriments du sol va influencer les traits des plantes qui vont ensuite déterminer l'accumulation et la décomposition de la litière (Quétier et al. 2007). Ces cascades peuvent également impliquer différents compartiments biotiques de l'écosystème associés par des relations trophiques. Ainsi la valeur de traits d'un organisme peut avoir un effet sur la valeur de traits des organismes positionnés au niveau suivant dans le

réseau trophique. Ce modèle représente une extension du modèle des traits de réponses-effets aux systèmes multitrophiques (Lavorel et al. 2013). Il peut être appliqué aux chaînes trophiques aériennes comme celles entre plantes et herbivores ou entre plantes et pollinisateurs (Lavorel et al. 2013) mais également aux chaînes trophiques souterraines souvent détritiques impliquant plantes et organismes du sol (Figure 3) (Valencia et al. 2018).

Cependant, l'absence d'étude mobilisant explicitement le cadre des traits fonctionnels à la fois pour les végétaux et les microorganismes du sol limite notre compréhension des potentiels effets en cascades des traits des plantes sur le fonctionnement des communautés microbiennes.

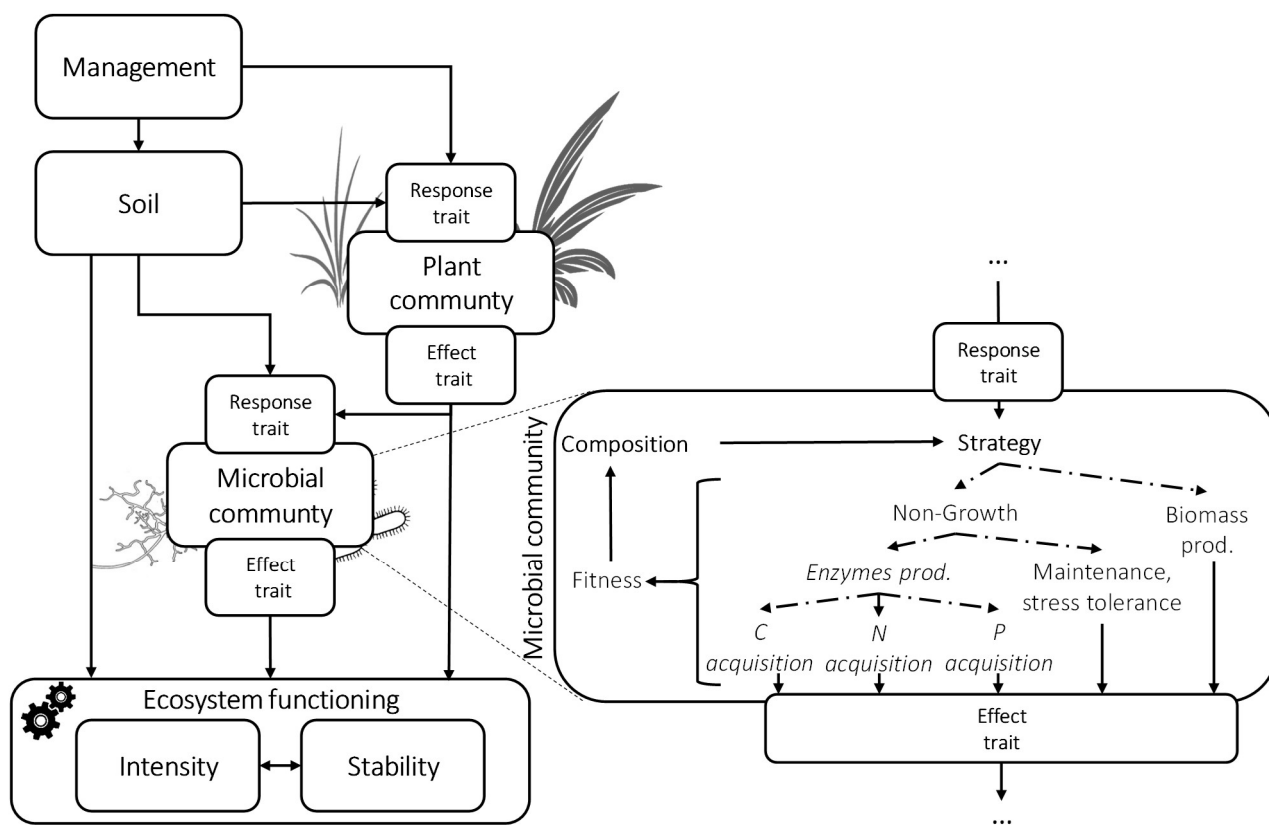

Figure 3. Adaptation du modèle de traits de réponse-effet (Lavorel and Garnier 2002) et son extension multitrophique (Lavorel et al. 2013) au cas des mécanismes de cascades entre gestion des prairies et fonctionnement des écosystèmes par l'intermédiaire de modifications des propriétés abiotiques du sol et des traits des plantes (A.). Représentation détaillée de l'effet de l'environnement sur les stratégies des microorganismes (et traits de réponses associés) déterminant la fitness et la composition des communautés microbiennes ainsi que l'effet des organismes sur le fonctionnement de l'écosystème (trait d'effet) et illustration de la position centrale des traits stœchiométriques et éco-enzymatiques dans les compromis ("trade-offs") fonctionnels (flèches pointillées) associés à la fois aux stratégies et à l'effet des organismes sur l'écosystème (B.).

#### 4 NIVEAU VERSUS RESILIENCE DES PROPRIETES DES ECOSYSTEMES

L'étude du fonctionnement des écosystèmes peut être appréhendée sous deux angles différents. Premièrement, on peut s'intéresser à comparer le niveau d'une propriété écosystémique dans différents écosystèmes à un instant donné. Cette approche couramment utilisée est pertinente par exemple pour comparer la capacité de différents écosystèmes à fournir un service écosystémique à un instant donné. Cependant, une limite de cette approche est de ne pas prendre en compte la dimension temporelle du fonctionnement des écosystèmes (Holling 1973, Southwood

1977). La deuxième approche consiste justement à étudier cette dynamique temporelle pour caractériser la **stabilité** du fonctionnement des écosystèmes, en particulier face aux perturbations ou aux périodes de stress. Suivant Schimel et al. (2007), nous définirons les perturbations à l'échelle microbienne comme des événements impliquant une perturbation physique pouvant induire directement une mortalité (par ex : labour) alors que les stress correspondent à des périodes ou les conditions induisent des contraintes physiologiques pour les microorganismes (Glossaire), par exemple une sécheresse (Schimel et al. 2007). Cette question de la stabilité des écosystèmes face aux perturbations et aux stress occupe l'écologie scientifique depuis déjà plusieurs décennies (Pimm 1984) et sa compréhension est indispensable pour parvenir à une appréhension complète du fonctionnement des écosystèmes et identifier d'éventuels compromis entre intensité et stabilité des processus écosystémiques.

#### 4.1 LE CONCEPT DE RESILIENCE

Dans cette littérature, le concept de résilience occupe une place importante. Ce terme de résilience aurait initialement été introduit en écologie en 1958 par Charles Sutherland Elton (Botton et al. 2006), un des pères de l'écologie scientifique contemporaine (Southwood and Clarke 1999). C. S. Elton définissait la résilience comme "l'amplitude des changements provoqués par une perturbation et la dynamique de récupération après la perturbation/stress" (Elton 1958, Botton et al. 2006). Holling (1996) met par la suite en avant deux définitions de la résilience utilisées en écologie : "engineering resilience" et "ecological resilience". Le premier concept d'"engineering resilience" se place dans le cadre d'un unique état d'équilibre de référence et considère la résilience comme la capacité d'un système à rester proche de cet état d'équilibre pendant la perturbation ou le stress et à revenir à ce point d'équilibre ensuite. D'autre part, le concept d'"ecological resilience" considère plusieurs états d'équilibres potentiels et définit la résilience comme la magnitude de perturbation ou de stress qui peut être absorbée par le système avant de changer de point d'équilibre. Ces concepts peuvent être appliqués tant à des composantes structurales des communautés (composition de la communauté) qu'à ses composantes fonctionnelles (structure fonctionnelle) ou aux propriétés des écosystèmes (Botton et al. 2006). On peut donc dire que l'"engineering resilience" permettra de caractériser la capacité d'un système à maintenir et à revenir à son état initial ou normal (par ex : composition de la communauté ou valeur d'une propriété écosystémique dans un contrôle expérimental), alors que le concept d'"ecological resilience" sera plus pertinent lorsque l'on s'intéresse à des mécanismes impliquant de potentiels changements d'états (ex : passage d'une communauté végétale ligneuse à une communauté herbacée). Dans le cadre de l'"engineering resilience", la résilience a été décomposée en deux paramètres : la **résistance** définie comme la capacité du système à maintenir un état proche de l'état normal durant la perturbation ou le stress et la **récupération** représentant la capacité du système à revenir à un état normal ensuite (Glossaire, Figure 4) (Ingrisch and Bahn 2018).

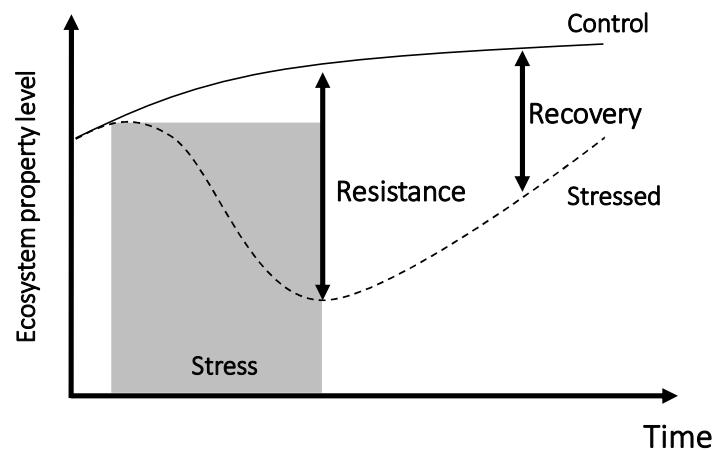

Figure 4. Représentation schématique de notre approche de la résilience, inscrite dans le cadre de l'"engineering resilience" (Holling 1973) et décomposée en deux paramètres : résistance et récupération (Ingrisch and Bahn 2018).

Dans le cadre de cette thèse, la résilience sera abordée sous l'angle de l'"engineering resilience". Nous chercherons à relier aux traits fonctionnels, la capacité des communautés à maintenir les propriétés écosystémiques durant des périodes de stress climatique, à des valeurs proches de celles observées dans des conditions climatiques normales.

## 4.2 TRAIT FONCTIONNELS ET RESILIENCE

Comme les périodes de stress climatiques sont souvent associées à une altération de l'accès aux ressources, il a été proposé que les organismes présentant une stratégie de type K (plantes conservatives et microbes oligotrophes) devraient présenter une meilleure résistance aux stress climatiques grâce à leur efficacité d'utilisation des ressources alors que les stratégies de type r (plantes exploitatives, microbes copiotrophes) devraient présenter une plus faible résistance mais une meilleure capacité de récupération, associée à leur taux de croissance plus rapide et à leur capacité à utiliser rapidement les ressources à disposition après la fin de la période de stress (Lepš et al. 1982, Diaz and Cabido 2001, De Vries and Shade 2014). **Cette hypothèse prédit donc un compromis entre résistance et récupération le long du continuum r-K (Pimm 1984).** Plusieurs études semblent confirmer cette hypothèse pour les plantes (MacGillivray et al. 1995, Ingrisch et al. 2018, Stampfli et al. 2018), les microorganismes du sol (De Vries et al. 2012a, De Vries and Shade 2014) et les interactions plantes-microorganismes (Karlowsky et al. 2018). En ce qui concerne les microorganismes du sol, ces études montrent une meilleure résistance à la sécheresse des communautés dominées par des champignons alors que les communautés dominées par des bactéries montrent une meilleure capacité de récupération (De Vries et al. 2012a, De Vries and Shade 2014, Karlowsky et al. 2018).

## 5 CADRE DES TRAIT FONCTIONNELS ET CHANGEMENTS GLOBAUX

Les changements globaux (changements d'utilisation des terres, changements climatiques), associés aux activités humaines, sont reconnus comme responsables de la crise actuelle de la biodiversité (Pimm et al. 1995). Les grands cycles biogéochimiques (cycles du carbone, azote, phosphore, eau) ont été fortement modifiés (Falkowski et al. 2000, Galloway et al. 2008, Abbott et al. 2019). Crise de la biodiversité et modifications des grands cycles biogéochimiques menacent la fourniture de services écosystémiques (Millennium Ecosystem Assessment 2005). La prédiction de la réponse de la biodiversité aux changements globaux et des répercussions sur le fonctionnement des écosystèmes et les services associés est donc un enjeu actuel majeur. L'écologie fonctionnelle propose un cadre conceptuel pour étudier les mécanismes associés à cette réponse (Lavorel and Garnier 2002, Lavorel 2013). Ses applications sont importantes pour la gestion de la biodiversité, dans des objectifs de restauration (Laughlin 2014) et d'optimisation des services écosystémiques fournis par les systèmes naturels mais également agricoles (Lavorel et al. 2011, Duru et al. 2015).

## 5.1 L'ENJEU AGRICOLE : L'ÉCOLOGIE FONCTIONNELLE AU SERVICE DE L'AGRICULTURE ÉCOLOGIQUEMENT-INTENSIVE

Les écosystèmes agricoles représentent approximativement 25% de la surface terrestre et 50% de la surface si l'on exclue les zones boréales, rocheuses, glacées et désertiques (Millennium Ecosystem Assessment 2005). Leurs contributions aux cycles biogéochimiques et à la fourniture de (dis)services écosystémiques sont très importantes (Millennium 2005, Swinton et al. 2007, Duru et al. 2015). La production de nourriture et de fibres est généralement le service pris en compte en premier lieu dans la gestion de ces agroécosystèmes. Cependant, de nombreux autres (dis)services découlent des surfaces agricoles (Swinton et al. 2007, Power 2010). Un des grands défis de l'agriculture du XXI<sup>ème</sup> siècle est d'ailleurs de réussir à mettre en place une agriculture capable d'optimiser l'ensemble des services écosystémiques, et non plus seulement de se focaliser sur le rendement, comme c'est le cas pour l'agriculture conventionnelle.

## 5.2 L'AGRICULTURE ÉCOLOGIQUEMENT-INTENSIVE

L'agroécologie (Altieri and others 1983, Francis et al. 2003, Altieri et al. 2015) et plus récemment l'agriculture **écologiquement-intensive** (Glossaire, Doré et al. 2011, Bommarco et al. 2013) ont été proposées comme modèles agricoles pouvant répondre à cet enjeu. Les deux idées centrales de ces modèles sont : 1) l'utilisation des fonctionnalités naturelles offertes par les écosystèmes au lieu d'utiliser des intrants de synthèses (Figure 5); 2) la fourniture d'un maximum de services écosystémiques au lieu d'une gestion uniquement orientée vers le rendement (Doré et al. 2011). La FAO définit l'intensification écologique (ou intensification durable) comme la « maximisation de la production primaire par unité de surface sans compromettre l'aptitude du système à maintenir sa propre capacité de production » (FAO 2009), autrement dit une maximisation de la productivité sans impact sur le service de maintien de la fertilité des sols. La capacité de résilience des systèmes agricoles aux stress climatiques a également été mise en avant comme un objectif central dans le développement de systèmes agroécologiques et écologiquement-intensifs dans le contexte actuel des changements climatiques (Bommarco et al. 2013, Altieri et al. 2015).

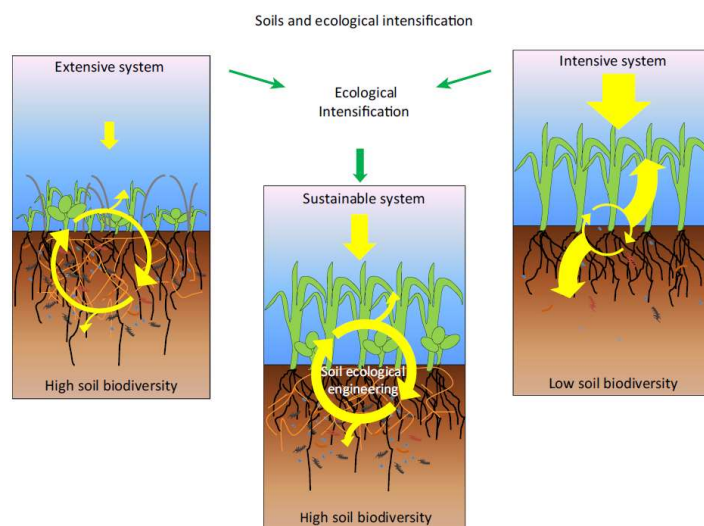

Figure 5. Schéma appliquant le concept **d'intensification écologique** des sols (tiré de Bender et al. (2016)). Le système extensif présente de faibles quantités d'intrants, des processus écosystémiques ralentis et de faibles pertes. Le système intensif (ou conventionnel-intensif dans notre terminologie) présente de fortes quantités d'intrants, des processus écosystémiques ralentis et de fortes pertes. Le système durable (ou écologiquement-intensif) présente des intrants moyens, des processus écosystémiques intensifiés et montre peu de pertes. Ainsi le système écologiquement-intensif optimise les processus internes de l'écosystème pour maximiser la fourniture de services écosystémiques (Bender et al. 2016).

L'écologie fonctionnelle, en offrant un cadre conceptuel permettant d'étudier les mécanismes déterminant le fonctionnement des écosystèmes à travers la réponse de la biodiversité, a été mise en avant comme une approche prometteuse pour l'agroécologie et l'intensification écologique de l'agriculture, en particulier au niveau de la gestion des communautés végétales (Garnier and Navas 2012, Duru et al. 2013, 2015a, 2019, Loucougaray et al. 2015) et des liens entre communautés végétales et communautés du sol (De Vries and Bardgett 2012, Wood et al. 2015, Faucon et al. 2017, Mariotte et al. 2018). Jusqu'ici, ces approches mobilisaient essentiellement les traits fonctionnels végétaux alors que les traits des organismes du sol et ceux des microorganismes en particulier ne sont pas directement pris en compte.

Les leviers de gestion visant à influencer l'intensité des processus écosystémiques à travers la modification des traits des plantes et la composition des communautés microbiennes commencent à être relativement bien établis (De Vries and Bardgett 2012) alors que les leviers potentiels pour augmenter la résilience restent encore à identifier (De Vries and Shade 2014).

### 5.3 L'ENJEU CLIMATIQUE : COMPRENDRE LA REPONSE DES ECOSYSTEMES A TRAVERS LE PRISME DES TRAITS FONCTIONNELS

L'augmentation de la concentration en gaz à effet de serre dans l'atmosphère, causée par les activités humaines, est responsable d'une augmentation de la température moyenne à l'échelle du globe (Allen et al. 2014). Ce réchauffement amplifie le cycle de l'eau (Huntington 2006) induisant une augmentation de la fréquence et de l'intensité des stress climatiques. Les épisodes de précipitations sont de plus en plus intenses et les périodes qui les séparent de plus en plus longues (Knapp et al. 2008, Allen et al. 2014). Ces épisodes climatiques associés à des changements hydriques des sols contraignent le fonctionnement des plantes (Chaves et al. 2003) et des microorganismes du sol (Schimel et al. 2007) avec de potentielles répercussions importantes sur le fonctionnement des écosystèmes terrestres (Schimel et al. 2007, Knapp et al. 2008). Des méta-analyses récentes mettent notamment en évidence des impacts importants des stress climatiques sur certaines propriétés écosystémiques microbiennes comme la biomasse microbienne (Ren et al. 2018), la libération de CO<sub>2</sub> (Canarini et al. 2017), le recyclage de l'N (Homyak et al. 2017) et l'activité des enzymes extracellulaires contrôlant la dépolymérisation de la matière organique (Xiao et al. 2018).

Dans ce contexte, mieux comprendre les mécanismes contrôlant la stabilité des écosystèmes est un enjeu important pour lequel l'écologie fonctionnelle offre un cadre conceptuel permettant d'évaluer les mécanismes impliqués. Les connaissances accumulées en écologie fonctionnelle permettent aujourd'hui de proposer un modèle reliant l'intensité de gestion des prairies, les ressources du sol, les traits/stratégies des plantes, la composition des communautés microbiennes, les traits/stratégies des microorganismes, l'intensité des processus écosystémiques et finalement leur résilience (Figure 6).

Les résultats des études de de Vries et al. (2012) comparant la résilience de sols de cultures et de prairies extensives ainsi que les travaux de Karlowsky et al. (2018) comparant prairies intensives et prairies abandonnées font partie des rares études ayant testé ce modèle. Leurs résultats tendent à confirmer l'existence d'un compromis entre résistance et récupération associé au continuum conservative-exploitative et champignons-bactéries, eux-mêmes sous l'influence de l'intensité de gestion. Cependant, ces travaux s'appuient sur la comparaison de systèmes très contrastés en termes d'intensité de gestion et les mécanismes par lesquels les différentes modalités de gestion influencent les traits des microorganismes et leur résilience restent peu compris.

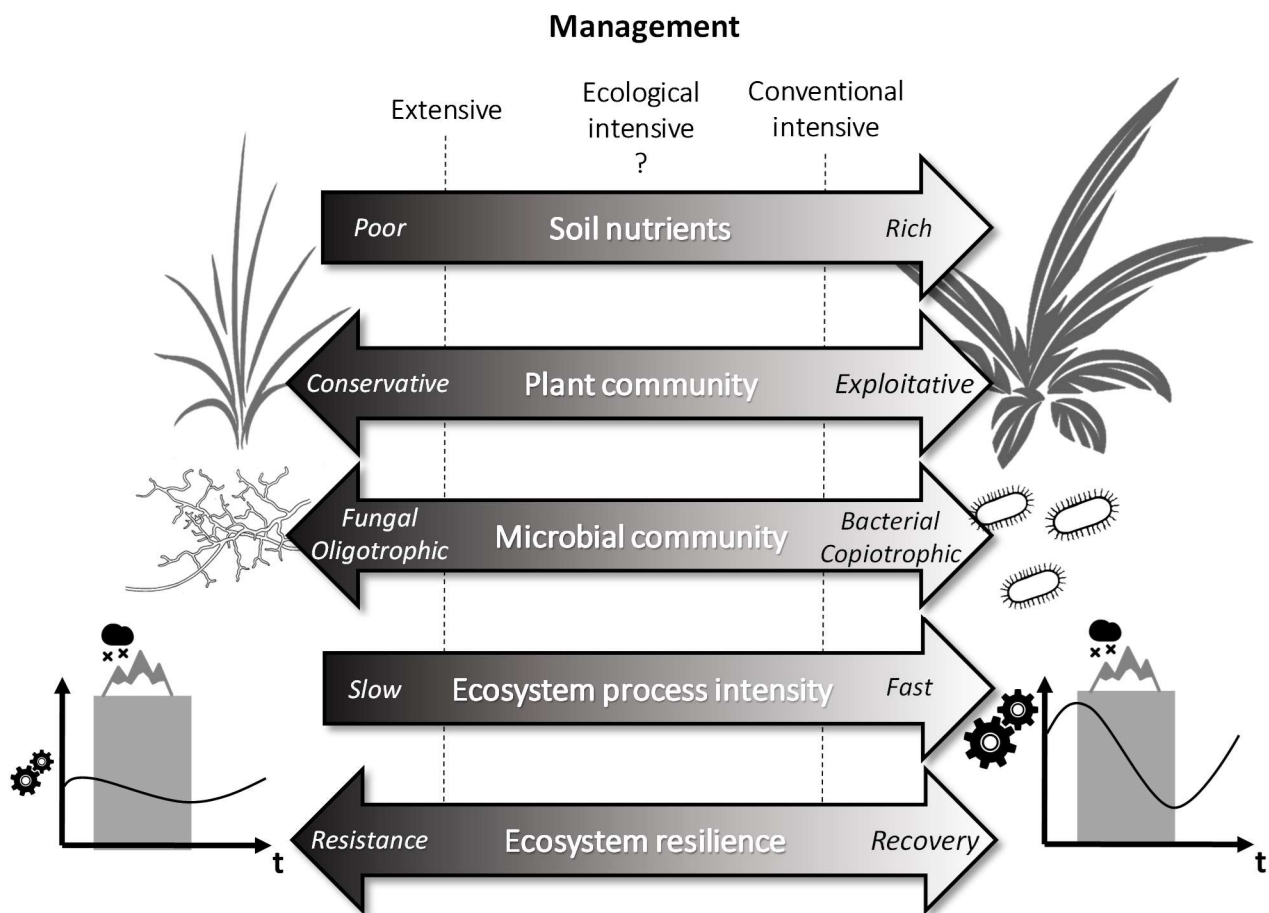

Figure 6. Modèle conceptuel représentant les associations fonctionnelles entre stratégie des plantes, des microorganismes, intensité et résilience des processus écosystémiques et position des modalités de gestion sur le continuum. Figure adaptée de Grigulis et al. 2013.

Il reste à explorer dans quelle mesure le modèle présenté en Figure 6 peut être appliqué pour prédire les différences de résilience entre systèmes moins contrastés en terme d'intensité de gestion, comme les systèmes conventionnels-intensifs vs. écologiquement-intensifs. De plus, pour identifier des leviers de gestion permettant d'améliorer la résilience des agroécosystèmes face aux changements climatiques à travers les traits fonctionnels, il serait très utile d'approfondir notre compréhension des mécanismes à travers lesquels la gestion modifie les communautés microbiennes du sol de manière à changer leur capacité à répondre aux stress climatiques (Figure 3).

## 6 HYPOTHESE ET STRUCTURE DE LA THESE

Ce travail de thèse s'appuie sur le cadre conceptuel développé en écologie fonctionnelle pour répondre à des problématiques posées par les changements globaux. Plus précisément, l'objectif était d'apporter des nouveaux éléments de compréhension des mécanismes microbiens par lesquels la gestion des agroécosystèmes prairiaux influence la stabilité des propriétés écosystémiques face à l'augmentation de l'intensité et de la durée des épisodes de stress climatiques.

L'hypothèse centrale de cette thèse repose sur le modèle théorique présenté dans la Figure 6, basé sur les concepts des stratégies r-K (conservative-exploitative pour les plantes et oligotrophe-copiotrophe pour les microorganismes) et les associations entre ces stratégies, les traits fonctionnels, la disponibilité en ressources et la résilience des écosystèmes aux épisodes de stress climatiques.

Cette hypothèse a été décomposée en deux sous-hypothèses. La première porte sur la réponse des communautés microbiennes aux pratiques agricoles modifiant la disponibilité en nutriments et les traits de plantes avant les périodes de stress. La deuxième porte sur la résilience aux stress climatiques de ces communautés microbiennes sélectionnées sous différentes modalités de gestion.

**Sous-hypothèse 1 :** En absence de stress, les pratiques agricoles augmentant la quantité de nutriments disponibles et favorisant des traits végétaux exploitatifs sélectionnent des espèces et des traits microbiens associés à une stratégie copiotrophe.

**Sous-hypothèse 2 :** La sélection de ces communautés copiotrophes est associée à une diminution de la résistance aux stress climatiques des propriétés écosystémiques microbiennes et une augmentation de leur récupération.

Cette hypothèse générale (Figure 6) a été testée via différentes approches expérimentales qui ont permis de comparer la résilience d'agroécosystèmes prairiaux sous différentes modalités d'intensité de gestions (extensive, conventionnelle-intensive, écologiquement-intensive) et d'explorer les mécanismes sous-jacents à travers le prisme des traits fonctionnels (Figure 3).



## 7 SITES D'ETUDES

Les expérimentations réalisées au cours de ma thèse se sont basées sur des prairies de trois régions réparties à travers l'Europe. Ces régions font partie du réseau de sites du projet européen Eco-serve (2013–2014 BiodivERSA/FACCE-JPI joint call) dont l'objectif était de mobiliser une approche par les traits fonctionnels pour comparer le fonctionnement d'agroécosystèmes en gestion conventionnelle-intensive et écologiquement-intensive (Garcia-Palacios et al. 2018). La modalité de gestion extensive a également été considérée dans cette thèse sur certaines expérimentations conduites sur le site principal en France (voir détails ci-dessous).

Ma principale région d'étude correspondait aux massifs préalpins (Vercors, Chartreuse) surmontant la ville de Grenoble en France (Figure 7). Ces massifs se caractérisent par un substrat calcaire, des paysages de moyenne montagne et une longue histoire d'utilisation des prairies pour l'élevage. Plus précisément, nos expérimentations se sont appuyées sur deux sites : le plateau des 4 Montagnes dans le massif du Vercors et le plateau des Petites Roches dans le massif de la Chartreuse. Ces deux plateaux se situent à des altitudes similaires (~1000m). Leurs climats sont très proches avec des températures moyennes annuelles de 8,1°C et 7,2°C et des précipitations moyennes de 1049mm et 1093mm pour le plateau des Petites Roches et le plateau des 4 Montagnes respectivement.

Dans le cadre d'une expérimentation conjointe du projet Eco-serve, le site du Vercors (France) mais également deux autres sites européens ont été étudiés :

Le premier est l'essai agronomique du centre FIBL (Institut de Recherche sur l'agriculture biologique Suisse). Localisé à Therwil au nord de la Suisse (Figure 7), cet essai agronomique compare différentes modalités de gestion (conventionnelle et biologique) depuis 1979, en faisant ainsi le plus long essai agronomique de ce type existant à ce jour. Cet essai agronomique se caractérise par une rotation de cultures incluant une phase sous prairie temporaire. Nos échantillonnages ont été conduits lors de cette phase de la rotation afin de pouvoir être comparés avec les autres sites, également en prairie. La température moyenne sur le site est de 9,5°C et les précipitations moyennes annuelles de 792mm.

Le troisième site utilisé pour l'expérimentation conjointe se situe au Portugal, à Montemor-o-Novo (Figure 7). Ce site est exploité en agroforesterie. Des chênes verts (*Quercus ilex*) et des chênes lièges (*Quercus suber*) sont cultivés en faible densité sur des prairies permanentes (Écologiquement-intensives) ou temporaires (Conventionnelles-intensives). La température moyenne annuelle sur le site est de 16,5 °C et les précipitations moyennes annuelles de 1483mm.

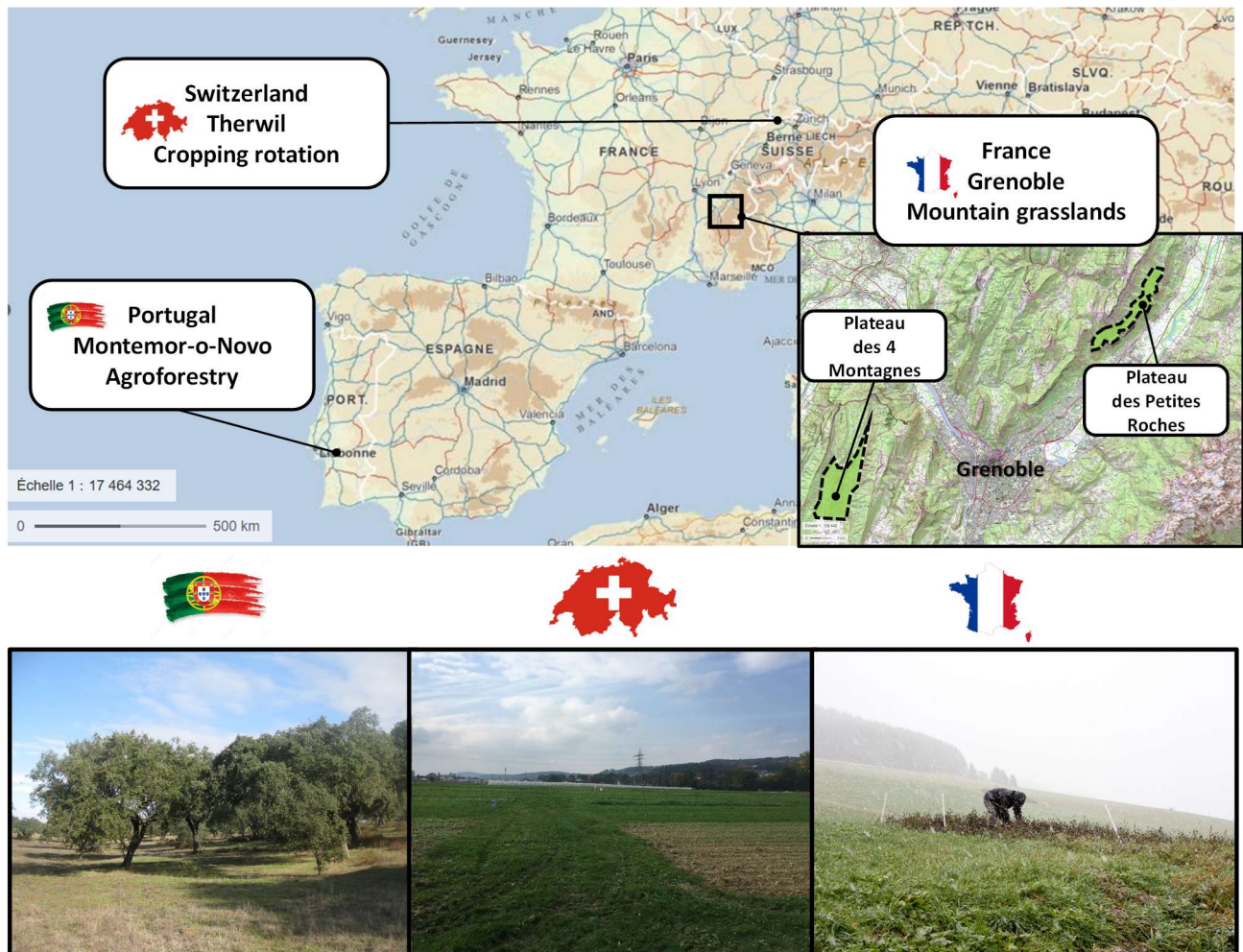

Figure 7. Localisation géographique et photos des sites d'études (Carte : [geoportail.gouv.fr](http://geoportail.gouv.fr), Photos : [ecoserve-project.eu](http://ecoserve-project.eu)).

## 8 EXPERIMENTATIONS

Durant cette thèse, trois expérimentations ont été réalisées s'appuyant sur les sites décrits dans la section précédente. Afin d'éviter les redondances, les détails des expérimentations et des méthodes utilisées ne seront pas donnés dans cette partie mais dans les chapitres respectifs à chaque expérimentation (Chapitres numérotés 1, 2 et 3 pour les expérimentations 1, 2 et 3 respectivement).

Cette partie cherchera plutôt à présenter les points communs et les complémentarités entre les trois expérimentations réalisées, qui ont permis une évaluation plus générale de mon hypothèse, détaillé dans le chapitre 4 (Discussion générale).

Ces trois expérimentations ont cherché à tester notre hypothèse générale pour différents types de stress climatiques, différentes durées de stress et sous différents degrés de contrôle des facteurs de gestion des prairies (Figure 8) qui seront détaillés dans cette partie.

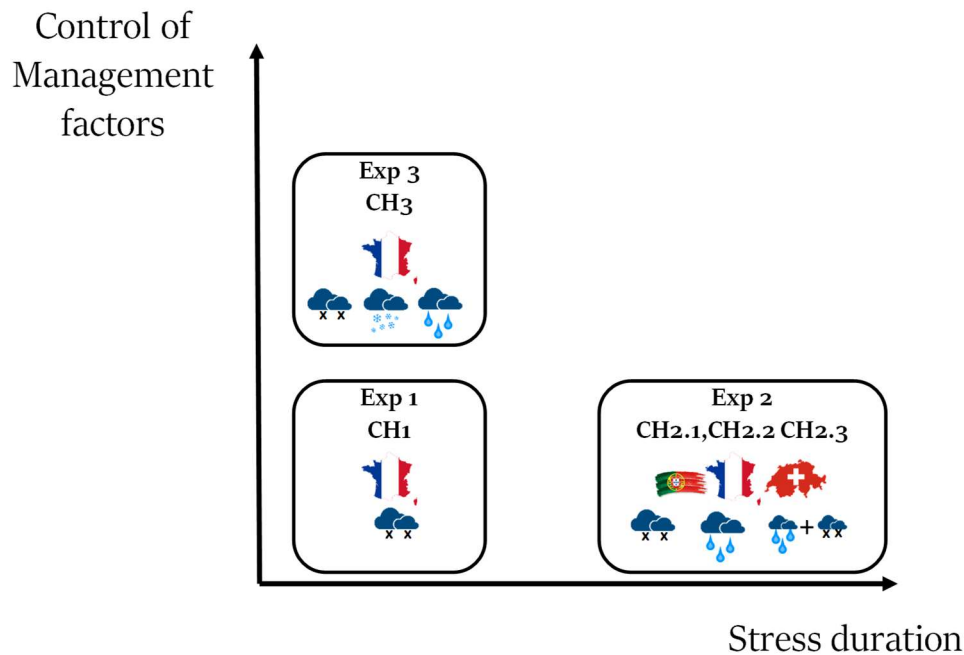

Figure 8. Positionnement des 3 expérimentations de cette thèse, en termes de durée de simulation des stress climatiques et de contrôle des facteurs de gestion.

## 8.1 RESUME DES EXPERIMENTATIONS

La **première expérimentation (Exp. 1)**, s'est appuyée sur des mésocosmes de **sols intacts** (voir détails ci-dessous, section 8.4 Degrés de contrôle des facteurs de gestion des prairies) pour évaluer la réponse à une sécheresse de **courte durée** (Figure 8) d'agroécosystèmes prairiaux sur le site du Vercors (France). Dans cette expérimentation, trois types de prairies ont été étudiées : des prairies permanentes **extensives**, des prairies permanentes intensives (définies comme **écologiquement-intensives**) et des prairies intensives labourées et semées (définies comme **conventionnelles-intensives**).

La **deuxième expérimentation (Exp. 2)**, s'appuyant également sur des mésocosmes de **sols intacts**, a cherché à évaluer les réponses à trois régimes de précipitations (sécheresse, fortes précipitations, régime intermittent) simulées sur une **longue durée** (Figure 8) dans des systèmes **conventionnels-intensifs** et **écologiquement-intensifs** sur les sites français (Vercors, même prairies que l'expérimentation 1), Suisse et Portugal.

Finalement, la **troisième expérimentation (Exp. 3)** a utilisé un sol de prairie **extensive** (site de Chartreuse, France) pour **reconstituer des mésocosmes**. Une partie de ces mésocosmes a ensuite été plantée avec du *Lolium perenne* (graminée couramment utilisée dans les mélanges semés en prairie temporaire intensive dans la région). La moitié des mésocosmes a ensuite été soumise à un traitement de fertilisation d'une dose équivalente à celle recommandée en prairie **conventionnelle-intensive** (Recommandation de la chambre de l'agriculture). Par la suite, trois stress climatiques ont été simulés sur une **courte durée** (détails ci-dessous) : sécheresse, inondation et gel/dégel (Figure 8).

Ainsi, en vue d'une analyse transversale des résultats qui sera réalisée dans la discussion générale (Chapitre 4), on peut considérer que deux expérimentations ont évalué des modalités de gestions extensives (Exp. 1 et 3), deux expérimentations ont évalué des modalités écologiquement-intensives (Exp. 1 et 2) et 3 expérimentations ont évaluées des modalités conventionnelles-intensives (Exp. 1, 2 et 3).

## 8.2 UN DESIGN EXPERIMENTAL COMMUN

Les trois expérimentations ont suivi un design similaire. Dans un premier temps les sols ont été soumis à différentes conditions de gestions en conditions climatiques normales suivie d'une caractérisation de l'état initial ( $T_0$ ). Dans un second temps une période de stress climatiques est simulée suivie d'un deuxième échantillonnage ( $T_1$ ) permettant de caractériser la résistance. Finalement, un retour à des conditions normales suivi d'un dernier échantillonnage ( $T_2$ ) a permis de caractériser la récupération (Figure 9).

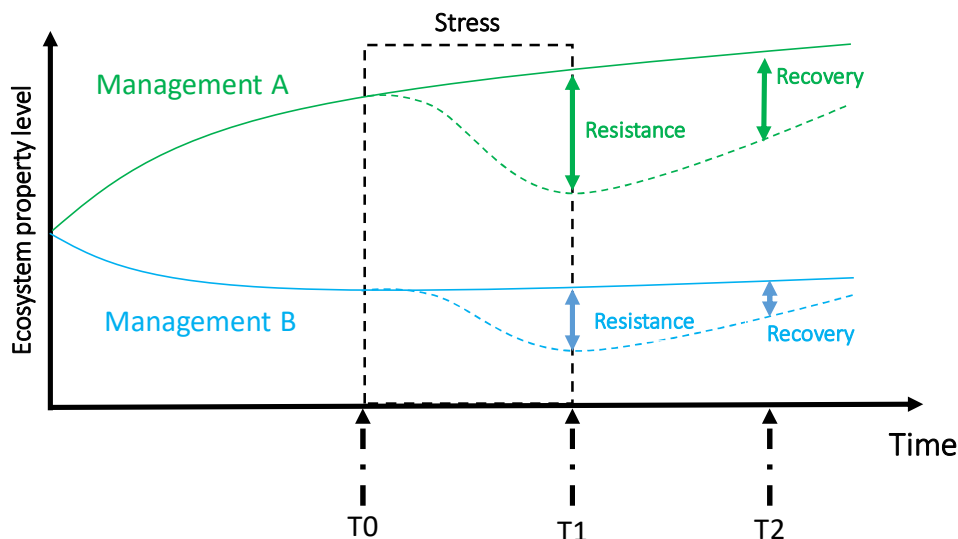

Figure 9. Répartition des échantillonnages sur les 3 expérimentations afin de caractériser l'état initial ( $T_0$ ), la résistance ( $T_1$ ) et la récupération ( $T_2$ ) des écosystèmes. Exemple de deux écosystèmes en gestion A (vert) et B (bleu) avec les lignes continues représentant les valeurs d'une propriété de l'écosystème dans des conditions climatiques normales et les lignes pointillées représentant cette même propriété écosystémique en conditions climatiques stressantes.

## 8.3 TYPES ET DUREES DES STRESS CLIMATIQUES SIMULES

Plusieurs types de stress climatiques ont été simulés lors de ces trois expérimentations. Le traitement sécheresse est commun aux trois expérimentations. Des traitements fortes précipitations et régime intermittent (forte précipitation suivi d'une période de sécheresse) ont également été simulés dans l'expérimentation 2 alors que des traitements inondation (sols engorgés) et gel/dégel ont été réalisés dans l'expérimentation 3 (Figure 8)

Les trois expérimentations différaient également au niveau de leur temporalité (Figure 8) : 10 jours de stress et 48 jours de récupération pour l'expérimentation 1, 263 jours de stress et 89 jours de récupération pour l'expérimentation 2 et 15 (Inondation, gel/dégel) ou 30 (sécheresse) jours de stress et 45 jours de récupération pour l'expérimentation 3.



## 8.4 DEGRES DE CONTROLE DES FACTEURS DE GESTION DES PRAIRIES

Deux types d'expérimentations ont été réalisés afin de faire varier le degré de contrôle des facteurs de gestion des prairies (Figure 8). Les expérimentations 1 et 2 se sont appuyées sur des méthodes qualifiées de « semi-field methods » (Schäffer et al. 2008). Ces méthodes se basent sur l'extraction de mésocosmes intacts de sol extraits avec leur végétation dans des parcelles de prairies différant selon leur historique de gestion. Ce type d'unité expérimentale a été qualifiée de modèle d'écosystème terrestre « Terrestrial Ecosystem Model » ou TME (Schäffer et al. 2008). En conservant un maximum des propriétés de l'écosystème *in situ* (structure du sol, communauté végétale, faunistique et microbienne...), les expérimentations réalisées sur des TME cherchent à se rapprocher de la réalité complexe du terrain et permettent ainsi de mieux étudier les processus et les interactions qui ont lieu dans les écosystèmes *in situ*. Elles ont l'avantage également de capturer les effets sur le long terme de la gestion (par ex : changement de la structure fonctionnelle des communautés végétales ou changement de teneur en matière organique des sols). Leur point faible se place sur la capacité à isoler les mécanismes qui contrôlent leurs propriétés. Les covariations, qui peuvent exister entre différents facteurs de gestion (fertilisation, labour, charge en bétail...) constituant l'historique de chaque TME et l'hétérogénéité des communautés végétales associées, empêchent d'isoler avec certitude les facteurs influençant le fonctionnement de l'écosystème (Figure 10).

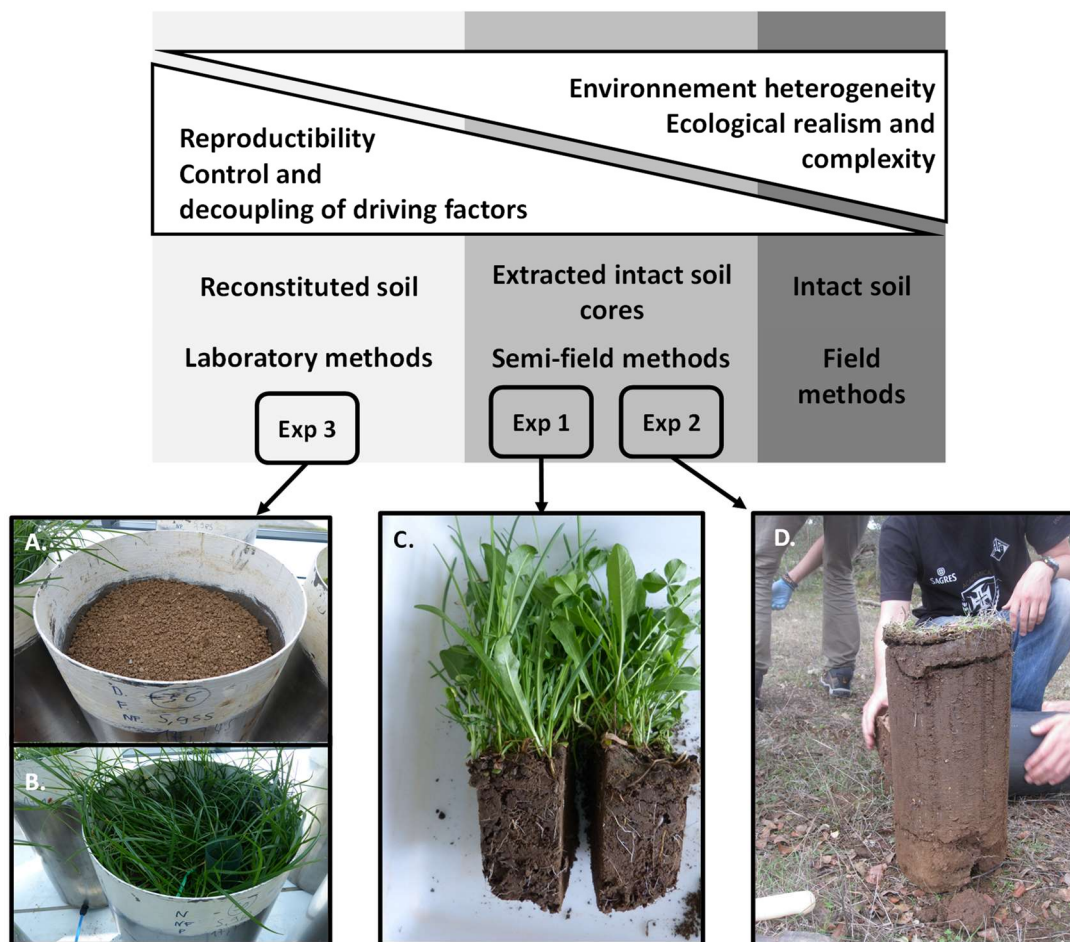

Figure 10. Compromis inhérent existant entre méthodes expérimentales. Un contrôle plus important des facteurs permettra une meilleure compréhension des mécanismes au coût d'un éloignement de la réalité complexe du terrain. Positions des 3 expérimentations sur ce compromis. A. Sol reconstitué après tamisage (Chartreuse, France). B. *Lolium perenne* semés sur le sol reconstitué. C. Mésocosme de sol intact issu d'une prairie de moyenne montagne (Vercors, France) lors de l'échantillonnage To. D. Mésocosme de sol intact (Portugal) lors de l'extraction au champ. Partie supérieure de la figure modifiée d'après Schäffer et al. (2008).

Dans l'objectif d'évaluer de manière robuste l'effet de certains facteurs de gestion, l'expérimentation 3 a été réalisée en conditions plus contrôlées, sur des mésocosmes dit "reconstitués" (Figure 10). Un sol de prairie de moyenne montagne a été prélevé sur le site du plateau des Petites Roches (Figure 7), tamisé, homogénéisé puis soumis à différents traitements reproduisant différentes situations de gestion d'une prairie (traitement fertilisation, voir partie précédente). Cette expérimentation a permis d'isoler l'effet sur le court terme de la fertilisation dans les modifications des propriétés de celui des communautés microbiennes du sol et de celui des plantes. Le point faible de ce type d'expérimentation est son éloignement potentiel du réalisme de terrain (Figure 10).

En croisant ces deux types d'expérimentations durant cette thèse (sur sols intacts et sur sols reconstitués), j'ai pu tester nos hypothèses dans des conditions proches de la réalité écologique du terrain puis étudier avec plus de précisions certains mécanismes sous-jacents aux observations sur les expérimentation "semi-field" sur sols intacts (Figure 10).

## 9 ORGANISATION DU DOCUMENT

Les résultats de chaque expérimentation sont présentés dans des chapitres différents (Expérimentation 1 : Chapitre 1, Expérimentation 2 : Chapitre 2.1, 2.2, 2.3 et Expérimentation 3 : Chapitre 3).

L'article basé sur la **première expérimentation (Article 1)** a permis de développer notre cadre conceptuel et de tester notre hypothèse générale sur l'association entre les stratégies/les traits des microorganismes et la résilience des communautés microbiennes. S'appuyant sur le site d'étude Français (Vercors), ce travail a permis de mettre en évidence des effets en cascade de la gestion des prairies de montagne sur la résilience des écosystèmes à travers des modifications du sol, des CWM végétaux et microbiens (**Chapitre 1, Figure 11**).

La **deuxième expérimentation**, basée sur les trois sites européens, a été déclinée en **trois articles (Articles 2, 3 et 4)** abordant différents aspects de la réponse des communautés microbiennes et de l'écosystème (Figure 11).

Dans un premier article basé sur l'expérimentation deux (**Article 2**) nous avons testé notre hypothèse générale sur la résilience des communautés microbiennes en comparant les sols en gestion conventionnelles-intensives et écologiquement-intensives des trois sites d'études à travers l'Europe et pour trois stress climatiques élargissant ainsi le test de notre hypothèse à de plus grandes gammes de sols et de stress climatiques (**Chapitre 3.2, Figure 11**).

Dans le deuxième article issu de cette expérimentation (**Article 3**), nous sommes sortis de la question de la gestion et du cadre de l'hypothèse générale, pour évaluer plus généralement comment l'intégration des enzymes extracellulaires dans le cadre conceptuel des traits fonctionnels, pouvait aider à comprendre les mécanismes de contrôle de l'activité enzymatique globale dans les sols, notamment le rôle des modification de la composition des communautés microbiennes (**Chapitre 2.2, Figure 11**).

Finalement, dans un troisième article (**Article 4**), nous avons cherché à évaluer comment l'activité enzymatique globale associée au cycle de l'azote ainsi que la composition et la diversité des communautés protéolytiques (séquençage de gènes fonctionnels) répondaient aux modalités de gestion (conventionnelle-intensive et écologiquement-intensive) et contrôlaient finalement l'assimilation de l'azote par les plantes et le lessivage des nitrates sous les différents régimes de précipitations simulés dans cette expérimentation (**Chapitre 3.3, Figure 11**).

La **troisième expérimentation** a fait l'objet d'un article (**Article 5**) dont l'objectif était d'aller plus précisément dans les mécanismes sous-jacents aux effets de la gestion des prairies observés dans les chapitres précédents. La fertilisation minérale et la présence de plantes ont été manipulés expérimentalement pour évaluer spécifiquement leurs effets sur la composition des communautés microbiennes, leur traits moyens (CWM) et sur la résilience des

communautés microbiennes aux stress climatiques. Ainsi, cette expérimentation a permis de tester de nouveau notre hypothèse générale sur la résilience mais dans ce cas en contrôlant précisément les facteurs influençant la stratégie et les traits des microorganismes (fertilisation et présence de plante), permettant ainsi de valider le rôle de la fertilisation dans les résultats observés dans les expérimentations précédentes (Chapitre 3, Figure 11).

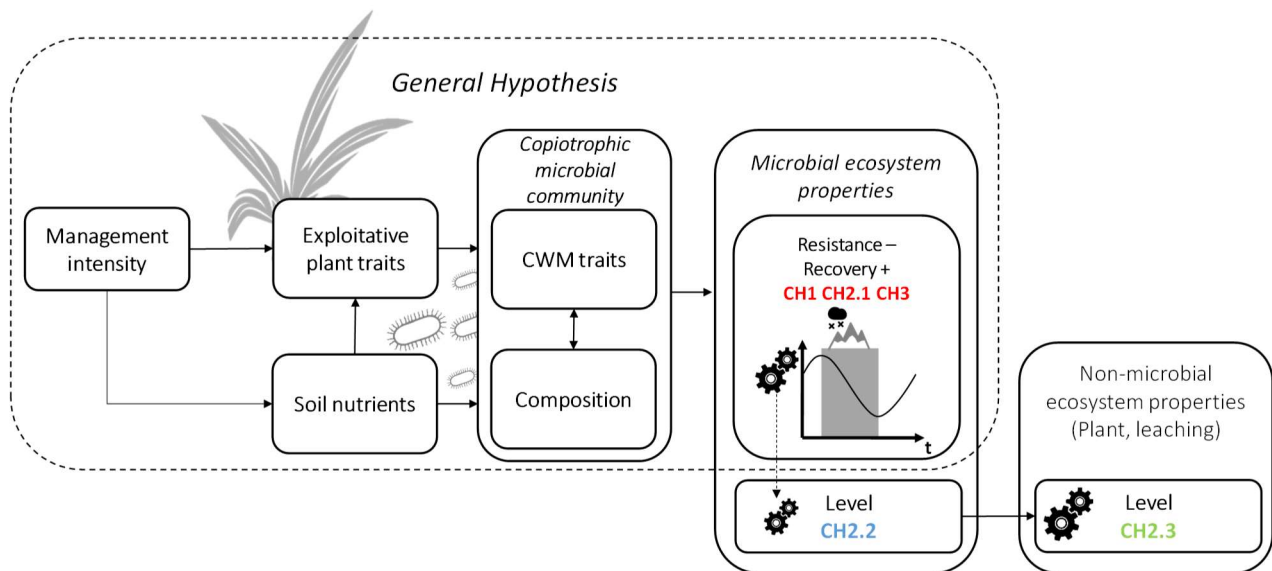

Figure 11. Représentation graphique de l'hypothèse générale de la thèse et positionnement des différents chapitres sur l'hypothèse. Les chapitres 1, 2.1 et 3 (en rouge), testent directement l'hypothèse générale pour différentes durées de simulation des stress climatiques et différents degrés de contrôle des facteurs de gestion (Figure 8). Les chapitres 2.2 et 2.3 sortent du cadre de l'hypothèse générale pour plus spécifiquement étudier les mécanismes microbiens de contrôle du niveau d'activité enzymatique totale des sols (CH2.3, bleu) et des répercussions sur les propriétés non-microbienne de l'écosystème (assimilation de l'azote par les plantes et lessivage des nitrates, CH2.3, Vert).

## RÉFÉRENCES

- Abbott, B. W., K. Bishop, J. P. Zarnetske, C. Minaudo, F. Chapin, S. Krause, D. M. Hannah, L. Conner, D. Ellison, S. E. Godsey, and others. 2019. Human domination of the global water cycle absent from depictions and perceptions. *Nature Geoscience*:1.
- Allen, M. R., V. R. Barros, J. Broome, W. Cramer, R. Christ, J. A. Church, L. Clarke, Q. Dahe, P. Dasgupta, N. K. Dubash, and others. 2014. IPCC fifth assessment synthesis report-climate change 2014 synthesis report. Intergovernmental Panel on Climate Change, Geneva, Switzerland.
- Allison, S. 2012. A trait-based approach for modelling microbial litter decomposition. *Ecology letters* 15:1058–1070.
- Allison, S. D., M. N. Weintraub, T. B. Gartner, and M. P. Waldrop. 2010. Evolutionary-economic principles as regulators of soil enzyme production and ecosystem function. Pages 229–243 *Soil enzymology*. Springer.
- Allison, V., L. Condrón, D. Peltzer, S. Richardson, and B. Turner. 2007. Changes in enzyme activities and soil microbial community composition along carbon and nutrient gradients at the Franz Josef chronosequence, New Zealand. *Soil Biology and Biochemistry* 39:1770–1781.
- Altieri, M. A., C. I. Nicholls, A. Henao, and M. A. Lana. 2015. Agroecology and the design of climate change-resilient farming systems. *Agronomy for Sustainable Development* 35:869–890.
- Altieri, M. A., and others. 1983. *Agroecology: the scientific basis of alternative agriculture*.
- Alves, R. J. E., W. Wanek, A. Zappe, A. Richter, M. M. Svenning, C. Schleper, and T. Urich. 2013. Nitrification rates in Arctic soils are associated with functionally distinct populations of ammonia-oxidizing archaea. *The ISME journal* 7:1620.
- Amigues, S. 2010. *Recherches sur les plantes: à l'origine de la botanique*. . Belin.
- Arrigo, K. R. 2004. Marine microorganisms and global nutrient cycles. *Nature* 437:349.
- Bach, H.-J., A. Hartmann, M. Schloter, and J. Munch. 2001. PCR primers and functional probes for amplification and detection of bacterial genes for extracellular peptidases in single strains and in soil. *Journal of Microbiological Methods* 44:173–182.
- Baldrian, P. 2019. The known and the unknown in soil microbial ecology. *FEMS microbiology ecology* 95:fiz005.
- Bardgett, R. D. 2018. Plant trait-based approaches for interrogating belowground function. *Biology and Environment: Proceedings of the Royal Irish Academy*. . JSTOR.
- Bardgett, R. D., L. Mommer, and F. T. De Vries. 2014. Going underground: root traits as drivers of ecosystem processes. *Trends in Ecology & Evolution* 29:692–699.
- Bender, S. F., C. Wagg, and M. G. van der Heijden. 2016. An underground revolution: biodiversity and soil ecological engineering for agricultural sustainability. *Trends in ecology & evolution* 31:440–452.
- Bernard, L., A. Foulquier, C. Gallet, S. Lavorel, and J.-C. Clément. 2019. Effects of snow pack reduction and drought on litter decomposition in subalpine grassland communities. *Plant and soil* 435:225–238.
- Bommarco, R., D. Kleijn, and S. G. Potts. 2013. Ecological intensification: harnessing ecosystem services for food security. *Trends in ecology & evolution* 28:230–238.
- Botton, S., M. Van Heusden, J. Parsons, H. Smidt, and N. Van Straalen. 2006. Resilience of microbial systems towards disturbances. *Critical reviews in microbiology* 32:101–112.
- Calow, P. 1987. Towards a definition of functional ecology. *Functional Ecology* 1:57–61.
- Canarini, A., L. P. Kiær, and F. A. Dijkstra. 2017. Soil carbon loss regulated by drought intensity and available substrate: A meta-analysis. *Soil Biology and Biochemistry* 112:90–99.
- Chaves, M. M., J. P. Maroco, and J. S. Pereira. 2003. Understanding plant responses to drought—from genes to the whole plant. *Functional plant biology* 30:239–264.
- Coleman, D. ., and D. A. Crossley. 1996. *Fundamentals of SOil Ecology*. London: Academic Press.
- Craine, J. M. 2009. *Resource strategies of wild plants*. Princeton University Press.
- Crowther, T. W., D. S. Maynard, T. R. Crowther, J. Peccia, J. R. Smith, and M. A. Bradford. 2014. Untangling the fungal niche: the trait-based approach. *Frontiers in microbiology* 5:579.
- Delgado-Baquerizo, M., D. J. Eldridge, F. T. Maestre, V. Ochoa, B. Gozalo, P. B. Reich, and B. K. Singh. 2018. Aridity decouples C: N: P stoichiometry across multiple trophic levels in terrestrial ecosystems. *Ecosystems* 21:459–468.
- Diamond, J. M. 1975. Assembly of species communities. *Ecology and evolution of communities*:342–444.



- Diaz, S., M. Cabido, and F. Casanoves. 1998. Plant functional traits and environmental filters at a regional scale. *Journal of vegetation science* 9:113–122.
- Diaz, S., J. Kattge, J. H. Cornelissen, I. J. Wright, S. Lavorel, S. Dray, B. Reu, M. Kleyer, C. Wirth, I. C. Prentice, and others. 2016. The global spectrum of plant form and function. *Nature* 529:167.
- Diaz, S., S. Lavorel, F. de Bello, F. Quétier, K. Grigulis, and T. M. Robson. 2007. Incorporating plant functional diversity effects in ecosystem service assessments. *Proceedings of the National Academy of Sciences* 104:20684–20689.
- Doré, T., D. Makowski, E. Malézieux, N. Munier-Jolain, M. Tchamitchian, and P. Tittone. 2011. Facing up to the paradigm of ecological intensification in agronomy: revisiting methods, concepts and knowledge. *European Journal of Agronomy* 34:197–210.
- Duckworth, J. C., M. Kent, and P. M. Ramsay. 2000. Plant functional types: an alternative to taxonomic plant community description in biogeography? *Progress in Physical Geography* 24:515–542.
- Duru, M., C. Jouany, X. Le Roux, M. Navas, and P. Cruz. 2013. From a conceptual framework to an operational approach for managing grassland functional diversity to obtain targeted ecosystem services: Case studies from French mountains. *Renew Agric Food Syst* 29:239–254.
- Duru, M., L. Pontes, J. Schellberg, J. P. Theau, and O. Therond. 2019. Grassland functional diversity and management for enhancing ecosystem services and reducing environmental impacts: A cross-scale analysis. Pages 211–230 *Agroecosystem Diversity*. Elsevier.
- Duru, M., O. Therond, G. Martin, R. Martin-Clouaire, M.-A. Magne, E. Justes, E.-P. Journet, J.-N. Aubertot, S. Savary, J.-E. Bergez, and others. 2015. How to implement biodiversity-based agriculture to enhance ecosystem services: a review. *Agronomy for sustainable development* 35:0.
- Diaz, S., and M. Cabido. 2001. Vive la difference: plant functional diversity matters to ecosystem processes. *Trends in ecology & evolution* 16:646–655.
- Diaz, S., M. Cabido, and F. Casanoves. 1999. Functional implications of trait-environment linkages in plant communities. *Ecological assembly rules: Perspectives, advances, retreats*:338–362.
- Elser, J., K. Acharya, M. Kyle, J. Cotner, W. Makino, T. Markow, T. Watts, S. Hobbie, W. Fagan, J. Schade, and others. 2003. Growth rate–stoichiometry couplings in diverse biota. *Ecology Letters* 6:936–943.
- Elton, C. S. 1958. *The ecology of invasions by plants and animals*. Methuen.
- Falkowski, P. G., T. Fenchel, and E. F. DeLong. 2008. The microbial engines that drive Earth's biogeochemical cycles. *science* 320:1034–1039.
- Falkowski, P., R. Scholes, E. Boyle, J. Canadell, D. Canfield, J. Elser, N. Gruber, K. Hibbard, P. Högberg, S. Linder, and others. 2000. The global carbon cycle: a test of our knowledge of earth as a system. *science* 290:291–296.
- Fanin, N., S. Hättenschwiler, and N. Fromin. 2014. Litter fingerprint on microbial biomass, activity, and community structure in the underlying soil. *Plant and soil* 379:79–91.
- Fanin, N., P. Kardol, M. Farrell, M.-C. Nilsson, M. J. Gundale, and D. A. Wardle. 2018. The ratio of Gram-positive to Gram-negative bacterial PLFA markers as an indicator of carbon availability in organic soils. *Soil Biology and Biochemistry*.
- Fanin, N., D. Moorhead, and I. Bertrand. 2016. Eco-enzymatic stoichiometry and enzymatic vectors reveal differential C, N, P dynamics in decaying litter along a land-use gradient. *Biogeochemistry* 129:21–36.
- FAO. 2009. *Glossary on organic agriculture*. Version 1.0. FAO, Rome.
- Faucon, M.-P., D. Houben, and H. Lambers. 2017. Plant functional traits: soil and ecosystem services. *Trends in plant science* 22:385–394.
- Fierer, N. 2017. Embracing the unknown: disentangling the complexities of the soil microbiome. *Nature Reviews Microbiology* 15:579–590.
- Fierer, N., A. Barberán, and D. C. Laughlin. 2014. Seeing the forest for the genes: using metagenomics to infer the aggregated traits of microbial communities. *Frontiers in microbiology* 5.
- Fierer, N., M. A. Bradford, and R. B. Jackson. 2007. Toward an ecological classification of soil bacteria. *Ecology* 88:1354–1364.
- Fierer, N., C. L. Lauber, K. S. Ramirez, J. Zaneveld, M. A. Bradford, and R. Knight. 2012. Comparative metagenomic, phylogenetic and physiological analyses of soil microbial communities across nitrogen gradients. *The ISME journal* 6:1007–1017.

- Fontaine, S., A. Mariotti, and L. Abbadie. 2003. The priming effect of organic matter: a question of microbial competition? *Soil Biology and Biochemistry* 35:837–843.
- Fortunel, C., E. Garnier, R. Joffre, E. Kazakou, H. Queded, K. Grigulis, S. Lavorel, P. Ansquer, H. Castro, P. Cruz, and others. 2009. Leaf traits capture the effects of land use changes and climate on litter decomposability of grasslands across Europe. *Ecology* 90:598–611.
- Francis, C., G. Lieblein, S. Gliessman, T. A. Breland, N. Creamer, R. Harwood, L. Salomonsson, J. Helenius, D. Rickerl, R. Salvador, and others. 2003. Agroecology: The ecology of food systems. *Journal of sustainable agriculture* 22:99–118.
- Frankena, J., H. Van Verseveld, and A. Stouthamer. 1988. Substrate and energy costs of the production of exocellular enzymes by *Bacillus licheniformis*. *Biotechnology and bioengineering* 32:803–812.
- Galloway, J. N., A. R. Townsend, J. W. Erisman, M. Bekunda, Z. Cai, J. R. Freney, L. A. Martinelli, S. P. Seitzinger, and M. A. Sutton. 2008. Transformation of the nitrogen cycle: recent trends, questions, and potential solutions. *Science* 320:889–892.
- Garcia-Palacios, P., A. Gattinger, H. Bracht-Jørgensen, L. Brussaard, F. Carvalho, H. Castro, J.-C. Clément, G. De Deyn, T. D’Hertefeldt, A. Foulquier, and others. 2018. Crop traits drive soil carbon sequestration under organic farming. *Journal of Applied Ecology* 55:2496–2505.
- Garnier, E., J. Cortez, G. Billès, M.-L. Navas, C. Roumet, M. Debussche, G. Laurent, A. Blanchard, D. Aubry, A. Bellmann, and others. 2004. Plant functional markers capture ecosystem properties during secondary succession. *Ecology* 85:2630–2637.
- Garnier, E., and M.-L. Navas. 2012. A trait-based approach to comparative functional plant ecology: concepts, methods and applications for agroecology. A review. *Agronomy for Sustainable Development* 32:365–399.
- Garnier, E., and M.-L. Navas. 2013. Diversité fonctionnelle des plantes: traits des organismes, structure des communautés, propriétés des écosystèmes: cours. . De Boeck.
- Gitay, H., and I. Noble. 1997. What are functional types and how should we seek them? In “Plant functional types: their relevance to ecosystem properties and global change”. (Eds TM Smith, HH Shugart, FI Woodward) pp. 3–19. . Cambridge University Press: Cambridge, UK.
- Graham, E. B., J. E. Knelman, A. Schindlbacher, S. Siciliano, M. Breulmann, A. Yannarell, J. Beman, G. Abell, L. Philippot, J. Prosser, and others. 2016. Microbes as engines of ecosystem function: when does community structure enhance predictions of ecosystem processes? *Frontiers in microbiology* 7:214.
- Green, J. L., B. J. Bohannan, and R. J. Whitaker. 2008. Microbial biogeography: from taxonomy to traits. *science* 320:1039–1043.
- Grigulis, K., S. Lavorel, U. Krainer, N. Legay, C. Baxendale, M. Dumont, E. Kastl, C. Arnoldi, R. D. Bardgett, F. Poly, and others. 2013. Relative contributions of plant traits and soil microbial properties to mountain grassland ecosystem services. *Journal of Ecology* 101:47–57.
- Grime, J. 1998. Benefits of plant diversity to ecosystems: immediate, filter and founder effects. *Journal of Ecology* 86:902–910.
- Grime, J. P. 1977. Evidence for the existence of three primary strategies in plants and its relevance to ecological and evolutionary theory. *The American Naturalist* 111:1169–1194.
- Grime, J. P. 2006. *Plant strategies, vegetation processes, and ecosystem properties*. . John Wiley & Sons.
- Hall, E. K., E. S. Bernhardt, R. L. Bier, M. A. Bradford, C. M. Boot, J. B. Cotner, P. A. del Giorgio, S. E. Evans, E. B. Graham, S. E. Jones, and others. 2018. Understanding how microbiomes influence the systems they inhabit. *Nature microbiology* 3:977.
- Ho, A., F.-M. Kerckhof, C. Luke, A. Reim, S. Krause, N. Boon, and P. L. Bodelier. 2013. Conceptualizing functional traits and ecological characteristics of methane-oxidizing bacteria as life strategies. *Environmental Microbiology Reports* 5:335–345.
- Ho, A., D. P. Di Lonardo, and P. L. Bodelier. 2017. Revisiting life strategy concepts in environmental microbial ecology. *FEMS microbiology ecology* 93:fix006.
- Holling, C. S. 1973. Resilience and stability of ecological systems. *Annual review of ecology and systematics* 4:1–23.
- Homyak, P. M., S. D. Allison, T. E. Huxman, M. L. Goulden, and K. K. Treseder. 2017. Effects of Drought Manipulation on Soil Nitrogen Cycling: A Meta-Analysis. *Journal of Geophysical Research: Biogeosciences*.

- Hooper, D. U., F. S. Chapin, J. J. Ewel, A. Hector, P. Inchausti, S. Lavorel, J. H. Lawton, D. Lodge, M. Loreau, S. Naeem, and others. 2005. Effects of biodiversity on ecosystem functioning: a consensus of current knowledge. *Ecological monographs* 75:3–35.
- Huntington, T. G. 2006. Evidence for intensification of the global water cycle: review and synthesis. *Journal of Hydrology* 319:83–95.
- Ingrisch, J., and M. Bahn. 2018. Towards a comparable quantification of resilience. *Trends in ecology & evolution*.
- Ingrisch, J., S. Karlowky, A. Anadon-Rosell, R. Hasibeder, A. König, A. Augusti, G. Gleixner, and M. Bahn. 2018. Land use alters the drought responses of productivity and CO<sub>2</sub> fluxes in mountain grassland. *Ecosystems* 21:689–703.
- Karlowky, S., A. Augusti, J. Ingrisch, R. Hasibeder, M. Lange, S. Lavorel, M. Bahn, and G. Gleixner. 2018. Land use in mountain grasslands alters drought response and recovery of carbon allocation and plant-microbial interactions. *Journal of Ecology* 106:1230–1243.
- Karpinets, T. V., D. J. Greenwood, C. E. Sams, and J. T. Ammons. 2006. RNA: protein ratio of the unicellular organism as a characteristic of phosphorous and nitrogen stoichiometry and of the cellular requirement of ribosomes for protein synthesis. *BMC biology* 4:30.
- Keddy, P. 1992a. A pragmatic approach to functional ecology. *Functional Ecology* 6:621–626.
- Keddy, P. A. 1992b. Assembly and response rules: two goals for predictive community ecology. *Journal of Vegetation Science* 3:157–164.
- Kivlin, S. N., and K. K. Treseder. 2014. Soil extracellular enzyme activities correspond with abiotic factors more than fungal community composition. *Biogeochemistry* 117:23–37.
- Knapp, A. K., C. Beier, D. D. Briske, A. T. Classen, Y. Luo, M. Reichstein, M. D. Smith, S. D. Smith, J. E. Bell, P. A. Fay, and others. 2008. Consequences of more extreme precipitation regimes for terrestrial ecosystems. *AIBS Bulletin* 58:811–821.
- Kramer, C., and G. Gleixner. 2008. Soil organic matter in soil depth profiles: distinct carbon preferences of microbial groups during carbon transformation. *Soil Biology and Biochemistry* 40:425–433.
- Krause, S., X. Le Roux, P. A. Niklaus, P. M. Van Bodegom, J. T. Lennon, S. Bertilsson, H.-P. Grossart, L. Philippot, and P. L. Bodelier. 2014. Trait-based approaches for understanding microbial biodiversity and ecosystem functioning. *Frontiers in Microbiology* 5.
- Kuzyakov, Y., E. Blagodatskaya, and S. Blagodatsky. 2009. Comments on the paper by Kemmitt et al.(2008)“Mineralization of native soil organic matter is not regulated by the size, activity or composition of the soil microbial biomass—A new perspective”[*Soil Biology & Biochemistry* 40, 61–73]: The biology of the Regulatory Gate. *Soil Biology and Biochemistry* 41:435–439.
- Lashermes, G., A. Gainvors-Claisse, S. Recous, and I. Bertrand. 2016. Enzymatic strategies and carbon use efficiency of a litter-decomposing fungus grown on maize leaves, stems, and roots. *Frontiers in microbiology* 7.
- Laughlin, D. C. 2011. Nitrification is linked to dominant leaf traits rather than functional diversity. *Journal of Ecology* 99:1091–1099.
- Laughlin, D. C. 2014. Applying trait-based models to achieve functional targets for theory-driven ecological restoration. *Ecology letters* 17:771–784.
- Laughlin, D. C., and J. Messier. 2015. Fitness of multidimensional phenotypes in dynamic adaptive landscapes. *Trends in Ecology & Evolution* 30:487–496.
- Lavorel, S. 2013. Plant functional effects on ecosystem services. *Journal of Ecology* 101:4–8.
- Lavorel, S., and E. Garnier. 2001. Aardvarck to Zyzyxia: functional groups across kingdoms. *The New Phytologist* 149:360–363.
- Lavorel, S., and E. Garnier. 2002. Predicting changes in community composition and ecosystem functioning from plant traits: revisiting the Holy Grail. *Functional ecology* 16:545–556.
- Lavorel, S., and K. Grigulis. 2012. How fundamental plant functional trait relationships scale-up to trade-offs and synergies in ecosystem services. *Journal of Ecology* 100:128–140.
- Lavorel, S., K. Grigulis, P. Lamarque, M.-P. Colace, D. Garden, J. Girel, G. Pellet, and R. Douzet. 2011a. Using plant functional traits to understand the landscape distribution of multiple ecosystem services. *Journal of Ecology* 99:135–147.

- Lavorel, S., S. McIntyre, J. Landsberg, and T. Forbes. 1997. Plant functional classifications: from general groups to specific groups based on response to disturbance. *Trends in Ecology & Evolution* 12:474–478.
- Lavorel, S., J. Storkey, R. D. Bardgett, F. de Bello, M. P. Berg, X. Le Roux, M. Moretti, C. Mulder, R. J. Pakeman, S. Diaz, and others. 2013. A novel framework for linking functional diversity of plants with other trophic levels for the quantification of ecosystem services. *Journal of Vegetation Science* 24:942–948.
- Leff, J. W., S. E. Jones, S. M. Prober, A. Barberán, E. T. Borer, J. L. Firn, W. S. Harpole, S. E. Hobbie, K. S. Hofmockel, J. M. Knops, and others. 2015. Consistent responses of soil microbial communities to elevated nutrient inputs in grasslands across the globe. *Proceedings of the National Academy of Sciences* 112:10967–10972.
- Legay, N., C. Baxendale, K. Grigulis, U. Krainer, E. Kastl, M. Schloter, R. D. Bardgett, C. Arnoldi, M. Bahn, M. Dumont, and others. 2014. Contribution of above-and below-ground plant traits to the structure and function of grassland soil microbial communities. *Annals of botany* 114:1011–1021.
- Legay, N., S. Lavorel, C. Baxendale, U. Krainer, M. Bahn, M.-N. Binet, A. A. Cantarel, M.-P. Colace, A. Foulquier, E.-M. Kastl, and others. 2016. Influence of plant traits, soil microbial properties, and abiotic parameters on nitrogen turnover of grassland ecosystems. *Ecosphere* 7.
- Legay, N., G. Piton, C. Arnoldi, L. Bernard, M.-N. Binet, B. Mouhamadou, T. Pommier, S. Lavorel, A. Foulquier, and J.-C. Clément. 2017. Soil legacy effects of climatic stress, management and plant functional composition on microbial communities influence the response of *Lolium perenne* to a new drought event. *Plant and Soil*:1–22.
- Lepš, J., J. Osbornová-Kosinová, and M. Rejmánek. 1982. Community stability, complexity and species life history strategies. *Vegetatio* 50:53–63.
- Li, Z., D. Tian, B. Wang, J. Wang, S. Wang, H. Y. Chen, X. Xu, C. Wang, N. He, and S. Niu. 2019. Microbes drive global soil nitrogen mineralization and availability. *Global change biology* 25:1078–1088.
- Litchman, E., K. F. Edwards, and C. A. Klausmeier. 2015. Microbial resource utilization traits and trade-offs: implications for community structure, functioning, and biogeochemical impacts at present and in the future. *Frontiers in microbiology* 6:254.
- Loreau, M. 2000. Biodiversity and ecosystem functioning: recent theoretical advances. *Oikos* 91:3–17.
- Lori, M., S. Symanczik, P. Mäder, N. Efosa, S. Jaenicke, F. Buegger, S. Tresch, A. Goesmann, and A. Gattinger. 2018. Distinct nitrogen provisioning from organic amendments in soil as influenced by farming system and water regime. *Frontiers in Environmental Science*:1–14.
- Loucougaray, G., L. Dobremez, P. Gos, Y. Pauthenet, B. Nottier, and S. Lavorel. 2015. Assessing the effects of grassland management on forage production and environmental quality to identify paths to ecological intensification in mountain grasslands. *Environmental management* 56:1039–1052.
- MacArthur, R. H., and E. O. Wilson. 1967. *The theory of island biogeography*. . Princeton University Press.
- MacGillivray, C., J. Grime, and T. I. S. P. (ISP) Team. 1995. Testing predictions of the resistance and resilience of vegetation subjected to extreme events. *Functional Ecology*:640–649.
- Malik, A. A., J. B. Martiny, E. L. Brodie, A. C. Martiny, K. K. Treseder, and S. D. Allison. 2018. Defining trait-based microbial strategies with consequences for soil carbon cycling under climate change. *bioRxiv*:445866.
- Malik, A. A., J. Puissant, T. Goodall, S. D. Allison, and R. I. Griffiths. 2019. Soil microbial communities with greater investment in resource acquisition have lower growth yield. *Soil Biology and Biochemistry*.
- Mariotte, P., Z. Mehrabi, T. M. Bezemer, G. B. De Deyn, A. Kulmatiski, B. Drigo, G. C. Veen, M. G. Van der Heijden, and P. Kardol. 2018. Plant–soil feedback: bridging natural and agricultural sciences. *Trends in ecology & evolution* 33:129–142.
- Martiny, J. B., S. E. Jones, J. T. Lennon, and A. C. Martiny. 2015. Microbiomes in light of traits: a phylogenetic perspective. *Science* 350:aac9323.
- Meunier, C. L., M. Boersma, R. El-Sabaawi, H. M. Halvorson, E. M. Herstoff, D. B. Van de Waal, R. J. Vogt, and E. Litchman. 2017. From Elements to Function: Toward Unifying Ecological Stoichiometry and Trait-Based Ecology. *Frontiers in Environmental Science* 5:18.
- Millennium, A. Ecosystem. 2005. *Ecosystems and human well-being*. . Island press Washington, DC:
- Moorhead, D. L., Z. L. Rinkes, R. L. Sinsabaugh, and M. N. Weintraub. 2013. Dynamic relationships between microbial biomass, respiration, inorganic nutrients and enzyme activities: informing enzyme-based decomposition models. *Frontiers in Microbiology* 4:223.

- Mooshammer, M., W. Wanek, S. Zechmeister-Boltenstern, and A. Richter. 2014. Stoichiometric imbalances between terrestrial decomposer communities and their resources: mechanisms and implications of microbial adaptations to their resources. *The Microbial Regulation of Global Biogeochemical Cycles*:191.
- Moreau, D., B. Pivato, D. Bru, H. Busset, F. Deau, C. Faivre, A. Matejcek, F. Strbik, L. Philippot, and C. Mougel. 2015. Plant traits related to nitrogen uptake influence plant-microbe competition. *Ecology* 96:2300–2310.
- Morrissey, E. M., R. L. Mau, M. Hayer, X.-J. A. Liu, E. Schwartz, P. Dijkstra, B. J. Koch, K. Allen, S. J. Blazewicz, K. Hofmockel, and others. 2019. Evolutionary history constrains microbial traits across environmental variation. *Nature ecology & evolution*:1.
- Mouchet, M. A., S. Villéger, N. W. Mason, and D. Mouillot. 2010. Functional diversity measures: an overview of their redundancy and their ability to discriminate community assembly rules. *Functional Ecology* 24:867–876.
- Nannipieri, P., J. Ascher, M. Ceccherini, L. Landi, G. Pietramellara, and G. Renella. 2003. Microbial diversity and soil functions. *European journal of soil science* 54:655–670.
- Naylor, D., and D. Coleman-Derr. 2018. Drought stress and root-associated bacterial communities. *Frontiers in plant science* 8:2223.
- Orwin, K. H., S. M. Buckland, D. Johnson, B. L. Turner, S. Smart, S. Oakley, and R. D. Bardgett. 2010. Linkages of plant traits to soil properties and the functioning of temperate grassland. *Journal of Ecology* 98:1074–1083.
- Petchey, O. L., and K. J. Gaston. 2006. Functional diversity: back to basics and looking forward. *Ecology letters* 9:741–758.
- Philippot, L., J. M. Raaijmakers, P. Lemanceau, and W. H. Van Der Putten. 2013. Going back to the roots: the microbial ecology of the rhizosphere. *Nature Reviews Microbiology* 11:789.
- Pimm, S. L. 1984. The complexity and stability of ecosystems. *Nature* 307:321–326.
- Pimm, S. L., G. J. Russell, J. L. Gittleman, and T. M. Brooks. 1995. The future of biodiversity. *Science* 269:347–350.
- Power, A. G. 2010. Ecosystem services and agriculture: tradeoffs and synergies. *Philosophical Transactions of the Royal Society of London B: Biological Sciences* 365:2959–2971.
- Quested, H., O. Eriksson, C. Fortunel, and E. Garnier. 2007. Plant traits relate to whole-community litter quality and decomposition following land use change. *Functional Ecology* 21:1016–1026.
- Quétier, F., A. Thébault, and S. Lavorel. 2007. Plant traits in a state and transition framework as markers of ecosystem response to land-use change. *Ecological monographs* 77:33–52.
- Ramirez, K. S., J. M. Craine, and N. Fierer. 2012. Consistent effects of nitrogen amendments on soil microbial communities and processes across biomes. *Global Change Biology* 18:1918–1927.
- Ramirez, K. S., C. L. Lauber, R. Knight, M. A. Bradford, and N. Fierer. 2010. Consistent effects of nitrogen fertilization on soil bacterial communities in contrasting systems. *Ecology* 91:3463–3470.
- Reich, P. B. 2014. The world-wide “fast-slow” plant economics spectrum: a traits manifesto. *Journal of Ecology* 102:275–301.
- Ren, C., J. Chen, X. Lu, R. Doughty, F. Zhao, Z. Zhong, X. Han, G. Yang, Y. Feng, and G. Ren. 2018. Responses of soil total microbial biomass and community compositions to rainfall reductions. *Soil Biology and Biochemistry* 116:4–10.
- Rocca, J. D., E. K. Hall, J. T. Lennon, S. E. Evans, M. P. Waldrop, J. B. Cotner, D. R. Nemergut, E. B. Graham, and M. D. Wallenstein. 2015. Relationships between protein-encoding gene abundance and corresponding process are commonly assumed yet rarely observed. *The ISME journal* 9:1693–1699.
- Rosinger, C., J. Rousk, and H. Sandén. 2019. Can enzymatic stoichiometry be used to determine growth-limiting nutrients for microorganisms?—A critical assessment in two subtropical soils. *Soil Biology and Biochemistry* 128:115–126.
- Sauvadet, M., N. Fanin, M. Chauvat, and I. Bertrand. 2019. Can the comparison of above-and below-ground litter decomposition improve our understanding of bacterial and fungal successions? *Soil Biology and Biochemistry*.
- Schäffer, A., P. van den Brink, F. Heimbach, S. Hoy, F. de Jong, J. Römbke, J. P. Sousa, and M. Roß-Nickoll. 2008. Semi-field methods are a useful tool for the environmental risk assessment of pesticides in soil. *Environmental Science and Pollution Research* 15:176–177.
- Schimel, J., T. C. Balsler, and M. Wallenstein. 2007. Microbial stress-response physiology and its implications for ecosystem function. *Ecology* 88:1386–1394.

- Schimel, J. P., and J. Bennett. 2004. Nitrogen mineralization: challenges of a changing paradigm. *Ecology* 85:591–602.
- Sinsabaugh, R. L., R. Antibus, A. Linkins, C. McClaugherty, L. Rayburn, D. Repert, and T. Weiland. 1993. Wood decomposition: nitrogen and phosphorus dynamics in relation to extracellular enzyme activity. *Ecology* 74:1586–1593.
- Sinsabaugh, R. L., B. H. Hill, and J. J. F. Shah. 2009. Ecoenzymatic stoichiometry of microbial organic nutrient acquisition in soil and sediment. *Nature* 462:795–798.
- Sinsabaugh, R. L., C. L. Lauber, M. N. Weintraub, B. Ahmed, S. D. Allison, C. Crenshaw, A. R. Contosta, D. Cusack, S. Frey, M. E. Gallo, and others. 2008. Stoichiometry of soil enzyme activity at global scale. *Ecology letters* 11:1252–1264.
- Southwood, R., and J. Clarke. 1999. Charles Sutherland Elton. 29 March 1900–1 May: Elected FRS 1953. . The Royal Society.
- Southwood, T. R. 1977. Habitat, the templet for ecological strategies? *Journal of animal ecology* 46:337–365.
- Stampfli, A., J. M. Bloor, M. Fischer, and M. Zeiter. 2018. High land-use intensity exacerbates shifts in grassland vegetation composition after severe experimental drought. *Global change biology* 24:2021–2034.
- Swinton, S. M., F. Lupi, G. P. Robertson, and S. K. Hamilton. 2007. Ecosystem services and agriculture: cultivating agricultural ecosystems for diverse benefits. . Elsevier.
- Treseder, K. K., and J. T. Lennon. 2015. Fungal traits that drive ecosystem dynamics on land. *Microbiol. Mol. Biol. Rev.* 79:243–262.
- Valencia, E., N. Gross, J. L. Quero, C. P. Carmona, V. Ochoa, B. Gozalo, M. Delgado-Baquerizo, K. Dumack, K. Hamonts, B. K. Singh, and others. 2018. Cascading effects from plants to soil microorganisms explain how plant species richness and simulated climate change affect soil multifunctionality. *Global change biology* 24:5642–5654.
- Violle, C., M.-L. Navas, D. Vile, E. Kazakou, C. Fortunel, I. Hummel, and E. Garnier. 2007. Let the concept of trait be functional! *Oikos* 116:882–892.
- De Vries, F. T., and R. D. Bardgett. 2012. Plant-microbial linkages and ecosystem nitrogen retention: lessons for sustainable agriculture. *Frontiers in Ecology and the Environment* 10:425–432.
- De Vries, F. T., M. E. Liiri, L. Björnlund, M. A. Bowker, S. Christensen, H. M. Setälä, and R. D. Bardgett. 2012a. Land use alters the resistance and resilience of soil food webs to drought. *Nature Climate Change* 2:276–280.
- De Vries, F. T., P. Manning, J. R. Tallwin, S. R. Mortimer, E. S. Pilgrim, K. A. Harrison, P. J. Hobbs, H. Quirk, B. Shipley, J. H. Cornelissen, and others. 2012b. Abiotic drivers and plant traits explain landscape-scale patterns in soil microbial communities. *Ecology Letters* 15:1230–1239.
- De Vries, F. T., and A. Shade. 2014. Controls on soil microbial community stability under climate change. *The Microbial Regulation of Global Biogeochemical Cycles*:132.
- Wallenstein, M. D., and E. K. Hall. 2012. A trait-based framework for predicting when and where microbial adaptation to climate change will affect ecosystem functioning. *Biogeochemistry* 109:35–47.
- Wardle, D. A., R. D. Bardgett, J. N. Klironomos, H. Setälä, W. H. Van Der Putten, and D. H. Wall. 2004. Ecological linkages between aboveground and belowground biota. *Science* 304:1629–1633.
- Waring, B. G., S. R. Weintraub, and R. L. Sinsabaugh. 2014. Ecoenzymatic stoichiometry of microbial nutrient acquisition in tropical soils. *Biogeochemistry* 117:101–113.
- Westoby, M. 1998. A leaf-height-seed (LHS) plant ecology strategy scheme. *Plant and soil* 199:213–227.
- Westoby, M., D. S. Falster, A. T. Moles, P. A. Vesk, and I. J. Wright. 2002. Plant ecological strategies: some leading dimensions of variation between species. *Annual review of ecology and systematics* 33:125–159.
- Wood, S. A., D. S. Karp, F. DeClerck, C. Kremen, S. Naeem, and C. A. Palm. 2015. Functional traits in agriculture: agrobiodiversity and ecosystem services. *Trends in ecology & evolution* 30:531–539.
- Wright, I. J., P. B. Reich, M. Westoby, D. D. Ackerly, Z. Baruch, F. Bongers, J. Cavender-Bares, T. Chapin, J. H. Cornelissen, M. Diemer, and others. 2004. The worldwide leaf economics spectrum. *Nature* 428:821.
- Xiao, W., X. Chen, X. Jing, and B. Zhu. 2018. A meta-analysis of soil extracellular enzyme activities in response to global change. *Soil Biology and Biochemistry* 123:21–32.
- Xu, Z., G. Yu, X. Zhang, N. He, Q. Wang, S. Wang, R. Wang, N. Zhao, Y. Jia, and C. Wang. 2017. Soil enzyme activity and stoichiometry in forest ecosystems along the North-South Transect in eastern China (NSTEC). *Soil Biology and Biochemistry* 104:152–163.



*"Ce qui vient au monde pour ne rien troubler ne mérite ni égards ni patience."*

René Char, Fureur et mystère, À la santé du serpent, VII (1948)



---

# CHAPITRE 1

## (ARTICLE 1)

Using proxies of microbial community-weighted means traits to explain cascading effect of management intensity, soil and plant traits on ecosystem resilience in mountain grasslands

---

Gabin Piton<sup>1</sup>, Nicolas Legay<sup>2,3</sup>, Cindy Arnoldi<sup>1</sup>, Sandra Lavorel<sup>1</sup>, Jean Christophe Clément<sup>1,4</sup>, Arnaud Foulquier<sup>1</sup>

<sup>1</sup> Univ. Grenoble Alpes, CNRS, LECA, 38000 Grenoble, France

<sup>2</sup> INSA Centre Val de Loire, Ecole de la Nature et du Paysage, 41000 Blois, France.

<sup>3</sup> CNRS, CITERES, UMR 7324, 37200 Tours, France.

<sup>4</sup> CARRTEL, Univ. Savoie Mont Blanc, INRA, 74200, Thonon-Les-Bains

This chapter has been accepted in *Journal of Ecology*.

## ABSTRACT

1. Trait-based approaches provide a framework to understand the role of functional biodiversity on ecosystem functioning under global change. While plant traits have been reported as potential drivers of soil microbial community composition and resilience, studies directly assessing microbial traits are scarce, limiting our mechanistic understanding of ecosystem functioning.

2. We used microbial biomass and enzyme stoichiometry and mass-specific enzymes activity as proxies of microbial community-weighted mean (CWM) traits, to infer trade-offs in microbial strategies of resource use with cascading effects on ecosystem resilience. We simulated a drought event on intact plant-soil mesocosms extracted from mountain grasslands along a management intensity gradient. Ecosystem processes and properties related to nitrogen cycling were quantified before, during and after drought to characterize ecosystem resilience.

3. Soil microbial CWM traits and ecosystem resilience to drought were strongly influenced by grassland type. Structural equation modelling revealed a cascading effect from management to ecosystem resilience through modifications in soil nutrients and plant and microbial CWM traits. Overall, our results depict a shift from high investment in extracellular enzymes in nutrient poor soils (oligotrophic strategy), to a copiotrophic strategy with low microbial biomass N:P and low investment in extracellular enzymes associated with exploitative plant traits in nutrient rich soils.

4. Microbial CWM traits responses to management intensity were highly related to ecosystem resilience. Microbial communities with a copiotrophic strategy had lower resistance but higher recovery to drought, while microbial communities with an oligotrophic strategy showed the opposite responses. The unexpected trade-off between plant and microbial resistance suggested that the lower resistance of copiotrophic microbial communities enabled plant resistance to drought.

5. *Synthesis* Grassland management has cascading effects on ecosystem resilience through its combined effects on soil nutrients and plant traits propagating to microbial traits and resilience. We suggest that intensification of permanent grassland management and associated increases in soil nutrient availability decreased plant-microbe competition for N under drought through the selection of drought-sensitive microbial communities with a copiotrophic strategy that promoted plant resistance. Including proxies of microbial CWM traits into the functional trait framework will strengthen our understanding of soil ecosystem functioning under global change.

**Keywords:** extracellular enzymes, functional traits, mountain grassland, nitrogen cycling, resistance, drought, soil microbial community, stoichiometry

## 1 INTRODUCTION

The response-effect trait framework is a powerful approach to understand how environmental changes influence ecosystem functioning and services through their effects on functional biodiversity (Lavorel and Garnier 2002, Diaz et al. 2007, Lavorel 2013, Bardgett 2018). Research suggests that plant traits related to the plant economics spectrum follow resource gradients worldwide (Wright et al. 2004, Reich 2014). Exploitative species characterized by organs with high nitrogen content (e.g. leaf nitrogen concentration, LNC) and low dry matter content (e.g. leaf dry matter content, LDMC) are favored in nutrient-rich conditions, while conservative species with opposite traits dominate nutrient-poor environments (Reich 2014). Empirical studies also indicate an effect of plant traits on aboveground and belowground ecosystem processes related to organic matter and nutrient cycling (Lavorel and Grigulis 2012, Grigulis et al. 2013). Ecosystems dominated by exploitative plant species produce more biomass of greater nutritional quality (Lavorel et al. 2011, Gardarin et al. 2014), with faster litter decomposition (Quested et al. 2007, Fortunel et al. 2009) and faster mineralization and nitrification (Orwin et al. 2010, Grigulis et al. 2013), as compared with ecosystems dominated by conservative plants. Exploitative plant species are also less resistant to drought, but with faster recovery (Karlowsky et al. 2018, Mackie et al. 2019). This continuum from slow to fast nutrient cycling along the plant economics spectrum has also been related to concomitant changes in soil microbial community composition and resilience: bacteria dominate at the exploitative end of the continuum and fungi at the conservative one, with respectively greater resilience and stronger resistance to drought (De Vries et al. 2012a, 2012b, Grigulis et al. 2013, De Vries and Shade 2014, Legay et al. 2014, Cole et al. 2019). These general patterns raise the question of a microbial economic spectrum paralleling the leaf one. The copiotroph-oligotroph framework has been proposed as a strategy continuum for microbes equivalent to the plant economics spectrum (Fierer et al. 2007). The copiotroph strategy is characterized by high growth rates but low resistance to

environmental stress, while oligotrophic microbes have the opposite traits. Fontaine et al. (2003) hypothesised that oligotrophs invest more than copiotrophs in the production of extracellular enzymes to extract carbon (C), nitrogen (N) and phosphorus (P) from complex organic molecules when these elements are limiting in their assimilable forms. Based on these assumptions, the oligotrophic strategy is expected to dominate in environments with low nutrient availability (fungal dominated) while copiotrophs would dominate in nutrient-rich environments (bacterial dominated). However, the shift from bacterial to fungal dominated microbial communities along conservative-exploitative plant traits continuum does not necessarily equate with a shift from oligotrophic to copiotrophic strategy. While fungi have generally more oligotrophic traits than bacteria, both types of strategies can be found in the bacterial and fungal kingdoms (Ho et al. 2017). Therefore, the exploration of trade-offs in soil microbial strategies needs to go beyond the taxonomic indicators such as the fungal:bacterial ratio which have been related *a priori* to functional traits; rather researchers should directly measure and test traits of interest (De Vries and Shade 2014). However, trait-based studies focusing on soil microbial communities are still scarce due to methodological and conceptual limitations (Martiny et al. 2015, Pommier et al. 2018). The small size and inability to cultivate most soil microorganisms (Vartoukian et al. 2010) coupled with their enormous diversity hampers the exploration of microbial traits at the species level.

Nevertheless, some functional parameters measured on the overall community can be used to describe the dominant strategy within microbial communities. Such characteristics represent community aggregated-traits, a concept initially proposed by Garnier et al. (2004) for plants. This concept has been largely implemented in macroorganism ecology using community weighted mean (CWM) traits calculated by weighting species trait values by their relative mass in the community (Diaz et al. 2007). Alternatively, CWMs have been directly quantified by direct sampling of biomass and measurement of average traits (Gaucherand and Lavorel 2007). Similarly, we propose microbial CWM traits

equivalent to CWMs based on species-level trait measurement (Garnier et al. 2004) but calculated based on microbial community-level properties. For example, when the overall trait expression can be measured (e.g. total microbial activity per gram of soil), the average trait value of a microbial biomass unit can be calculated by weighting the community-level activity by microbial biomass (e.g. activity per unit of microbial biomass or mass-specific activity). Mass-specific traits for resource acquisition such as the specific leaf area (i.e. the leaf surface per unit of leaf mass, representing light capture capacity (Wright et al. 2004)) are also commonly assessed for plants. Stoichiometric ratios of characteristics measured at the community-level (e.g. biomass or enzymatic stoichiometry) are unitless and can also be considered as proxies of microbial CWM traits, equivalent to CWM of leaf or roots stoichiometry. Mass-specific activities and stoichiometric ratios thus represent proxies of microbial community-weighted mean traits, independent of microbial biomass and approximating the average functional trait value within the community. They are commonly measured in microbial ecology (e.g. Fanin et al. 2014, Allison et al. 2007) but never considered as CWM traits. Considering these variables as proxies of CWM traits in the future might enable us to develop a functional trait framework (Lavorel and Garnier 2002) in microbial ecology.

Ecoenzymatic and stoichiometric theories appear as promising approaches to assess microbial strategies. Variations in the elemental stoichiometry of microorganisms could be used as proxy of microbial strategies (Arrigo 2004, Fierer et al. 2007). According to the growth rate hypothesis, high P content measured in organisms indicates high ribosomal RNA content and thus high growth rates (Elser et al. 2003), a trait characterizing copiotrophic microbes (Fierer et al. 2007). Nitrogen being more abundant in the resource acquisition machinery, a high N:P ratio in the microbial biomass would be expected to be related to a high investment in enzyme production (intra and extracellular) for resource acquisition, a trait expected under the oligotrophic strategy (Arrigo 2004, Fierer et al. 2007). Moreover, ecoenzymatic stoichiometry, that is the

stoichiometry of extracellular enzyme activities (EEA) involved in C, N and P acquisition, reflects an optimized microbial resource acquisition strategy at the community level oriented toward the most limiting element (Sinsabaugh et al. 2009, Moorhead et al. 2016). Modification of biomass and ecoenzymatic stoichiometry is a common mechanism by which microbial communities adapt to variations in resource availability, with strong implications for ecosystem functioning (Mooshammer et al. 2014).

Grasslands dominate agricultural surfaces in mountain landscapes (Lemaire et al. 2005) and provide multiple ecosystem services (Fontana et al. 2013, Brunner et al. 2016, Lavorel et al. 2017). During the last decades, they have been affected by an increase of extreme events (Lemaire and Pflimlin 2007, Beniston 2015). At the same time they have been subjected to a combination of abandonment of less productive or accessible land and management intensification of remaining surfaces, especially at valley bottoms (Hinojosa et al. 2019) where fertilizer inputs are increased and permanent grasslands are converted to tilled and sown grasslands (Dobremez et al. 2015). Modifications of grassland management intensity can influence plant and microbial traits which in turn affect ecosystem processes, services and resilience (De Vries and Bardgett 2012, Duru et al. 2013, Schirpke et al. 2017, Boeddinghaus et al. 2019). For example, intensive fertilisation increases soil nutrient contents (Diacono and Montemurro 2011, Gattinger et al. 2012) and favours exploitative plants and copiotrophic microbial communities (Quétier et al. 2007, Leff et al. 2015). Sowing can also directly implant exploitative species selected for their high productivity and high litter quality compared to original species, accelerating nutrient cycling (García-Palacios et al. 2013). These fertilised and possibly sown grasslands are also known for their lower resistance and faster recovery to stress than extensively managed grasslands (Ingrisch et al. 2018, Stampfli et al. 2018).

In this study we propose a trait-based approach using proxies of microbial community-weighted mean (CWM) traits, to describe trade-offs in microbial

strategies and secondly to depict cascading effects of mountain grassland management intensity on ecosystem resilience through modification of soil nutrients, plant and microbial traits. Accordingly, we decomposed our cascading effect hypothesis into two working hypotheses: under baseline conditions (H1) we hypothesized a selection of oligotrophic microbial communities with CWM traits indicating a high investment in extracellular and intracellular resource acquisition machinery (high mass-specific extracellular enzymes activity and high biomass N:P ratio) in extensive grasslands with nutrient poor soils and conservative plants (providing nutrient poor and recalcitrant litter). At the other end of the fertility gradient, nutrient rich soils and exploitative plants (providing high quality litter) in intensive grasslands are expected to select for copiotrophic microbial communities with a growth-oriented strategy (high P content relative to N and low investment in extracellular enzymes production). Then, we hypothesized for H2 a positive effect of the oligotrophic strategy on microbial biomass-N resistance to drought, since high extracellular depolymerization potential per unit of microbial biomass and high intracellular protein content (enzymatic machinery and stress resistance protein) should help to cope with nutritional and osmotic constraints. Conversely, a copiotrophic strategy should favour the recovery of microbial biomass-N after drought, resulting in a trade-off between resistance and resilience.

## 2 MATERIALS AND METHODS

### 2.1 STUDY AREA

The study site was located in the "Val d'Autrans" mountain area in the northern Vercors range of the French Pre-Alps (45°07'N, 5°31'E). Val d'Autrans is a plateau with 1800 ha of pastures (23% of total area) at an average elevation of 1000 m a.s.l. (Dobremez et al. 2015). Mean annual temperature is 7.2°C and mean annual precipitation 1093 mm (Loucougaray et al. 2015). Pasture management has been intensified during the last thirty years, with sown grasslands increasing from 21% of total grassland area in 1988 to 33% in 2010, and

increasing fertilization and mowing frequency (Dobremez et al. 2015). While sometimes intensive, fertilization is only organic due to the large number of livestock overwintering on farms.

### 2.2 MANAGEMENT INTENSITY ASSESSMENT AND GRASSLAND SELECTION

We selected twelve grasslands representing the large range of management practices in Val d'Autrans (Loucougaray et al. 2015). Land-use intensity (LUI) was assessed using the index proposed by Blüthgen et al. (2012) to characterize management effects on biodiversity (Gossner et al. 2016), and was calculated as follows:

$$LUI_i = \frac{F_i}{F_r} + \frac{M_i}{M_r} + \frac{G_i}{G_r}$$

Where  $F_i$  is the mean fertilization intensity ( $\text{kg}^{-1} \text{N ha}^{-1} \text{ year}^{-1}$ ),  $M_i$  is the mean mowing frequency (number of cut  $\text{year}^{-1}$ ),  $G_i$  is the mean grazing intensity (livestock units days of grazing  $\text{ha}^{-1} \text{ year}^{-1}$ ) of the  $i$ -th grassland calculated using data corresponding to the three years preceding the experiment based on farmer interviews.  $F_r$ ,  $M_r$  and  $G_r$  are the mean values of each of the LUI component, calculated on all studied grasslands. The twelve selected grasslands had a LUI ranging from 0.83 to 4.7 (mean  $\pm$  sd =  $3 \pm 0.8$ ). We considered as permanent extensive (PE; 'extensive' henceforth), those grasslands with a LUI value lower than the mean across the twelve grasslands, and as intensive grasslands with a LUI higher than the mean. We then split intensive grasslands into two types according to Common Agricultural Policy criteria: permanent intensive grasslands (PI) (not ploughed for over 5 years) and sown intensive grasslands (SI; 'sown grasslands' hereafter) which are ploughed every 3 or 4 years and sown with a mixture of productive grasses (*Lolium perenne* (L.) and *Dactylis glomerata* (L.)) and legumes (*Trifolium pratense* (L.)). Ploughing intensity was calculated as its frequency (1/number of years between ploughing events). A value of 30 years was used for permanent grasslands (period covered by farmer knowledge concerning ploughing of their fields). Ploughing intensity was not used in the LUI

calculation but to split intensive grasslands between permanent and sown grasslands. In total, our experiment comprised 5 sown, 3 permanent intensive and 4 extensive grasslands, with sown grasslands characterized by high organic fertilization and mowing intensity,

permanent intensive grasslands characterized by high organic fertilization and grazing while extensive grasslands were characterized by low fertilization, grazing and mowing intensity (Figure 12).

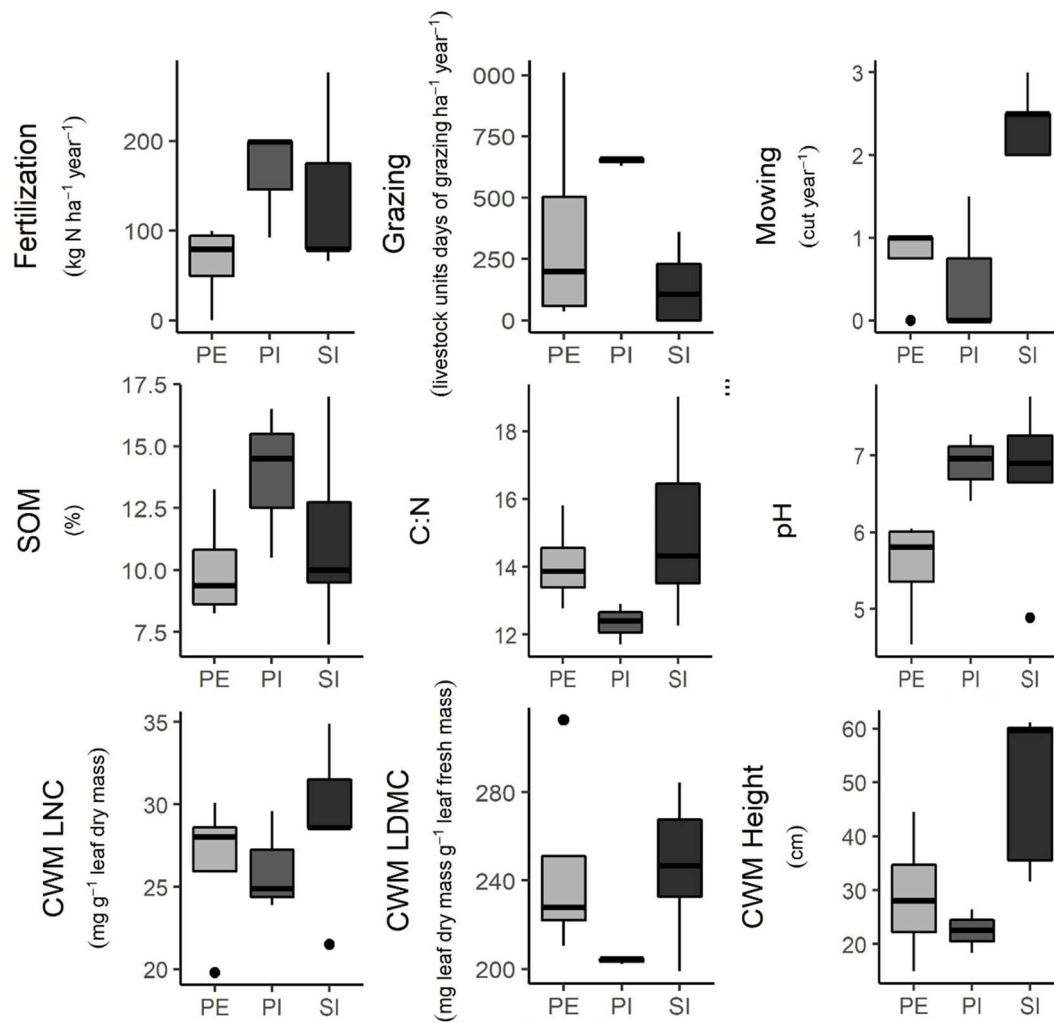

Figure 12 Land use intensity, soil abiotic properties and plant CWM traits of extensive (PE,  $n=4$ ), permanent intensive (PI,  $n=3$ ) and sown (SI,  $n=5$ ) grasslands. Box represents the lower and upper quartiles, bold line is the median, whiskers represent the 95% confidence interval and points are grasslands out of the 95% confidence interval.

### 2.3 PLANT COMMUNITY FUNCTIONAL FIELD ASSESSMENT

Plant functional traits (Leaf C and N content, Leaf Dry Matter Content and Height) were measured in August 2015 on all grasslands, using standard protocols (Perez-Harguindeguy et al. 2013). Plant community-weighted mean (CWM) trait values (Garnier et al. 2004) were calculated following Casanoves et al. (2011) :

$$Plant\ CWM = \sum_{i=1}^n p_i \times trait_i$$

Where  $p_i$  is the relative contribution of species  $i$  to the maximum biomass of the community (August 2015 harvest),  $n$  is the number of most abundant species (enough species to make up 80% of the total plant biomass as recommended by Garnier et al. 2006), and  $trait_i$  is the trait value of species  $i$ . Leaf litter was collected on each grassland at the end of the field season (September). Litter C and N concentrations were measured with an elemental analyser (Flash 1112 EA, Thermo-153 Finnigan, Bremen, Germany), P concentrations were analysed by atomic absorption spectrometry (Perkin Elmer ICP-OES 6500, Norwalk, USA).

### 2.4 EXPERIMENTAL DESIGN

In April 2016, 12 intact soil mesocosms (Schäffer et al. 2008) were randomly extracted from each of the 12 grasslands giving a total of 144 mesocosms. Each soil mesocosm comprised a 12x12x12 cm soil block and its vegetation. Intact soil mesocosms were immediately brought to a greenhouse with semi-controlled conditions, distributed following a randomized design and grown during 13 days with watering every 3 days. All mesocosms received the same amount of water, calculated to reach 100% of the water holding capacity (WHC). Mesocosms were open blocks limiting soil water saturation. During this period, we did not observe any plant senescence. This period was followed by a first destructive sampling (T0: 48 soil mesocosms, 4 per grassland). Then watering was stopped for 13 days leading to a decrease from 100% of the WHC to 24%, in average on the 12 grasslands (sd=0.05%). A second

destructive sampling occurred at the end of the drought (T1: 48 soil mesocosms, 4 per grassland) to assess ecosystem resistance. Finally, the remaining mesocosms were re-watered at 100%WHC during the next 48 days (time necessary for a full recovery of aboveground biomass compared to the pre-drought state), followed by the last destructive sampling (T2: 48 soil mesocosms, 4 per grassland) to assess ecosystem recovery. At each sampling date, half of each intact soil mesocosm was used for measuring soil and microbial properties and the other half for measuring plant properties.

### 2.5 SOIL PROPERTIES

Soil samples were sieved at 5-mm and stored at 4°C before processing within 48h. A 2.75-g subsample was stored at -20°C for quantification of extracellular enzymatic activities. Subsamples of 5-g of fresh soil were oven-dried at 70°C for 1 week and weighed to determine soil water content (SWC), followed by 4h at 550°C to determine soil organic matter (SOM) (Robertson et al. 1999). Soil subsamples were air dried and ground to powder to measure total C and N contents using a FlashEA 1112 elemental analyser (Fisher Scientific Inc., Waltham, MA, USA) and to determine soil pH in a 1:2.5 (soil:distilled water) solution. Solution of 0.5M  $K_2SO_4$  were used to extract soil nitrate ( $NO_3^-$ ), ammonium ( $NH_4^+$ ), total dissolved nitrogen (TDN) (Jones and Willett 2006), phosphate ( $PO_4^-$ ) and total dissolved phosphorus (TDP) on 10-g of fresh soil. N and P concentrations were measured on an automated photometric analyser using standard colorimetric methods (Gallery Plus: Thermo Fisher Scientific, Waltham, Massachusetts, USA). Dissolved organic nitrogen (DON) and phosphorus (DOP) were calculated as the difference between TDN or TDP and the mineral N ( $NO_3^-+NH_4^+$ ) or mineral P ( $PO_4^-$ ) respectively.

### 2.6 MICROBIAL ABUNDANCES, ACTIVITIES AND CWM TRAITS

Microbial biomass nitrogen (MBN) and phosphorus (MBP) contents were measured on 10-g of fresh soil, based on the difference of soil N or P content before and after chloroform-fumigation extraction (CFE) (Vance et

al. 1987). MBN and MBP were calculated using a correction factor of 0.45 and 0.40 respectively (Jenkinson et al. 2004). Potential nitrogen mineralization rates (PNM) were estimated after incubation of 10-g of fresh soil under anaerobic conditions for 7 days at 40°C in the dark (Wienhold 2007). During this period, mineralized organic N was accumulated as  $\text{NH}_4^+$ . The difference between  $\text{NH}_4^+$  content before and after incubation was used to calculate PNM rates ( $\mu\text{N/g dry soil/day}$ ).

Potential EEA of seven enzymes involved in the degradation of C-rich substrates ( $\alpha$ -Glucosidase,  $\beta$ -1,4-Glucosidase,  $\beta$ -D-Cellobiosidase, and  $\beta$ -Xylosidase), N-rich substrates ( $\beta$ -1,4-N-acetylglucosaminidase and leucine aminopeptidase) and P-rich substrates (phosphatase) were estimated using standardized fluorimetric techniques (Bell et al. 2013). Briefly, 2.75-g of soil were homogenized (1-min in a Waring blender) in 200-ml of sodium acetate buffer solution adjusted at soil pH (5.6). The soil slurries were added in duplicate to 96-deep-well microplates followed by the addition of a substrate solution for each enzyme. For each soil sample, duplicated standard curves (0-100- $\mu\text{M}$  concentration) were prepared by mixing 800- $\mu\text{l}$  of soil slurry with 200- $\mu\text{l}$  of 4-methylumbelliferone (MUB) or 7-amino-4-methylcoumarin (MUC) in 96-deep-well microplates. Microplates were incubated during 3-h (dark, 175-rpm, 20°C), and centrifuged at 2900-g for 3-min. Then soil slurries (250- $\mu\text{l}$ ) were transferred into black Greiner flat-bottomed microplate and scanned on a Varioskan Flash (Thermo Scientific) reader using excitation at 365-nm and emission at 450-nm (Bell et al. 2013).

For each soil sample, the four enzyme activities degrading C-rich substrates, the two enzymes activities degrading N-rich substrates and all the seven enzymes were summed to obtain extracellular enzyme activity for C-rich substrates (EEC), N-rich substrates (EEN) and overall (C+N+P) rich substrates (Total EEA) respectively. Phosphatase activity was used to represent extracellular enzyme activity for P rich substrates (EEP). EEC, EEN, EEP and Total EEA were calculated per gram of dry soil (global activities,  $\text{nmol activity g}^{-1} \text{ dry soil h}^{-1}$ ) to be used as ecosystem properties.

Three different proxies of microbial community-weighted (CWM) traits were calculated to characterize microbial strategies. Firstly, the microbial biomass N:P stoichiometric ratio was used as a proxy for cellular maintenance and resource acquisition versus growth allocation trade-off (Arrigo 2004, Karpinets et al. 2006). Secondly, ecoenzymatic ratios were calculated to represent microbial resource limitation associated with trade-offs between C, N and P acquisition. EEC:EEP, EEC:EEN and EEN:EEP ratios were calculated to represent the balance of C versus P, C versus N and N versus P acquisition respectively (Sinsabaugh et al. 2009). Thirdly, mass-specific enzymes activity was calculated as the total extracellular enzyme activities per unit of microbial biomass-N and considered as a proxy of the average investment in extracellular enzyme production per unit of microbe within the community (Malik et al. 2019).

## 2.7 VEGETATION PROPERTIES

At each sampling time, roots, leaves and stems (green aboveground biomass) and litter were manually sorted for each mesocosm. Litter was considered as dead plant tissue on the ground or still attached to the plant (brown aboveground biomass). Roots were carefully washed with water and sieved sequentially on a 5.6, 2 and 0.5-mm mesh to avoid any loss of fine roots. Leaves, stems, roots and litter were dried at 70°C for a week and weighted to measure root biomass, green aboveground biomass (leaf+stem) and litter mass. All plant material was ground and analysed for N and C contents using an elemental analyser (FlashEA 1112: Fisher Scientific, Waltham, Massachusetts, USA). Root/shoot ratios were calculated as the ratio of root to total aboveground green biomass.

## 2.8 STATISTICAL ANALYSES

To examine the effects of sampling time ( $T_0, T_1, T_2$ ) and grassland types (Sown Intensive, Permanent Intensive and Permanent Extensive) on soil, plant and microbial properties, mixed effect models were assessed with sampling time (ST) and grassland types (GT) as fixed factors, and grassland ( $n=12$ ) as random factor.



When necessary, data were transformed using log, square-root or inverse functions to fulfill assumptions of normal distribution and variance homogeneity of model residuals. Tukey tests were used for post-hoc comparisons between sampling times and grassland types.

We quantified ecosystem resilience of plant and microbial communities based on two key ecosystem properties: microbial biomass-N and total forage-N, for which drought and recovery relative responses were calculated as described by De Vries et al. (2016) to characterize resistance (Ra) and recovery (Rec) respectively for each grassland as:

$$Ra(Y)_i = \frac{Y_{T1i} - Y_{T0i}}{Y_{T0i}} * 100 ;$$

$$Rec(Y)_i = \frac{Y_{T2i} - Y_{T1i}}{Y_{T1i}} * 100$$

With  $Y_{T0i}$ ,  $Y_{T1i}$ ,  $Y_{T2i}$  the mean value for the grassland  $i$  ( $n=4$  mesocosms per grassland per sampling time) of the ecosystem property  $Y$  at  $T_0$ ,  $T_1$  and  $T_2$  respectively.

To examine potential trade-off among plant and microbial traits, initial ecosystem properties and resilience, management intensity components and soil abiotic resources, a multi-table analyses was conducted using 6 distinct tables (48 rows in each table). The following variables were used to characterize management intensity (overall LUI, fertilization intensity, grazing intensity, mowing intensity and ploughing intensity), soil abiotic properties (SOM, total soil C, total soil N, C:N, pH,  $\text{NH}_4^+$ ,  $\text{NO}_3^-$ , DON,  $\text{PO}_4^-$ , DOP, TDN:TDP), plant CWM traits (height, Leaf N content, Leaf dry matter content, forage N concentration, root:shoot, root N concentration, litter C:N, C:P and N:P ratio), proxies of soil microbial CWM traits (Mass-specific activity, Microbial biomass N:P, EEC:EEN, EEC:EEP, EEN:EEP), initial ecosystem properties (total forage-N, total root-N, microbial biomass-N, Total EEN, PNM) and ecosystem resilience (Resistance and Recovery indexes of total forage-N and microbial biomass-N). For soil abiotic properties, plant and microbial CWM traits and initial ecosystem properties tables, we used values measured at  $T_0$  or measured in the field for plant CWM traits.

Resistance and recovery indexes (one value per grassland) were integrated in the ecosystem resilience table. Firstly, vectorial correlation coefficient (RV)- were calculated to assess relationships between each pair of tables (Robert and Escoufier 1976). Null distributions of RV-coefficients were obtained by randomly permuting rows 1000 times within tables and proportion of null values greater than the observed RV-coefficients were used to assess coefficient significance. Secondly, we used Multiple co-inertia analysis (MCOA), an extension of co-inertia analyses that enables the simultaneous ordination of more than two tables (Chessel and Hanafi 1996). This method provides a sample ordination summarizing the information shared by multiple tables in a common structure (Chessel and Hanafi 1996, Foulquier et al. 2011, Legay et al. 2016). Using a covariance maximization criterion, MCOA optimises the variance within each individual table and the correlation between the scores from individual tables ordinations and the scores of a reference ordination (common structure of the multiple tables) (Bady et al. 2004).

Exploratory structural equation models (Shipley 2016) were used to investigate the cascading effects from grassland management to microbial communities (microbial-N) initial level, resistance and recovery through combined effects on soil nutrients and plant CWM traits propagating to proxies of microbial CWM traits (Figure 13.A). The purpose of exploratory SEM is to identify the main mechanisms within a series of potential mechanisms hypothesized based on current knowledge (Laughlin et al., 2007; Grace et al. 2015). This approach is considered as model-generating rather than model-confirmatory (Grace et al. 2015). Piecewise SEMs were used because of their lower sensitivity to sample size and their ability to include mixed effect models within the SEM structure (Lefcheck 2016). To test how management constrains plant and microbial CWM traits before drought, soil, plant and microbial properties measured at  $T_0$  were used in the SEMs (as for MCOA). Soil N was used

a

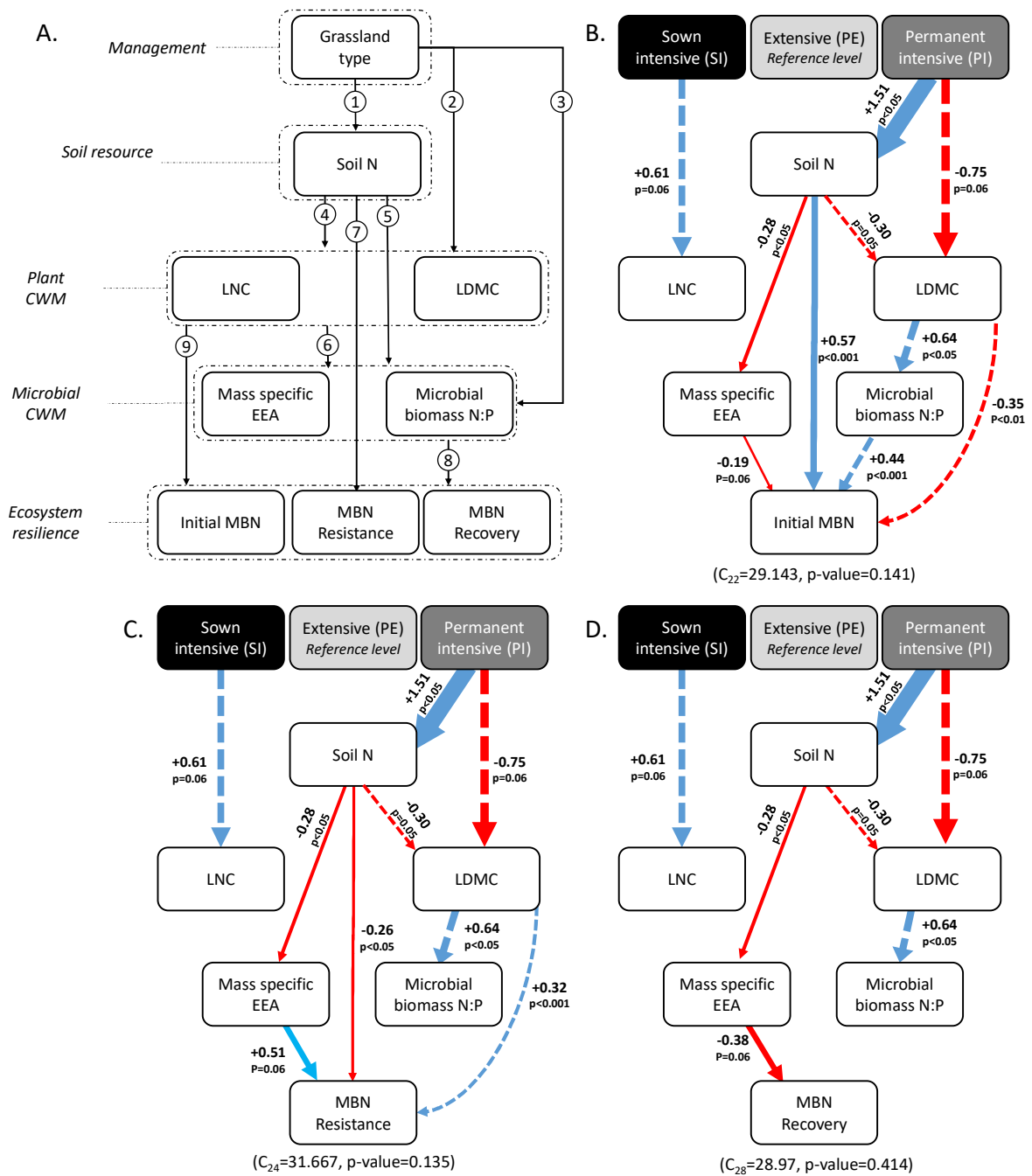

Figure 13 a priori causal structure explored with SEM, depicting cascading effects of management on microbial biomass-N resilience (A) and final SEM indicating conserved paths after model simplification process for initial microbial-N (B), microbial-N resistance (C) and microbial-N recovery (D) Arrows ending/starting on/from the dotted boxes in the a priori causal structure (A) were used to indicate paths ending/starting on/from all variables within the box. The a priori causal structure hypothesizes several paths between grassland management and microbial resilience. Management can directly influence soil N (arrows 1), through organic fertilization, mowing (export from the grassland), grazing (both import and export) and tillage. We also expect a direct effect of management on plant and microbial traits (arrows 2 and 3) especially in sown grasslands where productive plants with specific traits are sown and ploughing directly disturb the soil microbial community. Soil-N can influence plant and microbial traits (arrows 4 and 5). (Continued on next page)

Figure 13. (Continued from previous page) We expect in N poor soil the selection of conservative plants (low LNC and high LDMC) and microbial community with a resource extraction strategy (high mass-specific EEA and high biomass N:P). Plant traits can also influence microbial traits through litter quality (arrow 6) since low LNC and high LDMC are related to lower litter decomposability. Microbial traits are then expected to influence microbial biomass-N and their resilience (arrows 8). Soil N and plants traits can also directly influence microbial biomass-N and its resilience by influencing available N (arrow 7 and 9). One-headed arrows in final SEMs (B,C,D) represent validated causal relationships, arrow width is proportional to standardized effect sizes, red arrows represent positive effects, blue arrows represent negative effects, full arrow represents pathways from management to microbial CWM traits and resilience independent of plant traits while dashed arrows represent pathways operating through plant traits (see results section). Permanent extensive grasslands are used as reference level for assessing management effects; arrows starting from other grassland types indicate effects compared to permanent extensive grasslands.

(LNC) and leaf dry matter content (LDMC) were used as indicators of the plant economics spectrum (Reich 2014) and its response to soil fertility (Hodgson et al. 2011), and because these traits also control litter quality (Quasted et al. 2007, Fortunel et al. 2009). Microbial biomass N:P was used as an indicator of the relative investment between cellular maintenance and resource acquisition vs. growth (Arrigo 2004, Karpinets et al. 2006) and mass-specific extracellular enzymes activity as proxies of the investment in extracellular enzymes (Malik et al. 2019). Effects of these predictors were tested on initial MBN, MBN resistance and recovery indices with three independent SEMs. Firstly, the full model structures were tested, containing all potential paths of the *a priori* model (Figure 13.A). Next, the model structures were simplified by stepwise removal of non-significant relationships (De Vries and Bardgett 2016), with effect of each removals on model quality assessed with Bayesian information criterion (Hertzog, 2019). Standardized coefficients were then extracted from these most parsimonious models and used for interpretations.

All statistical analyses were performed with R software version 3.5.1 using packages : nlme (Team et al. 2016) for mixed effect model, ade4 (Dray et al. 2007) and vegan (Oksanen et al. 2011) for MCOA, piecewissem for SEM (Lefcheck 2016) ggplot2 and adegraphic (Siberchicot et al. 2017) for plotting.

### 3 RESULTS

#### 3.1 SOIL AND PLANT RESPONSE TO GRASSLAND TYPES, DROUGHT AND RECOVERY

Several soil and plant properties showed consistent drought response patterns across grassland types (non-significant GT x ST interaction, Table 1).  $\text{NH}_4$  (Tukey's test To-T1:  $p < 0.001$ ) and DON (Tukey's test To-T1:  $p < 0.001$ ) increased during drought in all grassland types, while  $\text{NO}_3^-$  decreased (Tukey's test To-T1:  $p < 0.001$ ) (Figure S1). After the recovery period, these N-pools recovered close to initial levels (Figure S1). Despite these strong responses of soil N pools, EEN was stable during drought (Tukey's test To-T1:  $p = 0.81$ ) and increased only during recovery (Tukey's test T1-T2:  $p = 0.001$ ) (Figure 14). Meanwhile total litter-N increased during and after drought, while total root-N decreased after drought (Figure S1).

Grassland type modulated patterns of drought response and recovery for several plant and microbial properties (GT x ST interaction, Table 1). Extensive grasslands were most stable as microbial biomass-N and forage dry mass did not differ between sampling times (Figure 14), while forage N concentration was stable during drought and decreased minimally after recovery (Tukey's test T1-T2:  $p < 0.001$ ). Consequently, total forage N decreased only slightly during drought (Tukey's test To-T1:  $-0.028 \text{ t.N.ha}^{-1}$ ,  $p = 0.03$ ) and remained stable after recovery (Tukey's test T1-T2:  $p = 0.86$ ). Intensive grasslands (permanent or sown) were more responsive, but their plant and soil microbial responses were

opposite (Figure 14). In permanent intensive grasslands forage dry mass and total forage-N were stable during drought, while microbial biomass-N decreased (Tukey's test To-T1:  $p < 0.001$ ). The opposite pattern was observed in sown grasslands with a decrease in both forage dry mass (Tukey's test To-T1:  $-0.81 \text{ t.ha}^{-1}$ ;  $p < 0.01$ ) and forage N concentration

(Tukey's test To-T1:  $-0.56\% \text{ N}$ ,  $p < 0.001$ ) resulting in a decrease by more than a third of total forage-N (Tukey's test To-T1:  $-0.042 \text{ tN.ha}^{-1}$ ,  $p < 0.001$ ). Meanwhile microbial biomass-N remained stable in these grasslands. After recovery, microbial biomass-N returned to its initial level in permanent intensive grasslands (Tukey's test To-T2:  $p = 0.11$ ). Forage dry mass exceeded its initial level at the end of the recovery period (Tukey's test To-T2:  $+1.18 \text{ t.ha}^{-1}$ ,  $p < 0.01$ ) but due to a concomitant decrease in forage N content (Tukey's test T1-T2:  $-1.45\% \text{ N}$ ,  $p < 0.001$ ), total forage-N remained stable. In sown grasslands,

microbial biomass-N also increased during the recovery period (Tukey's test T1-T2:  $p < 0.01$ ). Forage dry mass recovered from the negative impact of drought, but at the same time forage N concentration was halved (Tukey's test T1-T2 :  $-1.52\% \text{ N}$ ,  $p < 0.001$ ), resulting in a loss of a third of the remaining total forage-N (Tukey's test T1-T2:  $-0.026 \text{ tN.ha}^{-1}$ ,  $p = 0.03$ ) (Figure 14).

Permanent intensive grasslands had overall greater microbial biomass and activities (Figure 14). Enzyme activity decomposing N-rich substrates was highest in permanent intensive grasslands during the whole experiment (Tukey's tests PI-PE  $p = 0.03$ , PI-SI:  $p < 0.01$ ). Before drought, permanent intensive grasslands showed the highest microbial biomass-N (Tukey's tests PI-PE  $p < 0.01$ , PI-SI:  $p = 0.01$ ) and potential N mineralization rates (Tukey's tests PI-PE  $p = 0.05$ , PI-SI:  $p = 0.05$ ). These differences disappeared by the end of the drought period, but greater potential N mineralization rates were again

Table 1 Mixed effect model ( $n=144$ ), with sampling time (ST : before drought, end of drought, 48 after the end of drought) and grassland types (GT : sown, permanent intensive and extensive) as fixed effect and grassland identity ( $N=12$ ) as random effect

Ecosystem Properties	Sampling Time (ST)		Grassland Type (GT)		ST X GT	
	F(2,125)	p value	F(2,9)	p value	F(4,125)	p value
<i>Abiotic soil</i>						
Total Soil N	0.15	0.858	2.96	0.103	3.02	<b>0.020</b>
N.NH <sub>4</sub>	129.85	<b>&lt;0.001</b>	0.10	0.907	1.81	0.132
N.NO <sub>3</sub>	29.20	<b>&lt;0.001</b>	0.36	0.709	0.89	0.470
N.DON	220.23	<b>&lt;0.001</b>	0.97	0.416	2.58	<b>0.040</b>
<i>Soil microbial community</i>						
Microbial biomass-N	15.71	<b>&lt;0.001</b>	2.63	0.126	7.39	<b>&lt;0.001</b>
Potential N Mineralization	1.57	0.213	5.88	0.023	3.33	<b>0.013</b>
Total EEN	7.40	<b>&lt;0.001</b>	10.38	<b>&lt;0.01</b>	0.59	0.672
<i>Plant community</i>						
Forage Dry Mass	9.04	<b>&lt;0.001</b>	4.10	0.054	2.69	<b>0.034</b>
Forage [N]	184.23	<b>&lt;0.001</b>	0.45	0.600	11.35	<b>&lt;0.001</b>
Total Forage-N	25.84	<b>&lt;0.001</b>	3.47	0.076	2.56	<b>0.042</b>
Total Roots-N	33.01	<b>&lt;0.001</b>	0.22	0.803	0.42	0.792
Total Litter-N	51.61	<b>&lt;0.001</b>	4.44	<b>0.045</b>	1.00	0.411

observed in permanent intensive grasslands after the recovery period (Tukey's tests PI-PE:  $p < 0.01$ , PI-SI:  $p = 0.01$ ). Compared to extensive grasslands, sown grasslands had higher values for properties related to forage services before drought, with significantly higher

total forage-N and forage-N concentration (Tukey's test SI-PE:  $p = 0.03$  and  $p = 0.03$  respectively). However, differences observed at To were not maintained after drought or recovery (Figure 14).

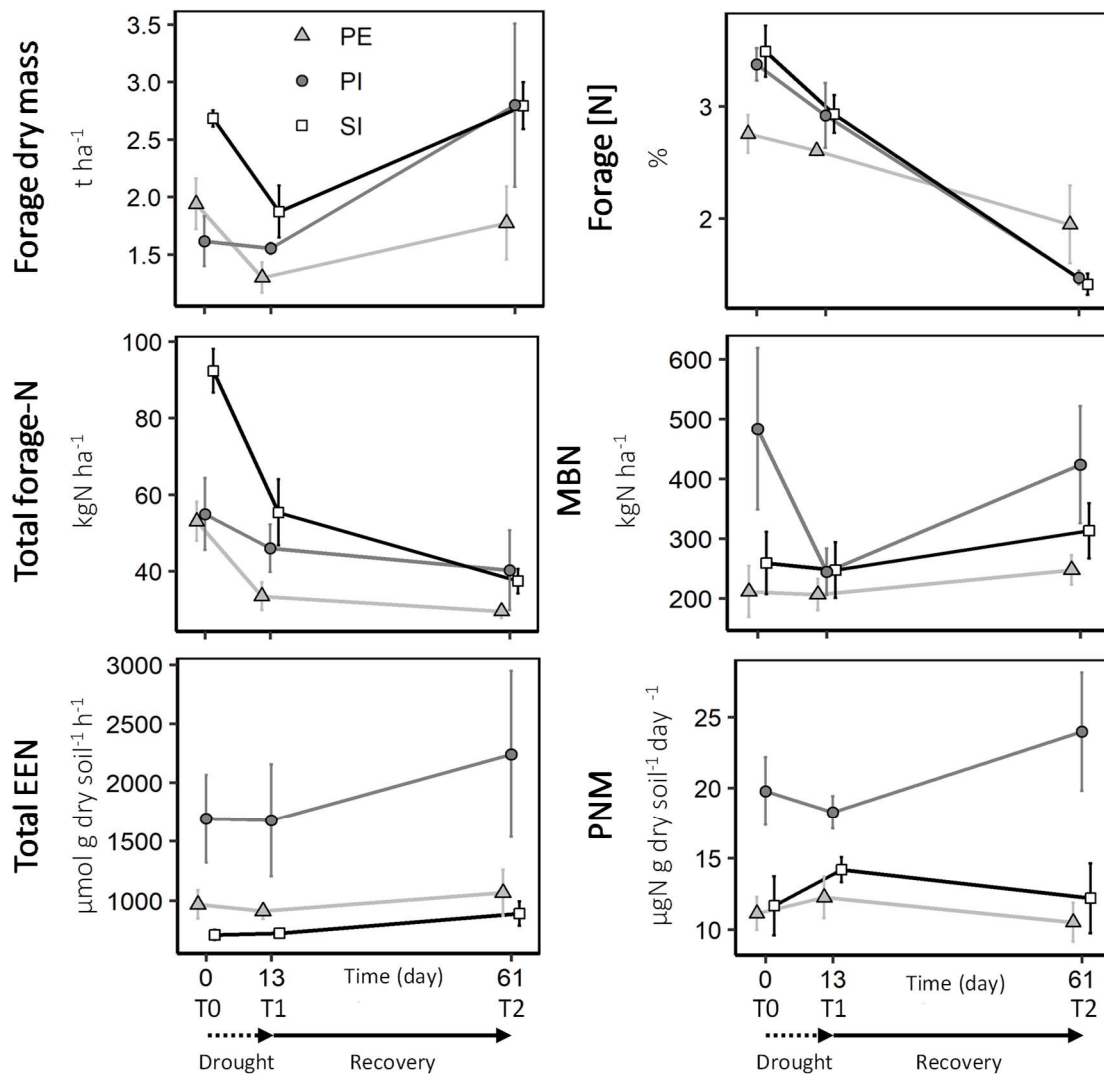

Figure 14 Mean value  $\pm$  standard error of ecosystem properties for the three grassland types (permanent extensive (PE,  $n=4$ ): light grey triangle, permanent intensive (PI,  $n=3$ ): dark grey circles, sown intensive (SI,  $n=5$ ): white squares) at the three sampling times: T0: before drought, T1: at the end of drought, T2: after recovery. Points have been jittered within each sampling time to facilitate comparisons among grassland types. Forage [N]=Forage N concentration, MBN=Microbial biomass-N, Total EEN=Extracellular enzyme activities degrading N rich substrates per gram of dry soil, PNM=Potential N mineralization per gram of dry soil.

### 3.2 COVARIATION AMONG MANAGEMENT INTENSITY, SOIL ABIOTIC PROPERTIES, PLANT AND MICROBIAL CWM TRAITS, INITIAL LEVEL AND RESILIENCE OF ECOSYSTEM PROPERTIES

Multi-table analysis showed that management intensity, soil abiotic properties, plant CWM traits, soil microbial CWM traits, initial ecosystem properties and ecosystem resilience variables were significantly related (simulated  $p$ -values  $< 0.01$ ) with RV coefficients ranging between 0.154 and 0.607 (Table 2). The first and second MCOA axes explained respectively 54 and 20% of the covariance among the 5 tables (Figure 15).

The first axis of the MCOA, was mostly related to a land use intensity (LUI) and grazing intensity gradient (Figure 15.A). This first MCOA axis also represented a gradient in soil organic matter and nutrient contents, increasing total soil C, total soil N, SOM, pH,  $\text{NO}_3$ ,  $\text{PO}_4$  and DOP and decreasing soil stoichiometric ratios (C:N, TDN:TDP) along this axis (Figure 15.B). Along this soil nutrient gradient, litter P concentration increased (low litter C:P and N:P), while litter C and community leaf dry matter content (LDMC) decreased (Figure 15.C). Next, microbial biomass N:P and mass-specific enzymes activity (EEA:MBN) decreased along this soil and plant quality gradient. Ecoenzymatic ratios indicated that the microbial resource acquisition strategy was oriented toward P acquisition (low EEC:EEP and EEN:EEP) in soils with low nutrients and P-poor and C-rich litter, and shifted to C acquisition and N acquisition in opposite conditions. Finally, initial ecosystem properties were also

related to the soil nutrient gradient with higher microbial biomass-N and activities (Total EEN, PNM) and lower root and total forage biomass-N in nutrient rich soils (Figure 15.E). Microbial-N resistance decreased along this gradient of soil nutrients, while microbial-N recovery and total forage-N resistance increased (Figure 15.F). To sum up, the first MCOA axis discriminated permanent intensive (PI) grasslands from extensive (PE) and sown (SI) grasslands. The permanent intensive grasslands were characterized by (1) more soil nutrients; (2) higher microbial biomass, microbial communities with a resource acquisition oriented toward C and N acquisition, with low mass-specific enzymes activity and biomass N:P; (3) plants with low LDMC and litter C concentration and high P concentration; (4) high forage quantity resistance and microbial recovery but low microbial resistance (Figure 15.A & F).

The second axis of the MCOA revealed a gradient of management intensity, mostly related with increasing mowing and ploughing intensity (Figure 15.A). Plant CWM traits were strongly correlated to this axis while a weaker correlation was observed for soil abiotic and microbial properties. Plant community varied from short plants with low LNC and high root:shoot ratio providing low total forage-N biomass, N poor forage and litter (high litter C:N) in extensive grasslands with low mowing and ploughing intensity (Figure 12, 4), to the opposite CWM traits in sown grasslands (Figure 15.A & C). Along this axis, total forage-N recovery decreased Figure 15 .E & F). Permanent intensive grasslands occupied an intermediate position on this axis.

*Table 2 Overall correlation among management intensity, abiotic soil properties, plant CWM traits, microbial CWM traits, initial ecosystem properties and ecosystem property resilience. Simulated  $p$ -values (bottom left part of the table) and RV coefficients (up-right part of the table) between each tables used in the MCOA. \*\*\*: simulated  $p$ -value  $< 0.001$ , \*\*: simulated  $p$ -value  $< 0.01$ . CWM=Community weighted mean traits, EP=Ecosystem properties*

	Management	Abiotic soil	Plant CWM	Microbial CWM	Initial EP	EP resilience
Management	-	0.154	0.31	0.226	0.303	0.21
Abiotic soil	**	-	0.363	0.445	0.516	0.607
Plant CWM	***	***	-	0.328	0.398	0.442
Microbial CWM	***	***	***	-	0.493	0.357
Initial EP	***	***	***	***	-	0.51
EP resilience	***	***	***	***	***	-

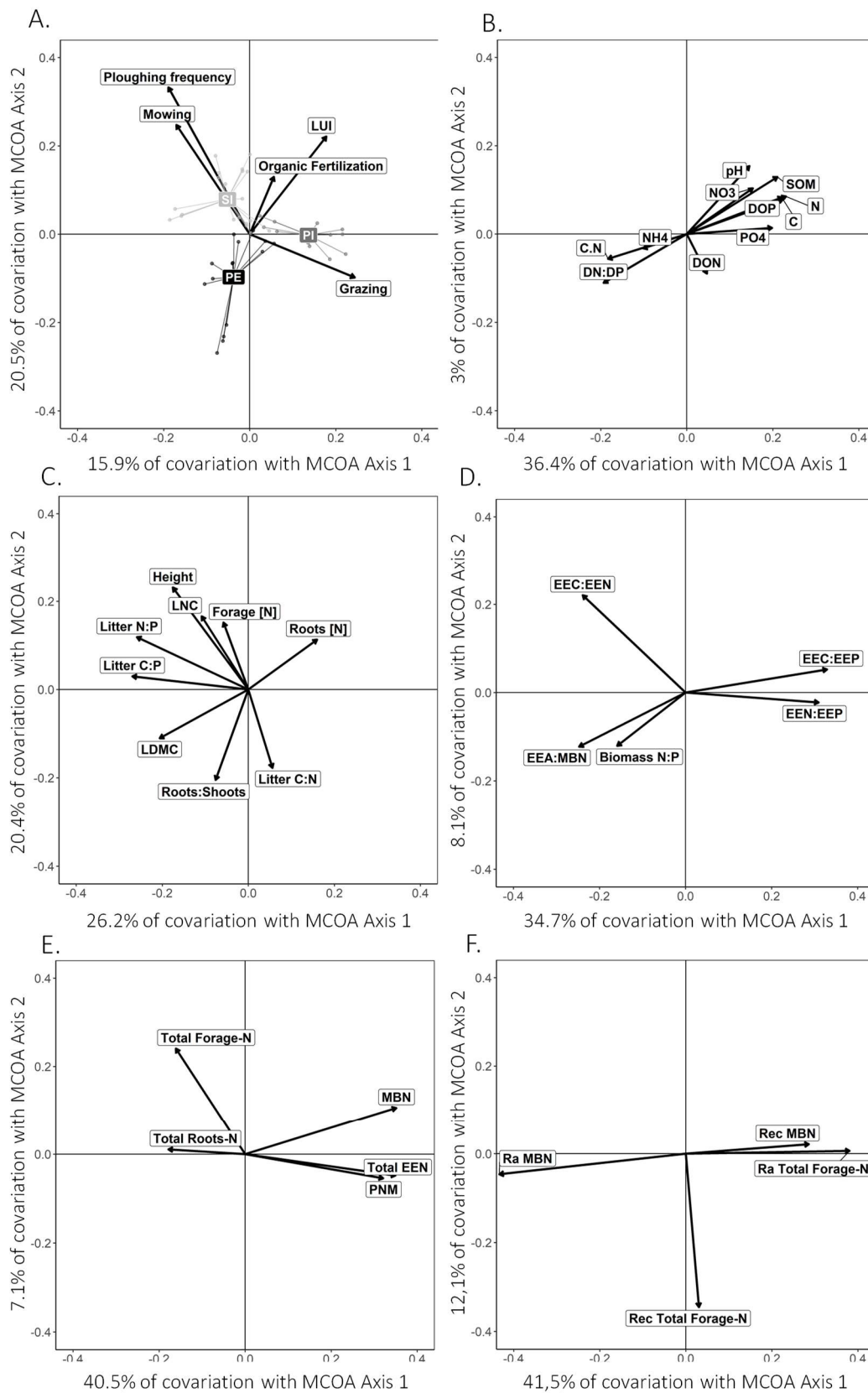

Figure 15 Results of MCOA performed on management intensity indices (A), soil abiotic properties (B), plant CWM traits (C), soil microbial CWM traits (D), initial ecosystem properties (E), ecosystem properties resistance and recovery (Continued on next page)

Figure 15. (Continued from previous page)  $R_a$  = Resistance index, and  $R_{ec}$  = recovery index. Resistance and recovery indices are presented only for properties significantly modified in at least in one grassland type during resistance or recovery ( $F$ ). Each of those 6 sets of variables is projected on the first two axes of the common structure from the MCOA. The arrow lengths represent the contribution of variables to the common structure. Sample scores (dots) and average grassland type scores (PE: Permanent extensive, PI: Permanent Intensive, SI: Sown intensive) are also represented on the first two axes of the common structure (A). RV-coefficient and p-values for the relationships between each tables are presented in Table 2.

### 3.3 STRUCTURAL EQUATION MODEL

SEMs containing all potential paths of the *a priori* model were accepted for Initial MBN ( $C_2 = 2.725$ ,  $p=0.256$ ), MBN Resistance ( $C_2 = 2.166$ ,  $p=0.898$ ) and MBN recovery ( $C_2 = 0.732$ ,  $p=0.694$ ), confirming that management modified soil nutrients and plant CWM traits, which in turn affected proxies of microbial CWM traits and microbial community resilience (Figure 13). Model simplification process led to a large model improvement for Initial MBN (delta BIC = -12.29), MBN Resistance (delta BIC = -11.13) and MBN Recovery (delta BIC = -22.091). Final SEMs depicted two pathways from management to microbial community resilience in the retained structure (full and dashed arrows on Figure 13). The first pathway (full arrows, Figure 13) acted independently of plant CWM traits, and showed that higher soil-N in permanent intensive grasslands increased initial microbial-N (Figure 13.B), decreased microbial-N resistance (Figure 13.C) and increased microbial-N recovery (Figure 13.D). These effects were direct effects, complemented by an indirect effect through mass-specific EEA, which decreased in N-rich soil and decreased initial microbial-N, increased microbial-N resistance and decreased microbial-N recovery. The second pathway (dashed arrows, Figure 13) operated through plant CWM traits, especially community LDMC responses. Intensive management of permanent grasslands decreased LDMC both directly and indirectly through its positive effect on soil-N. Decreased LDMC subsequently led to an increase of microbial biomass N:P, a decrease of initial microbial-N (Figure 13.B) and an increase of microbial-N resistance (Figure 13.C).

## 4 DISCUSSION

Trait-based approaches provide a framework to understand mechanisms involved in the cascading effect of management intensity on ecosystem functioning and its resilience to drought (Lavorel and Garnier 2002). In this study, we used microbial mass-specific enzymes activity as well as biomass and enzyme stoichiometry as proxies of microbial community-weighted mean (CWM) traits to describe microbial resource use strategies along a coupled gradient of plant CWM traits and soil nutrients availability with cascading effects on ecosystem resilience.

### 4.1 GRASSLAND MANAGEMENT INTENSITY INDIRECTLY DRIVES SOIL MICROBIAL CWM TRAITS THROUGH SOIL NUTRIENTS AND PLANT CWM TRAITS

Our first hypothesis was confirmed by our results, showing an influence of management intensity on the selection of microbial CWM traits through its effects on soil nutrients and plant CWM traits. A global shift in microbial strategies from an oligotrophic to a copiotrophic strategy occurred along the soil nutrient gradient and associated conservative-exploitative plant traits continuum (Figure 15), with nutrient-poor soils (low SOM and nutrient content) being associated with conservative plant communities (high LDMC, high litter C and low litter P concentration) and favouring microbial communities with high mass-specific extracellular enzymes activity and high biomass N:P ratio. These microbial CWM indicated a strategy oriented toward cellular maintenance and resource acquisition machinery (oligotrophic type) rather than growth (Fontaine et al. 2003, Arrigo 2004, Karpinets et al. 2006). Conversely, microbial communities in nutrient-rich soils with



exploitative plant communities had a lower investment in extracellular enzymes and a high P content, suggesting high ribosomal RNA content and faster growth rates coherent with a copiotrophic growth-oriented strategy (Elser et al. 2003, Karpinets et al. 2006). Along this gradient, ecoenzymatic ratios revealed a shift from C and N acquisition in copiotrophic communities in SOM and nutrient rich soils to P acquisition in oligotrophic communities in SOM poor and nutrient-limited soils (Figure 15). Ecoenzymatic stoichiometry was inversely correlated with soil and litter stoichiometry, supporting the resource allocation model which states that soil microbes invest in the production of enzymes that target the most limiting element (Sinsabaugh et al. 1993). These results suggest that it is possible to relate ecoenzymatic theory (Sinsabaugh et al. 2009) to the copiotrophic-oligotrophic continuum (Fierer et al. 2007) and indicate a central role of P limitation in the selection of microbial strategies along this continuum.

The SEM revealed that management drives microbial strategies through both soil and plant CWM trait modifications (Figure 13). The observed decrease in mass-specific enzymes activity with soil N content was in line with previous studies conducted along a 120 000-year-old soil development chronosequence in New Zealand (Allison et al. 2007), and across a large land use gradient in Britain (Malik et al. 2019). These results support the hypothesis that copiotrophs in nutrient-rich soils invest less in the production of extracellular enzymes to acquire C and other nutrients from complex organic molecules (Fontaine et al. 2003). While mass-specific enzymes activity was directly affected by soil N, microbial biomass N:P was indirectly driven by a decrease in plant LDMC in N rich soil. This plant trait underpins litter decomposability (Quested et al. 2007, Fortunel et al. 2009), which suggests an effect of litter quality, and potentially of associated root traits (Legay et al. 2014, De Vries and Bardgett 2016, Ren et al. 2017) on the stoichiometry of soil microorganisms (Fanin et al. 2014, Fanin and Bertrand 2016). Litter P concentration was highly negatively related with LDMC in our study (Figure 15.C) and might also have played a role in the effect of plant traits on microbial biomass N:P ratio. This

would be consistent with previous studies reporting a dominance of bacteria (with a more copiotrophic strategy in comparison with fungi) associated with P-rich plants (Güsewell and Gessner 2009, Boeddinghaus et al. 2019). Overall, our results support our first hypothesis, stating that nutrient poor soils and associated conservative plants select for soil microbial communities with an oligotrophic strategy characterized by a high extracellular and intracellular resource acquisition machinery, while nutrient rich soils and associated exploitative plant traits select for microbial communities with a growth-oriented copiotrophic strategy. Further, our results stress the relevance of using proxies of CWM traits in complement of other microbial community properties to depict the microbial economic spectrum and to understand the role of microbial ecophysiology in ecosystem functioning (Steinweg et al. 2014).

#### 4.2 CASCADING EFFECTS OF PLANT AND MICROBIAL COMMUNITY-WEIGHTED MEAN TRAITS ON ECOSYSTEM FUNCTIONING AND RESILIENCE

Trait responses to environment can cascade to ecosystem functioning (Lavorel and Garnier 2002). Focusing on microbial biomass-N as a central ecosystem property, our results confirmed the hypothesis (H2) that plant and microbial CWM traits selection by soil and management gradients feeds forward to ecosystem resilience. Soil-N was the main direct driver of microbial biomass-N before drought, but its influence also involved indirect paths through plant and microbial CWM traits. Firstly, a low LDMC characterizing exploitative plant communities in N rich soil was associated with greater microbial biomass-N likely due to higher litter quality (Fanin et al. 2014, Fanin and Bertrand 2016). Secondly, greater investment in extracellular enzymes by microbes to cope with low resource availability reduced microbial biomass-N build up. This negative effect of oligotrophic traits on microbial biomass-N could be explained by the high N cost of enzyme production (Frankena et al. 1988, Allison et al. 2010). Total extracellular enzymes activity (per gram of soil) increased along soil nutrient and microbial biomass gradients and was associated with a shift toward a copiotrophic strategy and exploitative P-

rich plants, consistent with previous results along a similar LUI gradient (Boeddinghaus et al. 2019). Using mass-specific activity gave us a better understanding of the relative contribution of microbial traits and biomass to variations in total enzymes activity (Allison et al. 2007). The high total activity in nutrient rich soils was more related to a high microbial biomass than to the CWM traits of its copiotrophic community producing fewer enzymes. Conversely, high investment in extracellular enzymes in nutrient poor soil compensated the impact of a reduced microbial biomass on total enzymatic activities.

The final objective of our study was to assess how the selection of plant and microbial CWM traits along a management intensity gradient could influence ecosystem resilience to drought. As expected, lower resistance but higher recovery of microbial biomass and activities were found in nutrient-rich permanent intensive grasslands associated with exploitative plants and copiotrophic microbes (Figure 13, 14, 15). The SEM confirmed our hypothesis on the influence of microbial CWM traits on microbial resistance and recovery (Figure 13). A high investment in extracellular enzymes enabled oligotrophic microbes to cope with decreased nutrient availability during dry periods while decreasing their recovery ability. While dry conditions result in an osmotic stress for soil microorganisms, they also increase their physiological stress by limiting nutrient access (Schimel et al. 2007). The maintenance of active extracellular enzymes in their close proximity might enable microorganisms to conserve access to labile organic-N during drought periods. High mass-specific enzymes activity and stress resistance were recently proposed by Malik et al. (2018) as distinct microbial strategies in a framework similar to the Grime's competitor-stress tolerator-ruderal framework (Grime 1977). Our results further suggest that high mass-specific enzymes activity might also confer resistance to stress such as a short drought. Moreover, an acceleration of N-cycling processes was observed at the end of the recovery period, particularly in permanent intensive grasslands characterized by copiotrophic microbial communities (Figure 14). Overall, these responses of microbial biomass and activities support our hypothesis 2 of a trade-off

between resistance and recovery along the oligotroph-copiotroph continuum (Pimm 1984, De Vries et al. 2012a, De Vries and Shade 2014). However, the decrease in microbial biomass-N during drought in permanent intensive grasslands was not associated with a change in soil N processes, which remained stable (Figure 14). This suggests that the resistant part of microbial communities maintained N-cycling levels through higher activity per unit of biomass (selection of oligotrophic microbes during drought) or that slow enzymes turnover in dry conditions maintained enzyme activity after the death of their producers (Steinweg et al. 2012, Kivlin et al. 2013).

These results are in line with studies inferring the copiotroph-oligotroph continuum based on microbial community composition with indicators such as the Gram+: Gram- ratio (e.g. Fanin et al. 2015) or the relative abundances of *Acidobacteria* as oligotrophic taxa and *Proteobacteria* and *Bacteroidetes* as copiotrophs (e.g. Fierer et al. 2012). Nevertheless, we argue that proxies of microbial CWM traits such as mass-specific activity and microbial biomass and ecoenzymatic stoichiometry provide added value. Being both response and effect traits, they directly reflect modifications in microbial resource utilization strategy with potential implications for ecosystem functioning, a quality that microbial community composition indicators do not have. However, CWM traits inform on the average strategy of the microbial community and only address mass ratio effects under the hypothesis that ecosystem functioning is determined by trait values of the dominant contributors to the community biomass (Grime 1998, Diaz et al. 2007), without accessing to the composition, diversity, or inter- and intraspecific trait variation within communities. Further studies need to explore the relative contribution of species turnover and phenotypic plasticity on CWM traits responses. Cross-fertilization between approaches characterizing microbial CWM traits, community composition (e.g. PLFA, DNA metabarcoding) and/or traits variations across microbial taxa (e.g. functional screening, quantitative stable isotope probing Lladó et al. 2016, Morrissey et al. 2019) are encouraged to advance our understanding of

mechanisms underpinning functional variations observed at the community-level.

#### 4.3 TRADE-OFF BETWEEN PLANT AND MICROBIAL RESISTANCE, AND CONSEQUENCES FOR ECOSYSTEM SERVICES

Soil microbial communities are essential for plant-N provisioning (Van Der Heijden et al. 2008), and their responses to climatic stress can have strong implications for plant nutrition and related ecosystem services. Higher resistance of total forage-N in permanent intensive grasslands was mainly explained by a higher resistance of forage biomass but not by a better forage-N content stability. The higher N availability and microbial activity in these grasslands might have helped plants to access the N sustaining their growth during the drought. Moreover, microbial biomass-N strongly decreased in permanent intensive grasslands releasing available N and potentially decreasing microbial competitive ability, while N-cycling activities remained stable. These conditions could have been beneficial for plant N provisioning, explaining the better resistance observed. This trade-off between plant and microbial resistance was already observed in previous studies implying drought legacy effects (Legay et al. 2017) or not (Bloor et al. 2018). Interestingly, Bloor et al. (2018) also observed higher plant resistance in nutrient rich soil while higher microbial resistance was observed in nutrient poor soils. Finally, we confirmed that conservative plant communities of extensive grasslands had higher forage-N content stability than intensive grasslands (Figure 14), consistent with their known dynamics of fodder quality across the growing season (Michaud et al. 2012) and with their higher drought resistance (Ingrisch et al. 2018, Stampfli et al. 2018).

Trade-offs in microbial strategies and their influence on microbial and plant resistance have important implications for ecosystem service supply and land management. We observed that permanent intensive grasslands dominated by exploitative plants associated with copiotrophic microbial communities were able to maintain forage-N provisioning during

drought. This occurred at the expense of a low microbial-N resistance but with no long lasting effect on soil fertility since microbial abundance and activity completely recovered after 48 days. Species-rich extensive grasslands (Loucougaray et al. 2015), dominated by oligotrophic microbes and conservative plants provided highly stable forage quality. Finally, while sown grasslands showed initially the highest capacity to provide forage services, this advantage was lost under drought conditions due to the lower resistance of their plant communities. Consequently, our results suggest that while sown grasslands may be more productive under favourable climate, permanent grasslands may optimize forage provisioning stability during extreme climatic events. Cole et al. (2019) came to similar conclusions for grassland restoration, demonstrating that management practices increasing agricultural yields trade-off with ecosystem stability. Thus, under current climate change context, a mosaic of permanent extensive and intensive grasslands should be favoured to optimize ecosystem services such as C storage, N retention, forage resilience, biodiversity maintenance and landscape cultural value (Andrieu et al. 2007, Loucougaray et al. 2015, Gos et al. 2016, Duru et al. 2019).

## 5 CONCLUSION

Using proxies of microbial CWM traits, our approach identified important trade-offs in microbial community strategies along inter-related management, soil and plant CWM trait gradients. High soil nutrient levels with exploitative plants in permanent intensive grasslands selected for microbial communities with CWM traits indicating a copiotrophic strategy, while nutrient poor soils with conservative vegetation favoured microbial communities with an oligotrophic strategy. Furthermore, we found that these variations in microbial CWM traits had important implications for ecosystem resilience. Copiotrophic microbial communities showed low resistance but high recovery to a drought event favouring plant resistance, while oligotrophic communities presented the opposite pattern. By depicting the cascading effects of grassland management on ecosystem resilience through plant and microbial

CWM traits, our study demonstrates the importance of including microbial communities in the response-effect trait framework for a better understanding of mechanisms driving grassland ecosystem response to global changes.

#### ACKNOWLEDGMENTS

This work was funded by ECO-SERVE project through the 2013–2014 BiodivERsA/FACCE-JPI joint call for research proposals, with the national funders ANR, NWO, FCT (BiodivERsA/001/2014), MINECO, FORMAS, and SNSF. This research was conducted at the Long-Term Socio-Ecological Research (LTSER) Zone Atelier Alpes, a member of the eLTER-Europe network. The authors would like to thank the owners of the different farms from where mesocosms have been extracted, Dana Mang for her help in sampling and laboratory analyses and Lionel Bernard for his R scripts used for the plots of this manuscript.

#### AUTHORS' CONTRIBUTIONS

G.P., N.L., J-C.C., A.F. conceived the idea and designed the experiment, G.P. conducted the experiment, G.P., N.L., C.A., J-C.C. and A.F. conducted sampling and laboratory analyses, G.P. analysed the data and led the writing of the manuscript. All authors contributed critically to the drafts and gave final approval for publication.

#### DATA ACCESSIBILITY

Data will be uploaded on Dryad Digital Repository.

#### CONFLICT OF INTEREST STATEMENT

The authors declare that the research was conducted in the absence of any commercial or financial relationships that could be construed as a potential conflict of interest.

## REFERENCES

- Allison, S. 2012. A trait-based approach for modelling microbial litter decomposition. *Ecology letters* 15:1058–1070.
- Allison, S. D., M. N. Weintraub, T. B. Gartner, and M. P. Waldrop. 2010. Evolutionary-economic principles as regulators of soil enzyme production and ecosystem function. Pages 229–243 *Soil enzymology*. Springer.
- Allison, V., L. Condron, D. Peltzer, S. Richardson, and B. Turner. 2007. Changes in enzyme activities and soil microbial community composition along carbon and nutrient gradients at the Franz Josef chronosequence, New Zealand. *Soil Biology and Biochemistry* 39:1770–1781.
- Andrieu, N., E. Josien, and M. Duru. 2007. Relationships between diversity of grassland vegetation, field characteristics and land use management practices assessed at the farm level. *Agriculture, ecosystems & environment* 120:359–369.
- Arrigo, K. R. 2004. Marine microorganisms and global nutrient cycles. *Nature* 437:349.
- Bady, P., S. Dolédec, B. Dumont, and J.-F. Fruget. 2004. Multiple co-inertia analysis: a tool for assessing synchrony in the temporal variability of aquatic communities. *Comptes Rendus Biologies* 327:29–36.
- Bardgett, R. D. 2018. Plant trait-based approaches for interrogating belowground function. *Biology and Environment: Proceedings of the Royal Irish Academy*. JSTOR.
- Bell, C. W., B. E. Fricks, J. D. Rocca, J. M. Steinweg, S. K. McMahon, and M. D. Wallenstein. 2013. High-throughput fluorometric measurement of potential soil extracellular enzyme activities. *Journal of visualized experiments: JoVE*.
- Beniston, M. 2015. Ratios of record high to record low temperatures in Europe exhibit sharp increases since 2000 despite a slowdown in the rise of mean temperatures. *Climatic Change* 129:225–237.
- Bloor, J. M., M. Zwicke, and C. Picon-Cochard. 2018. Drought responses of root biomass provide an indicator of soil microbial drought resistance in grass monocultures. *Applied Soil Ecology* 126:160–164.
- Blüthgen, N., C. F. Dormann, D. Prati, V. H. Klaus, T. Kleinebecker, N. Hölzel, F. Alt, S. Boch, S. Gockel, A. Hemp, and others. 2012. A quantitative index of land-use intensity in grasslands: integrating mowing, grazing and fertilization. *Basic and Applied Ecology* 13:207–220.

- Boeddinghaus, R. S., S. Marhan, D. Berner, S. Boch, M. Fischer, N. Hölzel, J. Kattge, V. H. Klaus, T. Kleinebecker, Y. Oelmann, and others. 2019. Plant functional trait shifts explain concurrent changes in the structure and function of grassland soil microbial communities. *Journal of Ecology*.
- Brunner, S. H., R. Huber, and A. Grêt-Regamey. 2016. A backcasting approach for matching regional ecosystem services supply and demand. *Environmental Modelling & Software* 75:439–458.
- Casanoves, F., L. Pla, J. A. Di Rienzo, and S. Diaz. 2011. FDiversity: a software package for the integrated analysis of functional diversity. *Methods in Ecology and Evolution* 2:233–237.
- Chessel, D., and M. Hanafi. 1996. Analyses de la co-inertie de K nuages de points. *Revue de statistique appliquée* 44:35–60.
- Cole, A. J., R. I. Griffiths, S. E. Ward, J. Whitaker, N. J. Ostle, and R. D. Bardgett. 2019. Grassland biodiversity restoration increases resistance of carbon fluxes to drought. *Journal of Applied Ecology*.
- De Vries, F. T., and R. D. Bardgett. 2012. Plant-microbial linkages and ecosystem nitrogen retention: lessons for sustainable agriculture. *Frontiers in Ecology and the Environment* 10:425–432.
- De Vries, F. T., and R. D. Bardgett. 2016. Plant community controls on short-term ecosystem nitrogen retention. *New Phytologist* 210:861–874.
- De Vries, F. T., C. Brown, and C. J. Stevens. 2016. Grassland species root response to drought: consequences for soil carbon and nitrogen availability. *Plant and Soil*:1–16.
- De Vries, F. T., M. E. Liiri, L. Björnlund, M. A. Bowker, S. Christensen, H. M. Setälä, and R. D. Bardgett. 2012a. Land use alters the resistance and resilience of soil food webs to drought. *Nature Climate Change* 2:276–280.
- De Vries, F. T., P. Manning, J. R. Tallwin, S. R. Mortimer, E. S. Pilgrim, K. A. Harrison, P. J. Hobbs, H. Quirk, B. Shipley, J. H. Cornelissen, and others. 2012b. Abiotic drivers and plant traits explain landscape-scale patterns in soil microbial communities. *Ecology Letters* 15:1230–1239.
- De Vries, F. T., and A. Shade. 2014. Controls on soil microbial community stability under climate change. *The Microbial Regulation of Global Biogeochemical Cycles*:132.
- Diacono, M., and F. Montemurro. 2011. Long-term effects of organic amendments on soil fertility. Pages 761–786 *Sustainable Agriculture Volume 2*. Springer.
- Dobremez, L., C. Chazoule, G. Loucougaray, Y. Pauthenet, B. Nottier, S. Lavorel, S. Madelrieux, A. Doré, and P. Fleury. 2015. Débats et controverses sur l'intensification fourragère dans le Vercors: quelles pratiques, quelles conceptions en jeu? *Fourrages* 221:33–45.
- Dray, S., A. B. Dufour, and D. Chessel. 2007. The ade4 package-II: Two-table and K-table methods. *R news* 7:47–52.
- Duru, M., C. Jouany, X. Le Roux, M. Navas, and P. Cruz. 2013. From a conceptual framework to an operational approach for managing grassland functional diversity to obtain targeted ecosystem services: Case studies from French mountains. *Renew Agric Food Syst* 29:239–254.
- Duru, M., L. Pontes, J. Schellberg, J. P. Theau, and O. Therond. 2019. Grassland functional diversity and management for enhancing ecosystem services and reducing environmental impacts: A cross-scale analysis. Pages 211–230 *Agroecosystem Diversity*. Elsevier.
- Diaz, S., S. Lavorel, F. de Bello, F. Quétier, K. Grigulis, and T. M. Robson. 2007. Incorporating plant functional diversity effects in ecosystem service assessments. *Proceedings of the National Academy of Sciences* 104:20684–20689.
- Elser, J., K. Acharya, M. Kyle, J. Cotner, W. Makino, T. Markow, T. Watts, S. Hobbie, W. Fagan, J. Schade, and others. 2003. Growth rate–stoichiometry couplings in diverse biota. *Ecology Letters* 6:936–943.
- Fanin, N., and I. Bertrand. 2016. Aboveground litter quality is a better predictor than belowground microbial communities when estimating carbon mineralization along a land-use gradient. *Soil Biology and Biochemistry* 94:48–60.
- Fanin, N., S. Hättenschwiler, and N. Fromin. 2014. Litter fingerprint on microbial biomass, activity, and community structure in the underlying soil. *Plant and Soil* 379:79–91.
- Fanin, N., S. Hättenschwiler, H. Schimann, and N. Fromin. 2015. Interactive effects of C, N and P fertilization on soil microbial community structure and function in an Amazonian rain forest. *Functional Ecology* 29:140–150.
- Fierer, N., M. A. Bradford, and R. B. Jackson. 2007. Toward an ecological classification of soil bacteria. *Ecology* 88:1354–1364.
- Fierer, N., C. L. Lauber, K. S. Ramirez, J. Zaneveld, M. A. Bradford, and R. Knight. 2012. Comparative metagenomic, phylogenetic and physiological

- analyses of soil microbial communities across nitrogen gradients. *The ISME journal* 6:1007–1017.
- Fontaine, S., A. Mariotti, and L. Abbadie. 2003. The priming effect of organic matter: a question of microbial competition? *Soil Biology and Biochemistry* 35:837–843.
- Fontana, V., A. Radtke, V. B. Fedrigotti, U. Tappeiner, E. Tasser, S. Zerbe, and T. Buchholz. 2013. Comparing land-use alternatives: Using the ecosystem services concept to define a multi-criteria decision analysis. *Ecological Economics* 93:128–136.
- Fortunel, C., E. Garnier, R. Joffre, E. Kazakou, H. Quested, K. Grigulis, S. Lavorel, P. Ansquer, H. Castro, P. Cruz, and others. 2009. Leaf traits capture the effects of land use changes and climate on litter decomposability of grasslands across Europe. *Ecology* 90:598–611.
- Foulquier, A., F. Malard, F. Mermillod-Blondin, B. Montuelle, S. Dolédec, B. Volat, and J. Gibert. 2011. Surface water linkages regulate trophic interactions in a groundwater food web. *Ecosystems* 14:1339–1353.
- Frankena, J., H. Van Verseveld, and A. Stouthamer. 1988. Substrate and energy costs of the production of exocellular enzymes by *Bacillus licheniformis*. *Biotechnology and bioengineering* 32:803–812.
- García-Palacios, P., R. Milla, M. Delgado-Baquerizo, N. Martín-Robles, M. Álvaro-Sánchez, and D. H. Wall. 2013. Side-effects of plant domestication: ecosystem impacts of changes in litter quality. *New Phytologist* 198:504–513.
- Gardarin, A., É. Garnier, P. Carrère, P. Cruz, D. Andueza, A. Bonis, M.-P. Colace, B. Dumont, M. Duru, A. Farruggia, and others. 2014. Plant trait–digestibility relationships across management and climate gradients in permanent grasslands. *Journal of Applied Ecology* 51:1207–1217.
- Garnier, E., J. Cortez, G. Billès, M.-L. Navas, C. Roumet, M. Debussche, G. Laurent, A. Blanchard, D. Aubry, A. Bellmann, and others. 2004. Plant functional markers capture ecosystem properties during secondary succession. *Ecology* 85:2630–2637.
- Garnier, E., S. Lavorel, P. Ansquer, H. Castro, P. Cruz, J. Dolezal, O. Eriksson, C. Fortunel, H. Freitas, C. Golodets, and others. 2006. Assessing the effects of land-use change on plant traits, communities and ecosystem functioning in grasslands: a standardized methodology and lessons from an application to 11 European sites. *Annals of botany* 99:967–985.
- Gattinger, A., A. Müller, M. Haeni, C. Skinner, A. Fliessbach, N. Buchmann, P. Mäder, M. Stolze, P. Smith, N. E.-H. Scialabba, and others. 2012. Enhanced top soil carbon stocks under organic farming. *Proceedings of the National Academy of Sciences* 109:18226–18231.
- Gaucherand, S., Lavorel, S., 2007. A new protocol for a quick survey of functional traits values in a plant community. *Austral Ecology* 32, 927–936.
- Gos, P., G. Loucougaray, M.-P. Colace, C. Arnoldi, S. Gaucherand, D. Dumazel, L. Girard, S. Delorme, and S. Lavorel. 2016. Relative contribution of soil, management and traits to co-variations of multiple ecosystem properties in grasslands. *Oecologia*:1–13.
- Gossner, M. M., T. M. Lewinsohn, T. Kahl, F. Grassein, S. Boch, D. Prati, K. Birkhofer, S. C. Renner, J. Sikorski, T. Wubet, and others. 2016. Land-use intensification causes multitrophic homogenization of grassland communities. *Nature* 540:266–269.
- Grace, J. B., S. M. Scheiner, and D. R. Schoolmaster Jr. 2015. Structural equation modeling: building and evaluating causal models: Chapter 8.
- Grigulis, K., S. Lavorel, U. Krainer, N. Legay, C. Baxendale, M. Dumont, E. Kastl, C. Arnoldi, R. D. Bardgett, F. Poly, and others. 2013. Relative contributions of plant traits and soil microbial properties to mountain grassland ecosystem services. *Journal of Ecology* 101:47–57.
- Grime, J. P. 1977. Evidence for the existence of three primary strategies in plants and its relevance to ecological and evolutionary theory. *The American Naturalist* 111:1169–1194.
- Güsewell, S., and M. O. Gessner. 2009. N: P ratios influence litter decomposition and colonization by fungi and bacteria in microcosms. *Functional Ecology* 23:211–219.
- Hertzog, L. R. 2018. How robust are Structural Equation Models to model miss-specification? A simulation study. *arXiv preprint arXiv:1803.06186*.
- Hinojosa, L., E. Tasser, J. Rüdiger, G. Leitinger, M. Schermer, E. F. Lambin, and U. Tappeiner. 2019. Geographical heterogeneity in mountain grasslands dynamics in the Austrian-Italian Tyrol region. *Applied Geography* 106:50–59.
- Ho, A., D. P. Di Lonardo, and P. L. Bodelier. 2017. Revisiting life strategy concepts in environmental microbial ecology. *FEMS microbiology ecology* 93:fix006.
- Hodgson, J., G. Montserrat-Martí, M. Charles, G. Jones, P. Wilson, B. Shipley, M. Sharafi, B. Cerabolini, J.

- Cornelissen, S. Band, and others. 2011. Is leaf dry matter content a better predictor of soil fertility than specific leaf area? *Annals of botany* 108:1337–1345.
- Ingrisch, J., S. Karlowisky, A. Anadon-Rosell, R. Hasibeder, A. König, A. Augusti, G. Gleixner, and M. Bahn. 2018. Land use alters the drought responses of productivity and CO<sub>2</sub> fluxes in mountain grassland. *Ecosystems* 21:689–703.
- Jenkinson, D. S., P. C. Brookes, and D. S. Powlson. 2004. Measuring soil microbial biomass. *Soil biology and biochemistry* 36:5–7.
- Karlowisky, S., A. Augusti, J. Ingrisch, R. Hasibeder, M. Lange, S. Lavorel, M. Bahn, and G. Gleixner. 2018. Land use in mountain grasslands alters drought response and recovery of carbon allocation and plant-microbial interactions. *Journal of Ecology* 106:1230–1243.
- Karpinets, T. V., D. J. Greenwood, C. E. Sams, and J. T. Ammons. 2006. RNA: protein ratio of the unicellular organism as a characteristic of phosphorous and nitrogen stoichiometry and of the cellular requirement of ribosomes for protein synthesis. *BMC biology* 4:30.
- Kivlin, S. N., B. G. Waring, C. Averill, and C. V. Hawkes. 2013. Tradeoffs in microbial carbon allocation may mediate soil carbon storage in future climates. *Frontiers in microbiology* 4, 261.
- Lavorel, S. 2013. Plant functional effects on ecosystem services. *Journal of Ecology* 101:4–8.
- Lavorel, S., and E. Garnier. 2002. Predicting changes in community composition and ecosystem functioning from plant traits: revisiting the Holy Grail. *Functional ecology* 16:545–556.
- Lavorel, S., and K. Grigulis. 2012. How fundamental plant functional trait relationships scale-up to trade-offs and synergies in ecosystem services. *Journal of Ecology* 100:128–140.
- Lavorel, S., K. Grigulis, P. Lamarque, M.-P. Colace, D. Garden, J. Girel, G. Pellet, and R. Douzet. 2011. Using plant functional traits to understand the landscape distribution of multiple ecosystem services. *Journal of Ecology* 99:135–147.
- Lavorel, S., K. Grigulis, G. Leitinger, M. Kohler, U. Schirpke, and U. Tappeiner. 2017. Historical trajectories in land use pattern and grassland ecosystem services in two European alpine landscapes. *Regional environmental change* 17:2251–2264.
- Lefcheck, J. S. 2016. piecewiseSEM: Piecewise structural equation modelling in r for ecology, evolution, and systematics. *Methods in Ecology and Evolution* 7:573–579.
- Leff, J. W., S. E. Jones, S. M. Prober, A. Barberán, E. T. Borer, J. L. Firn, W. S. Harpole, S. E. Hobbie, K. S. Hofmockel, J. M. Knops, and others. 2015. Consistent responses of soil microbial communities to elevated nutrient inputs in grasslands across the globe. *Proceedings of the National Academy of Sciences* 112:10967–10972.
- Legay, N., C. Baxendale, K. Grigulis, U. Krainer, E. Kastl, M. Schloter, R. D. Bardgett, C. Arnoldi, M. Bahn, M. Dumont, and others. 2014. Contribution of above-and below-ground plant traits to the structure and function of grassland soil microbial communities. *Annals of botany* 114:1011–1021.
- Legay, N., S. Lavorel, C. Baxendale, U. Krainer, M. Bahn, M.-N. Binet, A. A. Cantarel, M.-P. Colace, A. Foulquier, E.-M. Kastl, and others. 2016. Influence of plant traits, soil microbial properties, and abiotic parameters on nitrogen turnover of grassland ecosystems. *Ecosphere* 7.
- Legay, N., G. Piton, C. Arnoldi, L. Bernard, M.-N. Binet, B. Mouhamadou, T. Pommier, S. Lavorel, A. Foulquier, and J.-C. Clément. 2017. Soil legacy effects of climatic stress, management and plant functional composition on microbial communities influence the response of *Lolium perenne* to a new drought event. *Plant and Soil*:1–22.
- Lemaire, G., and A. Pflimlin. 2007. Les sécheresses passées et à venir: quels impacts et quelles adaptations pour les systèmes fourragers? *Fourrages* 190:163–180.
- Lemaire, G., R. Wilkins, and J. Hodgson. 2005. Challenges for grassland science: managing research priorities. *Agriculture, Ecosystems & Environment* 108:99–108.
- Lladó, S., L. Žifčáková, T. Vetrovsk, I. Eichlerová, and P. Baldrian. 2016. Functional screening of abundant bacteria from acidic forest soil indicates the metabolic potential of *Acidobacteria* subdivision 1 for polysaccharide decomposition. *Biology and fertility of soils* 52:251–260.
- Loucougaray, G., L. Dobremez, P. Gos, Y. Pauthenet, B. Nettié, and S. Lavorel. 2015. Assessing the effects of grassland management on forage production and environmental quality to identify paths to ecological intensification in mountain grasslands. *Environmental management* 56:1039–1052.
- Mackie, K. A., M. Zeiter, J. M. Bloor, and A. Stampfli. 2019. Plant functional groups mediate drought resistance

- and recovery in a multisite grassland experiment. *Journal of Ecology* 107:937–949.
- Malik, A. A., J. Puissant, T. Goodall, S. D. Allison, and R. I. Griffiths. 2019. Soil microbial communities with greater investment in resource acquisition have lower growth yield. *Soil Biology and Biochemistry*.
- Martiny, J. B., S. E. Jones, J. T. Lennon, and A. C. Martiny. 2015. Microbiomes in light of traits: a phylogenetic perspective. *Science* 350:aac9323.
- Michaud, A., D. Andueza, F. Picard, S. Plantureux, and R. Baumont. 2012. Seasonal dynamics of biomass production and herbage quality of three grasslands with contrasting functional compositions. *Grass and Forage Science* 67:64–76.
- Moorhead, D. L., R. L. Sinsabaugh, B. H. Hill, and M. N. Weintraub. 2016. Vector analysis of coenzyme activities reveal constraints on coupled C, N and P dynamics. *Soil Biology and Biochemistry* 93:1–7.
- Mooshammer, M., W. Wanek, S. Zechmeister-Boltenstern, and A. Richter. 2014. Stoichiometric imbalances between terrestrial decomposer communities and their resources: mechanisms and implications of microbial adaptations to their resources. *The Microbial Regulation of Global Biogeochemical Cycles*:191.
- Morrissey, E. M., R. L. Mau, M. Hayer, X.-J. A. Liu, E. Schwartz, P. Dijkstra, B. J. Koch, K. Allen, S. J. Blazewicz, K. Hofmockel, and others. 2019. Evolutionary history constrains microbial traits across environmental variation. *Nature ecology & evolution*:1.
- Oksanen, J., F. G. Blanchet, R. Kindt, P. Legendre, P. R. Minchin, R. O'hara, G. L. Simpson, P. Solymos, M. H. H. Stevens, and H. Wagner. 2011. *vegan*: Community ecology package. R package version:117–118.
- Orwin, K. H., S. M. Buckland, D. Johnson, B. L. Turner, S. Smart, S. Oakley, and R. D. Bardgett. 2010. Linkages of plant traits to soil properties and the functioning of temperate grassland. *Journal of Ecology* 98:1074–1083.
- Perez-Harguindeguy, N., S. Diaz, E. Garnier, S. Lavorel, H. Poorter, P. Jaureguiberry, M. Bret-Harte, W. K. Cornwell, J. M. Craine, D. E. Gurvich, and others. 2013. New handbook for standardised measurement of plant functional traits worldwide. *Australian Journal of botany* 61:167–234.
- Pimm, S. L. 1984. The complexity and stability of ecosystems. *Nature* 307:321–326.
- Pommier, T., A. A. Cantarel, K. Grigulis, S. Lavorel, N. Legay, C. Baxendale, R. D. Bardgett, M. Bahn, F. Poly, and J.-C. Clément. 2018. The added value of including key microbial traits to determine nitrogen-related ecosystem services in managed grasslands. *Journal of Applied Ecology* 55:49–58.
- Prieto, I., C. Roumet, R. Cardinael, C. Dupraz, C. Jourdan, J. H. Kim, J. L. Maeght, Z. Mao, A. Pierret, N. Portillo, and others. 2015. Root functional parameters along a land-use gradient: evidence of a community-level economics spectrum. *Journal of Ecology* 103:361–373.
- Quasted, H., O. Eriksson, C. Fortunel, and E. Garnier. 2007. Plant traits relate to whole-community litter quality and decomposition following land use change. *Functional Ecology* 21:1016–1026.
- Quétiér, F., A. Thébaud, and S. Lavorel. 2007. Plant traits in a state and transition framework as markers of ecosystem response to land-use change. *Ecological monographs* 77:33–52.
- Reich, P. B. 2014. The world-wide “fast–slow” plant economics spectrum: a traits manifesto. *Journal of Ecology* 102:275–301.
- Ren, C., J. Chen, J. Deng, F. Zhao, X. Han, G. Yang, X. Tong, Y. Feng, S. Shelton, and G. Ren. 2017. Response of microbial diversity to C: N: P stoichiometry in fine root and microbial biomass following afforestation. *Biology and fertility of soils* 53:457–468.
- Robert, P., and Y. Escoufier. 1976. A unifying tool for linear multivariate statistical methods: the RV-coefficient. *Applied statistics*:257–265.
- Robertson, G. P., D. C. Coleman, P. Sollins, C. S. Bledsoe, and others. 1999. *Standard soil methods for long-term ecological research*. Oxford University Press on Demand.
- Schäffer, A., P. van den Brink, F. Heimbach, S. Hoy, F. de Jong, J. Römbke, J. P. Sousa, and M. Rob-Nickoll. 2008. Semi-field methods are a useful tool for the environmental risk assessment of pesticides in soil. *Environmental Science and Pollution Research* 15:176–177.
- Schimel, J., T. C. Balsler, and M. Wallenstein. 2007. Microbial stress-response physiology and its implications for ecosystem function. *Ecology* 88:1386–1394.
- Schirpke, U., M. Kohler, G. Leitinger, V. Fontana, E. Tasser, and U. Tappeiner. 2017. Future impacts of changing land-use and climate on ecosystem services of mountain grassland and their resilience. *Ecosystem Services* 26:79–94.
- Shipley, B. 2016. *Cause and correlation in biology: a user's guide to path analysis, structural equations and causal inference with R*. Cambridge University Press.



- Siberchicot, A., A. Julien-Laferrière, A.-B. Dufour, J. Thioulouse, and S. Dray. 2017. adegraphics: An S4 Lattice-Based Package for the Representation of Multivariate Data. *R Journal* 9.
- Sinsabaugh, R. L., R. Antibus, A. Linkins, C. McClaugherty, L. Rayburn, D. Repert, and T. Weiland. 1993. Wood decomposition: nitrogen and phosphorus dynamics in relation to extracellular enzyme activity. *Ecology* 74:1586-1593.
- Sinsabaugh, R. L., B. H. Hill, and J. J. F. Shah. 2009. Ecoenzymatic stoichiometry of microbial organic nutrient acquisition in soil and sediment. *Nature* 462:795-798.
- Stampfli, A., J. M. Bloor, M. Fischer, and M. Zeiter. 2018. High land-use intensity exacerbates shifts in grassland vegetation composition after severe experimental drought. *Global change biology* 24:2021-2034.
- Steinweg, J. M., J. S. Dukes, E. A. Paul, and M. D. Wallenstein. 2014. Microbial responses to multi-factor climate change: effects on soil enzymes. *The Microbial Regulation of Global Biogeochemical Cycles*:105.
- Steinweg, J. M., J. S. Dukes, and M. D. Wallenstein. 2012. Modeling the effects of temperature and moisture on soil enzyme activity: linking laboratory assays to continuous field data. *Soil Biology and Biochemistry* 55:85-92.
- Team, R. C., J. Pinheiro, D. Bates, S. DebRoy, and D. Sarkar. 2016. nlme: linear and nonlinear mixed effects models. R package version 3.1-128.
- Van Der Heijden, M. G., R. D. Bardgett, and N. M. Van Straalen. 2008. The unseen majority: soil microbes as drivers of plant diversity and productivity in terrestrial ecosystems. *Ecology letters* 11:296-310.
- Vartoukian, S. R., R. M. Palmer, and W. G. Wade. 2010. Strategies for culture of "unculturable" bacteria. *FEMS microbiology letters* 309:1-7.
- Wright, I. J., P. B. Reich, M. Westoby, D. D. Ackerly, Z. Baruch, F. Bongers, J. Cavender-Bares, T. Chapin, J. H. Cornelissen, M. Diemer, and others. 2004. The worldwide leaf economics spectrum. *Nature* 428:821.
- Žifčáková, L., T. Vetrovsk, V. Lombard, B. Henrissat, A. Howe, and P. Baldrian. 2017. Feed in summer, rest in winter: microbial carbon utilization in forest topsoil. *Microbiome* 5:122.

SUPPLEMENTARY MATERIALS

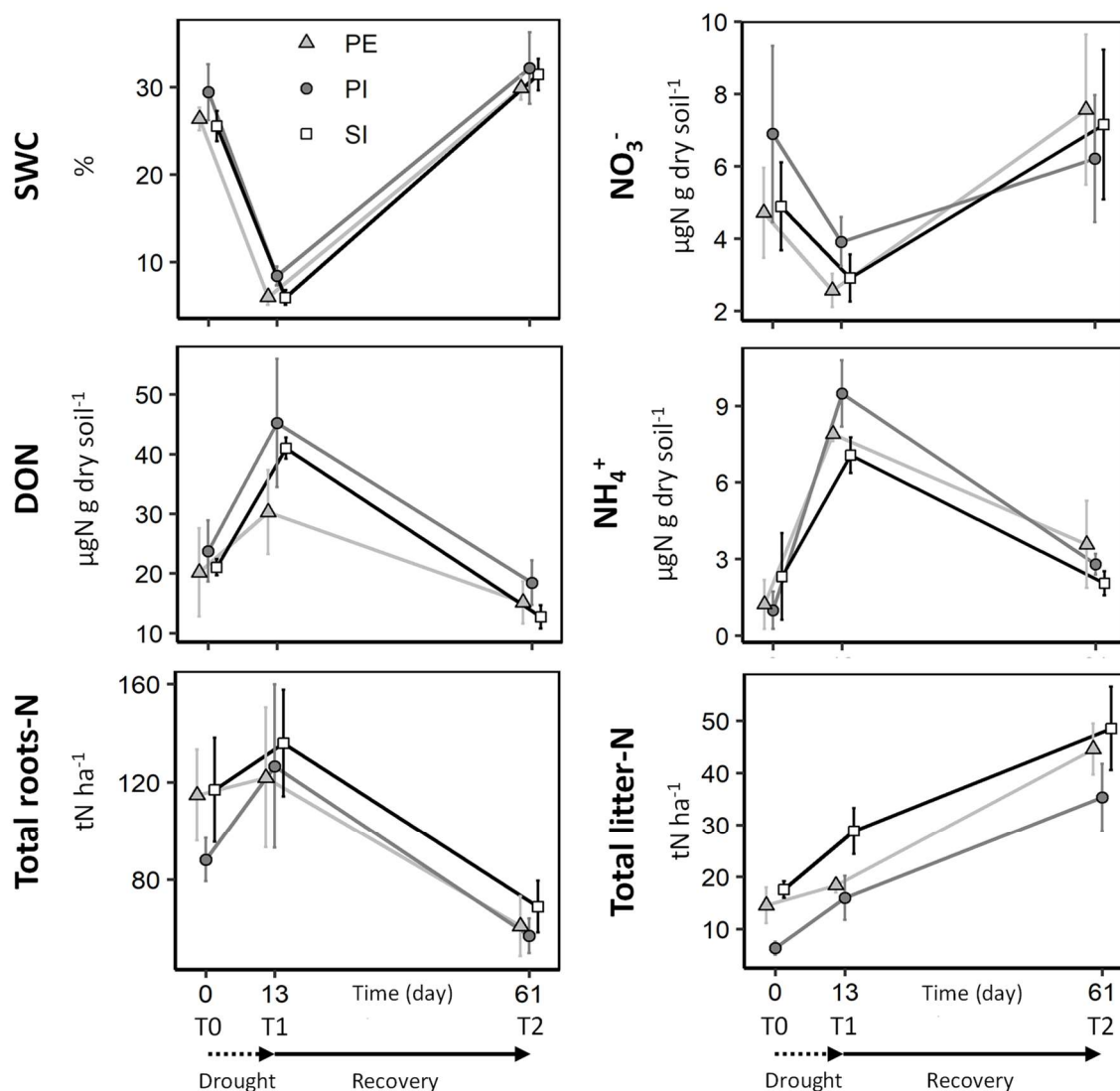

Figure S1 Mean value  $\pm$  standard error of ecosystem properties for the three grassland types (permanent extensive (PE,  $n=4$ ): light grey triangle, permanent intensive (PI,  $n=3$ ): dark grey circles, sown intensive (SI,  $n=5$ ): white squares) at the three sampling times: T0: before drought, T1: at the end of drought, T2: after recovery. Points have been jittered within each sampling time to facilitate comparisons among grassland types. SWC=Soil water content, DON=Dissolved organic N

## CONTRIBUTION PERSONNELLE AU CHAPITRE 1

J'ai conçu cette expérimentation et participé à l'échantillonnage des mésocosmes de sol intact avec l'aide de Nicolas Legay, Jean Christophe Clément et Arnaud Foulquier. J'ai assuré le maintien de l'expérimentation et N. Legay, J. C. Clément, A. Foulquier, C. Arnoldi, et Dana Mang (stagiaire de L2 sous ma supervision) m'ont ensuite aidé pour l'échantillonnage. J'ai ensuite conduit l'ensemble des analyses en laboratoire (mesures des pools de C, N et P et analyses d'activités enzymatiques) avec l'aide de C. Arnoldi, N. Legay, J. C. Clément, A. Foulquier et C. Arnoldi. J'ai réalisé l'ensemble des analyses statistiques avec l'aide d'A. Foulquier et L. Bernard. J'ai rédigé la 1<sup>ère</sup> version de cet article et mené l'ensemble des révisions suite aux retours de l'ensemble des co-auteurs et des reviewers de la revue *Journal of Ecology*. Je me suis également occupé des interviews des agriculteurs pour obtenir les données permettant de caractériser l'intensité de gestion de leurs prairies. J'ai ensuite fait un retour aux agriculteurs sous forme de fiches synthétisant les analyses des propriétés chimiques et biologiques de leurs sols ainsi que la résistance de leurs paramètres fourragers (masse sèche de fourrage et teneur en azote) estimée dans l'expérimentation présentée dans ce chapitre.

## CONCLUSION ET PERSPECTIVES DU CHAPITRE 1

Ce premier chapitre propose de considérer certaines caractéristiques des communautés microbiennes (stœchiométrie de la biomasse, activité enzymatique masse-spécifique et stœchiométrie enzymatique) comme des proxys des traits pondérés à la communauté (CWM) et de la stratégie d'acquisition des ressources dominante dans la communauté microbienne. Ces travaux permettent d'évaluer notre approche proposant une réflexion et une interprétation des résultats à travers le cadre conceptuel des traits fonctionnels. Nos résultats confirment que ces proxys des CWM microbiens sont : 1) influencés par l'intensité de gestion des prairies, à travers des modifications des ressources du sol et des traits des plantes ; 2) associés à la résilience des communautés microbiennes. La richesse en nutriments et les traits des plantes reflétant une stratégie exploitative sélectionnent des CWM microbiens indiquant une stratégie copiotrophe, diminuant la résistance mais augmentant la récupération des communautés microbiennes (biomasse) ce qui a permis de valider l'hypothèse principale de cette thèse : 1) pour la résilience à la sécheresse ; 2) sur un site d'étude balayant différentes modalités de gestions des prairies d'un territoire typique de moyenne montagne des Alpes du Nord.

Cependant, ce travail mené sur une seule zone d'étude ne permet pas de généraliser ces résultats. De plus, en s'appuyant uniquement sur la simulation de période de sécheresse et de récupération de courtes durées, cette expérimentation laisse certaines questions ouvertes : Qu'en est-il des autres types de stress climatiques ? Retrouve-t-on ce même compromis entre résistance et récupération pour des stress de plus longue durée ?

L'expérimentation présentée dans le chapitre suivant a cherché à répondre à ces questions. Premièrement, en s'appuyant sur trois sites d'études répartis à travers l'Europe, l'objectif était d'évaluer si nous pouvions mettre en évidence des patrons de réponse de la résilience des communautés microbiennes du sol à l'intensité de gestion plus généralisables au niveau des agroécosystèmes fourragers Européens. Deuxièmement, en simulant 3 types de stress climatiques (sec, humide et régime intermittent humide-sec) sur une longue durée (263 jours de stress, 89 jours de récupération), cette expérimentation a permis d'évaluer si la gestion influençait la résilience à plusieurs types de stress climatiques de longue durée.

*À vous, pour qui un trou dans la terre est une tombe,  
comment expliquer qu'il m'a été un berceau ?*

Michel Luneau, Parole d'arbre, 1994

---

# CHAPITRE 2.1

## (ARTICLE 2)

The resilience of soil microbial communities to climate change-induced rain regimes differs between conventional and ecological-intensive managed soils across European agroecosystems

---

Gabin Piton<sup>1</sup>, Laura Martinez<sup>2</sup>, Arnaud Foulquier<sup>1</sup>, Nicolas Legay<sup>3</sup>, Lijbert Brussaard<sup>2</sup>, Katarina Hedlund<sup>4</sup>, Eduardo Nascimento<sup>5</sup>, Filipa Reis<sup>5</sup>, Paulo Sousa<sup>5</sup>, Jean Christophe Clement<sup>6</sup>, Gerlinde De Deyn<sup>2</sup>

<sup>1</sup>Univ. Grenoble Alpes, Univ. Savoie Mont Blanc, CNRS, LECA, 38000 Grenoble, France

<sup>2</sup>Soil Biology Group, Wageningen University & Research, P.O. Box 47, 6700 AA Wageningen, The Netherlands

<sup>3</sup>École de la Nature et du Paysage, INSA Centre Val de Loire, 41000 Blois - CNRS, CITERES, UMR 7324, 37200 Tours, France.

<sup>4</sup>Department of Biology, Lund University, SE-223 62 Lund, Sweden.

<sup>5</sup>Centre for Functional Ecology, Department of Life Sciences, University of Coimbra, 3000-456 Coimbra, Portugal

<sup>6</sup>Univ. Savoie Mont Blanc, INRA, CARRTEL, 74200, Thonon-Les-Bains, France

This chapter is in preparation for submission in an international peer reviewed journal.

## ABSTRACT

Soil microbial communities play a fundamental role in ecosystem functioning, controlling nutrients and carbon cycling. However, little is known about how soil microbial communities under distinct management respond to climate change-induced rain regimes. Based on terrestrial ecosystem models extracted from grassland agroecosystems in three countries across Europe, we compared the resilience (resistance and recovery) of soil microbial communities under conventional-intensive and ecological-intensive management for three altered rain regimes (dry, wet and intermittent). Our results indicated management to affect microbial community composition (based on relative abundances of 27 individual phospholipid fatty acids), but not fungal:bacterial ratio. Moreover, conventional-intensive management promoted bacterial biomass and extracellular enzyme activity resistance while ecological-intensive management promoted their recovery. Conversely, microbial community composition resistance was higher in ecological-intensive managed soils. These management effects on microbial community resilience were consistent across the three altered rain regimes investigated, indicating common factors controlling microbial communities resilience to multiple climate stresses. We concluded that conventional-intensive management can show higher resistance of soil microbial community functioning during stress but ecological-intensive management promote the resistance of microbial community composition and long term recovery of their functioning.

## 1 INTRODUCTION

The soil microbial community controls the main ecosystem processes underpinning nutrients cycling, carbon (C) sequestration, and plant productivity in terrestrial ecosystems (Nannipieri et al. 2003, De Vries and Bardgett 2012, Bender et al. 2016). Increases of climate extremes intensity and frequency associated with current climate changes (Huntington 2006) might affect soil microbial communities and their functioning (Schimel et al. 2007, De Vries and Shade 2014, De Vries and Griffiths 2018). Drought effects on soil microbial communities have been extensively studied (see meta-analyses of Canarini et al. (2017) and Ren et al. (2018)), however other climate-change modifications of precipitation patterns such as heavy or intermittent rain regimes have been less investigated (De Vries and Griffiths 2018).

Moreover, the extent to which soil microbial communities are impacted and can recover from climatic stresses may differ substantially between soils under different managements still poorly known (De Vries and Shade 2014, De Vries and Griffiths 2018). Conventional-intensive soil management has a strong impact on microbial community composition and functioning resulting in a decline in soil biodiversity and biomass (De

Vries et al. 2013, Tsiafouli et al. 2015). A so called ecological intensive agriculture (eco-intensive hereafter) has been proposed as an alternative to conventional-intensive agriculture, by promoting biodiversity and biological processes to enhance ecosystem functioning and resilience (Bommarco et al. 2013, Bender et al. 2016). An eco-intensive system such as organic farming can promote soil organic matter content (Gattinger et al. 2012, Garcia-Palacios et al. 2018), microbial abundance and activity (Lori et al. 2017), taxonomic diversity (Mäder et al. 2002), and arbuscular mycorrhizal fungal (AMF) colonization (Mäder et al. 2000). Lower mineral N input and higher organic inputs in eco-intensive systems can also modify soil microbial community composition, selecting for higher fungal relative to bacterial abundance and affecting species composition within bacterial and fungal groups (Bossio et al. 1998, De Vries et al. 2006, Hartmann et al. 2015). Differences in fungal:bacterial ratio have been extensively associated with changes in ecosystem functioning and resilience (De Vries et al. 2011, 2012a, De Vries and Bardgett 2012, Grigulis et al. 2013, De Vries and Shade 2014, Legay et al. 2016, Cole et al. 2019), but it is less clear how much shift in community composition within these groups can lead to changes in ecosystem functioning and resilience.

The resilience concept has been used for decades to characterize the stability of ecosystems that are subjected to environmental stress or disturbance (Holling 1973, Pimm 1984). Resilience can be defined as the capacity of an ecosystem to persist and maintain its state and function in the face of stress (Ingrisch and Bahn 2018), and is composed of the resistance, that is the capacity to maintain its state during stress, and the recovery, which is the capacity to recover following after the end of the stress (Ingrisch and Bahn 2018). Factors controlling microbial community resilience are still poorly known (De Vries and Shade 2014).

Trait-based approaches and life strategy (strategy hereafter) concept in microbial ecology might shed light on the factors that control microbial community resilience (Lavorel and Garnier 2002, Allison and Martiny 2008, Wallenstein and Hall 2012, De Vries and Shade 2014, Krause et al. 2014, Malik et al. 2019). It has been proposed that the copiotroph-oligotroph strategy continuum (Fierer et al. 2007), equivalent to r-K strategy, could help classifying soil microbes according to their traits and resilience under climate changes (De Vries and Shade 2014, De Vries and Griffiths 2018). The oligotrophic strategy is characterized by low growth rates but high resistance to environmental stress. At the other end, copiotrophic microbes present opposite traits with low stress resistance but high growth rate, favoring recovery after a stress period (De Vries and Shade 2014, De Vries and Griffiths 2018).

The characterization of microbial strategies is challenging because of the difficulty to measure traits of soil microbes (Martiny et al. 2015). Yet, it has been proposed to predict microbial community stability under climate changes using the relative abundance of fungi towards bacteria and gram positive towards gram negative as increased abundance of fungi and gram positive bacteria, owing to their thicker cell-wall, is expected to increase microbial community resistance while decreasing recovery (De Vries and Shade 2014, De Vries and Griffiths 2018). However, overlaps in the strategy of broad taxonomic groups such as fungi and bacteria exist, potentially limiting their use as indicators for the copiotrophic-oligotrophic continuum (Ho et al.

2017), or as predictors of microbial community stability (De Vries and Shade 2014). Recently, Piton et al. (in review, Chapter 1) presented a novel approach, crossing community level properties to assess proxies of community weighted mean traits (CWM) representative of the dominant strategy in the microbial community, namely microbial biomass stoichiometry, extracellular enzyme stoichiometry and mass-specific activities. Using such approach, they observed that oligotrophic traits (high mass specific activity) can be associated with higher microbial community resistance but lower recovery to drought.

Managed grasslands are very common in agricultural landscapes (Lemaire et al. 2005) such as sown grasslands included in crop rotation or permanent ones, with large variability of management intensity. Few studies have assessed the effect of grasslands management on soil microbial community resilience (De Vries et al. 2012a, Jurburg et al. 2017, Karlowsky et al. 2018, Cole et al. 2019), and it is still not clear how conventional-intensive and eco-intensive systems might differ in their resilience capacity. Here, we used a cross country experiment (France, Switzerland and Portugal – Figure 16) to test how contrasting management (conventional-intensive vs. eco-intensive) affects soil microbial community composition, proxies of CWM traits, biomass and activity, and microbial community resilience to different altered rain regimes (Dry, Wet and Intermittent).

We hypothesized:

**H1**-Eco-intensive and conventional-intensive managed soils to have different microbial community composition, with more oligotrophic communities in eco-intensive managed soils.

**H2**-Eco-intensive soil microbial communities (biomass, activity and composition) to have higher resistance but lower recovery compared to conventional-intensive microbial communities, for all climate change-induced rain regimes, because of their oligotrophic strategy.



## 2 MATERIALS AND METHODS

### 2.1 EXPERIMENTAL DESIGN AND SETUP

The experiment was setup using Terrestrial model ecosystems (TMEs), which are intact soil cores defined as controlled, reproducible systems that attempt to simulate processes and interactions in a portion of the terrestrial ecosystem (Gillett and Witt 1980, Schäffer et al. 2008). TMEs were extracted at three sites across Europe in October 2015 (Figure 17). All sites were cultivated for forage at the sampling time: permanent and sown intensive mountain grasslands in France (Vercors), clover-grass in an arable cropping system in Switzerland (Therwil), and permanent and sown grasslands in an agroforestry system in Portugal (Montemor-o-Novo). Detailed information and characterization of the different sites, contrasting management and applied practices can be found in Table 3. Forty TMEs (40cm depth x 16.5cm diameter) encased in HDPE tubes were collected per country (Total of 120 TMEs). More precisely, four different plots have been sampled for each management (eco-intensive and conventional-intensive) in each country. Within each of these plots, 5 TMEs have been extracted (Figure 17). The TMEs were collected as described by (Knacker et al. 2004), using a retroexcavator and a special stainless-steel extractor (Figure 16).

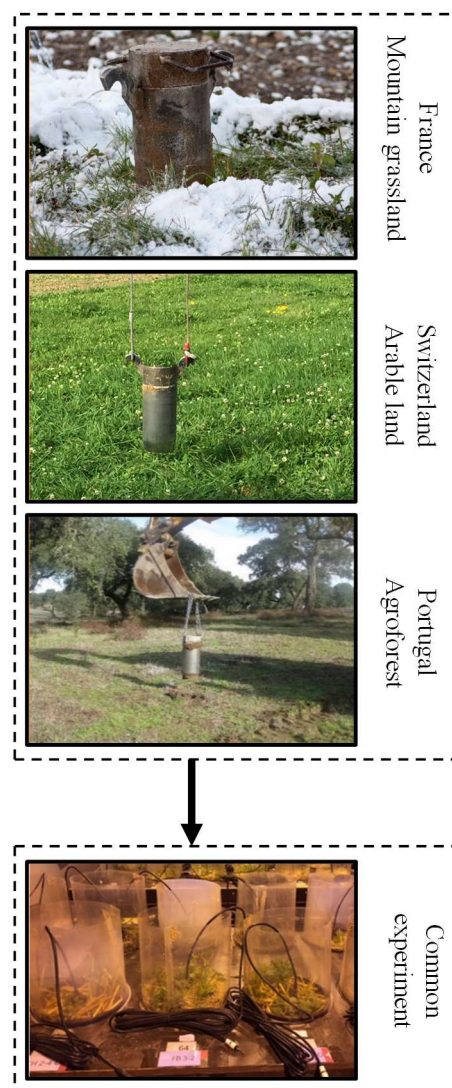

*Figure 16 Terrestrial model ecosystem (TME) sampling in the different countries and the joint experiment including all TMEs. TMEs (30 cm depth x 16.5 cm diameter) were extracted in autumn 2015, from grasslands in three countries (France, Portugal, Switzerland) from four plots under conventional-intensive farming and four plots under ecological intensive management within each country, with four TME extracted per plot.*

Table 3. Characterization of sites and their contrasting management. MAT= Mean annual temperature, MAP= Mean annual precipitation, N= Nitrogen, se= standard error. The Swiss site is based on a seven years crop rotation and terrestrial model ecosystems have been extracted in the second year of the grass clover period. The crop rotation is identical in the two managements and composed of the main crops: potato, winter wheat, soybean, maize, winter wheat and grass clover. All management practices indicated with an \* are specific for the two year grass clover period and can vary depending on the crops of the seven years crop rotation. + Soil was not tilled during the grass clover period but identically tilled between the two managements in the other phases of the rotation; except for more frequent mechanical weeding in eco-intensive.

Country (coordinates)	Land use	Study design	MAT, MAP	Soil type	Management	N Fertilizer (average N kg ha <sup>-1</sup> year <sup>-1</sup> )	Weed control	Tillage	Forage use	% Vegetation cover (se) / plant richness (se)	References
Switzerland 47°30'N 7°33'E	Grassland in rotation	Experimental plots (BIOORG and CONMIN)	9.7 °C, 791 mm	Haplic Luvisol	Ecological intensive (since 37 years)	Slurry* (120)	Mechanical	+	Grass cut 4 times a year for livestock *	Grass : 39 (3) Legumes : 61 (3) Other : 0 Richness: 6 (0)	(Fließbach, Oberholzer, Gunst, & Mäder, 2007)
					Conventional intensive (since 37 years)	Synthetic* (140)	Mechanical *	+	Grass cut 4 times a year for livestock *	Grass : 48 (4) Legumes : 51 (4) Other : 0 Richness: 6 (0)	
France 45°07'N 5°31'E	Mountain grassland	Farm comparison	7.2 °C, 1483 mm	Orthic Luvisols	Ecological intensive (since 50 years)	Cow manure (30)	Absent	Absent	Grazing 1-3 times a year	Grass : 51 (16) Legumes : 12 (3) Other : 37( 16) Richness: 7.5 (0.7)	Loucougaray et al. (2015)
					Conventional intensive (since 50 years)	Cow manure (70)	Absent	Every 3-4 year	Grazing 0-1 times a year and mowed 1-2 times a year	Grass : 59 (13) Legumes : 36 (14) Other: 5 (2) Richness: 6 (2)	
Portugal 38°42'N 8°19'W	Grassland in agroforest	Farm comparison	16.5 °C, 1093mm	Histic-mesic Inceptisol	Ecological intensive (since 18 years)	None (0)	Mechanical	Absent	Planned grazing by cattle and pigs	Grass : 28 (7) Legumes : 5 (1) Other : 66 (7) Richness: 33 (0.5)	García-Palacios et al. -(2018)
					Conventional intensive (since 18 years)	Synthetic (56)	Mechanical	Every 2nd year	Intensive grazing by sheep	Grass : 40 (2) Legumes : 10 (3) Other : 48 (5) Richness: 33 (2)	

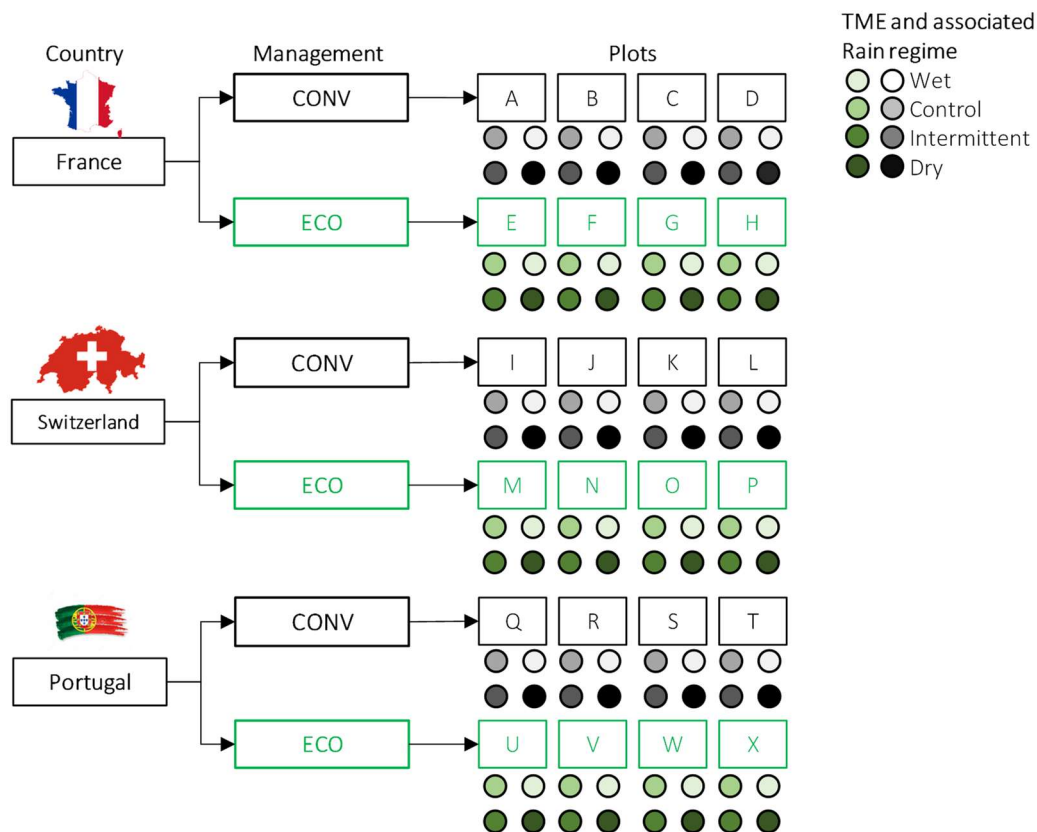

Figure 17 Experimental design: Soil monoliths origin, long-term management (CONV=Conventional-intensive, ECO=Ecological-intensive) and rain regime treatments.

After sampling, TMEs were transported in a refrigerated truck to the Laboratory of Soil Ecology and Ecotoxicology of Coimbra University. Upon arrival TMEs from the three countries were randomly placed inside special carts creating a temperature gradient between the lower and the upper part as described by (Ng et al. 2014). These carts were placed during the entire experiment inside a climate chamber with controlled air humidity ( $\approx 60\%$ ) and temperature ( $20^\circ\text{C} \pm$ ), and with a 16h:8h light:dark photoperiod. Decagon moisture sensors were used to monitor soil moisture in the upper 20cm layers of each TME three times a week (Mondays, Wednesdays, and Fridays) during the entire duration of the experiment.

Artificial rainwater (Velthorst 1993) was used to water TMEs three times a week during all the experiment. During the first 81 days, the amount of water was adjusted to obtain a soil moisture in the upper 20cm layer equivalent to 50%-60% of the maximum water holding capacity ( $\text{WHC}_{\text{max}}$ ) of the soil from each site where TMEs were collected. Those specific values of soil moisture (50%-60%  $\text{WHC}_{\text{max}}$ ) are considered as the "Normal" rain regime for each country. After this acclimation period under "Normal" rain regime, one TMEs were sampled to characterize initial state ( $T_0$ ). This first sampling was a destructive sampling, conducted on one TME per plot ( $N=32$ , 96 TMEs left). The upper 10cm of soil were sampled, sieved at 5mm, plant roots were hand-sorted and samples were stored at  $4^\circ\text{C}$  or  $-20^\circ\text{C}$  for further analyses.

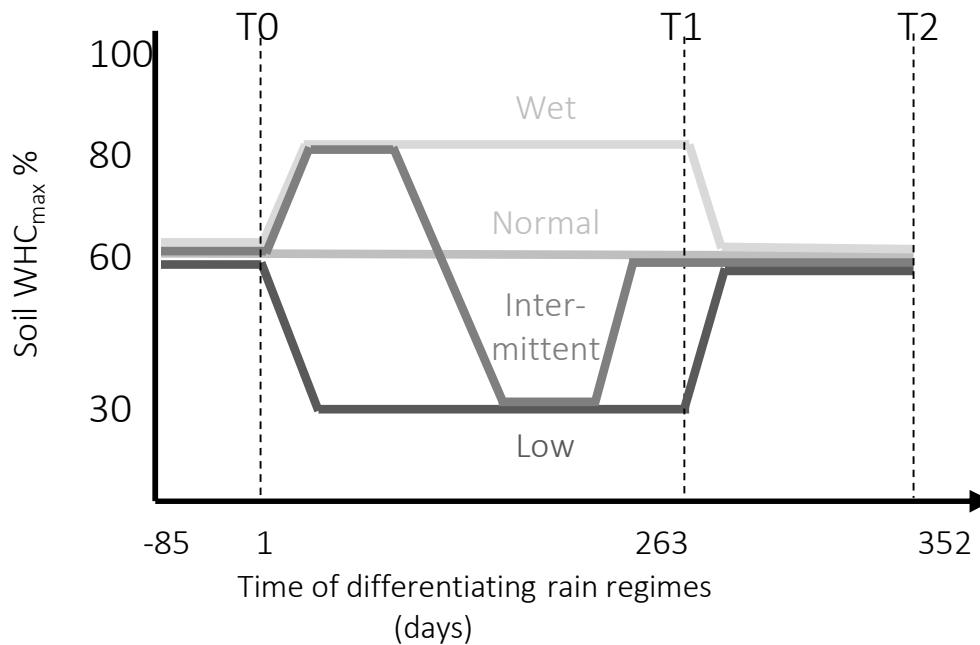

Figure 18. Overview of moisture dynamic within TMEs according to rain regimes. Rain regimes were adjusted according to the maximum water holding capacity (WHC<sub>max</sub>) of each soil.

After this acclimation period, 4 rain regimes were simulated during 263 days (Figure 18), with one rain regime simulated on each of the four TME from the 32 plots. For the Normal rain regime soil moisture was maintained at 50%-60% of the WHC<sub>max</sub>. For Low rain regime soil moisture was maintained at 20%-30% of the WHC<sub>max</sub> simulating a case of severe drought. For Wet rain regime soil moisture was maintained at 70%-80% of the WHC<sub>max</sub>, simulating a heavy rain. Finally Intermittent rain regime consisted in the simulation of a wet (74 days), low (125 days) and normal (64 days) cycles.

After this period, all TMEs were sampled using a non-destructive sampling (T<sub>1</sub>). One soil cores of 98cm<sup>3</sup> (5cm diameter and 5cm height) were collected from each TME. The soil was sieved at 5mm, plant roots were hand-sorted and samples were stored at 4°C or -20°C for further analyses. Pure sand encased into a small plastic cylinder were used to fill the holes left after sampling.

After this period of altered rain regimes, all TMEs were set again to Normal rain regime for 89 days followed by a last destructive sampling (T<sub>2</sub>) as described for T<sub>0</sub> (upper 10 cm).

Prior to the start of the differential rain regime, each TME was lined with a 2cm layer of crop residues from the specific field where TMEs were collected. During the entire experiment the vegetation of each TME was monitored *via* cutting the vegetation down to 5 cm whenever its height reached 20 cm to simulate grazing. A total of 13 vegetation cuts were done. The plant material from each cut at each TME was dried at 40 °C for 4 days and weighted after sampling. Plant material produced between T<sub>0</sub>-T<sub>1</sub> and between T<sub>1</sub>-T<sub>2</sub> periods were pooled and finely ground for further nutrient analysis.

Soil leachates of each TME were collected periodically throughout the experiment (at one to two weeks intervals). After each collection, volumes were measured and leachates acidified before storage at -20 °C until being processed for nutrient analysis. For each TME, leachates collected between T<sub>0</sub>-T<sub>1</sub> and between T<sub>1</sub>-T<sub>2</sub> periods were pooled for nutrient analysis.

## 2.2 SOIL ABIOTIC PROPERTIES:

Soil moisture was determined on a fresh soil subsample after one week at 70°C. Soil organic matter (SOM) concentration was measured on the dry soil as loss on ignition at 550 °C for 4 h. Total soil C and N content was measured using an elemental analyzer (FlashEA 1112, Fisher Scientific, Waltham, Massachusetts, USA) on oven-dried subsamples ground to a fine powder (5 µm diameter) with a ball mill (MM301, Retsch GmbH, Haan, Germany). Soil dissolved mineral and organic N were extracted from 3g of dried soil using a 1:10 soil to CaCl<sub>2</sub> (0.01M) extraction followed by centrifugation and filtering through 0.45µm cellulose acetate membrane filter (Houba et al. 2000). Soil dissolved mineral N pools (NH<sub>4</sub><sup>+</sup>, NO<sub>3</sub><sup>-</sup>, NO<sub>2</sub><sup>-</sup>) were measured by automated colorimetry (Brann enLuebbeTrAAcs 800 Autoanalyzer; Skalar Analytical B.V., Breda, the Netherlands) and dissolved organic N (DON) by a TOC-TN analyzer (Skalar Analytical B.V., Breda, the Netherlands).

DOC aromaticity was quantified by measuring the specific ultraviolet absorbance (SUVA) of the DOC extract using a spectrophotometer (Genesys 10S UV-VIS, Thermo Fisher Scientific Inc., Waltham MA, USA) and an equation from (Amery et al. 2008).

## 2.3 MICROBIAL COMMUNITY BIOMASS AND COMPOSITION

Microbial biomass and community composition were characterized by analysis of phospholipid fatty acids (PLFA, find all abbreviation list in SI Table 2). Lipid extractions were made using 3g of soil according to (Frostegård et al. 1993). The resulting fatty acid methyl esters were separated on a Hewlett Packard 6890 gas chromatograph (column HP 5). PLFAs i15:0, a15:0, 15:0, i16:0, 16:1ω9, i17:0, a17:0, cy17:0, 18:1ω7, cy19:0 were chosen to represent bacterial biomass. PLFA 18:2ω6 was used as an indicator of fungal biomass (Frostegård and Bååth 1996). Gram positive biomass was indicated by i15:0, a15:0, i16:0, i17:0, a17:0 (O'leary and Wilkinson 1988), Gram negative bacteria biomass by PLFAs 18:1ω7, cy17:0, cy19:0 (Wilkinson 1988, Zelles 1997) and Actinobacteria biomass by 10Me17:0 and 10Me18:0

(Lechevalier and Moss 1977, Kroppenstedt 1985). The NLFA 16:1ω5 was used as an indicator for AMF biomass (Olsson et al. 1995). Total microbial biomass-C has been estimated using the following conversion factors : 363.6nmol of bacterial PLFA = 1mg-C (Frostegård and Bååth 1996), 11.8nmol of fungal PLFA=1mg-C (Klamer and Bååth 2004) and 1.047nmol of NLFA = 1µg-C (Olsson et al. 1995).

The Fungal:Bacterial ratio and Gram+:Gram- ratio have been calculated as Fungal biomass-C: Bacterial biomass-C ratio (F:B here after), and Gram+ biomass-C: Gram- biomass-C ratio (GP:GN hereafter) respectively. Relative abundance (%mol PLFA) of 27 identified PLFA markers has been used to characterize the overall microbial community composition.

## 2.4 ENZYME ACTIVITIES

Potential extracellular enzymes activity (EEA) of seven enzymes involved in the degradation of C-rich substrates (α-Glucosidase (AG), β-1,4-Glucosidase (BG), β-D-Cellobiosidase (CB), and β-Xylosidase (XYL)), N-rich substrates (β-1,4-N-acetylglucosaminidase (NAG) and leucine aminopeptidase) and P-rich substrates (phosphatase (PHOS)) were estimated using standardized fluorimetric techniques (Bell et al. 2013). Briefly, 2.75g of soil was homogenized (1min in a Waring blender) in 200ml of a sodium acetate buffer solution adjusted to the mean pH (5.1 ± 0.7 SD, n=24) of soil samples measured at T<sub>0</sub>. The soil slurry (800µL) was then added in technical duplicates to a 96-deep-well microplate with 200µL of substrates at saturation concentration. Duplicated standard curves (0-100µM concentration) were prepared for each soil sample by mixing 800µL of soil slurry with 200µL of 4-methylumbelliferone (MUB) or 7-amino-4-methylcoumarin (MUC) in 96-deep-well microplates. Plates were incubated at 20°C in the dark (3h) on a rotary shaker (150rpm) before centrifugation at 2900g (3min). The supernatant (250µL) was transferred to a black Greiner flat-bottomed plate and fluorescence was measured on a microplate reader (Varioscan Flash, Thermo Scientific) with excitation wavelength set to 365nm and emission set to 450nm. After correcting for

negative controls, potential enzyme activities were expressed as nmol g soil<sup>-1</sup> h<sup>-1</sup>. Then, enzymes activities have been summed to represent enzyme activities degrading C-rich (EEC=AG+BG+CB+XYL), N rich (EEN=LAP+NAG) and P rich substrates (EEP=PHOS).

## 2.5 STATISTICAL ANALYSES

Redundancy analyses (RDA) were used to assess treatments effects on the overall microbial community composition (relative abundance of the 27 individuals PLFAs). Firstly, a RDA including the three sampling times was conducted to test management, rain regime, sampling time and their interactions. Secondly, RDAs were conducted for each sampling time testing management effect (To, T1, T2), Rain regime (T1, T2) and their interaction (T1, T2). Country was used as condition factor in all RDAs to correct for intercountry variations. RDAs were firstly tested for overall significance and then for each term using `anova.cca()` function (Oksanen et al. 2011). Variance partitioning was used to assess the relative proportion of soil microbial community composition explained by each factors using `varpart()` function (Oksanen et al. 2011).

The effects of rain regime and management on soil and microbial properties (biomass, activity, F:B, GP:GN) were tested separately for T1 and T2 using linear mixed effect models with rain regime and management as fixed effects, country and plots as random effects. Plot was nested in management nested in country within the random structure to take into account the nested design of the experiment (Crawley 2005).

To represent microbial community biomass and activity stability (absolute change in response to altered rain regime, whatever the direction), resistance and recovery indices from (Orwin and Wardle 2004) were calculated as follow :

$$Resistance_{ij} = 1 - \frac{2|D_{T1ij}|}{(C_{T1i} - |D_{T1ij}|)}$$

$$Recovery_{ij} = \frac{2|D_{T1ij}|}{(|D_{T1i}| - |D_{T2ij}|)} - 1$$

Where  $Resistance_{ij}$  and  $Recovery_{ij}$  are respectively the Resistance and Recovery of plot  $i$  ( $N=72$ ) under altered rain regime  $j$  (Dry, Wet or Intermittent), with  $C_{T1i}$  the value observed in control TMEs from the plot  $i$ , at the end of the stress period (T1),  $D_{T1ij}$  and  $D_{T2ij}$  the differences between the value of the TME under altered rain regime  $j$  and its associated control from same plot origin ( $i$ ) at the end of the stress period ( $D_{T1ij}$ ), or at the end of the recovery period ( $D_{T2ij}$ ). These indices are bounded between -1 and +1, with values of +1 indicating full resistance or recovery (identical value between control and stressed soil).

Microbial community composition resistance and recovery were measured as Bray-Curtis similarities between microbial community composition (relative abundance of the 27 individual PLFAs) from TMEs under altered rain regime at T1 (resistance) and T2 (recovery) and their associated control as proposed by de Vries and Shade (2014). This index is bounded between 0 and 1, with similarity of 1 meaning maximum resistance or recovery.

To assess if soil microbial community stability differed between rain regimes and managements, their effects on resistance and recovery indices were tested using mixed effect model with country as random factor. The potential associations between soil microbial community strategy and the resistance and recovery of their biomass, activity and composition were also tested. To do so, mixed effect correlations were conducted between soil microbial community indicators of the copiotrophic-oligotrophic continuum (F:B, GP:GN ratios and mass specific activities) measured before the stress period (To) and the resistance and recovery indices of the associated grassland ( $N=24$ ) to altered rain regimes.

### 3 RESULTS

When tested on the full dataset (To, T1 and T2), microbial community composition (relative abundance of 27 individual PLFAs) was significantly affected by treatments (RDA  $p$ -value $<0.001$ ) with significant effects of rain regime ( $p<0.001$ ), management ( $p<0.01$ ) and sampling time ( $p<0.001$ ) but not their interaction ( $p>0.05$ ). Two % of the variation were explained by rain regime, 1% by management, 7% by sampling time and 22% by country. RDA conducted for each sampling time did not detect any significant effect rain regime and management at To (RDA  $p$ -value=0.52) and T2 (RDA  $p$ -value=0.48). RDA conducted on community composition at T1 showed significant rain regime effect ( $p<0.001$ ), almost significant effect of management ( $p=0.08$ ) and no interaction ( $p=0.95$ ). Biplot from T1 RDA distinguished rain regimes along the first axis (Figure 19) with low coordinates for wet treatment followed by normal and intermittent treatments and finally dry treatment with the highest coordinates. Second axis discriminated management with higher coordinates for conventional-intensive soils compared to eco-intensive.

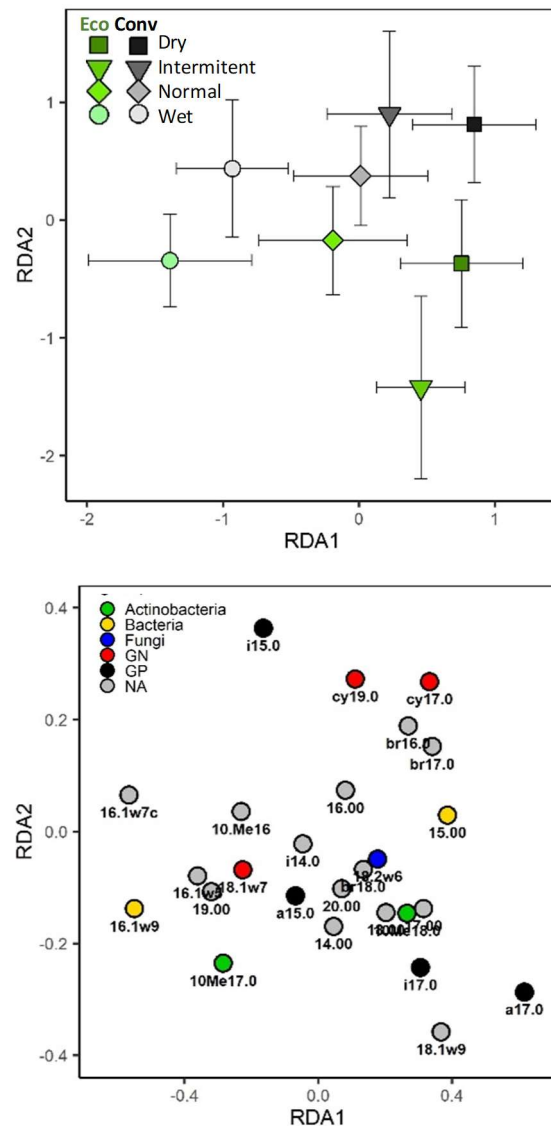

Figure 19. Redundancy analysis (RDA) ordination biplot of the relative abundance of 27 individuals PLFA measured at T1 (upper panel) constrained by rain regime (RR), management (M) and their interactions (upper panel). Ordination have been corrected for between country variations. Error bars (upper panel) represent 95% confidence interval for the coordinates on the first and second axes of the RDA. Points colours and shapes represent treatments (upper panel) or microbial group (lowert panel). GN=Gram negative bacteria PLFA, GP=Gram positive bacteria PLFA, NA=PLFA from unidentified microbial group



Neither soil microbial community biomass, activity, F:B and GP:GN ratios (Table 4) or soil abiotic characteristics (SI Table 1) were affected by management at T1. However, the rain regime showed strong effects on abiotic variables and microbial parameters (Table 4 and SI Table 1). Available C (DOC) and N (DIN) together with SOM were related to the rain regime gradient with a decrease of nutrient and C levels from dry to wet treatment. Soil resources, AMF biomass and GP:GN ratio were negatively related to the rain regime gradient, decreasing from dry to wet rain regime. EEN and EEP in the intermittent treatment were significantly lower than in the normal rain regime, while dry and wet rain regimes presented intermediate levels of activity between normal and intermittent treatment (SI Figure 2).

At the end of the recovery period (T2, 89 days of recovery), rain regime still had important effect on total extracellular enzyme activities (Table 4) but soil abiotic properties were no more influenced (SI Table 1). Soils under wet rain regimes showed lower EEN and EEP compared to dry and normal treatments (Table 4, SI Figure 3). EEC followed the same trend but only in conventional-intensive systems, while eco-intensive systems presented full recovery of EEC (significant interaction Table 4).

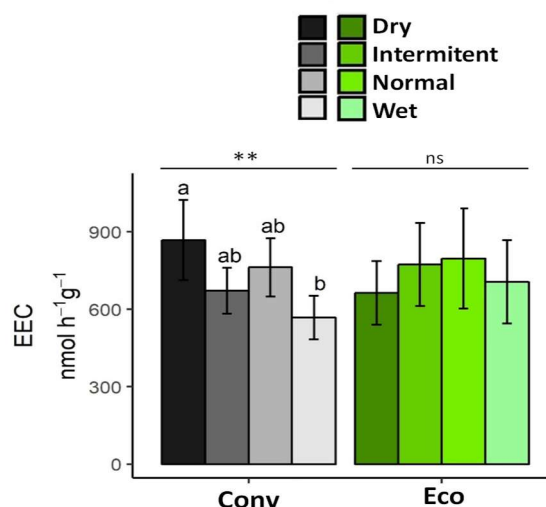

Figure 20. Effect of rain regimes on EEC in conventional-intensive (Conv, grey bars) and ecological-intensive managements (Eco, green bars) at T2. Results above each management represent rain regime effect within each management (ns=not significant, \*\*= $p$ -value $<0.01$ ). Different letters between rain regimes indicates significant differences between rain regimes within management treatment according to Tukey's test ( $p\leq 0.05$ ).

Table 4 P-values associated with rain regime (RR) and management (M) effects on **soil microbial community measured at T1 and T2**. BM=Biomass-C, EEC=Extracellular enzyme activities degrading C rich substrates, EEN= Extracellular enzyme activities degrading N-rich substrates EEP= Extracellular enzyme activities degrading P-rich substrates, Total EEA =EEC+EEN+EEP, F:B=Fungal:Bacterial ratio, GP:GN=Gram positive : Gram negative ratio.

	T1			T2		
	RR	M	RR X M	RR	M	RR X M
Bacterial BM	0.16	0.93	0.89	0.37	0.73	0.78
Fungal BM	0.11	0.96	0.55	0.63	0.79	0.89
AMF BM	<b>0.01</b>	0.50	0.58	0.45	0.56	0.64
Total BM	0.08	0.98	0.81	0.49	0.95	0.46
EEC	0.10	0.62	0.68	0.06	0.92	<b>0.03</b>
EEN	<b>0.04</b>	0.50	0.61	<b>&lt;0.01</b>	0.78	0.49
EEP	<b>0.01</b>	0.77	0.70	<b>&lt;0.001</b>	0.90	0.51
Total EEA	<b>0.02</b>	0.70	0.64	<b>&lt;0.001</b>	0.94	0.16
F:B	0.61	0.80	0.56	0.92	0.52	0.98
GP:GN	<b>&lt;0.01</b>	0.98	0.35	0.11	0.68	0.66



Table 5. P-values associated with rain regime (RR) and management (M) effects on soil microbial community resistance and recovery indices calculated following Orwin and Wardle (2004) and presented in Figure 22. BM=Biomass-C, AMF=Arbuscular mycorrhizal fungi, EEC=Extracellular enzyme activities degrading C rich substrates, EEN= Extracellular enzyme activities degrading N-rich substrates EEP= Extracellular enzyme activities degrading P-rich substrates, Total EEA =EEC+EEN+EEP.

	Resistance			Recovery		
	RR	M	RR×M	RR	M	RR×M
Bacterial BM	0.07	<b>0.02</b>	0.73	0.31	<b>0.00</b>	0.48
Fungal BM	0.44	0.51	0.26	0.43	0.46	0.56
AMF BM	0.35	0.51	0.56	0.16	0.81	0.10
Total BM	0.72	0.65	0.55	0.63	0.23	0.34
EEC	0.72	<b>0.05</b>	0.66	0.52	<b>0.05</b>	0.90
EEN	0.81	0.46	0.96	0.73	0.27	0.66
EEP	0.75	0.16	0.51	0.66	<b>0.04</b>	0.40
Total EEA	0.22	0.07	0.88	0.08	<b>0.01</b>	0.11

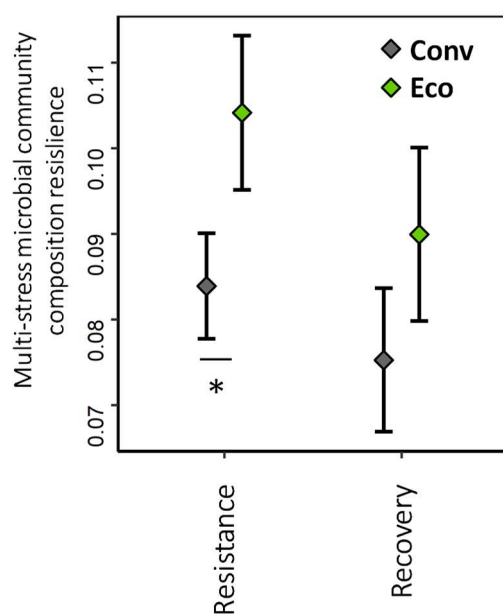

Figure 21 Effect of management on microbial community composition resistance, recovery calculated as Bray-Curtis distance between altered rain regime samples and their associated control. All altered rain regimes are plotted together since no interaction between rain regime and management was detected. Mean  $\pm$  standard error ( $n=36$ ) from mixed effect model using country as random factor. Black points = Conventional-intensive management, Green points = Ecological intensive management. Stars indicate significant difference between management according to Tuckey's post hoc test ( $p<0.05$ )

Surprisingly, resistance and recovery indices did not differ between rain regimes (Table 5) indicating similar effect of the three altered rain regimes (dry, wet and intermittent) on the microbial community resilience (absolute response whatever the direction). Contrastingly, management influenced microbial community stability (Table 5) with the resistance of microbial community composition being higher in eco-intensive soil compared to conventional-intensive, while no difference was found for recovery (Figure 21). A different pattern was observed for bacterial biomass and enzymes activities since eco-intensive microbial communities showed lower resistance for bacterial biomass and EEC compared to conventional-intensive systems (Figure 22). Opposite patterns were observed for recovery with microbial communities of eco-intensive systems showing higher recovery for bacterial biomass, EEC, EEP and total EEA than microbial communities of conventional-intensive systems (Figure 22).

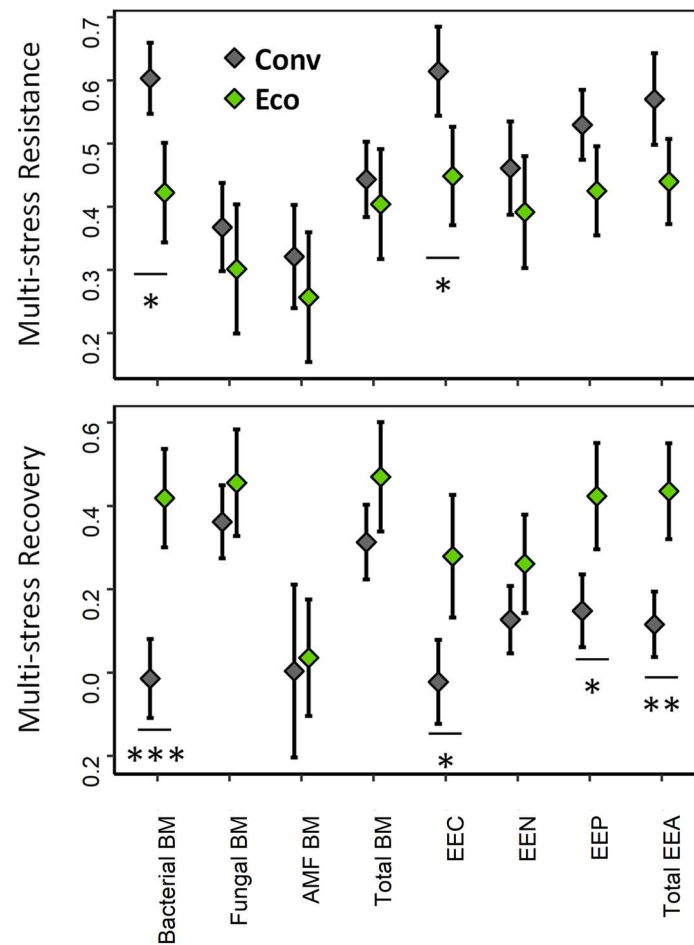

Figure 22. Effect of management on multi stress resistance and recovery of soil microbial community, calculated following Orwin and Wardle (2004). All altered rain regimes are plotted together since no interaction between rain regime and management was detected (Table 5). Mean  $\pm$  standard error ( $n=36$ ) from mixed effect model using country ( $N=3$ ) as random factor. Grey points = Conventional-intensive management, Green points = Ecological intensive management. Stars indicate significant difference between management according to Tuckey's post hoc test ( $*$ = $p<0.05$ ,  $**$ = $p<0.01$ ,  $***$  $p<0.001$ ).

Correlations between resistance indices and copiotrophic-oligotrophic indicators (Table 6) showed positive association between community composition resistance to intermittent rain regime and mass specific activity and almost significant positive associations of biomass-C resistance with GP:GN ( $p=0.07$ ) and mass specific activity ( $p=0.10$ ).

For recovery indices, biomass-C recovery to wet rain regime was positively associated with GP:GN, while community composition recovery to intermittent rain regime was positively associated with GP:GN and F:B ratios (Table 6).

Table 6. Correlation coefficients (coef) and p-values (p) from mixed effect models using country as random factor and assessing relationship between microbial community resistance or recovery indices (biomass-C, enzyme activity and community composition) and indicators of copiotrophic-oligotrophic indicators (Fungal : Bacterial (F:B) Gram positive : Gram negative (GP:GN) ratios and mass specific activity (EEA:BM)).

	Biomass-C						Enzyme activity						Community composition					
	Dry		Wet		Intermittent		Dry		Wet		Intermittent		Dry		Wet		Intermittent	
	coef	p	coef	p	coef	p	coef	p	coef	p	coef	p	coef	p	coef	p	coef	p
<b>Resistance</b>																		
<b>F:B</b>	0.16	0.55	0.18	0.59	0.40	0.12	0.29	0.28	0.24	0.39	0.07	0.79	-0.04	0.89	0.04	0.90	-0.02	0.93
<b>GP:GN</b>	0.46	0.07	-0.39	0.23	0.15	0.63	-0.16	0.52	-0.01	0.96	0.03	0.92	-0.01	0.97	0.33	0.23	0.42	0.10
<b>EEA:BM</b>	0.41	0.10	-0.21	0.45	0.16	0.57	-0.19	0.45	-0.18	0.53	0.06	0.83	0.14	0.58	0.51	0.06	<b>0.63</b>	<b>0.01</b>
<b>Recovery</b>																		
<b>F:B</b>	0.22	0.33	0.02	0.93	0.17	0.46	-0.14	0.53	-0.13	0.59	-0.10	0.66	0.04	0.85	0.13	0.62	<b>0.49</b>	<b>0.03</b>
<b>GP:GN</b>	-0.18	0.43	<b>0.55</b>	<b>0.02</b>	-0.12	0.61	0.09	0.68	0.30	0.22	-0.14	0.55	0.21	0.35	0.08	0.77	<b>0.44</b>	<b>0.05</b>
<b>EEA:BM</b>	-0.16	0.47	0.13	0.59	-0.27	0.24	0.13	0.57	-0.01	0.95	-0.19	0.41	0.09	0.70	0.46	0.07	0.30	0.18

## 4 DISCUSSION

### 4.1 EFFECT OF MANAGEMENT ON SOIL MICROBIAL COMMUNITY COMPOSITION

We hypothesized a different soil microbial community composition between eco-intensive and conventional-intensive managed soils. More precisely, we expected higher fungal:bacterial ratio under eco-intensive management, based on the rationale of lower N input compared to conventional-intensive management (Table 3). Our results confirmed distinct microbial community composition between management across countries (Figure 19). However, this management response was not associated with modification of the fungal:bacterial ratio as expected (De Vries et al. 2006), likely because our pairs of systems were not different enough in terms of fertilization (difference between conventional-intensive and eco-intensive managements are 20, 40 and 56 kg-N ha<sup>-1</sup> year<sup>-1</sup> for Switzerland, France

and Portugal respectively). Indeed, De Vries et al. (2006) showed an effect of N application rates on fungal biomass and F:B ratio only between treatments with a difference over 80 kg-N ha<sup>-1</sup> year<sup>-1</sup>. Thus while the F:B ratio might be a good indicator to discriminate microbial communities from extensively versus intensively managed soils (Bardgett et al. 1996, De Vries et al. 2006, De Vries and Bardgett 2012), we suggest that differences in microbial community composition between ecological and conventional-intensive are more associated with a change in the composition of fungal and bacterial communities rather than a change in their relative biomass. Such, management influence on the composition of soil microbial communities has already been demonstrated by Hartmann et al (2015) on the same Swiss site used in our experiment. We did not observe significant differences in soil abiotic properties between managements, while we found different litter traits and plant community compositions (see Chapter 2.3). Consequently, we hypothesized that management effect

on plant community composition and plant traits could explain microbial community composition differences observed in our study.

#### 4.2 EFFECT OF MANAGEMENT ON SOIL MICROBIAL COMMUNITY RESILIENCE

Our results confirmed management to affect soil microbial community resilience (resistance and recovery, Figure 21, Figure 22). Interestingly, management effects observed on resilience were consistent across the three simulated stresses (Table 5). With a current and predicted increase in the frequency and intensity of both wet and dry events (Huntington 2006), this consistency has important implications. This suggests that management changes affecting microbial community resilience for one stress (e.g. drought) will affect in the same way the resilience capacity to other climate-change induced stress (e.g. heavy rain).

Based on the hypothesis of a higher fungal:bacterial ratio and a more oligotrophic community under eco-intensive management, we initially expected a higher resistance but lower recovery of eco-intensive soil microbial communities compared to the ones in conventional-intensive soils. On the contrary, some components of soil microbial community under eco-intensive management (bacterial biomass and enzymatic activity), showed lower resistance but higher recovery. This lower resistance but high recovery of bacterial biomass suggests a more copiotrophic bacterial community under eco-intensive management. Copiotrophic microbes have low stress resistance but high growth rates increasing their recovery capacity (Fierer et al. 2007, De Vries and Shade 2014, De Vries and Griffiths 2018). Such selection of copiotrophic organisms would be consistent with the changes in litter traits observed by Lori et al (Chapter 2.3) under eco-intensive management on the same experiment, and with community weighted mean of microbial traits estimated from another experiment on the same French grasslands (Chapter 1). Indeed, in both experiments, litter of eco-intensive plant communities showed higher P content which can promote copiotrophic microbial community (Güsewell and Gessner 2009). This effect could be

explained by the higher P demand of copiotrophic microbes associated to their high ribosomal RNA content sustaining their high growth rate (Elser et al. 2003, Karpinets et al. 2006).

Interestingly, the resilience of microbial communities properties (Biomass, activity, composition) were poorly associated with F:B, GP:GN ratios or mass specific activities (Table 6), three proxies of the copiotrophic-oligotrophic continuum (Fontaine et al. 2003, De Vries and Shade 2014, De Vries and Griffiths 2018). Such results might be explained by the time length between T<sub>0</sub> sampling used to characterize microbial traits and strategies before the stress period and T<sub>1</sub> (263 days) and T<sub>2</sub> (352 days) used to characterize resistance and recovery, respectively. This likely also indicates that other proxies of microbial traits and strategies, associated with stress resistance need to be characterized.

Similar responses of resistance and recovery to management were observed for enzyme activity and bacterial biomass, but not fungal one. This association might indicate a more important role of bacteria in the control of soil enzymes activity than generally assumed (Sinsabaugh 2005, Romanı et al. 2006), encouraging investigations of bacterial enzymatic traits (Lladó et al. 2016, López-Mondéjar et al. 2019). Contrastingly, microbial community composition response to management seemed decoupled to the activity response, with higher resistance observed in eco-intensive soils while biomass and activity were less resistant in these soils. This pattern suggests that higher resistance of the microbial community composition is not an obligatory condition for a better resistance of the processes mediated by soil microbial community.

Overall, our results confirmed the hypothesized trade-off between resistance and recovery for microbial biomass and activity but not for community composition (Pimm 1984, De Vries et al. 2012a).

## 5 CONCLUSION

This study demonstrates that agroecosystems management strongly affects soil microbial community resilience through a resistance-recovery trade-off, with

consistent effects across multiple climate change-induced rain regimes. Conventional-intensive management seems to increase resistance of soil microbial community functioning during stress but eco-intensive management promotes the microbial community composition resistance and the long term recovery of microbial community functioning.

## REFERENCES

- Ai, C., S. Zhang, X. Zhang, D. Guo, W. Zhou, and S. Huang. 2018. Distinct responses of soil bacterial and fungal communities to changes in fertilization regime and crop rotation. *Geoderma* 319:156–166.
- Allison, S. D., and J. B. Martiny. 2008. Resistance, resilience, and redundancy in microbial communities. *Proceedings of the National Academy of Sciences* 105:11512–11519.
- Amery, F., F. Degryse, K. Cheyens, I. De Troyer, J. Mertens, R. Merckx, and E. Smolders. 2008. The UV-absorbance of dissolved organic matter predicts the fivefold variation in its affinity for mobilizing Cu in an agricultural soil horizon. *European Journal of Soil Science* 59:1087–1095.
- Bardgett, R. D., P. J. Hobbs, and Å. Frostegård. 1996. Changes in soil fungal: bacterial biomass ratios following reductions in the intensity of management of an upland grassland. *Biology and Fertility of Soils* 22:261–264.
- Bender, S. F., C. Wagg, and M. G. van der Heijden. 2016. An underground revolution: biodiversity and soil ecological engineering for agricultural sustainability. *Trends in ecology & evolution* 31:440–452.
- Bommarco, R., D. Kleijn, and S. G. Potts. 2013. Ecological intensification: harnessing ecosystem services for food security. *Trends in ecology & evolution* 28:230–238.
- Bossio, D. A., K. M. Scow, N. Gunapala, and K. Graham. 1998. Determinants of soil microbial communities: effects of agricultural management, season, and soil type on phospholipid fatty acid profiles. *Microbial ecology* 36:1–12.
- Canarini, A., L. P. Kiær, and F. A. Dijkstra. 2017. Soil carbon loss regulated by drought intensity and available substrate: A meta-analysis. *Soil Biology and Biochemistry* 112:90–99.
- Cole, A. J., R. I. Griffiths, S. E. Ward, J. Whitaker, N. J. Ostle, and R. D. Bardgett. 2019. Grassland biodiversity restoration increases resistance of carbon fluxes to drought. *Journal of Applied Ecology*.
- Crawley, M. J. 2005. *An introduction using R*. Wiley.
- Denef, K., D. Roobroeck, M. C. M. Wadu, P. Lootens, and P. Boeckx. 2009. Microbial community composition and rhizodeposit-carbon assimilation in differently managed temperate grassland soils. *Soil Biology and Biochemistry* 41:144–153.
- Elser, J., K. Acharya, M. Kyle, J. Cotner, W. Makino, T. Markow, T. Watts, S. Hobbie, W. Fagan, J. Schade, and others. 2003. Growth rate–stoichiometry couplings in diverse biota. *Ecology Letters* 6:936–943.
- Fanin, N., and I. Bertrand. 2016. Aboveground litter quality is a better predictor than belowground microbial communities when estimating carbon mineralization along a land-use gradient. *Soil Biology and Biochemistry* 94:48–60.
- Fierer, N., M. A. Bradford, and R. B. Jackson. 2007. Toward an ecological classification of soil bacteria. *Ecology* 88:1354–1364.
- Fierer, N., C. L. Lauber, K. S. Ramirez, J. Zaneveld, M. A. Bradford, and R. Knight. 2012a. Comparative metagenomic, phylogenetic and physiological analyses of soil microbial communities across nitrogen gradients. *The ISME journal* 6:1007–1017.
- Fierer, N., J. W. Leff, B. J. Adams, U. N. Nielsen, S. T. Bates, C. L. Lauber, S. Owens, J. A. Gilbert, D. H. Wall, and J. G. Caporaso. 2012b. Cross-biome metagenomic analyses of soil microbial communities and their functional attributes. *Proceedings of the National Academy of Sciences* 109:21390–21395.
- Fontaine, S., A. Mariotti, and L. Abbadie. 2003. The priming effect of organic matter: a question of microbial competition? *Soil Biology and Biochemistry* 35:837–843.
- Frostegård, Å., and E. Bååth. 1996. The use of phospholipid fatty acid analysis to estimate bacterial and fungal biomass in soil. *Biology and Fertility of Soils* 22:59–65.
- Frostegård, Å., E. Bååth, and A. Tunlio. 1993. Shifts in the structure of soil microbial communities in limed forests as revealed by phospholipid fatty acid analysis. *Soil Biology and Biochemistry* 25:723–730.
- García-Palacios, P., A. Gattinger, H. Bracht-Jørgensen, L. Brussaard, F. Carvalho, H. Castro, J.-C. Clément, G. De Deyn, T. D’Hertefeldt, A. Foulquier, and others. 2018. Crop traits drive soil carbon sequestration under organic farming. *Journal of Applied Ecology* 55:2496–2505.

- Gattinger, A., A. Muller, M. Haeni, C. Skinner, A. Fliessbach, N. Buchmann, P. Mäder, M. Stolze, P. Smith, N. E.-H. Scialabba, and others. 2012. Enhanced top soil carbon stocks under organic farming. *Proceedings of the National Academy of Sciences* 109:18226–18231.
- Gillett, J., and J. Witt. 1980. *Chemical Evaluation: Projected Application of Terrestrial Microcosm Technology*.
- Grigulis, K., S. Lavorel, U. Krainer, N. Legay, C. Baxendale, M. Dumont, E. Kastl, C. Arnoldi, R. D. Bardgett, F. Poly, and others. 2013. Relative contributions of plant traits and soil microbial properties to mountain grassland ecosystem services. *Journal of Ecology* 101:47–57.
- Güsewell, S., and M. O. Gessner. 2009. N: P ratios influence litter decomposition and colonization by fungi and bacteria in microcosms. *Functional Ecology* 23:211–219.
- Hartmann, M., B. Frey, J. Mayer, P. Mäder, and F. Widmer. 2015. Distinct soil microbial diversity under long-term organic and conventional farming. *The ISME journal* 9:1177.
- Ho, A., D. P. Di Lonardo, and P. L. Bodelier. 2017. Revisiting life strategy concepts in environmental microbial ecology. *FEMS microbiology ecology* 93:fix006.
- Holling, C. S. 1973. Resilience and stability of ecological systems. *Annual review of ecology and systematics* 4:1–23.
- Houba, V., E. Temminghoff, G. Gaikhorst, and W. Van Vark. 2000. Soil analysis procedures using 0.01 M calcium chloride as extraction reagent. *Communications in soil science and plant analysis* 31:1299–1396.
- Huntington, T. G. 2006. Evidence for intensification of the global water cycle: review and synthesis. *Journal of Hydrology* 319:83–95.
- Ingrisch, J., and M. Bahn. 2018. Towards a comparable quantification of resilience. *Trends in ecology & evolution*.
- Jurburg, S. D., T. Natal-da-Luz, J. Raimundo, P. V. Morais, J. P. Sousa, J. D. van Elsas, and J. F. Salles. 2017. Bacterial communities in soil become sensitive to drought under intensive grazing. *Science of The Total Environment*.
- Karlowisky, S., A. Augusti, J. Ingrisch, R. Hasibeder, M. Lange, S. Lavorel, M. Bahn, and G. Gleixner. 2018a. Land use in mountain grasslands alters drought response and recovery of carbon allocation and plant-microbial interactions. *Journal of Ecology* 106:1230–1243.
- Karpinets, T. V., D. J. Greenwood, C. E. Sams, and J. T. Ammons. 2006. RNA: protein ratio of the unicellular organism as a characteristic of phosphorous and nitrogen stoichiometry and of the cellular requirement of ribosomes for protein synthesis. *BMC biology* 4:30.
- Klamer, M., and E. Bååth. 2004. Estimation of conversion factors for fungal biomass determination in compost using ergosterol and PLFA 18: 206, 9. *Soil Biology and Biochemistry* 36:57–65.
- Knacker, T., C. A. van Gestel, S. E. Jones, A. M. Soares, H.-J. Schallnaß, B. Förster, and C. A. Edwards. 2004. Ring-testing and field-validation of a Terrestrial Model Ecosystem (TME)—an instrument for testing potentially harmful substances: conceptual approach and study design. *Ecotoxicology* 13:9–27.
- Krause, S., X. Le Roux, P. A. Niklaus, P. M. Van Bodegom, J. T. Lennon, S. Bertilsson, H.-P. Grossart, L. Philippot, and P. L. Bodelier. 2014. Trait-based approaches for understanding microbial biodiversity and ecosystem functioning. *Frontiers in Microbiology* 5.
- Kroppenstedt, R. 1985. Fatty acid and menaquinone analysis of actinomycetes and related organisms. *Chemical methods in bacterial systematics*:173–199.
- Lavorel, S., and E. Garnier. 2002. Predicting changes in community composition and ecosystem functioning from plant traits: revisiting the Holy Grail. *Functional ecology* 16:545–556.
- Lechevalier, M. P., and C. W. Moss. 1977. Lipids in bacterial taxonomy—a taxonomist’s view. *CRC critical reviews in microbiology* 5:109–210.
- Leff, J. W., S. E. Jones, S. M. Prober, A. Barberán, E. T. Borer, J. L. Firn, W. S. Harpole, S. E. Hobbie, K. S. Hofmockel, J. M. Knops, and others. 2015. Consistent responses of soil microbial communities to elevated nutrient inputs in grasslands across the globe. *Proceedings of the National Academy of Sciences* 112:10967–10972.
- Legay, N., C. Baxendale, K. Grigulis, U. Krainer, E. Kastl, M. Schloter, R. D. Bardgett, C. Arnoldi, M. Bahn, M. Dumont, and others. 2014. Contribution of above-and below-ground plant traits to the structure and function of grassland soil microbial communities. *Annals of botany* 114:1011–1021.
- Legay, N., S. Lavorel, C. Baxendale, U. Krainer, M. Bahn, M.-N. Binet, A. A. Cantarel, M.-P. Colace, A. Foulquier, E.-M. Kastl, and others. 2016. Influence of plant traits, soil microbial properties, and abiotic parameters on

- nitrogen turnover of grassland ecosystems. *Ecosphere* 7.
- Lemaire, G., R. Wilkins, and J. Hodgson. 2005. Challenges for grassland science: managing research priorities. *Agriculture, Ecosystems & Environment* 108:99–108.
- Li, F., L. Chen, J. Zhang, J. Yin, and S. Huang. 2017. Bacterial community structure after long-term organic and inorganic fertilization reveals important associations between soil nutrients and specific taxa involved in nutrient transformations. *Frontiers in Microbiology* 8:187.
- Lladó, S., L. Žifčáková, T. Vetrovsk, I. Eichlerová, and P. Baldrian. 2016. Functional screening of abundant bacteria from acidic forest soil indicates the metabolic potential of *Acidobacteria* subdivision 1 for polysaccharide decomposition. *Biology and fertility of soils* 52:251–260.
- López-Mondéjar, R., C. Algora, and P. Baldrian. 2019. Lignocellulolytic systems of soil bacteria: A vast and diverse toolbox for biotechnological conversion processes. *Biotechnology Advances*.
- Lori, M., S. Symnaczik, P. Mäder, G. De Deyn, and A. Gattinger. 2017. Organic farming enhances soil microbial abundance and activity—A meta-analysis and meta-regression. *PLoS One* 12:e0180442.
- Mäder, P., S. Edenhofer, T. Boller, A. Wiemken, and U. Niggli. 2000. Arbuscular mycorrhizae in a long-term field trial comparing low-input (organic, biological) and high-input (conventional) farming systems in a crop rotation. *Biology and fertility of Soils* 31:150–156.
- Mäder, P., A. Fliessbach, D. Dubois, L. Gunst, P. Fried, and U. Niggli. 2002. Soil fertility and biodiversity in organic farming. *Science* 296:1694–1697.
- Malik, A. A., J. B. Martiny, E. L. Brodie, A. C. Martiny, K. K. Treseder, and S. D. Allison. 2019. Defining trait-based microbial strategies with consequences for soil carbon cycling under climate change. *The ISME journal*:1–9.
- Martiny, J. B., S. E. Jones, J. T. Lennon, and A. C. Martiny. 2015. Microbiomes in light of traits: a phylogenetic perspective. *Science* 350:aac9323.
- Nannipieri, P., J. Ascher, M. Ceccherini, L. Landi, G. Pietramellara, and G. Renella. 2003. Microbial diversity and soil functions. *European journal of soil science* 54:655–670.
- Ng, E., C. Bandow, D. Proença, S. Santos, R. Guilherme, P. Morais, J. Römcke, and J. Sousa. 2014. Does altered rainfall regime change pesticide effects in soil? A terrestrial model ecosystem study from Mediterranean Portugal on the effects of pyrimethanil to soil microbial communities under extremes in rainfall. *Applied soil ecology* 84:245–253.
- O’leary, W., and S. Wilkinson. 1988. Gram-positive bacteria. *Microbial lipids* 1:117–201.
- Oksanen, J., F. G. Blanchet, R. Kindt, P. Legendre, P. R. Minchin, R. O’hara, G. L. Simpson, P. Solymos, M. H. H. Stevens, and H. Wagner. 2011. *vegan: Community ecology package*. R package version:117–118.
- Olsson, P. A., E. Bååth, I. Jakobsen, and B. Söderström. 1995. The use of phospholipid and neutral lipid fatty acids to estimate biomass of arbuscular mycorrhizal fungi in soil. *Mycological Research* 99:623–629.
- Orwin, K. H., and D. A. Wardle. 2004. New indices for quantifying the resistance and resilience of soil biota to exogenous disturbances. *Soil Biology and Biochemistry* 36:1907–1912.
- Pimm, S. L. 1984. The complexity and stability of ecosystems. *Nature* 307:321–326.
- Quétier, F., A. Thébault, and S. Lavorel. 2007. Plant traits in a state and transition framework as markers of ecosystem response to land-use change. *Ecological monographs* 77:33–52.
- Ren, C., J. Chen, X. Lu, R. Doughty, F. Zhao, Z. Zhong, X. Han, G. Yang, Y. Feng, and G. Ren. 2018. Responses of soil total microbial biomass and community compositions to rainfall reductions. *Soil Biology and Biochemistry* 116:4–10.
- Roman, A. M., H. Fischer, C. Mille-Lindblom, and L. J. Tranvik. 2006. Interactions of bacteria and fungi on decomposing litter: differential extracellular enzyme activities. *Ecology* 87:2559–2569.
- Schäffer, A., P. van den Brink, F. Heimbach, S. Hoy, F. de Jong, J. Römcke, J. P. Sousa, and M. Roß-Nickoll. 2008. Semi-field methods are a useful tool for the environmental risk assessment of pesticides in soil. *Environmental Science and Pollution Research* 15:176–177.
- Schimel, J., T. C. Balsler, and M. Wallenstein. 2007. Microbial stress-response physiology and its implications for ecosystem function. *Ecology* 88:1386–1394.
- Sinsabaugh, R. L. 2005. Fungal enzymes at the community scale. *Mycology Series* 23:349.
- Tsiafouli, M. A., E. Thébault, S. P. Sgardelis, P. C. De Ruiter, W. H. Van Der Putten, K. Birkhofer, L. Hemerik, F. T. De Vries, R. D. Bardgett, M. V. Brady, and others. 2015. Intensive agriculture reduces soil biodiversity across Europe. *Global change biology* 21:973–985.

- Velthorst, E. 1993. Manual for chemical water analyses. . Department of Soil Science and Geology, Agricultural University.
- De Vries, F. T., and R. D. Bardgett. 2012. Plant-microbial linkages and ecosystem nitrogen retention: lessons for sustainable agriculture. *Frontiers in Ecology and the Environment* 10:425–432.
- De Vries, F. T., and R. I. Griffiths. 2018. Impacts of Climate Change on Soil Microbial Communities and Their Functioning. Pages 111–129 *Developments in Soil Science*. . Elsevier.
- De Vries, F. T., J. W. Van Groenigen, E. Hoffland, and J. Bloem. 2011. Nitrogen losses from two grassland soils with different fungal biomass. *Soil Biology and Biochemistry* 43:997–1005.
- De Vries, F. T., E. Hoffland, N. van Eekeren, L. Brussaard, and J. Bloem. 2006. Fungal/bacterial ratios in grasslands with contrasting nitrogen management. *Soil Biology and Biochemistry* 38:2092–2103.
- De Vries, F. T., M. E. Liiri, L. Bjørnlund, M. A. Bowker, S. Christensen, H. M. Setälä, and R. D. Bardgett. 2012a. Land use alters the resistance and resilience of soil food webs to drought. *Nature Climate Change* 2:276–280.
- De Vries, F. T., P. Manning, J. R. Tallwin, S. R. Mortimer, E. S. Pilgrim, K. A. Harrison, P. J. Hobbs, H. Quirk, B. Shipley, J. H. Cornelissen, and others. 2012b. Abiotic drivers and plant traits explain landscape-scale patterns in soil microbial communities. *Ecology Letters* 15:1230–1239.
- De Vries, F. T., and A. Shade. 2014. Controls on soil microbial community stability under climate change. *The Microbial Regulation of Global Biogeochemical Cycles*:132.
- De Vries, F. T., E. Thébault, M. Liiri, K. Birkhofer, M. A. Tsiafouli, L. Bjørnlund, H. B. Jørgensen, M. V. Brady, S. Christensen, P. C. de Ruiter, and others. 2013. Soil food web properties explain ecosystem services across European land use systems. *Proceedings of the National Academy of Sciences* 110:14296–14301.
- Wallenstein, M. D., and E. K. Hall. 2012. A trait-based framework for predicting when and where microbial adaptation to climate change will affect ecosystem functioning. *Biogeochemistry* 109:35–47.
- Wang, Y., H. Ji, and C. Gao. 2016. Differential responses of soil bacterial taxa to long-term P, N, and organic manure application. *Journal of Soils and Sediments* 16:1046–1058.
- Wilkinson, S. 1988. Gram-negative bacteria. *Microbial Lipids*. 1:299–488.
- Zelles, L. 1997. Phospholipid fatty acid profiles in selected members of soil microbial communities. *Chemosphere* 35:275–294.



## SUPPLEMENTARY MATERIALS

## SI-TABLES

SI Table 1: P-values associated with rain regime (RR) and management (M) effects on **soil abiotic properties measured at T1 and T2**. SOM=Soil organic matter, TC=Total soil Carbon, TN=Total soil nitrogen, C:N=TC:TN, DOC=Dissolved organic carbon, SUVA=Aromaticity, DIN=Dissolved inorganic nitrogen, DON=Dissolved organic nitrogen.

	T1			T2		
	Rain regime	Management	RR X M	Rain regime	Management	RR X M
<b>SOM</b>	<b>&lt;0.001</b>	0.76	0.78	0.17	0.62	0.49
<b>TC</b>	0.29	0.95	0.30	0.69	0.52	0.77
<b>TN</b>	0.23	0.37	0.81	0.76	0.40	0.78
<b>C:N</b>	0.08	0.18	0.74	0.36	0.50	0.80
<b>DOC</b>	<b>&lt;0.001</b>	0.58	0.48	0.13	0.40	0.65
<b>SUVA</b>	0.18	0.75	0.57	<b>0.03</b>	0.55	0.37
<b>DIN</b>	<b>&lt;0.01</b>	0.44	0.67	0.20	0.58	0.89
<b>DON</b>	0.38	0.35	0.69	0.39	0.48	0.08
<b>Moisture</b>	<b>&lt;0.001</b>	0.40	0.52	0.35	0.38	0.94

SI Table 2: Abbreviations table

Abbreviation	Variable	Reference
<b>PLFA</b>	Phospholipid fatty acids	(Frostegard et al. 1993)
<b>NLFA</b>	Neutral lipid fatty acids	(Olsson et al. 1995)
<b>EEC</b>	Enzyme activities degrading C-rich substrates (sum of 4 enzymes : AG+BG+CB+XYL)	(Bell & al. 2013)
<b>EEN</b>	Enzyme activities degrading N-rich substrates (sum of 2 enzymes : LAP + NAG)	(Bell & al. 2013)
<b>EEP</b>	Enzyme activities degrading P-rich substrates (1 enzyme : PHOS)	(Bell & al. 2013)
<b>EEA</b>	Total extracellular enzyme activity (EEA=EEC+EEN+EEP)	(Bell & al. 2013)
<b>TC</b>	Total soil Carbon	
<b>TN</b>	Total soil Nitrogen	
<b>TP</b>	Total soil phosphorus	
<b>DOC</b>	Dissolved Organic Carbon	(Houba et al. 2000)
<b>DIN</b>	Dissolved Mineral Nitrogen	(Houba et al. 2000)
<b>SUVA</b>	Aromaticity	(Amery et al. 2008)

## SI – FIGURES

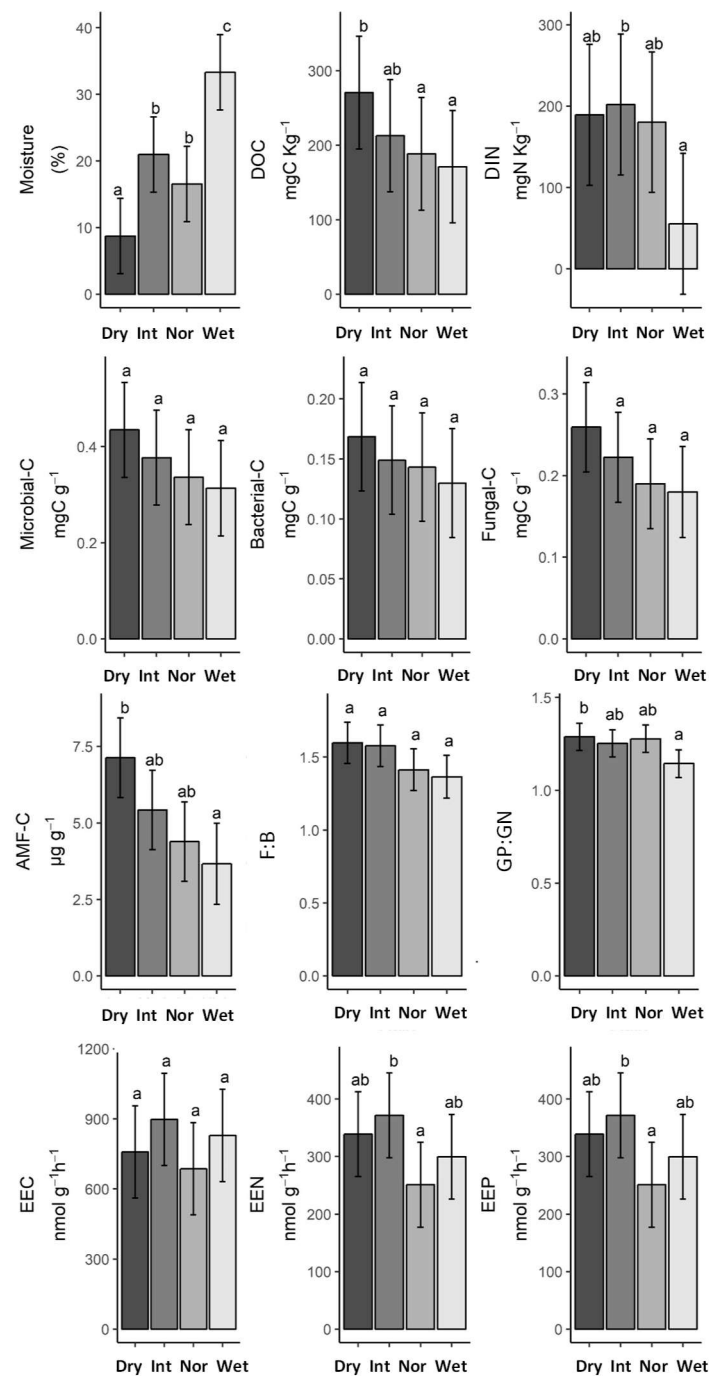

SI Figure 2. Rain regimes effects on soil abiotic and microbial community properties at T1. Eco-intensive and conventional-intensive managements have been merged since no management effect was detected (Table 4). Different letters between rain regimes indicates significant differences according to Tukey's test ( $p \leq 0.05$ ).

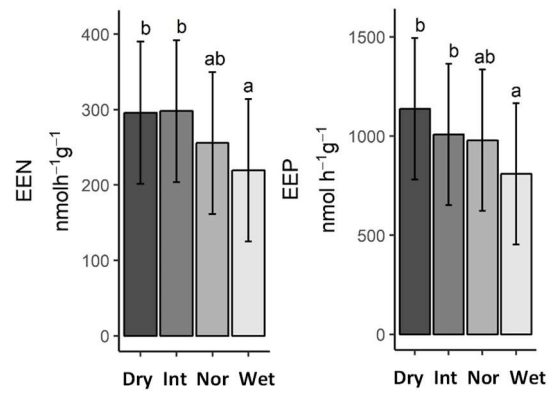

SI Figure 3. Rain regimes effects on extracellular enzyme N and P related activities at T<sub>2</sub>. Eco-intensive and conventional-intensive managements have been merged since no management effect was detected (Table 4). Different letters between rain regimes indicates significant differences according to Tukey's test ( $p \leq 0.05$ ).

## CONTRIBUTION PERSONNELLE AU CHAPITRE 2.1

L'expérimentation conjointe (France, Suisse, Portugal) sur laquelle s'appuie ce chapitre a été imaginée avant mon arrivée en thèse par les chercheurs Européens à l'initiative du projet Eco-serve (Lijbert Brussaard (head), Andreas Gattinger, Paul Mäder, José Paulo Sousa, Gerlinde De Deyn, Helene Bracht-Jørgensen, Katarina Hedlund, Tina D'Hertefeldt, Rubén Milla, Sandra Lavorel, Arnaud Foulquier, Jean-Christophe Clément). L'échantillonnage des TME a également été réalisé avant mon arrivée par Nicolas Legay, Arnaud Foulquier et Jean Christophe Clément (pour le site Français) et par les collaborateurs suisses et portugais pour les autres sites. Le maintien de l'expérimentation a ensuite été mené par l'équipe portugaise (José Paulo Sousa, Eduardo Nascimento, Filipa Reis, Filipe Carvalho, Pedro Martins da Silva). J'ai participé aux échantillonnages au Portugal avec la majorité des membres du projet. Ma contribution a été importante à la suite de l'expérimentation puisque j'ai été responsable de l'élaboration de la base de données (sol, microbiologie, faune du sol) et de l'élaboration d'une approche statistique commune visant à homogénéiser les analyses des différents articles issus de cette expérimentation.

Plus précisément concernant les données utilisées dans ce chapitre, j'ai conduit les analyses en laboratoire des analyses enzymatiques et les analyses des teneurs en C et N des sols avec l'aide de C. Arnoldi, J.C. Clément et A. Foulquier.

J'ai réalisé l'ensemble des analyses statistiques présentées dans ce chapitre, ainsi que la rédaction de la 1<sup>ère</sup> version de cet article et de cette 2<sup>ème</sup> version suite à une révision par l'ensemble des co-auteurs.

## CONCLUSION ET PERSPECTIVES DU CHAPITRE 2.1

Ce chapitre 2.1 a permis d'étendre le test de notre hypothèse générale sur la résilience : à trois sites d'études répartis à travers l'Europe et à trois types de stress climatiques simulés sur une longue durée. Les résultats confirment le compromis entre résistance et récupération pour la biomasse (bactérienne) et l'activité enzymatique totale du sol. Cette réponse s'applique à la résilience aux trois types de stress climatiques simulés, suggérant des facteurs communs contrôlant la résilience des communautés microbiennes à de multiples stress. Comme observé dans le chapitre 1, ce sont les sols de prairies conventionnelles-intensives (« sown intensive » pour le territoire de montagne étudié dans le chapitre 1) qui présentent la plus haute résistance alors que ce sont les sols de prairies éco-intensives (« permanent intensive » dans le chapitre 1) qui présentent la meilleure capacité de récupération. Parmi nos observations, les principales différences entre modalités de gestions pouvant potentiellement expliquer ces différences de résiliences sont une différence de composition de la communauté microbienne (évaluée avec l'abondance relative de 27 PLFAs) et des différences concomitantes de traits des litières, avec une plus grande richesse en phosphore observée pour les plantes des prairies éco-intensives (voir chapitre 2.3) comme déjà observé dans le chapitre 1 (associée également à une plus faible teneur en matière sèche des feuilles). Ainsi ces résultats suggèrent que les traits des plantes et des litières associées pourraient jouer un rôle important dans le contrôle de la résilience des communautés microbiennes face à de multiples stress via une modification de la composition de ces communautés.

Le chapitre suivant (2.2) s'appuiera sur les données de la même expérimentation pour évaluer comment l'intégration des enzymes extracellulaires dans le cadre conceptuel des traits fonctionnels peut apporter des éléments de compréhension de la stratégie d'acquisition des ressources des différents groupes microbiens (champignon, bactérie gram positive, bactérie gram négative) (point 1 ci-dessous) et des mécanismes de contrôle des propriétés écosystémiques microbiennes (point 2 ci-dessous) le long de gradients climatiques et de conditions de sol. Ainsi, ce chapitre 2.2 portera en particulier sur : 1) l'étude des relations entre CWM microbiens et composition des communautés microbiennes sur l'ensemble du jeu de données (To, T1 et T2) balayant de larges gradients de conditions climatiques et de sol ; 2) la question du rôle des CWM microbiens et de la composition de la communauté, dans le contrôle des niveaux des propriétés écosystémiques microbiennes (biomasse, activité totale), ces propriétés étant seulement abordées au niveau de leur stabilité dans le chapitre 2.1.

*“See simplicity in the complicated,  
Seek greatness in little things.  
In the universe, the difficult things are done as if they  
were easy.”*

Lao Tseu, VI-V<sup>ème</sup> siècles avant J.-C.

---

# CHAPITRE 2.2

## (ARTICLE 3)

Implementing ecoenzymes in the trait framework  
bring new insights on the microbial community  
composition control on ecosystem functioning.

---

Gabin Piton<sup>1</sup>, Arnaud Foulquier<sup>1</sup>, Laura Martinez<sup>2</sup>, Nicolas Legay<sup>3</sup>, Lijbert Brussaard<sup>2</sup>, Katarina Hedlund<sup>4</sup>, Eduardo Nascimento<sup>5</sup>, Filipa Reis<sup>5</sup>, Paulo Sousa<sup>5</sup>, Gerlinde De Deyn<sup>2</sup>, Jean Christophe Clement<sup>6</sup>

<sup>1</sup>Univ. Grenoble Alpes, Univ. Savoie Mont Blanc, CNRS, LECA, 38000 Grenoble, France

<sup>2</sup>Soil Biology Group, Wageningen University & Research, P.O. Box 47, 6700 AA Wageningen, The Netherlands

<sup>3</sup>École de la Nature et du Paysage, INSA Centre Val de Loire, 41000 Blois - CNRS, CITERES, UMR 7324, 37200 Tours, France.

<sup>4</sup>Department of Biology, Lund University, SE-223 62 Lund, Sweden.

<sup>5</sup>Centre for Functional Ecology, Department of Life Sciences, University of Coimbra, 3000-456 Coimbra, Portugal

<sup>6</sup>Univ. Savoie Mont Blanc, INRA, CARRTEL, 74200, Thonon-Les-Bains, France

This chapter is in preparation for submission in an international peer reviewed journal.

## ABSTRACT

Response-effect traits model represents a powerful framework to assess how environment influences ecosystem functioning through community assembly. While common in plant ecology, this framework is rarely implemented in microbial ecology. Based on a terrestrial ecosystem model experiment, assessing ecosystem response to different rain regimes across countries and managements, we investigated: 1) associations between microbial community composition and proxies of their resource acquisition strategy (ecoenzymatic traits) along resources gradients; 2) how mass specific enzyme activities and community composition control microbially-mediated ecosystem processes (Total soil enzymes activity). First, tight associations were observed between ecoenzymatic traits (enzymatic stoichiometry and mass specific activity) and community composition, bringing new elements on the resource acquisition strategy of the functional groups investigated (fungi, gram positive and gram negative bacteria), explaining their variations along resource gradients. Second, we demonstrated that biomass explained most of the total enzymes activity before altered rain regimes while mass specific activities explained most variation during altered rain regime scenarios. Our results showed that variation of community composition is the main driver of the variation of mass specific enzyme activity prior perturbation, while community members' acclimation (modification of mass specific enzyme activity independent of community composition shift) was more important under altered rain regimes. Investigating factors controlling variations of microbial community-weighted mean traits, such as mass-specific activity and ecoenzymatic stoichiometry, in the response-effect trait framework proves to be a promising approach to understand and model microbial community composition and ecosystem level processes response to climate change.

## 1 INTRODUCTION

The linkage between response and effect traits provide a mechanistic basis to understand community assembly and cascading effect on ecosystem functioning (Lavorel and Garnier 2002, Litchman et al. 2015) (Figure 23). However, this framework is less frequently used in microbial ecology (Chapter 1). Plant and microbial traits associated with resource acquisition are both response and effect traits (Lavorel and Garnier 2002, Litchman et al. 2015). Heterotrophic soil microbes present different resource acquisition strategies mostly based on extracellular organic matter decomposition and assimilation of its depolymerized compounds (Sinsabaugh and Follstad Shah 2012). Traits associated with extracellular enzyme production (ecoenzymatic traits) and nutrients uptake are probably key in physiological and evolutionary trade-off (Malik et al. 2019a) (Figure 23). Indeed, the production of extracellular enzymes has high energy and nitrogen (N) costs (Frankena et al. 1988, Allison et al. 2010), at the

expense of the investment in other metabolic pathways such as growth or cellular maintenance and stress tolerance (Malik et al. 2019a). It has been proposed that oligotrophic species in resource-poor environments invest more in extracellular enzymes to cope with low resource availability compared to copiotrophic species with a growth oriented strategy dominating in resource-rich environments (Fontaine et al. 2003, Fierer et al. 2007).

Trades-off also exist between the production of different enzymatic classes since enzymes should match with substrate availability while satisfying the nutritional need of the microbial cell (Figure 23). Biomass stoichiometry is relatively constrained in heterotrophic microbes (Fanin et al. 2013, Zechmeister-Boltenstern et al. 2015), with high biomass C:N and N:P ratios reported in fungi and/or oligotrophic microbes (Fierer et al. 2007, Strickland and Rousk 2010, Litchman et al. 2015). To match this stoichiometric constraints, microbes optimize their enzyme production for C, N and P acquisition toward the most limiting element to maximize their



fitness (resource allocation model (Sinsabaugh et al. 1993)). Thus, enzymatic stoichiometry, that is the relative investment by microbes for C, N or P acquisition enzymes (Sinsabaugh et al. 2009), is considered here as a proxy of the nutritional constraint on microbial communities.

Piton et al (Chapter 1) demonstrated that mass-specific enzymes activities (activity per unit of microbial biomass) and enzymes stoichiometry can be considered as proxies of community-weighted mean (CWM) traits representative of the dominant strategy in the microbial community. Decreases in mass-specific extracellular enzyme activity along soil resource gradients (Allison et

al. 2007b, Malik et al. 2019b and Chapter 1) suggest that oligotrophic microbes invest more in the production of extracellular enzymes (Fontaine et al. 2003). Thus ecoenzymatic CWM traits (mass specific activity and enzymatic stoichiometry) are promising candidates to understand how the soil microbial community responds to environmental changes. Such understanding might bring new elements on the mechanisms behind the cascading effect from environment to ecosystem functioning through microbial response-effect traits.

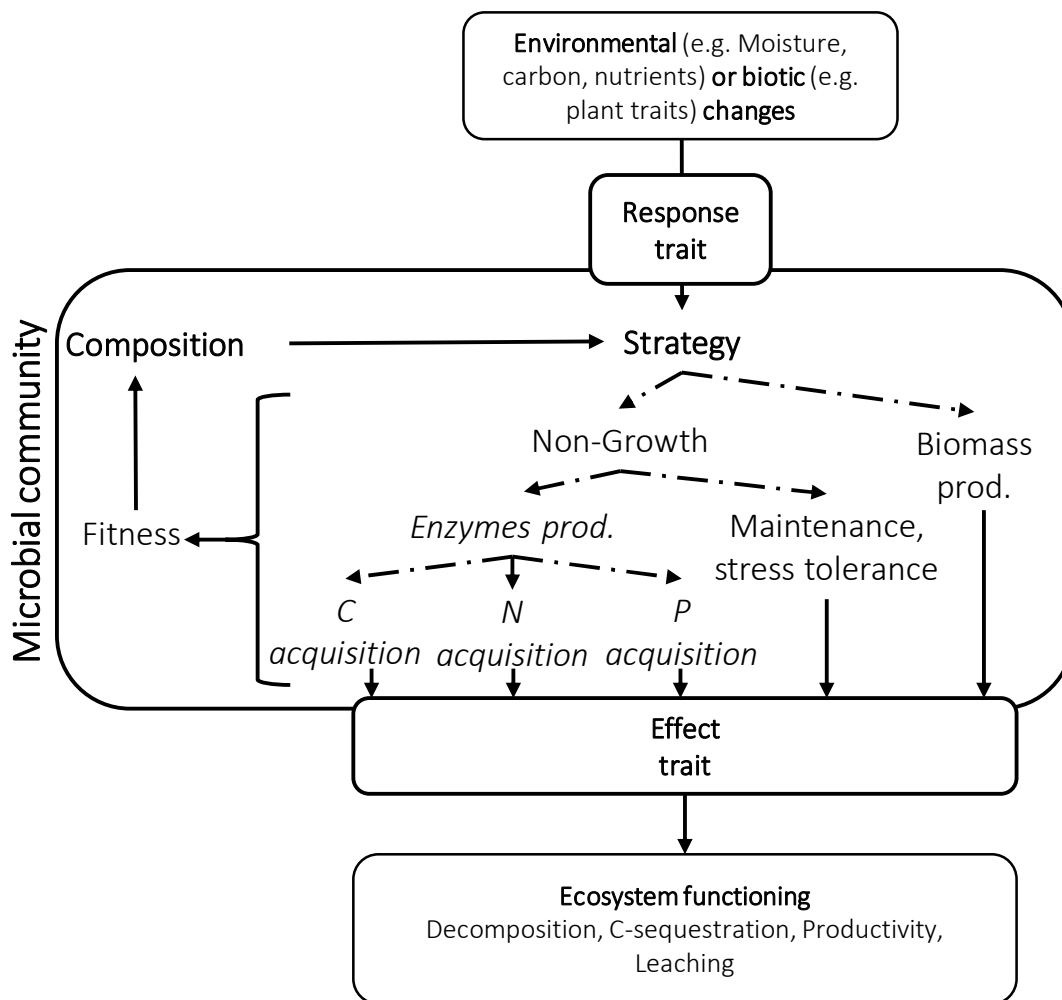

Figure 23 Response-effect trait model (Lavorel and Garnier 2002) adapted for soil microbial community, demonstrating the central position of ecoenzymatic traits (Enzyme production for C, N and P acquisition) in evolutionary and/or physiological trade-off (dotted arrows) affecting fitness and community composition, and microbial community effect on ecosystem functioning.

The total extracellular enzyme activities in soils controls decomposition and mineralization of organic matter (Schimel and Bennett 2004). These microbial ecosystem processes are controlled by mechanisms scaling from individual to community level (Sinsabaugh 2005, Burns et al. 2013). Extracellular enzymes are broadly produced among soil microbes (Allison et al. 2007a, Vranova et al. 2013), so that total soil enzyme activity is assumed to be firstly controlled by the total microbial biomass (Kivlin et al. 2013). However a decoupling between biomass and total enzyme activity can be induced by enzyme stabilization on inorganic surfaces and organic colloids and persistence after the death of their producers (Nannipieri et al. 2018), or when extracellular enzyme production per unit of mass differs among microbes (Allison et al. 2007b, Burns et al. 2013, Kivlin et al. 2013, Steinweg et al. 2013). Variations in mass-specific activity at the community level can emerge from change in community composition (Li et al. 2019) or community members' acclimation to environmental changes (Schimel et al. 2007). There is evidence for a large variation of enzyme production rates across community and taxa (Lladó et al. 2016, Manoharan et al. 2017, Žifčáková et al. 2017). At broad taxonomic scale, a more important enzymatic machinery for fungi is expected compared to bacteria explaining their succession during litter decomposition (Sinsabaugh 2005), while the importance of bacteria in soil enzyme activity has also been showed (Manoharan et al. 2017, López-Mondéjar et al. 2019). Several studies also indicate a variation in enzymatic investment within bacterial and fungal groups (Lladó et al. 2016, Pierre-Emmanuel et al. 2016). Gram positive and Gram negative bacteria are considered as oligotrophic and copiotrophic respectively (Fierer et al. 2007, Fanin et al. 2018). Gram positive bacteria use more recalcitrant carbon (C) compounds and produce more enzymes to extract energy and nutrients from organic matter. Comparatively, Gram negative bacteria use labile C compounds and produce less enzymes (Fanin et al. 2018, Naylor and Coleman-Derr 2018). Together these studies suggest the potential important contribution of the microbial community composition to ecosystem functioning (Graham & al (2016). Finally, experimental results also gave support for

community members' acclimation to environmental change, with variable enzyme investment within microbial populations (Allison et al. 2014, Lashermes et al. 2016). Thus, the control of total extracellular enzyme activity in soil relies on four parameters: variation in microbial biomass, difference in community composition, community members' acclimation and enzyme stabilization. Empirical studies would gain from a better mechanistic understanding by adopting a trait based framework decoupling mechanisms driving such microbially mediated ecosystem processes. A first step would be to assess the relative importance of biomass and mass-specific activity for total enzymatic activity. Then, crossing mass specific activity and community composition would enable to assess the relative importance of community composition *vs.* (community members' acclimation + enzyme stabilization) in the variation of mass specific activity. To assess the relative importance of these four parameters, their physical control in a manipulated experiment would be very difficult and implicate highly artificial environment. Even if some drawback exist, statistical control in the structural equation model framework can be used as an alternative to assess different mechanisms in experimental or observational study where factors affecting the processes under investigation cannot be physically controlled (Shipley 2016).

Based on experimental data assessing ecosystem functioning across managements (conventional intensive *vs.* ecological intensive) and countries (France, Switzerland and Portugal) under 4 rain regime scenarios (Dry, Normal, Intermittent and Wet rain regimes, during 263 days, followed by 89 days of recovery), we used ecoenzymatic CWM traits (Chapter 1): 1) to elucidate traits associated with community composition along abiotic gradients ; and 2) to disentangle mechanisms driving the total soil enzymatic activity.

We hypothesized:

**H1)** high mass specific activity (oligotrophic trait), and nutrient acquisition strategy, to be associated with fungi and/or Gram positive dominated community, explaining their dominance in low nutrients and low moisture conditions.

After testing this hypothesis, we assessed the relative importance of biomass variation and mass specific activity in the variation of total soil enzyme activity (ecosystem property). Structural equation models were used to investigate how soil abiotic factors and community composition control these two parameters, to disentangle the different mechanisms driving total enzymatic activity in soil.

We further hypothesized that microbial biomass variation would be the main driver of total enzyme activity in soil, especially in stable conditions, whereas altered rain regimes can induce mass specific activity adjustment in response to resource availability changes (**H2.1**). These mass specific modifications are mainly controlled by changes in microbial community composition and only marginally by community members' acclimation or enzyme stabilization (**H2.2**).

## 2 MATERIALS AND METHODS

### EXPERIMENTAL DESIGN AND VARIABLES MEASUREMENT METHODS

Experimental design and methods were detailed in chapter 2.1. (p84, 2.1 Experimental design and setup). To avoid redundancy, this part is not repeated here.

#### 2.1 VARIABLES SELECTION

Only a subpart of the variables measured have been used in this chapter. These variables can be split in four groups:

##### 2.1.1 Soil abiotic environment

Three abiotic variables have been used to characterized soil abiotic environment potentially

affecting soil microbial community: soil N, pH and moisture.

We used total soil N to represent soil nutrient availability. We choose total soil N over dissolved mineral N pools because dissolved pools can vary on a shorter time scale, close to the time scale of the microbial community response. Thus, it is more difficult to disentangle if these pools affect soil microbial community or if they are affected by it. On the other hand, it is less likely that total soil N was influenced by microbial community on the time scale of the experiment.

We did not use total soil C, firstly because we expect soil N to be a more important driver of microbial community composition, especially for the F:B ratio (De Vries et al. 2006) and because total soil C was highly related to total soil N on the data set ( $R^2=0.77$ ). Dissolved organic C was not included neither for the same reason than dissolved N pools.

##### 2.1.2 Total Microbial biomass-C and total extracellular enzymes activity.

Total microbial biomass-C and total extracellular enzymes activity (per gram of dry soil) have been calculated as described in chapter 2.1.

##### 2.1.3 Microbial community composition.

Fungal:Bacterial (F:B) and Gram positive:Gram negative (GP:GN) ratios have been calculated as described in chapter 2.1. and the relative abundances of the 27 individuals PLFA were used to describe the overall community composition.

##### 2.1.4 Ecoenzymatic traits

Two kinds of ecoenzymatic traits have been calculated: mass specific activity and ecoenzymatic stoichiometry. Mass specific activities (EEA: Mic-C) were calculated by weighting total enzymes activity with total microbial biomass-C (Mic-C). This indicator has been used as a proxy of the average investment in extracellular enzyme activity of one mass-unit of microbe (Allison et al. 2007b, Moorhead et al. 2013, Malik et al. 2019b). Ecoenzymatic stoichiometry has been also calculated following (Sinsabaugh et al. 2009) : the enzymatic C:N ratio (EEC:EEN) was calculated as  $\ln(\text{BG}):\ln(\text{NAG}+\text{LAP})$ ,

the enzymatic C:P ratio (EEC:EEP) was calculated as  $\ln(\text{BG}):\ln(\text{PHOS})$  and the enzymatic N:P ratio (EEN:EEP) was calculated as  $\ln(\text{NAG}+\text{LAP}):\ln(\text{PHOS})$ . These indicators were used to represent the orientation of the resource acquisition strategy (towards C, N or P).

## 2.2 STATISTICAL APPROACH

### 2.2.1 Microbial community composition

A Principal Coordinates Analysis (PCOA) was conducted on the relative abundances of the 27 individual PLFAs measured at To, T1 and T2 (full dataset). Then, sample coordinates from this PCOA were used to produce a synthetic variable representing the overall variation in microbial community composition.

### 2.2.2 Correlations between soil abiotic properties, microbial community composition and ecoenzymatic traits.

Effects of sampling time, microbial community composition (F:B, GP:GN, PCOA-1) and soil abiotic properties (Soil-N, pH and moisture) on ecoenzymatic stoichiometry (EEC:EEN, EEC:EEP and EEN:EEP) have been assessed using mixed effect models with sampling time and microbial community composition or soil abiotic properties and their interactions as explanatory variables, ecoenzymatic stoichiometry as response variable, and with country and plot nested in country as random factors. We also assessed correlations between microbial composition and soil abiotic properties (Soil-N, pH, moisture) for each sampling time (To, T1, T2) using mixed effect correlations.

### 2.2.3 Factor controlling microbial biomass and total extracellular enzyme activity

Total enzyme activity can be decomposed as follow:

$$\ln(\text{EEA}) = \ln\left(\frac{\text{EEA}}{\text{Biomass}} \times \text{Biomass}\right)$$

$$\ln(\text{EEA}) = \ln\left(\frac{\text{EEA}}{\text{Biomass}}\right) + \ln(\text{Biomass})$$

Thus the natural logarithm of the soil enzyme activity can be decomposed in the sum of the natural

logarithm of mass specific activity  $\left(\ln\left(\frac{\text{EEA}}{\text{Biomass}}\right)\right)$ , a CWM trait and natural logarithm of biomass  $\left(\ln(\text{Biomass})\right)$ . To assess the relative importance of these 2 components (Biomass and mass specific activity) in the control of total enzyme activity, regressions of  $\ln(\text{EEA})$  on  $\ln(\text{Biomass})$  were fitted for each sampling time. The proportion explained by the model represents the importance of biomass in the control of total enzyme activity in soil while the non-explained variation was attributed to variation in mass specific activities.

Then, piecewise structural equation models (SEM) were used to assess the most important mechanisms driving both parameters (Biomass and mass specific activity,

Figure 24). This method is less sensitive to sample size and enables to implement mixed effect model in the SEM structure (Lefcheck 2016). In such approach, Shipley's test of directed separation (based on a chi-square test, see (Shipley 2000, 2009)) is used to assess model goodness-of-fit, testing if missing paths exist in the model structure. When several models are accepted, information criterion such as Akaike information criterion or Bayesian Information Criterion (BIC) can be used to identify the best model. To obtain the most parsimonious model we used a three steps selection process, testing a series of potential mechanisms through which soil abiotic environment might influence extracellular enzyme activities, established based on our knowledge of the system (Laughlin et al. 2007, Grace et al. 2015). Firstly, a SEM was fitted with the most parsimonious a priori structure (Figure 24), stating that mass specific activity was only driven by community composition (H2.2), then model fit was assessed a first time. In the case of model rejection ( $p\text{-val} < 0.05$ ), potential missing paths in the SEM structure (direct effect of soil abiotic properties on mass specific activities, indicating community members acclimation or modification of enzyme turnover by abiotic conditions) were evaluated using d-sep test (Shipley 2000, 2003). Secondly, missing paths were added and model fit was newly assessed. Finally, we used a stepwise removal process of non-significant relationships. As de Vries & al (2016), we tested the effect of each removal using information criterion. Bayesian

Information Criterion (BIC) was used instead of Akaike information criterion because BIC presented better ability to identify true model in a simulation study with conditions close to our experiment (Hertzog, 2019). Each removal is retained if it did not induce a significant

increase of BIC criteria ( $\Delta BIC < 2$ ) compared to the model with the lower BIC. Global model fit and quality of the final model was verified using Fisher's C test,  $R^2$  of endogenous variables and paths significances before starting interpretation, as suggested by Hertzog (2018).

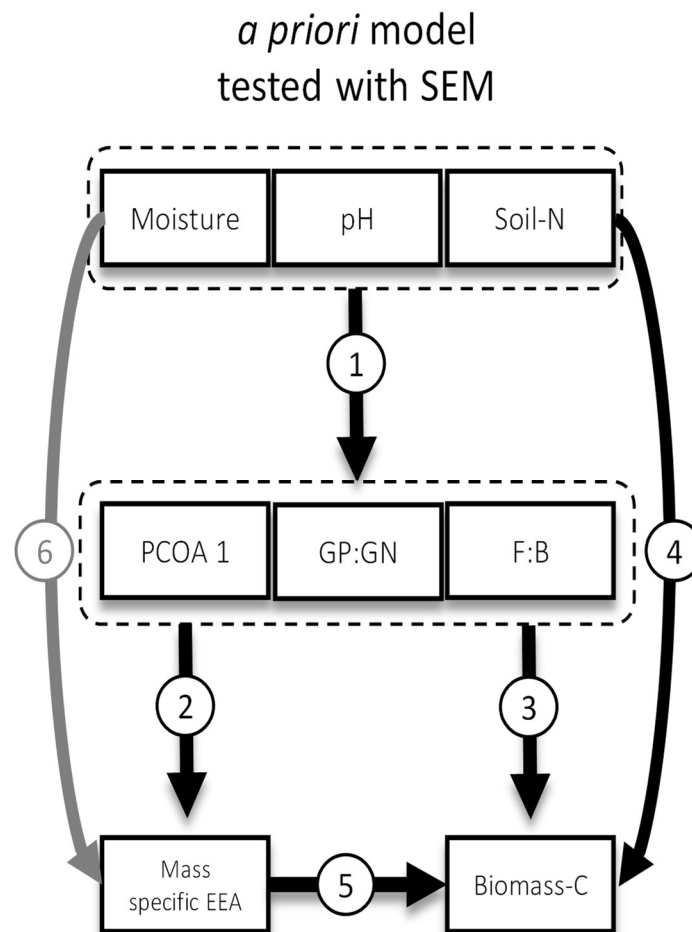

Figure 24 *a priori* model tested using SEM stating : soil abiotic factors influence on microbial community composition (arrow 1); community composition effect on mass specific activity (arrow 2) explained by difference in enzyme production between taxa ; community composition effect on biomass-C (arrow 3) explained by stoichiometry, growth or carbon use efficiency difference between taxa; direct abiotic effect of soil abiotic properties which influence amount and availability of resources (arrow 4) ; potential cost of enzyme production for biomass-C build up (arrow 5) ; direct effect of soil abiotic properties on mass specific activity representing either a community members' acclimation (change in enzyme production without modification of community composition) or enzyme stabilization (arrow 6). This last effect in grey was initially not included in the model and only added according to d-sep test (Shiple 2000, 2003, Lefcheck 2016).

Microbial community composition	Time	Soil abiotic properties					
		Soil-N		pH		Moisture	
		Coef	p	Coef	p	Coef	p
F:B	To	<b>-0.62</b>	<b>0.00</b>	<b>-0.40</b>	<b>0.05</b>	<b>-0.68</b>	<b>0.00</b>
	T1	-0.21	0.08	-0.17	0.13	<b>-0.25</b>	<b>0.01</b>
	T2	<b>-0.28</b>	<b>0.02</b>	<b>-0.33</b>	<b>0.00</b>	<b>-0.36</b>	<b>0.00</b>
GP:GN	To	-0.18	0.17	-0.14	0.22	<b>-0.54</b>	<b>0.01</b>
	T1	<b>-0.41</b>	<b>0.00</b>	<b>-0.26</b>	<b>0.00</b>	-0.20	0.03
	T2	<b>-0.22</b>	<b>0.03</b>	<b>-0.24</b>	<b>0.00</b>	-0.21	0.05
PCOA-1	To	<b>-0.26</b>	<b>0.00</b>	<b>-0.18</b>	<b>0.03</b>	<b>-0.57</b>	<b>0.00</b>
	T1	<b>-0.40</b>	<b>0.00</b>	<b>-0.43</b>	<b>0.00</b>	0.09	0.30
	T2	-0.12	0.14	<b>-0.39</b>	<b>0.00</b>	-0.02	0.83

Table 1: Bivariate correlations between microbial community composition and soil abiotic properties at To, T1 and T2. Coef= standardized coefficient, p=correlation p-value.

### 3 RESULTS

#### 3.1 INFLUENCE OF SOIL ABIOTIC PROPERTIES ON MICROBIAL COMMUNITY COMPOSITION

A large proportion (43%) of the microbial community composition was explained by the first axis of the PCOA (PCOA-1, Figure 25). PLFAs contributing the most to this axis (coordinates higher than 0.1 or lower than -0.1) were two Gram negative (18:1w7 and cy17:0) and one from Gram positive (a15:0) bacteria negatively related to the PCOA-1 and two Gram positive (i15:0 and i17:0), one from Actinobacteria (10Me17:0) and one from unclassified bacteria (15:0) positively associated to the PCOA-1 (Figure 25).

The F:B ratio decreased in nutrient rich, alkaline soils under wet condition, as demonstrated by a negative association with soil-N (To, T2), pH (To, T2) and moisture (To, T1, T2) (Table 1). The GP:GN ratio also decreased with nutrient availability (i.e. soil-N at T1 and T2), and alkalinity (i.e. pH at T1, and T2). PCOA-1 (Figure 25) showed almost the same behaviour, with negative association with pH (To, T1, T2), soil-N (To, T1) and moisture (To) (Table 1).

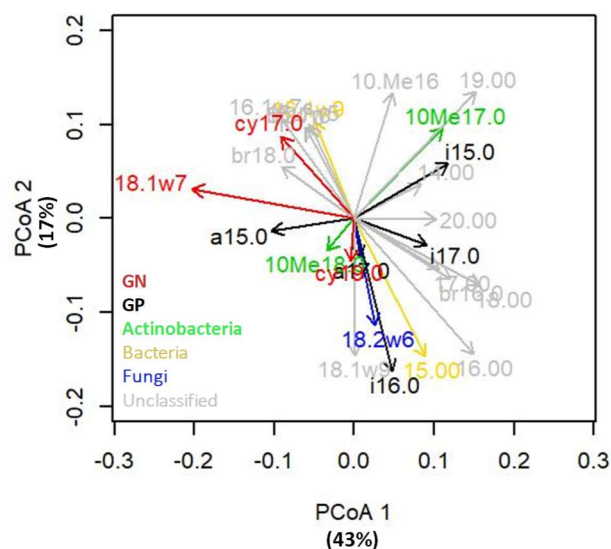

Figure 25. PCOA plot of the 27 individual PLFAs from the 3 sampling times (To, T1 and T2) representing the overall variation of the microbial community composition. Colours represent microbial groups.

### 3.2 INFLUENCE OF SOIL ABIOTIC PROPERTIES AND MICROBIAL COMMUNITY COMPOSITION ON ECOENZYMATIC STOICHIOMETRY

The association between ecoenzymatic EEC:EEN and EEC:EOP and soil abiotic properties highly varied between sampling times (significant interaction between soil properties and time, Figure 26). EEC:EOP ratios showed positive association with soil pH (T1 and T2) and

moisture (T2). Negative association between soil-N and EEC:EEN was observed only at T<sub>0</sub>, while EEC:EEN showed negative association with pH at T<sub>0</sub> shifting to positive at T<sub>1</sub> and T<sub>2</sub>. EEN:EOP showed more constant relationships with soil abiotic properties, increasing with soil-N and pH and decreasing with soil moisture at all sampling times (Figure 26).

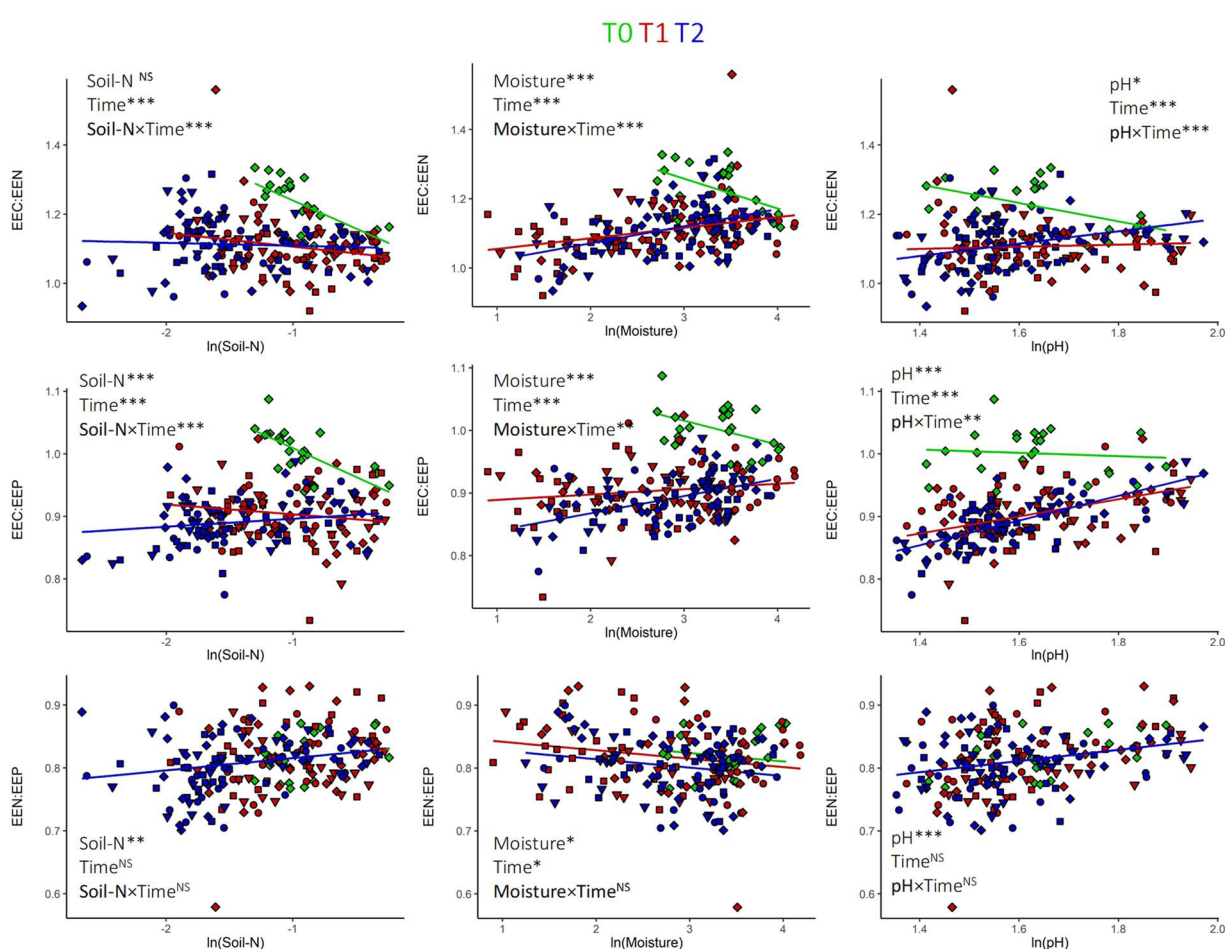

Figure 26 Correlations between ecoenzymatic stoichiometry and soil abiotic properties (Soil-N, moisture and pH) at different sampling times (T<sub>0</sub>: green, T<sub>1</sub>: red, T<sub>2</sub>: blue) and significance tested with mixed effect model using country as random factor. NS:  $p > 0.05$ , \*:  $p < 0.05$ , \*\*:  $p < 0.01$ , \*\*\*:  $p < 0.001$ . Points shapes represent the different rain regimes (square=dry, diamond=normal, triangle=intermittent, wet=circle).

Conversely, associations between microbial community composition and ecoenzymatic stoichiometry were highly constant between sampling times (Figure 27). More fungal dominated community (i.e. high F:B) showed N acquisition strategy as demonstrated by positive correlation observed with EEN:EEP and negative one with EEC:EEN (Figure 27). GP:GN ratio shifted

toward more P-oriented strategy with increasing Gram positive abundance, and towards C and N oriented strategy for Gram negative bacteria as demonstrated by negative associations of GP:GN with EEC:EEP and EEN:EEN (Figure 27). PCOA-1 showed the same association with ecoenzymatic stoichiometry than the GP:GN ratio (data not shown).

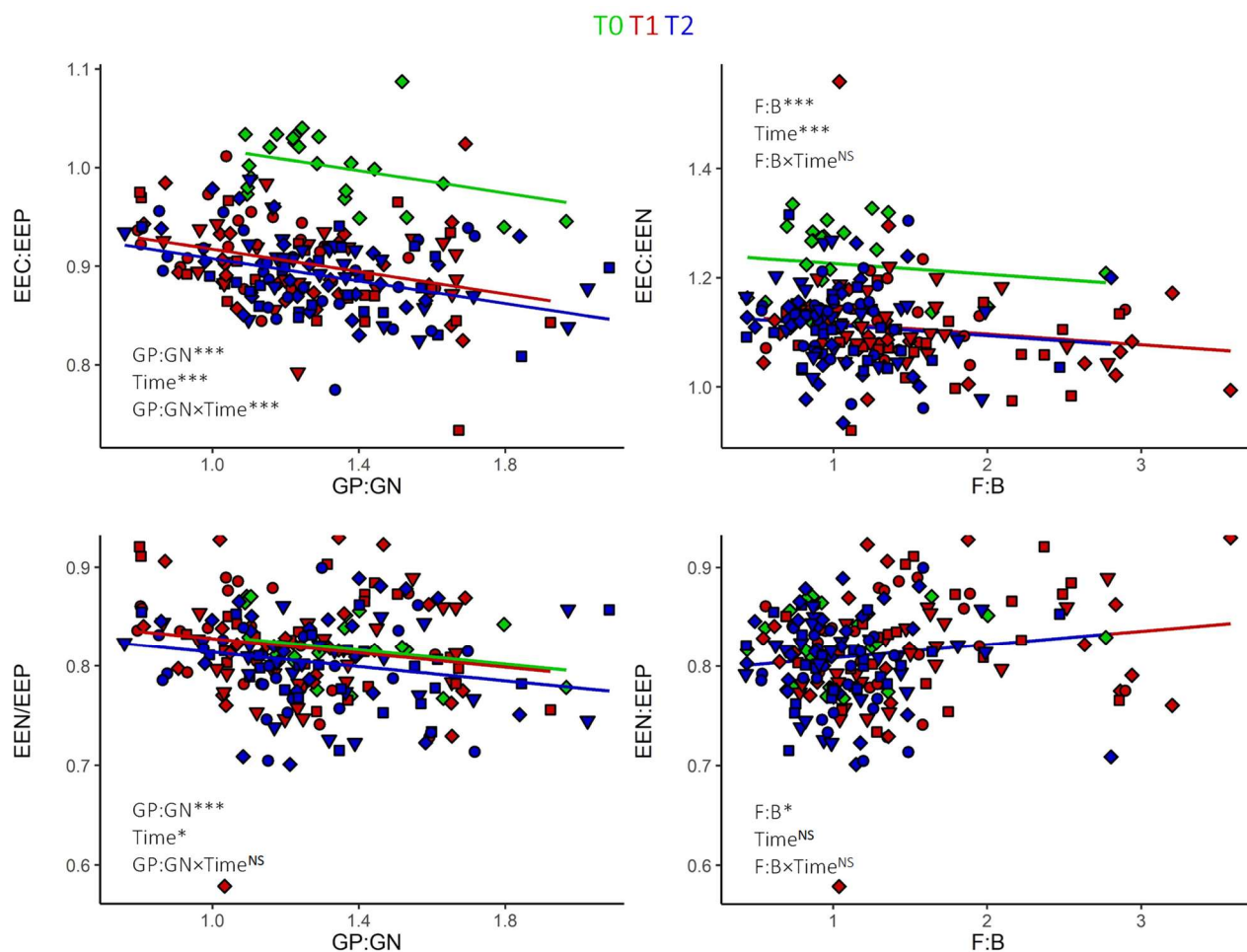

Figure 27 : Correlation between ecoenzymatic stoichiometry and community composition (Gram positive : Gram negative and Fungal : Bacterial ratios) at different sampling time (T<sub>0</sub>: green, T<sub>1</sub>: red, T<sub>2</sub>: blue) and significance tested using mixed effect model using country as random factor. NS:  $p > 0.05$ , \*:  $p < 0.05$ , \*\*:  $p < 0.01$ , \*\*\*:  $p < 0.001$ . Points shapes represent the different rain regimes (square=dry, diamond=normal, triangle=intermittent, wet=circle).



### 3.3 CONTRIBUTIONS OF MICROBIAL BIOMASS AND MASS-SPECIFIC ACTIVITY TO TOTAL ENZYMATIC ACTIVITY

The total enzymatic activity was significantly correlated with microbial biomass at all sampling times ( $p < 0.001$ ), with  $R^2$  varying from 91% of the EEA variation explained by biomass at T<sub>0</sub>, to 46% at T<sub>1</sub> and 62% at T<sub>2</sub> indicating a higher contribution of mass specific activity to total soil enzyme activity before and at the end of the altered rain regime period (Figure 28).

### 3.4 DRIVERS OF MICROBIAL BIOMASS AND MASS-SPECIFIC ACTIVITY

Due to their high covariation, PCOA-1 and GP:GN ratio ( $R^2 = 0.42, p < 0.001$ ), showed similar responses to soil abiotic factors and had the same effect on mass specific activity and biomass. Yet, PCOA-1 better explained mass specific EEA and was therefore conserved in the final structural equation model (Figure 29). At T<sub>0</sub> the SEM with full *a priori* structure stating that mass specific activity was only driven by community

composition, and not by community members' acclimation and enzyme stabilization, was accepted ( $C6 = 6.05, p = 0.42, BIC = 88.68$ ). Then model simplification based on BIC criterion led to the removal of 6 paths (Figure 29,  $C18 = 10.31, p = 0.92, BIC = 77.05$ ). At T<sub>1</sub> the SEM with full *a priori* structure was rejected ( $C6 = 18.34, p = 0.005, BIC = 136.47$ ) indicating missing paths in the SEM structure: Composition was not sufficient to explain mass specific activity, suggesting community members' acclimation and/or enzyme stabilization also occurred. D-sep tests examination showed a missing path between mass specific activity and moisture. The addition of this path improved the SEM which was finally accepted ( $C4 = 2.838, p = 0.59, BIC = 125.51$ ), then model simplification led to the removal of 2 paths (Figure 29,  $C8 = 11.17, p = 0.19, BIC = 124.75$ ). At T<sub>2</sub> the *a priori* model was accepted ( $C6 = 7.89, p = 0.25, BIC = 126.56$ ) and model simplification based on BIC criterion led to the removal of 4 paths (Figure 29,  $C14 = 15.75, p = 0.33, BIC = 116.17$ ).

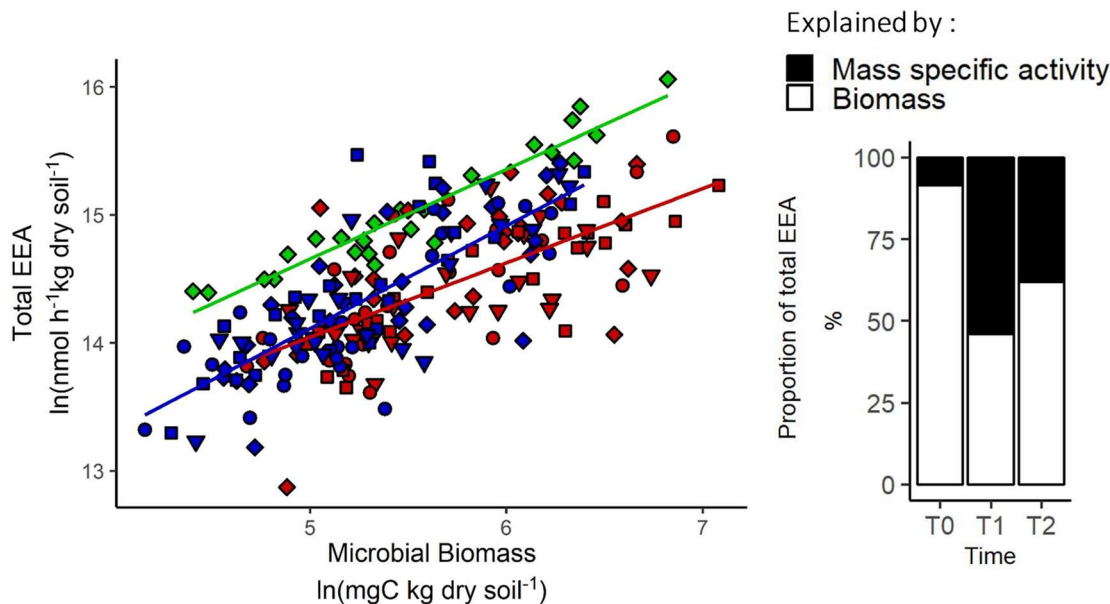

Figure 28: Correlation between the natural logarithm of the total enzymatic activity and the natural logarithm of microbial biomass for the three sampling times (T<sub>0</sub>: green point solid line, T<sub>1</sub>: red point, dotted line T<sub>2</sub>: blue point dashed line), left panel. Proportion of total enzymatic activity explained by biomass ( $R^2$  of the correlation between natural logarithm of the total enzymatic activity and the natural logarithm of microbial biomass) and mass specific activity (variation not explained by biomass), right panel.

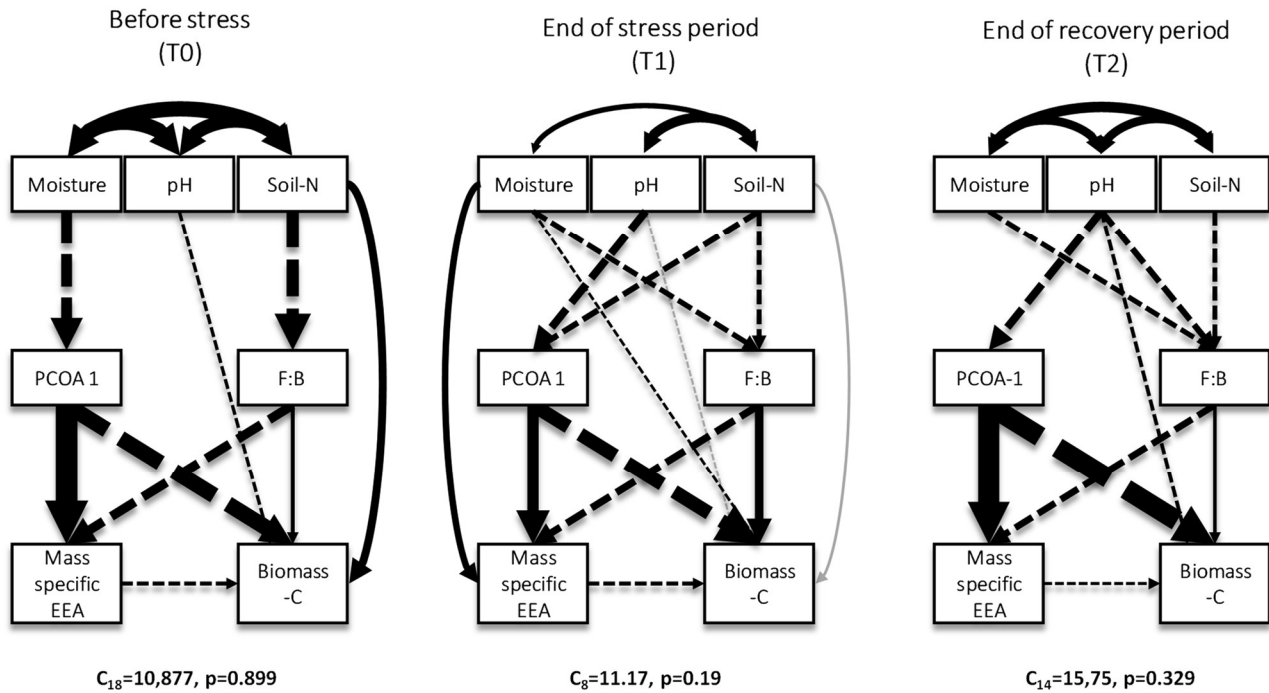

Figure 29: Final structural equation models at  $T_0$ ,  $T_1$  and  $T_2$ . Hypothetical causal relationships are represented by one-headed arrow and free correlations between residuals with double-headed arrows. Arrow width represents standardized effect size. Solid line represents positive effect and dashed line negative effect. Black arrows represent significant effect and grey arrow non-significant effect conserved during selection process.

## 4 DISCUSSION

### 4.1 ECOENZYMATIC CWM TRAITS AND MICROBIAL COMMUNITY COMPOSITION ALONG ABIOTIC GRADIENTS

Variations of microbial community composition along environmental gradients have been extensively reported (Fierer and Jackson 2006, Allison et al. 2007b, Lauber et al. 2009, De Vries et al. 2012, Fierer et al. 2012a, Ren et al. 2018, Martinez-Almoyna et al. 2019) however they rarely explored how the observed community shifts could explain microbial traits variations (Fierer et al. 2012b, Leff et al. 2015). The first aim of this study was to assess the relationships between microbial community composition and ecoenzymatic CWM traits along environmental gradients to explore potential mechanisms underlying variations in microbial traits.

Observed associations between soil abiotic properties and community composition were consistent

with the literature (De Vries et al. 2006, Ho et al. 2017, Naylor and Coleman-Derr 2018), indicating that oligotrophic environments (low resource availability) favour fungi and Gram positive bacteria, while resource-rich conditions were beneficial for Gram negative (Figure 29). Our trait-based approach showed distinct ecoenzymatic CWM traits associated with these three microbial groups, potentially explaining their dominance in oligotrophic and copiotrophic environments.

Fungi were associated with low investment in extracellular enzyme production and their ecoenzymatic stoichiometry suggested their enzyme production to be oriented preferentially toward N acquisition. Gram positive bacteria were associated with a higher investment in extracellular enzymes production oriented toward P acquisition. Finally, Gram negative bacteria showed lower investment in enzyme production and a strategy oriented toward C acquisition.

The lower mass specific enzymatic activity in fungal dominated communities (Figure 29) was unexpected

since fungi are commonly considered as principal enzyme producers in soil (Sinsabaugh 2005, Romaní et al. 2006). However, only hydrolytic enzymes were measured in this study and not oxidative ones, which could have biased this observation. Oxidative enzymes production was observed in both bacterial and fungal groups (Allison et al. 2007a), but the capacity to produce enzymes degrading lignin is more restricted in microbes than hydrolase production, with important contribution attributed to fungi such as white-rot basidiomycetes (Kirk and Farrell 1987, Boer et al. 2005). Thus, the pattern observed here might also corresponds to a shift from a resource acquisition strategy based on hydrolytic enzymes for bacteria, to a strategy more based on oxidative enzymes from fungi. Similar work, crossing hydrolase and oxidase measurement should bring light on such potential trade-off. Overall, this result was consistent with the growing idea that bacteria are also important in organic matter degradation (López-Mondéjar et al. 2019). Beside, fungal dominance in N-poor soil observed at T<sub>0</sub> and T<sub>2</sub> (Table 1), associated with higher relative production of N-acquisition enzyme (Figure 27), supported the resource allocation model, which predicts higher investment in N acquisition to be beneficial when N is limiting (Sinsabaugh et al. 1993). Considering also the higher biomass C:N ratio of fungi compared to bacteria (Strickland and Rousk 2010), higher biomass C:N combined with lower EEC:EEN ratio seems to be two response traits associated to low N but high C availability (Mooshammer et al. 2014) likely explaining fungal dominance in such environments.

Decrease of GP:GN and PCOA-1 was associated with variations in ecoenzymatic stoichiometry indicating a shift from P to C acquisition concomitant to a reduction of mass specific activity, consistent with our hypothesis H<sub>1</sub>. The most constant abiotic driver of GP:GN and ecoenzymatic C:P ratio was pH. pH is known to strongly influence P availability, potentially explaining why microbes invest more in P acquisition in acidic soil and shift for C acquisition under neutral conditions where pH constraint on P availability is released (Xu et al. 2017). Our results are also consistent with Gram positive having a more oligotrophic strategy (Naylor and Coleman-Derr

2018) and depict two traits that might explain their dominance in resource poor and acidic soil : a higher investment in extracellular enzymes to cope with low resource availability (Fontaine et al. 2003, Allison et al. 2007b, Malik et al. 2019b), and a preferential investment in P acquisition to cope with low P availability. Contrastingly, Gram negative bacteria showed a copiotrophic strategy, producing less enzymes (Fontaine et al. 2003), and relying on labile C from plants (Fanin et al. 2018), two traits that might explain their dominance in neutral and resource rich soil.

Ecoenzymatic EEC:EEN ratio was related to soil N at T<sub>0</sub>, and became more associated to soil moisture at T<sub>1</sub> and T<sub>2</sub> (Figure 26), while remaining strongly negatively associated with F:B at all sampling times (Figure 27). The relationship between ecoenzymatic EEC:EEP and GP:GN ratio was also more stable through the experiment than the relationship between ecoenzymatic EEC:EEP ratio and soil abiotic factors. This suggests that ecoenzymatic stoichiometry was tightly associated with community composition. Thus, the predicted links between ecoenzymatic stoichiometry and C and nutrient availability (Sinsabaugh et al. 1993, 2009) might be limited if other factors such as soil moisture modify community composition. Here, for instance, fungi selected under low soil moisture kept a strategy oriented toward N-acquisition even if decoupled with nutrient availability.

#### 4.2 ECOENZYMATIC TRAITS AND TOTAL ENZYMATIC ACTIVITIES IN SOILS: DISENTANGLING MECHANISMS.

The second aim of this study was to assess the relative importance of different mechanisms (including trait response) to control total enzymes activity in soils.

Control of total enzymes activity in soil has been decomposed into biomass control and mass specific activity control (CWM trait effect). Our result confirms our hypothesis that biomass primarily controlled total soil enzyme activity under stable conditions while mass specific activity became the most important factor to predict variations under altered rain regimes (Figure 28). This shows the importance and need of a better

understanding of the factors controlling microbial CWM traits variation to model and predict ecosystem level processes, and, especially their transient response to climate changes. Using SEM, we tried to disentangle the mechanisms controlling biomass and mass specific activity variations.

#### 4.2.1 Factors controlling microbial biomass

Microbial biomass was directly affected by soil-N at To (Figure 29). Associated with soil organic matter quantity, higher soil N represents higher amount of resources available for microbes to build up biomass. We also found an important effect through community composition with F:B ratio having a positive effect on microbial biomass-C (Figure 29), which might be explained by a higher fungal biomass C:N (Strickland and Rousk 2010), a lower nutrient demand or a higher carbon use efficiency (Hodge et al. 2000, Keiblinger et al. 2010, Zechmeister-Boltenstern et al. 2015), indicating a higher capacity to build up microbial biomass-C for a same amount of resources. Conversely, PCOA-1, had a negative relationship with microbial biomass-C. This link with PCOA-1 was probably not due to a difference in biomass stoichiometry, as PCOA-1 was not associated with F:B ratio. However, oligotrophic community as indicated by PCOA-1 was likely to be characterized by a lower investment in biomass production (Figure 23) (Malik et al. 2019a, 2019b). The positive effect of bacterial community composition on mass specific EEA, translating into a negative effect on biomass suggests that oligotrophic community invests more C in non-growth products such as enzymes (Malik et al. 2019a).

To sum up, our results might depict two parallel mechanisms influencing microbial biomass-C through modifications in community composition: 1) a positive effect of fungal abundance through microbial biomass stoichiometry; 2) a negative effect of oligotrophic bacterial community through a higher investment in non-growth products. The importance of C from microbial origin in soil organic C sequestration is increasingly recognized (Schmidt et al. 2011, Liang et al. 2017), and our results suggested two potential parallel mechanisms controlling C sequestration (Trivedi et al. 2013).

#### 4.2.2 Factors controlling mass specific activity

Isolation studies have reported differences in enzymatic traits among microbial taxa (Lladó et al. 2016, Pierre-Emmanuel et al. 2016), supporting the possibility of a community composition effect on total enzyme activity in soils. However, in empirical studies directly measuring total enzymes activity in soil, the effect of community composition on enzymes activity has rarely been assessed after correction for the biomass effect (Kivlin et al. 2013). Using mass specific activity to correct for biomass effect, our results gave support to this mechanism. Indeed, microbial community composition was the first driver of variation in mass specific activity (Figure 29), which showed strong association with F:B, GP:GN and the first PCOA axis used as a proxy of variation in the overall community composition. It is interesting to note that PCOA-1 was a better predictor than copiotrophic:oligotrophic indicator such as the GP:GN ratio for mass specific activity. This invites for further investigations of enzymatic traits variation at a finer taxonomic resolution than broad groups such as fungi, gram positive and gram negative bacteria (Ho et al. 2017).

Direct positive effect of soil moisture on mass specific activity was detected at T1 suggesting other mechanisms than biomass and community composition to control soil enzyme activity. This direct effect can be attributed to community members' acclimation: modification of mass specific activity without change in community composition induced by phenotypic plasticity or species adaptation (Schimel et al. 2007, Allison et al. 2014, Lashermes et al. 2016), and/or enzyme stabilization (Nannipieri et al. 2018). Our statistical approach does not enable us to decouple these 2 mechanisms. However, enzyme turn-over is expected to be down regulated by soil drought, thus increasing the enzyme pool in soil (Steinweg et al. 2012, Kivlin et al. 2013), though we observed a negative effect of dry conditions. Consequently, we attribute the positive effect of soil moisture on enzyme production to community members' acclimation, whereas enzyme stabilization might be only marginal. Community members' acclimation suggests a decrease of enzyme production under low soil moisture,

and might result from a redirecting of metabolism from resource acquisition to stress resistance (Schimel et al. 2007). More studies on enzyme turnover in different environmental conditions such as Schimel et al. (2017) would be very valuable to decouple biotic vs. abiotic mechanisms driving total enzymatic activity in soil.

Overall, our results confirmed that microbial biomass is the first driver of the variation in total enzymatic activity in soil, followed by community composition and community members' acclimation, the two last mechanisms becoming especially important to explain variation under altered climate scenarios.

## 5 CONCLUSION

Interpreting our results through the lens of the response-effect trait framework, our results indicate that differences in ecoenzymatic CWM traits among microbial taxa might explain the response of community composition along environmental gradients. We also demonstrated that traits shift associated with microbial community composition response to environmental gradients can lead to modifications of ecosystem level processes. Our results also demonstrated that disentangling the effect of biomass and mass-specific activity is necessary to better understand the mechanisms underlying the response of microbially-mediated ecosystem processes to environmental variations (Billings and Ballantyne 2013, Kivlin et al. 2013). We argue that empirical studies looking at microbially mediated processes should develop a more mechanistic understanding of how microbial community drives ecosystem level processes by implementing this framework. The quantification of the relative importance of microbial biomass variation vs. trait variations (mass specific activity, enzyme stoichiometry) under different climate and land use scenarios, and the assessment of how much trait variations are related to community composition and/or community members' acclimation, would bring relevant insights to improve emerging trait based models (Allison 2012).

## REFERENCES

- Allison, S. 2012. A trait-based approach for modelling microbial litter decomposition. *Ecology letters* 15:1058–1070.
- Allison, S. D., T. B. Gartner, K. Holland, M. Weintraub, and R. L. Sinsabaugh. 2007a. Soil enzymes: linking proteomics and ecological processes. Pages 704–711 *Manual of Environmental Microbiology, Third Edition*. American Society of Microbiology.
- Allison, S. D., L. Lu, A. G. Kent, and A. C. Martiny. 2014. Extracellular enzyme production and cheating in *Pseudomonas fluorescens* depend on diffusion rates. *Frontiers in microbiology* 5:169.
- Allison, S. D., M. N. Weintraub, T. B. Gartner, and M. P. Waldrop. 2010. Evolutionary-economic principles as regulators of soil enzyme production and ecosystem function. Pages 229–243 *Soil enzymology*. Springer.
- Allison, V., L. Condron, D. Peltzer, S. Richardson, and B. Turner. 2007b. Changes in enzyme activities and soil microbial community composition along carbon and nutrient gradients at the Franz Josef chronosequence, New Zealand. *Soil Biology and Biochemistry* 39:1770–1781.
- Billings, S. A., and F. Ballantyne. 2013. How interactions between microbial resource demands, soil organic matter stoichiometry, and substrate reactivity determine the direction and magnitude of soil respiratory responses to warming. *Global Change Biology* 19:90–102.
- Boer, W. de, L. B. Folman, R. C. Summerbell, and L. Boddy. 2005. Living in a fungal world: impact of fungi on soil bacterial niche development. *FEMS microbiology reviews* 29:795–811.
- Burns, R. G., J. L. DeForest, J. Marxsen, R. L. Sinsabaugh, M. E. Stromberger, M. D. Wallenstein, M. N. Weintraub, and A. Zoppini. 2013. Soil enzymes in a changing environment: current knowledge and future directions. *Soil Biology and Biochemistry* 58:216–234.
- Diaz, S., S. Lavorel, F. de Bello, F. Quétier, K. Grigulis, and T. M. Robson. 2007. Incorporating plant functional diversity effects in ecosystem service assessments. *Proceedings of the National Academy of Sciences* 104:20684–20689.
- Fanin, N., N. Fromin, B. Buatois, and S. Hättenschwiler. 2013. An experimental test of the hypothesis of non-homeostatic consumer stoichiometry in a plant litter-microbe system. *Ecology Letters* 16:764–772.
- Fanin, N., P. Kardol, M. Farrell, M.-C. Nilsson, M. J. Gundale, and D. A. Wardle. 2018. The ratio of Gram-

- positive to Gram-negative bacterial PLFA markers as an indicator of carbon availability in organic soils. *Soil Biology and Biochemistry*.
- Fierer, N., M. A. Bradford, and R. B. Jackson. 2007. Toward an ecological classification of soil bacteria. *Ecology* 88:1354–1364.
- Fierer, N., and R. B. Jackson. 2006. The diversity and biogeography of soil bacterial communities. *Proceedings of the National Academy of Sciences* 103:626–631.
- Fierer, N., C. L. Lauber, K. S. Ramirez, J. Zaneveld, M. A. Bradford, and R. Knight. 2012a. Comparative metagenomic, phylogenetic and physiological analyses of soil microbial communities across nitrogen gradients. *The ISME journal* 6:1007–1017.
- Fierer, N., J. W. Leff, B. J. Adams, U. N. Nielsen, S. T. Bates, C. L. Lauber, S. Owens, J. A. Gilbert, D. H. Wall, and J. G. Caporaso. 2012b. Cross-biome metagenomic analyses of soil microbial communities and their functional attributes. *Proceedings of the National Academy of Sciences* 109:21390–21395.
- Fontaine, S., A. Mariotti, and L. Abbadie. 2003. The priming effect of organic matter: a question of microbial competition? *Soil Biology and Biochemistry* 35:837–843.
- Frankena, J., H. Van Verseveld, and A. Stouthamer. 1988. Substrate and energy costs of the production of exocellular enzymes by *Bacillus licheniformis*. *Biotechnology and bioengineering* 32:803–812.
- Grace, J. B., S. M. Scheiner, and D. R. Schoolmaster Jr. 2015. Structural equation modeling: building and evaluating causal models: Chapter 8.
- Ho, A., D. P. Di Lonardo, and P. L. Bodelier. 2017. Revisiting life strategy concepts in environmental microbial ecology. *FEMS microbiology ecology* 93:fix006.
- Hodge, A., D. Robinson, and A. Fitter. 2000. Are microorganisms more effective than plants at competing for nitrogen? *Trends in plant science* 5:304–308.
- Keiblinger, K. M., E. K. Hall, W. Wanek, U. Szukics, I. Hämmerle, G. Ellersdorfer, S. Böck, J. Strauss, K. Sterflinger, A. Richter, and others. 2010. The effect of resource quantity and resource stoichiometry on microbial carbon-use-efficiency. *FEMS Microbiology Ecology* 73:430–440.
- Kirk, T. K., and R. L. Farrell. 1987. Enzymatic “combustion”: the microbial degradation of lignin. *Annual Reviews in Microbiology* 41:465–501.
- Kivlin, S. N., B. G. Waring, C. Averill, and C. V. Hawkes. 2013. Tradeoffs in microbial carbon allocation may mediate soil carbon storage in future climates. *Frontiers in microbiology* 4:261.
- Lashermes, G., A. Gainvors-Claisse, S. Recous, and I. Bertrand. 2016. Enzymatic strategies and carbon use efficiency of a litter-decomposing fungus grown on maize leaves, stems, and roots. *Frontiers in microbiology* 7.
- Lauber, C. L., M. Hamady, R. Knight, and N. Fierer. 2009. Pyrosequencing-based assessment of soil pH as a predictor of soil bacterial community structure at the continental scale. *Appl. Environ. Microbiol.* 75:5111–5120.
- Laughlin, D. C., S. R. Abella, W. W. Covington, and J. B. Grace. 2007. Species richness and soil properties in *Pinus ponderosa* forests: a structural equation modeling analysis. *Journal of Vegetation Science* 18:231–242.
- Lavorel, S., and E. Garnier. 2002. Predicting changes in community composition and ecosystem functioning from plant traits: revisiting the Holy Grail. *Functional ecology* 16:545–556.
- Lefcheck, J. S. 2016. piecewiseSEM: Piecewise structural equation modelling in r for ecology, evolution, and systematics. *Methods in Ecology and Evolution* 7:573–579.
- Leff, J. W., S. E. Jones, S. M. Prober, A. Barberán, E. T. Borer, J. L. Firn, W. S. Harpole, S. E. Hobbie, K. S. Hofmockel, J. M. Knops, and others. 2015. Consistent responses of soil microbial communities to elevated nutrient inputs in grasslands across the globe. *Proceedings of the National Academy of Sciences* 112:10967–10972.
- Li, Y., C. Nie, Y. Liu, W. Du, and P. He. 2019. Soil microbial community composition closely associates with specific enzyme activities and soil carbon chemistry in a long-term nitrogen fertilized grassland. *Science of the Total Environment* 654:264–274.
- Liang, C., J. P. Schimel, and J. D. Jastrow. 2017. The importance of anabolism in microbial control over soil carbon storage. *Nature microbiology* 2:17105.
- Litchman, E., K. F. Edwards, and C. A. Klausmeier. 2015. Microbial resource utilization traits and trade-offs: implications for community structure, functioning, and biogeochemical impacts at present and in the future. *Frontiers in microbiology* 6:254.
- Lladó, S., L. Žifčáková, T. Vetrovsk, I. Eichlerová, and P. Baldrian. 2016. Functional screening of abundant bacteria from acidic forest soil indicates the metabolic

- potential of Acidobacteria subdivision 1 for polysaccharide decomposition. *Biology and fertility of soils* 52:251–260.
- López-Mondéjar, R., C. Algora, and P. Baldrian. 2019. Lignocellulolytic systems of soil bacteria: A vast and diverse toolbox for biotechnological conversion processes. *Biotechnology Advances*.
- Malik, A. A., J. B. Martiny, E. L. Brodie, A. C. Martiny, K. K. Treseder, and S. D. Allison. 2019a. Defining trait-based microbial strategies with consequences for soil carbon cycling under climate change. *The ISME journal*:1–9.
- Malik, A. A., J. Puissant, T. Goodall, S. D. Allison, and R. I. Griffiths. 2019b. Soil microbial communities with greater investment in resource acquisition have lower growth yield. *Soil Biology and Biochemistry*.
- Manoharan, L., S. K. Kushwaha, D. Ahrén, and K. Hedlund. 2017. Agricultural land use determines functional genetic diversity of soil microbial communities. *Soil Biology and Biochemistry* 115:423–432.
- Martinez-Almoyna, C., W. Thuiller, L. Chalmandrier, M. Ohlmann, A. Foulquier, J.-C. Clément, L. Zinger, and T. Münkemüller. 2019. Multi-trophic  $\beta$ -diversity mediates the effect of environmental gradients on the turnover of multiple ecosystem functions. *Functional Ecology*.
- Moorhead, D. L., Z. L. Rinkes, R. L. Sinsabaugh, and M. N. Weintraub. 2013. Dynamic relationships between microbial biomass, respiration, inorganic nutrients and enzyme activities: informing enzyme-based decomposition models. *Frontiers in Microbiology* 4:223.
- Mooshammer, M., W. Wanek, S. Zechmeister-Boltenstern, and A. Richter. 2014. Stoichiometric imbalances between terrestrial decomposer communities and their resources: mechanisms and implications of microbial adaptations to their resources. *The Microbial Regulation of Global Biogeochemical Cycles*:191.
- Nannipieri, P., C. Trasar-Cepeda, and R. P. Dick. 2018. Soil enzyme activity: a brief history and biochemistry as a basis for appropriate interpretations and meta-analysis. *Biology and Fertility of Soils* 54:11–19.
- Naylor, D., and D. Coleman-Derr. 2018. Drought stress and root-associated bacterial communities. *Frontiers in plant science* 8:2223.
- Pierre-Emmanuel, C., M. François, S. Marc-André, D. Myriam, C. Stéven, Z. Fabio, B. Marc, P. Claude, T. Adrien, G. Jean, and others. 2016. Into the functional ecology of ectomycorrhizal communities: environmental filtering of enzymatic activities. *Journal of Ecology* 104:1585–1598.
- Ren, C., W. Zhang, Z. Zhong, X. Han, G. Yang, Y. Feng, and G. Ren. 2018. Differential responses of soil microbial biomass, diversity, and compositions to altitudinal gradients depend on plant and soil characteristics. *Science of the Total Environment* 610:750–758.
- Romaní, A. M., H. Fischer, C. Mille-Lindblom, and L. J. Tranvik. 2006. Interactions of bacteria and fungi on decomposing litter: differential extracellular enzyme activities. *Ecology* 87:2559–2569.
- Schimel, J., T. C. Balser, and M. Wallenstein. 2007. Microbial stress-response physiology and its implications for ecosystem function. *Ecology* 88:1386–1394.
- Schimel, J., C. A. Becerra, and J. Blankinship. 2017. Estimating decay dynamics for enzyme activities in soils from different ecosystems. *Soil Biology and Biochemistry* 114:5–11.
- Schimel, J. P., and J. Bennett. 2004. Nitrogen mineralization: challenges of a changing paradigm. *Ecology* 85:591–602.
- Schmidt, M. W., M. S. Torn, S. Abiven, T. Dittmar, G. Guggenberger, I. A. Janssens, M. Kleber, I. Kögel-Knabner, J. Lehmann, D. A. Manning, and others. 2011. Persistence of soil organic matter as an ecosystem property. *Nature* 478:49.
- Shipley, B. 2000. A new inferential test for path models based on directed acyclic graphs. *Structural Equation Modeling* 7:206–218.
- Shipley, B. 2003. Testing recursive path models with correlated errors using d-separation. *Structural Equation Modeling* 10:214–221.
- Shipley, B. 2009. Confirmatory path analysis in a generalized multilevel context. *Ecology* 90:363–368.
- Shipley, B. 2016. Cause and correlation in biology: a user's guide to path analysis, structural equations and causal inference with R. Cambridge University Press.
- Sinsabaugh, R. L. 2005. Fungal enzymes at the community scale. *Mycology Series* 23:349.
- Sinsabaugh, R. L., R. Antibus, A. Linkins, C. McClaugherty, L. Rayburn, D. Repert, and T. Weiland. 1993. Wood decomposition: nitrogen and phosphorus dynamics in relation to extracellular enzyme activity. *Ecology* 74:1586–1593.
- Sinsabaugh, R. L., and J. J. Follstad Shah. 2012. Ecoenzymatic stoichiometry and ecological theory.

- Annual Review of Ecology, Evolution, and Systematics 43:313–343.
- Sinsabaugh, R. L., B. H. Hill, and J. J. F. Shah. 2009. Ecoenzymatic stoichiometry of microbial organic nutrient acquisition in soil and sediment. *Nature* 462:795–798.
- Steinweg, J. M., J. S. Dukes, E. A. Paul, and M. D. Wallenstein. 2013. Microbial responses to multi-factor climate change: effects on soil enzymes. *Frontiers in microbiology* 4:146.
- Steinweg, J. M., J. S. Dukes, and M. D. Wallenstein. 2012. Modeling the effects of temperature and moisture on soil enzyme activity: linking laboratory assays to continuous field data. *Soil Biology and Biochemistry* 55:85–92.
- Strickland, M. S., and J. Rousk. 2010. Considering fungal: bacterial dominance in soils—methods, controls, and ecosystem implications. *Soil Biology and Biochemistry* 42:1385–1395.
- Trivedi, P., I. C. Anderson, and B. K. Singh. 2013. Microbial modulators of soil carbon storage: integrating genomic and metabolic knowledge for global prediction. *Trends in microbiology* 21:641–651.
- Vranova, V., K. Rejsek, and P. Formanek. 2013. Proteolytic activity in soil: a review. *Applied Soil Ecology* 70:23–32.
- De Vries, F. T., E. Hoffland, N. van Eekeren, L. Brussaard, and J. Bloem. 2006. Fungal/bacterial ratios in grasslands with contrasting nitrogen management. *Soil Biology and Biochemistry* 38:2092–2103.
- De Vries, F. T., P. Manning, J. R. Tallwin, S. R. Mortimer, E. S. Pilgrim, K. A. Harrison, P. J. Hobbs, H. Quirk, B. Shipley, J. H. Cornelissen, and others. 2012. Abiotic drivers and plant traits explain landscape-scale patterns in soil microbial communities. *Ecology Letters* 15:1230–1239.
- Xu, Z., G. Yu, X. Zhang, N. He, Q. Wang, S. Wang, R. Wang, N. Zhao, Y. Jia, and C. Wang. 2017. Soil enzyme activity and stoichiometry in forest ecosystems along the North-South Transect in eastern China (NSTEC). *Soil Biology and Biochemistry* 104:152–163.
- Zechmeister-Boltenstern, S., K. M. Keiblinger, M. Mooshammer, J. Peñuelas, A. Richter, J. Sardans, and W. Wanek. 2015. The application of ecological stoichiometry to plant–microbial–soil organic matter transformations. *Ecological Monographs* 85:133–155.
- Žifčáková, L., T. Vetrovsk, V. Lombard, B. Henrissat, A. Howe, and P. Baldrian. 2017. Feed in summer, rest in winter: microbial carbon utilization in forest topsoil. *Microbiome* 5:122.



## CONTRIBUTION PERSONNELLE AU CHAPITRE 2.2

Ma contribution à l'expérimentation 2 et aux analyses en laboratoire dont les résultats sont utilisés dans ce chapitre ont déjà été détaillées dans le chapitre précédent (contribution personnelle au chapitre 2.1).

De même que le chapitre 2.1, j'ai réalisé l'ensemble des analyses statistiques présentées dans ce chapitre, ainsi que la rédaction de la 1<sup>ère</sup> version de cet article et de la 2<sup>ème</sup> version présentée ici et qui suit une révision de la 1<sup>ère</sup> version par l'ensemble des co-auteurs.

## CONCLUSION ET PERSPECTIVES DU CHAPITRE 2.2

Dans ce chapitre 2.2, nous avons exploré comment les CWM écoenzymatiques (activité enzymatique masse-spécifique et stoechiométrie enzymatique) étaient associés à la composition des communautés microbiennes et aux gradients abiotiques du sol. Ces analyses suggérant un rôle important de la composition des communautés microbiennes dans le contrôle des CWM écoenzymatiques. Dans un second temps, nous avons évalué l'importance relative de la biomasse et de l'activité masse-spécifique dans le contrôle de l'activité enzymatique totale des sols (propriété écosystémique microbienne) aux différentes phases de l'expérimentation. L'utilisation de modèles d'équations structurelles (SEM), a permis d'identifier les différents mécanismes microbiens contrôlant cette propriété de l'écosystème (variation de la biomasse microbienne, variation de la composition de la communauté microbienne, acclimatation des microorganismes).

L'activité enzymatique totale du sol est considérée comme l'étape limitante de la minéralisation de la matière organique, contrôlant ainsi la fourniture en nutriments aux plantes et leurs potentielles pertes (ex : lixiviation). Cependant les répercussions potentielles d'un changement des niveaux d'activités enzymatiques sur les propriétés écosystémiques non-microbiennes n'ont pas été évaluées dans ce chapitre. Le chapitre suivant (2.3) viendra évaluer le rôle de l'activité enzymatique totale du sol dans le contrôle de propriétés écosystémiques non-microbiennes associées au cycle de l'azote (fourniture d'azote aux plantes et lessivage des nitrates). La quantification de l'abondance et de la diversité de gènes fonctionnels codant pour des protéases extracellulaires a également été mise en oeuvre dans le chapitre suivant afin d'évaluer le rôle potentiel des caractéristiques de la communauté protéolytique dans le contrôle du fonctionnement de l'écosystème, en parallèle des activités enzymatiques. Ces analyses moléculaires sur les gènes fonctionnels n'ont pu être faites que sur les sols de l'échantillonnage en fin de période de stress (T1). Le chapitre suivant ne porte donc que sur les données issues de cet échantillonnage.

*"Ce que j'ai appris, je le dois à la collaboration de mon berger, et aussi, puisqu'il faut tout dire, à la collaboration de l'insecte rampant, à celle du papillon et de l'oiseau chanteur. Si je n'avais passé de longues heures, couché sur l'herbe, à regarder ou à entendre ces petits êtres, mes frères, peut-être aurais-je moins compris combien est vivante aussi la grande terre qui porte sur son sein tous ces infiniment petits et les entraîne avec nous dans l'insondable espace. »*

Elisée reclus, Histoire d'une montagne, 1876

---

# CHAPITRE 2.3

## (ARTICLE 4)

Compared to conventional, ecological intensive management promotes beneficial proteolytic soil microbial communities for agro-ecosystem functioning under climate change-induced rain regimes

---

Martina Lori<sup>1,2+</sup>, Gabin Piton<sup>3+</sup>, Sarah Symanczik<sup>1</sup>, Nicolas Legay<sup>4</sup>, Lijbert Brussaard<sup>5</sup>, Sebastian Jaenicke<sup>6</sup>, Eduardo Nascimento<sup>7</sup>, Filipa Reis<sup>7</sup>, Paulo Sousa<sup>7</sup>, Paul Mäder<sup>1</sup>, Andreas Gättinger<sup>1,2</sup>, Jean-Christophe Clément<sup>3,8</sup>, Arnaud Foulquier<sup>3</sup>

+ **Shared first co-authorship**

<sup>1</sup> Department of Soil Sciences, Research Institute of Organic Agriculture (FiBL), Ackerstrasse 113, 5070 Frick, Switzerland

<sup>2</sup> Organic Farming with focus on Sustainable Soil Use, Karl-Glöckner-Str. 21 C, Justus-Liebig University Giessen, 35394 Giessen, Germany

<sup>3</sup> Univ. Grenoble Alpes, Univ. Savoie Mont Blanc, CNRS, LECA, 38000 Grenoble, France

<sup>4</sup> École de la Nature et du Paysage, INSA Centre Val de Loire, 41000 Blois - CNRS, CITERES, UMR 7324, 37200 Tours, France.

<sup>5</sup> Soil Biology Group, Wageningen University & Research, P.O. Box 47, 6700 AA Wageningen, The Netherlands

<sup>6</sup> Bioinformatics and Systems Biology, Heinrich-Buff-Ring 58, Justus-Liebig-University Giessen, 35392 Giessen, Germany

<sup>7</sup> Centre for Functional Ecology, Department of Life Sciences, University of Coimbra, 3000-456 Coimbra, Portugal

<sup>8</sup> Univ. Savoie Mont Blanc, INRA, CARRTEL, 74200, Thonon-Les-Bains, France

This chapter has been submitted in the journal **Scientific Report** the 19<sup>th</sup> 2019.

Referencing is different in this article, following *Scientific Report* authors guidelines.

## ABSTRACT

Projected climate change and rainfall variability will affect soil microbial communities, biogeochemical cycling and agriculture. Nitrogen (N) is the most limiting nutrient in agroecosystems and its cycling and availability is highly dependent on microbial driven processes. In agroecosystems, hydrolysis of organic nitrogen (N) is an important step in controlling soil N availability. We analyzed the effect of management (ecological intensive vs. conventional intensive) on N-cycling processes and involved microbial communities under climate change-induced rain regimes. Terrestrial model ecosystems originating from agroecosystems across Europe were subjected to four different rain regimes for 263 days. Using structural equation modelling we identified direct impacts of rain regimes on N-cycling processes, whereas N-related microbial communities were more resistant. In addition to rain regimes, management indirectly affected N-cycling processes via modifications of N-related microbial community composition. Ecological intensive management promoted a beneficial N-related microbial community composition involved in N-cycling processes under climate change-induced rain regimes. Exploratory analyses identified phosphorous-associated litter properties as possible drivers for the observed management effects on N-related microbial community composition. This work provides insights into mechanisms controlling agro-ecosystem functioning under climate change and stresses the importance of plant properties in shaping composition and functioning of N-related microbial communities

## 1 INTRODUCTION

As in many terrestrial ecosystems, nitrogen (N) is the most limiting nutrient for plant growth in agroecosystems<sup>1-3</sup> and its availability in soils is dependent on N-cycling processes driven by microbes<sup>4</sup>. The general importance of microbes in driving soil N mineralization and availability was recently confirmed by a meta-analysis compiling data of nearly two-hundred studies<sup>5</sup>. The last century has been characterized by a considerable increase of N inputs in agricultural soils<sup>4,6-8</sup>, mostly in mineral form ( $\text{NH}_4^+$  and  $\text{NO}_3^-$ ), making plant growth less dependent on microbial N provisioning. Ecological intensification has been proposed as an alternative approach, integrating ecological processes into management strategies of agroecosystems in order to reduce anthropogenic inputs and enhance ecosystem services<sup>9</sup>. Ecological intensive management (eg. organic farming) can increase soil organic carbon content<sup>10</sup>, change plant traits<sup>11</sup>, improve soil microbial abundance and activity<sup>12</sup> and affect diversity as well as select for distinct microbial community composition compared to conventionally intensively managed systems<sup>13</sup>. Several experimental studies have shown a link between microbial diversity and soil processes<sup>14,15</sup> and evidence

showing a tight association between plant traits, soil microbial community properties and ecosystem functioning is accumulating<sup>16,17</sup>. On a global scale, it was recently identified that microbial diversity is positively related to multifunctionality in terrestrial ecosystems<sup>18</sup>. Authors suggest that a loss in microbial diversity, likely resulting from human activities and climate change, will result in reduced rates at which multiple ecosystem processes and services are maintained. In addition, it was demonstrated that an increase of soil biodiversity, including microbial diversity, should go with a specific community composition as part of ecological intensification in agriculture<sup>19</sup>: soil microbial diversity and composition might directly influence ecosystem functioning under environmental changes, as previously reported for aboveground biodiversity<sup>20</sup>.

It has already been shown that climate disturbances have important impacts on N dynamics in ecosystems<sup>21,22</sup> with potential legacy effects on ecosystem functioning and resilience to further disturbances<sup>23</sup>. In general, plant and microbial responses to climate disturbances vary between communities depending on the functional traits of the constituents<sup>24,25</sup>. Thus, environmental changes might alter soil biogeochemical functioning and N cycling

through their effects on microbial abundance, diversity and community composition<sup>21,22, 26-28</sup>.

An important step in the N cycle is the hydrolysis of organic molecules where N is released from its bound forms and made bioavailable<sup>29</sup>. Proteins, chitin and peptidoglycan are quantitatively the most important N containing molecules in soil<sup>30</sup> and therefore, their hydrolysis is important for N-related ecosystem functioning such as plant N provisioning. The use of degenerated oligonucleotides targeting the functional genes *alkaline (apr)* and *neutral (npr) metallopeptidases*<sup>31</sup>, encoding for major soil proteases, allows to trace abundance, diversity and composition of proteolytic microbial communities in soil<sup>32,33</sup>. In a laboratory study enhanced stability of *apr* diversity and composition in organic versus conventional managed soil was observed under drought stress, concomitant with higher plant N provisioning<sup>34</sup>. Those results indicate that proteolytic microbial communities selected under organic farming have a better capacity to maintain plant nutrition of a model crop under dry conditions.

However, general knowledge about the effect of management on proteolytic microbial communities and associated ecosystem processes is still lacking. Thus, the present study aims to analyze and link N-related microbial communities with two important N-related agroecosystem processes (forage-N uptake and NO<sub>3</sub><sup>-</sup> leaching) in differently managed (conventional intensive vs. ecological intensive) agricultural systems under different rain regimes. We conducted a terrestrial model ecosystem (TME) incubation experiment with soil and plant from paired, i.e. conventional intensively and ecological intensively managed, agroecosystems across Europe (mountain grassland in France, agroforest in Portugal and arable land in Switzerland). The TMEs were subjected to manipulated rainfall variability (normal, wet, dry and intermittent). N-related microbial communities were characterized by *apr* and *npr* abundance, *apr* diversity and composition as well as enzymatic activity involved in degradation of N containing molecules - leucine aminopeptidase activity (LAP) for protein degradation potential and β-1,4-N-

acetylglucosaminidase (NAG) for chitin and peptidoglycan degradation<sup>35</sup>.

Across countries we hypothesize rain regime and management to affect forage-N uptake and NO<sub>3</sub><sup>-</sup> leaching, either directly and/or indirectly via modifications of N-related microbial communities (Figure 30).

In detail we hypothesize:

I. Management system (ecological-intensive vs. conventional-intensive; **H1.1**), soil organic matter (SOM) (**H1.2**) and rain regime (wet, dry, intermittent vs. normal; **H1.3**) have direct effects on N-related microbial community abundance, activity, diversity and composition (Figure 30).

More precisely, ecological-intensive management, higher SOM concentration and wet rain regime are expected to positively affect N-related microbial community abundance, activity, diversity and community composition. Dry rain regime is expected to have an opposite effect with lower abundance, activity, diversity and shifted community composition whereas the intermittent rain regime might have no visible effect in regard to activity and abundance.

II. N-related ecosystem processes (i.e. forage-N uptake and NO<sub>3</sub><sup>-</sup> leaching) are influenced by management and SOM concentration mainly indirectly via the microbial community (Figure 30, **H2.1**) and mainly directly by rain regime (Figure 30, **H2.2**).

More precisely, ecological-intensive management and high SOM concentration are expected to improve forage-N uptake via changes in the N-related microbial community (Figure 30, H1.1 and H1.2). Highest forage-N uptake and NO<sub>3</sub><sup>-</sup> leaching is expected under wet, followed by intermittent and normal rain regime whereas lowest uptake and NO<sub>3</sub><sup>-</sup> leaching are expected under dry rain regime mainly due to direct effects from water scarcity independent of N-related microbial community.

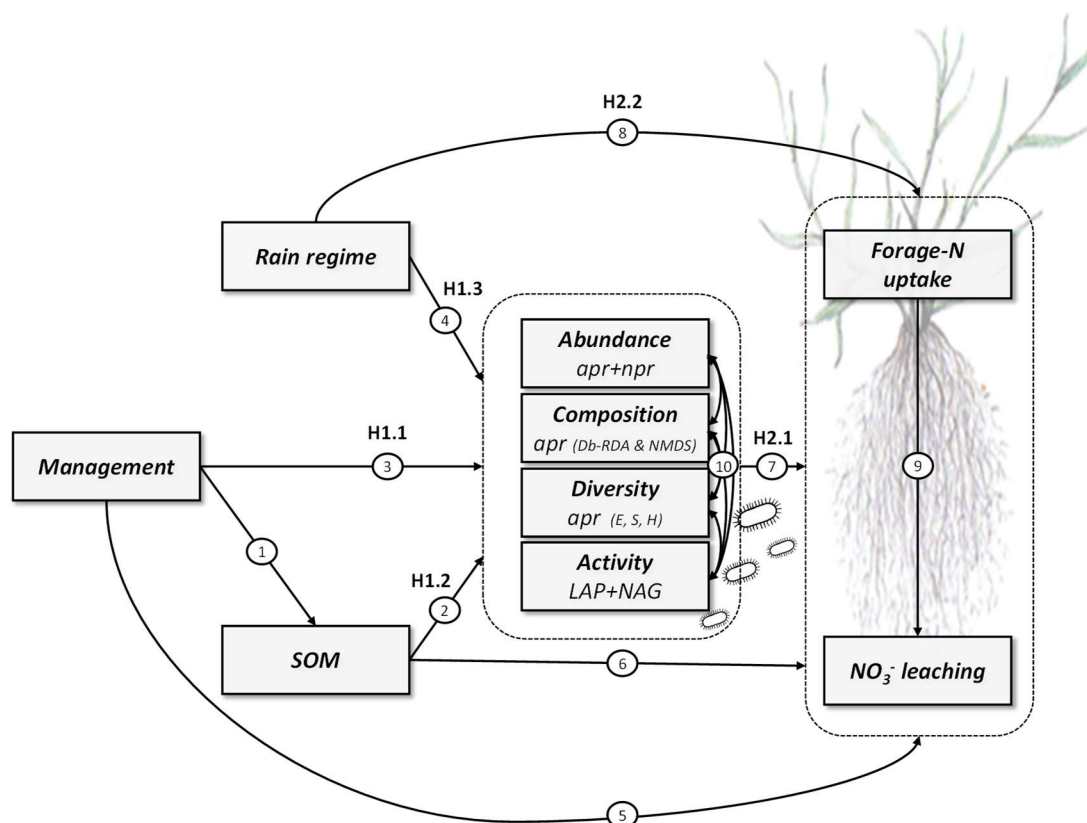

Figure 30 A priori models tested with structural equation modelling (SEM). Arrows ending/starting on/from the dotted box indicate paths ending/starting on/from all variables within the box. Our causal structure implies that management can affect the nitrogen (N)-related microbial community indirectly through modification of soil organic matter (SOM) concentration (arrows 1 and 2) or directly (e.g. plant traits or disturbance regime, arrow 3). By driving water availability, rain regime can directly influence microbial abundance/activity and community composition (arrow 4). N-related microbial communities can affect N-cycling processes (arrow 7) through the regulation of N released from organic matter. SOM concentration can influence forage-N uptake and  $\text{NO}_3^-$  leaching through its effect on water and nutrient retention (arrow 6). A direct path between management and N-cycling processes was added to represent properties not included in our model (e.g. plant diversity or trait, arrow 5). Rain regime can directly affect forage-N uptake and  $\text{NO}_3^-$  leaching by driving plant water availability and potentially exceeding soil retention capacity (arrow 8). Forage-N uptake can buffer  $\text{NO}_3^-$  leaching by removing N from the soil (arrow 9). Free correlations between each pair of properties of N-related microbial communities have been added to represent potential covariation due to other causes than SOM concentration, management or rain regime (arrows 10). One-headed arrows represent causal relationships; double-headed arrows represent free correlations. Diversity indices: E= evenness, S= richness, H= Shannon diversity. Activity: LAP= leucine aminopeptidase extracellular enzyme activities, NAG=  $\beta$ -1,4-N-acetylglucosaminidase. Abundance: apr= alkaline metallopeptidase, npr= neutral metallopeptidase. NMDS= Non-metric multidimensional scaling, db-RDA= distance based redundancy analysis.

## 2 MATERIAL AND METHODS

### 2.1 EXPERIMENTAL SET UP AND INCUBATION CONDITIONS

Experimental design and methods used were detailed in chapter 2.1. (p84, 2.1 Experimental design and setup) To avoid redundancy, this part is not repeated here. This chapter used only the subset of variables associated with N cycling, that is soil N pools (Total Soil N, NH<sub>4</sub><sup>+</sup>, NO<sub>3</sub><sup>-</sup>+NO<sub>2</sub><sup>-</sup>, DON), SOM and extracellular enzymes activities degrading N-rich substrates (NAG+LAP). Analysis not described in previous chapter are detailed below. Moreover, this **chapter only used data from T1 sampling** as composition of proteolytic microbial communities was assessed only for this sampling.

### 2.2 ANALYSIS OF ABOVEGROUND PLANT BIOMASS

All individual aboveground vegetation cuts of a TME during the altered rain regime period were pooled and homogenized. Carbon (C) and N concentrations of dried (40 °C) and ball milled samples were then assessed by combustion (CN Vario Max; Elementar Analysen Systeme GmbH, Hanau, Germany). Forage-N uptake was calculated in kg N per day and hectare (ha) (1):

$$(1) \text{ Forage - N uptake } (kg \text{ N day}^{-1} \text{ ha}^{-1}) = \frac{\text{Plant biomass } (kg) \times \text{plant N concentration } (\%)}{\text{Time } (days) \times \text{TME surface } (ha)}$$

### 2.3 LEACHATES ANALYSES

NO<sub>3</sub><sup>-</sup> content in leachates was measured on an automated photometric analyzer (Gallery Plus: Thermo Fisher Scientific, Waltham, Massachusetts, USA). NO<sub>3</sub><sup>-</sup> leaching was assessed by calculating the total amount of NO<sub>3</sub><sup>-</sup> lost from each TME per day and hectare (2).

$$(2) \text{ NO}_3^- \text{ leaching } (mg \text{ NO}_3^- \text{ day}^{-1} \text{ ha}^{-1}) = \frac{\text{Volume } (L) \times \text{NO}_3^- \text{ concentration } (mg \text{ NO}_3^- \text{ L}^{-1})}{\text{Time } (days) \times \text{TME surface } (ha)}$$

### 2.4

### 2.5 ABUNDANCE OF PROTEOLYTIC MICROBIAL COMMUNITIES

Abundance of alkaline (*apr*) and neutral (*npr*) metallopeptidase genes was assessed by quantitative polymerase chain reaction (qPCR) using degenerated oligonucleotides<sup>31</sup>. Beforehand, DNA was isolated from lyophilized soil samples using the FastDNA SPIN Kit for Soil (96x) (MP Biomedicals, CA, USA). Prior to DNA extraction each sample was spiked with an exact amount of plasmid carrying an artificial sequence to normalize DNA extraction efficiency rates between the samples and to test for presence of PCR inhibitors. DNA concentrations were measured using a Qubit Fluorometer (Thermo Fisher Scientific, Waltham, USA). Prior to qPCR, cycling conditions of oligonucleotides were optimized using different soil DNA dilutions and annealing temperatures to reach standard curves with an R<sup>2</sup>>0.999 and amplification efficiencies between 0.8 and 1 (SI Table 4). qPCR reactions were performed using a SYBR green approach (Kapa SYBR® Fast qPCR Kit Master Mix (2×) Universal; Kapa Biosystems, Wilmington, MA, USA) on a CFX96 Touch™ Real-Time PCR Detection System (Bio-Rad, Switzerland). Biological replicates were analyzed in technical duplicates. Negative controls and serial dilutions of plasmids carrying the gene of interest were included as triplicates to calculate standard curves for absolute quantification. Size and quality of generated amplicons were controlled by melting curve analyses and gel electrophoresis.

### 2.6 COMPOSITION AND DIVERSITY OF PROTEOLYTIC MICROBIAL COMMUNITIES

DNA extracts were processed in a two-step PCR approach using fluidigm tagged *apr* primers for the first PCR performed in quadruplicates. Oligonucleotide sequences and cycling conditions are listed in SI Table 4. PCR quadruplicates of each sample were subsequently pooled and loaded on agarose gels (1.75 %) for visualization and validation. Target bands were cut out and purified using the QIAquick gel extraction kit (QIAGEN, Switzerland). The subsequent second PCR, library preparation and sequencing on an Illumina MiSeq

sequencing system using the 2x250 bp Reagent Kit v2 (Illumina, San Diego, CA, USA), was performed at the Genome Quebec Innovation Center (Montreal, Canada) according to the amplicon guidelines provided by Illumina. The FastQC<sup>41</sup> and MultiQC<sup>42</sup> tools were used to assess quality of the sequencing data. Forward and reverse sequences were merged (overlap up to 250 base pairs) using Flash<sup>43</sup>. Operational taxonomic unit (OTU) clustering on 97% similarity was performed using UPARSE<sup>44</sup> and taxonomic annotation of OTUs was performed within MGX<sup>45</sup>. The raw sequences are openly deposited at the European Nucleotide Archive under the accession number PRJEB33546.

## 2.7 STATISTICAL ANALYSES

Hereafter, forage-N uptake and  $\text{NO}_3^-$  leaching are defined as “N-cycling processes” while  $\text{NH}_4^+$ ,  $\text{NO}_3^- + \text{NO}_2$ , and DON content are defined as “N-related soil indicators”. The term “N-related microbial indicators” is composed of the abundance, diversity and composition of proteolytic microbial communities as well as the extracellular enzymatic activity potential degrading organic N rich substrates (NAG+LAP). Treatment effects on N-cycling processes as well as N-related soil and microbial indicators were first assessed using linear mixed effect models and then integrated and linked in a hypothetical causal network using structural equation modeling (SEM).

### 2.7.1 Proteolytic microbial community analyses

In order to assess variations in proteolytic microbial community composition, *apr* OTU abundances were subjected to a Hellinger transformation using the ‘decostand’ function implemented in the vegan package<sup>46</sup>. Overall variation in proteolytic microbial community composition was visualized using nonmetric multidimensional scaling (NMDS) based on Bray-Curtis distance metrics. Permutational multivariate analysis of variance (PERMANOVA) was then performed using the ‘adonis’ function with country used as strata to statistically assess treatment effects on the distance matrix within each country. Significant factors of the PERMANOVA were implemented as constraining terms

in a distance-based redundancy analysis (db-RDA) using the capscale function<sup>46</sup> with Bray-Curtis distance metrics and country set as a conditioning term. This db-RDA was used to identify the sub-part of microbial community composition under the influence of treatments. Analysis of variance (ANOVA) was used to test for treatment effects of the capscale object in the db-RDA. Both ordinations were computed using the vegan package<sup>46</sup>.

OTUs being most important in differentiating between treatments were assessed with the ‘simper.pretty’ and ‘kruskal.pretty’ function<sup>47</sup> using false discovery rate corrections. Only OTUs significantly differing between treatments were selected for biplotting in the ordinations. All analyses were run on R 3.4.1<sup>48</sup>.

Alpha-diversity was assessed based on richness, evenness and Shannon index calculated using UPARSE<sup>44</sup>. Coordinates of the ordinations (NMDS and db-RDA) were extracted and used in the following statistical analyses as proxy of the proteolytic microbial community composition. Coordinates extracted from the NMDS were used as indicator of the overall variation while coordinates from db-RDA were used as indicators of the sub-part of microbial community composition under the influence of treatments (constrained composition).

### 2.7.2 Rain regime and management effects (mixed effects models)

Effects of rain regime and management on N-cycling processes and on N-related soil and microbial indicators were assessed using mixed effect models with rain regime and management as fixed factors, country and plot as random factors. Plot was nested in management and together they were nested in country to take into account the nested design of the experiment<sup>49</sup>. Data were transformed using log, square-root or inverse functions to satisfy the assumption of normal distribution and variance homogeneity of model residuals when necessary. Post-hoc comparisons were done using Tukey’s honest significant difference test. Mixed effect models and post-hoc comparisons were run under R.3.5.1<sup>48</sup> using the nlme<sup>50</sup> and lsmeans<sup>51</sup> packages.



### 2.7.3 Direct and indirect effects of management and rain regime on N-cycling processes (SEM)

Piecewise SEM model selection<sup>52-54</sup> was used to identify the best causal network explaining rain regime, management and SOM effects on N-cycling processes through N-related microbial communities. Exploratory SEM is useful when systems have been poorly studied yet and can help to identify main mechanisms within a series of potential mechanisms hypothesized based on current knowledge<sup>52,53</sup>. Shipley's test of d-separation<sup>55</sup> was used to assess if missing paths in the hypothesized structure exist. Next, a d-separation test was used to generate Fisher's C statistic for the overall SEM<sup>54,55</sup>. Herewith identified significant p-values indicate that the hypothesized structure is wrong - in other words: some other paths not included in the hypothesized structure exist. Piecewise SEM makes results less sensitive to sample size and enables to include mixed effect models within the SEM structure<sup>54</sup>. We used a model selection process to obtain the most parsimonious model depicting rain regime and management effects on N-cycling processes through the N-related microbial community. Initially, we fitted the full model containing all potential paths of our *a priori* model (Figure 1). Next, variables without any significant relationship to rain regime, management, SOM or N-cycling processes (non-informative variables) were removed. Lastly, we simplified the model by removing relationships between remaining variables starting with less significant relationships so as to retain the most significant ones. Each path removal was conserved if the model quality based information-theoretic criterion (BIC) was improved<sup>56</sup>. After the most parsimonious model was obtained, global model fit and quality were verified using Fisher's C test and  $R^2$  of endogenous variables before interpreting path coefficients as suggested by Hertzog<sup>56</sup>. All variables were transformed with log, square root or inverse log functions to respect normality of residuals. Furthermore, all paths were standardized. All models in the SEM used plot nested in management and together they were nested in country. Analyses were conducted using piecewiseSEM package<sup>54</sup> run under R.3.5.1<sup>48</sup>.

### 2.7.4 Identification of variables potentially involved in driving the management effect on proteolytic (*apr*) microbial community composition

Additional analyses were conducted to assess a potential relationship between soil properties, litter properties, vegetation composition and vegetation diversity with the sub-part of the proteolytic microbial community composition under the influence of management (coordinates of the first axis of the db-RDA measured in TMEs subjected to normal rain regime). Vegetation composition and vegetation diversity as well as litter traits have been measured *in situ* at the plot level<sup>11</sup>, from where the TMEs of the current experiment were obtained; soil properties were measured in the TMEs at the start of the experiment (texture) or in the same soil core as soil microbial community composition. Linear regression between the respective variables and proteolytic (*apr*) microbial community composition was conducted using country as random factor. All variables were also tested for potential management effects using ANOVA such as mixed effect models using country as random factor.

## 3 RESULTS

Overall, mixed effect models showed rain regime to only affect N-cycling processes and N-related soil indicators (Table 7, SI Figure 4). Only few rain effects on N-related microbial communities were found (Table 7 and 3). No management effects on N-cycling processes, SOM and N-related soil indicators were observed (Table 7). In contrast, N-related microbial community composition was consistently affected by management across countries (Figure 31, Table 8). Piecewise SEM disentangled direct and indirect relationships between management, rain regime and SOM with N-related processes through N-related microbial communities (Figure 32, SI Table 5). Four main paths were observed: i) direct effects of rain regime on N-cycling processes, ii) an indirect effect of rain regime on N-cycling processes via modification of enzymatic activity (LAP+NAG), iii) an indirect effect of management on N-cycling processes via proteolytic (*apr*) community composition (db-RDA

coordinates) independent of SOM, and iv) management-independent SOM-effects via microbial activity and overall proteolytic (*apr*) community composition on N-cycling processes. Finally, P-associated litter properties and vegetation composition assessed *in situ* showed significant differences between management and significant associations with proteolytic (*apr*) microbial community composition (db-RDA coordinates) (Table 9).

### 3.1 RAIN REGIME AND MANAGEMENT EFFECTS ON N-CYCLING PROCESSES AND N-RELATED SOIL INDICATORS

Forage-N uptake increased from dry to normal and from normal to wet treatments while the intermittent treatment did not significantly differ from dry and normal treatments (SI Figure 4).  $\text{NO}_3^-$  leaching increased from dry to normal treatments and from normal to

intermittent and wet treatments (SI Figure 4). Soil  $\text{NH}_4^+$  and  $\text{NO}_3^- + \text{NO}_2^-$  concentrations were significantly affected by rain regime, and DON content marginally so (Table 7). Soil  $\text{NH}_4^+$  increased under dry treatments while  $\text{NO}_3^- + \text{NO}_2^-$  content decreased under wet compared to normal treatments (SI Figure 4).

### 3.2 RAIN REGIME AND MANAGEMENT EFFECTS ON N-RELATED MICROBIAL INDICATORS

Enzymatic activity (LAP+NAG) was affected by rain regime (Table 7, Figure 32). Highest values were found in normal ( $371.7 \text{ nmol g soil}^{-1} \text{ h}^{-1}$ ), followed by low ( $338.9 \text{ nmol g soil}^{-1} \text{ h}^{-1}$ ) and wet rain regimes ( $300.0 \text{ nmol g soil}^{-1} \text{ h}^{-1}$ ) while lowest values were identified in intermittent rain regime ( $251.0 \text{ nmol g soil}^{-1} \text{ h}^{-1}$ ). Abundance of *apr* + *npr* as well as *apr* richness and Shannon diversity were neither affected by management nor by rain regime (Table 7).

Table 7. Effects of rain regime (RR) and management (M) on nitrogen (N)-cycling processes and N-related soil and microbial indicators. Effects were assessed by a mixed effects model using rain regime and management as fixed effects and plot nested in country as random factor.  $R^2_m$ = marginal  $R^2$  representing the variation explained by fixed factors (RR and M),  $R^2_c$ = conditional  $R^2$  representing the variation explained by fixed (RR and M) and random factors (Country and Plot). N= nitrogen, SOM= soil organic matter, DON= dissolved organic nitrogen, LAP= leucine aminopeptidase extracellular enzyme activities, NAG=  $\beta$ -1,4-N-acetylglucosaminidase extracellular enzyme activities, *apr*= alkaline metalloproteinase, *npr*= neutral metalloproteinase. Non-metric multidimensional scaling (NMDS) and distance based redundancy analysis (db-RDA) coordinates of the first (Axis 1) and second axis (Axis 2). Df= degrees of freedom.

Parameter	Rain regime		Management		RR X M		$R^2_m$	$R^2_c$
	Df (3,66)		Df (1,2)		Df (3,66)			
	F	p-value	F	p-value	F	p-value		
<i>N-cycling processes</i>								
Forage N uptake	11.01	<0.001	0.21	0.691	0.53	0.665	0.22	0.40
$\text{NO}_3^-$ leaching	53.88	<0.002	1.55	0.340	1.55	0.210	0.59	0.67
<i>N-related soil indicators</i>								
SOM	7.06	<0.001	0.16	0.730	0.51	0.680	0.02	0.94
Total Soil N	1.39	0.255	1.19	0.389	0.30	0.828	0.03	0.79
$\text{NH}_4^+$	15.08	<0.001	0.49	0.556	1.45	0.235	0.14	0.76
$\text{NO}_3^- + \text{NO}_2^-$	3.81	0.014	0.68	0.495	0.57	0.638	0.09	0.39
DON	2.62	0.058	0.84	0.456	1.61	0.196	0.11	0.33
<i>N-related microbial indicators</i>								
Activity (LAP+NAG)	2.90	0.041	0.67	0.499	0.61	0.613	0.07	0.43
Abundance ( <i>apr</i> + <i>npr</i> )	0.63	0.600	0.03	0.870	2.08	0.110	0.03	0.70
Richness ( <i>apr</i> )	1.73	0.170	0.01	0.932	0.85	0.472	0.05	0.39
Shannon diversity ( <i>apr</i> )	1.37	0.259	0.18	0.712	0.46	0.709	0.05	0.28

	Df	F	R <sup>2</sup>	p
Rain regime	3	0.98	0.03	n.s
<b>Management</b>	1	1.34	0.01	<b>0.001</b>
M x RR	3	0.95	0.03	n.s

Table 8. Overall effects of rain regime and management on proteolytic microbial community composition. Effects were assessed by PERMANOVA (999 permutations) on a distance matrix based on alkaline metallopeptidase (*apr*) operational taxonomic units (OTUs) using Bray-Curtis distance metrics and with country as strata to assess treatment effect across countries. Df= degree of freedom, n.s= non-significant

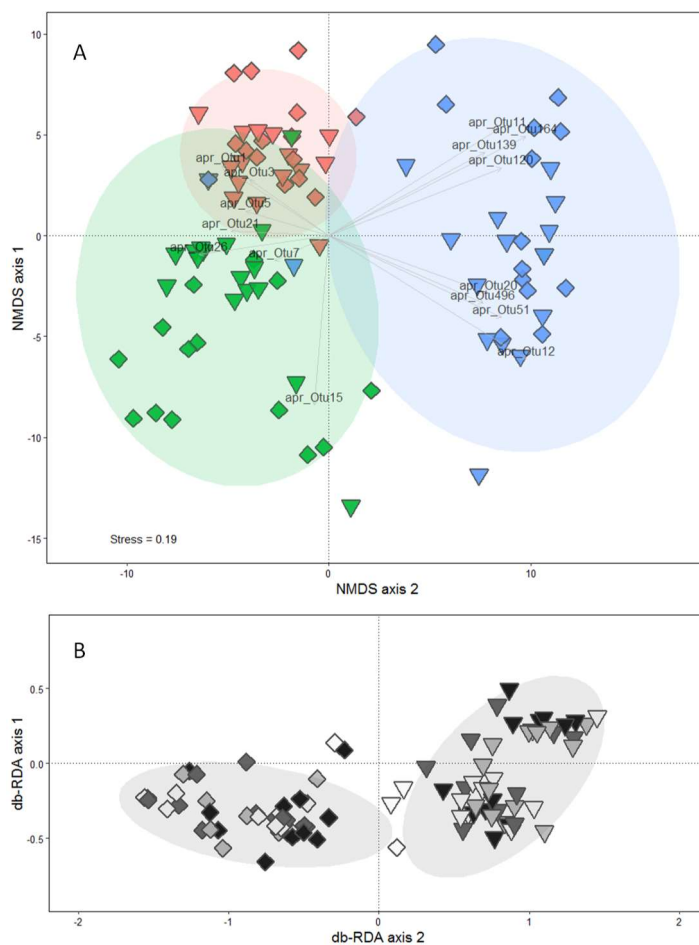

Figure 31. Overall proteolytic microbial community composition (A) and proteolytic microbial community composition under the influence of management only (B). Dissimilarity between alkaline metallopeptidase (*apr*) operational taxonomic units (OTUs) (97 % sequence similarity) based on Bray-Curtis distance metrics are ordinated by nonmetric multidimensional scaling (NMDS) (A) and distance-based redundancy analysis (db-RDA) using the capscale function constraining for management and conditioning for country (B). Triangles represent ecological intensive management, and squares represent conventional intensive management. In A, the different symbol fills represent the different countries: red= Switzerland, green= France and blue= Portugal. In B, the different symbol fills represent the four rain regimes: black= dry, dark-grey= normal, light-grey= intermittent and white= flood. Ellipses represent the 95 % confidence intervals of countries (A) and management (B), respectively. Vectors indicate OTUs being statistically influential for the differentiation between countries (identified via *simper.pretty* analysis and Kruskal tests with *fdr* p-value corrections).

Sequencing of proteolytic (*apr*) microbial communities revealed in total 25023 different OTUs with 97% sequence similarity (OTU list can be found in SI File 1). Overall assessment of proteolytic (*apr*) microbial community composition using NMDS showed strong variation across countries (Figure 31A). PERMANOVA showed management effects but no rain regime effect (Table 8). Next, a db-RDA ordination conditioning for countries was used to depict proteolytic (*apr*) microbial community composition only under the influence of management (Figure 31B). ANOVA on the capscale object of the db-RDA confirmed the significant management effect (Table 8,  $p = 0.002$ ). Using the `simper.pretty` function, a total of 18 single *apr* OTUs being most important in discriminating between countries could be identified (Figure 31A) but could not get assigned to sequences yet known/described. Since significant *apr* OTUs were found specifically for each country it is assumed that no bias, such as chimeric products, was present but rather that databases are still not complete/deep enough to assign functional gene sequences to taxa. OTUs significantly discriminating between management or rain regime were not found. Overall, only approximately one third of all *apr* OTUs could be assigned to already identified sequences, which were dominated by *Pseudomonas* (SI File 1), while two thirds are of yet unknown sources.

### 3.3 DIRECT AND INDIRECT EFFECTS OF MANAGEMENT, SOM AND RAIN REGIME ON N-CYCLING PROCESSES VIA SOIL MICROBIAL COMMUNITY MODIFICATIONS

The SEM selection process led to the removal of *apr* evenness and Shannon diversity indices from the final model since neither were significantly related to rain regime, management, SOM or N-cycling processes. Next, model simplification using BIC criterion enabled a large model improvement (Initial BIC= 364.49, Final BIC= 302.52). Simplified SEM structure showed good fit with observations (indicated by Fisher's C test  $p$ -value higher than 0.05:  $C_{48} = 53.22$ ,  $p$ -value= 0.28, Figure 32). The final SEM includes fourteen significant paths. Endogenous variables (overall proteolytic (*apr*) microbial

composition, constrained proteolytic (*apr*) microbial composition, richness (*apr*), activity (LAP + NAG), abundance (*apr* + *npr*), forage-N uptake,  $\text{NO}_3^-$  leaching) showed marginal  $R^2$  (fixed factors effect) ranging from 0.09 to 0.80 (mean= 0.39) and conditional  $R^2$  (fixed and random factors effects) ranging from 0.32 to 0.88 (mean= 0.61) (see SI Table 5 for details). SEM analysis confirmed that management, rain regime and SOM concentration influenced N-cycling processes. Rain regime did directly and indirectly affect N-cycling processes whereas exclusively indirect effects were observed for SOM and management on N-cycling processes through modifications of N-related microbial communities. Conditional  $R^2$ s were 0.60 and 0.72 for forage-N uptake and  $\text{NO}_3^-$  leaching respectively, and indicated that more than half of the variation in N-cycling processes was explained by our models. Marginal  $R^2$ , representing the variation explained by fixed factors only (rain regimes, management, soil and microbial properties), were 0.27 and 0.56 for forage N-uptake and  $\text{NO}_3^-$  leaching, respectively.

Altogether, SEM depicted four major paths (Figure 32). Firstly, SEM analysis indicated strong direct effects of rain regime on N-cycling processes. Wet and intermittent rain regime increased  $\text{NO}_3^-$  leaching compared to normal rain regime (used as reference) whereas dry rain regime decreased  $\text{NO}_3^-$  leaching. Furthermore, wet directly increased and dry decreased forage-N uptake compared to normal rain regime. Secondly, SEM analyses indicated indirect effects of rain regime on N-cycling processes via modification of enzymatic activity. Intermittent rain regime decreased forage-N uptake via negative effects on microbial activity (LAP + NAG). Thirdly, SEM indicated an indirect positive effect of ecological intensive management (compared to conventional intensive management as reference) on N-cycling processes through an effect on proteolytic (*apr*) microbial community composition represented by the db-RDA coordinates. Microbial community composition in ecologically intensively managed soils had a positive effect on forage-N uptake, which in turn translated into decreased  $\text{NO}_3^-$  leaching. Lastly, SEM showed that SOM concentration was a main driver in shaping N-related

microbial communities via an increase in the abundance (*apr* + *npr*), activity (LAP + NAG) and richness (*apr*) as well as a modification of the overall proteolytic (*apr*) microbial community composition (represented by

NMDS coordinates). Furthermore, a positive indirect effect of SOM concentration on forage-N uptake via microbial activity (LAP + NAG) was observed.

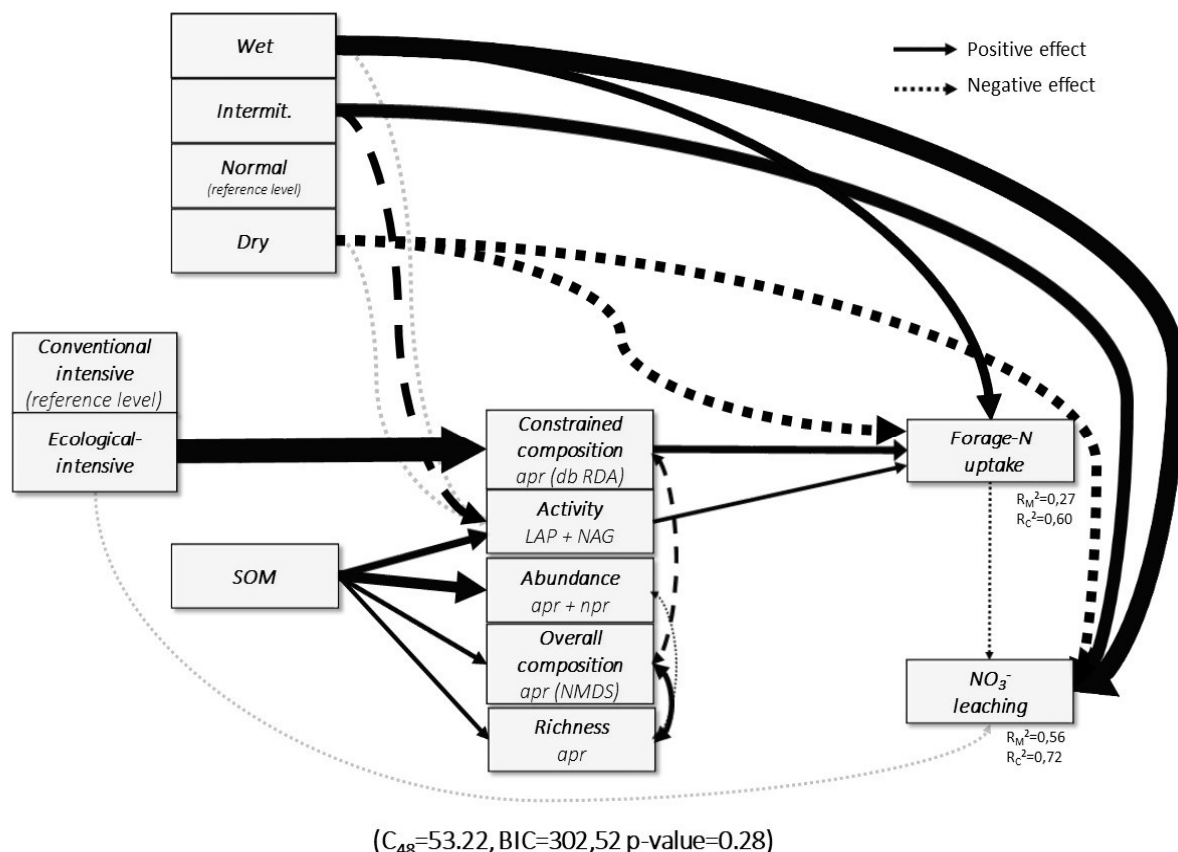

Figure 32. Structural equation model (SEM) representing paths from rain regime and management to nitrogen (N)-cycling processes through soil organic matter (SOM) concentration and N-related microbial communities. Arrow width represents standardized effect size, black arrows represent significant paths, light grey arrows represent non-significant paths conserved during model selection process (see SI Table 5 for all coefficient values and significance). Marginal  $R^2$  ( $R^2_m$ ) and conditional  $R^2$  ( $R^2_c$ ) are given only for ecosystem processes (see SI Table 5 for  $R^2$  of all endogenous variables). One-headed arrows represent causal relationships while double-headed arrows represent free correlations. LAP= leucine aminopeptidase, NAG=  $\beta$ -1,4-N-acetylglucosaminidase, *apr*= alkaline metallopeptidase, *npr*= neutral metallopeptidase, NMDS= Non-metric multidimensional scaling, db-RDA= distance based redundancy analysis. 'Constrained composition *apr* (db-RDA)'= projected score of the first db-RDA axis of proteolytic (*apr*) microbial community composition (representing the sub part of the composition constrained by management), 'Overall composition *apr* (NMDS)'= projected score of the first NMDS axis of proteolytic (*apr*) microbial community (representing the overall proteolytic microbial community composition).

3.4 IDENTIFICATION OF VARIABLES POTENTIALLY INVOLVED IN DRIVING THE MANAGEMENT EFFECT ON PROTEOLYTIC MICROBIAL COMMUNITY COMPOSITION

Management significantly affected P-associated litter traits, with higher litter-P content and lower litter C:P, N:P as well as lignin:P ratios in ecological intensively compared to conventional intensively managed systems (Table 9) whereas no such effects on soil properties were found (SI Table 6). Management effects on the vegetation

composition in ecological intensively managed systems were found only for plant cover in the group “other” (non-grass and non-leguminous species) (Table 9). High conditional R<sup>2</sup> and low marginal R<sup>2</sup> observed for litter-P content, litter C:P and lignin:P ratio as well as the amount of non-grass and non-leguminous species indicated a large influence of country compared to management. Conversely, litter N:P ratio variation was mostly explained by management and only marginally by country.

Table 9. Management effect on litter properties and their correlation with proteolytic (apr) microbial community composition assessed using mixed effect model with country as random factor. R<sup>2</sup><sub>m</sub>= marginal R<sup>2</sup>, R<sup>2</sup><sub>c</sub>= conditional R<sup>2</sup>. ADF= acid detergent fibre, ADL= acid detergent lignin, LCI= lignocellulose index (lignin/(lignin + cellulose)), C= carbon, N= nitrogen, P= phosphorous, db-RDA= distance based redundancy analyses, apr= alkaline metalloproteinase.

Plant community properties	Management effect			Correlation with constrained apr composition (db-RDA axis 1)		
	p	R <sup>2</sup> <sub>m</sub>	R <sup>2</sup> <sub>c</sub>	p	R <sup>2</sup> <sub>m</sub>	R <sup>2</sup> <sub>c</sub>
<i>Litter Trait</i>						
ADF (% dry mass)	0.0703	0.01	0.97	0.552	0.02	0.02
ADL (% dry mass)	0.4786	0.00	0.99	0.652	0.01	0.01
Cellulose (% dry mass)	0.3157	0.01	0.73	0.793	0.00	0.00
LCI	0.7709	0.00	0.94	0.744	0.00	0.00
C (% dry mass)	0.7193	0.00	0.97	0.623	0.01	0.01
N (% dry mass)	0.2209	0.00	0.97	0.551	0.02	0.02
<b>P (% dry mass)</b>	<b>0.0362</b>	<b>0.05</b>	<b>0.79</b>	<b>0.007</b>	<b>0.31</b>	<b>0.72</b>
C:N	0.8610	0.00	0.95	0.544	0.02	0.02
<b>N:P</b>	<b>0.0017</b>	<b>0.32</b>	<b>0.43</b>	<b>0.003</b>	<b>0.32</b>	<b>0.32</b>
<b>C:P</b>	<b>0.0001</b>	<b>0.06</b>	<b>0.95</b>	<b>0.006</b>	<b>0.33</b>	<b>0.87</b>
lignin:N	0.0917	0.00	0.96	0.863	0.00	0.00
<b>lignin:P</b>	<b>0.0007</b>	<b>0.06</b>	<b>0.92</b>	<b>0.313</b>	<b>0.04</b>	<b>0.04</b>
<i>Vegetation composition and diversity</i>						
legumes cover (%)	0.2320	0.02	0.74	0.768	0.00	0.00
grass cover (%)	0.1806	0.06	0.24	0.168	0.08	0.08
<b>Others (non-grass, non-legumes) cover (%)</b>	<b>0.0179</b>	<b>0.07</b>	<b>0.77</b>	<b>0.009</b>	<b>0.29</b>	<b>0.68</b>
Plant richness	0.3403	0.00	0.98	0.757	0.00	0.00
Plant shannon diversity	0.3292	0.01	0.82	0.873	0.00	0.00

Except for lignin:P ratio, all litter and vegetation parameters affected by management were significantly correlated with the sub-part of proteolytic (*apr*) microbial community composition under the influence of management (constrained composition, db-RDA axis 1) (Table 9). Litter-P content, litter C:P and litter N:P ratio as well as the amount of non-grass and non-leguminous species explained almost equivalent parts of the proteolytic (*apr*) microbial community composition with marginal  $R^2$ s around 0.30. Contrary, the correlation between proteolytic (*apr*) microbial community composition and litter N:P ratio presented no country effects (marginal  $R^2$  equal to conditional  $R^2$ ), indicating that the intercept of the correlation between litter N:P ratio and *apr* composition was not conditioned by country. Thus, litter N:P ratio was more consistent between countries than the other plant properties and a better candidate to be the driver of proteolytic (*apr*) microbial community composition.

## 4 DISCUSSION

Management, SOM, rainfall variability and climate change affect soil microbial communities, biogeochemical cycling and thus soil fertility and ecosystem services in agro-ecosystems. The current study aimed at assessing the effects of contrasting rain regimes as proxies of forecasts under climate change (dry, wet, intermittent vs. normal), management (ecological intensive vs. conventional intensive) and SOM concentration on N-related ecosystem processes that are potentially microbially mediated, in forage agroecosystems across three European countries.

In general, results confirmed our overall hypotheses (Figure 30) stating that across countries, rain regime, management and SOM directly and/or indirectly *via* modifications of N-related microbial communities, affect forage-N uptake and  $\text{NO}_3^-$  leaching (Figure 32). Ecological intensive management influenced exclusively N-related microbial community composition and not abundance, activity and diversity (Table 7 and 8) and thus hypothesis H1.1 was validated for composition but not for other microbial community parameters. SOM positively affected N-related microbial community abundance,

activity and diversity and modified community composition (Figure 32), which is in agreement with hypothesis H1.2. Rain regime exclusively affected N-related microbial enzymatic activities but not abundance, diversity and composition (Table 7 and 8) indicating high resistance of N-related microbial community, and these results being partially in agreement with hypothesis H1.3 (Figure 30). Finally, our results are in agreement with our second hypothesis (Figure 30) that N-related ecosystem processes are positively influenced mainly directly by rain regime (H2.2), and by ecological-intensive management and SOM mainly indirectly *via* N-related microbial communities (H2.1). Overall our results provide new insights into potential mechanisms controlling agro-ecosystem functioning under projected climate changes.

Hereafter, we first discuss how management and SOM indirectly influence N-related ecosystem processes through modification of proteolytic (*apr*) microbial community composition. Subsequently, we discuss how rain regime directly affects N-related ecosystem processes and soil indicators, but only to a lesser extent microbial communities.

### 4.1 MANAGEMENT AND SOM INFLUENCE N-RELATED ECOSYSTEM PROCESSES THROUGH MODIFICATION OF N-RELATED MICROBIAL COMMUNITIES

During the last twenty years many studies assessed long-term management effects on the microbial community composition in soil<sup>13,57</sup>. Yet, only few studies focused on a functional group of microorganisms and even less have assessed repercussions on ecosystem processes. In the present study, effects of management on proteolytic (*apr*) microbial community composition were found (Figure 31, Table 8) and SEM depicted ecological intensive management to affect proteolytic microbial community composition promoting forage-N uptake and buffering  $\text{NO}_3^-$  leaching (Figure 32). Even though there are good theoretical (Figure 30) and experimental<sup>34</sup> reasons to interpret these SEM as causal model, results should be considered as a potential causal model rather than a proof of causality<sup>53</sup>. The fact that management

effects on N-cycling processes occur through *apr* composition, and not *via* other proteolytic microbial community properties such as *apr* abundance or diversity stresses that not only “how many functional genes” (abundance of a functional group) or “how many functional OTUs” (diversity within a functional group) matters but also “which functional OTUs” (composition of the functional group)<sup>58</sup>. The involvement of proteolytic microbial community composition in promoting N-related ecosystem processes might be explained by distinct traits associated to certain organisms/species carrying the *apr* sequence – some organisms might encode for more efficiently or differently working proteases, produce other enzymes involved in N-hydrolysis or even harbor other traits favoring forage-N uptake. Furthermore, the presence of *apr* sequences within organisms is only a discrete trait indicating a potential to produce the respective enzyme. Thus, moving forward to realized and continuous trait measurement<sup>59</sup> by relating taxa to enzyme production and kinetics could help to elucidate why and when functional gene encoding microbial community composition matters. Additionally, functional screening using isolation and physiological characterization<sup>60</sup> as well as shotgun metagenomics and metatranscriptomics assessing the entire metabolic potential of a given community<sup>61</sup> could help to bridge parts of this gap. When analyzing proteolytic microbial community composition in detail, we found *apr* OTUs discriminating between countries, whereas across all countries no *apr* OTUs significantly discriminating between managements could be found. Overall, only one third of *apr* OTUs could be assigned to known sequences/database entries, calling for future research to identify hidden functional players in the proteolytic gene pool. The annotated sequences were dominated by *Pseudomonas*, which is in line with the current literature<sup>34,62</sup>. However, annotation also revealed some sequences to be associated to organisms outside the prokaryotes. In general, results of amplicon sequencing targeting functional genes should be interpreted cautiously due to some limitations<sup>63</sup>. Even though highly degenerated, primers might miss certain sequences and thus diversity and composition might be

under- or overestimated. Furthermore, PCR, library preparation, sequencing, and especially annotation bear further bias. Besides *apr*, also *npr* targets protease encoding microbial communities and are functionally involved in N-related ecosystem processes but have been shown to be less responsive to water treatments<sup>34</sup>. Overall, our results seem to confirm the central role of proteolytic microbial communities in regulating the N cycling in the context of climate change. Thus we call for a deeper characterization of this functional group, especially by moving forward and investigating their realized traits to understand why and where proteolytic community composition matter for ecosystem functioning.

In the present study no management effect on SOM concentration was found (Table 7) indicating management to affect proteolytic microbial community composition independent of SOM concentration. The absence of management effects on SOM in the current study is inconsistent with recent global scale meta-analyses reporting beneficial effects of ecological intensive management (organic farming) on soil organic carbon (SOC) stocks<sup>10,11</sup>. In the respective meta-analyses, the beneficial effect of ecological intensive management was attributed to higher organic C inputs and distinct plant traits. Plants can influence microbial community composition<sup>64</sup>, for example *via* litter quality<sup>65</sup> and rhizodeposition<sup>66</sup>. Measurements on six sites across Europe (including the ones assessed in the current study) showed that higher crop residue decomposability in conventional intensive systems explain the beneficial effect of ecological intensive systems on SOC<sup>11</sup>. However, the beneficial effect of ecological intensification on SOC was absent if litter N concentrations of the compared systems were not distinct enough. Among the sites with no beneficial effect of ecological intensification<sup>11</sup> on SOC are the sites used in the current experiment. Linear regression between soil properties, litter and vegetation diversity and composition with the sub-part of the proteolytic microbial community composition under the influence of management (coordinates of the first axis of the db-RDA) was used to identify possible drivers for the



observed management effect. It showed that litter N properties were not correlated with proteolytic (*apr*) microbial community composition, but litter P properties were. Out of all litter- P properties associated with proteolytic (*apr*) microbial community composition, exclusively litter N:P ratios were not conditioned by country (Table 9). The lower litter N:P ratios in the ecological intensively vs. conventional intensively managed systems were mostly due to higher litter P concentration. Lower abundance of grasses and legumes relative to forbs in ecological intensive plots (except in Switzerland, Table 9 and Table 3 (p86, Chapter 2.1)) can in part explain lower litter N:P ratios<sup>67,68</sup>. Our results indicate that the management effect on proteolytic microbial community composition acts through contrasting litter quality in ecological intensive and conventional intensive systems. Lower litter N:P ratios in plant communities on ecological intensively managed plots probably release more P and less N<sup>69</sup>. Such differences might have modified nutritional constraints for microbes and could explain the observed selection of different proteolytic microbial communities. Under the respective condition, microbial communities might have developed a more efficient enzymatic machinery and can thus better extract N from soil organic matter, some of which being profitable to forage plants. Lower litter N:P ratios might have also potentially selected for more copiotrophic microbes (Piton et al. under review, Chapter 1) and thus increase the mineralization potential. Characterized by a low biomass N:P ratio and fast growth rates<sup>70</sup>, copiotrophic microbes might shift from N immobilization to N mineralization at a lower N:P ratio compared to oligotrophic microbes<sup>69</sup>. P additions can select for microbial community with traits associated to a more copiotrophic lifestyle resulting in increased N mineralization and soil inorganic N concentration and, paralleled by decreased organic N concentration<sup>71</sup>. Thus, differences in litter P concentration and its repercussion on litter N:P might modify proteolytic microbial community composition translating into a positive effect on forage-N uptake. These results encourage further research on how litter can shape soil proteolytic microbial communities.

#### 4.2 RAIN REGIME AFFECTS N-RELATED ECOSYSTEM PROCESSES AND -SOIL INDICATORS BUT ONLY MARGINALLY -MICROBIAL COMMUNITIES

Consistent rain regime effects on N-related ecosystem processes, and soil indicators were identified across countries (Table 7). In general, forage-N uptake increased under wet and decreased under dry rain regime (Figure 32, SI Figure 4). N-related soil indicator responses to rain regime were in line with a current meta-analysis<sup>22</sup> with increase of  $\text{NH}_4^+$  under reduced precipitation, while no effect on  $\text{NO}_3^-$  was present. However, in the wet rain regime, soil  $\text{NO}_3^- + \text{NO}_2^-$  decreased, probably due to enhanced losses *via* leaching, plant uptake or gaseous emissions<sup>72</sup>.

Microbial communities are also supposed to be sensitive to soil water potential and thus expected to be responsive to rain regimes. A meta-analysis identified microbial activity to decrease with decreasing soil moisture in a consistent way across biomes and climatic conditions<sup>73</sup>. Despite the strong rain regime effects on N-related ecosystem processes and soil indicators, only N-related microbial activity was significantly affected by rain regimes whereas no effects on N-related microbial community abundance, diversity and composition were observed (Table 7 and 8). This response confirms that rain regime does affect N-related microbial communities but suggests that activity is more water sensitive than the other microbial parameters. Furthermore, rain regime effects on N-related microbial activity did not follow a rain gradient as hypothesized. Conversely, we observed that all rain regimes tend to decrease activity, which suggests that different mechanisms are acting in these contrasted rain regimes but all leading to a decrease in activity (Chapter 2.2). Studies assessing effects of soil moisture on N-related functional genes are scarce, making comparisons with our results difficult.

Several explanations are possible for the weak rain regime effect on N-related microbial communities observed in the current experiment, while higher climate sensitivity has been observed for the same functional genes (*apr* and *npr*)<sup>34</sup>. The fact that the dry, wet and intermittent rain regimes were distinct enough to affect plant growth and N uptake but not enough to affect N-

related microbial communities, potentially indicates lower sensitivity of N-related microbial communities to soil moisture variation compared to plants. All TMEs, even the dry ones, received water during the 263 days they experienced distinct rain regimes (amount and intensity differed) and current microbial community characterization was conducted only on the top soil layer (5 cm). Thus, although soil moisture was quite distinct at the sampling time, the microbial community might have been able to profit from the few precipitation events during the dry rain regime whereas plants did not<sup>74</sup>. Lastly, rain regime effects on N-related microbial communities might have been compensated by other factors such as enhanced rhizodeposition by plants under moderate drought<sup>75</sup>.

#### 4.3 SYNTHESIS AND OUTLOOK

Our experiment revealed strong direct impacts of rain regimes on N-cycling processes, whereas N-related microbial communities were exclusively affected in terms of activity. We did not find management to directly affect N-related microbial community abundance, diversity and activity and abiotic N-related soil indicators. However, management did directly affect N-related microbial community composition resulting in increased forage-N uptake and reduced  $\text{NO}_3^-$  leaching under ecological intensive vs. conventional intensive management across all rain regimes.

Furthermore, we found SOM concentration to affect N-related microbial communities resulting in increased forage-N uptake and decreased  $\text{NO}_3^-$  leaching (Figure 32). The SOM effect was independent of management suggesting that management effects on microbial community act through other paths than SOM concentration. Our additional analyses indicate a role of litter- P associated properties, especially litter N:P ratio, in shaping N-related microbial community composition (Table 8). While the importance of litter traits for soil C sequestration was already shown<sup>11</sup>, and our results extend the importance of litter traits to the N-cycle.

However, part of variation of N-cycling processes was not explained by our models (Table 7 and SI Table

5), demonstrating that our understanding of factors controlling ecosystem processes and functioning is still to be improved to be ready for implementing resilient ecological intensive agriculture. Investigations into the associations between ecosystem processes and other functional groups than considered in the present study should be encouraged.

#### ACKNOWLEDGEMENTS

This work was funded by the ECO-SERVE project through the 2013–2014 BiodivERSA/FACCE-JPI joint call for research proposals, with the national funders ANR, NWO, FCT (BiodivERSA/001/2014), MINECO, FORMAS and SNF. Eduardo Nascimento was supported by *CNPq – Brazil (CNPq Fellowship Holder – Brazil)*. The authors would like to thank to Filipe Carvalho for helping in the maintenance of the mesocosm experiment. Thanks to Cindy Arnoldi for help with chemical and enzymatic analyses. We are greatly indebted to the owners of the different farms from where the TMEs were collected. The DOK trial from which the Swiss TMEs were extracted is funded by the Swiss Federal Office of Agriculture. The bioinformatics support of the BMBF-funded project Bielefeld-Gießen Center for Microbial Bioinformatics–BiGi (grant 031A533) within the German Network for Bioinformatics Infrastructure (de.NBI) is gratefully acknowledged.

#### AUTHOR CONTRIBUTIONS

LB, PS, PM, AG, JCC and AF initiated the idea of the experiment together with other partners of the ECO-SERVE project. All authors contributed to the elaboration of the experimental design and participated in sampling. EN, FR and PS carried out the experiment in the Laboratory of Soil Ecology and Ecotoxicology of the University of Coimbra. ML conducted the laboratory work of the characterization of the proteolytic microbial community. ML and SJ ran the bioinformatic analyses and analyzed proteolytic microbial community composition. GP, NL, JCC, AF conducted the enzymatic assays. GP conducted the mixed effect model and structural equation model analyses. ML and GP wrote the

first draft and edited it based on significant comments from SS, NL, LB, SJ, PS, PM, AG, JCC and AF. All authors gave final approval for publication.

### ADDITIONAL INFORMATION

The authors declare that the research was conducted in the absence of any commercial or financial relationships that could be construed as a potential conflict of interest.

### REFERENCES

1. Elser, J. J. et al. Global analysis of nitrogen and phosphorus limitation of primary producers in freshwater, marine and terrestrial ecosystems. *Ecol. Lett.* 10, 1135–1142 (2007).
2. Meisinger, J. J., Schepers, J. S. & Raun, W. R. Crop Nitrogen Requirement and Fertilization. in *Nitrogen in Agricultural Systems* 563–612 (2008). doi:10.2134/agronmonogr49
3. Vitousek, P. M., Porder, S., Houlton, B. Z. & Chadwick, O. Terrestrial phosphorus limitation : mechanisms , implications , and nitrogen – phosphorus interactions. *Ecol. Appl.* 20, 5–15 (2010).
4. Canfield, D. E., Glazer, A. N. & Falkowski, P. G. The Evolution and Future of Earth’s Nitrogen Cycle. *Science.* 330, 192–196 (2010).
5. Li, Z. et al. Microbes drive global soil nitrogen mineralization and availability. *Global Change Biology* 25, (2019).
6. Austin, A. T. & Vitousek, P. M. Nutrient dynamics on a precipitation gradient in Hawai’i. *Oecologia* 113, 519–529 (1998).
7. Galloway, J. N. et al. Transformation of the nitrogen cycle: Recent trends, questions, and potential solutions. *Science.* 320, 889–892 (2008).
8. Fowler, D. et al. The global nitrogen cycle in the twenty- first century. *Philosophical Trans. R. Soc. B* 368, 2–13 (2013).
9. Bommarco, R., Kleijn, D. & Potts, S. G. Ecological intensification: Harnessing ecosystem services for food security. *Trends Ecol. Evol.* 28, 230–238 (2013).
10. Gattinger, A. et al. Enhanced top soil carbon stocks under organic farming. *Proc. Natl. Acad. Sci.* 109, 18226–18231 (2012).
11. García-Palacios, P. et al. Crop traits drive soil carbon sequestration under organic farming. *J. Appl. Ecol.* 00, 1–10 (2018).
12. Lori, M., Symnaczik, S., Mäder, P., De Deyn, G. & Gattinger, A. Organic farming enhances soil microbial abundance and activity—A meta-analysis and meta-Regression. *PLoS One* 12, 1–25 (2017).
13. Hartmann, M., Frey, B., Mayer, J., Mäder, P. & Widmer, F. Distinct soil microbial diversity under long-term organic and conventional farming. *ISME J.* 9, 1–18 (2014).
14. Philippot, L. et al. Loss in microbial diversity affects nitrogen cycling in soil. *ISME J.* 7, 1609–1619 (2013).
15. Wagg, C., Bender, S. F., Widmer, F. & van der Heijden, M. G. A. Soil biodiversity and soil community composition determine ecosystem multifunctionality. *Proc. Natl. Acad. Sci.* 111, 5266–5270 (2014).
16. Grigulis, K. et al. Relative contributions of plant traits and soil microbial properties to mountain grassland ecosystem services. *J. Ecol.* 101, 47–57 (2013).
17. Legay, N. et al. Contribution of above- and below-ground plant traits to the structure and function of grassland soil microbial communities. *Ann. Bot.* 114, 1011–1021 (2014).
18. Delgado-Baquerizo, M. et al. Microbial diversity drives multifunctionality in terrestrial ecosystems. *Nat. Commun.* 7, 1–8 (2016).
19. Bender, S. F., Wagg, C. & van der Heijden, M. G. A. An Underground Revolution: Biodiversity and Soil Ecological Engineering for Agricultural Sustainability. *Trends Ecol. Evol.* 31, 440–452 (2016).
20. Isbell, F. et al. Biodiversity increases the resistance of

- ecosystem productivity to climate extremes. *Nature* 526, 574–577 (2015).
21. Borken, W. & Matzner, E. Reappraisal of drying and wetting effects on C and N mineralization and fluxes in soils. *Glob. Chang. Biol.* 15, 808–824 (2009).
  22. Homyak, P. M., Allison, S. D., Huxman, T. E., Goulden, M. L. & Treseder, K. K. Effects of Drought Manipulation on Soil Nitrogen Cycling: A Meta-Analysis. *J. Geophys. Res. Biogeosciences* 122, 3260–3272 (2017).
  23. Legay, N., Piton, G., Arnoldi, C., Bernard, L. & Binet, M. Soil legacy effects of climatic stress, management and plant functional composition on microbial communities influence the response of *Lolium perenne* to a new drought event. *Plant Soil* 424, 233–254 (2018).
  24. De Vries, F. T. & Shade, A. Controls on soil microbial community stability under climate change. *Front. Microbiol.* 4, 1–16 (2013).
  25. Díaz, S. & Cabido, M. Vive la différence: plant functional diversity matters to ecosystem processes. *Trends Ecol. Evol.* 16, 646–655 (2001).
  26. Naeem, S. & Wright, J. P. Disentangling biodiversity effects on ecosystem functioning: Deriving solutions to a seemingly insurmountable problem. *Ecol. Lett.* 6, 567–579 (2003).
  27. Cardinale, B. J. et al. Biodiversity loss and its impact on humanity. *Nature* 486, 59–67 (2012).
  28. de Vries, F. T. de et al. Soil bacterial networks are less stable under drought than fungal networks. *Nat. Commun.* 9, (2018).
  29. Schimel, J. P. & Bennett, J. Nitrogen mineralization: challenges of a changing paradigm. *Ecology* 85, 591–602 (2004).
  30. Geisseler, D., Horwath, W. R., Joergensen, R. G. & Ludwig, B. Pathways of nitrogen utilization by soil microorganisms - A review. *Soil Biol. Biochem.* 42, 2058–2067 (2010).
  31. Bach, H. J., Hartmann, a., Schloter, M. & Munch, J. C. PCR primers and functional probes for amplification and detection of bacterial genes for extracellular peptidases in single strains and in soil. *J. Microbiol. Methods* 44, 173–182 (2001).
  32. Fuka, M. et al. Changes of diversity pattern of proteolytic bacteria over time and space in an agricultural soil. *Microb. Ecol.* 57, 391–401 (2009).
  33. Sakurai, M., Suzuki, K., Onodera, M., Shinano, T. & Osaki, M. Analysis of bacterial communities in soil by PCR-DGGE targeting protease genes. *Soil Biol. Biochem.* 39, 2777–2784 (2007).
  34. Lori, M. et al. Distinct Nitrogen Provisioning From Organic Amendments in Soil as Influenced by Farming System and Water Regime. *Front. Environ. Sci.* 6, 1–14 (2018).
  35. Moorhead, D. L., Rinkes, Z. L., Sinsabaugh, R. L. & Weintraub, M. N. Dynamic relationships between microbial biomass, respiration, inorganic nutrients and enzyme activities: Informing enzyme-based decomposition models. *Front. Microbiol.* 4, 1–12 (2013).
  36. Ng, E. L. et al. Does altered rainfall regime change pesticide effects in soil? A terrestrial model ecosystem study from Mediterranean Portugal on the effects of pyrimethanil to soil microbial communities under extremes in rainfall. *Appl. Soil Ecol.* 84, 245–253 (2014).
  37. Fließbach, A., Oberholzer, H.-R., Gunst, L. & Mäder, P. Soil organic matter and biological soil quality indicators after 21 years of organic and conventional farming. *Agric. Ecosyst. Environ.* 118, 273–284 (2007).
  38. Loucougaray, G. et al. Assessing the Effects of Grassland Management on Forage Production and Environmental Quality to Identify Paths to Ecological Intensification in Mountain Grasslands. *Environ. Manage.* 56, 1039–1052 (2015).
  39. Houba, V. J. G., Temminghoff, E. J. M., Gaikhorst, G.

- A. & van Vark, W. Soil analysis procedures using 0.01 M calcium chloride as extraction reagent. *Commun. Soil Sci. Plant Anal.* 31, 1299–1396 (2000).
40. Bell, C. W. et al. High-throughput Fluorometric Measurement of Potential Soil Extracellular Enzyme Activities. *J. Vis. Exp.* 81, 1–16 (2013).
41. Andrews, S. FastQC: a quality control tool for high throughput sequence data. <http://www.bioinformatics.babraham.ac.uk/projects/fastqc> (2010).
42. Ewels, P., Magnusson, M., Lundin, S. & Käller, M. MultiQC: Summarize analysis results for multiple tools and samples in a single report. *Bioinformatics* 32, 3047–3048 (2016).
43. Magoč, T. & Salzberg, S. L. FLASH: Fast length adjustment of short reads to improve genome assemblies. *Bioinformatics* 27, 2957–2963 (2011).
44. Edgar, R. C. UPARSE: highly accurate OTU sequences from microbial amplicon reads. *Nat. Methods* 10, 996–998 (2013).
45. Jaenicke, S. et al. Flexible metagenome analysis using the MGX framework. *Microbiome* 6, 1–9 (2018).
46. Oksanen, J. et al. *vegan: Community Ecology Package*. R Package. version 2.3-2 <https://CRAN.R-project.org/package=vegan> (2015).
47. Steinberger, A. *asteinberger9\_seqscripts*. [https://github.com/asteinberger9/seq\\_scripts](https://github.com/asteinberger9/seq_scripts) (2018).
48. Team, R. C. R: A language and environment for statistical computing. R Foundation for Statistical Computing. <https://www.r-project.org/> (2017). doi:10.4236/ajps.2017.87116
49. Crawley, M. J. *The R book*. (WILEY, 2013).
50. Pinheiro, J., Douglas, B., Sakat, D., Sarkar, D. & Team, R. C. Linear and Nonlinear Mixed Effects Models. <https://CRAN.R-project.org/package=nlme> (2018).
51. Lenth, R. V. Least-Squares Means: The R Package *lsmeans*. *J. Stat. Softw.* 69, (2016).
52. Laughlin, D. C., Abella, S. R., Covington, W. W. & Grace, J. B. Species richness and soil properties in *Pinus ponderosa* forests: A structural equation modeling analysis. *J. Veg. Sci.* 18, 231 (2007).
53. Grace, J. B., Scheiner, S. M. J. & Schoolmaster, D. R. Structural equation modeling: building and evaluating causal models: Chapter 8. in *Ecological statistics: contemporary theory and application* 168–199 (Oxford University Press, 2015).
54. Lefcheck, J. S. *piecewiseSEM: Piecewise structural equation modelling in r for ecology, evolution, and systematics*. *Methods Ecol. Evol.* 7, 573–579 (2016).
55. Shipley, B. *Cause and Correlation in Biology A User's Guide to Path Analysis, Structural Equations and Causal Inference with R*. (Cambridge University Press, 2016).
56. Hertzog, L. R. How robust are Structural Equation Models to model misspecification? A simulation study. *arXiv:1803.06186v3* 1–24 (2019).
57. Li, R. et al. Pyrosequencing Reveals the Influence of Organic and Conventional Farming Systems on Bacterial Communities. *PLoS One* 7, 1–12 (2012).
58. Bender, S. F., Wagg, C. & van der Heijden, M. G. An Underground Revolution: Biodiversity and Soil Ecological Engineering for Agricultural Sustainability. *Trends Ecol. Evol.* 31, 440–452 (2016).
59. Martiny, J. B. H., Jones, S. E., Lennon, J. T. & Martiny, A. C. Microbiomes in light of traits: A phylogenetic perspective. *Science* (80-. ). 350, 1–8 (2015).
60. Lladó, S., Žifčáková, L., Větrovský, T., Eichlerová, I. & Baldrian, P. Functional screening of abundant bacteria from acidic forest soil indicates the metabolic potential of *Acidobacteria* subdivision 1 for polysaccharide decomposition. *Biol. Fertil. Soils* 52, 251–260 (2016).
61. Žifčáková, L. et al. Feed in summer, rest in winter: microbial carbon utilization in forest topsoil.

- Microbiome 5, 1–12 (2017).
62. Baraniya, D. et al. Protease encoding microbial communities and protease activity of the rhizosphere and bulk soils of two maize lines with different N uptake efficiency. *Soil Biol. Biochem.* 96, 176–179 (2016).
63. Taberlet, P. & Coissac, E. Environmental DNA. *Mol. Ecol.* 21, 1789–1793 (2012).
64. Hargreaves, S. K., Williams, R. J. & Hofmockel, K. S. Environmental filtering of microbial communities in agricultural soil shifts with crop growth. *PLoS One* 10, 1–14 (2015).
65. Fanin, N., Hättenschwiler, S. & Fromin, N. Litter fingerprint on microbial biomass, activity, and community structure in the underlying soil. *Plant Soil* 379, 79–91 (2014).
66. Philippot, L., Raaijmakers, J. M., Lemanceau, P. & Van Der Putten, W. H. Going back to the roots: The microbial ecology of the rhizosphere. *Nat. Rev. Microbiol.* 11, 789–799 (2013).
67. He, J.-S., Wang, L., Flynn, D. F. B., Fang, X. W. & Ma, W. J. Leaf nitrogen:phosphorus stoichiometry across Chinese grassland biomes. *Oecologia* 2, 177–184 (2008).
68. Sadras, V. O. The N:P stoichiometry of cereal, grain legume and oilseed crops. *F. Crop. Res.* 95, 13–29 (2006).
69. Güsewell, S. & Gessner, M. O. N:P ratios influence litter decomposition and colonization by fungi and bacteria in microcosms. *Funct. Ecol.* 23, 211–219 (2009).
70. Karpinets, T. V., Greenwood, D. J., Sams, C. E. & Ammons, J. T. RNA: Protein ratio of the unicellular organism as a characteristic of phosphorous and nitrogen stoichiometry and of the cellular requirement of ribosomes for protein synthesis. *BMC Biol.* 4, 1–10 (2006).
71. Changhui, W., Feng, Z., Xiang, Z. & Kuanhu, D. Geoderma The effects of N and P additions on microbial N transformations and biomass on saline-alkaline grassland of Loess Plateau of Northern China. *Geoderma* 213, 419–425 (2014).
72. Skiba, U. & Smith, K. A. The control of nitrous oxide emissions from agricultural and natural soils. *Glob. Chang. Sci.* 2, 1994–2001 (2000).
73. Manzoni, S., Schimel, J. P. & Porporato, A. Responses of soil microbial communities to water stress: Results from a meta-analysis. *Ecology* 93, 930–938 (2012).
74. Rennenberg, H. et al. Nitrogen balance in forest soils: Nutritional limitation of plants under climate change stresses. *Plant Biol.* 11, 4–23 (2009).
75. Preece, C. & Peñuelas, J. Rhizodeposition under drought and consequences for soil communities and ecosystem resilience. *Plant Soil* 409, 1–17 (2016).

SUPPLEMENTARY MATERIALS

SI FIGURES

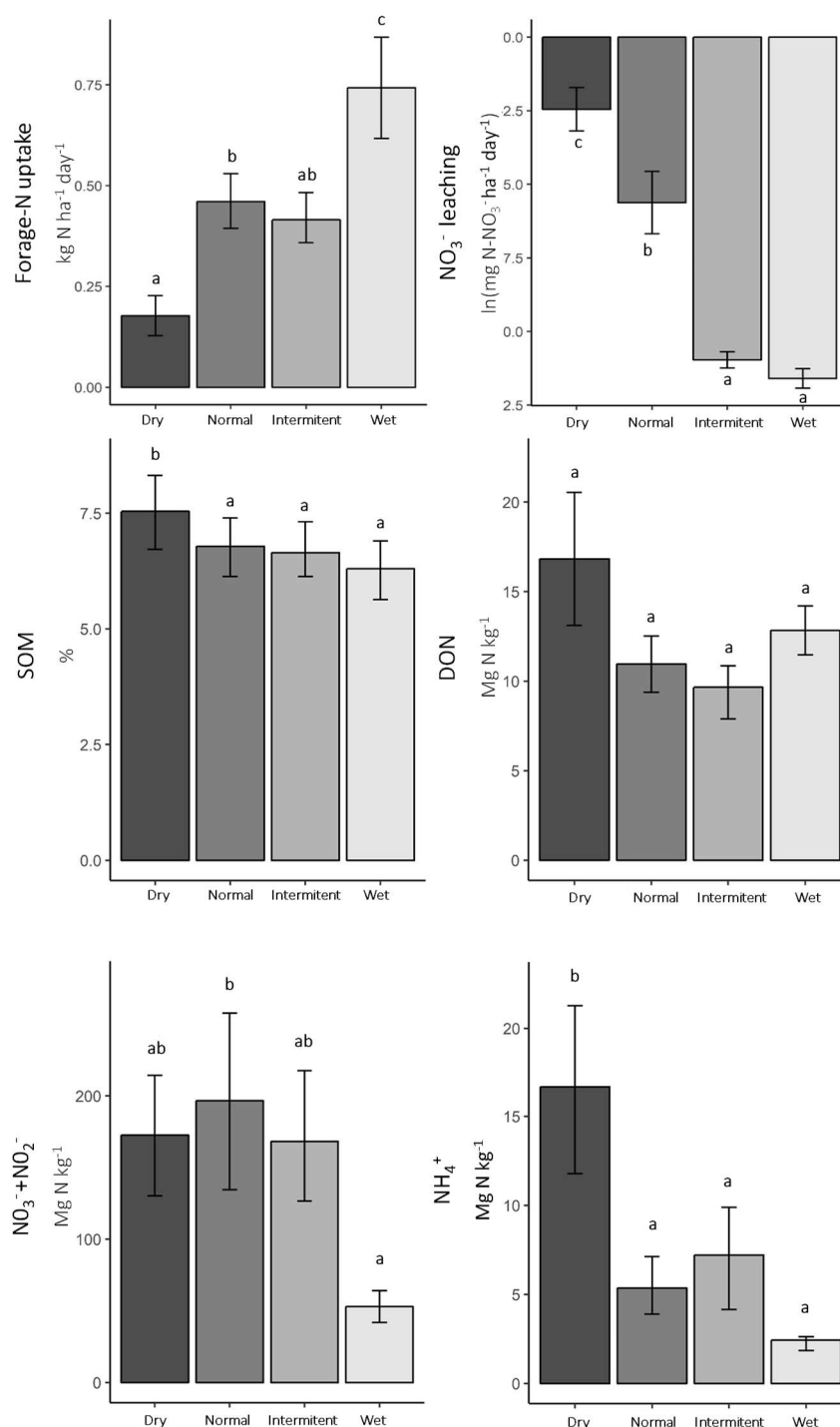

SI Figure 4: Forage-nitrogen (N) uptake, NO<sub>3</sub><sup>-</sup> leaching, soil organic matter (SOM), NH<sub>4</sub><sup>+</sup>, NO<sub>3</sub><sup>-</sup> + NO<sub>2</sub><sup>-</sup> and dissolved organic nitrogen (DON) as affected by rain regime. Results derive from post hoc comparison on mixed effect models. Different letters indicate significant differences between treatments according to Tukey's honest significant difference test with a significance level of p ≤ 0.05. Error bars represent standard error, n=24

## SI TABLES

SI Table 4. Overview of oligonucleotide sequences and cycling conditions used for quantitative polymerase chain reaction (qPCR) and amplicon sequencing. *apr*= alkaline metalloproteinase, *npr*= neutral metalloproteinase, *FP*= Forward Primer, *RP*= Reverse Primer, *C1*= Fluidigm-tag C1, *C2*= Fluidigm-tag C2

Name	Target gene	C1/C2 Tag	Sequence	Reference	Annealing temperature [° C]	Number of Cycles	Primer concentration
FP <i>apr</i> I	<i>apr</i>		TAY GGB TTC AAY TCC AAY AC	Bach et al. (2001)	55	35	750nM
RP <i>apr</i> II	<i>apr</i>		VGC GAT SGA MAC RTT RCC	Bach et al. (2001)			
FP <i>npr</i> I	<i>npr</i>		GTD GAY GCH CAY TAY TAY GC	Bach et al. (2001)	55	35	750nM
RP <i>npr</i> II	<i>npr</i>		ACM GCA TGB GTY ADY TCA TG	Bach et al. (2001)			
C1-FP <i>apr</i> I	<i>apr</i>	ACACTGACGACATGGTTCTACA	TAY GGB TTC AAY TCC AAY AC	Lori et al. (2018)	54	39	600nM
C2-RP <i>apr</i> II	<i>apr</i>	TACGGTAGCAGAGACTTGGTCT	VGC GAT SGA MAC RTT RCC	Lori et al. (2018)			



SI Table 5. Data underlying structural equation model depicted in Figure 32. Structural equation model (SEM) representing paths from rain regime and management to nitrogen (N)-cycling processes through soil organic matter (SOM) concentration and N-related microbial communities. Arrow width represents standardized effect size, black arrows represent significant paths, light grey arrows represent non-significant paths conserved during model selection process (see SI Table 5 for all coefficient values and significance). Marginal  $R^2$  ( $R^2_m$ ) and conditional  $R^2$  ( $R^2_c$ ) are given only for ecosystem processes (see SI Table 5 for  $R^2$  of all endogenous variables). One-headed arrows represent causal relationships while double-headed arrows represent free correlations. LAP= leucine aminopeptidase, NAG=  $\beta$ -1,4-N-acetylglucosaminidase, apr= alkaline metalloproteinase, npr= neutral metalloproteinase, NMDS= Non-metric multidimensional scaling, db-RDA= distance based redundancy analysis. 'Constrained composition apr (db-RDA)'= projected score of the first db-RDA axis of proteolytic (apr) microbial community composition (representing the sub part of the composition constrained by management), 'Overall composition apr (NMDS)'= projected score of the first NMDS axis of proteolytic (apr) microbial community (representing the overall proteolytic microbial community composition). representing rain regime and management effects on nitrogen (N)-cycling processes through soil organic matter (SOM) concentration and N-related microbial communities. Estimate= estimated standardized coefficient, p= p-value, NMDS= Non-metric multidimensional scaling, db-RDA= distance based redundancy analyses, apr= alkaline metalloproteinase, npr= neutral metalloproteinase, LAP= leucine aminopeptidase extracellular enzyme activities, NAG=  $\beta$ -1,4-N-acetylglucosaminidase. Marginal  $R^2$  ( $R^2_m$ ) and conditional  $R^2$  ( $R^2_c$ ) for endogenous variables are: Overall composition (apr):  $R^2_m= 0.09$ ,  $R^2_c= 0.72$ , Constrained composition (apr):  $R^2_m= 0.80$ ,  $R^2_c=0.88$ , Richness (apr):  $R^2_m= 0.10$ ,  $R^2_c=0.32$ , Activity (LAP + NAG):  $R^2_m= 0.36$ ,  $R^2_c= 0.39$ , Abundance (apr + npr):  $R^2_m= 0.56$ ,  $R^2_c= 0.61$ , forage-N uptake:  $R^2_m= 0.27$ ,  $R^2_c= 0.60$ ,  $\text{NO}_3^-$  leaching:  $R^2_m= 0.56$ ,  $R^2_c= 0.72$ .

Response	Predictor	Estimate	p
Hypothesized causal relationship			
Overall structure (apr, NMDS Axis 1)	SOM	0.332	0.018
Constrained structure (apr, db-RDA Axis 1)	Management (Ecological intensive)	1.800	0.010
Richness (apr)	SOM	0.313	0.020
Activity (LAP + NAG)	Rain regime (Dry)	-0.305	0.190
Activity (LAP + NAG)	Rain regime (Flood)	-0.312	0.179
Activity (LAP + NAG)	Rain regime (Intermittent)	-0.638	0.007
Activity (LAP + NAG)	SOM	0.548	p<0.001
Activity (LAP + NAG)	Management (Ecological intensive)	0.224	0.320
Abundance (apr + npr)	SOM	0.756	p<0.001
Forage-N uptake	Rain regime (Dry)	-0.734	0.004
Forage-N uptake	Rain regime (Flood)	0.630	0.010
Forage-N uptake	Rain regime (Intermittent)	-0.022	0.929
Forage-N uptake	Constrained structure (apr, db-RDA Axis 1)	0.395	0.035
Forage-N uptake	Activity (LAP + NAG)	0.228	0.048
$\text{NO}_3^-$ leaching	Rain regime (Dry)	-0.727	p<0.001
$\text{NO}_3^-$ leaching	Rain regime (Flood)	1.426	p<0.001
$\text{NO}_3^-$ leaching	Rain regime (Intermittent)	0.982	p<0.001
$\text{NO}_3^-$ leaching	SOM	-0.077	0.505
$\text{NO}_3^-$ leaching	Forage-N uptake	-0.206	0.006
$\text{NO}_3^-$ leaching	Management (Ecological intensive)	-0.217	0.225
Free covariation			
Abundance (apr + npr)	Richness (apr)	0.145	0.084
Constrained structure (apr, db-RDA Axis 1)	Activity (LAP + NAG)	-0.020	0.423
Overall structure (apr, NMDS Axis 1)	Richness (apr)	0.384	p<0.001
Overall structure (apr, NMDS Axis 1)	Constrained structure (apr, db-RDA Axis 1)	-0.299	0.002

SI Table 6. Management effect on soil properties and their correlation with proteolytic (*apr*) microbial community composition assessed using mixed effect model with country as random factor.  $R^2_m$ = marginal  $R^2$ ,  $R^2_c$ = conditional  $R^2$ . C= carbon, N= nitrogen, P= phosphorous, SOM= soil organic matter, DOC= dissolved organic carbon, DON= dissolved organic nitrogen, DMN= dissolved mineral nitrogen, db-RDA= distance based redundancy analyses, *apr*= alkaline metalloproteinase.

Soil properties	Management effect			Correlation with constrained <i>apr</i> composition (db-RDA axis 1)		
	p	$R^2_m$	$R^2_c$	p	$R^2_m$	$R^2_c$
SOM (%)	0.46	0.00	0.82	0.70	0.01	0.01
C (%)	0.91	0.00	0.72	0.99	0.00	0.00
N (%)	0.43	0.01	0.73	0.48	0.02	0.02
P (mg/Kg)	0.35	0.03	0.17	0.07	0.14	0.14
C:N	0.41	0.03	0.14	0.25	0.06	0.06
C:P	0.89	0.00	0.49	0.37	0.03	0.03
N:P	0.50	0.01	0.52	0.12	0.10	0.10
pH	0.65	0.01	0.31	0.63	0.01	0.01
DOC (mgC/Kg)	0.35	0.01	0.66	0.68	0.01	0.01
NH <sub>4</sub> <sup>+</sup> (mgN/Kg)	0.71	0.01	0.16	0.62	0.01	0.01
NO <sub>3</sub> <sup>-</sup> + NO <sub>2</sub> <sup>-</sup> (mgN/Kg)	0.62	0.01	0.54	0.36	0.04	0.04
DON (mgN/Kg)	0.95	0.00	0.00	0.35	0.04	0.04
PO <sub>4</sub> (µgP/g dry soil)	0.48	0.02	0.08	0.16	0.08	0.08
DOC:DMN	0.26	0.04	0.25	0.40	0.03	0.03
DMN:PO <sub>4</sub>	0.25	0.05	0.22	0.08	0.13	0.13
DOC:PO <sub>4</sub>	0.26	0.05	0.11	0.28	0.05	0.05
Silt (%)	0.581	0.00	0.95	0.657	0.01	0.05
Clay (%)	0.884	0.00	0.13	0.668	0.01	0.01
Sand (%)	0.707	0.00	0.93	0.629	0.02	0.06

### CONTRIBUTION PERSONNELLE AU CHAPITRE 2.3

Ma contribution à l'expérimentation 2 et à la majorité des analyses en laboratoire dont les résultats sont utilisés dans ce chapitre a déjà été détaillée dans le chapitre précédent (Contribution personnelle au chapitre 2.1). J'ai également réalisé les analyses en laboratoire de la teneur en nutriments des lessivas qui ont été utilisées spécifiquement pour ce chapitre. Les analyses moléculaires présentés dans ce chapitre (gène *apr* et *npr*) ont été réalisées par Martina Lori.

J'ai écrit ce chapitre en étroite collaboration avec Martina Lori (PhD student à FIBL, Suisse), avec qui nous partageons le statut de premier auteur. Pour cet article, j'ai réalisais les analyses statistiques (modèles mixtes et modèles d'équations structurelles) et Martina les analyses bio-informatiques et l'analyses du tableau d'OTUs. L'ensemble des parties (introduction, matériels et méthodes, résultats et discussion) ont été écrit à 4 mains, sur base de très nombreux échanges (quasi quotidien) avec Martina durant la période de rédaction. De même les révisions des différentes versions suite aux nombreux échanges avec les co-auteurs sur cet article ont été réalisée ensemble.

## CONCLUSION ET PERSPECTIVES DU CHAPITRE 2.3

Dans ce chapitre 2.3, nous avons évalué comment certaines propriétés écosystémiques non-microbiennes (assimilation de l'azote par les plantes et lixiviation des nitrates) étaient contrôlées directement et indirectement par la gestion et le régime de précipitation à travers des modifications de différentes composantes des communautés microbiennes associées au cycle de l'azote (activités enzymatiques extracellulaires, abondance, diversité et composition des communautés microbiennes protéolytiques). Les résultats confirment le rôle de l'activité enzymatique extracellulaire (dont les mécanismes de contrôle précis ont été étudiés dans le chapitre précédent 2.2.) dans le fonctionnement général de l'écosystème, avec un effet positif sur l'assimilation de l'azote par les plantes induisant ensuite une réduction de la quantité de nitrate lessivée. Alors que les mesures de cette activité enzymatique ne montrent pas de réponse à la gestion, de même que l'abondance et la diversité des communautés microbiennes protéolytiques, la composition des communautés microbiennes protéolytiques diffère entre les sols en gestion conventionnelle-intensive et éco-intensive, montrant un effet positif des microorganismes protéolytiques des systèmes éco-intensifs sur l'assimilation de l'azote par les plantes. La plus grande richesse en phosphore des plantes des systèmes éco-intensifs et notamment le ratio N:P de leur litière qui y est associé, semble expliquer cette différence de composition des communautés protéolytiques. Les résultats des chapitres 1 et 2.1 avaient déjà mis en évidence que la gestion des prairies pouvait influencer le niveau et la résilience des propriétés écosystémiques microbiennes, notamment *via* des modifications des traits des plantes (teneurs en matière sèche foliaire et en P des litières). Ce chapitre 2.3 semble également souligner leur importance dans le contrôle de la composition des communautés protéolytiques avec des effets en cascade sur les propriétés écosystémiques non-microbiennes.

L'ensemble des résultats des 3 chapitres basés sur l'expérience 2 (2.1, 2.2, 2.3) mettent en avant la position centrale des traits des plantes et des microorganismes du sol dans les mécanismes de réponses des communautés microbiennes aux changements globaux et dans leurs effets sur le fonctionnement et la résilience des écosystèmes. Un point fort de cette expérimentation ainsi que de l'expérimentation 1 est l'utilisation de "Terrestrial Ecosystem Model" constitués de sols intacts, permettant ainsi de se rapprocher de la réalité écologique *in situ*. Cependant, un point faible de ces expérimentations est de ne pas permettre de découpler les effets des différents facteurs composant les différentes modalités de gestion (fertilisation, charge pastorale, fauche) et leurs effets à court terme (ex : augmentation de la quantité en nutriments suite à une fertilisation) et leurs effets sur le long terme (ex : modification de la structure fonctionnelle des communautés végétales suite à une répétition d'apport en nutriments).

Le chapitre suivant (3) présente les résultats d'une troisième expérimentation cherchant justement à évaluer spécifiquement l'effet à court terme d'un épisode de fertilisation, et de la présence de plantes (*Lolium perenne*) sur la composition des communautés microbiennes, leurs traits moyens (CWM) et finalement sur la résilience des propriétés écosystémiques microbiennes à différents stress climatiques. Ainsi, cette 3<sup>ème</sup> expérimentation a permis de tester notre hypothèse générale sur la résilience dans des conditions de contrôle précis des facteurs de gestion, permettant ainsi d'avoir une évaluation plus précise des mécanismes de contrôle de la résilience des communautés microbiennes du sol.

*“Savoir s'étonner à propos est le premier pas fait sur la route de la découverte.”*

*Louis Pasteur (1822-1895), père de la microbiologie*

---

# CHAPITRE 3

## (ARTICLE 5)

Mineral fertilization affects soil microbial community composition and traits and decrease microbial ecosystem properties resistance to climatic stresses, with and without plants.

---

Gabin Piton<sup>1</sup>, Arnaud Foulquier<sup>1</sup>, Lionel Bernard<sup>1</sup>, Cindy Arnoldi<sup>1</sup>, Bastien Audemard<sup>1</sup>, Aurélie Bonin<sup>1</sup>, Jonathan Gervaix<sup>2</sup>, Christian Miquel<sup>1</sup>, Thomas Pommier<sup>2</sup>, Viet Tran-Khac<sup>3</sup>, Roberto Geremia<sup>1</sup>, Jean Christophe Clement<sup>3</sup>

<sup>1</sup>Univ. Grenoble Alpes, Univ. Savoie Mont Blanc, CNRS, LECA, 38000 Grenoble, France

<sup>2</sup>Université Lyon I, INRA, CNRS, Ecologie Microbienne Lyon, 69100, Villeurbanne, France

<sup>3</sup>Univ. Savoie Mont Blanc, INRA, CARRTEL, 74200, Thonon-Les-Bains, France

This chapter is in preparation for submission in an international peer reviewed journal.

## ABSTRACT

Previous studies showed that management intensity of grassland ecosystems affects soil microbial traits and the resilience of microbial ecosystem properties to climatic stresses. However, little is known about the mechanisms underlying this response. In this study we tested how mineral fertilization (Nitrogen and Phosphorous) and plant presence affect soil microbial community composition (16S and 18S markers) and proxies of microbial community-weighted mean traits (biomass and enzymatic stoichiometry and mass specific activity) of a mountain grassland soil. We also looked how much the resistance and recovery to three climatic stresses (drought, flood and freeze/thaw) for 10 microbial properties representing global microbial biomass, activities and community composition were impacted. We hypothesized that fertilization selected microbial taxa and traits associated with a copiotrophic strategy, while climatic stresses increasing osmotic constraint and reducing resource diffusion (drought and freeze/thaw) favored oligotrophic microbial communities. Our results confirmed fertilization and climatic stresses to affect microbial community composition. However, contrary to our hypothesis, taxa selected under fertilization (*Actinobacteria*) increased with soil drying while *Bacteroidetes* and *Deltaproteobacteria* showed opposite response, challenging the idea that taxa selected under fertilization should be outcompeted under stress conditions. Fertilization and soil moisture also affected microbial CWM traits, but these functional responses were highly distinct depending on plant presence, stressing the role of plant in the microbial community response to global change. We also hypothesized that copiotrophic community selected under fertilization had lower resistance (absolute change in response to climatic stress, whatever the direction) but higher recovery (rate of recovery relative to the impact induce by the climatic stress) of microbial ecosystem properties. Consistent with this hypothesis, fertilization decreased the resistance of a large panel of microbial properties in both planted and unplanted conditions. To a lower extent, fertilization also increased recovery as hypothesized. We conclude that mineral fertilization is an important mechanism underlying grassland management intensification effect on microbial community composition and traits and is highly influenced by plant presence. Moreover, we predict that mineral fertilization can decrease ecosystem stability under climate changes.

## 1 INTRODUCTION

Soil microbial communities play a central role in ecosystem functioning, controlling most of the biogeochemical processes underlying the nutrient and carbon (C) cycles (Nannipieri et al. 2003, Falkowski et al. 2008). In a context of global change, land-use changes and associated modifications in resource availability (C and nutrients) and plant traits, affect soil microbial community composition, diversity and activity (De Vries et al. 2006, Grigulis et al. 2013, Hartmann et al. 2015, Cenini et al. 2016, Lori et al. 2017, Boeddinghaus et al. 2019), and likely constrain the response of microbial communities to extreme climatic events with potential implications on the stability of ecosystem functioning and the maintenance of ecosystem services provisioning (De

Vries and Shade 2014, Legay et al. 2017, De Vries and Griffiths 2018, Lori et al. 2018).

Mineral fertilization is commonly used in conventional intensive agriculture to increase productivity with potential effects on microbial communities (Ramirez et al. 2010, 2012, Leff et al. 2015) and ecosystem nutrient retention (Schlesinger 2009, De Vries and Bardgett 2012, Reay et al. 2012). Resource availability to soil microbes can be modified directly by mineral fertilization through an increase in nutrients availability (Ramirez et al. 2012) and also indirectly through the plant response to fertilization (Ramirez et al. 2010, Leff et al. 2015, Legay et al. 2016) altering plant derived-C inputs in soils (Baptist et al. 2015) and plant-microbes' interactions (Cantarel et al. 2015). Such variations in resource availability might induce changes

in microbial diversity and community composition with implications in terms of ecosystem functioning.

Shifts in microbial community composition associated with resource availability have been attributed to variations of strategies and traits across soil microbial diversity, with some taxa dominating when resource is scarce (oligotrophic strategy) and other taxa being more competitive when resource availability is high (copiotrophic strategy) (Fierer et al. 2007, Ho et al. 2017). Such shift along the copiotroph-oligotroph continuum with resource availability might be followed by a change in the fungal : bacterial ratio, with fungi being generally considered as more oligotrophic than bacteria, though both strategies exist in each group (Ho et al. 2017). Several experiments suggest higher sensitivity of bacteria to fertilization compared to fungi (Marschner et al. 2003, Ai et al. 2018), while fungi would be more tightly associated to changes in plant communities (Cassman et al. 2016, Ai et al. 2018). Although the copiotroph-oligotroph continuum was first proposed in regards of resource availability and acquisition strategies (Fierer et al. 2007, Ho et al. 2017), it has also been used to infer the microbial communities stability under climate disturbance, revealing potential associations between the copiotroph-oligotroph continuum and resilience to climatic disturbances (De Vries and Shade 2014, De Vries and Griffiths 2018). Resilience represents the capacity of the microbial community to persist and maintain its state and functioning in the face of disturbance and can be decomposed in two parameters : the resistance representing the capacity of the microbial community to maintain its state during disturbance, and the recovery, the capacity to recover to normal state following a disturbance (Ingrisch and Bahn 2018). Theory predict a trade-off between the ability to benefit from increased resource availability and the ability to survive under stress conditions (defined according to Schimel et al (2007) as “something that creates physiological challenges that threaten microbial function or survival”), with copiotrophs predicted to be outcompeted by oligotrophs under stress conditions (Fierer et al. 2007). Oligotrophic microbes have been hypothesized to have higher resistance but lower recovery to climatic stress

(e.g. drought) conditions compared to copiotrophic microbes, due to their lower growth rate and higher resource use efficiency (De Vries and Shade 2014). The few studies assessing how microbial community resilience differ across resources conditions and microbial community composition confirmed this trade-off between resistance and resilience in the presence of plants (De Vries et al. 2012, Karlowsky et al. 2018), Chapter 1 and 2.1). Others studies assessing soil microbial community resilience with and without plant demonstrate that plants can highly modify soil microbial community resilience (Orwin and Wardle 2005, Koyama et al. 2017). However, how plant presence and resource availability interact to control microbial community resilience is still poorly understood. Moreover, while drought effects on soil microbial communities has been extensively studied (see meta-analyses of Canarini et al. (2017) and Ren et al.(2018)), the capacity of soil microbial communities to withstand other climatic stresses such as flood and freeze/thaw events have been rarely assessed (De Vries and Griffiths 2018).

Characterizing soil microbial traits and associated resource-acquisition strategies (e.g. position on the copiotroph-oligotroph continuum) remains challenging due to methodological and conceptual limitations (Krause et al. 2014, Martiny et al. 2015, Ho et al. 2017, Malik et al. 2019, Morrissey et al. 2019). While a large number of studies have tried to identify copiotrophic and oligotrophic microbial taxa, only few consistent results at the phylum level have been reported (see Ho et al. (2017) for review). *Acidobacteria* and *Verrucomicrobia* have been consistently identified as oligotrophic across studies and *Actinobacteria* and *Betaproteobacteria* (sub)phyla have been associated to the copiotrophic strategy though results are less consistent (Ho et al. 2017). Recently, Piton et al (Chapter 1, Chapter 2.2) proposed the use of proxies of community-weighted mean (CWM) traits such as the stoichiometry of biomass or extracellular enzymes and the mass-specific enzyme activity to infer dominant resource-acquisition strategies and trait shifts across microbial communities, providing a mechanistic understanding of microbial community response to global changes (response trait) and microbial control of



ecosystem functioning (effect traits) (Lavorel and Garnier 2002). Based on the growth rate hypothesis (Elser et al. 2003), copiotrophic microbes might have low biomass C:P and N:P ratios due to their high cellular content in P-rich RNA associated with high growth rates (Elser et al. 2003, Arrigo 2004, Karpinetes et al. 2006). To survive under high stress conditions and low substrate availability, oligotrophic microbes might have higher C:P and N:P ratio due to increased C and N-rich desiccation resistance structure and enzyme machinery (Arrigo 2004, Delgado-Baquerizo et al. 2018), and might produce more extracellular enzymes to obtain resources from organic matter (Fontaine et al. 2003, Malik et al. 2019). Piton et al (Chapter 1 and 2.2) also used ecoenzymatic stoichiometry (Sinsabaugh et al. 2009), that is the relative investment in C, N and P-acquisition enzymes to assess the direction of resource acquisition strategy across the copiotrophic-oligotrophic continuum, and they depicted a higher investment for C acquisition at the copiotrophic end and for nutrient (N, P) acquisition at the oligotrophic one.

In this study we assessed how mineral fertilization and plant presence shaped microbial community composition and proxies of microbial CWM traits, and how these changes could affect soil microbial community resilience (biomass, composition and activity) to three climatic stresses (drought, freeze/thaw and flood). While mineral fertilization effect on microbial community resilience was assessed for the three climatic stresses, plant presence effect was assessed only for drought due to experimental constraint.

We hypothesized:

**H1)** fertilization to select microbial taxa and traits associated with a copiotrophic strategy.

**H2)** climatic stresses increasing osmotic constraint and reducing resource diffusion (drought and freeze/thaw) to select microbial taxa and traits associated with an oligotrophic strategy.

**H3)** that copiotrophic community selected under fertilization to induce a lower resistance but higher recovery of microbial ecosystem properties.

By crossing fertilization and drought treatment with a plant presence treatment, this study also sought to explore how plant influences microbial community response to fertilization (H1), drought (H2) and the implications for microbial community resilience (H3).

## 2 MATERIALS AND METHODS

### 2.1 FIELD SITE AND SOIL SAMPLING

The study site was a grassland localized in the Chartreuse mountain range in the center of the French Prealp (45°36' N, 5°90'E). The grassland altitude was 930m a.s.l. Management was extensive since decades with one mowing per year and no fertilization. The 15 first cm of the topsoil were extracted in the spring (5<sup>th</sup> and 6<sup>th</sup> of April 2018) and sieved at 7mm to remove plant residues. After homogenization, soil was used to fill 48 mesocosms (25cm diameter and 40cm depth). All mesocosms were transported in the alpine green-house of the Joseph Fourier alpine station (Grenoble) with temperature maintained at 20°C during the experiment. Mesocosms were weighted before the start of the experiment (mean fresh soil weight: 11.8 kg, 95% confidence interval  $\pm$  0.1kg). All along the experiment, control mesocosms (unplanted soil, control climates) were weighted twice a week and compared with their initial weight to assess water loss. All mesocosms received the same amount of water equal to this water loss in control mesocosms (in average 300mL per week), to maintain a stable soil moisture in control mesocosms equal to the initial field value (24 g water per g of fresh soil, 66% of maximum water holding capacity). During the first 30 days, soil water content of all mesocosms was kept constant for soil acclimation. In parallel, seeds of *Lolium perenne* from Arbiotech® (Saint Gilles, France) were put in individual pots filled with subsamples of the mesocosm soil until germination and seedling establishment. *L. perenne* was used as a phytometer because it is usually sown in intensively managed grasslands in the French Alps (Loucougaray et al. 2015, Legay et al. 2017). After 30 days of growth, 25 individuals of *L. perenne* were planted in 16 mesocosms, with a 4 cm distance between each individual and 4 cm distance

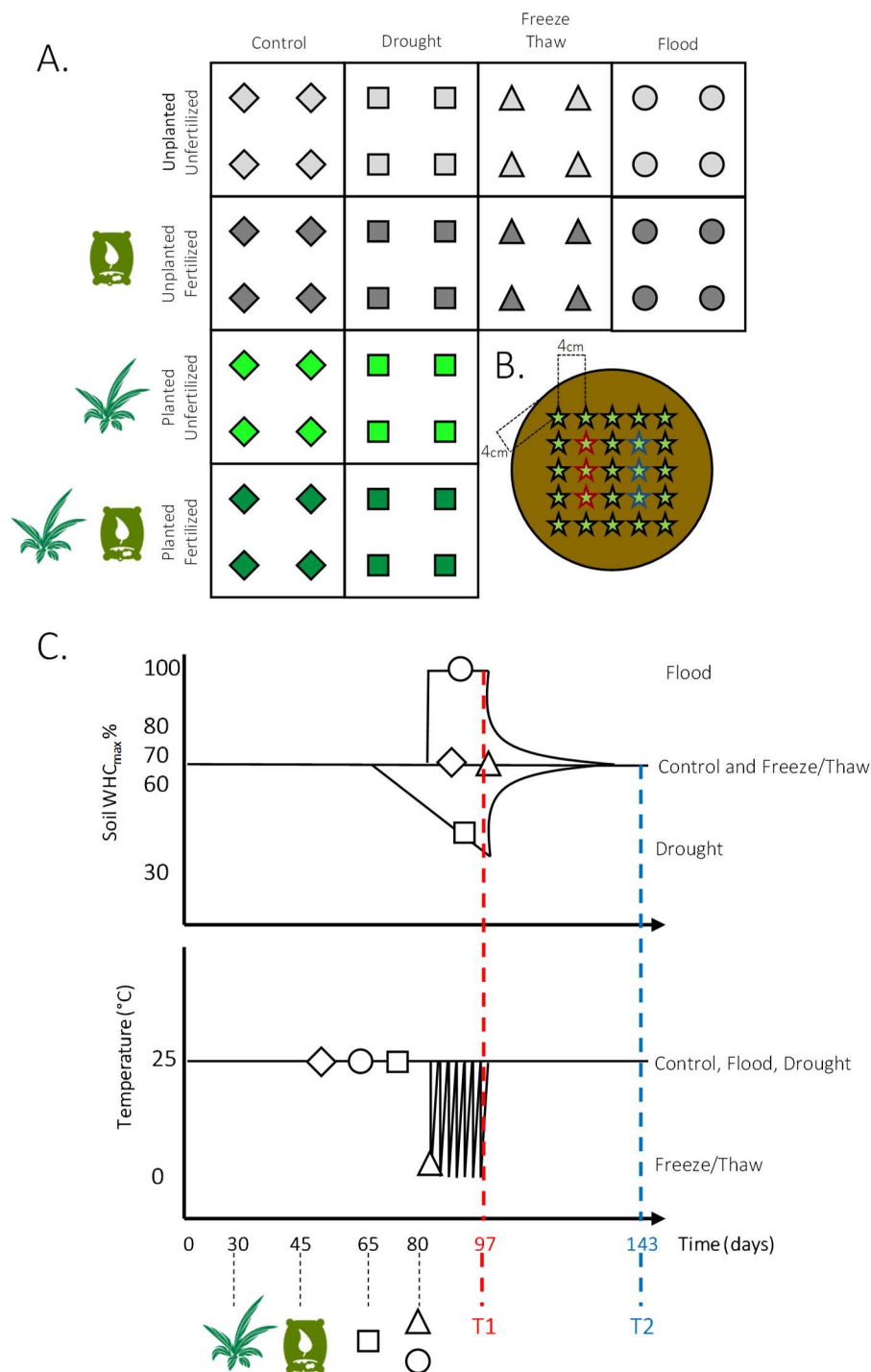

**Figure 33. Experimental design.** Treatments and replicates (A). Four climatic conditions were simulated: control (diamond), drought (square), freeze/thaw (triangle) and flood (circle) and crossed with fertilization treatment (unfertilized=light colour, fertilized=dark colour). Control and drought, fertilized and unfertilized treatments have been additionally crossed with a planted treatment (unplanted=grey colour, planted=green colour). Points represent replicates ( $n=4$ ,  $N=48$ ). Mesocosm design (B). In planted treatment 25 individuals (stars) of *Lolium perenne* have been planted with 4 cm distance between each individual and 4 cm distance minimum with mesocosm edge. Samplings for both planted and unplanted soil have been done on the emplacement of the three individuals neither on a border, neither in the centre (red stars= $T_1$  sampling, blue stars= $T_2$  sampling). Experimental schedule (C.) 20 days after soil sampling, *Lolium perenne* individuals have been planted in associated treatments. 20 days later half of the mesocosms have been fertilized. Drought treatments have started 20 days after fertilization, flood and freeze/thaw 15 days later. All mesocosms have been sampled at the day 90 of the experiment ( $T_1$ ). Then water in flooded mesocosms has been removed by collecting leaching and all treatments were again watered as control until day 135 when all mesocosms were sampled again ( $T_2$ ).

minimum with mesocosm edge (Figure 33). At day 45, half of the mesocosms (planted and unplanted soil) were fertilized with mineral N (50%-N as  $\text{NO}_3^-$  and 50%-N as  $\text{NH}_4^+$ ) and mineral P ( $\text{P}_2\text{O}_5$ ) equivalent to 150 kg N/ha and 80kg  $\text{P}_2\text{O}_5$ /ha representing the regional recommendation for intensive sown grasslands (Guide régionale de fertilisation 2016, chambre d'agriculture). Twenty days after fertilization (day 65), watering was stopped on 16 mesocosms (4 unplanted soil/unfertilized, 4 unplanted soil/fertilized, 4 planted soil/unfertilized, 4 planted soil/fertilized) during 32 days (until day 97). In parallel, from day 80 to day 97, 8 mesocosms (4 unplanted/fertilized and 4 unplanted/unfertilized) were watered until complete soil saturation (water level maintained at 1 cm above top soil level) to simulate flood. During the same period 6 freeze/thaw cycles (12h at  $-10^\circ\text{C}$ , 36h at  $20^\circ\text{C}$ ) were simulated on 8 mesocosms (4 unplanted/unfertilized and 4 unplanted/fertilized). At day 97, three soil cores (5cm diameter, 15cm depth) were sampled on the location of three *L.perenne* individuals in each mesocosm (Figure 33) and pooled in a composite sample to assess resistance (T1 sampling, Figure 33). After sampling, the holes left by each soil core were filled with sterilized pure sand encased in a plastic grid allowing water circulation. After T1, all mesocosms were again equally and normally watered based on water loss measured in control mesocosms. In the day 143 all the mesocosms were again sampled following the same process as T1 to assess recovery (T2 Sampling, Figure 33).

## 2.2 PLANT ANALYSES

Plants shoots and roots in planted mesocosms were manually sorted from the three soil cores. Plants shoots and roots were separated and dried at  $70^\circ\text{C}$  for a week and weighted to measure roots and shoots biomass. All plant material was ground and analyzed for N and C contents using an elemental analyser (FlashEA 1112: Fisher 302 Scientific, Waltham, Massachusetts, USA).

## 2.3 SOIL ANALYSES

Composite soil samples were split in subsamples, some of which for molecular analyses were immediately

frozen in liquid nitrogen and stored at  $-80^\circ\text{C}$  until analysis. Subsamples for enzymatic analyses were frozen at  $-20^\circ\text{C}$  until analysis. Subsamples for C, N and P pools were put at  $4^\circ\text{C}$  and analyzed within 24h.

Subsamples of 5-g of fresh soil were oven-dried at  $70^\circ\text{C}$  for 1 week and weighed to determine soil water content (SWC), followed by 4h at  $550^\circ\text{C}$  to determine soil organic matter (SOM) (Robertson et al. 1999). Soil subsamples were air dried and ground to powder to measure total C and N contents using a FlashEA 1112 elemental analyser (FlashEA 1112: Fisher 302 Scientific, Waltham, Massachusetts, USA) and to determine soil pH in a 1:2.5 (soil:distilled water) solution. Dissolved organic carbon (DOC), nitrate ( $\text{NO}_3^-$ ), ammonium ( $\text{NH}_4^+$ ), total dissolved nitrogen (TDN) were extracted on 10 g of fresh soil using 0.5M  $\text{K}_2\text{SO}_4$  solution following Jones and Willett (2006). N concentrations were measured on an automated photometric analyser using standard colorimetric methods (Gallery Plus: Thermo Fisher Scientific, Waltham, Massachusetts, USA). Dissolved organic nitrogen (DON) were calculated as the difference between TDN and total inorganic N ( $\text{N-NO}_3^- + \text{N-NH}_4^+$ ). DOC concentration was measured by the CARRETEL-INRA technical platform (Thonon-les-Bain).  $\text{PO}_4$  was extracted on 10g of fresh soil using 0.5M  $\text{NaHCO}_3$  solution as described by (Brookes et al. 1982).

## 2.4 MICROBIAL BIOMASS AND ACTIVITIES

Microbial biomass nitrogen (MBN), carbon (MBC) and phosphorus (MBP) contents were measured on 10-g fresh soil, using chloroform fumigation extraction-methods as described by Vance et al. (1987) for MBN and MBC and by Brooks et al. (1981) for MBP. Spike procedure ( $25\mu\text{gP-PO}_4/\text{g}$  soil were added on two samples) was conducted as described in Brooks et al. (1982) and used to estimate and correct for P recovery during extraction. Microbial biomass element contents were calculated as the difference between fumigated and non-fumigated samples and adjusted using conversion factors of 0.45, 0.45 and 0.40 for MBC, MBN and MBP respectively (Jenkinson et al. 2004). Biomass stoichiometry (MCN:MBN, MBC:MBP and MBN:MBP) ratios were calculated and used as microbial community-weighted

mean traits (Chapitre1). Potential N mineralization (PNM) was estimated after incubation of 10-g of fresh soil under anaerobic conditions for 7 days at 40°C in the dark (Wienhold 2007), inducing accumulation of mineralized  $\text{NH}_4^+$ . PNM rate was calculated as the difference between  $\text{NH}_4^+$  content before and after incubation ( $\mu\text{gN/g}$  dry soil/day).

Seven potential extracellular enzymes activities (EEA) involved in the degradation of C-rich substrates ( $\alpha$ -Glucosidase,  $\beta$ -1,4-Glucosidase,  $\beta$ -D-Cellobiosidase, and  $\beta$ -Xylosidase), N-rich substrates ( $\beta$ -1,4-N-acetylglucosaminidase and leucine aminopeptidase) and P-rich substrates (phosphatase) were estimated using standardized fluorimetric techniques (Bell et al. 2013). Briefly, 2.75-g of soil were homogenized (1-min in a Waring blender) in 200-ml of sodium acetate buffer solution adjusted at soil pH (5.8). The soil slurries were added in duplicate to 96-deep-well microplates followed by the addition of a substrate solution for each enzyme at enzyme saturation concentration. Duplicated standard curves (0-100- $\mu\text{M}$  concentration) were prepared by mixing 800-ml of soil slurry with 200-ml of 4-methylumbelliferone (MUB) or 7-amino-4-methylcoumarin (MUC) in 96-deep-well microplates for each soil sample. Microplates were incubated during 3-h (dark, 175-rpm, 20°C), and centrifuged at 2900-g for 3-min. Then soil slurries (250- $\mu\text{L}$ ) were transferred into black Greiner flat-bottomed microplate and scanned on a Varioskan Flash reader (Thermo Scientific) using excitation at 365-nm and emission at 450-nm (Bell et al. 2013). After correcting for negative controls, potential enzyme activities were expressed as  $\text{nmol g soil}^{-1} \text{ h}^{-1}$ . The four enzyme activities degrading C-rich substrates, the two enzymes activities degrading N-rich substrates and all the seven enzymes were summed to obtain extracellular enzyme activity for C-rich substrates (EEC), N-rich substrates (EEN) and total extracellular enzyme activity (EEA) respectively. Phosphatase activity was used to represent extracellular enzyme activity for P rich substrates (EEP). EEC, EEN, EEP and EEA were calculated per gram of dry soil (global activities,  $\text{nmol activity g}^{-1} \text{ dry soil h}^{-1}$ ) and per micro-gram of microbial biomass (MBC+MBN+MBP) (mass specific activities,

$\text{nmol activity } \mu\text{g-microbe}^{-1} \text{ h}^{-1}$ ) Ecoenzymatic ratios (EEC:EEP, EEC:EEN and EEN:EEP) were calculated and used as CWM traits with mass specific activities (Chapter 1).

Potential nitrification enzyme activity (NEA) were estimated according to (Koper et al. 2010) following (Dassonville et al. 2011). Briefly, 3 g of each soil was incubated under aerobic conditions (180 rpm, 28°C, 10 h) in a solution of  $(\text{NH}_4)_2\text{SO}_4$  (0, 0.5, 1, 2, 5 and 15 mg N/L) and rates of  $\text{NO}_2$  and  $\text{NO}_3$  production were measured after 2, 4, 8 and 10 hr by ionic chromatography (DX120; Dionex, Salt Lake City, UT, USA). Maximal nitrification rate (NEA) were assessed by plotting nitrification rates along the gradient of  $\text{NH}_4\text{-N}$  concentrations (Lineweaver and Burk 1934). Potential denitrification activity (DEA) was estimated following Attard et al. (2011). Briefly, 10 g dry weight (dw) soil was placed at 28°C under anaerobic conditions using 90:10 He: $\text{C}_2\text{H}_2$  mixture inhibiting  $\text{N}_2\text{O}$ -reductase activity. Each sample was supplemented with 3 ml  $\text{KNO}_3$  (50 mg N- $\text{NO}_3 \text{ g}^{-1}$  dw), glucose (0.5 mg C/g dw) and sodium glutamate (0.5 mg C/g dw) (Attard et al. 2011), completed with distilled water to reach water holding capacity.  $\text{N}_2\text{O}$  was measured at 2, 3, 4, 5 and 6 hr using a gas chromatograph (microGC R3000; SRA Instruments, Marcy l'Etoile, France). Substrate-induced respiration (SIR) was measured following (Anderson and Domsch 1978). Briefly, 5 g of soil samples were placed in airtight flask, with 1.2 mg of C-glucose  $\text{g}^{-1}$  of dried soil. Then, samples were incubated at 28°C during 5 hours with  $\text{CO}_2$  concentrations measured each hour. The slope of the linear regression between time and with  $\text{CO}_2$  concentrations was used to estimate aerobic respiration ( $\text{g C-CO}_2^{-1} \text{ h}^{-1}$ ).

## 2.5 MOLECULAR ANALYSES

Soil biodiversity was estimated using environmental DNA metabarcoding targeting two universal DNA markers (SI Table 7), one amplifying all Bacteria (v5-6 region of the 16S rRNA gene) and one amplifying all Eukaryotes (v6-v7 region of the 18S rRNA gene). Extracellular DNA was extracted from 10g of soil following (Taberlet et al. 2012). Four PCR replicates were run for each DNA extract. Forward and reverse primers

were tagged with a combination of two different 8-nucleotide labels to discriminate PCR products after sequencing. PCR products were purified using MinElute™ PCR purification kit (Qiagen, Hilden, Germany). Extraction and PCR blank and positive controls were included to control for potential contaminations. High-throughput sequencing of Bacterial amplicons (200-350 bp) were sequenced on an Illumina MiSeq (2 x 250 bp paired-end reads) platform and eukaryotes amplicons were performed on an Illumina HiSeq 2500 platform (2x150 bp paired-end reads for Eukaryotes).

Sequencing data were then curated using OBITools software package (Boyer et al. 2016) and R scripts following Zinger et al. (2019). Firstly, paired-end reads were assembled and assigned to their respective samples on the basis of the tags combination. Secondly, reads were dereplicated. Low quality sequences were excluded by removing all sequences including “Ns” and all sequences observed less than 100 times. Thirdly, unique sequences were clustered at 97% similarity into operational taxonomic units (OTUs) using sumacust package (Mercier et al. 2013). Most abundant sequence of each OTU was assumed to be the true sequence. Finally, taxonomic annotation of OTUs was performed using ecotag program from OBITools package (Boyer et al. 2016). OTUs with alignment score of the best match (best identity score from ecotag program) in the reference database below 0.95% was excluded because considered as potential chimera or degraded sequences. Then, potential contaminations were removed by excluding all OTUs with maximum number of observations in blanks and negative controls. After cleaning, PCR replicates were summed for each sample and rarefied to the similar sequencing depth equal to the number of reads of the sample with the least reads numbers (Bacteria: 22 571 sequences/sample, Eukaryota: 93 742 sequences/sample). Rarefaction curves were also obtained for each sample using vegan package (Oksanen et al. 2011) to assess to which extent the sequencing depth captured the diversity present in our samples (SI Figure 5). All fungal sequences were extracted from the Eukaryota dataset for further analyses focusing only on

Bacterial and Fungal communities. Others groups of Eukaryota are not yet analysed and thus are not included in this version.

## 2.6 NET ECOSYSTEM CO<sub>2</sub> EXCHANGE

Net Ecosystem CO<sub>2</sub> Exchange (NEE) was measured semi-continuously during the experiment (one measure on each mesocosm one time a week) as described in Niu et al. (2008). Briefly, CO<sub>2</sub> exchange was measured using Vaisala GMP343 CARBOCAP® infrared sensor, attached in a hermetic transparent plexiglass chamber (diameter identical with mesocosm and 50cm height), with two small fans running within the chamber during measurement to homogenize air. CO<sub>2</sub> concentration in the chamber was recorded every 5 seconds during a 5 minutes period. NEE was calculated as the CO<sub>2</sub> flux rate during the recording period (ppm CO<sub>2</sub> s<sup>-1</sup>). Current version does not use all data from this semi continuous NEE monitoring and only uses the measures conducted the days before T1 and T2. Same measures have also been done without light for the planted mesocosms to disentangle ecosystem respiration from plant productivity. These data are not presented in the current version.

## 2.7 STATISTICAL ANALYSES

Two-ways and three-ways permutational multivariate analysis of variance (PERMANOVA) using Bray-Curtis distance matrices were used to test treatments effects on bacterial and fungal community composition. Non-metric multidimensional scaling (NMDS) using Bray-Curtis distances were used to represent bacterial and fungal community composition at T1 and T2 (four distinct NMDS). Microbial community composition data were transformed using Hellinger transformation before NMDS and PERMANOVA analyses. To assess how the soil moisture effect on soil abiotic and microbial community properties (biomass, activities, traits and abundances of main phyla and subphyla) was mediated by fertilization and plant presence, analysis of covariance (ANCOVA) were used. Quadratic term was added for soil moisture effect when this term significantly improved the model. Freeze/Thaw treatment was removed from the dataset for this

ANCOVA analysis using moisture as covariable but compared with others treatments using ANOVA.

Table 10. List of abbreviations for the 9 microbial ecosystem properties used to assess biomass and activity resistance and recovery of soil microbial community.

Abbreviation	Microbial property
MBC	Microbial biomass-C
MBN	Microbial biomass-N
MBP	Microbial biomass-P
SIR	Substrate-induced Respiration
NEE	Net ecosystem exchange
EEA	Extracellular enzymes activity (sum of 9 enzymes)
NMP	Nitrogen Mineralization Potential
NEA	Nitrification Enzyme Activity (potential)
DEA	Denitrification enzyme Activity (potential)

Resistance and recovery indices for 9 microbial ecosystem properties (List and abbreviations in Table 10) were calculated following Orwin and Wardle (2004):

$$Resistance_{ijk} = 1 - \frac{2|D_{T1ijk}|}{(C_{T1i} + |D_{T1ijk}|)}$$

$$Recovery_{ijk} = \frac{2|D_{T1ijk}|}{(|D_{T1ijk}| + |D_{T2ijk}|)} - 1$$

Where  $Resistance_{ijk}$  and  $Recovery_{ijk}$  are respectively the Resistance and Recovery of mesocosm  $i$  ( $N=32$ ) under climatic stress  $j$  (Drought, Freeze/Thaw or Flood) and condition  $k$  (unfertilized/unplanted, unfertilized/planted, fertilized/unplanted, fertilized/planted), with  $C_{T1i}$  the mean value measured at the end of the stress period ( $T_1$ )

in control mesocosms under condition  $k$ .  $D_{T1ijk}$  and  $D_{T2ijk}$  are the differences between the mean value in the control under condition  $k$  and the value in the mesocosm  $i$  under altered climate  $j$  and same condition  $k$ , at the end of the stress period ( $D_{T1ij}$ ), or at the end of the recovery period ( $D_{T2ij}$ ). These indices are bounded between -1 and +1, with value of +1 corresponding to full resistance or recovery.

Resistance and recovery of bacterial and fungal community composition were measured as Bray-Curtis similarities between microbial community composition based on bacterial (16S) and fungal (18S) operational taxonomic units (OTUs) from mesocosms under altered climate and their associated control as proposed by de Vries and Shade (2013). This index is bounded between 0 and 1, with similarity of 1 meaning maximum resistance or recovery. Fertilization effect on microbial community biomass, activities and composition resistance and recovery was tested using ANOVA 1 within each combination of climate and plant treatments.

### 3 RESULTS

#### 3.1 TREATMENTS EFFECTS ON MICROBIAL COMMUNITY COMPOSITION

Proportions of bacterial and fungal community composition explained by fertilization increased from  $T_1$  to  $T_2$  for both (Table 11) and fertilization always better explained bacterial community composition (from 7 to 19% explained) compared to fungi (from 3 to 5% explained). Proportion explained by plants also increased from  $T_1$  to  $T_2$  but had more effect on fungal community composition (from 13 and 27% of explained) compared to bacteria (from 7% to 19% explained) (Table 11). Differences between planted and unplanted communities were especially clear at  $T_2$  with negative coordinates on NMDS2 for bacteria and positive coordinates on NMDS1 for fungi (Figure 34).

In unplanted soils, climatic stress was the main factor explaining variation in bacterial ( $T_1$  : 37%,  $T_2$ : 24%) and fungal ( $T_1$  : 30%,  $T_2$  : 16%) community composition (Figure 34, Table 11). At  $T_1$ , flood showed

distinct community composition for bacteria and fungi. Other climatic stresses induced different effects, with drought, freeze/thaw inducing relatively similar shift in community composition compared to flood (especially for Bacteria) (Figure 34). At T2, distinct bacterial community compositions were still observed among climatic treatments and were organized as follow:

Freeze/thaw, Drought, Control and Flood, along a gradient from high NMDS2 and low NMDS1 coordinates to the opposite coordinates (Figure 34). While climatically stressed soils differed from control soil in term of fungal community composition at T1 (excepted for drought), differences among climatic stresses were less clear at T2.

Table 11. *P*-values and  $R^2$  associated with the effects of climatic stresses and fertilization in unplanted soil and with the effects of drought, fertilization and plant presence on bacterial and fungal community composition. Effects were assessed by PERMANOVA on a Bray-Curtis distance matrix based on bacterial (16S) and fungal (18S) operational taxonomic units (OTUs).

	T1		T2	
	$R^2$	p-value	$R^2$	p-value
<b>Bacteria</b>				
<b>Planted and unplanted soil</b>				
Drought (D)	<b>0.10</b>	<b>p&lt;001</b>	<b>0.04</b>	<b>0.04</b>
Fertilization (F)	<b>0.12</b>	<b>p&lt;001</b>	<b>0.19</b>	<b>p&lt;001</b>
Plant (P)	<b>0.07</b>	<b>p&lt;001</b>	<b>0.19</b>	<b>p&lt;001</b>
D × F	0.03	0.07	0.02	0.22
D × P	0.03	0.10	0.03	0.18
F × P	<b>0.04</b>	<b>0.03</b>	<b>0.05</b>	<b>0.01</b>
D × F × P	0.03	0.15	0.02	0.22
Total $R^2$	0.43		0.53	
<b>Unplanted soil</b>				
Climatic stress	<b>0.37</b>	<b>p&lt;001</b>	<b>0.24</b>	<b>p&lt;001</b>
Fertilization	<b>0.07</b>	<b>p&lt;01</b>	<b>0.15</b>	<b>p&lt;001</b>
Climatic stress × Fertilization	0.09	0.06	<b>0.10</b>	<b>0.02</b>
Total $R^2$	0.53		0.50	
<b>Fungi</b>				
<b>Planted and unplanted soil</b>				
Drought (D)	<b>0.10</b>	<b>p&lt;001</b>	0.03	0.11
Fertilization (F)	<b>0.05</b>	<b>0.02</b>	<b>0.05</b>	<b>0.02</b>
Plant (P)	<b>0.13</b>	<b>p&lt;001</b>	<b>0.27</b>	<b>p&lt;001</b>
D × F	0.02	0.60	0.02	0.57
D × P	0.03	0.33	0.03	0.21
F × P	0.03	0.38	<b>0.05</b>	<b>0.02</b>
D × F × P	0.03	0.30	0.02	0.37
Total $R^2$	0.39		0.48	
<b>Unplanted soil</b>				
Climatic stress	<b>0.30</b>	<b>p&lt;001</b>	<b>0.16</b>	<b>p&lt;001</b>
Fertilization	0.03	0.18	<b>0.05</b>	<b>0.03</b>
Climatic stress × Fertilization	0.08	0.36	0.10	0.20
Total $R^2$	0.41		0.30	

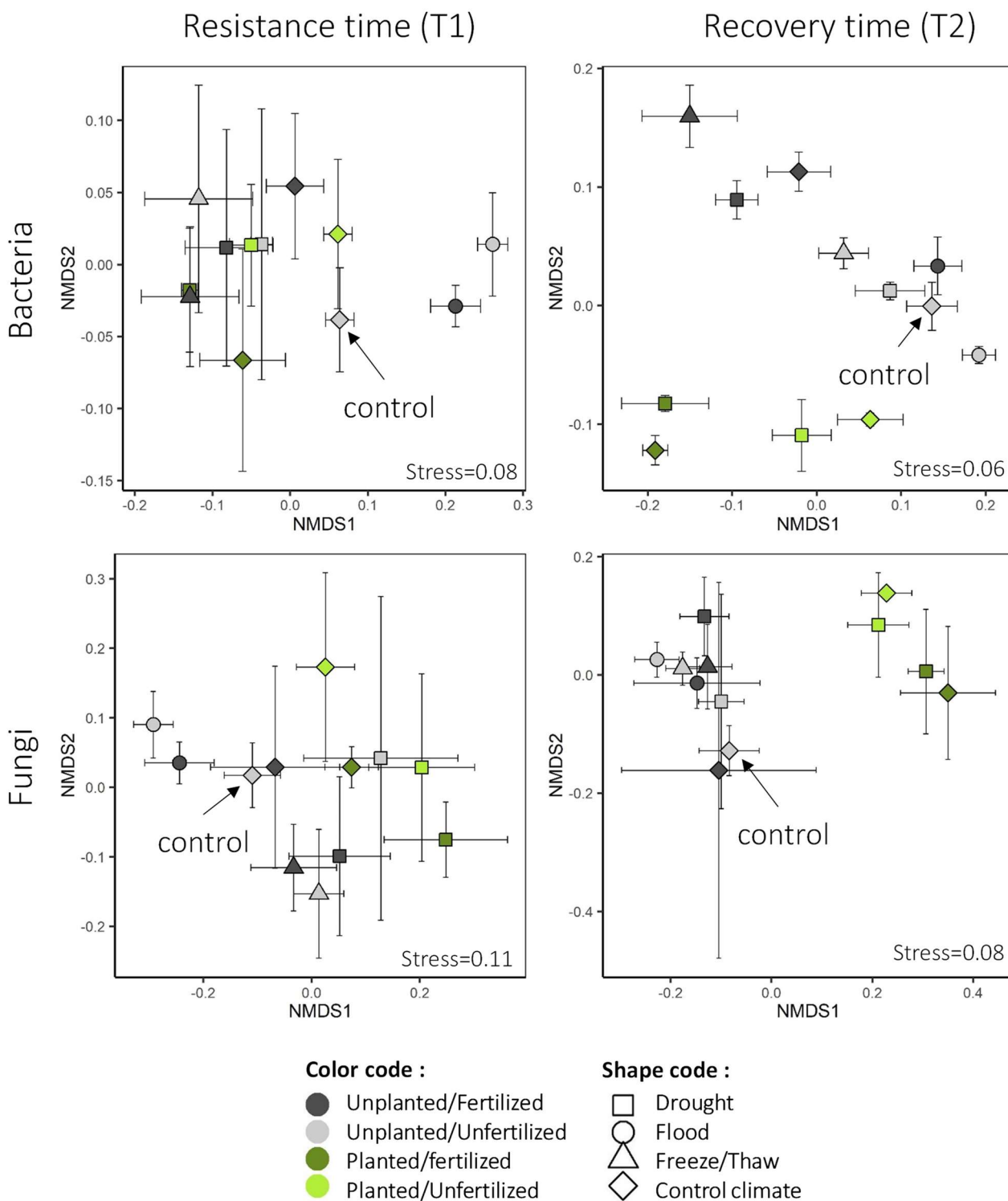

Figure 34. Bacterial and fungal community composition at T1 and T2 represented in four distinct NMDS. Points represent centroids of each treatment. Grey points = unplanted soil, green points = planted soil, light colour = unfertilized soil, dark colour=fertilized soil, diamond=control climate, circle=flood, square=drought, triangle=freeze/thaw. Arrows point to the “full control” (Unplanted/Unfertilized/control climate). Errors bars represent 95% confidence interval for the coordinates on the first and second axes of the NMDS.



Fertilization modified the effect of climatic stress almost significantly at T1 for bacteria (Drought × fertilization interaction:  $p=0.07$ , Climatic stress × fertilization :  $p = 0.06$ ) and significantly at T2 in unplanted soils (Climatic stress × fertilization,  $p=0.02$ ). Plant presence also modified the effect of fertilization on bacterial community at T1 and T2 and on fungal community at T2.

ANCOVA conducted on the most abundant bacterial and fungal phyla (Figure 35) indicated a positive effect of fertilization and a negative effect of soil moisture on the relative abundance of *Actinobacteria*, while *Proteobacteria* and *Bacteroidetes* showed the opposite

pattern. The relative abundance of *Acidobacteria*, *Verrucomicrobia* and *Gemmatimonadetes* increased with soil moisture. *Actinobacteria* were significantly more abundant under freeze/thaw conditions while *Gemmatimonadetes* abundance was significantly lower under these conditions. Analyses at lower taxonomic resolution within *Proteobacteria* (SI Figure 6) indicated that the relative abundance of *Betaproteobacteria* increased with soil moisture especially in fertilized soils. *Gammaproteobacteria* increased with moisture only in planted and fertilized soils. The relative abundance of *Alphaproteobacteria* decreased with soil moisture and was more important under with freeze/thaw conditions.

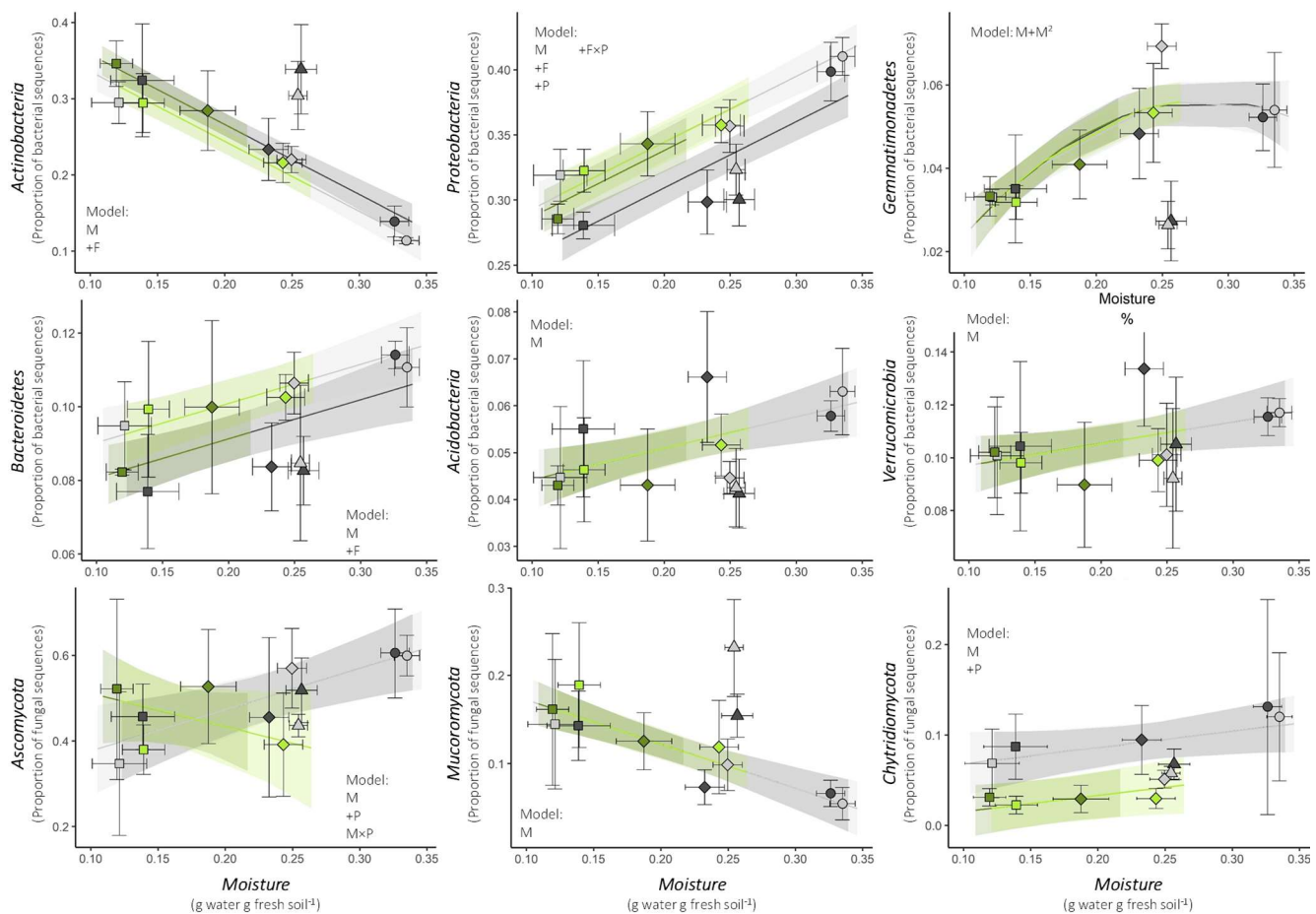

Figure 35 Effects of soil moisture, fertilization and plant on the relative abundance (proportion of bacterial or fungal sequences) of the most abundant (proportion > 0.05) bacterial and fungal phyla at T1. Lines represent predicted value and shades represent 95% confidence interval from ANCOVA model (only significant factors were used for model fit and were represented on each plot : M=moisture, M<sup>2</sup>=moisture<sup>2</sup>, F=Fertilization, P=Plant). Points represent mean of each treatments at T1. Error bar around points are 95% confidence interval (n=4). See Table 10 for abbreviation of microbial properties and Figure 34 for graphical legend of colours and shapes codes. Grey points and lines = unplanted soil, green points and lines = planted soil, light colour points and lines = unfertilized soil, dark colour points and lines = fertilized soil, diamond=control climate, circle=flood, square=drought, triangle=freeze/thaw.

Conversely, *Deltaproteobacteria* increased with soil moisture and were less abundant in fertilized soils (SI Figure 6).

The relative abundance of several fungal phyla was influenced by soil moisture and plant presence but not by fertilization (Figure 35). *Ascomycota* abundance increased with soil moisture in unplanted soils, while a decrease with soil moisture was observed in planted ones. *Mucoromycota* relative abundance decreased with soil moisture and were more abundant under freeze/thaw conditions. *Chytridiomycota* relative abundance increased with soil moisture and they were less abundant in the presence of plant (Figure 35). Though *Basidiomycota* was the second most abundant phylum (mean 0.27, 95% confidence interval  $\pm$  0.04) after *Ascomycota*, relative abundance of *Basidiomycota* was not affected by treatments and moisture. The *Glomeromycetes* class, representing arbuscular mycorrhizal fungi increased their relative abundance in the presence of plant only in unfertilized soils (SI Figure 6).

### 3.2 TREATMENTS EFFECTS ON SOIL AND MICROBIAL STOICHIOMETRIC TRAITS

Soil moisture, plant and fertilization had complex, often interacting effects on the soil abiotic resources, microbial biomass stoichiometry as well as on the enzymatic stoichiometry as indicated by the ANCOVA (Figure 36). Fertilization increased TDN (in control climate, freeze/thaw and drought), PO<sub>4</sub> and EEC:EEN (only in planted soil under control climate) and decreased DOC:TDN, DOC:PO<sub>4</sub>, TDN:PO<sub>4</sub> and EEN:EEP (only in planted soil) (Figure 36). Plant presence decreased DOC, TDN, PO<sub>4</sub>, TDN:PO<sub>4</sub> and increased DOC:TDN (Figure 36). Soil moisture gradient was negatively associated with TDN, TDN:PO<sub>4</sub>, DOC:PO<sub>4</sub>, MBC:MBP, MBC:MBN (only in planted soil), MBN:MBP (only in unplanted/fertilized) mass specific activity (SI Figure 9) while positively associated with DOC:TDN, EEC:EEP, EEN:EEP, EEC:EEN (only in planted/fertilized soil) and MBC:MBN (only in unplanted/fertilized soil) (Figure 36).

### 3.3 TREATMENTS EFFECTS ON MICROBIAL COMMUNITY BIOMASS AND ACTIVITY

Fertilization increased MBN (only in in dry soil), soil and decreased SIR and DEA (SI Figure 7). Plant increased MBC, SIR, DEA, NMP (only in fertilized soil) and decreased NEA (SI Figure 7). Soil moisture gradient was positively associated with MBC, MBP, MBN (excepted in unplanted/fertilized soils where MBN decreased with soil moisture), and negatively associated with NEA. SIR and EEA showed quadratic relationship with soil moisture with the higher activities observed at intermediate moisture. DEA also depicted a quadratic relationship with soil moisture, slightly decreasing from dry (0.1g water/g fresh soil) to medium moisture (0.17g water/g fresh soil) followed by a sharp increase (SI Figure 7).

### 3.4 FERTILIZATION EFFECT ON MICROBIAL COMMUNITY BIOMASS, ACTIVITY AND COMPOSITION RESISTANCE AND RECOVERY

Fertilization had a predominantly negative effect on the resistance of microbial biomass and activities (Figure 37). Fertilization decreased SIR, NMP, NEA drought resistance in planted soil and NEE and DEA drought resistance in unplanted soil. Fertilization also decreased MBC, MBP, NMP, NEA and DEA flood resistance. Two positive effects of fertilization were observed, on SIR flood resistance and MBP drought resistance in unplanted soil (Figure 37). Recovery indices were less responsive to fertilization with a positive effect on NMP drought resilience in planted soil and a decrease of SIR flood resilience (Figure 38).

Microbial community composition resistance and recovery were also affected by fertilization (Figure 39). Fungal community composition flood resistance increased with fertilization while increasing recovery of bacterial community composition to drought (unplanted soil) and flood was observed.

Freeze/thaw resistance and resilience indices of microbial biomass, activities and community composition were not affected by fertilization (Figure 37, Figure 38, Figure 36)

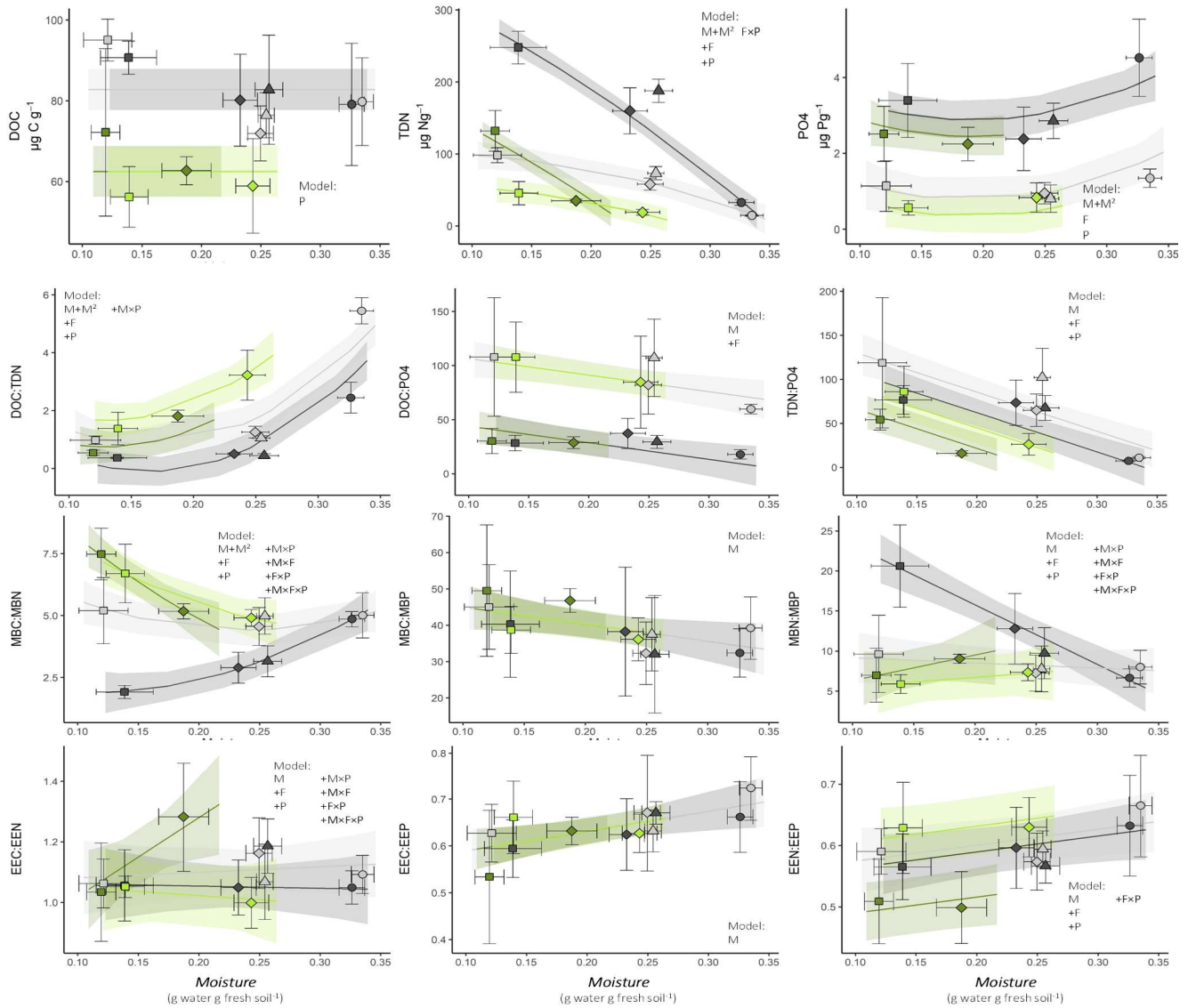

Figure 36 Effects of soil moisture, fertilization and plant on soil C, N and P pools, microbial biomass and enzymatic stoichiometry at T1. Lines represent predicted value and shades represent 95% confidence interval from ANCOVA model (only significant factors were used for model fit and were represented on each plot : M=moisture, M<sup>2</sup>=moisture<sup>2</sup>, F=Fertilization, P=Plant). Points represent mean of each treatments at T1. Error bar around points are 95% confidence interval (n=4). See Table 10 for abbreviation of microbial properties and Figure 34 for graphical legend of colours and shapes codes. Grey points and lines = unplanted soil, green points and lines = planted soil, light colour points and lines = unfertilized soil, dark colour points and lines = fertilized soil, diamond=control climate, circle=flood, square=drought, triangle=freeze/thaw.

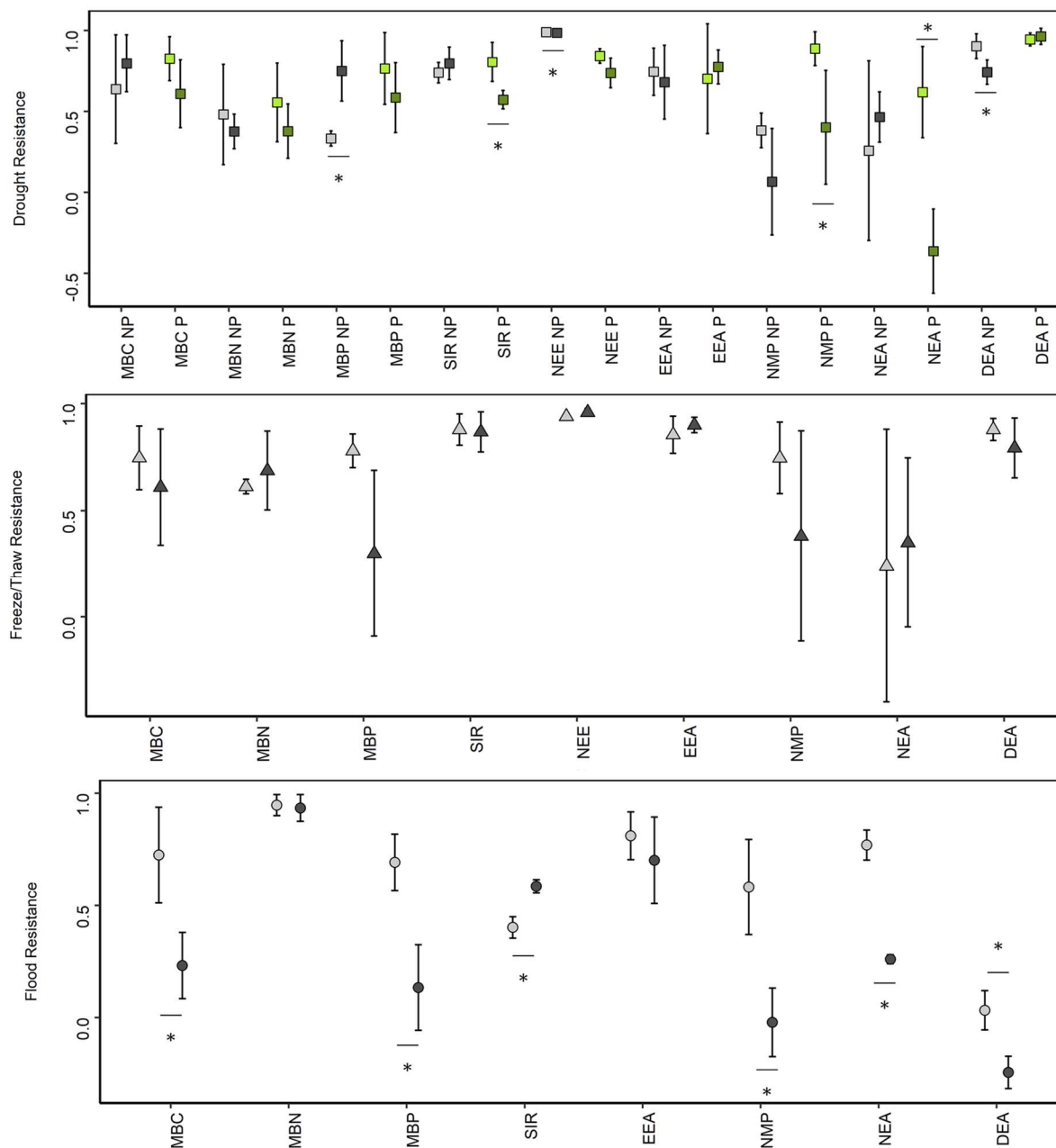

Figure 37 Effect of fertilization on drought (planted (P) and unplanted (NP) soil), freeze/thaw and flood resistance of microbial biomass and activities. Resistance were assessed using indice from Orwin and Wardle (2004). Points represent mean, errorbars are 95% confidence interval (n=4). Stars represent significant differences between fertilization treatments according to Tukey's test (p≤0.05). See Table 10 for abbreviations of microbial properties and Figure 34 graphical legend of colours and shapes. Grey points = unplanted soil, green points = planted soil, light colour = unfertilized soil, dark colour=fertilized soil, diamond=control climate, circle=flood, square=drought, triangle=freeze/thaw. NEE flood resistance has not been tested because of very low signal of soil respiration.

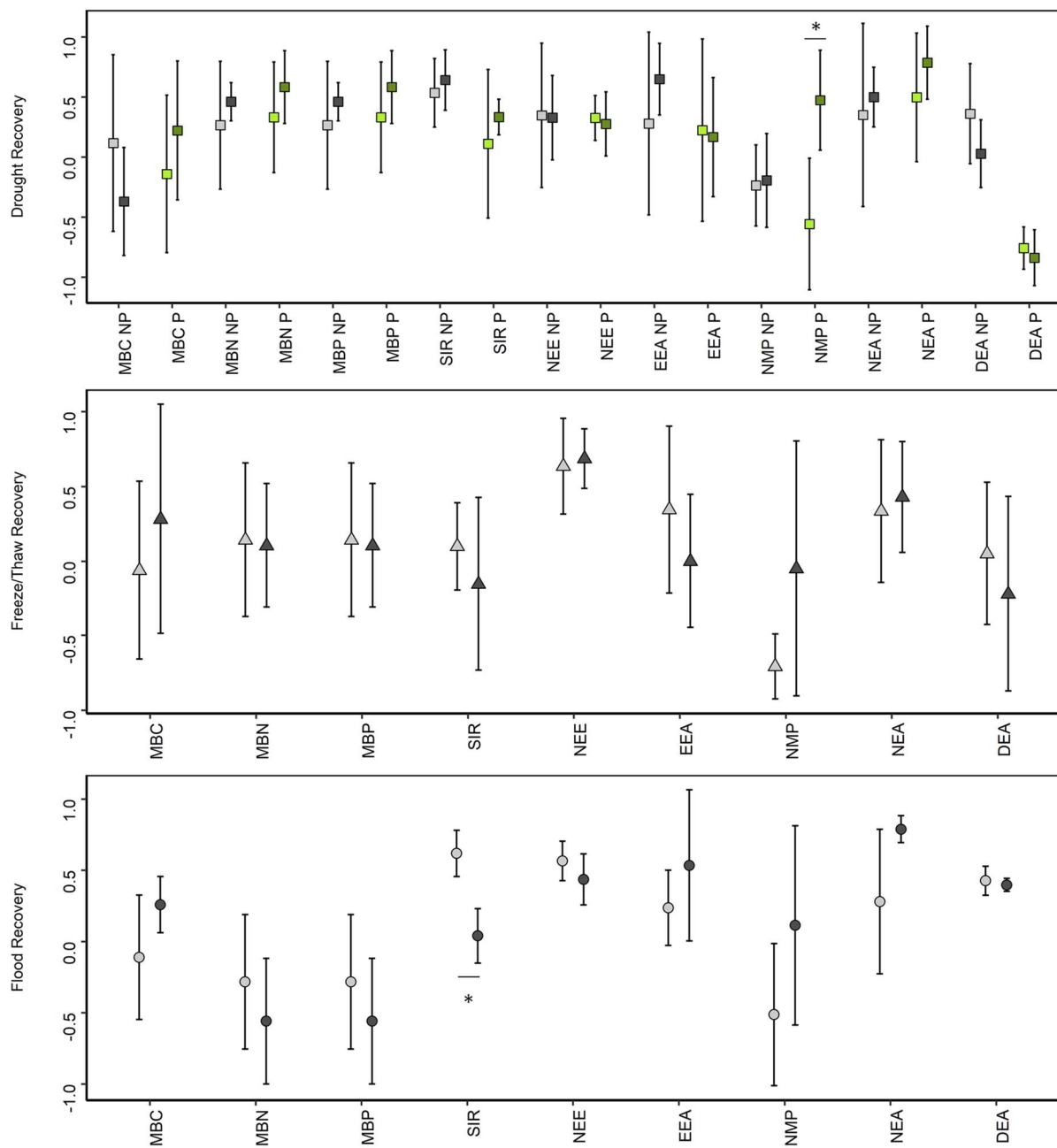

Figure 38 Effect of fertilization on drought (planted (P) and unplanted (NP) soil), freeze/thaw and flood recovery of microbial biomass and activities. Recovery were assessed using indice from Orwin and Wardle (2004). Points represent mean, errorbar are 95% confidence interval (n=4). Stars represent significant differences between fertilization treatment according to Tukey's test ( $p \leq 0.05$ ). See Table 10 for abbreviation of microbial properties and Figure 34 for graphical legend of colours and shapes codes. Grey points = unplanted soil, green points = planted soil, light colour = unfertilized soil, dark colour = fertilized soil, diamond = control climate, circle = flood, square = drought, triangle = freeze/thaw.

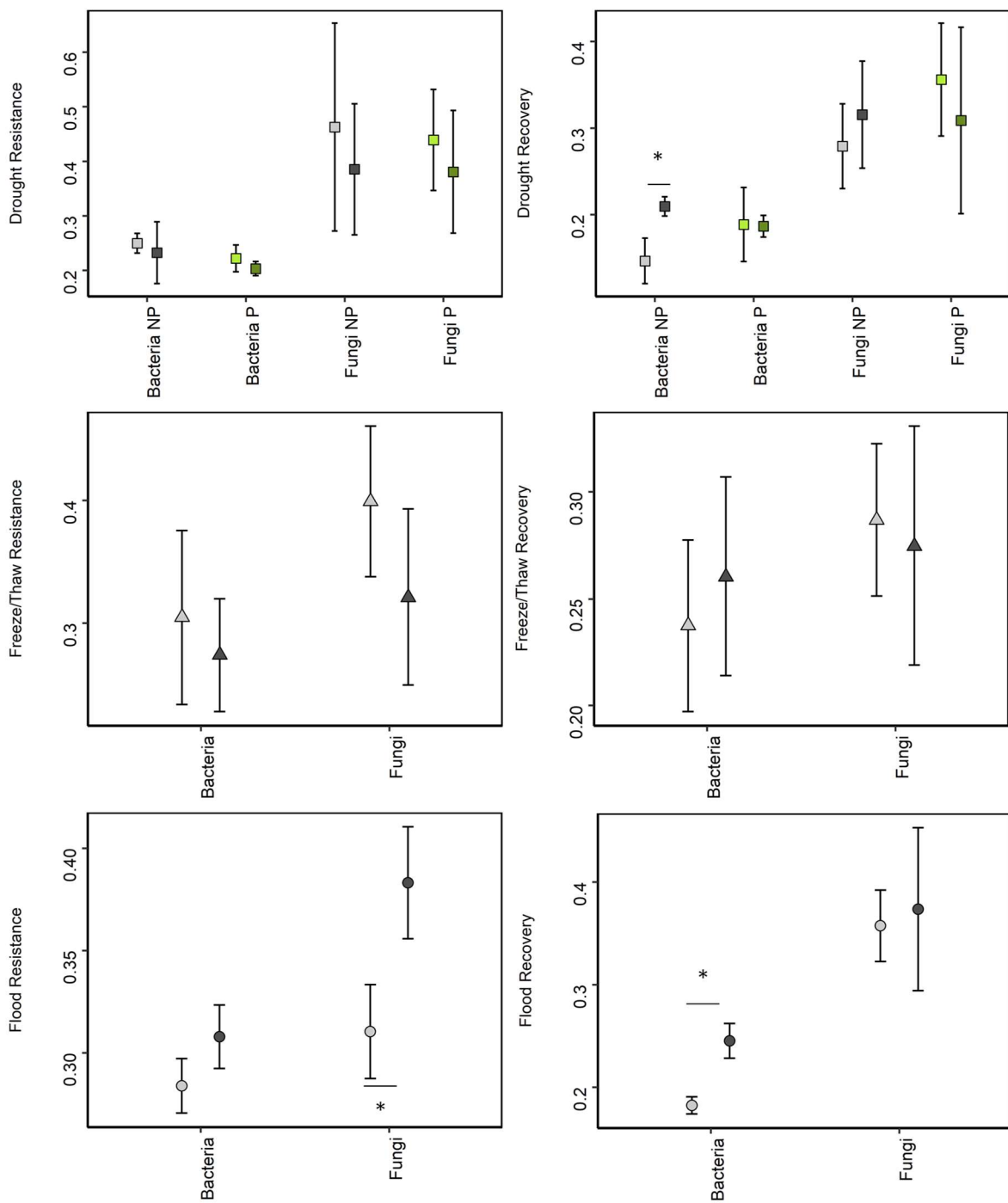

Figure 39 Effect of fertilization on drought (planted (P) and unplanted (NP) soil), freeze/thaw and flood resistance of bacteria and fungal stoichiometry and community composition. Resistance were assessed using bray-curtis distance between altered climate treatemtns and associated control. Points represent mean and error bar are 95% confidence interval (n=4). Stars represent significant differences between fertilization treatments according to Tukey’s test ( $p \leq 0.05$ ). See Figure 34 for graphical legend of colours and shapes codes. Grey points = unplanted soil, green points = planted soil, light colour = unfertilized soil, dark colour=fertilized soil, diamond=control climate, circle=flood, square=drought, triangle=freeze/thaw.

## 4 DISCUSSION

### 4.1 HYPOTHESIS 1: FERTILIZATION SELECTS MICROBIAL TAXA AND TRAITS ASSOCIATED WITH A COPIOTROPHIC STRATEGY

Fertilization effect on microbial community composition has been reported in studies in the presence (Ramirez et al. 2010, Fierer et al. 2012, Leff et al. 2015) or absence of plants (Ramirez et al. 2012), but rarely simultaneously (Kennedy et al. 2004). Our results indicated that fertilization modified both bacterial and fungal community composition and microbial CWM traits with common trends between planted and unplanted soils for the fertilization effect on the relative abundances of the most abundant bacterial and fungal phyla (Figure 35). *Actinobacteria* increased with fertilization in both planted and unplanted soils, consistent with the review of Ho et al. 2017 reporting several fertilization studies where *Actinobacteria* have been associated to a copiotrophic strategy. Conversely, *Proteobacteria* and *Bacteroidetes* abundances decreased with fertilization in our experiment. Yet, different classes of *Proteobacteria* showed distinct responses to fertilization, the decrease with fertilization observed for *Proteobacteria* phylum being mostly due to a decrease of the class *Deltaproteobacteria* (Figure 35, Figure SI 6). On the contrary, class *Beta-* and *Gammaproteobacteria* depicted a more copiotrophic behavior and increased with fertilization in planted soil. These results indicate different strategies within the *Proteobacteria* phylum, consistent with results from (Männistö et al. 2016) in subarctic tundra soils. Fertilization also affected fungal community composition but with no clear trend at the phylum level. The class of arbuscular mycorrhizal fungi (*Glomeromycetes*) increased in planted soil only without fertilization, which is consistent with the idea that fertilization suppresses mycorrhizal association (Mäder et al. 2000, Treseder 2004, Verbruggen and Toby Kiers 2010). Our results also indicated that bacterial community composition was more strongly influenced by fertilization than by plant presence compared to fungal community (Table 11), in line with previous studies indicating higher sensitivity of bacterial community to

fertilization (Marschner et al. 2003, Ai et al. 2018), and tighter association between plant and fungal communities compared to bacteria (Cassman et al. 2016, Ai et al. 2018). Significant interactions between fertilization and plant effects (Table 11) also confirmed the role of plants as a driver of microbial community composition modulating the effect of fertilization (Kennedy et al. 2004).

By crossing microbial community composition characterization with measures of microbial traits we identified specific traits associated with microbial communities selected under fertilization in the presence of absence of plants. Copiotrophic microbial communities selected under fertilization were expected to have lower biomass C:N, C:P and N:P ratios with a higher P content reflecting higher growth rates (Elser et al. 1996, 2003, Karpinets et al. 2006), while lower C and N contents indicating lower investment in enzyme machinery and stress resistance compounds (Arrigo 2004, Delgado-Baquerizo et al. 2018). Lower mass specific activity (Fontaine et al. 2003) and a shift in ecoenzymatic stoichiometry from nutrient (N and/or P) to C acquisition (Chapter 1 and 2.2) are also expected for copiotrophic communities under higher nutrient availability following the resource allocation model (Sinsabaugh et al. 1993).

Without plant, our results showed fertilization to affect microbial biomass stoichiometry associated to N-content at T1, decreasing MBC:MBN and increasing MBN:MBP (Figure 36). This pattern was surprising if interpreted only through the lens of the copiotrophic-oligotrophic continuum since MBC:MBN and MBN:MBP were expected to positively covary, as both ratios have been proposed to increase with the relative abundance of slow growing oligotrophs relative to fast growing copiotrophs (Arrigo 2004, Karpinets et al. 2006, Fierer et al. 2007). However, this stoichiometric response of microbial biomass was only transitory since, at T2 (data not shown), MBC:MBN was neither negatively (as at T1) nor positively associated to MBN:MBP. Moreover, microbial biomass stoichiometry response to fertilization at T2 showed lower MBN:MBP in fertilized soil consistent with a selection of copiotrophs (data not shown).

Microbial traits in the presence of plants showed a different response to fertilization. While microbial biomass stoichiometry was not affected by fertilization, ecoenzymatic stoichiometry indicated a reduced investment in N acquisition in response to fertilization (Figure 36). This trait response is consistent with previous results depicting a nutrient acquisition strategy for oligotrophic microbes (Chapter 1 and 2.3). Since this response pattern was only observed in the presence of plant, it suggests that fertilization indirectly modified these microbial traits through the plant response such as increased roots biomass and exploitative roots traits (low roots C:N). This shift in root traits induced by fertilization is usually highly associated with microbial trait response (Legay et al. 2014), for instance through changes in C exudates quantity or quality (Baptist et al. 2015). Our results confirmed such mechanism with roots biomass being positively related to EEC:EEN ( $p < 0.01$ ,  $R^2 = 0.46$ , SI Figure 8) and negatively with EEN:EEP ( $p < 0.01$ ,  $R^2 = 0.44$ , SI Figure 8), and roots C:N positively associated with EEN:EEP ( $p < 0.05$ ,  $R^2 = 0.36$ , SI Figure 8) suggesting a decreased investment in N acquisition enzymes with exploitative roots traits (N-rich roots) and high roots biomass increasing exudations (Baptist et al. 2015). To sum up, increased nutrient availability in the absence of plants in fertilized soils induced a modification in microbial biomass stoichiometry. In the presence of plants, decreased nutrient availability and modifications of soil environment through roots development induced a modification of the investment in extracellular enzymes production by soil microbial communities.

Overall our results confirmed our hypothesis H1 and showed that fertilization has important effects on microbial community composition and CWM traits, and that plant presence modified microbial community response to fertilization.

#### 4.2 HYPOTHESIS 2: CLIMATIC STRESS INCREASING OSMOTIC CONSTRAINTS AND REDUCING RESOURCE DIFFUSION (DROUGHT AND FREEZE/THAW) SELECT MICROBIAL TAXA AND TRAITS ASSOCIATED WITH AN OLIGOTROPHIC STRATEGY

Theory predicts a lower resistance to dry conditions and associated limitations in substrate diffusion for copiotrophic microbes compared to oligotrophs because of a lower nutrient use efficiency and resistance to starvation (Fierer et al. 2007). However, experiment crossing resource inputs and climatic stresses, and assessing microbial community composition are scarce (Bastida et al. 2017, Nguyen et al. 2018). This limits our capacity to identify if taxa responding positively to fertilization (copiotrophs) are actually the ones negatively affected by stress as predicted by theory (Fierer et al. 2007). Our results depicted consistent relationships between response to fertilization and response to soil moisture across bacterial phyla (Figure 35). This confirms potential associations between bacterial resource utilization strategy and stress resistance. However, this response was opposite to predictions based on theory as taxa responding positively to fertilization also increased with soil drying, refuting our hypothesis 2. *Actinobacteria* increased with fertilization and decreased with soil moisture, while *Bacteroidetes*, and *Deltaproteobacteria* decreased with fertilization and increased with soil moisture. Selection of *Actinobacteria* under dry conditions is well known (Bouskill et al. 2013), likely explained by the capacity of some *Actinobacteria* taxa to form spores and to grow under dry conditions and at low osmotic potential (Klevenskaya 1960, Williams et al. 1972, Manzoni et al. 2012). As discussed by Ho et al. (2017), even if generally responding positively to fertilization, *Actinobacteria* can present features commonly associated to oligotrophic strategy (stress resistance and ability to depolymerize complex carbon substrate). Abundances of other bacteria phyla (not affected by fertilization) also followed the soil moisture gradient: *Acidobacteria*, *Verrucomicrobia*, *Gemmatimonadetes* and *Alphaproteobacteria* (Figure 35). The response patterns of *Acidobacteria* and *Verrucomicrobia* are consistent with results from



(Barnard et al. 2013) describing a decrease of these phyla after 5 months of drought and an increase after rewetting in three Californian grasslands. These two phyla have often been associated with oligotrophy (Ho et al. 2017), also suggesting that phyla commonly classified as oligotrophs might be less resistant to dry condition (Barnard et al. 2013). The counterintuitive increase of copiotrophic taxa and decrease of oligotrophic taxa with soil drying in our study might be explained by the associated increase of soil mineral-N content (Figure 36). As copiotrophic taxa are more competitive under higher N availability, we suggest that the positive effect of soil drying on soil mineral-N content might have favoured taxa responding positively to fertilization in our experiment. It is also important to notice that drought simulation was moderate in terms of intensity and duration. It is possible that more severe or longer drought periods would have shifted selection from resource acquisition traits to stress resistance traits, thus favouring oligotrophs as predicted by theory (Fierer et al. 2007).

Interestingly, we also observed similarity between drought and freeze/thaw resistance in bacteria with several taxa increasing their abundances in both dry and freeze/thaw soils (*Actinobacteria* and *Alphaproteobacteria*), while phylum *Gemmatimonadetes* abundance decreased with drought and freeze/thaw treatments. This suggests common traits associated to drought and freeze/thaw resistance. These two stresses share some common effects on soil abiotic environment such as decreasing water availability and nutrient diffusion, and increasing osmotic constraint (Schimel et al. 2007). Thus, traits associated with physiological acclimation to stress and production of osmolites, trehalose, exopolysaccharides, spore and others protective features might be favoured under both dry or freeze/thaw conditions (Schimel et al. 2007, De Vries and Griffiths 2018). Such cross tolerance between freeze-thaw and other osmotic stresses have also been reported for lake microorganisms (Wilson et al. 2012). Mooshammer et al (2017) also showed that freeze/thaw and heat can induce markedly similar effects on microbial community composition and functioning, suggesting comparable

physiological costs associated with different climatic stresses (Mooshammer et al. 2017).

Soil moisture also affected microbial CWM traits. Some consistent trends across treatments were observed for P-associated traits. MBC:MBP decreased while EEC:EEP and EEN:EEP increased with soil drying (Figure 36). This pattern indicates a relax of P limitation with increasing soil moisture and higher P limitation in dry soil, while  $PO_4$  content slightly increased at low soil moisture. This might be explained by the high sensitivity of P mobility to soil moisture, limiting especially P supply for microbes in dry condition (Dijkstra et al. 2015). This might also indicate a higher microbial investment in growth machinery (P-rich RNA) at high soil moisture level and a higher investment in C-rich resistance structure at low soil moisture (Delgado-Baquerizo et al. 2018) consistent with our hypothesis of a selection of traits theoretically associated with an oligotrophic strategy in dry soil. Mass specific activities also increased with soil drying consistently with this hypothesis (Figure SI9).

Conversely, microbial communities showed two highly distinct responses to soil moisture for N-associated traits, depending on nutrient availability and plants presence. The MBC:MBN and MBN:MBP in unplanted/fertilized soil depicted completely opposite response to soil moisture when compared to planted soil (both fertilized and unfertilized). In planted soils, MBC:MBN increased with soil drying which might be explained by an increase in the relative abundance of fungi relative to bacteria (Strickland and Rousk 2010). Several mechanisms might explain such increase of fungi in dry conditions especially in the presence of plants. Firstly, fungi were shown to better maintain incorporation of plant-derived C during drought compared to bacteria (Fuchslueger et al. 2014). Secondly, by increasing the competition for N in dry condition, plants might favour fungi that use more efficiently N (Hodge et al. 2000), and are more resistant to drought compared to bacteria (Lennon et al. 2012, Manzoni et al. 2012). On the other hand, in unplanted/fertilized soils, MBC:MBN decreased and MBN:MBP highly increased with soil drying. This might be due to a strong

accumulation of bacterial N-rich osmolites with soil drying (Schimel et al. 2007). The absence of N-accumulation with soil drying in unfertilized soil supports the osmolites accumulation mechanism, with bacteria unable to accumulate osmolites in unfertilized soil because of a too expensive N cost of such physiological response (Schimel et al. 2007). These results showed that plant and nutrient availability control the response of microbial-N pools to soil drying, likely via a modification of the fungal:bacterial ratio and osmolites accumulation.

Overall, microbial community composition and trait response to soil fertilization and moisture observed in this study challenge the copiotrophic-oligotrophic continuum model (Fierer et al. 2007). First, the better adaptation of copiotrophic taxa to dry condition was opposed to theoretical prediction. Second, the decoupling of traits theoretically associated along the copiotrophic-oligotrophic continuum suggests that the trait syndrome varying along the copiotrophic-oligotrophic continuum is not highly constrained, at least on shortly after a significant nutrient input. These results might also suggest other functional dimensions not included in the copiotrophic-oligotrophic continuum which should be considered (Ho et al. 2017, Malik et al. 2019). Our study stresses the necessity to implement functional trait framework in microbial ecology to elucidate functional variations across microbial diversity.

#### 4.3 HYPOTHESIS 3: COPIOTROPHIC COMMUNITY SELECTED UNDER FERTILIZATION INDUCES LOWER RESISTANCE BUT HIGHER RECOVERY OF MICROBIAL ECOSYSTEM PROPERTIES

The final aim of our study was to assess how fertilization and plant influenced the resilience (resistance and recovery) of microbial biomass, activities and composition. Soil microbial communities are of central importance for ecosystem functioning, driving most of soil processes underlying nutrient cycling and C sequestration (Nannipieri et al. 2003, Falkowski et al. 2008), and containing important C, N and P stocks that might be released and lost from the ecosystem (Bardgett 2005, De Vries and Bardgett 2012). Climatic stresses can

induce important alterations of microbial community diversity, biomass and microbially-mediated processes with important implications for ecosystem functioning (Schimel et al. 2007). However, little is known about how fertilization and plant can affect the stability of the different components of the microbial community (De Vries and Shade 2014). Assessing fertilization effect on the resistance and the recovery to three climatic stress (drought, flood and freeze/thaw) for 9 microbial ecosystem properties representing biomass (MBC, MBN, MBP), activities (SIR, EEA, NEA, DEA) and for the bacterial and fungal communities composition, our study confirmed that fertilization highly influenced microbial community and ecosystem stability in the presence or absence of plant. Specifically, we hypothesized that copiotrophic microbial communities selected under fertilization would be less resistant but more able to recovery (De Vries et al. 2012, De Vries and Shade 2014, De Vries and Griffiths 2018). Most of the fertilization effect on microbial community resistance to climate stress confirmed this hypothesis, with fertilization decreasing resistance of almost all measured microbial properties, at least in one condition (fertilized or not, planted or not). Planted and unplanted soils showed almost the same number of microbial properties for which resistance was negatively impacted by fertilization but the properties impacted were different. Planted soils showed a of Substrate-induced respiration (SIR), Potial nitrogen mineralization (PNM) and nitrification rates (NEA) drought resistance while unplanted soils showed decrease of Net ecosystem exchange (NEE) and Denitrification rate (DEA). Flood resistance (only tested without plant) of MBC, MBP, NMP, NEA and DEA were also negatively affected by fertilization. Conversely, the freeze/thaw resistance (only tested without plant as well), was not affected by fertilization. Only three microbial properties (SIR, MBP and fungal community composition) presented the opposite patterns with a higher resistance when soil was fertilized. However, these patterns were explained by similar effects of fertilization and climatic stresses. In other words, fertilization already altered these properties in the same direction than climatic stresses, reducing the differences between fertilized/control climate and fertilized/climate

stress. Overall, our results confirmed our hypothesis 3 that microbial community selected under fertilization (copiotrophs) generally have a lower resistance to climatic stresses associated with alterations of soil moisture.

Also consistent with our hypothesis, the recovery of several microbial properties increased in response to fertilization. However, recovery was less responsive to fertilization compared to resistance with only few properties affected. With fertilization, PNM drought recovery increased in planted treatment and bacterial community composition recovery to drought and flood increased in unplanted soils.

These results bring new evidences that intensive grassland management can decrease ecosystem drought resistance as demonstrated in Chapters 1 and 2.1 and in previous studies (Ingrisch et al. 2018, Karlowsky et al. 2018, Cole et al. 2019), and extend the negative effect of fertilization to flood but not freeze/thaw resistance. Our experiment also brings new insights on the underlying mechanisms. By manipulating only fertilization, we confirmed experimentally the role of fertilization in the negative effect of land use intensity on ecosystem resistance observed in less controlled experiments (e.g. Chapter 1 and 2.1). As the effect of fertilization on recovery was less clear in our results, we suggest that other factors such as shifts in plant community functional composition with fertilization (selection of exploitative plants) might be the main drivers of the higher recovery usually observed in intensive managed grasslands (Ingrisch et al. 2018, Karlowsky et al. 2018).

## 5 CONCLUSION

Our study demonstrated that mineral fertilization (N-P) modifies the microbial community composition. But contrary to our hypothesis, taxa selected under fertilization (copiotrophs) increased with soil drying, challenging the idea that microbes selected under fertilization should be more sensitive to osmotic stress. Fertilization and soil moisture also affected microbial CWM traits, but these functional responses were highly distinct depending on the presence or absence of plants, stressing the role of plant in the functional response of

soil microbial communities to global changes. Finally, fertilization showed a negative effect on the resistance of a large panel of microbial properties and only few positive effects on recovery. High mineral fertilization associated with conventional intensification of agriculture is thus expected to alter microbial community composition and traits leading to a decrease of ecosystem stability under climate change, threatening associated ecosystem services.

### NEXT STEPS

*Four analyzes are planned to go further in the questions raised by the preliminary analyzes presented here. First, qPCR analyses on 16S and 18S markers are planned to assess the fungal:bacterial ratio (Yergeau et al. 2007, Rousk et al. 2010) and should help us to explore potential associations between CWM traits and microbial community composition. Second, I would like to test the proportion of taxa responding to treatments (fertilization, climatic stress, plant presence) at different taxonomic resolution (Phylum, class, order, family, OTU). Such analyses should help us to identify the taxonomic resolution at which functional difference occurred. Then, I would like to assess if taxa responded to different treatments and if yes how it is organized (e.g. is taxa responding positively to fertilization, more often responds positively or negatively to drought?). Such analysis should enable us to assess if Actinobacteria responding positively to fertilization and soil drying are really the same taxa, indicating taxa sharing copiotrophic and oligotrophic features, or if it is different taxa within the Actinobacteria phyla that have different strategies. Overall, these analyzes might bring interesting insights on the associations and trade-offs between the responses to resource availability and stress.*

*Third, metatranscriptomic are currently running on the unplanted soils. These analyzes should inform us on the expression of a large number of metabolic pathways associated with C, N, P metabolism and stress resistance in the different treatments. This should help us to understand the functional mechanisms underlying the response we observed for CWM traits and microbial ecosystem properties. Finally, Net Ecosystem Exchange*

(NEE) have been measured semi-continuously all along the experiment (one measure on each mesocosm once a week). Current version only used the measures conducted the days before T1 and T2. Analysis of the full data-set should enable us to examine precisely the dynamic of CO<sub>2</sub> during the stress and the recovery period and the repercussions on cumulative CO<sub>2</sub> fluxes.

## REFERENCES

- Ai, C., S. Zhang, X. Zhang, D. Guo, W. Zhou, and S. Huang. 2018. Distinct responses of soil bacterial and fungal communities to changes in fertilization regime and crop rotation. *Geoderma* 319:156–166.
- Anderson, J., and K. Domsch. 1978. A physiological method for the quantitative measurement of microbial biomass in soils. *Soil biology and biochemistry* 10:215–221.
- Arrigo, K. R. 2004. Marine microorganisms and global nutrient cycles. *Nature* 437:349.
- Attard, E., S. Recous, A. Chabbi, C. De Berranger, N. Guillaumaud, J. Labreuche, L. Philippot, B. Schmid, and X. Le Roux. 2011. Soil environmental conditions rather than denitrifier abundance and diversity drive potential denitrification after changes in land uses. *Global Change Biology* 17:1975–1989.
- Baptist, F., I. Aranjuelo, N. Legay, L. Lopez-Sangil, G. Molero, P. Rovira, and S. Nogués. 2015. Rhizodeposition of organic carbon by plants with contrasting traits for resource acquisition: responses to different fertility regimes. *Plant and soil* 394:391–406.
- Bardgett, R. 2005. *The biology of soil: a community and ecosystem approach*. Oxford University Press.
- Barnard, R. L., C. A. Osborne, and M. K. Firestone. 2013. Responses of soil bacterial and fungal communities to extreme desiccation and rewetting. *The ISME journal* 7:2229.
- Bastida, F., I. Torres, T. Hernández, and C. García. 2017. The impacts of organic amendments: Do they confer stability against drought on the soil microbial community? *Soil Biology and Biochemistry* 113:173–183.
- Bell, C. W., B. E. Fricks, J. D. Rocca, J. M. Steinweg, S. K. McMahon, and M. D. Wallenstein. 2013. High-throughput fluorometric measurement of potential soil extracellular enzyme activities. *Journal of visualized experiments: JoVE*.
- Boeddinghaus, R. S., S. Marhan, D. Berner, S. Boch, M. Fischer, N. Hölzel, J. Kattge, V. H. Klaus, T. Kleinebecker, Y. Oelmann, and others. 2019. Plant functional trait shifts explain concurrent changes in the structure and function of grassland soil microbial communities. *Journal of Ecology*.
- Bouskill, N. J., H. C. Lim, S. Borglin, R. Salve, T. E. Wood, W. L. Silver, and E. L. Brodie. 2013. Pre-exposure to drought increases the resistance of tropical forest soil bacterial communities to extended drought. *The ISME journal* 7:384.
- Boyer, F., C. Mercier, A. Bonin, Y. Le Bras, P. Taberlet, and E. Coissac. 2016. obitools: A unix-inspired software package for DNA metabarcoding. *Molecular ecology resources* 16:176–182.
- Brookes, P., D. Powlson, and D. Jenkinson. 1982. Measurement of microbial biomass phosphorus in soil. *Soil biology and biochemistry* 14:319–329.
- Canarini, A., L. P. Kiær, and F. A. Dijkstra. 2017. Soil carbon loss regulated by drought intensity and available substrate: A meta-analysis. *Soil Biology and Biochemistry* 112:90–99.
- Cantarel, A. A., T. Pommier, M. Desclos-Theveniau, S. Diquélou, M. Dumont, F. Grassein, E.-M. Kastl, K. Grigulis, P. Latné, S. Lavorel, and others. 2015. Using plant traits to explain plant–microbe relationships involved in nitrogen acquisition. *Ecology* 96:788–799.
- Cassman, N. A., M. F. Leite, Y. Pan, M. De Hollander, J. A. Van Veen, and E. E. Kuramae. 2016. Plant and soil fungal but not soil bacterial communities are linked in long-term fertilized grassland. *Scientific reports* 6:23680.
- Cenini, V. L., D. A. Fornara, G. McMullan, N. Ternan, R. Carolan, M. J. Crawley, J.-C. Clément, and S. Lavorel. 2016. Linkages between extracellular enzyme activities and the carbon and nitrogen content of grassland soils. *Soil Biology and Biochemistry*.
- Cole, A. J., R. I. Griffiths, S. E. Ward, J. Whitaker, N. J. Ostle, and R. D. Bardgett. 2019. Grassland biodiversity restoration increases resistance of carbon fluxes to drought. *Journal of Applied Ecology*.
- Dassonville, N., N. Guillaumaud, F. Piola, P. Meerts, and F. Poly. 2011. Niche construction by the invasive Asian knotweeds (species complex *Fallopia*): impact on activity, abundance and community structure of denitrifiers and nitrifiers. *Biological invasions* 13:1115–1133.
- Delgado-Baquerizo, M., D. J. Eldridge, F. T. Maestre, V. Ochoa, B. Gozalo, P. B. Reich, and B. K. Singh. 2018. Aridity decouples C: N: P stoichiometry across

- multiple trophic levels in terrestrial ecosystems. *Ecosystems* 21:459–468.
- Dijkstra, F. A., M. He, M. P. Johansen, J. J. Harrison, and C. Keitel. 2015. Plant and microbial uptake of nitrogen and phosphorus affected by drought using  $^{15}\text{N}$  and  $^{32}\text{P}$  tracers. *Soil Biology and Biochemistry* 82:135–142.
- Elser, J., K. Acharya, M. Kyle, J. Cotner, W. Makino, T. Markow, T. Watts, S. Hobbie, W. Fagan, J. Schade, and others. 2003. Growth rate–stoichiometry couplings in diverse biota. *Ecology Letters* 6:936–943.
- Elser, J. J., D. R. Dobberfuhl, N. A. MacKay, and J. H. Schampel. 1996. Organism size, life history, and N:P stoichiometry: toward a unified view of cellular and ecosystem processes. *BioScience* 46:674–684.
- Falkowski, P. G., T. Fenchel, and E. F. Delong. 2008. The microbial engines that drive Earth's biogeochemical cycles. *science* 320:1034–1039.
- Fierer, N., M. A. Bradford, and R. B. Jackson. 2007. Toward an ecological classification of soil bacteria. *Ecology* 88:1354–1364.
- Fierer, N., C. L. Lauber, K. S. Ramirez, J. Zaneveld, M. A. Bradford, and R. Knight. 2012. Comparative metagenomic, phylogenetic and physiological analyses of soil microbial communities across nitrogen gradients. *The ISME journal* 6:1007–1017.
- Fontaine, S., A. Mariotti, and L. Abbadie. 2003. The priming effect of organic matter: a question of microbial competition? *Soil Biology and Biochemistry* 35:837–843.
- Fuchslueger, L., M. Bahn, K. Fritz, R. Hasibeder, and A. Richter. 2014. Experimental drought reduces the transfer of recently fixed plant carbon to soil microbes and alters the bacterial community composition in a mountain meadow. *New Phytologist* 201:916–927.
- Grigulis, K., S. Lavorel, U. Krainer, N. Legay, C. Baxendale, M. Dumont, E. Kastl, C. Arnoldi, R. D. Bardgett, F. Poly, and others. 2013. Relative contributions of plant traits and soil microbial properties to mountain grassland ecosystem services. *Journal of Ecology* 101:47–57.
- Hartmann, M., B. Frey, J. Mayer, P. Mäder, and F. Widmer. 2015. Distinct soil microbial diversity under long-term organic and conventional farming. *The ISME journal* 9:1177.
- Ho, A., D. P. Di Lonardo, and P. L. Bodelier. 2017. Revisiting life strategy concepts in environmental microbial ecology. *FEMS microbiology ecology* 93:fix006.
- Hodge, A., D. Robinson, and A. Fitter. 2000. Are microorganisms more effective than plants at competing for nitrogen? *Trends in plant science* 5:304–308.
- Ingrisch, J., and M. Bahn. 2018. Towards a comparable quantification of resilience. *Trends in ecology & evolution*.
- Ingrisch, J., S. Karlowsky, A. Anadon-Rosell, R. Hasibeder, A. König, A. Augusti, G. Gleixner, and M. Bahn. 2018. Land use alters the drought responses of productivity and  $\text{CO}_2$  fluxes in mountain grassland. *Ecosystems* 21:689–703.
- Jenkinson, D. S., P. C. Brookes, and D. S. Powlson. 2004. Measuring soil microbial biomass. *Soil biology and biochemistry* 36:5–7.
- Karlowsky, S., A. Augusti, J. Ingrisch, R. Hasibeder, M. Lange, S. Lavorel, M. Bahn, and G. Gleixner. 2018. Land use in mountain grasslands alters drought response and recovery of carbon allocation and plant-microbial interactions. *Journal of Ecology* 106:1230–1243.
- Karpinets, T. V., D. J. Greenwood, C. E. Sams, and J. T. Ammons. 2006. RNA: protein ratio of the unicellular organism as a characteristic of phosphorous and nitrogen stoichiometry and of the cellular requirement of ribosomes for protein synthesis. *BMC biology* 4:30.
- Kennedy, N., E. Brodie, J. Connolly, and N. Clipson. 2004. Impact of lime, nitrogen and plant species on bacterial community structure in grassland microcosms. *Environmental Microbiology* 6:1070–1080.
- Klevenskaya, I. 1960. Growth of soil actinomycetes in media of varying osmotic pressure. *Mikrobiologia* 29:161–164.
- Koper, T. E., J. M. Stark, M. Y. Habteselassie, and J. M. Norton. 2010. Nitrification exhibits Haldane kinetics in an agricultural soil treated with ammonium sulfate or dairy-waste compost. *FEMS microbiology ecology* 74:316–322.
- Koyama, A., J. M. Steinweg, M. L. Haddix, J. S. Dukes, and M. D. Wallenstein. 2017. Soil bacterial community responses to altered precipitation and temperature regimes in an old field grassland are mediated by plants. *FEMS microbiology ecology* 94:fix156.
- Krause, S., X. Le Roux, P. A. Niklaus, P. M. Van Bodegom, J. T. Lennon, S. Bertilsson, H.-P. Grossart, L. Philippot, and P. L. Bodelier. 2014. Trait-based approaches for understanding microbial biodiversity and ecosystem functioning. *Frontiers in Microbiology* 5.

- Lavorel, S., and E. Garnier. 2002. Predicting changes in community composition and ecosystem functioning from plant traits: revisiting the Holy Grail. *Functional ecology* 16:545–556.
- Leff, J. W., S. E. Jones, S. M. Prober, A. Barberán, E. T. Borer, J. L. Firn, W. S. Harpole, S. E. Hobbie, K. S. Hofmockel, J. M. Knops, and others. 2015. Consistent responses of soil microbial communities to elevated nutrient inputs in grasslands across the globe. *Proceedings of the National Academy of Sciences* 112:10967–10972.
- Legay, N., S. Lavorel, C. Baxendale, U. Krainer, M. Bahn, M.-N. Binet, A. A. Cantarel, M.-P. Colace, A. Foulquier, E.-M. Kastl, and others. 2016. Influence of plant traits, soil microbial properties, and abiotic parameters on nitrogen turnover of grassland ecosystems. *Ecosphere* 7.
- Legay, N., G. Piton, C. Arnoldi, L. Bernard, M.-N. Binet, B. Mouhamadou, T. Pommier, S. Lavorel, A. Foulquier, and J.-C. Clément. 2017. Soil legacy effects of climatic stress, management and plant functional composition on microbial communities influence the response of *Lolium perenne* to a new drought event. *Plant and Soil*:1–22.
- Lineweaver, H., and D. Burk. 1934. The determination of enzyme dissociation constants. *Journal of the American chemical society* 56:658–666.
- Lori, M., S. Symanczik, P. Mäder, N. Efoza, S. Jaenicke, F. Buegger, S. Tresch, A. Goesmann, and A. Gattinger. 2018. Distinct nitrogen provisioning from organic amendments in soil as influenced by farming system and water regime. *Frontiers in Environmental Science*:1–14.
- Lori, M., S. Symnaczik, P. Mäder, G. De Deyn, and A. Gattinger. 2017. Organic farming enhances soil microbial abundance and activity—A meta-analysis and meta-regression. *PLoS One* 12:e0180442.
- Loucougaray, G., L. Dobremez, P. Gos, Y. Pauthenet, B. Nettiér, and S. Lavorel. 2015. Assessing the effects of grassland management on forage production and environmental quality to identify paths to ecological intensification in mountain grasslands. *Environmental management* 56:1039–1052.
- Mäder, P., S. Edenhofer, T. Boller, A. Wiemken, and U. Niggli. 2000. Arbuscular mycorrhizae in a long-term field trial comparing low-input (organic, biological) and high-input (conventional) farming systems in a crop rotation. *Biology and fertility of Soils* 31:150–156.
- Malik, A. A., J. B. Martiny, E. L. Brodie, A. C. Martiny, K. K. Treseder, and S. D. Allison. 2019. Defining trait-based microbial strategies with consequences for soil carbon cycling under climate change. *The ISME journal*:1–9.
- Männistö, M., L. Ganzert, M. Tirola, M. M. Häggblom, and S. Stark. 2016. Do shifts in life strategies explain microbial community responses to increasing nitrogen in tundra soil? *Soil Biology and Biochemistry* 96:216–228.
- Manzoni, S., J. P. Schimel, and A. Porporato. 2012. Responses of soil microbial communities to water stress: results from a meta-analysis. *Ecology* 93:930–938.
- Marschner, P., E. Kandeler, and B. Marschner. 2003. Structure and function of the soil microbial community in a long-term fertilizer experiment. *Soil Biology and Biochemistry* 35:453–461.
- Martiny, J. B., S. E. Jones, J. T. Lennon, and A. C. Martiny. 2015. Microbiomes in light of traits: a phylogenetic perspective. *Science* 350:aac9323.
- Mercier, C., F. Boyer, A. Bonin, and E. Coissac. 2013. SUMATRA and SUMACLUSt: fast and exact comparison and clustering of sequences. Pages 27–29 *Programs and Abstracts of the SeqBio 2013 workshop*. Abstract. . Citeseer.
- Mooshammer, M., F. Hofhansl, A. H. Frank, W. Wanek, I. Hämmerle, S. Leitner, J. Schneckner, B. Wild, M. Watzka, K. M. Keiblinger, and others. 2017. Decoupling of microbial carbon, nitrogen, and phosphorus cycling in response to extreme temperature events. *Science Advances* 3:e1602781.
- Morrissey, E. M., R. L. Mau, M. Hayer, X.-J. A. Liu, E. Schwartz, P. Dijkstra, B. J. Koch, K. Allen, S. J. Blazewicz, K. Hofmockel, and others. 2019. Evolutionary history constrains microbial traits across environmental variation. *Nature ecology & evolution*:1.
- Nannipieri, P., J. Ascher, M. Ceccherini, L. Landi, G. Pietramellara, and G. Renella. 2003. Microbial diversity and soil functions. *European journal of soil science* 54:655–670.
- Nguyen, L. T., Y. Osanai, K. Lai, I. C. Anderson, M. P. Bange, D. T. Tissue, and B. K. Singh. 2018. Responses of the soil microbial community to nitrogen fertilizer regimes and historical exposure to extreme weather events: Flooding or prolonged-drought. *Soil Biology and Biochemistry* 118:227–236.
- Niu, S., M. Wu, Y. Han, J. Xia, L. Li, and S. Wan. 2008. Water-mediated responses of ecosystem carbon fluxes to climatic change in a temperate steppe. *New Phytologist* 177:209–219.

- Oksanen, J., F. G. Blanchet, R. Kindt, P. Legendre, P. R. Minchin, R. O'hara, G. L. Simpson, P. Solymos, M. H. H. Stevens, and H. Wagner. 2011. *vegan*: Community ecology package. R package version:117–118.
- Orwin, K. H., and D. A. Wardle. 2004. New indices for quantifying the resistance and resilience of soil biota to exogenous disturbances. *Soil Biology and Biochemistry* 36:1907–1912.
- Orwin, K. H., and D. A. Wardle. 2005. Plant species composition effects on belowground properties and the resistance and resilience of the soil microflora to a drying disturbance. *Plant and Soil* 278:205–221.
- Ramirez, K. S., J. M. Craine, and N. Fierer. 2012. Consistent effects of nitrogen amendments on soil microbial communities and processes across biomes. *Global Change Biology* 18:1918–1927.
- Ramirez, K. S., C. L. Lauber, R. Knight, M. A. Bradford, and N. Fierer. 2010. Consistent effects of nitrogen fertilization on soil bacterial communities in contrasting systems. *Ecology* 91:3463–3470.
- Reay, D. S., E. A. Davidson, K. A. Smith, P. Smith, J. M. Melillo, F. Dentener, and P. J. Crutzen. 2012. Global agriculture and nitrous oxide emissions. *Nature climate change* 2:410.
- Ren, C., J. Chen, X. Lu, R. Doughty, F. Zhao, Z. Zhong, X. Han, G. Yang, Y. Feng, and G. Ren. 2018. Responses of soil total microbial biomass and community compositions to rainfall reductions. *Soil Biology and Biochemistry* 116:4–10.
- Robertson, G. P., D. C. Coleman, P. Sollins, C. S. Bledsoe, and others. 1999. *Standard soil methods for long-term ecological research*. Oxford University Press on Demand.
- Rousk, J., E. Bååth, P. C. Brookes, C. L. Lauber, C. Lozupone, J. G. Caporaso, R. Knight, and N. Fierer. 2010. Soil bacterial and fungal communities across a pH gradient in an arable soil. *The ISME journal* 4:1340.
- Schimel, J., T. C. Balser, and M. Wallenstein. 2007. Microbial stress-response physiology and its implications for ecosystem function. *Ecology* 88:1386–1394.
- Schlesinger, W. H. 2009. On the fate of anthropogenic nitrogen. *Proceedings of the National Academy of Sciences* 106:203–208.
- Sinsabaugh, R. L., R. Antibus, A. Linkins, C. McClaugherty, L. Rayburn, D. Repert, and T. Weiland. 1993. Wood decomposition: nitrogen and phosphorus dynamics in relation to extracellular enzyme activity. *Ecology* 74:1586–1593.
- Sinsabaugh, R. L., B. H. Hill, and J. J. F. Shah. 2009. Ecoenzymatic stoichiometry of microbial organic nutrient acquisition in soil and sediment. *Nature* 462:795–798.
- Strickland, M. S., and J. Rousk. 2010. Considering fungal: bacterial dominance in soils—methods, controls, and ecosystem implications. *Soil Biology and Biochemistry* 42:1385–1395.
- Taberlet, P., E. Coissac, F. Pompanon, C. Brochmann, and E. Willerslev. 2012. Towards next-generation biodiversity assessment using DNA metabarcoding. *Molecular ecology* 21:2045–2050.
- Treseder, K. K. 2004. A meta-analysis of mycorrhizal responses to nitrogen, phosphorus, and atmospheric CO<sub>2</sub> in field studies. *New Phytologist* 164:347–355.
- Vance, E. D., P. C. Brookes, and D. S. Jenkinson. 1987. An extraction method for measuring soil microbial biomass C. *Soil biology and Biochemistry* 19:703–707.
- Verbruggen, E., and E. Toby Kiers. 2010. Evolutionary ecology of mycorrhizal functional diversity in agricultural systems. *Evolutionary Applications* 3:547–560.
- De Vries, F. T., and R. D. Bardgett. 2012. Plant-microbial linkages and ecosystem nitrogen retention: lessons for sustainable agriculture. *Frontiers in Ecology and the Environment* 10:425–432.
- De Vries, F. T., and R. I. Griffiths. 2018. Impacts of Climate Change on Soil Microbial Communities and Their Functioning. Pages 111–129 *Developments in Soil Science*. Elsevier.
- De Vries, F. T., E. Hoffland, N. van Eekeren, L. Brussaard, and J. Bloem. 2006. Fungal/bacterial ratios in grasslands with contrasting nitrogen management. *Soil Biology and Biochemistry* 38:2092–2103.
- De Vries, F. T., M. E. Liiri, L. Bjørnlund, M. A. Bowker, S. Christensen, H. M. Setälä, and R. D. Bardgett. 2012. Land use alters the resistance and resilience of soil food webs to drought. *Nature Climate Change* 2:276–280.
- De Vries, F. T., and A. Shade. 2014. Controls on soil microbial community stability under climate change. *The Microbial Regulation of Global Biogeochemical Cycles*:132.
- Wienhold, B. J. 2007. Comparison of laboratory methods and an in situ method for estimating nitrogen mineralization in an irrigated silt-loam soil. *Communications in soil science and plant analysis* 38:1721–1732.
- Williams, S., M. Shameemullah, E. Watson, and C. Mayfield. 1972. *Studies on the ecology of*

actinomycetes in soil—vi. the influence of moisture tension on growth and survival. *Soil Biology and Biochemistry* 4:215–225.

Wilson, S. L., C. Frazer, B. F. Cumming, P. A. Nuin, and V. K. Walker. 2012. Cross-tolerance between osmotic and freeze-thaw stress in microbial assemblages from temperate lakes. *FEMS microbiology ecology* 82:405–415.

Yergeau, E., S. Bokhorst, A. H. Huiskes, H. T. Boschker, R. Aerts, and G. A. Kowalchuk. 2007. Size and structure of bacterial, fungal and nematode communities along an Antarctic environmental gradient. *FEMS microbiology ecology* 59:436–451.

Zinger, L., P. Taberlet, H. Schimann, A. Bonin, F. Boyer, M. De Barba, P. Gaucher, L. Gielly, C. Giguet-Covex, A. Iribar, and others. 2019. Body size determines soil community assembly in a tropical forest. *Molecular ecology* 28:528–543.



SUPPLEMENTARY MATERIALS

SUPPLEMENTARY FIGURES

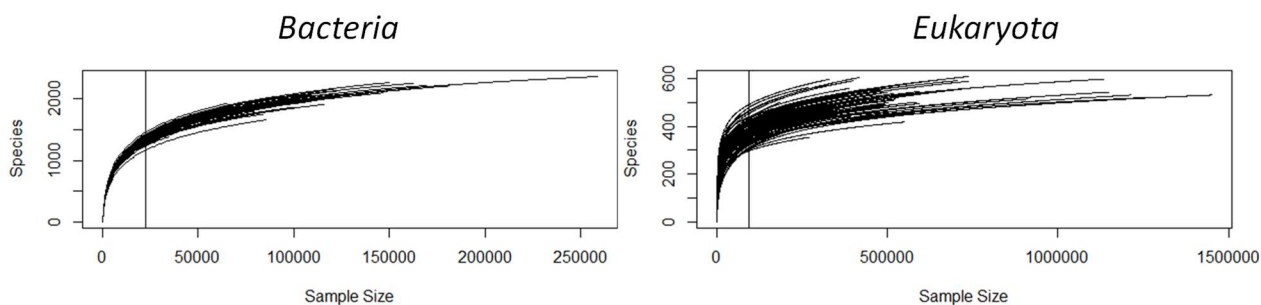

SI Figure 5. Rarefaction curves for *Bacteria* and *Eukaryota*. Vertical lines represent resampling size used for data rarefaction of each sample to have similar sequencing depth equal to the number of reads of the sample with the lowest reads numbers (*Bacteria*: 22 571 sequences/sample, *Eukaryota* : 93 742 sequences/sample).

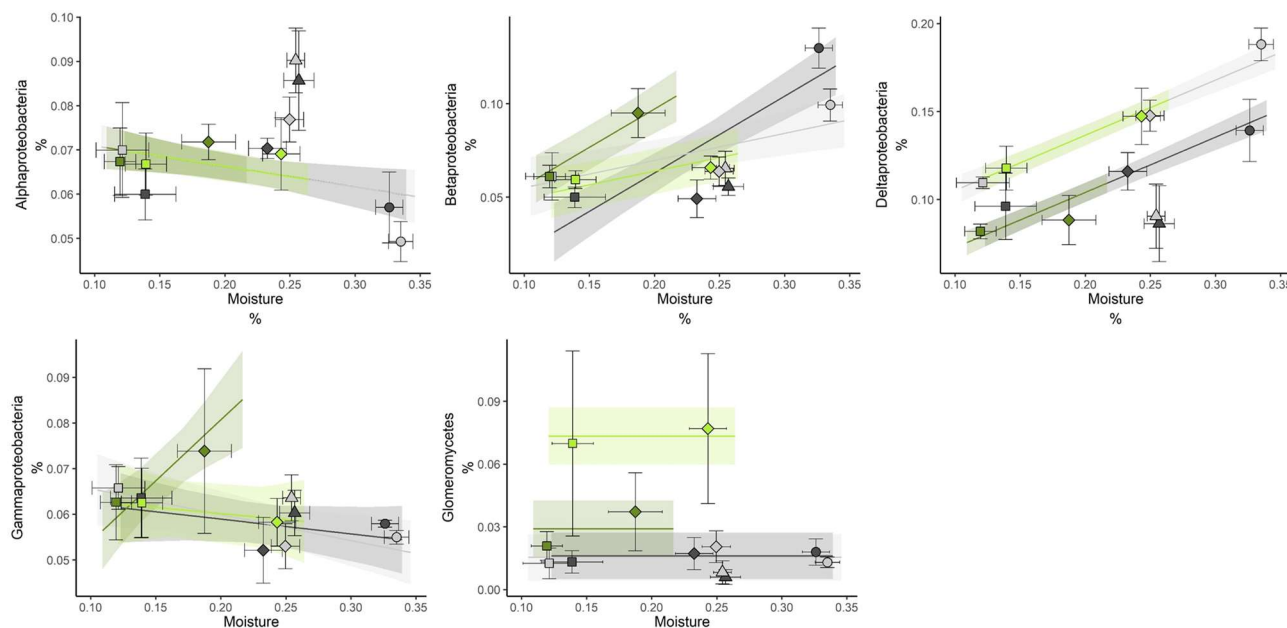

SI Figure 6. Effects of soil moisture, fertilization and plant on bacterial and fungal subphylum. Lines represent predicted value and shades represent 95% confidence interval from ANCOVA model (only significant factors were used for model fit). Points represent mean of each treatments at T1. Error bars around points are 95% confidence interval (n=4). Grey points and lines = unplanted soil, green points and lines = planted soil, light colour points and lines = unfertilized soil, dark colour points and lines = fertilized soil, diamond=control climate, circle=flood, square=drought, triangle=freeze/thaw.

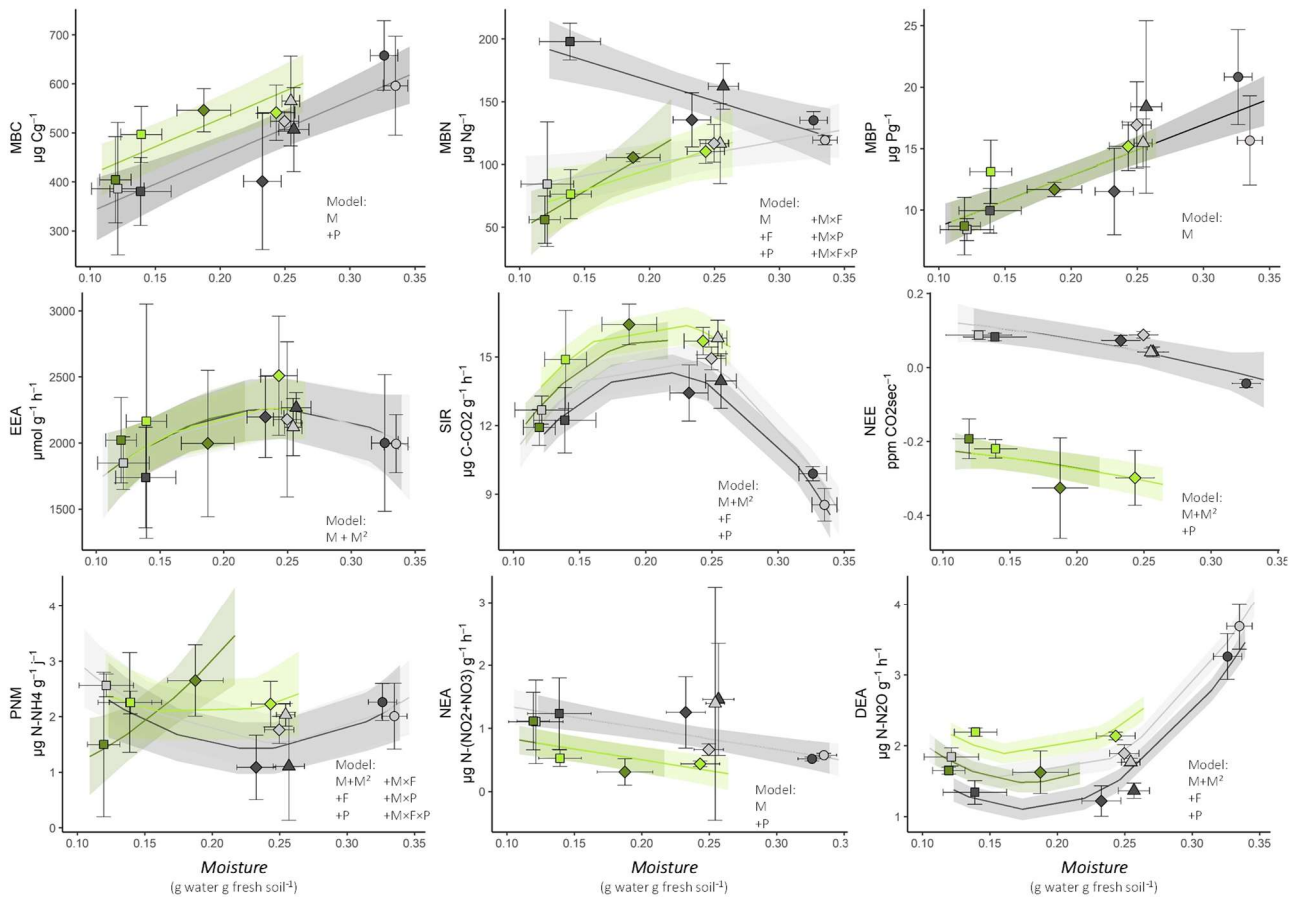

SI Figure 7. Effects of soil moisture, fertilization and plant on soil abiotic properties, microbial biomass and activities at T1. Points represent mean of each treatments. Grey points = unplanted soil, green points = planted soil, light colour = unfertilized soil, dark colour=fertilized soil, diamond=control climate, circle=flood, square=drought, triangle=freeze/thaw. Error bar are 95% confidence interval (n=4). Lines represent predicted value and shades represent 95% confidence interval from ANCOVA model (only significant factors were used for model fit and were represented on each plot : M=moisture, M<sup>2</sup>=moisture<sup>2</sup>, F=Fertilization, P=Plant).

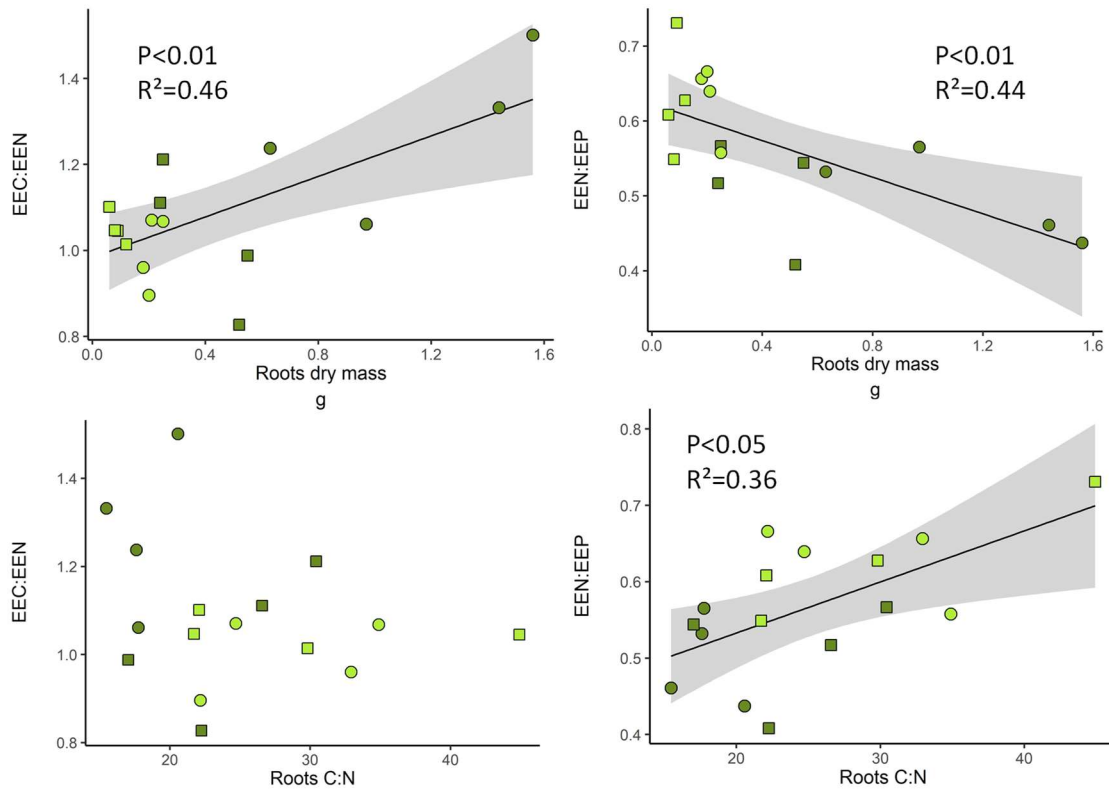

SI Figure 8 Correlation between roots properties and ecoenzymatic stoichiometry at T1. Light green points=unfertilized, Dark green points=Fertilized. Square=Drought, Circle=Control climate.

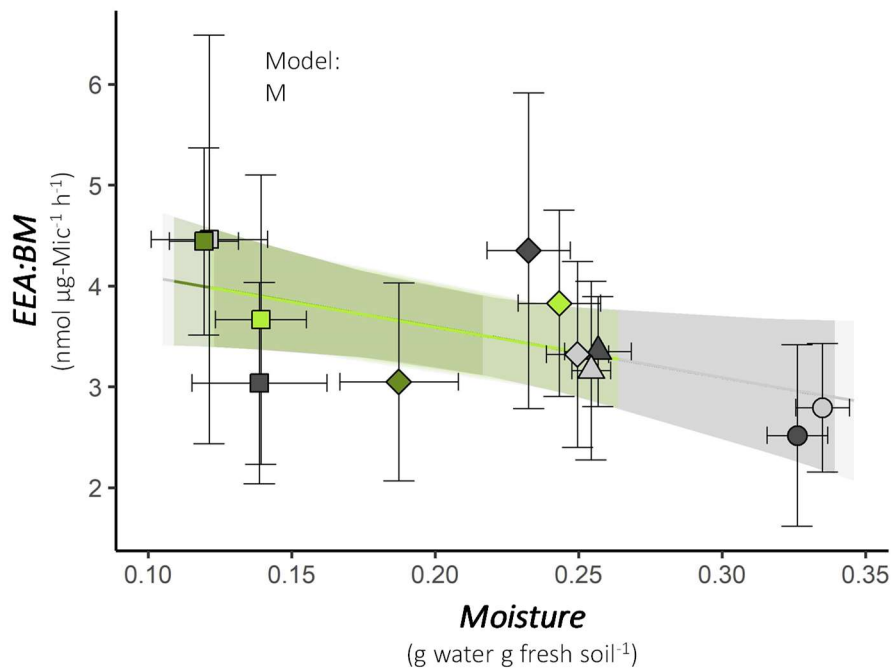

SI Figure 9 Effects of soil moisture, fertilization and plant on mass specific activity (EEA:BM) at T1. Points represent mean of each treatments. Grey points = unplanted soil, green points = planted soil, light colour = unfertilized soil, dark colour=fertilized soil, diamond=control climate, circle=flood, square=drought, triangle=freeze/thaw. Error bars are 95% confidence interval (n=4). Lines represent predicted value and shades represent 95% confidence interval from ANCOVA model (only significant factors were used for model fit and were represented on each plot : M=moisture, M<sup>2</sup>=moisture<sup>2</sup>, F=Fertilization, P=Plant).

## SUPPLEMENTARY TABLES

	<b>Bacteria</b>	<b>Eukaryota</b>
<b>Primers set</b>		
Targeted region	V5-V6 regions, 16S rRNA gene	V7 region, 18S rRNA gene
Forward primer (5'-3')	GGATTAGATACCCTGGTAGT <sup>†</sup>	TTTGTCTGSTTAATTSCG <sup>‡</sup>
Reverse primer (5'-3')	CACGACACGAGCTGACG <sup>†</sup>	TCACAGACCTGTTATTGC <sup>‡</sup>
<b>PCR conditions</b>		
Number of cycles	35	45
PCR cycles characteristics (Denaturation, Annealing, Elongation - Final elongation)	95°C(30s), 57°C(30s), 72°C(90s)	95°C(30s), 45°C(30s)
	-	
	72°C(7min)	72°C(60s) - 72°C(7min)
<b>Illumina platform</b>	MiSeq 2x250	HiSeq 2x150
† (Fliegerova et al. 2014); ‡ (Guardiola et al. 2015)		

SI Table 7 Overview of primers characteristics and cycling conditions used for polymerase chain reaction (PCR) and amplicon sequencing

---

### CONTRIBUTION PERSONNELLE AU CHAPITRE 3

J'ai conçu cette expérimentation avec l'aide de Jean Christophe Clément, Arnaud Foulquier, Roberto Geremia et Lionel Bernard. J'ai mis en place le dispositif expérimental (montage des mésocosmes, tests préliminaires etc.) avec Lionel Bernard. L'échantillonnage du sol a été réalisé avec l'aide de L. Bernard, Babette Massinon, Pierre-Louis Rey, Rémy Lasseur et Romane Piton-Ducroz pour le tamisage de la demi-tonne de sol et Lucas Paysan pour l'extraction du sol à la pelleuse. Je me suis ensuite occupé de la conduite de l'expérimentation et de la simulation des stress climatiques avec l'aide de L. Bernard et Bastien Audemard (stagiaire de L2 sur l'expérimentation). Le suivi semi-continu des flux de CO<sub>2</sub> tout au long de l'expérimentation a été réalisé par B. Audemard que je supervisais pour son stage. J'ai conduit les échantillonnages et les extractions des pools de C, N et P avec l'aide de L. Bernard, B. Audemard, C. Arnoldi, A. Foulquier, J.C. Clément et R. Piton-Ducroz. J'ai ensuite conduit les analyses des pools de N avec l'aide de C. Arnoldi et B. Audemard et les analyses enzymatiques avec l'aide de C. Arnoldi, B. Audemard, J.C. Clément et A. Foulquier. Les analyses des pools de C et P ont été réalisées par Viet Tran-Khac sur la plateforme technique du CARTELL (UMR INRA-Université de Savoie Mont Blanc) à Thonon-les-Bains et les analyses de la DEA, NEA et SIR par Jonathan Gervais sur la plateforme d'écologie microbienne du Laboratoire d'Ecologie Microbienne de Lyon. J'ai réalisé avec l'aide de Christian Miquel l'extraction et l'amplification de l'ADN dont le séquençage a été réalisé par FASTERIS (Genève, Suisse). J'ai ensuite conduit l'ensemble des analyses bioinformatiques avec les conseils d'Aurélien Bonin et d'A. Foulquier. J'ai réalisé les analyses statistiques et la rédaction de la 1<sup>ère</sup> version de cet article et de la 2<sup>ème</sup> version présentée ici qui suit une révision de la 1<sup>ère</sup> version par J.C. Clément et A. Foulquier. Les analyses métatranscriptomiques en préparation seront réalisées par moi-même et R. Geremia.

---

### CONCLUSION ET PERSPECTIVES DU CHAPITRE 3

Ce chapitre 3 démontre expérimentalement le rôle important que peut avoir la fertilisation dans le contrôle de la composition des communautés et des CWM microbiens ainsi que de la résilience des propriétés écosystémiques microbiennes. Les résultats confirment clairement notre hypothèse générale en ce qui concerne l'effet de la disponibilité en nutriments sur la résilience. En effet, les communautés copiotrophes sélectionnées avec la fertilisation sont clairement associées à une diminution de la résistance des propriétés écosystémiques microbiennes. Bien que leur récupération plus élevée, également attendue d'après notre hypothèse, soit observée, cette réponse de la récupération à la fertilisation est moins importante que celle de la résistance.

Le chapitre suivant viendra conclure cette thèse en présentant une discussion générale, dans un premier temps de l'approche utilisée dans cette thèse en particulier concernant la signification fonctionnelle des CWM microbiens utilisés. Dans un second temps, l'ensemble des résultats obtenus seront mis en vis-à-vis de notre hypothèse générale. Finalement, je présenterai des propositions dans la perspective du développement de l'approche par les traits microbiens par extension de l'approche proposée dans cette thèse.

*"Ce soir, vous nous apportez le dernier cri de la science ; cependant, vous le savez aussi bien que moi, votre thèse sera dépassée. La vérité demeure inaccessible, il n'y a que des vérités provisoires, des tentatives de vérité. Au fond, votre théorie expose la façon moderne d'habiter l'ignorance. »*

Eric-Emmanuel Schmit, La nuit de feu (2015)

---

# CHAPITRE 4

## DISCUSSION

APPROCHE DE LA RESILIENCE DES ECOSYSTEMES PRAIRIAUX PAR LE  
CONCEPT DE TRAIT FONCTIONNEL MICROBIEN :

SYNTHESE, DISCUSSION ET PERSPECTIVES

---



Les changements globaux (changements d'utilisation des terres, changements climatiques) et leurs répercussions sur la biodiversité et les cycles biogéochimiques (Pimm et al. 1995, Falkowski et al. 2000, Galloway et al. 2008) posent un enjeu majeur à l'écologie scientifique : prédire la réponse de la biodiversité à ces changements et les répercussions sur le fonctionnement des écosystèmes. Proposant un cadre conceptuel pour comprendre les mécanismes associés à cet enjeu, l'écologie fonctionnelle pourrait apporter certains éléments de réponse (Lavorel and Garnier 2002). L'approche par les traits fonctionnels s'est largement développée en écologie végétale, améliorant ainsi notre compréhension du rôle de la biodiversité végétale dans les interactions plante-sol et le fonctionnement des écosystèmes (Wardle et al. 2004, Grigulis et al. 2013, Bardgett et al. 2014, Bardgett 2018). Ces travaux se sont fortement appuyés sur les agroécosystèmes prairiaux (Garnier and Navas 2012, Duru et al. 2013), qui sont également l'objet de cette thèse. Cependant, dans ces études, le concept de traits fonctionnels *sensu stricto* (Lavorel and Garnier 2002, Violle et al. 2007) reste peu appliqué aux microorganismes du sol, limitant notre compréhension du rôle des microorganismes du sol dans le fonctionnement des écosystèmes. De plus, les études ont mobilisé le cadre des traits fonctionnels aux agroécosystèmes prairiaux sans différencier intensification conventionnelle et écologique, alors que les effets sur le fonctionnement des écosystèmes de ces deux types d'intensification peuvent être très contrastés (Bender et al. 2016). Ces réflexions sur une approche basée sur les traits fonctionnels (Lavorel and Garnier 2002, Violle et al. 2007) et appliquée à l'intensification écologique de l'agriculture (Bommarco et al. 2013, Duru et al. 2015, Bender et al. 2016) sont à la base du projet Eco-Serve (BiodivERsA/FACCE-JPI) dans lequel s'inscrit ce travail de thèse.

L'objectif général de ma thèse fut d'évaluer les potentialités d'une transposition du cadre conceptuel des traits fonctionnels (Lavorel and Garnier 2002, Violle et al. 2007) aux microorganismes du sol. Plus précisément, dans le cadre de l'intensification écologique de l'agriculture, j'ai mobilisé cette approche afin d'apporter de nouveaux éléments de compréhension concernant les mécanismes déterminant la réponse des communautés microbiennes à différentes modalités de gestion des prairies (extensive, écologiquement-intensive et conventionnelle-intensive) et leurs effets sur le fonctionnement et la stabilité de ces écosystèmes lors d'épisodes de stress climatiques.

## 1 SYNTHÈSE DES RESULTATS

Dans une première expérimentation (Chapitre 1), nous avons évalué comment la gestion des prairies, en modifiant les propriétés du sol ainsi que les CWM végétaux et microbiens, pouvait influencer la réponse des propriétés de l'écosystème à une **sécheresse** intense de **courte durée** (10 jours). Ce travail s'est appuyé sur des mésocosmes de **sols intacts** (avec leur végétation), prélevés dans 12 **prairies de montagne** représentant trois modalités de gestion : permanente extensive (**extensive**), permanente intensive (**éco-intensive**) et temporaire intensive (**conventionnelle-intensive**). Cette étude a démontré comment l'utilisation de **proxys des CWM microbiens** pouvait permettre : 1) de caractériser la **stratégie dominante** au sein des communautés microbiennes ; 2) d'étudier leurs **associations avec les CWM des plantes** ; 3) de mieux comprendre les **mécanismes en cascade** par lesquels les modalités de **gestion des prairies influencent la résilience** de l'écosystème à travers des modifications des CWM végétaux et microbiens.

La deuxième expérimentation (Chapitre 2) a permis d'évaluer l'effet de différents régimes de précipitations simulés sur une **longue période** (263 jours), sur le fonctionnement écosystémique de mésocosmes de **sols intacts** issus d'agroécosystèmes prairiaux **éco-intensifs** et **conventionnels-intensifs** répartis dans **trois pays Européens** (France, Portugal, Suisse). Un premier article (Chapitre 2.1) a montré que les  **patrons de résistance et de récupération** des propriétés écosystémiques microbiennes (biomasse bactérienne et activités enzymatiques) sont **opposés** entre les communautés microbiennes des sols **éco-intensifs** (résistance faible, récupération élevée) et celles des sols **conventionnels-intensifs** (résistance élevée, récupération faible). Cet effet de la gestion est **observé pour les trois types de stress climatiques** simulés, suggérant des facteurs communs contrôlant la résilience des propriétés écosystémiques microbiennes à de multiples stress. Ces différences de résiliences entre modalités de gestion sont

**couplées** à des différences de **composition des communautés microbiennes** et de **traits des litières** qui pourraient en être à l'origine. Un deuxième article, basé sur l'expérimentation deux (Chapitre 2.2) a permis de montrer comment l'implémentation des **enzymes extracellulaires** dans le **cadre conceptuel des traits fonctionnels** pouvait apporter de nouveaux éléments quant aux : 1) **stratégies d'acquisition des ressources** de différents groupes microbiens (Champignons, bactéries gram-positives et bactéries gram-négatives) ; 2) différents **mécanismes** (variation de la biomasse, variation de la composition, acclimatation des organismes) **contrôlant l'activité enzymatique totale** du sol (propriété écosystémique microbienne) sous différentes conditions climatiques. Finalement un troisième article basé sur l'expérimentation deux (Chapitre 2.3) a permis de mettre en évidence que la gestion **éco-intensive** sélectionnait des **communautés protéolytiques bénéfiques** pour certaines propriétés écosystémiques non-microbiennes (fourniture d'azote aux plantes, rétention des nitrates). Cette modification des communautés protéolytiques serait associée à la **richesse en P des communautés végétales** dans les systèmes éco-intensifs.

La troisième expérimentation (Chapitre 4) a été réalisée dans un **cadre plus contrôlé**, permettant ainsi d'isoler et de vérifier l'effet de la fertilisation minérale sur les communautés microbiennes et leur résilience à plusieurs stress climatiques. De plus, en contrôlant la présence de plantes, cette expérimentation a permis d'évaluer également le rôle des plantes dans la réponse des communautés microbiennes. L'article basé sur cette expérimentation (Chapitre 3) démontre le rôle important que peut avoir la **fertilisation** dans le **contrôle** de la **composition** des communautés, des **CWM microbiens** et de la **résilience des propriétés écosystémiques microbiennes**. Les résultats ont également démontré que les **plantes** peuvent jouer un rôle important de **médiateur** de la réponse fonctionnelle des communautés microbiennes à la fertilisation et aux stress climatiques. Finalement, nos résultats montrent que la fertilisation et les stress climatiques impliquant une contrainte osmotique (sécheresse, gel/dégel) ont des effets similaires sur les phyla bactériens.

La confrontation de ces résultats avec l'hypothèse générale de ma thèse sera détaillée dans la section 3 de ce chapitre, après une discussion sur l'approche que j'ai mobilisée pour évaluer les traits et les stratégies des microorganismes du sol.

## 2 DISCUSSION DE LA SIGNIFICATION FONCTIONNELLE DES PROXYS DE CWM MICROBIENS

Une hypothèse forte faite en amont de la formulation de l'hypothèse centrale de cette thèse est que certains proxys des CWM microbiens pourraient nous renseigner sur la stratégie dominante au sein des communautés microbiennes du sol le long du continuum copiotrophe-oligotrophe. Avant de confronter nos résultats à notre hypothèse générale sur les associations entre le continuum copiotrophe-oligotrophe et la résilience des communautés microbiennes, cette première partie cherchera à discuter la signification fonctionnelle des proxys des CMW utilisés dans cette thèse (stœchiométrie de la biomasse microbienne, activité masse-spécifique, stœchiométrie écoenzymatique), en examinant les conditions environnementales auxquelles ils sont associés.

### 2.1 STŒCHIOMETRIE DE LA BIOMASSE MICROBIENNE

Les variations des ratios stœchiométriques de la biomasse microbienne ont fait l'objet de nombreuses études (Mooshammer et al. 2014). Elles montrent qu'un couplage existe entre la stœchiométrie de la biomasse microbienne et celle des ressources disponibles, indiquant une certaine plasticité à l'échelle de la communauté. Cette plasticité serait principalement expliquée par des changements dans la composition des communautés microbiennes (Makino et al. 2003, Fanin et al. 2013, 2017, Mooshammer et al. 2014). En effet, par exemple, les champignons présenteraient des ratios C:N et C:P de leur biomasse plus élevé que les bactéries (Cleveland and Liptzin 2007, Strickland and Rousk 2010, Mougnot et al. 2014) et seraient ainsi favorisés sur les substrats riches en C. Ces variations restent cependant

relativement contraintes à une gamme de valeurs largement inférieure aux variations observées dans la stœchiométrie des ressources utilisées par les microorganismes (Makino et al. 2003, Mooshammer et al. 2014). Le carbone dans les microorganismes est principalement observé dans les composés structuraux et de réserve (Delgado-Baquerizo et al. 2018), l'azote serait associé à la maintenance cellulaire (Karpinets et al. 2006) à la machinerie enzymatique (Arrigo 2004) et le phosphore jouerait un rôle principalement dans la machinerie de croissance (Sturner and Elser 2002). Sur cette base, la stœchiométrie de la biomasse peut être utilisée comme indicateur de l'investissement par les microbes dans les différentes fonctions métaboliques, représentatives de leur stratégie d'utilisation des ressources (Arrigo 2004, Karpinets et al. 2006, Fierer et al. 2007, Litchman et al. 2015, Delgado-Baquerizo et al. 2018). On s'attend ainsi à ce que les ratios C:N, C:P et N:P augmentent le long du continuum copiotrophe-oligotrophe, traduisant une augmentation de l'investissement dans les composés structuraux, les réserves, la maintenance et la machinerie enzymatique au détriment de la machinerie de croissance (Arrigo 2004, Karpinets et al. 2006, Fierer et al. 2007, Litchman et al. 2015, Delgado-Baquerizo et al. 2018) **La comparaison des ratios N:P de la biomasse microbienne à travers un gradient de conditions de sol et de traits des plantes dans l'expérimentation 1 montre effectivement que des conditions attendues comme favorables à une stratégie copiotrophe sont associées à un ratio N:P de la biomasse plus faible**, indiquant une stratégie orientée vers un plus fort taux de croissance (Elser et al. 2003, Karpinets et al. 2006). Cependant, l'expérimentation 3 indique que les ratios C:N, C:P et N:P peuvent se découpler lorsqu'une communauté microbienne est soumise à des variations importantes de son environnement, notamment dans le cadre d'un épisode de fertilisation et de stress climatique. Le ratio C:N montre une corrélation négative avec le ratio N:P à la fin de la période de stress (T1) qui n'est plus observée à l'issue de la période de récupération (T2) et une association positive avec le ratio C:P à T2 absente à T1. Seuls les ratios C:P et N:P conservent une corrélation positive à T1 et à T2, cohérente avec les attendus théoriques (Tableau 12).

Tableau 12. Tableau de corrélation entre les différents ratios caractérisant la stœchiométrie de la biomasse microbienne de l'expérimentation 3. Partie supérieur droite : p-valeur. Partie inférieure gauche : coefficient de corrélation de Pearson

T1 (End of stress period)			
T1	C:N	C:P	N:P
C:N	-	0.29	<b>p&lt;0.001</b>
C:P	0.16	-	<b>p&lt;0.001</b>
N:P	<b>-0.66</b>	<b>0.5</b>	-
T2 (End of recovery period)			
T2	C:N	C:P	N:P
C:N	-	<b>p&lt;0.01</b>	0.15
C:P	<b>0.46</b>	-	<b>p&lt;0.001</b>
N:P	-0.21	<b>0.74</b>	-

Ce découplage est principalement associé à une immobilisation importante de l'azote dans la biomasse microbienne avec la fertilisation, diminuant fortement le ratio C:N et augmentant le ratio N:P. Cette immobilisation est d'autant plus importante que l'humidité du sol est faible en condition non-plantée. Ce patron de réponse détaillé dans le chapitre 3 pourrait être associé à l'accumulation d'osmolytes riches en N par les bactéries du sol pour mieux résister à la sécheresse (Schimel et al. 2007). Ces résultats suggèrent qu'une plasticité importante de la stœchiométrie de la biomasse microbienne à l'échelle de la communauté est possible, non seulement en réponse à des variations dans la stœchiométrie des ressources (Fanin et al. 2013, 2017) mais également associée à des réponses physiologiques impliquant spécifiquement certains éléments (l'azote dans notre cas).

Ainsi, nous estimons que **la mesure de la stœchiométrie de la biomasse microbienne semble un candidat prometteur dans le cadre d'une approche par les CWM microbiens**. La stœchiométrie de la biomasse permet de capturer certaines réponses fonctionnelles des microorganismes. L'utilisation de ces traits à travers le prisme du modèle copiotrophe-oligotrophe semble robuste pour comparer différents sols présentant des différences en termes de disponibilité des ressources sur un long terme (Exp. 1). Cependant, **en dehors de ces situations d'équilibre entre la communauté microbienne et les ressources** (par exemple suite à un épisode de variations importantes des ressources ou des conditions de stress), **ces CWM doivent être interprétés avec prudence si l'on veut les utiliser comme indicateurs des stratégies copiotrophe et oligotrophe** car leurs variations à court terme semblent pouvoir être associées à des réponses physiologiques difficilement découplables des variations le long du continuum copiotrophe-oligotrophe (Exp. 3).

## 2.2 ACTIVITES MASSE-SPECIFIQUES

L'investissement dans la production d'enzymes extracellulaires est également un trait potentiellement associé au spectre copiotrophe-oligotrophe (Fontaine et al. 2003). En effet le modèle d'acquisition des ressources stipule que l'investissement dans la production des enzymes extracellulaires est optimisé en fonction de la disponibilité en ressources (Sinsabaugh et al. 1993).

Les activités masse-spécifiques mesurées avant la simulation des stress climatique (T<sub>0</sub>) dans les expériences 1 et 2 semblent d'abord contrôlées négativement par la teneur du sol en C, N et P, comme observé dans des études *in situ* (Allison et al. 2007, Malik et al. 2019). **Ces résultats sont en accord avec le modèle d'acquisition des ressources (Sinsabaugh et al. 1993) et l'idée d'un plus faible investissement des copiotrophes dans la production d'enzymes extracellulaires dans les sols riches en ressources (Fontaine et al. 2003)**. Cependant, à la fin des périodes de stress (T<sub>1</sub>) de l'expérimentation deux, les mesures réalisées sous différents régimes de précipitations montrent que cette relation peut être effacée par un effet de l'humidité du sol (Chapitre 2.2), montrant que des conditions sèches réduisent les activités masse-spécifiques, probablement à cause d'une **diminution de la production d'enzymes due à une redirection de l'énergie vers les voies métaboliques de résistance à la sécheresse** (Schimel et al. 2007). Finalement, l'expérimentation 3 ne montre pas de variation significative des activités masse-spécifiques en réponse aux traitements (uniquement une corrélation négative avec l'humidité du sol), malgré des variations observées sur la stœchiométrie de la biomasse microbienne. Ceci suggère qu'un certain temps est nécessaire pour que la réponse de ce paramètre fonctionnel soit observable. Ce temps de réponse peut s'expliquer par le turnover des enzymes dans le sol qui peuvent persister même après la mort de leurs producteurs (Steinweg et al. 2012, Kivlin et al. 2013, Schimel et al. 2017). Ainsi, face à ces différents éléments, il semble possible de **considérer les activités masse-spécifiques comme un indicateur des variations dans l'investissement enzymatique lors de comparaison de sols sur le moyen (plusieurs mois) et long (année) terme, et moins sur le court terme (jour, semaine)**.

## 2.3 STœCHIOMETRIE ENZYMATIQUE

Nos résultats mettent également en évidence de nouvelles caractéristiques potentiellement associées au continuum copiotrophe-oligotrophe. L'augmentation de la richesse en nutriments et la sélection de plantes exploitatives fournissant des litières riches en phosphore, induisent un ralentissement dans l'investissement des enzymes d'acquisition pour les nutriments en faveur de l'acquisition du carbone (Exp. 1 et 2). Les résultats du chapitre 2.2 (Exp. 2) montrent que ces changements dans la stœchiométrie écoenzymatique sont fortement reliés à la composition des communautés microbiennes. L'augmentation de l'abondance relative en bactéries Gram négatives et la diminution de la proportion de champignons et de bactéries Gram positives sont associées à une augmentation de

l'investissement dans l'acquisition du carbone relativement à l'acquisition de l'azote, favorisée par les champignons, et de l'acquisition du phosphore, favorisée par les Gram positives. Ces fortes associations à la fois avec des conditions de ressources et des groupes fonctionnels associés à des conditions copiotrophes ou oligotrophes, apportent des **évidences empiriques d'une association entre le continuum copiotrophe-oligotrophe** (Fierer et al. 2007, Ho et al. 2017) **et la stœchiométrie enzymatique** (Sinsabaugh et al. 2009). Cependant, comme discuté dans le chapitre 2.2, la diminution observée dans l'investissement pour l'acquisition du carbone en condition oligotrophe se limite aux hydrolases ciblant les formes de carbone les plus simples. Les conditions oligotrophes étant souvent associées à des apports importants de carbone complexes (par ex. litières riches en lignine), il est fort probable que l'investissement dans les enzymes ciblant ces composés (oxydases) soit plus élevé dans ces milieux. De potentiels compromis entre l'investissement dans les hydrolases et les oxydases restent à étudier pour avoir une idée plus complète des variations de stratégies enzymatiques dans le monde microbien.

#### 2.4 VERS UN MODELE DE STRATEGIE A TROIS DIMENSIONS ?

Malik et al. (2018a) ont très récemment proposé un modèle de stratégies à trois dimensions Y-A-S, sur la même idée que le modèle C-S-R de Grime (Grime 1977). La première stratégie (A), qualifiée de « resource acquisition », se caractérise par un fort investissement dans les enzymes extracellulaires. Cette stratégie prend la place de la stratégie des plantes compétitrices de Grime (1977) et aurait la position des oligotrophes du modèle copiotrophes-oligotrophes à deux dimensions (Fontaine et al. 2003, Fierer et al. 2007). Les deux autres stratégies proposées par Malik et al 2018a sont la stratégie Y pour « High yield » caractérisée par une maximisation de la fraction des ressources allouées à la croissance (stratégie analogue à la stratégie rudérale de Grime (1977)) et la stratégie S pour « Stress tolerance » orientée vers les voies métaboliques de résistance au stress (même nom dans le modèle de Grime 1977).

La diminution des activités masse-spécifiques, en réponse à une diminution des précipitations sur une longue durée observée dans l'expérimentation 2 est difficile à expliquer à travers le prisme du modèle copiotrophe-oligotrophe. En effet, selon ce modèle, l'augmentation du stress est sensée augmenter l'abondance relative en oligotrophes et donc augmenter les activités masse-spécifiques. Ces résultats peuvent cependant être expliqués par le nouveau modèle de Malik et al. (2018a). La diminution de l'humidité du sol serait associée à la sélection d'une stratégie de résistance au stress caractérisée par un faible investissement dans les enzymes extracellulaires. Ainsi, **l'utilisation des activités masse-spécifiques comme proxy de la stratégie des microorganismes semble plus cohérente avec le modèle de Malik et al. (2018) qu'avec le modèle plus simpliste copiotrophe-oligotrophe** (Fierer et al. 2007). De plus fortes activités masse-spécifiques indiqueraient une stratégie d'acquisition des ressources alors que de faibles activités masse-spécifiques indiqueraient une stratégie « high yield » en conditions non-stressantes ou une stratégie de « stress tolerance » en condition de stress.

Les ratios stœchiométriques C:P et N:P de la biomasse microbienne pourraient ensuite permettre de discriminer ces deux stratégies. Une plus grande richesse en phosphore de la biomasse microbienne est attendue pour une stratégie Y orientée vers la croissance (Arrigo 2004, Fierer et al. 2007) alors qu'une stratégie de tolérance au stress serait caractérisée par des teneurs en carbone et azote plus élevées dû à leur abondance dans des composés de résistance au stress (Delgado-Baquerizo et al. 2018). Ce modèle est cohérent avec ce qui a été démontré chez les plantes, où le ratio N:P est plus élevé pour les espèces "stress tolérantes" que chez les rudérales (équivalent de la stratégie Y), avec les plantes compétitrices présentant un ratio intermédiaire (Güsewell 2004, Carnicer et al. 2015).

**Ces éléments nous permettent de proposer les activités masse-spécifiques et la stœchiométrie de la biomasse (ratio C:P et N:P) comme deux CWM facilement mesurables et renseignant potentiellement sur la position des communautés microbiennes dans le triangle de stratégie Y-A-S de Malik et al (2018a).** Cependant,

l'utilisation de ce modèle reste conditionnée aux éléments détaillés dans la partie précédente soulignant que certaines conditions doivent être rassemblées pour que les activités masse-spécifiques et la stœchiométrie de la biomasse puissent être considérées comme des indicateurs fiables de la stratégie (mesure potentiellement biaisée si réalisée à court terme après un épisode de forte variation environnementale). La prochaine étape sera de tester la validité de ce modèle (Figure 40) sur des données autres que celle de cette thèse et balayant une plus large gamme de conditions de ressources et d'intensités de stress. En absence de validation de ce modèle, la suite de cette discussion continuera à s'appuyer essentiellement sur le modèle copiotrophe-oligotrophe, qui fut le modèle initial de nos réflexions.

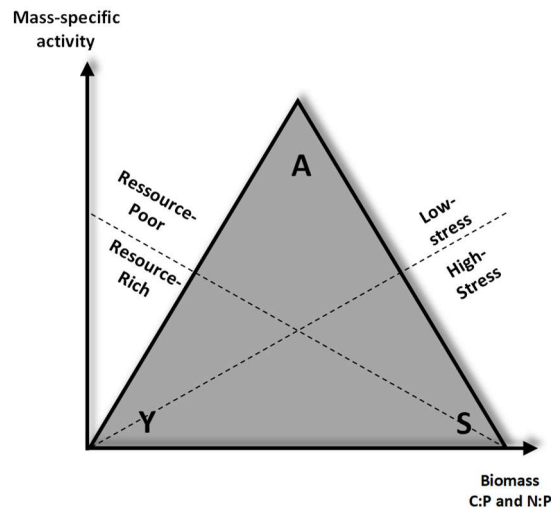

Figure 40. Proposition d'utilisation des activités masse-spécifiques et de la stœchiométrie de la biomasse microbienne pour prédire la stratégie des microorganismes du sol sur le modèle conceptuel des stratégies Y-A-S (Malik et al. 2018a).

### 3 ÉVALUATION TRANSVERSALE DE L'HYPOTHESE GENERALE : VARIATION FONCTIONNELLE DES COMMUNAUTÉS MICROBIENNES ET RESILIENCE

L'hypothèse générale de cette thèse s'appuie sur une série d'études ayant exploré les variations fonctionnelles chez les communautés végétales et microbiennes, en particulier le long de gradients d'intensité d'usage et de disponibilité en azote (De Vries et al. 2006, 2012b, De Vries and Bardgett 2012, Grigulis et al. 2013, Legay et al. 2014, 2016). Ces travaux ont amené à l'élaboration d'un modèle proposant que les systèmes extensifs, pauvres en azote, se caractérisent par des communautés végétales conservatives peu productives et associées à des communautés microbiennes dominées par des champignons, avec une activité microbienne ralentie et une forte capacité à conserver l'azote. D'un autre côté, les système plus « intensifs », riches en azote présentent les caractéristiques opposées : communautés végétales exploitatives et productives, dominées par des bactéries stimulant l'activité microbienne et les pertes d'azote (De Vries et al. 2006, 2012b, De Vries and Bardgett 2012, Grigulis et al. 2013, Legay et al. 2014, 2016).

La partie précédente de la discussion nous a permis d'établir que les proxys des CWM microbiens peuvent être utilisés pour caractériser la stratégie dominante dans les communautés microbiennes du sol, en particulier dans des conditions non-stressés. Sur base d'une synthèse transversale des résultats des trois expérimentations réalisées au cours de cette thèse (Tableau 13), la prochaine partie discutera de la cohérence de nos résultats avec la **sous-hypothèse 1** de ma thèse stipulant que : « En absence de stress, les pratiques agricoles augmentant la quantité de nutriments disponibles et favorisant des traits végétaux exploitatifs sélectionnent des espèces et des traits microbiens associée à une stratégie copiotrophe ». Dans un second temps nous discuterons de la **deuxième sous-hypothèse** c'est-à-dire que : « La sélection de ces communautés copiotrophes est associée à une diminution de la résistance aux stress climatiques des propriétés écosystémiques microbiennes et une augmentation de leur récupération ».

Tableau 13 Synthèse transversale des patterns de réponse des agroécosystèmes extensifs, eco-intensifs et conventionnels-intensifs dans les 3 expérimentations

	Extensive management		Ecological-intensive management		Conventional-intensive management		
	Experimentation 1	Experimentation 3	Experimentation 1	Experimentation 2	Experimentation 1	Experimentation 2	Experimentation 3
	Permanent extensive grasslands	Unfertilized extensive grassland soil	Permanent Intensive grasslands	Eco-intensive forage systems across Europe	Sown intensive grasslands	Conventionnal-intensive forage systems across Europe	Fertilized extensive grassland soil
<b>Soil</b>	Nutrient poor	Nutrient poor	Nutrient rich	-	Nutrient poor	-	Nutrient rich
<b>Plant CWM traits</b>	N & P poor conservative plants	-	P rich exploitative plants	P rich exploitative plants	N rich exploitative plants	N rich exploitative plants	-
<b>Plant ecosystem properties level</b>	Low biomass (only before drought)	Low biomass (only before drought)	Low biomass (only before drought)	Indirect positive effect on plant N uptake through proteolytic community.	High biomass (only before drought)	Indirect negative effect on plant N uptake through proteolytic community.	High biomass (only before drought)
<b>Soil microbial community composition</b>	not assessed	Lower relative abundance of : Actinobacteria, Beta-Gammaproteobacteria , Higher relative abundance of : Bacteroidetes, Deltaproteobacteria , Glomeromycetes	not assessed	Difference of overall microbial community composition (PLFA) and of proteolytic community (apr)	not assessed	Difference of overall microbial community composition (PLFA) and of proteolytic community (apr)	Higher relative abundance of : Actinobacteria, Beta-Gammaproteobacteria , Lower relative abundance of : Bacteroidetes, Deltaproteobacteria , Glomeromycetes
<b>Microbial CWM traits</b>	Oligotrophic microbes with P acquisition strategy	Unplanted soil : high biomass C:N / Planted soil : N acquisition strategy	Copiotrophes with C & N acquisition strategy	-	Oligotrophes with C & P oriented strategy	-	Unplanted soil : Low biomass C:N / Planted soil : C & P acquisition strategy
<b>Microbial ecosystem properties</b>	Low biomass and activity	-	High biomass and activity	-	Low biomass and activity	-	-
<b>Ecosystem properties resistance</b>	High microbial resistance	High microbial resistance	High plant resistance Low microbial resistance	Low microbial resistance	Low plant resistance High microbial resistance	High microbial resistance	Low microbial resistance
<b>Ecosystem properties recovery</b>	Low microbial recovery	Low microbial resistance (Less important than resistance response)	High plant recovery High microbial recovery	High microbial recovery	Low plant recovery Low microbial recovery	Low microbial recovery	High microbial recovery (Less important than resistance response)

### 3.1 VARIATIONS FONCTIONNELLES DES COMMUNAUTES MICROBIENNES EN CONDITIONS NON-STRESSANTE

En condition non stressante (avant la simulation de la sécheresse), les résultats de l'expérience 1 montrent que les prairies éco-intensives riches en MO et en nutriments présentent un faible ratio N:P de la biomasse microbienne, indiquant une stratégie copiotrophe orientée vers la croissance (Karpinets et al. 2006, Litchman et al. 2015) et de faibles activités masse-spécifiques indiquant un faible investissement dans la production d'enzymes extracellulaires (Fontaine et al. 2003). A l'opposé les communautés microbiennes des prairies extensives et conventionnelles-intensives, plus pauvres en MO et en nutriments, présentent des CWM microbiens indiquant une stratégie oligotrophe orientée vers la maintenance cellulaire et la machinerie enzymatique. Ces résultats sont en accord avec notre sous-hypothèse générale 1 d'une association entre richesse en ressources et stratégie des microorganismes. Cependant, la relation avec les traits des plantes semble plus complexe. Les résultats de l'expérience 1 montrent deux syndromes de traits exploitatifs chez les communautés végétales. D'un côté, les prairies éco-intensives (nommée "Permanent intensive" dans le chapitre 1) présentent des plantes riches en phosphore avec une faible teneur en matière sèche foliaire alors que les prairies conventionnelles-intensives montrent des plantes riches en azote avec une hauteur élevée. Nos résultats montrent une association des CWM indicateurs d'une stratégie copiotrophe avec les plantes riches en phosphore alors que le ratio champignons:bactéries a généralement été associé à la richesse en azote des plantes (De Vries et al. 2006, 2012b), bien que ces études n'aient pas mesuré les traits végétaux associés au phosphore. Ainsi, nos résultats suggèrent qu'il est important de prendre également en compte les autres éléments que l'azote et en particulier le phosphore. Cet élément pourrait être l'élément limitant ou co-limitant avec l'azote et le carbone pour les microorganismes du sol, même en climat tempéré. En effet, l'importance du phosphore en climat tropical est plus largement reconnue qu'en climat tempéré en raison de la pauvreté en phosphore des sols sous ces climats (Fanin et al. 2015). Cependant, certaines études récentes soulignent également l'importance potentielle du phosphore dans le contrôle des communautés microbiennes des agroécosystèmes tempérés (Delgado-Baquerizo et al. 2017, Boeddinghaus et al. 2019). De plus, les résultats de l'expérience 2 confirment également l'importance du carbone et du pH comme déterminants de la composition et des CWM des communautés microbiennes, comme déjà établi dans d'autres études en ce qui concerne la composition (Fierer et al. 2007, Lauber et al. 2009, Fanin et al. 2018).

### 3.2 VARIATIONS FONCTIONNELLES DES COMMUNAUTES MICROBIENNES ET RESILIENCE AUX STRESS CLIMATIQUES

La sous-hypothèse 2 de ma thèse s'appuyait sur un lien entre stratégie des microorganismes du sol et résilience des propriétés écosystémiques microbiennes. Les microorganismes oligotrophes présenteraient une meilleure résistance et une plus faible récupération en comparaison aux microorganismes copiotrophes (De Vries et al. 2012a). Les résultats des expérimentations 1 et 2 confirment clairement la présence d'un compromis entre résistance et récupération de la biomasse et des activités des communautés microbiennes du sol. Les deux expériences montrent une plus faible résistance mais une meilleure récupération de la biomasse et de l'activité microbienne dans les systèmes éco-intensifs en comparaison aux systèmes conventionnels-intensifs (Exp. 1 et 2) et extensifs (Exp. 1). Le fait que les systèmes éco-intensifs aient été associés à des traits copiotrophes et les systèmes conventionnels-intensifs et extensifs à des traits oligotrophes dans l'expérimentation 1 confirme notre hypothèse sur l'association entre résilience et stratégies des microorganismes du sol. Le modèle d'équations structurelles (SEM) construit sur les données de l'expérimentation 1 confirme directement cette association entre CWM microbiens et résilience de la biomasse microbienne. L'expérimentation 2 ne retrouve pas de telles associations entre les CWM microbiens évalués (seulement les activités masse-spécifiques, la stœchiométrie de la biomasse n'ayant pas été mesurée) et les patrons de résilience. Seule une différence de composition de la communauté microbienne entre les deux modalités de gestion, concomitante



à des différences de traits des litières pourrait expliquer ces différences de résilience. Ceci pourrait être dû à la plus longue durée de l'expérience (9 mois de précipitations modifiées contre 10 jours dans l'expérience 1) rendant plus difficile la détection d'une corrélation entre les CWM microbiens mesurés à l'état initial et la dynamique de la communauté microbienne sur une longue période expérimentale. Cependant, dans les deux expérimentations la plus faible résistance et la plus forte récupération sont observées en présence de communautés végétales fournissant des litières plus riches en phosphore. Ces résultats montrent qu'en plus de contrôler le fonctionnement des communautés microbiennes en absence de perturbation (Delgado-Baquerizo et al. 2017, Boeddinghaus et al. 2019), le phosphore pourrait également jouer un rôle central dans la résilience aux épisodes de stress climatiques.

Les résultats de l'expérimentation 3 confirment également une plus faible résistance des propriétés écosystémiques microbiennes pour les communautés copiotrophes sélectionnées par la fertilisation (six propriétés impactées négativement sur neuf) en accord avec notre hypothèse générale. Cependant, l'effet positif attendu de la fertilisation sur la récupération reste marginal (Une propriété impactée positivement sur neuf). Ceci suggère qu'à court terme, la fertilisation peut directement diminuer la résistance des communautés microbiennes alors que son effet potentiel sur la capacité de récupération des communautés microbiennes peut demander plus de temps. Une telle réponse sur le plus long terme de la récupération pourrait s'expliquer par une dépendance aux changements de la structure fonctionnelle des communautés végétale associé à une fertilisation répétée (Exp. 1 et 2), plutôt qu'à une dépendance à la disponibilité en nutriments uniquement (Exp. 3).

Nos résultats montrent également que la résistance et la récupération de la biomasse et l'activité microbienne (propriétés écosystémiques microbiennes) peuvent être découplées de la réponse de la composition des communautés. En effet, l'expérimentation 2 montre une plus faible résistance de la biomasse et de l'activité microbienne dans les systèmes éco-intensifs comparés aux systèmes conventionnels-intensifs alors que le contraire est observé pour la résistance de la composition de la communauté microbienne. L'expérience 3 met également en évidence de tels découplages avec une récupération plus élevée de la composition des communautés bactériennes en condition fertilisée qui n'est associée à aucune amélioration de la récupération de la biomasse ou de l'activité. Ces résultats suggèrent que **la connaissance de la stratégie dominante dans la communauté peut être suffisante pour prédire la résilience des propriétés écosystémiques microbiennes telles que la biomasse ou l'activité totale, mais insuffisante pour prédire la réponse de la composition.**

Nos résultats pointent également l'importance de la compétition pour les ressources entre plantes et microorganismes pour appréhender la réponse des écosystèmes aux perturbations climatiques. Du point de vue de la réponse des communautés végétales, les systèmes éco-intensifs montrent une meilleure capacité à maintenir leur fourniture d'azote en conditions climatiques perturbées. Cette capacité semble associée à des communautés microbiennes copiotrophes présentant une faible capacité à maintenir leur biomasse pendant la perturbation (Chapitre 1 et 2.1) et incluant des microorganismes protéolytiques résistants et bénéfiques pour l'approvisionnement en azote des plantes (Chapitre 2.3). Ainsi, les résistances des communautés végétales et microbiennes peuvent être découplées, la faible résistance d'une communauté pouvant être bénéfique à la résistance de l'autre (Bloor et al. 2018).

Dans l'ensemble, ces résultats mettent en évidence que les systèmes extensifs, éco-intensifs et conventionnels-intensifs présentent trois fonctionnements distincts qui ne peuvent être résumés sur un axe comme notre hypothèse initiale (Introduction, Figure 6). Ceci nous amène à proposer un autre modèle résumant le fonctionnement de ces trois types de systèmes (Figure 41)

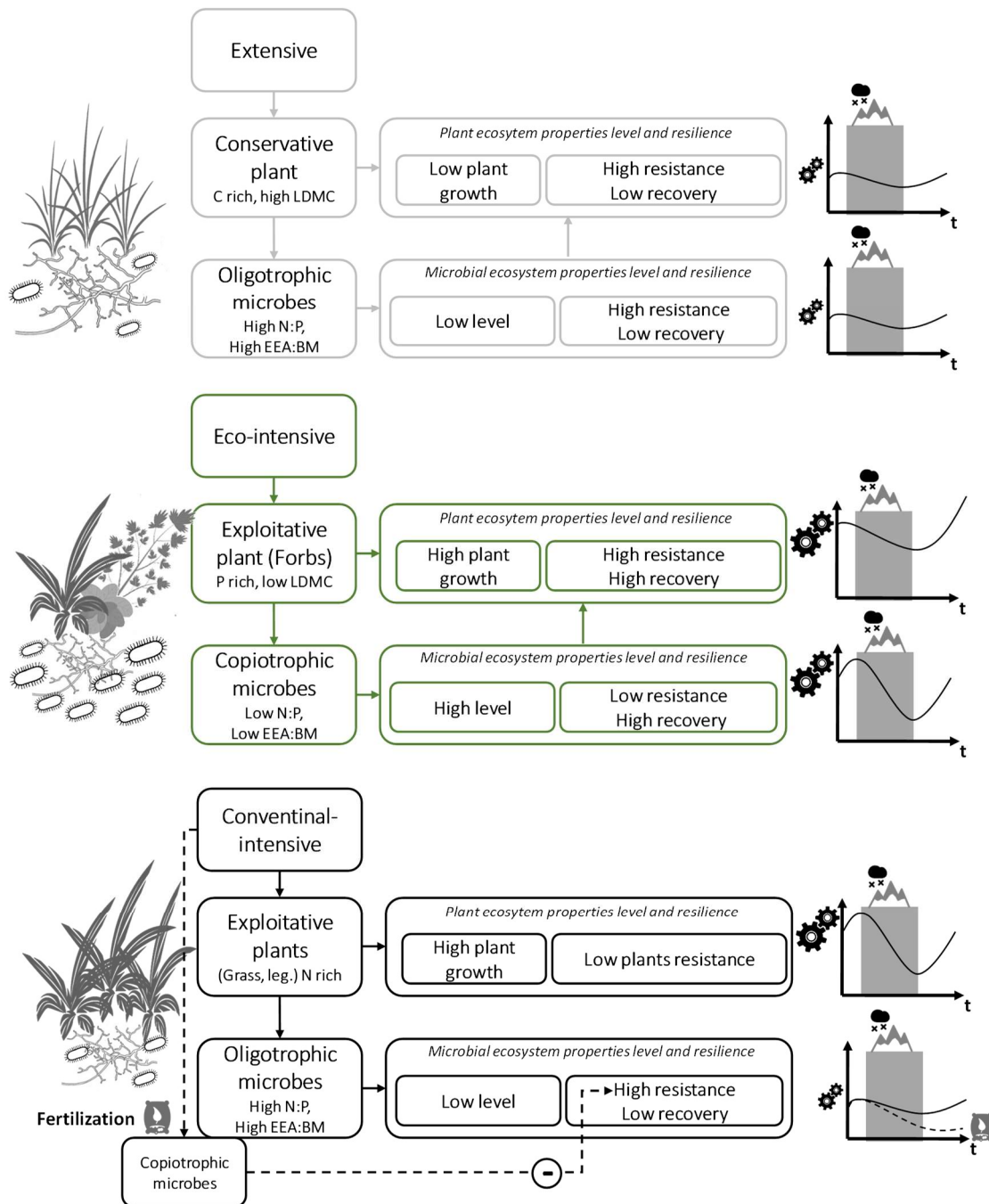

Figure 41. Modèle décrivant les associations fonctionnelles entre traits des plantes, composition des communautés microbiennes, niveau des propriétés écosystémiques microbiennes et végétales et leur résilience (Résistance et Récupération). Copio=dominance de copiotrophes, Dans les **systèmes extensifs**, l'absence de fertilisation sélectionne des espèces végétales conservatives riches en C et pauvres en P favorisant des microorganismes oligotrophes associés à une faible biomasse et une faible activité microbienne et à une haute résistance des communautés microbienne et végétale (Chapitre 1). Dans les systèmes **conventionnels-intensifs**, la fertilisation minérale et le semis de plantes fourragères (graminées et légumineuses) conduit à des traits végétaux exploitatifs associés à une forte teneur en N mais une faible teneur en P des plantes (Chapitres 1, 2.3). Les plantes montrent une forte productivité grâce à la sélection de variétés productives et l'apport de fertilisants (Chapitres 1, 2.3 et 3). La présence d'organismes oligotrophes liés à la pauvreté en P des litières et à la faible de teneur en matière organique des sols, augmente la résistance de la biomasse et de l'activité (Chapitres 1 et 2.1). Cependant, la sélection de copiotrophes juste à la suite d'un épisode de fertilisation peut amener à une diminution de la résistance (Chapitre 3). (Suite de la légende sur la page suivante)

Figure 37 (Suite de la page précédente). Dans les systèmes **éco-intensifs**, l'absence de semis favorise les plantes riches en P (Dicotylédones non légumineuse) (Chapitres 1, 2.3). La richesse en P des plantes favorise les microorganismes copiotrophes (Chapitres 1, 2.3) augmentant la biomasse et accélérant le recyclage des nutriments (Chapitres 1, 2.3) favorisant la croissance des plantes. Ces communautés microbiennes copiotrophes présentent une faible résistance mais une forte récupération (Chapitres 1, 2.1) augmentant la stabilité de l'approvisionnement des plantes en N (Chapitres 1, 2.3).

### 3.3 MECANISMES DE CONTROLE DES PROPRIETES FONCTIONNELLES DES COMMUNAUTES MICROBIENNES ET DE LEUR RESILIENCE

Les covariations entre propriétés du sol et traits végétaux sur le terrain rendent difficile le découplage entre le rôle du sol et celui des plantes dans le contrôle des CWM microbiens. Cependant plusieurs éléments de cette thèse supportent l'idée d'un rôle central des plantes. Les modèles d'équations structurelles construits dans l'expérience 1 suggèrent que certains CWM microbiens associés à la résistance de la biomasse microbienne (ratio N:P de la biomasse) seraient déterminés par les traits des plantes plutôt que par les propriétés du sol. L'importance des plantes est également confirmée par les expérimentations 2 et 3. L'expérimentation 2 montre un effet du mode de gestion (éco-intensif vs. conventionnel intensif) sur la composition des communautés microbiennes du sol (Chapitre 2.1 et 2.3), sur les patterns de résilience (Chapitre 2.1) et sur l'effet des communautés microbiennes sur les processus écosystémiques (Chapitre 2.3). L'absence de différence en termes de propriétés du sol entre modalités de gestion semble indiquer que les propriétés du sol ne sont pas impliquées dans les patrons observés. Cependant, des variations des traits des litières montrent une forte association avec les modalités de gestion et les communautés microbiennes (Chapitre 2.1 et 2.3). Ces résultats tendent à confirmer le contrôle des caractéristiques fonctionnelles des communautés microbiennes par les traits végétaux (Bardgett 2018). L'expérimentation 3, dans laquelle une fertilisation minérale a été simulée en conditions plantée et non plantée, confirme expérimentalement le rôle des plantes dans la résilience des communautés microbiennes du sol (Koyama et al. 2017). En effet, l'effet négatif de la fertilisation sur la résistance des propriétés écosystémiques microbiennes est observé en présence et en absence de plantes mais les propriétés affectées diffèrent.

### 3.4 PERSPECTIVES APPLIQUEES DANS LE CADRE DE L'INTENSIFICATION ECOLOGIQUE DE L'AGRICULTURE

L'objectif d'une intensification écologique de l'agriculture est de s'appuyer sur les processus intrinsèques aux écosystèmes pour maximiser les fonctions et les services écosystémiques (Bender et al. 2013). Ce travail de thèse s'est appuyé sur des agroécosystèmes prairiaux classifiés *a priori* comme étant éco-intensifs, sur base de leurs modalités de gestion (Table 3, chapitre 2.1). Leur qualification de prairie éco-intensive peut cependant être discutée puisque les analyses ne montrent pas d'effet bénéfique global sur la teneur en matière organique (discuté dans le chapitre 2.3). Cependant, nos résultats montrent que des communautés végétales fournissant des litières riches en phosphore, caractéristique observée globalement dans les systèmes éco-intensifs étudiés, probablement liée à leurs plus grandes richesses en dicotylédones non légumineuses, sélectionnent des communautés microbiennes favorisant la stabilité de la fourniture d'azote aux plantes lors d'épisodes de stress climatiques (Chapitre 1 et Chapitre 2.3). Ces résultats supportent l'idée que le pilotage des traits fonctionnels végétaux est une perspective prometteuse dans le cadre de l'intensification écologique de l'agriculture (Garnier and Navas 2012). Les résultats de l'expérimentation 3 montrent quant à eux que la fertilisation minérale peut diminuer la résistance des propriétés écosystémiques microbiennes aux épisodes de stress climatiques, mettant en avant l'intérêt d'une réduction de la fertilisation pour augmenter la stabilité des agroécosystèmes face aux changements climatiques.

## 4 DEVELOPPEMENT DE L'APPROCHE PAR LES TRAITS MICROBIENS : PERSPECTIVES

Le besoin de passer d'une approche taxinomique de la diversité microbienne à une approche fonctionnelle est de plus en plus reconnu et a fait l'objet de nombreuses publications ces dernières années (Green et al. 2008, Wallenstein and Hall 2012, Crowther et al. 2014, Krause et al. 2014, Litchman et al. 2015, Martiny et al. 2015, Treseder and Lennon 2015). Une des difficultés majeures à l'application du concept de trait fonctionnel aux microorganismes du sol est la difficulté technique de mesurer des traits à l'échelle individuelle (Krause et al. 2014, Martiny et al. 2015). Malgré le fait que nous n'ayons pas réalisé de telles mesures dans cette thèse, notre travail montre que certains paramètres fonctionnels des communautés microbiennes (par ex. : CWM) peuvent être évalués, intégrés dans le cadre conceptuel des traits fonctionnels et ainsi faire avancer notre compréhension de la réponse des communautés microbiennes aux changements globaux et leur rôle dans le fonctionnement des écosystèmes (Lavorel and Garnier 2002), tout en respectant la définition du trait fonctionnel comme une caractéristique mesurée à l'échelle de l'individu (Violle et al. 2007). Ainsi, cette thèse montre que l'écologie microbienne dispose déjà de certains outils pour mobiliser ces concepts initialement développés en écologie végétale (Voir Chapitre 1 : Introduction).

Une perspective intéressante de ce travail de thèse serait de mobiliser le cadre conceptuel proposé avec d'autres méthodes disponibles en écologie microbienne. La partie suivante cherchera à discuter les perspectives offertes par ces méthodes en vue d'une extension de l'approche présentée dans cette thèse. Les approches de shotgun métagénomiques, de métatranscriptomique et de métaprotéomique offrent une opportunité de caractériser les paramètres fonctionnels des communautés microbiennes (Fierer 2017). Fierer et al. (2014) ont notamment proposé la **shotgun métagénomique** pour évaluer les traits agrégés à la communauté (ou CAT), théoriquement similaire aux CWM (Garnier et al. 2004, Fierer et al. 2014).

En utilisant cette méthode sur une large gamme de sols de prairies en climat tempéré soumis à une fertilisation (N, P ou N et P), Leff et al. (2015) ont montré que les communautés microbiennes copiotrophes sélectionnées suite à un apport de nutriments (N et/ou P) sont associées à une réduction de la taille du génome et que l'apport de N induit également une augmentation des gènes associés au métabolisme des carbohydrates (Leff et al. 2015). Sur deux expérimentations à long terme de fertilisation, Fierer et al. (2012) ont quant à eux montré une augmentation des gènes associés à la réplication de l'ADN/ARN, au transport des électrons et au métabolisme des protéines et une diminution des gènes associés à la décomposition de l'azote organique sous forme d'urée le long du gradient de fertilisation en N. Finalement, dans une étude très récente, Santillan et al. (2019) ont utilisé la **métagénomique** dans le cadre des CAT pour classifier les traits et les taxa dans un modèle de type C-S-R (Santillan et al. 2019). Leurs résultats suggèrent que les microorganismes compétiteurs (C) présenteraient des traits associés aux processus métaboliques (acides aminés, nucléotides, ARN) et à la paroi cellulaire. Les rudérales (R) présenteraient des traits associés aux processus métaboliques (carbohydrates, lipides et petite molécules) mais également à la production d'énergie (respiration cellulaire, transport d'électrons, processus d'oxydoréductions). Finalement les "stress tolérants" (S) présenteraient une plus forte efficacité d'acquisition des nutriments et des traits pouvant être associés à la résistance au stress. Les C partagent avec les R des traits associés à l'activité ribosomale (en accord avec de plus faibles ratio C:P et N:P chez ces organismes) et les R partagent avec les S des traits associés à la sporulation. L'utilisation de la métatranscriptomique est également un outil très prometteur pour évaluer les variations temporelles dans l'expression des gènes. Žifčáková et al. (2017) ont mis en évidence des variations saisonnières dans l'expression de gènes associés à l'utilisation des ressources chez les communautés bactériennes et fongiques d'un sol de forêt de résineux (Žifčáková et al. 2017). Finalement, une étude récente de Malik et al. (2018b) utilisant la **métaprotéomique** met en évidence des compromis entre des traits associés à la croissance, à la résistance aux stress et à l'acquisition des ressources.

Ces méthodes permettent ainsi d'apporter d'autres éléments que ceux apportés avec les méthodes utilisées dans cette thèse. Leur intérêt majeur est d'évaluer simultanément une grande quantité de traits associés à l'ensemble des fonctions microbiennes : acquisition des ressources, croissance mais également les traits associés à la résistance au stress. En effet cette dernière classe de trait n'a pas été évaluée directement dans ce travail de thèse limitant notre capacité à expliquer les mécanismes sous-jacents aux patterns de résilience. C'est entre autres pour cette raison que des analyses métatranscriptomiques sont actuellement en cours sur les sols de l'expérimentation 3 (Section « Next step » chapitre 3). Ces analyses devraient nous permettre de préciser la réponse fonctionnelle des communautés microbiennes du sol à la fertilisation et aux stress climatiques, tant du point de vue de leur stratégie de gestion des ressources, que de croissance et de résistance au stress. En croisant la métatranscriptomique avec les données d'activités globales et de CWM stœchiométriques et écoenzymatiques nous allons pouvoir évaluer la capacité de ces différentes méthodes à capturer la stratégie et les fonctions microbiennes.

Le développement des méthodes de culture (Vartoukian et al. 2010) est également une piste à encourager dans la perspective d'une caractérisation des traits à une échelle plus fine (population) et la construction de bases de données de traits. Par exemple, les travaux de Lladó et al. (2016), dans lesquels 20% et 32% des bactéries présentes dans la litière et le sol d'une forêt de conifères ont été isolés et cultivés, mettent en lumière la diversité fonctionnelle existante dans ces sols. Leurs résultats montrent en particulier que les isolats appartenant aux Acidobactéries produisent la plus large gamme d'enzymes extracellulaires et les activités les plus élevées parmi les bactéries isolées, soulignant leur importance dans le fonctionnement de ces écosystèmes.

Par ailleurs, les méthodes de **Stable Isotope Probing** permettent d'isoler l'ADN des organismes consommant un substrat marqué isotopiquement. Ces méthodes permettent ainsi d'associer certains taxa non-cultivables avec certaines fonctions (par ex. consommation d'un polluant (Thomas et al. 2019)). Le croisement de ces méthodes avec des analyses métagénomiques permettent d'assigner une large gamme de traits aux organismes marqués. Par exemple, croisant SIP et métagénomique Thomas et al. (2019) ont identifié les différents taxa impliqués dans les différentes étapes de dégradation d'un hydrocarbure aromatique polycyclique (polluant). L'étude du métagénome de l'ADN marqué a ensuite permis de déterminer les autres caractéristiques fonctionnelles (par ex : métabolismes des carbohydrates, du phosphore, de l'azote, réponse au stress) des organismes dégradant le polluant, mettant en évidence des caractéristiques fonctionnelles différentes en conditions plantée et non plantée et révélant des adaptations fonctionnelles des communautés (polluant, rhizodépôts) (Thomas et al. 2019). Ces dernières années les méthodes de SIP se sont encore améliorées avec le développement des **SIP quantitatives ou qSIP**. Ces méthodes ont par exemple permis de caractériser les traits associés à la croissance et l'assimilation du C à l'échelle de la population le long d'un gradient altitudinal (Morrissey et al. 2019). Leurs résultats montrent que l'histoire évolutive explique une bien plus large proportion des valeurs de traits que l'environnement. L'échelle taxonomique de la famille participe particulièrement à l'explication des traits alors que les résolutions plus larges (ordre, classe, phylum) ont une très faible capacité à prédire les traits. Ces résultats démontrent que l'histoire évolutive contraint les valeurs de traits chez les microorganismes (un *Bacillus sp.* présentera un fort taux de croissance alors qu'un *Actinoallomurus sp* aura le trait opposé quel que soit l'écosystème). Ces résultats tendent à confirmer la possibilité de prédire les traits à partir de la phylogénie à condition d'utiliser une résolution taxonomique suffisamment fine. Morrissey et al. (2019) proposent ensuite de croiser ces mesures de trait à l'échelle de la population avec les abondances relatives mesurées par metabarcoding pour calculer des CWM de la même façon que chez les plantes (Garnier et al. 2004). La comparaison de cette méthode d'estimation des CWM avec les proxys proposés dans cette thèse représente une perspective très intéressante pour le développement de l'approche fonctionnelle en écologie microbienne.

## 5 CONCLUSION GENERALE

Proposant une approche basée sur le cadre conceptuel des traits fonctionnels, ce travail de thèse a permis d'apporter de nouveaux éléments de compréhension des mécanismes fonctionnels contrôlant la résilience des écosystèmes prairiaux, en particulier la résilience de son compartiment microbien. Les résultats des trois expérimentations réalisées dans ce travail tendent à confirmer notre hypothèse générale démontrant que : 1) en absence de stress, les pratiques agricoles augmentant la quantité de nutriments disponibles (ex : fertilisation) et favorisant des traits végétaux exploitatifs (particulièrement les traits associés à une plus grande richesse en phosphore), sélectionnent des communautés microbiennes copiotrophes qui diminuent la résistance des propriétés écosystémiques microbiennes aux stress climatiques mais augmentent leur récupération. Ces résultats confirment le compromis existant entre résistance et récupération face aux stress climatique et démontrent l'association entre ce compromis, l'intensité de gestion des prairies, les ressources du sol, les traits des plantes et pour la première fois certains proxys des traits microbiens pondérés à la communauté (CWM). S'appuyant sur une large gamme d'agroécosystèmes prairiaux à travers l'Europe, ces travaux montrent que la gestion écologiquement intensive, en modifiant sur le long terme la structure fonctionnelle des communautés végétales, peut sélectionner des communautés microbiennes présentant une faible résistance mais une meilleure capacité de récupération en comparaison aux communautés microbiennes des sols en gestion conventionnelle-intensive. Finalement, une expérimentation ayant étudié spécifiquement les effets à court terme d'un épisode de fertilisation minérale montre que cette pratique change la composition et les CWM microbiens avec des répercussions négatives sur la résistance des propriétés écosystémiques microbiennes à différents stress climatiques. Pour conclure, cette thèse montre que les apports de nutriments aux sols et les modifications des traits des plantes associées aux changement d'utilisation des terres peuvent avoir des répercussions majeures sur les traits microbiens et finalement sur la résilience des écosystèmes au changement climatique.

## RÉFÉRENCES

- Allison, V., L. Condrón, D. Peltzer, S. Richardson, and B. Turner. 2007. Changes in enzyme activities and soil microbial community composition along carbon and nutrient gradients at the Franz Josef chronosequence, New Zealand. *Soil Biology and Biochemistry* 39:1770–1781.
- Arrigo, K. R. 2004. Marine microorganisms and global nutrient cycles. *Nature* 437:349.
- Bardgett, R. D. 2018. Plant trait-based approaches for interrogating belowground function. *Biology and Environment: Proceedings of the Royal Irish Academy*. JSTOR.
- Bardgett, R. D., L. Mommer, and F. T. De Vries. 2014. Going underground: root traits as drivers of ecosystem processes. *Trends in Ecology & Evolution* 29:692–699.
- Bender, S. F., C. Wagg, and M. G. van der Heijden. 2016. An underground revolution: biodiversity and soil ecological engineering for agricultural sustainability. *Trends in ecology & evolution* 31:440–452.
- Bloor, J. M., M. Zwicke, and C. Picon-Cochard. 2018. Drought responses of root biomass provide an indicator of soil microbial drought resistance in grass monocultures. *Applied Soil Ecology* 126:160–164.
- Boeddinghaus, R. S., S. Marhan, D. Berner, S. Boch, M. Fischer, N. Hölzel, J. Kattge, V. H. Klaus, T. Kleinebecker, Y. Oelmann, and others. 2019. Plant functional trait shifts explain concurrent changes in the structure and function of grassland soil microbial communities. *Journal of Ecology*.
- Bommarco, R., D. Kleijn, and S. G. Potts. 2013. Ecological intensification: harnessing ecosystem services for food security. *Trends in ecology & evolution* 28:230–238.
- Carnicer, J., J. Sardans, C. Stefanescu, A. Ubach, M. Bartrons, D. Asensio, and J. Penuelas. 2015. Global biodiversity, stoichiometry and ecosystem function responses to human-induced C–N–P imbalances. *Journal of Plant Physiology* 172:82–91.

- Cleveland, C. C., and D. Liptzin. 2007. C: N: P stoichiometry in soil: is there a “Redfield ratio” for the microbial biomass? *Biogeochemistry* 85:235–252.
- Crowther, T. W., D. S. Maynard, T. R. Crowther, J. Peccia, J. R. Smith, and M. A. Bradford. 2014. Untangling the fungal niche: the trait-based approach. *Frontiers in microbiology* 5:579.
- Delgado-Baquerizo, M., D. J. Eldridge, F. T. Maestre, V. Ochoa, B. Gozalo, P. B. Reich, and B. K. Singh. 2018. Aridity decouples C: N: P stoichiometry across multiple trophic levels in terrestrial ecosystems. *Ecosystems* 21:459–468.
- Delgado-Baquerizo, M., P. B. Reich, A. N. Khachane, C. D. Campbell, N. Thomas, T. E. Freitag, W. Abu Al-Soud, S. Sørensen, R. D. Bardgett, and B. K. Singh. 2017. It is elemental: soil nutrient stoichiometry drives bacterial diversity. *Environmental microbiology* 19:1176–1188.
- Duru, M., C. Jouany, X. Le Roux, M. Navas, and P. Cruz. 2013. From a conceptual framework to an operational approach for managing grassland functional diversity to obtain targeted ecosystem services: Case studies from French mountains. *Renew Agric Food Syst* 29:239–254.
- Duru, M., O. Therond, G. Martin, R. Martin-Clouaire, M.-A. Magne, E. Justes, E.-P. Journet, J.-N. Aubertot, S. Savary, J.-E. Bergez, and others. 2015. How to implement biodiversity-based agriculture to enhance ecosystem services: a review. *Agronomy for sustainable development* 35:0.
- Elser, J., K. Acharya, M. Kyle, J. Cotner, W. Makino, T. Markow, T. Watts, S. Hobbie, W. Fagan, J. Schade, and others. 2003. Growth rate–stoichiometry couplings in diverse biota. *Ecology Letters* 6:936–943.
- Falkowski, P., R. Scholes, E. Boyle, J. Canadell, D. Canfield, J. Elser, N. Gruber, K. Hibbard, P. Högberg, S. Linder, and others. 2000. The global carbon cycle: a test of our knowledge of earth as a system. *science* 290:291–296.
- Fanin, N., N. Fromin, S. Barantal, and S. Hättenschwiler. 2017. Stoichiometric plasticity of microbial communities is similar between litter and soil in a tropical rainforest. *Scientific reports* 7:12498.
- Fanin, N., N. Fromin, B. Buatois, and S. Hättenschwiler. 2013. An experimental test of the hypothesis of non-homeostatic consumer stoichiometry in a plant litter–microbe system. *Ecology Letters* 16:764–772.
- Fanin, N., S. Hättenschwiler, H. Schimann, and N. Fromin. 2015. Interactive effects of C, N and P fertilization on soil microbial community structure and function in an Amazonian rain forest. *Functional Ecology* 29:140–150.
- Fanin, N., P. Kardol, M. Farrell, M.-C. Nilsson, M. J. Gundale, and D. A. Wardle. 2018. The ratio of Gram-positive to Gram-negative bacterial PLFA markers as an indicator of carbon availability in organic soils. *Soil Biology and Biochemistry*.
- Fierer, N. 2017. Embracing the unknown: disentangling the complexities of the soil microbiome. *Nature Reviews Microbiology* 15:579–590.
- Fierer, N., A. Barberán, and D. C. Laughlin. 2014. Seeing the forest for the genes: using metagenomics to infer the aggregated traits of microbial communities. *Frontiers in microbiology* 5.
- Fierer, N., M. A. Bradford, and R. B. Jackson. 2007. Toward an ecological classification of soil bacteria. *Ecology* 88:1354–1364.
- Fontaine, S., A. Mariotti, and L. Abbadie. 2003. The priming effect of organic matter: a question of microbial competition? *Soil Biology and Biochemistry* 35:837–843.
- Galloway, J. N., A. R. Townsend, J. W. Erisman, M. Bekunda, Z. Cai, J. R. Freney, L. A. Martinelli, S. P. Seitzinger, and M. A. Sutton. 2008. Transformation of the nitrogen cycle: recent trends, questions, and potential solutions. *Science* 320:889–892.
- Garnier, E., J. Cortez, G. Billès, M.-L. Navas, C. Roumet, M. Debussche, G. Laurent, A. Blanchard, D. Aubry, A. Bellmann, and others. 2004. Plant functional markers capture ecosystem properties during secondary succession. *Ecology* 85:2630–2637.
- Garnier, E., and M.-L. Navas. 2012. A trait-based approach to comparative functional plant ecology: concepts, methods and applications for agroecology. A review. *Agronomy for Sustainable Development* 32:365–399.
- Green, J. L., B. J. Bohannan, and R. J. Whitaker. 2008. Microbial biogeography: from taxonomy to traits. *science* 320:1039–1043.
- Grigulis, K., S. Lavorel, U. Krainer, N. Legay, C. Baxendale, M. Dumont, E. Kastl, C. Arnoldi, R. D. Bardgett, F. Poly, and others. 2013. Relative contributions of plant traits and soil microbial properties to mountain grassland ecosystem services. *Journal of Ecology* 101:47–57.

- Grime, J. P. 1977. Evidence for the existence of three primary strategies in plants and its relevance to ecological and evolutionary theory. *The American Naturalist* 111:1169–1194.
- Güsewell, S. 2004. N: P ratios in terrestrial plants: variation and functional significance. *New phytologist* 164:243–266.
- Ho, A., D. P. Di Lonardo, and P. L. Bodelier. 2017. Revisiting life strategy concepts in environmental microbial ecology. *FEMS microbiology ecology* 93:fix006.
- Karpinets, T. V., D. J. Greenwood, C. E. Sams, and J. T. Ammons. 2006. RNA: protein ratio of the unicellular organism as a characteristic of phosphorous and nitrogen stoichiometry and of the cellular requirement of ribosomes for protein synthesis. *BMC biology* 4:30.
- Kivlin, S. N., B. G. Waring, C. Averill, and C. V. Hawkes. 2013. Tradeoffs in microbial carbon allocation may mediate soil carbon storage in future climates. *Frontiers in microbiology* 4:261.
- Koyama, A., J. M. Steinweg, M. L. Haddix, J. S. Dukes, and M. D. Wallenstein. 2017. Soil bacterial community responses to altered precipitation and temperature regimes in an old field grassland are mediated by plants. *FEMS microbiology ecology* 94:fix156.
- Krause, S., X. Le Roux, P. A. Niklaus, P. M. Van Bodegom, J. T. Lennon, S. Bertilsson, H.-P. Grossart, L. Philippot, and P. L. Bodelier. 2014. Trait-based approaches for understanding microbial biodiversity and ecosystem functioning. *Frontiers in Microbiology* 5.
- Lauber, C. L., M. Hamady, R. Knight, and N. Fierer. 2009. Pyrosequencing-based assessment of soil pH as a predictor of soil bacterial community structure at the continental scale. *Appl. Environ. Microbiol.* 75:5111–5120.
- Lavorel, S., and E. Garnier. 2002. Predicting changes in community composition and ecosystem functioning from plant traits: revisiting the Holy Grail. *Functional ecology* 16:545–556.
- Leff, J. W., S. E. Jones, S. M. Prober, A. Barberán, E. T. Borer, J. L. Firn, W. S. Harpole, S. E. Hobbie, K. S. Hofmockel, J. M. Knops, and others. 2015. Consistent responses of soil microbial communities to elevated nutrient inputs in grasslands across the globe. *Proceedings of the National Academy of Sciences* 112:10967–10972.
- Legay, N., C. Baxendale, K. Grigulis, U. Krainer, E. Kastl, M. Schloter, R. D. Bardgett, C. Arnoldi, M. Bahn, M. Dumont, and others. 2014. Contribution of above-and below-ground plant traits to the structure and function of grassland soil microbial communities. *Annals of botany* 114:1011–1021.
- Legay, N., S. Lavorel, C. Baxendale, U. Krainer, M. Bahn, M.-N. Binet, A. A. Cantarel, M.-P. Colace, A. Foulquier, E.-M. Kastl, and others. 2016. Influence of plant traits, soil microbial properties, and abiotic parameters on nitrogen turnover of grassland ecosystems. *Ecosphere* 7.
- Litchman, E., K. F. Edwards, and C. A. Klausmeier. 2015. Microbial resource utilization traits and trade-offs: implications for community structure, functioning, and biogeochemical impacts at present and in the future. *Frontiers in microbiology* 6:254.
- Lladó, S., L. Žifčáková, T. Vetrovsk, I. Eichlerová, and P. Baldrian. 2016. Functional screening of abundant bacteria from acidic forest soil indicates the metabolic potential of Acidobacteria subdivision 1 for polysaccharide decomposition. *Biology and fertility of soils* 52:251–260.
- Makino, W., J. Cotner, R. Sterner, and J. Elser. 2003. Are bacteria more like plants or animals? Growth rate and resource dependence of bacterial C: N: P stoichiometry. *Functional Ecology* 17:121–130.
- Malik, A. A., J. Puissant, T. Goodall, S. D. Allison, and R. I. Griffiths. 2019. Soil microbial communities with greater investment in resource acquisition have lower growth yield. *Soil Biology and Biochemistry*.
- Martiny, J. B., S. E. Jones, J. T. Lennon, and A. C. Martiny. 2015. Microbiomes in light of traits: a phylogenetic perspective. *Science* 350:aac9323.
- Mooshammer, M., W. Wanek, S. Zechmeister-Boltenstern, and A. Richter. 2014. Stoichiometric imbalances between terrestrial decomposer communities and their resources: mechanisms and implications of microbial adaptations to their resources. *The Microbial Regulation of Global Biogeochemical Cycles*:191.
- Morrissey, E. M., R. L. Mau, M. Hayer, X.-J. A. Liu, E. Schwartz, P. Dijkstra, B. J. Koch, K. Allen, S. J. Blazewicz, K. Hofmockel, and others. 2019. Evolutionary history constrains microbial traits across environmental variation. *Nature ecology & evolution*:1.



- Mouginot, C., R. Kawamura, K. L. Matulich, R. Berlemont, S. D. Allison, A. S. Amend, and A. C. Martiny. 2014. Elemental stoichiometry of Fungi and Bacteria strains from grassland leaf litter. *Soil Biology and Biochemistry* 76:278–285.
- Pimm, S. L., G. J. Russell, J. L. Gittleman, and T. M. Brooks. 1995. The future of biodiversity. *Science* 269:347–350.
- Santillan, E., H. Seshan, F. Constancias, and S. Wuertz. 2019. Trait-based life-history strategies explain succession scenario for complex bacterial communities under varying disturbance. *Environmental microbiology*.
- Schimel, J., T. C. Balsler, and M. Wallenstein. 2007. Microbial stress-response physiology and its implications for ecosystem function. *Ecology* 88:1386–1394.
- Schimel, J., C. A. Becerra, and J. Blankinship. 2017. Estimating decay dynamics for enzyme activities in soils from different ecosystems. *Soil Biology and Biochemistry* 114:5–11.
- Sinsabaugh, R. L., R. Antibus, A. Linkins, C. McClaugherty, L. Rayburn, D. Repert, and T. Weiland. 1993. Wood decomposition: nitrogen and phosphorus dynamics in relation to extracellular enzyme activity. *Ecology* 74:1586–1593.
- Sinsabaugh, R. L., B. H. Hill, and J. J. F. Shah. 2009. Ecoenzymatic stoichiometry of microbial organic nutrient acquisition in soil and sediment. *Nature* 462:795–798.
- Steinweg, J. M., J. S. Dukes, and M. D. Wallenstein. 2012. Modeling the effects of temperature and moisture on soil enzyme activity: linking laboratory assays to continuous field data. *Soil Biology and Biochemistry* 55:85–92.
- Sturner, R. W., and J. J. Elser. 2002. *Ecological stoichiometry: the biology of elements from molecules to the biosphere*. Princeton University Press.
- Strickland, M. S., and J. Rousk. 2010. Considering fungal: bacterial dominance in soils—methods, controls, and ecosystem implications. *Soil Biology and Biochemistry* 42:1385–1395.
- Thomas, F., E. Corre, and A. Cébron. 2019. Stable isotope probing and metagenomics highlight the effect of plants on uncultured phenanthrene-degrading bacterial consortium in polluted soil. *The ISME journal*:1.
- Treseder, K. K., and J. T. Lennon. 2015. Fungal traits that drive ecosystem dynamics on land. *Microbiol. Mol. Biol. Rev.* 79:243–262.
- Vartoukian, S. R., R. M. Palmer, and W. G. Wade. 2010. Strategies for culture of “unculturable” bacteria. *FEMS microbiology letters* 309:1–7.
- Villéger, S., N. W. Mason, and D. Mouillot. 2008. New multidimensional functional diversity indices for a multifaceted framework in functional ecology. *Ecology* 89:2290–2301.
- Violle, C., M.-L. Navas, D. Vile, E. Kazakou, C. Fortunel, I. Hummel, and E. Garnier. 2007. Let the concept of trait be functional! *Oikos* 116:882–892.
- De Vries, F. T., and R. D. Bardgett. 2012. Plant-microbial linkages and ecosystem nitrogen retention: lessons for sustainable agriculture. *Frontiers in Ecology and the Environment* 10:425–432.
- De Vries, F. T., E. Hoffland, N. van Eekeren, L. Brussaard, and J. Bloem. 2006. Fungal/bacterial ratios in grasslands with contrasting nitrogen management. *Soil Biology and Biochemistry* 38:2092–2103.
- De Vries, F. T., M. E. Liiri, L. Bjørnlund, M. A. Bowker, S. Christensen, H. M. Setälä, and R. D. Bardgett. 2012a. Land use alters the resistance and resilience of soil food webs to drought. *Nature Climate Change* 2:276–280.
- De Vries, F. T., P. Manning, J. R. Tallwin, S. R. Mortimer, E. S. Pilgrim, K. A. Harrison, P. J. Hobbs, H. Quirk, B. Shipley, J. H. Cornelissen, and others. 2012b. Abiotic drivers and plant traits explain landscape-scale patterns in soil microbial communities. *Ecology Letters* 15:1230–1239.
- Wallenstein, M. D., and E. K. Hall. 2012. A trait-based framework for predicting when and where microbial adaptation to climate change will affect ecosystem functioning. *Biogeochemistry* 109:35–47.
- Wardle, D. A., R. D. Bardgett, J. N. Klironomos, H. Setälä, W. H. Van Der Putten, and D. H. Wall. 2004. Ecological linkages between aboveground and belowground biota. *Science* 304:1629–1633.
- Žifčáková, L., T. Vetrovsk, V. Lombard, B. Henrissat, A. Howe, and P. Baldrian. 2017. Feed in summer, rest in winter: microbial carbon utilization in forest topsoil. *Microbiome* 5:122.



## RESUME

Dans le contexte actuel du changement climatique et de l'augmentation de la fréquence et de l'intensité des épisodes climatiques extrêmes, une question centrale pour l'écologie scientifique est de comprendre les répercussions de ces changements sur le fonctionnement des écosystèmes. Les communautés microbiennes du sol contrôlent une grande partie des processus écosystémiques déterminant la circulation de l'énergie et des nutriments. Dans le cadre des agroécosystèmes se pose donc la question de l'influence des pratiques agricoles sur les communautés microbiennes du sol et sur leur aptitude à maintenir le fonctionnement des écosystèmes face au changement climatique. L'intensification écologique de l'agriculture a récemment été proposée comme une approche intégrant les processus écologiques dans la stratégie de gestion des agroécosystèmes, dans l'objectif d'optimiser leur fonctionnement et leur résilience. L'écologie fonctionnelle pourrait répondre à certains des enjeux posés par le changement climatique et l'intensification écologique de l'agriculture. Dans cette thèse, j'ai cherché à mobiliser le cadre conceptuel des traits fonctionnels pour apporter de nouveaux éléments de compréhension de l'influence de différentes modalités d'intensité de gestion d'agroécosystèmes prairiaux (gestion extensive, conventionnelle-intensive et écologiquement-intensive) : 1) sur les caractéristiques fonctionnelles des communautés microbiennes du sol; 2) sur la capacité de ces communautés microbiennes à maintenir le fonctionnement de l'écosystème face à des périodes de stress climatiques (résilience). Dans le cadre de ma thèse, trois expérimentations ont été réalisées en faisant varier le degré de contrôle des facteurs de gestion, le type de stress climatique et la durée de ces stress. S'appuyant sur des agroécosystèmes prairiaux répartis dans trois pays Européens (France, Suisse, Portugal), les résultats des deux premières expérimentations de cette thèse montrent que les communautés microbiennes des sols des prairies écologiquement-intensives disposent d'une plus faible capacité à maintenir les propriétés écosystémiques microbiennes durant les stress (faible résistance) mais disposent d'une meilleure capacité de récupération comparée aux communautés microbiennes des sols en gestion conventionnelle-intensive. Une autre étude montre que la gestion éco-intensive favorise des communautés microbiennes protéolytiques bénéfiques à l'assimilation de l'azote pour les plantes en conditions perturbées. L'étude des traits végétaux suggère que ces effets de la gestion sur la composition des communautés microbiennes et sur leur résilience passe par certains traits, notamment une augmentation de la richesse en phosphore des litières en gestion écologiquement-intensive. En effet ces traits fonctionnels des plantes semblent influencer les traits microbiens, favorisant des communautés microbiennes copiotrophes, caractérisées par un ratio azote:phosphore faible de leur biomasse et un faible investissement dans la production d'enzymes extracellulaires, deux traits négatifs pour la résistance au stress mais favorisant une récupération rapide. Ainsi, ces deux expérimentations soulignent l'importance de la gestion des traits des plantes dans le contrôle des traits microbiens et de la résilience des écosystèmes au changement climatique. La troisième expérimentation a cherché à tester spécifiquement les effets d'un épisode de fertilisation minérale sur la résilience des communautés microbiennes à différents stress climatiques. Les résultats montrent que la fertilisation modifie la composition et les traits microbiens avec des répercussions négatives sur la stabilité de l'écosystème face à la sécheresse et à l'inondation. Mobilisant une approche par le concept de trait fonctionnel microbien, ce travail de thèse apporte de nouveaux éléments de compréhension des effets de l'intensité de gestion sur la résilience des écosystèmes prairiaux face aux stress climatiques.

## ABSTRACT

In the current context of climate change, associated with increases of climate extremes frequency and intensity, understanding the ecosystem response to climate variability is a central challenge in ecology. Soil microbial communities control most ecosystem processes driving energy and nutrients fluxes. In the context of agriculture management, an important question is to understand the influence of farming practices on soil microbial communities and their capacity to maintain ecosystem functioning under climate change. Ecological-intensive agriculture has been recently proposed as an approach integrating ecological processes in management strategies to optimise agroecosystems functioning and resilience to climate change. Functional ecology might be relevant to address these challenges associated with climate change and ecological-intensification of agriculture. In this PhD thesis, I used the functional trait framework to grassland ecosystems to address how different modalities of management intensity (extensive, conventional-intensive, ecological-intensive management) influence: 1) functional parameters of soil microbial communities; 2) the capacity of these soil microbial communities to maintain ecosystem functioning during and after climatic stresses (Resilience). During my PhD, three experiments have been conducted using different degrees of control of management factors and simulating different kind of climatic stresses, with different durations. Based on grassland agroecosystems in three countries across Europe (France, Switzerland, Portugal), results from the first two experiments of this PhD showed that ecological-intensive management select soil microbial communities with a lower capacity to maintain microbial ecosystem properties during stresses (resistance) but with higher capacity to recover compared with soil microbial communities of soils under conventional-intensive management. Moreover, another study showed that ecological-intensive management promotes beneficial proteolytic soil microbial communities for plant nitrogen uptake under climate change-induced rain regimes. Plant functional traits assessment suggest this management effect on microbial communities composition and resilience to be explained by higher litter phosphorous content in ecological-intensive systems. Indeed, this plant functional trait affect microbial traits, favouring copiotrophic microbial community characterized by a lower nitrogen:phosphorous ratio of their biomass and a lower investment in extracellular enzymes production, two traits decreasing stress resistance but increasing recovery capacities. Thereby, these two experiments stress the relevance of plant traits management to control soil microbial traits and the resilience of soil microbial communities to climate changes. A third experiment tested specifically the impact of a mineral fertilisation event on the resilience of soil microbial communities to different climatic stresses. Results clearly demonstrated that fertilization modify soil microbial community composition and soil microbial traits and decrease ecosystem stability under climatic stresses. Implementing an approach based on the microbial functional trait concept, this thesis brings new insights on the effects of management intensity on grassland ecosystem resilience to climatic stress.