



**HAL**  
open science

# Temporal Processing In The Amygdalo-Prefronto-Dorsostriatal Network In Rats

Lucille Tallot

► **To cite this version:**

Lucille Tallot. Temporal Processing In The Amygdalo-Prefronto-Dorsostriatal Network In Rats. Neurobiology. Université Paris Saclay (COMUE), 2015. English. NNT : 2015SACLS215 . tel-03083324

**HAL Id: tel-03083324**

**<https://theses.hal.science/tel-03083324>**

Submitted on 19 Dec 2020

**HAL** is a multi-disciplinary open access archive for the deposit and dissemination of scientific research documents, whether they are published or not. The documents may come from teaching and research institutions in France or abroad, or from public or private research centers.

L'archive ouverte pluridisciplinaire **HAL**, est destinée au dépôt et à la diffusion de documents scientifiques de niveau recherche, publiés ou non, émanant des établissements d'enseignement et de recherche français ou étrangers, des laboratoires publics ou privés.

NNT : 2015SACLS215

THESE DE DOCTORAT  
DE  
L'UNIVERSITE PARIS-SACLAY  
PREPAREE A  
L'UNIVERSITE PARIS-SUD

ECOLE DOCTORALE N° 568  
BIOSIGNE Signalisations et réseaux intégratifs en biologie

Sciences de la vie et de la santé

Par

**Mme Lucille Tallot**

Traitement de l'information temporelle dans le réseau amygdalo-préfronto-  
dorsostriatal chez le rat

**Thèse présentée et soutenue à Orsay, le 18 décembre 2015:**

**Composition du Jury :**

Mr, Hirc Gurden	Directeur de Recherche, CNRS	Président/ Examineur
Mme, Sylvie Droit-Volet	Professeur des Universités	Rapporteur
Mme, Nadine Ravel	Chargée de Recherche, CNRS	Rapporteur
Mme, Valérie Doyère	Directrice de Recherche, CNRS	Directrice de thèse
Mme, Regina Sullivan	Professor, NYU/NKI	Co-directrice de thèse







## Remerciements

*“The essence of courage is timing. Take me, for example. I’ll show up to fight anybody, anywhere. I’ll just show up a day late.” Jarod Kintz, \$3.33*

Je souhaiterais tout d’abord remercier le Dr. Valérie Doyère pour m’avoir accueillie au sein de son équipe et m’avoir aidée, dirigée et soutenue pendant ces trois années de thèse. Merci également au Dr. Nicole El Massioui pour son accueil. Je souhaite aussi remercier tous les membres de l’équipe Cognition & Emotion avec qui j’ai interagi à un moment ou à un autre (Najia, Jeroen, Daphné, Nadia, Arnaud, Olivier, Jacques, Tatiane, Manel et Marine). Merci à tous pour la bonne humeur, les gâteaux et les petits déjeuners/réunions.

I also wish to thank Pr. Regina Sullivan for welcoming me in her team at the Nathan Kline Institute and for sharing with me her expertise on the ontogeny of aversive conditioning. I would like to thank the members from the team that I met during the months I spent there and particularly Karina for her help with my experiments.

J’aimerais remercier le Dr. Nadine Ravel et le Pr. Sylvie Droit-Volet d’avoir accepté d’être rapporteur de ce travail de thèse ainsi que les Dr. Jennifer Coull (malgré son absence accidentelle le jour de la soutenance) and Dr. Hirc Gurden pour avoir accepté de faire partie de mon jury de thèse.

Thanks to Pr. Bruce Brown for his help and knowledge on everything timing related.

Thanks to Dr. Lorenzo Diaz-Mataix for teaching me how to implant and record rats as well as for his general help with experiments and for his niceness both in France and in New York.

Merci à tous les animaliers pour leur aide (Calette, Nathalie, Joël, Céline, Fabien et Aurélie). Merci encore à Nathalie pour son aide immuno-histochimique et pour ne pas avoir craqué quand rien ne fonctionnait (c’est ça d’avoir la poisse). Merci à Gérard Dutrieux pour son savoir-faire technique.

A tous les gens que j’ai rencontrés lors de cette thèse et que je n’aurai jamais connus sinon, merci d’avoir rendus ces trois ans passionnants.

Merci à Charlotte, ma co-thésarde, pour m’avoir supportée pendant trois longues années et pour avoir acceptée de me supporter encore un peu plus longtemps en partant avec moi en Nouvelle-Zélande.

Merci à Syrina et à Emmanuelle pour cette super année à New York, pour leur soutien sans faille même dans les moments de déprime. Merci également à Arnaud et à Jordi. And thanks also to all of the shuttle people!

Merci à tous les thésards et étudiants de l’ex-CNPS (nouveau Neuro-PSI) pour les discussions de couloir et autres. Merci à Elsa, Laura et Charlotte pour ces soirées entre doctorantes. Merci à Florian, Yan, Nathalie, Claire et Victor pour les discussions étranges et les repas au CESFO.

Merci à Aurore d'avoir partagé une chambre d'hôtel et un AirBnB avec moi et pour m'avoir remotivé plusieurs fois par son attitude passionnée pour la recherche. Merci à Julie également pour ce premier mois à New York et pour nos discussions sur le temps chez les ratons (et pour les margaritas).

Finalement, merci à ma famille et à mes amis (Nadège, Nanthida, Cynthia,...) pour leur soutien tout au long de ce travail de thèse et pour s'être retenus de m'assassiner lors des périodes de stress.

Merci à tous, ce travail n'aurait jamais abouti sans chacun d'entre vous et il vous ait dédié.

# **Table of contents**

Abbreviations .....	9
<b>CHAPTER 1 General introduction .....</b>	<b>13</b>
<b>I. Time in learning .....</b>	<b>15</b>
A. Timing : circadian vs. milliseconds vs. interval .....	15
1. Definition .....	15
2. Scalar property of time .....	17
B. Explicit vs. implicit temporal tasks .....	19
1. Explicit tasks .....	20
2. Implicit tasks .....	22
C. Time in associative learning .....	22
1. Effect of the modulation of the CS-US interval on learning the association .....	24
2. Temporal error detection .....	26
3. Temporal coding hypothesis (TCH) .....	27
4. Early learning vs. late expression .....	29
D. Models of interval timing .....	31
1. Internal clock by Treisman .....	32
2. Scalar Expectancy Theory (SET) .....	33
3. Sequential state models .....	35
4. Multiple Oscillators Model of Timing .....	36
5. Striatal Beat Frequency model (SBF) .....	38
<b>II. Neurobiological basis of interval timing .....</b>	<b>41</b>
A. Electrophysiological correlates of temporal processing .....	43
1. Population encoding in humans .....	43
2. Single cell recordings in animals .....	44
3. Population encoding in animals .....	49
B. Why an amygdalo-prefronto-striatal network? .....	55
1. Prefronto-striatal network and time .....	55
2. Amygdala and neural correlates of time (see Annex, article n°4: Diaz-Mataix et al, 2014) .....	57
3. Amygdalo-prefronto-striatal connectivity .....	58
<b>III. Thesis objectives .....</b>	<b>60</b>
<b>CHAPTER 2 Study of temporal behavior in a conditioned suppression task .....</b>	<b>63</b>
<b>Article n°1: Individual trial analysis evidences clock and non-clock based conditioned suppression behaviors in rats .....</b>	<b>65</b>
<b>CHAPTER 3 Neuronal correlates of interval timing .....</b>	<b>95</b>
<b>I. INTRODUCTION .....</b>	<b>97</b>
A. Discovery and description of oscillations .....	97
B. Analyses of oscillations .....	98
1. Power spectrum density (PSD) .....	99
2. Coherence .....	99
C. Oscillations and Pavlovian conditioning .....	101
<b>II. Materials &amp; methods .....</b>	<b>104</b>
A. Experiment 1: early learning .....	104



B.	Experiment 2: after overtraining .....	106
C.	Analysis of LFPs for both experiments.....	108
<b>III.</b>	<b>RESULTS.....</b>	<b>112</b>
A.	Neural correlates of time in animals at the beginning of training.....	112
1.	Habituation.....	112
2.	Learning of a 30s CS-US interval .....	113
3.	Shift to a 10s CS-US interval .....	115
4.	Comparison of 30s versus 10s.....	116
B.	Neural correlates of time in overtrained behaving animals .....	128
1.	Behavior .....	128
2.	Power spectrum density .....	129
3.	Coherence.....	130
<b>IV.</b>	<b>DISCUSSION .....</b>	<b>136</b>
<b>CHAPTER 4</b>	<b>Detection of a temporal error by pre-weaning rats.....</b>	<b>141</b>
<b>I.</b>	<b>INTRODUCTION.....</b>	<b>143</b>
A.	Ontogeny of associative learning and timing.....	143
	<b>Article n°2: Developmental emergence of fear/threat learning: .....</b>	<b>144</b>
	<b>Neurobiology, associations and timing.....</b>	<b>144</b>
B.	Using reconsolidation as a tool to detect duration discrimination .....	170
1.	What is reconsolidation ? .....	170
2.	How to block reconsolidation?.....	171
3.	Consolidation and reconsolidation in infants .....	172
<b>II.</b>	<b>Results and discussion.....</b>	<b>174</b>
	<b>Article n°3: Ontogeny of temporal prediction error in rats.....</b>	<b>174</b>
<b>CHAPTER 5</b>	<b>General discussion and conclusion.....</b>	<b>193</b>
<b>I.</b>	<b>Characterization of the network in adults .....</b>	<b>195</b>
<b>II.</b>	<b>What about infants?.....</b>	<b>197</b>
<b>III.</b>	<b>Conclusion.....</b>	<b>198</b>
<b>BIBLIOGRAPHY</b>	<b>.....</b>	<b>201</b>
<b>ANNEXES.....</b>	<b>.....</b>	<b>223</b>
	<b>Article n°4: The amygdala: A potential player in timing CS–US intervals.....</b>	<b>225</b>
	<b>Publications and communications .....</b>	<b>237</b>
	<b>Résumé en français .....</b>	<b>239</b>

## **Abbreviations**

ACC = Anterior Cingulate Cortex

ACT-R = Adaptive Character of Thought-Rational

BLA = Basolateral nucleus of the Amygdala

BeT = Behavioral theory of Timing

CeA = Central nucleus of the Amygdala

CORT = corticosterone

CR = Conditioned Response

CS = Conditioned Stimulus

CTA = Conditioned Taste Aversion

CV = Coefficient of Variation

Cx = Cortex

dmSTR = dorso-medial striatum

DREADD = Designer Receptors Exclusively Activated by Designer Drugs

DRL = Differential Reinforcement of Low rates

EEG = Electroencephalography

ERP = Event Related Potential

FI = Fixed Interval

fMRI = Functional Magnetic Resonance Imaging

IL = Infralimbic cortex

i.p = Intraperitoneal

ITI = inter-trial interval

LA = Lateral nucleus of the Amygdala

LeT = Learning to Time

LFP = Local Field Potential

LH = Limited hold

LTM = Long Term Memory

LTP = Long Term Potentiation

MEG = Magnetoencephalography

mTOR = mammalian Target of Rapamycin

MTS = Multiple Time Scale

PET = Positron Emission Tomography

PFC = Prefrontal Cortex

PI = Peak Interval

PL = Prelimbic cortex

PN = Post-Natal

PTSD = Post-traumatic Stress Disorder

PSD = Power Spectrum Density

SBF = Striatal Beat Frequency

SBFn = Striatal Beat Frequency with Adaptive Character of Thought-Rational module

SET = Scalar Expectancy Theory

SMA = Supplementary Motor Area

TCH = Temporal Coding Hypothesis

TMS = Transcranial Magnetic Stimulation

US = Unconditioned Stimulus

USV = Ultrasonic Vocalization

« Qui a le temps et attend le temps perd son temps. »  
William Camden



# **CHAPTER 1**

## **General introduction**



A sense of time has been described in most species in the world, from drosophila to humans, as well as in fish, pigeons, rats (for a review, see Buhusi and Meck 2005) and even honeybees (Craig et al. 2014). It is an essential parameter of life. It allows for individuals to encode the order and the causality of events but also to adapt their behavior to respond at the most appropriate time, for example by creating temporal maps of events (Balsam and Gallistel 2009). Numerous psychological or neurological disorders have been associated with temporal deficits, like Parkinson's disease and schizophrenia (for a recent review, see Allman and Meck 2012). Problems with timing have also been linked with impulsive behavior. Impulsivity is indeed often described as making actions without planning or as mistiming responses (Evenden 1999; Winstanley et al. 2006a; Rubia et al. 2009). Furthermore, it is associated with lesions in structures involved in timing (both cortical and subcortical) (Winstanley et al. 2004, 2006b; Crews and Boettiger 2009). A lot remains to be understood about the neurological basis of timing, from a cellular to a network level.

## **I. TIME IN LEARNING**

### **A. Timing : circadian vs. milliseconds vs. interval**

#### **1. Definition**

The study of time can be divided in three main categories depending on the durations involved: milliseconds, interval and circadian timing. Interval timing englobes the memorization and detection of durations from a few seconds to a few hours. It is usually separated from milliseconds timing, which deals with sub-second durations (for a recent review, see Spencer and Ivry 2013). Milliseconds timing is essential for all motor actions like walking, talking or playing an instrument. We can also separate interval timing from circadian rhythms, which involve durations of around 24 hours and are implicated in daily rhythms of life like hunger and sleep (for reviews, see Gachon et al. 2004; Partch et al. 2014).

Certain characteristics are fundamentally different between these three domains of timing. Firstly, they are considered to be dependent on different neural circuits (for a recent review on milliseconds timing, see Merchant et al. 2014, and for a recent review on circadian timing, see



Dibner et al. 2010). Secondly, circadian timing is very precise (a few minutes of variability on a 24h scale for most species) but not flexible, as it works only for a 24-hour range (Czeisler et al. 1999), whereas interval timing is very flexible (it ranges from 1s to a few hours) but not as precise, especially for long durations, as precision decreases with the length of the timed stimulus (Buhusi and Meck 2005). Milliseconds timing falls in between in terms of flexibility and precision (see Figure 1.1, Buhusi and Meck 2005). Furthermore, interval timing allows the processing of several durations at once and shifting from one duration to another instantly (Meck and Church 1984) similarly to milliseconds timing, whereas circadian timing takes several days to adapt to a new light-dark cycle (as demonstrated by the existence of jet-lag). Processing of several durations at the same time can use either simultaneous processing by multiple mechanisms, or sequential processing by one mechanism. Data in rats (Buhusi and Meck 2009; Matell and Meck 2004) seem to suggest the use of multiple mechanisms, whereas data in humans seem to go in the direction of one main mechanism (van Rijn and Taatgen 2008). These characteristics may be influenced by the fact that interval and millisecond timing require learning, whereas circadian timing is innate; while the distinction between interval and circadian timing is clear-cut, the distinction between milliseconds and interval timing may be more artificial (the separation between the two is imprecise in current research).

Of course, these different types of timing are not completely independent processes. For example, a link between interval timing and the circadian clock has been shown in several species (humans, rats, mice and drosophila), as the perception of short intervals changes depending on the phase of the day (Aschoff 1998; Nakajima et al. 1998; Morofushi et al. 2001; Shurtleff et al. 1990; Agostino et al. 2011). Furthermore, mice put under a light-light schedule (i.e. with no dark phase), which produces a strong desynchronization of circadian rhythms, showed a lack of temporal control in an interval timing task. Injecting levodopa (L-dopa, a compound similar to dopamine usually given to Parkinson's patients to increase dopamine levels in the brain) prior to the interval timing task in those arrhythmic mice improved their temporal response (Bussi et al. 2014). The authors chose dopamine as a target because they observed daily variations in dopamine levels, variations that had disappeared in the arrhythmic mice. Dopamine has been shown to be involved in timing as it changes how time is accumulated and modifies temporal behavior (MacDonald and Meck 2005; Maricq and Church 1983; Meck 1996).

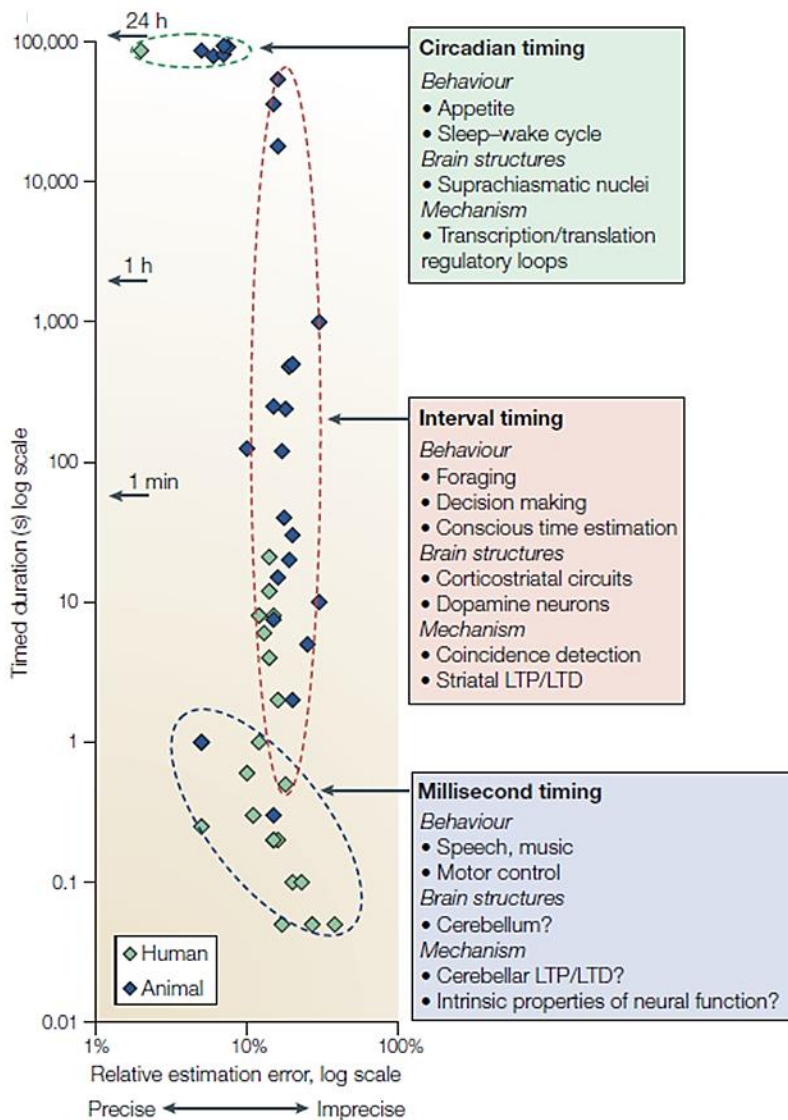


Figure 1.1: Timing across different time-scales. Represented here is the relative precision as a function of the measured duration for the three main types of timing (millisecond, interval and circadian) from an ensemble of studies in both humans and animals. From Buhusi and Meck, 2005.

## 2. Scalar property of time

Another difference between these three types of timing, which is linked with precision, is whether they follow the scalar property (i.e. the application of Weber's law to temporal measures) (Gibbon 1977; Gibbon et al. 1984). This property describes that temporal precision decreases in an inversely proportional manner to the duration measured (i.e. it is more difficult to discriminate 32 s

from 34 s than 2 s from 4 s although the actual numerical difference is the same between the two conditions). The scalar property means that individuals maintain the same relative precision (i.e. a similar coefficient of variation, CV) over a large range of durations. When plotting on relative time, temporal behavior curves will superimpose (Figure 1.2, Matell and Meck, 2000).

The scalar property is not present ubiquitously in interval timing tasks as it disappears when the task becomes difficult, like timing two separate durations (Keen and Machado 1999) or for very short durations (<1 s) and very long durations (>100 s) (for reviews, see Lejeune and Wearden, 2006; Wearden and Lejeune, 2008). Longer durations are rarely tested in humans because they may develop counting strategies (Clément and Droit-Volet 2006; Rattat and Droit-Volet 2012), which could explain why temporal tasks in humans often violate the scalar law (Lewis and Miall 2009).

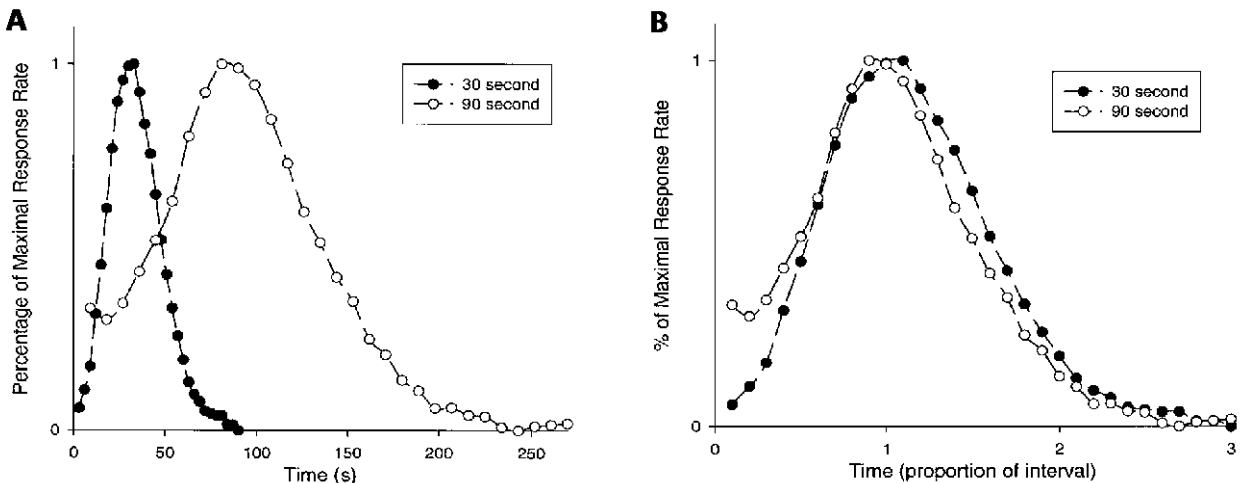


Figure 1.2: Temporal behavior and scalar property in rats. Represented in A is the temporal behavior of rats when they have to respond at two different durations (30s and 90s) to get a reward. Each curve peaks at the optimal time to get the reward, but the curves show different widths. In B, the same temporal behavior is reported but on a normalized temporal scale; the two curves show an almost perfect superposition, indicative that the width (precision) is proportional to the duration being timed. This is representative of the scalar property of interval timing. From Matell and Meck, 2000.

In an attempt to assess the generality of this principle, Lejeune and Wearden (1991) compared the data obtained using the same type of temporal task in different animal species ranging from freshwater turtles to cats. They calculated the CV as a measure of the precision of within-interval temporal control. These authors demonstrated that the CV was constant over a broad range of

durations (30 to 500 s) for each species; however, it increased with longer durations (following a deviation from scalar property). In addition, they also reported that the CV varied from one species to another. This suggests that even though the main mechanism of timing seems conserved across species, there may be some functional differences between species.

Timing of durations can also be modulated by the temporal context. In a context of short duration, there will be a tendency to overestimate an interval, which follows Vierordt's law. He was the first to compare temporal perception with actual durations over a large magnitude of intervals. In a task where many different durations are presented and have to be reproduced, short durations have a tendency to be overestimated, whereas long durations have a tendency to be underestimated in humans; showing that they have a bias toward the mean of the distributed durations (Lejeune and Wearden 2009). The shift from overestimation to underestimation varies depending on the range of durations of the task. A value of 0.75s is often seen when studying durations in the seconds range (e.g. Kanai et al., 2006), whereas for longer durations (up to 80 min), Yarmey (2000) showed an indifference point at around 2 min.

## **B. Explicit vs. implicit temporal tasks**

Different tasks have been developed in both humans and animals to measure their sense of time and how it can be modulated. Most of these studies use behavior as an index of temporal learning, which may not always be correct as time may be learned but not expressed behaviorally (this will be discussed later). Temporal tasks can be divided in two main types: implicit *versus* explicit timing (for recent reviews, see Coull and Nobre, 2008; Coull et al., 2011). In implicit tasks, a subject's knowledge of the durations used is not necessary for its performance, meaning that it does not have to time during the task but it may do so nonetheless (like during Pavlovian conditioning, working memory tasks and entrainment). In these tasks, accurate timing may facilitate detection of a stimulus or allow for a better regulation of behavior, but is not necessary to perform adequately. Explicit tasks are any paradigms where the durations have to be known to respond. In this case, learning of the duration is necessary for accurate performance (like for temporal discrimination, temporal production and reproduction tasks and tasks with temporal motor control).

## 1. Explicit tasks

Interval timing is usually studied using explicit tasks, as time is an essential element of these tasks. By having an animal press a lever (or any other motor action) to get a reward (Figure 1.3) (instrumental conditioning, Skinner, 1938), it is possible to study response rates and to look at how they are modified across time. One such task is the fixed interval (FI) task, in which the animal learns that the reward will be delivered if it responds after a specific amount of time after the onset of a stimulus (visual or auditory, usually) or after the previous reinforcement. After the rewarded press, the stimulus is terminated and a new trial can begin. From these rules, the animal can follow four types of behavior: it can press continuously during the stimulus, it can increase its lever pressing gradually over time, it can wait until the interval has passed and press once, or it can start pressing slightly before the time and continue until it gets the reward. The average response rate usually follows a scallop shape with few responses at the beginning of the interval and a high rate toward the end (Dews 1970), whereas the response on individual trials follows a “break-run” pattern where the animal does not respond until a certain time (variable between trials) and then respond at a high constant rate (Schneider 1969). This seems to be the most efficient way of responding to decrease effort and optimize reward.

To measure behavior without the bias of the offset of the stimulus, probe trials were added in which the stimulus was presented for a longer period (usually three times the FI duration) without reward; this is called a peak interval task (PI, developed by Catania in 1970 and first used to look at temporal behavior by Roberts in 1981). Using a PI task, Gibbon and Church (1990) showed that rats follow a low-high-low pattern of responding in individual trials in a similar way to the behavior observed in a FI task. When these individual responses were averaged, the resulting curve followed a smooth increase and decrease with a maximum at the expected time of reinforcement with a mostly symmetrical shape (Figure 1.2). Roberts (1981) has also shown that a higher reinforcement gives a higher level of response but the time of the peak is not modulated by the reinforcement level, meaning that the strength of reinforcement can change the animal’s response but does not change its temporal pattern; therefore these two aspects may be encoded separately. Very similar temporal responses have been shown in an adapted PI task in humans (e.g. Rakitin et al., 1998).

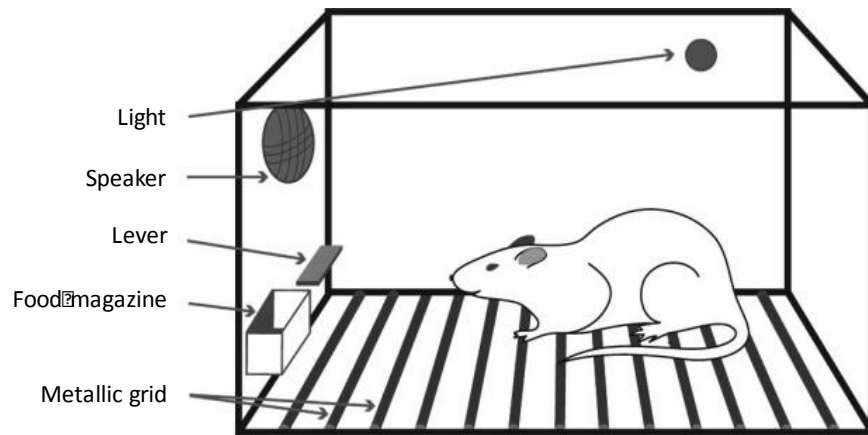


Figure 1.3: Graphical representation of a typical behavioral box for rats. It can be used for implicit and explicit temporal tasks. It contains a light and a speaker to produce visual and auditory stimuli as well as a lever and a food delivery mechanism. The floor is constituted of an metallic grid than can deliver electrical foot shocks. It is possible to add an odor delivery system or to present multiple levers to look at more complex behaviors.

Temporal discrimination tasks can also be used. They are interesting because they give an idea of a subject capacity to encode a large range of durations. Stubbs (1968) developed this task in pigeons. The animals were presented with 10 possible durations (from 1 to 10 s) and had to respond on a different key if the duration presented was “short” (1 to 5 s) or “long” (5 to 10s). A more complex task based on temporal discrimination is the temporal bisection, where a subject learns two durations, one considered short and the other considered long (for example 2s versus 16s) and each duration is associated to a specific response (for example ‘short’ is associated with the right lever, whereas ‘long’ is associated with the left lever). After the subject has learned to respond correctly in most trials, then intermediate durations are introduced and the subject has to respond ‘short’ or ‘long’ (Church and Deluty 1977). This allows for the measurement of the point of subjective equality, the duration for which the subject answers ‘short’ as often as ‘long’. Temporal generalization tasks are also similar in function, and consist in learning one duration (for example 5s) and then, when being presented variable durations, having to determine if they are the same or different (Church and Gibbon 1982).

Some explicit tasks cannot be used in animals as they involve verbal instructions, like temporal production, which consists in asking the individual to produce a temporal interval using a motor response after having been told a specific duration (for example 1.5s).

## 2. Implicit tasks

Interval timing has been proposed as the basis for many non-seemingly temporal behaviors like associative learning or rate estimation of prey capture (for a review, see Matell and Meck, 2000). Implicit timing or temporal predictions are used remarkably often in day-to-day life. One aspect of temporal prediction is the hazard function, i.e. the increased expectation for an event with passing time given that the event has not yet occurred. For example, when you are waiting in your car at a red light, your expectation that it is going to turn green increases as time passes until you decide that the light is broken and that you should move. This increased temporal expectation (often measured through the length of the foreperiod, i.e. the interval between the predictive stimulus and the event) reduces response latency because of increased motor preparation (Niemi and Naatanen 1981). It also allows for better discrimination of stimulus by increasing attention (Rolke and Hofmann 2007; Lasley and Cohn 1981; Westheimer and Ley 1996). Another aspect of temporal predictions is our ability to detect patterns and regular stimuli. Repeated stimuli (i.e. in a predictable pattern) can “entrain” brain function, making predictable stimulus easier and faster to detect and to discriminate (Barnes and Asselman 1991).

Implicit timing is also involved in associative tasks, such as Pavlovian conditioning, in which a stimulus predicts the arrival of a salient event and therefore helps to adapt the behavior at the right time. For example, in the case of an aversive situation, it is more efficient to freeze only for a short amount of time since that allows for the expression of other behaviors like foraging.

### C. Time in associative learning

Pavlovian or classical conditioning (as opposed to instrumental conditioning; Skinner, 1938) consists in pairing an initially neutral stimulus with a stimulus that has an inherent biological value (either appetitive or aversive), called the unconditioned stimulus (US). The neutral stimulus will

acquire the properties of a conditioned stimulus (CS) and will come to evoke conditioned responses (CR) that are related to the responses naturally evoked by the US (Figure 1.4, Pavlov, 1927). The CS and US become associated; an association can be thought of as a link between the mental representations of two events. In a typical Pavlovian task, the events would be a sound and food delivery (Figure 1.4). The strength of the CS-US association is usually determined via the magnitude of the CR.

The CS will come to predict *when* the US will arrive (e.g. Davis et al., 1989; Díaz-Mataix et al., 2014; Pavlov, 1927). The first observations relating Pavlovian conditioning with timing were made by Pavlov himself, who noticed that animals would start responding toward the end of the CS, just before the US was presented, even when changing the CS-US interval, in a phenomenon he called inhibition of delay. This is similar to what Skinner (1938) observed in individual trials in a FI task where animals would start responding around 2/3 of the length of the interval. Pavlov (1927) concluded that “time has acquired the properties of the conditioned stimulus”. Gallistel has also created a model of associative learning involving time; he considers that the nature of every association is its temporal link and, therefore, there are no non-temporal associations (Gallistel, 1990).

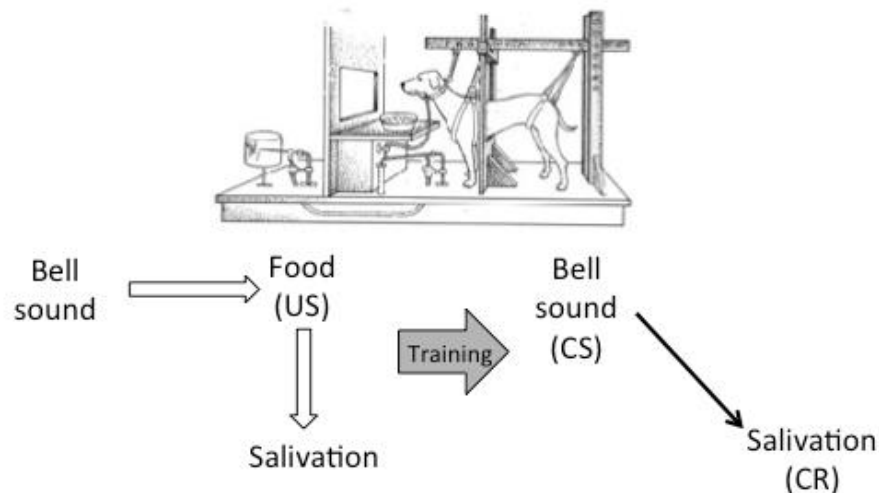


Figure 1.4: Description of Pavlovian conditioning. After several presentations of the sound of a bell followed by the presentation of food (US, unconditioned stimulus), the sound of the bell will become a conditioned stimulus (CS). Presentation of the CS alone will induce a conditioned response (CR, salivation) without presentation of the US. Image from <http://graulab.tamu.edu/J-Grau/Psyc340/Outlines/HistPrecedents-Psy.html>



## 1. Effect of the modulation of the CS-US interval on learning the association

Modulations of the temporal relationship between the CS and the US modify the amplitude of the CR and therefore seem to act on the strength of the learning. We can describe four paradigms in Pavlovian conditioning where the temporal relationship between the CS and the US is modified: forward-delay, forward-trace, simultaneous and backward conditioning (Figure 1.5). In forward-delay conditioning, the US is presented at the end of the CS (they usually are co-terminating), whereas in forward-trace conditioning an interval is introduced between the end of the CS and the arrival of the US. In simultaneous conditioning, both the CS and the US are presented for the same amount of time. In backward conditioning, the US ends before the onset of the CS.

Pavlov (1927) found that simultaneous and backward conditioning paradigms do not produce a CR. One explanation for these results is that for an association to be learned the CS must predict the arrival of the US, therefore forward conditioning should give a stronger CR (informational hypothesis, Egger and Miller, 1963). Rescorla proposed another explanation in 1968, by saying that the predictiveness of the CS depends on the contingency between the CS and the US. He proposed that learning is influenced by the probability of the US in the presence of the CS minus the probability of the US outside of the CS. Indeed, in both backward and simultaneous conditioning, the CS does not add information on the arrival of the US, therefore it may be useless to learn an association between the two, explaining the low level/absence of CR. Rescorla argued that temporal contingency, and not just temporal contiguity, is necessary for learning an association.

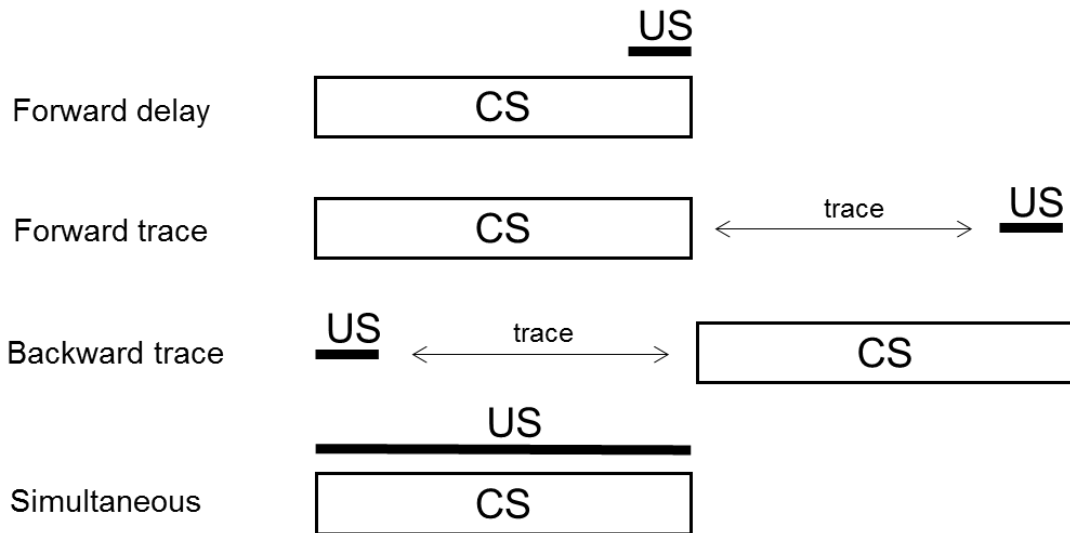


Figure 1.5: Description of different paradigms of Pavlovian conditioning. In forward delay, the US arrives at the end of the CS and they co-terminate. In trace conditioning the US is separated from the CS by a trace interval; in the forward paradigm the US follows the CS, whereas in the backward paradigm the US appears before the CS. In simultaneous conditioning the CS and the US are present at the same time for their entire duration.

Pavlov (1927) also noted that the longer the duration between the onset of the CS and US in forward conditioning (for both delay and trace), the lower the CR's magnitude (Holland 1980). Another aspect of time in Pavlovian conditioning is that for longer CS-US durations, behavioral expression appears later in training, therefore these associations seem to take longer to learn (Balsam 1984). It appears that the important factor here is the ratio between the CS-US interval and the inter-trial interval (ITI). In effect, for a similar ratio, the speed of acquisition is similar and higher ratios increase the speed of acquisition (Gibbon et al. 1977).

There are four main explanations for this lower responding during the CS in trace conditioning. The first is that the memory trace is decaying during the trace interval between the CS and US resulting in weaker learning expressed by weaker responding. The second depends on the view that the CS becomes a safety signal when the US is farther, since the US never happens during the CS. With a longer duration, it comes close to an unpaired paradigm and the CS should decrease CR compared to the context since the animal learns that the context is more predictive than the CS. The third option is that the animal learns perfectly fine the association but shifts its responding to the time of arrival of the US, so there is less responding during the CS (Balsam 1984; Huerta et al.

2000). This last option has a lot of evidence in eyeblink conditioning where the time of CR changes with training until the CR is anticipated (Joscelyne and Kehoe, 2007; Kehoe and Joscelyne, 2005; for a recent review, see Sánchez-Campusano et al., 2011). Eyeblink conditioning is a form of Pavlovian conditioning where the CS is usually auditory and the US is an air puff to the cornea resulting in eye closure (as the CR). However, all of these results use the strength of the behavior as a direct measure of the strength of learning, which may not be exact. In effect, another possibility is that the CR is not a good index of temporal learning.

## 2. Temporal error detection

Predictions are necessary for adapting behavior; when the prediction is violated by the actual events, then the memory needs to be updated. It is possible to detect the absence of an expected stimulus (negative error prediction) or the presence of an unexpected stimulus (positive error prediction). It is therefore very dependent on expectation and on the memorized time of arrival of the stimulus. It forms the basis of many learning models like the temporal difference learning models (Sutton and Barto 1981). Indeed, temporal error detection is sufficient to induce updating of memories (see Chapter 4, I. B.). It has been studied extensively in appetitive Pavlovian conditioning (for a recent review, see Bermudez and Schultz, 2014 for animals and Garrison et al., 2013 for humans), as well as in aversive conditioning (for a review, see Li and McNally, 2014).

Specific brain responses have been linked to error detection in Pavlovian conditioning and are dependent on expectations. For example for dopaminergic cells, with training, the US becomes fully anticipated and the neural response to the US is reduced while the response to the CS is increased (McNally et al. 2011; Schultz 2013) (Figure 1.6B). When the US is unexpected, there is an increase in firing just after the US (Figure 1.6A), and when an expected US is absent, there is a decrease in firing at the expected time of arrival of the US compared to baseline levels of firing (Figure 1.6C) (Schultz 1998).

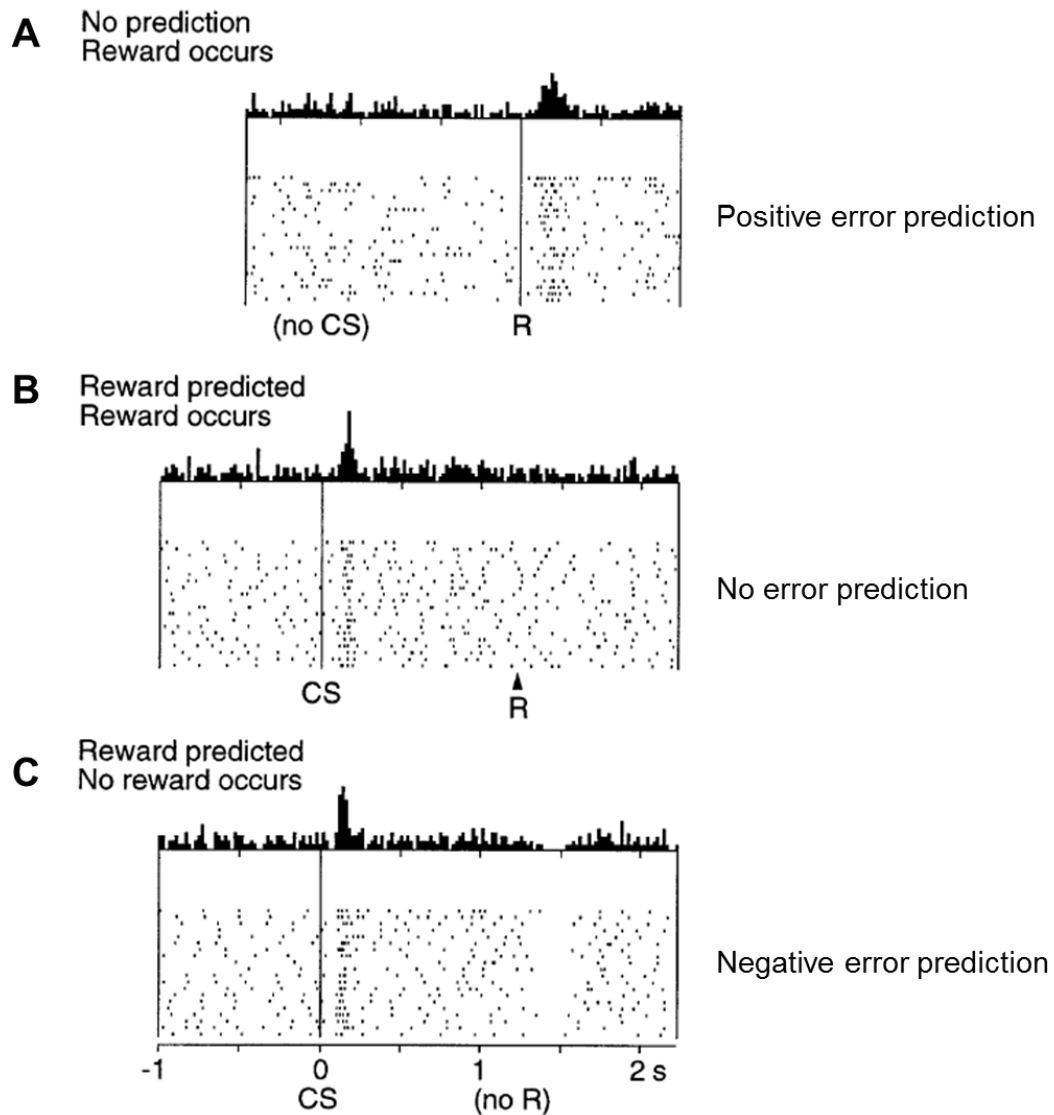


Figure 1.6: Example of one dopamine neuron firing rate response to an unpredicted reward (A), a predicted reward (B) and the absence of a predicted reward (C). From Schultz, 1998.

### 3. Temporal coding hypothesis (TCH)

The temporal coding hypothesis (TCH) describes associative learning as being separate from performance, meaning that an association can be learned even though there is no behavioral expression of that learning. It rests on three main principles of temporal learning. Firstly, close contiguity between events is necessary and sufficient for the formation of an association. Secondly, the temporal relationship between events is automatically learned and this temporal information has an important role in how a subject responds to these events. Thirdly, temporal information from

different training sessions can be integrated in temporal maps if they have common elements (Barnet et al., 1991; Matzel et al., 1988; Miller and Barnet, 1993, for review, see Molet and Miller, 2014; Savastano and Miller, 1998).

Following these principles, an association is formed in all four Pavlovian paradigms described in Figure 1.5, but when the CS does not have any predictive value, then there are no anticipatory responses, as most measured CRs are anticipatory. By looking at other learning indexes, associative learning was observed in backward (Arcediano et al. 2003; Molet et al. 2012) and simultaneous (Farley and Alkon 1987; Barnet et al. 1991) paradigms. Looking at neural responses before they are translated to higher-order cognitive systems, Farley and Alkon (1987) have shown stronger conditioning for simultaneous than for forward association in the mollusk *Hermissenda*. Looking at more complex conditioning paradigms is a good way to understand how temporal relationships are learned and implemented (e.g Arcediano et al., 2003; Barnet et al., 1991; Cole et al., 1995; Molet et al., 2012, for a review see Molet and Miller, 2014). Arcediano et al (2003) used sensory preconditioning (Figure 1.7A) to prove the existence of backwards associations. They first present a stimulus S2 followed by a stimulus S1 and then, in a second phase, they ran a backward conditioning between the US and S1. If backward associations are possible, then the response to S2 should be stronger than the response to S1, and this is what they observed.

Using a very interesting second-order conditioning paradigm, Cole et al (1995) demonstrated that time is automatically learned and that links between events are assembled in temporal maps allowing for association between two stimuli even though they were never paired. In a first phase, the authors associated a stimulus (S1) and the US with a 5s trace between the two, then in the second phase they presented S1 followed by S2 (S1 and S2 are both 5s long stimulus), so that the US time is at the end of S2 (see Figure 1.7B). When testing S2 they observed a stronger CR than with S1 even though S2 has never been directly associated with the US. It seems that during each phase, the association and the precise temporal relationship between stimuli are learned, which allows the creation of mental temporal maps that can be integrated to create a whole picture. By remembering the temporal order and the interval between the three stimuli it becomes clear that S2 is closer in time to the US than S1, therefore inducing a stronger CR (Cole et al. 1995). Those results support

the view that time is automatically learned and is used to create maps of events for predicting situations.

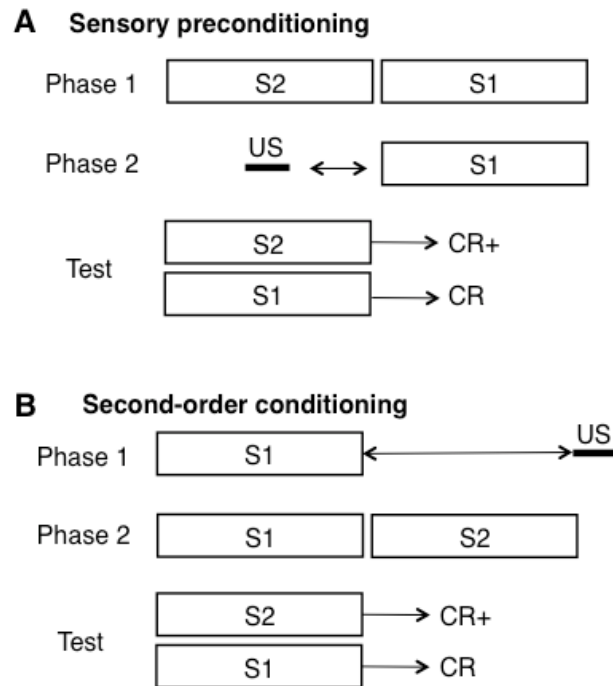


Figure 1.7: Description of sensory preconditioning (A) and second-order conditioning (B) There are two associative phases in those paradigms followed by a test phase. S1 and S2 are two stimuli that can be discriminated. A represents the paradigm used in Arcediano et al (2003) whereas B represents the paradigm used in Cole et al (1995).

The TCH can be used as a bridge between associative and timing models. However, it is not sufficient in itself, since it does not explain how time is perceived, and it is not a complete model of associative conditioning. Timing is an essential part of associative learning but does not represent all of it; there are also non-temporal parameters that are learned during an association. Different parameters must be detected and memorized to learn an association (temporal relationships, but also valence, intensity and spatial information).

#### 4. Early learning vs. late expression

It seems that time is learned very quickly but that most measured instrumental behaviors become temporally precise after many training sessions (usually at least 200 to 300 trials). The absence of a peak response at the expected time of arrival of the US in early learning (Gibbon and

Balsam 1981) does not mean that the animal has not learned the interval. Theories of timing do not necessarily require for expression of temporal behavior to be present at the time of learning (Balsam et al. 2002). For example, Ohyama and Mauk (2001) showed that learning of a long interval in eyeblink conditioning appears before expression of a temporal CR. They first trained rabbits with a “long” CS-US interval (700 – 750ms) but stopped before the emergence of robust CR and then, in a second phase, overtrained the animals with a “short” interval (250 – 300ms). When they tested the animals with long probes (1 000 – 1250ms) they observed a response with two peaks, one at each trained duration, the short and the long, showing that the animals had learned the long duration even though they had not reached a training level sufficient to express it.

Learning the temporal parameters of a task requires only a few trials (Bevins and Ayres 1995; Davis et al. 1989; Díaz-Mataix et al. 2013; Drew et al. 2005; Shionoya et al. 2013; Balsam et al. 2002). Davis et al (1989) showed that only two CS-US associations are necessary for rats to learn the CS-US interval (from a few hundred milliseconds to around 50s). They conditioned rats to different CS (light) – US (foot shock) intervals and they showed that a startle response to a loud noise is maximally potentiated when the loud noise is delivered at the expected time of the shock during the CS. Temporal learning can be observed even after just one trial of contextual conditioning (Bevins and Ayres, 1995). The authors presented only one US while in the context, with different durations between placement of the animal in the context and the foot shock. They showed more freezing at the beginning of the session for the shorter durations and a more general freezing for longer durations. Balsam et al (2002) and Drew et al (2005) showed a similar early temporal learning in goldfish. When they looked at individual trials across acquisition, they saw that the only value that changed with training was the peak rate of responding and not the time of peak responding or the start and stop values (i.e. when the animal starts and stops responding on individual trials). Shionoya et al (2013) showed that looking at other behavioral dependent variables than freezing can give more information on temporal learning. Rats trained with 10 CS-US presentations (odor and foot shock) expressed a temporal pattern of respiration that shifted when changing the CS-US interval. Diaz-Mataix et al (2013) used reconsolidation as a tool to show that rats, tested 24 hours after learning, can detect changes in the CS-US interval even after conditioning with only one association. After learning, a memory goes through consolidation to become stable. If the memory is reactivated by the presentation of a cue associated with the learning, then the memory can go

through reconsolidation to become stable once more. These two processes can be disrupted by injecting a protein synthesis inhibitor (Nader et al., 2000; for more details, see Chapter 4, I. B.). Importantly, reconsolidation is only activated when new information is added to the initial memory; this new information can be a change in the CS-US interval, as shown by Diaz-Mataix et al (2013), and rats detect a change in CS-US interval even after only one pairing during training.

The main message here is that many results suggest that learning the temporal relation between two stimuli occurs at the same time as learning their association. Intervals seem to be encoded automatically and this from the very first pairings presented. Behavior does not always follow learning because we may not be looking at the right expression of this learning. Balsam and Gallistel (2009) have hypothesized that the knowledge of the CS-US interval is necessary for learning the association. However, others consider that associative learning and temporal learning are separate processes (for a recent review, see Delamater et al., 2014).

#### **D. Models of interval timing**

Different models of timing have been developed to try to explain how we measure and learn time in most situations (implicit and explicit). Hoagland (1933) described a master chemical clock of time, inspired by the circadian rhythms described within the suprachiasmatic nucleus. He noticed that his wife would count quicker when she had a fever than a healthy individual, making him think of the existence of an internal clock that could be modulated by physiological changes like body temperature. Indeed, most species from insects to primates process temporal information as if they are using a stopwatch (Church 1978, 1984; Buhusi and Meck 2005; Matell and Meck 2000). Animal's internal clock seems to encode time in a linear fashion (Church 1984; Gibbon and Church 1981) and can be used to time signals from different modalities in a sequential or a simultaneous manner (Gibbon et al. 1984; Olton et al. 1988). It can also be stopped and reset as shown in gap paradigms (where the insertion of a “pause” in the timed stimulus induces a shift of the temporal behavior dependent on the duration of the “pause”) (Church, 1984, 1978; Roberts and Church, 1978; see the introduction of Chapter 2 for more information).

There are three main categories of pacemaker based timing models:



- pacemaker-accumulator models (accumulation of beats from a central pacemaker into an accumulator)
- sequential states models (transitions between different states can be used to measure how much time has passed)
- oscillatory models (activity of different oscillators encodes time and oscillators are reset at the beginning of a stimulus)

Some of these models will be described in the following paragraphs, however for more in depth reviews of psychological models of timing, see Matell and Meck, 2000; Rijn et al., 2014). It should be noted that there are also models of timing that are not based on pacemaker mechanisms. Indeed, there is a lack of biological evidence for the existence of an internal pacemaker clock. Furthermore, a basic pacemaker clock will not follow the scalar property, as it should become more precise for long durations, whereas the CV has been shown to be relatively constant over a range of durations and even to increase at very long durations for animals (see Chapter 1.I.A.2.). Staddon and Higa (1999) developed a pacemaker free clock model based on the memory trace of the Multiple Time Scale model of habituation (MTS, Staddon and Higa, 1996). This model involves a logarithmic like function for encoding duration in memory which presents the scalar property without need for modifications, i.e. the memory trace decay of the MTS. They argue that an internal sense of time only requires some internal variable that varies in a monotonic way as time passes and not necessarily a pacemaker. The authors also consider that there may be no internal clock but, instead, when an individual discriminates between two durations, it is actually differentiating the ‘age’ of two memories. However, modern pacemaker models have additional parameters to adapt to the scalar property of time. They remain the most prevalent models in current research and are still at the heart of our understanding of interval timing.

### 1. Internal clock by Treisman

Treisman (1963) and Creelman (1962) proposed the first descriptions of an internal clock based on a classical information-processing model. It is composed of three main components: a clock (itself composed of a pacemaker, a switch and an accumulator), a memory and a decision stages (see Figure 1.8). A start signal is detected (onset of a stimulus), the switch is closed and the

ticks produced by the pacemaker are sent to the accumulator. At the offset of the stimulus (or at the time of reinforcement or response), the switch is opened, so that the accumulation stops and the quantity of ticks accumulated is stored in memory. The accumulator is reset to 0 at the beginning of each stimulus. After repeated presentations, the offset of the stimulus can be predicted by comparison of the current accumulated ticks with the durations in memory. This internal clock follows Weber's law by adding variability to the retrieval from memory.

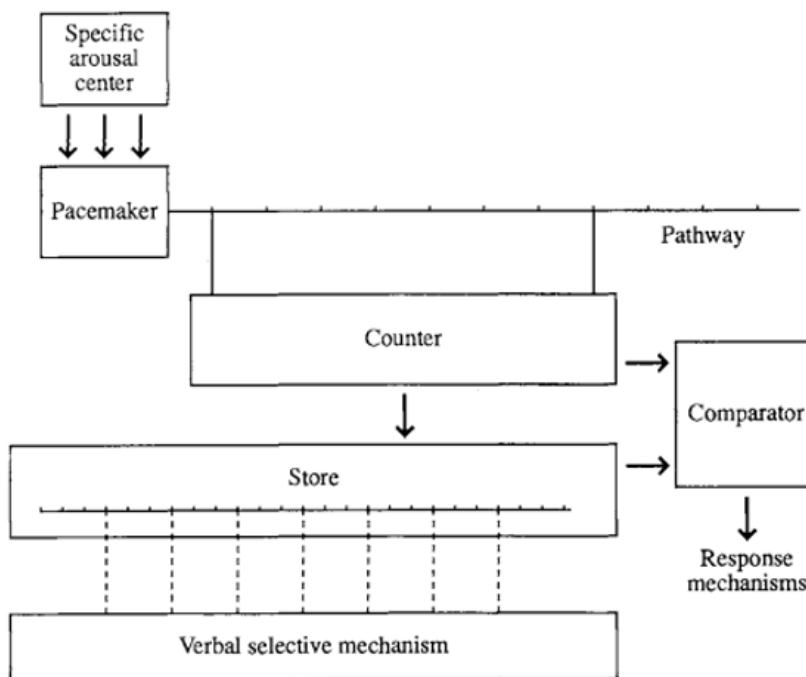


Figure 1.8: Representation of the internal clock from Treisman (1963). It is constituted of a pacemaker that produces “ticks” and a counter that accumulates those “ticks”. The amount of “ticks” can be stored in memory and later compared to the current number of “ticks” to allow for the determination of the timed interval.

## 2. Scalar Expectancy Theory (SET)

The Scalar Timing Theory or Scalar Expectancy Theory (SET) was developed by Gibbon in 1977 and further improved by Church in 1984 (Figure 1.9). It expands on the memory stage as well as adding a decision rule to Treisman's internal clock. The pacemaker emits pulses at a variable (between trials) but stable (over a single trial) rate ( $\lambda$ ) that are stored in the accumulator. When an important event occurs the switch opens and the value (i.e. the number of pulses that have occurred

since the previous salient event) in the accumulator is multiplied by a random factor ( $k^*$ ) and transferred to the memory.

Due to the fact that  $\lambda$  and  $k^*$  are random variables, the value in the accumulator and the value in memory will be variable, even for the same duration. Each trial adds a new value to the memory, so that after several trials the memory will contain a distribution of temporal values for the reinforcement. In a trial, the subject compares the current value in the accumulator with a sample taken from its reference memory, and applies a ‘decision rule’. If the ratio between the accumulator value and the memory value crosses a threshold ( $\Theta$ ), a response is emitted. SET proposes a linear encoding of time between the pacemaker and the accumulator, so that the accumulated ticks directly represent the physical durations. The scalar property emerges in the memory stage and is mainly due to  $k^*$  and not to the variability in  $\lambda$  between trials (Gibbon and Church 1990; Gibbon et al. 1984).

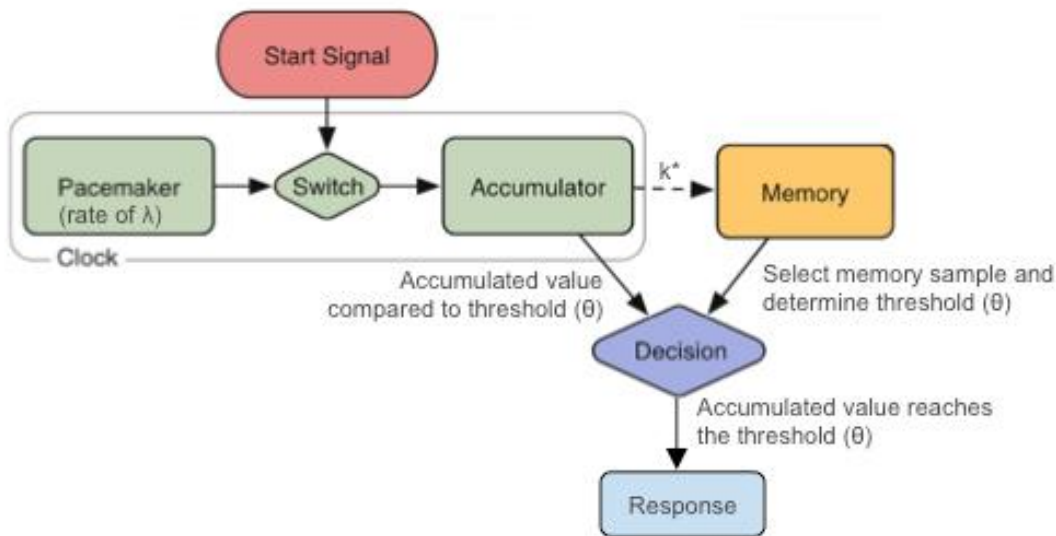


Figure 1.9: Outline of the SET model using a color code of green for the clock component, yellow for the memory component and blue for the decision component. The start signal closes the switch, which allows for the accumulation of ticks (at a rate of  $\lambda$ ) in the accumulator. At the end of the stimulus the accumulated ticks are saved in memory after being multiplied by the random factor  $k^*$ . On each trial, a memory sample is chosen from memory and is compared to the accumulated value until it reaches a threshold of similarity to the memory sample, which triggers a response. Adapted from Rijn et al., 2014.

SET is the main psychological model used today and explains most behavioral results. However, it does not account for the disappearance of the scalar property for shorter durations or for difficult tasks since the existence of the scalar law is intrinsic to the function of this model (for a review see, Machado et al., 2009). Also it does not explain why, in a bisection task, the point of subjective equality is at the geometric mean and not at the harmonic mean as would be expected in SET (for mathematical demonstration, see Staddon and Higa, 1999). The main problem for these pacemaker-accumulator models is that it is not biologically plausible to have a linear unbounded accumulator. Indeed, the timing of longer duration would require the accumulation of a very large amount of activity (if neuronal spikes are the ‘ticks’ of the clock then measuring durations above tens of seconds is impossible). There is no known biological system that could sustain such an accumulation.

### 3. Sequential state models

The Behavioral Theory of Timing (BeT), designed by Killeen and Fetterman in 1988, uses behavioral states as indices for timing. A sequence of particular behaviors can therefore represent a specific duration. For example, a rat can measure the time before a lever press in a FI paradigm as a sequence of behavioral states, like running around the box, grooming, going toward the houselight and then responding. By using this specific sequence of behaviors the animal will know when to respond. And, reinforcement following the lever press will reinforce the whole sequence of actions and not just the individual response. It has been studied by looking at the various behaviors of animals before responding. Fetterman et al (1998), studying both pigeons and rats, have shown that these behaviors can be better predictors of the choice response in temporal discrimination than the real time points, when the animal does not time correctly. But these adjunctive behaviors are not always observable or reliable (Reid et al. 1993; Lejeune et al. 1998).

The Learning to Time model (LeT) was developed by Machado in 1997 and is based on BeT and how behavioral states can serve as timing cues. In contrast to BeT, each state is activated serially and it does not depend on a pacemaker (in BeT each state represents a tick of the pacemaker). Each state is coupled with an operant response from 0 to 1 depending on the availability of food during

this state, so that a state where food is present has a higher coupling and stabilizes the operant response. LeT, however, has similar flaws to the BeT model in that adjunctive behaviors are highly variable and difficult to observe.

It is also unlikely that very long durations (more than minutes) could be encoded by the same succession of behavioral states. Using oscillators is a good way to decrease the amount of information necessary for encoding longer durations, as described in the Multiple Oscillators Model of Timing (developed from SET by Church and Broadbent, 1990) and also the work from Miall (1989) on oscillators.

#### 4. Multiple Oscillators Model of Timing

The Multiple Oscillators Model of Timing is a connectionist model of timing (as opposed to an information processing model) that consists of the same basic elements as SET but using oscillators as pacemakers, and the accumulator is replaced by indicators of the phases of the oscillators (Figure 1.10, Church and Broadbent, 1990). Indeed, biological oscillators are common and may represent a more plausible clock than an accumulation system. The memory stage is modified, so that encoded duration is not a single value anymore but the weighted connections of a matrix; an infinite amount of information can then be stored, compared to the growing size of the memory component in SET when many durations must be remembered.

The use of oscillators in a model of timing is based on the fact that an interval of time can be encoded in the phase of a single oscillator. To be precise in timing it would be necessary to have oscillators with a very wide range of periods from a few hundred milliseconds to a few years. However, this would allow the connection of interval timing with circadian rhythm (which depends on the circadian clock, an oscillator with a period of 24h). It would in fact require only about 30 pacemakers to cover the whole range of durations if each successive pacemaker had a period twice as long as the preceding one. Retrieval of memorized durations involves another set of oscillators and indicators that are different from the ones that perform the encoding, so that both can be modulated separately. In this model, memorized time and measured time are encoded as vectors and

the similarity between the two is measured as the cosine of the angle: when this value is above a set threshold, then the system responds.

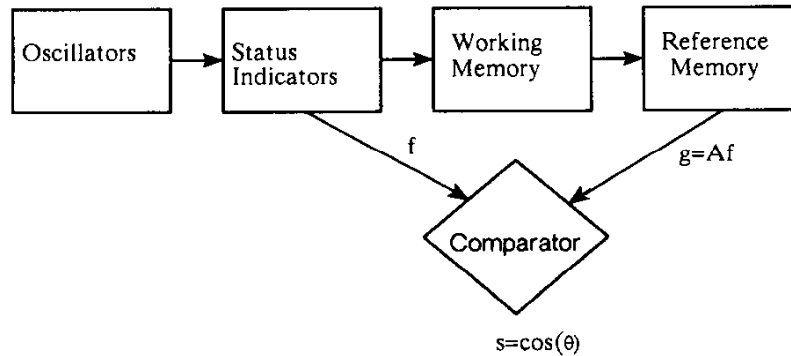


Figure 1.10: Schematic representation of a connectionist model of timing. From Church and Broadbent, 1990.

Trying to find a biologically plausible way for the brain to encode durations, Miall in 1989 has proposed a mechanism to store intervals from a few milliseconds to tens of seconds by using beat frequencies in oscillators. Indeed this does not require pacemaker oscillators with a wide range of periods like in the Multiple Oscillators Model of Timing (Church and Broadbent 1990). This beating frequency involves a group of oscillators with different frequencies (but these frequencies can be in close range) that spike for a small part of their cycle. The beat frequency of a pair of oscillators is the frequency at which they fire simultaneously. For a larger group of oscillators than a pair, the beat frequency is the smallest common multiple of their periods. Thus, the beat frequency is much lower than any of the oscillators' frequency.

To time a new duration, the oscillators need just to be reset. Learning an interval can involve a Hebbian mechanism (basic mechanism of synaptic plasticity where the timely and repeated activation of synapse B by neuron A increases the synaptic efficacy for A to stimulate B) between the oscillators and a postsynaptic cell that will be activated only when the right number of oscillators fire simultaneously (Miall 1989). For a group of 500 oscillators the maximum encoded time seems to be 20s, but increasing the number of oscillators will also increase the maximum duration. Furthermore, adding inhibitory oscillators will increase the specificity of encoding of each interval.

It is possible to store multiple intervals even though the number is quickly limited by a lack of discrimination between the peaks of activity. However, this type of temporal encoding requires that the oscillators maintain their frequency over the whole duration to be timed or that they drift in a highly reproducible way in each trial.

#### 5. Striatal Beat Frequency model (SBF)

Based on the work of Miall in 1989, Matell and Meck (2004, 2000) have proposed an internal clock residing in a cortico-striatal network called the Striatal Beat Frequency model (SBF). Medium spiny neurons of the striatum are connected to thousands of cortical neurons that oscillate at stable but specific frequencies. Medium spiny neurons are therefore able to detect coincident activation of a larger number of cortical neurons and may encode this activity as they require many convergent inputs to fire (Matell et al. 2003) (Figure 1.11). One cortical neuron may not represent one of the oscillators of the model, but instead a population of these neurons with a similar frequency of activity will have a pattern of global activity that resembles a sinusoidal, as modeled in the SBF. At the start of a stimulus, the activity of the oscillatory neurons is synchronized while they still oscillate at their own frequency, so that they quickly become desynchronized and their peak activity is rarely coincident. The striatal neurons can detect these coincident activations and, in doing so, encode the interval. With an increasing number of oscillators, an increasing amount of intervals can be encoded and stay different.

Learning in this model could involve long-term potentiation (LTP) facilitated by the dopamine release at the time of reinforcement (salient event) between the oscillators and the striatal neurons. The potentiation modifies the synaptic strengths of the medium spiny neurons, and acts as a filtering mechanism to limit their firing to specific durations, based on previous experiences, and therefore could represent the memory stage. The cortical oscillators would have the role of the clock (both pacemaker and accumulator), whereas the firing of the medium spiny neurons is the decision stage (Matell and Meck 2000).

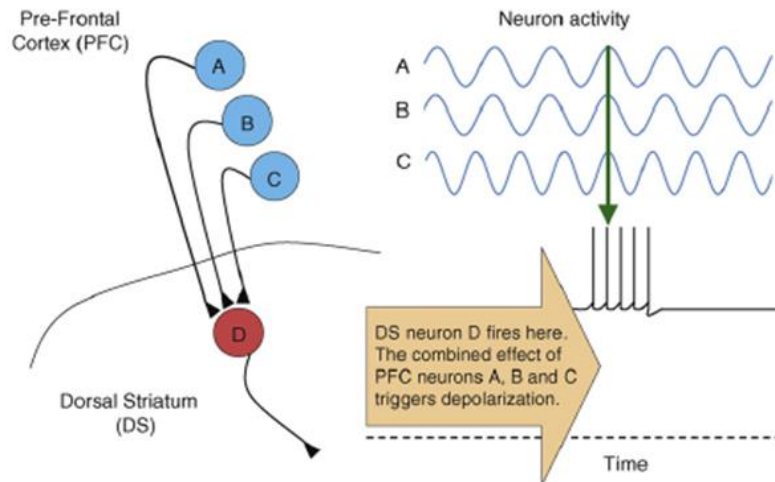


Figure 1.11: Explanation of the working of the Striatal Beat Frequency model. Neurons from the PFC converge on a single medium spiny neuron (D) of the dorsal striatum. When the three cortical neurons (A, B, C) are active at the same time then the depolarization of the striatal neuron is sufficient for it to start firing. From Meck et al., 2008.

The Adaptive Character of Thought-Rational (ACT-R) model is often used to explain behavior (e.g. Anderson et al., 1998; van Maanen et al., 2012). It can be integrated to the SBF model to create a more comprehensive model of timing and memory (Figure 1.12). This SBFn model explains more complex temporal behaviors, such as the simultaneous encoding of multiple durations (van Rijn et al. 2014). The memory and decision stages of the SBF are replaced by the ones from ACT-R. All memories stored in this memory component are subject to decay (Gonzalez et al, 2003) and blending (i.e. a memory is modified by previous memories, such as context). Therefore, a duration is going to be considered longer if the context is “short” and vice versa for long, which follows Vierordt’s law (see Chapter 1.I.B.). Also when using this model, the scalar property has to originate from the clock component and not the memory stage (since ACT-R cannot explain the scalar property). The authors add this aspect by having the pacemaker produce pulse with a gradually decreasing rate, this means that for longer durations the pulses are farther apart, inducing a larger uncertainty (van Rijn et al. 2014).



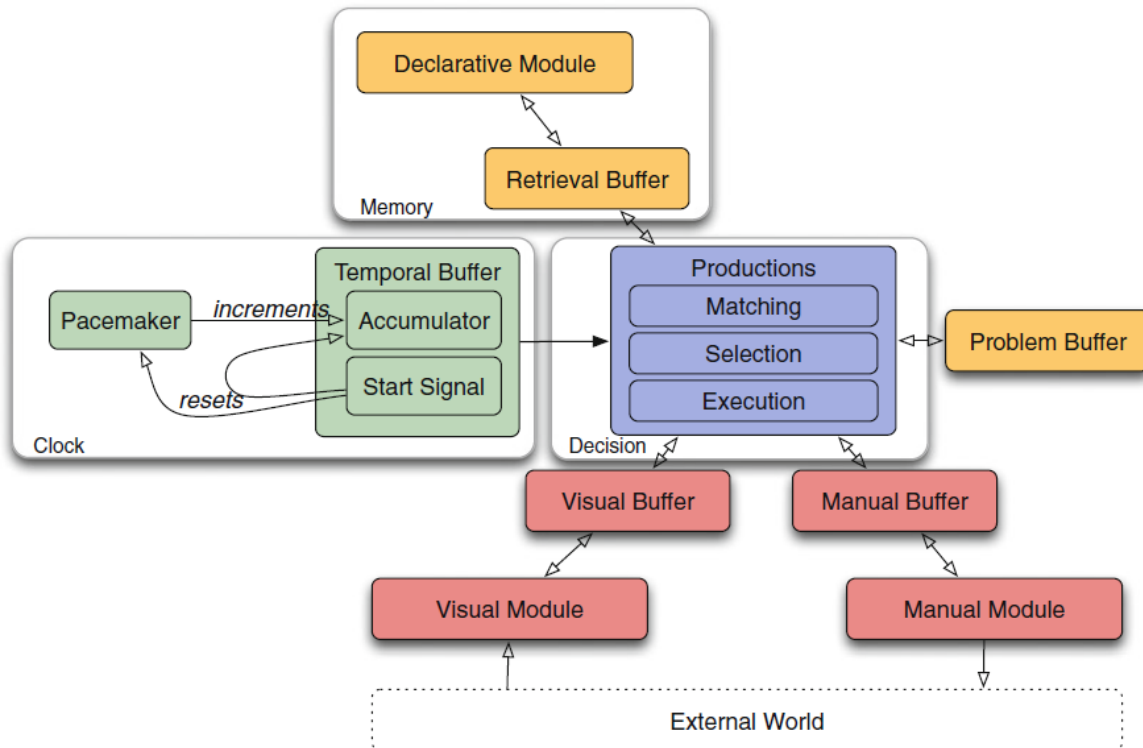


Figure 1.12: An outline of the integrated-architecture timing model. The Clock component is similar to the clock stage found in SET. The Decision and Memory components, as well as the other components, are provided by ACT-R. The color of the components matches the colors used in Figure 9. From Van Rijn et al., 2014.

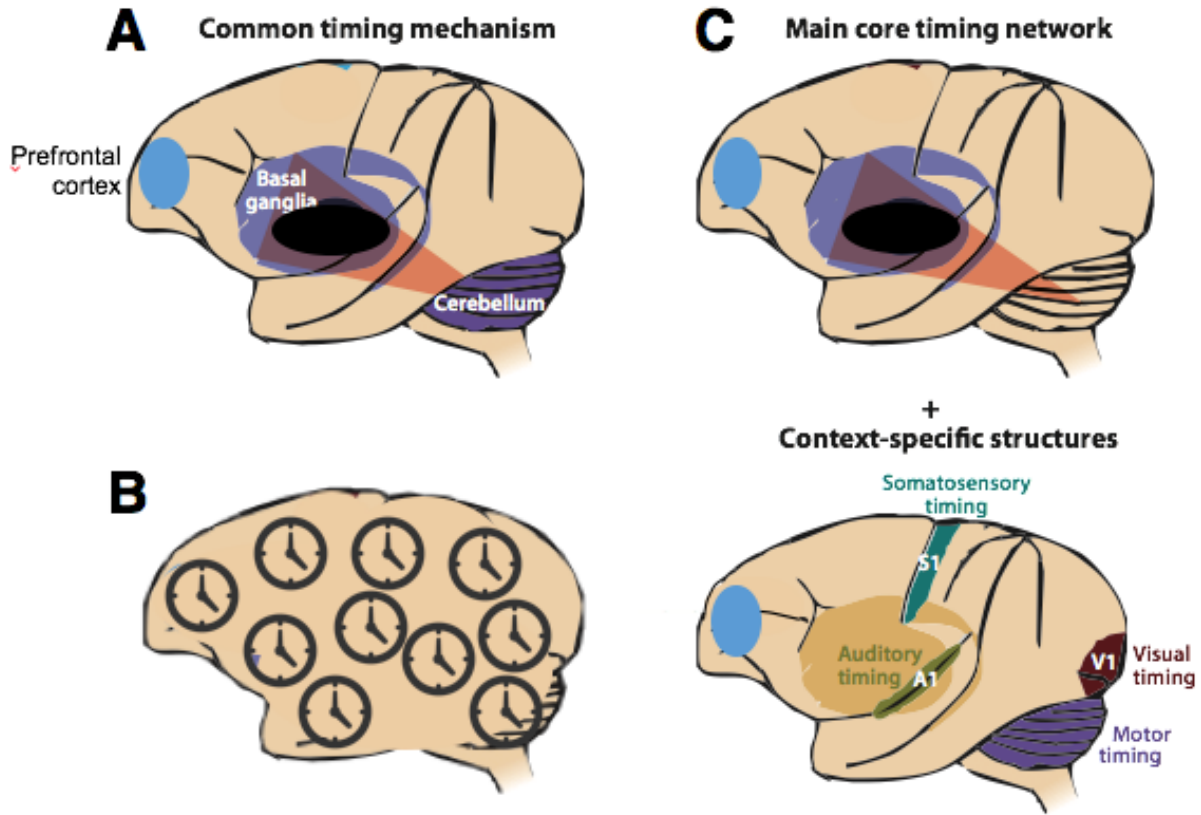
None of these psychological models have been proven to exist in a biological unit and only the SBF has tried to find a neural basis for its function, the cortico-striatal network. However, many studies have looked at brain recordings to try to determine how time is encoded in the brain.

## II. NEUROBIOLOGICAL BASIS OF INTERVAL TIMING

One of the core debates on the neurobiological basis of timing is whether it is dependent on one central timing center or if timing is present all over the brain in separate clusters (Figure 1.13A-B). One of the arguments for a central clock is the fact that, in different tasks, there is a similar temporal variance at least for larger than hundreds of milliseconds intervals (Gibbon et al. 1997). There is also a strong correlation between performance in self-paced timing tasks and duration discrimination, implying again the use of a common timing mechanism (Keele et al. 1985).

However, other studies support the hypothesis that every cortical circuit has the capacity to time and that there are local clocks that are activated depending on the type of task or stimuli (Karmarkar and Buonomano, 2007, Figure 1.13B). *In vitro* studies, testing circumscribed cortical networks, have demonstrated the possibility of independent autonomous cortical clocks. In effect, Johnson et al (2010) showed that chronic rhythmic stimulation in organotypic cortical slices (auditory and somatosensory) can entrain the cell activity to reflect the intervals between stimulation, in the hundreds of milliseconds range. Chubykin et al (2013) have shown that it is possible to « teach » an interval of time to a slice of primary visual cortex by using a carbachol infusion as the US and electrical stimulation of the underlying white matter as the CS, while they recorded neurons from layer 5. Changing the interval between the CS and the US provoked a change in the responses of the neurons so that they shifted to the new time. The response described is a decreasing ramping of spikes that reaches basal level at the expected time of arrival of the US. In a basal state, this threshold is reached at around 1s and it can be shifted later or earlier by changing the “CS-US” interval. It is, therefore, possible to have “reward” timing in a very simple system consisting only of a part of the primary visual cortex, and this learning is dependent on cholinergic innervations (Chubykin et al. 2013).

Another hybrid mechanism has been described, where there is a main core timing module (the cortico-thalamo-striatal network) that interacts with task dependent areas that may be specifically involved according to stimulus modality or task demands, such as implicit vs. explicit timing (Figure 1.13C, Coull et al., 2013; Merchant et al., 2008).



**Figure 1.13: Representation of three possible timing mechanisms in the brain.** (A) There is a main timing circuit in the brain that involves the basal ganglia, the cerebellum and the PFC. It sends temporal information to the rest of the brain. (B) Timing is present everywhere and is a basic feature of neurons or neural networks. (C) A main timing circuit (constituted of the basal ganglia and the PFC) is always involved in timing and specialized regions, such as the visual cortex or the cerebellum, are used depending on the context. Adapted from Merchant et al., 2013.

To address these issues, it is necessary to look at neuronal activity from a single neuron to populations of neurons in multiple brain areas in different types of tasks. Functional magnetic resonance imaging (fMRI) gives a very precise spatial resolution, but lacks temporal precision (usually in a range of a few seconds to a few minutes), which is the opposite of the data given by electroencephalography (EEG) which is only spatially precise for cortical structures but has a better temporal resolution than fMRI (in the range of milliseconds). Magnetoencephalography (MEG) has both high spatial and temporal resolution (less than a millisecond) in cortical and more subcortical structures but requires the structure to be oriented (i.e. a majority of neurons in the structure must

follow the same direction). *In vivo* recordings in awake animals give access to single and population neuronal activity with high temporal resolution in any brain area. Patterns of single cell firing activity and synchronous spike activity of neural ensembles could reflect a local processing of time. They can generate depolarization/hyperpolarization slow oscillatory rhythms either locally (through recurrent networks) or in distant brain areas. Neural oscillations are an ubiquitous property of brain function and have important roles in learning, memory and cognitive processes such as those involved in timing and time perception (for reviews see, Buzsáki and Draguhn, 2004; Buzsáki et al., 2013; Hanslmayr and Staudigl, 2014; Matell and Meck, 2004). Slow (<50Hz) oscillations are associated with large fluctuations of neurons' membrane potential and cover large brain areas, whereas fast oscillations result from smaller fluctuations in membrane potentials and are restricted to smaller neural volumes. Changes in oscillatory rhythms may represent timing function at network level.

## **A. Electrophysiological correlates of temporal processing**

### **1. Population encoding in humans**

The neural correlates of timing have been studied a lot in humans using different techniques ranging from fMRI to EEG and MEG that do not permit the same temporal or spatial resolution as electrophysiology recordings in animals. As a brief summary, a few structures have been detected as active during timing tasks across a lot of different studies; the supplementary motor area (SMA), the pre-SMA, the PFC, the striatum, the inferior parietal cortex and the cerebellum (Lewis and Miall 2006; Brannon et al. 2008; Coull et al. 2011; Harrington et al. 2004, 2010; Wiener et al. 2010b). The pre-SMA (or rostral SMA) seems more involved in perceptually based timing in the supra-second range whereas the caudal SMA may be more important for sensorimotor based timing in the sub-second range (Schwartz et al. 2012). However, timing of a stimulus offset may be encoded in the corresponding sensory cortex (van Wassenhove and Lecoutre 2015).

Wiener et al (2010b) wrote a meta-analysis and showed that the structures involved often depend on the type of task and on the durations used. As usual, it is important to have many controls so that the effects observed are really due to timing processed and not to working memory or another

cognitive aspect of the task. Often the phase of temporal processing (encoding, maintenance and decision) is overlooked. Wiener et al (2010b) concluded that only two main structures are involved in temporal encoding: the PFC and the SMA. Harrington and collaborators (2010) used an auditory temporal discrimination task with, as controls, a pitch discrimination task (with similar difficulty) and a sensory task, which allows dissociating structures involved in sensory discrimination *versus* the ones involved in timing. They increased the delay between the two measured durations, to be able to separate structures involved in timing from structures involved in working memory. The striatum is the only structure that was more active during the encoding of durations than during the maintenance. The SMA and pre-SMA had a high activity for both encoding and maintenance. However, all of these structures show a higher activity for the timing task than for the sensory tasks. The cerebellum and frontal cortex were more active in the timing paradigm only in the decision stage. When separating types of timing tasks, explicit timing seems to involve a fronto-striatal network (SMA, right inferior frontal cortex and basal ganglia) (Coull and Nobre 2008; Coull et al. 2013), whereas implicit timing activates the left inferior parietal cortex and the right PFC (Coull and Nobre, 1998; Coull et al., 2000; Vallesi et al., 2009; Wiener et al., 2010a).

These experiments are in agreement with the idea that there is a main circuit for timing and annex structures that are involved depending on the context. The main circuit seems to be a cortico-basal ganglia-thalamic network as those are the structures revealed in multiple timing tasks (Allman et al. 2014; Merchant et al. 2013a; Coull et al. 2011, 2013). Furthermore in a rare study of supra-seconds intervals in humans, a fronto-striatal circuit activation was observed in a PI task (Hinton and Meck 2004). However, we are still far from understanding the specific roles of these structures in temporal detection, encoding, memorization or comparison.

## 2. Single cell recordings in animals

Studies of single cell recordings associated with passing time are numerous (more than 70 separate studies in a range of species, see Table 1.1 and 1.2) and cover several decades of research. As a brief summary, we can observe five main patterns of responses that encode durations in single cells: ramping activity (increasing or decreasing across time), phasic activity at the beginning or end of a stimulus (that is proportional to the duration of the stimulus), activity at various regular temporal

units (absolute time cells), sustained activity, and peak activity at a specific time point (relative time cells).

Ramping activity, when a neuron's firing rate increases with passing time, has been observed in many studies (e.g. Donnelly et al., 2015; Fuster et al., 1982; Knudsen et al., 2014; Kojima and Goldman-Rakic, 1982; Paz et al., 2006; Sakai, 1974; Soltysik et al., 1975) and may represent the increased expectation of the animal. It is difficult to know whether expectation is similar to timing since it may involve different mechanisms, such as the accumulation of activity over time or an increase in attention until a given stimulus has finished, rather than precise temporal control. Trying to look at ramping activity in a more temporal way, Donnelly et al (2015) used a delay task in which the animal has to wait for 5s before making a nose poke response after the onset of the trial. At the end of the 5s, a light comes on (for 500ms) and indicates in which hole the animal must go, a task which requires a high attention level to detect the cue. The authors compared correct responses with premature responses (when the animal did not wait for the cue to respond), and they found that ramping activity in both PFC and striatum started earlier in premature trials. However, the slope of the curve was similar, so that the activity reached the threshold for action earlier on premature trials than on correct trials. This may explain why animals responded earlier on those trials. The authors saw no ramping activity in trials where the animal did not respond. Ramping activity has also been associated with the hazard function (Riehle et al. 1997; Renoult et al. 2006; Lucchetti and Bon 2001; Heinen and Liu 1997; Leon and Shadlen 2003; Janssen and Shadlen 2005) as it often correlates with increased expectation.

It is also possible to observe different amplitudes of phasic responses to a stimulus (either at the onset or at the offset) depending on its known length. They have been shown in a range of durations (from 1 to tens of seconds) and could be used to discriminate between durations (Fiorillo et al. 2008; Sakurai et al. 2004; Ohmae et al. 2008; Jaramillo and Zador 2011; Yumoto et al. 2011; Roux et al. 2003; Chiba et al. 2008, 2015). For example, Fiorillo et al (2008) used a Pavlovian appetitive task where the different CSs predicted the length of the CS-US interval. The authors showed progressively smaller onset responses coupled with increasingly larger responses to the US for increasing CS-US durations.

*Table 1.1: Temporal correlates of time at the single cell level in explicit timing tasks*

Cx = Cortex

Tasks	Brain structures	Species	Durations (in s)	Results				References
				Ramping activity	Sustained activity	Phasic response at onset or offset of cue	Relative timing cells	
Time production	Motor Cx	rat	1 - 2	X	X		X	Knudsen et al. 2014
	Premotor Cx	monkey	2.5 - 4.5	X				Lebedev et al. 2008 ;
	Presupplementary Cx Supplementary motor Cx	monkey	2 - 8	X				Mita et al. 2009; Roux et al. 2003
Time reproduction	Prefrontal Cx	monkey	2 - 7		X	X		Yumoto et al. 2011
	Premotor Cx	monkey	0.45 - 1				X	Merchant et al. 2013b
	Prefrontal Cx	rat	1.5 - 2.5	X			X	Xu et al. 2014
		rat	12	X				Parker et al. 2014
Peak interval	Medial agranular Cx	rat	10 - 40				X	Matell et al. 2003
	Primary visual Cx	rat	10 - 20	X			X	Matell et al. 2011
		rat and mice	1 - 2		1.2		1.2, 3	Chubykin et al. 2013; Liu et al. 2015; Shuler and Bear, 2006
	Striatum	rat	10 - 40				1.2	Matell et al. 2003; Portugal et al. 2011
Differential reinforcement of low rates (DRL)	Prefrontal Cx	monkey	2	X	X			Niki and Watanabe, 1979
	Hippocampus	rat	15	X				Young and McNaughton, 2000
Limited hold (LH)	Prefrontal Cx	pigeon	1.5	X				Kalenscher et al. 2006
	Ventral striatum	monkey	1				X	Shidara et al. 1998
	Primary visual Cx	rat	1.5		X		X	Namboodiri et al. 2015
Temporal discrimination	Prefrontal Cx	monkey	0.2 - 2	1,2,3,4	4	1,2,3,4		Genovesio et al. 2006, 2009; Oshio et al. 2006, 2008
		rat	3 - 4	X			X	Kim et al. 2013
	Parietal Cx	monkey	0.3 - 0.8	X				Leon and Shadlen, 2003
	Striatum	monkey	0.2 - 2			X		Chiba et al. 2008, 2015
	Motor Cx	monkey	0.6 - 1.2	X		X		Roux et al. 2003
Serial fixed interval	Hippocampus	rat	1 - 3			1		Nakazono et al. 2015; Sakurai. 2002
	Dorsal striatum	rat	10 - 60				X	Mello et al. 2015

Table 1.2: Temporal correlates of time at the single cell level in implicit timing tasks

Tasks	Brain structures	Species	Durations (in s)	Results				References
				Ramping activity	Sustained activity	Phasic response at onset or offset of cue	Relative timing cells	
Pavlovian aversive delay	Auditory Cx	rat	2				X	Armony et al., 1998; Quirk et al., 1997
	Prefrontal Cx	rat	30		X			Pendyam et al., 2013
Pavlovian aversive trace	Basal amygdala	rat	30		X			Pendyam et al., 2013
	Prefrontal Cx	rat	20	X				Gilmartin and McEchron, 2005
Pavlovian appetitive delay	Hippocampus	rabbit	10 - 20				X	McEchron et al., 2003
	Amygdala	monkey	2		X			Bermudez et al., 2012
Pavlovian appetitive trace	Nucleus accumbens	rat	10					Day et al., 2006
	Substantia nigra	monkey	1 - 16s			X		Fiorello et al., 2008
Pavlovian appetitive trace	Orbitofrontal Cx	mice	2		a			Zhou et al., 2015
	Basolateral amygdala	cat	1.5	X				Paz et al., 2006
Pavlovian appetitive trace	Parietal Cx	monkey	0.5 - 2	X				Janssen and Shadlen, 2005
	Prefrontal Cx	monkey	0.5 - 2.5	2,4,5,6	5	1		Jin et al., 2009; Joseph and Barone, 1987; Narayanan and Laubach, 2009; Rainer et al., 1999; Sakurai et al., 2004; Tsujimoto and Sawaguchi, 2005
Delayed matching to sample / working memory	Prefrontal Cx	rat	0 - 20					Horst and Laubach, 2012
	Prefrontal Cx	monkey	2 - 20	1.2			2, 3	Brody et al., 2003; Fuster et al., 1982; Kojima and Goldman-Rakic, 1982
Delayed matching to sample / working memory	Orbitofrontal Cx	monkey	0.5 - 2.5			X		Roesch and Olson, 2005
	Motor Cx	monkey	0.5 - 2.5	2, 3	2	3		Narayanan and Laubach, 2009; Ohmae et al., 2008
Delayed matching to sample / working memory	Premotor Cx	monkey	2 - 4	1.2	1,2,4		4	Hikosaka et al., 1989; Jin et al., 2009; Soltysic et al., 1975; Tremblay et al., 1998
	Striatum	monkey	2 - 5	X			X	Schultz et al., 1992
Delayed matching to sample / working memory	Ventral striatum	monkey	1 - 30	X	X			Hampson and Deadwyler, 2003
	Subiculum	rat	0.7 - 1.2	X				Sakon et al., 2014
Delayed matching to sample / working memory	Hippocampus	monkey	10 - 20					Gill et al., 2011; Kraus et al., 2013; MacDonald et al., 2011, 2013; Pastalkova et al., 2008
	Hippocampus	rat	10 - 20				X	Jaramillo and Zador, 2011
Delayed matching to sample / working memory	Primary auditory Cx	rat	0.3 - 1.5			X		Sakai, 1974
	Prefrontal Cx	monkey	3-6	X			X	Lucchetti and Bon, 2001; Lucchetti et al., 2005
Delayed matching to sample / working memory	Premotor Cx	monkey	0 - 5	X				Komura et al., 2001
	Premotor Cx	rat	0 - 2	X				Donnelly et al., 2015
Delayed matching to sample / working memory	Posterior thalamus	rat	5	X				Miyazaki et al., 2011
	Prefrontal Cx	rat	1.5 - 20		X			Totah et al., 2013a
Delayed matching to sample / working memory	Dorsal raphe	rat	8	X				Apicella et al., 1992; Hikosaka et al., 1989; Sardo et al., 2000
	Ventral tegmental area	rat	8	X				Donnelly et al., 2015; Khamassi et al., 2008
Delayed matching to sample / working memory	Striatum (caudate and putamen)	monkey	1.5 - 4.5	1,2,3,4	4			Crowe et al., 2014; Merchant et al., 2011, 2013b
	Striatum	monkey	0.45 - 1	2	2		1, 2, 3	Bartolo et al., 2014
Delayed matching to sample / working memory	Ventral striatum	rat	1 - 5	2			1	
	Ventral striatum	rat	0.45 - 1	2			1, 2, 3	
Entrainment	Premotor Cx	monkey	0.45 - 1	2	2			
	Striatum	monkey	0.45 - 1				X	



Absolute time cells have been described in the hippocampus (Pastalkova et al. 2008; MacDonald et al. 2011, 2013; Kraus et al. 2013), in the PFC (Sakurai et al. 2004; Jin et al. 2009; Kojima and Goldman-Rakic 1982; Horst and Laubach 2012; Oshio et al. 2008; Kim et al. 2013), in the basal ganglia (Jin et al. 2009; Mello et al. 2015) and in the premotor cortex (Merchant et al. 2011). To describe those timing cells, MacDonald and collaborators have used a go/no-go paradigm with a delay. The rat has to remember the object that is presented at the beginning of a trial for 10s to know if it should dig or not to get a reward. During this delay, neurons in the hippocampus fire sequentially to cover the whole duration and this firing can be rearranged if the duration is changed (MacDonald et al. 2011). Most neurons were modulated by both space and time, and few neurons depended only on time. They have shown that this activity is not dependent on locomotion, on speed or on head placement (MacDonald et al. 2011, 2013). More recently, Mello et al (2015) have described such timing cells in the dorsal striatum of rats in a serial FI task. They showed that striatal neurons become active at a specific time points during an interval and that this pattern of activity is modulated by the duration of the interval. There is a temporal rescaling of those striatal neurons, and their activity does not seem due to motor responses. Therefore, these “time” cells seem similar to the space cells described in the hippocampus (O’Keefe and Dostrovsky 1971) and may interact with those cells to form spatio-temporal maps of events.

It is difficult to differentiate a sustained activity due to the presence of the stimulus from a sustained activity representing the duration, when the stimulus is present during the whole duration to be timed. For example, sustained activity is often described in working memory task and may represent the maintenance of the stimulus in short-term memory (Hikosaka et al. 1989; Soltysik et al. 1975; Hampson and Deadwyler 2003; Narayanan and Laubach 2009; Ohmae et al. 2008; Tremblay et al. 1998). Namboodiri et al (2015) have shown very recently that the primary visual cortex can encode time with sustained activity, and with peak activity at the time where the motor action is necessary. They used a modified DRL-LH (Differential reinforcement of low rates with limited hold) type of task, in which the rat, a variable amount of time after a nosepoke, received a visual stimulus from goggles and could then lick to receive a water reward. The longer the animal waited the bigger the reward, however if the animal waited for more than 1.5s then there was no reward. It is very important in this task for the animal to be precise in the timing of its licking behavior to receive a bigger reward but not miss a reward. They calculated that the optimal time of

responding is 1.1s, which is very close to what the rats did. By separating trials depending on whether they were timed to the visual stimuli or to the nose poke entry, the authors determined that 10% of the cells they recorded in the primary visual cortex were timing units. The activity of these cells was highly correlated with the behavioral timing, but only on trials that were visually-timed. Furthermore, their activity preceded slightly the behavior. Optogenetic modulation of this activity induced a shift in behavior to earlier responding. They conclude that the primary visual cortex has a role in controlling the timing of highly stereotyped actions (Namboodiri et al. 2015). Their experiment controls very well for non-timing related activity and shows that sustained activity can be involved in encoding intervals of time.

Relative time activity, an increase or decrease of the firing rate of a neuron at the end of a learned interval (usually reinforcement time or when the animal must respond), requires to be tested in paradigms in which the period post-expected US can be studied (probe trials), like in a PI procedure. This is probably why it has been described in only a few studies (less than 15). Using such a task, Matell et al (2003) have shown that some neurons in the PFC and in the striatum show pattern of responding that are very similar to the temporal behavior of the rat and seem to represent the time of reinforcement. In the case of tasks with no probe trials, it is difficult to know if the activity is ramping or represents relative time, because we cannot see the post-expected reinforcement activity. For example, Narayanan and Laubach (2009) showed ramping activity in the dorsomedial PFC, which seems to reach a plateau just before the arrival of the reinforcement; on a probe trial it might have peaked and gone back to baseline level after the expected time of reinforcement. Relative time cells have also been described in implicit timing tasks, like Pavlovian conditioning. Armony et al (1998) and Quirk et al (1997) described a late tone-induced response that appeared after training in the auditory cortex of rats. This was an increase in firing late in the CS just before the arrival of the US so that the activity does not increase from the beginning of the CS like in the case of ramping activity.

### 3. Population encoding in animals

In comparison to the studies of unit activity in timing and of oscillations in humans, fewer papers have focused on population level activity related to time in animals (Tables 1.3 and 1.4).

Nonetheless, they cover a large range of model species and of time intervals, as well as explicit and implicit tasks similar to the ones studied with unit recordings. Different techniques can give us a view of neural activity at the population level in animals, such as multiunits recordings, local field potentials (LFPs, which represent the oscillatory activity of a population of cells and can be recorded in any brain structure), calcium imaging, microdialysis, and PET-scan (Positron Emission Tomography), but with a wide range of temporal resolution (from the millisecond range to the minute range). It is possible to observe similar patterns of activation as in unit data in some of the recordings that have good temporal resolution, like multiunits, LFP and calcium imaging.

Even fewer studies have used explicit temporal tasks to look at population encoding of time (Table 1.3). In a temporal discrimination task using PET scan imaging in monkeys, Onoe et al, (2001) showed modifications in blood flow in specific structures that were correlated to the length of the estimated interval. Those structures included the dorsolateral PFC, the basal ganglia, the posterior inferior parietal cortex and the posterior cingulate cortex. The paradigm of this study was a visual temporal discrimination task with short intervals (under 1.5s). These results confirm the lesions and inactivation studies showing the importance of the striatum and PFC in interval timing. Event related potentials (ERPs) can be measured from the local EEG signal and represent an electrophysiological response to a stimulus. ERPs can be modulated by timing, as shown in rats by Onoda et al (2003, 2006). They used an auditory time discrimination task, with a simple reaction time task as a control. They showed an involvement of the frontal cortex, the hippocampus and the cerebellum in discriminating between 2s and 8s (Onoda et al. 2003) and of the frontal cortex, striatum, hippocampus, thalamus, and cerebellum for durations shorter than 2s (Onoda and Sakata 2006). Matell and Meck (2004) have proposed that the ERP signal could be representative of the reset of the cortical neurons at the beginning of a stimulus in the SBF model which would seem logical with the observation of a time dependent ERP in the frontal cortex in both tasks. However, those types of recordings do not give precise information on when during temporal learning those structures are involved.

Several frequency bands are observed at the same time in LFPs' recordings of awake and behaving animals. Most frequency bands have been described in several mammalian species and neural oscillations seem to be a conserved phenomenon across mammalian evolution (Buzsáki et

al. 2013). Looking at the synchronicity of oscillations in different structures, also called coherence, gives information on the communication between those structures (for more information on oscillations and their analysis, see the introduction of Chapter 3). When two structures are highly coherent, this makes information transfer easier since the other structure is already primed to receive the spiking activity from the first.

Looking at oscillations, Nakazono et al (2015) showed a sustained increase in theta power (4-9 Hz) in the hippocampus during the comparison between a 1s stimulus and a 3s stimulus in a temporal discrimination task. Thus, the hippocampus may be involved in the decision stage of the clock (the comparison between memorized and measured durations). Contradictorily, using a PI task, Hattori and Sakata (2014) found a correlation between the temporal behavior and the striatum theta wave (6-12 Hz), but not between the behavior and the hippocampal theta band. Parker et al (2014) have shown a correlation between timing behavior and unit ramping activity in the medial PFC that was itself coherent with a burst of 4 Hz oscillations. Timing was impaired when disrupting dopamine signaling in the PFC, and the impairment was correlated with a decreased 4-Hz burst of oscillations and single unit ramping activity.

*Table 1.3: Temporal correlates of time at the population level in explicit timing tasks*

Tasks	Brain structures	Species	Durations (in s)	Results				References
				Frequency band	PSD	Coherence	Other	
Temporal discrimination	Frontal Cx Hippocampus Cerebellum	rat	2 - 8				ERP	Onoda et al, 2003
	Frontal Cx Striatum Thalamus	rat	0.5 - 2				ERP	Onoda and Sakata, 2006
	Hippocampus	rat	1 - 3	theta (4-9 Hz)	X			Nakazono et al, 2015
	Dorsolateral prefrontal Cx Posterior inferior parietal Cx Posterior cingulate Cx Striatum	monkey	0.4 - 1.5				Increased blood flow	Onoe et al, 2001
Peak interval	Striatum	rat	30	theta (6-12 Hz)	X			Hattori and Sakata, 2013
	Medial prefrontal Cx	rat	12	theta (4 Hz)	X			Parker et al, 2014

*Table 1.4: Temporal correlates of time at the population level in implicit timing tasks.*

Tasks	Brain structures	Species	Durations (in s)	Results				References
				Frequency band	PSD	Coherence	Other	
Pavlovian appetitive delay	Substantia nigra	monkey	2 – 16				Multiunits (phasic onset response)	Kobayashi and Schultz, 2008
	Striatum Basolateral amygdala	cat	3	gamma (35-45 Hz)		X		Popescu et al, 2009
	Auditory Cx	rat	10	gamma (50-80 Hz)	X			Headley et al, 2011
Pavlovian aversive delay	Basal amygdala	cat	15	theta (4-7 Hz)			Multiunits and cross-correlograms	Paré and Collins, 2000
	Hippocampus Lateral amygdala	mice	10	theta (5-6 Hz)				Pape et al, 2005
Pavlovian appetitive trace	Rhinal Cx Basolateral amygdala	cat	1.5	gamma (35-45 Hz)	X			Bauer et al, 2007
	Lateral habenula	zebrafish	20 - 30				Increased calcium activity	Cheng et al, 2014
Entrainment	Hippocampus	mice	0.15	theta (4-12 Hz)	X			Abe et al, 2014
	Striatum	monkey	0.45 - 1	beta (10 - 30 Hz) gamma (30 - 80 Hz)	X			Bartolo et al, 2014
	Piriform Cx	rat	240				amino acid increase (glutamate and GABA)	Hegoburu et al, 2009
Expectation	Anterior cingulate Cx Prelimbic Cx	rat	8	delta (1 - 4 Hz) theta (8 - 12 Hz)	X	X		Totah et al, 2013
	Motor Cx	monkey	0.7 - 2	beta (12-40 Hz)	X			Kilavik et al, 2012

For implicit tasks (Table 1.4), such as Pavlovian conditioning, most studies observed ramping activity throughout the timed stimulus. Kobayashi and Schultz (2008), recording multiunit activities in a Pavlovian appetitive conditioning, have shown modulated responses in dopamine neurons of the substantia nigra after the onset of a CS depending on the CS-US interval it predicted; for longer CS-US intervals, the response at the onset was decreased, and the response after the reward increased. In rats, in a Pavlovian aversive paradigm, Headley and Weinberger (2011) measured LFPs in the auditory cortex. In a representation across time, there was a decrease in power in the gamma range and an increase in theta power during the CS. In an appetitive Pavlovian trace conditioning in cats, Bauer et al (2007) observed a ramping low gamma activity in the rhinal cortices, the basolateral nucleus of the amygdala (BLA) and the lateral nucleus of the amygdala (LA) but only after overtraining. In a task in which the animal must pay attention for 8s to detect the visual stimulus that indicates which hole to choose between three, Totah and collaborators (2013) recorded LFPs in two regions of the PFC, the anterior cingulate cortex (ACC) and the prelimbic cortex (PL). They showed an increase in delta oscillations power (1-4 Hz) in a ramping manner in the ACC only in correct trials (incorrect trials are any trials where the animal made the wrong choice), and a sustained increase in the PL. Kilavik et al (2012) showed an increase in the beta band power related to temporal preparation for a motor response in the motor cortex of two monkeys performing a reaching task with two different delays. The much shorter durations used compared to the previous experiments (0.7 – 2 s range) may not have allowed for the characterization of a ramping pattern.

In entrainment tasks, in which a stimulus is presented at regular intervals, the observed change is usually an increased activity at the entrained frequency even after removal of the stimulus. For example, Abe et al (2014) showed an increase in theta power in the hippocampus of mice at 150ms intervals following the pattern of the presented 4 KHz sound. Bartolo et al (2014) showed entrainment in beta and gamma bands in the striatum of monkeys during an internally driven rhythmic tapping task with intervals ranging from 450ms to 1s. Very recently, in zebrafish larvae, entrainment to a visual stimulus was observed in the lateral habenula (similar to the mammalian structure) with an increased calcium metabolism at the expected time of arrival of the fixed neutral stimulus (Cheng et al. 2014). Meanwhile for longer durations (4 min), Hegoburu et al (2009) saw transient amino acid increases (GABA and glutamate) in the piriform cortex of rat during an

olfactory Pavlovian aversive conditioning, in which trials are given at a regular interval. These increases were present at the regular interval after training even without presentation of the CS, meaning that the animals seemed to have encoded the inter-trial interval (ITI). They did not observe such increases in the amygdala.

Looking at the connectivity between structures, Popescu et al (2009) detected an increase in gamma band coherence between the BLA and the striatum during the CS with a peak at the arrival of the reward that was bigger for the CS associated with the US than for the CS not associated with the US; this appeared with training. In the study by Pape et al (2005), there was a progressive increase in correlated theta power between CA1 of the hippocampus and the LA across the CS in an aversive Pavlovian delay paradigm in mice. Totah and collaborators (2013) showed that coherence (in a 12 Hz band), between two sub-structures of the PFC (ACC and PL), was increased in a ramping manner during the 8s in which the rat had to stay focused to detect a very rapid visual stimulus. They also looked at phase-locking of spikes to oscillations, meaning whether spikes are repeatedly more present at certain phases of the oscillation. Phase-locking of spikes with delta oscillations in the ACC was increased significantly more in correct than incorrect trials just before the presentation of the stimulus (2s before). The same pattern was observed in the PL for phase-locking of spikes to beta oscillations (13-30 Hz). Therefore, oscillatory correlates of time have been described in diverse regions of the cortex as well as in subcortical structures, like the striatum, hippocampus and amygdala.

## **B. Why an amygdalo-prefronto-striatal network?**

### 1. Prefronto-striatal network and time

Based on the previous paragraphs, it is clear that the striatum and the PFC (among many other brain areas) show neural correlates of time in a wide range of situations. Furthermore, these two structures have also been studied in the domain of interval timing using lesions and pharmacology. The importance of the striatum and dopamine neurotransmission in timing has been described for a long time in both humans and animals (e.g. Agostino et al., 2011; Cheng et al., 2007; Coull et al., 2012, 2011; Gu et al., 2011; Höhn et al., 2011; Jones and Jahanshahi, 2011; Lake and Meck, 2013;



Meck, 2006; Pleil et al., 2011). This is in accord with reports of timing dysfunction in Parkinson's disease where dopamine transmission is low (e.g. Harrington et al., 2011; Jones et al., 2008) and in Huntington's disease where the striatum is degenerating (e.g. Höhn et al., 2011; Paulsen et al., 2004; Rowe et al., 2010). However, some Parkinson's patients presented no deficit in a time perception task (Wearden et al. 2008) and in motor timing (Spencer and Ivry 2005). Of course, these effects may depend on the stage of the disease and on the clinical variability of symptoms between patients. Interestingly, deep brain stimulation of the subthalamic nucleus improved temporal performance in Parkinson patients, another proof of the important role of the basal ganglia in timing (Koch et al. 2004a).

The PFC has also been linked with a timing function for many years. Indeed, acetylcholine production in the frontal cortex seems involved in the memory and comparison stage (Meck 1996). Furthermore, blocking dopamine receptors D1 in the PFC impairs temporal control in a FI task, whereas selectively activating prefrontal neurons that express this receptor improve performance (Narayanan et al. 2012). The PFC is critically involved in simultaneous temporal processing, meaning measuring two durations at once, as shown by lesion studies (Meck and MacDonald 2007; Olton et al. 1988; Pang et al. 2001). Moreover, lesions of the PFC in humans usually lead to impulsive behavior, a sign of deficient timing (Bechara et al. 1994; Berlin et al. 2004). Deficits in timing tasks have also been observed after disruptions of activity in the PFC using transcranial magnetic stimulation (TMS) (Jones et al., 2004; Koch et al., 2003; for a review of the effects of TMS on timing, see Koch et al., 2009). In the opposite manner, TMS of the PFC in patients with Parkinson disease's improved their temporal perception in a temporal reproduction task (Koch et al. 2004b). The role of a cortico-striatal network in timing has been extensively described in imaging and recordings studies (for reviews, see Buhusi and Meck, 2005; Durstewitz, 2004; Ivry and Spencer, 2004; Meck and Benson, 2002).

The PFC and the striatum have many other roles, including roles in Pavlovian conditioning (for a review on the network involved in aversive conditioning, see Herry and Johansen, 2014; for a review on the role of the PFC in aversive conditioning, see Courtin et al., 2013). The PL seems involved in the expression of fear, whereas the infralimbic cortex is more implicated in extinction

(Sotres-Bayon and Quirk 2010). The dorsal striatum is involved in motor responses and also in decision making (Balleine et al. 2007).

## 2. Amygdala and neural correlates of time (see Annex, article n°4: Diaz-Mataix et al, 2014)

An open question remains whether the amygdala has a role in computing temporal intervals. It should be noted that most lesions of the amygdala do not induce any deficits in typical timing tasks (e.g. Meck and MacDonald, 2007; Olton et al., 1987). However, since lesions of the amygdala block learning of aversive associations, it is not possible to know the role of the amygdala in learning the temporal aspect of aversive conditioning by using lesions. Indeed, the amygdala is the main structure involved in Pavlovian aversive conditioning (for reviews, see Herry and Johansen, 2014; LeDoux, 2014). It should be noted that the amygdala is divided in many sub-nuclei, two of which have the most impact in aversive conditioning: the BLA and the central nucleus of the amygdala (CeA). The BLA is the main sensory input region of the amygdala, whereas the CeA is the major output center of the amygdala (for a review, see Marek et al., 2013).

The amygdala has been shown to be involved in timing in both human and animal studies, but its involvement seems to be dependent on the parameters of the experiment (duration or valence of the stimulus and strength of training, among them). Timing long durations with few training trials does not seem to involve the amygdala (Rorick-Kehn and Steinmetz 2005; Maren 2000; Hegoburu et al. 2009; Quirk et al. 1997). On the other hand, neural correlates of time were observed in the amygdala when using overtrained subjects and when looking at a population activity, such as LFPs, fMRI and MEG (Applegate et al. 1982; Paré and Collins 2000; Paz et al. 2006; Bauer et al. 2007; Popescu et al. 2009; Rorick-Kehn and Steinmetz 2005; Pape et al. 2005; Bermudez et al. 2012; Seymour et al. 2005; Moses et al. 2007). However, none of these studies have directly looked at the involvement of the amygdala in timing by using temporal tasks that permit a precise modulation of temporal expectations, like in the PI task. The amygdala has also been shown to have a role in detecting changing CS-US time intervals, as specific inactivation of protein synthesis in this area (by injection of anisomycin) inhibits reconsolidation after temporal error detection (Díaz-Mataix et al. 2013). In a more general manner, the amygdala is involved in error detection in both humans and animals (Moses et al. 2007; Metereau and Dreher 2012; Seymour et al. 2005; Wood et al. 2012;

Herry et al. 2007; Dunsmoor et al. 2008; Boll et al. 2012; Belova et al. 2007; Johansen et al. 2010; Bucci and Macleod 2007; Furlong et al. 2010; Calu et al. 2010; Roesch et al. 2010). As error detection is based on the memory of previous temporal intervals, the results suggest a role of the amygdala in comparing durations.

Although not focusing directly on the role of the amygdala in encoding time, some studies have used the PI task to examine the role of the interaction between the PFC and the amygdala in interval timing. Indeed, the insertion of an emotional cue (positive or negative) in the to-be-timed stimulus produces a disruption of the temporal behavior (i.e. temporal underestimation) (Aum et al. 2004, 2007; Brown et al. 2007; Matthews et al. 2012; Meck and MacDonald 2007). Matthews et al (2012) found that the involvement of the PFC in timing was differently affected by infusion of nomifensine (dopamine and norepinephrine reuptake inhibitor) depending on the presence or absence of an aversive distractor. On the other hand, Meck and MacDonald (2007) found that this impairment in timing is prevented by lesion of the amygdala, but not by lesioning the PFC. The latter result provides evidence for the importance of the amygdala in the attentional control of temporal processing.

### 3. Amygdalo-prefronto-striatal connectivity

Like discussed previously, the PFC, the striatum and the amygdala are involved in temporal processes and associative learning. Therefore, the study of the reciprocal relationships between the amygdala and these areas might bring a better understanding of the mechanisms and neural substrates underlying the processing and storage of the CS-US interval in Pavlovian associations. Furthermore, descriptive studies of anatomical connectivity have shown (1) reciprocal connections between the BLA and the PFC, and (2) unidirectional connections from BLA to striatum, from PFC to striatum (McDonald 1991b, 1991a; Courtin et al. 2013; Felix-Ortiz et al. 2015; Hart et al. 2014), as well as a major efferent pathway from the PFC to the striatum (McGeer et al. 1977) (Figure 14). More specifically, the PL part of the PFC projects to the BLA (McDonald et al. 1996; McDonald 1998). Moreover, Guo et al (2015) described monosynaptic inputs from both PL and BLA to the striatum. More specifically, both the BLA and the PL project to the dorso-medial striatum (dmSTR) (Voorn et al. 2004; Gabbott et al. 2005). Connectivity between the amygdala, the PFC and the

striatum has also been shown in non-human primates by using bi-directional tracer injection (Cho et al. 2013b).

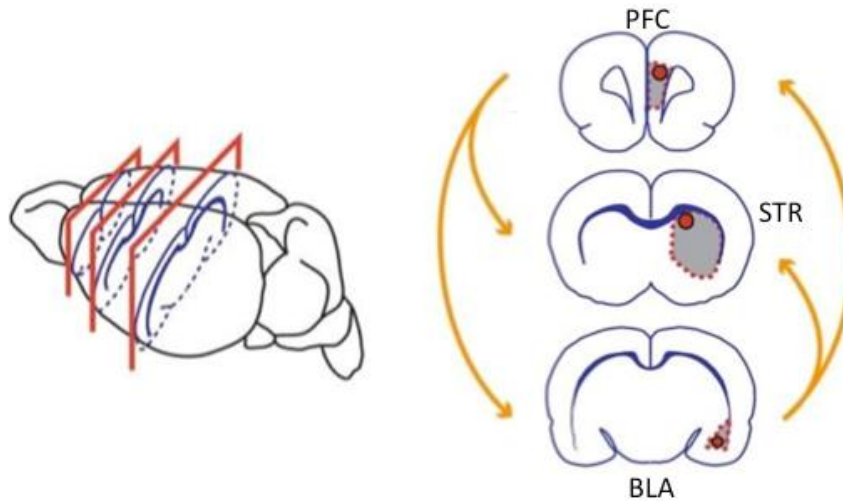


Figure 1.14: Amygdalo-prefronto-striatal connectivity. The arrows represent mono-synaptic connections between structures.

Interactions between these brain areas have been studied in emotion processing. The interaction between the PFC and the amygdala has been described in fear encoding and extinction (e.g. Arruda-carvalho and Clem, 2014; J.-H. Cho et al., 2013; for a recent review, see, Marek et al., 2013). Arruda-Carvalho and Clem (2014) used optogenetic to study specifically the inputs from the PL and the infralimbic cortex (IL) to the BLA. The authors showed that aversive conditioning strengthened the excitatory synapses between PL and BLA but not between IL and BLA. Also, interestingly, electrical stimulation of the PFC decreases the output of the CeA evoked by the BLA (Quirk et al. 2003). It seems that the amygdala produces a powerful inhibition on the activity of the PFC by acting on local interneurons, as measured in anesthetized rats (Dilgen et al. 2013). Furthermore, the indirect connection between the CeA and the dorsal striatum is involved in conditioned freezing to a cue, but not to the context, as shown using asymmetrical lesions in rats (Ferreira et al. 2008). The role of this amygdalo-prefronto-striatal network connectivity in aversive tasks has also been described in humans. Collins et al (2014) have shown that high synchronization between PFC and amygdala, as well as between PFC and caudate nucleus (caudate and putamen in primates form a similar structure to the striatum in rodents, with the putamen being the dorso-lateral striatum and the caudate the dorso-medial as well as the ventral striatum) are correlated with good performance in an active avoidance task

### III. THESIS OBJECTIVES

In summary, time is an essential parameter of learning, and is embedded in most behaviors. However, the neurobiological basis of how we encode and memorize intervals of time is still unknown, even though many psychological models of timing have been developed over the past 50 years. The previous paragraphs have hopefully convinced you that the PFC, the striatum and the amygdala are involved in temporal processes, among other structures, and also that timing is probably dependent on a network of structures; even though temporal patterns of neuronal responding are present in many brain areas and may be a fundamental characteristic of neurons.

The work realized during this PhD was dedicated to observing neural correlates of time during a very simple learning task, a Pavlovian aversive conditioning paradigm, in which timing is implicitly learned as a basis of the association, but precise temporal responding is not necessary. We concentrated on a network of three structures that are highly involved in both associative conditioning and time, the amygdalo-prefronto-striatal network. By using an electrophysiological and a development approach, we aimed at characterizing some of the neural correlates of time in this network.

In chapter 2, we asked whether rats can present a precise temporal behavior in Pavlovian aversive conditioning by using conditioned suppression (i.e. the presentation of a CS previously associated with an aversive US will suppress the instrumental appetitive response that the animal has previously learned). We used various analyses both on the average behavior and on individual trials to characterize the temporal behavior of rats in this task. Furthermore, we tested how rats responded to the insertion of a “pause” during the CS, and showed that this gap shifts the rats’ temporal behavior.

In chapter 3, we recorded LFPs in our network of interest (amygdalo-prefronto-striatal) and looked for neural correlates of time early in learning, and after overtraining. We observed such correlates in the amygdala, the striatum and the PFC as well as in the interaction between those structures.

In pre-weaning rats, both the striatum and PFC are immature, while the amygdala is functional. Therefore, in chapter 4, we looked at pre-weaning rats and their ability to memorize and compare temporal intervals. For this, we tested whether changing the CS-US interval in a Pavlovian aversive conditioning would trigger reconsolidation of the pups' long-term aversive memory. Our results suggest that the amygdala may be sufficient for temporal processing early in life.



## **CHAPTER 2**

# **Study of temporal behavior in a conditioned suppression task**





# **Article n°1: Individual trial analysis evidences clock and non-clock based conditioned suppression behaviors in rats**

Behavioural Processes, in press

## **Individual trial analysis evidences clock and non-clock based conditioned suppression behaviors in rats**

Lucille Tallot<sup>1</sup>, Daphné Capela<sup>1</sup>, Bruce L. Brown<sup>2</sup> & Valérie Doyère<sup>1</sup>

<sup>1</sup>Univ Paris-Saclay, Univ Paris-Sud, CNRS, Institut des Neurosciences Paris-Saclay, UMR 9197, Orsay, France

<sup>2</sup>Department of Psychology, Queens College, and the Graduate Center, The City University of New York, Flushing, NY 11367, USA

Corresponding authors: Lucille Tallot (lucille.tallot@gmail.com) and Valérie Doyère (valerie.doyere@u-psud.fr)

## Abstract

We analyzed the temporal pattern of conditioned suppression of lever-pressing for food in rats conditioned with tone-shock pairings using either a 10 or 15s conditioned stimulus (CS)-unconditioned stimulus (US) interval with a CS duration that was three times the CS-US interval. The analysis of average suppression and of individual trials was performed during Probe CS-alone trials and when a short gap was inserted during the CS. The pattern of suppression followed the classical temporal rules: (1) scalar property, (2) a shift in peak suppression due to a gap, compatible with a Stop rule, (3) a three-state pattern of lever-pressing in individual trials, with abrupt start and stop of suppression. The peak of the average suppression curve, but not the middle time, was anticipatory to the programmed US time. The pattern of lever-pressing in individual trials unraveled two types of start of suppression behavior: a clock-based biphasic responding, with a burst of lever-pressing before suppression, and a non-clock based monophasic reduction of lever-pressing close to the CS onset. The non-clock based type of behavior may be responsible for the anticipatory peak time, and the biphasic pattern of lever-pressing may reflect the decision stage described in clock models.

*Keywords:* interval timing; fear conditioning; start/stop; gap; peak procedure

## 1. Introduction

Interval timing, the capacity to estimate time intervals in the range of seconds to minutes, is critical in everyday life, in particular to prepare for action in a most efficient manner. For example, being capable of estimating the time between the lightning and the thunderclap will help you decide whether you have time to run back home or should protect yourself on site, decisions that may save your life in extreme situations. In Pavlovian aversive conditioning, the laboratory experimental equivalent, the subject not only learns that a conditioned stimulus (CS) predicts the arrival of an unpleasant noxious stimulus (unconditioned stimulus, US), but also *when* the US is due to arrive. Although the CS-US interval is learned very rapidly, the emergence of a temporally organized behavior related to the expectancy of US arrival may take tens to hundreds of pairings, depending on the behavioral index analyzed (Davis et al. 1989; Díaz-Mataix et al. 2013; Balsam et al. 2002; Drew et al. 2005; Bevins and Ayres 1995; Shionoya et al. 2013).

The question of the neurobiological bases of timing remains. While the neurobiology of Pavlovian aversive conditioning has been very well described over the years from a cellular to a network level (Herry and Johansen 2014; LeDoux 2014), the study of timing characteristics has mostly been limited to instrumental appetitive conditioning. As the neural circuitry underlying instrumental appetitive conditioning differs from the one involved in Pavlovian aversive conditioning (Hollerman et al. 2000; Herry and Johansen 2014; LeDoux 2014), one may wonder whether temporally modulated behavior may also differ depending on the type of task used. Alternatively, if timing is subserved by the same neuronal circuit whatever the task, we would expect no such differences. Therefore, differences in some aspects of temporal behavior depending on the type of task used could inform us on the possible existence of a single internal clock.

The study of interval timing in a Pavlovian aversive task has been sparse. LaBarbera and Church (1974), using a conditioned suppression paradigm (Estes and Skinner 1941) in which foot-shock USs were given at regular intervals while rats were lever-pressing for food, showed that well-trained animals suppressed their lever-pressing following a temporal pattern that resembled the one seen in typical fixed interval (FI) instrumental appetitive tasks (Dews 1970; Schneider 1969). In other studies, when a foot-shock US was delivered at a fixed time after the onset of a CS and non-

reinforced probe trials were interleaved as in a peak interval (PI) paradigm, the pattern of suppression followed the typical Gaussian shape (Boulanger-Bertolus et al., in press.; Meck and MacDonald, 2007). Davis et al. (1989) also reconstructed this pattern in a potentiated startle preparation. Finally, Balsam et al. (2002) reported the expected bell-shaped curve of conditioned activity to an electrical shock in a Pavlovian preparation with goldfish. In rat studies, it was also observed that the temporal patterns conformed to the scalar property (e.g. temporal precision is proportional to the timed interval) as suppression curves for different intervals superimposed well when rescaled on a normalized time axis (Boulanger-Bertolus et al., in press.; LaBarbera and Church, 1974; Meck and MacDonald, 2007). These data suggest that the processes underlying temporal control of behavior in Pavlovian aversive conditioning may be the same as those in instrumental appetitive tasks. However, the time of maximal average suppression in rats was earlier than the programmed time of US arrival, suggesting that the peak of expectancy for the US was anticipated (Boulanger-Bertolus et al., in press.; Meck and MacDonald, 2007). This anticipation contrasts with the results classically reported in the instrumental appetitive PI task, for which the peak time falls in the temporal vicinity of the programmed reinforcement time or slightly after (Aum et al., 2007, 2004; Buhusi and Meck, 2006; Orduna et al., 2008; Roberts et al., 1989). In our study, we aimed at exploring the question of whether (1) the mean suppression curve reflects a single temporally controlled behavior, which could be anticipatory because of the nature of the task, or (2) several behaviors may be at play, so that the envelope of the mean suppression curve peaks at an earlier time.

Since Gibbon and Church's (1990) report, it is well established that rats' behavior, trained in an appetitive instrumental PI task, follows a binary response pattern on individual trials: stable rates of responding transition from a low level of responding to a high level and back to a low level with no intermediate rates (e.g. Aum et al., 2004; Balci et al., 2009; Church et al., 1994; MacDonald et al., 2012; Matell et al., 2006; Matthews et al., 2012). The times of state changes are called start and stop times, respectively, and are under the control of putative decision thresholds as incorporated in Scalar Expectancy Theory (SET, Church et al., 1994). The SET model is one of the foremost internal clock models of the past twenty years of timing research. It is based on the presence of a pacemaker that produces pulses that are accumulated across the duration of a salient event in an accumulator. The accumulated durations are saved in memory to be later compared to

currently measured intervals. As time elapses, if the contents of both accumulator and memory are sufficiently similar (above a set threshold) a decision to start responding is made, and then, when they become sufficiently dissimilar, a decision to stop responding is made. The recent literature has highlighted the importance of analyzing start and stop behaviors, as they may be independently manipulated, and may thus be more informative than the molar measure of peak time based on mean response rate functions (Matthews et al. 2012; MacDonald et al. 2012; Matell et al. 2006; Taylor et al. 2007; Balci et al. 2009). Whether the same type of start and stop behavior underlies the mean temporal bell-shaped curve of conditioned suppression is not known.

Interval timing processes in instrumental tasks have also often been analyzed using a gap procedure, where the impact of introducing a brief interruption in the to-be-timed stimulus is studied to enable assessment of underlying clock mechanisms. When a gap is added in a PI task, depending on the length of the gap and its position in the to-be-timed stimulus, the response of the animal is shifted in time (Roberts and Church 1978; Roberts 1981; Roberts et al. 1989; Meck and Church 1987; Cabeza de Vaca et al. 1994; Swearingen and Buhusi 2010). Three timing modes have been inferred: Run, Stop or Reset. In the Run mode, the clock continues to time during the gap, so there is no temporal shift in behavior. In Stop, the clock does not time during the gap but memory is retained of the time elapsed before the gap, so behavior is shifted by the duration of the gap. And finally, in Reset, the gap returns the clock to zero, and timing starts anew after the gap, i.e. from the second onset of the to-be-timed stimulus (Kaiser et al. 2002; Buhusi et al. 2006; Roberts 1981; Roberts and Church 1978). Gap trials have received a good deal of attention in interval timing research but studies have been limited to appetitive instrumental paradigms (Cabeza de Vaca et al. 1994; Meck and Church 1987; Orduña et al. 2008; Roberts and Church 1978; Roberts 1981; Roberts et al. 1989). In Pavlovian aversive tasks, the effect of a gap has been mainly studied through the use of trace fear conditioning, in which a gap is inserted between the CS offset and the US. The decrement in the conditioned response produced by that type of gap is well known, but little attention has been paid to temporal control. The impact of a gap interrupting the CS temporarily on CS-US interval processing has never been assessed, and it is thus not known whether in well-trained animals under Pavlovian aversive conditioning it would interrupt the timing of CS-US interval, and produce a Stop or Reset type of behavior as in instrumental tasks.

In the present study, we used a conditioned suppression paradigm with auditory fear conditioning in rats to assess the timing processes underlying temporal expectancy of the US. In those well-trained animals, we looked at the temporal pattern of the mean response rate function as well as individual trial behavior, and assessed the effects of a gap during the CS, while comparing two CS-US intervals.

## **2. Materials & Methods**

### **2.1. Subjects**

Behavioral experiments were carried out on 20 adult male Sprague-Dawley rats (Harlan Laboratories, France) in accordance with the guidelines of the European Community Council Directives of September 22nd 2010 (2010/63/UE) and the French National Committee (2013/118) for the care and use of laboratory animals. All efforts were made to minimize the number of animals used and their suffering. Rats were housed in standard laboratory cages five by five and maintained on a 12/12hr light/dark cycle. Rats were weighted daily (initial weight of approximately 300 - 350g) and reduced at 85-90% of their normal weight for the whole duration of the experiment. Training was run six days a week.

### **2.2 Apparatus and Stimuli**

Training took place in a set of four identical conditioning chambers (30 x 25 x 30 cm, Coulbourn Instruments, USA), equipped with a shock floor, a speaker, a lever and a food magazine that dispensed 45mg grain-based pellets (BioServ), and placed in sound attenuating enclosures with a ventilation fan (60dB background noise). Behavioral protocols were controlled by Graphic State software (Coulbourn Instruments, USA).

### **2.3 Conditioned Suppression Training and Gap Testing**

#### **2.3.1 Instrumental training (9 sessions).**

Following one day of magazine training (30 pellets were presented at random intervals), a lever press response for food was shaped in one or two sessions on a continuous reinforcement schedule where each lever press produced the delivery of one pellet as a reward. When a criterion of 60 lever presses in 30 min or less was met, a partial reinforcement schedule was added for seven

sessions with a variable interval of 30.5s (VI, 1-60s range). The rats presented an average of 60 lever presses per minute at the end of the VI training.

### **2.3.2 Conditioned suppression training (5 sessions).**

Animals underwent auditory Pavlovian aversive conditioning with a 7 kHz-80dB tone as a conditioned stimulus (CS) and a mild 0.3mA-0.5s footshock as an unconditioned stimulus (US), while the VI schedule of food reinforcement was maintained throughout the sessions. The rats performed an average of 50 lever presses per minute during this phase of the training. The intensity of the US was adjusted individually when necessary (see 2.3.3). Two groups of 10 rats received Pavlovian conditioning, each with different CS-US intervals, concurrently with the VI schedule for lever pressing. Each trial consisted of the presentation of a 45s-long CS with the US delivered at 15s for one group (group US@15s), or a 30s-long CS with the US at 10s for the other (group US@10s). Sessions consisted of 12 CS-US trials with intertrial intervals (ITIs) randomly chosen from a list with a mean of 3 min (120s, 150s, 180s, 240s and 300s). ITI values remained the same in all subsequent sessions.

### **2.3.3 Conditioned suppression with a peak-interval paradigm (PI) (30 sessions).**

While keeping CS-US trials, Probe trials consisting of the presentation of the CS alone were added to enable the analysis of temporal patterns of behavior. The first 24 sessions consisted of 16 trials with a mix of 12 reinforced trials (CS+US) and 4 Probe trials (CS alone). For the last six sessions the number of Probe trials was increased to 8 to prepare for the next phase (Gap tests). ITI values and trial types were randomly distributed, with the constraint that there could be no more than two successive trials of the same type. The rats reached a global level of lever-press responding of 80 responses per min after the 8<sup>th</sup> PI session, and this level was maintained for the rest of the experiment. During the first 3 weeks of training, the behavior of each individual rat was checked at the end of each week to visually assess if there was suppressive behavior or not; if not, then the shock intensity was increased by 0.05mA. The shock intensity was then maintained at that final level until the end of the experiment. Shock was increased to 0.5mA for 1 rat (group US@15s) and to 0.4 mA for 7 rats (4 from group US@15s and 3 from group US@10s).

### **2.3.4 Gap tests (6 sessions).**



Sessions consisted of 20 trials with a mix of 12 reinforced trials (CS+US), 4 Probe trials (CS alone) and 4 Gap trials (CS+gap). For the Gap trials, the tone CS had a pause of 3s, starting 3s after the tone onset for the group US@15s, and a pause of 2s starting at 2s after the tone onset for the group US@10s, and no US was delivered.

## 2.4 Data Analysis

Only Probe trials and Gap trials were analyzed for the last 6 sessions of PI training and the 6 sessions of Gap testing. To characterize the temporal pattern of behavior, the number of lever presses per bin of 0.5s was recorded for 10s before the CS (baseline) and for the entire duration of the CS (including the gap if present). We then calculated for each rat a mean suppression ratio across all sessions following the formula:  $y = 1 - [b/(a+b)]$ , where  $b$  is the mean number of presses for each bin during the CS, and  $a$  the mean number of presses per bin during the pre-CS period. A suppression ratio of 0.5 represents no suppression, i.e. a similar level of presses during CS than during the pre-CS, whereas a value of 1.0 represents complete suppression. The mean suppression curve for each rat was fitted using a Gaussian function with a ramp (Peak-fit software) with the following formula:

$$y = A_3 * \exp(-0.5 * (((X - A_1) / A_2))^2) + A_4 * (X - A_1) + A_0 - 0.5$$

with  $A_0$  as the basal level of suppression,  $A_1$  as the center of the function,  $A_2$  as standard deviation ( $\sigma$ ),  $A_3$  as the value of the peak and  $A_4$  as the slope of the ramp. In all figures,  $A_1$  was taken as the peak time and  $[2 * A_2]$  as the width of the temporal function, and the mean suppression ratio is represented following smoothing using a 3s-sliding window.

In appetitive instrumental peak interval tasks, responding in individual trials has been described as a three-state function delimited by start and stop times, representing when the judgment of similarity between elapsed time and the time of programmed reinforcement reaches a first decision threshold when response rate increases, followed by the time when it reaches a second decision threshold value when response rate decreases (Gibbon and Church, 1990). In the present protocol, however, start and stop times would correspond to the start of suppression (i.e. reduction in lever-press rate) and the termination of suppression (i.e. increase in rate). Measures derived from start and stop times provide an estimate of remembered time (middle time =  $[\text{start} + \text{stop}] / 2$ ), and a variability estimate similar to the psychophysical interval of uncertainty (spread = stop – start). We subjected the data of individual trials to a regression analysis using a custom Power Basic program

(described in Aum et al., 2004) that yielded the proportion of variance accounted for ( $\eta^2$ ) by the three-state model on each trial. For each trial, an exhaustive search of the data was conducted for the best-fit start and stop times. The search for start began 1s after the tone onset in half-second steps for all Probe and Gap trials. A minimum duration of 4s was set for the second state. Trials that could be fitted with a high-low-high three-state pattern were considered as showing good temporal control at both start and stop times ('late onset' trials). For the remaining trials, a subset were successfully fitted with a high-low-high pattern if the 10s pre-CS period was included in the analysis, thus representing trials for which the suppression was too soon after tone onset for the 3-state fit to be possible ('early onset' trials). The third category corresponds to the remaining trials that could not be fitted with the high-low-high pattern ('bad' trials). Median and interquartile of start, stop, spread and middle times were calculated for each animal.

Group (mean  $\pm$  SEM) data were subjected to Student t-tests or one-way ANOVA (GraphPad Prism, v6.0), with an alpha level of .05. Furthermore, the effect size was measured for all significant tests by Cohen's d test using the following website: [http://www.psychometrica.de/effect\\_size.html](http://www.psychometrica.de/effect_size.html).

### **3. Results**

#### **3.1 Temporal pattern of behavior during Probe trials**

##### **3.1.1 Mean suppression curves.**

The mean suppression curves of both groups during the last week of PI training showed a classical temporal pattern, with an increase in suppression level that reached a maximum close to the expected time of arrival of the shock and then returned to pre-CS level (Fig. 1A). Notably, however, the time at which the suppression was maximal was significantly earlier than the programmed time of US arrival (US@15s: mean =  $10.86 \pm 0.37$ ,  $t(9) = 11.1$ ,  $p < .001$ ; US@10s: mean =  $7.45 \pm 0.55$ ,  $t(9) = 4.62$ ,  $p = .0013$ ).

We first verified that the temporal behavior in our conditioned suppression paradigm followed the scalar property of time (precision is inversely proportional to the duration timed; Gibbon, 1977). Indeed, the best superposition between the mean curves from the two groups (normalizing the suppression ratio by its mean) was obtained after a multiplicative transformation

of the time axis by a 1.5 factor ( $\eta^2 = .97$ , Fig. 1B), compared to an additive transform (translation of 5s,  $\eta^2 = .93$ ) or to no transform ( $\eta^2 = .91$ ). The scalar property was confirmed through the analysis of the width of the curves, a measure of temporal precision. Weber's fraction (width/peak time) did not differ between the two groups (US@10s:  $1.33 \pm .54$  and US@15s:  $.86 \pm .13$ ;  $t(18) = .82$ ,  $p = .42$ ). Group mean widths did not differ between groups US@15s and US@10s after the multiplicative transform (Fig. 1E,  $t(18) = 0.54$ ,  $p = .60$ ), while they did differ when they were not modified (additive and no transform:  $t(18) = 2.54$ ,  $p = .02$ ,  $d = 1.14$ ). Interestingly, the same was true for the peak time (Fig. 1F, multiplicative transform:  $t(18) = .34$ ,  $p = .74$ .; no transform:  $t(18) = 5.12$ ,  $p < .001$ ,  $d = 2.29$ ; additive transform:  $t(18) = 2.37$ ,  $p = .03$ ,  $d = 1.1$ ), a result that suggests that the anticipated maximal suppression also followed a proportional rule.

### **3.1.2 Individual trial analysis.**

It is now well established that the animal's behavior in instrumental appetitive peak interval tasks follows a three-state pattern at the level of individual trials (Gibbon and Church 1990; Matthews et al. 2012; MacDonald et al. 2012; Matell et al. 2006). We determined whether the same rule applies in the conditioned suppression task, with start and stop times that would, respectively, indicate the beginning and end of a period of suppression of lever pressing by analyzing the data from the last week of PI training. We first concentrated on the group for which the US was delivered at 15s. Visual examination of data on individual trials indicated that for some trials a substantial decrease in lever pressing occurred just after the onset of the sound, which would potentially prevent the detection of a start time on these trials if only the CS period was included in the analysis (see Fig. 2A for an example).

The results from the 3-state analysis program (see Material & Methods) were thus grouped in three categories, (1) 'late onset' trials, for which a high-low-high pattern could be fitted using only the data within the CS period, in the same way as previously done in the literature (Gibbon and Church, 1990); (2) 'early onset' trials, for which a high-low-high pattern was detected only when adding the pre-CS data; and (3) 'bad' trials, the remaining trials for which no high-low-high pattern could be detected. There were on average a similar number of trials in each category (Fig. 2B). Furthermore, the proportion of each type of trial was similar from the second week of training (data not shown), indicating that the temporal behavior had reached a stable state. Mean suppression

ratios for each of the three categories of trials exhibited a visible temporal pattern for the three types of trials, but with a lower level of suppression for the ‘bad’ trials (Fig. 2C). For those trials, the level of lever-pressing during the pre-CS period (baseline for suppression calculation) was significantly lower than for the two other types of trials (one-way ANOVA,  $F(2,8) = 25.70$ ,  $p < .001$ ,  $d = 2.39$  with Bonferroni multiple comparisons showing a significant difference between ‘late onset’ and ‘bad’ ( $p = .003$ ) and between ‘early onset’ and ‘bad’ ( $p < .001$ ); Fig. 2D) trials, a result that may explain why it was impossible to detect the 3-state pattern. The distribution of start times was skewed toward the onset of the trial, although to a lesser extent for ‘late onset’ trials than for ‘early onset’ trials (Fig. 2E). Interestingly, the distribution of stop times followed a Gaussian-like distribution that was similar for both ‘early onset’ and ‘late onset’ trials (Fig. 2F).

Focusing on the ‘late onset’ trials only, the alignment of lever-pressing to the start time for each individual trial showed the expected abrupt decrease in lever-pressing behavior (Fig. 3B) as well as the expected abrupt increase in lever-pressing when aligned to the stop times (Fig 3C). This validates the hypothesis that, in our paradigm, suppression behavior followed start and stop rules. Of most interest is the burst of lever-pressing behavior around the start and stop times (visible in a representative individual trial, Fig. 3A). Notably, when the same analysis was made for the ‘early onset’ type of trials, this biphasic pattern was no longer visible for the start times (Fig. 3B), while the pattern for the stop times remained unchanged (Fig. 3C). It should be noted that both of these patterns were found as early as the second week of probe training (data not shown). We assessed whether start, stop and spread were correlated as classically reported, that is, a positive correlation between start and stop, as well as between stop and spread, and a negative correlation between start and spread (Gibbon and Church, 1990). Start and stop times were poorly correlated (mean of all rats’ correlations:  $0.10 \pm 0.12$ ; not significantly different from 0:  $t(9) = 0.80$ ,  $p = .45$ ), while start and spread were negatively correlated (mean correlation:  $-0.33 \pm 0.07$ ; significantly different from 0:  $t(9) = 4.6$ ,  $p = .001$ ) (Fig. 3D-F represents the values for each rat). Stop and spread times were positively correlated to a higher extent (mean correlation:  $0.78 \pm 0.06$ ; significantly different from 0:  $t(9) = 13.28$ ,  $p < .001$ ).

The mean ( $\pm$ SEM) start, stop, spread, and middle times, and the relative spread (spread/middle time) obtained for the two groups for the ‘late onset’ trials are shown in Table 1.

The proportion of ‘late onset’ trials was similar for both groups (US@15s =  $37 \pm 7\%$  and US@10s =  $41 \pm 5\%$ ). The two groups differed significantly in spread times ( $t(18) = 3.59, p = .002, d = 1.58$ ), in agreement with the scalar property. Furthermore the relative spread did not differ between the two groups ( $t(18) = 0.91, p = .37$ ). While stop and middle times differed (stop:  $t(18) = 3.29, p = .004, d = 1.47$ ; middle:  $t(18) = 2.27, p = .036, d = 1.01$ ), the start times ( $t(18) = 0.65, p = .53$ ) did not differ significantly between the two groups. Notably, the middle times were either not different from or later than the programmed US time (US@15s,  $t(9) = 0.40, p = .70$ .; US@10s,  $t(9) = 2.38, p = .041$ ), in contrast to the result obtained with peak times on the mean suppression curves (see Fig. 1A and part 3.1.1). The interquartile range for all the measures did not differ significantly between the two groups (start:  $t(18) = .05, p = .96$ ; stop:  $t(18) = 1.17, p = .26$ ; spread:  $t(18) = 0.35, p = .73$ ; middle,  $t(18) = 1.14, p = .27$ ).

### 3.1.3 Impact of ‘early onset’ behavior on suppression functions.

When the ‘bad’ and ‘early onset’ trials were discarded, the resulting average suppression curve peaked later, closer to the programmed US time. In a comparison of all trials vs. ‘late onset’ trials, there was a significant shift in mean peak time for both group US@15s,  $10.86 \pm 0.39$  vs.  $12.83 \pm 0.49, t(9) = 3.3, p = .004, d = 1.48$ , and US@10s,  $7.45 \pm 0.58$  vs.  $8.77 \pm 0.25, t(9) = 3.11, p = 0.013, d = 1.15$ ), although peak time still remained significantly different from the programmed US time on ‘late onset’ trials (US@15s:  $t(9) = 4.66, p = .001$ ; US@10s:  $t(9) = 5.2, p < .001$ ).

## 3.2 Gap Tests

### 3.2.1 Mean suppression curves.

Introducing a gap during the CS shifted the mean suppression curve to the right for both groups when looking at all trials (Fig. 4A-B). Peak times were significantly shifted to the right by the insertion of the gap (Gap peak time vs. Probe peak time, US@15s:  $t(9) = 6.84, p < .001, d = 2.22$ ; US@10s:  $t(9) = 3.71, p = .005, d = 1.05$ , Fig. 4C-D), implying that the clock did not follow a Run mode during the gap. For both groups, the shift in peak time was significantly smaller than the Reset prediction (Gap peak time vs. [Probe peak time + 6s] for US@15s,  $t(9) = 4.41, p = .002, d = 1.43$ ; Gap peak time vs. [Probe peak time + 4s] for US@10s,  $t(9) = 6.82, p < .001, d = 1.93$ ), but did not differ from the Stop prediction (Gap peak time vs. [Probe peak time + 3s] for US@15s,  $t(9) = 1.22, p = .25$ ; Gap peak time vs. [Probe peak time + 2s] for US@10s,  $t(9) = 1.55, p = .15$ ). There was no

significant difference in the widths of the curves between Probe and Gap trials (US@15s,  $t(9) = .12$ ,  $p = .91$ ; US@10s,  $t(9) = 2.06$ ,  $p = .07$ ; Fig. 4E-F), consistent with an additive effect of the gap on the temporal shift in the suppression function. Furthermore, Weber fraction for Probe and Gap trials was significantly different for the US@15s group ( $t(9) = 3.60$ ,  $p = .006$ ,  $d = 1.19$ ) showing that the shift by the gap did not follow the scalar property. This was not the case for the US@10s group, ( $t(9) = 0.24$ ,  $p = .81$ ) possibly because the shift was small. Thus, the behavior of the animals followed a Stop rule where time did not accumulate during the gap, but memory of pre-gap duration was retained across the gap.

### 3.2.2 Individual trial analysis.

The effects of a gap on start, stop and middle times as well as on the spread were analyzed for both US@15s and US@10s groups. For both Probe and Gap trials, starts were measured from 1s after the onset of the CS without inclusion of pre-CS lever-presses (i.e., the data shown represents only ‘late onset’ type of behavior). For both groups the distribution of start times was modified in Gap trials with a majority of the start times shifted after the end of the gap (Fig. 5A-B). Statistical analyses showed that for group US@15s (Fig. 5C), there was a significant shift in time for start (Probe vs. Gap,  $t(9) = 5.37$ ,  $p < .001$ ,  $d = 1.40$ ) and middle ( $t(9) = 2.43$ ,  $p = .04$ ,  $d = 1.05$ ) times, but the shift did not reach significance for stop times ( $t(9) = 1.78$ ,  $p = .11$ ). For group US@10s (Fig. 5D), the effects were similar, but a significant difference between Probe and Gap trials was found for stop ( $t(9) = 3.0$ ,  $p = .015$ ,  $d = 0.98$ ) but not for middle times ( $t(9) = 2.16$ ,  $p = .06$ ) and start times ( $t(9) = 1.37$ ,  $p = .20$ ). There was no effect of the gap on the spread (US@15s:  $t(9) = .92$ ,  $p = .38$ ; US@10s:  $t(9) = 1.97$ ,  $p = .08$ ), which suggest that the effect of the gap was not scalar. Furthermore, the relative spread of individual trial values was significantly different between Probe and Gap trials for the US@15s group ( $t(9) = 3.1$ ,  $p = .014$ ,  $d = 0.75$ ) confirming the results obtained for the molar analysis. Also similarly to the average measures, there was no significant difference between the relative spread of Probe and Gap trials for the US@10s group ( $t(9) = .68$ ,  $p = 0.51$ ).

As the gap had an effect on start, stop and middle times, we tested whether these values were shifted following a Stop or Reset rule compared to the values obtained during the Probe trials. The magnitude of the shifts in start and middle times for the US@15s group confirmed that the animals’ behavior followed a Stop rule (Probe + gap duration) and not a Reset (Probe + gap + pre-gap

durations) rule (for start times, Stop:  $t(9) = 1.53$ ,  $p = .16$  and Reset:  $t(9) = 8.06$ ,  $p < .001$ ,  $d = 2.25$ ; for middle times, Stop:  $t(9) = .20$ ,  $p = .84$  and Reset:  $t(9) = 2.79$ ,  $p = .011$ ,  $d = 1.23$ ). This was not as clear for the US@10s group where the shifts of both stop and middle times did not differ significantly from the Stop nor the Reset rule predictions (for stop times, Stop:  $t(9) = 1.26$ ,  $p = .24$ . and Reset:  $t(9) = .47$ ,  $p = .64$ ; for middle times, Stop:  $t(9) = .34$ ,  $p = .74$  and Reset:  $t(9) = 1.50$ ,  $p = .087$ ). The insertion of the gap had no effect on the interquartile range of start, stop, middle times and spread for either group ( $t(9) < 1.7$ ,  $p > 0.13$ , Figure 5E-F). In sum, the individual trial analysis confirmed the analysis performed on mean suppression curves, although the effects were less reliably obtained. Thus, the insertion of a gap of  $1/5^{\text{th}}$  of the CS-US interval during the CS, at  $1/5^{\text{th}}$  of the CS-US interval after the CS onset produced a shift in temporal behavior compatible with a Stop rule of the timing processes.

An examination of response rate aligned at start time is depicted for Probe and Gap trials for both groups (Fig. 5G-H), and shows a burst of lever-pressing before abrupt suppression in both types of trials for the two groups. This biphasic pattern of behavior was also observed for the few trials for which the start time was very close ( $< 2\text{s}$ ) after the CS onset (13% and 14% of trials for US@10s and US@15s, respectively) or after the end of the gap (27% and 22% of trials for US@10s and US@15s, respectively) (data not shown). Thus, the biphasic pattern of lever-presses when the animal starts suppressing was not modified by the insertion of the gap.

#### **4. Discussion**

We have shown that conditioned suppression's temporal behavior follows similar rules to those for appetitive instrumental peak interval tasks. We observed that in individual trials behavior was consistent with a 3-state pattern (high-low-high level of lever-pressing), and that the insertion of a gap during the CS produced a shift of the suppression function toward the right. Both mean suppression curves and individual trial analyses converged on the conclusion that the magnitude of the shift was compatible with a Stop rule, as if the clock stopped timing during the gap while pre-gap duration was held in memory. Importantly, the individual trial analysis has evidenced two types of suppression behavior, one with a biphasic pattern of lever-pressing at start time, observed in the 'late onset' trials, the other with a monophasic abrupt suppression at start time, observed in

the ‘early onset’ type of trials. The latter type of behavior was at least in part responsible for the anticipatory peak times of the mean suppression curves, as we observed a peak time closer to the programmed US time when the analysis was restricted to the ‘late onset’ trials. Interestingly, as in previous studies (Balsam et al., 2002; Drew et al., 2005), the middle time was closer to the programmed US time than the peak time.

The comparison of Probe trials for two CS-US intervals (15 and 10s) tends to confirm that the conditioned suppression of well-trained rats exhibited a temporal pattern that conformed to the scalar property, both when analyzed at the molar and molecular levels. Both the widths of the mean suppression curves and the spread times on individual trials showed a longer duration of suppression when the animals were trained with a 15-s CS-US interval than with a 10-s interval, and the curves best superimposed with a multiplicative transform. Furthermore, the Weber fraction and the relative spread was similar for both durations. These results thus confirm previous reports (Boulanger-Bertolus et al., in press.; LaBarbera and Church, 1974; Meck and MacDonald, 2007) and extend them to behavior observed during individual trials. Of note, though, is the lack of a change in start times, which may indicate that they were not completely under temporal control (see below for more discussion on this point).

When a gap with a duration of 1/5th of the CS-US interval was inserted at 1/5th of the CS-US interval after the CS onset (i.e. 3s gap starting at 3s after CS onset in the case of the 15s CS-US interval; 2s gap starting at 2s after CS onset in the case of the 10s CS-US interval), the temporal pattern of suppression behavior was shifted additively for a duration equivalent to the gap duration. This was shown in the shift of peak time without a change in width of the mean suppression curve. The individual trial analysis confirmed this result, although differences did not reach significance for all measures; there was only a trend for stop times for group US@15s, probably due to an increase in variability because of the scalar property of time, compared to the stop times of group US@10s. The additive shift was confirmed by the modification of the Weber fraction during the Gap trials, as compared to Probe trials, for both average and individual trial values (at least for the US@15s group). Thus, a short interruption during the CS introduces a pause in the timing of the CS, in a similar manner as in standard instrumental PI tasks (Cabeza de Vaca et al., 1994; Meck and Church, 1987; Roberts and Church, 1978; Roberts, 1981; Roberts et



al., 1989). Buhusi and Meck (2009) showed that a gap of 1/3rd of the timed stimulus duration induced a reset of the clock whereas a gap of 1/10th of the timed stimulus duration produced a shift consistent with a stop rule. Our gap of 1/5th of the CS-US duration falls in between these two ratios, and the results obtained (a stop of the clock during the gap) are consistent with these results obtained in appetitive instrumental conditioning. The results thus extend to a Pavlovian paradigm the findings that a short interruption of a stimulus shifts the peak time. Whether the effect of a gap changes depending upon the duration and/or location of the gap is a question for future investigations.

The individual trial analysis, when strictly restricted to the CS duration, showed that conditioned suppression behavior followed a three-state pattern which conformed to the classical clock-based rules regarding the start and stop decision processes assumed in SET (Gibbon and Church, 1990) on more than a third of the trials. This was shown through an abrupt change in behavior when lever-presses were aligned to the start or stop times. Furthermore, the positive (start/stop and spread/stop) and negative (start/spread) correlations were similar to what has been reported for instrumental PI tasks (Cheng and Westwood, 1993; Church et al., 1994; Gibbon and Church, 1990). The correlation between start and stop times was weak, presumably due to the skewed distribution of the start times, with a high proportion at very low values. Although a skewed distribution of start times have been reported previously in instrumental appetitive tasks (Brunner et al., 1997), it remains possible that the Pavlovian and/or aversive aspect of the task may have rendered the distribution even more skewed, and thus weakened the correlations. Of interest were the biphasic patterns of lever-pressing at start and stop times for these 'late onset' trials: an initial burst of lever-pressing before suppression at the start time, and a burst of responding when the animal resumed lever-press behavior at stop time. The rebound-type effect at stop time is reminiscent of the one that has been reported at the cessation of the CS-US trial in early conditioned suppression studies (Estes and Skinner, 1941). The present data suggest that a sudden change in the stimulus is not required for this rebound of lever-pressing and that compensatory mechanisms may also be triggered when a decision threshold is reached and the animal stops suppressing and resumes lever-pressing. The burst before suppression at start time was somewhat more surprising. An edge effect at start and stop times had been reported in PI task, but was interpreted as potentially resulting from the method of analysis (Gibbon and Church,

1990; Matell and Portugal, 2007). In our study, however, the program selected a best three-state fit rather than a large difference between adjacent time bins, to determine break points. Also, individual trial inspection showed a good proportion of trials with such a biphasic pattern at start time (see a representative example in Fig. 3A). Last, the pattern was not observed in the ‘early onset’ type of trials (for which the program had also detected a start time; see Fig. 3B). Therefore, the biphasic pattern observed in our study reflects the animals’ behavior. It should be noted that the biphasic pattern that we observed, i.e. an initial opposite modulation of responding before reaching the high state, is less likely to be seen in an appetitive situation as low-level behavioral activity is seen before the start, and therefore it would be difficult to observe a further decrease (floor effect). Our results suggest that the biphasic pattern may be a signature of change in behavior under a clock-based decision threshold. It also indicates that the start time may in fact be earlier than is commonly assumed, i.e. at the initiation of the biphasic pattern and not at the end.

The individual trial analysis also showed that a fair amount (~1/3rd) of trials of the remaining trials could be fitted with a three-state pattern as long as pre-CS lever-presses were included in the fitting analysis of the first high state, while leaving the other parameters the same. These ‘early onset’ trials represented trials for which the suppression was almost immediate after the CS onset, as shown by the distribution of the start times. Furthermore, the realignment of the lever-presses to the start times revealed that the suppression behavior for these trials was qualitatively different from the one observed in the other trials only at the start time: an abrupt drop of lever-pressing instead of a biphasic pattern of lever-pressing. In contrast, the behavior at stop times resembled that for the ‘late-onset’ trials. This observation suggests that the monophasic pattern at start time may reflect some reflex-type of suppression behavior triggered by the CS onset, which would thus not be clock-based. Nevertheless, the animals’ behavior during ‘early onset’ type trials may have still been controlled by a clock-based decision threshold for reengaging in a lever-pressing behavior after the subjective US time had passed. Interestingly a similar non-temporally-controlled response was observed at the CS onset in other conditioned suppression studies (Bouton et al., 2008; Jozefowicz et al., 2011; Miles et al., 2011). Jozefowicz et al. (2011) suggested that it was triggered by the general aversiveness of the training conditions (i.e. presence of footshocks). This response may decrease with training, as suggested in

Boulanger-Bertolus et al. (in press). Training with longer CS-US intervals may also render easier the extraction of behaviors under temporal control from other competing types of behaviors.

The 'early onset' type of behavior was at least in part responsible for the anticipatory peak time in the mean suppression curve. Considering only trials that could be fitted and categorized as 'late onset' trials, the averaged suppression curve peaked at a later time than when all trials were included, although the peak time was still significantly earlier than the US time. Notably, this was not the case for middle times, which were centered to the programmed US time. An anticipatory peak time has been observed previously in both appetitive and aversive Pavlovian paradigms (Boulanger-Bertolus et al., in press; Drew et al., 2005; Meck and MacDonald, 2007). However, no anticipatory peak time was observed in several other appetitive Pavlovian studies (Kirkpatrick and Church, 2000; Tam and Bonardi, 2012a, 2012b; Tam et al., 2013). The lack of anticipation in the Pavlovian appetitive studies does not seem to be due to differences in the amount of training, as they used a large range of number of CS-US trials (from 300 to 1500). Our study used a similar range of training trials (420 CS-US), suggesting that undertraining may not have been responsible for the observed anticipatory peak of temporal behavior.

Interestingly, only the study by Meck and MacDonald (2007) showed an anticipation in an appetitive setting using Pavlovian cues. However, they used a form of Pavlovian Instrumental Transfer (i.e., looking at the potentiation of a lever pressing response to an appetitive CS), whereas the other studies used a more classical conditioned response, i.e., head entries in the magazine. Therefore, the anticipatory behavior observed in conditioned suppression may be due to the competition between instrumental and Pavlovian behaviors.

In sum, our results demonstrate clock-like behavior, compatible with start/stop decision rules hypothesized in SET, in a Pavlovian aversive conditioning task. They also highlight non-clock based behaviors responsible for at least some of the anticipatory suppression observed in the mean suppression curve. The individual trial analysis has also revealed a biphasic pattern of lever-pressing at start time which may reflect a decision process.

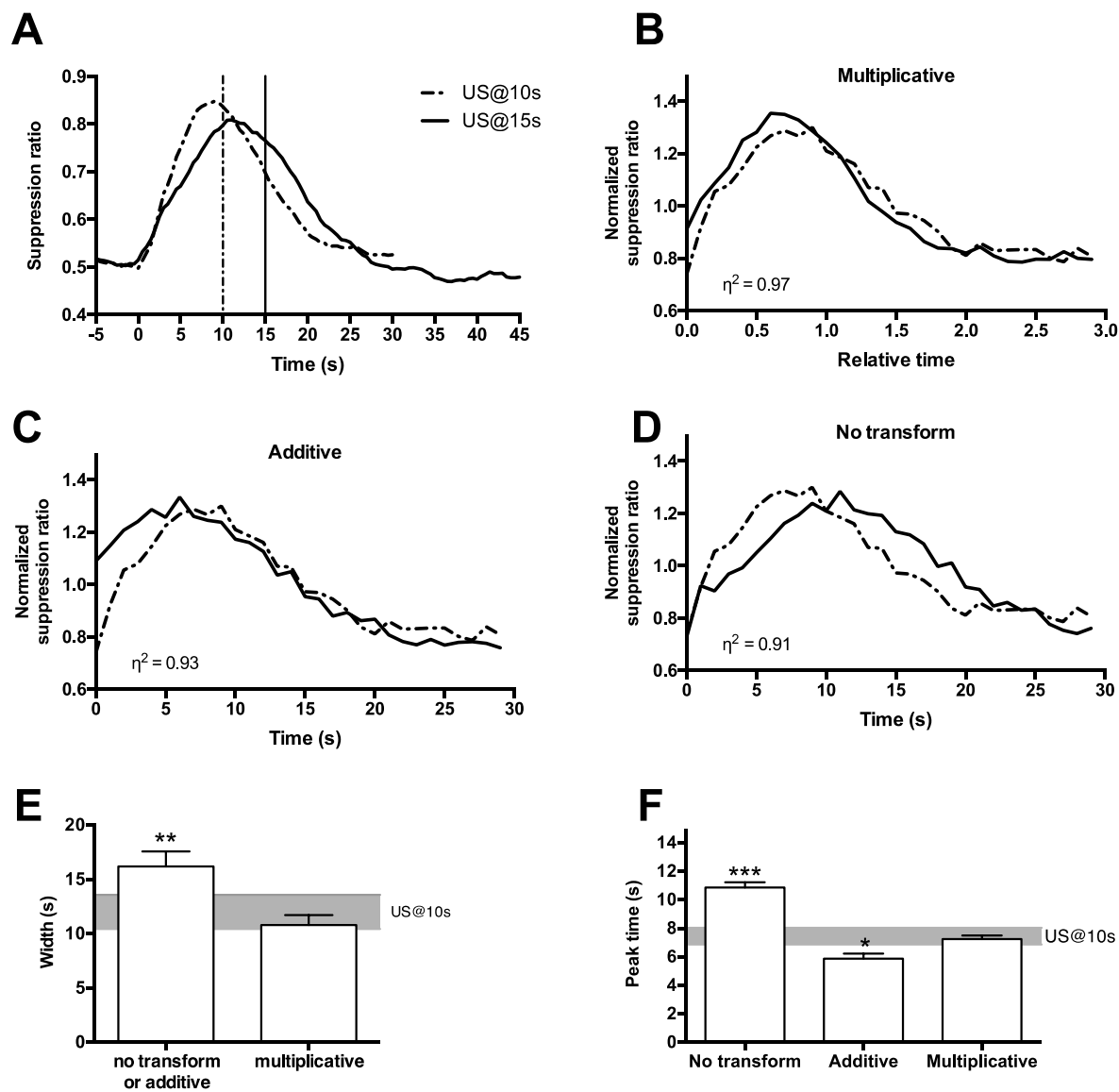
## Figures

Table 1

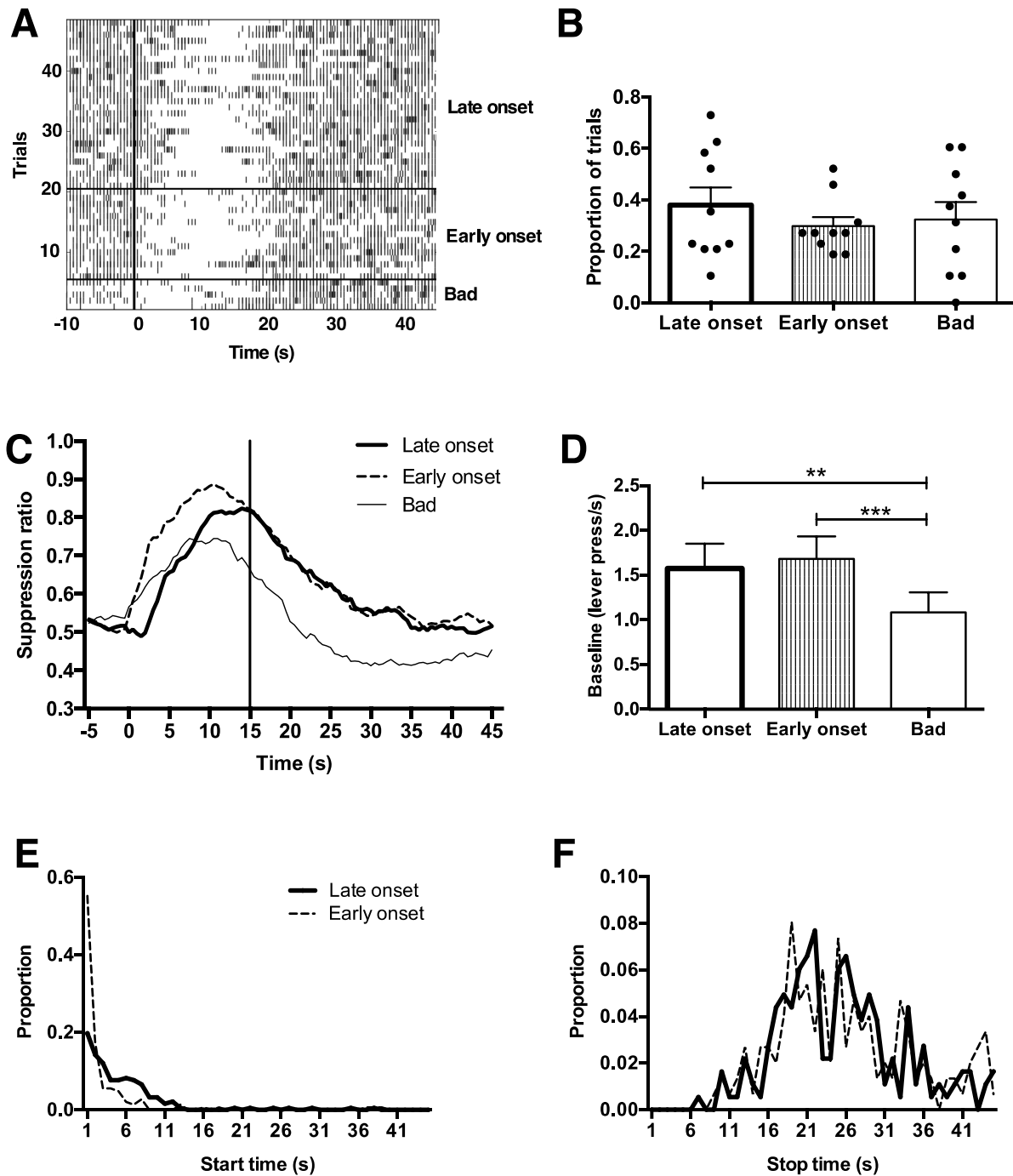
*Start, stop and middle times as well as the spread and relative spread (spread/middle time) for both US@15s and US@10s groups.*

	Median					Interquartile range			
	US@10s	US@15s	<i>t</i>	<i>p</i>	<i>d</i>	US@10s	US@15s	<i>t</i>	<i>p</i>
Start	4.48 ± 1.28	3.73 ± 0.52	0.65	0.53		3.78 ± 0.92	3.73 ± 0.65	0.05	0.96
Stop	20.6 ± 1.12	26.3 ± 1.42	3.3	0.004	1.47	6.81 ± 1.09	8.53 ± 1.09	1.17	0.26
Spread	14.3 ± 0.81	21.3 ± 1.90	3.59	0.002	1.61	8.94 ± 0.92	8.53 ± 0.84	0.35	0.73
Middle	12.5 ± 1.10	15.3 ± 0.70	2.27	0.036	1.01	4.35 ± 0.45	5.14 ± 0.58	1.14	0.27
Relative spread	1.34 ± 0.10	1.45 ± 0.09	0.91	0.37		0.53 ± 0.05	0.47 ± 0.06	0.77	0.45

*Note.* The mean ( $\pm$  SEM) of the medians is given as well as the mean ( $\pm$  SEM) of the median interquartile ranges. The t-test values as well as the *p* values and *d* values of the comparison between the US@10s and the US@15s group are also presented.

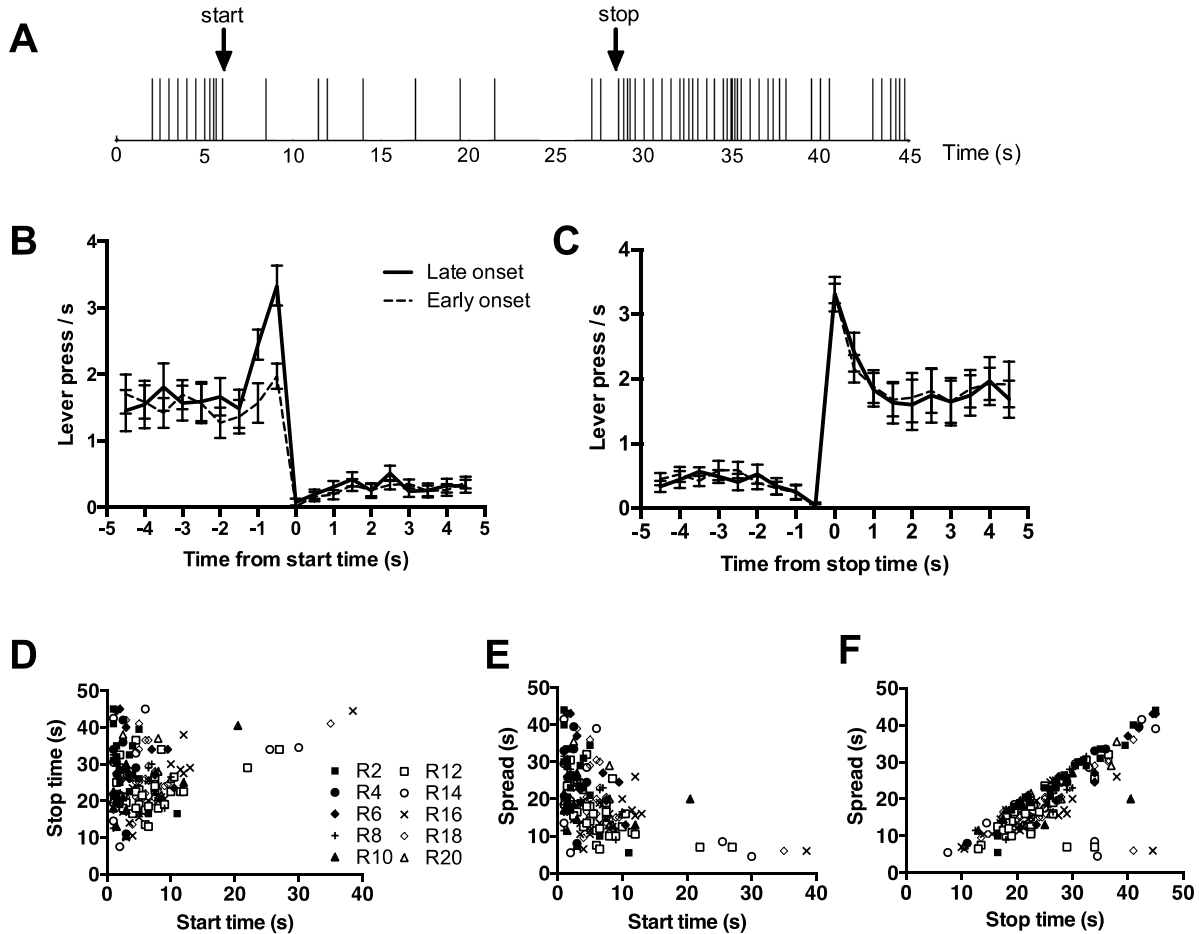


*Figure 1.* Test of the scalar property of the mean suppression curves between the two groups US@10s and US@15s. (A) Representation of the mean suppression curve across time (for the duration of the CS and 5s before CS) for both groups US@10s and US@15s. The superposition of the two curves, normalized by their mean suppression, after multiplicative transform on the x-axis (B), additive transform (C) and no transform (D) of the US@15s curve are presented, as well as the  $\eta^2$  value of the superposition. Mean  $\pm$  SEM of the width (E) and the peak time (F) of the US@15s group, after the different transforms, were compared to the value obtained experimentally from the US@10s group (represented by the grey area, mean  $\pm$  SEM). \*  $p < .05$ , \*\*  $p < .01$  and \*\*\*  $p < .001$

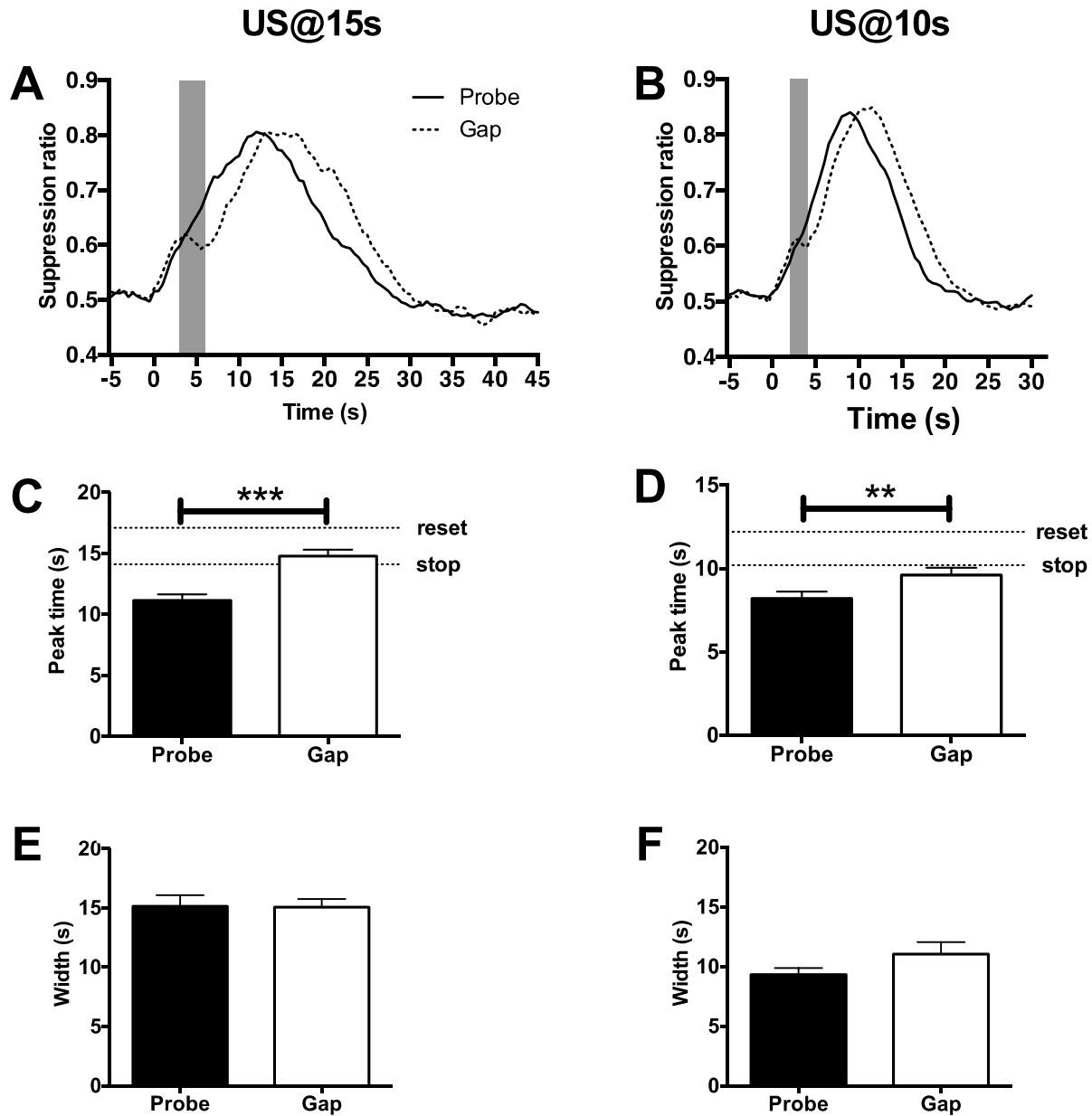


*Figure 2.* Characterization of individual trials for the US@15s group. Trials were separated in three categories ('late onset', 'bad' and 'early onset') based on individual trial data (see Materials and Methods). (A) Example of a raster plot representing every Probe trial for one rat, separating trials depending on their type. Each bar represents one response; the onset of the CS is indicated by the vertical line. The mean (+ SEM) proportion of each trial type is pictured in (B) with individual rat

data (each dot represents one rat). (C) Mean suppression curve across the duration of the CS (45s) for ‘late onset’, ‘bad’ and ‘early onset’ trials, with the mean (+ SEM) baseline level of lever presses presented in (D). The distribution of start times (E) and stop times (F) is presented for both ‘late onset’ and ‘early onset’ trials. \*\*  $p < .01$  and \*\*\*  $p < .001$

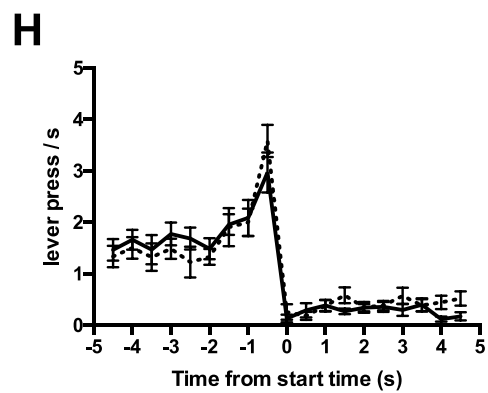
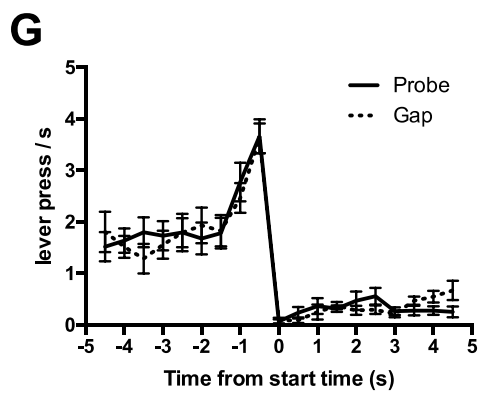
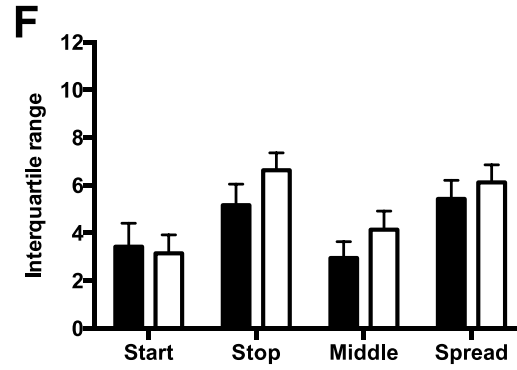
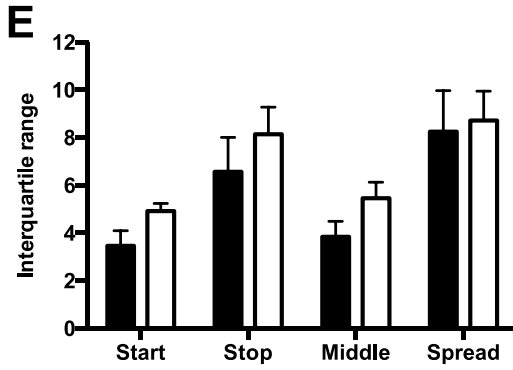
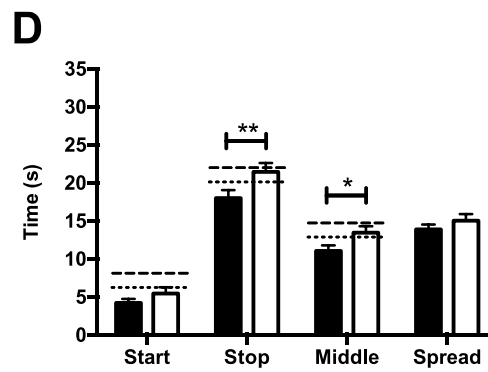
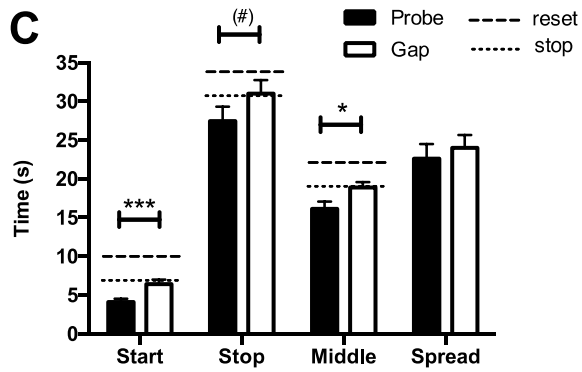
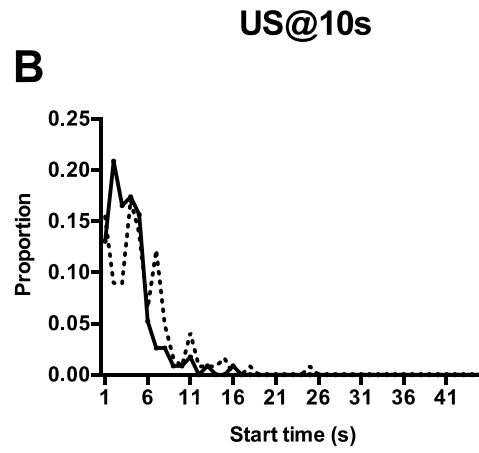
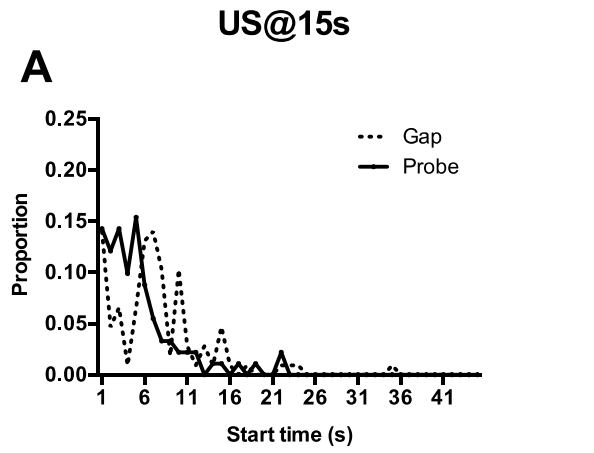


*Figure 3.* Start and stop times for the US@15s group. (A) Example of one representative ‘late onset’ trial with each bar representing one lever press; start and stop times are indicated by arrows. (B) Average ( $\pm$  SEM) number of lever presses after realignment of each trial using the start time as  $t = 0s$  for both ‘late onset’ and ‘early onset’ trials. (C) Similar to (B) with realignment to the stop time. Representation of the correlations between stop and start times (D), between spread and start times (E) and between spread and stop times (F) for each rat. Each symbol represents one trial for start, stop or spread.



*Figure 4.* Modulation of temporal behavior by the insertion of a gap during the CS. (A-B) The mean suppression curve across time is represented with the gap as a grey area (lasts 3s with an onset at 3s for the US@15s group (A) and lasts 2s with an onset at 2s for the US@10s group (B)). (C-D) Mean (+ SEM) peak time for the Probe and Gap trials for the US@15s group (C) and the US@10s group (D). The values expected for stop or reset modes, based on the probe trials, are presented as horizontal dotted lines. (E-F) mean (+ SEM) width of the suppression curves for probe and gap trials for the US@15s group (E) and the US@10s group (F). \*\* $p < .01$  and \*\*\*  $p < .001$





*Figure 5 (on the left side).* Effect of a gap during the CS on individual trial values for “late onset” trials only. The distribution of start times is presented for US@15s (A) and US@10s (B) groups. The mean (+ SEM) of the medians of start, stop middle and spread values is presented for Probe (black bar) and Gap (white bar) trials for the US@15s group (C) and the US@10s group (D) as well as the expected reset (dashed line) and stop (dotted line) values for start, stop and middle times. The mean (+ SEM) of the median interquartile ranges is also presented in bar form (E-F). Average ( $\pm$  SEM) number of lever presses after realignment of each trial using the start time as  $t = 0$ s for both Probe and Gap trials (G-H). \* $p < .05$ ; \*\* $p < .01$ ; \*\*\*  $p < .001$  and (#):  $p = .054$

## References

- Aum, S.W., Brown, B.L., Hemmes, N.S., 2007. The effect of intruded events on peak time: the role of reinforcement history during the intruded event. *Behav Processes* 74, 187–197. doi:10.1016/j.beproc.2006.11.001
- Aum, S.W., Brown, B.L., Hemmes, N.S., 2004. The effects of concurrent task and gap events on peak time in the peak procedure. *Behav Processes* 65, 43–56. doi:10.1016/S0376-6357(03)00152-9
- Balci, F., Gallistel, C.R., Allen, B.D., Frank, K.M., Gibson, J.M., Brunner, D., 2009. Acquisition of peak responding: What is learned? *Behav Processes* 80, 67–75. doi:10.1016/j.beproc.2008.09.010
- Balsam, P.D., Drew, M.R., Yang, C., 2002. Timing at the start of associative learning. *Learn Motiv* 33, 141–155. doi:10.1006/lmot.2001.1104
- Bevins, R.A., Ayres, J.J.B., 1995. One-trial context fear conditioning as a function of the interstimulus interval. *Anim Learn Behav* 23, 400–410. doi:10.3758/BF03198940
- Boulanger-Bertolus, J., Knippenber, J., Verschueren, A., Le Blanc, P., Brown, B.L., Mouly, A.-M., Doyère, V., 2015. Temporal behavior in auditory fear conditioning: Stimulus property matters. *Int J Comp Psychol* 28.
- Bouton, M.E., Frohardt, R.J., Sunsay, C., Waddell, J., Morris, R.W., 2008. Contextual control of inhibition with reinforcement: Adaptation and timing mechanisms. *J Exp Psychol Anim Behav Process* 34, 223–236. doi:10.1037/0097-7403.34.2.223.Contextual
- Brunner, D., Fairhurst, S., Stolovitzky, G., Gibbon, J., 1997. Mnemonics for variability: remembering food delay. *J Exp Psychol Anim Behav Process* 23, 68–83. doi:10.1037/0097-7403.23.1.68
- Buhusi, C. V, Meck, W.H., 2009. Relativity theory and time perception: single or multiple clocks? *PLoS One* 4. doi:10.1371/journal.pone.0006268
- Buhusi, C. V, Meck, W.H., 2006. Time sharing in rats: A peak-interval procedure with gaps and distracters. *Behav Processes* 71, 107–15. doi:10.1016/j.beproc.2005.11.017
- Buhusi, C. V, Paskalis, J.-P.G., Cerutti, D.T., 2006. Time-sharing in pigeons: Independent effects of gap duration, position and discriminability from the timed signal. *Behav Processes* 71, 116–125. doi:10.1016/j.beproc.2005.10.006
- Cabeza de Vaca, S., Brown, B.L., Hemmes, N., 1994. Internal clock and memory processes in animal timing. *J Exp Psychol Anim Behav Process* 20, 184–198. doi:10.1037/0097-7403.20.2.184
- Cheng, K., Westwood, R., 1993. Analysis of single trials in pigeons' timing performance. *J Exp Psychol Anim Behav Process* 19, 56–67. doi:10.1037/0097-7403.19.1.56
- Church, R.M., Meck, W.H., Gibbon, J., 1994. Application of scalar timing theory to individual trials. *J Exp Psychol Anim Behav Process* 20, 135–155. doi:10.1037/0097-7403.20.2.135

- Davis, M., Schlesinger, L.S., Sorenson, C.A., 1989. Temporal specificity of fear conditioning: effects of different conditioned stimulus-unconditioned stimulus intervals on the fear-potentiated startle effect. *J Exp Psychol Anim Behav Process* 15, 295–310.
- Dews, P.B., 1970. The theory of fixed-interval responding, in: *The Theory of Reinforcement Schedules*. pp. 43–61.
- Díaz-Mataix, L., Ruiz Martinez, R.C., Schafe, G.E., LeDoux, J.E., Doyère, V., 2013. Detection of a temporal error triggers reconsolidation of amygdala-dependent memories. *Curr Biol* 23, 1–6. doi:10.1016/j.cub.2013.01.053
- Drew, M.R., Zupan, B., Cooke, A., Couvillon, P.A., Balsam, P.D., 2005. Temporal control of conditioned responding in goldfish. *J Exp Psychol Anim Behav Process* 31, 31–39. doi:10.1037/0097-7403.31.1.31
- Estes, W.K., Skinner, B.F., 1941. Some quantitative properties of anxiety. *J Exp Psychol* 29, 390–400. doi:10.1037/h0062283
- Gibbon, J., 1977. Scalar expectancy theory and Weber's law in animal timing. *Psychol Rev* 84, 279–325. doi:10.1037/0033-295X.84.3.279
- Gibbon, J., Church, R.M., 1990. Representation of time. *Cognition* 37, 23–54.
- Herry, C., Johansen, J.P., 2014. Encoding of fear learning and memory in distributed neuronal circuits. *Nat Neurosci* 17, 1644–1654. doi:10.1038/nn.3869
- Hollerman, J.R., Tremblay, L., Schultz, W., 2000. Involvement of basal ganglia and orbitofrontal cortex in goal-directed behavior. *Prog Brain Res* 126, 193–215. doi:10.1016/S0079-6123(00)26015-9
- Jozefowicz, J., Witnauer, J.E., Miller, R.R., 2011. Two components of responding in Pavlovian lick suppression. *Learn Behav* 39, 138–145. doi:10.3758/s13420-010-0012-4
- Kaiser, D.H., Zentall, T.R., Neiman, E., 2002. Timing in pigeons: Effects of the similarity between intertrial interval and gap in a timing signal. *J Exp Psychol Anim Behav Process* 28, 416–422. doi:10.1037//0097-7403.28.4.416
- Kirkpatrick, K., Church, R.M., 2000. Independent effects of stimulus and cycle duration in conditioning: The role of timing processes. *Anim Learn Behav* 28, 373–388. doi:10.3758/BF03200271
- LaBarbera, J.D., Church, R.M., 1974. Magnitude of fear as a function of expected time to all aversive event. *Anim Learn Behav* 2, 199–202. doi:10.3758/BF03199177
- LeDoux, J.E., 2014. Coming to terms with fear. *Proc Natl Acad Sci* 111, 2871–2878. doi:10.1073/pnas.1400335111
- MacDonald, C.J., Cheng, R.-K., Meck, W.H., 2012. Acquisition of “Start” and “Stop” response thresholds in peak-interval timing is differentially sensitive to protein synthesis inhibition in the dorsal and ventral striatum. *Front Integr Neurosci* 6, 1–16. doi:10.3389/fnint.2012.00010

- Matell, M.S., Bateson, M., Meck, W.H., 2006. Single-trials analyses demonstrate that increases in clock speed contribute to the methamphetamine-induced horizontal shifts in peak-interval timing functions. *Psychopharmacology (Berl)* 188, 201–212. doi:10.1007/s00213-006-0489-x
- Matell, M.S., Portugal, G.S., 2007. Impulsive responding on the peak-interval procedure. *Behav Processes* 74, 198–208. doi:10.1016/j.biotechadv.2011.08.021.Secreted
- Matthews, A.R., He, O.H., Buhusi, M., Buhusi, C. V., 2012. Dissociation of the role of the prelimbic cortex in interval timing and resource allocation: beneficial effect of norepinephrine and dopamine reuptake inhibitor nomifensine on anxiety-inducing distraction. *Front Integr Neurosci* 6, 1–12. doi:10.3389/fnint.2012.00111
- Meck, W.H., Church, R.M., 1987. Nucleus Basalis Magnocellularis and Medial Septal Area Lesions Differentially Impair Temporal Memory. *J Neurosci* 7, 3505–3511.
- Meck, W.H., MacDonald, C.J., 2007. Amygdala inactivation reverses fear's ability to impair divided attention and make time stand still. *Behav Neurosci* 121, 707–720. doi:10.1037/0735-7044.121.4.707
- Miles, L., Davis, M., Walker, D., 2011. Phasic and sustained fear are pharmacologically dissociable in rats. *Neuropsychopharmacology* 36, 1563–1574. doi:10.1038/npp.2011.29
- Orduña, V., García, A., Menez, M., Hong, E., Bouzas, A., 2008. Performance of spontaneously hypertensive rats in a peak-interval procedure with gaps. *Behav Brain Res* 191, 72–76. doi:10.1016/j.bbr.2008.03.012
- Roberts, S., 1981. Isolation of an internal clock. *J Exp Psychol Anim Behav Process*. doi:10.1037/0097-7403.7.3.242
- Roberts, S., Church, R.M., 1978. Control of an internal clock. *J Exp Psychol Anim Behav Process* 4, 318–337. doi:10.1037/0097-7403.4.4.318
- Roberts, W.A., Cheng, K., Cohen, J.S., 1989. Timing light and tone signals in pigeons. *J Exp Psychol Anim Behav Process* 15, 23–35. doi:10.1037/0097-7403.15.1.23
- Schneider, B.A., 1969. A two-state analysis of fixed-interval responding in the pigeon. *J Exp Anal Behav* 12, 677–687. doi:10.1901/jeab.1969.12-677
- Shionoya, K., Hegoburu, C., Brown, B.L., Sullivan, R.M., Doyère, V., Mouly, A.-M., 2013. It's time to fear! Interval timing in odor fear conditioning in rats. *Front Behav Neurosci* 7, 1–17. doi:10.3389/fnbeh.2013.00128
- Swearingen, J.E., Buhusi, C. V., 2010. The pattern of responding in the peak-interval procedure with gaps: An individual-trials analysis. *J Exp Psychol Anim Behav Pr* 36, 443–455. doi:10.1037/a0019485.The
- Tam, S.K.E., Bonardi, C., 2012a. Dorsal hippocampal lesions disrupt Pavlovian delay conditioning and conditioned-response timing. *Behav Brain Res* 230, 259–67. doi:10.1016/j.bbr.2012.02.016
- Tam, S.K.E., Bonardi, C., 2012b. Dorsal hippocampal involvement in appetitive trace conditioning and

interval timing. *Behav Neurosci* 126, 258–69. doi:10.1037/a0027164

Tam, S.K.E., Jennings, D.J., Bonardi, C., 2013. Dorsal hippocampal involvement in conditioned-response timing and maintenance of temporal information in the absence of the CS. *Exp brain Res* 227, 547–59. doi:10.1007/s00221-013-3530-4

Taylor, K.M., Horvitz, J.C., Balsam, P.D., 2007. Amphetamine affects the start of responding in the peak interval timing task. *Behav Processes* 74, 168–175. doi:10.1016/j.beproc.2006.11.005



## **CHAPTER 3**

# **Neuronal correlates of interval timing**





# I. INTRODUCTION

## A. Discovery and description of oscillations

Richard Caton was the first to show the existence of oscillatory electrical activity in the brain of animals (cats, rabbits and monkeys), he published his work in 1875. He also demonstrated that this activity can be modified by sensory stimuli in particular brain regions. He analyzed the electrical activity in awake animals, and measured, for example, negative variations in energy in the visual cortex when he presented a light to the animal. He also described an increase of oscillations during sleep. Indeed, oscillations' amplitude is smaller in awake animals because brain activity is desynchronized, whereas during sleep the activity is more synchronized, and thus the amplitude is increased.

Fifteen years later, Adolf Beck (1891) rediscovered the existence of oscillations in basal brain activity, but added the description of the desynchronization of action potentials during the presentation of a stimulus, and of evoked potentials. In 1929, Hans Berger published his work on recording spontaneous brain activity in humans using what would later become the electroencephalogram (EEG). Hans Berger used the Greek letter alpha to designate 8–12 Hz frequencies observed first in resting participants, then used beta for 12–30 Hz frequencies in 'more attentive' participants. Subsequently, gamma (30 to 100 Hz) and delta (below 4 Hz) were named. The 4 to 7 Hz band was designated theta to stand for thalamus, because thalamic lesions in monkeys shifted cortical dynamics from alpha to theta (Walter and Dovey 1944). All of those historical recordings were performed in cortical regions. Theta rhythms were first described in the hippocampus and are visible *in vivo* (Buzsáki 2002) and *in vitro* (Kowalczyk et al. 2012). The specific bands vary depending on the brain area and the species; for example, hippocampal theta rhythm in the human is close to 1-4 Hz, whereas in rodents it is more of a 4-10 Hz band (Jacobs 2014).

Neural oscillations are one of the most conserved phenomenon in mammalian evolution, they may serve to maintain spike communications in brains of very different sizes, so that the speed of computing information is similar even in very large brains (Buzsáki et al. 2013). The goal of this

paragraph is not to be an exhaustive view of the role of oscillations in memory, but only to show examples on why oscillations are studied more and more in the field of learning and why they give different information than single unit recordings. They represent a supplementary level of information allowing for more complex encoding (at the level of population of cells that is still quickly accessible (depending on the phase of oscillation) (Averbeck et al. 2006). It is possible to predict memory formation from oscillatory activity (Hanslmayr and Staudigl 2014). Furthermore, the phase of the oscillation when the association occurs can modulate learning. For example, if eyeblink conditioning trials are presented during a high theta phase, then learning is quicker (Hoffman et al. 2015). By using transcranial magnetic stimulation (using a small magnetic field to modulate brain oscillatory power), Helfrich and collaborators (2014) have demonstrated that synchronized cortical activity across several frequency scales is essential for conscious perception and cognition. Indeed when they modulated oscillations in the parieto-occipital cortex, they changed the visual experience of the participants.

## **B. Analyses of oscillations**

We present here briefly different types of analyses that can be performed on local field potentials (LFP) recordings, similar to the ones recorded during this study. LFP are intra-cerebral recordings that represent the sum of extracellular electrical activity of a small volume (usually around 250 microns in diameter, Katzner et al., 2009) of neurons around the electrode tip. The recorded volume is dependent on the size and the impedance of the electrode (i.e. smaller and higher impedance electrodes record smaller volumes). LFP are mostly generated by synchronized synaptic currents and are not very influenced by action potentials (for a recent review, see Buzsáki et al., 2012).

For a long time, it was considered that only oriented (i.e. where neurons are assembled in the same direction) structure could produce oscillations. However, oscillations have been recorded and analyzed from many structures that are not organized, such as the striatum and the amygdala (Pape et al. 2005; Popescu et al. 2009; Bauer et al. 2007; Berke 2009; DeCoteau et al. 2007; Frederick et al. 2014; Tort et al. 2008).

## 1. Power spectrum density (PSD)

Power spectrum density (PSD) gives an idea of the repartition of the power of different frequency bands in a signal (Figure 3.1). It is calculated from the raw signal and helps determine which frequency bands are prominent during the trial. For example, in Figure 3.1 we can observe that a 65 to 90 Hz band is more prominent than the others across the whole duration of the trial.

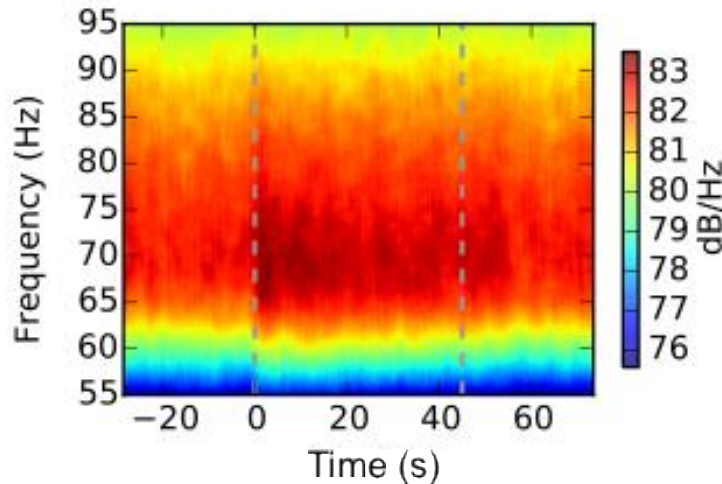


Figure 3.1: Example of a power spectrum density (PSD) graph. The dashed lines represent the onset and offset of an aversive stimulus. The color bar on the side represents the strength of the different frequency bands over time.

Different ways to calculate the PSD exist. The PSD is the average of the Fourier transform squared over a large time interval, so it represents a single sample of the Fourier transform of the signal. In our study, we used a time-domain analysis, because we needed to estimate the variation of the PSD signal over time. We used a multitaper approach (developed initially by David J. Thomson in 1982) as it takes into account that each trial is noisy and therefore represents only a portion of the process of interest. It is very useful for smaller sets of data as it produces multiple estimates of the PSD from the same sample by using a sliding window of timer over the sample. Then, all the estimates are averaged to give a better estimation of the underlying processes.

## 2. Coherence

Coherence is the synchronization of two structures by a power-power coupling (i.e. the power in two structures is modified in the same direction) and/or a phase-phase coupling (i.e. the two

structures oscillate at a similar frequency) between two bands of same frequency. Coherence is thought to represent communication between structures via synchronization of oscillations, the “communication-through-coherence” hypothesis (for a review, see Fries, 2005). Phase synchronization can be present even with a lag, meaning that the two structures can oscillate at the same frequency but one may be delayed in time (Figure 3.2). This is more biologically relevant since some time is necessary for neural activity to go from one structure to another (Fell and Axmacher 2011).

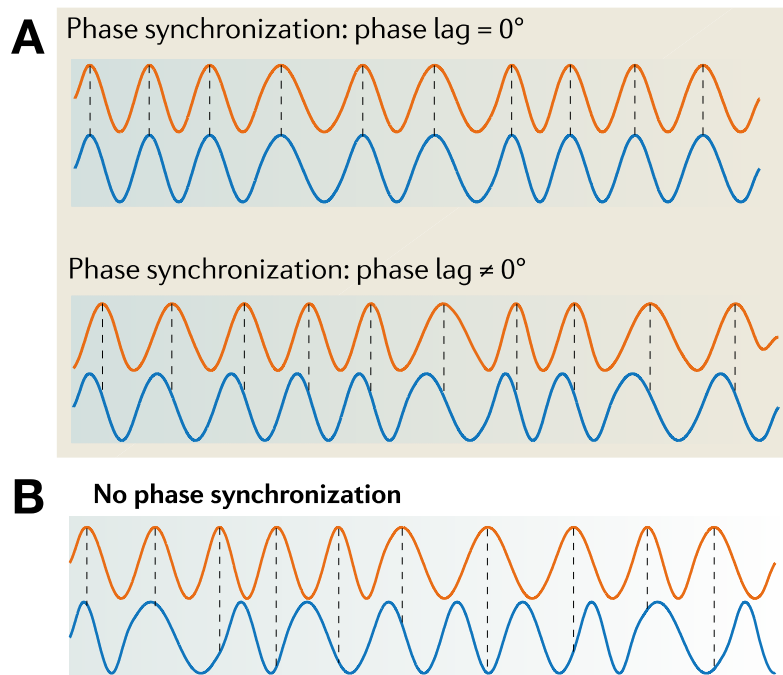


Figure 3.2: Schematic description of the difference between phase synchronization and no phase synchronization. In (A) the orange and the blue signal are phase-synchronized with or without phase lag, meaning that the peak of the orange signal always arrives at the same moment of the phase of the blue signal. In (B) the blue and orange signals are out of phase, so that the orange curve peaks at different stages of the blue signal’s phase. Adapted from Fell and Axmacher, 2011.

Coherence is important to integrate information over different brain areas (for reviews, see Buzsáki and Schomburg, 2015; Fell and Axmacher, 2011; Plankar et al., 2012). For example, in humans, good decision making is correlated with an increased synchronization of theta rhythm between the anterior hippocampus and different prefrontal cortices (Guitart-Masip et al. 2013). Coherence can also underscore less complex behaviors, like anxiety and avoidance behaviors. In

mice, theta coherence between the ventral striatum and the PFC is correlated with avoidance performance and is in general higher in an anxiogenic context than in a normal context (Adhikari et al. 2010).

### **C. Oscillations and Pavlovian conditioning**

We have already described studies in which oscillatory activity was studied in correlation with temporal behavior (see Chapter 1. II. C.). Oscillatory activity has also been linked with memory processes (Hanslmayr and Staudigl 2014; Hasselmo and Stern 2014). Oscillations have been linked with associative learning in humans (Miltner et al., 1999; for a recent review, see Christoffersen and Schachtman, 2016), and in animals (e.g. Paré and Collins, 2000; Popa et al., 2010; Seidenbecher et al., 2003, see Paré et al., 2002 for a review on the role of amygdala oscillations in emotional learning, see Martin and Ravel, 2014 for a review on the role of beta and gamma oscillations in olfactory learning).

Fear conditioning enhances gamma oscillations in the auditory cortex in Pavlovian aversive conditioning (Headley and Weinberger 2013). Looking only at the LA, Paré and Collins (2000) have shown increased theta rhythm, as well as increased cell firing at specific phases of the theta wave, just after the presentation of a stimulus that predicts the arrival of the shock 5s later (this only appears after training and is not present for neutral stimuli, therefore it may represent expectation of the shock). The authors argue that this increased synchronization could facilitate interaction with other structures involved in the formation of this aversive memory. Increased theta coherence in an amygdalo-hippocampo-prefrontal network during sleep improves fear memory consolidation, implying a role of oscillations in encoding and in memorization (Popa et al. 2010). Furthermore, theta synchronization between the hippocampus and the amygdala is increased when mice are presented with a threatening stimulus (previously associated with a footshock), therefore showing a role of oscillations in retrieval of memory (Seidenbecher et al. 2003). Gamma oscillations are also involved in the encoding of valence and of emotional memory (for a recent review, see Headley and Paré, 2013). For example, high level of gamma oscillations during extinction correlates with higher levels of spontaneous recovery of fear after extinction (Courtin et al. 2014).

Artificial stimulation at a theta rhythm in the hippocampus before presentation of three shocks in a new context impairs freezing to the context in rats, therefore showing that inducing a fixed-frequency theta oscillations in the hippocampus alters memory formation (Lipponen et al. 2012). It had also been previously shown that fimbria-fornix lesions, which disrupts the endogenous theta rhythm in the hippocampus (Rawlins et al. 1979), inhibits contextual fear learning (Phillips and LeDoux 1995). In an eyeblink conditioning task, animals with higher theta power pre-stimulus learn more rapidly (Berry and Thompson 1978) as well as when training occurs during specific periods of theta rhythm (Griffin et al. 2004).

The interaction in the activity of different brain areas has also been associated with Pavlovian conditioning. Theta coupling between LA, CA1 and PL is increased during fear retrieval and decreased during fear extinction (Lesting et al. 2011). Furthermore, interference in theta coupling between CA1 and LA by electrical stimulation disrupted fear and extinction recall. Thus, there seems to be a role of theta in transmitting information between these structures to allow for use of previously stored memories (Lesting et al. 2013). Theta-gamma coupling in the BLA was increased during presentation of the aversive CS, whereas periods of safety were associated with enhanced gamma oscillations in the BLA and an increase in the coupling between gamma oscillations in the BLA and theta oscillations in the PFC (Stujenske et al. 2014).

**No study has looked directly at the role of oscillations in the processing of time during Pavlovian conditioning. We looked for neural correlates of time in an amygdalo-prefronto-dorsostriatal network during aversive conditioning in early learning (i.e. which animals have learned the CS-US interval but do not express full instrumental temporal behavior), and compared these results to overtrained animals (i.e. that present temporal behavior). This network seemed to be a good candidate for the integration of temporal and associative components of Pavlovian aversive conditioning. Oscillations are an interesting target for the encoding of time (see oscillatory models of the internal clock, Chapter 1. I. D. 4.) and they give information on activity at the level of population of neurons as well as on inter-structures communication. We looked at a modification of the CS-US interval in early learning animals (as we know they can differentiate between those two durations after only two CS-US**

associations, Diaz-Mataix et al., 2013), as well as when a gap is introduced during the CS in the overtrained animals (as we could measure the modulation of the temporal behavior).



## II. MATERIALS & METHODS

### A. Experiment 1: early learning

#### **Subjects**

Experiments were carried out on 26 adult male Sprague-Dawley rats (~300g, Harlan Laboratories, France) in accordance with the guidelines of the European Community Council Directives of September 22nd 2010 (2010/63/UE) and the French National Committee (2013/118) for the care and use of laboratory animals. All efforts were made to minimize the number of animals used and their suffering. Rats were housed in standard laboratory cages by pairs, and maintained on a 12/12hr light/dark cycle with *ad libitum* access to food and water.

#### **Surgery**

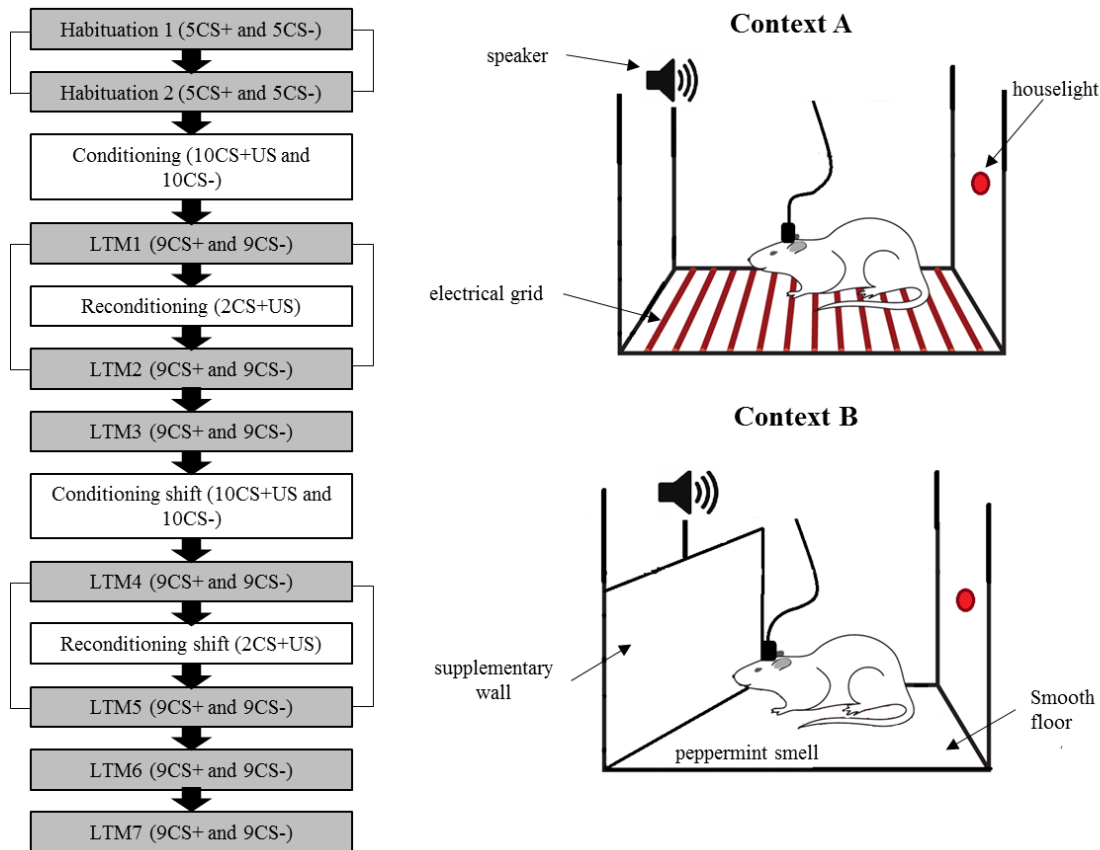
Animals were anesthetized with pentobarbital (54.7mg/kg, ip). Tolfedine (0.01ml/100g, sc) and atropine (0.01mg/kg, im) were given prior to surgery. An antibiotic (Convenia, Zoetis ; 0.1ml per rat, sc) was injected at the end of the surgery. After the surgery, the rats were housed individually in standard laboratory cages and allowed to recover for one week. Recording electrodes were made from var-insulated nichrome wire (68 $\mu$ m diameter). Wires were sharpened (0.7-1.0 M $\Omega$ ) and placed in a 33 Gauge tube (PHYMEP, Paris, France), the tip extending 1mm. Single recording electrodes were implanted in three brain area in the right hemisphere for each rat: in the dorso-medial striatum (AP: 1.0mm; L: 2.2mm; DV: 4mm ), in the PL cortex (AP: 3.0mm; L: 0.8mm; DV: 3.3mm) and in the BLA (AP -2.7mm, L 4.7mm, DV 8.5mm). Reference and ground electrodes, made of silver wire, were placed epidurally over the cerebellum for the ground and over the visual cortex for the reference. Electrodes were assembled into a circular plug (Ginder Scientific, Canada, reference GS09PLG-220) and fixed on the skull with dental acrylic cement.

#### **Behavioral and Recording Apparatus**

Behavioral training took place in a set of two identical conditioning chambers (30 x 25 x 30cm, Coulbourn Instruments, USA), equipped with a shock floor and a speaker, all placed in a sound attenuating enclosure with a ventilation fan (60dB background noise). The conditioning chambers were classical conditioning boxes except that there was no ceiling and the walls were

higher to keep rats from escaping (see Figure 3.3, right side). Behavioral protocols were controlled by Graphic State software (Coulbourn Instruments, USA). An infrared digital camera, mounted in front of each chamber, allowed recording during behavioral procedures for later behavioral scoring. Rats were allowed to freely explore the chamber before each behavioral procedure for variable amount of time depending on the sessions.

Animals underwent auditory Pavlovian conditioning with a 1 kHz CS- (60s, 80dB) and a 7 kHz CS+ (60s, 80dB), following the steps described in Figure 3.3, left side. Animals were first habituated to the two stimuli in the recording environment (see Context B, Figure 3.3) over two days with presentation of 5 CS+ and 5 CS- each day. They were afterwards conditioned in the conditioning context (see Context A, Figure 3.3) by presenting 10 CS+ with a US at 30s after the onset of the CS+ and 10 CS-. The CS+ and the US never co-terminated. The US was a strong foot-shock of 0.8mA lasting 1s. The animals were then tested in an extinction session (LTM1 for long term memory test 1) by presenting 9 CS+ and 9 CS- in context B. The animals were reconditioned with a 30s CS-US interval in context A by presenting 2 CS-US pairings and then tested two more days in extinction (LTM2 and 3) in context B. The conditioning was shifted to a 10s CS-US interval and the animals were tested similarly to before. CS+ and CS- were presented randomly (while making sure that there was never more than 3 consecutive presentations of the same CS) with an average ITI of 3 min, making the conditioning sessions 1h25 long, the habituation sessions 45min long and the LTM sessions 1h15 long. This experiment was performed three times to reach a large enough number of rats, with approximately 8 rats each time. No recordings after LTM4 were performed for the first group of 10 rats.



**Figure 3.3: Description of the protocol and the experimental setup.** On the left side, the protocol is detailed. The sessions in gray were recorded, whereas the sessions in white were not recorded. The lines on the side represent the sessions that were averaged for the results. On the right side, two schemes represent the two contexts used during the experiment. Context A is a classical conditioning box with a metallic grid floor that delivers foot-shocks, a red house light and a speaker on top of the box; it was used for the sessions in white in the protocol (not recorded). In context B, an additional wall was added to change the shape of the box, the floor was changed to a smooth plastic surface and a peppermint odor was added; it was used for the sessions in gray in the protocol (recorded). LTM = long-term memory.

## **B. Experiment 2: after overtraining**

### **Subjects**

All of the animals of the group US@15s from Chapter 1 were implanted and recorded during this experiment. We used the animals from the US@15s group, so that the brain activity at the expected arrival of the US would potentially be less masked by onset effects. For more information on the previous training of these rats, see Chapter 2, Materials and Methods.

## **Surgery**

The rats were implanted in the same way as the rats in experiment 1.

## **Behavioral and Recording Apparatus**

The recordings took place in two identical conditioning chambers (30 x 25 x 30cm, Coulbourn Instruments, USA), equipped with a shock floor, a speaker, a lever and a magazine and food distributor, all placed in a sound attenuating enclosure with a ventilation fan (60dB background noise). The conditioning chambers were classical Skinner boxes except that the ceiling was removed and the walls increased in height.

## **Behavior and recordings**

One week after surgery, rats were food deprived anew (to maintain them at 90% of their expected normal weight) and retrained in the task with two sessions of VI30 followed by five days of PI training. Afterwards, the protocol went to PI + gap trials (see Figure 3.4). The gap was 5s long and started 3s after the onset of the CS. For the first twelve days, for each session, there was a mix of 12 FI trials (CS+US), 6 Probe trials and 6 Gap trials. For the last four days, we switched the recording and behavioral sessions to a mix of 12 CS+US, 4 Probe and 4 Gap trials to improve the behavior. For more details on the behavioral protocols, see Chapter 2, Materials and Methods. Recordings sessions were done every other day; in those sessions, the rat did not have access to the lever nor to the magazine, thus reducing movement-related artefacts and dissociating electrophysiological activity from changes in motor control. Interleaved with those recording sessions, the behavior was measured in regular PI + gap sessions, where the rat had access to the lever and the magazine.

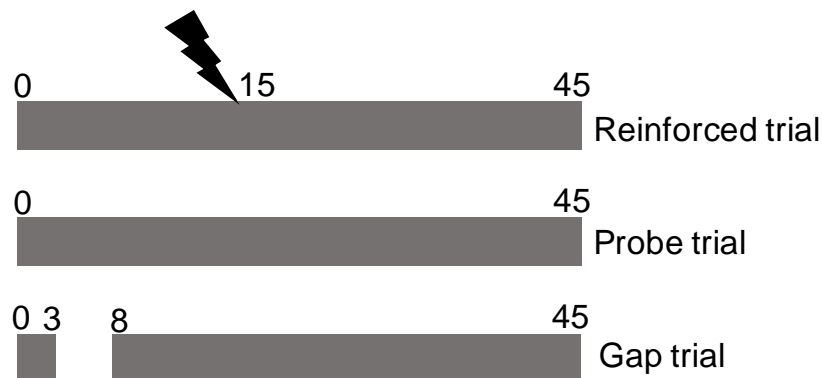
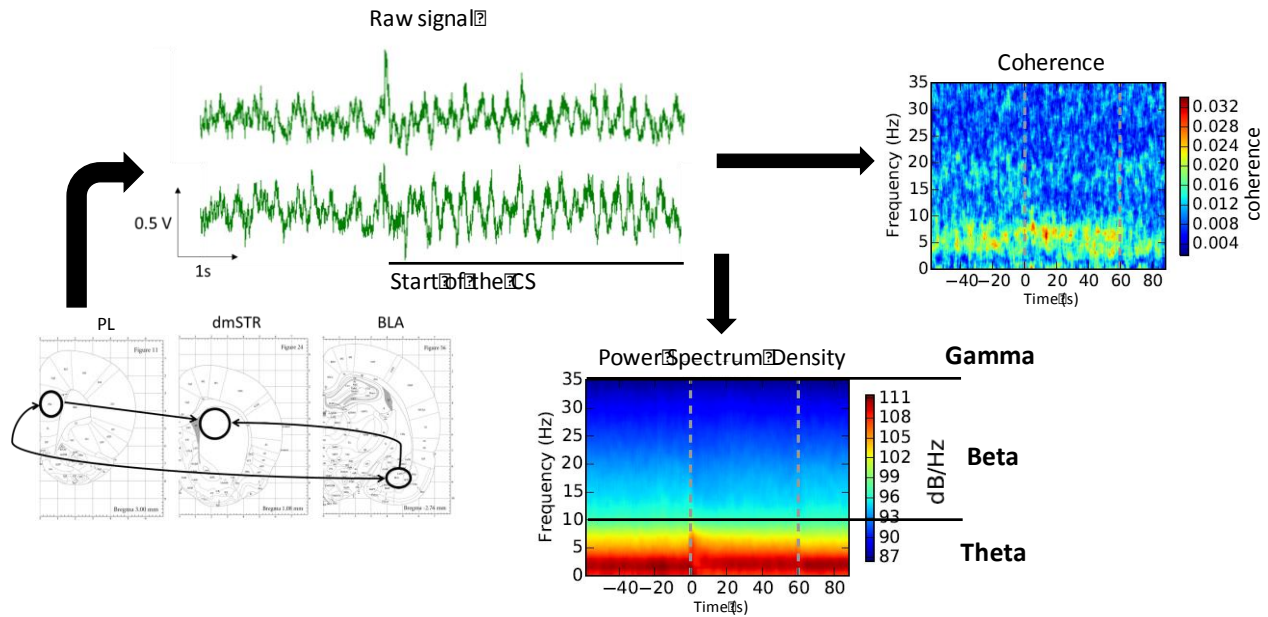


Figure 3.4: Description of the trials presented during a session of PI + gap trials. The CS was 45s long with the US presented at 15s, only for the reinforced trials. Gap trials presented a pause in the CS from 3 to 8s. Probe trials were presentation of the CS alone.

### C. Analysis of LFPs for both experiments

During recording, local field potentials (LFPs) were amplified 100x (Grass amplifiers, model P511), band-pass filtered (0.3Hz-1kHz) and acquired at 10kHz in Spike2 via a CED interface (Power 1401 mkII, CED, UK). Raw LFP traces from the BLA, PL and dmSTR (see an example in Figure 3.5) included the 60 s pre-CS period, the 60 s CS-period and a 30 s post-CS period for experiment 1, and 30s pre-CS period, the 45 s CS-period and the 30s post-CS period of each trial for experiment 2.



**Figure 3.5: Representation of the analysis of local field potentials (LFPs).** LFPs were recorded simultaneously from the prelimbic cortex (PL), the dorso-medial striatum (dmSTR) and the basolateral amygdala (BLA). Represented here are an example of the raw signal measured from the electrodes and examples of both types of analysis performed: power spectrum density and coherence. The three ranges of frequencies studied are presented on the power spectrum density graph: theta (between 2 and 10 Hz), beta (between 10 and 35 Hz) and gamma (between 35 and 100 Hz).

The power spectrum density (PSD) and coherence (COH) (Figure 3.5) were computed based on 3 s windows centered on each time-point, and time-points were calculated every 0.25s (i.e. the 3s analysis window was advanced in 0.25s steps in the interval). The PSD was calculated using an adaptive weighted multitaper method (as developed by Dr. Michael Graupner). The coherence between LFP signals was computed from the FFT and the weights of the multitaper spectrum estimation (method implemented from Prieto et al., 2009). The analysis parameters of the multitaper method were as follow: time-bandwidth product = 3.5, number of used tapers = 7.

Significant ( $p < 0.05$ ) changes in the mean PSD and COH from baseline (based on the 60s pre-CS period) were determined using a non-parametric cluster-level 1 sample t-test (as described

in Maris and Oostenveld, 2007 and implemented by Gramfort et al., 2013). The procedure uses a cluster analysis with permutation test for calculating corrected p-values. Randomized data were generated with random sign flips. PSD and coherence are presented respectively as dB/Hz and as a coherence value (from 0 to 1, with 0 representing no coherence and 1 representing a complete similarity between the signals). All analyses routines were implemented in custom Python scripts written by Dr. Michael Graupner at NYU.

## **Histology**

Upon completion of electrophysiological experiments, rats were perfused with 4% paraformaldehyde. Brains were removed and post-fixed in 4% PFA and then cryoprotected in 18% sucrose solution. Coronal sections 40 $\mu$ m thick were then cut on a microtome and stained with thionin for identification of recording sites.

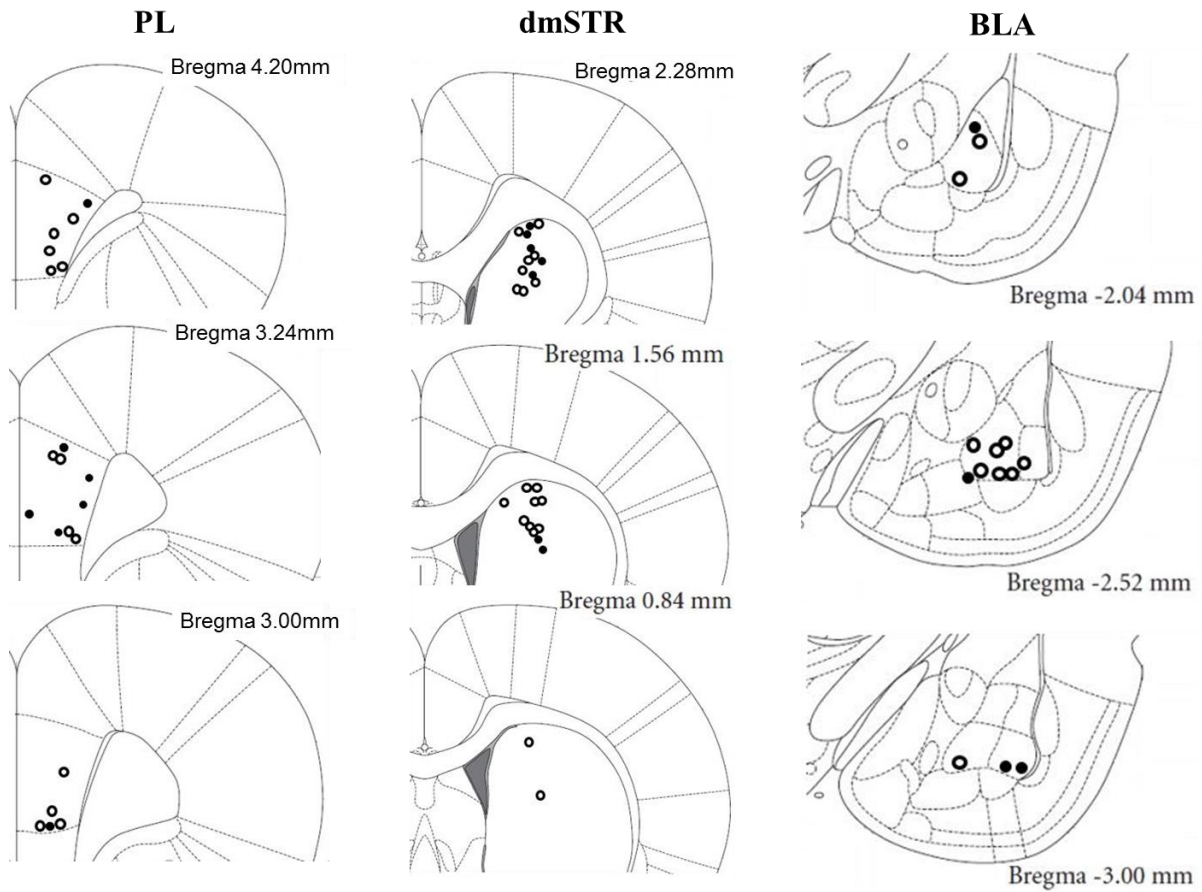


Figure 3.6: Histological placement of electrodes recording tips in the basolateral amygdala (BLA), the prelimbic cortex (PL) and the dorsomedial striatum (dmSTR). Electrodes from experiment 1 are represented with an empty circle, whereas electrodes from experiment 2 are represented with a full circle.



### III. RESULTS

We first verified the placement of the electrodes for both experiments (Figure 3.6). We only analyzed the recordings from the electrodes that were in the BLA, the PL and the dorsomedial striatum (dmSTR) (Table 3.1). These structures were chosen because they are involved in timing processes and are part of a closely interacting network (see Chapter 1, II). For experiment 1, we started with 26 animals, but 8 could not be recorded from because of technical issues. For experiment 2, from 10 animals only 7 were used in recordings.

*Table 3.1: Number of subjects with correct placement of electrodes for each structure and pair of structures.*

	PL	BLA	dmSTR	PL-BLA	PL-dmSTR	BLA-dmSTR
Experiment 1	12	9	18	8	12	9
Experiment 2	7	5	7	5	7	5

#### A. Neural correlates of time in animals at the beginning of training

We used an aversive conditioning paradigm with a CS of 60s and presented the US either at 30s or at 10s. Having the US in the middle of the CS during training means that the only cue that gives information on the arrival of the US is the time. To keep the training to a minimum, we presented 12 CS-US associations in total for each CS-US duration (Figure 3.3, left panel). In this experiment, we used two CSs that the animal should discriminate, a CS- that was never associated with the US, and a CS+ that was associated with the US. Furthermore, we changed the context between training and recordings sessions to make sure that the animals did not fear the context (Figure 3.3, right panel). For ease of reading, the figures are placed at the end of each part (p.118-128 for experiment 1 and p.131-135 for experiment 2).

##### 1. Habituation

We first looked at the effect of the two CSs during the habituation sessions (both sessions were averaged) to determine if the sounds themselves had any effect on brain activity in our network of

interest. We did not observe any significant modulation of activity in any of the structures for theta and beta waves (for both PSD and coherence) during habituation. The only exception was for the gamma band power, as presented in Figure 3.7. The data from the CS+ is presented in Figure 3.7A, with the non-normalized PSD for PL, BLA and dmSTR in the upper panel, and the significant modulations of the PSD signal compared to the pre-CS baseline in the lower panels (values in a blue range represent a significant decrease of power, whereas values in a yellow/red range represent a significant increase of power). Then, the data from the CS- is presented similarly in Figure 3.7B. The significant differences between CS+ and CS- signals are presented in Figure 3.7C. These graphs of significant differences allowed us to determine a frequency band of interest (65-80 Hz) that is presented for both CS+ and CS- in average form normalized to the baseline (Figure 3.7D). All other electrophysiology figures in this chapter are presented in the same way.

We observed a significant increase in gamma (65-80 Hz) band power for the CS+ over most of the duration of the stimulus for both the PL and the dmSTR, and we saw a shorter effect in the BLA (Figure 3.7A). There was a small onset effect in the CS- for the PL (Figure 3.7B) but no effect in the other structures. The increase in gamma power in the PL during the CS+ resulted in a significant difference between CS+ and CS- (Figure 3.7C); this can also be observed in the average even though it does not reach significance in our selected range (Figure 3.7D). This range of frequencies was selected based on the significant modulation observed after conditioning.

## 2. Learning of a 30s CS-US interval

To determine the effects that were due to training *versus* a natural effect of the stimuli used, we compared habituation to data after training with a CS-US interval of 30s (LTM). For the CS+, we observed significant differences for theta and beta frequencies (for both PSD and coherence), but the modification by training in the gamma band power did not reach significance (probably because of the activity already present during habituation). Therefore, we cannot conclude anything on the role of these gamma oscillations in our study, as we cannot differentiate our effects from repetition effects (i.e. presenting the CS+ additional times modulates the brain response without influence from the aversive training). We also observed significant differences (in both theta and beta bands) between habituation and LTM for the CS-, which poses the question of generalization. Indeed, we

expected the animals to show no modulation of their responses to the CS- after the conditioning, as it had never been associated with a particular outcome.

Searching for temporal and associative learning neural correlates, we looked at the differences between CS+ and CS- during training, as differences between the two should represent the modulations due to the aversive learning. We first looked at the recordings after the 30s training. Looking at the PSD for the CS+ (Figure 3.8A) we can see two frequency bands that show a modulation with the presentation of the CS+, one between 4 and 7 Hz (i.e. in the theta range) that is increased, and another between 13-18 Hz (i.e. in the beta range) that is decreased for both PL and dmSTR. For the BLA we only see the decrease in the beta band. Similar responses are observed for the CS- (Figure 3.8B), but the responses seem smaller than for the CS+ and maintained over a shorter duration. When looking at significant differences between CS+ and CS-, a 4-7 Hz band was visible in the PL and the dmSTR, whereas a 13-18 Hz band was visible in the BLA and dmSTR (Figure 3.8C).

The average power of the 4-7 Hz band (Figure 3.8D) follows a similar decay pattern for PL and dmSTR with a significant difference between CS+ and CS- that lasts from 0 to 15s for the PL, and from 0 to 30s for the dmSTR. Thus, it is possible that the theta power in both PL and dmSTR represents a decaying memory trace that encodes the time of arrival of the US. In the BLA (Figure 3.7D, middle panel), we only observed an onset response for the CS+ only.

The average power of the 13-18 Hz band (Figure 3.8E) presents a similar drop followed by a return to baseline pattern for the three structures and for both CSs. There are significant differences between CS+ and CS- only for the BLA and the dmSTR. Notably, the 13-18 Hz band in the BLA is significantly different between the CS+ and the CS- in an area around 15 to 25s, and in an area around 5 to 20s for the dmSTR.

Looking at the coherence during the CS+ (Figure 3.9A), we observed one 4 – 7 Hz band of interest between PL and dmSTR that was significantly higher than baseline over the whole duration of the CS+, which seems logical considering the PSD data of these structures. For the coherence in pairs of structures implicating the BLA (i.e. PL-BLA and BLA-dmSTR), the significant increase in

coherence was observable in a slightly higher frequency band (6-9 Hz). For the CS- (Figure 3.9B), the same bands of frequency were visible, but the significant increase was shorter in time. When looking at the difference between CS+ and CS-, there was significant differences only for the 4-7 Hz coherence between PL and dmSTR between 7 and 20s (Figure 3.8C). This was confirmed in the 4-7 Hz average graph (Figure 3.9D). For PL-BLA and BLA-dmSTR in a 6-9 Hz band, the coherence during the CS+ was higher than during the CS- but this was not significant. Based on the results from the PSD (Figure 3.8), we also looked at the coherence in a 13-18 Hz band but no significant modification across time (Figure 3.9E).

### 3. Shift to a 10s CS-US interval

The animals were conditioned again with a shifted CS-US interval of 10s and tested 24h later (LTM4 and 5, Figure 3.3 left side). When looking at the PSD, it is reassuring to note that the same bands are visible than during the 30s sessions (Figure 3.8 and 3.10). For the CS+, we observed a significant increase in a 4-7 Hz band in the PL and the dmSTR and a significant decrease in a 13-18 Hz band in PL, BLA and dmSTR (Figure 3.10A). When looking at the CS- signals, we observed no significant modulation in the BLA, but a significant decrease in beta power in the dmSTR and a significant increase in theta power in the PL (Figure 3.10B). No significant difference was observed between CS+ and CS- except in the PL toward the end of the CSs (Figure 3.10C). We can see from the average results that this is due to a general increase in power over the course of the CS- visible in both 4-7 and 13-18 Hz bands (Figure 3.10D-E), which may be due to the increased training (when compared to the CS- response in the 30s sessions). In the 4-7 Hz band (Figure 3.10D), we mainly observed an onset response for the CS+, whereas for the 13-18 Hz band (Figure 3.10E), there was still the initial decrease followed by a slow return to the baseline level. Interestingly, the significant part (compared to CS-) of the 13-18 Hz band of the BLA is shifted to before 10s (Figure 3.10E, middle panel) whereas it was just before 30s in the previous condition (Figure 3.8E, middle panel).

Looking at the coherence, we observed this time the same 4-7 Hz band in all pairs of structures for both CS+ (Figure 3.11A) and CS- (Figure 3.11B). This band of frequency was significantly increased in both cases, but over a longer duration for the CS+ than for the CS- (where it is restricted to the onset). There was no significant difference between CS+ and CS- when looking

over the whole range of frequencies (Figure 3.11C). However, when looking at the average of the 4-7 Hz band (Figure 3.11D), we noticed two significant regions in time, when comparing CS+ and CS-, one around 10s and another around 25s, which may represent the two CS-US durations that were learned during the experiment. No differences were observed in the other pairs of structures (Figure 3.11D) or for the 13-18 Hz band (Figure 3.11E).

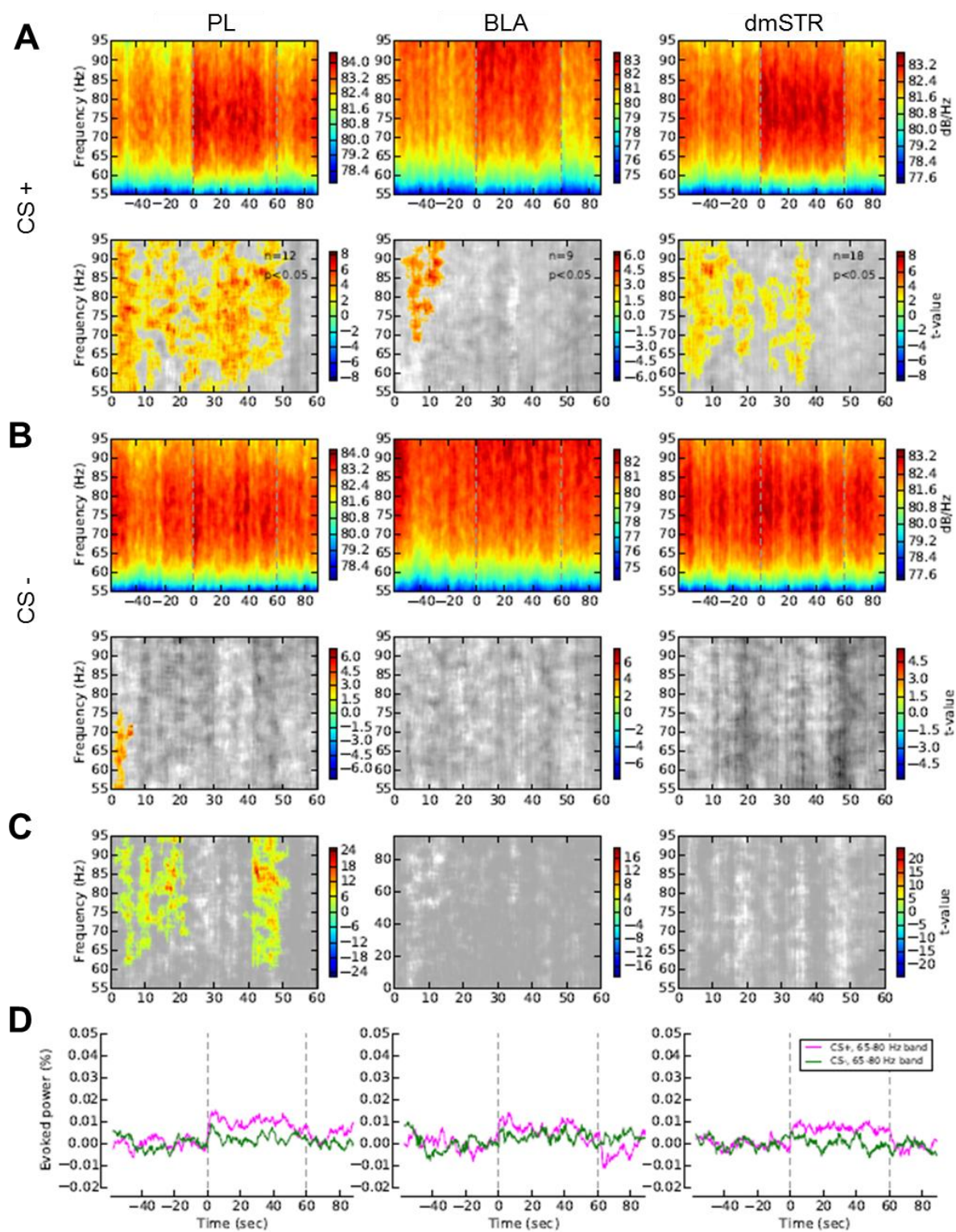
#### 4. Comparison of 30s versus 10s

To further separate associative from temporal neural correlates, we looked at differences between the two durations for the CS+ only (Figure 3.12 and 3.13). When looking at the differences in PSD in the 4-7 Hz band between 30s and 10s for the CS+, we observed a similar trend for the PL and the dmSTR, with a bigger onset response for the 10s sessions but a quick return to baseline, whereas the 30s signal was increased over a longer duration (Figure 3.12A). This difference reaches significance only in the dmSTR between 10 and 25s (Figure 3.12A, right panel). Interestingly, the BLA showed a similar onset difference (10s higher than 30s) but whereas the 30s signal returned to baseline levels, the 10s signal went below the baseline, which could potentially represent the fact that, in the 10s condition, the 50s left in the CS+ became a safety signal.

When looking at the beta band, no significant difference was detected (Figure 3.12B). However, it may be interesting to note that only the dmSTR has a very similar pattern of activity for both conditions. This return to the baseline from the initial decrease may thus represent some kind of representation of the whole CS duration and therefore not change between the 30s and 10s. Interestingly, in the BLA, the slope of the return to baseline seems steeper for the 10s than for the 30s condition, therefore potentially showing an encoding of the learned temporal relationship.

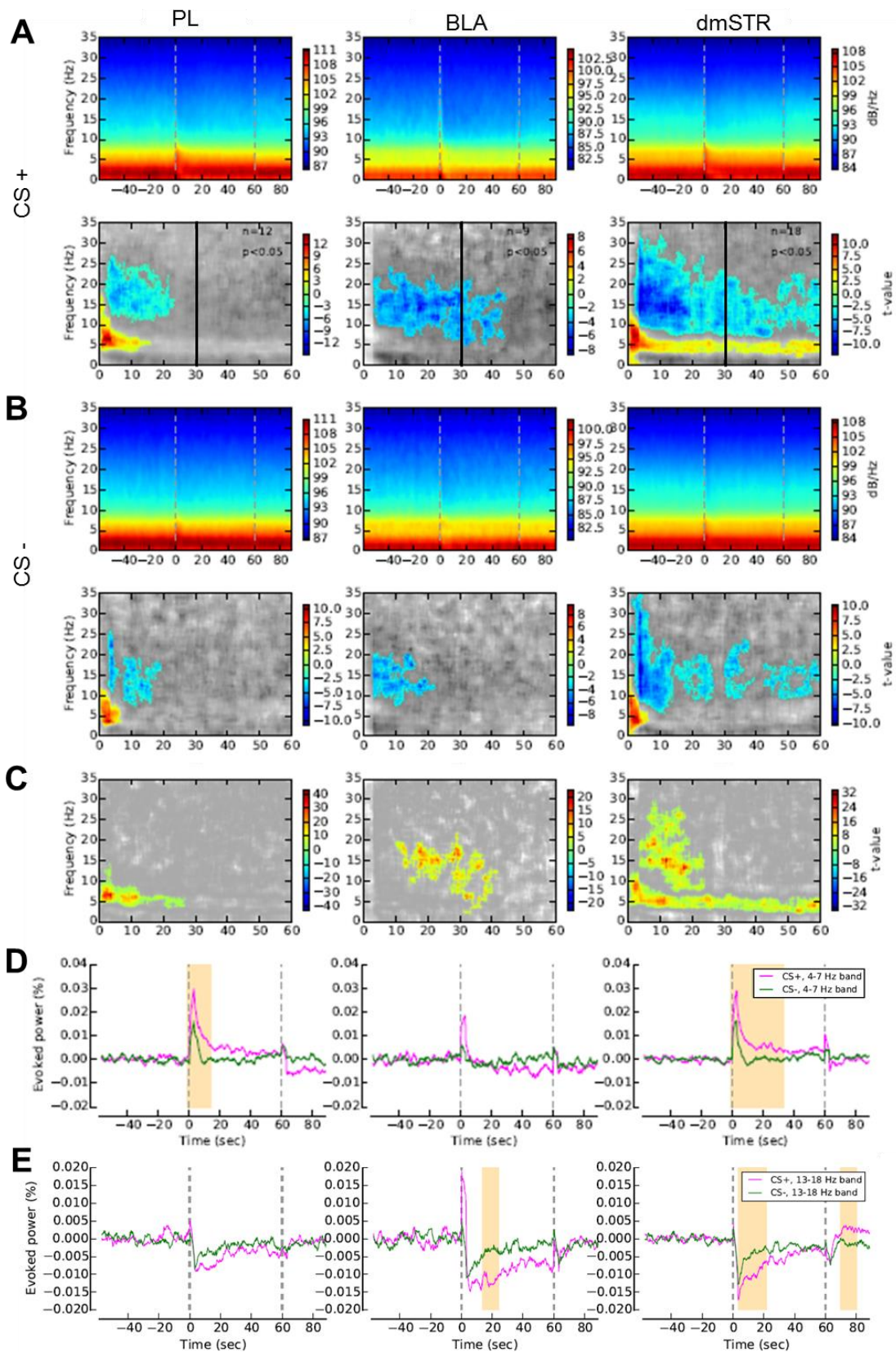
The fact that the onset response is always higher for the 10s than for the 30s signal may be due to the mix of the onset and the temporal response (since 10s is close to the onset), to the increased training (since they received 12 supplementary CS-US associations) or because a CS-US duration of 10s induces a stronger associative strength (as we saw in Chapter 1. I. C.).

When looking at the difference in coherence between the two conditioning for the theta band (Figure 3.13A), we observed similar patterns of responding for both conditions in PL-BLA and BLA-dmSTR. It seems like the higher coherence is maintained for a longer duration in the 30s condition than in the 10s for the PL-dmSTR. Interestingly, in the 10s condition there was an initial increase at the onset followed by a decrease, and a second increase around 30s (Figure 3.13A, middle panel). The difference between the two conditioning conditions reached significance only around 35s. There was no modulation of coherence for the 13-18Hz band in any pair of structures (Figure 3.13B).

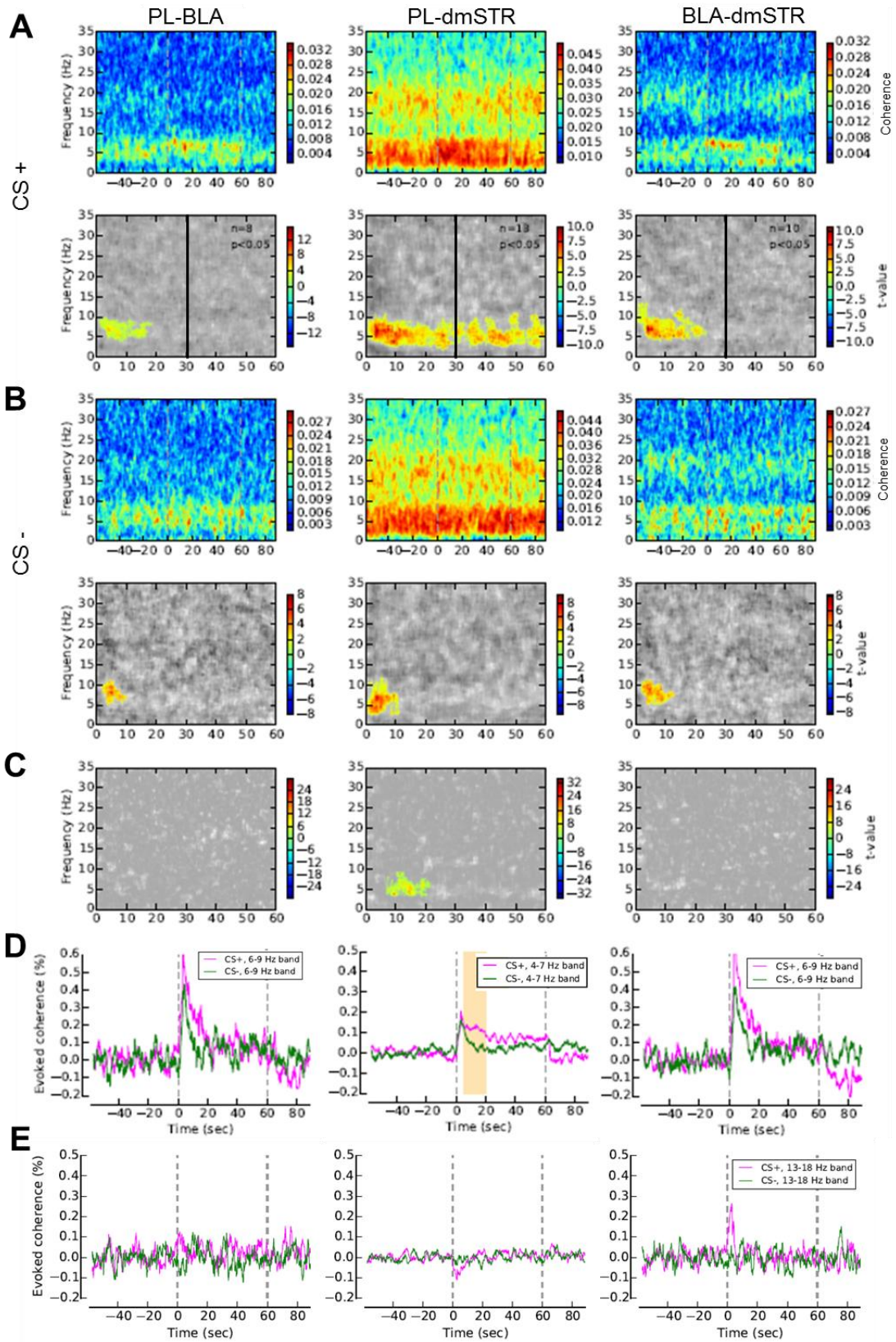


*(on the left side)* Figure 3.7: Power spectrum density (PSD) changes during habituation in a gamma (55-95 Hz) frequency band recorded from the prelimbic cortex (PL), the basolateral amygdala (BLA) and the dorsomedial striatum (dmSTR). (A) PSD (upper panels) during the CS+ trials for the PL, the dmSTR and the BLA before, during, and after 60-s CS presentation (onset and offset marked by dashed gray lines). Non-parametric cluster analysis (lower panels) reveals significant ( $p < 0.05$ ) PSD increases or decreases as t-values, compared to the baseline level of activity. The gray color code depicts non-significant changes (note the different time-scale in the lower panels, which encompasses the stimulus period only). Number of animals for each structure is given in the lower panels as well as p value. (B) Same depiction as in (A) but for the CS-. (C) Non-parametric cluster analysis of power spectrum differences between CS+ and CS- trials. (D) Comparison of the mean PSD normalized to the baseline of the 65-80 Hz frequency band between CS+ (pink) and CS- (green) trials.

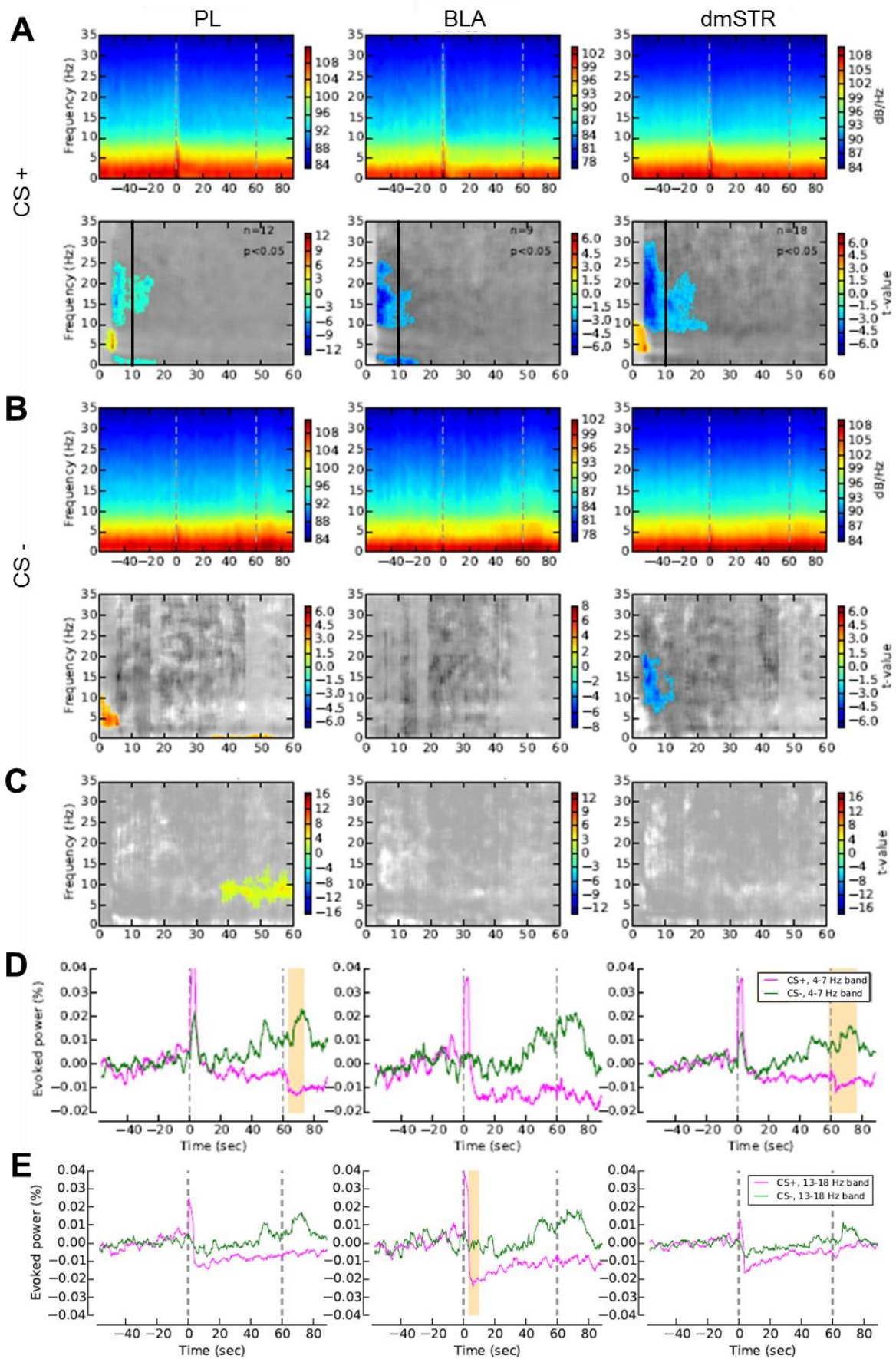




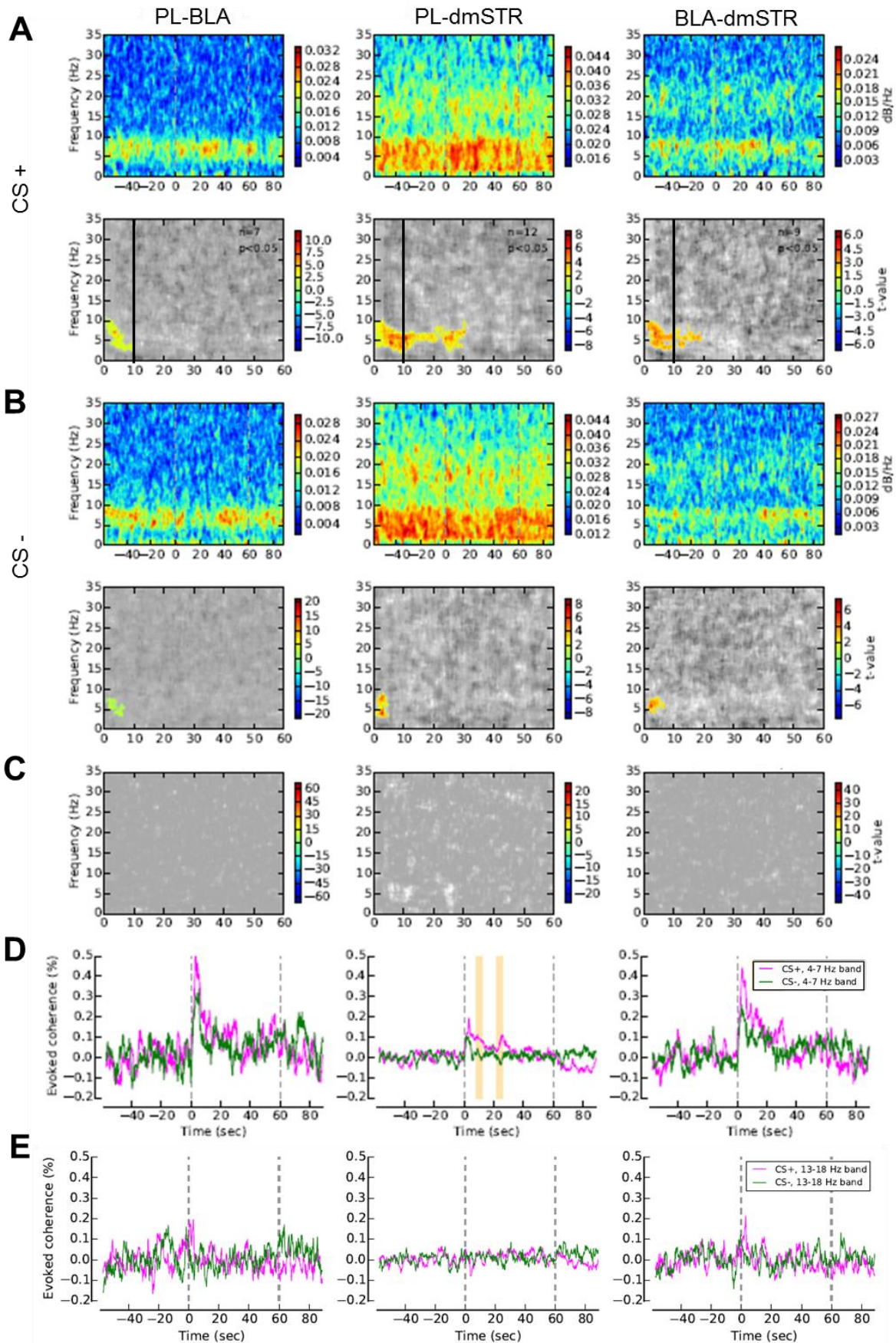
*(on the left side)* Figure 3.8: Power spectrum density (PSD) changes after learning the 30s CS-US interval, in low frequencies (0 – 35 Hz) recorded from the prelimbic cortex (PL), the basolateral amygdala (BLA) and the dorsomedial striatum (dmSTR). (A) PSD (upper panels) during CS+ trials for the PL, the dmSTR and the BLA before, during, and after 60-s CS presentation (onset and offset marked by dashed gray lines). Non-parametric cluster analysis (lower panels) reveals significant ( $p < 0.05$ ) power spectrum increases or decreases as t-values, compared to the baseline level of activity. The gray color code depicts non-significant changes (note the different time-scale in the lower panels, which encompasses the stimulus period only). Number of animals for each structure is given in the lower panels as well as p value. A black bar at 30s represents the learned time of arrival of the US. (B) Same depiction as in (A) but for the CS-. (C) Non-parametric cluster analysis of power spectrum differences between CS+ and CS- trials. (D) Comparison of the mean PSD normalized to the baseline of the 4 – 7 Hz Hz frequency band between CS+ (pink) and CS- (green) trials. Orange regions represent significant differences between CS+ and CS- trials over the covered duration ( $p < 0.05$ ). (E) Similar to (D) but for a 13 – 18 Hz band.



(on the left side) Figure 3.9: Coherence changes after learning the 30s CS-US interval, in low frequencies (0 – 35 Hz) between the prelimbic cortex (PL), the basolateral amygdala (BLA) and the dorsomedial striatum (dmSTR). (A) Coherence (upper panels) between PL-BLA, PL-dmSTR and BLA-dmSTR during CS+ trials, before, during and after the 60-s CS presentation (onset and offset marked by dashed gray lines). Non-parametric cluster analysis (lower panels) reveals significant ( $p < 0.05$ ) power spectrum increases or decreases as t-values, compared to the baseline level of activity. The gray color code depicts non-significant changes (note the different time-scale in the lower panels, which encompasses the stimulus period only). Number of animals for each structure is given in the lower panels as well as p value. A black bar at 30s represents the learned time of arrival of the US. (B) Same depiction as in (A) but for the CS-. (C) Non-parametric cluster analysis of power spectrum differences between CS+ and CS- trials. (D) Comparison of the mean coherence normalized to the baseline of the 4 – 7 Hz frequency band between CS+ (pink) and CS- (green) trials for the PL-dmSTR coherence and between 6 – 9 Hz for PL – BLA and BLA – dmSTR. (E) Similar to (D) but for a 13 – 18 Hz band. Orange regions represent significant differences between CS+ and CS- trials over the covered duration ( $p < 0.05$ ).



*(on the left side)* Figure 3.10: Power spectrum density (PSD) changes after shifting to the 10s CS-US interval, in low frequencies (0 – 35 Hz) recorded from the prelimbic cortex (PL), the basolateral amygdala (BLA) and the dorsomedial striatum (dmSTR). (A) PSD (upper panels) during CS+ trials for the PL, the dmSTR and the BLA before, during, and after 60-s CS presentation (onset and offset marked by dashed gray lines). Non-parametric cluster analysis (lower panels) reveals significant ( $p < 0.05$ ) power spectrum increases or decreases as t-values, compared to the baseline level of activity. The gray color code depicts non-significant changes (note the different time-scale in the lower panels, which encompasses the stimulus period only). Number of animals for each structure is given in the lower panels as well as p value. A black bar at 10s represents the learned time of arrival of the US. (B) Same depiction as in (A) but for the CS-. (C) Non-parametric cluster analysis of power spectrum differences between CS+ and CS- trials. (D) Comparison of the mean PSD normalized to the baseline of the 4 – 7 Hz frequency band between CS+ (pink) and CS- (green) trials. (E) Similar to (D) but for a 13 – 18 Hz band. Orange regions represent significant differences between CS+ and CS- trials over the covered duration ( $p < 0.05$ ).



(on the left side) Figure 3.11: Coherence changes after shifting to the 10s CS-US interval, in low frequencies (0 – 35 Hz) between the prelimbic cortex (PL), the basolateral amygdala (BLA) and the dorsomedial striatum (dmSTR). (A) Coherence (upper panels) between PL-BLA, PL-dmSTR and BLA-dmSTR during CS+ trials, before, during and after the 60-s CS presentation (onset and offset marked by dashed gray lines). Non-parametric cluster analysis (lower panels) reveals significant ( $p < 0.05$ ) power spectrum increases or decreases as t-values, compared to the baseline level of activity. The gray color code depicts non-significant changes (note the different time-scale in the lower panels, which encompasses the stimulus period only). Number of animals for each structure is given in the lower panels as well as p value. A black bar at 10s represents the learned time of arrival of the US. (B) Same depiction as in (A) but for the CS-. (C) Non-parametric cluster analysis of power spectrum differences between CS+ and CS- trials. (D) Comparison of the mean coherence normalized to the baseline of the 4 – 7 Hz frequency band between CS+ (pink) and CS- (green) trials. (E) Similar to (D) but for a 13 – 18 Hz band. Orange regions represent significant differences between CS+ and CS- trials over the covered duration ( $p < 0.05$ ).

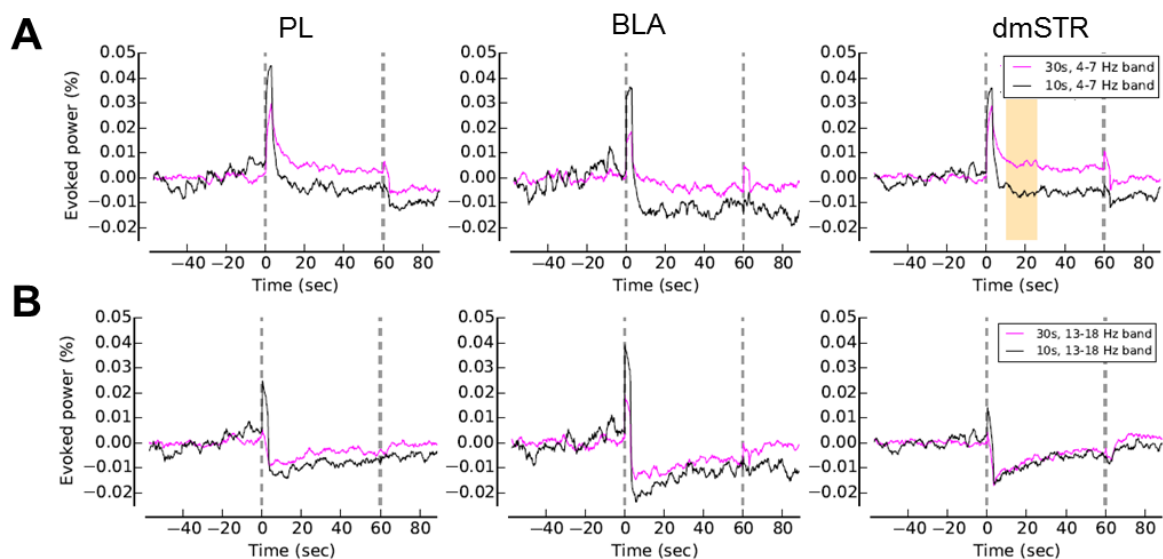
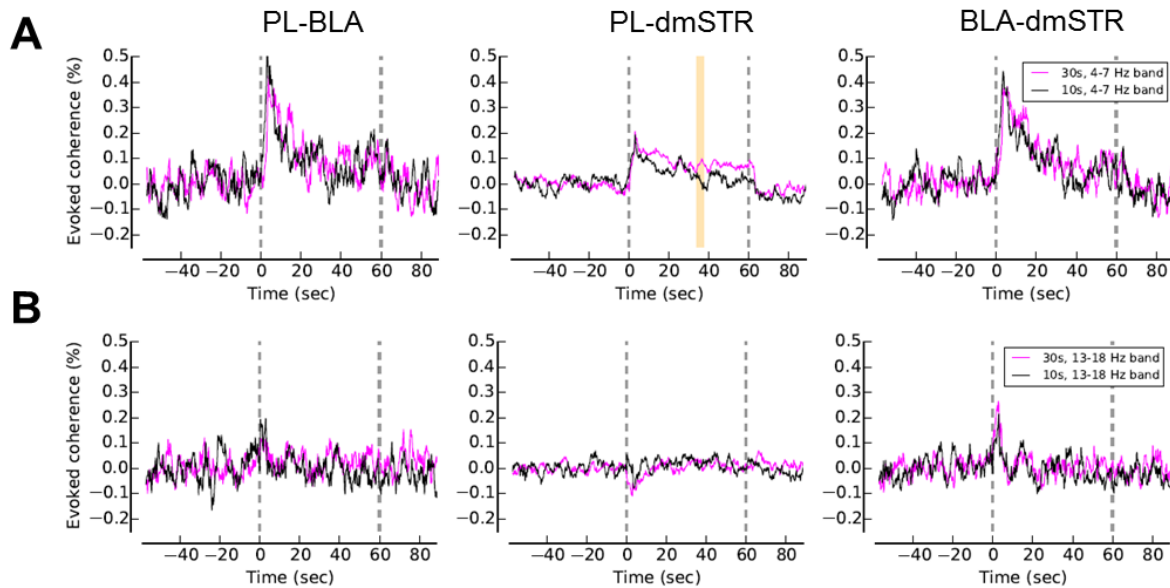


Figure 3.12: Effect of a shift from 30s to 10s of the CS-US interval on low frequency power spectrum density (PSD). Comparison of the mean PSD for the CS+, normalized to the baseline frequency band between 30s (pink) and 10s (black) trials, for a 4 – 7 Hz band (A) and a 13 – 18 Hz band (B). Orange regions represent significant differences between 30s and 10s sessions over the covered duration ( $p < 0.05$ ). The dashed lines represent the onset and offset of the CS.





**Figure 3.13: Effect of a shift from 30s to 10s of the CS-US interval on low frequency coherence.** Comparison of the mean coherence for the CS+, normalized to the baseline frequency band between 30s (pink) and 10s (black) trials, for a 4 – 7 Hz band (A) and a 13 – 18 Hz band (B). Orange regions represent significant differences between 30s and 10s sessions over the covered duration ( $p < 0.05$ ). The dashed lines represent the onset and offset of the CS.

## **B. Neural correlates of time in overtrained behaving animals**

All of the previous results led us to investigate how those neural correlates of time are modified by training and the expression of temporal behavior, since several studies have shown that the CS-US interval is learned from the first CS-US association even though most behavioral expression appear only after overtraining (see Chapter 1. I. C. 3.). For that, we took some of the rats at the end of the experiment described in Chapter 2 and implanted them to record brain activity during presentation of the CS. We used the insertion of a gap as a modification of temporal rules and index to differentiate associative from temporal neural correlates.

### **1. Behavior**

Similarly to what was presented in Chapter 2, we looked at the average curve of temporal behavior (Figure 3.14A) as well as at the peak time (obtained via fitting a Gaussian curve on the average data, Figure 3.14B). It should be noted that for two rats, the average curve could not be

fitted (as the data were too variable across the CS), so they were removed from the behavioral analysis, resulting in a final number of animals of 5. However, they were kept for the electrophysiological results as it was considered that the absence of temporal behavioral output did not mean that they had forgotten the temporal rules of the task (and therefore could still show neural correlates of temporal learning). The deterioration of the temporal behavior compared to before the surgery may be due to the fact that we changed the ratio of reinforced/non-reinforced trials, as well as to the difficulty the rats had to reach the food because of the electrophysiological cap.

Like previously (Chapter 2), the peak time of the Probe trials was anticipated compared to the reinforced time (i.e.  $9.1 \pm 1.3$ s compared to 15s;  $t(4) = 4.51$ ,  $p < 0.001$ ). As expected, we observed a shift in time of the curve with the insertion of the gap compared to the Probe trials ( $t(4) = 3.20$ ,  $p < 0.05$ ); this shift followed a ‘stop’ rule ( $t(4) = 0.82$ , n.s.) and not a ‘reset’ rule ( $t(4) = 3.23$ ,  $p < 0.05$ ) (Figure 3.14B). This means that, during the gap, the animals maintained in memory the pre-gap duration. Thus, brain activity during the gap could represent this short-term memory of time.

## 2. Power spectrum density

Looking at the LFPs in the BLA, PL and dmSTR, we first searched for the effect of overtraining (in comparison to what was observed early in training, see exp1), and further compared Probe and Gap trials to reveal activity modulated by time *versus* associative conditioning. We first looked at the PSD in the low frequency range (Figure 3.15). During the Probe trials, we did not observe any significant modulation of power in the PL and BLA, but saw a significant decrease of power in a beta range of frequency (10-25 Hz) that lasted from 3s to 25s in the dmSTR (Figure 3.15B). Similarly, in the Gap trials, we observed a significant effect only in the dmSTR in the same beta band (Figure 3.15A). Looking at the average power, we can see that during the Gap trials, the decrease also started at the onset, but there was a return to baseline level during the gap that was followed by a second decrease after the end of the gap that reached the same level as the Probe signal (Figure 3.15D). This produced a significant difference between Probe and Gap signals from 5 to 15s (Figure 3.15C). The lower number of animals that we recorded from the BLA could explain the absence of effect that we see here. However, since we have the same number of animals for both the dmSTR and the PL, it is possible that there was no modulation of the PL in those frequencies

bands during this task. In any case, increasing the number of animals seems necessary to confirm these results.

Then we looked at the PSD for higher frequencies, in the gamma range (55 – 95 Hz) (Figure 3.16). In the Probe trials, we observed significant differences compared to the baseline for both the PL (from onset to 25s) and the dmSTR over the whole duration of the CS in a 60 to 70 Hz band (Figure 3.16B). However, only the dmSTR showed significant modulation of power in the Gap trials starting after the gap and it seems to be in a higher frequency band (from 60 to 75 Hz) (Figure 3.16A). No significant difference was observed between Gap and Probe trials (Figure 3.16C and D). It should be noted, however, that the insertion of the gap provoked a sudden decrease followed by a re-increase of gamma power (probably explaining why the power does not reach significance compared to the baseline before the gap). However, I would argue that the response for both Probe and Gap are similar and may represent the expectation of the US over the course of the CS (increased at the beginning and decreasing over time).

### 3. Coherence

We also looked at the coherence in theta, beta and gamma bands, but did not observe significant differences compared to the baseline in any couple of structures. However, coherence seemed noisier, and it is possible that more animals are necessary to extract the signal from the noise.

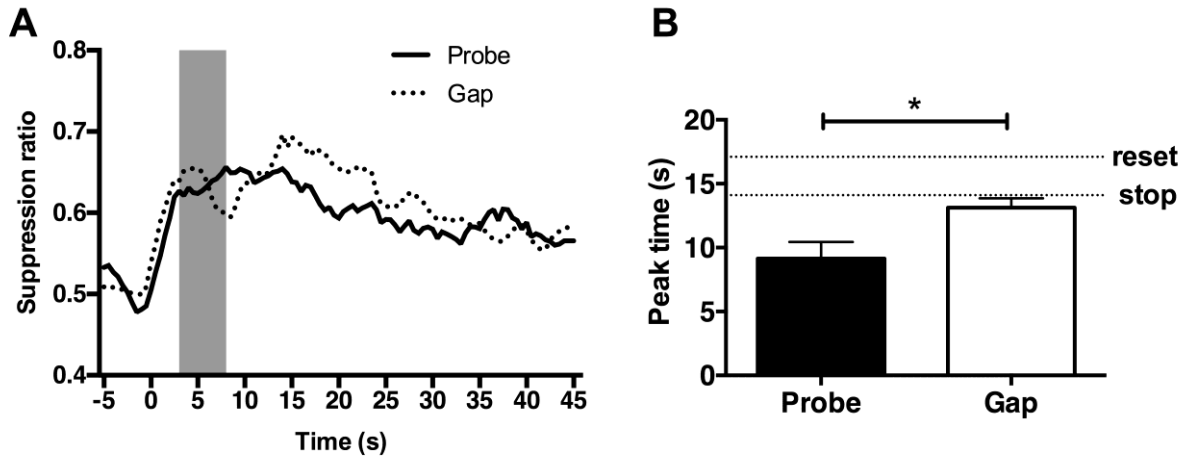
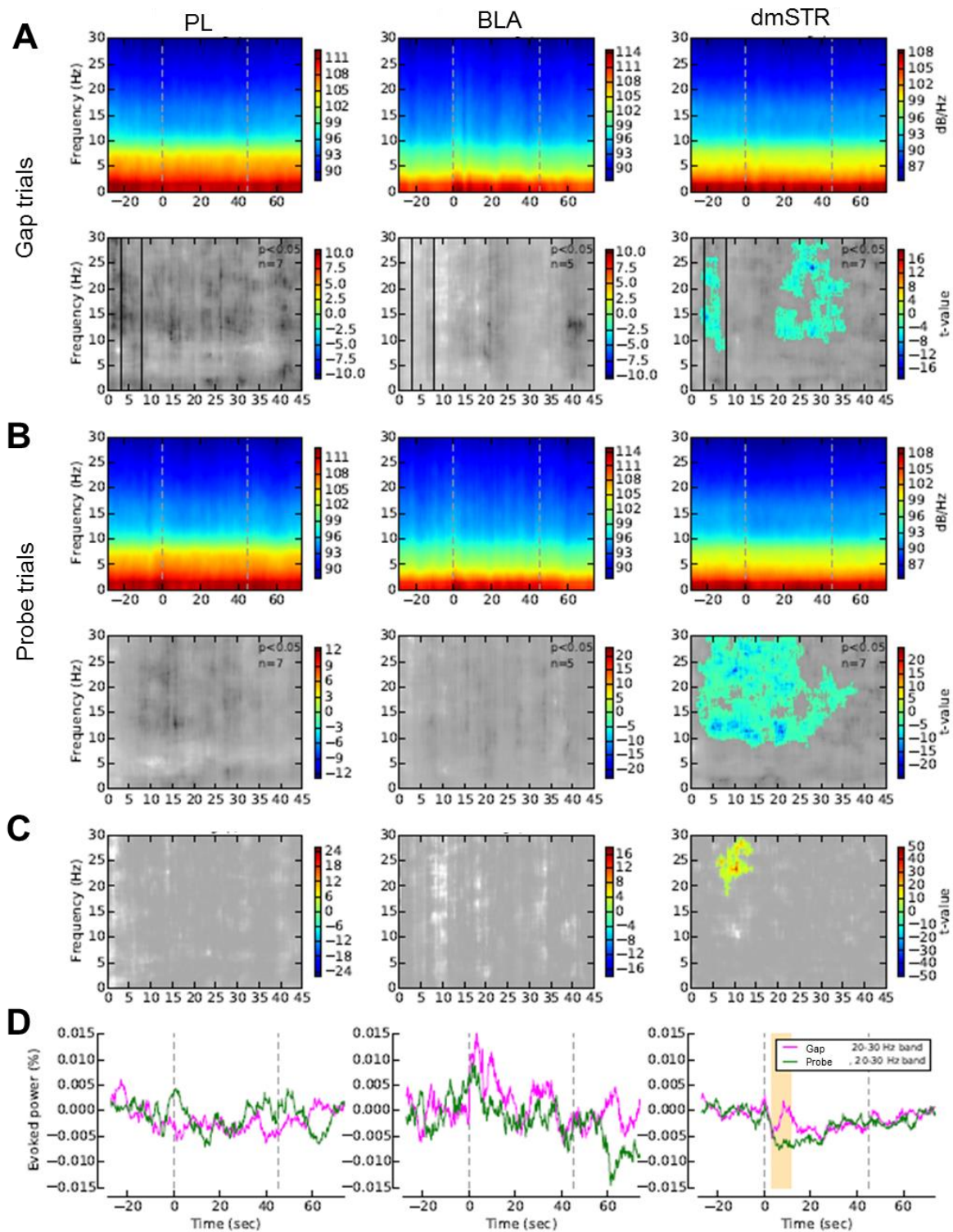
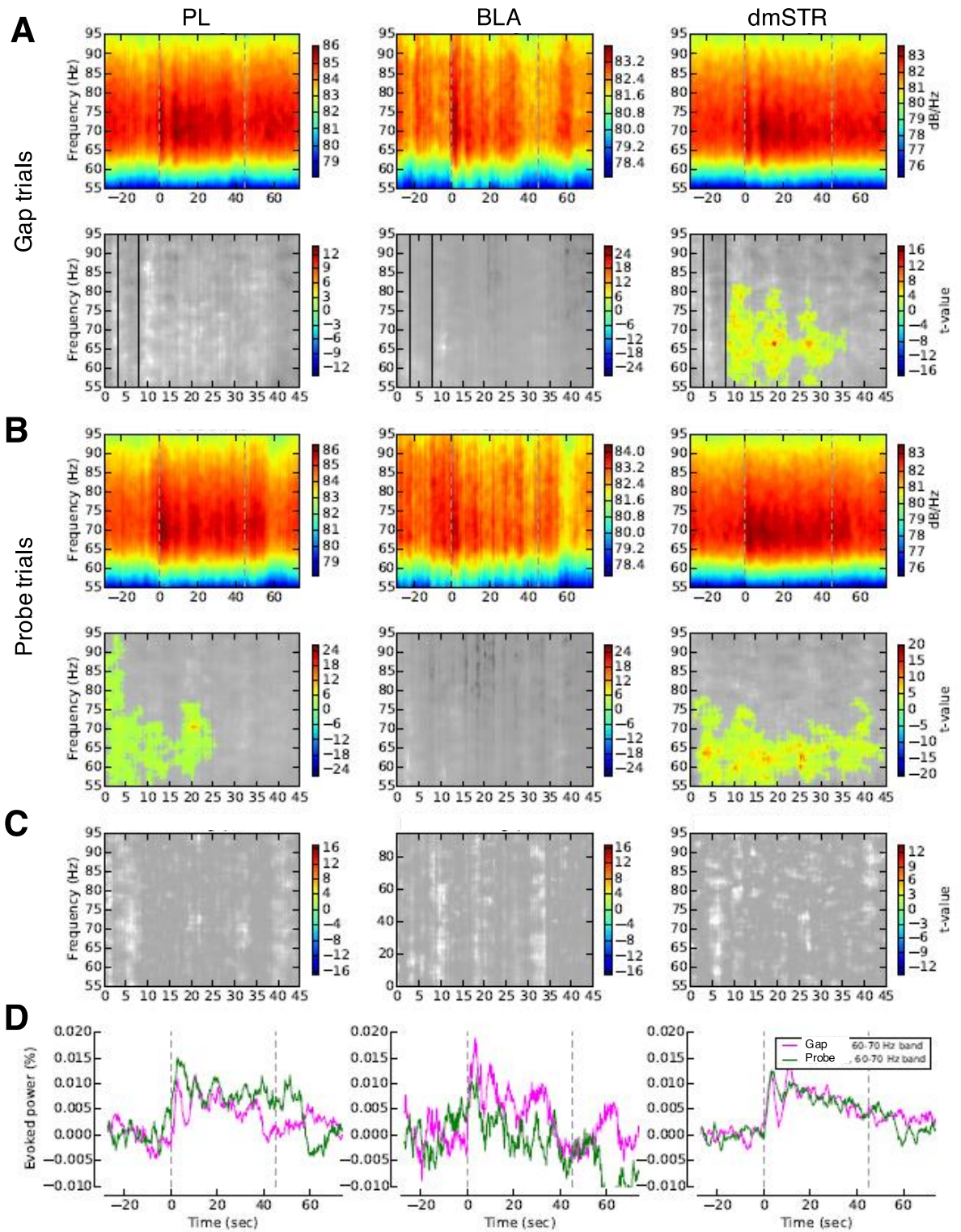


Figure 3.14: Temporal behavior of the recorded animals during the Probe and Gap trials. (A) The mean suppression curve across time (with a window smoothing of 3s) is represented with the gap as a gray area (lasts 5s with an onset at 3s). (B) Mean (+ SEM) peak time for the Probe and Gap trials. The values expected for stop and reset modes, based on the Probe trials, are presented as horizontal dotted lines. \*  $p < 0.05$



(on the left side) Figure 3.15: Time-related oscillatory changes in theta and beta bands recorded from the prelimbic cortex (PL), the basolateral amygdala (BLA) and the dorsomedial striatum (dmSTR). A: Power spectrum density (PSD, upper panels) in LFP power for the PL, the BLA and the dmSTR for 30s before, during the 45-s CS presentation and 30s after (onset and offset marked by dashed gray lines) for the Gap trials (the gap is represented by the two thin black lines at 3s and 8s of the 45s of the CS+gap). Non-parametric cluster analysis (lower panels) reveals significant ( $p < 0.05$ ) power spectrum increases or decreases as t-values, compared to the baseline level of activity. The gray color code depicts non-significant changes (note the different time-scale in the lower panels, which encompasses the stimulus period only). Number of animals for each structure is given in the lower panels as well as p value. B: Same depiction as in A but for the Probe trials. (C) Non-parametric cluster analysis of power spectrum differences between Gap and Probe trials. (D) Comparison of the mean PSD of the 20-30 Hz frequency band, normalized to the baseline, for Gap (pink) and Probe (green) trials. Orange regions represent significant differences between Probe and Gap trials over the covered duration ( $p < 0.05$ ).



*(on the left side)* Figure 3.16: Time-related oscillatory changes in gamma band recorded from the prelimbic cortex (PL), the basolateral amygdala (BLA) and the dorsomedial striatum (dmSTR). A: Power spectrum density (PSD, upper panels) in LFP power for the PL, the dmSTR and the BLA before, during, and after 60-s CS presentation (onset and offset marked by dashed gray lines) for the Gap trials (the gap is represented by the two thin black lines at 3s and 8s). Non-parametric cluster analysis (lower panels) reveals significant ( $p < 0.05$ ) power spectrum increases or decreases as t-values, compared to the baseline level of activity. The gray color code depicts non-significant changes (note the different time-scale in the lower panels, which encompasses the stimulus period only). Number of animals for each structure is given in the lower panels as well as p value. B: Same depiction as in A but for the Probe trials. (C) Non-parametric cluster analysis of power spectrum differences between Gap and Probe trials. (D) Comparison of the mean PSD normalized to the baseline of the 60-70 Hz frequency band between Gap (pink) and Probe (green) trials. Orange regions represent significant differences between Probe and Gap trials over the covered duration ( $p < 0.05$ ).



## IV. DISCUSSION

By recordings local field potentials during the modification of temporal rules in Pavlovian aversive conditioning in both early learning and overtrained animals, we have observed neural correlates of time in an amygdalo-prefronto-dorsostriatal network (Table 3.2). For animals that have just learned the association, we observed temporal modulation of a beta band in the BLA and dmSTR, as well as of a theta band in the PL and dmSTR. The coherence in theta oscillations between the dmSTR and PL was also modified when the CS-US interval was changed. For the overtrained animals, we observed neural correlates of time in beta and gamma bands in the dmSTR, and in gamma frequencies for the PL.

*Table 3.2: Summary of the observed neural correlates that were modified by changing the temporal rules of the task.* In red are presented significant increases and in blue significant decreases.

	Early learning		Overtraining	
	PSD	Coherence	PSD	Coherence
<b>Theta</b>	PL, dmSTR	PL-dmSTR	X	X
<b>Beta</b>	BLA, dmSTR	X	dmSTR	X
<b>Gamma</b>	?	X	dmSTR, PL	X

We observed some differences in the frequency bands linked with time between overtraining and early training animals (Table 3.2). Indeed, some of the activity was present in early learning, but not in overtrained animals. For example, we did not observe any change in theta activity (PSD or coherence) in overtrained animals. The beta power in the BLA was also no longer modulated. In contrast, a change in activity in a gamma band was observed in the dmSTR and the PL only in overtrained animals, and not at the beginning of training (but this may have been masked by the non-conditioned response that we observed during habituation). Of interest is the change in beta band power of the dmSTR that was maintained over training, and therefore may represent a neural correlate of time that is not dependent on training, meaning that it is not dependent on a well-shaped behavioral expression of temporal expectation.

Data from the lab in similarly overtrained animals have shown neuronal correlates of the CS-US interval in the BLA and the dmSTR (paper submitted). In that study, changes in PSD in a theta band (3-6 Hz) were modulated by changing the CS-US interval in both dmSTR and BLA. This modulation was specific of this frequency band as no effect was observed for a 6-9 Hz band. However, a similar temporal pattern was observed in a 60-70 Hz gamma band. Furthermore, when looking at the coherence between those two structures, a significant interaction with time was obtained for the 3-6 Hz band. Interestingly, when testing the scalar property of time for those signals, the 3-6 Hz coherence signal presented the best superposition between the two CS-US intervals.

The validity of our results can be discussed on several fronts. It could be noted that the sound used for the CS+ in experiment 1 was the same as the sound used for the CS in the experiment 2. Therefore, considering the results in gamma frequencies during the habituation of the experiment 1, one could wonder whether some of the activity we observed in gamma frequencies in experiment 2 may be due to the sound itself. However, the patterns of activity seem different and we observed differences between Gap and Probe trials that cannot be explained by the frequency effect (since the same frequency was used for both types of trials). We also observed some generalization from the CS+ to the CS-, as we observed significant responses to the CS- after training compared to the responses measured during the habituation. This generalization may have masked some effects when comparing CS+ with CS-. Interestingly, with increased training (comparison between the 30s and the 10s sessions), we tended to observe a decrease of response to the CS-, which seems logical as training should facilitate the discrimination between the CS+ and the CS-. It seems plausible that we did not observe similar activity in the amygdala and in BLA-STR coherence compared to the previous experiment done in the lab because we did not have enough animals implanted in the amygdala. It would thus be interesting to add more animals to determine more precisely the interaction of the amygdala with this prefronto-striatal network. The absence of a modulation of this coherence in early training animals may be due to the fact that it is linked to behavioral expression of expectancy and that it requires further training to appear.

In general, we never observed any modification of coherence in the gamma band compared to the baseline in any condition, potentially because gamma oscillations are more involved in intra-structure communication than inter-structure. Indeed, fast oscillations lose power quickly over long

distances (because dendrites represent low-pass filters) compared to slow oscillations; therefore slow oscillations are usually considered to be a better vehicle for transmission of information over long distances (Buzsaki and Shomburg, 2015).

Looking back at previous studies of oscillations in animal models, it is very rare for people to have looked specifically at timing and used an appropriate task for it (see Chapter 1. II. C.). The main results are somewhat contradictory. Studies have shown an implication of hippocampus theta wave (4-9 Hz) in temporal discrimination (Nakazono et al. 2015) and of the striatum (but not the hippocampus) theta wave (6-12 Hz) in a PI task (Hattori and Sakata 2014). As we did not record in the hippocampus we cannot compare completely our results to those previous experiments, but we did also observe an implication of theta oscillations in the striatum (even though we observed it for a lower theta band, 4-7 Hz). Interestingly in a MEG study in humans, changes in beta power were associated with inter-stimulus intervals. Indeed, when presenting sounds at regular intervals (390, 585 or 780 ms), the onset of a sound provoked a decrease in beta power that was similar for all durations tested but the speed of return to the baseline level was modulated so that maximal power slightly preceded the next sound (Fujioka et al. 2012). This goes very well with what we observed both in early learning and in overtrained animals, especially when looking at the 13-18 Hz band in the BLA of early learning animals. Thus, our results concur with the literature to conclude that beta oscillations may have an important role in interval timing and not just in motor control (Engel and Fries 2010).

When looking at implicit timing tasks, we can sometimes deduce a temporal modulation of some neural correlates measured, even though the paradigms are not optimal for this. In a Pavlovian aversive conditioning task similar to our experiment, Pape et al (2005) showed an increase in theta power (5-6 Hz) correlation between the hippocampus and LA across the presentation of an aversive CS, whereas Popescu et al (2009) showed an increase in coherence in low gamma (35-45 Hz) between the posterior ventral striatum and the BLA when comparing a CS+ to a CS-. Bauer et al (2007) observed also ramping in a low gamma range in the BLA of cats but only after the animals were trained over more than a week. Interestingly, Bartolo et al (2014) showed entrainment of a beta (10-30 Hz) and a gamma (30 – 80 Hz) band in the dorsolateral striatum of monkeys (i.e. putamen), therefore involving similar bands of frequencies to the ones that were time-modulated in

our results. It is however difficult to obtain a whole picture since very different structures were recorded.

A lot remains to be done to understand these results. First, it would be interesting to confirm that our results are time dependent by recording control animals who were conditioned with the CS-US of 10s first and then shifted to 30s; as this would allow us to separate training effects from timing effects. Furthermore, more in-depth analyses would be interesting. We could try using an analysis of PSD with a better temporal resolution like the wavelet or the Hilbert transform (Le Van Quyen et al. 2001). Such an analysis would be especially interesting for the gap experiment as it would allow us to refine our understanding of what happens at the start and the end of the gap. It would also be important to look at interactions between the frequencies bands we observed, like cross-frequency coupling. This measure represents the modulation of the amplitude of the higher frequency oscillations by the phase of the lower frequency oscillations in the same or in two separate brain areas. For example, in a go/no-go task, the phase amplitude coupling in the orbitofrontal cortex of rats encoded good versus bad decisions (van Wingerden, et al, 2014). It would also be interesting to look at separating the two possible origins of our increased coherence (either power-power or phase-phase).

Furthermore, going back to the connectivity in our network of interest (Figure 1.14), the connectivity between PL and dmSTR is unidirectional from the PL to the dmSTR, similarly to the connectivity between BLA and dmSTR (BLA -> dmSTR), making it interesting to test, in the coherence, which structure drives the other. If the dmSTR seems to drive the PL and BLA, it would be logical to assume that the coherence is actually produced by another structure that is upstream of this network.

The next step, after the characterization of the neuronal signals involved in interval timing, is showing causation between the two. With the numerous new tools at our disposal to precisely alter brain function (like optogenetics and DREADD [Designer Receptors Exclusively Activated by Designer Drugs]), it is becoming possible to determine very finely what brain mechanisms are essential for many cognitive processes, thus making it possible to do the same for the processing of time. Of course, these types of studies first require a thorough description of time-dependent brain

signals to know which signal to modify. It is also possible to modulate the phase of oscillations by using optogenetics stimulations (Witt et al. 2013); this would allow us to determine if modifying the interactions in the theta band of frequency between the dmSTR and PL, for example, would disrupt temporal behavior.

## **CHAPTER 4**

### **Detection of a temporal error by pre-weaning rats**



## I. INTRODUCTION

It is widely accepted that subcortical structures mature earlier than cortical ones and neural maturation usually follows an inferior to superior and a posterior to anterior axis. (e.g. Lodygensky et al. 2010). In the case of our network of interest, the striatum and amygdala should therefore mature before the prefrontal cortex. But how to define brain maturation? A system can be functional even if it is not adult-like. There can be many properties that mature at different rates, like the connectivity with other structures, the electrophysiological properties of the neurons, or the cytoarchitecture of the structure. Michel and Moore (1995) argue that brain maturation should be defined by measuring behavioral development. Of course this necessitates having precise behavioral measures that are dependent on only one structure, which is very rare.

### A. Ontogeny of associative learning and timing



**Article n°2: Developmental emergence of fear/threat learning:  
Neurobiology, associations and timing**

Genes, Brain and Behavior (2015)

**Developmental emergence of fear/threat learning:  
Neurobiology, associations and timing**

<sup>1,2,3</sup>Lucille Tallot, <sup>1</sup>Valerie Doyère and <sup>2,3</sup>Regina M. Sullivan

<sup>1</sup>Institut des Neurosciences Paris Saclay (Neuro-PSI), UMR 9197, CNRS / Université Paris-Sud, 91405 Orsay, France

<sup>2</sup>Emotional Brain Institute, The Nathan S. Kline Institute for Psychiatric Research, Orangeburg, NY 10962, United States

<sup>3</sup>Child Study Center Institute for Child and Adolescent Psychiatry, New York University Langone Medical Center, New York, NY, 10016 United States

**Corresponding authors:** Lucille Tallot (lucille.tallot@gmail.com) and Regina Sullivan (regina.sullivan@nyumc.org)

Regina Sullivan  
NYU Child Study Center  
1 Park Ave, 8<sup>th</sup> floor  
New York, New York 10016

Lucille Tallot  
Institut des Neurosciences Paris Saclay UMR 9197, CNRS / Université Paris-Sud  
Université Paris-Sud, Bat. 446, rue Claude Bernard  
91405 Orsay, France

**Running title:** Development of aversive learning and timing

**Keywords:** Pavlovian conditioning, amygdala, ontogeny, interval timing, pup, corticosterone, contextual learning, aversive conditioning, neural circuits

**Abbreviations:**

BLA: basolateral nucleus of the amygdala

CeA: central nucleus of the amygdala

CORT: corticosterone

CR: conditioned response

CS: conditioned stimulus

DRL: differential reinforcement of low responding

IL: infralimbic cortex

PFC: prefrontal cortex

PL: prelimbic cortex

PN: post-natal day

US: unconditioned stimulus

USV: ultrasonic vocalization

## **Abstract**

Pavlovian fear or threat conditioning, where a neutral stimulus takes on aversive properties through pairing with an aversive stimulus, has been an important tool for exploring the neurobiology of learning. In the past decades, this neurobehavioral approach has been expanded to include the developing infant. Indeed, protracted postnatal brain development permits the exploration of how incorporating the amygdala, prefrontal cortex and hippocampus into this learning system impacts the acquisition and expression of aversive conditioning. Here we review the developmental trajectory of these key brain areas involved in aversive conditioning and relate it to pups' transition to independence through weaning. Overall, the data suggests that adult-like features of threat learning emerge as the relevant brain areas become incorporated into this learning. Specifically, the developmental emergence of the amygdala permits cue learning and the emergence of the hippocampus permits context learning. We also describe unique features of learning in early life that block threat learning and enhance interaction with the mother or exploration of the environment. Finally, we describe the development of a sense of time within this learning and its involvement in creating associations. Together these data suggest that the development of threat learning is a useful tool for dissecting adult-like functioning of brain circuits, as well as providing unique insights into ecologically relevant developmental changes.

## Introduction

Classical conditioning has been a powerful tool for unraveling the neurobiology of learning and memory in adults and has enabled us to better understand the multiple and complex pathways used for learning within the brain (for reviews see Pattwell *et al.*, 2013; Stanton, 2000). Pavlov (1927) first described classical conditioning, also called Pavlovian conditioning, where an initially neutral stimulus becomes a conditioned stimulus (CS) after pairing with a stimulus that has an inherent biological value (unconditioned stimulus, US). After several CS-US pairings, the CS comes to evoke various conditioned responses (CR), which resemble or are related to the ones elicited by the US.

Great advances have been made in our understanding of the neurobiology of associative learning in humans and animals by using aversive/threat conditioning in which the US is unpleasant or threatening (for reviews see Fanselow & Poulos, 2005; Janak & Tye, 2015; LeDoux, 2014). Research in infant rats has provided insight into the ontogeny of threat learning by identifying the gradual development of the neural circuitry supporting aversive conditioning (Landers & Sullivan, 2012; Pattwell *et al.*, 2013). The study of the ontogeny of threat conditioning in humans has been less developed, although the past decade has seen great progress, indicating the human brain circuit is likely homologous to that seen in rodents (Glenn *et al.*, 2012; Jovanovic *et al.*, 2013; Lau *et al.*, 2008; Shechner *et al.*, 2015; Sterzer, 2010; Tottenham *et al.*, 2015). Additionally, an essential aspect of learning associations is the detection and memorization of temporal intervals between events (Balsam *et al.*, 2010; Pavlov, 1927). During Pavlovian conditioning, the CS acquires a predictive value for the US, including *when* it is due to arrive, in as few as one trial (Davis *et al.*, 1989; Díaz-Mataix *et al.*, 2013). It has been suggested that learning time may be a prerequisite to learning the association (Arcediano *et al.*, 2003; Balsam & Gallistel, 2009). Whether it also applies to early life associative learning is not known, although recent work suggests that the development of this timing system may be critical to learning in the infant (Brannon *et al.*, 2004; Droit-Volet, 2013).

One approach in developmental research is to ask how adult-like characteristics of learning emerge as additional brain areas are incorporated into the learning circuit (e.g. Hunt *et al.*, 1994; 1997 Stanton *et al.*, 1992; for a review Stanton, 2000), and as plasticity mechanisms subserving learning develop (e.g. Blaise & Bronzino, 2003; Ehrlich *et al.*, 2013, 2012; Thompson *et al.*, 2008). Another approach is to ask how learning might differ during ontogeny as the demands

of unique ecological niches change with maturation and the transition to independence (Landers & Sullivan, 2012). Here we review literature on the development of aversive learning that highlights both of these approaches. We consider the ecological significance of the slowly developing neural circuitry through integration of newly emerging information and their potential relevance to the development of fear learning in humans (Casey *et al.*, 2015). This is a complex learning system involving multiple brain areas and a complex behavioral expression. Furthermore, all of this must occur within the highly complex and evolving ecological niche of the developing altricial mammal as they change from being completely dependent on the caregiver to an independent organism. This review will highlight how the ecological niche and brain development interact to produce dramatically different learning and behavioral expression following aversive learning.

### **The Basic Circuitry Supporting Aversive Learning**

In the case of aversive learning, the US is often an electrical shock, whereas a neutral tone, light or odor serves as the CS. The amygdala and associated structures are essential for learning this association (for reviews see Herry & Johansen, 2014; Phelps & LeDoux, 2005) (Figure 1). Indeed the sensory and somatosensory inputs are integrated in the basolateral nucleus of the amygdala (BLA, i.e. comprising the lateral and basal subnuclei), which then drives the central nucleus of the amygdala (CeA) that controls behavioral outputs. The CeA by acting on the periaqueductal gray will induce freezing; the typical CR measured in aversive conditioning. The CeA also controls other brain areas that drive CR such as increases in heart rate and in corticosteroid release associated with aversive cues.

The place or context where the learning took place is also associated with the US. It is also possible to use the context as the CS during CS-US conditioning. Both of these types of learning involve the interaction between the hippocampus and the amygdala (e.g. Selden *et al.*, 1991; Kim & Fanselow, 1992; Phillips & LeDoux, 1992; Phelps & LeDoux, 2005).

Once established, the aversive response to the CS may be decreased in strength through repeated presentation of the CS without the US, an active learning process referred to as extinction (Bouton *et al.*, 2006). Extinction involves interaction between the amygdala, the prefrontal cortex (PFC) and the hippocampus (Maren & Quirk, 2004; Quirk & Mueller, 2008; Sotres-Bayon *et al.*, 2006). More specifically the prelimbic cortex (PL) is involved in the expression of aversive conditioning by projecting to the BLA whereas the infralimbic cortex

(IL) is involved in extinction learning possibly by activating the amygdala-intercalated cells that inhibit the activity of the CeA (Myers & Davis, 2007). This aversive learning and extinction system is phylogenetically preserved and has been demonstrated in humans, nonhuman primates, rodents but also aplysia and nematode (for reviews see Krasne *et al.*, 2011; LeDoux, 2000; 2014; Walters *et al.*, 1981).

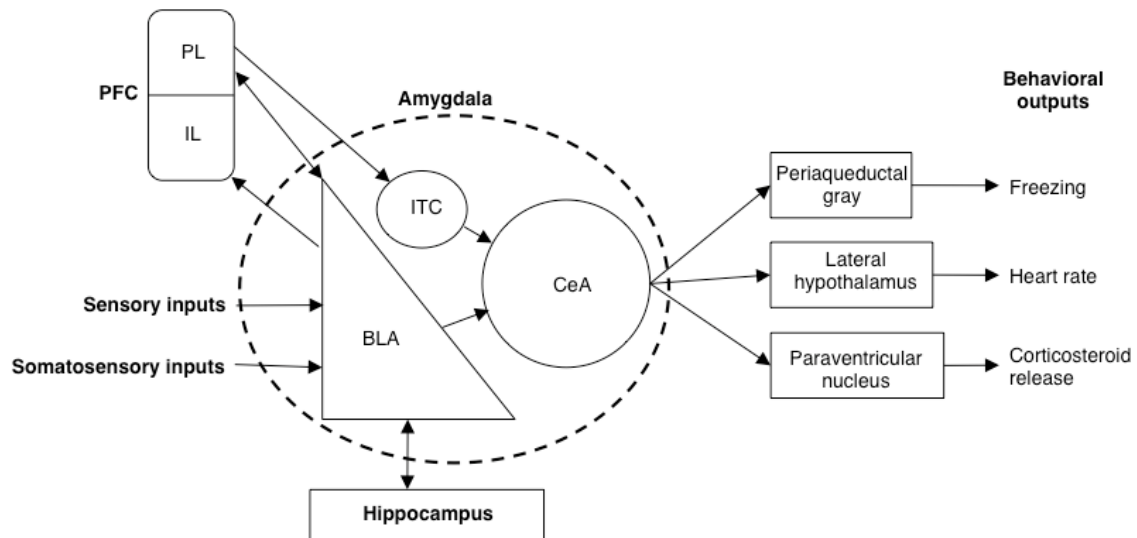


Figure 1: Schematic representation of a simplified circuit for aversive conditioning in adult rats and some of the behavioral outputs of the system. The structures involved in cued conditioning, contextual conditioning and extinction are represented. PFC: prefrontal cortex, PL: prelimbic cortex, IL: infralimbic cortex, BLA: basolateral nucleus of the amygdala, CeA: central nucleus of the amygdala, ITC: amygdala-intercalated cells.

### Developmental Emergence of Fear Expression and Ecological Significance

As we consider the development of aversive conditioning, it is important to consider how the expression of fear might change during maturation and to place fear into a developmentally significant context. The delayed expression of fear is common in many altricial species and presumably emerges when fear expression fits the ecological niche of each species (e.g. Hebb, 1946; Harlow & Zimmermann, 1958; Schaffer & Emerson, 1964; Hinde, 1974; Hinde & Stevenson-Hinde, 1987). For example, in infant rabbits the aversive response to a hawk flying overhead changes from 2 months to 6 months, transitioning, as the bunny leaves the mother's care, from a fleeing to a freezing response (Pongrácz & Altbäcker, 2000). Infant birds respond to a shaking nest (i.e. a predator landing on the nest) with freezing and transition to escaping as the ability to fly emerges (Kuhlmann, 1909). Humans also change their fear response, with fear of heights and fear of strangers emerging at around 8-months-old. This closely coincides with the emergence of

crawling, when dangerous situations might be encountered (Freedman, 1961; Schaffer & Emerson, 1964).

While the neurobiology of most of these developmentally relevant changes in fear expression is unknown, some of it has been described for rodents. For example, infant rats do not show emergence of freezing until they reach about post-natal day 10 (PN10) (Takahashi, 1994). They begin to make brief excursions outside the nest at this age (Bolles & Woods, 1964), which is coincident with emergence of activity within the amygdala (Sullivan *et al.*, 2000a). There are also developmental changes in how amygdala-dependent fear behavior is expressed even after the emergence of activity in the amygdala. Indeed, specific components of the adult fear response sequentially emerge with maturation. For example, the fear startle response only appears after PN23 (Barnet & Hunt, 2006; Hunt *et al.*, 1994). Aversive conditioning induces an increase in heart rate in pre-weaning animals, but a decrease in adults. PN23 (i.e. weaning age) animals can present either of these behaviors (Hunt *et al.*, 1997). Ultrasonic vocalizations (USV) are often described as a more infantile behavior and are present more often in younger animals; with maturation, animals perform less USVs (Hofer *et al.*, 2002).

### **Developmental Emergence of Aversive Learning: Amygdala-dependent cue learning**

Pups are born with a functional sense of smell (Alberts, 1984) but their hearing and vision senses only appear later in life (PN13-14) (Blatchley *et al.*, 1987; de Villers-Sidani *et al.*, 2007; Freeman *et al.*, 1999). Pups engage in somatosensory learning, especially associated with the whisker system for nipple location and nursing (Landers & Sullivan, 1999; Sullivan *et al.*, 2003). Interestingly, pups appear to categorize punishment differently than adults. Indeed, many stimuli, even those with aversive qualities, when paired with a novel odor, can produce a subsequent *preference to that odor or an avoidance of that odor* depending on the age of the animal (Camp & Rudy, 1988; Haroutunian & Campbell, 1979; Sullivan, *et al.*, 1986a, b). It should be noted, however, that pups do feel pain, and that pain threshold changes across age do not correlate with this effect (Collier & Bolles, 1980; Emerich *et al.*, 1985; Fitzgerald, 2005; Stehouwer & Campbell, 1978; Yi & Barr, 1995). Overall, young pups show dramatic differences in learning compared to adults. Furthermore, adolescents also differ from adults in aversive learning, since adolescent mice show enhanced threat learning yet similar anxiety levels (Hefner & Holmes, 2007). As will be reviewed below, critical features for the ontogeny

of aversive learning are the development of the amygdala and the stress hormone corticosterone (CORT) (Moriceau & Sullivan, 2006; Moriceau *et al.*, 2006; Sullivan, *et al.*, 2000a).

As the neurobehavioral development of aversive learning was explored, it became obvious that it involved a dual process. Firstly, pups were not learning to avoid an odor paired with shock, suggesting immaturity of the threat learning system. Secondly, the pairing of an odor with shock was causing pups to approach the odor, suggesting that this conditioning procedure was activating a very different neural circuit compared to adults. While this review focuses on the aversive learning system, it should be noted that this early life conditioning activates a circuit used by pups to learn about the maternal odor, called the attachment circuit. It involves norepinephrine release from the locus coeruleus to produce learning associated changes within brain structures processing olfactory information, such as the olfactory bulb and piriform cortex (Langdon *et al.*, 1997; Sullivan *et al.*, 2000b, 1994, 1992).

Exploration of why pups fail to learn about fear involved focusing on the amygdala because of its well-documented importance in this type of learning in adults. One hypothesis was that the amygdala was too immature to be incorporated into the fear learning circuit; and indeed, the amygdala does not participate in classical odor-shock conditioning until PN10, when it starts producing odor avoidance and freezing (Rainekei, *et al.*, 2010a, 2012). A causal role was also defined for the amygdala: amygdala suppression by muscimol (GABA<sub>A</sub> agonist) before PN10 does not alter learning, unlike its effects in older pups (Moriceau & Sullivan, 2006; Moriceau *et al.*, 2006). The literature on the cellular, molecular, volumetric and connectivity development of the amygdala supports this view (Berdel *et al.*, 1997; Berdel & Morys, 2000; Bouwmeester *et al.*, 2002; Chareyron *et al.*, 2012). In particular, long-term potentiation in BLA could not be induced by tetanic stimulation in pups younger than PN10, in contrast to older pups. This suggests that the impairment in aversive learning in young pups may be due to impaired synaptic plasticity in the amygdala (Thompson *et al.*, 2008). At a more cellular level, Ehrlich *et al.*, (2012, 2013) comparing pups from PN7 to PN35 showed that many essential electrophysiological properties of BLA neurons (like frequency selectivity, input resistance, maximal firing frequency as well as GABA transmission) change dramatically until their maturation around PN28. These modulations during development are of course not restricted to the amygdala, as, for example, the ability to induce long-term depression in the hippocampus differs between rat pups younger than PN16 and adults (Blaise & Bronzino, 2003; Errington *et al.*, 1995).



However, further exploration of pup threat learning revealed that the amygdala was sufficiently mature to support fear learning in pups as young as PN6, provided sufficient levels of the stress hormone CORT was present in the amygdala (Moriceau & Sullivan, 2006). Indeed, within the ages of PN6 and PN15, the pups' amygdala is uniquely dependent upon CORT for aversive learning plasticity. As is explained below, this short 10-day period is defined by modulation of stress hormone levels, switching the aversive learning system on or off.

### **The Stress Hormone Corticosterone Permits Infant Cue Learning**

To understand the unique power of CORT to control aversive learning in infancy, it is critical to understand the developing stress system in rat pups. Before the age of PN10, infant rats' CORT levels are relatively low and fail to show the stress-induced increase typical of older pups and adults (Butte *et al.*, 1973; Cote & Yasumura, 1975; Grino *et al.*, 1994; Guillet & Michaelson, 1978; Guillet *et al.*, 1980; Henning, 1978; Levine *et al.*, 1967; Levine, 1962; Takeuchi *et al.*, 1977; Walker *et al.*, 1991; Walker & Vrana, 1993). This period of suppressed hypothalamic-pituitary-adrenal axis activation during early life is called the "stress hyporesponsive period". During this period, pups' basal CORT levels gradually increase, and data suggest that pups reach a critical level of CORT at PN10, which allows the onset of neuronal activation linked to learning within the amygdala (for a recent review, see Hostinar *et al.*, 2014). Injection of CORT in pups with a premature amygdala (PN8) was shown to increase 2-DG uptake in the posterior piriform cortex and amygdala during olfactory aversive conditioning (Moriceau *et al.*, 2006). However, when the amygdala is too immature (before PN6), injection of CORT has no effect on aversive learning (Upton & Sullivan, 2010). A causal link between CORT and amygdala-dependent aversive learning was established through effects of intra-amygdala CORT increase in young pups and intra-amygdala CORT decrease in older pups (Moriceau & Sullivan 2004, 2006; Moriceau *et al.* 2006). A similar pattern of emergence of the amygdala has been described for innate aversive stimuli, such as predator odor (Moriceau *et al.*, 2004; Takahashi, 1994; Wiedenmayer & Barr, 2001).

A more ecologically relevant role of CORT's modulation was also studied by using the mother's own ability to either increase or decrease her pups' stress hormone levels (Stanton & Levine, 1990; Stanton *et al.*, 1987; Suchecki *et al.*, 1993; Wiedenmayer *et al.*, 2003). Amygdala dependent learning was evoked in PN6-7 pups by placing them with a fearful mother, capable

of provoking in them a robust CORT increase (Debiec & Sullivan, 2014). For older pups (PN12-15), maternal presence was used to block shock-induced CORT release and provoke an inhibition of amygdala-dependent aversive learning (Moriceau & Sullivan, 2006; Shionoya *et al.*, 2007). Social stimuli can “buffer” or attenuate the release of stress-induced CORT, a phenomenon referred to as “social buffering” that occurs in many species (Hennessy *et al.*, 2009, 1995, 2002; Hostinar *et al.*, 2014; Kikusui *et al.*, 2006). Social buffering has also been described in 1-year-old human babies, who show increased exploratory behaviors, as well as decreased fear responses, in the presence of the mother compared to during her absence (Ainsworth & Bell, 1970). Social buffering also exists in human adults, as described by Ditzen *et al.* (2007), where interaction with the romantic partner before a stressful situation decreased cortisol’s blood level and heart rate in adult women.

By PN16, pups show adult-like aversive learning with respect to independence from CORT levels controlling amygdala learning plasticity (Upton & Sullivan, 2010). These data demonstrate the ecological significance and strong social context-dependent emergence of aversive learning in pups, and suggest that the CORT effects on pup learning are finely tuned to the changing demands of the pups’ ecological niche. Recently, a similar system has emerged in humans, with a role of the caretaker in modulating the activity of the amygdala (Tottenham *et al.*, 2012). Tottenham *et al.* (2012) showed increased activity in the dorsal region of the left amygdala and increased connectivity of the amygdala with cortical structures (prefrontal cortex, motor cortex and insula) when the subjects (from 4 to 16 years old) were viewing pictures of their mother compared to pictures of strangers.

It is important to note that rat pups can learn to avoid odors *in utero*, although this learning is not amygdala-dependent. Specifically, pups learn to avoid odors paired with malaise when the US is either a very strong foot shock (>1.0mA), or a LiCl injection, both of which produce gastrointestinal illness in pups (Haroutunian & Campbell, 1979). This infant learning emerges during the fetal period well before development of the amygdala, and depends upon learning associated changes within the olfactory bulb and piriform cortex. At weaning, the amygdala becomes engaged in olfactory malaise learning (Raineke *et al.*, 2009; Shionoya *et al.*, 2006) similarly to the adult (Touzani & Sclafani, 2005). The ability of malaise and exteroceptive aversive stimuli (i.e. shock) to engage distinct types of learning has received previous support and involves developmental changes in the categorization of reward (Camp & Rudy, 1988; Haroutunian & Campbell, 1979).

It has been shown that the failure to learn aversion in the case of exteroceptive stimuli (shock, tailpinch) is due to the activation of the attachment circuitry involved in learning maternal odor. Later in life, when the rat starts exploring outside the nest (PN10-16), its aversive learning becomes dependent on the absence of the mother. With the mother present, the attachment circuitry will be activated, but if the mother is absent, then the amygdala-dependent threat circuitry is engaged. This effect is due to the modulation of pups' CORT level by the mother: high CORT is necessary for the function of the amygdala in pups between PN6 and PN16. Before PN6, the amygdala cannot be engaged in threat learning due to immaturity (Sullivan *et al.*, 2000a). Together, these data illustrate that odor learning in infancy is biased towards attachment learning.

### **Ontogeny of interval timing**

Interval timing is the detection and memorization of intervals of time in a range of a few seconds to a few hours. As mentioned previously, the temporal aspect of the CS-US conditioning is an essential part of learning the association. Timing is also very much involved in interactions between individuals and in decision making, allowing individuals to adapt their behavior to the changing environment. From their birth, infants are dependent on temporal patterns, the most obvious one being the feeding rhythm that is controlled by the mother (Levin & Stern, 1975). They also need to interact in a timely manner with their mother and their littermates/siblings to allow for reciprocity and for attachment to occur. We will discuss here the ontogeny of the processing of temporal intervals from birth to adolescence in humans and animals.

Interval timing in children has mainly been studied in typical instrumental timing tasks, whether with motor demand, such as temporal reproduction (Chelonis *et al.*, 2004; Crowder & Hohle, 1970; Droit-Volet & Rattat, 1999; Droit-Volet, 1998; Espinosa-Fernández *et al.*, 2004, 2003; Szelag *et al.*, 2002), or without, as in temporal bisection (e.g. Droit-Volet & Wearden, 2001; McCormack *et al.*, 1999) or temporal generalization (e.g. Droit-Volet *et al.* 2001; Droit-Volet 2002; McCormack *et al.* 1999) tasks. In these tasks, children as young as 3-years old show some temporal capabilities, although their performances are adult-like only when they reach the age of 8 years old. Only a few studies have looked at behavioral correlates of timing in Pavlovian tasks in human infants. One of the oldest experiment is the one by Brackbill & Fitzgerald (1972) where they showed temporal entrainment to a stimulus in 1-month-old human infants. After regular presentations (every 20s) of a light stimulus in a dark room, the infants

expressed pupillary constriction at the expected time of arrival of the light even in the absence of that stimulus. Even younger babies, one to three days old, showed deceleration of heart rate at the expected time of delivery of the glucose US at the first omission trial (Clifton, 1974). A similar pattern of heart rate response was reported in 4-month-old babies using visual cues (Colombo & Richman, 2002). Looking at another CR, Pouthas *et al.* (1995) showed that newborns and 2-month-old babies can temporally adapt their sucking response depending on the duration between non-nutritive sucks. Thus, it seems that human infants may have a sense of time from birth, when assessed with Pavlovian-like procedures, but temporal performance and its precision may evolve and improve until 8 years old, when it resembles adult-like characteristics of interval timing (for a review see Droit-Volet, 2011).

Very few papers have examined temporal behavior in young animals and most concentrated on rodents. Weanlings (PN21) behave similarly to adults in a fixed interval task, but they show poorer performances in a DRL (differential reinforcement of low responding) task (Lejeune *et al.*, 1986; Lejeune & Jasselette, 1987). However, a fixed interval task does not require inhibitory motor control, as the animal can respond anytime, although it will only be rewarded if it responds after a certain time has passed. In contrast, the DRL task depends on motor inhibition, as it requires withholding a response for a certain interval of time to get a reward. Therefore, the difference in performance at a young age could be due to non-temporal deficits in the younger animals. Only a few studies have looked at implicit timing in Pavlovian conditioning. In eyeblink conditioning, an air puff (i.e. the US) is given to the cornea very shortly (<1s) after the CS onset and provokes eye closure. This CR is very dependent on timing, i.e. when the eyeblink becomes anticipatory of the US. Animals as young as PN17 learn eyeblink conditioning (Stanton *et al.*, 1992). Interestingly, the speed of acquisition and the percentage of CRs are much lower for PN17 than for PN24 animals, reflecting more difficulty to learn the association, and therefore perhaps also the CS-US temporal relationship, for younger animals. It is impossible to look at younger animals using this task as their eyes are often closed. In conditioning tasks with supra-second CS-US intervals, rat pups develop a freezing CR in trace conditioning, in which the CS is separated from the US by an empty trace interval, only from PN17, i.e. later than in classical delay conditioning (Moye & Rudy, 1987). However, even in a delay conditioning paradigm, when the CS-US interval is longer than 20s, a late development of learning is also observed and it reaches adult level only at PN25 (Barnet & Hunt, 2005). The delayed learning in trace conditioning and in long CS-US interval in pups may thus be due to a deficit in associating the CS and the US when the interval is long,

suggesting that pups younger than PN25 may have difficulty with learning more difficult temporal relationships. However, failure to express a good level of CR does not mean lack of learning the CS-US interval, as the latter may be silent or expressed through other behaviors (Brown *et al.*, 1997; Ohyama & Mauk, 2001; Savastano & Miller, 1998).

Recently, second-by-second analyses of breathing and freezing have demonstrated temporally regulated behavior in rats as young as PN12 in an olfactory aversive conditioning, although the temporal pattern was not similar to the one observed in adults (Boulanger-Bertolus *et al.*, 2014). Decreases in freezing and in respiratory rate were observed in anticipation to the US arrival in pups, whereas only the change in respiration was temporally related in adults. Pups showed different temporal pattern of freezing and respiratory rate depending on the CS-US duration (20 or 30s), therefore presenting temporal modulation of behavior. Furthermore, the temporal precision of these rats was proportional to the CS-US interval (i.e. followed the well-known scalar property of timing). Thus, it seems that temporal learning is possible in young pups, but may be expressed in a different manner during development. Furthermore, it may reach adult-like full functionality only at a later age.

Knowledge on the neurobiology of interval timing has come from studies mainly in adult humans and animals. Research in the infant is sparse and recent. However, different brain areas important for timing may mature at different ages (Figure 2), thus raising the possibility of a developmental modification of the brain networks subserving time learning. The main structures described as active during timing tasks in the supra-second range in adults are the prefrontal cortex (PFC) and the striatum (for a review see Buhusi & Meck 2005). The PFC is described as the last part of the cortex to mature, usually said to become completely mature at adulthood (rats: Van Eden & Uylings, 1985; Casey *et al.*, 2005; Nonneman & Corwin, 1981; humans: Gogtay *et al.*, 2004). The striatum does not show adult-like activation following Pavlovian conditioning in juvenile (PN22-24) rats (Boulanger Bertolus *et al.*, 2014) and is still maturing after adolescence in humans (Sowell *et al.*, 1999). The hippocampus, a structure also potentially important for interval timing (for a recent review, see Eichenbaum, 2013) is also a late developing structure in humans (Gogtay *et al.*, 2006) and in rats (still maturing during the third and fourth post-natal week, Campbell *et al.*, 1969). The cerebellum is also a critical structure for timing in sub-second range (such as in eyeblink conditioning) and starts being similar to its adult counterpart after PN21 (Altman, 1972a, 1972b). Finally, recent data have suggested that the amygdala may play a role in processing the CS-US interval (for a review,

see Díaz-Mataix *et al.*, 2014), and, as explained above, is mature very early during development.

Neurodevelopmental studies of neurophysiological bases of timing have concentrated on human subjects by analyzing brain activity in situations where timing is modulated. They used a typical electrophysiological brain response, the event related potential (ERP) or functional imaging techniques. No developmental difference of either performance or brain activation in fMRI (functional magnetic resonance imaging) was observed in a temporal discrimination task for children between 8 and 15 years old (Neufang *et al.*, 2008). In a comparison of a wider range of ages, an age-dependent modulation of the recruitment of activated brain areas was observed between 10 and 53 years old, with no difference in performance (Smith *et al.*, 2011). Youngest participants showed a wider and earlier activation of the brain (most of the posterior brain and frontal cortices), whereas older participants showed a more focalized activation in the fronto-striatal system. In a Pavlovian-like approach, 10-month-old babies showed a modulation of ERPs above the frontal cortex, similar to the one seen in adults, in response to an unexpected appearance of a stimulus after training with regular presentation of that stimulus (Brannon *et al.*, 2008). To our knowledge, there is no such study in animals, with the exception of one study in zebrafish larvae (Cheng *et al.*, 2014), which suggests a detection of unexpected omission in structures homologous to the habenula and the amygdala.

In sum, it seems that temporal processing and learning exist before weaning in rats or immediately after birth in humans, although with less precision than in adults. The main structures described in adults as important for interval timing (i.e. striatum, prefrontal cortex and hippocampus) are immature in pre-weaning animals or in children, raising the question of the neural bases of timing in young subjects. However, it is very difficult to get precise findings on the neurobiological basis of time in human babies, as deep brain recording techniques are not usable in human babies and artificial modulation of brain activity is also impossible. Therefore, it is necessary to find efficient techniques to study timing in very young animals; for example by looking at temporally modulated behaviors that appear early in learning (like respiratory rate, Boulanger-Bertolus *et al.*, 2014), by using more elaborate conditioning paradigms (like second-order conditioning used in adults, Savastano & Miller, 1998) or by using entrainment where a stimulus is presented at regular intervals and induces regular responses (as in adults: Sumbre *et al.*, 2008). Developing these approaches is critical to inform us on how timing processes mature relative to the development of functional connectivity in

larger networks, as well as whether pups can learn and memorize CS-US intervals before or only when the amygdala gets incorporated into the fear/threat conditioning circuit.

### **Development of Contextual Learning**

During threat conditioning, the context where the association takes place is also learned, and this involves the hippocampus and its connection to the amygdala. That is, simply placing an animal in the context where the conditioning occurred is sufficient to produce an aversive response like freezing. The addition of contextual information about aversive learning has profound influences on the responses to the CS and enables threat behaviors to be tied to a specific location. Specifically, presentation of a cue in the same context as conditioning took place produces enhanced fear expression. As mentioned earlier, it is also possible to use the context as a CS. The hippocampus can support contextual learning in collaboration with the amygdala. It should be noted that the hippocampus supports many different types of learning, all of which emerge at different ages (Stanton, 2000).

It has been shown previously that, in rats, contextual fear learning emerges around weaning age when pups are becoming independent of the caregiver (Rainecki *et al.*, 2010a; Rudy, 1993; Schreiber *et al.*, 2014). Silencing of the hippocampus at that age abolishes contextual learning (Rainecki *et al.*, 2010b). The implication of infant aversive memories being formed without any learning of the context has yet to be properly explored. However, when the context is directly associated to the US with unpaired presentations of the CS, then PN17-18 rats show very weak contextual learning compared to adults (Esmorís-Arranz *et al.*, 2008). Paradoxically, recent data from a study in which the context was used as the CS, showed that after functional emergence of contextual learning, it becomes impaired again in PN29 mice only to reappear at PN33 (Pattwell *et al.*, 2011). This transient developmental attenuation of learning could hold the ecological role of helping animals to explore more during adolescence (Spear, 2000).

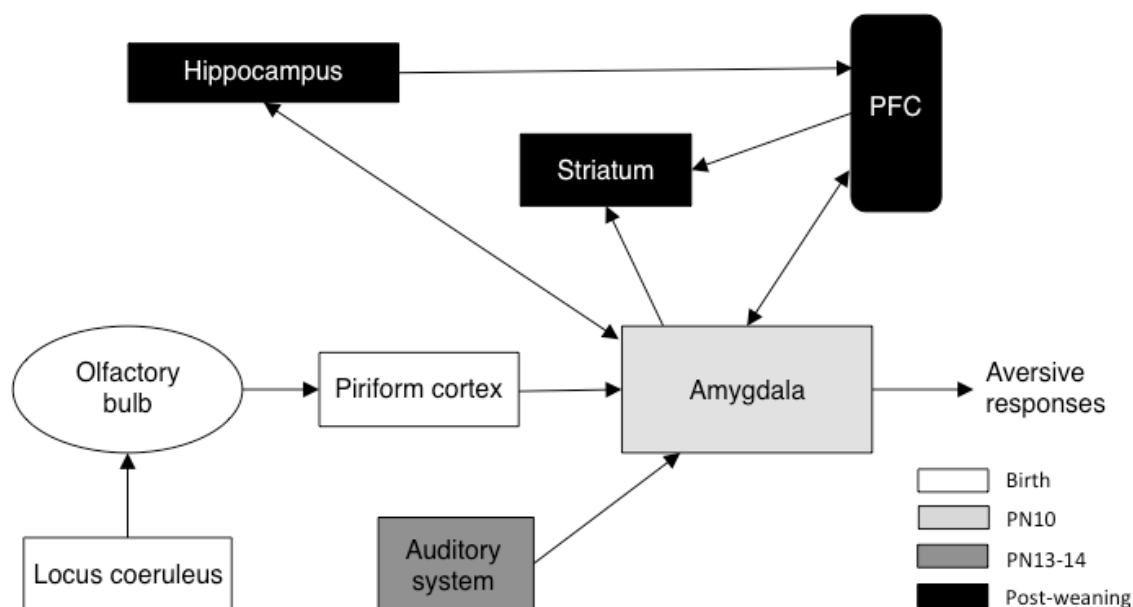


Figure 2: Representation of the maturation of the different structures of the aversive circuits during development in the rat. The olfactory bulb is functional from birth, whereas the amygdala becomes mature at PN10. The auditory system matures around PN13-14, and after weaning the striatum, hippocampus and prefrontal cortex become adult-like.

### Concluding Remarks

We have described in this review the development of behavioral responses to aversive conditioning and linked this development with the maturation of supporting brain structures in rodents and humans. Infant rats show dramatic transitions in all phases of threat learning due, in part, to the gradual and sequential maturation of the brain structures involved (Figure 2) but also due to unique ecologically relevant environmental factors that adapt threat learning to age appropriate learning. Clues in the human developmental literature suggest that these ecologically relevant mechanisms may exist in humans.

Very little research has been done on the neural basis of infants' ability to process time, even though interval timing has been described in young children and pups. As the main structures described in timing tasks in adults, both rodents and humans, are considered immature in juveniles, it seems likely that timing in the young is subserved by other neural structures that become less critical for timing behavior in the adult. Understanding the development of timing capabilities will be critical to decipher the mechanisms underlying associative learning and memory in the young.



Our understanding of the development of threat and its underlying neural circuitry indicates that this circuit has dynamic developmental periods during which this learning is prevented. Two mechanisms of learning prevention were highlighted: functional connectivity within defined neural circuits and the presence of the caregiver. This review also highlighted the considerable convergence between human and rodent literature, suggesting that mechanisms learned from the rodent have translational value for humans, both at the juvenile and adult stages. Together, these data highlight the importance of understanding threat/fear circuitry from early infant development, onward through adolescence, and into adulthood. Successful treatment outcomes in children and adolescents will likely need to consider these unique developmental epochs, as there is still much to learn on how early life trauma can influence this learning and how to modulate the pathological aspects of it in later life.

## Bibliography

- Ainsworth, M. D., & Bell, S. M. (1970) Attachment, exploration, and separation: illustrated by the behavior of one-year-olds in a strange situation. *Child Dev*, 41, 49–67.
- Alberts, J. R. (1984) Sensory-perceptual development in the Norway rat: A view toward comparative studies. In *Comparative perspectives on the development of memory* (pp. 65–101).
- Altman, J. (1972a) Postnatal Development of the Cerebellar Cortex in the Rat. II. PHASES IN THE MATURATION OF PURKINJE CELLS AND OF THE MOLECULAR LAYER. *J Comp Neurol*, 145, 399–464.
- Altman, J. (1972b) Postnatal Development of the Cerebellar Cortex in the Rat. III. MATURATION OF THE COMPONENTS OF THE GRANULAR LAYER. *J Comp Neurol*, 145, 465–514.
- Arcediano, F., Escobar, M., & Miller, R. R. (2003) Temporal integration and temporal backward associations in human and nonhuman subjects. *Learn Behav*, 31, 242–256.
- Balsam, P. D., Drew, M. R., & Yang, C. (2002) Timing at the start of associative learning. *Learn Motiv*, 33, 141–155.
- Balsam, P. D., Drew, M. R., & Gallistel, C. R. (2010) Time and associative learning. *Comp Cogn Behav Rev*, 5, 1–22.
- Balsam, P. D., & Gallistel, C. R. (2009) Temporal maps and informativeness in associative learning. *Trends Neurosci*, 32, 73–78.
- Barnet, R. C., & Hunt, P. S. (2005) Trace and long-delay fear conditioning in the developing rat. *Learn Behav*, 33, 437–443.
- Barnet, R. C., & Hunt, P. S. (2006) The expression of fear-potentiated startle during development: integration of learning and response systems. *Behav Neurosci*, 120, 861–872.
- Berdel, B., Moryś, J., & Maciejewska, B. (1997) Neuronal changes in the basolateral complex during development of the amygdala of the rat. *Int J Dev Neurosci*, 15, 755–765.
- Berdel, B., & Moryś, J. (2000) Expression of calbindin-D28k and parvalbumin during development of rat's basolateral amygdaloid complex. *Int J Dev Neurosci*, 18, 501–513.
- Blaise, J. H., & Bronzino, J. D. (2003) Effects of stimulus frequency and age on bidirectional synaptic plasticity in the dentate gyrus of freely moving rats. *Exp Neurol*, 182, 497–506.
- Blatchley, B. J., Cooper, W. A., & Coleman, J. R. (1987) Development of auditory brainstem response to tone pip stimuli in the rat. *Dev Brain Res*, 32, 75–84.
- Bolles, R. C., & Woods, P. J. (1964) The ontogeny of behaviour in the albino rat. *Anim Behav*, 12, 427–441.
- Boulanger Bertolus, J., Hegoburu, C., Ahers, J. L., Londen, E., Rousselot, J., Szyba, K., Thévenet, M., Sullivan-Wilson, T., Doyère, V. Sullivan, R. M., Mouly, A.-M. (2014) Infant rats can learn time intervals before the maturation of the striatum: evidence from odor fear conditioning. *Front Behav Neurosci*, 8, 1–12.
- Bouton, M. E., Westbrook, R. F., Corcoran, K., & Maren, S. (2006) Contextual and temporal modulation of extinction: behavioral and biological mechanisms. *Biol Psychiatry*, 60, 352–360.

- Bouwmeester, H., Smits, K., & Van Ree, J. M. (2002) Neonatal development of projections to the basolateral amygdala from prefrontal and thalamic structures in rat. *J Comp Neurol*, 450, 241–255.
- Brackbill, Y., & Fitzgerald, H. E. (1972) Stereotype temporal conditioning in infants. *Psychophysiology*, 9, 569–577.
- Brannon, E. M., Roussel, L. W., Meck, W. H., & Woldorff, M. (2004) Timing in the baby brain. *Cogn Brain Res*, 21, 227–233.
- Brannon, E. M., Libertus, M. E., Meck, W. H., & Woldorff, M. G. (2008) Electrophysiological measures of time processing in infant and adult brains: Weber's Law holds. *J Cogn Neurosci*, 20, 193–203.
- Brown, B. L., Hemmes, N. S., & Cabeza de Vaca, S. (1997) Timing of the CS-US Interval by Pigeons in Trace and Delay Autoshaping. *Q J Exp Psychol*, 50, 40–53.
- Buhusi, C. V., & Meck, W. H. (2005) What makes us tick? Functional and neural mechanisms of interval timing. *Nat Rev Neurosci*, 6, 755–765.
- Butte, J. C., Kakihana, R., Farnham, M. L., & Noble, E. P. (1973) The relationship between brain and plasma corticosterone stress response in developing rats. *Endocrinology*, 92, 1775–1779.
- Camp, L. L., & Rudy, J. W. (1988) Changes in the categorization of appetitive and aversive events during postnatal development of the rat. *Dev Psychobiol*, 21, 25–42.
- Campbell, B. A., Lytle, L. D., & Fibiger, H. C. (1969) Ontogeny of adrenergic arousal and cholinergic inhibitory mechanisms in the rat. *Science*, 166, 635–637.
- Casey, B. J., Tottenham, N., Liston, C., & Durston, S. (2005) Imaging the developing brain: what have we learned about cognitive development? *Trends Cogn Sci*, 9, 104–110.
- Casey, B. J., Glatt, C. E., & Lee, F. S. (2015) Treating the developing versus developed brain: translating preclinical mouse and human studies. *Neuron*, 86, 1358–1368.
- Chareyron, L. J., Lavenex, P. B., & Lavenex, P. (2012) Postnatal development of the amygdala: A stereological study in rats. *J Comp Neurol*, 520, 1965–1984.
- Chelonis, J. J., Flake, R. A., Baldwin, R. L., Blake, D. J., & Paule, M. G. (2004) Developmental aspects of timing behavior in children. *Neurotoxicol Teratol*, 26, 461–476.
- Cheng, R. K., Jesuthasan, S. J., & Penney, T. B. (2014) Zebrafish forebrain and temporal conditioning. *Philos Trans R Soc Biol Sci*, 369, 1–8.
- Clifton, R. K. (1974) Heart rate conditioning in the newborn infant. *J Exp Child Psychol*, 18, 9–21.
- Collier, A. C., & Bolles, R. C. (1980) The ontogenesis of defensive reactions to shock in preweanling rats. *Dev Psychobiol*, 13, 141–150.
- Colombo, J., & Richman, W. A. (2002) Infant timekeeping: attention and temporal estimation in 4-month-olds. *Psychol Sci*, 13, 475–479.
- Cote, T. E., & Yasumura, S. (1975) Effect of ACTH and histamine stress on serum corticosterone and adrenal cyclic AMP levels in immature rats. *Endocrinology*, 96, 1044–1047.
- Crowder, A. M. H., & Hohle, R. H. (1970) Time estimation by young children with and without informational feedback. *J Exp Child Psychol*, 10, 295–307.
- Davis, M., Schlesinger, L. S., & Sorenson, C. A. (1989) Temporal specificity of fear conditioning: effects of different conditioned stimulus-unconditioned stimulus intervals on the fear-potentiated startle effect. *J Exp Psychol Anim Behav Process*, 15, 295–310.

- de Villers-Sidani, E., Chang, E. F., Bao, S., & Merzenich, M. M. (2007) Critical period window for spectral tuning defined in the primary auditory cortex (A1) in the rat. *J Neurosci*, 27, 180–189.
- Debiec, J., & Sullivan, R. M. (2014) Intergenerational transmission of emotional trauma through amygdala-dependent mother-to-infant transfer of specific fear. *Proc Natl Acad Sci*, 111, 1–6.
- Díaz-Mataix, L., Ruiz Martinez, R. C., Schafe, G. E., LeDoux, J. E., & Doyère, V. (2013) Detection of a temporal error triggers reconsolidation of amygdala-dependent memories. *Curr Biol*, 23, 1–6.
- Díaz-Mataix, L., Tallot, L., & Doyère, V. (2014) The amygdala: a potential player in timing CS-US intervals. *Behav Processes*, 101, 112–22.
- Ditzen, B., Neumann, I. D., Bodenmann, G., von Dawans, B., Turner, R. A., Ehlert, U., & Heinrichs, M. (2007) Effects of different kinds of couple interaction on cortisol and heart rate responses to stress in women. *Psychoneuroendocrinology*, 32, 565–574.
- Droit-Volet, S. (1998) Time estimation in young children: an initial force rule governing time production. *J Exp Child Psychol*, 68, 236–249.
- Droit-Volet, S. (2002) Scalar timing in temporal generalization in children with short and long stimulus durations. *Q J Exp Psychol Sect A*, 55, 1193–1209.
- Droit-Volet, S. (2011) Child and Time. In *Multidisciplinary Aspects of Time and Time Perception* (pp. 151–173). Springer-Verlag: Berlin Heidelberg.
- Droit-Volet, S. (2013) Time perception in children: A neurodevelopmental approach. *Neuropsychologia*, 51, 220–234.
- Droit-Volet, S., Clément, A., & Wearden, J. (2001) Temporal generalization in 3- to 8-year-old children. *J Exp Child Psychol*, 80, 271–288.
- Droit-Volet, S., & Rattat, A. C. (1999) Are time and action dissociated in young children's time estimation? *Cogn Dev*, 14, 573–595.
- Droit-Volet, S., & Wearden, J. H. (2001) Temporal bisection in children. *J Exp Child Psychol*, 80, 142–159.
- Ehrlich, D. E., Ryan, S. J., & Rainnie, D. G. (2012) Postnatal development of electrophysiological properties of principal neurons in the rat basolateral amygdala. *J Physiol*, 590, 4819–4838.
- Ehrlich, D. E., Ryan, S. J., Hazra, R., Guo, J.-D., & Rainnie, D. G. (2013) Postnatal maturation of GABAergic transmission in the rat basolateral amygdala. *J Neurophysiol*, 110, 926–941.
- Eichenbaum, H. (2013) Memory on time. *Trends Cogn Sci*, 17, 83–90.
- Emerich, D., Scalzo, F., Enters, E., Spear, N., & Spear, L. (1985) Effects of 6-hydroxydopamine-induced catecholamine depletion on shock-precipitated wall climbing of infant rat pups. *Dev Psychobiol*, 18, 215–227.
- Errington, M. L., Bliss, T. V., Richter-Levin, G., Yenik, K., Doyère, V., & Laroche, S. (1995) Stimulation at 1-5 Hz does not produce long-term depression or depotentiation in the hippocampus of the adult rat in vivo. *J Neurophysiol*, 74, 1793–1799.
- Esmorís-Arranz, F. J., Méndez, C., & Spear, N. E. (2008) Contextual fear conditioning differs for infant, adolescent, and adult rats. *Behav Processes*, 78, 340–350.
- Espinosa-Fernández, L., Miró, E., Cano, M. C., & Buéla-Casal, G. (2003) Age-related changes and gender differences in time estimation. *Acta Psychol (Amst)*, 112, 221–232.

- Espinosa-Fernández, L., de la Torre Vacas, L., García-Viedma, M. D. R., García-Gutiérrez, A., & Torres Colmenero, C. J. (2004) Temporal performance in 4-8 year old children. The effect of chronometric information in task execution. *Acta Psychol (Amst)*, 117, 295–312.
- Fanselow, M. S., & Poulos, A. M. (2005) The neuroscience of mammalian associative learning. *Annu Rev Psychol*, 56, 207–34.
- Fitzgerald, M. (2005) The development of nociceptive circuits. *Neuroscience*, 6, 507–520.
- Freedman, D. G. (1961) The infant's fear of strangers and the flight response. *J Child Psychol Psychiatry*, 2, 242–248.
- Freeman, S., Plotnik, M., Elidan, J., & Sohmer, H. (1999) Development of short latency vestibular evoked potentials in the neonatal rat. *Hear Res*, 137, 51–58.
- Glenn, C. R., Klein, D. N., Lissek, S., Britton, J. C., Pine, D. S., & Hajcak, G. (2012) The development of fear learning and generalization in 8-13 year-olds. *Dev Psychobiol*, 54, 675–684.
- Gogtay, N., Giedd, J., Lusk, L., Hayashi, K. M., Greenstein, D., Vaituzis, A. C., Nugent, T. F., Herman, D. H., Clasen, L. S., Toga, A. W., Rapoport, J. L., Thompson, P. M. (2004) Dynamic mapping of human cortical development during childhood through early adulthood. *Proc Natl Acad Sci*, 101, 8174–8179.
- Gogtay, N., Nugent, T. F., Herman, D. H., Ordonez, A., Greenstein, D., Hayashi, K. M., Clasen, L., Toga, A. W., Giedd, J. N., Rapoport, J. L., Thompson, P. M. (2006) Dynamic mapping of normal human hippocampal development. *Hippocampus*, 16, 664–672.
- Grino, M., Paulmyer-Lacroix, O., Faudon, M., Renard, M., & Anglade, G. (1994) Blockade of alpha 2-adrenoceptors stimulates basal and stress-induced adrenocorticotropin secretion in the developing rat through a central mechanism independent from corticotropin-releasing factor and arginine vasopressin. *Endocrinology*, 135, 2549–2557.
- Guillet, R., & Michaelson, S. M. (1978) Corticotropin responsiveness in the neonatal rat. *Neuroendocrinology*, 27, 119–125.
- Guillet, R., Saffran, M., & Michaelson, S. M. (1980) Pituitary-adrenal response in neonatal rats. *Endocrinology*, 106, 991–994.
- Harlow, H. F., & Zimmermann, R. R. (1958) The development of affectional responses in infant monkeys. *Proc Am Philos Soc*, 102, 501–509.
- Haroutunian, V., & Campbell, B. A. (1979) Emergence of interoceptive and exteroceptive control of behavior in rats. *Science*, 205, 927–929.
- Hebb, D. O. (1946) On the nature of fear. *Psychol Rev*, 53, 259.
- Hefner, K. B. A., & Holmes, A. (2007) Ontogeny of fear-, anxiety- and depression-related behavior across adolescence in C57BL/6J mice. *Behav Brain Res*, 176, 210–215.
- Hennessy, M. B., Long, S. J., Nigh, C. K., Williams, M. T., & Nolan, D. J. (1995) Effects of peripherally administered corticotropin-releasing factor (CRF) and a CRF antagonist: does peripheral CRE activity mediate behavior of guinea pig pups during isolation? *Behav Neurosci*, 109, 1137–1145.
- Hennessy, M. B., O'Leary, S. K., Hawke, J. L., & Wilson, S. E. (2002) Social influences on cortisol and behavioral responses of preweaning, periadolescent, and adult guinea pigs. *Physiol Behav*, 76, 305–314.

- Hennessy, M. B., Kaiser, S., & Sachser, N. (2009) Social buffering of the stress response: diversity, mechanisms, and functions. *Front Neuroendocrinol*, 30, 470–482.
- Henning, S. J. (1978) Plasma concentrations of total and free corticosterone during development in the rat. *Am J Physiol*, 235, 451–456.
- Herry, C., & Johansen, J. P. (2014) Encoding of fear learning and memory in distributed neuronal circuits. *Nat Neurosci*, 17, 1644–1654.
- Hinde, R. A. (1974) *Biological basis of human social behavior*. McGraw-Hill.
- Hinde, R. A., & Stevenson-Hinde, J. (1987) Interpersonal relationships and child development. *Dev Rev*, 7, 1–21.
- Hofer, M. A., SHair, H. N., & Brunelli, S. A. (2002) Ultrasonic vocalizations in rat and mouse pups. *Curr Protoc Neurosci*, 8–14.
- Hostinar, C. E., Sullivan, R. M., & Gunnar, M. R. (2014) Psychobiological mechanisms underlying the social buffering of the hypothalamic-pituitary-adrenocortical axis: a review of animal models and human studies across development. *Psychol Bull*, 140, 256–282.
- Hunt, P. S., Richardson, R., & Campbell, B. A. (1994) Delayed development of fear-potentiated startle in rats. *Behav Neurosci*, 108, 69–80.
- Hunt, P. S., Hess, M. F., & Campbell, B. A. (1997) Conditioned cardiac and behavioral response topography to an olfactory CS dissociates with age. *Anim Learn Behav*, 25, 53–61.
- Janak, P. H., & Tye, K. M. (2015) From circuits to behaviour in the amygdala. *Nature*, 517, 284–292.
- Jovanovic, T., Nylocks, K. M., & Gamwell, K. L. (2013) Translational neuroscience measures of fear conditioning across development: applications to high-risk children and adolescents. *Biol Mood Anxiety Disord*, 3, 17.
- Kikusui, T., Winslow, J. T., & Mori, Y. (2006) Social buffering: relief from stress and anxiety. *Philos Trans R Soc London Biol Sci*, 361, 2215–2228.
- Kim, J. J., & Fanselow, M. S. (1992) Modality-specific retrograde amnesia of fear. *Science* (80- ), 256, 675–677.
- Krasne, F. B., Fanselow, M. S., & Zelikowsky, M. (2011) Design of a neurally plausible model of fear learning. *Front Behav Neurosci*, 5, 41.
- Kuhlmann, F. (1909) Some preliminary observations on the development of instincts and habits in young birds. *Psychol Rev Monogr Suppl*, 11, 49–84.
- Landers, M. S., & Sullivan, R. M. (1999) Vibrissae-Evoked Behavior and Conditioning before Functional Ontogeny of the Somatosensory Vibrissae Cortex. *J Neurosci*, 19, 5131–5137.
- Landers, M. S., & Sullivan, R. M. (2012) The development and neurobiology of infant attachment and fear. *Dev Neurosci*, 34, 101–114.
- Langdon, P. E., Harley, C. W., & McLean, J. H. (1997) Increased 6 adrenoceptor activation overcomes conditioned olfactory learning induced by serotonin depletion. *Dev Brain Res*, 102, 291–293.
- Lau, J. Y. F., Lissek, S., Nelson, E. E., Lee, Y., Roberson-Nay, R., Poeth, K., ... Pine, D. S. (2008) Fear conditioning in adolescents with anxiety disorders: results from a novel experimental paradigm. *J Am Acad Child Adolesc Psychiatry*, 47, 94–102.
- LeDoux, J. E. (2014) Coming to terms with fear. *Proc Natl Acad Sci*, 111, 2871–2878.

- Lejeune, H., Jasselette, P., Nagy, J., & Peree, F. (1986) Fixed interval performance in weanling rats: a comparison with adult and senile subjects. *Physiol Behav*, 38, 337–343.
- Lejeune, H., & Jasselette, P. (1987) DRL performance in the weanling rat: a comparison with adult subjects. *Physiol Behav*, 40, 271–278.
- Levin, R., & Stern, J. M. (1975) Maternal influences on ontogeny of suckling and feeding rhythms in the rat. *J Comp Physiol Psychol*, 89, 711–721.
- Levine, S. (1962) Plasma-free corticosteroid response to electric shock in rats stimulated in infancy. *Science* (80- ), 135, 795–796.
- Levine, S., Haltmeyer, G. C., Karas, G. G., & Denenberg, V. H. (1967) Physiological and behavioral effects of infantile stimulation. *Physiol Behav*, 2, 55–59.
- Maren, S., & Quirk, G. J. (2004) Neuronal signalling of fear memory. *Nat Rev Neurosci*, 5, 844–852.
- McCormack, T., Brown, G. D. A., Maylor, E. A., Darby, R. J., & Green, D. (1999) Developmental changes in time estimation: comparing childhood and old age. *Dev Cogn Neurosci*, 35, 1143–1155.
- Moriceau, S., Roth, T. L., Okotoghaide, T., & Sullivan, R. M. (2004) Corticosterone controls the developmental emergence of fear and amygdala function to predator odors in infant rat pups. *Int J Dev Neurosci*, 22, 415–422.
- Moriceau, S., Wilson, D., Levine, S., & Sullivan, R. M. (2006) Dual circuitry for odor-shock conditioning during infancy: corticosterone switches between fear and attraction via amygdala. *J Neurosci*, 26, 6737–6748.
- Moriceau, S., & Sullivan, R. M. (2004) Corticosterone influences on mammalian neonatal sensitive-period learning. *Behav Neurosci*, 118, 274–281.
- Moriceau, S., & Sullivan, R. M. (2006) Maternal presence serves as a switch between learning fear and attraction in infancy. *Nat Neurosci*, 9, 1004–1006.
- Moye, T. B., & Rudy, J. W. (1987) Ontogenesis of trace conditioning in young rats: dissociation of associative and memory processes. *Dev Psychobiol*, 20, 405–414.
- Myers, K. M., & Davis, M. (2007) Mechanisms of fear extinction. *Mol Psychiatry*, 12, 120–150.
- Neufang, S., Fink, G. R., Herpertz-Dahlmann, B., Willmes, K., & Konrad, K. (2008) Developmental changes in neural activation and psychophysiological interaction patterns of brain regions associated with interference control and time perception. *Neuroimage*, 43, 399–409.
- Nonneman, A. J., & Corwin, J. V (1981) Differential effects of prefrontal cortex ablation in neonatal, juvenile, and young adult rats. *J Comp Physiol Psychol*, 95, 588–602.
- Ohyama, T., & Mauk, M. (2001) Latent acquisition of timed responses in cerebellar cortex. *J Neurosci*, 21, 682–90.
- Pattwell, S. S., Bath, K. G., Casey, B. J., Ninan, I., & Lee, F. S. (2011) Selective early-acquired fear memories undergo temporary suppression during adolescence. *Proc Natl Acad Sci*, 108, 1182–1187.
- Pattwell, S. S., Lee, F. S., & Casey, B. J. (2013) Fear learning and memory across adolescent development. *Horm Behav*, 64, 380–389.
- Pavlov, I. P. (1927) *Conditioned reflexes : An Investigation of the physiological activity of the cerebral cortex* Dover Publications.

- Phelps, E. A., & LeDoux, J. E. (2005) Contributions of the amygdala to emotion processing: from animal models to human behavior. *Neuron*, 48, 175–187.
- Phillips, R. G., & LeDoux, J. E. (1992) Differential contribution of amygdala and hippocampus to cued and contextual fear conditioning. *Behav Neurosci*, 106, 274–285.
- Pongrácz, P., & Altbäcker, V. (2000) Ontogeny of the responses of European rabbits (*Oryctolagus cuniculus*) to aerial and ground predators. *Can J Zool*, 78, 655–665.
- Pouthas, V., Paindorge, B., & Jacquet, A. (1995) Apprendre à mesurer la durée : étude chez des enfants âgés de 4 à 7 ans. *Annee Psychol*, 95, 593–619.
- Quirk, G. J., & Mueller, D. (2008) Neural mechanisms of extinction learning and retrieval., 33, 56–72.
- Raineki, C., Shionoya, K., Sander, K., & Sullivan, R. M. (2009) Ontogeny of odor-LiCl vs. odor-shock learning: similar behaviors but divergent ages of functional amygdala emergence. *Learn Mem*, 16, 114–121.
- Raineki, C., Moriceau, S., & Sullivan, R. M. (2010a) Developing a neurobehavioral animal model of infant attachment to an abusive caregiver. *Biol Psychiatry*, 67, 1137–1145.
- Raineki, C., Holman, P. J., Debiec, J., Bugg, M., Beasley, A., & Sullivan, R. M. (2010b) Functional emergence of the hippocampus in context fear learning in infant rats. *Hippocampus*, 20, 1037–1046.
- Raineki, C., Rincon Cortés, M., Belnoue, L., & Sullivan, R. M. (2012) Effects of early-life abuse differ across development: infant social behavior deficits are followed by adolescent depressive-like behaviors mediated by the amygdala. *J Neurosci*, 32, 7758–7765.
- Rudy, J. W. (1993) Contextual conditioning and auditory cue conditioning dissociate during development. *Behav Neurosci*, 107, 887–891.
- Savastano, H. I., & Miller, R. R. (1998) Time as content in Pavlovian conditioning. *Behav Processes*, 44, 147–162.
- Schaffer, H. R., & Emerson, P. E. (1964) The Development of social attachments in infancy. *Monogr Soc Res Child Dev*, 29, 1–70.
- Schreiber, W. B., Asok, A., Jablonski, S. A., Rosen, J. B., & Stanton, M. E. (2014) Egr-1 mRNA expression patterns in the prefrontal cortex, hippocampus, and amygdala during variants of contextual fear conditioning in adolescent rats. *Brain Res*, 1576, 63–72.
- Selden, N. R., Everitt, B. J., Jarrard, L. E., & Robbins, T. W. (1991) Complementary roles for the amygdala and hippocampus in aversive conditioning to explicit and contextual cues. *Neuroscience*, 42, 335–350.
- Shechner, T., Britton, J. C., Ronkin, E. G., Jarcho, J. M., Mash, J. A., Michalska, K. J., ... Pine, D. S. (2015) Fear conditioning and extinction in anxious and nonanxious youth and adults: examining a novel developmentally appropriate fear-conditioning task. *Depress Anxiety*, 32, 277–288.
- Shionoya, K., Moriceau, S., Lunday, L., Miner, C., Roth, T. L., & Sullivan, R. M. (2006) Development switch in neural circuitry underlying odor-malaise learning. *Learn Mem*, 13, 801–808.
- Shionoya, K., Moriceau, S., Bradstock, P., & Sullivan, R. M. (2007) Maternal attenuation of hypothalamic paraventricular nucleus norepinephrine switches avoidance learning to preference learning in preweanling rat pups. *Horm Behav*, 52, 391–400.



- Smith, A. B., Giampietro, V., Brammer, M., Halari, R., Simmons, A., & Rubia, K. (2011) Functional development of fronto-striato-parietal networks associated with time perception. *Front Hum Neurosci*, 5, 1–11.
- Sotres-Bayon, F., Cain, C. K., & LeDoux, J. E. (2006) Brain mechanisms of fear extinction: historical perspectives on the contribution of prefrontal cortex. *Biol Psychiatry*, 60, 329–336.
- Sowell, E. R., Thompson, P. M., Holmes, C. J., Jernigan, T. L., & Toga, A. W. (1999) In vivo evidence for post-adolescent brain maturation in frontal and striatal regions. *Nat Neurosci*, 2, 859–861.
- Spear, L. P. (2000) The adolescent brain and age-related behavioral manifestations. *Neurosci Biobehav Rev*, 24, 417–463.
- Stanton, M. E. (2000) Multiple memory systems, development and conditioning. *Behav Brain Res*, 110, 25–37.
- Stanton, M. E., Wallstrom, J., & Levine, S. (1987) Maternal contact inhibits pituitary-adrenal stress responses in preweanling rats. *Dev Psychobiol*, 20, 131–145.
- Stanton, M. E., & Levine, S. (1990) Inhibition of infant glucocorticoid stress response: specific role of maternal cues. *Dev Psychobiol*, 23, 411–426.
- Stanton, M. E., Freeman, J. H., & Skelton, R. W. (1992) Eyeblink conditioning in the developing rat. *Behav Neurosci*, 106, 657–665.
- Stehouwer, D. J., & Campbell, B. A. (1978) Habituation of the forelimb-withdrawal response in neonatal rats. *J Exp Psychol Anim Behav Process*, 4, 104–119.
- Sterzer, P. (2010) Born to be criminal? What to make of early biological risk factors for criminal behavior. *Am J Psychiatry*, 167, 1–3.
- SucHECKI, D., Rosenfeld, P., & Levine, S. (1993) Maternal regulation of the hypothalamic-pituitary-adrenal axis in the infant rat: the roles of feeding and stroking. *Brain Res Dev Brain Res*, 75, 185–192.
- Sullivan, R. M., Brake, S. C., Hofer, M. A., & Williams, C. L. (1986) Huddling and independent feeding of neonatal rats can be facilitated by a conditioned change in behavioral state. *Dev Psychobiol*, 19, 625–635.
- Sullivan, R. M., Hofer, M. A., & Brake, S. C. (1986) Olfactory-guided orientation in neonatal rats is enhanced by a conditioned change in behavioral state. *Dev Psychobiol*, 19, 615–623.
- Sullivan, R. M., Zyzak, D. R., Skierkowski, P., & Wilson, D. A. (1992) The role of olfactory bulb norepinephrine in early olfactory learning. *Dev Brain Res*, 70, 279–282.
- Sullivan, R. M., Wilson, D. A., Lemon, C., & Gerhardt, G. A. (1994) Bilateral 6-OHDA lesions of the locus coeruleus impair associative olfactory learning in newborn rats. *Brain Res*, 643, 306–309.
- Sullivan, R. M., Landers, M., Yeaman, B., & Wilson, D. A. (2000a) Good memories of bad events in infancy. *Nature*, 407, 38–39.
- Sullivan, R. M., Stackenwalt, G., Nasr, F., Lemon, C., & Wilson, D. A. (2000b) Association of an odor with an activation of olfactory bulb noradrenergic  $\beta$ -receptors or locus coeruleus stimulation is sufficient to produce learned approach responses to that odor in neonatal rats. *Behav Neurosci*, 114, 957–962.

- Sullivan, R. M., Landers, M. S., Flemming, J., Vaught, C., Young, T. A., & Jonathan Polan, H. (2003) Characterizing the functional significance of the neonatal rat vibrissae prior to the onset of whisking. *Somatosens Mot Res*, 20, 157–162.
- Sumbre, G., Muto, A., Baier, H., & Poo, M. (2008) Entrained rhythmic activities of neuronal ensembles as perceptual memory of time interval. *Nature*, 456, 102–106.
- Szelag, E., Kowalska, J., Rymarczyk, K., & Pöppel, E. (2002) Duration processing in children as determined by time reproduction: implications for a few seconds temporal window. *Acta Psychol (Amst)*, 110, 1–19.
- Takahashi, L. K. (1994) Organizing action of corticosterone on the development of behavioral inhibition in the preweanling rat. *Dev Brain Res*, 81, 121–127.
- Takeuchi, T., Ogawa, M., Furihata, C., Kawachi, T., & Sugimura, T. (1977) Perinatal changes in amylase and serum corticosterone levels in rats. *Biochim Biophys Acta*, 497, 657–662.
- Thompson, J. V, Sullivan, R. M., & Wilson, D. A. (2008) Developmental emergence of fear learning corresponds with changes in amygdala synaptic plasticity. *Brain Res*, 1200, 58–65.
- Tottenham, N., Shapiro, M., Telzer, E. H., & Humphreys, K. L. (2012) Amygdala response to mother. *Dev Sci*, 15, 307–319.
- Tottenham, N., Lumian, D. S., & Silvers, J. A. (2015) Hierarchical Development of the Human Neurobiology involved in Aversion-Learning. *Biol Psychiatry*, 77, 25-29.
- Touzani, K., & Sclafani, A. (2005) Critical role of amygdala in flavor but not taste preference learning in rats. *Eur J Neurosci*, 22, 1767–1774.
- Upton, K. J., & Sullivan, R. M. (2010) Defining age limits of the sensitive period for attachment learning in rat pups. *Dev Psychobiol*, 52, 453–464.
- Van Eden, C. G., & Uylings, H. B. (1985) Cytoarchitectonic development of the prefrontal cortex in the rat. *J Comp Neurol*, 241, 253–267.
- Walker, C. D., Scribner, K. A., Cascio, C. S., & Dallman, M. F. (1991) The pituitary-adrenocortical system of neonatal rats is responsive to stress throughout development in a time-dependent and stressor-specific fashion. *Endocrinology*, 128, 1385–1395.
- Walker, S. J., & Vrana, K. E. (1993) Pituitary corticotroph function during the stress hyporesponsive period in neonatal rats. *Neuroendocrinology*, 57, 1003–1010.
- Walters, E. T., Carew, T. J., & Kandel, E. R. (1981) Associative Learning in *Aplysia*: evidence for conditioned fear in an invertebrate. *Science* (80- ), 211, 504–506.
- Wiedenmayer, C. P., & Barr, G. A. (2001) Developmental changes in responsivity to threat are stimulus-specific in rats. *Dev Psychobiol*, 39, 1–7.
- Wiedenmayer, C. P., Magarinos, A. M., McEwen, B. S., & Barr, G. A. (2003) Mother lowers glucocorticoid levels of preweaning rats after acute threat. *Ann N Y Acad Sci*, 1008, 304–307.
- Yi, D. K., & Barr, G. A. (1995) The induction of Fos-like immunoreactivity by noxious thermal, mechanical and chemical stimuli in the lumbar spinal cord of infant rats. *Pain*, 60, 257–265.

## **B. Using reconsolidation as a tool to detect duration discrimination**

### 1. What is reconsolidation ?

Stress related disorders such as post-traumatic stress disorders (PTSD) can be characterized as disorders involving the disturbance of emotional learning and memory processes, resulting in enhanced maintenance of fear memories (LeDoux et al. 2009). It is the main reason why the mechanisms of extinction and reconsolidation have been studied so extensively in aversive paradigms. After learning an association between a CS and an aversive US, if the CS alone is presented repeatedly, the individual is going to learn a new association between the CS and the absence of a salient event. This new learning decreases the fearful responses to the CS and is called extinction. However, after extinction, fearful behavior can return due to presentation of the context where the association was learned (renewal), unpaired presentation of the US (reinstatement), or the passage of time (spontaneous recovery) (Bouton et al. 2006; Delamater and Westbrook 2014). Return of the fear response after extinction is always less intense than after conditioning and decreases in intensity with an increase of extinction sessions. In summary, extinction is not stable over time and therefore may not a good candidate to attenuate pathological anxiety responses. It is however the basis of exposure therapy, which has shown some beneficial effect in patients (for a recent review, see Rodriguez et al. 2012).

To understand reconsolidation it is important to first understand the principle of synaptic consolidation (for a review, see Dudai 2004). Memory consolidation, was discovered and named by Muller & Pilzecker in 1900 (from Dudai 2004). In the context of associative learning, Duncan observed that giving electrical shocks to rats just after learning would impair the memory 24 hours later but not at short term (Duncan 1949). It is possible to disrupt new learning, but only for a few hours after learning, when the memory is labile. Injection of a protein synthesis inhibitor is another way to block the stabilization of a memory (described in aversive conditioning by Schafe et al. 1999 and in the amygdala by Schafe and LeDoux 2000). Reconsolidation is a second state of lability/stabilization that a memory goes through after reactivation (i.e. presentation of a cue associated with the learning after consolidation of the association in long-term memory) (Dudai 2004). Przybylski and Sara coined the term reconsolidation in 1997. Reconsolidation is also dependent on protein synthesis (described in the amygdala in the case of aversive conditioning by Nader et al. 2000). Memory

reconsolidation has been observed in numerous species from the nematode *C. elegans* to humans, and it has been described in diverse brain structures (for a review, see Besnard et al. 2012), therefore showing that this is a very important process.

Reconsolidation and extinction seem to be complementary mechanisms, since the only difference between the two, at least in the laboratory, is the number of CS presentations during the reactivation session. However, the two processes seem separate at a molecular level, shifting from one to the other after a sufficient number of CS presentations (at least seven in the case of a two CS-US conditioning) (Merlo et al. 2014). Reconsolidation acts on the initial memory and seems to disrupt it on the long term, potentially making it a better target for treating PTSD (for a recent review of reconsolidation in humans, see Schwabe et al. 2014). However, since it requires the use of drugs, it is more difficult to implement in humans.

More recently it has been discovered that error detection is essential for the induction of reconsolidation after reactivation by presentation of the cue. In fact, detection of a temporal mismatch suffices. If reactivation consists of presenting exactly the same CS-US pairing (same cues and same interval between cues) as during learning, then there is no reconsolidation involved afterwards. However if the CS-US interval is changed, then reconsolidation is activated (Díaz-Mataix et al. 2013). New information is necessary for reconsolidation to happen, and changing the CS-US interval is a sufficient modification from learning to induce this mechanism. Therefore, when reconsolidation is activated the CS-US interval has been learned. Thus, this paradigm is perfect for a rapid determination of the ability to memorize and discriminate temporal intervals.

## 2. How to block reconsolidation?

Protein synthesis and mRNA synthesis are essential for consolidation, but only protein synthesis seems crucial for reconsolidation (Parsons et al. 2006). Therefore, the main drugs used to block reconsolidation act directly on protein synthesis, like anisomycin (e.g. Nader et al. 2000; Díaz-Mataix et al. 2013), or indirectly, like propranolol (e.g. Kindt et al. 2009; Debiec and Ledoux 2004) or rapamycin (e.g. Blundell et al. 2008; Mac Callum et al. 2014). However, rapamycin blocks the protein synthesis of only 10-15% of protein, instead of 70-95% for anisomycin (Parsons et al. 2006; Morris et al. 2006), and may thus induce less undesirable secondary effects.

In our experiment we used rapamycin, an inhibitor of mTOR (mammalian Target of Rapamycin), which is a serine/threonine protein kinase that controls the initiation and capacity of a subset of mRNA translation in neurons primarily through phosphorylation of two downstream targets, p70-kDa ribosomal s6 kinase (p70s6K) and eukaryotic initiation factor 4E-binding protein 1 (4EBP1) (Raught et al. 2001; Hay and Sonenberg 2004). Using rapamycin to block reconsolidation in a fear startle paradigm, Glover et al (2010) found no effect of rapamycin on the reconsolidation of an olfactory cue based learning, but rapamycin did block reconsolidation of contextual learning. However, rapamycin was shown to block reconsolidation of an auditory cue fear conditioning (Mac Callum et al. 2014) showing that the effect of rapamycin is not restricted to contextual learning.

### 3. Consolidation and reconsolidation in infants

Consolidation has been demonstrated in rat pups (HaLey, 2013), but the consolidation period may be longer and more vulnerable to amnesic agents for younger individuals (Blozovski and Buser 1988). This may be linked to infantile amnesia, which represents the accelerated forgetting shown in early life in humans and animals (for a recent review, see Madsen and Kim 2015).

Reconsolidation has been demonstrated in rat pups as young as PN3 and requires protein synthesis, like in adults (Gruest et al. 2004; Languille et al. 2008, 2009). The authors injected anisomycin i.p. to block reconsolidation in a conditioned taste aversion (CTA) paradigm (i.e. the association of a taste with a lithium chloride i.p. injection that induces illness). The taste will thus be avoided because of its link with illness. It is a stronger aversive learning than classical aversive conditioning (although very strong footshocks can induce a similar learning in pups), and it is dependent on a different neural circuit (Shionoya et al. 2006). Therefore it is important to first show that reconsolidation can be blocked in classical Pavlovian aversive conditioning.

**We wished to determine if juvenile pups, which present an immature dorsal striatum and PFC, can memorize a CS-US interval (looking at long-term memory, 24h after learning) and if they can detect a change in this interval. We used a simple paradigm of Pavlovian aversive conditioning with a phase of reactivation that is followed or not by**

**rapamycin injection, since it does not require a long training. If the animal detects a difference between the reactivation and the conditioning phase, it should induce reconsolidation and therefore the injection of rapamycin should decrease the expression of fear in those animals.**

## II. RESULTS AND DISCUSSION

### **Article n°3: Ontogeny of temporal prediction error in rats**

In preparation

#### **Ontogeny of temporal prediction error in rats**

Lucille Tallot<sup>1,2,3,4\*</sup>, Lorenzo Diaz-Mataix<sup>3</sup>, Rosemary Perry<sup>3,4</sup>, Joseph E. LeDoux<sup>3</sup>, Anne-Marie Mouly<sup>5</sup>, Regina Sullivan<sup>3,4</sup>, Valérie Doyère<sup>1,2\*</sup>

<sup>1</sup> Univ Paris-Saclay, Institut des Neurosciences Paris-Saclay, UMR 9197, Orsay, F-91405;

<sup>2</sup> CNRS, Orsay, F-91405;

<sup>3</sup>Emotional Brain Institute, Center for Neural Science, New York University, New York, NY 10003, USA

<sup>4</sup> Child Study Center Institute for Child and Adolescent Psychiatry, New York University Langone Medical Center, New York, NY, 10016 United States

<sup>5</sup>Center of Research in Neurosciences of Lyon, CNRS UMR 5292, INSERM U1028, Lyon, France

\*corresponding authors: lucille.tallot@gmail.com, valerie.doyere@u-psud.fr

## Abstract

When a memory is reactivated after learning (by the presentation of a cue associated with the learning), the memory becomes labile and can be disrupted by inhibiting protein synthesis (Nader et al, 2000). However, the destabilization of the previously learned memory necessitates the addition of new information (the reactivation phase must be different from the initial learning), for example by changing the interval between the conditioned stimulus (CS) and the unconditioned stimulus (US) in a Pavlovian aversive conditioning (Diaz-Mataix et al, 2013). We used this paradigm to test whether juvenile rats can memorize a CS-US interval and detect when it is modified. We report here that juvenile rats can process changing CS-US intervals. We observed the expected amnesic effect of rapamycin when we presented the CS alone as reactivation and saw no effect when the rapamycin was injected outside of reactivation. However, we observed an increase in freezing when rapamycin was injected after changing the CS-US interval that made us think that pups do not reconsolidate in a similar way to adults. Indeed in adults we observed the expected amnesic effect, whereas adolescent rats showed an intermediate phenotype. We propose one possible explanation for our unexpected results in juvenile rats.

**Keywords:** interval timing; reconsolidation; juvenile rats; rapamycin; long-term memory; adolescents



## Introduction

Learning based on prediction error detection, when something differs from the fully predicted, enables the organism to adapt according to changed causal relationships between events. During Pavlovian aversive conditioning, the conditioned stimulus (CS) acquires a predictive value for the unconditioned stimulus (US), including when it is due to arrive, in as few as one trial (Balsam et al., 2002; Davis et al., 1989; Díaz-Mataix et al., 2013). Error detection depends heavily on the capacity to detect and memorize the intervals between the CS and the US, and is critical for triggering the updating of aversive memories, in an amygdala-dependent manner (Díaz-Mataix et al., 2013)

Animals as young as post-natal (PN) day 10 can learn about aversive associations, in relation to the maturation of the amygdala (Sullivan et al., 2000). However, several studies have highlighted how the mechanisms underlying aversive memory formation in pups are not identical to adult ones (Moriceau and Sullivan 2006; Moriceau et al. 2006; Sullivan et al. 2000; for a recent review, see Landers and Sullivan 2012). Whether pup's aversive learning follows the same rules as in adults in relation to temporal error prediction, is not known. To our knowledge, only two studies have reported temporal error prediction in the young, and they are in humans. Clifton (1974) has evidenced a decrease in heart rate at the expected time of a glucose reward, when omitted for the first time, in babies as young as 1-3 days old. Another study showed a frontal cortex even-related potential (ERP) modulation in 10-month old babies similar to the one seen in adults in response to an unexpected stimulus, deviant from trained temporal regularity (Brannon et al., 2004). Research in animals has concentrated on the development of temporally regulated behaviors during acquisition, and there are again only a few studies. Timed eyeblink has been observed in PN17-18 rat pups after more than 200 conditioning training trials (Stanton et al., 1992). More recently, Boulanger-Bertolus et al. (2014) have shown patterns of breathing and freezing related to the CS-US interval within 10 pairings during an olfactory aversive conditioning in rat pups as young as PN12, although the temporal pattern was not similar to the one observed in adults. While showing that the infant, human or rat, can develop a temporal expectancy of an upcoming event while exposed to temporal regularities or conditioning, these studies do not inform on whether early in life the inter-event time is memorized in long-term memory (i.e. at 24h) and enables updating of memories when a temporal prediction error is detected, as in adults.

In adult rats, prediction error detection, by presenting a CS omitting the US or a trial with a changed CS-US interval 24h after a tone(CS)-shock(US) conditioning, triggers a reconsolidation process, a process which requires the synthesis of new proteins (Nader et al., 2000). Disruption of reconsolidation of auditory fear conditioning in adults has been demonstrated using intra-amygdala infusion or intraperitoneal injection of protein synthesis inhibitors, such as anisomycin or rapamycin (e.g. Nader et al. 2000; Díaz-Mataix et al. 2013; Blundell et al. 2008; Mac Callum et al. 2014). Rapamycin is an inhibitor of mTORC1 involved in a pathway that includes PI3K, AKT and PKB. Modulation of most of these molecular targets impairs or enhances reconsolidation (for a review see Baldi and Bucherelli 2015).

Here, using rapamycin in a reconsolidation paradigm after an auditory fear conditioning, we tested whether juvenile (PN18-20) rat pups can detect errors in associations, either with a US omission or a change in the CS-US interval, when presented 24h after training. The results show that juvenile pups do form a long-term memory of the CS-US interval, and detect a 10s vs. 30s temporal prediction error. However, the resulting reconsolidation process becomes adult-like only after adolescence, thus highlighting specific infant-type mechanisms for associative learning and memory.

## **Materials and Methods**

### **Subjects**

**Juveniles:** We used male and female PN18-20 Long Evans rats born and bred in our colony (originally from Harlan Laboratories). A total of 167 pups were conditioned. Rats were housed in polypropylene cages (34 x 29 x 17 cm) with their mother and littermates and maintained in a  $20 \pm 1$  °C environment with a 12/12 hr light/dark cycle. Food and water were provided ad libitum. The day of birth was considered P0 and litters were culled to 12 pups (6 males and 6 females) on P1. No more than one male and one female were used from the same litter for one experimental group. Pups were separated from the mother only for the duration of the session (maximum 1h).

**Adolescents:** We used 24 male and female PN30-40 Long Evans rats born and bred in our colony (originally from Harlan Laboratories). Rats were housed in polypropylene cages (34 x 29 x 17 cm) with same-sex littermates (four per cages) and maintained in a  $20 \pm 1$  °C environment with a 12/12 hr light/dark cycle. Food and water were provided ad libitum. No more than one male and one female were used from the same litter for one experimental group.

**Adults:** We used 12 adults male Sprague Dawley rats (> PN60) proved by Hilltop Lab

Animals and weighing 250 – 300g at the beginning of the experiment. Rats were housed by pair in polypropylene cages (34 x 29 x 17 cm) and maintained in a  $20 \pm 1$  °C environment with a 12/12 hr light/dark cycle.

All procedures were in accordance with the NIH Guide for the Care and Use of Experimental Animals, and were approved by the New York University Animal Care and Use Committee.

### **Behavioral Apparatus and Stimuli**

Juveniles and adolescents: Four identical chambers constructed of aluminum and Plexiglas walls (Mouse Test Cage, Coulbourn Instruments, Allentown, PA), with metal stainless steel rod flooring that was connected to a shock generator (Model H13-15; Coulbourn Instruments). The chambers were enclosed within a sound-isolation cubicle (Model H10-24A; Coulbourn Instruments). Habituation, conditioning and reactivation took place in context 1 which consisted of a grid floor, a yellow house light and was cleaned with ethanol. Cue test took place in context 2 which consisted of white board covering the grid, a red house light and was cleaned with Windex. Chamber grid floors, trays and walls were thoroughly cleaned between sessions. Rats were allowed to freely explore the chamber before each behavioral procedure for variable amount of time depending on the sessions (7 min for fear conditioning, 4 min for reactivation, and 5 min for test session). The conditioned stimulus (CS) was a 40 s, 5 kHz, 80dB tone (background of 70dB). The unconditioned stimulus (US) was a 0.5 second footshock with an intensity of 0.6 mA.

An infrared digital camera, mounted on top of each chamber, allowed recording during behavioral procedures for later behavioral scoring. Stimulus presentation and behavior recording was controlled through a computer equipped with Freeze Frame software (Coulbourn Instruments) for pups and adolescents, and Graphic State Software (Coulborn Instruments) and video recording for adults.

### **Aversive Conditioning and Memory Procedures**

#### Handling

All animals were handled for two days before the start of the experiment. Juvenile pups were removed from the nest in pairs and manipulated for 5 min. Adolescents were also handled by pairs to reduce stress, whereas adults were handled separately.

### Aversive Conditioning Procedure

All rats were exposed to the conditioning context during 30 min for habituation to the context 1 (Day 1). On Day 2, rats were placed in the conditioning chambers and CS-US trials were delivered. The US was delivered 30 or 10 seconds after the onset of the 40-s CS depending on the group (see Figure 1). Mean inter-trial interval was 4 min (3-5 min range). Rats were conditioned with either 5 CS-US or 10 CS-US pairings and the first CS was presented ten minutes after placement in the context.

### Memory Reactivation

The memory reactivation session took place 24 h after aversive conditioning. A single presentation consisting of either a CS-US pairing or a CS alone was presented seven minutes after placement in the context. The US was delivered either at the same time after the tone onset as during conditioning (no shift groups), or at a different time after the tone onset as than during conditioning (shift groups) (see Figure 1). Immediately after exposure to the stimulus, the rats received an intraperitoneal (i.p.) injection of either rapamycin (LC Laboratories, 10mg/mL diluted in water with 10% DMSO and 10% Tween 20, 20mg/kg for juvenile pups and 40 mg/kg for adolescents and adults) or vehicle. The non-reactivated rats were simply removed from the home cage for the injection and then returned.

### Post-Reactivation Long-Term Memory (PR-LTM) test

The retention test was given 24 h after drug injection in context 2. The memory retention test consisted of the presentations of 3 CS alone (without a US). The first CS was presented five minutes after placement in the context. Mean inter-trial interval was 4 min (3-5 min range).

### **Measurement of Freezing Behavior**

Freezing was used to measure the conditioned emotional aversive response, and was defined as the cessation of all movement with the exception of respiration-related movement and non-awake or rest body posture. Freezing was scored via the Freeze Frame software with a fixed threshold of 12 and a minimal bin size of 0.25s. For adolescents and adults, freezing was scored manually. For reactivation and PR-LTM sessions, the analysis of freezing was restricted to the first 10s of tone presentation for equivalent comparisons between all groups and conditions. For assessing the reactivity to the footshock US during the reactivation session, freezing during the 10s before and 10s after the US were compared.

## **Statistical Analysis**

The analyses were performed with GraphPad Prism v6.0. Data were analyzed for each vehicle vs. rapamycin comparison by using unpaired t-test assuming equal variance after performing the unpaired F-test for variance. The significance level was set at  $\alpha=0.05$ .

## **Results**

For all the described experiments no effect was seen on the pre-CS period between vehicle and rapamycin ( $t(21-22) < 1.09$ , n.s.). Also, sampling some animals among the different sets of experiments in pups, we found no effect of rapamycin was seen on the weight of the animals compared to the injection of vehicle ( $t(44) = 0.13$ , n.s.).

### **Impairment of auditory fear memory reconsolidation in juvenile pups**

Reconsolidation has been demonstrated in pups as young as PN3 in a conditioned taste aversion paradigm (Languille et al., 2008). However, conditioned taste aversion does not rely on precise CS-US timing and involves a different neural network than the traditional Pavlovian aversive conditioning in young pups (Shionoya et al., 2006). Whether reconsolidation of a cue-fear conditioning can be disrupted in juvenile pups with an i.p. injection of rapamycin had yet to be tested. As reconsolidation processes are initiated when the association is well learned so that a mismatch between reactivation and initial training conditions can be detected (Díaz-Mataix et al., 2013; Morris et al., 2006; Pedreira et al., 2004; Rodriguez-Ortiz et al., 2005) but the learning must not be too strong either (Eisenberg et al., 2003; Suzuki et al., 2004), we first assessed reconsolidation after two levels of conditioning (5 CS-US or 10 CS-US).

The classical way to demonstrate reconsolidation is to inject a protein synthesis inhibitor immediately after the presentation of a single CS as a reactivation procedure to make the memory labile again. If reconsolidation has been impaired, a decrease in the conditioned response is observed at the cue test, 24 hours later. Using the same procedure in pups (Figure 1), we thus tested whether a single injection of rapamycin immediately after memory reactivation with a CS produced an impairment of CS-US long-term memory, as expressed by a decrease in level of freezing to the CS. Freezing behavior during reactivation and during the post-reactivation long-term memory (PR-LTM) test is shown in Figure 2. After training with 5

CS-US pairings, there was a tendency for a reduced amount of freezing during the first CS of PR-LTM test in the rapamycin group as compared to the vehicle group ( $t(22) = 1.84$ ,  $p = 0.078$ , Figure 2A), while they did not differ during the reactivation session ( $t(22) = 0.56$ , n.s.). When trained with 10 CS-US pairings, the reduction in freezing during PR-LTM in rapamycin group compared to the vehicle group reached significance ( $t(22) = 3.03$ ,  $p = 0.006$ , figure 2B), while not differing during reactivation ( $t(22) = 0.57$ , n.s.).

With repetition of the CS alone during the PR-LTM test, the difference between rapamycin and vehicle groups tended to decrease, but the difference between rapamycin and vehicle groups remained significant when looking at the three CSs presentations ( $t(22) = 2.19$ ,  $p = 0.04$ ).

Thus, reconsolidation can be disrupted with an i.p. injection of rapamycin in juvenile rat pups as long as a sufficient training is provided. Therefore, for all subsequent experiments a conditioning with 10 CS-US pairings was used to give access to the assessment of an effect of rapamycin on a reactivated memory and the analyses focused on the first CS presentation of PR-LTM test, where the effect is the most salient.

### **Detection of changing CS-US time intervals**

We next tested whether a change in CS-US interval between 10 and 30s would be detected by juvenile pups as a temporal prediction error and trigger a reconsolidation process, as it has been reported previously in adults (Díaz-Mataix et al., 2013). These authors have shown that reactivating the memory with a single CS-US pairing triggered a reconsolidation process, which was disrupted by a protein synthesis inhibitor, only if a change in the CS-US interval was detected. We thus tested the effect of rapamycin in juvenile animals when the reactivation consisted of a single pairing with a shift in the CS-US interval (Shift group), either from 30s to 10s (earlier) or from 10s to 30s (later), or when the CS-US interval (30s or 10s) was not changed (No-shift group) (Figure 1). If a reconsolidation was triggered by the reactivation, rapamycin was expected to disrupt it and lower levels of freezing would be obtained during PR-LTM as when a CS alone served for reactivation (see above, Figure 2).

Juvenile animals injected with rapamycin after memory reactivation with a shift in the time of arrival of the shock showed a higher level of freezing during PR-LTM compared to the vehicle group ( $t(46) = 3.71$ ,  $p < 0.001$ , Figure 3A), while there was no difference during the reactivation session ( $t(46) = 0.59$ , n.s.). When looking at each Earlier or Later sub-group separately, the effect was similar for both conditions, although it reached significance only for

the Later group ( $t(22) = 3.57, p = 0.002$ ) while a tendency was observed in the Earlier group ( $t(22) = 1.8, p = 0.088$ ). When rapamycin was injected after a reactivation with no change in the CS-US interval, however, no significant difference was observed with the vehicle group during PR-LTM ( $t(46) = 0.23, n.s.$ ; 30s – 30s:  $t(22) = 0.66, n.s.$ ; 10s – 10s:  $t(22) = 0.25, n.s.$ ) or reactivation ( $t(46) = 0.23, n.s.$ ; 30s – 30s:  $t(22) = 0.80, n.s.$ ; 10s – 10s:  $t(22) = 0.36, n.s.$ ). As a further control, we tested the effect of rapamycin without reactivation and saw no difference between rapamycin and vehicle groups during the PR-LTM test ( $t(21) = 0.62, n.s.$ ). Thus, the increase observed in the shift condition was due to an effect of rapamycin on a process triggered by the detection of the changing time interval, and not by rapamycin, alone or in combination with a footshock delivery. Overall these results show that temporal prediction error was detected by juvenile pups and triggered a process sensitive to rapamycin.

### **Behavioral response to an expected versus an unexpected US**

The unexpected increase in freezing in the shift groups with rapamycin made us wonder whether the pup's behavior to the US when delivered at a different time than expected was comparable to the one observed in adults in the same conditions. Figure 4 presents the reactivity to the US during the reactivation session, expressed as the percent change in freezing during the 10s immediately after the shock delivery compared to the 10s immediately preceding the shock. For juvenile pups (Figure 4A), when there was no surprise (the shock arrived at the same time as during conditioning) we observed a decrease in freezing of approximately 50%, representing an increase in activity following the shock. This decrease was significantly different from 0 (30s-30s,  $t(23) = 7.32, p < 0.001$ ; 10s-10s,  $t(23) = 4.82, p < 0.001$ ). A similar decrease was observed in the group that received the shock later than expected (difference from 0,  $t(23) = 8.25, p < 0.001$ ). When the shock was delivered earlier than expected, however, no significant change in the amount of freezing was observed (difference from 0,  $t(23) = 0.09, n.s.$ ).

For comparison, adult rats submitted to similar conditions (Figure 4B, data taken from the experiment published in Diaz-Mataix et al., 2013, but that were not reported) showed a similar pattern of response. The 30s-30s group and the Later group showed both a significant decrease in freezing after the shock (difference from 0,  $t(15) = 6.46, p < 0.001$  and  $t(10) = 4.87, p < 0.001$ , respectively), whereas the Earlier group showed no significant change in level of freezing (difference from 0,  $t(11) = 0.64, n.s.$ ).

In sum, while the delivery of the US at an unexpected time had a different impact on the

freezing level depending on whether it arrives earlier or later than expected, the impact was similar for juvenile pups and adult rats. Therefore, it is unlikely that a differential reactivity to the footshock during reactivation in juvenile pups was responsible for the increase in freezing during PR-LTM in the Shift-rapamycin group.

### **Effect of rapamycin on reconsolidation across development**

To determine if the increase of freezing we observed in the pups after a shift in the CS-US interval was specific of this age group, we also tested adolescent (PN30-40) and adult rats (> PN60) (Figure 5). We used only the condition where we observed the strongest effect in pups, meaning when rapamycin or vehicle was injected immediately after a shift in CS-US interval from 10s to 30s (Later condition). In adults, we observed a decrease in freezing in the rapamycin group showing an impairment of reconsolidation ( $t(10) = 2.55$ ,  $p < 0.05$ ), in agreement with the literature (e.g. Nader et al. 2000; Díaz-Mataix et al. 2013; Blundell et al. 2008; Mac Callum et al. 2014). In contrast, for the adolescent rats we observed no effect of rapamycin during the PR-LTM test ( $t(22) = 1.19$ , n.s.) Therefore, the increase in freezing that we observed in juvenile pups after injection of rapamycin seems to be specific to this age.

## **Discussion**

The present study confirmed that it is possible to block a mechanism that resembles reconsolidation in juvenile pups by inhibiting mTOR dependent protein synthesis. This was shown through a decrease in freezing response to the CS in long-term memory when rapamycin was injected immediately after memory reactivation with a CS alone, whereas no effect was observed when the memory had not been reactivated before the injection of rapamycin. Moreover, we showed, for the first time, that juvenile pups can memorize and remember for at least 24h the CS-US interval, and detect a change in this interval. However, the attempt at blocking reconsolidation when shifting the CS-US interval in juveniles provoked an increase in freezing, i.e. an opposite result than the one observed in adults.

The increase in freezing that we observed when rapamycin was injected after the detection of a shift in CS-US interval can be explained neither by an effect of rapamycin itself, as a decrease in freezing was obtained when reactivation was performed with a CS alone trial, nor by the presence of a shock during the reactivation, as no such increase was observed when



there was no change to the CS-US interval during reactivation (no shift group).

In adults, a potentiation of the initial memory (i.e. an increase in freezing in PR-LTM test) has been obtained by the injection of either a NMDA agonist (DCS) (Lee et al., 2006) or a PKA agonist (Tronson et al., 2006) immediately after reactivation with a CS alone. In adults, the shift from reconsolidation to extinction depends on the number of CS presentations during the re-exposure session (between 4 and 7 CS presentation) (Merlo et al., 2014), and the injection of DCS just before the presentation of enough CSs to activate extinction enhances extinction (Lee et al., 2006). Memory strength in the young is weaker than in adults for the same number of pairings, and this is exemplified in our study by the fact that 5 CS-US pairings were not sufficient for the prediction error to be detected in the young, whereas two CS-US presentations are sufficient in adults (Mac Callum et al., 2014). It is thus possible that, in juveniles, one CS-US presentation was sufficient to activate the extinction pathway over the reconsolidation one.

It has been recently demonstrated that temporal prediction error and trace dominance are both at play to determine whether a memory trace will be sensitive to amnesic agents (Alfei et al., 2015). The balance between these two processes may depend on the age of the animal, with the new learning triggered during reactivation being stronger than the 24-h old memory in juveniles. Following this logic, rapamycin (through a mechanism that remains to be elucidated, see below) could have resulted in an increase in freezing for the shift group because of a potentiation of the reactivation learning, and in a decrease in freezing for the CS alone group because of a potentiation of extinction learning. In the non-shift groups, there was nothing new to learn, and thus nothing to potentiate.

Through which mechanism rapamycin has enhanced the reactivated memory in juvenile pups? A number of possibilities come to mind. mTOR's function may be different at that age, or the neural circuits involved in reconsolidation of fear memory may not have been completely mature (with some of the structures mature but not others), thus tipping the balance of activity in this network and producing very dissimilar results to what is observed in adults. Alternatively, rapamycin, because of its action on protein synthesis, may have decreased neurogenesis in key structures for fear learning (like the amygdala) and, as a result, improved the retention of the memory formed during reactivation. In effect, post-natal neurogenesis has been observed in the amygdala (Bernier et al., 2002) and these new neurons seem to be involved in cued fear memory in adults (Hung et al., 2015). The addition of new neurons can destabilize

memories and is thought to be one of the causes of infantile amnesia (for a review, see Madsen and Kim 2015). Thus, decreasing neurogenesis at an early age may benefit, rather than disrupt, the new memory that is incorporated during the reactivation. Further experiments will be needed to evaluate each of these possibilities.

Whatever the mechanistic reason for which rapamycin had an unexpected effect in pups, our results demonstrate that juveniles do learn and store the CS-US interval in long-term memory, for at least 24h, and can detect a temporal error between 10 and 30s. Interestingly, the rapamycin seemed to be more effective when the arrival of the US was shifted to a later (10s  $\square$  30s) than to an earlier (30s  $\square$  10s) time. This may reflect the fact that learning the association may be easier with a short CS-US interval than with a long one. In effect, it is well known that conditioned responses' strength is higher for shorter CS-US durations compared to longer durations with the same amount of training (Holland, 1980; Pavlov, 1927). The literature also converges to the conclusion that reconsolidation processes are initiated only when additional learning is invoked during the reactivation procedure (Díaz-Mataix et al., 2013; Sevenster et al., 2012; our present shift vs. no-shift results; for a review, see Lee, 2009). Thus, there may have been a better error detection when the initial memory was strong enough (similarly to the difference we observed between 5 and 10 pairings).

Another possibility would be the difference in the processing of the error detection during the reactivation trial, rather than the strength of the initial learning. When the US arrived later than expected, there were two errors detected, the first one being the absence of the US at 10s (i.e. negative prediction error) and the second being the unexpected presence of the US at 30s (i.e. positive prediction error). As the CS duration was kept constant (i.e. 60s), it could be argued that there were also two errors detected in the earlier condition, the unexpected presence of the US at 10s and the absence of the US at 30s; however it seems plausible that the presence of the US at 10s may have disrupted the detection of the second error at 30s. In addition, it is not known, in adults or in juveniles, whether positive and negative prediction errors have equivalent power to trigger the update in long-term memory. Beyond the implications on learning and reconsolidation processes and possibly on mTOR function in juvenile animals, we have demonstrated that juvenile rats can memorize and process temporal intervals.

Interval timing is usually considered to depend on a cortico-striatal network (for reviews see, Buhusi and Meck 2005; Meck et al. 2008), but in juvenile rats both prefrontal cortex and

striatum are usually considered to be immature (both in cellular functioning and connectivity, for prefrontal cortex: Van Eden & Uylings, 1985; Casey et al., 2005; Nonneman & Corwin, 1981, and for the striatum: Boulanger Bertolus et al. 2014). The amygdala may also process the CS-US interval and detect temporal errors (for a review, see Díaz-Mataix et al., 2014). Therefore, it is possible that, in young rats, a different network is sufficient for timing and processing the CS-US interval, one involving the amygdala.

## Figures

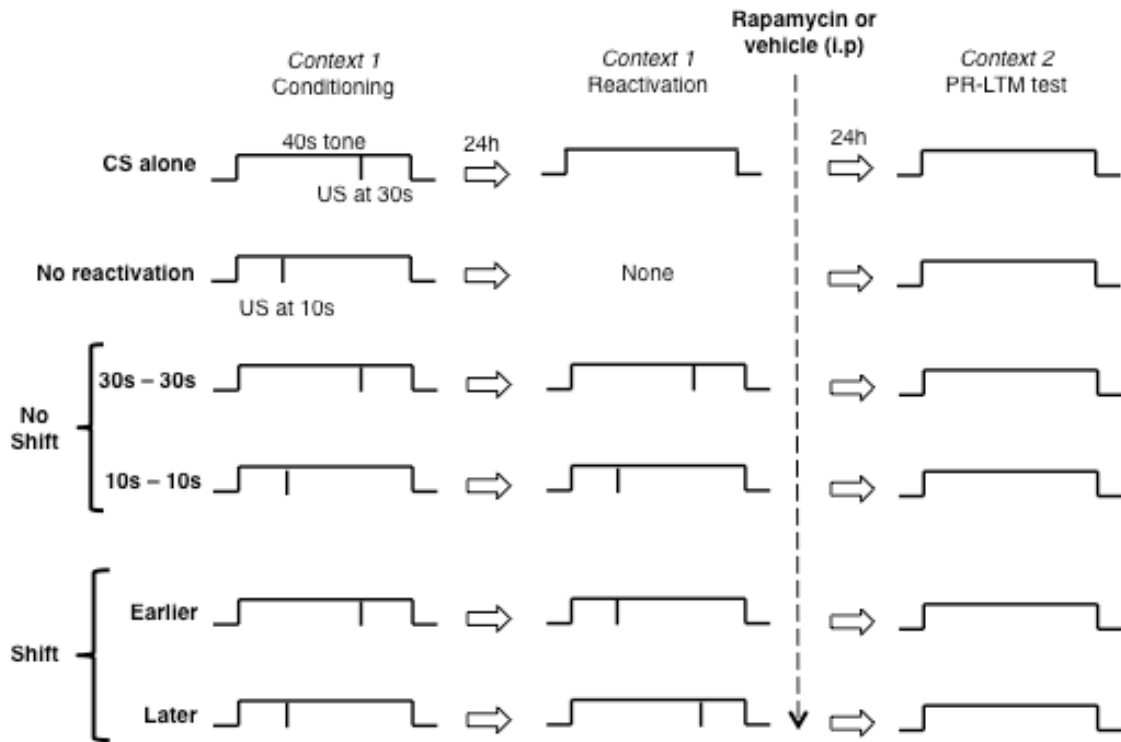


Figure 1: Schematic of the different experimental procedures. See Materials and Methods section for details (PR-LTM test: post-reactivation long-term memory test).

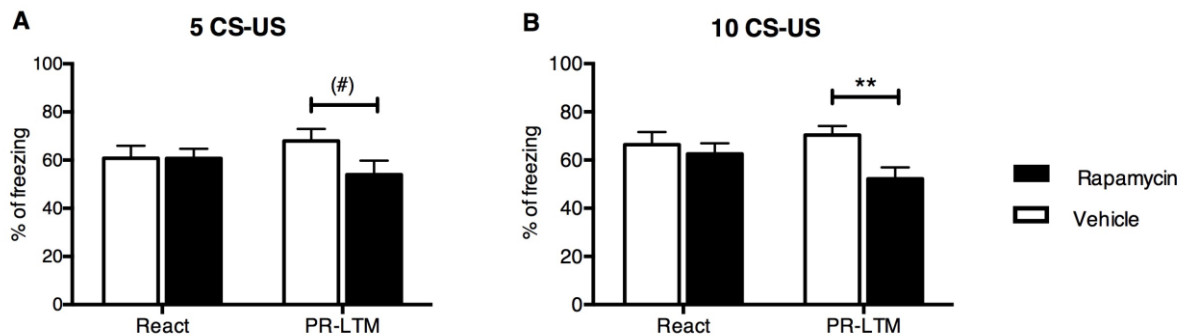


Figure 2: Rapamycin disrupts reconsolidation in juvenile pups after reactivation with a single CS alone. Each histogram shows the percentage of freezing (mean + SEM) to the CS during reactivation with a single CS alone (React) and during the post-reactivation long-term memory test (PR-LTM) in rat pups injected with vehicle (white bars) or with rapamycin (black bars) after conditioning with 5 CS-US trials (A,  $n = 12$  per group), or with 10 CS-US trials (B,  $n = 12$  per group). (#)  $p = 0.08$ , \*\* $p < 0.01$ .

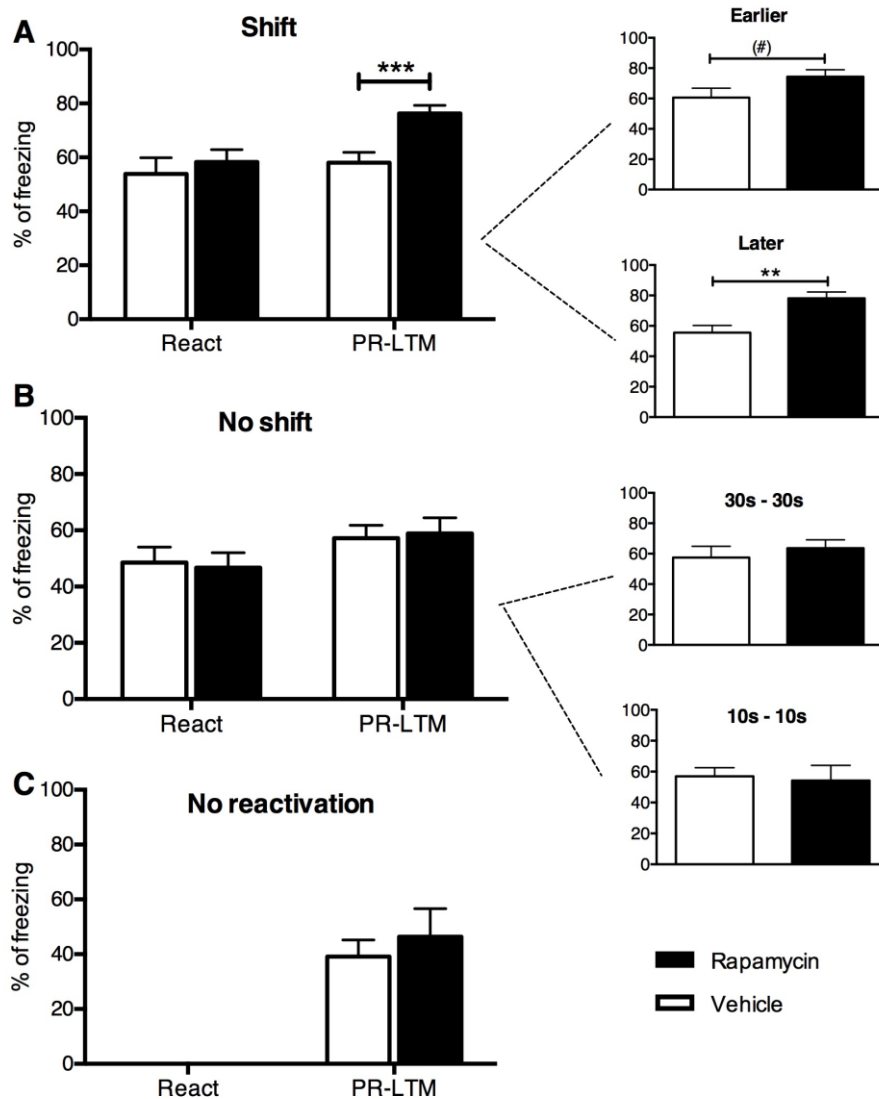


Figure 3: Juvenile rat pups can detect a change in CS-US interval. Each histogram shows the percentage of freezing (mean + SEM) to the CS during reactivation (React) and during the post-reactivation long-term memory (PR-LTM) test in rat pups injected with vehicle (white bars) or with rapamycin (black bars): (A) When the CS-US interval was modified during reactivation compared to training, whether it was for an earlier (30s to 10s, n = 12 per group) or for a later (10s to 30s, n = 12 per group) time; (B) When the CS-US interval was not changed (10s-10s, n = 12 per group; 30s-30s, n = 12 per group); (C) When the memory was not reactivated (n = 11-12 per group). (#)  $p=0.0853$ , \*\* $p<0.01$  and \*\*\* $p<0.001$ .

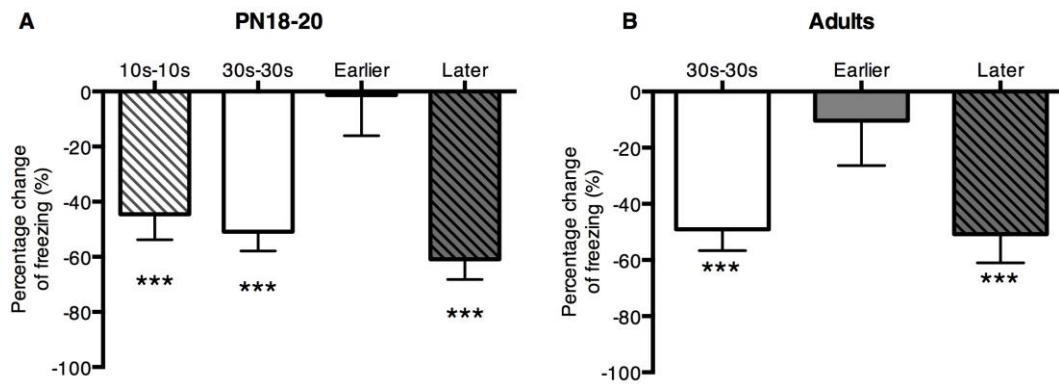


Figure 4: Reactivity to the shock during reactivation was similar between juvenile pups (n = 24 per group) (A) and adult rats (n = 11 – 16 per group) (B). Each histogram represents the mean (+ SEM) percentage change in freezing during the 10s after the shock compared to the 10s before the shock during the single CS-US trial of reactivation. The statistics represent a significant difference with 0. \*\*\*p < 0.001.

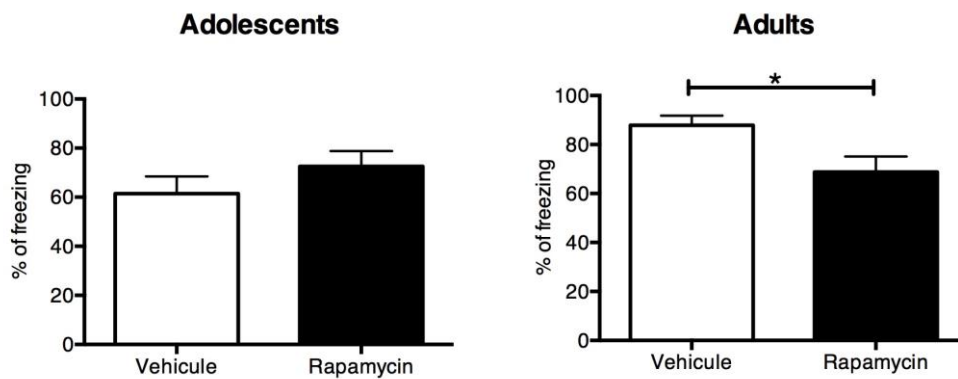


Figure 5: Comparison across development of the effect of rapamycin after a shift in the CS-US interval (Later condition). Each histogram shows the percentage of freezing (mean + SEM) to the CS during the post-reactivation long-term memory test in adolescents (PN30-40) (n = 12 per group) and adults (>PN60) (n = 6 per group) injected with vehicle (white bars) or with rapamycin (black bars). \* p < 0.05

## References

- Alfei, J.M., Ferrer Monti, R.I., Molina, V.A., Bueno, A.M., Urcelay, G.P., 2015. Prediction error and trace dominance determine the fate of fear memories after post-training manipulations. *Learn. Mem.* 22, 385–400. doi:10.1101/lm.038513.115
- Baldi, E., Bucherelli, C., 2015. Brain sites involved in fear memory reconsolidation and extinction of rodents. *Neurosci. Biobehav. Rev.* 53, 160–190. doi:10.1016/j.neubiorev.2015.04.003
- Balsam, P.D., Drew, M.R., Yang, C., 2002. Timing at the start of associative learning. *Learn. Motiv.* 33, 141–155. doi:10.1006/lmot.2001.1104
- Bernier, P.J., Bedard, A., Vinet, J., Levesque, M., Parent, A., 2002. Newly generated neurons in the amygdala and adjoining cortex of adult primates. *Proc. Natl. Acad. Sci. U. S. A.* 99, 11464–11469. doi:10.1073/pnas.172403999
- Blundell, J., Kouser, M., Powell, C.M., 2008. Systemic inhibition of mammalian target of rapamycin inhibits fear memory reconsolidation. *Neurobiol. Learn. Mem.* 90, 28–35. doi:10.1016/j.nlm.2007.12.004
- Boulanger Bertolus, J., Hegoburu, C., Ahers, J.L., Londen, E., Rousselot, J., Szyba, K., Thévenet, M., Sullivan-Wilson, T., Doyère, V., Sullivan, R.M., Mouly, A.-M., 2014. Infant rats can learn time intervals before the maturation of the striatum: evidence from odor fear conditioning. *Front. Behav. Neurosci.* 8, 1–12. doi:10.3389/fnbeh.2014.00176
- Brannon, E.M., Roussel, L.W., Meck, W.H., Woldorff, M., 2004. Timing in the baby brain. *Cogn. brain Res.* 21, 227–233. doi:10.1016/j.cogbrainres.2004.04.007
- Buhusi, C. V, Meck, W.H., 2005. What makes us tick? Functional and neural mechanisms of interval timing. *Nat. Rev. Neurosci.* 6, 755–765. doi:10.1038/nrn1764
- Casey, B.J., Tottenham, N., Liston, C., Durston, S., 2005. Imaging the developing brain: what have we learned about cognitive development? *Trends Cogn. Sci.* 9, 104–110. doi:10.1016/j.tics.2005.01.011
- Clifton, R.K., 1974. Heart rate conditioning in the newborn infant. *J. Exp. Child Psychol.* 18, 9–21. doi:10.1016/0022-0965(74)90084-8
- Davis, M., Schlesinger, L.S., Sorenson, C.A., 1989. Temporal specificity of fear conditioning: effects of different conditioned stimulus-unconditioned stimulus intervals on the fear-potentiated startle effect. *J. Exp. Psychol. Anim. Behav. Process.* 15, 295–310.
- Díaz-Mataix, L., Ruiz Martinez, R.C., Schafe, G.E., LeDoux, J.E., Doyère, V., 2013. Detection of a temporal error triggers reconsolidation of amygdala-dependent memories. *Curr. Biol.* 23, 1–6. doi:10.1016/j.cub.2013.01.053
- Díaz-Mataix, L., Tallot, L., Doyère, V., 2014. The amygdala: a potential player in timing CS-US intervals. *Behav. Processes* 101, 112–22. doi:10.1016/j.beproc.2013.08.007
- Eisenberg, M., Kobil, T., Berman, D.E., Dudai, Y., 2003. Stability of retrieved memory: inverse

- correlation with trace dominance. *Science* (80-. ). 301, 1102–1104. doi:10.1126/science.1086881
- Holland, P.C., 1980. CS-US interval as a determinant of the form of Pavlovian appetitive conditioned responses. *J. Exp. Psychol. Anim. Behav. Process.* 6, 155–174. doi:10.1037/0097-7403.6.2.155
- Hung, H.C., Hsiao, Y.H., Gean, P.W., 2015. Learning Induces Sonic Hedgehog Signaling in the Amygdala which Promotes Neurogenesis and Long-Term Memory Formation. *Int. J. Neuropsychopharmacol.* 18, 1–11. doi:10.1093/ijnp/pyu071
- Landers, M.S., Sullivan, R.M., 2012. The development and neurobiology of infant attachment and fear. *Dev. Neurosci.* 34, 101–114. doi:000336732
- Languille, S., Gruet, N., Richer, P., Hars, B., 2008. The temporal dynamics of consolidation and reconsolidation decrease during postnatal development. *Learn. Mem.* 15, 434–442. doi:10.1101/lm.933208
- Lee, J.L.C., 2009. Reconsolidation: maintaining memory relevance. *Trends Neurosci.* 32, 413–20. doi:10.1016/j.tins.2009.05.002
- Lee, J.L.C., Milton, A.L., Everitt, B.J., 2006. Reconsolidation and extinction of conditioned fear: inhibition and potentiation. *J. Neurosci.* 26, 10051–10056. doi:10.1523/JNEUROSCI.2466-06.2006
- Mac Callum, P.E., Hebert, M., Adamec, R.E., Blundell, J., 2014. Systemic inhibition of mTOR kinase via rapamycin disrupts consolidation and reconsolidation of auditory fear memory. *Neurobiol. Learn. Mem.* 112, 176–85. doi:10.1016/j.nlm.2013.08.014
- Madsen, H.B., Kim, J.H., 2015. Ontogeny of memory: An update on 40 years of work on infantile amnesia. *Behav. Brain Res.* 1–11. doi:10.1016/j.bbr.2015.07.030
- Meck, W.H., Penney, T.B., Pouthas, V., 2008. Cortico-striatal representation of time in animals and humans. *Curr. Opin. Neurobiol.* 18, 145–152. doi:10.1016/j.conb.2008.08.002
- Merlo, E., Milton, A.L., Goozée, Z.Y., Theobald, D.E., Everitt, B.J., 2014. Reconsolidation and extinction are dissociable and mutually exclusive processes: behavioral and molecular evidence. *J. Neurosci.* 34, 2422–2431. doi:10.1523/JNEUROSCI.4001-13.2014
- Moriceau, S., Sullivan, R.M., 2006. Maternal presence serves as a switch between learning fear and attraction in infancy. *Nat. Neurosci.* 9, 1004–1006. doi:10.1038/nn1733
- Moriceau, S., Wilson, D., Levine, S., Sullivan, R.M., 2006. Dual circuitry for odor-shock conditioning during infancy: corticosterone switches between fear and attraction via amygdala. *J. Neurosci.* 26, 6737–6748. doi:10.1523/JNEUROSCI.0499-06.2006
- Morris, R.G.M., Inglis, J., Ainge, J.A., Olverman, J., Tulloch, J., Dudai, Y., Kelly, P.A.T., 2006. Memory reconsolidation: sensitivity of spatial memory to inhibition of protein synthesis in dorsal hippocampus during encoding and retrieval. *Neuron* 50, 479–489. doi:10.1016/j.neuron.2006.04.012
- Nader, K., Schafe, G.E., Le Doux, J.E., 2000. Fear memories require protein synthesis in the amygdala for reconsolidation after retrieval. *Nature* 406, 722–726. doi:10.1038/35021052



- Nonneman, A.J., Corwin, J. V., 1981. Differential effects of prefrontal cortex ablation in neonatal, juvenile, and young adult rats. *J. Comp. Physiol. Psychol.* 95, 588–602.
- Pavlov, I.P., 1927. *Conditioned reflexes : An Investigation of the physiological activity of the cerebral cortex*, Dover Publications.
- Pedreira, M.E., Pérez-Cuesta, L.M., Maldonado, H., 2004. Mismatch between what is expected and what actually occurs triggers memory reconsolidation or extinction. *Learn. Mem.* 11, 579–585. doi:10.1101/lm.76904
- Rodriguez-Ortiz, C.J., De la Cruz, V., Gutiérrez, R., Bermudez-Rattoni, F., 2005. Protein synthesis underlies post-retrieval memory consolidation to a restricted degree only when updated information is obtained. *Learn. Mem.* 12, 533–537. doi:10.1101/lm.94505
- Sevenster, D., Beckers, T., Kindt, M., 2012. Retrieval per se is not sufficient to trigger reconsolidation of human fear memory. *Neurobiol. Learn. Mem.* 97, 338–45. doi:10.1016/j.nlm.2012.01.009
- Shionoya, K., Moriceau, S., Lunday, L., Miner, C., Roth, T.L., Sullivan, R.M., 2006. Development switch in neural circuitry underlying odor-malaise learning. *Learn. Mem.* 13, 801–808. doi:10.1101/lm.316006
- Stanton, M.E., Freeman, J.H., Skelton, R.W., 1992. Eyeblink conditioning in the developing rat. *Behav. Neurosci.* 106, 657–665.
- Sullivan, R.M., Landers, M., Yeaman, B., Wilson, D.A., 2000. Good memories of bad events in infancy. *Nature* 407, 38–39. doi:10.1038/35024153
- Suzuki, A., Josselyn, S.A., Frankland, P.W., Masushige, S., Silva, A.J., Kida, S., 2004. Memory reconsolidation and extinction have distinct temporal and biochemical signatures. *J. Neurosci.* 24, 4787–4795. doi:10.1523/JNEUROSCI.5491-03.2004
- Tronson, N.C., Wiseman, S.L., Olausson, P., Taylor, J.R., 2006. Bidirectional behavioral plasticity of memory reconsolidation depends on amygdalar protein kinase A. *Nat. Neurosci.* 9, 167–169. doi:10.1038/nm1628
- Van Eden, C.G., Uylings, H.B., 1985. Cytoarchitectonic development of the prefrontal cortex in the rat. *J. Comp. Neurol.* 241, 253–267. doi:10.1002/cne.902410302

## **CHAPTER 5**

### **General discussion and conclusion**



The goal of this PhD was to better characterize the role of an amygdalo-prefronto-striatal network in the processing of time and more specifically in the encoding and memorization of the CS-US interval in Pavlovian aversive conditioning. This task was chosen as it represents an implicit encoding of duration in a very simple paradigm that can be modulated easily and precisely as the parameters are independent from the behavior of the animal. We have described precise temporal behavior in a conditioned suppression task and observed neural correlates of time in an amygdalo-prefronto-striatal network in both early learning and overtrained animals. We have also shown temporal error detection capacities in pre-weaning rats with an immature amygdalo-prefronto-striatal network.

## I. CHARACTERIZATION OF THE NETWORK IN ADULTS

Wishing to determine more precisely the neural circuitry involved in processing the CS-US interval, we recorded LFPs in an amygdalo-prefronto-striatal network at different learning stages in a Pavlovian aversive conditioning. Early learning animals presented potential neural correlates of time in theta power for the PL and the dmSTR, and in beta power for the BLA and dmSTR, as well as in the theta coherence between the PL and the dmSTR. As has been discussed in the introduction, temporal learning in Pavlovian aversive conditioning happens at the first CS-US presentation, but most instrumental behaviors present precise temporal behavior only after many weeks of training. Therefore, we decided to compare these neural correlates to those of overtrained animals. We used animals trained in a conditioned suppression task, in which the decrease in lever pressing serves as a marker of temporal expectation, and characterized this behavioral response. We observed similar temporal characteristics to those present in appetitive instrumental conditioning, the typical paradigm used in timing research in animals. However, we noticed an anticipatory peak suppression response. Based on an individual trial analysis, we showed the existence of two types of suppression behavior, one controlled by the internal clock and the other influenced mostly by the onset of the CS. Furthermore, we observed a temporal shift of behavior with the insertion of a gap during the CS, meaning that conditioned suppression is sensitive to fine changes in the temporal parameters of the CS-US association.

In those overtrained animals, we observed similar changes in the beta power of the dmSTR as in early learning animals. However, we observed the apparition of a modulation in gamma power in the dmSTR and the PL, and the disappearance of the increased theta activity

present in the PL and dmSTR as well as of the beta modulation in the BLA. It should be noted, however, that those results are not definitive yet and would benefit from adding more recordings, especially for the overtrained animals, but they still give us a good idea of what's happening in these brain areas during temporal processing. There is an evolution in how our network of interest processes time across learning, maybe underlying the apparition of instrumental temporal behavior or an increased temporal precision (as we cannot determine temporal precision in our early learning animals, they could have required more training to become very precise). It seems thus possible that two different networks are involved in the learning of time *versus* the temporal expression of behavior. It seems viable that task-dependent structures are involved in a general temporal sense and allow subjects to encode the durations of the multitude of stimuli in our environment, but that planning actions and more rigorous temporal control of behavior necessitate the involvement of a larger circuit (i.e. including the cortico-striatal loop).

Concerning the two types of start behaviors described in Chapter 2, as we did not record behavior during electrophysiology sessions, it is not possible to separate the 'clock' trials from the 'non-clock' trials like we did in Chapter 2. We did observe a maximum decrease in beta power (that could represent the memorized US time) that was anticipated compared to the actual US time, similarly to the behavior. However, it would be interesting to look at individual trial LFP to see whether they follow a similar three states pattern compared to the behavior. It is possible that only certain frequency bands or specific brain area would follow such a pattern, therefore this would require a large-scale testing. It would also be interesting to look at unit activity, as it represents a binary response (i.e. either a spike or no spike) and is therefore closer to the behavioral response (i.e. pressing the lever or not) than the PSD which has a range of responses. Instead, oscillations could encode the shift from a low to a high state or the inverse (i.e. the start and stop times) and not the actual states, potentially through changes in interaction between structures. These changes might be different between "good" and "onset" trials. Since we average over all trials in our analysis it remains possible that we are losing some information that is specific to "good" trials that show actual temporal regulation of behavior.

Going back to the different internal clock models that exist, most of them are dependent on a pacemaker. However, the MTS model developed by Staddon and Higga (1999) described time has being encoded by the decay of the memory trace. This type of logarithmic-like function resembles the curve that we observed in both the PL and dmSTR in the theta range in early

learning. We did not design our experiment as a way to test for different internal clock models' validity, but our results seem to point more toward a memory decay type of model than a pacemaker one at the beginning of learning. However, we did also see signs of increased coherence between PL and dmSTR at the programmed US times, which could thus represent the comparison stage described in the SBF model (i.e. comparison between measured and memorized time). It should be noted that no experiment has demonstrated the existence of the cortical oscillators that are an essential part of the SBF model. It would be interesting to record oscillations in various cortical regions and determine if we can separate different oscillators and whether their activity influences striatal neurons firing.

## II. WHAT ABOUT INFANTS?

In spite of decades of research showing the involvement of a cortico-basal ganglia circuit in timing, lesions of these structures do not usually induce large deficits in timing tasks both in humans (e.g. Aparicio et al. 2005; van der Steen et al. 2015; Schwartz et al. 2011) and in animals (Meck and MacDonald 2007; Olton et al. 1988; Pang et al. 2001), except maybe in the case of large striatal lesions, but those kind of lesions have motor impacts that may also influence the temporal behavior (Meck 2006). As another approach to determining the role of the striatum and PFC in timing, we looked at pre-weaning rat pups which present a working but immature network (therefore a potentially more naturalistic model than lesions), as neither the PFC nor the striatum show adult-like activation and connectivity at that age. We showed that those rat pups are, however, still capable of learning and remembering time (i.e. they can detect changes in CS-US interval compared to a previously memorized duration). Pavlovian aversive conditioning is extremely dependent on the function of the amygdala in both adults and infants. It is thus possible that the amygdala is sufficient for temporal learning in this paradigm.

When taking into account those results, it seems as if the role of the prefronto-striatal network may not be as essential as previously described, or that a different network may be involved in timing in young animals (all the way to adolescence). If indeed, there is a shift between two networks, we would expect to see deficits in timing tasks when the shift between the two occurs. This may be represented in our adolescent results; indeed adolescents would present a mature striatum and a maturing PFC. However, we cannot be sure whether the absence of effect in the adolescent animals was due to a problem with timing capabilities or a problem with reconsolidation. To determine which of the two possibilities it is, we would need to look

at another parameter of temporal learning (maybe breathing patterns) or describe more precisely the reconsolidation mechanisms present at this age. To our knowledge there is no study of timing or reconsolidation in PN30-40 rats which could help us with this question. It is thus possible that the shift from one network to the other could happen in a very short developmental window.

The other possibility is that a more restricted network is used in young animals, but the network expands with age to involve the prefronto-striatal circuit. Adding these structures could permit more complex and more precise temporal behaviors as with increased training (e.g. conditioning with longer trace durations, which necessitates the prefrontal cortex, or motor inhibition for specific durations like in the DRL task), behaviors which are deficient or imprecise in young animals (Lejeune and Jasselette 1987; Moye and Rudy 1987; Barnett and Hunt 2005). The usefulness of a simplified timing network would be evident for infants as they need to adapt to their environment, even though their brain is not mature, while the temporal requirements on their behavior may not be as precise as in adults. Pups are still very dependent on the mother rhythm and they may follow her temporal behavior, therefore not necessitating more than a basic processing of durations. An imperfect timing circuit could partly explain infantile amnesia (i.e. the fact that early-life memories are more easily forgotten, for a review see Madsen & Kim, 2015), as the inability to form coherent temporal maps could decrease the stability of memories.

### **III. CONCLUSION**

The results of this thesis go in the direction of a general timing system, formed of a cortico-striatal loop, and task-specific structures. However, each brain area may be capable of a basic form of temporal processing; this would permit infants to time, and also compensation of most deficits induced by lesions in adults. It also may explain why there is no strict pathology of time in humans, as the timing system may be so essential that it is very redundant in the brain, making it difficult to characterize. Indeed, most deficits described in humans are relatively slight, even in the case of Huntington's and Parkinson's patients, who present major neurodegeneration of involved brain areas (striatum and dopaminergic transmission) (e.g. Wearden et al. 2008; Spencer and Ivry 2005; Paulsen et al. 2004; Rowe et al. 2010). Of course, it is still necessary to refine those results, as discussed in each chapter, and also to determine

the generality of what was described here; i.e. whether the role of the amygdala in timing depends on the type of task used, as well as whether other structures are involved.





# BIBLIOGRAPHY



- Abe R, Sakaguchi T, Kitajo K, Ishikawa D, Matsumoto N, Matsuki N, Ikegaya Y. 2014. Sound-induced modulation of hippocampal  $\theta$  oscillations. *Neuroreport* **25**: 1368–1374.
- Adhikari A, Topiwala MA, Gordon JA. 2010. Synchronized activity between the ventral hippocampus and the medial prefrontal cortex during anxiety. *Neuron* **65**: 257–69.
- Agostino P V, Do Nascimento M, Bussi IL, Eguía MC, Golombek DA. 2011. Circadian modulation of interval timing in mice. *Brain Res* **1370**: 154–163.
- Allman MJ, Meck WH. 2012. Pathophysiological distortions in time perception and timed performance. *Brain* **135**: 656–677.
- Allman MJ, Teki S, Griffiths TD, Meck WH. 2014. Properties of the internal clock: first- and second-order principles of subjective time. *Annu Rev Psychol* **65**: 743–71.
- Anderson JR, Bothell D, Lebiere C, Matessa M. 1998. An integrated theory of list memory. *J Mem Lang* **38**: 341–380.
- Aparicio P, Diedrichsen J, Ivry RB. 2005. Effects of focal basal ganglia lesions on timing and force control. *Brain Cogn* **58**: 62–74.
- Applegate CD, Frysinger RC, Kapp BS, Gallagher M. 1982. Multiple unit activity recorded from amygdala central nucleus during Pavlovian heart rate conditioning in rabbit. *Brain Res* **238**: 457–62.
- Arcediano F, Escobar M, Miller RR. 2003. Temporal integration and temporal backward associations in human and nonhuman subjects. *Learn Behav* **31**: 242–256.
- Armory JL, Quirk GJ, LeDoux JE. 1998. Differential effects of amygdala lesions on early and late plastic components of auditory cortex spike trains during fear conditioning. *J Neurosci* **18**: 2592–2601.
- Arruda-carvalho XM, Clem RL. 2014. Pathway-Selective Adjustment of Prefrontal-Amygdala Transmission during Fear Encoding. *J Neurosci* **34**: 15601–15609.
- Aschoff J. 1998. Human perception of short and long time intervals: its correlation with body temperature and the duration of wake time. *J Biol Rhythms* **13**: 437–442.
- Aum SW, Brown BL, Hemmes NS. 2007. The effect of intruded events on peak time: the role of reinforcement history during the intruded event. *Behav Processes* **74**: 187–197.
- Aum SW, Brown BL, Hemmes NS. 2004. The effects of concurrent task and gap events on peak time in the peak procedure. *Behav Processes* **65**: 43–56.
- Averbeck BB, Latham PE, Pouget A. 2006. Neural correlations, population coding and computation. *Nat Rev Neurosci* **7**: 358–366.
- Balci F, Gallistel CR, Allen BD, Frank KM, Gibson JM, Brunner D. 2009. Acquisition of peak responding: What is learned? *Behav Processes* **80**: 67–75.
- Balleine BW, Delgado MR, Hikosaka O. 2007. The Role of the Dorsal Striatum in Reward and Decision-Making. *J Neurosci* **27**: 8161–8165.
- Balsam P. 1984. Relative time in trace conditioning. *Ann N Y Acad Sci* **423**: 211–227.
- Balsam PD, Drew MR, Yang C. 2002. Timing at the start of associative learning. *Learn Motiv* **33**: 141–155.
- Balsam PD, Gallistel CR. 2009. Temporal maps and informativeness in associative learning. *Trends Neurosci* **32**: 73–78.
- Barnes GR, Asselman PT. 1991. The mechanism of prediction in human smooth pursuit eye movements. *J Physiol* **439**: 439–461.
- Barnet RC, Arnold HM, Miller RR. 1991. Simultaneous conditioning demonstrated in second-order

- conditioning: Evidence for similar associative structure in forward and simultaneous conditioning. *Learn Motiv* **22**: 253–268.
- Barnet RC, Hunt PS. 2005. Trace and long-delay fear conditioning in the developing rat. *Learn Behav* **33**: 437–443.
- Bartolo R, Prado L, Merchant H. 2014. Information processing in the primate basal ganglia during sensory-guided and internally driven rhythmic tapping. *J Neurosci* **34**: 3910–3923.
- Bauer EP, Paz R, Paré D. 2007. Gamma oscillations coordinate amygdalo-rhinal interactions during learning. *J Neurosci* **27**: 9369–9379.
- Bechara A, Damasio AR, Damasio H, Anderson SW. 1994. Insensitivity to future consequences following damage to human prefrontal cortex. *Cognition* **50**: 7–15.
- Beck A. 1891. The determination of localizations in the brain and spinal cord with the aid of electrical phenomena.
- Belova M a, Paton JJ, Morrison SE, Salzman CD. 2007. Expectation modulates neural responses to pleasant and aversive stimuli in primate amygdala. *Neuron* **55**: 970–84.
- Berger H. 1929. Über das Elektrenkephalogramm des Menschen. *Arch Psychiatr Nervenkr* **87**: 527–570.
- Berke JD. 2009. Fast oscillations in cortical-striatal networks switch frequency following rewarding events and stimulant drugs. *Eur J Neurosci* **30**: 848–59.
- Berlin HA, Rolls ET, Kischka U. 2004. Impulsivity, time perception, emotion and reinforcement sensitivity in patients with orbitofrontal cortex lesions. *Brain* **127**: 1108–1126.
- Bermudez MA, Göbel C, Schultz W. 2012. Sensitivity to temporal reward structure in amygdala neurons. *Curr Biol* **22**: 1839–1844.
- Bermudez MA, Schultz W. 2014. Timing in reward and decision processes. *Philos Trans R Soc London Biol Sci* **369**: 1–6.
- Berry S, Thompson R. 1978. Prediction of learning rate from the hippocampal electroencephalogram. *Science (80- )* **200**: 1298–1300.
- Besnard A, Caboche J, Laroche S. 2012. Reconsolidation of memory: a decade of debate. *Prog Neurobiol* **99**: 61–80.
- Bevins RA, Ayres JJB. 1995. One-trial context fear conditioning as a function of the interstimulus interval. *Anim Learn Behav* **23**: 400–410.
- Blozovski D, Buser P. 1988. Passive avoidance memory consolidation and reinstatement in the young rat. *Neurosci Lett* **89**: 114–119.
- Blundell J, Kouser M, Powell CM. 2008. Systemic inhibition of mammalian target of rapamycin inhibits fear memory reconsolidation. *Neurobiol Learn Mem* **90**: 28–35.
- Boll S, Gamer M, Gluth S, Finsterbusch J, Büchel C. 2012. Separate amygdala subregions signal surprise and predictiveness during associative fear learning in humans. *Eur J Neurosci* 1–10.
- Boulanger-Bertolus J, Knippenber J, Verschueren A, Le Blanc P, Brown BL, Mouly A-M, Doyère V. 2015. Temporal behavior in auditory fear conditioning: Stimulus property matters. *Int J Comp Psychol* **28**.
- Bouton ME, Westbrook RF, Corcoran K, Maren S. 2006. Contextual and temporal modulation of extinction: behavioral and biological mechanisms. *Biol Psychiatry* **60**: 352–360.
- Brannon EM, Libertus ME, Meck WH, Woldorff MG. 2008. Electrophysiological measures of time processing in infant and adult brains: Weber’s Law holds. *J Cogn Neurosci* **20**: 193–203.
- Brody CD, Hernández A, Zainos A, Romo R. 2003. Timing and Neural Encoding of Somatosensory

- Parametric Working Memory in Macaque Prefrontal Cortex. *Cereb Cortex* **13**: 1196–1207.
- Brown BL, Richer P, Doyère V. 2007. The effect of an intruded event on peak-interval timing in rats: Isolation of a postcue effect. *Behav Processes* **74**: 300–310.
- Bucci DJ, Macleod JE. 2007. Changes in neural activity associated with a surprising change in the predictive validity of a conditioned stimulus. *Eur J Neurosci* **26**: 2669–76.
- Buhusi C V, Meck WH. 2009. Relative time sharing: new findings and an extension of the resource allocation model of temporal processing. *Philos Trans R Soc Lond B Biol Sci* **364**: 1875–85.
- Buhusi C V, Meck WH. 2006. Time sharing in rats: A peak-interval procedure with gaps and distracters. *Behav Processes* **71**: 107–15.
- Buhusi C V, Meck WH. 2005. What makes us tick? Functional and neural mechanisms of interval timing. *Nat Rev Neurosci* **6**: 755–765.
- Buhusi C V, Paskalis J-PG, Cerutti DT. 2006. Time-sharing in pigeons: Independent effects of gap duration, position and discriminability from the timed signal. *Behav Processes* **71**: 116–125.
- Bussi IL, Levín G, Golombek DA, Agostino P V. 2014. Involvement of dopamine signaling in the circadian modulation of interval timing. *Eur J Neurosci* **40**: 2299–2310.
- Buzsáki G. 2002. Theta Oscillations in the Hippocampus. *Neuron* **33**: 325–340.
- Buzsáki G, Anastassiou CA, Koch C. 2012. The origin of extracellular fields and currents — EEG, ECoG, LFP and spikes. *Nat Rev Neurosci* **13**: 407–420.
- Buzsáki G, Draguhn A. 2004. Neuronal oscillations in cortical networks. *Science (80- )* **304**: 1926–1929.
- Buzsáki G, Logothetis N, Singer W. 2013. Scaling brain size, keeping timing: evolutionary preservation of brain rhythms. *Neuron* **80**: 751–64.
- Buzsáki G, Schomburg EW. 2015. What does gamma coherence tell us about inter-regional neural communication? *Nat Neurosci* **18**: 484–489.
- Cabeza de Vaca S, Brown BL, Hemmes N. 1994. Internal clock and memory processes in animal timing. *J Exp Psychol Anim Behav Process* **20**: 184–198.
- Calu DJ, Roesch MR, Haney RZ, Holland PC, Schoenbaum G. 2010. Neural correlates of variations in event processing during learning in central nucleus of amygdala. *Neuron* **68**: 991–1001.
- Catania AC. 1970. Reinforcement schedules and psychophysical judgments: A study of some temporal properties of behavior. In *The theory of reinforcement schedules*, pp. 1–42.
- Caton R. 1875. Electrical currents of the brain. *J Nerv Ment Dis* **2**: 610.
- Cheng R-K, Ali YM, Meck WH. 2007. Ketamine “unlocks” the reduced clock-speed effects of cocaine following extended training: Evidence for dopamine–glutamate interactions in timing and time perception. *Neurobiol Learn Mem* **88**: 149–159.
- Cheng RK, Jesuthasan SJ, Penney TB. 2014. Zebrafish forebrain and temporal conditioning. *Philos Trans R Soc Biol Sci* **369**: 1–8.
- Chiba A, Oshio K-I, Inase M. 2015. Neuronal representation of duration discrimination in the monkey striatum. *Physiol Rep* **3**: 1–17.
- Chiba A, Oshio K-I, Inase M. 2008. Striatal neurons encoded temporal information in duration discrimination task. *Exp Brain Res* **186**: 671–676.
- Cho J-H, Deisseroth K, Bolshakov VY. 2013a. Synaptic Encoding of Fear Extinction in mPFC-amygdala Circuits. *Neuron* **80**: 1491–1507.
- Cho YT, Ernst M, Fudge JL. 2013b. Cortico-amygdala-striatal circuits are organized as hierarchical subsystems through the primate amygdala. *J Neurosci* **33**: 14017–30.

- Christoffersen GRJ, Schachtman TR. 2016. Electrophysiological CNS-processes related to associative learning in humans. *Behav Brain Res* **296**: 211–232.
- Chubykin AA, Roach EB, Bear MF, Hussain Shuler MG. 2013. A Cholinergic Mechanism for Reward Timing within Primary Visual Cortex. *Neuron* **77**: 723–735.
- Church RM. 1984. Properties of the internal clock. *Ann NY Acad Sci* **423**: 566–582.
- Church RM. 1978. The internal clock. In *Cognitive processes in animal behavior*, pp. 277–310.
- Church RM, Broadbent HA. 1990. Alternative representations of time, number, and rate. *Cognition* **37**: 55–81.
- Church RM, Deluty MZ. 1977. Bisection of temporal intervals. *J Exp Psychol Anim Behav Process* **3**: 216–228.
- Church RM, Gibbon J. 1982. Temporal generalization. *J Exp Psychol Anim Behav Process* **8**: 165–186.
- Church RM, Meck WH, Gibbon J. 1994. Application of scalar timing theory to individual trials. *J Exp Psychol Anim Behav Process* **20**: 135–155.
- Clément A, Droit-Volet S. 2006. Counting in a time discrimination task in children and adults. *Behav Processes* **71**: 164–171.
- Cole RP, Barnet RC, Miller RR. 1995. Temporal encoding in trace conditioning. *Anim Learn Behav* **23**: 144–153.
- Collins KA, Mendelsohn A, Cain CK, Schiller D. 2014. Taking Action in the Face of Threat: Neural Synchronization Predicts Adaptive Coping. *J Neurosci* **34**: 14733–14738.
- Coull JT, Cheng R-K, Meck WH. 2011. Neuroanatomical and neurochemical substrates of timing. *Neuropsychopharmacology* **36**: 3–25.
- Coull JT, Davranche K, Nazarian B, Vidal F. 2013. Functional anatomy of timing differs for production versus prediction of time intervals. *Neuropsychologia* **51**: 309–319.
- Coull JT, Frith CD, Büchel C, Nobre AC. 2000. Orienting attention in time: behavioural and neuroanatomical distinction between exogenous and endogenous shifts. *Neuropsychologia* **38**: 808–819.
- Coull JT, Hwang HJ, Leyton M, Dagher A. 2012. Dopamine Precursor Depletion Impairs Timing in Healthy Volunteers by Attenuating Activity in Putamen and Supplementary Motor Area. *J Neurosci* **32**: 16704–16715.
- Coull JT, Nobre AC. 2008. Dissociating explicit timing from temporal expectation with fMRI. *Curr Opin Neurobiol* **18**: 137–144.
- Coull JT, Nobre AC. 1998. Where and when to pay attention: the neural systems for directing attention to spatial locations and to time intervals as revealed by both PET and fMRI. *J Neurosci* **18**: 7426–35.
- Courtin J, Bienvenu TCM, Einarsson EO, Herry C. 2013. Medial prefrontal cortex neuronal circuits in fear behavior. *Neuroscience* **240**: 219–242.
- Courtin J, Karalis N, Gonzalez-Campo C, Wurtz H, Herry C. 2014. Persistence of amygdala gamma oscillations during extinction learning predicts spontaneous fear recovery. *Neurobiol Learn Mem* **113**: 82–9.
- Craig DPA, Varnon CA, Sokolowski MBC, Wells H, Abramson CI. 2014. An assessment of fixed interval timing in free-flying honey bees (*Apis mellifera ligustica*): an analysis of individual performance. *PLoS One* **9**: 1–14.
- Creelman CD. 1962. Human Discrimination of Auditory Duration. *J Acoust Soc Am* **34**: 582.

- Crews FT, Boettiger CA. 2009. Impulsivity, Frontal Lobes and Risk for Addiction. *Pharmacol Biochem Behav* **93**: 237–247.
- Crowe DA, Zarco W, Bartolo R, Merchant H. 2014. Dynamic representation of the temporal and sequential structure of rhythmic movements in the primate medial premotor cortex. *J Neurosci* **34**: 11972–11983.
- Czeisler CA, Duffy JF, Shanahan TL, Brown EN, Mitchell JF, Rimmer DW, Ronda JM, Silva EJ, Allan JS, Emens JS, et al. 1999. Stability, precision, and near-24-hour period of the human circadian pacemaker. *Science (80- )* **284**: 2177–2181.
- Davis M, Schlesinger LS, Sorenson CA. 1989. Temporal specificity of fear conditioning: effects of different conditioned stimulus-unconditioned stimulus intervals on the fear-potentiated startle effect. *J Exp Psychol Anim Behav Process* **15**: 295–310.
- Day JJ, Wheeler RA, Roitman MF, Carelli RM. 2006. Nucleus accumbens neurons encode Pavlovian approach behaviors: Evidence from an autoshaping paradigm. *Eur J Neurosci* **23**: 1341–1351.
- Debiec J, Ledoux JE. 2004. Disruption of reconsolidation but not consolidation of auditory fear conditioning by noradrenergic blockade in the amygdala. *Neuroscience* **129**: 267–72.
- DeCoteau WE, Thorn C, Gibson DJ, Courtemanche R, Mitra P, Kubota Y, Graybiel AM. 2007. Oscillations of Local Field Potentials in the Rat Dorsal Striatum During Spontaneous and Instructed Behaviors. *J Neurophysiol* **97**: 3800–3805.
- Delamater AR, Desouza A, Rivkin Y, Derman R. 2014. Associative and temporal processes: A dual process approach. *Behav Processes* **101**: 38–48.
- Delamater AR, Westbrook RF. 2014. Psychological and Neural Mechanisms of Experimental Extinction: A Selective Review. *Neurobiol Learn Mem* **108**: 38–51.
- Dews PB. 1970. The theory of fixed-interval responding. In *The theory of reinforcement schedules*, pp. 43–61.
- Díaz-Mataix L, Ruiz Martinez RC, Schafe GE, LeDoux JE, Doyère V. 2013. Detection of a temporal error triggers reconsolidation of amygdala-dependent memories. *Curr Biol* **23**: 1–6.
- Díaz-Mataix L, Tallot L, Doyère V. 2014. The amygdala: a potential player in timing CS-US intervals. *Behav Processes* **101**: 112–22.
- Dibner C, Schibler U, Albrecht U. 2010. The mammalian circadian timing system: organization and coordination of central and peripheral clocks. *Annu Rev Physiol* **72**: 517–549.
- Dilgen J, Tejada HA, O'Donnell P. 2013. Amygdala inputs drive feedforward inhibition in the medial prefrontal cortex. *J Neurophysiol* **110**: 221–229.
- Donnelly NA, Paulsen O, Robbins TW, Dalley JW. 2015. Ramping single unit activity in the medial prefrontal cortex and ventral striatum reflects the onset of waiting but not imminent impulsive actions. *Eur J Neurosci* **41**: n/a–n/a.
- Drew MR, Zupan B, Cooke A, Couvillon PA, Balsam PD. 2005. Temporal control of conditioned responding in goldfish. *J Exp Psychol Anim Behav Process* **31**: 31–39.
- Dudai Y. 2004. The neurobiology of consolidations, or, how stable is the engram? *Annu Rev Psychol* **55**: 51–86.
- Duncan CP. 1949. The retroactive effect of electroshock on learning. *J Comp Physiol Psychol* **42**: 32–44.
- Dunsmoor JE, Bandettini P a, Knight DC. 2008. Neural correlates of unconditioned response diminution during Pavlovian conditioning. *Neuroimage* **40**: 811–7.
- Durstewitz D. 2004. Neural representation of interval time. *Neuroreport* **15**: 745–9.
- Egger MD, Miller NE. 1963. When is a reward reinforcing? An experimental study of the information



- hypothesis. *J Comp Physiol Psychol* **56**: 132–137.
- Engel AK, Fries P. 2010. Beta-band oscillations—signalling the status quo? *Curr Opin Neurobiol* **20**: 156–165.
- Estes WK, Skinner BF. 1941. Some quantitative properties of anxiety. *J Exp Psychol* **29**: 390–400.
- Evenden JL. 1999. Varieties of impulsivity. *Psychopharmacology (Berl)* **146**: 348–361.
- Farley J, Alkon DL. 1987. In vitro associative conditioning of Hermissenda: cumulative depolarization of type B photoreceptors and short-term associative behavioral changes. *J Neurophysiol* **57**: 1639–1668.
- Felix-Ortiz AC, Burgos-Robles A, Bhagat ND, Leppla CA, Tye KM. 2015. Bidirectional modulation of anxiety-related and social behaviors by amygdala projections to the medial prefrontal cortex. *Neuroscience* 1–13.
- Fell J, Axmacher N. 2011. The role of phase synchronization in memory processes. *Nat Rev Neurosci* **12**: 105–18.
- Ferreira TL, Shammah-Lagnado SJ, Bueno OFA, Moreira KM, Fornari RV, Oliveira MGM. 2008. The indirect amygdala–dorsal striatum pathway mediates conditioned freezing: Insights on emotional memory networks. *Neuroscience* **153**: 84–94.
- Fetterman JG, Killeen PR, Hall S. 1998. Watching the clock. *Behav Processes* **44**: 211–224.
- Fiorillo CD, Newsome WT, Schultz W. 2008. The temporal precision of reward prediction in dopamine neurons. *Nat Neurosci* **11**: 966–973.
- Frederick A, Bourget-Murray J, Chapman CA, Amir S, Courtemanche R. 2014. Diurnal influences on electrophysiological oscillations and coupling in the dorsal striatum and cerebellar cortex of the anesthetized rat. *Front Syst Neurosci* **8**: 1–15.
- Fries P. 2005. A mechanism for cognitive dynamics: neuronal communication through neuronal coherence. *Trends Cogn Sci* **9**: 474–80.
- Fujioka T, Trainor LJ, Large EW, Ross B. 2012. Internalized timing of isochronous sounds is represented in neuromagnetic  $\beta$  oscillations. *J Neurosci* **32**: 1791–802.
- Furlong TM, Cole S, Hamlin AS, McNally GP. 2010. The role of prefrontal cortex in predictive fear learning. *Behav Neurosci* **124**: 574–586.
- Fuster JM, Bauer RH, Jervey JP. 1982. Cellular discharge in the dorsolateral prefrontal cortex of the monkey in cognitive tasks. *Exp Neurol* **77**: 679–694.
- Gabbott PLA, Warner TA, Jays PRL, Salway P, Busby SJ. 2005. Prefrontal cortex in the rat: Projections to subcortical autonomic, motor, and limbic centers. *J Comp Neurol* **492**: 145–177.
- Gachon F, Nagoshi E, Brown SA, Ripperger J, Schibler U. 2004. The mammalian circadian timing system: from gene expression to physiology. *Chromosoma* **113**: 103–112.
- Garrison J, Erdeniz B, Done J. 2013. Prediction error in reinforcement learning: A meta-analysis of neuroimaging studies. *Neurosci Biobehav Rev* **37**: 1297–1310.
- Genovesio A, Tsujimoto S, Wise SP. 2009. Feature- and Order-Based Timing Representations in the Frontal Cortex. *Neuron* **63**: 254–266.
- Genovesio A, Tsujimoto S, Wise SP. 2006. Neuronal activity related to elapsed time in prefrontal cortex. *J Neurophysiol* **95**: 3281–3285.
- Gibbon J. 1977. Scalar expectancy theory and Weber’s law in animal timing. *Psychol Rev* **84**: 279–325.
- Gibbon J, Baldock MD, Locurto C, Gold L, Terrace HS. 1977. Trial and intertrial durations in autoshaping. *J Exp Psychol Anim Behav Process* **3**: 264–284.

- Gibbon J, Balsam PD. 1981. Spreading association in time. In *Autoshaping and conditioning theory*, pp. 219–253.
- Gibbon J, Church RM. 1990. Representation of time. *Cognition* **37**: 23–54.
- Gibbon J, Church RM. 1981. Time left: linear versus logarithmic subjective time. *J Exp Psychol Anim Behav Process* **7**: 87–107.
- Gibbon J, Church RM, Meck WH. 1984. Scalar timing in memory. *Ann N Y Acad Sci* **423**: 52–77.
- Gibbon J, Malapani C, Dale CL, Gallistel CR. 1997. Toward a neurobiology of temporal cognition: advances and challenges. *Curr Opin Neurobiol* **7**: 170–184.
- Gilmartin MR, Helmstetter FJ. 2010. Trace and contextual fear conditioning require neural activity and NMDA receptor-dependent transmission in the medial prefrontal cortex. *Learn Mem* **17**: 289–96.
- Gilmartin MR, McEchron MD. 2005. Single neurons in the dentate gyrus and CA1 of the hippocampus exhibit inverse patterns of encoding during trace fear conditioning. *Behav Neurosci* **119**: 164–79.
- Glover EM, Ressler KJ, Davis M. 2010. Differing effects of systemically administered rapamycin on consolidation and reconsolidation of context vs. cued fear memories. *Learn Mem* **17**: 577–81.
- Gramfort A, Luessi M, Larson E, Engemann D a, Strohmeier D, Brodbeck C, Goj R, Jas M, Brooks T, Parkkonen L, et al. 2013. MEG and EEG data analysis with MNE-Python. *Front Neurosci* **7**: 267.
- Griffin AL, Asaka Y, Darling RD, Berry SD. 2004. Theta-Contingent Trial Presentation Accelerates Learning Rate and Enhances Hippocampal Plasticity During Trace Eyeblink Conditioning. *Behav Neurosci* **118**: 403–411.
- Gruest N, Richer P, Hars B. 2004. Memory consolidation and reconsolidation in the rat pup require protein synthesis. *J Neurosci* **24**: 10488–10492.
- Gu BM, Cheng RK, Yin B, Meck WH. 2011. Quinpirole-induced sensitization to noisy/sparse periodic input: temporal synchronization as a component of obsessive-compulsive disorder. *Neuroscience* **179**: 143–150.
- Guitart-Masip M, Barnes GR, Horner A, Bauer M, Dolan RJ, Duzel E. 2013. Synchronization of Medial Temporal Lobe and Prefrontal Rhythms in Human Decision Making. *J Neurosci* **33**: 442–451.
- Guo Q, Wang D, He X, Feng Q, Lin R, Xu F, Fu L, Luo M. 2015. Whole-Brain Mapping of Inputs to Projection Neurons and Cholinergic Interneurons in the Dorsal Striatum. *PLoS One* **10**: e0123381.
- HaLey DDW. 2013. Infant Memory Consolidation. In *The Infant Mind: Origins of the Social Brain*.
- Hampson RE, Deadwyler SA. 2003. Temporal firing characteristics and the strategic role of subicular neurons in short-term memory. *Hippocampus* **13**: 529–541.
- Hanslmayr S, Staudigl T. 2014. How brain oscillations form memories — A processing based perspective on oscillatory subsequent memory effects. *Neuroimage* **85**: 648–655.
- Harrington DL, Boyd L a, Mayer AR, Sheltraw DM, Lee RR, Huang M, Rao SM. 2004. Neural representation of interval encoding and decision making. *Brain Res Cogn Brain Res* **21**: 193–205.
- Harrington DL, Castillo GN, Greenberg PA, Song DD, Lessig S, Lee RR, Rao SM. 2011. Neurobehavioral Mechanisms of Temporal Processing Deficits in Parkinson’s Disease. *PLoS One* **6**: e17461.
- Harrington DL, Zimbelman JL, Hinton SC, Rao SM. 2010. Neural Modulation of Temporal Encoding,

- Maintenance, and Decision Processes. *Cereb Cortex* **20**: 1274–1285.
- Hart G, Leung BK, Balleine BW. 2014. Dorsal and ventral streams: the distinct role of striatal subregions in the acquisition and performance of goal-directed actions. *Neurobiol Learn Mem* **108**: 104–18.
- Hasselmo ME, Stern CE. 2014. Theta rhythm and the encoding and retrieval of space and time. *Neuroimage* **85 Pt 2**: 656–66.
- Hattori M, Sakata S. 2014. Brain electrophysiological activity correlates with temporal processing in rats. *Behav Processes* **101**: 97–102.
- Hay N, Sonenberg N. 2004. Upstream and downstream of ran GTPase. *Genes Dev* **18**: 1926–1945.
- Headley DB, Paré D. 2013. In sync: gamma oscillations and emotional memory. *Front Behav Neurosci* **7**: 170.
- Headley DB, Weinberger NM. 2013. Fear Conditioning Enhances Gamma Oscillations and Their Entrainment of Neurons Representing the Conditioned Stimulus. *J Neurosci* **33**: 5705–5717.
- Headley DB, Weinberger NM. 2011. Gamma-band activation predicts both associative memory and cortical plasticity. *J Neurosci* **31**: 12748–12758.
- Hegoburu C, Sevelinges Y, Thevenet M, Gervais R, Parrot S, Mouly A-M. 2009. Differential dynamics of amino acid release in the amygdala and olfactory cortex during odor fear acquisition as revealed with simultaneous high temporal resolution microdialysis. *Learn Mem* **16**: 687–697.
- Heinen SJ, Liu M. 1997. Single-neuron activity in the dorsomedial frontal cortex during smooth-pursuit eye movements to predictable target motion. *Vis Neurosci* **14**: 853–865.
- Helfrich RF, Knepper H, Nolte G, Strüber D, Rach S, Herrmann CS, Schneider TR, Engel AK. 2014. Selective Modulation of Interhemispheric Functional Connectivity by HD-tACS Shapes Perception. *PLoS Biol* **12**: e1002031.
- Herry C, Bach DR, Esposito F, Di Salle F, Perrig WJ, Scheffler K, Lüthi A, Seifritz E. 2007. Processing of temporal unpredictability in human and animal amygdala. *J Neurosci* **27**: 5958–66.
- Herry C, Johansen JP. 2014. Encoding of fear learning and memory in distributed neuronal circuits. *Nat Neurosci* **17**: 1644–1654.
- Hikosaka O, Sakamoto M, Usui S. 1989. Functional properties of monkey caudate neurons. III. Activities related to expectation of target and reward. *J Neurophysiol* **61**: 814–832.
- Hinton SC, Meck WH. 2004. Frontal–striatal circuitry activated by human peak-interval timing in the supra-seconds range. *Cogn Brain Res* **21**: 171–182.
- Hoagland H. 1933. The physiological control of judgments of duration: evidence for a chemical clock. *J Gen Psychol* **9**: 267–287.
- Hoffman AN, Parga A, Paode P, Watterson LR, Nikulina EM, Hammer RP, Conrad CD. 2015. Chronic stress enhanced fear memories are associated with increased amygdala zif268 mRNA expression and are resistant to reconsolidation. *Neurobiol Learn Mem* **120**: 61–68.
- Höhn S, Dallérac G, Faure A, Urbach YK, Nguyen HP, Riess O, von Hörsten S, Le Blanc P, Desvignes N, El Massioui N, et al. 2011. Behavioral and in vivo electrophysiological evidence for presymptomatic alteration of prefrontostriatal processing in the transgenic rat model for huntington disease. *J Neurosci* **31**: 8986–8997.
- Holland PC. 1980. CS-US interval as a determinant of the form of Pavlovian appetitive conditioned responses. *J Exp Psychol Anim Behav Process* **6**: 155–174.
- Hollerman JR, Tremblay L, Schultz W. 2000. Involvement of basal ganglia and orbitofrontal cortex in goal-directed behavior. *Prog Brain Res* **126**: 193–215.
- Horst NK, Laubach M. 2012. Working with memory: Evidence for a role for the medial prefrontal

- cortex in performance monitoring during spatial delayed alternation. *J Neurophysiol* **108**: 3276–3288.
- Huerta PT, Sun LD, Wilson M a, Tonegawa S. 2000. Formation of temporal memory requires NMDA receptors within CA1 pyramidal neurons. *Neuron* **25**: 473–480.
- Hussain Shuler MG, Bear MF. 2006. Reward timing in the primary visual cortex. *Science (80-)* **311**: 1606–1609.
- Ivry RB, Spencer RMC. 2004. The neural representation of time. *Curr Opin Neurobiol* **14**: 225–32.
- Jacobs J. 2014. Hippocampal theta oscillations are slower in humans than in rodents: implications for models of spatial navigation and memory. *Philos Trans R Soc Lond B Biol Sci* **369**: 20130304.
- Janssen P, Shadlen MN. 2005. A representation of the hazard rate of elapsed time in macaque area LIP. *Nat Neurosci* **8**: 234–241.
- Jaramillo S, Zador AM. 2011. The auditory cortex mediates the perceptual effects of acoustic temporal expectation. *Nat Neurosci* **14**: 246–251.
- Jin DZ, Fujii N, Graybiel AM. 2009. Neural representation of time in cortico-basal ganglia circuits. *Proc Natl Acad Sci* **106**: 19156–19161.
- Johansen JP, Tarpley JW, LeDoux JE, Blair HT. 2010. Neural substrates for expectation-modulated fear learning in the amygdala and periaqueductal gray. *Nat Neurosci* **13**: 979–86.
- Johnson HA, Goel A, Buonomano D V. 2010. Neural dynamics of in vitro cortical networks reflects experienced temporal patterns. *Nat Neurosci* **13**: 917–919.
- Jones CG, Rosenkranz K, Rothwell J, Jahanshahi M. 2004. The right dorsolateral prefrontal cortex is essential in time reproduction: an investigation with repetitive transcranial magnetic stimulation. *Exp Brain Res* **158**: 366–372.
- Jones CRG, Jahanshahi M. 2011. Dopamine modulates striato-frontal functioning during temporal processing. **5**: 1–3.
- Jones CRG, Malone TJL, Dirnberger G, Edwards M, Jahanshahi M. 2008. Basal ganglia, dopamine and temporal processing: Performance on three timing tasks on and off medication in Parkinson's disease. *Brain Cogn* **68**: 30–41.
- Joscelyne A, Kehoe EJ. 2007. Time and stimulus specificity in extinction of the conditioned nictitating membrane response in the rabbit (*Oryctolagus cuniculus*). *Behav Neurosci* **121**: 50–62.
- Joseph JP, Barone P. 1987. Prefrontal unit activity during a delayed oculomotor task in the monkey. *Exp Brain Res* **67**: 460–468.
- Kaiser DH, Zentall TR, Neiman E. 2002. Timing in pigeons: Effects of the similarity between intertrial interval and gap in a timing signal. *J Exp Psychol Anim Behav Process* **28**: 416–422.
- Kalenscher T, Ohmann T, Windmann S, Freund N, Güntürkün O. 2006. Single forebrain neurons represent interval timing and reward amount during response scheduling. *Eur J Neurosci* **24**: 2923–2931.
- Kanai R, Paffen CLE, Hogendoorn H, Verstraten F a J. 2006. Time dilation in dynamic visual display. *J Vis* **6**: 1421–1430.
- Karmarkar UR, Buonomano D V. 2007. Timing in the Absence of Clocks: Encoding Time in Neural Network States. *Neuron* **53**: 427–438.
- Katzner S, Nauhaus I, Benucci A, Bonin V, Ringach DL, Carandini M. 2009. Local Origin of Field Potentials in Visual Cortex. *Neuron* **61**: 35–41.
- Keele SW, Pokorny RA, Corcos DM, Ivry R. 1985. Do perception and motor production share common timing mechanisms: A correlational analysis. *Acta Psychol (Amst)* **60**: 173–191.

- Keen R, Machado A. 1999. How pigeons discriminate the relative frequency of events. *J Exp Anal Behav* **72**: 151–175.
- Kehoe EJ, Joscelyne A. 2005. Temporally specific extinction of conditioned responses in the rabbit (*Oryctolagus cuniculus*) nictitating membrane preparation. *Behav Neurosci* **119**: 1011–1022.
- Khamassi M, Mulder AB, Tabuchi E, Douchamps V, Wiener SI. 2008. Anticipatory reward signals in ventral striatal neurons of behaving rats. *Eur J Neurosci* **28**: 1849–1866.
- Kilavik BE, Ponce-Alvarez A, Trachel R, Confais J, Takerkart S, Riehle A. 2012. Context-related frequency modulations of macaque motor cortical LFP beta oscillations. *Cereb Cortex* **22**: 2148–2159.
- Killeen PR, Fetterman JG. 1988. A behavioral theory of timing. *Psychol Rev* **95**: 274–295.
- Kim J, Ghim J-W, Lee JH, Jung MW. 2013. Neural correlates of interval timing in rodent prefrontal cortex. *J Neurosci* **33**: 13834–13847.
- Kindt M, Soeter M, Vervliet B. 2009. Beyond extinction: erasing human fear responses and preventing the return of fear. *Nat Neurosci* **12**: 256–258.
- Knudsen EB, Powers ME, Moxon KA. 2014. Dissociating Movement from Movement Timing in the Rat Primary Motor Cortex. *J Neurosci* **34**: 15576–15586.
- Kobayashi S, Schultz W. 2008. Influence of reward delays on responses of dopamine neurons. *J Neurosci* **28**: 7837–7846.
- Koch G, Brusa CAL, Caltagirone C, Oliveri M, Peppe A, Tiraboschi P, Stanzione P. 2004a. Subthalamic deep brain stimulation improves time perception in Parkinson's disease. *Neuroreport* **15**: 1071–1073.
- Koch G, Oliveri M, Brusa L, Stanzione P, Torriero S, Caltagirone C. 2004b. High-frequency rTMS improves time perception in Parkinson disease. *Neurology* **63**: 2405–6.
- Koch G, Oliveri M, Caltagirone C. 2009. Neural networks engaged in milliseconds and seconds time processing: evidence from transcranial magnetic stimulation and patients with cortical or subcortical dysfunction. *Philos Trans R Soc B Biol Sci* **364**: 1907–1918.
- Koch G, Oliveri M, Torriero S, Caltagirone C. 2003. Underestimation of time perception after repetitive transcranial magnetic stimulation. *Neurology* **60**: 1844–1846.
- Kojima S, Goldman-Rakic PS. 1982. Delay-related activity of prefrontal neurons in rhesus monkeys performing delayed response. *Brain Res* **248**: 43–50.
- Komura Y, Tamura R, Uwano T, Nishijo H, Kaga K, Ono T. 2001. Retrospective and prospective coding for predicted reward in the sensory thalamus. *Nature* **412**: 546–549.
- Kowalczyk T, Bocian R, Konopacki J. 2012. The generation of theta rhythm in hippocampal formation maintained in vitro. *Eur J Neurosci* **37**: 679–699.
- Kraus BJ, Robinson RJ, White JA, Eichenbaum H, Hasselmo ME. 2013. Hippocampal “Time Cells”: Time versus Path Integration. *Neuron* **78**: 1090–1101.
- LaBarbera JD, Church RM. 1974. Magnitude of fear as a function of expected time to all aversive event. *Anim Learn Behav* **2**: 199–202.
- Lake JI, Meck WH. 2013. Differential effects of amphetamine and haloperidol on temporal reproduction: dopaminergic regulation of attention and clock speed. *Neuropsychologia* **51**: 284–92.
- Languille S, Davis S, Richer P, Alcacer C, Laroche S, Hars B. 2009. Extracellular signal-regulated kinase activation is required for consolidation and reconsolidation of memory at an early stage of ontogenesis. *Eur J Neurosci* **30**: 1923–30.
- Languille S, Gruet N, Richer P, Hars B. 2008. The temporal dynamics of consolidation and

- reconsolidation decrease during postnatal development. *Learn Mem* **15**: 434–442.
- Lasley DJ, Cohn T. 1981. Detection of a luminance increment: effect of temporal uncertainty. *J Opt Soc Am* **71**: 845.
- Le Van Quyen M, Foucher J, Lachaux J, Rodriguez E, Lutz A, Martinerie J, Varela FJ. 2001. Comparison of Hilbert transform and wavelet methods for the analysis of neuronal synchrony. *J Neurosci Methods* **111**: 83–98.
- Lebedev MA, O’Doherty JE, Nicolelis MAL. 2008. Decoding of temporal intervals from cortical ensemble activity. *J Neurophysiol* **99**: 166–186.
- LeDoux JE. 2014. Coming to terms with fear. *Proc Natl Acad Sci* **111**: 2871–2878.
- LeDoux JE, Keane T, Shiromani P. 2009. *Post-Traumatic Stress Disorder*. Humana Press, Totowa, NJ.
- Lejeune H, Cornet S, Ferreira MA, Wearden JH. 1998. How do Mongolian gerbils (*Meriones unguiculatus*) pass the time? Adjunctive behavior during temporal differentiation in gerbils. *J Exp Psychol Anim Behav Process* **24**: 352–368.
- Lejeune H, Jasselette P. 1987. DRL performance in the weanling rat: a comparison with adult subjects. *Physiol Behav* **40**: 271–278.
- Lejeune H, Wearden JH. 2006. Scalar properties in animal timing : Conformity and violations. *Q J Exp Psychol* **59**: 1875 –1908.
- Lejeune H, Wearden JH. 1991. The comparative psychology of fixed-interval responding: Some quantitative analyses. *Learn Motiv* **22**: 84–111.
- Lejeune H, Wearden JH. 2009. Vierordt’s The Experimental Study of the Time Sense (1868) and its legacy. *Eur J Cogn Psychol* **21**: 941–960.
- Leon MI, Shadlen MN. 2003. Representation of time by neurons in the posterior parietal cortex of the macaque. *Neuron* **38**: 317–27.
- Lesting J, Daldrup T, Narayanan V, Himpe C, Seidenbecher T, Pape H-C. 2013. Directional theta coherence in prefrontal cortical to amygdalo-hippocampal pathways signals fear extinction. *PLoS One* **8**: e77707.
- Lesting J, Narayanan RT, Kluge C, Sangha S, Seidenbecher T, Pape H-C. 2011. Patterns of coupled theta activity in amygdala-hippocampal-prefrontal cortical circuits during fear extinction. *PLoS One* **6**: e21714.
- Lewis P a, Miall RC. 2006. Remembering the time: a continuous clock. *Trends Cogn Sci* **10**: 401–6.
- Lewis PA, Miall RC. 2009. The precision of temporal judgement: milliseconds, many minutes, and beyond. *Philos Trans R Soc Lond B Biol Sci* **364**: 1897–1905.
- Li SSY, McNally GP. 2014. The conditions that promote fear learning: Prediction error and Pavlovian fear conditioning. *Neurobiol Learn Mem* **108**: 14–21.
- Lipponen A, Woldemichael BT, Gurevicius K, Tanila H. 2012. Artificial Theta Stimulation Impairs Encoding of Contextual Fear Memory. *PLoS One* **7**: e48506.
- Liu C-H, Coleman JE, Davoudi H, Zhang K, Hussain Shuler MG. 2015. Selective Activation of a Putative Reinforcement Signal Conditions Cued Interval Timing in Primary Visual Cortex. *Curr Biol* **25**: 1551–1561.
- Lodygensky GA, Vasung L, Sizonenko S V, Hüppi PS. 2010. Neuroimaging of cortical development and brain connectivity in human newborns and animal models. *J Anat* **217**: 418–428.
- Lucchetti C, Bon L. 2001. Time-modulated neuronal activity in the premotor cortex of macaque monkeys. *Exp Brain Res* **141**: 254–260.

- Lucchetti C, Ulrici A, Bon L. 2005. Dorsal premotor areas of nonhuman primate: functional flexibility in time domain. *Eur J Appl Physiol* **95**: 121–130.
- Mac Callum PE, Hebert M, Adamec RE, Blundell J. 2014. Systemic inhibition of mTOR kinase via rapamycin disrupts consolidation and reconsolidation of auditory fear memory. *Neurobiol Learn Mem* **112**: 176–85.
- MacDonald CJ, Carrow S, Place R, Eichenbaum H. 2013. Distinct hippocampal time cell sequences represent odor memories in immobilized rats. *J Neurosci* **33**: 14607–14616.
- MacDonald CJ, Cheng R-K, Meck WH. 2012. Acquisition of “Start” and “Stop” response thresholds in peak-interval timing is differentially sensitive to protein synthesis inhibition in the dorsal and ventral striatum. *Front Integr Neurosci* **6**: 1–16.
- MacDonald CJ, Lepage KQ, Eden UT, Eichenbaum H. 2011. Hippocampal “time cells” bridge the gap in memory for discontinuous events. *Neuron* **71**: 737–749.
- MacDonald CJ, Meck WH. 2005. Differential effects of clozapine and haloperidol on interval timing in the supraseconds range. *Psychopharmacology (Berl)* **182**: 232–244.
- Machado A. 1997. Learning the temporal dynamics of behavior. *Psychol Rev* **104**: 241–265.
- Machado A, Malheiro MT, Erhagen W. 2009. Learning to Time: A Perspective. *J Exp Anal Behav* **92**: 423–458.
- Madsen HB, Kim JH. 2015. Ontogeny of memory: An update on 40 years of work on infantile amnesia. *Behav Brain Res* 1–11.
- Marek R, Strobel C, Bredy TW, Sah P. 2013. The amygdala and medial prefrontal cortex: partners in the fear circuit. *J Physiol*.
- Maren S. 2000. Auditory fear conditioning increases CS-elicited spike firing in lateral amygdala neurons even after extensive overtraining. *Eur J Neurosci* **12**: 4047–4054.
- Maricq A V, Church RM. 1983. The differential effects of haloperidol and methamphetamine on time estimation in the rat. *Psychopharmacology (Berl)* **79**: 10–15.
- Maris E, Oostenveld R. 2007. Nonparametric statistical testing of EEG- and MEG-data. *J Neurosci Methods* **164**: 177–190.
- Martin C, Ravel N. 2014. Beta and gamma oscillatory activities associated with olfactory memory tasks: different rhythms for different functional networks? *Front Behav Neurosci* **8**: 218.
- Matell MS, Bateson M, Meck WH. 2006. Single-trials analyses demonstrate that increases in clock speed contribute to the methamphetamine-induced horizontal shifts in peak-interval timing functions. *Psychopharmacology (Berl)* **188**: 201–212.
- Matell MS, Meck WH. 2004. Cortico-striatal circuits and interval timing: coincidence detection of oscillatory processes. *Brain Res Cogn Brain Res* **21**: 139–70.
- Matell MS, Meck WH. 2000. Neuropsychological mechanisms of interval timing behavior. *BioEssays* **22**: 94–103.
- Matell MS, Meck WH, Nicolelis MAL. 2003. Interval timing and the encoding of signal duration by ensembles of cortical and striatal neurons. *Behav Neurosci* **117**: 760–773.
- Matell MS, Shea-Brown E, Gooch C, Wilson AG, Rinzel J. 2011. A heterogeneous population code for elapsed time in rat medial agranular cortex. *Behav Neurosci* **125**: 54–73.
- Matthews AR, He OH, Buhusi M, Buhusi C V. 2012. Dissociation of the role of the prelimbic cortex in interval timing and resource allocation: beneficial effect of norepinephrine and dopamine reuptake inhibitor nomifensine on anxiety-inducing distraction. *Front Integr Neurosci* **6**: 1–12.
- Matzel LD, Held FP, Miller RR. 1988. Information and expression of simultaneous and backward associations: Implications for contiguity theory. *Learn Motiv* **19**: 317–344.

- McDonald AJ. 1998. Cortical pathways to the mammalian amygdala. *Prog Neurobiol* **55**: 257–332.
- McDonald AJ. 1991a. Organization of amygdaloid projections to the prefrontal cortex and associated striatum in the rat. *Neuroscience* **44**: 1–14.
- McDonald AJ. 1991b. Topographical organization of amygdaloid projections to the caudatoputamen, nucleus accumbens, and related striatal-like areas of the rat brain. *Neuroscience* **44**: 15–33.
- McDonald AJ, Mascagni F, Guo L. 1996. Projections of the medial and lateral prefrontal cortices to the amygdala: A Phaseolus vulgaris leucoagglutinin study in the rat. *Neuroscience* **71**: 55–75.
- McEchron MD, Tseng W, Disterhoft JF. 2003. Single neurons in CA1 hippocampus encode trace interval duration during trace heart rate (fear) conditioning in rabbit. *J Neurosci* **23**: 1535–1547.
- McGeer PL, McGeer EG, Scherer U, Singh K. 1977. A glutamatergic corticostriatal path? *Brain Res* **128**: 369–373.
- McNally GP, Johansen JP, Blair HT. 2011. Placing prediction into the fear circuit. *Trends Neurosci* **34**: 283–92.
- Meck WH. 2006. Neuroanatomical localization of an internal clock: a functional link between mesolimbic, nigrostriatal, and mesocortical dopaminergic systems. *Brain Res* **1109**: 93–107.
- Meck WH. 1996. Neuropharmacology of timing and time perception. *Cogn Brain Res* **3**: 227–242.
- Meck WH, Benson AM. 2002. Dissecting the Brain's Internal Clock: How Frontal–Striatal Circuitry Keeps Time and Shifts Attention. *Brain Cogn* **48**: 195–211.
- Meck WH, Church RM. 1987. Nucleus Basalis Magnocellularis and Medial Septal Area Lesions Differentially Impair Temporal Memory. *J Neurosci* **7**: 3505–3511.
- Meck WH, Church RM. 1984. Simultaneous temporal processing. *J Exp Psychol Anim Behav Process* **10**: 1–29.
- Meck WH, MacDonald CJ. 2007. Amygdala inactivation reverses fear's ability to impair divided attention and make time stand still. *Behav Neurosci* **121**: 707–720.
- Meck WH, Penney TB, Pouthas V. 2008. Cortico-striatal representation of time in animals and humans. *Curr Opin Neurobiol* **18**: 145–152.
- Mello GBM, Soares S, Paton JJ. 2015. A Scalable Population Code for Time in the Striatum. *Curbio* **25**: 1113–1122.
- Merchant H, Bartolo R, Pérez O, Méndez JC, Mendoza G, Gámez J, Yc K, Prado L. 2014. Neurophysiology of timing in the hundreds of milliseconds: multiple layers of neuronal clocks in the medial premotor areas. *Adv Exp Med Biol* **829**: 143–54.
- Merchant H, Harrington DL, Meck WH. 2013a. Neural basis of the perception and estimation of time. *Annu Rev Neurosci* **36**: 313–36.
- Merchant H, Pérez O, Zarco W, Gámez J. 2013b. Interval tuning in the primate medial premotor cortex as a general timing mechanism. *J Neurosci* **33**: 9082–9096.
- Merchant H, Zarco W, Bartolo R, Prado L. 2008. The Context of Temporal Processing Is Represented in the Multidimensional Relationships between Timing Tasks. *PLoS One* **3**: e3169.
- Merchant H, Zarco W, Perez O, Prado L, Bartolo R. 2011. Measuring time with different neural chronometers during a synchronization-continuation task. *Proc Natl Acad Sci* **108**: 19784–19789.
- Merlo E, Milton AL, Goozée ZY, Theobald DE, Everitt BJ. 2014. Reconsolidation and extinction are dissociable and mutually exclusive processes: behavioral and molecular evidence. *J Neurosci* **34**: 2422–2431.
- Metereau E, Dreher J-C. 2012. Cerebral Correlates of Salient Prediction Error for Different Rewards and Punishments. *Cereb Cortex* **477–487**.



- Miall C. 1989. The Storage of Time Intervals Using Oscillating Neurons. *Neural Comput* **1**: 359–371.
- Michel GF, Moore CL. 1995. *Developmental psychobiology: An interdisciplinary science*. MIT press.
- Miller RR, Barnet RC. 1993. The role of time in elementary associations. *Curr Dir Psychol Sci* **2**: 106–111.
- Miltner WHR, Braun C, Arnold M, Witte H, Taub E. 1999. Coherence of gamma-band EEG activity as a basis for associative learning. ... **397**.
- Mita A, Mushiake H, Shima K, Matsuzaka Y, Tanji J. 2009. Interval time coding by neurons in the presupplementary and supplementary motor areas. *Nat Neurosci* **12**: 502–507.
- Miyazaki K, Miyazaki KW, Doya K. 2011. Activation of Dorsal Raphe Serotonin Neurons Underlies Waiting for Delayed Rewards. *J Neurosci* **31**: 469–479.
- Molet M, Miguez G, Cham HX, Miller RR. 2012. When does integration of independently acquired temporal relationships take place? *J Exp Psychol Anim Behav Process* **38**: 369–380.
- Molet M, Miller RR. 2014. Timing: An attribute of associative learning. *Behav Processes* **101**: 4–14.
- Morofushi M, Shinohara K, Kimura F. 2001. Menstrual and circadian variations in time perception in healthy women and women with premenstrual syndrome. *Neurosci Res* **41**: 339–344.
- Morris RGM, Inglis J, Ainge JA, Olverman J, Tulloch J, Dudai Y, Kelly PAT. 2006. Memory reconsolidation: sensitivity of spatial memory to inhibition of protein synthesis in dorsal hippocampus during encoding and retrieval. *Neuron* **50**: 479–489.
- Moses SN, Houck JM, Martin T, Hanlon FM, Ryan JD, Thoma RJ, Weisend MP, Jackson EM, Pekkonen E, Tesche CD. 2007. Dynamic neural activity recorded from human amygdala during fear conditioning using magnetoencephalography. *Brain Res Bull* **71**: 452–60.
- Moye TB, Rudy JW. 1987. Ontogenesis of trace conditioning in young rats: dissociation of associative and memory processes. *Dev Psychobiol* **20**: 405–414.
- Nader K, Schafe GE, Le Doux JE. 2000. Fear memories require protein synthesis in the amygdala for reconsolidation after retrieval. *Nature* **406**: 722–726.
- Nakajima T, Uchiyama M, Enomoto T, Shibui K, Ishibashi K, Kanno O, Okawa M. 1998. Human time production under constant routine. *Psychiatry Clin Neurosci* **52**: 240–241.
- Nakazono T, Sano T, Takahashi S, Sakurai Y. 2015. Theta oscillation and neuronal activity in rat hippocampus are involved in temporal discrimination of time in seconds. *Front Syst Neurosci* **9**.
- Namboodiri VMK, Huertas MA, Monk KJ, Shouval HZ, Shuler MGH. 2015. Visually Cued Action Timing in the Primary Visual Cortex. *Neuron* **86**: 319–330.
- Narayanan NS, Land BB, Solder JE, Deisseroth K, Dileone RJ. 2012. Prefrontal D1 dopamine signaling is required for temporal control. *Proc Natl Acad Sci U S A* **109**: 20726–20731.
- Narayanan NS, Laubach M. 2009. Delay activity in rodent frontal cortex during a simple reaction time task. *J Neurophysiol* **101**: 2859–2871.
- Niemi P, Naatanen R. 1981. Foreperiod and simple reaction time. *Psychol Bull* **89**: 133–162.
- Niki H, Watanabe M. 1979. Prefrontal and cingulate unit activity during timing behavior in the monkey. *Brain Res* **171**: 213–224.
- O’Keefe J, Dostrovsky J. 1971. The hippocampus as a spatial map. Preliminary evidence from unit activity in the freely-moving rat. *Brain Res* **34**: 171–175.
- Ohmae S, Lu X, Takahashi T, Uchida Y, Kitazawa S. 2008. Neuronal activity related to anticipated and elapsed time in macaque supplementary eye field. *Exp Brain Res* **184**: 593–598.
- Ohyama T, Mauk M. 2001. Latent acquisition of timed responses in cerebellar cortex. *J Neurosci* **21**: 682–90.

- Olton DS, Meck WH, Church RM. 1987. Separation of hippocampal and amygdaloid involvement in temporal memory dysfunctions. *Brain Res* **404**: 180–8.
- Olton DS, Wenk GL, Church RM, Meck WH. 1988. Attention and the frontal cortex as examined by simultaneous temporal processing. *Neuropsychologia* **26**: 307–318.
- Onoda K, Sakata S. 2006. An ERP study of temporal discrimination in rats. *Behav Processes* **71**: 235–240.
- Onoda K, Takahashi E, Sakata S. 2003. Event-related potentials in the frontal cortex, hippocampus, and cerebellum during a temporal discrimination task in rats. *Cogn Brain Res* **17**: 380–387.
- Onoe H, Komori M, Onoe K, Takechi H, Tsukada H, Watanabe Y. 2001. Cortical networks recruited for time perception: a monkey positron emission tomography (PET) study. *Neuroimage* **13**: 37–45.
- Orduña V, García A, Menez M, Hong E, Bouzas A. 2008. Performance of spontaneously hypertensive rats in a peak-interval procedure with gaps. *Behav Brain Res* **191**: 72–76.
- Oshio K-I, Chiba A, Inase M. 2006. Delay period activity of monkey prefrontal neurones during duration-discrimination task. *Eur J Neurosci* **23**: 2779–2790.
- Oshio K-I, Chiba A, Inase M. 2008. Temporal filtering by prefrontal neurons in duration discrimination. *Eur J Neurosci* **28**: 2333–2343.
- Pang KC., Yoder R., Olton D. 2001. Neurons in the lateral agranular frontal cortex have divided attention correlates in a simultaneous temporal processing task. *Neuroscience* **103**: 615–628.
- Pape H-C, Narayanan RT, Smid J, Stork O, Seidenbecher T. 2005. Theta activity in neurons and networks of the amygdala related to long-term fear memory. *Hippocampus* **15**: 874–880.
- Paré D, Collins DR. 2000. Neuronal correlates of fear in the lateral amygdala: multiple extracellular recordings in conscious cats. *J Neurosci* **20**: 2701–2710.
- Paré D, Collins DR, Pelletier JG. 2002. Amygdala oscillations and the consolidation of emotional memories. *Trends Cogn Sci* **6**: 306–314.
- Parker KL, Chen K-H, Kingyon JR, Cavanagh JF, Narayanan NS. 2014. D 1 -Dependent 4 Hz Oscillations and Ramping Activity in Rodent Medial Frontal Cortex during Interval Timing. *J Neurosci* **34**: 16774–16783.
- Parsons RG, Gafford GM, Baruch DE, Riedner BA, Helmstetter FJ. 2006. Long-term stability of fear memory depends on the synthesis of protein but not mRNA in the amygdala. *Eur J Neurosci* **23**: 1853–1859.
- Partch CL, Green CB, Takahashi JS. 2014. Molecular Architecture of the Mammalian Circadian Clock. *Trends Cell Biol* **24**: 90–99.
- Pastalkova E, Itskov V, Amarasingham A, Buzsáki G. 2008. Internally generated cell assembly sequences in the rat hippocampus. *Science (80- )* **321**: 1322–1327.
- Paulsen JS, Zimelman JL, Hinton SC, Langbehn DR, Leveroni CL, Benjamin ML, Reynolds NC, Rao SM. 2004. fMRI biomarker of early neuronal dysfunction in presymptomatic Huntington's disease. *Am J Neuroradiol* **25**: 1715–1721.
- Pavlov IP. 1927. *Conditioned reflexes : An Investigation of the physiological activity of the cerebral cortex*.
- Paz R, Pelletier JG, Bauer EP, Paré D. 2006. Emotional enhancement of memory via amygdala-driven facilitation of rhinal interactions. *Nat Neurosci* **9**: 1321–1329.
- Pendyam S, Bravo-Rivera C, Burgos-Robles A, Sotres-Bayon F, Quirk GJ, Nair SS. 2013. Fear signaling in the prelimbic-amygdala circuit: a computational modeling and recording study. *J Neurophysiol* **110**: 844–861.

- Phillips RG, LeDoux JE. 1995. Lesions of the fornix but not the entorhinal or perirhinal cortex interfere with contextual fear conditioning. *J Neurosci* **15**: 5308–15.
- Plankar M, Brežan S, Jerman I. 2012. The principle of coherence in multi-level brain information processing. *Prog Biophys Mol Biol*.
- Pleil KE, Cordes S, Meck WH, Williams CL. 2011. Rapid and Acute Effects of Estrogen on Time Perception in Male and Female Rats. *Front Integr Neurosci* **5**: 1–15.
- Popa D, Duvarci S, Popescu AT, Léna C, Paré D. 2010. Coherent amygdalocortical theta promotes fear memory consolidation during paradoxical sleep. *Proc Natl Acad Sci U S A* **107**: 6516–9.
- Popescu AT, Popa D, Paré D. 2009. Coherent gamma oscillations couple the amygdala and striatum during learning. *Nat Neurosci* **12**: 801–807.
- Portugal GS, Wilson AG, Matell MS. 2011. Behavioral sensitivity of temporally modulated striatal neurons. *Front Integr Neurosci* **5**.
- Prieto G a., Parker RL, Vernon III FL. 2009. A Fortran 90 library for multitaper spectrum analysis. *Comput Geosci* **35**: 1701–1710.
- Przybylski J, Sara SJ. 1997. Reconsolidation of memory after its reactivation. *Behav Brain Res* **84**: 241–246.
- Quirk GJ, Armony JL, LeDoux JE. 1997. Fear conditioning enhances different temporal components of tone-evoked spike trains in auditory cortex and lateral amygdala. *Neuron* **19**: 613–624.
- Quirk GJ, Likhtik E, Pelletier JG, Paré D. 2003. Stimulation of medial prefrontal cortex decreases the responsiveness of central amygdala output neurons. *J Neurosci* **23**: 8800–7.
- Rainer G, Rao SC, Miller EK. 1999. Prospective coding for objects in primate prefrontal cortex. *J Neurosci* **19**: 5493–5505.
- Rakitin BC, Gibbon J, Penney TB, Malapani C, Hinton SC, Meck WH. 1998. Scalar expectancy theory and peak-interval timing in humans. *J Exp Psychol Anim Behav Process* **24**: 15–33.
- Rattat A-C, Droit-Volet S. 2012. What is the best and easiest method of preventing counting in different temporal tasks? *Behav Res Methods* **44**: 67–80.
- Raught B, Gingras AC, Sonenberg N. 2001. The target of rapamycin (TOR) proteins. *Proc Natl Acad Sci U S A* **98**: 7037–7044.
- Rawlins JNP, Feldon J, Gray J a. 1979. Septo-hippocampal connections and the hippocampal theta rhythm. *Exp Brain Res* **37**: 49–63.
- Reid AK, Bacha G, Morán C. 1993. The Temporal Organization of Behavior on Periodic Food Schedules. *J Exp Anal Behav* **59**: 1–27.
- Renoult L, Roux S, Riehle A. 2006. Time is a rubberband: neuronal activity in monkey motor cortex in relation to time estimation. *Eur J Neurosci* **23**: 3098–3108.
- Rescorla R a. 1968. Probability of shock in the presence and absence of CS in fear conditioning. *J Comp Physiol Psychol* **66**: 1–5.
- Riehle a, Grün S, Diesmann M, Aertsen a. 1997. Spike synchronization and rate modulation differentially involved in motor cortical function. *Science* **278**: 1950–1953.
- Roberts S. 1981. Isolation of an internal clock. *J Exp Psychol Anim Behav Process*.
- Roberts S, Church RM. 1978. Control of an internal clock. *J Exp Psychol Anim Behav Process* **4**: 318–337.
- Roberts WA, Cheng K, Cohen JS. 1989. Timing light and tone signals in pigeons. *J Exp Psychol Anim Behav Process* **15**: 23–35.
- Rodriguez P, Holowka DW, Marx BP. 2012. Assessment of posttraumatic stress disorder-related

- functional impairment: a review. *J Rehabil Res Dev* **49**: 649–65.
- Roesch MR, Calu DJ, Esber GR, Schoenbaum G. 2010. Neural correlates of variations in event processing during learning in basolateral amygdala. *J Neurosci* **30**: 2464–71.
- Roesch MR, Olson CR. 2005. Neuronal activity in primate orbitofrontal cortex reflects the value of time. *J Neurophysiol* **94**: 2457–2471.
- Rolke B, Hofmann P. 2007. Temporal uncertainty degrades perceptual processing. *Psychon Bull Rev* **14**: 522–526.
- Rorick-Kehn LM, Steinmetz JE. 2005. Amygdalar unit activity during three learning tasks: eyeblink classical conditioning, Pavlovian fear conditioning, and signaled avoidance conditioning. *Behav Neurosci* **119**: 1254–76.
- Roux S, Coulmance M, Riehle A. 2003. Context-related representation of timing processes in monkey motor cortex. *Eur J Neurosci* **18**: 1011–1016.
- Rowe KC, Paulsen JS, Langbehn DR, Duff K, Leigh J, Wang C, Rourke JJFO, Stout JC, Moser DJ, Group P-HI of the HS. 2010. Self-Paced Timing Detects and Tracks Change in Prodromal Huntington Disease. *Neuropsychology* **24**: 435–442.
- Rubia K, Halari R, Christakou A, Taylor E. 2009. Impulsiveness as a timing disturbance: neurocognitive abnormalities in attention-deficit hyperactivity disorder during temporal processes and normalization with methylphenidate. *Philos Trans R Soc Lond B Biol Sci* **364**: 1919–1931.
- Sakai M. 1974. Prefrontal unit activity during visually guided lever pressing in the monkey. *Brain Res* **81**: 297–309.
- Sakon JJ, Naya Y, Wirth S, Suzuki WA. 2014. Context-dependent incremental timing cells in the primate hippocampus. *Proc Natl Acad Sci* **111**: 18351–18356.
- Sakurai Y. 2002. Coding of auditory temporal and pitch information by hippocampal individual cells and cell assemblies in the rat. *Neuroscience* **115**: 1153–1163.
- Sakurai Y, Takahashi S, Inoue M. 2004. Stimulus duration in working memory is represented by neuronal activity in the monkey prefrontal cortex. *Eur J Neurosci* **20**: 1069–1080.
- Sánchez-Campusano R, Gruart A, Delgado-García JM. 2011. Timing and causality in the generation of learned eyelid responses. *Front Integr Neurosci* **5**: 39.
- Savastano HI, Miller RR. 1998. Time as content in Pavlovian conditioning. *Behav Processes* **44**: 147–162.
- Schafe GE, LeDoux JE. 2000. Memory consolidation of auditory pavlovian fear conditioning requires protein synthesis and protein kinase A in the amygdala. *J Neurosci* **20**: RC96.
- Schafe GE, Nadel N V, Sullivan GM, Harris A, LeDoux JE. 1999. Memory Consolidation for Contextual and Auditory Fear Conditioning Is Dependent on Protein Synthesis, PKA, and MAP Kinase. *Learn Mem* **6**: 97–110.
- Schneider BA. 1969. A two-state analysis of fixed-interval responding in the pigeon. *J Exp Anal Behav* **12**: 677–687.
- Schultz W. 1998. Predictive reward signal of dopamine neurons. *J Neurophysiol* **80**: 1–27.
- Schultz W. 2013. Updating dopamine reward signals. *Curr Opin Neurobiol* **23**: 229–238.
- Schultz W, Apicella P, Scarnati E, Ljungberg T. 1992. Neuronal activity in monkey ventral striatum related to the expectation of reward. *J Neurosci* **12**: 4595–4610.
- Schwabe L, Nader K, Pruessner JC. 2014. Reconsolidation of human memory: Brain mechanisms and clinical relevance. *Biol Psychiatry* **76**: 274–280.

- Schwartz M, Keller PE, Patel AD, Kotz SA. 2011. The impact of basal ganglia lesions on sensorimotor synchronization, spontaneous motor tempo, and the detection of tempo changes. *Behav Brain Res* **216**: 685–691.
- Schwartz M, Rothermich K, Kotz SA. 2012. Functional dissociation of pre-SMA and SMA-proper in temporal processing. *Neuroimage* **60**: 290–298.
- Seidenbecher T, Laxmi TR, Stork O, Pape H-C. 2003. Amygdalar and hippocampal theta rhythm synchronization during fear memory retrieval. *Science (80- )* **301**: 846–50.
- Seymour B, O’Doherty JP, Koltzenburg M, Wiech K, Frackowiak R, Friston K, Dolan R. 2005. Opponent appetitive-aversive neural processes underlie predictive learning of pain relief. *Nat Neurosci* **8**: 1234–40.
- Shidara M, Aigner TG, Richmond BJ. 1998. Neuronal signals in the monkey ventral striatum related to progress through a predictable series of trials. *J Neurosci* **18**: 2613–2625.
- Shionoya K, Hegoburu C, Brown BL, Sullivan RM, Doyère V, Mouly A-M. 2013. It’s time to fear! Interval timing in odor fear conditioning in rats. *Front Behav Neurosci* **7**: 1–17.
- Shionoya K, Moriceau S, Lunday L, Miner C, Roth TL, Sullivan RM. 2006. Development switch in neural circuitry underlying odor-malaise learning. *Learn Mem* **13**: 801–808.
- Shurtleff D, Raslear TG, Simmons L. 1990. Circadian variations in time perception in rats. *Physiol Behav* **47**: 931–939.
- Skinner BF. 1938. *The behavior of organisms: an experimental analysis*.
- Soltysik S, Hull C, Buchwald N, Fekete T. 1975. Single unit activity in basal ganglia of monkeys during performance of a delayed response task. *Electroencephalogr ....*
- Sotres-Bayon F, Quirk GJ. 2010. Prefrontal control of fear: more than just extinction. *Curr Opin Neurobiol* **20**: 231–5.
- Spencer RMC, Ivry RB. 2013. Cerebellum and Timing. In *Handbook of the Cerebellum and Cerebellar Disorders*, pp. 1201–1219.
- Spencer RMC, Ivry RB. 2005. Comparison of patients with Parkinson’s disease or cerebellar lesions in the production of periodic movements involving event-based or emergent timing. *Brain Cogn* **58**: 84–93.
- Staddon JE, Higa JJ. 1996. Multiple time scales in simple habituation. *Psychol Rev* **103**: 720–33.
- Staddon JE, Higa JJ. 1999. Time and memory: towards a pacemaker-free theory of interval timing. *J Exp Anal Behav* **71**: 215–51.
- Stubbs A. 1968. The discrimination of stimulus duration by pigeons. *J Exp Anal Behav* **11**: 223–238.
- Stujenske JM, Likhtik E, Topiwala MA, Gordon JA. 2014. Fear and safety engage competing patterns of theta-gammacoupling in the basolateral amygdala. *Neuron* **83**: 919–933.
- Sutton RS, Barto AG. 1981. Toward a modern theory of adaptive networks: expectation and prediction. *Psychol Rev* **88**: 135–170.
- Swearingen JE, Buhusi C V. 2010. The pattern of responding in the peak-interval procedure with gaps: An individual-trials analysis. *J Exp Psychol Anim Behav Pr* **36**: 443–455.
- Taylor KM, Horvitz JC, Balsam PD. 2007. Amphetamine affects the start of responding in the peak interval timing task. *Behav Processes* **74**: 168–175.
- Thomson DJ. 1982. Spectrum estimation and harmonic analysis. *Proc IEEE* **70**: 1055–1096.
- Tort ABL, Kramer M a, Thorn C, Gibson DJ, Kubota Y, Graybiel AM, Kopell NJ. 2008. Dynamic cross-frequency couplings of local field potential oscillations in rat striatum and hippocampus during performance of a T-maze task. *Proc Natl Acad Sci U S A* **105**: 20517–22.

- Totah NKB, Jackson ME, Moghaddam B. 2013. Preparatory Attention Relies on Dynamic Interactions between Prelimbic Cortex and Anterior Cingulate Cortex. *Cereb Cortex* **23**: 729–738.
- Treisman M. 1963. Temporal discrimination and the indifference interval. Implications for a model of the “internal clock.” *Psychol Monogr* **77**: 1–31.
- Tremblay L, Hollerman JR, Schultz W. 1998. Modifications of reward expectation-related neuronal activity during learning in primate striatum. *J Neurophysiol* **80**: 964–977.
- Tsujimoto S, Sawaguchi T. 2005. Neuronal activity representing temporal prediction of reward in the primate prefrontal cortex. *J Neurophysiol* **93**: 3687–3692.
- Vallesi A, McIntosh AR, Stuss DT. 2009. Temporal preparation in aging: A functional MRI study. *Neuropsychologia* **47**: 2876–2881.
- van der Steen MCM, Schwartze M, Kotz SA, Keller PE. 2015. Modeling effects of cerebellar and basal ganglia lesions on adaptation and anticipation during sensorimotor synchronization. *Ann N Y Acad Sci* **1337**: 101–110.
- van Maanen L, van Rijn H, Taatgen N. 2012. RACE/A: An Architectural Account of the Interactions Between Learning, Task Control, and Retrieval Dynamics. *Cogn Sci* **36**: 62–101.
- van Rijn H, Gu B-M, Meck WH. 2014. Neurobiology of Interval Timing. **829**.
- van Rijn H, Taatgen NA. 2008. Timing of multiple overlapping intervals: How many clocks do we have? *Acta Psychol (Amst)* **129**: 365–375.
- van Wassenhove V, Lecoutre L. 2015. Duration estimation entails predicting when. *Neuroimage* **106**: 272–283.
- Voorn P, Vanderschuren LJM., Groenewegen HJ, Robbins TW, Pennartz CM. 2004. Putting a spin on the dorsal–ventral divide of the striatum. *Trends Neurosci* **27**: 468–474.
- Walter WG, Dovey VJ. 1944. Electro-encephalography in cases of sub-cortical tumour. *J Neurol Neurosurg Psychiatry* **7**: 57–65.
- Wearden JH, Lejeune H. 2008. Scalar properties in human timing: conformity and violations. *Q J Exp Psychol* **61**: 569–587.
- Wearden JH, Smith-Spark JH, Cousins R, Edelstyn NMJ, Cody FWJ, O’Boyle DJ. 2008. Stimulus timing by people with Parkinson’s disease. *Brain Cogn* **67**: 264–79.
- Westheimer G, Ley E. 1996. Temporal uncertainty effects on orientation discrimination and stereoscopic thresholds. *J Opt Soc Am A* **13**: 884.
- Wiener M, Turkeltaub P, Branch Coslett H. 2010a. Implicit timing activates the left inferior parietal cortex. *Neuropsychologia* **48**: 3967–3971.
- Wiener M, Turkeltaub P, Coslett HB. 2010b. The image of time: A voxel-wise meta-analysis. *Neuroimage* **49**: 1728–1740.
- Winstanley CA, Eagle DM, Robbins TW. 2006a. Behavioral models of impulsivity in relation to ADHD: Translation between clinical and preclinical studies. *Clin Psychol Rev* **26**: 379–395.
- Winstanley CA, Theobald DEH, Cardinal RN, Robbins TW. 2004. Contrasting roles of basolateral amygdala and orbitofrontal cortex in impulsive choice. *J Neurosci* **24**: 4718–4722.
- Winstanley CA, Theobald DEH, Dalley JW, Cardinal RN, Robbins TW. 2006b. Double dissociation between serotonergic and dopaminergic modulation of medial prefrontal and orbitofrontal cortex during a test of impulsive choice. *Cereb Cortex* **16**: 106–114.
- Witt A, Palmigiano A, Neef A, El Hady A, Wolf F, Battaglia D. 2013. Controlling the oscillation phase through precisely timed closed-loop optogenetic stimulation: a computational study. *Front Neural Circuits* **7**: 49.

- Wood KH, Ver Hoef LW, Knight DC. 2012. Neural mechanisms underlying the conditioned diminution of the unconditioned fear response. *Neuroimage* **60**: 787–799.
- Xu M, Zhang S-Y, Dan Y, Poo M-M. 2014. Representation of interval timing by temporally scalable firing patterns in rat prefrontal cortex. *Proc Natl Acad Sci* **111**: 480–485.
- Yarmey DA. 2000. Retrospective duration estimations for variant and invariant events in field situations. *Appl Cogn Psychol* **14**: 45–57.
- Young B, McNaughton N. 2000. Common firing patterns of hippocampal cells in a differential reinforcement of low rates of response schedule. *J Neurosci* **20**: 7043–7051.
- Yumoto N, Lu X, Henry TR, Miyachi S, Nambu A, Fukui T, Takada M. 2011. A neural correlate of the processing of multi-second time intervals in primate prefrontal cortex. *PLoS One* **6**: 1–7.
- Zhou J, Jia C, Feng Q, Bao J, Luo M. 2015. Prospective coding of dorsal raphe reward signals by the orbitofrontal cortex. *J Neurosci* **35**: 2717–2730.

# ANNEXES





# Article n°4: The amygdala: A potential player in timing CS–US intervals

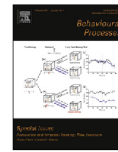
Behavioural Processes 101 (2014) 112–122



Contents lists available at ScienceDirect

Behavioural Processes

journal homepage: [www.elsevier.com/locate/behavproc](http://www.elsevier.com/locate/behavproc)



## The amygdala: A potential player in timing CS–US intervals



Lorenzo Díaz-Mataix<sup>a</sup>, Lucille Tallot<sup>b</sup>, Valérie Doyère<sup>b,c,\*</sup>

<sup>a</sup> Center for Neural Science, New York University, New York, NY 10003, USA

<sup>b</sup> Univ Paris-Sud, Centre de Neurosciences Paris-Sud, UMR 8195, Orsay F-91405, France

<sup>c</sup> CNRS, Orsay F-91405, France

### ARTICLE INFO

#### Article history:

Received 28 March 2013

Received in revised form 15 July 2013

Accepted 6 August 2013

#### Keywords:

Timing

Amygdala

Pavlovian conditioning

Memory

### ABSTRACT

Pavlovian conditioning is the reference paradigm for the study of associative learning based on the programmed relation of two stimuli, the conditioned stimulus (CS) and the unconditioned stimulus (US). Some authors believe that learning the CS–US interval is a co-requisite of or a pre-requisite to learning the CS–US association. There is a substantial literature showing that the amygdala is a critical player in Pavlovian conditioning, with both aversive and appetitive USs. We review a sparse but growing body of literature suggesting that the amygdala may also participate in processing the timing of the CS–US interval. We discuss whether the amygdala, in particular its central, basal and lateral nuclei, in concert with the network it belongs to, may play a role in learning the CS–US interval. We also suggest new and dedicated strategies that would result in better knowledge of the neural mechanisms underlying the learning of the CS–US time interval in isolation from the CS–US association.

© 2013 Elsevier B.V. All rights reserved.

### Contents

1. Introduction.....	112
2. The amygdala and learning and memory of the CS–US association.....	113
3. Involvement of the amygdala in interval timing processing.....	114
3.1. Prediction error detection in the amygdala.....	115
3.2. Neural correlates of temporal expectancy.....	115
3.3. Involvement of the amygdala in the development of time-related correlates.....	117
4. Discussion.....	118
5. Further outstanding questions.....	118
Acknowledgements.....	119
References.....	119

## 1. Introduction

In Pavlovian learning, a neutral stimulus called the conditioned stimulus (CS) acquires predictive value through its pairing with a stimulus that has an inherent value, the unconditioned stimulus (US). The subject not only learns that the CS predicts the US but also learns when the US is due to arrive (Balsam et al., 2010; Pavlov, 1927). Although the emergence of fully expressed temporally shaped anticipatory behavior may take many training trials, the learning of the CS–US time interval may be quite rapid (Balsam et al., 2002; Davis et al., 1989; Díaz-Mataix et al., 2013; Drew et al.,

2005). In fact, it has been suggested that the temporal aspect of the learning experience might be a fundamental component for learning an association (Arcediano et al., 2003; Balsam and Gallistel, 2009). This important role of time in associative learning was incorporated in temporal difference learning models (Sutton and Barto, 1981) and is the foundation of the prediction error detection studies in which the omission of the US is detected at the neural level at the time it was expected to arrive. When the US is fully anticipated, the neural reactivity to the US is reduced (McNally et al., 2011; Schultz, 2013). Even though neural conditioned responses have been shown in several brain structures such as hippocampus, prefrontal cortex, striatum, perirhinal cortex, cerebellum, and auditory cortex (Freeman and Steinmetz, 2011; Kent and Brown, 2012; Suzuki, 2008; Weinberger, 2007), many studies have pointed to the amygdala as the key brain structure involved in the acquisition, processing and storing of Pavlovian associations (LeDoux, 2000;

\* Corresponding author at: Centre de Neurosciences Paris-Sud (CNPS), UMR8195, Université Paris-Sud, Bat. 446, 91405 Orsay, France.  
E-mail address: [valerie.doyere@u-psud.fr](mailto:valerie.doyere@u-psud.fr) (V. Doyère).

Maren and Quirk, 2004; Orsini and Maren, 2012; Paré and Duvarci, 2012). Assuming that time is a core part of the Pavlovian associations then there should be neural correlates of time detectable in the amygdala. In the present paper, after a short review of the neural mechanisms in the amygdala underlying memory processes in Pavlovian conditioning, we present a set of studies that may indicate an involvement of the amygdala in processing and storage of the CS–US time interval.

## 2. The amygdala and learning and memory of the CS–US association

Progress in the neurobiology of associative learning has been largely in the field of Pavlovian aversive conditioning. The amygdala is a complex group of nuclei situated in the temporal lobe, and among these subnuclei some have been particularly involved in the biology of fear conditioning. The lateral nucleus (LA), the basal nucleus (B) and the central nucleus (CE) of the amygdala are particularly involved in the learning and memory processes related to aversive conditioning (Fig. 1). For the purpose of the present review, when no distinction is made between LA and B we will refer to it as BLA, the basolateral nucleus. The amygdala is a key information integration or association system in the service of controlling emotional responses. It receives inputs from all sensory modalities (auditory, visual, olfactory, somatosensory, gustatory, and visceral), as well as connections from higher-order processing structures such as the prefrontal cortex, the perirhinal cortex, and the hippocampal formation. Of the many outputs of the amygdala, connections to brainstem areas involved in the control of species-typical defense responses (freezing, flight) and physiological homeostatic systems (the autonomic nervous system and networks controlling the release of stress hormones) are particularly relevant. Internal connections allow the amygdala to integrate converging sensory and higher-order information, to process it within its networks, and then to generate outputs that affect behavioral and physiological responses in threatening situations.

The same cells in the LA integrate information about both CS and US, as has been shown with *in vivo* single cell recordings (Romanski et al., 1993; Rosenkranz and Grace, 2002; Toyomitsu et al., 2002; Uwano et al., 1995). Particularly well studied is auditory threat (fear) conditioning in which the CS is a tone and the US usually a mild foot-shock. As for some other types of memories, aversive memories undergo both consolidation after initial acquisition, and

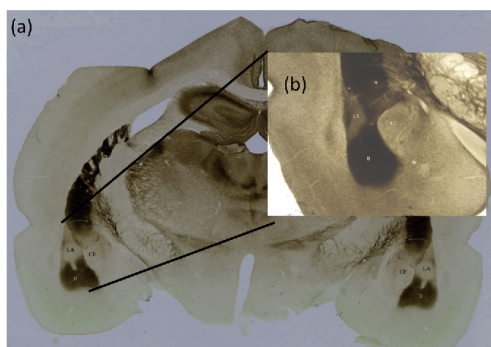
reconsolidation after memory recall. While consolidation refers to a time window after initial learning during which the memory trace is labile and sensitive to disruption, reconsolidation is the process by which a previously consolidated memory is susceptible to change during a finite temporal window after its retrieval (Dudai, 2012). The lateral amygdala has been reported as a key structure for acquisition, expression, consolidation and reconsolidation of threat (fear) memories. The functional inactivation of the LA, for example by a local infusion of muscimol (GABA<sub>A</sub> agonist), or lesion of this nucleus before training causes deficits in the acquisition of auditory fear conditioning, whereas when the lesion or drug infusion is given after training, fear expression is affected (Amorapanth et al., 2000; Campeau and Davis, 1995; Goossens and Maren, 2001; LeDoux et al., 1990; Muller et al., 1997; Nader et al., 2001; Wilensky et al., 1999; for a recent review see Johansen et al., 2011).

Single cell and population activity recordings in the LA have shown that plasticity occurs in this area during learning (Collins and Paré, 2000; Goossens et al., 2003; Quirk et al., 1995; Rogan et al., 1997). The use of drugs that block N-methyl-D-aspartate (NMDA) receptors has shown that plasticity in the LA is required for acquisition and consolidation of fear memories (for review see Johansen et al., 2011; Maren and Quirk, 2004). Moreover, the amplitude of the behavioral conditioned response is correlated with the magnitude of the plasticity in the LA (Schafe et al., 2005). These plasticity changes are believed to reflect changes in synaptic morphology (Cole et al., 2012; Ostroff et al., 2010). Accordingly, anisomycin (a protein synthesis inhibitor) has been shown to block both the consolidation and the reconsolidation of fear memories when infused into the LA (Debiec et al., 2006, 2010; Nader et al., 2000; Schafe et al., 2000).

Much also is now known about the molecular cascade and the cell machinery resulting in the synthesis of the new proteins required for the formation of these memories (for a recent review see Johansen et al., 2011). For example, MAPK cascade and immediate early genes such as Arc and zif-268 play a critical role in the LA in both the consolidation and reconsolidation of auditory aversive conditioning (Duvarci et al., 2005; Maddox and Schafe, 2011; Maddox et al., 2010; Ploski et al., 2008; Schafe et al., 2000). By contrast there are other proteins (eukaryotic initiation factors 4E and 4G) that have been involved specifically in its consolidation (Hoeffler et al., 2011). Whether other molecules might be implicated selectively in its reconsolidation remains to be elucidated. Very recently it has also been shown that epigenetic modifications in the LA are also required for both memory consolidation and reconsolidation (Maddox et al., 2013a,b).

Memory reconsolidation has the advantage that it provides a tool to access the memory structure once memory has been stored. Using reconsolidation we found that the LA rather than storing just a global emotional value, stores the memory of the CS–US association in a selective manner linked to the particular sensory characteristics of both the CS and the US (Díaz-Mataix et al., 2011; Doyère et al., 2007).

The LA sends projections to CE both directly and indirectly via the basal and intercalated nuclei. The CE, in turn, projects to areas of the brainstem and hypothalamus that control the expression of conditioned responses, hormonal secretions and autonomic responses. In addition to the LA, B and CE nuclei also play important roles in processing and storing the fear memory trace (Amano et al., 2011; Goossens and Maren, 2001; McHugh et al., 2013; Wilensky et al., 2006; for review see Paré and Duvarci, 2012). Recent data in aversive conditioning have highlighted even more parcellation of each nucleus, showing, for instance, differential function of the medial and the lateral subdivisions of the CE (Ciocchi et al., 2010; Duvarci et al., 2011) as well as the dorsal and ventral parts of the LA (An et al., 2012; Bergstrom et al., 2012; Repa et al., 2001). In addition to the afferents conveying sensory information from the CS and the



**Fig. 1.** Photomicrographs of acetylcholinesterase-stained rat brain sections. (a) Coronal section showing the left and the right amygdalae and their subnuclei. (b) Higher magnification photo of the left amygdala its main subnuclei. LA: lateral amygdala; B: basal amygdala; CE: central amygdala (photomicrographs provided by Claudia Farb).

**Table 1**  
Error detection.

Reference	Species	Conditioning	Sensory modality	Methodology	Number of trials	Duration CS	Duration trace	Targeted sites
Moses et al. (2007)	Humans	Aversive	Visual	MEG	100	1.4s	—	Amygdala
Mietreau and Dreher (2013)	Humans	Trace appetitive and aversive	Visual	fMRI	25	1s	6s	Amygdala
Seymour et al. (2005)	Humans	Aversive and appetitive	Visual	fMRI	30	4s	—	Amygdala
Wood et al. (2012)	Humans	Aversive	Auditory	fMRI	32	10s	—	Amygdala
Herry et al. (2007)	Humans	Temporal unpredictability	Auditory	fMRI	—	40ms	0.2 ± 0.12 s	Amygdala
Dunsmoor et al. (2008)	Humans	Aversive	Auditory	fMRI	40	10s	—	Amygdala
Boll et al. (2013)	Humans	Aversive	Visual	fMRI	20	10s	—	CEA (not BLA)
Belova et al., 2007	Monkeys	Trace appetitive and aversive	Visual	Single unit	Overtraining	350ms	1.5 s	BLA
Johansen et al. (2010b)	Rats	Aversive	Auditory	Single unit	16	20s	—	LA
Bucci and MacLeod (2007)	Rats	Appetitive	Visual	c-fos	40	10s	—	BLA, CE
Furlong et al. (2010)	Rats	Aversive	Auditory	c-fos	10	30s	—	LA (not B, CE)
Díaz-Mataix et al. (2013)	Rats	Aversive	Auditory	c-fos	10	30s	—	LA (not CE)
Calu et al. (2010)	Rats	Simple choice task	Olfactory	zif-268	10	30s	—	CE
Roesch et al., 2010	Rats	Simple choice task	Olfactory	Single unit	Overtraining	500ms	—	B
Herry et al. (2007)	Mice	Temporal unpredictability	Auditory	Single unit	Overtraining	200ms	0.2 ± 0.14 or 1.4 ± 1.3 s	LA, B (not CE)
Herry et al. (2007)	Mice	Temporal unpredictability	Auditory	c-fos	—	20ms	0.2 ± 0.14 or 1.4 ± 1.3 s	CE
								LA, B

Detailed description of the conditioning parameters, conditions, methods and targeted brain areas of each of the studies examining the role of the amygdala in processing prediction error detection. CS: conditioned stimulus; LA: lateral nucleus of the amygdala; B: basal nucleus of the amygdala; CE: central nucleus of the amygdala; BLA: basal and lateral nucleus of the amygdala; CEA: central regions of the amygdala (central, medial and cortical nuclei); fMRI: functional magnetic resonance imaging; MEG: magnetoencephalography; s: seconds; ms: milliseconds.

US to the amygdala, LA, B, and CE nuclei of the amygdala receive afferents from higher association areas such as the hippocampus and the prefrontal cortex. Using a combination of anterograde tracing and a tool to visualize synapses of activated neurons (transgenic “Venus rat”) it has been recently found that these hippocampal and prefrontal afferents control the LA in a complementary and differential way for the expression of fear memories (Knapska et al., 2012).

A particular case of Pavlovian aversive conditioning is eyeblink conditioning in which a short CS (in the range of hundreds of milliseconds) is paired with an aversive eyelid stimulation. While the cerebellum is the major brain structure responsible for this type of learning (Thompson and Steinmetz, 2009), the amygdala and particularly its basal and lateral nuclei may also be involved in the acquisition and expression of eyeblink conditioned responses (Lee and Kim, 2004; Plakke et al., 2009; Sakamoto and Endo, 2010; for a recent review see Chau and Galvez, 2012).

The amygdala not only has a significant role in processing negative emotions but also positive ones. The LA and B nuclei are involved in establishing motivational and affective values to the CS in both aversive and appetitive situations (Balleine and Killcross, 2006; Metereau and Dreher, 2013). There is a substantial literature on the differential roles of BLA and CE nuclei in Pavlovian appetitive conditioning, mainly based on excitotoxic lesion or functional inactivation approaches. For instance, with an auditory or visual CS, it has been found that the CE is necessary for learning but not for expressing conditioned orienting responses toward the CS. In contrast, food-related conditioned responses were not dependent on CE functional integrity (Groshek et al., 2005; McDannald et al., 2004). It has also been shown that the lesion of CE, but not BLA, impairs Pavlovian appetitive learning measured with conditioned approach responses (Cardinal et al., 2002; Parkinson et al., 2000). However, the B nucleus has been found to be critical for enhancement of eating driven by a learned appetitive cue (Holland and Petrovich, 2005). In a consistent finding, after Pavlovian appetitive learning, rats with lesions of the CE failed to exhibit Pavlovian instrumental transfer (PIT) but showed normal CS-potentiated feeding, and mirror image results were obtained after BLA lesion (Holland and Gallagher, 2003). More recently, the same group (Petrovich et al., 2009) found that the CE but not the BLA is a crucial interface for aversive cues to exert control over appetitive behaviors. While these studies demonstrate complementary and differential roles of BLA and CE nuclei, they do not permit a distinction among the potential specific roles of different subnuclei. The use of other methodologies such as immunohistochemistry to analyze immediate early genes (e.g. Fos) highlights differential involvements of each of the amygdala subnuclei and subparts (e.g. medial, lateral or capsular parts of the central nucleus) at different stages of Pavlovian appetitive learning (Cole et al., 2013). The combination of Fos imaging and retrograde tracers suggest that particular cell populations within the CE may mediate conditioned orienting responses (Lee et al., 2010). Further studies are needed to delineate the precise involvement of all the amygdala subnuclei and their subparts in appetitive conditioning and associated behavioral conditioned responses.

### 3. Involvement of the amygdala in interval timing processing

In contrast to the sizeable amount of existing data on the role of the amygdala in Pavlovian conditioning, very little is known about the involvement of this area in processing the CS–US time interval. The role of the amygdala in the processing of the Pavlovian time interval can be unraveled through three types of approaches: (1) One approach involves prediction error detection in which either

the US is omitted after learning has occurred, or is presented in an unexpected manner most of the time separately from the CS. Reactivity to the omission of the US may be indicating not only surprise for the absence of the US, but also for its absence at that particular time. (2) Another approach focuses on ongoing neural activity as a temporal correlate of the US expectancy. (3) The third approach consists in searching whether amygdala lesion or dysfunction affects the development of time-related behavioral or neurophysiological correlates in other brain areas. In the following sections we review these approaches, although in most cases the authors did not specifically investigate the temporal aspect of the CS–US association.

### 3.1. Prediction error detection in the amygdala

Among the literature investigating the involvement of the amygdala in prediction error detection a diversity of techniques, subjects and conditioning paradigms have been used (see Table 1). In humans, prediction error detection increases fMRI signals in the amygdala (Metereau and Dreher, 2013) but also decreases the US evoked amygdala BOLD signal when it is fully predicted (Dunsmoor et al., 2008; Wood et al., 2012). Using magnetoencephalography (MEG) Moses et al. (2007) found that the amygdala anticipates the arrival of the US based on prior learning of contingencies, and also showed related activation to the omission of the US. In another study Seymour et al. (2005) found that the omission of an expected increase in pain induced an increase in the amygdala BOLD signal whereas the omission of an expected pain relief decreased it. Recently, with high resolution fMRI, Boll et al. (2013) specifically showed that the central region (central, medial and cortical nuclei), but not the basolateral region (lateral, basal and accessory basal nuclei) of the amygdala increases the BOLD signal in the case of a surprise outcome (unexpected or omitted US). Assessing specifically the effect of temporal patterns on amygdala activity Herry et al. (2007) found an increase in the fMRI signal when temporal irregularity was detected.

Single unit recordings in non-human primates (Belova et al., 2007) and in rodents (Calu et al., 2010; Herry et al., 2007; Johansen et al., 2010a,b; Roesch et al., 2010) looking more specifically at selected amygdala nuclei have shown various changes in cellular firing rate in all amygdalar nuclei at the omission or the unexpected presentation of the US. Belova et al. (2007) showed that prediction error detection modulated firing rate in the BLA, with some neurons increasing or decreasing their firing rate in response to the omission of the US whether appetitive or aversive. Calu et al. (2010) and Roesch et al. (2010) using a reward choice task examined the firing rate in CE and B, and reported increased firing rate in both nuclei to the omission of the reward. By contrast the unexpected presentation of the reward induced an increased firing rate in B but not in the CE. Johansen et al. (2010b) showed that the magnitude of the firing rate evoked by an eyelid shock in the LA decreased as the expectation for the US was increased, as it was shown in humans by Dunsmoor et al. (2008). Interestingly Herry et al. (2007) found in mice an increased firing rate in the LA and B nuclei to an unpredictable temporal sequence compared to a predictable one.

Using immunohistochemistry, Herry et al. (2007) confirmed that the unpredictable temporal sequence triggered an activation of c-fos in LA and B, but showed no change in CE. In contrast, Bucci and MacLeod (2007) using a serial compound Pavlovian appetitive conditioning protocol in rats showed that the omission of a predicted CS increased the c-fos activity in CE while decreasing it in the BLA. In agreement with neurophysiological studies in rats and humans (Dunsmoor et al., 2008; Johansen et al., 2010b), a decrease in c-fos activity with repeated training as compared to early in training has been reported in LA, but not in B or CE,

i.e. when the CS–US association is well learned (Furlong et al., 2010).

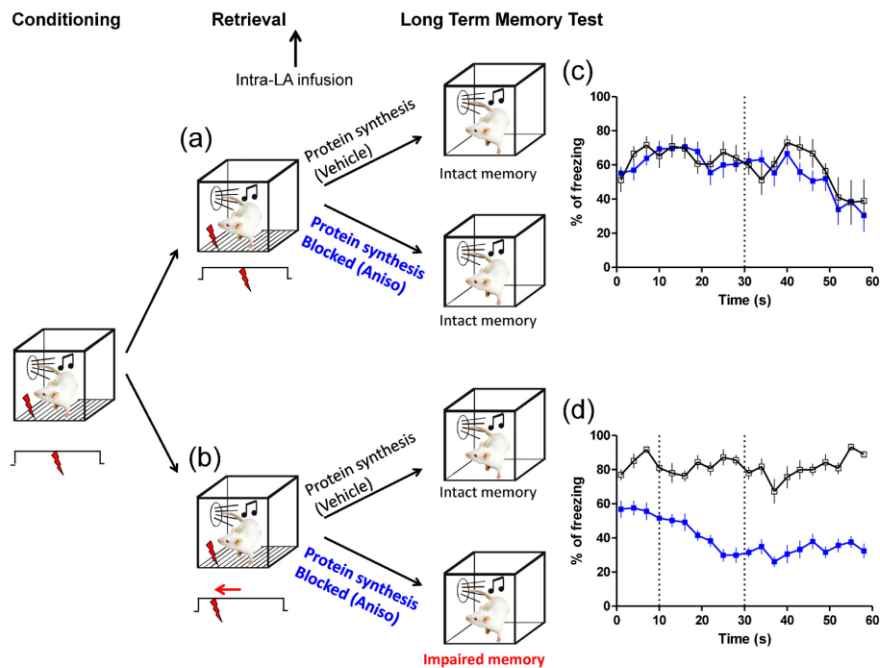
All these studies, with the exception of Herry et al. (2007) in which time was explicitly manipulated, showed amygdala reactivity to omitted or unexpected events, or a decrease in amygdala reactivity to the US when it is fully predicted, without explicitly addressing the role of the temporal component in triggering these effects. Recently, we have specifically developed an experimental design to ask whether a change in the CS–US interval without changing any other parameter (e.g. duration of the CS) would trigger a change in the amygdala activity (Díaz-Mataix et al., 2013; Fig. 2). We found that changing the CS–US interval during memory reactivation induces a selective increase in zif-268 activity in the LA but not in the CE.

With regard to prediction error, it is worth mentioning that, inspired by learning models and temporal-difference models (Rescorla and Wagner, 1972; Sutton and Barto, 1981), McNally has specifically used blocking and temporal primacy paradigms combined with lesion or pharmacology to determine which neural networks in relation to the amygdala may be involved in the detection and processing of positive and negative prediction errors, processes which are at play not only in fear learning, but also in fear overexpectation and extinction (for review see Li and McNally, 2013; McNally and Westbrook, 2006). Some of these experiments that are important for the present review are discussed later in Section 3.3.

### 3.2. Neural correlates of temporal expectancy

If the subject is expecting the US at a specific time after the CS onset, then one might expect a neural correlate to show a temporal pattern paralleling the behavioral conditioned responses, that is, a progressive change in the ongoing neural activity during the presentation of the CS, as time elapses, which should culminate near or at the expected time of the US arrival before leveling back to baseline levels. The studies testing the involvement of the amygdala in processing the CS–US interval have done so by presenting the US co-terminating with the CS and by keeping the same duration for the CS in reinforced and non-reinforced trials. In this approach, the CS during an unreinforced trial always ends with the “surprise” effect of US omission (as in prediction error, see above), so it is not possible to differentiate between the timed-expectancy of the US and the effect of US absence *per se*. Thus the existing data so far provide the amygdalar neural correlates of the rise in expectancy, which may or may not be related to the specific time of the US arrival, and do not offer any real amygdalar neural correlate of timed-expectancy isolated from a surprise effect. Furthermore, none of these experiments so far has looked beyond the time of US arrival in the presence of the CS (as in peak interval procedures), nor have they tested for the scalar property (Gibbon, 1991) of these time-related neural correlates using different CS–US intervals, paradigms which would differentiate timing from other processes (e.g. absolute timing, sensitization, orienting response, or change in CS salience). However, in some of the studies we review below, the pattern of the neural activity peaked or showed a plateau prior to US omission (Bauer et al., 2007; Bermudez et al., 2012; Paz et al., 2006; Popescu et al., 2009) and may thus be indicators of potential correlates of the temporal expectancy of US arrival in the amygdala.

Among all the studies we review here, diverging results have been reported (see Table 2). Applegate et al. (1982) found a sustained, although stable, anticipatory multiunit activity in the CE in a Pavlovian heart rate conditioning in rabbits. Using Pavlovian aversive conditioning in cats, Paré and Collins (2000) found that there was a US-anticipatory gradual increase in LA firing rate, and also in the amplitude of the tone-evoked responses as the



**Fig. 2.** A change in the CS–US time interval is detected very early in training and, when it is presented during memory retrieval, induces synaptic plasticity in the lateral amygdala and triggers the reconsolidation of aversive memories. Rats were conditioned with a 60-s tone as a CS. The US was a 1-s footshock delivered 30s after the onset of the CS. Twenty-four hours after conditioning, rats were placed back in the conditioning chamber and memory was reactivated (retrieval) with the presentation of the same 30-s CS–US time interval (a) or a different, shorter, 10-s CS–US interval (b). Immediately after reactivation, vehicle or anisomycin was infused into the LA. The blockade of new protein synthesis by anisomycin impaired the long-term memory (less freezing) of only those rats in which memory was retrieved by presenting a shifted CS–US (d, blue filled symbols), as compared to vehicle injected rats (d, open black symbols), and as compared to the non-shifted condition (c, open black and blue filled symbols, respectively for vehicle and anisomycin groups). Thus, memory reconsolidation only occurred when a temporal mismatch between the expected and the actual time of arrival of the US was detected. (c) and (d) are graphs representing the average  $\pm$  standard error of mean of the freezing during the 60-s time of presentation of the conditioned stimulus averaged over the long-term memory test. Adapted from Díaz-Mataix et al. (2013).

US was expected to arrive. Similarly, in Pavlovian trace appetitive conditioning in cats, it has been shown that the cells in the B nucleus of the amygdala increased their firing rate during the CS, rising as the arrival time of the US approached (Paz et al., 2006). This effect was seen late in training but not during the first conditioning sessions. Interestingly, in this same study the authors showed an increase in the spike correlation between the basal amygdala and the rhinal cortices which appeared earlier in training than the behavioral conditioned response. In agreement with the previous study, the same group using the same behavioral paradigm showed late in training a gradual increase in the gamma frequency power (35–45 Hz) in the BLA along the duration of the CS as well as an enhancement of the coherence in this same frequency range between the BLA and the rhinal cortices (Bauer et al., 2007). Such temporally-related increase in the gamma coherence later in training was also shown between the BLA and the striatum (Popescu et al., 2009) in an appetitive conditioning paradigm in cats. Fear conditioning in mice has been found to induce an increase in the theta frequency range (4–8 Hz) of the power spectrum which progressively develops during the presentation of the CS (Pape et al., 2005). The authors also found a time-related increase in the theta-band coherence between LA and hippocampus (CA1). Bermudez et al. (2012) using single unit recordings in an appetitive paradigm in rhesus monkeys found that

28% of the neurons of the amygdala (with no significant differences between LA, B and CE) exhibited a gradual increase in their firing rate during the presentation of the CS. In agreement with these studies, Seymour et al. (2005) showed in humans an anticipatory CS-evoked increase in the fMRI BOLD signal in the amygdala in either appetitive or aversive paradigms. Using MEG recordings in humans, Moses et al. (2007) also reported signs of anticipatory increased activity in the amygdala close to the time of the expected aversive US arrival.

Rorick-Kehn and Steinmetz (2005) found a progressive increase in the proportion of firing neurons specifically in the CE but not in the BLA in eyeblink conditioning in rats. However this effect was not observed when the rats were conditioned with a Pavlovian fear conditioning paradigm. Other studies also failed to find positive neural correlates of the temporal expectancy of the US. Using single unit recording in the LA in rats, auditory fear conditioning did not induce a gradual change in the cellular activity in this area along the presentation of the CS (Maren, 2000; Quirk et al., 1997). However in these same animals a gradual change was observed in the auditory cortex (Quirk et al., 1997). Similarly, in an olfactory fear conditioning paradigm in rats (Hegoburu et al., 2009), glutamate and GABA release was correlated to the time of arrival of the US in the posterior piriform (olfactory) cortex while no change was observed in the B amygdala.

**Table 2**  
Ramping neural activity.

Result	Reference	Species	Conditioning	Sensory modality	Methodology	Number of trials	CS-US interval	Duration trace	Amygdala sites	Other sites
+	Applegate et al. (1982)	Rabbits	Aversive	Auditory	Multi-unit	20	5 s		CE	
+	Paré and Collins (2000)	Cats	(Trace) Aversive	Auditory	Multi-unit and LFP	25	15 s		LA	
+	Paz et al. (2006)	Cats	Trace appetitive	Visual	Single unit	300	3 s	1.5 s	B ↔ Rhinal Cx	
+	Bauer et al. (2007)	Cats	Trace appetitive	Visual	LFP	300	3 s	1.5 s	BLA ↔ Rhinal Cx	
+	Popescu et al. (2009)	Cats	Appetitive	Auditory	LFP	300	3 s		(BLA) ↔ Striatum	
+	Rorick-Kehn and Steinmetz (2005)	Rats	Eyeblink	Auditory	Single unit	900	350 ms		CE	
+	Pape et al. (2005)	Mice	Aversive	Auditory	LFP	6	10 s		LA ↔ CA1	
+	Bermudez et al. (2012)	Monkeys	Appetitive	Visual	Single unit	Overtraining	2 s		LA, B, CE	
+	Seymour et al. (2005)	Humans	Appetitive and aversive	Visual	fMRI	30	4 s		Amygdala	
+	Moses et al. (2007)	Humans	Aversive	Visual	fMRI	100	1.4 s		Amygdala	
+	Rorick-Kehn and Steinmetz (2005)	Rats	Eyeblink	Auditory	Single unit	900	350 ms		BLA	
-	Rorick-Kehn and Steinmetz (2005)	Rats	Eyeblink	Auditory	Single unit	30	4 s		BLA, CE	
-	Maren (2000)	Rats	Aversive	Auditory	Single unit	5 or 75	2 s		LA	
-	Hegoburu et al. (2009)	Rats	Aversive	Olfactory	Microdialysis	6	4 min ITI		B	Olfactory Cx
-	Quirk et al. (1997)	Rats	Aversive	Auditory	Single unit	20	2 s		LA	Auditory Cx

Detailed description of the conditioning parameters, conditions, methods and targeted brain areas of each of the studies examining the role of the amygdala in processing temporally-triggered expectancy during the conditioned stimulus presentation period (ramping neural activity). Lines with the double arrow denote a relationship between the two pointed areas in processing the temporally-triggered expectancy during the CS presentation. CS: conditioned stimulus; LA: lateral nucleus of the amygdala; B: basal nucleus of the amygdala; CE: central nucleus of the amygdala; Cx: cortex; CA1: CA1 field of the hippocampus; LFP: local field potential; fMRI: functional magnetic resonance imaging; s: seconds; ms: milliseconds; +: positive result in the amygdala; -: negative result in the amygdala.

**3.3. Involvement of the amygdala in the development of time-related correlates**

The gradual time-related activity triggered by the expectancy of the US has also been reported in other brain areas. To the purpose of this review we focus on the studies that have shown an involvement of the amygdala in the appearance of either time-related behavioral or neurophysiological correlates.

In eyeblink conditioning in rats Blankenship et al. (2005) found that lesion of the CE but not the BLA prevented the gradual increase during the tone CS (450 ms in duration) in the hippocampal (CA1) unit activity which develops normally over training sessions (10 training sessions of 100 conditioning trials each). Similarly, the ramping single-unit activity during the tone CS (2 s in duration) in the auditory cortex (Te1 and Te3) that develops after conditioning with only 20 CS-US pairings, was also prevented by the lesion of the whole amygdala (Armony et al., 1998).

In a specific three-stage paradigm to test temporal-difference fear learning, by using temporal primacy to produce unblocking or blocking of fear learning, Cole and McNally (2009) found that the blockade of the NR2B NMDA receptors subunit in the BLA prevented learning in response to both the positive and negative prediction errors, showing that neural plasticity in the BLA is required for such learning related to the prediction error detection that we have previously discussed. In contrast, the infusion of a  $\mu$ -opioid antagonist into the ventrolateral midbrain periaqueductal gray (vlPAG), an area which receives inputs from the CE and is important for controlling conditioned defensive responses, enhanced learning in response to positive predictive error but impaired learning in response to negative predictive error. This work points out the importance of the BLA, but also PAG as an important structure related to the amygdala involved in detecting and/or processing prediction error in fear learning.

Using fear memory reconsolidation as a tool to access previously formed memories, we (Díaz-Mataix et al., 2013; Fig. 2) found that a change in the interval between the CS and the US, either shortening it or lengthening it, is a powerful tool in triggering the reconsolidation of amygdala-dependent memories, and that a single CS-US pairing is sufficient for the CS-US interval to be learned. We used a modified fear conditioning protocol with tone-CS and foot-shock-US pairings during training in rats. The difference in our conditioning protocol was that the US was presented in the middle of the CS (i.e. the US arriving at 30 s after the onset of a 60-s CS), thus allowing the modification of the CS-US interval without changing any other parameter of the procedure (e.g. same CS duration). After consolidation of the initial fear memory with a given CS-US interval, the delivery of one trial with a CS-US interval different from the previously learned interval triggered a reconsolidation process which could be prevented by a protein synthesis blockade in the LA but not in the CE. Importantly, reconsolidation of the CS-evoked memories was not induced if the CS-US interval had not been changed during reactivation. These data thus show that reconsolidation of a fear memory following a temporal shift in CS-US interval depends upon protein synthesis in the LA, but not in the CE, as was suggested by the differential increase in zif-268 expression after retrieval (see Section 3.1). However, when analyzing the time course of the freezing behavior during the unreinforced CS presentation during long-term memory tests, the remaining freezing, expressed by the groups of rats who had experienced a blockade of reconsolidation, reflected a temporal pattern potentially characteristic of the new CS-US interval that had been presented during the reactivation of memory (i.e. maximum freezing early during the 60-s CS when the CS-US interval had been changed from 30 to 10 s during reactivation [Fig. 2d], as compared to a maximum freezing peaking later during the 60-s CS when the CS-US interval had been changed from 10 to 30 s during

reactivation [see Fig. 3B in Díaz-Mataix et al., 2013]. If confirmed, these latter data would suggest that when a change in the temporal parameters during reactivation is detected, the new temporal relationship between the CS and the US during reactivation, acquired in a single trial, may not be dependent on the LA. Further studies will be needed to fully understand the role of the amygdala and its subnuclei in the initial CS–US interval learning and the updating of this information.

#### 4. Discussion

In most of the human studies, due to technical resolution constraints, it is difficult to distinguish between specific amygdalar nuclei; however, in all of the studies we have reviewed above, the amygdala seems to play a role in either the detection of a prediction error, or in showing a gradual temporal activation potentially linked to the time of arrival of the US. The implication of the amygdala seems to be independent of the experimental parameters and conditions (CS duration, US valence, strength of training). Only in a very recent study (Boll et al., 2013) in which high resolution fMRI was used, did the authors find a differential involvement of the central regions versus the basolateral regions of the amygdala.

In some of the papers studying the neural correlates of temporal expectancy in non-primate animals negative results are reported for the involvement of the amygdala. A low level of training (from 6 to 75 training trials) and a long duration of the CS (from 2 s to 4 min) were common characteristics of these studies. Moreover, all these papers studied the involvement of the amygdala by measuring single unit electrical activity. By contrast, the studies that found a positive role of the amygdala in processing the CS–US interval used an overtraining protocol and/or measured the neural activity with local field potentials, fMRI or MEG (see Table 2). This pattern of positive or negative results may indicate that measuring single unit electrical activity might not provide an appropriate measure of the neural correlates of the US expectancy early in training. In addition, only a small percentage of the LA cells are recruited to express conditioned freezing behavior (Han et al., 2009) and among them, some may stay potentiated even after extinction (An et al., 2012; Ciochi et al., 2010; Repa et al., 2001), showing that not all the cells in a given nucleus are recruited at every memory stage (Li et al., 2013). When the involvement of the amygdala was tested early in training by using immunohistochemistry or local field potentials methods, then the lateral and basal nuclei of the amygdala seemed to play a more important role than the central nucleus, for which contradictory results have been found.

In the foregoing review of the literature no specific experiments have been performed to examine explicitly the role of the amygdala in the detection and processing of the time interval that is imbedded in the Pavlovian CS–US association. Classical timing studies involve a peak interval methodology which assesses the temporal pattern of the behavioral response by presenting non-reinforced probe trials during which the CS is presented for a longer time than the CS–US interval. This approach allows studying not only the rising expectancy during the CS period but also the decline in expectancy after the US time of arrival has passed. In order to isolate the neural basis of learning the CS–US interval from the association itself, specific experimental designs resembling the design used with the peak interval experiments need to be implemented. Additional post-acquisition tests involving shifts in the CS–US interval would provide responses to temporally displaced US presentation within the CS, as well as to omitted US in absence of a CS offset, and would also assess whether the scalar property of timing (Gibbon, 1991) holds at the neural level. Our

results obtained with a modified peak interval methodology (Díaz-Mataix et al., 2013) suggest, however, that the learning of the new CS–US interval may be quite rapid, thus rendering the collection of a sufficient amount of recordings during the learning phase challenging.

Although not focusing on the role of the amygdala in processing the CS–US interval, some seminal studies have used the peak interval approach to examine the role of the interactions between the prefrontal cortex (PFC) and the amygdala in interval timing. These studies utilize the fact that an emotional cue, with a positive or negative valence through its association with food or foot-shocks, respectively, produces a drastic disruption of the temporal behavior (i.e. temporal underestimation) when intruded during the to-be-timed stimulus (Aum et al., 2004, 2007; Brown et al., 2007; Matthews et al., 2012; Meck and MacDonald, 2007). Matthews et al. (2012) found an involvement of the PFC in timing the interval that is differently affected by local infusion of nomifensine (dopamine and norepinephrine reuptake inhibitor) depending on the presence or absence of the fear distractor. On the other hand, Meck and MacDonald (2007) found that the impairment in timing induced by an emotionally salient stimulus (fear) is prevented by lesion of the amygdala but not by lesioning the PFC. The latter result provides evidence for the importance of the amygdala in the attentional control of temporal processing.

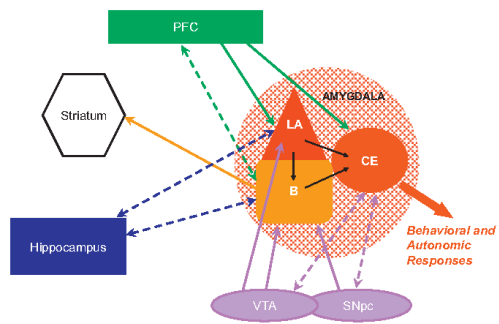
#### 5. Further outstanding questions

One of the difficulties in studying the neural correlates of processing and storing the CS–US time interval is that overtraining is necessary for the full expression of a temporally-triggered behavioral conditioned response. However there is evidence that the CS–US interval can be learned before it is behaviorally expressed (Ohya and Mauk, 2001), and this learning can be as rapid as after a few or even a single CS–US presentation (Balsam et al., 2002; Davis et al., 1989; Díaz-Mataix et al., 2013; Drew et al., 2005). It has also been shown that contiguity between the CS and the US at the time of learning is not always a pre-requisite for making the association and that learning might be behaviorally silent, while contiguity may be required for behavioral expression of learning (Arcediano et al., 2003; Molet et al., 2012). Whether neural correlates of memory for duration or time when no behavior is expressed differ from the ones when the temporal behavior is fully expressed remains to be investigated. It is possible that the LA, B and CE may play differential roles in the learning and expression of the CS–US interval. These issues need to be addressed in experiments with dedicated experimental designs.

Another critical parameter central in the timing literature is the duration of the CS–US time interval, as different brain networks may be differentially involved in the processing of short (less than 1 second) and long durations (for review see: Buhusi and Meck, 2005; Coull et al., 2011). In the studies we have reviewed here, the amygdala seems to be implicated in processing the CS–US interval in a wide range of durations (from 200 ms to 30 s). Whether the amygdala and its subnuclei play a similar role, or not, in the learning and processing both short (<1 s) and long ranges of durations remains to be studied.

The amygdala receives and sends projections to many different brain structures, and some of the papers reviewed here studied the relationship between the amygdala and other brain areas (rhinal cortices, striatum, hippocampus). The striatum and the prefrontal cortex have been reported as structures playing a critical role in timing (for review see: Buhusi and Meck, 2005; Coull et al., 2011). Interactions between the PFC and the amygdala may be important in interval timing (Matthews et al., 2012; Meck and MacDonald, 2007), and PFC, PAG and amygdala may work in





**Fig. 3.** Diagram showing the intra-amygdala connectivity and its connectivity with brain areas relevant to timing processing. Solid lines denote unidirectional projections. Dashed lines denote reciprocal connection between the two structures the arrows are pointing to. Connections within the different amygdala nuclei are in black. The other lines have the same color as the afferent brain area to the amygdala. Connections between brain areas in the diagram not exiting or arriving to the amygdala have not been represented. LA: lateral nucleus of the amygdala; B: basal nucleus of the amygdala; CE: central nucleus of the amygdala; VTA: ventral tegmental area; SNpc: substantia nigra pars compacta; PFC: prefrontal cortex.

concert for prediction error detection (Li and McNally, 2013). The dopaminergic system and the mesencephalic dopaminergic nuclei (ventral tegmental area, substantia nigra) are crucial for detection of prediction error (Schultz, 2013) and the hippocampus is a critical mediator in memory consolidation and may also be involved in time memory (Eichenbaum, 2013; MacDonald et al., 2011). The amygdala sends and/or receives projections from all these brain structures (see Fig. 3), putting it in a central position to orchestrate time processing. Based on the literature we have reviewed here and our own experiments (Díaz-Mataix et al., 2013), it is likely that the amygdala is one of the multiple structures that act together in a real-time neural network to detect and process interval timing. Although learning the association between the CS and the US may involve critically the LA, the few data aiming at understanding the role of the amygdala in time-interval processing point to the engagement of other brain areas in adding the time parameter into the CS-US association. An open question remains whether the amygdala has a control or a receiving role in computing time intervals, or whether each brain area/cell population processes time for associative learning at each node of the network for its own specialized function. Therefore, the study of the reciprocal relationship between the amygdala and these areas might bring a better understanding of the mechanisms and neural substrates underlying the processing and storage of the CS-US interval in Pavlovian associations.

Another, but not the least outstanding question is: What cellular mechanism would the amygdala use to store memory traces for the CS-US interval? In the memory field, long-term potentiation (LTP)-like mechanisms are believed to support the memory trace (for review see: Neves et al., 2008; Sigurdsson et al., 2007). Studies of LTP have highlighted the role of temporal parameters (i.e. Hebbian rules) in triggering plasticity and its direction (potentiation, LTP or depression, LTD). LTP has been demonstrated in the amygdala both *in vitro* and *in vivo* (Chapman et al., 1990; Doyère et al., 2003; Humeau and Lüthi, 2007), as well as LTD (Heinbockel and Pape, 2000; Lin et al., 2000; Kaschel et al., 2004). Consistent with the contiguity requirement for behavioral expression of learning, presynaptic stimulation and postsynaptic depolarization must occur together in time for LTP to be induced (Weisskopf et al., 1999; Tsvetkov et al., 2004; Humeau et al., 2005), and LTP in the amygdala shows associative properties (Doyère et al., 2003;

Humeau et al., 2003). Contiguity between the CS and the activation of the amygdala cells is necessary to enable the development of behavioral conditioned responses to the CS (Johansen et al., 2010a). Furthermore, it has been also shown that plasticity in the LA is sensitive to contingency degradation as is fear learning (Bauer et al., 2001). The timing for LTP is in the range of milliseconds while in most of the Pavlovian learning paradigms the CS-US interval is in the range of seconds. The big challenge for neurobiological theory of Pavlovian learning is how to reconcile those two time ranges. Whether the brain can achieve this by cellular/membrane oscillations and/or network reverberatory mechanisms within the amygdala, or between the amygdala and its related brain areas (Johnson et al., 2008; Seidenbecher et al., 2003) is not known. It is however interesting to note that neural correlates of temporal expectancies (see Section 3.2) have often reported changes in oscillatory neural activities (in either theta or gamma frequencies) either within the amygdala or between it and other brain areas. Further studies are needed for a full analysis of the frequency spectrum in the amygdala networks and related structures during Pavlovian conditioning to unravel their role in learning the CS-US interval and in its behavioral expression.

To summarize, very little is known about the role and the mechanisms by which the amygdala processes and stores information about the CS-US time interval. After reviewing the studies that indirectly addressed this issue, we suggest possible successful strategies to clearly elucidate the contribution of the amygdala, its subnuclei, and its related areas to the processing, encoding, storing and retrieving of the CS-US time interval in associative learning. As mentioned earlier, recent studies have highlighted the fact that the amygdala is doing much more than processing a global emotional value, and is storing the CS-US association in a highly selective manner. It is time to put time in the amygdala and design specific experiments to address the question of its role in learning the CS-US time interval as the core of the CS-US association.

#### Acknowledgements

We would like to thank Bruce L. Brown for his availability for timeless discussions on time in general and for the present review. We would like to thank Claudia Farb for her kindly provision of the amygdala photomicrographs. Grant support from Partner University Funds, CNRS-NYU LIA, ANR grants.

#### References

- Amano, T., Duvarci, S., Popa, D., Paré, D., 2011. The fear circuit revisited: contributions of the basal amygdala nuclei to conditioned fear. *J. Neurosci.* 31, 15481–15489.
- Amorapanth, P., LeDoux, J.E., Nader, K., 2000. Different lateral amygdala outputs mediate reactions and actions elicited by a fear-arousing stimulus. *Nat. Neurosci.* 3, 74–79.
- An, B., Hong, I., Choi, S., 2012. Long-term neural correlates of reversible fear learning in the lateral amygdala. *J. Neurosci.* 32, 16845–16856.
- Applegate, C.D., Frysinger, R.C., Kapp, B.S., Gallagher, M., 1982. Multiple unit activity recorded from amygdala central nucleus during Pavlovian heart rate conditioning in rabbit. *Brain Res.* 238, 457–462.
- Arediano, F., Escobar, M., Miller, R.R., 2003. Temporal integration and temporal backward associations in human and nonhuman subjects. *Learn. Behav.* 31, 242–256.
- Armony, J.L., Quirk, G.J., LeDoux, J.E., 1998. Differential effects of amygdala lesions on early and late plastic components of auditory cortex spike trains during fear conditioning. *J. Neurosci.* 18, 2592–2601.
- Aum, S.W., Brown, B.L., Hemmes, N.S., 2004. The effects of concurrent task and gap events on peak time in the peak procedure. *Behav. Process.* 65, 43–56.
- Aum, S.W., Brown, B.L., Hemmes, N.S., 2007. The effect of intruded events on peak time: the role of reinforcement history during the intruded event. *Behav. Process.* 74, 187–197.
- Balleine, B.W., Killcross, S., 2006. Parallel incentive processing: an integrated view of amygdala function. *Trends Neurosci.* 29, 272–279.
- Balsam, P.D., Gallistel, C.R., 2009. Temporal maps and informativeness in associative learning. *Trends Neurosci.* 32, 73–78.
- Balsam, P.D., Drew, M.R., Yang, C., 2002. Timing at the start of associative learning. *Learn. Motiv.* 33, 141–155.

- Balsam, P.D., Drew, M.R., Gallistel, C.R., 2010. Time and associative learning. *Comp. Cogn. Behav. Rev.* 5, 1–22.
- Bauer, E.P., LeDoux, J.E., Nader, K., 2001. Fear conditioning and LTP in the lateral amygdala are sensitive to the same stimulus contingencies. *Nat. Neurosci.* 4, 687–688.
- Bauer, E.P., Paz, R., Paré, D., 2007. Gamma oscillations coordinate amygdalo-rhinal interactions during learning. *J. Neurosci.* 27, 9369–9379.
- Belova, M.A., Paton, J.J., Morrison, S.E., Salzman, C.D., 2007. Expectation modulates neural responses to pleasant and aversive stimuli in primate amygdala. *Neuron* 55, 970–984.
- Bergstrom, H.C., McDonald, C.G., Dey, S., Tang, H., Selwyn, R.G., Johnson, L.R., 2012. The structure of Pavlovian fear conditioning in the amygdala. *Brain Struct. Funct.* (Epub ahead of print).
- Bermudez, M.A., Göbel, C., Schultz, W., 2012. Sensitivity to temporal reward structure in amygdala neurons. *Curr. Biol.* 22, 1839–1844.
- Blankenship, M.R., Huckfeldt, R., Steinmetz, J.J., Steinmetz, J.E., 2005. The effects of amygdala lesions on hippocampal activity and classical eyeblink conditioning in rats. *Brain Res.* 1035, 120–130.
- Boll, S., Gamer, M., Gluth, S., Finsterbusch, J., Büchel, C., 2013. Separate amygdala subregions signal surprise and predictiveness during associative fear learning in humans. *Eur. J. Neurosci.* 37, 758–767.
- Brown, B.L., Richer, P., Doyère, V., 2007. The effect of an intruded event on peak-interval timing in rats: isolation of a postcue effect. *Behav. Process.* 74, 300–310.
- Bucci, D.J., Macleod, J.E., 2007. Changes in neural activity associated with a surprising change in the predictive validity of a conditioned stimulus. *Eur. J. Neurosci.* 26, 2669–2676.
- Buhusi, C.V., Meck, W.H., 2005. What makes us tick? Functional and neural mechanisms of interval timing. *Nat. Rev. Neurosci.* 6, 755–765.
- Calu, D.J., Roesch, M.R., Haney, R.Z., Holland, P.C., Schoenbaum, G., 2010. Neural correlates of variations in event processing during learning in central nucleus of amygdala. *Neuron* 68, 991–1001.
- Campeau, S., Davis, M., 1995. Involvement of the central nucleus and basolateral complex of the amygdala in fear conditioning measured with fear-potentiated startle in rats trained concurrently with auditory and visual conditioned stimuli. *J. Neurosci.* 15, 2301–2311.
- Cardinal, R.N., Parkinson, J.A., Hall, J., Everitt, B.J., 2002. Emotion and Motivation: the role of the amygdala, ventral striatum, and prefrontal cortex. *Neurosci. Biobehav. Rev.* 26, 321–352.
- Chapman, P.F., Kairiss, E.W., Keenan, C.L., Brown, T.H., 1990. Long-term synaptic potentiation in the amygdala. *Synapse* 6, 271–278.
- Chau, L.S., Galvez, R., 2012. Amygdala's involvement in facilitating associative learning-induced plasticity: a promiscuous role for the amygdala in memory acquisition. *Front. Integr. Neurosci.* 6, 92. <http://dx.doi.org/10.3389/fint.2012.00092>.
- Ciochi, S., Herry, C., Grenier, F., Wolff, S.B., Letzkus, J.J., Vlachos, I., Ehrlich, I., Sprengel, R., Deisseroth, K., Stadler, M.B., Müller, C., Lüthi, A., 2010. Encoding of conditioned fear in central amygdala inhibitory circuits. *Nature* 468, 277–282.
- Cole, S., McNally, G.P., 2009. Complementary roles for amygdala and periaqueductal gray in temporal-difference fear learning. *Learn. Mem.* 16, 1–7.
- Cole, C.J., Mercado, V., Restivo, L., Yiu, A.P., Sekeres, M.J., Han, J.H., Vetere, G., Pekar, T., Ross, P.J., Neve, R.L., Frankland, P.W., Josselyn, S.A., 2012. ME2 negatively regulates learning-induced structural plasticity and memory formation. *Nat. Neurosci.* 15, 1255–1264.
- Cole, S., Powell, D.J., Petrovich, G.D., 2013. Differential recruitment of distinct amygdala nuclei across appetitive associative learning. *Learn. Mem.* 20, 295–299.
- Collins, D.R., Paré, D., 2000. Differential fear conditioning induces reciprocal changes in the sensory responses of lateral amygdala neurons to the CS(+) and CS(-). *Learn. Mem.* 7, 97–103.
- Coull, J.T., Cheng, R.K., Meck, W.H., 2011. Neuroanatomical and neurochemical substrates of timing. *Neuropsychopharmacology* 36, 3–25.
- Davis, M., Schlesinger, L.S., Sorenson, C.A., 1989. Temporal specificity of fear conditioning: effects of different conditioned stimulus-unconditioned stimulus intervals on the fear-potentiated startle effect. *J. Exp. Psychol. Anim. Behav. Process.* 15, 295–310.
- Debiec, J., Doyère, V., Nader, K., LeDoux, J.E., 2006. Directly reactivated, but not indirectly reactivated, memories undergo reconsolidation in the amygdala. *Proc. Natl. Acad. Sci. U. S. A.* 103, 3428–3433.
- Debiec, J., Díaz-Mataix, L., Bush, D.E., Doyère, V., LeDoux, J.E., 2010. The amygdala encodes specific sensory features of an aversive reinforcer. *Nat. Neurosci.* 13, 536–537.
- Díaz-Mataix, L., Debiec, J., LeDoux, J.E., Doyère, V., 2011. Sensory-specific associations stored in the lateral amygdala allow for selective alteration of fear memories. *J. Neurosci.* 31, 9538–9543.
- Díaz-Mataix, L., Ruiz Martínez, R.C., Schafe, G.E., LeDoux, J.E., Doyère, V., 2013. Detection of a temporal error triggers reconsolidation of amygdala-dependent memories. *Curr. Biol.* 23, 467–472.
- Doyère, V., Schafe, G.E., Sigurdsson, T., LeDoux, J.E., 2003. Long-term potentiation in freely moving rats reveals asymmetries in thalamic and cortical inputs to the lateral amygdala. *Eur. J. Neurosci.* 17, 2703–2715.
- Doyère, V., Debiec, J., Monfils, M.H., Schafe, G.E., LeDoux, J.E., 2007. Synapse-specific reconsolidation of distinct fear memories in the lateral amygdala. *Nat. Neurosci.* 10, 414–416.
- Drew, M.R., Zupan, B., Cooke, A., Couvillon, P.A., Balsam, P.D., 2005. Temporal control of conditioned responding in goldfish. *J. Exp. Psychol. Anim. Behav. Process.* 31, 31–39.
- Dudai, Y., 2012. The restless engram: consolidations never end. *Annu. Rev. Neurosci.* 35, 227–247.
- Dunsmoor, J.E., Bandettini, P.A., Knight, D.C., 2008. Neural correlates of unconditioned response diminution during Pavlovian conditioning. *Neuroimage* 40, 811–817.
- Duvarci, S., Nader, K., LeDoux, J.E., 2005. Activation of extracellular signal-regulated kinase-mitogen-activated protein kinase cascade in the amygdala is required for memory reconsolidation of auditory fear conditioning. *Eur. J. Neurosci.* 21, 283–289.
- Duvarci, S., Popa, D., Paré, D., 2011. Central amygdala activity during fear conditioning. *J. Neurosci.* 31, 289–294.
- Eichenbaum, H., 2013. Memory on time. *Trends Cogn. Sci.* 17, 81–88.
- Freeman, J.H., Steinmetz, A.B., 2011. Neural circuitry and plasticity mechanisms underlying delay eyeblink conditioning. *Learn. Mem.* 18, 666–677.
- Furlong, T.M., Cole, S., Hamlin, A.S., McNally, G.P., 2010. The role of prefrontal cortex in predictive fear learning. *Behav. Neurosci.* 124, 574–586.
- Gibbon, J., 1991. Origins of scalar timing. *Learn. Motiv.* 22, 3–38.
- Goossens, K.A., Maren, S., 2001. Contextual and auditory fear conditioning are mediated by the lateral, basal, and central amygdaloid nuclei in rats. *Learn. Mem.* 8, 148–155.
- Goossens, K.A., Hobin, J.A., Maren, S., 2003. Auditory-evoked spike firing in the lateral amygdala and Pavlovian fear conditioning: mnemonic code or fear bias? *Neuron* 40, 1013–1022.
- Groshek, F., Kerfoot, E., McKenna, V., Polackwich, A.S., Gallagher, M., Holland, P.C., 2005. Amygdala central nucleus function is necessary for learning, but not expression, of conditioned auditory orienting. *Behav. Neurosci.* 119, 202–212.
- Han, J.H., Kushner, S.A., Yiu, A.P., Hsiang, H.L., Buch, T., Waisman, A., Bontempi, B., Neve, R.L., Frankland, P.W., Josselyn, S.A., 2009. Selective erasure of a fear memory. *Science* 323, 1492–1496.
- Hegoburu, C., Sevelings, Y., Thévenet, M., Gervais, R., Parrot, S., Mouly, A.M., 2009. Differential dynamics of amino acid release in the amygdala and olfactory cortex during odor fear acquisition as revealed with simultaneous high temporal resolution microdialysis. *Learn. Mem.* 16, 687–697.
- Heinbockel, T., Pape, H.C., 2000. Input-specific long-term depression in the lateral amygdala evoked by theta frequency stimulation. *J. Neurosci.* 20, RC68.
- Herry, C., Bach, D.R., Esposito, F., Di Salle, F., Perrig, W.J., Scheffler, K., Lüthi, A., Seifritz, E., 2007. Processing of temporal unpredictability in human and animal amygdala. *J. Neurosci.* 27, 5958–5966.
- Hoefler, C.A., Cowansage, K.K., Arnold, E.C., Banko, J.L., Moerke, N.J., Rodriguez, R., Schmidt, E.K., Kloss, E., Chorev, M., Lloyd, R.E., Pierre, P., Wagner, G., LeDoux, J.E., Klann, E., 2011. Inhibition of the interactions between eukaryotic initiation factors 4E and 4G impairs long-term associative memory consolidation but not reconsolidation. *Proc. Natl. Acad. Sci. U. S. A.* 108, 3383–3388.
- Holland, P.C., Gallagher, M., 2003. Double dissociation of the effects of lesions of basolateral and central amygdala on conditioned stimulus-potentiated feeding and Pavlovian-instrumental transfer. *Eur. J. Neurosci.* 17, 1680–1694.
- Holland, P.C., Petrovich, G.D., 2005. A neural systems analysis of the potentiation of feeding by conditioned stimuli. *Physiol. Behav.* 86, 747–761.
- Humeau, Y., Lüthi, A., 2007. Dendritic calcium spikes induce bi-directional synaptic plasticity in the lateral amygdala. *Neuropharmacology* 52, 234–243.
- Humeau, Y., Shaban, H., Bissière, S., Lüthi, A., 2003. Presynaptic induction of heterosynaptic associative plasticity in the mammalian brain. *Nature* 426, 841–845.
- Humeau, Y., Herry, C., Kemp, N., Shaban, H., Fourcaudot, E., Bissière, S., Lüthi, A., 2005. Dendritic spine heterogeneity determines afferent-specific Hebbian plasticity in the amygdala. *Neuron* 45, 119–131.
- Johansen, J.P., Hamanaka, H., Monfils, M.H., Behnia, R., Deisseroth, K., Blair, H.T., LeDoux, J.E., 2010a. Optical activation of lateral amygdala pyramidal cells instructs associative fear learning. *Proc. Natl. Acad. Sci. U. S. A.* 107, 12692–12697.
- Johansen, J.P., Tarpley, J.W., LeDoux, J.E., Blair, H.T., 2010b. Neural substrates for expectation-modulated fear learning in the amygdala and periaqueductal gray. *Nat. Neurosci.* 13, 979–986.
- Johansen, J.P., Cain, C.K., Ostroff, L.E., LeDoux, J.E., 2011. Molecular mechanisms of fear learning and memory. *Cell* 147, 509–524.
- Johnson, L.R., Hou, M., Ponce-Alvarez, A., Gribelyuk, L.M., Alphas, H.H., Albert, L., Brown, B.L., LeDoux, J.E., Doyère, V., 2008. A recurrent network in the lateral amygdala: a mechanism for coincidence detection. *Front. Neural Circuits* 2, 3.
- Kaschel, T., Schubert, M., Albrecht, D., 2004. Long-term depression in horizontal slices of the rat lateral amygdala. *Synapse* 53, 141–150.
- Kent, B.A., Brown, T.H., 2012. Dual functions of perirhinal cortex in fear conditioning. *Hippocampus* 22, 2068–2079.
- Knapaska, E., Macias, M., Mikosz, M., Nowak, A., Owczarek, D., Wawrzyniak, M., Pieprzyk, M., Cymerman, I.A., Werka, T., Sheng, M., Maren, S., Jaworski, J., Kaczmarek, L., 2012. Functional anatomy of neural circuits regulating fear and extinction. *Proc. Natl. Acad. Sci. U. S. A.* 109, 17093–17098.
- LeDoux, J.E., 2000. Emotion circuits in the brain. *Annu. Rev. Neurosci.* 23, 155–184.
- LeDoux, J.E., Cicchetti, P., Xagoraris, A., Romanski, L.M., 1990. The lateral amygdaloid nucleus: sensory interface of the amygdala in fear conditioning. *J. Neurosci.* 10, 1062–1069.
- Lee, T., Kim, J.J., 2004. Differential effects of cerebellar, amygdalar, and hippocampal lesions on classical eyeblink conditioning in rats. *J. Neurosci.* 24, 3242–3250.
- Lee, H.J., Gallagher, M., Holland, P.C., 2010. The central amygdala projection to the substantia nigra reflects prediction error information in appetitive conditioning. *Learn. Mem.* 17, 531–538.

- Li, S.S., McNally, G.P., 2013. The conditions that promote fear learning: prediction error and Pavlovian fear conditioning. *Neurobiol. Learn. Mem.* (Epub ahead of print).
- Li, Y., Meloni, E.G., Carlezon, W.A., Milad, M.R., Pitman, R.K., Nader, K., Bolshakov, V.Y., 2013. Learning and reconsolidation implicate different synaptic mechanisms. *Proc. Natl. Acad. Sci. U. S. A.* 110, 4798–4803.
- Lin, H.C., Wang, S.J., Luo, M.Z., Gean, P.W., 2000. Activation of group II metabotropic glutamate receptors induces long-term depression of synaptic transmission in the rat amygdala. *J. Neurosci.* 20, 9017–9024.
- MacDonald, C.J., Lepage, K.Q., Eden, U.T., Eichenbaum, H., 2011. Hippocampal time cells bridge the gap in memory for discontinuous events. *Neuron* 71, 737–749.
- Maddox, S.A., Schafe, G.E., 2011. The activity-regulated cytoskeletal-associated protein (Arc/Arg3.1) is required for reconsolidation of a Pavlovian fear memory. *J. Neurosci.* 31, 7073–7082.
- Maddox, S.A., Monsey, M.S., Schafe, G.E., 2010. Early growth response gene 1 (Egr-1) is required for new and reactivated fear memories in the lateral amygdala. *Learn. Mem.* 18, 24–38.
- Maddox, S.A., Watts, C.S., Doyère, V., Schafe, G.E., 2013a. A naturally-occurring histone acetyltransferase inhibitor derived from *Garcinia indica* impairs newly acquired and reactivated fear memories. *PLoS ONE* 8, e54463.
- Maddox, S.A., Watts, C.S., Schafe, G.E., 2013b. p300/CBP histone acetyltransferase activity is required for newly acquired and reactivated fear memories in the lateral amygdala. *Learn. Mem.* 20, 109–119.
- Maren, S., 2000. Auditory fear conditioning increases CS-elicited spike firing in lateral amygdala neurons even after extensive overtraining. *Eur. J. Neurosci.* 12, 4047–4054.
- Maren, S., Quirk, G.J., 2004. Neuronal signalling of fear memory. *Nat. Rev. Neurosci.* 5, 844–852.
- Matthews, A.R., He, O.H., Buhusi, M., Buhusi, C.V., 2012. Dissociation of the role of the prelimbic cortex in interval timing and resource allocation: beneficial effect of norepinephrine and dopamine reuptake inhibitor nomifensine on anxiety-inducing distraction. *Front. Integr. Neurosci.* 6, 111.
- McDannald, M., Kerfoot, E., Gallagher, M., Holland, P.C., 2004. Amygdala central nucleus function is necessary for learning but not expression of conditioned visual orienting. *Eur. J. Neurosci.* 20, 240–248.
- McHugh, S.B., Marques-Smith, A., Li, J., Rawlins, J.N., Lowry, J., Conway, M., Gilmour, G., Tricklebank, M., Bannerman, D.M., 2013. Hemodynamic responses in amygdala and hippocampus distinguish between aversive and neutral cues during Pavlovian fear conditioning in behaving rats. *Eur. J. Neurosci.* 37, 498–507.
- McNally, G.P., Westbrook, R.F., 2006. Predicting danger: the nature, consequences, and neural mechanisms of predictive fear learning. *Learn. Mem.* 13, 245–253.
- McNally, G.P., Johansen, J.P., Blair, H.T., 2011. Placing prediction into the fear circuit. *Trends Neurosci.* 34, 283–292.
- Meck, W.H., Macdonald, C.J., 2007. Amygdala inactivation reverses fear's ability to impair divided attention and make time stand still. *Behav. Neurosci.* 121, 707–720.
- Metereau, E., Dreher, J.C., 2013. Cerebral correlates of salient prediction error for different rewards and punishments. *Cereb. Cortex* 23, 477–487.
- Molet, M., Miguez, G., Cham, H.X., Miller, R.R., 2012. When does integration of independently acquired temporal relationships take place? *J. Exp. Psychol. Anim. Behav. Process.* 38, 369–380.
- Moses, S.N., Houck, J.M., Martin, T., Hanlon, F.M., Ryan, J.D., Thoma, R.J., Weisend, M.P., Jackson, E.M., Pekkonen, E., Tesche, C.D., 2007. Dynamic neural activity recorded from human amygdala during fear conditioning using magnetoencephalography. *Brain Res. Bull.* 71, 452–460.
- Muller, J., Corodimas, K.P., Fridel, Z., LeDoux, J.E., 1997. Functional inactivation of the lateral and basal nuclei of the amygdala by muscimol infusion prevents fear conditioning to an explicit conditioned stimulus and to contextual stimuli. *Behav. Neurosci.* 111, 683–691.
- Nader, K., Schafe, G.E., LeDoux, J.E., 2000. Fear memories require protein synthesis in the amygdala for reconsolidation after retrieval. *Nature* 406, 722–726.
- Nader, K., Majidshad, P., Amoranpanth, P., LeDoux, J.E., 2001. Damage to the lateral and central, but not other, amygdaloid nuclei prevents the acquisition of auditory fear conditioning. *Learn. Mem.* 8, 156–163.
- Neves, G., Cooke, S.F., Bliss, T.V., 2008. Synaptic plasticity, memory and the hippocampus: a neural network approach to causality. *Nat. Rev. Neurosci.* 9, 65–75.
- Ohyama, T., Mauk, M., 2001. Latent acquisition of timed responses in cerebellar cortex. *J. Neurosci.* 21, 682–690.
- Orsini, C.A., Maren, S., 2012. Neural and cellular mechanisms of fear and extinction memory formation. *Neurosci. Biobehav. Rev.* 36, 1773–1802.
- Ostrov, L.E., Cain, C.K., Bedont, J., Monfils, M.H., LeDoux, J.E., 2010. Fear and safety learning differentially affect synapse size and dendritic translation in the lateral amygdala. *Proc. Natl. Acad. Sci. U. S. A.* 107, 9418–9423.
- Pape, H.C., Narayanan, R.T., Smid, J., Stork, O., Seidenbecher, T., 2005. Theta activity in neurons and networks of the amygdala related to long-term fear memory. *Hippocampus* 15, 874–880.
- Paré, D., Collins, D.R., 2000. Neuronal correlates of fear in the lateral amygdala: multiple extracellular recordings in conscious cats. *J. Neurosci.* 20, 2701–2710.
- Paré, D., Duvvarci, S., 2012. Amygdala microcircuits mediating fear expression and extinction. *Curr. Opin. Neurobiol.* 22, 717–723.
- Parkinson, J.A., Robbins, T.W., Everitt, B.J., 2000. Dissociable roles of the central and basolateral amygdala in appetitive emotional learning. *Eur. J. Neurosci.* 12, 405–413.
- Pavlov, I.P., 1927. *Conditional Reflexes*. Dover Publications, New York.
- Paz, R., Pelletier, J.G., Bauer, E.P., Paré, D., 2006. Emotional enhancement of memory via amygdala-driven facilitation of rhinal interactions. *Nat. Neurosci.* 9, 1321–1329.
- Petrovich, G.D., Ross, C.A., Mody, P., Holland, P.C., Gallagher, M., 2009. Central, but not basolateral, amygdala is critical for control of feeding by aversive learned cues. *J. Neurosci.* 29, 15205–15212.
- Plakke, B., Freeman, J.H., Poremba, A., 2009. Metabolic mapping of rat forebrain and midbrain during delay and trace eyeblink conditioning. *Neurobiol. Learn. Mem.* 92, 335–344.
- Ploski, J.E., Pierre, V.J., Smucny, J., Park, K., Monsey, M.S., Overeem, K.A., Schafe, G.E., 2008. The activity-regulated cytoskeletal-associated protein (Arc/Arg3.1) is required for memory consolidation of pavlovian fear conditioning in the lateral amygdala. *J. Neurosci.* 28, 12383–12395.
- Popescu, A.T., Popa, D., Paré, D., 2009. Coherent gamma oscillations couple the amygdala and striatum during learning. *Nat. Neurosci.* 12, 801–807.
- Quirk, G.J., Repa, C., LeDoux, J.E., 1995. Fear conditioning enhances short-latency auditory responses of lateral amygdala neurons: parallel recordings in the freely behaving rat. *Neuron* 15, 1029–1039.
- Quirk, G.J., Armony, J.L., LeDoux, J.E., 1997. Fear conditioning enhances different temporal components of tone-evoked spike trains in auditory cortex and lateral amygdala. *Neuron* 19, 613–624.
- Repa, J.C., Muller, J., Apergis, J., Desrochers, T.M., Zhou, Y., LeDoux, J.E., 2001. Two different lateral amygdala cell populations contribute to the initiation and storage of memory. *Nat. Neurosci.* 4, 724–731.
- Rescorla, R.A., Wagner, A.R., 1972. A theory of Pavlovian conditioning: variations in the effectiveness of reinforcement and nonreinforcement. In: Black, A.H., Prokasy, W.F. (Eds.), *Classical Conditioning II: Current Research and Theory*. Appleton Century Crofts, New York, pp. 64–99.
- Roesch, M.R., Calu, D.J., Esber, G.R., Schoenbaum, G., 2010. Neural correlates of variations in event processing during learning in basolateral amygdala. *J. Neurosci.* 30, 2464–2471.
- Rogan, M.T., Stäubli, U.V., LeDoux, J.E., 1997. Fear conditioning induces associative long-term potentiation in the amygdala. *Nature* 390, 604–607.
- Romanski, L.M., Clugnet, M.C., Bordi, F., LeDoux, J.E., 1993. Somatosensory and auditory convergence in the lateral nucleus of the amygdala. *Behav. Neurosci.* 107, 444–450.
- Rorick-Kehn, L.M., Steinmetz, J.E., 2005. Amygdalar unit activity during three learning tasks: eyeblink classical conditioning, Pavlovian fear conditioning, and signaled avoidance conditioning. *Behav. Neurosci.* 119, 1254–1276.
- Rosenkranz, J.A., Grace, A.A., 2002. Dopamine-mediated modulation of odour-evoked amygdala potentials during pavlovian conditioning. *Nature* 417, 282–287.
- Sakamoto, T., Endo, S., 2010. Amygdala, deep cerebellar nuclei and red nucleus contribute to delay eyeblink conditioning in C57BL/6 mice. *Eur. J. Neurosci.* 32, 1537–1551.
- Schafe, G.E., Atkins, C.M., Swank, M.W., Bauer, E.P., Sweatt, J.D., LeDoux, J.E., 2000. Activation of ERK/MAP kinase in the amygdala is required for memory consolidation of pavlovian fear conditioning. *J. Neurosci.* 20, 8177–8187.
- Schafe, G.E., Doyère, V., LeDoux, J.E., 2005. Tracking the fear engram: the lateral amygdala is an essential locus of fear memory storage. *J. Neurosci.* 25, 10010–10014.
- Schultz, W., 2013. Updating dopamine reward signals. *Curr. Opin. Neurobiol.* 23, 229–238.
- Seidenbecher, T., Laxmi, T.R., Stork, O., Pape, H.C., 2003. Amygdalar and hippocampal theta rhythm synchronization during fear memory retrieval. *Science* 301, 846–850.
- Seymour, B., O'Doherty, J.P., Koltzenburg, M., Wiech, K., Frackowiak, R., Friston, K., Dolan, R., 2005. Opponent appetitive-aversive neural processes underlie predictive learning of pain relief. *Nat. Neurosci.* 8, 1234–1240.
- Sigurdsson, T., Doyère, V., Cain, C.K., LeDoux, J.E., 2007. Long-term potentiation in the amygdala: a cellular mechanism of fear learning and memory. *Neuropharmacology* 52, 215–227.
- Sutton, R.S., Barto, A.G., 1981. Toward a modern theory of adaptive networks: expectation and prediction. *Psychol. Rev.* 88, 135–170.
- Suzuki, W.A., 2008. Associative learning signals in the brain. *Prog. Brain Res.* 169, 305–320.
- Thompson, R.F., Steinmetz, J.E., 2009. The role of the cerebellum in classical conditioning of discrete behavioral responses. *Neuroscience* 162, 732–755.
- Toyomitsu, Y., Nishijo, H., Uwano, T., Kuratsu, J., Ono, T., 2002. Neuronal responses of the rat amygdala during extinction and reassociation learning in elementary and configural associative tasks. *Eur. J. Neurosci.* 15, 753–768.
- Tsvetkov, E., Shin, R.M., Bolshakov, V.Y., 2004. Glutamate uptake determines pathway specificity of long-term potentiation in the neural circuitry of fear conditioning. *Neuron* 41, 139–151.
- Uwano, T., Nishijo, H., Ono, T., Tamura, R., 1995. Neuronal responsiveness to various sensory stimuli, and associative learning in the rat amygdala. *Neuroscience* 68, 339–361.
- Weinberger, N.M., 2007. Auditory associative memory and representational plasticity in the primary auditory cortex. *Hear. Res.* 229, 54–68.

- Weisskopf, M.G., Bauer, E.P., LeDoux, J.E., 1999. L-type voltage-gated calcium channels mediate NMDA-independent associative long-term potentiation at thalamic input synapses to the amygdala. *J. Neurosci.* 19, 10512–10519.
- Wilensky, A.E., Schafe, G.E., LeDoux, J.E., 1999. Functional inactivation of the amygdala before but not after auditory fear conditioning prevents memory formation. *J. Neurosci.* 19, RC48, 1–5.
- Wilensky, A.E., Schafe, G.E., Kristensen, M.P., LeDoux, J.E., 2006. Rethinking the fear circuit: the central nucleus of the amygdala is required for the acquisition, consolidation, and expression of Pavlovian fear conditioning. *J. Neurosci.* 26, 12387–12396.
- Wood, K.H., Ver Hoef, L.W., Knight, D.C., 2012. Neural mechanisms underlying the conditioned diminution of the unconditioned fear response. *Neuroimage* 60, 787–799.



## Publications and communications

### Publications

- **Talbot L.**, Diaz-Mataix L., Perry R., LeDoux J.E., Mouly A-M., Sullivan R.M & Doyère V. Ontogeny of temporal prediction error in rats. In prep.
- **Talbot L.**, Capela D, Brown B.L. & Doyère V. Individual trial analysis evidences clock and non-clock based conditioned suppression behaviors in rats. *Behavioural Processes* (in press)
- **Talbot L.**, Doyère V. & Sullivan, R. M. Developmental emergence of fear/threat learning: Neurobiology, associations and timing. *Genes, Brain and Behavior* (2015)
- Diaz-Mataix L., **Talbot L.** & Doyère, V. The amygdala: A potential player in timing CS-US intervals. *Behavioural Processes* (2014) 101, 112-122.

### Communications

- 12-15 september 2015: **Poster** for the European Brain and Behavior Association (EBBS) in Verona, Italy. Title: “Temporal error detection in pre-weaning rats.”
- 14-15 october 2014: **Oral presentation** for the GDR Multielectrodes in IMAGIF, Gif-sur-Yvette, France. Title: “Temporal expectancy in fear conditioning.”
- 31 march – 3 april 2014: **Poster** for the COST TIMELY conference in Corfu, Greece on Time and Temporal Perception. Title: “Interval timing in aversive conditioning: Neural correlates in amygdala and related networks in rats.”
- 15 november 2013: **Oral presentation** for the last meeting of the PUF (Partner University Fund) in New York, USA between the teams of Dr. Valérie Doyère, Dr. Regina Sullivan, Dr. Joe LeDoux, Dr. Bruce Brown, Dr. Anne-Marie Mouly and Dr. Sylvie Droit-Volet. Title: “Temporal anticipation in fear conditioning: An analysis of local field potential (LFP) in the amygdalo-prefronto-striatal network.”
- 24-26 september 2013: **Poster** for the MCC (Neural circuits for adaptive control of behavior ) in Paris, France. Title: “Temporal anticipation in fear conditioning: a coherence analysis in LFP in the amygdalo-prefronto-striatal network early in training.”
- 28 june 2013: **Oral presentation** for the meeting of the ANR Emotion(s) - Cognition – Comportement on Psychological Time. University Blaise Pascal, Clermont-Ferrand, France. Title: “Encoding and memorisation of time: Role of the amygdalo-prefronto-striatal network in anticipatory processes.”



## Résumé en français

### Chapitre 1 : Introduction générale

Le temps est une dimension essentielle de la vie. Il est nécessaire entre autres pour réaliser des mouvements coordonnés, communiquer mais aussi prendre des décisions. En effet, en formant des cartes temporelles, il nous est possible de relier les événements de notre quotidien (Cole et al, 1995), nous donnant une notion de cause à effet ainsi que des capacités d'anticipation dans des situations connues. Un dysfonctionnement des capacités temporelles est corrélé à un plus faible quotient intellectuel ainsi qu'à d'autres troubles cognitifs. Les malades atteints d'autisme, de la maladie de Parkinson, de la maladie de Huntington, mais également de la maladie d'Alzheimer, présentent des troubles de leurs fonctions temporelles. Il est essentiel de mieux comprendre comment le cerveau détecte, encode et mémorise des durées car c'est une base fondamentale de l'apprentissage.

La recherche dans le domaine du temps peut être divisée en trois grandes catégories, suivant les durées impliquées : le temps des millisecondes, le temps des intervalles (« interval timing ») et le temps circadien (pour revue, voir Buhusi & Meck, 2005). L'*interval timing* prend en compte des durées de quelques centaines de millisecondes à quelques heures et est l'objet de cette thèse. Les rythmes circadiens, quant à eux, jouent un rôle dans la prise de nourriture, dans le cycle veille-sommeil, ainsi que dans l'hibernation et d'autres rythmes saisonniers naturels. Les structures impliquées dans les rythmes circadiens sont majoritairement les noyaux suprachiasmatiques présents dans l'hypothalamus. L'étude des cycles circadiens étant un domaine de recherche à part entière, je n'approfondirai pas ce sujet. Pour l'ordre des millisecondes, le cervelet semble être la structure essentielle. Ce type de mesure temporelle est nécessaire pour l'habileté motrice et la coordination fine, elle est donc utilisée pour le langage, la musique ou la marche par exemple.

C'est l'*interval timing* qui est impliqué dans la prise de décision et la formation de cartes temporelles d'évènements. Les structures impliquées sont très diverses et incluent le striatum et le cortex préfrontal. De plus, ce type de mesures temporelles suit la loi de Weber, donnant ce qu'on appelle la propriété scalaire. Cette propriété implique que la précision temporelle est proportionnelle à la durée mesurée (ce qui signifie qu'il est plus facile de discriminer 2s de 4s que 32s de 34s même si la différence entre les deux durées est la même).



De nombreuses tâches ont été développées pour étudier les capacités temporelles, elles peuvent être séparées en deux catégories suivant si elles impliquent un processus temporel implicite ou explicite, c'est-à-dire si la réussite de la tâche nécessite d'avoir une notion précise des durées ou non. La majorité des tâches utilisées dans la recherche sont des tâches explicites, mais il a été montré que le temps est impliqué dans énormément de situations, dont le cas du conditionnement Pavlovien associatif. Dans le conditionnement Pavlovien, un stimulus conditionné (SC, souvent un son ou une lumière) est présenté en proximité temporelle avec un stimulus inconditionné (SI), soit appétitif comme de la nourriture, soit aversif comme un choc électrique, qui induit des réponses comportementales inconditionnées. Après plusieurs présentations de cette association, le SC va induire la production de réponses comportementales conditionnées (RC) liées au SI. De manière intéressante, dans ce type de paradigme, le temps est appris très rapidement mais il n'est exprimé dans des comportements instrumentaux qu'après surentraînement (Balsam et al, 2002 ; Davis et al, 1989 ; Diaz-Mataix et al, 2013a ; Drew et al, 2005). En effet il est intéressant de noter que certains comportements présentent un caractère temporel tôt dans l'apprentissage comme l'accélération de la nage chez le poisson rouge (Balsam et al, 2002) ou le changement de rythme respiratoire chez le rat (Shionoya et al, 2013).

Il existe de nombreux modèles qui décrivent une horloge interne, cet outil qui permettrait de mesurer les intervalles temporels. Les principaux modèles sont des modèles dits à pacemaker, dont le plus connu est celui de la « Scalar Expectancy Theory » (SET ; Gibbon, 1977). Il est constitué d'une partie horloge, qui contient un pacemaker qui produit les tics de l'horloge et un accumulateur qui les additionne, et d'une partie mémoire où les durées sont stockées, pour ensuite permettre la comparaison entre le nombre de tics engrangés au moment présent par rapport aux précédentes durées mémorisées. Finalement, le résultat de la comparaison est utilisé pour prendre une décision sur l'action à effectuer.

Un autre modèle, basé sur le SET, a cherché à trouver des bases neurobiologiques pour cette horloge interne, il s'agit du « Striatum Beat Frequency » modèle (SBF) (Matell & Meck, 2000). Le cortex préfrontal jouerait le rôle de producteur et d'accumulateur des tics, tandis que le striatum servirait de comparateur entre les durées mémorisées et les durées mesurées au moment présent. Il existe aussi des modèles sans pacemaker comme le modèle de Staddon et Higga (1999) où l'indice utilisé pour mesurer le temps qui passe est le déclin de la force du

souvenir (qui suit une fonction similaire à une fonction logarithmique).

Il existe plusieurs hypothèses sur les bases neurobiologiques de cette horloge interne. La première est qu'il existe un réseau central, constitué du cortex préfrontal et des ganglions de la base, qui s'occuperait de mesurer les intervalles de temps de manière globale et le cervelet serait, lui, impliqué dans la mesure des millisecondes. Une deuxième hypothèse est que le temps est une capacité intrinsèque des structures neuronales et qu'il est présent de manière ubiquitaire. Et la dernière hypothèse est une théorie mixte où le réseau central interagirait avec des structures spécifiques à la situation pour mesurer et encoder les durées (Merchant et al, 2013).

De manière générale, de très nombreuses structures ont été associées avec l'encodage temporel que ce soit des régions corticales ou sous-corticales. Toutefois, certaines structures ressortent lors de l'analyse de ces données : cortex préfrontal, striatum et hippocampe sont souvent corrélés avec les durées mesurées que ce soit dans des études de l'activité de neurones individuels ou de populations de neurones.

L'amygdale est une structure essentielle pour l'apprentissage Pavlovien aversif, et elle joue également un rôle dans la détection d'erreur (c'est-à-dire la comparaison entre les événements actuels et les événements prédits). Le temps étant un élément essentiel de l'apprentissage associatif, il semble logique de penser que l'amygdale jouerait un rôle dans l'encodage des relations temporelles entre SC et SI. Toutefois, il existe très peu d'études électrophysiologiques sur cette thématique (pour revue, voir Diaz-Mataix et al, 2014), alors qu'elles présentent un intérêt certain car les études lésionnelles ont pour problème qu'elles empêchent l'apprentissage de l'association. C'est pourquoi nous nous sommes intéressés à enregistrer l'activité neuronale dans un réseau de structures afin de déterminer comment le temps est encodé au niveau oscillatoire.

Le travail de cette thèse a été dédié à l'étude des corrélats neuronaux de la durée dans une tâche d'apprentissage associatif simple dans laquelle le temps est appris comme base de l'association, mais un schéma de réponses précis dans le temps n'est pas nécessaire. Nous nous sommes concentrés sur un réseau neuronal connectant le cortex préfrontal avec le striatum dorsal et l'amygdale basolatérale. Pour déterminer le rôle de ce réseau neuronal dans l'apprentissage temporel, nous avons utilisé deux approches complémentaires : électrophysiologique et neurodéveloppementale.

## Chapitre 2 : Etude du comportement temporel dans une tâche de suppression conditionnée

La réponse de « freezing » (immobilité complète de l'animal liée au stress) ne présente pas de modulation temporelle précise. C'est pourquoi nous avons utilisé la tâche de suppression conditionnée pour étudier la précision temporelle chez le rat dans un apprentissage Pavlovien aversif. Cette tâche nécessite un apprentissage initial d'une réponse instrumentale, qui sera ensuite modulée par la présentation du SC. Ici, nous avons entraîné des rats à appuyer sur un levier pour obtenir de la nourriture, avec un intervalle de renforcement variable, de façon à ce que les rats répondent de manière continue au cours de la séance. Nous avons ensuite introduit un SC associé à un choc électrique léger sur les pattes, ce qui induit une diminution du comportement d'appui sur levier (i.e. la suppression conditionnée). En ajoutant des essais avec le SC seul, nous pouvons observer l'effet du SC en dehors du SI.

De manière classique, les tâches utilisées pour étudier le temps sont des tâches instrumentales appétitives. Or, les bases neurobiologiques de l'apprentissage Pavlovien aversif sont mieux connues que celles de l'apprentissage instrumental, d'où l'intérêt de mieux caractériser le comportement temporel dans une tâche Pavlovienne aversive. Nous avons démontré que la réponse de suppression conditionnée chez le rat suit un schéma similaire à celui observé dans les tâches instrumentales. En effet, le comportement moyen sur les séances se présente sous la forme d'une courbe Gaussienne avec un pic (i.e. maximum de suppression) proche du temps attendu du renforcement, tandis que le comportement sur les essais individuels suit un schéma en trois états (haut taux – bas taux – haut taux de réponse). Toutefois nous observons dans notre tâche une anticipation du pic de réponse qui n'est pas observée dans la littérature en situation appétitive instrumentale.

Pour déterminer l'origine de cette anticipation, nous avons analysé les essais individuels. Nous avons donc déterminé les moments de passage entre les états haut et bas de suppression, appelés temps de début et de fin (« start » et « stop »). Nous avons ainsi caractérisé trois types de comportements de suppression : « précoce », « tardif » et « mauvais » selon si la phase pré-SC était prise en compte dans l'analyse. Les suppressions « précoces » expliquent en partie l'anticipation du pic de réponse. De plus, lors de ces essais, le comportement ne présente pas une forme biphasique d'appuis sur levier au moment du temps de « start », laissant penser qu'il n'est pas dépendant de l'horloge interne.

De plus, nous avons aussi voulu déterminer comment le comportement temporel était modifié par l'insertion d'une pause dans le SC, aussi appelée « gap ». Quand un gap d'une durée de 1/5<sup>ème</sup> de la durée de l'intervalle SC-SI est inséré à 1/5<sup>ème</sup> de l'intervalle après le début du SC, il induit un comportement d'arrêt de l'horloge, c'est-à-dire que l'animal n'accumule pas le temps du gap mais maintient en mémoire la durée de SC qui a précédé le gap. Nous avons donc validé cette tâche de conditionnement aversif qui peut être utilisé pour l'étude de l'expression de l'apprentissage temporel.

### Chapitre 3 : Corrélats neurologiques du traitement temporel

L'analyse électrophysiologique dans des paradigmes de mémoire et d'apprentissage est en plein essor. Ces techniques permettent de plus en plus une analyse fine de la communication intra et inter-structures et cela chez l'animal vigile. Il est donc possible d'étudier en temps réel comment des structures interagissent lors d'un apprentissage tout en mesurant des réponses comportementales. Il semble de plus en plus évident qu'aucun comportement même très simple ne dépend que d'une seule structure, d'où l'intérêt grandissant d'étudier l'interaction entre structures. Pour cela l'analyse des oscillations est très intéressante car elle apporte un niveau supérieur d'encodage de l'information par rapport à l'activité unitaire.

Pour ce qui est de l'apprentissage temporel, les oscillations semblent un outil parfait pour encoder des durées de manière simple. Un « tic » pourrait correspondre un cycle d'oscillations. Un large spectre de durées peut être encodé en utilisant l'activation simultanée de multiples oscillateurs ; en effet, si des oscillateurs sont actifs pour une petite période de leur cycle, alors les périodes où plusieurs oscillateurs sont actifs sont rares (Miall, 1989). L'accélération ou le ralentissement de l'horloge, suite à l'administration de diverses drogues, pourrait s'expliquer par un changement de fréquence des oscillateurs impliqués. D'ailleurs, le modèle SBF implique une activation des neurones épineux du striatum par les oscillations du cortex préfrontal (Matell & Meck, 2000). Bien entendu, un oscillateur ne serait probablement pas un neurone, mais plutôt une petite population neuronale.

Nous avons enregistré les potentiels de champ locaux de notre circuit d'intérêt (amygdalo-préfronto-striatal) au début d'un apprentissage Pavlovien aversif, ainsi qu'après surentraînement dans la tâche de suppression conditionnée décrite précédemment. En

changeant les règles temporelles apprises dans ces deux cas, il nous a été possible d'extraire des corrélats neuronaux dépendants du temps. Cela nous a donc permis de déterminer les similarités entre un stade où le temps est appris, mais non exprimé comportementalement, et un stade où un comportement temporel est produit. Pour le groupe de début d'apprentissage, nous avons modulé la durée de l'intervalle SC-SI afin d'observer des modifications de l'activité cérébrale. Pour le groupe en surentraînement, nous avons utilisé l'insertion du « gap » dans le SC comme modulation temporelle ; en effet, comme le « gap » produit un décalage du comportement temporel, on peut s'attendre à observer un décalage similaire des corrélats neuronaux dépendants du temps.

Nous avons observé une modulation positive de la puissance des oscillations thêta dans le cortex pré-limbique et le striatum dorso-médian ainsi qu'une augmentation de la cohérence entre ces deux structures au début d'apprentissage, mais pas après surentraînement. Nous avons également noté une modulation négative de la puissance des ondes bêta dans le striatum qui est maintenue avec le surentraînement, alors qu'une modulation des ondes bêta au niveau de l'amygdale basolatérale n'a été observée qu'au début de l'apprentissage. Enfin, nous n'avons pas pu caractériser de manière précise le rôle des oscillations gamma dans l'apprentissage temporel à cause d'effets non spécifiques associés aux sons utilisés. Toutefois les données en surentraînement manquent de puissance statistique à cause d'un faible nombre d'animaux enregistrés.

Nos résultats mettent en évidence l'implication de notre réseau d'intérêt dans le traitement de l'intervalle SC-SI. Cependant, de nombreuses analyses sont encore nécessaires pour décortiquer le rôle de ce réseau d'intérêt dans l'encodage des intervalles de temps, comme par exemple, le couplage inter-fréquences ainsi que la direction du signal entre structures en regardant le délai entre deux signaux. De plus, il s'agit ici d'une étude descriptive, il sera nécessaire de tester la causalité entre ces corrélats neuronaux et l'apprentissage temporel, peut-être en utilisant des techniques telles que l'optogénétique ou les DREADD (Designer Receptors Exclusively Activated by Designer Drugs).

#### Chapitre 4 : Détection d'erreurs temporelles chez le raton avant-sevrage

Afin de déterminer si le striatum et le cortex préfrontal sont vraiment nécessaires à l'apprentissage temporel, nous avons testé la capacité de raton pré-sevrage à détecter des

changements d'intervalles temporels, car ces structures sont immatures à cet âge. Chez l'adulte, le changement inattendu du moment d'arrivée du SI déclenche une phase de labilité de la trace mnésique, la rendant sensible à un blocage de la synthèse protéique au niveau de l'amygdale (Diaz-Mataix et al, 2013). Cette mémoire est ensuite stabilisée à nouveau, c'est ce qu'on appelle la reconsolidation. En effet, lors d'un apprentissage, un souvenir va d'abord passer par une phase labile où il est sensible à diverses modulations dites amnésiantes, avant de se stabiliser, c'est ce qu'on appelle la consolidation. La reconsolidation est la seconde phase de stabilisation qui suit un rappel de l'apprentissage initial. Il apparaît que présenter un stimulus associé avec l'apprentissage va réactiver le souvenir et le rendre de nouveau labile ; toutefois la situation de réactivation doit être légèrement différente de la situation d'apprentissage sinon le processus n'est pas enclenché.

Nous avons décidé d'utiliser ce protocole chez le raton afin de déterminer s'il peut détecter un changement dans des intervalles appris à long-terme (ici 24h). La première étape a été de déterminer si la reconsolidation existe bien chez le raton. Il existe très peu d'articles sur la reconsolidation chez le jeune (Gruest et al, 2004 ; Languille et al, 2008 et Languille et al, 2009) ; de plus, le type de conditionnement utilisé (apprentissage d'aversion gustative) ne peut pas être modulé temporellement. Nous avons donc d'abord utilisé le test classique de la reconsolidation après conditionnement classique son-choc, c'est-à-dire que la phase de réactivation consiste en la présentation du SC seul. Nous avons bien observé la diminution attendue de la réponse de peur (ici le *freezing* était mesuré), 24h après la réactivation chez les animaux injectés avec de la rapamycine, un inhibiteur de synthèse protéique, comparé aux animaux contrôles.

Nous avons ensuite modulé l'intervalle SC-SI lors de la réactivation, soit plus tard, soit plus tôt. A la place de la diminution attendue du souvenir, nous avons observé une augmentation de l'immobilité après changement de l'intervalle SC-SI uniquement chez les animaux injectés avec la rapamycine. Nous n'avons observé aucun effet de la rapamycine lorsque nous n'avons pas changé l'intervalle SC-SI.

En regardant chez des animaux plus âgés, considérés comme adolescents, nous n'avons pas observé d'effet de la rapamycine sur la reconsolidation après changement de l'intervalle SC-SI. Toutefois, chez l'adulte nous avons bien obtenu la diminution de *freezing* attendue après détection d'erreur temporelle et injection de rapamycine.

Nous avons donc démontré que des rats avant le sevrage sont capables de mémoriser et différencier des intervalles de temps, malgré le fait qu'ils présentent un striatum et un cortex préfrontal immatures. Nous faisons l'hypothèse qu'à cet âge, l'amygdale est suffisante pour encoder et rappeler des intervalles impliqués dans un apprentissage très dépendant de l'amygdale. Il est possible que l'apprentissage temporel chez le raton soit dépendant de structures spécifiques aux tâches utilisées, ce qui pourrait expliquer pourquoi cet apprentissage est moins précis chez le bébé et l'enfant humain que chez l'adulte. Avec le développement et l'ajout du circuit préfronto-striatal, des tâches temporelles plus complexes et plus précises sont possibles.

### Conclusion

Au cours de cette thèse, nous avons cherché à mieux caractériser le rôle du réseau amygdalo-préfronto-dorsostriatal dans le traitement de l'information temporelle dans le cadre d'une tâche d'apprentissage Pavlovien aversif. Nous avons choisi cette tâche car sa neurobiologie est très décrite dans la littérature, et elle permet une manipulation simple des composantes temporelles, ne requiert pas un apprentissage long et représente un aspect implicite de l'apprentissage temporel. En effet, dans cette tâche, le rat n'a pas de nécessité d'avoir un sens temporel précis pour avoir une bonne performance car ce qui lui arrive n'est pas dépendant de son comportement.

Nous avons caractérisé des corrélats neuronaux modulés par le temps chez des animaux au début d'apprentissage (donc non dépendant d'une réponse comportementale) et après surentraînement. Ces résultats présentent des courbes de type logarithmique dans les fréquences bêta qui pourraient représenter le déclin de la trace du souvenir décrit comme étant la base de notre sens temporel par Staddon & Higga (1999).

Nos résultats nous amènent à conclure que le circuit sous-tendant nos capacités temporelles est constitué d'une boucle cortico-striatale à laquelle s'ajoute des structures spécifiques suivant les nécessités de la tâche, comme l'amygdale dans un apprentissage émotionnel. Il semble normal que les mécanismes temporels soient très redondants, car un sens du temps semble essentiel à la vie.









**Titre :** Traitement de l'information temporelle dans le réseau amygdalo-préfronto-dorsostriatal chez le rat

**Mots clés :** potentiels de champ locaux, intervalles de temps, développement, prédiction d'erreur, conditionnement associatif

**Résumé :** Le temps est une dimension essentielle de la vie. Il est nécessaire, entre autres, pour réaliser des mouvements coordonnés, pour communiquer, mais aussi dans la prise de décisions. L'objectif principal de cette thèse était de caractériser le rôle d'un réseau amygdalo-préfronto-dorsostriatal dans la mémorisation et l'encodage du temps chez le rat. Dans un premier temps, nous avons décrit le comportement temporel du rat lors d'une tâche de suppression conditionnée (i.e. la suppression d'une réponse instrumentale d'appui sur levier par la présentation d'un son associé à un stimulus aversif), démontrant ainsi un contrôle temporel fin du comportement dans une situation Pavlovienne aversive. Dans un deuxième temps, nous avons analysé les potentiels de champs locaux (analyse fréquentielle des activités oscillatoires) de notre réseau d'intérêt au début d'un apprentissage

associatif et après surentraînement dans la tâche de suppression conditionnée. En effet, le comportement temporel moteur nécessite un grand nombre de séances d'apprentissage pour devenir optimal, alors que l'apprentissage temporel est, lui, très rapide. Cette étude nous a permis de caractériser des corrélats neuronaux temporels au sein de ce réseau, que ce soit au niveau des structures individuelles ou au niveau de l'interaction entre ces structures. De plus, ces corrélats neuronaux sont modifiés selon le niveau d'entraînement des animaux. Enfin, dans une troisième étude, nous avons démontré que des rats juvéniles (pré-sevrage), qui présentent un cortex préfrontal ainsi qu'un striatum dorsal immatures, peuvent mémoriser et différencier des intervalles de temps, ouvrant donc la question sur le rôle de ce réseau dans l'apprentissage temporel au cours du développement.

**Title:** Temporal processing in the amygdalo-prefronto-dorsostriatal network in rats

**Keywords:** local field potentials, interval timing, development, error prediction, associative conditioning

**Abstract:** Time is an essential dimension of life. It is necessary for coordinating movement, for communication, but also for decision-making. The principal goal of this work was to characterize the role of an amygdalo-prefronto-dorsostriatal network in the memorization and encoding of time in a rat model. Firstly, we described temporal behavior in a conditioned suppression task (i.e. the suppression of an instrumental lever-pressing response for food by the presentation of a cue associated with an aversive event), therefore showing a precise temporal control in Pavlovian aversive conditioning. Secondly, we measured local field potentials in our network of interest at the beginning of associative learning and after overtraining in the conditioned suppression task.

In effect, motor temporal behavior requires a large number of training sessions to become optimum, but temporal learning happens very early in training. This study allowed us to characterize, using frequency analysis of oscillatory activities, neuronal correlates of time in this network both at the level of individual structures, but also in their interactions. Interestingly, these neural correlates were modified by the level of training. Finally, we demonstrated that juvenile rats (pre-weaning), with an immature prefrontal cortex and dorsal striatum, can memorize and discriminate temporal intervals, raising questions on the role of this amygdalo-prefronto-dorsostriatal network in temporal learning during development.