



**HAL**  
open science

# Classical and quantum particles interacting with their environment: stability analysis and asymptotic issues

Léo Vivion

► **To cite this version:**

Léo Vivion. Classical and quantum particles interacting with their environment: stability analysis and asymptotic issues. Number Theory [math.NT]. Université Côte d'Azur, 2020. English. NNT: 2020COAZ4039 . tel-03135254

**HAL Id: tel-03135254**

**<https://theses.hal.science/tel-03135254>**

Submitted on 8 Feb 2021

**HAL** is a multi-disciplinary open access archive for the deposit and dissemination of scientific research documents, whether they are published or not. The documents may come from teaching and research institutions in France or abroad, or from public or private research centers.

L'archive ouverte pluridisciplinaire **HAL**, est destinée au dépôt et à la diffusion de documents scientifiques de niveau recherche, publiés ou non, émanant des établissements d'enseignement et de recherche français ou étrangers, des laboratoires publics ou privés.



# THÈSE DE DOCTORAT

Particules classiques et  
quantiques en interaction avec  
leur environnement : analyse de  
stabilité et problèmes  
asymptotiques

**Léo VIVION**

Laboratoire de Mathématiques J.A. Dieudonné (LJAD)

**Présentée en vue de l'obtention  
du grade de docteur en Sciences  
d'Université Côte d'Azur**

**Dirigée par** : Thierry Goudon

**Soutenue le** : 8 septembre 2020

**Devant le jury, composé de :**

David Chiron, MCF, Université Côte d'Azur

Isabelle Gallagher, PR, ENS Paris

Thierry Goudon, DR, INRIA

Daniel Han-Kwan, CR, École Polytechnique

Mikaela Iacobelli, PR, ETH Zürich

Clément Mouhot, PR, Cambridge University

Frédéric Rousset, PR, Université Paris-Sud



---

PARTICULES CLASSIQUES ET QUANTIQUES EN  
INTERACTION AVEC LEUR ENVIRONNEMENT : ANALYSE  
DE STABILITÉ ET PROBLÈMES ASYMPTOTIQUES

---

Soutenue devant le jury, composé de :

---

---

David CHIRON	MCF	Université Côte d'Azur	Examinateur
Isabelle GALLAGHER	PR	ENS Paris	Examinatrice
Thierry GOUDON	DR	INRIA	Directeur de Thèse
Daniel HAN-KWAN	CR	École Polytechnique	Examinateur
Mikaela IACOBELLI	PR	ETH Zürich	Examinatrice
Clément MOUHOT	PR	Cambridge University	Rapporteur
Frédéric ROUSSET	PR	Université Paris-Sud	Rapporteur

---

---

**Résumé :** Au début des années 2000, inspirés par les travaux fondateurs de A.O. Caldeira et A.J. Leggett, L. Bruneau et S. de Bièvre ont introduit un modèle hamiltonien décrivant les échanges d'énergie entre une particule classique et son environnement, ce modèle étant tel que l'environnement agit sur la particule comme une force de friction. D'un côté ce modèle a été étendu au cas de plusieurs particules et, lorsque le nombre de particules considérées est très grand, un modèle cinétique a également été dérivé. Dans la suite ce modèle sera appelé système *Vlasov-Onde*. De l'autre, comme ce modèle est hamiltonien il est possible de considérer une version quantique de celui-ci. Nous appellerons un tel modèle système *Schrödinger-Onde*. L'objet de cette thèse est l'étude asymptotique de certaines dynamiques des systèmes Vlasov et Schrödinger-Onde.

Dans le cas cinétique il existe des solutions stationnaires telles que la densité de particule dans l'espace des phases soit spatialement homogène. Dans ce cas, par analogie avec le système Vlasov-Poisson, nous nous sommes posé la question de l'existence d'un effet d'amortissement Landau pour de petites perturbations de ces solutions particulières. Nous avons dans un premier temps obtenu un nouveau critère de stabilité linéaire qui nous a ensuite permis de démontrer, en adaptant les travaux de J. Bedrossian, N. Masmoudi, C. Mouhot et C. Villani, un effet d'amortissement Landau non linéaire dans le cas de l'espace entier et du tore. Nous avons en particulier obtenu de nouvelles contraintes (provenant de l'interaction avec l'environnement) sur le taux d'amortissement et nous avons fait le lien entre les équilibres stables du système Vlasov-Onde et ceux du système Vlasov-Poisson, notamment en justifiant qu'un des paramètres du système joue un rôle analogue à la longueur de Jeans dans le cas Vlasov-Poisson attractif. Cette étude théorique est complétée par une étude numérique qui nous a permis de conforter notre compréhension de l'impact des paramètres intervenant dans le système Vlasov-Onde sur la dynamique de ces solutions.

Dans le cas du système Schrödinger-Onde nous nous sommes posé la question de la possibilité de mettre en évidence un effet de friction, provenant du milieu et agissant sur la particule quantique. Pour ce faire nous avons dans un premier temps justifié l'existence d'ondes solitaires (ces solutions particulières où la dispersion de l'équation de Schrödinger est parfaitement compensée par un effet attractif) ainsi que la stabilité orbitale des états fondamentaux (une onde solitaire minimisant l'énergie sous une contrainte de masse). Ce résultat de stabilité orbitale nous assure alors qu'une perturbation d'un état fondamental reste en tout temps proche de celui-ci modulo les invariances du système, ici translation et changement de phase. En particulier un état fondamental peut potentiellement se *déplacer* et nous avons étudié l'existence d'un effet de friction à travers ce possible *déplacement*. Si dans le cas Schrödinger-Newton l'invariance galiléenne assure l'existence d'états fondamentaux se déplaçant en ligne droite à vitesse constante, le système Schrödinger-Onde ne possède pas cette invariance et l'analogie avec le cas classique suggère que la vitesse de *déplacement* va nécessairement converger vers zéro. Cette conjecture a été étudiée et confirmée numériquement.

Les deux études numériques esquissées précédemment ont nécessité le développement d'une discrétisation temporelle des équations prenant en compte la forme des interactions entre les particules et l'environnement afin de garantir que les échanges d'énergie au niveau discret sont *consistants* avec ceux au niveau continu.

**Mots clefs :** Équations de type Vlasov, particules interagissant avec leur environnement, Amortissement Landau, gaz de Lorentz inélastiques, systèmes quantiques ouverts, équations de type Schrödinger, états fondamentaux, stabilité orbitale, méthode des éléments finis, schémas semi-lagrangien.

**Abstract:** At the beginning of the 2000's, inspired by the pioneering works of A.O. Caldeira and A.J. Leggett, L. Bruneau and S. de Bièvre introduced an Hamiltonian model describing exchanges of energy between a classical particle and its environment in a way that these exchanges lead to a friction effect on the particle. On one hand this model has been extended to the case of several particles and, when the number of particle is large, a kinetic model has also been derived. Hereafter this model will be referred as the *Vlasov-Wave* system. On the other hand, since this model is Hamiltonian, it is possible to consider its quantum version. We call this new model the *Schrödinger-Wave* system. The aim of this thesis is to study the asymptotic of particular dynamics of the Vlasov and Schrödinger-Wave systems.

In the kinetic case there exists stationary solutions such that the particle density in the phase space is spatially homogeneous. Then, by analogy with the Vlasov-Poisson system we considered the question of the existence of a Landau damping effect for small perturbations of these particular solutions. We obtain a new linear stability criterion which allows us then to obtain, by adapting the works of J. Bedrossian, N. Masmoudi, C. Mouhot and C. Villani, a proof of non linear Landau damping in the free space and torus cases. In particular we exhibit new constraints (due to the interactions with the environment) on damping rates. We also exhibit a link between stable equilibria of the Vlasov-Wave system and those for the Vlasov-Poisson system and we highlight the similarity between a parameter of the system and the Jeans' length in the attractive Vlasov-Poisson case. This study led to a numerical one which allows us to reinforce our comprehension on the role of the system's parameters, more precisely on their role on solutions' dynamic.

In the Schrödinger-Wave case we investigated the possibility of highlighting a friction effect on the quantum particle coming from the environment. As a first step we justify the existence of solitary waves (these solutions where the dispersion of the Schrödinger equation is perfectly compensated by an attractive effect) and the orbital stability of ground states (a solitary wave minimizing the energy under a mass constraint). This orbital stability result insures that a small perturbation of a ground state stays, up to the equation's invariances (here translation and change of phase), close to it uniformly in time. Then a ground state might possibly *move* and we study the existence of a friction effect through this possible *displacement*. If in the Schrödinger-Newton case the Galilean invariance allows to construct a solution which is a ground states moving on a straight line at constant momentum, the Schrödinger-Wave system is not Galilean invariant and the analogy with the classical case suggested that the momentum of a *moving* ground state converges to zero. This conjecture has been studied and confirmed numerically.

The numerical investigations require the development of a time discretization of the considered equations taking into account the expression of the interactions between particles and the environment in order to insure that the energy exchanges at numerical ground are *consistent* with those at continuous level.

**Key words:** Vlasov-like equations, interacting particles, Landau damping, inelastic Lorentz gas, open quantum system, Schrödinger-like equations, ground states, orbital stability, finite elements method, semi-Lagrangian schemes.



<b>1</b>	<b>Introduction générale</b>	<b>1</b>
1.1	Le contexte physique . . . . .	1
1.2	Le modèle de L. Bruneau et S. De Bièvre . . . . .	4
1.2.1	Le rôle de la dimension $n$ des membranes . . . . .	6
1.2.2	Le rôle des oscillations transverses . . . . .	7
1.3	Extension aux cas cinétiques et quantiques . . . . .	8
1.3.1	Le système Vlasov-Onde : version cinétique de (1.3a)–(1.3b) . . . . .	9
1.3.2	Le système Schrödinger-Onde : version quantique de (1.3a)–(1.3b) . . . . .	11
1.4	Contributions et perspectives . . . . .	12
1.4.1	Amortissement Landau pour le modèle Vlasov-Onde . . . . .	13
1.4.2	Investigation d’un effet de friction quantique à travers l’étude d’ondes solitaires . . . . .	17
1.4.3	Approximations numériques . . . . .	21
1.4.4	Gaz de Lorentz inélastique non dissipatif . . . . .	23
<b>2</b>	<b>Landau damping in dynamical Lorentz gases</b>	<b>35</b>
2.1	Introduction . . . . .	35
2.1.1	Preliminaries . . . . .	38
2.1.2	Rewriting the equations . . . . .	38
2.1.3	Homogeneous solutions . . . . .	39
2.1.4	Equations for the fluctuations . . . . .	40
2.1.5	The kernel $p_c$ . . . . .	42
2.2	Linearized Landau damping . . . . .	47
2.2.1	The linearized system . . . . .	47
2.2.2	Linearized Landau damping in finite regularity . . . . .	49
2.2.3	Linearized Landau damping in analytic regularity . . . . .	58
2.2.4	Stability criterion for large wave speeds . . . . .	61
2.3	Non linear Landau damping: the free space problem . . . . .	62
2.3.1	Functional framework . . . . .	63
2.3.2	Main result . . . . .	70
2.3.3	Estimate of the $L^2_{(k)}L^2_{(t)}$ norm of $A_{s_4}\widehat{\varrho}$ . . . . .	74
2.4	Non linear Landau damping: periodic framework . . . . .	78
2.4.1	Functional framework . . . . .	79



2.4.2	Main result . . . . .	85
2.4.3	Bootstrap analysis: sketch of proof of Proposition 2.4.12 . . . . .	89
2.5	Discussion of the stability criterion . . . . .	92
2.5.1	Towards a Landau-Penrose criterion . . . . .	93
2.5.2	Computations of Laplace transforms for the Penrose criterion . . . . .	97
2.5.3	Stable and unstable states . . . . .	100
<b>3</b>	<b>Numerical investigation of Landau damping in dynamical Lorentz gases</b>	<b>105</b>
3.1	Introduction . . . . .	105
3.2	Discretization of the wave equation with a transparent boundary condition . . . . .	111
3.2.1	Radially symmetric wave equation . . . . .	111
3.2.2	Discretization of the radial wave equation (3.14a)–(3.14c). . . . .	112
3.3	Discretization of (3.1a)–(3.1b) . . . . .	113
3.4	Discretization of (3.7a)–(3.7b) . . . . .	115
3.4.1	Time-discretisation . . . . .	116
3.4.2	Discretisation of the kinetic equation with the PFC scheme . . . . .	117
3.5	Discrete energy balance . . . . .	118
3.5.1	The one-particle model . . . . .	119
3.5.2	The kinetic model . . . . .	121
3.6	Numerical results . . . . .	122
3.6.1	Simulations for a single particle . . . . .	124
3.6.2	Simulations for $N$ particles . . . . .	130
3.6.3	Simulations for the Vlasov equation . . . . .	137
3.7	Conclusion . . . . .	142
<b>4</b>	<b>On quantum dissipative systems: ground states and orbital stability</b>	<b>145</b>
4.1	Introduction . . . . .	145
4.1.1	Motivation . . . . .	145
4.1.2	Solitary waves . . . . .	149
4.2	Main results . . . . .	150
4.2.1	Ground states . . . . .	151
4.2.2	Orbital stability . . . . .	152
4.2.3	Strengthened orbital stability . . . . .	152
4.3	Existence of ground states: proof of Theorem 4.2.1 . . . . .	158
4.4	Orbital stability: concentration-compactness approach . . . . .	164
4.5	Strengthened orbital stability: approach by linearization . . . . .	167
4.6	Orbital stability on finite time for data with a high initial momentum . . . . .	169
4.7	Coercivity of $\mathcal{L}_+$ : proof of Lemma 4.2.8 . . . . .	173
4.8	Perturbation analysis: proof of Proposition 4.2.14 . . . . .	177
4.9	Admissible form functions: proof of Proposition 4.2.7 . . . . .	182
<b>5</b>	<b>Numerical investigation of solitary waves stability for dissipative systems</b>	<b>189</b>
5.1	Introduction . . . . .	189
5.1.1	Motivation . . . . .	192
5.1.2	Conjectures and main results . . . . .	193
5.2	Numerical results . . . . .	199
5.3	Numerical schemes . . . . .	201
5.3.1	Discretization of the Schrödinger-Wave system . . . . .	201
5.3.2	Computation of a ground state $(Q, \Psi)$ . . . . .	209

5.4	Discrete properties of the scheme . . . . .	211
<b>6</b>	<b>Particles subjected to a high random acceleration</b>	<b>221</b>
6.1	Introduction and mains results . . . . .	222
6.2	Sketch of the proof of Theorem 6.1.1 . . . . .	225
6.3	An example of random force field satisfying <b>(H2)</b> – <b>(H5)</b> . . . . .	228
<b>A</b>	<b>Additional details on non linear Landau damping in the free space case</b>	<b>233</b>
A.1	Remarks on the continuity of the solution with respect to the bootstrap norms	233
A.1.1	Local existence in $C^0([0, T], H_P^\sigma)$ . . . . .	233
A.1.2	The Vlasov-Wave case . . . . .	235
A.1.3	Continuity with the last bootstrap's norms . . . . .	236
A.2	Bootstrap analysis: end of the proof of Proposition 2.3.9 . . . . .	237
A.2.1	Estimate of the $L_{(k)}^\infty L_{(t)}^2$ norm of $A_{s_2} \widehat{q}$ . . . . .	237
A.2.2	Estimates on $g$ : general approach . . . . .	239
A.2.3	Estimate of the $H_P^{s_4}$ norm of $\langle \nabla_v \rangle g(t)$ . . . . .	239
A.2.4	Estimate of the $H_P^{s_4}$ norm of $\langle \nabla_x \rangle g(t)$ . . . . .	247
A.2.5	Estimates of the $H_P^{s_3}$ norm of $ \nabla_x ^\delta g(t)$ . . . . .	250
A.2.6	Estimate of the $L_{(k, \xi)}^\infty$ norm of $\langle \nabla_{x,v} \rangle^{s_1} g(t)$ . . . . .	256
A.2.7	Integral estimates . . . . .	258
<b>B</b>	<b>Analytic Cauchy theory for the Vlasov-Wave system</b>	<b>261</b>
B.1	Difference with the free space problem . . . . .	261
B.2	Local analysis . . . . .	262
B.3	Extension of the strong analyticity property . . . . .	269
<b>C</b>	<b>Cauchy theory for the Schrödinger-Wave system</b>	<b>277</b>
<b>D</b>	<b>Semi-Classical analysis: from Schrödinger-Wave to Vlasov-Wave</b>	<b>285</b>



---

## List of Figures

---

1.1 Interactions entre la particule et le milieu . . . . .	5
1.2 Application de la formule de Duhamel dans le cas d'une d�corr�lation temporelle	26
1.3 Application de la formule de Duhamel dans le cas d'une d�corr�lation spatiale	28
1.4 Application de la formule de Duhamel dans le cas des variables doubl�es (cas $X_1 = X_{d+1}$ ) . . . . .	31
1.5 Application de la formule de Duhamel dans le cas des variables doubl�es (cas $X_1 \neq X_{d+1}$ ) . . . . .	31
2.1 Propagation cone . . . . .	46
3.1 Particle-wave interactions . . . . .	106
3.2 Single particle with a confining potential: phase portrait . . . . .	125
3.3 Single particle with a confining potential: evolution of the particle velocity . .	126
3.4 Single particle without external force: delay between the particle position and the potential . . . . .	127
3.5 Single particle without external force: phase portrait and velocity evolution .	128
3.6 Single particle with a constant force $\mathcal{F}$ . . . . .	129
3.7 Asymptotic speed versus strength of the external force . . . . .	130
3.8 Two particles in a confining potential, evolution of the velocities I . . . . .	131
3.9 Two particles in a confining potential, evolution of the velocities II . . . . .	131
3.10 Two particles in a confining potential, evolution of the mean velocity . . . . .	132
3.11 Two particles: weak interaction . . . . .	133
3.12 Two particles: weak interaction, evolution of the velocities . . . . .	133
3.13 Two particles: strong interaction . . . . .	134
3.14 Two particles: strong interaction, evolution of the velocities . . . . .	134
3.15 Two particles: strong interaction, phase portrait . . . . .	135
3.16 $N$ -particles, evolution of a cloud . . . . .	136
3.17 $N$ -particles, evolution of the mean velocity . . . . .	136
3.18 Kinetic model, evolution of the force field: cases $c \gg 1$ and $c \ll 1$ . . . . .	138
3.19 Kinetic model: the case $c \ll 1$ , the particles distribution function $F$ . . . . .	138
3.20 The case $n = 1$ : the force field . . . . .	139
3.21 The case $n = 1$ : the macroscopic density $\rho$ . . . . .	139
3.22 Kinetic model: the case $c = 1$ and $\lambda = 10$ . . . . .	141

3.23	Kinetic model, evolution of the force field: with $c = 0.1$ and $\lambda = 1$ and $c = 0.1$ and $\lambda = 0.25$ . . . . .	141
4.1	Two possible graphs representing $I_M, J_M, K_M$ as a function of the mass $M$ . . . . .	160
4.2	Illustration of the strategy . . . . .	183
5.1	The solitary wave $(Q_h, \Upsilon_h)$ of mass $M = 2$ . . . . .	199
5.2	Evolution of the energy when the imaginary time method is applied . . . . .	200
5.3	Evolution of the error term $\epsilon_h^1$ along time . . . . .	201
5.4	Evolution of the error term $\epsilon_h^2$ along time . . . . .	202
5.5	Evolution of the error term $\epsilon_h^3$ along time . . . . .	202
5.6	Evolution of the modulus of the wave function and of the potential . . . . .	203
5.7	Evolution of the real part of the wave function . . . . .	204
5.8	Exponential decay of $p_h^a(t)$ depending on $c$ . . . . .	205
5.9	Investigation of the proportionality between the exponential decay to zero of $p_h^a$ and $1/c$ . . . . .	205
B.1	Analyticity radius as a function of the time variable . . . . .	270





Bien que cette thèse soit une thèse de mathématiques, elle s'inscrit dans le champ de la physique mathématique et il me semble important avant toute chose de rappeler quel est le contexte physique sous-jacent ici ; une bonne compréhension de celui-ci permettant alors de mettre en perspective les résultats obtenus, de comprendre pourquoi les questions abordées dans cette thèse l'ont été, et enfin, d'avoir une idée plus précise des perspectives et applications de cette recherche.

Cette introduction va donc commencer par rappeler le contexte physique et aborder certaines problématiques de modélisation pour ensuite entrer réellement dans l'explication des résultats qu'apporte cette thèse à ce champ de recherche.

## 1.1 Le contexte physique

Le contexte physique sous-jacent tout au long de ce manuscrit est celui des phénomènes de dissipation d'énergie, un exemple particulièrement simple étant le cas d'un système classique (*i.e.* régit par les lois de la mécanique newtonienne) soumis à une force de friction. Dans ce cadre, un tel système est usuellement décrit par l'équation de friction linéaire suivante

$$\ddot{q}(t) = -\nabla_x V(q(t)) - \gamma \dot{q}(t), \quad \gamma > 0,$$

ou plus généralement par l'équation de friction non linéaire

$$\ddot{q}(t) = -\nabla_x V(q(t)) + F_{fric}^\mu(\dot{q}(t)), \quad F_{fric}(x) = -\gamma |x|^\mu \frac{x}{|x|}, \quad \mu \in \mathbb{R}. \quad (1.1)$$

Ici la fonction  $q : t \in \mathbb{R} \rightarrow \mathbb{R}^d$  représente la position du centre masse d'une particule classique (ex : une bille) soumise à un champ de force extérieure dérivant d'un potentiel  $V : x \in \mathbb{R}^d \rightarrow \mathbb{R}$  (ex : la gravité) ainsi qu'à une force de frottement provenant de l'interaction de cette particule avec un milieu extérieur (ex : frottement de l'air, de l'eau, etc). La force de friction  $F_{fric}$  dépend de deux paramètres  $\gamma > 0$  et  $\mu \in \mathbb{R}$  caractérisant le milieu extérieur et le régime considéré. À ce système est attachée une énergie

$$\mathcal{E}(t) = H(q(t), \dot{q}(t)) = \frac{1}{2} |\dot{q}(t)|^2 + V(q(t)),$$



qui, à cause de la force de friction, n'est pas conservée mais est décroissante au cours du temps

$$\frac{d}{dt}\mathcal{E}(t) = -\gamma|\dot{q}(t)|^{\mu+1} \leq 0.$$

L'équation (1.1) fournit donc un modèle simple de système dissipatif au niveau classique.

Il est à noter que les applications de ce modèle ne se limitent pas au cas d'une bille se déplaçant dans un fluide. Nous pouvons par exemple évoquer le modèle de Drude, dont un des objectifs est d'étudier la loi d'Ohm en électricité, et où  $q(t)$  représente cette fois-ci le mouvement en moyenne d'un électron se déplaçant dans un métal. Toutefois, dans ce genre de contexte où les objets physiques étudiés proviennent de l'infiniment petit, un modèle inscrit dans un cadre classique a bien souvent des limitations et il est alors préférable d'étudier ces phénomènes directement au niveau quantique. Dans le contexte de cette thèse, ceci amène naturellement à se poser la question de la possibilité de modéliser des effets de dissipation au niveau quantique.

Au niveau quantique une particule n'est plus modélisée par un point matériel mais par un objet mathématique appelé fonction d'onde  $u : t \in \mathbb{R} \mapsto u(t) \in L^2(\mathbb{R}^d, \mathbb{C})$  qui à chaque instant  $t$  associe une fonction à valeurs complexes de carré intégrable. La dynamique de cette fonction d'onde est régie par une équation de Schrödinger qui est l'équivalent au niveau quantique des équations de Newton :

$$i\partial_t u + \frac{1}{2}\Delta_x u = V u. \quad (1.2)$$

Ici l'équation de Schrödinger a été écrite dans le cas où la particule quantique étudiée est soumise au potentiel  $V$ . Dans ce cas cette équation peut être obtenue de façon systématique à partir du modèle classique

$$\ddot{q}(t) = -\nabla_x V(q(t)).$$

Au niveau classique, l'hamiltonien

$$H(q, p) = \frac{1}{2}|p|^2 + V(q)$$

est conservé et il existe une transformation canonique de celui-ci en un opérateur  $\hat{H}$  tel que l'équation de Schrödinger (1.2) puisse se ré-écrire à partir de cet opérateur :

$$i\partial_t u = \hat{H}u.$$

Il est à noter que cette construction est possible uniquement lorsqu'au niveau classique un hamiltonien est conservé. Le modèle quantique ainsi obtenu conserve alors le nouvel hamiltonien

$$\mathcal{H}(u) = \int_{\mathbb{R}^d} \hat{H}u \bar{u} dx = \frac{1}{2} \int_{\mathbb{R}^d} |\nabla_x u|^2 dx + \int_{\mathbb{R}^d} V |u|^2 dx,$$

et n'est donc pas un système dissipatif. En particulier, il est impossible à partir de cette méthode (appelée première quantification) d'obtenir à partir du modèle classique (1.1) un équivalent quantique de celui-ci.

La solution pour pallier ce problème et avoir des modèles de dissipation quantique va tout de même utiliser cette approche par opération de première quantification. Pour ce faire, il est important, pour commencer, de prendre conscience d'une limitation du modèle classique (1.1) : d'un point de vue conceptuel ce modèle est profondément ancré dans le cadre de la mécanique newtonienne et ne permet pas de penser la notion de friction en dehors de

celui-ci. Comme en mécanique newtonienne une particule est soumise à la somme des forces extérieures il *faut* que l'action du milieu soit modélisée par une force. Ensuite, cette force devant s'opposer au déplacement de la particule, il *faut* que sa direction soit l'opposée du vecteur vitesse et enfin on choisit (ou observe expérimentalement) qu'une force de la forme  $F_{\text{fric}}$  convient. La façon dont est construit ce modèle ne prend de sens que dans le cadre de la mécanique newtonienne et ne peut pas être adaptée de façon simple à d'autres cadres, tel que celui de la mécanique quantique.

Un premier pas important pour pouvoir étendre la notion de force de friction à d'autres cadres que celui de la mécanique classique est donc de repenser la notion de friction avec un langage ne dépendant pas de concepts spécifiques à la mécanique newtonienne. L'approche détaillée ci-après est parfaitement résumée par la citation suivante de A.O. Caldeira et A.J. Leggett tirée de [19, Section 3]

*[We] regard the “system” and its environment as together forming a closed system (the “universe”) which can be described by a Lagrangian or Hamiltonian, to solve (in principle!) for the motion of the whole and to derive from this solution a description of the properties of the system (which, of course, would now more properly be called a subsystem). In this picture **the phenomenon of dissipation is simply the transfer of energy from the single degree of freedom characterising the “system” to the very complex set of degrees of freedom describing the “environment”**; it is implicitly assumed that the energy, once transferred, effectively disappears into the environment and is not recovered within any time of physical interest.*

En paraphrasant cette citation, l'idée est la suivante. Tout d'abord le phénomène de friction est vu uniquement comme un cas particulier des effets de dissipation d'énergie. Ensuite, l'idée abstraite générale pour obtenir un système dissipant son énergie à un milieu extérieur est de considérer un modèle décrivant la particule, l'environnement et leurs interactions, de telle sorte que le système global soit un système hamiltonien réversible en temps et que l'interaction entre la particule et le milieu se fasse par transfert d'énergie de l'un à l'autre. Pour que la particule s'arrête (ou que sa vitesse converge vers zéro) il faut donc que celle-ci transmette toute son énergie cinétique au milieu et que celui-ci ne lui rende pas. Ceci pose le problème suivant : le fait que le milieu prenne de l'énergie à la particule mais ne lui rende pas est a priori incompatible avec un modèle réversible en temps. L'astuce est alors de remarquer qu'en terme d'ordre de grandeur, le milieu a un nombre de degrés de liberté bien supérieur à celui de la particule. Sur un intervalle de temps  $[t, t + \delta t]$  il est alors statistiquement très probable que la particule donne une partie de son énergie cinétique au milieu ; il est en revanche très peu probable que cette énergie lui soit redonnée dans sa globalité par le milieu. En effet, intuitivement, le scénario générique le plus probable à partir de la description ci-dessus est que, sur un petit intervalle de temps  $[t, t + \delta t]$  comme sur un grand intervalle de temps  $[t, +\infty)$ , l'énergie donnée par la particule au milieu se répartisse de façon uniforme sur tous les degrés de liberté du système global au cours du temps. En particulier une grande proportion de cette énergie est alors absorbée définitivement par le milieu.

Du point de vue de la modélisation cette nouvelle approche ne nécessite pas de description extrêmement précise des interactions *réelles* entre la particule considérée et le milieu. En particulier il est possible de considérer uniquement un milieu abstrait. Ce milieu abstrait est alors présent dans le modèle uniquement pour décrire les échanges d'énergie entre la particule et le milieu réel et n'a absolument pas vocation à décrire l'état précis du mi-

lieu réel. Dans la suite, ce que nous considérerons et appellerons *milieu* désignera donc ce milieu abstrait introduit uniquement pour décrire les échanges d'énergie entre la particule et le milieu réel mais n'ayant pas forcément de réalité physique. En particulier toutes les quantités faisant intervenir ce milieu n'ont pas de dimension.

La stratégie décrite ci-dessus a donné lieu à de nombreux développements et modèles (à titre d'exemple nous pouvons citer [2, 16, 27, 28, 29, 30, 40, 41, 42, 62, 64, 66, 96]) et nous renvoyons le lecteur intéressé à l'introduction de [66] ou encore à [16, Section 6]<sup>1</sup> où un formalisme général est développé et permet de faire le lien entre une grande partie de ces modèles.

## 1.2 Le modèle de L. Bruneau et S. De Bièvre

Dans cette thèse je me suis intéressé aux modèles cinétiques et quantiques provenant du modèle classique suivant, introduit par L. Bruneau et S. De Bièvre au début des années 2000 dans [16] :

$$\ddot{q}(t) = -\nabla_x V(q(t)) - \iint_{\mathbb{R}^d \times \mathbb{R}^n} \nabla_x \sigma_1(q(t) - y) \sigma_2(z) \psi(t, y, z) dy dz, \quad t \in \mathbb{R} \quad (1.3a)$$

$$(\partial_{tt}^2 \psi - c^2 \Delta_z \psi)(t, x, z) = -\lambda^2 \sigma_2(z) \sigma_1(x - q(t)), \quad t \in \mathbb{R}, x \in \mathbb{R}^d, z \in \mathbb{R}^n \quad (1.3b)$$

où  $t \mapsto q(t) \in \mathbb{R}^d$  représente la position du centre de masse de la particule au cours du temps,  $(t, x, z) \mapsto \psi(t, x, z) \in \mathbb{R}$  représente le milieu abstrait avec lequel la particule interagit et où  $x \in \mathbb{R}^d \mapsto \sigma_1(x)$  et  $z \in \mathbb{R}^n \mapsto \sigma_2(z)$  sont des fonctions de forme connues. Ces fonctions de forme seront supposées tout au long de ce manuscrit être  $C^\infty$  à support compact, à symétrie sphérique et telles que leur profil radial soit décroissant. Ce système est naturellement complété par le jeu de données initiales

$$(q(0), \dot{q}(0)) = (q_0, p_0), \quad (\psi(0, x, z), \partial_t \psi(0, x, z)) = (\psi_0(x, z), \psi_1(x, z)). \quad (1.4)$$

La vitesse de propagation des ondes  $c$  est un paramètre important du modèle. Nous verrons notamment que certains résultats ne sont valables que sous une contrainte sur la taille de  $c$ . Un peu plus loin nous verrons également que considérer le régime  $c \rightarrow +\infty$  aide à se forger des intuitions et apporte même des informations non triviales. C'est ici que le paramètre  $\lambda$  aura un rôle à jouer. Originellement, dans l'article [16], uniquement le régime  $\lambda = 1$  était considéré. Cependant, lorsque le régime  $c \rightarrow +\infty$  est considéré, prendre  $\lambda = 1$  conduit à des dynamiques assez peu intéressantes alors que considérer que  $\lambda$  et  $c$  ont le même ordre de grandeur (ce qu'on peut écrire simplement  $\lambda = c$ ) sera plus fructueux. Dans la suite, et suivant le contexte, nous considérerons  $\lambda = 1$  ou  $c$ .

Dans ce modèle il est important de noter que  $x \in \mathbb{R}^d$  est une variable de position (homogène à une longueur donc) alors que  $z \in \mathbb{R}^n$  est une variable transverse à la position  $x$  ; cette variable intervient uniquement dans la description du milieu et n'a pas de dimension. L'équation sur le milieu est une équation des ondes faisant intervenir uniquement l'opérateur Laplacien sur la variable  $z$ , le milieu est donc vu comme un milieu oscillant dans une direction transverse au déplacement de la particule.

L'idée intuitive derrière ce modèle, présentée dans [16] et illustrée en Figure 1.1, est la suivante. En chaque point  $x \in \mathbb{R}^d$  de l'espace physique le milieu est représenté par une membrane pouvant osciller dans une direction transverse. Lorsque la particule se déplace, à

<sup>1</sup>Cette Section n'est pas présente dans la version publiée de cet article.

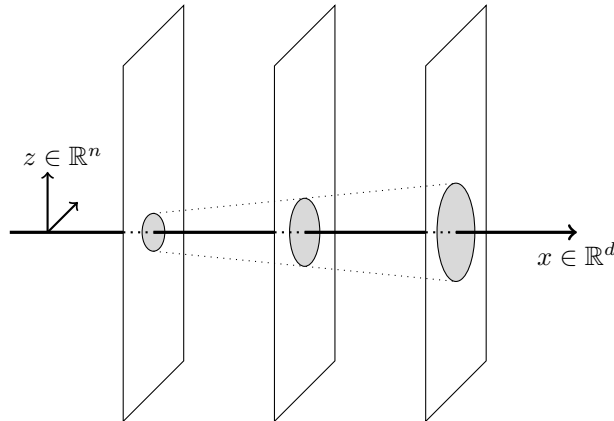

Figure 1.1: Interactions entre la particule et le milieu

chaque fois qu'elle heurte une membrane, elle l'active en lui donnant un peu de son énergie cinétique. Le modèle étant réversible, le milieu peut redonner une partie de cette énergie à la particule mais ces oscillations sont telles qu'il peut également disperser une partie de cette énergie en  $|z| \rightarrow +\infty$ . En particulier, en remarquant que le terme de force provenant du milieu et agissant sur la particule dans (1.3a) ne dépend du milieu que sur le support de  $\sigma_2$ , une fois qu'une oscillation du milieu sort du support de  $\sigma_2$ , l'énergie portée par cette oscillation est définitivement absorbée par le milieu. On s'attend donc qu'en temps grand la particule transmette toute son énergie cinétique au milieu.

Ce système est réversible en temps et conserve l'énergie  $\mathcal{E}_c(t) = H_c(q(t), \dot{q}(t), \psi(t), \partial_t \psi(t))$  où  $H_c$  est l'hamiltonien défini par

$$H_c(q, p, \psi, \chi) = \frac{1}{2}|p|^2 + V(q) + \iint \sigma_1(q-y)\sigma_2(z)\psi(y, z) dx dz + \frac{1}{2\lambda^2} \iint (|\chi|^2 + c^2|\nabla_z \psi|) dx dz.$$

De plus, dans le cas où la particule n'est pas soumise à un champ de force extérieur ( $V \equiv 0$ ), une autre quantité est conservée : le moment total  $\mathcal{P}_c(t) = P_c(\dot{q}(t), \psi(t), \partial_t \psi(t))$  où  $P_c$  est la fonctionnelle définie par

$$P_c(p, \psi, \chi) = p - \frac{1}{\lambda^2} \iint \chi \nabla_x \psi dx dz.$$

Dans ce même article, L. Bruneau et S. De Bièvre ont montré qu'asymptotiquement, dans le cas où la dimension  $n$  de l'espace où vit la variable transverse  $z$  est égal à 3, le milieu agit sur la particule comme une force de friction linéaire. L'énoncé suivant (légèrement imprécis sur certaines hypothèses techniques afin de rester concis, pour des énoncés exacts nous renvoyons le lecteur à [16, Theorems 2 & 4]) résume leurs résultats.

**Théorème 1.2.1** *Soit  $n = 3$ ,  $\lambda = 1$  et  $(q, \psi)$  une solution d'énergie finie de (1.3a)–(1.3b). Pour tout  $\eta \in (0, 1)$  il existe une vitesse de propagation des ondes critique  $c_0 = c_0(\eta) > 0$  et des constantes  $\gamma, K > 0$  telles que*

- Force constante : si  $V(x) = \mathcal{F} \cdot x$  où  $\mathcal{F}$  est un vecteur constant de  $\mathbb{R}^d$  petit devant  $c^{-1}$ , alors il existe une position  $q_\infty \in \mathbb{R}^d$  et une vitesse asymptotique  $v(\mathcal{F}) \in \mathbb{R}^d$  telles que pour tout  $c \geq c_0$ ,

$$|q_\infty + t v(\mathcal{F}) - q(t)| \leq K e^{-\frac{\gamma(1-\eta)}{c^3} t};$$

- Potentiel confinant : si  $V(x) \rightarrow_{|x| \rightarrow +\infty} +\infty$ , alors, lorsque  $t \rightarrow +\infty$ , la vitesse de la particule  $\dot{q}(t)$  converge vers 0 et sa position  $q(t)$  converge vers un point critique  $q^*$

du potentiel  $V$ . De plus, si  $q^*$  est un minimum non dégénéré de  $V$ , alors, pour tout  $c \geq c_0$ ,

$$|q(t) - q^*| \leq K e^{-\frac{\gamma(1-\eta)}{2c^3}t}.$$

Commentons brièvement ce résultat. Tout d'abord, le fait que cet énoncé justifie que le milieu agisse sur la particule comme une force de friction linéaire provient des taux de convergences qui sont en exponentielle décroissante. Par exemple, dans le cas où la particule n'est soumise à aucun champ de force extérieur (premier item avec  $\mathcal{F} = 0$ ), la vitesse asymptotique est calculable explicitement et on trouve  $v(\mathcal{F} = 0) = 0$ . Dans ce cas le théorème assure que la particule atteint une position d'équilibre avec un taux en exponentielle décroissante. Ce taux est exactement le même taux que la solution de (1.1) lorsque  $\mu = 1$ , d'où l'effet de friction linéaire. Intéressons nous ensuite à la contrainte sur la vitesse de propagation des ondes :  $c \geq c_0$ . Cette contrainte peut être comprise intuitivement de la façon suivante : une fois que la particule donne un peu de son énergie cinétique à une membrane, comme le système global est réversible en temps, le milieu peut redonner cette énergie à la particule. La contrainte  $c \geq c_0$  permet alors d'assurer que le milieu oscille suffisamment rapidement pour réussir à évacuer une partie de ce gain d'énergie hors du support de  $\sigma_2$  avant que la particule ne puisse récupérer en intégralité l'énergie cinétique qu'elle avait perdue. Il est à noter que cette contrainte est surtout importante pour obtenir les taux de convergence en exponentielle décroissante ; le deuxième point assure par exemple que la position de la particule va converger quel que soit la valeur de  $c$  (mais le taux de convergence exponentiel n'est obtenu que sous la contrainte  $c \geq c_0$ ). Enfin, terminons avec une remarque sur le taux de convergence exponentiel qui est proportionnel à  $c^{-3}$ . Il peut être surprenant que ce taux diminue lorsque  $c$  croît alors même que nous venons de dire que ces taux exponentiels ont nécessité la condition  $c \geq c_0$  pour être obtenus. Cette décroissance montre que la vitesse des ondes  $c$  influence également les échanges d'énergies entre la particule et le milieu. Si l'on considère une particule se déplaçant à la vitesse  $v$ , alors son interaction avec une membrane donnée a lieu sur un temps de l'ordre de  $R_1/|v|$  (où  $R_1$  désigne la taille du support de  $\sigma_1$ ). Il est alors possible de calculer l'énergie transférée par la particule au milieu sur cet intervalle de temps (cf [16, Section 2]) et de se rendre compte que ce transfert d'énergie diminue lorsque  $c$  croît. En particulier, plus  $c$  est grand, plus il faut du temps au milieu pour absorber toute l'énergie cinétique de la particule.

Avant d'introduire les modèles cinétiques et quantiques provenant de (1.3a)–(1.3b) qui seront étudiés dans ce manuscrit, j'aimerais m'attarder encore sur deux questions à propos de ce modèle : pourquoi la condition  $n = 3$  intervient dans le Théorème 1.2.1 ? et que se passe-t-il pour un modèle où les oscillations du milieu n'ont pas lieu dans des directions transverses au déplacement de la particule mais dans l'espace physique ?

### 1.2.1 Le rôle de la dimension $n$ des membranes

Pour comprendre le rôle de la dimension des membranes, les calculs effectués dans [16, Section 2] sont très instructifs. Ceux-ci consistent à calculer la réaction du milieu lorsqu'une particule se déplace à vitesse constante  $v$  ainsi que la force que cette réaction engendrerait dans le couplage (1.3a)–(1.3b) : pour  $q(t) = q_0 + tv$  il s'agit de résoudre (1.3b) puis, avec cette solution  $\psi_{q_0}^v(t)$ , de calculer

$$\mathcal{F}(v) = \iint \nabla_x \sigma_1(q_0 + tv - y) \sigma_2(z) \psi_{q_0}^v(t, y, z) dy dz.$$

Ceci conduit à

$$\mathcal{F}(v) = \mathcal{F}_r(|v|) \frac{v}{|v|}, \quad \mathcal{F}_r(|v|) < 0,$$

avec au voisinage de  $|v| = 0$

$$\mathcal{F}_r(|v|) = -\gamma \frac{\lambda^2}{c^2} \left( \frac{|v|}{c} \right)^{n-2} + o\left( \frac{|v|}{c} \right)^{n-2},$$

où  $\gamma > 0$  s'exprime explicitement en fonction de  $\sigma_1$  et  $\sigma_2$  uniquement (et est exactement la constante  $\gamma$  du Théorème 1.2.1). En particulier, pour de petites vitesses  $v$ , le milieu exerce une force de friction sur la particule qui peut être comparée à la force  $F_{fric}^\mu$  de (1.1). Cette force de friction est linéaire uniquement dans le cas  $n = 3$ . Dans le cas  $n \geq 4$  le milieu agit comme une force de friction non linéaire  $F_{fric}^\mu$  avec  $\mu \geq 2$  (il est intéressant de noter que pour (1.1), le cas  $\mu \geq 2$  et  $V \equiv 0$  conduit à une convergence vers 0 de la vitesse de la particule mais à une divergence de sa position :  $|q(t)| \rightarrow +\infty$ ). Les cas  $n = 1$  et  $2$  ne sont pas couverts par cette analyse, la formule obtenue pour le coefficient de friction  $\gamma$  n'ayant de sens que pour  $n \geq 3$ . Ceci vient essentiellement de l'intégrabilité ou non du noyau de Poisson. En particulier, les solutions stationnaires  $(q, p, \psi, \chi) = (q_0, 0, \Psi, 0)$  où  $-c^2 \Delta_z \Psi(x, z) = -\lambda^2 \sigma_2(z) \sigma_1(x - q_0)$ , sont d'énergie finie uniquement dans le cas  $n \geq 3$ .

### 1.2.2 Le rôle des oscillations transverses

Considérer l'équivalent du modèle de L. Bruneau et S. De Bièvre dans le cas d'oscillations non transversales revient à étudier le système suivant

$$\ddot{q}(t) = -\nabla_x V(q(t)) - \int_{\mathbb{R}^d} \nabla_x \sigma_1(q(t) - y) \psi(t, y) dy, \quad t \in \mathbb{R} \quad (1.5a)$$

$$(\partial_{tt}^2 \psi - c^2 \Delta_x \psi)(t, x) = -\lambda^2 \sigma_1(x - q(t)), \quad t \in \mathbb{R}, x \in \mathbb{R}^d, \quad (1.5b)$$

qui conserve le nouvel Hamiltonien

$$H(q, p, \psi, \chi) = \frac{1}{2} |p|^2 + V(q) + \int \sigma_1(q - x) \psi(x) dx + \frac{1}{2\lambda^2} \int (|\chi|^2 + c^2 |\nabla_x \psi|^2) dx.$$

La version relativiste de ce modèle a été étudiée par A. Komech, H. Spohn et M. Kunze à la fin des années 90 [64, 62]. Le couplage Maxwell-Lorentz qui consiste essentiellement à remplacer l'équation des ondes par les équations de Maxwell a également été étudié par les deux premiers auteurs dans [63]. Ce genre de modèle a été introduit pour étudier l'effet de Cherenkov (encore appelé amortissement par radiation) qui se produit lorsqu'une particule se déplace dans un champ oscillant avec une vitesse supérieure à celle de propagation des ondes du champ (tel un avion supersonique se déplaçant à une vitesse supérieure à celle du son dans l'air, bien que l'effet de Cherenkov fasse plutôt référence aux cas où une particule se déplace plus vite que la vitesse de la lumière dans le milieu considéré<sup>2</sup>).

Le comportement asymptotique de ce système diffère de celui de (1.3a)–(1.3b). Un exemple particulièrement évocateur est le cas où  $V \equiv 0$  pour lequel la vitesse de la particule converge, mais plus nécessairement vers 0. Il est en fait même possible dans ce cas

<sup>2</sup> Un tel phénomène n'entre pas en contradiction avec les postulats de la mécanique relativiste. Par exemple, dans un milieu tel que l'eau la vitesse de propagation de la lumière est de  $c \simeq 0.75c_0$  où  $c_0$  désigne ici la vitesse de la lumière dans le vide. En particulier il est bien possible pour une particule de se déplacer plus vite que  $c$  tout en ne dépassant pas  $c_0$ .

de construire des solutions d'énergie finie où la particule se déplace à vitesse constante :  $(q(t), \psi(t, x)) = (q_0 + tv, \Psi_v(x - q_0 - tv))$  où  $\Psi_v$  est déterminé par l'équation de Poisson

$$(|v|^2 - c^2)\Delta_x \Psi_v(x) = -\lambda^2 \sigma_1(x).$$

Notons que (1.3a)–(1.3b) admet également ce genre de solution :  $(q(t), \psi(t, x, z)) = (q_0 + tv, \Psi_v(x - q_0 - tv, z))$  où  $\Psi_v$  est cette fois-ci solution de

$$(|v|^2 \Delta_x - c^2 \Delta_z) \Psi_v(x, z) = -\lambda^2 \sigma_1(x) \sigma_2(z).$$

L'existence de telles solutions n'entre pas en contradiction avec le Théorème 1.2.1 car elles sont d'énergie infinie (contrairement au cas de (1.5a)–(1.5b) où elles sont d'énergie finie lorsque  $d \geq 3$ ). En effet, comme

$$\iint |\nabla_z \Psi_v|^2 dx dz = \iint \frac{\lambda^4 |\zeta|^2}{(c^2 |\zeta|^2 - |v|^2 |k|^2)^2} |\hat{\sigma}_1(k)|^2 |\hat{\sigma}_2(\zeta)|^2 dk d\zeta,$$

et comme  $\sigma_1$  et  $\sigma_2$  sont positives avec  $\hat{\sigma}_1(0) \neq 0$  et  $\hat{\sigma}_2(0) \neq 0$ , pour qu'une telle solution soit d'énergie finie il faut donc que

$$(k, \zeta) \in \mathbb{R}^d \times \mathbb{R}^n \mapsto \frac{|\zeta|^2}{(c^2 |\zeta|^2 - |v|^2 |k|^2)^2}$$

soit localement intégrable au voisinage de  $(0, 0)$ . Quelque soit les dimensions  $d$  et  $n$  considérées ce n'est jamais le cas. On voit ici apparaître l'importance de l'hypothèse de finitude de l'énergie dans le Théorème 1.2.1.

Cette hypothèse peut s'interpréter physiquement comme une hypothèse sur la température du milieu. En l'absence d'interaction avec une particule, supposer que le milieu est d'énergie finie permet d'utiliser la dispersion des ondes pour justifier qu'il va converger vers la position d'équilibre  $\psi \equiv 0$  où toutes les membranes sont au repos. A l'inverse, dans le cas où l'énergie du milieu est infinie, nous pouvons très bien imaginer une situation où il y a en permanence des ondes venant de "l'infini" et où les membranes n'atteignent alors jamais la position d'équilibre  $\psi \equiv 0$ . Ces oscillations permanentes des membranes sont alors interprétées comme étant l'agitation thermique interne du milieu. Le comportement asymptotique du système (1.3a)–(1.3b) est bien sûr très différent dans ce cas de figure. Une étude de la relation d'Einstein à temps fini a été faite dans [27] et [1, Chap. 6 et 7] lorsque le milieu n'est pas à température nulle.

En guise de conclusion, l'intérêt principal du système (1.3a)–(1.3b) est qu'il fournit un modèle hamiltonien d'interaction "particule/milieu" particulièrement simple tout en ayant la qualité de reproduire, dans le cas des petites vitesses, des interactions de type force de friction et notamment, de type force de friction linéaire lorsque  $n = 3$ .

### 1.3 Extension aux cas cinétiques et quantiques

Dans cette thèse je me suis principalement intéressé aux modèles cinétiques et quantiques dérivant du modèle de L. Bruneau et S. De Bièvre. Avant d'évoquer les résultats que j'ai obtenus, introduisons d'abord ces modèles en faisant un rapide panorama des résultats déjà existants.

### 1.3.1 Le système Vlasov-Onde : version cinétique de (1.3a)–(1.3b)

Le système (1.3a)–(1.3b) s'étend naturellement au cas de  $N$  particules en sommant l'action de toutes les particules sur le milieu :

$$\ddot{q}_i(t) = -\nabla_x V(q_i(t)) - \iint_{\mathbb{R}^d \times \mathbb{R}^n} \nabla_x \sigma_1(q_i(t) - y) \sigma_2(z) \psi(t, y, z) dy dz, \quad t \in \mathbb{R} \quad (1.6a)$$

$$(\partial_{tt}^2 \psi - c^2 \Delta_z \psi)(t, x, z) = -\lambda^2 \sigma_2(z) \sum_{j=1}^N \sigma_1(x - q_j(t)), \quad t \in \mathbb{R}, x \in \mathbb{R}^d, z \in \mathbb{R}^n \quad (1.6b)$$

où  $q_i$  désigne la position de la  $i$ -ième particule. Les résultats sur le comportement en temps long de ce système, même dans le cas  $N = 2$ , sont beaucoup plus faibles que dans le cas d'une seule particule. Ceci provient des échanges d'énergie qui sont bien plus complexes lorsque deux particules sont proches : typiquement, lorsque  $|q_i(t) - q_j(t)| \leq R_1$  (où  $R_1$  désigne la taille du support de  $\sigma_1$ ) la particule  $q_i$  échange de l'énergie avec les membranes au voisinage de la particule  $q_j$ , énergie qui peut ensuite être donnée par les membranes à la particule  $q_j$ . Le mieux qui ait été obtenu pour ce système est un travail récent de A. Vavasseur [104] où il est démontré dans le cas  $n = 3$  que la vitesse des particules converge vers 0 et que leur position converge en un minimum du potentiel  $V$ . Cependant, aucun taux de convergence n'est obtenu, même sous une contrainte du type  $c \geq c_0$ .

Lorsque le nombre  $N$  de particules est grand il est classique d'utiliser une approche statistique pour décrire ce genre de système. Cette approche consiste à étudier la densité de probabilité de présence des particules dans l'espace des phases  $(t, x, v) \mapsto F(t, x, v)$  plutôt que la trajectoire individuelle de chacune des particules. À partir du système à  $N$  particules une limite de champ moyen peut être effectuée pour obtenir le système cinétique suivant, que nous appellerons équation de Vlasov-Onde tout au long de ce manuscrit et qui régit la dynamique de la densité de particules  $F$  :

$$\partial_t F + v \cdot \nabla_x F - \nabla_x \left( V + \sigma_1 \star_x \int \sigma_2 \psi dz \right) \cdot \nabla_v F = 0, \quad t \in \mathbb{R}, x \in \mathbb{R}^d, v \in \mathbb{R}^d \quad (1.7a)$$

$$\partial_{tt}^2 \psi - c^2 \Delta_z \psi = -\lambda^2 \sigma_2(z) \left( \sigma_1 \star_x \int F dv \right), \quad t \in \mathbb{R}, x \in \mathbb{R}^d, z \in \mathbb{R}^n \quad (1.7b)$$

complété par

$$F|_{t=0} = F_0, \quad (\psi, \partial_t \psi)|_{t=0} = (\psi_0, \psi_1). \quad (1.8)$$

Cette limite de champ moyen a été obtenue rigoureusement dans [52] et l'existence globale d'une unique solution a été justifiée dans [25]. Dans ce même article, dans le régime  $\lambda = c$  il a également été montré qu'asymptotiquement, lorsque  $c \rightarrow +\infty$ , le système (1.7a)–(1.7b) converge vers le système

$$\partial_t F + v \cdot \nabla_x F - \nabla_x \left( V + \sigma_1 \star_x \int \sigma_2 \psi dz \right) \cdot \nabla_v F = 0, \quad t \in \mathbb{R}, x \in \mathbb{R}^d, v \in \mathbb{R}^d \quad (1.9a)$$

$$-\Delta_z \psi = -\sigma_2(z) \left( \sigma_1 \star_x \int F dv \right), \quad t \in \mathbb{R}, x \in \mathbb{R}^d, z \in \mathbb{R}^n. \quad (1.9b)$$

En particulier l'équation de Poisson sur  $\psi$  peut être explicitement résolue :  $\psi(t) = \Gamma(z) \sigma_1 \star (\int F(t) dv)$  où  $\Delta_z \Gamma = \sigma_2$ . En injectant cette expression dans (1.9a) on obtient alors l'équation de Vlasov suivante

$$\partial_t F + v \cdot \nabla_x F - \nabla_x \left( V - \kappa \Sigma \star_x \int F dv \right) \cdot \nabla_v F = 0, \quad (1.10)$$



où  $\kappa = \|\nabla_z \Gamma\|_{L^2_z}^2 > 0$  et  $\Sigma = \sigma_1 \star \sigma_1$ . La constante  $\kappa$  étant positive et  $\sigma_1$  étant une fonction à symétrie sphérique positive dont le profil radial est décroissant, cette équation de Vlasov est de type attractive. En choisissant de façon judicieuse des fonctions de forme  $\sigma_1$  et  $\sigma_2$  dépendant de  $c$ , il a même été démontré que lorsque  $c \rightarrow +\infty$ , l'équation de Vlasov-Onde est asymptotique au système Vlasov-Poisson attractif. Notons que dans le régime  $\lambda = 1$  la limite  $c \rightarrow +\infty$  conduit à l'équation  $-\Delta_z \psi = 0$  pour le milieu. Le milieu  $\psi$  est donc spatialement homogène, le champ de force qu'il exerce sur la densité de particules  $F$  est alors identiquement nul et l'équation limite obtenue est une simple équation de Liouville

$$\partial_t F + v \cdot \nabla_x F - \nabla_x V \cdot \nabla_v F = 0.$$

L'existence d'états d'équilibres et leur stabilité lorsque le potentiel  $V$  est un potentiel confinant est étudié dans [26] et l'influence de la présence d'un terme dissipatif additionnel est étudié dans [4] à travers l'ajout de l'opérateur de Fokker-Planck. Enfin, dans un travail récent, A. Vavasseur a obtenu sous certaines conditions la convergence de la densité spatiale  $\rho(t) = \int F(t) dv$  vers un état d'équilibre [104].

Le système Vlasov-Onde peut être vu comme un modèle de gaz de Lorentz "mou" inélastique et dissipatif. L'adjectif "mou" fait référence au milieu, qui du point de vue des particules est vu comme un obstacle mou (les membranes créent des potentiels pouvant être traversés par les particules). L'adjectif inélastique fait référence au fait que, en considérant uniquement le sous système des particules constituant le gaz, ce sous-système ne conserve pas d'énergie. Bien sûr, le système Vlasov-Onde étant obtenu à partir du système hamiltonien (1.3a)–(1.3b), il conserve lui aussi un hamiltonien au cours du temps :  $\mathcal{E}_k(t) = H_k(F(t), \psi(t), \partial_t \psi(t))$  où

$$H_k(F, \psi, \chi) = \iint \left( \frac{v^2}{2} + V + \sigma_1 \star_x \int \sigma_2 \psi dz \right) F dx dv + \frac{1}{2\lambda^2} \iint (|\chi|^2 + c^2 |\nabla_z \psi|) dx dz,$$

mais cet hamiltonien est conservé par le système global et pas par le sous système composé uniquement des particules du gaz. Il est à noter qu'à nouveau, lorsque le potentiel  $V$  est identiquement nul, le moment total du système  $\mathcal{P}_k(t) = P_k(F(t), \psi(t), \partial_t \psi(t))$  où

$$P_k(F, \psi, \chi) = \iint v F dx dv - \frac{1}{\lambda^2} \iint \chi \nabla_x \psi dx dv,$$

est conservé<sup>3</sup>. Enfin, l'adjectif dissipatif fait référence aux interactions entre les particules constituant le gaz et le milieu avec lequel elles interagissent. Lorsque le milieu agit sur le mouvement des particules mais que le déplacement des particules ne modifie pas le milieu on parle alors de gaz de Lorentz non dissipatif. A l'inverse, lorsque les particules du gaz ont une action sur le milieu on parle alors de gaz de Lorentz dissipatif.

Cette terminologie est utilisée par analogie avec le travail fondateur de Lorentz [79] où est étudié le mouvement d'électrons dans un métal. Dans ce modèle le métal constitue le milieu et les atomes le constituant sont vues comme des obstacles fixes, sphériques et durs. Les électrons se déplaçant dans le métal constituent le gaz et subissent une réflexion spéculaire lorsqu'ils entrent en collision avec un atome du métal. Avec la terminologie précédente ce modèle est donc un gaz de Lorentz "dur" (les obstacles sont infranchissables

<sup>3</sup> Le système Vlasov-Onde conserve beaucoup d'autres quantités. Le champ de force régissant la dynamique d'une particule typique étant à divergence nulle, toute quantité s'écrivant sous la forme  $\int \mathcal{A}(F(t)) dx dv$  est conservée au cours du temps. En particulier la positivité, toutes les normes  $L^p_{x,v}$  ainsi que l'entropie  $\mathcal{A}(F) = -F \log(F)$  sont conservées.

par les électrons) élastique (les réflexions spéculaires font que l'énergie cinétique des électrons avant et après chaque collision est la même, le gaz conserve donc son énergie au cours du temps) et non dissipatif (les atomes constituant le métal sont fixes, le déplacement des électrons n'influe pas l'état du milieu). Ce travail initial de Lorentz a donné lieu à de très nombreux développements, suivant si les obstacles sont "durs" ou "mous", suivant si ils sont répartis de façon périodique ou aléatoire, suivant si le gaz est élastique ou non et dissipatif ou non. En guise d'exemples nous renvoyons le lecteur aux articles [2, 14, 18, 43, 47, 83] mais beaucoup d'autres travaux auraient pu être cités.

### 1.3.2 Le système Schrödinger-Onde : version quantique de (1.3a)–(1.3b)

Les versions quantiques de (1.3a)–(1.3b) ont pour l'instant été l'objet de peu de développements. À ma connaissance, seuls les travaux de L. Bruneau [15] et de S. De Bièvre, J. Faupin et B. Schubnel [24] ont abordé cette question. Dans ces deux articles le modèle considéré est celui obtenu en effectuant la seconde quantification de (1.3a)–(1.3b) et leur étude porte sur le spectre du problème stationnaire sous-jacent. Le procédé de seconde quantification consiste, en plus de la quantification de la trajectoire de la particule  $q$ , à quantifier les champs de force agissant sur celle-ci. Le milieu  $\psi$  est donc lui même quantifié dans ces modèles.

Le modèle étudié dans cette thèse est le suivant, où seule la trajectoire de la particule est quantifiée à travers la fonction d'onde  $(t, x) \mapsto u(t, x) \in \mathbb{C}$

$$i\partial_t u + \frac{1}{2}\Delta_x u = \left( V + \sigma_1 \star_x \int \sigma_2 \psi dz \right) u, \quad t \in \mathbb{R}, x \in \mathbb{R}^d \quad (1.11a)$$

$$\partial_{tt}^2 \psi - c^2 \Delta_z \psi = -\lambda^2 \sigma_2(z) \left( \sigma_1 \star_x |u|^2 \right), \quad t \in \mathbb{R}, x \in \mathbb{R}^d, z \in \mathbb{R}^n \quad (1.11b)$$

qui est naturellement complété par les données initiales

$$u(0, x) = u_0(x), \quad (\psi(0, x, z), \partial_t \psi(0, x, z)) = (\psi_0(x, z), \psi_1(x, z)). \quad (1.12)$$

Justifions brièvement l'introduction et l'étude de ce système, notamment vis à vis du modèle où le milieu  $\psi$  est lui même quantifié. Tout d'abord, dans l'esprit de la dérivation du système Vlasov-Poisson à partir du système Schrödinger-Poisson via une limite semi-classique [76], il est possible de faire le lien entre ce modèle et la version cinétique (1.7a)–(1.7b) du modèle de L. Bruneau et S. De Bièvre. Plus précisément, en introduisant la constante de Planck  $h$  dans (1.11a) ainsi que la transformée de Wigner de la fonction d'onde  $u_h$ :

$$W_h(t, x, \xi) = \frac{1}{(2\pi)^d} \int_{\mathbb{R}^d} e^{-i\xi \cdot y} u_h(t, x + \frac{h}{2}y) \bar{u}_h(t, x - \frac{h}{2}y) dy.$$

il est possible de justifier que  $(W_h, \psi_h)$  converge vers une solution du système Vlasov-Onde (1.7a)–(1.7b) lorsque  $h \rightarrow 0$ . Ensuite, ce modèle entre parfaitement dans l'esprit de la stratégie développée en début d'introduction : il décrit les échanges d'énergie entre une particule quantique et un milieu abstrait modélisé en chaque point de l'espace par une membrane pouvant vibrer dans une direction transverse à la direction spatiale  $x$ . Ce modèle entre donc dans la classe des systèmes quantiques pouvant modéliser des effets dissipatifs et son étude est aussi légitime que celle où le milieu est lui même quantifié. Par ailleurs, comme le milieu  $\psi$  intervenant dans le modèle classique (1.3a)–(1.3b) est un milieu abstrait servant uniquement à modéliser les échanges d'énergie entre un système donné et le milieu extérieur, la nécessité de sa quantification peut être discutée. Enfin, la dernière raison est que contrairement à [15] et [24], nous étudions dans ce manuscrit la dynamique du système

(1.11a)–(1.11b). Considérer ce modèle plus simple où le milieu n'est pas quantifié est une étape naturelle pour une première étude dans cette direction.

Terminons en mentionnant que ce système conserve la masse de la fonction d'onde  $u$

$$\mathcal{M}(t) = \|u(t)\|_{L_x^2}^2,$$

ainsi que l'énergie  $\mathcal{E}_q(t) = H_q(u(t), \psi(t), \partial_t \psi(t))$  où  $H_q$  est l'hamiltonien défini par

$$\begin{aligned} H_q(u, \psi, \chi) = \frac{1}{2} \int |\nabla_x u|^2 dx + \int \left( V + \sigma_1 \star_x \int \sigma_2 \psi dz \right) |u|^2 dx \\ + \frac{1}{2\lambda^2} \iint (|\chi|^2 + c^2 |\nabla_z \psi|) dx dz. \end{aligned} \quad (1.13)$$

Dans le cas où le potentiel  $V$  est identiquement nul, le moment total  $\mathcal{P}_q(t) = P_q(u(t), \psi(t), \partial_t \psi(t))$  où

$$P_q(u, \psi, \chi) = \text{Im} \int \nabla_x u \bar{u} dx - \frac{1}{\lambda^2} \iint \chi \nabla_x u dx dz, \quad (1.14)$$

est également conservé. De plus, dans le cas  $\lambda = 1$  ce système est asymptotique à l'équation de Schrödinger linéaire (1.2) lorsque  $c \rightarrow +\infty$ , alors que dans le cas  $\lambda = c$  il est asymptotique à l'équation de type Hartree suivante

$$i\partial_t u + \frac{1}{2} \Delta_x u = (V - \kappa \Sigma \star_x |u|^2) u, \quad (1.15)$$

où  $\Sigma = \sigma_1 \star \sigma_1$  et  $\kappa = \|\nabla_z \Gamma\|_{L_z^2}^2 > 0$ . En particulier la non linéarité est à nouveau attractive.

## 1.4 Contributions et perspectives

Il est possible de regrouper les travaux présents dans cette thèse en trois problèmes distincts. Les deux premiers sont de nature semblable dans le sens où dans les deux cas la question abordée est celle de la stabilité autour de certaines solutions particulières d'un système dynamique.

Dans le premier cas le système Vlasov-Onde est étudié au voisinage d'équilibres spatialement homogène  $F(t, x, v) = \mathcal{M}(v)$  alors que dans le second cas c'est le système Schrödinger-Onde qui est étudié autour d'ondes solitaires  $u(t, x) = Q(x)e^{i\omega t}$  d'énergie minimale. Bien que dans ces deux cas la nature de la question soit similaire, les mécanismes mis en jeu sont distincts et les outils mathématiques pour les étudier sont en conséquence très différents. Par exemple, dans le premier cas la structure hamiltonienne du système Vlasov-Onde n'est pas utilisée et la mesure de la régularité des solutions joue un rôle important, alors que dans le second cas la structure hamiltonienne du système Schrödinger-Onde est absolument essentielle et la régularité des solutions n'est pas utilisée. L'investigation de chacun de ces deux problèmes a mené à un travail numérique : dans le premier cas pour étudier un critère de stabilité linéaire, et, dans le second cas, pour étudier certaines dynamiques de façon plus précise que ce que l'étude théorique a permis. Cette étude numérique a également permis de conforter la compréhension du rôle des paramètres du modèle, notamment la dimension  $n$  des membranes et la vitesse de propagation des ondes  $c$ .

Le troisième problème se positionne dans le cadre de la théorie de l'homogénéisation. Plus précisément (en reprenant les définitions introduites précédemment), le comportement d'un gaz de Lorentz "mou" aléatoire, élastique et non dissipatif est étudié, l'objectif étant d'obtenir si possible une équation satisfaite par la moyenne stochastique de la densité de particule lorsqu'un certain paramètre d'échelle  $\epsilon$  converge vers 0.

### 1.4.1 Amortissement Landau pour le modèle Vlasov-Onde

On considère ici le système Vlasov-Onde (1.7a)–(1.7b) sans potentiel extérieur  $V \equiv 0$ . Dans ce cas il est aisé de vérifier que les solutions ayant une donnée initiale de la forme  $F_0(x, v) = \mathcal{M}(v)$ ,  $(\psi_0(x, z), \psi_1(x, z)) = (\Psi(z), 0)$  où  $\Psi$  est solution de

$$-c^2 \Delta_z \Psi(z) = -\lambda^2 \sigma_2(z) \left( \int \sigma_1 dx \right) \left( \int \mathcal{M} dv \right),$$

sont des solutions stationnaires :  $(F(t, x, v), \psi(t, x, z)) = (\mathcal{M}(v), \Psi(z))$ . Ces solutions ont la particularité que la densité spatiale  $\rho(t) = \int F(t) dv$  est constante et le terme de force  $\nabla_x(\sigma_1 \star \int \sigma_2 \psi(t) dz)$  est nul. Il est alors naturel de se poser la question de la stabilité de ces solutions particulières. Cette étude a été effectuée dans le cas du tore  $x \in \mathbb{T}^d$ , comme dans le cas de l'espace entier  $x \in \mathbb{R}^d$ .

#### Le cas Vlasov-Poisson.

Pour le système de Vlasov-Poisson (nous rappelons que le système Vlasov-Ondes est asymptotique à ce système dans le régime  $\lambda = c$ ,  $c \rightarrow +\infty$ ), les fonctions spatialement homogènes sont également des solutions stationnaires et l'étude de leur stabilité a donné lieu à de nombreux travaux. Cette étude a commencé avec l'article [67] de L. Landau où il est justifié que dans le cas du tore, et sous une condition de stabilité linéaire sur  $\mathcal{M}$ , le problème linéarisé est stable en un sens fort. Cette stabilité forte non attendue porte depuis le nom d'amortissement Landau. Le premier résultat perturbatif justifiant l'existence d'un effet d'amortissement Landau au niveau non linéaire a été obtenu par C. Mouhot et C. Villani dans [87]. Depuis, de nombreux autres résultats ont été obtenus [10, 12, 13, 36, 53, 54, 59]. Par exemple dans [12] la régularité minimale requise est améliorée, dans [13] le cas  $x \in \mathbb{R}^d$  est étudié, ou plus récemment, dans [59] et [53] une nouvelle approche lagrangienne est développée.

En restant évasif, l'effet d'amortissement Landau obtenu dans tous ces travaux peut s'énoncer de la façon générique suivante.

**Théorème 1.4.1** *Pour une donnée initiale  $F_0$  proche d'un équilibre spatialement homogène  $\mathcal{M}$  ( $\|F_0 - \mathcal{M}\| \leq \epsilon$ ) et sous une contrainte de stabilité linéaire sur  $\mathcal{M}$ ,*

- *la solution  $F(t)$  est asymptotique à une solution du transport libre : il existe un profil limite  $F^\infty$  tel que*

$$\|F(t) - F^\infty(x + tv, v)\| \xrightarrow{t \rightarrow +\infty} 0,$$

- *la densité spatiale de particule  $\rho(t)$  converge fortement vers une constante : il existe une constante  $\rho^\infty$  tel que*

$$\|\rho(t) - \rho^\infty\| \xrightarrow{t \rightarrow +\infty} 0$$

- *le champ de force (provenant du couplage avec l'équation de Poisson ici) converge fortement vers 0.*

Les normes considérées dans cet énoncé dépendent du contexte ( $x \in \mathbb{T}^d$  ou  $x \in \mathbb{R}^d$ ) et les taux de convergence dépendent du contexte également ( $x \in \mathbb{T}^d$  ou  $x \in \mathbb{R}^d$ ) mais aussi de la régularité mesuré par les normes en jeu. Typiquement, dans le cas du tore, les normes mises en jeu sont des normes (sous-)analytiques et les taux de convergence sont en exponentielle (fractionnaire) décroissante, alors que dans le cas de l'espace entier, des normes Sobolev sont

suffisantes mais les taux de convergence sont en toute généralité<sup>4</sup> limité par la dimension  $d$  de l'espace.

Avant de revenir au cas du système Vlasov-Onde, rappelons deux mécanismes très simples mais fondamentaux dans chacune de ces études de l'amortissement Landau. Le premier est un mécanisme lié à l'opérateur de transport libre  $\partial_t + v \nabla_x$ . Une solution  $F(t)$  de l'équation de transport libre avec donnée initiale  $F_0$  s'écrit  $F(t, x, v) = F_0(x - tv, v)$  et en considérant la transformée de Fourier de cette solution on obtient  $\widehat{F}(t, k, \xi) = \widehat{F}_0(k, \xi + tk)$ . En particulier la transformée de Fourier de la densité spatiale  $\rho(t) = \int F(t) dv$  est  $\widehat{\rho}(t, k) = \widehat{F}_0(k, tk)$ . Le lemme de Riemann-Lebesgue assure alors que cette quantité décroît au cours du temps et que le taux de décroissance peut être mesuré par la régularité de la donnée initiale  $F_0$  : plus cette donnée initiale est régulière par rapport à la variable  $v$  plus le taux de décroissance est grand. De plus, ce taux de convergence dépend lui-même du mode de Fourier  $k$  considéré : plus  $|k|$  est grand, plus le mode de Fourier  $\widehat{\rho}(t, k)$  décroît vite. Le second mécanisme important est au niveau de la structure de l'équation linéarisé autour de l'équilibre spatialement homogène  $\mathcal{M}$ . Considérer la transformée de Fourier de cette équation intégrée en vitesse conduit à un système d'équations découplées et fermées sur les modes de Fourier de la densité spatiale  $\rho(t)$  :

$$\widehat{\rho}(t, k) = A(t, k) + \int_0^t K(t - \tau, k) \widehat{\rho}(\tau, k) d\tau,$$

où  $A$  dépend uniquement de la donnée initiale  $F_0$  et où  $K$  est un noyau dépendant de l'équilibre  $\mathcal{M}$ . À partir de ces équations et sous un critère de stabilité sur le noyau  $K$  (donc sur  $\mathcal{M}$ ) il est possible de justifier que les modes de Fourier ont le même type de décroissance que dans le cas de l'équation de transport libre. Par exemple, dans le cas où  $F_0$  et  $\mathcal{M}$  sont de régularité finie on obtient

$$|\widehat{\rho}(t, k)| \lesssim \langle tk \rangle^{-r} := \left( \sqrt{1 + |tk|^2} \right)^{-r} \quad (1.16)$$

où le taux  $r$  est limité par la régularité de  $F_0$  ainsi que celle de  $\mathcal{M}$ .

### Le cas Vlasov-Onde.

En revenant au système Vlasov-Onde et par analogie avec le système Vlasov-Poisson il est naturel de poser la question de l'existence ou non d'un effet d'amortissement Landau au voisinage des solutions spatialement homogènes. Ces résultats sont l'objet du Chapitre 2. En particulier nous avons abordé les questions suivantes :

- Est-il possible de justifier un effet d'amortissement Landau linéaire ? et non linéaire ?
- Si oui, comment la contrainte de stabilité linéaire portant sur l'équilibre  $\mathcal{M}$  est modifiée par le couplage avec l'équation des ondes ? et comment la régularité des normes et les taux de convergences sont modifiés ?

La stratégie pour aborder ces questions a été la suivante. Tout d'abord, dans ce contexte la structure hamiltonienne de l'équation de Vlasov-Onde n'étant pas utilisée, nous commençons par résoudre explicitement l'équation des ondes en fonction de la densité spatiale  $\rho$ , que nous ré-injectons dans l'équation de Vlasov afin d'obtenir l'équation suivante

$$\partial_t F + v \cdot \nabla_x F - \nabla_x \left( \Phi_I(t, x) - \Sigma \star \int_0^t p_c(t - \tau) \rho(\tau) d\tau \right) \cdot \nabla_v F = 0 \quad (1.17)$$

<sup>4</sup>Ce résultat peut être amélioré dans le cas où les données ont une transformée de Fourier dont le support est "loin" du point  $(k, \xi) = (0, 0)$ , cf [13].

où  $\Phi_I(t, x)$  est un potentiel dépendant uniquement des données initiales  $\psi_0$  et  $\psi_1$  et des fonctions de forme  $\sigma_1$  et  $\sigma_2$ , où  $\Sigma = \sigma_1 \star \sigma_1$  et où  $p_c(t)$  dépend uniquement de la fonction de forme  $\sigma_2$ . Cette ré-écriture du système Vlasov-Onde a l'avantage de permettre des comparaisons plus immédiates avec le système Vlasov-Poisson. Par exemple, à part dans le cas où des effets de compensation ont lieu, il est possible de déduire directement de cette équation que le taux de convergence du terme de force

$$\nabla_x \left( \Phi_I(t, x) - \Sigma \star \int_0^t p_c(t - \tau) \rho(\tau) d\tau \right) \quad (1.18)$$

va dépendre de la décroissance en temps de  $\Phi_I(t)$  et  $p_c(t)$ . Cette première étude est effectuée à la fin de la Section 2.1 du Chapitre 2. Ces deux fonctions venant du couplage avec l'équation des ondes, leur décroissance provient de la dispersion des ondes et est limitée en toute généralité par la dimension  $n$  des membranes. Toutefois, il est à noter que dans le cas où  $n$  est impaire il est possible de tirer parti du principe de Huygens fort ainsi que de la compacité du support de la fonction de forme  $\sigma_2$  pour justifier que ces fonctions sont dans ce cas à support compact en temps. Cette remarque permettra d'obtenir des résultats d'amortissement Landau en régularité (sous-)analytique.

Il est important de noter que si la fonction  $p_c$  décroît au cours du temps, son taux de décroissance est indépendant du mode de Fourier  $k$  considéré. La décroissance temporelle seule de  $p_c$  ne sera donc pas suffisante pour obtenir des taux de décroissance de la forme  $\langle tk \rangle^{-r}$  comme c'était le cas pour le système Vlasov-Poisson. Un moyen simple de s'en convaincre est de considérer le cas où  $p_c(t)$  décroît comme  $\langle t \rangle^{-m}$ , d'imaginer que l'on ait l'estimation a priori  $|\widehat{\rho}(t, k)| \lesssim \langle tk \rangle^{-r}$  et d'étudier le taux de convergence de  $\int_0^t p_c(t - \tau) \widehat{\rho}(\tau, k) d\tau$ . Un rapide calcul montre alors que

$$\left| \int_0^t p_c(t - \tau) \widehat{\rho}(\tau, k) d\tau \right| \lesssim \int_0^t \langle t - \tau \rangle^{-m} \langle \tau k \rangle^{-r} d\tau \lesssim \langle t \rangle^{-m} + \langle tk \rangle^{-r} \leq C(k) \langle tk \rangle^{-\min(m, r)}$$

où la constante  $C(k)$  explose comme  $|k|^{\min(m, r)}$ . Il est donc nécessaire d'être capable d'absorber un facteur  $|k|^{\min(m, r)}$ . Dans le contexte du système Vlasov-Onde la fonction de forme  $\sigma_1$  étant naturellement régulière, nous utilisons la décroissance de sa transformée de Fourier pour absorber ce terme. Contrairement au cas du système Vlasov-Poisson, les résultats d'amortissement Landau que nous avons obtenus sont donc directement limités par la régularité du potentiel  $\Sigma$ .

L'étude du problème linéarisé est faite dans la Section 2.2 du Chapitre 2. Une fois la décroissance de  $\Phi_I(t)$  et  $p_c(t)$  bien comprise ainsi que la nécessité d'utiliser la régularité de  $\sigma_1$ , cette étude suit la même stratégie que pour le système Vlasov-Poisson, c'est à dire exploiter le découplage des modes de Fourier de la densité spatiale  $\rho(t)$  :

$$\widehat{\rho}(t, k) = \mathcal{A}(t, k) + \int_0^t \mathcal{K}(t - \tau, k) \widehat{\rho}(\tau, k) d\tau,$$

où cette fois-ci  $\mathcal{A}$  dépend de  $F_0$ ,  $\psi_0$ ,  $\psi_1$  et  $\mathcal{M}$  et où

$$\mathcal{K}(t, k) = \int_0^t p_c(t - \tau) K(\tau, k) d\tau,$$

$K$  étant le même noyau que pour l'équation de Vlasov (1.10). En particulier la contrainte de stabilité linéaire porte toujours sur l'équilibre  $\mathcal{M}$  mais au travers de l'opérateur  $\mathcal{K}$  qui n'est plus le même que pour l'équation de Vlasov. Pour clôturer l'étude du problème linéaire il

est donc important de comprendre comment la demi-convolution en temps avec  $p_c$  modifie la géométrie des équilibres stables. Cette étude est l'objet de la Section 2.5 du Chapitre 2. En particulier nous avons justifié que dans le cas  $\lambda = 1$ , pourvu que  $c$  soit suffisamment grand, tout équilibre  $\mathcal{M}$  est stable (ce qui est cohérent avec l'asymptotique vers le transport libre). Dans le cas  $\lambda = c$ , nous avons obtenu que dans le régime  $c \rightarrow +\infty$  le même critère de stabilité de Penrose que dans le cas de l'équation de Vlasov (1.10) doit être satisfait. À l'inverse, le régime  $c \rightarrow 0$  conduit à l'instabilité de tous les équilibres. Nous avons fait le lien entre cette instabilité et la longueur de Jeans (cf [87, Example 2.3]). Dans les régimes intermédiaires  $c \sim 1$  un critère a été obtenu mais est assez peu utilisable en pratique.

Ceci a naturellement conduit à une étude numérique, le but de cette étude étant de tester si dans le régime  $c \sim 1$  il est "facile" d'obtenir des équilibres  $\mathcal{M}$  stables. Cette étude ainsi que la conception du schéma spécifique sur lequel elle est basée font l'objet du Chapitre 3. Nous en avons également profité pour tester si dans le cas  $n = 1$  un effet d'amortissement Landau a lieu. En effet, comme nous l'avons vu la décroissance du noyau  $p_c$  est directement liée à la dispersion de l'équation des ondes, dispersion qui n'existe pas en dimension  $n = 1$ . Dans ce cas un simple calcul montre même que

$$p_c(t) \xrightarrow[t \rightarrow +\infty]{} C^{ste}(\sigma_2) > 0,$$

et toute l'étude théorique précédente basée sur la décroissance de  $p_c$  ne s'applique pas. L'étude numérique suggère quant à elle qu'il n'y a pas d'amortissement Landau dans ce cas (nous avons réussi à obtenir une solution faiblement perturbée et non amortie).

L'étude de l'amortissement Landau non linéaire est l'objet des Sections 2.3 (cas de l'espace entier  $x \in \mathbb{R}^d$ ) et 2.4 (cas du tore  $x \in \mathbb{T}^d$ ) du Chapitre 2. Une fois le problème linéaire bien compris et notamment les différences avec le cas Vlasov-Poisson, les résultats déjà existants de [12] et [13] sont applicables sans nouvelles difficultés supplémentaires et permettent d'obtenir des résultats pouvant s'énoncer sous la forme du Théorème 1.4.1. En particulier la gestion des possibles termes d'échos plasma n'est ni plus aisée ni plus compliquée avec ce modèle. Afin que ce manuscrit soit auto-contenu nous avons tout de même fait ces démonstrations dans le cas du système Vlasov-Onde. Pour que les résultats principaux de cette thèse ne soient pas noyés dans des points techniques déjà plus ou moins connus, certains de ceux-ci sont abordés uniquement en annexe à la fin de ce manuscrit (cf Annexe A et B où est démontré, entre autres, l'existence de solutions analytiques locales pour le système Vlasov-Onde).

### Perspectives.

La continuité naturelle de ces recherches est l'étude de l'amortissement Landau lorsque les ondes ne sont plus transverses mais se propagent dans la direction spatiale  $x$  (par exemple en considérant la version cinétique du système (1.5a)–(1.5b)). Dans ce cas le système cinétique s'écrit à nouveau sous la forme (1.17) mais les propriétés du noyau  $p_c$  sont très différentes. En considérant par exemple la transformée de Fourier de la partie du terme de force non local en temps dans (1.18) on obtiendrait

$$k|\hat{\sigma}_1(k)|^2 \left( \int_0^t \frac{\sin(c|k|[t-\tau])}{c|k|} \hat{\rho}(\tau, k) d\tau \right).$$

Si  $p_c$  dépend désormais des modes de Fourier  $k$  (ce qui est une bonne nouvelle vis à vis de l'indépendance du possible taux d'amortissement par rapport à la régularité de  $\sigma_1$ ), la contrepartie est qu'à  $k$  fixé  $p_c$  ne décroît plus mais oscille. Ceci n'est pas aussi dramatique que dans le cas des ondes transverses et  $n = 1$ , car les oscillations de  $p_c$  peuvent être

utilisées pour obtenir de la décroissance ponctuelle du côté des variables physiques (via un lemme de phase stationnaire, ce qui revient exactement à refaire la preuve de la dispersion ponctuelle des ondes). Néanmoins, tous les résultats obtenus dans cette thèse, même ceux au niveau linéaire, se basent sur la décroissance de chacun des modes de Fourier de la densité spatiale  $\rho$ , cf (1.16). Une première question importante est donc celle de la cohabitation de ces deux phénomènes de dispersion : est-il possible d'obtenir à partir des oscillations (à  $k$  fixé) de  $p_c(t, k)$  la décroissance de  $\widehat{\rho}(t, k)$  ? sinon, est-il possible d'utiliser des estimations de dispersion ponctuelle du côté des variables physiques pour obtenir un effet d'amortissement Landau sans une décroissance de  $\widehat{\rho}(t, k)$  de la forme (1.16) ? En somme, comment se combine les effets dispersifs de l'équation des ondes et de l'équation de Vlasov au voisinage d'un équilibre spatialement homogène : est-ce que ces deux phénomènes conduisent à de la dispersion (dans ce cas sous quelle forme, plutôt celle des ondes ou celle de l'équation de Vlasov) ? ou est-ce qu'ils se "détruisent" mutuellement ?

### 1.4.2 Investigation d'un effet de friction quantique à travers l'étude d'ondes solitaires

On considère ici le système Schrödinger-Onde. Tout d'abord, l'existence d'une unique solution globale dans les espaces fonctionnels naturels du point de vue de l'énergie  $H_q$  (cf Annexe C) ainsi que la limite semi-classique permettant de lier ce système au système Vlasov-Onde (cf Annexe D) ont été effectués. La démonstration de ce type de résultat étant très classique et n'ayant pas apporté de difficultés nouvelles, nous ne commenterons pas plus ces travaux ici. Passons désormais au cœur de l'étude.

#### Ondes solitaires.

Une onde solitaire pour ce système est une solution de la forme

$$u(t, x) = Q(x)e^{i\omega t}, \quad \psi(t, x, z) = \Psi(x, z),$$

où  $(Q, \Psi)$  est solution du système

$$\begin{cases} -\frac{1}{2}\Delta_x Q + \omega Q + \left(\sigma_1 \star \int \sigma_2 \Psi dz\right) Q = 0, \\ -c^2 \Delta_z \Psi(x, z) = -\lambda^2 \sigma_2(z) \sigma_1 \star Q^2(x). \end{cases}$$

Il est important de noter que dans le cas  $\lambda = c$ , les solutions de ce système sont indépendantes du paramètre  $c$ . L'existence de telles solutions est suggérée par le caractère attractif du système asymptotique lorsque  $\lambda = c$  et  $c \rightarrow +\infty$  ; l'effet attractif sous-jacent permettant l'existence de solutions stationnaires où la dispersion de l'équation de Schrödinger est parfaitement compensée par l'effet attractif de la non linéarité. En résolvant explicitement en fonction de  $Q$  l'équation de Poisson sur  $\Psi$  on obtient

$$\Psi(x, z) = \frac{\lambda^2}{c^2} \Gamma(z) \sigma_1 \star Q^2(x),$$

où  $\Delta_z \Gamma = \sigma_2$ . En injectant alors ce résultat dans l'équation sur  $Q$  on aboutit à l'équation de Choquard

$$-\frac{1}{2}\Delta_x Q + \omega Q - \kappa \frac{\lambda^2}{c^2} (\Sigma \star Q^2) Q = 0, \quad (1.19)$$

où  $\kappa = \|\nabla_z \Gamma\|_{L_z^2}^2$  et  $\Sigma = \sigma_1 \star \sigma_1$ . Cette équation bien connue a déjà été activement étudiée (voir par exemple [77, 70, 68] et leurs références). A partir de ces études nous savons que



cette équation admet une famille de solutions non triviales, et le système Schrödinger-Onde admet en conséquence plein d'ondes solitaires. Cependant, rien ne garantit que les ondes solitaires ainsi obtenues soient stables.

### Stabilité orbitale des états fondamentaux.

Le Chapitre 4 est consacré à la construction d'ondes solitaires orbitalement stables (*i.e.* stables modulo les invariances de l'équation). Celles-ci ont été obtenues en minimisant l'hamiltonien  $H_q$  (définie par (1.13)) sous une contrainte de masse  $\|Q\|_{L_x^2}^2 = M$ . Cette approche est tout à fait classique, les ondes solitaires ainsi obtenues sont appelées *état fondamental* ou encore *ground states* et leur stabilité peut s'obtenir à l'aide d'arguments variationnels [22, 73, 74] ou par linéarisation de l'énergie [107, 108, 85, 84]. Bien que ces deux approches soient bien balisées, le cas particulier du système Schrödinger-Onde a conduit à une difficulté inattendue, conséquence de la combinaison des deux remarques suivantes :

- l'équation de Choquard est une équation non linéaire non locale en espace,
- la fonction de forme  $\sigma_1$  étant régulière, le potentiel  $\Sigma$  n'est pas homogène et l'équation de Choquard considérée ne possède donc pas d'invariance d'échelle.

Pour comprendre d'où provient cette difficulté technique il est intéressant de considérer le cas du système Schrödinger-Newton, pour lequel l'étude de la stabilité orbitale des états fondamentaux est bien comprise. Lorsque  $d = 3$ , ceci revient à considérer  $\Sigma(x) = \Sigma^0(x) = 1/|x|$  dans l'équation de Choquard (1.19). Si dans ce cas l'unicité (à translation et changement de phase près) de l'état fondamental à contrainte de masse  $M$  fixée a pu être obtenue [70], la démonstration de celle-ci utilise de façon cruciale l'expression de  $\Sigma^0$  et nous n'avons pas réussi à l'adapter au cas  $\Sigma$  régulier. Ceci implique que nous n'avons pas de caractérisation variationnelle de l'état fondamental et la variété engendrée par l'ensemble des états fondamentaux de masse  $M$

$$S_M = \left\{ (Q, \Psi) \text{ t.q. } \|Q\|_{L_x^2}^2 = M \text{ et } H_q(Q, \Psi, 0) = \inf_{\|u\|_{L_x^2}^2 = M} H_q(u, \psi, \chi) \right\}$$

n'est en conséquence pas connue de façon satisfaisante. Si cela n'empêche pas l'approche variationnelle d'être appliquée, cela conduit à un résultat particulièrement faible. L'approche par linéarisation de l'énergie a donc été retenue. Pour pouvoir l'appliquer une étape importante est de caractériser le noyau de l'opérateur  $L_+$  défini par

$$L_+ f = -\frac{1}{2} \Delta_x f + \omega f - \kappa (\Sigma \star Q^2) f - 2\kappa (\Sigma \star Q f) Q.$$

Si dans le cas  $\Sigma^0(x) = 1/|x|$ , le noyau de cet opérateur est parfaitement connu [68], la démonstration repose à nouveau de façon cruciale sur l'expression du potentiel  $\Sigma^0$ . En particulier nous n'avons pas réussi à obtenir en toute généralité la caractérisation du noyau de  $L_+$  pour  $\Sigma$  régulier quelconque. Nous avons en revanche réussi à l'obtenir pour certains potentiels  $\Sigma$  réguliers. Typiquement, dans un premier temps, pour des potentiels  $\Sigma$  proches de  $\Sigma^0$ . De façon informelle (pour un résultat précis nous renvoyons le lecteur au Theorem 4.2.9 du Chapitre 4), et en notant  $\mathcal{A}$  l'ensemble des fonctions de formes  $\sigma_1$  pour lesquelles le noyau de l'opérateur  $L_+$  a pu être caractérisé, nous avons obtenu le résultat de stabilité orbitale suivant.

**Théorème 1.4.2** *Soit  $\sigma_1 \in \mathcal{A}$  et  $(Q, \Psi)$  un état fondamental. Alors, pour une donnée initiale  $(u_0, \psi_0, \psi_1)$  proche de  $(Q, \Psi, 0)$*

$$\|u_0 - Q\|_{H_x^1} + \|\psi_0 - \Psi\|_{L_x^2 \dot{H}_z^1} + \|\psi_1\|_{L_x^2 L_z^2} \leq \epsilon,$$

et telle que  $\|u_0\|_{L_x^2} = \|Q\|_{L_x^2}$ , la solution  $(u, \psi)$  de (1.11a)–(1.11b) est orbitalement stable : il existe deux fonctions  $t \mapsto x(t) \in \mathbb{R}^d$  et  $t \mapsto \gamma(t) \in \mathbb{R}$  telles que

$$\sup_{t \geq 0} \|u(t) - Q(\cdot - x(t))e^{i\gamma(t)}\|_{H_x^1} + \|\psi(t) - \Psi(\cdot - x(t), \cdot)\|_{L_x^2 \dot{H}_z^1} + \|\partial_t \psi(t)\|_{L_x^2 L_z^2} \leq \epsilon.$$

### Améliorations du théorème de stabilité orbitale.

Dans le cas  $\lambda = c$ , comme nous l'avons déjà fait remarquer, l'équation sur  $(Q, \Psi)$  est indépendante de  $c$  : si  $(u(\cdot, x), \psi(t, x, z)) = (Q(x)e^{i\omega t}, \Psi(x, z))$  est une onde solitaire du système Schrödinger-Onde pour une valeur  $c_0$  donnée, alors elle l'est quelque soit la valeur de  $c$ . De plus,  $u(t)$  est également une onde solitaire du système asymptotique (1.15). Ce résultat s'étend également aux cas des états fondamentaux. En particulier un état fondamental orbitalement stable l'est quelque soit la valeur de  $c$  et l'est également pour (1.15). Il est alors intéressant de se poser la question de la dépendance en  $c$  de la contrainte de petitesse sur les données initiales dans le Théorème 1.4.2. Dans ce cas il est en fait possible de l'améliorer en changeant la contrainte de petitesse en

$$\|u_0 - Q\|_{H_x^1} + \|\psi_0 - \Psi\|_{L_x^2 \dot{H}_z^1} + \frac{1}{c} \|\psi_1\|_{L_x^2 L_z^2} \leq \epsilon,$$

la conclusion devenant

$$\sup_{t \geq 0} \|u(t) - Q(\cdot - x(t))e^{i\gamma(t)}\|_{H_x^1} + \|\psi(t) - \Psi(\cdot - x(t), \cdot)\|_{L_x^2 \dot{H}_z^1} + \frac{1}{c} \|\partial_t \psi(t)\|_{L_x^2 L_z^2} \leq \epsilon.$$

Cette amélioration est satisfaisante dans le sens où, comme attendu, la contrainte sur les variations du milieu est très faible dans le régime  $c \gg 1$ . Cependant elle ne permet pas de retrouver le cas suivant. Comme le système asymptotique (1.15) est invariant par transformation galiléenne (ce n'est pas le cas du système Schrödinger-Onde), si  $u$  est une solution de (1.15), alors

$$v(t, x) = u(t, x - tp)e^{ip \cdot (x - tp)} e^{i\frac{|p|^2}{2}t}, \quad p \in \mathbb{R}^d,$$

est également une solution de (1.15), le résultat de stabilité orbitale est encore valide lorsque la donnée initiale  $u_0$  est remplacée par la nouvelle donnée initiale  $v_0$  d'impulsion arbitrairement grande :  $v_0(x) = u_0(x)e^{ip \cdot x}$ . Ce cas n'étant pas couvert par l'amélioration précédente, nous avons fait un effort supplémentaire pour obtenir le résultat de stabilité orbitale en temps fini (mais arbitrairement grand lorsque  $c \rightarrow +\infty$ ) suivant. Dans cet énoncé  $p_0$  désigne l'impulsion de la donnée initiale  $u_0$

$$p_0 = \text{Im} \int \nabla_x u_0 \overline{u_0} dx$$

alors que  $p(t)$  désigne l'impulsion à l'instant  $t$  de la fonction d'onde  $u$

$$p(t) = \text{Im} \int \nabla_x u(t) \overline{u(t)} dx.$$

**Théorème 1.4.3** Soit  $\sigma_1 \in \mathcal{A}$ ,  $(Q, \Psi)$  un état fondamental et  $(u_0, \psi_0, \psi_1)$  une donnée initiale proche de  $(Q, \Psi, 0)$  dans le sens nouveau

$$\|u_0 e^{-i\frac{p_0}{M} \cdot x} - Q\|_{H_x^1} + \|\psi_0 - \Psi\|_{L_x^2 \dot{H}_z^1} + \frac{1}{c} \|\psi_1\|_{L_x^2 L_z^2} \leq \epsilon$$

et telle que  $\|u_0\|_{L_x^2}^2 = \|Q\|_{L_x^2}^2 = M$ . Alors, dans le régime  $c \geq |p_0|\epsilon^{-2}$ , la solution  $(u, \psi)$  de (1.11a)–(1.11b) est orbitalement stable sur l'intervalle de temps fini  $[0, T_f]$  (où  $T_f =$

$T_f(\epsilon, p_0, c)$  diverge vers  $+\infty$  lorsque  $c \rightarrow +\infty$ ) : il existe deux fonctions  $t \mapsto x(t) \in \mathbb{R}^d$  et  $t \mapsto \gamma(t) \in \mathbb{R}$  telles que

$$\begin{aligned} \sup_{0 \leq t \leq T_f} \|u(t)e^{-i\frac{p(t)}{M} \cdot x} - Q(\cdot - x(t))e^{i\gamma(t)}\|_{H_x^1} \\ + \|\psi(t) - \Psi(\cdot - x(t), \cdot)\|_{L_x^2 \dot{H}_z^1} + \frac{1}{c} \|\partial_t \psi(t)\|_{L_x^2 L_z^2} \leq \epsilon. \end{aligned}$$

La stratégie pour obtenir ce théorème est la suivante et se base sur la conservation du moment total  $P_q$  défini par (1.14). Tout d'abord, pour le système asymptotique (1.15), la conservation du moment total devient une conservation de l'impulsion de la fonction d'onde  $u$ . La première étape consiste à comprendre comment obtenir un résultat de stabilité orbitale avec une donnée initiale  $u_0$  d'impulsion  $p_0$  arbitrairement grande sans utiliser l'invariance galiléenne de l'équation mais uniquement la conservation de l'impulsion. Une fois ceci compris, la conservation du moment total  $P_q$  du système Schrödinger-Onde montre que lorsque  $c \gg 1$ , l'impulsion de la fonction d'onde varie lentement. En particulier, il est possible de justifier que sur un intervalle de temps fini  $[0, T_f(\epsilon, p_0, c)]$ , l'impulsion de la fonction d'onde  $u(t)$  est essentiellement constante

$$|p_0 - p(t)| \leq \epsilon.$$

Cette conservation approximative de l'impulsion sur l'intervalle de temps  $[0, T_f]$  est alors suffisante pour appliquer la même stratégie que lorsque l'impulsion est parfaitement conservée, comme c'était le cas pour le système asymptotique (1.15).

### Effet de friction pour le système Schrödinger-Onde.

Une fois ces résultats de stabilité orbitale des états fondamentaux obtenus, nous les avons utilisés pour étudier les effets dissipatifs du système Schrödinger-Onde, la stratégie étant d'étudier l'impact de la perte de l'invariance galiléenne sur la dynamique des solutions. En effet, si pour le problème asymptotique l'invariance galiléenne assure que pour une donnée initiale de la forme  $u_0(x) = Q(x)e^{i\frac{p_0}{M} \cdot x}$ , l'état fondamental va se déplacer en ligne droite à vitesse constante, dans le cas du système Schrödinger-Onde aucun calcul explicite n'est possible et le mieux que l'on puisse faire est (au moins dans le cas où  $|p_0| \ll 1$ ) appliquer le résultat de stabilité orbitale du Théorème 1.4.2. Ce résultat nous assure alors que la solution va rester en tout temps proche de l'état fondamental modulo une translation et un changement de phase. Nous souhaiterions alors comprendre comment le défaut d'invariance galiléenne impacte la translation  $x(t)$  de l'état fondamental. Par analogie avec le modèle classique (1.3a)–(1.3b) et dans le cas où la dimension  $n$  des membranes est égale à 3 nous conjecturons que la fonction  $x(t)$  va rester bornée et même converger exponentiellement rapidement vers une position d'équilibre. Si nous ne sommes pas en mesure pour l'instant de prouver cette conjecture, il est néanmoins possible de la confronter à des simulations numériques. Notamment, bien qu'aucune formule explicite ne puisse être obtenue, dans le cas d'une donnée initiale de la forme

$$u_0(x) = Q(x)e^{i\frac{p_0}{M} \cdot x}, \quad \psi_0(x, z) = \Psi(x, z), \quad \psi_1(x, z) = 0,$$

des calculs heuristiques (consistant essentiellement à supposer que le soliton  $Q$  se déplace sans déformation) suggèrent que dans le régime  $c \gg p_0$  la solution sera de la forme

$$\begin{cases} u(t, x) = Q(x - q(t)) \exp\left(i\frac{p(t)}{M} \cdot (x - q(t))\right) \exp\left(i\omega t + \frac{i}{2M^2} \int_0^t |p(s)|^2 ds\right) + \mathcal{O}(\epsilon) \\ \psi(t, x, z) = \varphi(t, x, z) + \mathcal{O}(\epsilon) \end{cases}$$

où  $(q(t), p(t), \varphi(t))$  est solution du système

$$\begin{cases} M\dot{q}(t) = p(t) \\ \dot{p}(t) = - \iint \nabla_x (\sigma_1 \star Q^2)(q(t) - y) \sigma_2(z) \varphi(t, y, z) dy dz \\ \partial_{tt}^2 \varphi - c^2 \Delta_z \varphi = -c^2 \sigma_2(z) (\sigma_1 \star Q^2)(x - q(t)) \end{cases}$$

avec donnée initiale  $(q(0), p(0), \varphi(0)) = (0, p_0, \Psi)$ . La confrontation de ces calculs heuristiques avec des simulations numériques est l'objet du Chapitre 5 où on observe que les résultats de ces simulations sont en accord avec les calculs heuristiques. En particulier, le système régissant la dynamique des paramètres  $(q(t), p(t), \varphi(t))$  étant exactement le modèle classique (1.3a)–(1.3b) de L. Bruneau et S. De Bièvre où la fonction de forme  $\sigma_1$  est remplacée par la nouvelle fonction de forme  $\widetilde{\sigma}_1 = \sigma_1 \star Q^2$ , les conclusions du Théorème 1.2.1 s'appliquent et assurent que l'état fondamental va converger exponentiellement rapidement vers une position d'équilibre. De plus, le taux exponentiel de convergence est en  $\gamma/c$  où la constante  $\gamma$  est calculable explicitement en fonction de  $\widetilde{\sigma}_1$  et  $\sigma_2$ . La nouvelle fonction de forme  $\widetilde{\sigma}_1$  dépendant désormais du soliton  $Q$ , le coefficient de friction  $\gamma = \gamma(Q)$  dépend également de  $Q$ .

### Perspectives.

Bien sûr la suite naturelle de ces travaux est désormais de démontrer rigoureusement la conjecture sur la dynamique des états fondamentaux. Si obtenir un résultat aussi précis que ce que suggèrent les calculs heuristiques est pour l'instant loin d'être accessible, des résultats plus modestes peuvent être envisagés. Par exemple, justifier que lorsque la dimension  $n$  des membranes est égale à 3, la translation  $x(t)$  de l'état fondamental est nécessairement bornée (avec une constante de bornitude qui dépend de  $c$  et diverge vers  $+\infty$  lorsque  $c \rightarrow +\infty$ ) serait déjà un premier résultat intéressant. À l'inverse, dans le cas  $n \geq 4$ , l'analogie avec le cas classique suggère l'existence de solutions pour lesquelles la translation  $x(t)$  est non bornée. L'obtention de telles solutions est également un résultat envisageable. Un résultat dans ce sens serait d'autant plus intéressant si, en plus de la non bornitude de la translation, il justifie que l'impulsion  $p(t)$  de la fonction d'onde  $u(t)$  converge vers 0 avec un taux comparable à celui d'une solution classique de (1.1) lorsque  $V \equiv 0$ ,  $\mu = n - 2$  et  $\gamma = \gamma(Q)/c$ . La construction de telles solutions peut peut-être s'inspirer des articles [86] et [65] où les auteurs construisent des dynamiques particulières sous la forme de  $K$  ondes solitaires se déplaçant en mouvement rectiligne uniforme (cas de l'équation de Schrödinger non linéaire classique [86]) ou selon la dynamique du problème à deux corps (cas de l'équation de Hartree attractive [65]).

Dans une autre direction, améliorer le résultat de stabilité orbitale en temps fini du Théorème 1.4.3 pour en faire un résultat en temps infini serait une très bonne chose. Le faire nécessite une bonne compréhension de la répartition au cours du temps du surplus d'énergie dû à l'impulsion potentiellement grande de la donnée initiale  $u_0$ . Ceci peut être un point de départ pour une recherche dans cette direction.

### 1.4.3 Approximations numériques

Afin de mener les études numériques esquissées précédemment nous avons développé des schémas pour résoudre les systèmes Vlasov-Onde et Schrödinger-Onde (*cf* Chapitre 3 et Chapitre 5). Si individuellement la résolution numérique des équations de Vlasov, des ondes et Schrödinger est tout à fait classique, nous avons tout de même dû faire attention à la discrétisation temporelle de leur couplage afin que les propriétés énergétiques valables au

niveau continu le soit également au niveau discret. En particulier, si la conservation de l'énergie totale du système est une propriété importante au niveau continu que nous aimerions conserver au niveau discret, cette propriété seule n'est pas suffisante pour assurer que les échanges d'énergie au niveau discret entre le milieu et les particules sont *consistants* avec les échanges d'énergie au niveau continu. En effet, nous pourrions imaginer être malchanceux et avoir un schéma conservant l'énergie totale du système mais pour lequel la répartition de l'énergie au cours du temps entre les particules et le milieu n'est pas la même qu'au niveau continu. Nous avons donc fait un effort spécifique au niveau de la discrétisation temporelle pour assurer que les schémas utilisés ont une propriété de *consistance* vis à vis des échanges d'énergie.

### Le système Schrödinger-Onde.

Expliquons brièvement ce que nous appelons *consistance* par rapport aux échanges d'énergie. Pour cela revenons sur les propriétés énergétiques du système Schrödinger-Onde au niveau continu. D'un côté, si  $\psi$  est une solution d'une équation des ondes de la forme

$$\partial_{tt}^2 \psi - c^2 \Delta_z \psi = \lambda^2 f,$$

alors l'énergie de  $\psi$  définie par

$$E_{\text{onde}}(t) = \frac{1}{2\lambda^2} \iint \left( |\partial_t \psi(t, x, z)|^2 + c^2 |\nabla_z \psi(t, x, z)|^2 \right) dx dz,$$

vérifie

$$\frac{d}{dt} E_{\text{onde}}(t) = \iint \psi(t, x, z) f(t, x, z) dx dz.$$

En particulier cette énergie est conservée lorsque  $f \equiv 0$ . De l'autre côté, si  $u$  est solution d'une équation de Schrödinger de la forme

$$i \partial_t \psi + \frac{1}{2} \Delta_x u = \phi u,$$

(où  $\phi$  est un potentiel à valeurs réelles) alors l'énergie de la fonction d'onde  $u$  définie par

$$E_{\text{schro}}(t) = \frac{1}{2} \int |\nabla_x u(t, x)|^2 dx + \int \phi(t, x) |u(t, x)|^2 dx$$

est telle que

$$\frac{d}{dt} E_{\text{schro}}(t) = \int \partial_t \phi(t, x) |u(t, x)|^2 dx.$$

En particulier cette énergie est conservée au cours du temps lorsque  $\phi$  est un potentiel stationnaire. En revenant alors au système Schrödinger-Onde (1.11a)–(1.11b), l'énergie totale de ce système ( $E_{\text{tot}} = E_{\text{schro}} + E_{\text{onde}}$ ) est conservée parce que le second membre de l'équation des ondes (1.11b)

$$f(t, x, z) = -\sigma_2(z) \sigma_1 \star |u|^2(t, x)$$

et le potentiel

$$\phi(t, x) = \iint \sigma_1(x - y) \sigma_2(z) \psi(t, y, z) dy dz$$

intervenant dans l'équation de Schrödinger (1.11a) sont tels que

$$\int \partial_t \phi(t, x) |u(t, x)|^2 dx + \iint \psi(t, x, z) f(t, x, z) dx dz = 0.$$

Il suit de ceci que, pour qu'un schéma numérique discrétisant le système Schrödinger-Onde soit satisfaisant d'un point de vue énergétique, il faut que les trois propriétés suivantes soient satisfaites :

- (i) le schéma discrétisant l'équation des ondes est tel que l'analogue discret de  $E_{\text{onde}}$  est conservé lorsque le terme source  $f$  est nul,
- (ii) le schéma discrétisant l'équation de Schrödinger est tel que l'analogue discret de  $E_{\text{schrö}}$  est conservé lorsque le potentiel  $\phi$  est indépendant du temps,
- (iii) le couplage de ces deux équations au niveau discret est tel que la somme des équivalents discrets de  $\int \partial_t \phi(t) |u(t)|^2 dx$  et  $\iint f(t) \psi(t) dx dz$  est nulle.

Les deux premiers points sont classiques et peuvent être obtenus via le schéma de Newmark pour les ondes et un schéma de Crank-Nicholson pour l'équation de Schrödinger. Il est à noter que dans le cas où le potentiel  $\phi$  est réel (ce qui est notre cas), ce schéma de Crank-Nicholson permet également de conserver la masse de la fonction d'onde. Nous avons ensuite réussi à obtenir le troisième point grâce à une discrétisation temporelle bien choisie du couplage entre les ondes et l'équation de Schrödinger. Ce troisième point est doublement important car, couplé avec les points (i) et (ii), il assure que l'énergie totale discrète est conservée et c'est également lui qui assure que les échanges d'énergie au niveau discret sont *consistants* avec les échanges d'énergie au niveau continu.

#### Le système Vlasov-Onde.

Le même raisonnement peut être effectué pour le système Vlasov-Onde et conduit aux trois mêmes points à vérifier (modulo des changements évidents liés au fait que désormais l'équation de Schrödinger (1.11a) est remplacée par l'équation de Vlasov (1.7a)). Il est à noter que dans ce cas la densité de particules  $F$  conserve beaucoup de quantités (et non plus seulement la masse comme c'était le cas pour le couplage avec l'équation de Schrödinger). Il n'est pas possible de conserver toutes ces quantités au niveau discret et un choix doit être fait (nous renvoyons le lecteur intéressé à l'article [37] où plusieurs approches sont détaillées et comparées, c'est cette étude qui a guidé notre choix). Le choix que nous avons fait (utiliser le schéma *Positive and Flux Conservative*) ne permet pas d'avoir que l'analogue du point (ii) est satisfait. En revanche il permet d'assurer la conservation de la masse, de la positivité et d'avoir un principe du maximum pour la densité discrète de particules. Malgré ce choix nous avons tout de même discrétisé le couplage temporel entre l'équation de Vlasov et des ondes de telle sorte que le point (iii) soit satisfait. Ceci permet d'assurer, bien que l'énergie totale du système ne soit pas conservée, que les échanges d'énergie au niveau discret sont *consistants* avec ceux au niveau continu. Ceci nous assure également que l'erreur faite sur l'énergie totale provient uniquement de l'erreur commise sur l'énergie de la densité de particule.

#### 1.4.4 Gaz de Lorentz inélastique non dissipatif

Dans le Chapitre 6, qui est le résultat d'une collaboration avec A. Vasseur, nous étudions le comportement asymptotique d'un gaz de particules soumis à un champ de force extérieur  $E$ . Contrairement au cas du système Vlasov-Onde, l'état de ce champ de force n'est pas modifié par l'état des particules, nous avons donc affaire ici à un système linéaire. En contrepartie nous avons considéré la situation où l'état précis de ce champ de force en chaque point de l'espace et en tout temps ne peut pas être connu de façon satisfaisante. Le champ de force extérieur  $E$  est alors modélisé par un processus stochastique  $(t, x, \omega) \mapsto E(t, x, \omega)$

(où  $\omega$  désigne la variable d'aléa qui vit dans un certain espace de probabilité  $(\Omega, \mathcal{A}, d\mu)$ ) pour lequel nous supposons connaître certains de ses comportements en moyenne. Le champ de force  $E$  étant un processus stochastique, la densité de particules dans l'espace des phases  $(t, x, v, \omega) \mapsto f(t, x, v, \omega)$  l'est également. La question alors naturelle est : quelles propriétés peut on obtenir sur ce nouveau processus ? Si posé avec un tel niveau de généralité cette question ne peut avoir de réponse unique, une approche particulièrement fructueuse et classique, consistant à effectuer un changement d'échelle (spatial et/ou temporel), permet de la préciser : existe-t-il un changement d'échelle, paramétrisé par un réel  $\epsilon > 0$ , tel qu'il est possible de caractériser le comportement de la moyenne stochastique du processus  $f_\epsilon$  lorsque le paramètre  $\epsilon$  converge vers zéro ? Dit en d'autres termes : est-il possible

- de justifier que la quantité  $\mathbb{E}[f_\epsilon]$  converge lorsque  $\epsilon \rightarrow 0$  ?
- si oui, d'obtenir une équation déterministe satisfaite par cette limite ?

Une fois une telle limite déterminée une nouvelle question naturelle à se poser est : la dynamique d'une réalisation donnée du processus  $f_\epsilon$  est elle *proche* (en un sens à préciser) de la dynamique limite de  $\mathbb{E}[f_\epsilon]$  lorsque  $\epsilon \rightarrow 0$  ? Il est noter que ces questions ont une réponse immédiate lorsque le changement d'échelle considéré est tel que, dans la limite  $\epsilon \rightarrow 0$ , le nouveau champ de force  $\mathcal{E}_\epsilon$  a une action nulle. Ces cas sont bien sûr sans grand intérêt et nous considérerons donc uniquement des changements d'échelles pour lesquels l'action du champ de force sur les particules est non nul dans la limite  $\epsilon \rightarrow 0$ .

Le problème développé brièvement ci-dessus est bien connu et a été abordé de façons diverses, tant en utilisant des approches probabilistes qu'EDPistes. L'étude effectuée au Chapitre 6 s'inscrit dans la continuité d'une approche EDPiste particulièrement simple introduite au début des années 2000 par F. Poupaud et A. Vasseur dans [91]. Avant d'aborder le contenu de ce Chapitre rappelons brièvement les mécanismes de cette stratégie.

### La stratégie Poupaud-Vasseur.

La stratégie Poupaud-Vasseur (noté à partir de maintenant (PV)) peut s'appliquer lorsqu'une hypothèse de décorrélation temporelle est faite sur le champ de force aléatoire  $E$  et repose alors sur la formule de Duhamel (qui est appliquée au maximum deux fois consécutivement). Afin de détailler cette stratégie introduisons l'équation de Liouville satisfaite par la densité de particule  $f_\epsilon$  :

$$\begin{cases} \partial_t f_\epsilon + v \cdot \nabla_x f_\epsilon + \mathcal{E}_\epsilon(t, x, \omega) \cdot \nabla_v f_\epsilon = 0, \\ f_\epsilon(0, x, v, \omega) = f_i(x, v) \end{cases} \quad (1.20)$$

où la donnée initiale  $f_i$  est déterministe et où  $\mathcal{E}_\epsilon$  désigne le champ de force exprimé dans la nouvelle échelle :

$$\mathcal{E}_\epsilon(t, x, \omega) = \frac{1}{\eta(\epsilon)} E\left(\frac{t}{\tau(\epsilon)}, \frac{x}{\lambda(\epsilon)}, \omega\right),$$

avec les paramètres d'échelle choisis de telle sorte que

$$\frac{\tau(\epsilon)}{\eta(\epsilon)^2} \sim 1 \quad \text{et} \quad \frac{\tau(\epsilon)}{\lambda(\epsilon)} \sim 1.$$

Ce choix sera justifié en partie dans la suite, pour une justification complète nous renvoyons le lecteur à l'article original [91]. Comme nous l'avons mentionné précédemment nous ne

nous intéressons qu'aux cas où l'action du champ de force  $\mathcal{E}_\epsilon$  est non nulle dans le régime  $\epsilon \rightarrow 0$ , ce qui impose  $\eta(\epsilon) = \mathcal{O}(1)$ . Pour fixer les idées choisissons donc

$$\eta(\epsilon) = \epsilon, \quad \tau(\epsilon) = \epsilon^2 \quad \text{et} \quad \lambda(\epsilon) = \epsilon^2.$$

En ce qui concerne les propriétés satisfaites par le champ de force  $E$  nous supposons (entre autres, pour un jeu complet d'hypothèses nous renvoyons le lecteur à [91]) que la moyenne stochastique de  $E$  est nulle en tout temps et en tout point de l'espace :  $\mathbb{E}[E(t, x, \cdot)] = 0$ , et que la variable aléatoire  $E(t, x, \cdot)$  est indépendante de  $E(s, y, \cdot)$  dès que  $|t - s| \geq 1$  :  $\mathbb{E}[E(t, x, \cdot) \otimes E(s, y, \cdot)] = \mathbb{E}[E(t, x, \cdot)] \otimes \mathbb{E}[E(s, y, \cdot)] = 0$ .

Expliquons comment la stratégie (PV) justifie que la famille  $(\mathbb{E}[f_\epsilon])_\epsilon$  admet une sous famille convergente. Pour cela nous allons utiliser un argument de compacité basé sur le théorème d'Arzela-Ascoli. Commençons par préciser que nous allons travailler avec l'espace fonctionnel  $C^0([0, T], L^p(\mathbb{R}^d \times \mathbb{R}^d) - w)$ . Le point clef pour pouvoir appliquer le théorème d'Arzela-Ascoli est donc de justifier que pour  $\varphi \in C_c^\infty(\mathbb{R}^d \times \mathbb{R}^d)$  la famille  $(\iint \mathbb{E}[f_\epsilon] \varphi \, dx \, dv)_\epsilon$  est équicontinue, propriété impliquée par l'uniforme bornitude par rapport à  $\epsilon$  de la famille  $(\frac{d}{dt} \iint \mathbb{E}[f_\epsilon] \varphi \, dx \, dv)_\epsilon$ . Comme  $f_\epsilon$  est une solution de (1.20),

$$\begin{aligned} \frac{d}{dt} \iint_{\mathbb{R}^d \times \mathbb{R}^d} \mathbb{E}[f_\epsilon](t, x, v) \varphi(x, v) \, dx \, dv &= \iint_{\mathbb{R}^d \times \mathbb{R}^d} \mathbb{E}[f_\epsilon](t, x, v) v \cdot \nabla_x \varphi(x, v) \, dx \, dv \\ &+ \mathbb{E} \left[ \iint_{\mathbb{R}^d \times \mathbb{R}^d} f_\epsilon(t, x, v, \cdot) \mathcal{E}_\epsilon(t, x, \cdot) \cdot \nabla_v \varphi(x, v) \, dx \, dv \right]. \end{aligned} \quad (1.21)$$

En utilisant la méthode des caractéristiques on obtient que

$$f_\epsilon(t, x, v, \omega) = f_i(X_\epsilon(0, t, x, v, \omega), V_\epsilon(0, t, x, v, \omega)) \quad (1.22)$$

où  $(X_\epsilon(s, t, x, v, \omega), V_\epsilon(s, t, x, v, \omega))$  est solution du système

$$\begin{cases} \dot{x}(s) = v(s) \\ \dot{v}(s) = \mathcal{E}_\epsilon(x(s), \omega) \end{cases}$$

de donnée  $(x, v)$  à l'instant  $t$  :  $(X_\epsilon(t, t, x, v, \omega), V_\epsilon(t, t, x, v, \omega)) = (x, v)$ . Le champ de vecteurs régissant la dynamique de  $(X_\epsilon, V_\epsilon)$  étant à divergence nulle il est alors clair que  $\|\mathbb{E}[f_\epsilon](t)\|_{L^p} \leq \|f_i\|_{L^p}$  et le premier terme du membre de droite de (1.21) est uniformément borné par rapport à  $\epsilon^5$ . Le choix de la nouvelle échelle implique *a priori* que le second terme explose comme  $\epsilon^{-1}$ . L'idée est alors d'exploiter l'hypothèse de moyenne nulle du champ de force  $E$  en séparant la densité de particule  $f_\epsilon(t, x, v, \cdot)$  en deux : une partie indépendante du champ de force  $\mathcal{E}_\epsilon(t, x, \cdot)$  (la moyenne stochastique de l'intégrale correspondante est donc nulle) et une seconde partie dépendant du champ de force  $\mathcal{E}_\epsilon(t, x, \cdot)$  mais tel que l'intégrale correspondante soit d'ordre exactement 1 (*cf* Figure 1.2). Cette décomposition se fait, comme annoncé, via l'application de la formule de Duhamel : en introduisant  $S_t$  le groupe du transport libre

$$S_t \varphi(x, v) = \varphi(x - tv, v),$$

et en appliquant la formule de Duhamel à (1.20), on obtient

$$f_\epsilon(t) = S_{\tau(\epsilon)} f(t - \tau(\epsilon)) - \int_0^{\tau(\epsilon)} S_\sigma [\mathcal{E}_\epsilon \cdot \nabla_v f_\epsilon(t - \sigma)] \, d\sigma.$$

<sup>5</sup>Nous avons par la même occasion que pour tout  $t$  la famille  $(\iint \mathbb{E}[f_\epsilon](t) \varphi \, dx \, dv)_\epsilon$  est relativement compact, second point à vérifier pour pouvoir appliquer le théorème d'Arzela-Ascoli.



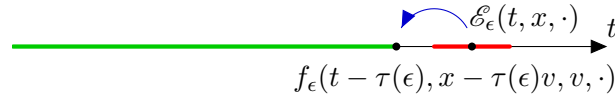

Figure 1.2: Application de la formule de Duhamel dans le cas d'une décorrélation temporelle : en rouge sont représentés les instants  $s$  pour lesquels  $\mathcal{E}_\epsilon(t, x, \cdot)$  est corrélé à  $\mathcal{E}_\epsilon(s, y, \cdot)$  et en vert sont représentés les instants  $s$  pour lesquels  $f_\epsilon(t - \tau(\epsilon), x - \tau(\epsilon)v, v, \cdot)$  dépend potentiellement de  $\mathcal{E}_\epsilon(s, y, \cdot)$ .

D'un côté l'expression (1.22) assure que  $f_\epsilon(t)$  dépend de la réalisation de  $\mathcal{E}_\epsilon(s)$  uniquement pour  $s \leq t$ . Comme le changement d'échelle assure que  $\mathcal{E}_\epsilon(t)$  et  $\mathcal{E}_\epsilon(s)$  sont indépendants dès que  $|t - s| \geq \tau(\epsilon)$ ,  $f_\epsilon(t - \tau(\epsilon), x - \tau(\epsilon)v, v, \cdot)$  est donc indépendant de  $\mathcal{E}_\epsilon(t, x, \cdot)$  :

$$\begin{aligned} \mathbb{E} \left[ \iint_{\mathbb{R}^d \times \mathbb{R}^d} f_\epsilon(t - \tau(\epsilon), x - \tau(\epsilon)v, v, \cdot) \mathcal{E}_\epsilon(t, x, \cdot) \cdot \nabla_v \varphi(x, v) dx dv \right] \\ = \iint_{\mathbb{R}^d \times \mathbb{R}^d} \mathbb{E}[f_\epsilon](t - \tau(\epsilon), x - \tau(\epsilon)v, v) \mathbb{E}[\mathcal{E}_\epsilon(t, x, \cdot)] \cdot \nabla_v \varphi(x, v) dx dv = 0. \end{aligned}$$

De l'autre côté, le second terme est d'ordre  $\tau(\epsilon)/\eta(\epsilon)$ , le produit avec  $\mathcal{E}_\epsilon(t)$  est donc d'ordre  $\tau(\epsilon)/\eta(\epsilon)^2 = 1$ . Nous venons ainsi de justifier (de façon évasive il est vrai) que la famille  $(\frac{d}{dt} \iint \mathbb{E}[f_\epsilon] \varphi dx dv)_\epsilon$  est uniformément bornée par rapport à  $\epsilon$ . Le théorème d'Arzela-Ascoli peut alors être appliqué et assure que, quitte à extraire une sous famille, la famille  $(\mathbb{E}[f_\epsilon])_\epsilon$  converge vers  $f \in L^\infty(0, T; L^p(\mathbb{R}^d \times \mathbb{R}^d))$  dans  $C^0([0, T]; L^p(\mathbb{R}^d \times \mathbb{R}^d) - w)$ . Il resterait alors à déterminer l'équation satisfaite par la limite  $f$ . Pour cela il suffirait de passer à la limite dans (1.21). Si la convergence de  $(\mathbb{E}[f_\epsilon])_\epsilon$  vers  $f$  assure facilement que  $\frac{d}{dt} \iint \mathbb{E}[f_\epsilon] \varphi dx dv$  converge vers  $\frac{d}{dt} \iint f \varphi dx dv$  dans  $\mathcal{D}'(0, T)$  et que  $\iint \mathbb{E}[f_\epsilon] v \cdot \nabla_x \varphi dx dv$  converge vers  $\iint f v \cdot \nabla_x \varphi dx dv$ , il faut travailler un peu plus pour obtenir la limite du troisième terme. Nous renvoyons le lecteur intéressé à [91] et précisons seulement ici que l'équation limite obtenue est une équation de Fokker-Planck cinétique (la diffusion n'a lieu que sur les variables de vitesse donc) et que la matrice de diffusion associée à cette équation est directement liée à la matrice de corrélation  $\mathbb{E}[E(t, x, \cdot) \otimes E(s, y, \cdot)]$ . Nous avons suffisamment décrit la stratégie (PV) pour pouvoir désormais présenter ce qu'apporte ce manuscrit à ce champ de recherche.

### Application de la stratégie (PV) pour des champs de force aléatoires stationnaires.

Si la stratégie (PV) a conduit à de nombreux développements [78, 9, 49, 50], en l'état elle nécessite une hypothèse de décorrélation temporelle qui est limitante dans certains cas. Par exemple, le cas d'un champ de force  $E$  stationnaire  $((x, \omega) \mapsto E(x, \omega))$  ne peut pas être traité. L'objet du Chapitre 6 est d'étendre, au prix d'hypothèses supplémentaires que nous allons détailler, la stratégie (PV) à ce cas. Une hypothèse supplémentaire importante que nous avons fait est de supposer que les particules ont une direction de déplacement privilégiée, l'idée étant bien sûr d'utiliser cette direction comme une direction temporelle afin de pouvoir adapter, sous une hypothèse de décorrélation spatiale du champ de force  $E$ , la stratégie (PV) classique. Plus précisément, nous avons considéré l'équation de Liouville

$$\begin{cases} \partial_t f_\epsilon + \left( \frac{1}{\epsilon} \vec{e}_1 + v \right) \cdot \nabla_x f_\epsilon + \mathcal{E}_\epsilon(x, \omega) \cdot \nabla_v f_\epsilon = 0, \\ f_\epsilon(0, x, v, \omega) = f_i(x, v) \end{cases} \quad (1.23)$$

où  $\vec{e}_1$  désigne le premier vecteur de la base canonique de  $\mathbb{R}^d$  et où  $\mathcal{E}_\epsilon$  désigne à nouveau le champ de force exprimé dans la nouvelle échelle :

$$\mathcal{E}_\epsilon(t, x, \omega) = \frac{1}{\eta(\epsilon)} E\left(\frac{x}{\lambda(\epsilon)}, \omega\right).$$

Pour fixer les idées, considérons le cas où les paramètres d'échelles sont tels que

$$\eta(\epsilon) = \epsilon^{3/4} \quad \text{et} \quad \lambda(\epsilon) = \epsilon^{1/2}.$$

Comme précédemment nous allons expliquer rapidement pourquoi un tel choix est pertinent. Avant cela précisons que nous supposons toujours que le processus  $E(x, \cdot)$  est de moyenne stochastique nulle pour tout  $x \in \mathbb{R}^d$  et que nous faisons la nouvelle hypothèse que le processus  $E(x, \cdot)$  est indépendant de  $E(y, \cdot)$  dès que  $|x_1 - y_1| \geq 1$  (où  $x_i$  désigne la  $i$ -ème coordonnée du vecteur  $x$ ).

Le choix des paramètres d'échelle est obtenu de la façon suivante. D'une part on veut toujours que l'action du champ de force  $\mathcal{E}_\epsilon$  soit non nulle dans la limite  $\epsilon \rightarrow 0$  (ce qui impose  $\eta(\epsilon) = \mathcal{O}(1)$ ). D'autre part, afin de garantir que la direction  $\vec{e}_1$  est une direction de déplacement privilégiée des particules, nous devons considérer un régime où l'ordre de grandeur du champ de force  $\mathcal{E}_\epsilon$  est petit devant  $\epsilon^{-1}$ . Nous avons choisis  $\eta(\epsilon) = \epsilon^{3/4}$  qui vérifie bien ces deux conditions mais n'importe quel autre choix de la forme  $\eta(\epsilon) = \epsilon^q$  avec  $q \in [0, 1)$  aurait été satisfaisant. Ensuite, afin de justifier que le dernier terme dans (1.23) est d'ordre 1 en moyenne stochastique, nous allons comme précédemment appliquer la formule de Duhamel à  $f_\epsilon$  sur un petit intervalle de temps de taille  $\tau(\epsilon)$  choisi de telle sorte que

$$\frac{\tau(\epsilon)}{\eta(\epsilon)^2} \sim 1, \quad \text{c'est à dire} \quad \tau(\epsilon) \sim \epsilon^{3/2}.$$

Il est à noter que cette fois-ci, afin d'exploiter la direction de déplacement privilégiée, la formule de Duhamel est appliquée avec le groupe

$$\tilde{S}_t \varphi = \varphi \left( x - t \left( \frac{1}{\epsilon} \vec{e}_1 + v \right), v \right).$$

On obtient donc

$$f_\epsilon(t) = \tilde{S}_{\tau(\epsilon)} f(t - \tau(\epsilon)) - \int_0^{\tau(\epsilon)} \tilde{S}_\sigma [\mathcal{E}_\epsilon \cdot \nabla_v f_\epsilon(t - \sigma)] d\sigma$$

et il s'agit désormais de justifier que

$$f_\epsilon \left( t - \tau(\epsilon), x - \tau(\epsilon) \left( \frac{1}{\epsilon} \vec{e}_1 + v \right), v, \cdot \right) \quad \text{et} \quad \mathcal{E}_\epsilon(x, \cdot)$$

sont indépendants (*cf* Figure 1.3). Notons qu'à  $v$  fixé, pour  $\epsilon$  suffisamment petit il est toujours possible de justifier que

$$\tau(\epsilon) \left( \frac{1}{\epsilon} \vec{e}_1 + v \right) \geq \epsilon^{1/2} = \lambda(\epsilon)$$

(notons que si ici  $\lambda(\epsilon) = \mathcal{O}(\epsilon^{1/2})$  semble être suffisant, c'est lors de l'obtention de l'équation satisfaite par la limite de  $\mathbb{E}[f_\epsilon]$  que l'échelle  $\lambda(\epsilon) \sim \epsilon^{1/2}$  s'avère être nécessaire). Pour conclure en exploitant l'hypothèse de décorrélation spatiale selon la direction  $\vec{e}_1$  du champ de force  $\mathcal{E}_\epsilon$ , il suffit donc de justifier que  $f_\epsilon(t, x, v, \cdot)$  dépend de la réalisation de  $\mathcal{E}_\epsilon$  uniquement pour  $y_1 \leq x_1$ . Ceci s'obtient en appliquant la méthode des caractéristiques et en exploitant la

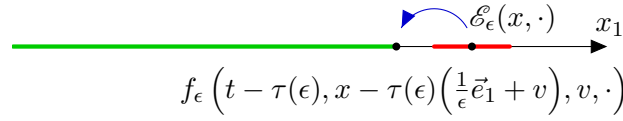

Figure 1.3: Application de la formule de Duhamel dans le cas d'une décorrélation spatiale : en rouge sont représentés les points  $y$  pour lesquels  $\mathcal{E}_\epsilon(x, \cdot)$  est corrélé à  $\mathcal{E}_\epsilon(y, \cdot)$  et en vert sont représentés les points  $y$  pour lesquels  $f_\epsilon(t - \tau(\epsilon), x - \tau(\epsilon)(\frac{1}{\epsilon}\vec{e}_1 + v), v, \cdot)$  dépend potentiellement de  $\mathcal{E}_\epsilon(y, \cdot)$ .

direction de déplacement privilégiée (qui permet de justifier que la caractéristique  $X_\epsilon$  est croissante selon la direction  $\vec{e}_1$ ).

Pour justifier que la famille  $(\frac{d}{dt} \iint \mathbb{E}[f_\epsilon] \varphi dx dv)_\epsilon$  est uniformément bornée par rapport à  $\epsilon$ , nous devons encore dire quelque chose sur le terme  $\partial_{x_1} f_\epsilon / \epsilon$  qui lui aussi explose lorsque  $\epsilon \rightarrow 0$  :

$$\begin{aligned} & \frac{d}{dt} \iint_{\mathbb{R}^d \times \mathbb{R}^d} \mathbb{E}[f_\epsilon](t, x, v) \varphi(x, v) dx dv \\ &= \frac{1}{\epsilon} \iint \mathbb{E}[f_\epsilon](t, x, v) \partial_{x_1} \varphi(x, v) dx dv + \iint_{\mathbb{R}^d \times \mathbb{R}^d} \mathbb{E}[f_\epsilon](t, x, v) v \cdot \nabla_x \varphi(x, v) dx dv \\ & \quad + \mathbb{E} \left[ \iint_{\mathbb{R}^d \times \mathbb{R}^d} f_\epsilon(t, x, v, \cdot) \mathcal{E}_\epsilon(t, x, \cdot) \cdot \nabla_v \varphi(x, v) dx dv \right]. \end{aligned}$$

Pour pouvoir traiter ce terme nous avons supposé que la donnée initiale  $f_i$  est homogène par rapport à la variable  $x_1$ :

$$f_i(x, v) = \tilde{f}_i(\tilde{x}, v) \quad \text{où} \quad x = (x_1, \tilde{x}).$$

Si cette hypothèse est naturelle dans un certain nombre de contexte physique où une direction de déplacement est privilégiée, elle n'est bien sûr pas suffisante pour assurer que  $f_\epsilon(t)$  est indépendant de  $x_1$  en tout temps. De façon plus problématique ceci est également faux en toute généralité pour sa moyenne stochastique  $\mathbb{E}[f_\epsilon](t)$ . Afin de justifier que  $\mathbb{E}[f_\epsilon](t)$  est homogène par rapport à la variable  $x_1$  (et donc que  $\partial_{x_1} \mathbb{E}[f_\epsilon](t) = 0$ ) nous avons donc dû faire l'hypothèse supplémentaire suivante sur le champ de force  $E$  : le processus aléatoire  $E : \mathbb{R}^d \times \Omega \rightarrow \mathbb{R}^d$  est stationnaire selon la direction  $\vec{e}_1$ , c'est à dire que pour tout  $y \in \mathbb{R}$ , il existe une transformation bijective  $\psi_y : \Omega \rightarrow \Omega$  conservant les volumes et telle que pour tout  $(x, \omega) \in \mathbb{R}^d \times \Omega$ ,

$$E(x + y\vec{e}_1, \omega) = E(x, \psi_y(\omega)).$$

Cette hypothèse, couplée avec l'homogénéité de la donnée initiale  $f_i$  par rapport à la variable  $x_1$ , assure en quelque sorte que le système considéré est *en moyenne* invariant par translation selon la direction  $\vec{e}_1$ , ce qui permet de conclure que  $\partial_{x_1} \mathbb{E}[f_\epsilon](t) = 0$ .

Cette brève présentation a mis en exergue les arguments nouveaux présent dans ce manuscrit qui ont permis d'adapter la méthode (PV) au cas où le champ de force  $E$  ne possède pas de décorrélation temporelle mais uniquement une décorrélation spatiale. Il faudrait bien sûr encore préciser comment déterminer l'équation satisfaite par la limite de  $(\mathbb{E}[f_\epsilon])_\epsilon$ . Il n'y a ici pas d'arguments nouveaux, il suffit de combiner les arguments déjà présentés avec ceux de la stratégie classique. Tout ceci est l'objet du Chapitre 6.

### Questions ouvertes.

Comme nous l'avons déjà mentionné, une question naturelle une fois qu'il est justifié que  $\mathbb{E}[f_\epsilon]$  converge vers un certain élément limite  $f$  solution d'une équation déterministe connue est : une réalisation donnée du processus  $f_\epsilon$  converge-t-elle vers la limite de la moyenne stochastique du processus  $f_\epsilon$  lorsque  $\epsilon \rightarrow 0$  ? En d'autres termes, existe-t-il un sens de convergence (potentiellement faible) pour lequel il est possible de justifier que  $f_\epsilon(\omega)$  converge vers  $f$  ?

*Le cas originel* (1.20). Dans ce cas où le champ de force possède une décorrélation temporelle la réponse (positive pour certains changement d'échelle, négative pour d'autres) à cette question a été obtenue par T. Goudon et A. Vasseur dans [51]. Nous aimerions obtenir un résultat analogue dans le cas du système (1.23). Afin d'expliquer les difficultés nouvelles pour obtenir un tel résultat commençons par détailler brièvement les idées de la preuve de [51]. Pour cela commençons par admettre que pour avoir une convergence de  $f_\epsilon(\omega)$  vers  $f$  en un sens satisfaisant il suffit de justifier que

- $\mathbb{E}[f_\epsilon]$  converge vers  $f$ ,
- et  $\text{Var}(f_\epsilon) = \mathbb{E}[f_\epsilon^2] - \mathbb{E}[f_\epsilon]^2$  converge vers 0.

Le premier point est déjà assuré par la méthode (PV) et pour obtenir le second point, de façon formelle, il faudrait justifier que  $\mathbb{E}[f_\epsilon^2]$  converge vers  $f^2$ . De façon plus précise, comme la convergence de  $\mathbb{E}[f_\epsilon]$  vers  $f$  se fait dans l'espace  $C^0([0, T]; L^p(\mathbb{R}^d \times \mathbb{R}^d) - w)$ , il faut justifier que pour  $\varphi \in C_c^\infty(\mathbb{R}^d \times \mathbb{R}^d)$ ,

$$\begin{aligned} \text{Var} \left( \iint_{\mathbb{R}^d \times \mathbb{R}^d} f_\epsilon(t, x, v, \cdot) \varphi(x, v) dx dv \right) \\ = \mathbb{E} \left[ \left( \iint_{\mathbb{R}^d \times \mathbb{R}^d} f_\epsilon(t, x, v, \cdot) \varphi(x, v) dx dv \right)^2 \right] - \mathbb{E} \left[ \iint_{\mathbb{R}^d \times \mathbb{R}^d} f_\epsilon(t, x, v, \cdot) \varphi(x, v) dx dv \right]^2 \end{aligned}$$

converge vers 0. Comme d'un côté

$$\begin{aligned} \mathbb{E} \left[ \left( \iint_{\mathbb{R}^d \times \mathbb{R}^d} f_\epsilon(t, x, v, \cdot) \varphi(x, v) dx dv \right)^2 \right] \\ = \mathbb{E} \left[ \iiint_{\mathbb{R}^{2d} \times \mathbb{R}^{2d}} f_\epsilon(t, x, v, \cdot) f_\epsilon(t, y, w, \cdot) \varphi(x, v) \varphi(y, w) dx dy dv dw \right] \end{aligned}$$

et que de l'autre

$$\begin{aligned} \mathbb{E} \left[ \iint_{\mathbb{R}^d \times \mathbb{R}^d} f_\epsilon(t, x, v, \cdot) \varphi(x, v) dx dv \right]^2 \xrightarrow{\epsilon \rightarrow 0} \left( \iint_{\mathbb{R}^d \times \mathbb{R}^d} f(t, x, v) \varphi(x, v) dx dv \right)^2 \\ = \iiint_{\mathbb{R}^{2d} \times \mathbb{R}^{2d}} f(t, x, v) f(t, y, w) \varphi(x, v) \varphi(y, w) dx dy dv dw, \end{aligned}$$

il est en fait suffisant de démontrer que la moyenne stochastique du nouveau processus

$$F_\epsilon(t, X, V, \cdot) = f_\epsilon(t, x, v, \cdot) f_\epsilon(t, y, w, \cdot), \quad \text{où } X = (x, y) \in \mathbb{R}^{2d} \quad \text{et } V = (v, w) \in \mathbb{R}^{2d},$$

converge vers  $F(t, X, V) = f(t, x, v) f(t, y, w)$  dans  $C^0([0, T]; L^p(\mathbb{R}^{2d} \times \mathbb{R}^{2d}) - w)$ . Précisons que cette méthode de doublement des variables est bien connue et n'est pas une spécificité

de cet article. Il est alors possible de vérifier que  $F_\epsilon$  est une solution de la nouvelle équation de Liouville

$$\begin{cases} \partial_t F_\epsilon + V \cdot \nabla_X F_\epsilon + \vec{\mathcal{E}}_\epsilon(t, X, \omega) \cdot \nabla_V F_\epsilon = 0 \\ F_\epsilon(0, X, V) = f_i(x, v) f_i(y, w) \end{cases} \quad (1.24)$$

où  $\vec{\mathcal{E}}_\epsilon$  désigne le nouveau champ de force agissant sur la densité de particule  $F_\epsilon$  et est tel que

$$\vec{\mathcal{E}}_\epsilon(t, X, \omega) = \begin{pmatrix} \mathcal{E}_\epsilon(t, x, \omega) \\ \mathcal{E}_\epsilon(t, y, \omega) \end{pmatrix}.$$

En particulier le champ de force  $\vec{\mathcal{E}}_\epsilon$  satisfait des propriétés très semblables à celles de  $\mathcal{E}_\epsilon$  et il est possible d'appliquer la méthode (PV) pour justifier que  $(\mathbb{E}[F_\epsilon])_\epsilon$  converge dans  $C^0([0, T]; L^p(\mathbb{R}^{2d} \times \mathbb{R}^{2d}) - w)$  vers un certain élément  $G \in L^\infty(0, T; L^p(\mathbb{R}^{2d} \times \mathbb{R}^{2d}))$ . De plus  $G$  satisfait une équation déterministe connue. Comme

$$F(0, X, V) = f_i(x, v) f_i(y, w) = G(0, X, V),$$

il reste alors à justifier que  $G$  et  $F$  sont solutions de la même équation et que cette équation possède une propriété d'unicité (point pouvant être potentiellement délicat). Précisons qu'il est justifié dans [51] que suivant les changements d'échelle considérés,  $F$  et  $G$  ne sont pas nécessairement solutions de la même équation.

*Le cas sans décorrélation temporelle* (1.23). En suivant l'approche précédente nous aimerions donc être capable de justifier que le processus  $F_\epsilon(t, X, V, \cdot) = f_\epsilon(t, x, v, \cdot) f_\epsilon(t, y, w, \cdot)$ , où  $f_\epsilon$  est cette fois-ci une solution de (1.23), converge en moyenne stochastique vers  $F(t, X, V) = f(t, x, v) f(t, y, w)$ . Désormais  $F_\epsilon$  est solution de l'équation de Liouville suivante

$$\begin{cases} \partial_t F_\epsilon + \left( \frac{1}{\epsilon} (\vec{e}_1 + \vec{e}_{d+1}) + V \right) \cdot \nabla_X F_\epsilon + \vec{\mathcal{E}}_\epsilon(X, \omega) \cdot \nabla_V F_\epsilon = 0, \\ F_\epsilon(0, X, V, \omega) = F_i(X, V) = f_i(x, v) f_i(y, w) \end{cases} \quad (1.25)$$

où le champ de force  $\vec{\mathcal{E}}_\epsilon$  est tel que

$$\vec{\mathcal{E}}_\epsilon(X, \omega) = \begin{pmatrix} \mathcal{E}_\epsilon(x, \omega) \\ \mathcal{E}_\epsilon(y, \omega) \end{pmatrix}.$$

Contrairement au cas précédent, les propriétés satisfaites par  $\vec{\mathcal{E}}_\epsilon$  ne sont pas exactement les mêmes que celles satisfaites par  $\mathcal{E}_\epsilon$  et ceci s'avère problématique pour appliquer l'adaptation de la stratégie (PV) développée dans ce manuscrit. En effet, pour pouvoir appliquer cette nouvelle méthode il faut que le nouveau champ de force  $\vec{\mathcal{E}}_\epsilon$  satisfasse une hypothèse de décorrélation spatiale selon la direction  $\vec{e}_1 + \vec{e}_{d+1}$  (typiquement  $\vec{\mathcal{E}}_\epsilon(X, \cdot)$  et  $\vec{\mathcal{E}}_\epsilon(Y, \cdot)$  sont indépendants dès que  $|(X - Y) \cdot (\vec{e}_1 + \vec{e}_{d+1})| \geq \lambda(\epsilon)$ ) qui n'est en fait pas satisfaite : il existe des points  $X$  et  $Y$  tel que  $|(X - Y) \cdot (\vec{e}_1 + \vec{e}_{d+1})|$  est arbitrairement grand et tel que  $\vec{\mathcal{E}}_\epsilon(X, \cdot)$  et  $\vec{\mathcal{E}}_\epsilon(Y, \cdot)$  sont corrélés. Ceci est conséquence du fait que

$$\begin{pmatrix} \mathcal{E}_\epsilon(x, \omega) \\ \mathcal{E}_\epsilon(y, \omega) \end{pmatrix} \quad \text{et} \quad \begin{pmatrix} \mathcal{E}_\epsilon(y, \omega) \\ \mathcal{E}_\epsilon(x, \omega) \end{pmatrix}$$

sont toujours corrélés. Si la direction privilégiée de déplacement  $\vec{e}_1 + \vec{e}_{d+1}$  permet de justifier que la nouvelle caractéristique  $\tilde{X}_\epsilon$  est croissante selon les directions  $\vec{e}_1$  et  $\vec{e}_{d+1}$ , et donc que

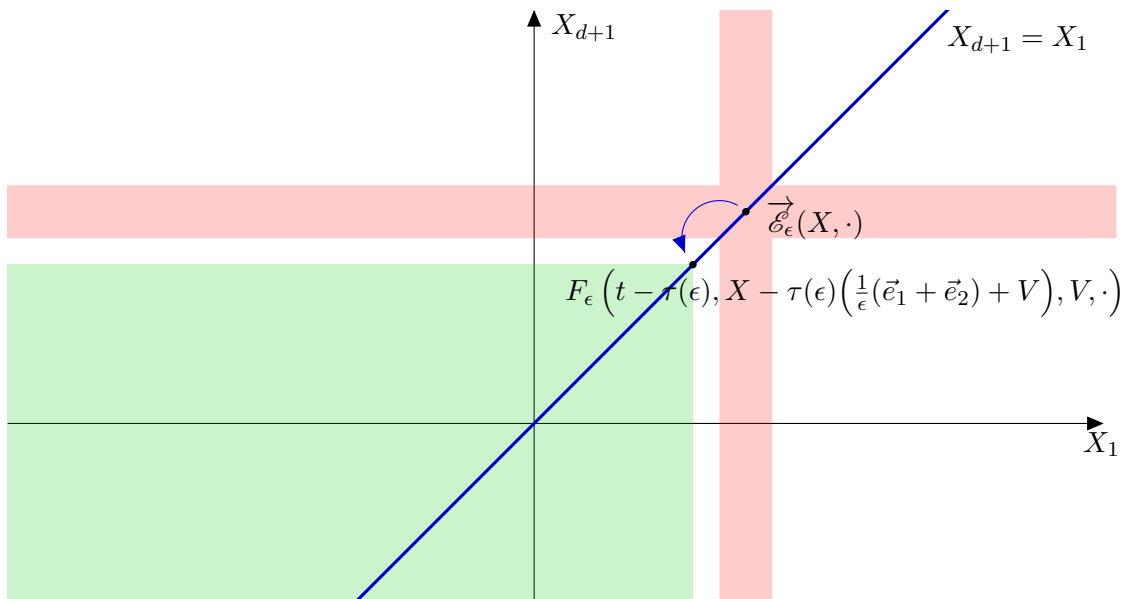

Figure 1.4: Application de la formule de Duhamel dans le cas des variables doublées (cas  $X_1 = X_{d+1}$ ) : en rouge sont représentés les points  $Y$  pour lesquels  $\vec{\mathcal{E}}_\epsilon(X, \cdot)$  est corrélé à  $\vec{\mathcal{E}}_\epsilon(Y, \cdot)$  et en vert sont représentés les points  $Y$  pour lesquels  $F_\epsilon(t - \tau(\epsilon), X - \tau(\epsilon)([\vec{e}_1 + \vec{e}_{d+1}]/\epsilon + V), V, \cdot)$  dépend potentiellement de  $\vec{\mathcal{E}}_\epsilon(Y, \cdot)$ . Ici  $F_\epsilon(t - \tau(\epsilon), X - \tau(\epsilon)([\vec{e}_1 + \vec{e}_{d+1}]/\epsilon + V), V, \cdot)$  et  $\vec{\mathcal{E}}_\epsilon(X, \cdot)$  sont indépendants.

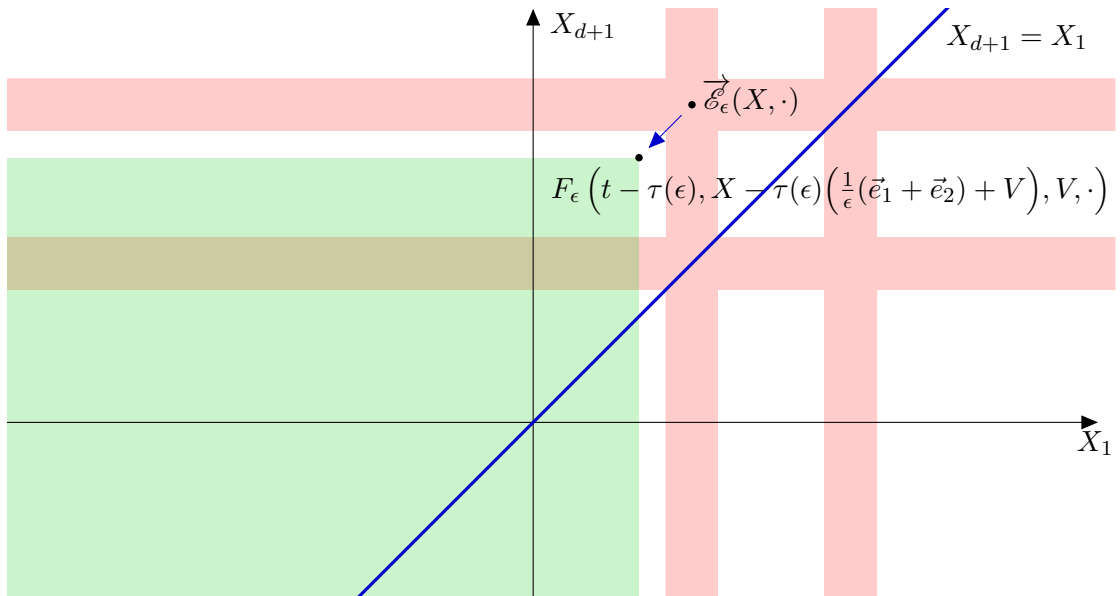

Figure 1.5: Application de la formule de Duhamel dans le cas des variables doublées (cas  $X_1 \neq X_{d+1}$ ) : en rouge sont représentés les points  $Y$  pour lesquels  $\vec{\mathcal{E}}_\epsilon(X, \cdot)$  est corrélé à  $\vec{\mathcal{E}}_\epsilon(Y, \cdot)$  et en vert sont représentés les points  $Y$  pour lesquels  $F_\epsilon(t - \tau(\epsilon), X - \tau(\epsilon)([\vec{e}_1 + \vec{e}_{d+1}]/\epsilon + V), V, \cdot)$  dépend potentiellement de  $\vec{\mathcal{E}}_\epsilon(Y, \cdot)$ . Ici  $F_\epsilon(t - \tau(\epsilon), X - \tau(\epsilon)([\vec{e}_1 + \vec{e}_{d+1}]/\epsilon + V), V, \cdot)$  et  $\vec{\mathcal{E}}_\epsilon(X, \cdot)$  sont potentiellement corrélés.

$F_\epsilon(t, X, V, \cdot)$  dépend de la réalisation de  $\vec{\mathcal{E}}_\epsilon(Y, \cdot)$  uniquement pour  $Y_1 \leq X_1$  et  $Y_{d+1} \leq X_{d+1}$ , cela n'est donc pas suffisant pour justifier que

$$F_\epsilon \left( t - \tau(\epsilon), X - \tau(\epsilon) \left( \frac{1}{\epsilon} (\vec{e}_1 + \vec{e}_{d+1}) + V \right), V, \cdot \right) \quad \text{et} \quad \vec{\mathcal{E}}_\epsilon(X, \cdot)$$

sont indépendants, cf Figure 1.4 et 1.5.

Précisons tout de même deux choses. La première est que les autres propriétés essentielles qui doivent être vérifiées pour pouvoir appliquer la nouvelle méthode (PV) sont bien satisfaites : la donnée initiale  $F_i$  est homogène dans le plan de direction  $(\vec{e}_1, \vec{e}_{d+1})$ , le processus  $\vec{\mathcal{E}}_\epsilon$  est stationnaire selon la direction  $\vec{e}_1 + \vec{e}_{d+1}$  et la moyenne stochastique de  $\vec{\mathcal{E}}_\epsilon(X, \cdot)$  est nulle pour tout  $X \in \mathbb{R}^{2d}$ . Le second point est qu'il existe des changements d'échelle pour lesquels il est possible de justifier que

$$F_\epsilon \left( t - \tau(\epsilon), X - \tau(\epsilon) \left( \frac{1}{\epsilon} (\vec{e}_1 + \vec{e}_{d+1}) + V \right), V, \cdot \right) \quad \text{et} \quad \vec{\mathcal{E}}_\epsilon(X, \cdot)$$

sont indépendants (même lorsque  $X_1 \neq X_{d+1}$ ), mais que tous ces changements d'échelle sont tels que l'équation satisfaite par la limite de  $\mathbb{E}[F_\epsilon]$  n'est pas la même équation que celle satisfaite par  $F(t, X, V) = f(t, x, v)f(t, y, w)$ . En effet (en l'état) pour pouvoir justifier cette propriété d'indépendance il faudrait en Figure 1.5 que, lorsque la formule de Duhamel est appliquée,  $F_\epsilon(t - \tau(\epsilon), X - \tau(\epsilon)([\vec{e}_1 + \vec{e}_{d+1}]/\epsilon + V), V, \cdot)$  soit translaté de l'autre côté de la bande rouge qui intersecte le quart de plan vert. Comme le long de la droite  $\{X - s([\vec{e}_1 + \vec{e}_{d+1}]/\epsilon + V) \text{ t.q. } s \in \mathbb{R}\}$ , passer de l'autre côté de cette bande rouge depuis le point  $X$  nécessite toujours un déplacement de l'ordre  $|X_1 - X_{d+1}|$ , ceci peut être justifié lorsque l'échelle considérée est telle que

$$\frac{\tau(\epsilon)}{\epsilon} \xrightarrow{\epsilon \rightarrow 0} +\infty.$$

Notons qu'avec l'échelle  $\eta(\epsilon)^{3/4}$ , nous avons  $\tau(\epsilon) \sim \epsilon^{3/2}$  et que dans ce cas  $\tau(\epsilon)/\epsilon \rightarrow 0$ . Par contre pour tout changement d'échelle de la forme  $\eta(\epsilon) = \epsilon^q$  avec  $q \in (0, 1/2)$ ,  $\tau(\epsilon) \sim \epsilon^{2q}$  et alors

$$\frac{\tau(\epsilon)}{\epsilon} \sim \epsilon^{2q-1} \xrightarrow{\epsilon \rightarrow 0} +\infty.$$

Pour ces changements d'échelle il est donc possible de justifier que  $(\mathbb{E}[F_\epsilon])_\epsilon$  converge vers un certain  $G \in L^\infty(0, T; L^p(\mathbb{R}^{2d} \times \mathbb{R}^{2d}))$  dans  $C^0([0, T]; L^p(\mathbb{R}^{2d} \times \mathbb{R}^{2d}) - w)$  ainsi que de déterminer l'équation satisfaite par  $G$ . Cependant pour tous ces changements d'échelle, l'équation satisfaite par  $G$  est toujours différente de celle satisfaite par  $F$ . En effet, pour ceux-ci  $\lambda(\epsilon) = \epsilon^{2q-1}$  et donc  $\lambda(\epsilon) \rightarrow +\infty$  au lieu de converger vers 0. Comme cela avait déjà été remarqué dans [51], ceci a pour conséquence que  $G$  et  $F$  ne satisfont pas la même équation. Il semblerait donc que sans argument supplémentaire, la stratégie (PV) ne puisse pas justifier que  $f_\epsilon(\omega)$  converge vers  $f$ .







---

Landau damping in dynamical Lorentz gases

---

This chapter is devoted to the analysis of the Landau damping effect for the Vlasov-Wave system (1.7a)–(1.7b). The content is based on the article [P1], jointly with T. Goudon, but it contains a substantial additional material, with further detailed remarks and clarifications, including the Appendices A and B).

## 2.1 Introduction

In this work, we go back to the analysis of Landau damping mechanisms in kinetic equations. This effect has been brought out for the Vlasov equation of plasma physics in the pioneering work of L. Landau [67], and extended to gravitational models in astrophysics [80, 81], where it is thought to play a key role in the stability of galaxies. It can be interpreted as a stability statement about steady solutions, leading to a decay of the self-consistent force. A complete mathematical analysis of the Landau damping for non linear Vlasov equations has been performed in [87], and revisited later on in [12, 13] (see also [59]). Similar behaviors have been revealed for the 2D Euler system [11]. The phenomena are surprising since they describe damping mechanisms, counter-intuitive for *reversible* equations which apparently do not present any dissipative process.

The starting point of this contribution comes from an original model introduced by L. Bruneau and S. De Bièvre [16] describing the motion of a *single* classical particle interacting with its environment. The particle is described by its position  $t \mapsto q(t) \in \mathbb{R}^d$ , while the behavior of the environment is embodied into a scalar field  $(t, x, z) \in (0, \infty) \times \mathbb{R}^d \times \mathbb{R}^n \mapsto \psi(t, x, z)$ . The dynamic is modeled by the following set of differential equations

$$\begin{cases} \ddot{q}(t) = -\nabla V(q(t)) - \iint_{\mathbb{R}^d \times \mathbb{R}^n} \sigma_1(q(t) - y) \sigma_2(z) \nabla_x \Psi(t, y, z) dy dz, \\ \partial_{tt}^2 \Psi(t, x, z) - c^2 \Delta_z \Psi(t, x, z) = -\sigma_2(z) \sigma_1(x - q(t)), \quad x \in \mathbb{R}^d, z \in \mathbb{R}^n. \end{cases} \quad (2.1)$$

It corresponds to the intuition of a particle moving through an infinite set of  $n$ -dimensional elastic membranes, one for each position  $x \in \mathbb{R}^d$ . The physical properties of the membranes are characterized by the wave speed  $c > 0$ . The coupling between the particles and the environment is governed by two form functions  $\sigma_1, \sigma_2$ , which are both non negative, smooth and

radially symmetric functions; they can be seen as determining the influence domain of the particle in each direction, the direction of particle's motion and the direction of wave propagation, respectively. It is therefore relevant to assume both form functions have a compact support. The particle exchanges its kinetic energy with the vibrations of the membranes. These mechanisms eventually act like a friction force since particle's energy is evacuated in the membranes, and, depending on the shape of the external potential  $x \mapsto V(x)$ , they determine the large time behavior of the particle. We refer the reader to [2, 27, 28, 29, 66, 96] for further studies of the system (2.1), that include numerical experiments and interpretation by means of random walks.

The system (2.1) can be generalized by considering a set of  $N$  particles going through the membranes. The mean field regime  $N \rightarrow \infty$  leads to the following PDE system

$$\partial_t F + v \cdot \nabla_x F - \nabla_x (V + \Phi[\Psi]) \cdot \nabla_v F = 0, \quad t \geq 0, \quad x \in \mathbb{R}^d, \quad v \in \mathbb{R}^d, \quad (2.2a)$$

$$(\partial_{tt}^2 \Psi - c^2 \Delta_z \Psi)(t, x, z) = -\sigma_2(z) \int_{\mathbb{R}^d} \sigma_1(x - y) \rho(t, y) dy, \quad t \geq 0, \quad x \in \mathbb{R}^d, \quad z \in \mathbb{R}^n, \quad (2.2b)$$

$$\rho(t, x) = \int_{\mathbb{R}^d} F(t, x, v) dv, \quad (2.2c)$$

$$\Phi[\Psi](t, x) = \iint_{\mathbb{R}^d \times \mathbb{R}^n} \sigma_1(x - y) \sigma_2(z) \Psi(t, y, z) dz dy, \quad t \geq 0, \quad x \in \mathbb{R}^d, \quad (2.2d)$$

where now  $(t, x, v) \mapsto F(t, x, v)$  is interpreted as the particles distribution function in phase space,  $x \in \mathbb{R}^d$  being the position variable, and  $v \in \mathbb{R}^d$  the velocity variable. The system (2.2a)–(2.2d) is completed by initial conditions

$$F|_{t=0} = F_0, \quad (\Psi, \partial_t \Psi)|_{t=0} = (\Psi_0, \Psi_1). \quad (2.3)$$

We refer the reader to [52, 103] for the derivation of the  $N$ -particles system and the analysis of the mean field regime that leads to (2.2a)–(2.2d). The existence of solutions of (2.2a)–(2.2d) is investigated in [25]. Furthermore, asymptotic issues are also discussed that reveal an unexpected connection with the *gravitational* Vlasov-Poisson equation. This relation with another model of statistical physics can guide the intuition to analyze further mathematical properties of (2.2a)–(2.2d). In this spirit, the existence of equilibrium states and their stability is discussed in [4], adding in the kinetic model a dissipative effect with the Fokker-Planck operator, and in [26] where a variational approach is adopted for the collisionless model, following [56, 57, 109].

We wish to continue this analysis, adopting a different viewpoint. In [4, 26] the effect of a confining potential  $x \mapsto V(x)$  is considered, which governs the shape of the equilibrium states. Here, we change the geometry of the problem, replacing the confining assumption on the external potential, by the assumption that particles' motion holds in the  $d$ -dimensional torus  $\mathbb{T}^d$ . In such a framework, like for the usual Vlasov-Poisson system, we can find space-homogeneous stationary solutions, and we wish to investigate their stability. This question is directly reminiscent to the well-known phenomena of damping brought out in plasma physics by L. Landau [67]: for the electrostatic Vlasov-Poisson system, it can be shown that the electric field of the linearized system decays exponentially fast. For gravitational interactions a similar discussion dates back to D. Lynden-Bell [80, 81]. In fact, Landau's

analysis [67] was concerned with the linearized equation only. Of course the linearization procedure is questionable and the non linear dynamics might significantly depart from the linear behavior, as pointed out in [7]. A stunning analysis of the non linear problem in the analytic framework has been recently performed by C. Mouhot & C. Villani [87, 106]. A simplified analysis of the Landau damping has been proposed in [12]; we also refer the reader to [36] for results based on Sobolev regularity (with a definition of the force which involves only a finite number of Fourier modes, though). The Landau damping around homogeneous solutions has also been investigated in the whole space  $\mathbb{R}^d$  [13], thus dealing with a set of particles having an infinite mass. See also [59] for an alternative approach that uses integration along phase-space characteristics. We wish to address these issues for the system (2.2a)–(2.2d), still when  $V = 0$ . The analysis of the non-linear equations is quite involved; it requires a complex functional framework and fine estimates in order to control the non linear effects, the so-called “plasma echoes”, that can break the damping mechanisms observed on the linearized model. By the way, it has been recently shown that insufficient regularity of the perturbation can annihilate the damping mechanisms, and the proof (which, though, is very specific to the coupling with the Poisson equation; it is not clear that the argument applies for more regular convolution kernels) precisely uses the role of the plasma echoes against damping [10]. Nevertheless it turns out that identifying stability conditions for the linearized problem plays a central role in the analysis of the non linear stability, see [87, Condition **(L)**]. Beyond their interest for the specific model (2.2a)–(2.2d) of particles interacting with their environment, the results we are going to discuss can be thought of with some generality. Indeed, as we shall detail below, the equation for the particle distribution function can be recast as follows

$$\partial_t F + v \cdot \nabla_x F - \nabla_x \Phi_I \cdot \nabla_v F - \nabla_x \Phi_S \cdot \nabla_v F = 0,$$

where the potential splits into two parts, that both induce new issues compared to the case of the “standard” Vlasov system (hereafter simply referred to as the “Vlasov equation”):

- $\Phi_I(t, x)$  does not depend on  $F$ : this is a *linear* contribution in the equation. The damping then relies on suitable time-decay properties, here related to the dispersion properties of the free wave equation.
- the self-consistent potential  $\Phi_S(t, x)$  is defined by a convolution with respect to space, combined with a half-convolution with respect to time

$$\Phi_S(t, x) = - \int_0^t \int \Sigma(x - y) p_c(t - s) \rho(s, y) dy ds.$$

Then the Landau damping relies on properties of the kernel  $\Sigma$ , which is quite similar to the analysis of the Vlasov case, but also on decay properties of the kernel  $p_c$ .

The discussion is organized as follows. We start by checking that we can find homogeneous solutions in Section 2.1.1. We also introduce different, but complementary, ways to think of the equations and we make a series of comments explaining how the problem differs from the usual Vlasov system. We complete this preliminary section by paying a specific attention to the properties of the kernel  $p_c$ , depending on the dimension  $n$ , which play a crucial role in the analysis. In Section 2.2, which is the heart of this work, we turn to the linearized problem. The analysis of the linearized equation reduces to study a certain integral equation, satisfied by the Fourier coefficients of the macroscopic density. That the damping occurs relies on a stability criterion on the kernel of this Volterra equation, which, at least, can be verified when  $c$ , the speed of wave propagation, is large enough. Next, we briefly explain

the method for proving the non linear Landau damping for the free space problem, for which the functional framework is less intricate, in Section 2.3. We present how the main arguments should be adapted for the torus in Section 2.4. We further discuss the stability criterion in Section 2.5, in the spirit of the Penrose criterion. Quite surprisingly, we are led to an intricate expression, much more complicated than for the Vlasov model. Nevertheless, these expressions allows us to establish some conclusions close to what is known on the gravitational Vlasov case. We also propose several interpretations of criteria that lead to (un)stable solutions. We will go back to the interpretation of the stability criteria with the numerical investigation discussed in Chapter 3.

### 2.1.1 Preliminaries

In what follows,  $\mathbb{X}^d$  stands indifferently for  $\mathbb{T}^d$  or  $\mathbb{R}^d$ , and for given functions  $\phi : x \in \mathbb{X}^d \mapsto \phi(x)$  and  $g : v \in \mathbb{R}^d \mapsto g(v)$ , we denote

$$\langle \phi \rangle_{\mathbb{X}^d} = \int_{\mathbb{X}^d} \phi(x) dx, \quad \langle g \rangle_{\mathbb{R}^d} = \int_{\mathbb{R}^d} g(v) dv,$$

where  $dx$  is either the usual Lebesgue measure on  $\mathbb{X}^d = \mathbb{R}^d$  or the normalized Lebesgue measure on  $\mathbb{X}^d = \mathbb{T}^d$ . We shall also use indifferently the notation  $\widehat{\cdot}$  for the Fourier coefficients of a  $\mathbb{T}^d$ -periodic function

$$\varphi : \mathbb{T}^d \rightarrow \mathbb{R}, \quad \widehat{\varphi}(k) = \int_{\mathbb{T}^d} e^{-ik \cdot x} \varphi(x) dx \text{ for } k \in \mathbb{Z}^d,$$

or the Fourier transform over  $\mathbb{R}^m$  (with  $m = d$  or  $m = n$ )

$$\varphi : \mathbb{R}^m \rightarrow \mathbb{R}, \quad \widehat{\varphi}(\xi) = \int_{\mathbb{R}^m} e^{-ix \cdot \xi} \varphi(x) dx \text{ for } \xi \in \mathbb{R}^m.$$

We equally use the same notation for a function  $\phi$  depending on  $x \in \mathbb{X}^d$  and  $v \in \mathbb{R}^d$

$$\widehat{\varphi}(k, \xi) = \iint_{\mathbb{X}^d \times \mathbb{R}^m} e^{-ik \cdot x} e^{-i\xi \cdot v} \varphi(x, v) dv dx,$$

for  $\xi \in \mathbb{R}^m$  and either  $k \in \mathbb{Z}^d$  (case  $\mathbb{X}^d = \mathbb{T}^d$ ) or  $k \in \mathbb{R}^d$  (case  $\mathbb{X}^d = \mathbb{R}^d$ ). In the sequel, we shall use the shorthand notation  $k \in \mathbb{X}^{*d}$  to encompass these two situations. Throughout the paper, we shall use the notations

$$\langle x \rangle = \sqrt{1 + x^2}$$

and, given a real number  $s$ ,  $s^+$  means  $s + \epsilon$  for  $\epsilon > 0$  arbitrarily small. We write  $A \lesssim B$  when we can find a constant  $C > 0$  such that  $A \leq CB$ . Here,  $A, B$  are in general functions of time, space, velocity, or their associated Fourier variables; it is thus understood that  $C$  is uniform over these variables. In certain circumstances, we write  $A \lesssim_r B$  to emphasize the fact that the constant  $C$  depends on the parameter  $r$ .

### 2.1.2 Rewriting the equations

Due to the linearity of the wave equation, the solution of (2.2b) can be split into a contribution that depends only on the initial condition  $(\Psi_0, \Psi_1)$  and a contribution that depends only on  $\rho$ , see [25, Eq. (6)–(8)]. Accordingly, we split the potential into

$$\Phi = \Phi_I + \Phi_S,$$

where  $\Phi_I$  depends only on  $(\Psi_0, \Psi_1)$  as follows

$$\Phi_I(t, x) = \frac{1}{(2\pi)^n} \iint_{\mathbb{R}^n \times \mathbb{X}^d} \sigma_1(x - y) \left( \widehat{\Psi}_0(y, \zeta) \cos(c|\zeta|t) + \widehat{\Psi}_1(y, \zeta) \frac{\sin(c|\zeta|t)}{c|\zeta|} \right) \widehat{\sigma}_2(\zeta) \, dy \, d\zeta \quad (2.4)$$

and the coupling term reads

$$\begin{aligned} \Phi_S(t, x) &= - \int_0^t p_c(t-s) \Sigma \star \rho(s, x) \, ds, \\ \Sigma &= \sigma_1 \star \sigma_1, \\ p_c(t) &= \int_{\mathbb{R}^n} \frac{\sin(c|\zeta|t)}{c|\zeta|} |\widehat{\sigma}_2(\zeta)|^2 \frac{d\zeta}{(2\pi)^n}. \end{aligned} \quad (2.5)$$

The properties of the function  $t \mapsto p_c(t)$ , collected in Lemma 2.1.3 below, play a crucial role in the asymptotic analysis of (2.2a)–(2.2d).

### 2.1.3 Homogeneous solutions

Let  $\rho_0 > 0$  and let  $v \mapsto M(v)$  be a given function such that  $\int_{\mathbb{R}^d} M(v) \, dv = 1$ . We claim that

$$\mathcal{M} : (x, v) \in \mathbb{X}^d \times \mathbb{R}^d \longmapsto \mathcal{M}(x, v) = \rho_0 M(v)$$

is a stationary solution of (2.2a)–(2.2d), associated to a spatially homogeneous potential  $\Phi$ , when starting from spatially homogeneous data for the wave equation. On the torus, since  $M$  and  $dx$  are normalized,  $\rho_0$  is the mass of the solution  $\mathcal{M}$ . With  $F = \mathcal{M}$ , the right hand side of the wave equation (2.2b) becomes

$$-\sigma_2(z) \iint_{\mathbb{X}^d \times \mathbb{R}^d} \sigma_1(x - y) \mathcal{M}(y, v) \, dv \, dy = -\sigma_2(z) \langle \sigma_1 \rangle_{\mathbb{X}^d} \langle \mathcal{M} \rangle_{\mathbb{R}^d},$$

which depends only on the variable  $z \in \mathbb{R}^n$ . Therefore, considering space-homogeneous initial data  $(x, z) \mapsto (\Psi_0^H(z), \Psi_1^H(z))$ , the solution of the wave equation

$$\partial_{tt}^2 \Psi^H - c^2 \Delta_z \Psi^H = -\sigma_2(z) \langle \sigma_1 \rangle_{\mathbb{X}^d} \langle \mathcal{M} \rangle_{\mathbb{R}^d}$$

is given by the inverse Fourier transform of

$$\widehat{\Psi}^H(t, \xi) = \widehat{\Psi}_0^H(\xi) \cos(c|\xi|t) + \widehat{\Psi}_1^H(\xi) \frac{\sin(c|\xi|t)}{c|\xi|} - \frac{1 - \cos(c|\xi|t)}{c^2|\xi|^2} \widehat{\sigma}_2(\xi) \langle \sigma_1 \rangle_{\mathbb{X}^d} \langle \mathcal{M} \rangle_{\mathbb{R}^d},$$

and it does not depend on the space variable  $x$ . Accordingly, the associated potential

$$\Phi[\Psi^H](t, x) = \langle \sigma_1 \rangle_{\mathbb{X}^d} \iint_{\mathbb{R}^n} \sigma_2(z) \Psi^H(t, z) \, dz$$

does not depend on  $x$ . We obtain

$$(\partial_t + v \cdot \nabla_x) \mathcal{M} = 0 = \nabla_x \Phi[\Psi^H] \cdot \nabla_v \mathcal{M},$$

and finally  $(\mathcal{M}, \Psi^H)$  is a homogeneous solution of (2.2a)–(2.2d). We bring the attention of the reader to the fact that, in the case  $\mathbb{X}^d = \mathbb{R}^d$ , the homogeneous solutions have infinite mass and infinite energy.

**Remark 2.1.1 (Stationary solutions)** *A specific case of interest corresponds to stationary solutions. Let us associate to  $\mathcal{M}$ , the function*

$$\Psi_{\text{eq}}(z) = \frac{1}{c^2} \Gamma(z) \langle \sigma_1 \rangle_{\mathbb{X}^d} \langle \cdot \mathcal{M} \rangle_{\mathbb{R}^d},$$

where  $\Gamma$  is the solution of  $\Delta_z \Gamma(z) = \sigma_2(z)$ . It defines a stationary solution  $\Psi_{\text{eq}}$  for the wave equation (2.2c) (with initial data  $\Psi_0^H = \Psi_{\text{eq}}$  and  $\Psi_1^H = 0$ ). The associated potential thus reads

$$\iint_{\mathbb{X}^d \times \mathbb{R}^n} \sigma_1(x-y) \sigma_2(z) \Psi_{\text{eq}}(z) \, dx \, dz = \langle \sigma_1 \rangle_{\mathbb{X}^d} \int_{\mathbb{R}^n} \sigma_2(z) \Psi_{\text{eq}}(z) \, dz,$$

which does not depend on the space variable  $x \in \mathbb{X}^d$ , nor on the time variable  $t$ .

### 2.1.4 Equations for the fluctuations

Given a space-homogeneous solution  $(\mathcal{M}, \Psi^H)$ , we expand the solution as

$$F(t, x, v) = \mathcal{M}(v) + f(t, x, v), \quad \Psi(t, x, z) = \Psi^H(t, z) + \psi(t, x, z). \quad (2.6)$$

The fluctuations  $(f, \psi)$  satisfy

$$\partial_t f + v \cdot \nabla_x f - \nabla_x \Phi[\psi] \cdot \nabla_v (\mathcal{M} + f) = 0, \quad (2.7a)$$

$$\Phi[\psi](t, x) = \iint_{\mathbb{X}^d \times \mathbb{R}^n} \sigma_1(x-y) \sigma_2(z) \psi(t, y, z) \, dy \, dz, \quad (2.7b)$$

$$\partial_{tt}^2 \psi - c^2 \Delta_z \psi = -\sigma_2(z) \int_{\mathbb{R}^d} \sigma_1(x-y) \varrho(t, y) \, dy, \quad (2.7c)$$

$$\varrho(t, x) = \int_{\mathbb{R}^d} f(t, x, v) \, dv, \quad (2.7d)$$

completed by the initial conditions

$$f(0, x, v) = f_0(x, v), \quad (\psi(0, x, z), \partial_t \psi(0, x, z)) = (\psi_0(x, z), \psi_1(x, z)). \quad (2.8)$$

As said above, it can be convenient to set  $\psi(t, x, z) = \psi_I(t, x, z) + \psi_S(t, x, z)$ , with the contribution from the initial data

$$\widehat{\psi}_I(t, x, \xi) = \widehat{\psi}_0(x, \xi) \cos(c|\xi|t) + \widehat{\psi}_1(x, \xi) \frac{\sin(c|\xi|t)}{c|\xi|}$$

and the self-consistent contribution

$$\widehat{\psi}_S(t, x, \xi) = - \int_0^t \frac{\sin(c|\xi|[t-\tau])}{c|\xi|} \widehat{\sigma}_2(\xi) \sigma_1 \star \varrho(\tau, x) \, d\tau.$$

Plugging this into the expression of the potential, we get

$$\Phi[\psi](t, x) = \sigma_1 \star (\mathcal{F}_I(t) - \sigma_1 \star \mathcal{G}_\varrho(t))(x),$$

where we have set

$$\mathcal{F}_I(t, x) = \int_{\mathbb{R}^n} \sigma_2(z) \psi_I(t, x, z) \, dz$$

and

$$\mathcal{G}_\varrho(t, x) = \int_0^t p_c(t-\tau) \varrho(\tau, x) \, d\tau.$$

Hence, the evolution equation for the fluctuation  $f$  can be recast as

$$\partial_t f + v \cdot \nabla_x f - \nabla \sigma_1 \star (\mathcal{F}_I - \sigma_1 \star \mathcal{G}_\varrho) \cdot \nabla_v (\mathcal{M} + f) = 0. \quad (2.9)$$

Finally, let us introduce

$$g(t, x, v) = f(t, x + tv, v),$$

which allows us to get rid of the advection operator. We remark that

$$\partial_t g(t, x, v) = (\partial_t + v \cdot \nabla_x) f(t, x + tv, v)$$

and

$$(\nabla_v f)(t, x + tv, v) = \nabla_v [f(t, x + tv, v)] - t \nabla_x f(t, x + tv, v) = (\nabla_v - t \nabla_x) g(t, x, v).$$

Thus, (2.9) becomes

$$\partial_t g(t, x, v) = \nabla \sigma_1 \star (\mathcal{F}_I - \sigma_1 \star \mathcal{G}_\varrho)(t, x + tv) \cdot (\nabla_v - t \nabla_x)(\mathcal{M} + g)(t, x, v), \quad (2.10a)$$

$$g(0, x, v) = f_0(x, v). \quad (2.10b)$$

The following rough statement gives the flavor of the result we wish to justify.

**Theorem** *We assume that the data  $\sigma_1, \sigma_2, \psi_0, \psi_1, f_0$  are smooth enough. We assume, furthermore, that the analog of the **(L)**-condition for the Vlasov-Wave equation holds. If, initially, the fluctuation is small enough, then, we can find an asymptotic profile  $g^\infty$  so that  $g(t) - g^\infty$  and the applied force  $\nabla \sigma_1 \star (\mathcal{F}_I - \sigma_1 \star \mathcal{G}_\varrho)$  tend to 0 as  $t \rightarrow \infty$ .*

The precise statements are given in Theorem 2.3.7 (case  $\mathbb{X}^d = \mathbb{R}^d$ ) and Theorem 2.4.9 (case  $\mathbb{X}^d = \mathbb{T}^d$ ) Let us make a few comments to announce the forthcoming analysis.

- The stability condition **(L)** (see Section 2.5), like for the usual Vlasov equation, imposes that a certain symbol cannot reach the value 1. In particular, the stability condition holds provided the wave speed  $c$  is large enough, see Proposition 2.2.11.
- The functional framework is a bit intricate. Roughly speaking, we distinguish two types of results, depending whether we work with analytic functions and regularity measured by means of Gevrey spaces (for the torus, the result applies only in this framework), or with functions having enough Sobolev regularity (the result on  $\mathbb{R}^d$  applies in this context, and we can also establish the damping for the *linearized* problems in both cases  $\mathbb{X}^d = \mathbb{R}^d$  and  $\mathbb{X}^d = \mathbb{T}^d$ ).
- Typically the smallness assumption is imposed on a certain space  $X$  (of Gevrey or Sobolev type), but the damping holds in slightly “less regular” spaces  $Y$ , with  $X \subset Y$ . The rate of convergence depends on the functional framework (Gevrey vs. Sobolev) and how far  $Y$  is from  $X$ .
- For the problem on  $\mathbb{R}^d$ , we shall need to assume  $d \geq 3$ ; the method breaks down in smaller dimensions, for reasons that already appeared for the Vlasov-Poisson system [13].

For the usual Vlasov equation, the main ingredients to justify the Landau damping can be recapped as follows:

- the transport operator induces a phase mixing phenomena, which is a source of decay for the macroscopic density  $\varrho$ ;



- when linearizing the system around the homogeneous solution, the Fourier modes of  $\varrho$  decouple, leading to a Volterra equation for the Fourier transform of the density. It permits to identify a stability criterion, that depends on the homogeneous solution and on the potential so that the linear dynamics induced by the force term does not annihilate the effects of the phase mixing;
- it remains to control the non linear effects, with the plasma echoes that tend to contribute against the phase mixing.

Technically, in order to address this program, one assumes the smallness of the data and justifies uniform boundedness with respect to time, and, eventually, the Landau damping. In particular, the echoes should be controlled by means of the underlying norms. Rewriting the potential with (2.4)–(2.5), we realize that the system (2.2a)–(2.2d) substantially differs from the usual Vlasov system dealt with in [87] and [12, 13] in the following aspects:

- there is an additional term  $\nabla_x \Phi_I \cdot \nabla_v F$ , with a force *independent* on the particles density. This linear perturbation could drive the solution far from the homogeneous state  $\mathcal{M}$ ;
- the self-consistent potential  $\Phi_S$  involves a half-convolution with respect to the time variable, inducing a sort of memory effect. In particular, the function  $p_c$  dramatically influences the expression of the stability criterion.

As we shall see, the analysis of the linearized problem, and the stability criterion, sensibly differ from the Vlasov case. Nevertheless, this linearized analysis remains at the heart of the proof of the Landau damping: once the Landau damping established for the linearized equation, the arguments of [87] and [12, 13] can be adapted to handle the nonlinear problem. Furthermore, we will also bring out the analogies with the gravitational Vlasov-Poisson problem, in terms of conditions of the equilibrium profile. We address both the confined case  $\mathbb{X}^d = \mathbb{T}^d$  and the free space problem  $\mathbb{X}^d = \mathbb{R}^d$ , underlying the differences needed depending on the technical framework.

### 2.1.5 The kernel $p_c$

As said above, the decay properties of the kernel  $p_c$ , consequences of the dispersion properties of the wave equations, are crucial for the analysis. When  $n \geq 3$ ,  $p_c$  is integrable and satisfies

$$\int_0^\infty p_c(t) dt = \frac{\kappa}{c^2}, \quad \text{with} \quad \kappa = \int_{\mathbb{R}^n} \frac{|\widehat{\sigma}_2(\zeta)|^2}{|\zeta|^2} d\zeta < \infty,$$

see [25, Lemma 4.4]. The following statement strengthens this result, depending on the dimension  $n \geq 2$  and the assumptions on the form function  $\sigma_2$ . Roughly speaking, we distinguish the case of odd dimensions  $n \geq 3$  where the necessary estimates are consequences of the Huygens' principle, and even dimensions where the dispersion effects are weaker. Similar considerations apply when dealing with the term  $\mathcal{F}_I$ .

**Lemma 2.1.3** *Let  $n \geq 2$  and let  $\sigma_2$  belong to the Besov space  $B_1^{n-1,1}$ .*

(i) *There exists a constant  $C(\sigma_2) > 0$  such that*

$$|p_c(t)| \leq \frac{C(\sigma_2)}{c \langle ct \rangle^{\frac{n-1}{2}}}.$$

- (ii) Moreover, if  $|\sigma_2(z)| \lesssim \langle z \rangle^{-m_2}$  with  $m_2 > n + (n-1)/2$ , then there exists a constant  $C(\sigma_2) > 0$  such that

$$|p_c(t)| \leq \frac{C(\sigma_2)}{c \langle ct \rangle^{n-1}}.$$

Let  $n \geq 3$  be an odd integer.

- (iii) Suppose that  $|\sigma_2(z)| \lesssim \langle z \rangle^{-m_2}$  for some  $m_2 > n + \alpha$ , with  $\alpha > 0$ . Then there exists a constant  $C(\sigma_2) > 0$  such that

$$|p_c(t)| \leq \frac{C(\sigma_2)}{c \langle ct \rangle^\alpha}.$$

- (iv) Let  $\lambda > 0$ . If  $|\sigma_2(z)| \lesssim \exp(-\lambda_2|z|)$  for some  $\lambda_2 > \lambda$ , then there exists a constant  $C(\sigma_2) > 0$  such that

$$|p_c(t)| \leq \frac{C(\sigma_2) e^{-\lambda|ct|}}{c}.$$

- (v) If  $\sigma_2 \in C_c^0(\mathbb{R}^n)$  with  $\text{supp}(\sigma_2) \subset B(0, R_2)$ , then  $p_c$  has a compact support included in  $[0, \frac{2R_2}{c}]$  and it satisfies

$$|p_c(t)| \leq C \frac{\|\sigma_2\|_{L^{2n/(n+2)}} \|\sigma_2\|_{L^2}}{c},$$

for a certain constant  $C > 0$ .

The decay of  $p_c$  is intimately connected to the energy dissipation mechanisms through the vibration of the medium, which are at the heart of the qualitative properties of the model introduced in [16]. In dimension  $n = 1$ , a direct computation by means of D'Alembert formula shows that

$$p_c(t) = \frac{1}{2c} \int_{-\infty}^{+\infty} \sigma_2(z) \left( \int_{z-ct}^{z+ct} \sigma_2(s) ds \right) dz \xrightarrow{t \rightarrow \infty} \frac{1}{2c} \|\sigma_2\|_{L_z^2}^2 > 0.$$

Hence, in this case  $p_c \notin L^1(0, \infty)$ , there is no loss of memory at all; numerical simulations indeed confirm that there is no damping phenomena, see Chapter 3. Similarly, working in the torus  $\mathbb{T}^n$  for the wave equation leads to

$$p_c(t) = \sum_{\ell \neq 0} \frac{|\widehat{\sigma}_2(\ell)|^2}{c\ell} \sin(c\ell t) + |\widehat{\sigma}_2(0)|^2 t.$$

It shows that there is no possible energy dispersion mechanism in this geometry.

As we shall see later on the rate of the Landau damping is directly related to the decay rate of  $p_c$ . If even dimensions  $n$  are considered the best decay rate provided by Lemma 2.1.3 leads to  $|p_c(t)| \lesssim \langle t \rangle^{-(n-1)}$ . However, the Landau damping also requires some regularity on the Cauchy data for the Vlasov equation. For instance, the analysis of the non linear Landau damping in  $\mathbb{R}^d$ , inspired from [13], leads to suppose that the data lies in the Sobolev space  $H^{36}$  (which might be sub-optimal, see [13, Remark 1]). This imposes a constraint on the decay of  $p_c$ , which amount to a condition on the dimension  $n$  for the wave equation (like  $n-1 \geq 36$ , see **(H1)** and **(A1)**–**(A2)**). Then, one may wonder to identify minimal regularity assumptions to obtain the Landau damping. The alternative proof of [59], which is less demanding in terms of regularity, could be adapted in order to extend the result in this direction. It is easier to discuss the linearized problem, for which we obtain  $n \geq 6$  (see

Remark 2.2.6). We point out that when  $n$  is odd the only condition is  $n \geq 3$ , for both the linear and the non linear cases.

**Proof.** The proof relies on dispersion estimates for the wave equation, that we shall use in several places. Let us denote  $(\dot{W}, W)$  the group of the wave equation (with propagation speed  $c = 1$ ): we write the solution of the Cauchy problem

$$\begin{cases} (\partial_{tt}^2 - c^2 \Delta_z) \Upsilon(t, z) = 0, \\ (\Upsilon, \partial_t \Upsilon)|_{t=0} = (\Upsilon_0, \Upsilon_1). \end{cases} \quad (2.11)$$

as  $\Upsilon(t, \cdot) = \dot{W}(ct) \Upsilon_0 + \frac{1}{c} W(ct) \Upsilon_1$ . In terms of Fourier variable,  $\dot{W}(t)$  corresponds to the multiplication by  $\cos(|\zeta|t)$  and  $W(t)$  to the multiplication by  $\sin(|\zeta|t)/|\zeta|$ :

$$\widehat{\dot{W}(ct) \Upsilon_0}(\zeta) = \cos(c|\zeta|t) \widehat{\Upsilon}(\zeta) \quad \text{and} \quad \frac{1}{c} \widehat{W(ct) \Upsilon_1}(\zeta) = \frac{\sin(c|\zeta|t)}{c|\zeta|} \widehat{\Upsilon}(\zeta).$$

Therefore,  $p_c$  can be cast as

$$p_c(t) = \frac{1}{c} \int_{\mathbb{R}^n} \sigma_2 W(ct) \sigma_2 dz.$$

The dispersion estimates rely on the operators  $U^\pm(t)$  defined by

$$\widehat{U^\pm \Upsilon}(\zeta) = e^{\pm i|\zeta|t} \widehat{\Upsilon}(\zeta).$$

Indeed, since  $\dot{W}(t) = (U^+ + U^-)/2$  and  $W(t) = (U^+ - U^-)/(2i\sqrt{-\Delta_z})$  an estimate with  $U^\pm(t)$  can be translated into an estimate for  $\dot{W}(t)$  and  $W(t)$ . The basic estimate states as follows (see e. g. [46, Proof of Proposition 3.1] and the references therein): if  $\Upsilon$  has its Fourier transform supported in  $\{\zeta \in \mathbb{R}^n \mid 2^{j-1} \leq |\zeta| \leq 2^{j+1}\}$ , then

$$\|U^\pm(t) \Upsilon\|_{L_z^\infty} \leq C \min\left(2^{nj}, 2^{\frac{n+1}{2}j} |t|^{-\frac{n-1}{2}}\right) \|\Upsilon\|_{L_z^1}. \quad (2.12)$$

Estimate (2.12) can be refined as follows, see [99, Proof Of Lemma 3.2],

$$\begin{aligned} |U^\pm(t) \Upsilon(z)| \\ \leq C_N \min\left(2^{nj}, 2^{\frac{n+1}{2}j} |t|^{-\frac{n-1}{2}}, 2^{(\frac{n+1}{2}-N)j} |t|^{-\frac{n-1}{2}} ||t| - |z||^{-N}\right) \|\Upsilon\|_{L_z^1}, \end{aligned} \quad (2.13)$$

where  $N$  can be any integer. Such an estimate can be seen as a generalization of Huygens' principle which holds only in odd dimensions: it tells us that  $U^\pm(t) \Upsilon$  reaches its maximum next to the cone  $t = |z|$ . In order to use these estimates, we introduce a sequence  $\varphi_j \in \mathcal{S}(\mathbb{R}^n)$  such that  $\sum_j \widehat{\varphi}_j(\zeta) = 1$  and for any  $j \in \mathbb{Z}$ ,  $\text{supp}(\widehat{\varphi}_j) \subset \{\zeta \mid 2^{j-1} \leq |\zeta| \leq 2^{j+1}\}$ . We set  $\Upsilon_j = \varphi_j \star \Upsilon$  so that  $\Upsilon = \sum_j \Upsilon_j$  and thanks to (2.12) we get

$$\|U^\pm(t) \Upsilon\|_{L_z^\infty} \leq C \min\left(\sum_{j \in \mathbb{Z}} 2^{nj} \|\Upsilon_j\|_{L_z^1}, |t|^{-\frac{n-1}{2}} \sum_{j \in \mathbb{Z}} 2^{\frac{n+1}{2}j} \|\Upsilon_j\|_{L_z^1}\right), \quad (2.14)$$

where  $\sum_j 2^{sj} \|\Upsilon_j\|_{L_z^1}$  is nothing but the  $\dot{B}_1^{s,1}$ -norm of  $\Upsilon$ . We refer the reader to [46] for a thorough introduction to Besov spaces: the homogeneous Besov spaces  $\dot{B}_1^{s,1}$  satisfy a scale invariance property but there is no obvious embedding relations between  $\dot{B}_1^{s,1}$  and  $\dot{B}_1^{s',1}$  for  $s \geq s'$  (if  $s' \geq 0$ ,  $2^{sj} \geq 2^{s'j}$  for  $j \geq 0$  but  $2^{sj} < 2^{s'j}$  for  $j < 0$ ). In order to make use of a single functional space, we prefer to work with the non homogeneous Besov spaces  $B_1^{s,1}$ : we have  $B_1^{s,1} \subset \dot{B}_1^{s,1}$  for  $s \geq 0$  and  $B_1^{s,1}$  embeds into  $B_1^{s',1}$  for  $s \geq s'$ . Therefore, we get

$$\|U^\pm(t) \Upsilon\|_{L_z^\infty} \leq C \min\left(1, |t|^{-\frac{n-1}{2}}\right) \|\Upsilon\|_{B_1^{n,1}} \lesssim \langle t \rangle^{-\frac{n-1}{2}} \|\Upsilon\|_{B_1^{n,1}}. \quad (2.15)$$

Similarly, from (2.13) we get

$$\begin{aligned} & |U^\pm(t)\Upsilon(z)| \\ & \leq C_N \min \left( \|\Upsilon\|_{\dot{B}_1^{n,1}}, |t|^{-\frac{n-1}{2}} \|\Upsilon\|_{\dot{B}_1^{\frac{n+1}{2},1}}, |t|^{-\frac{n-1}{2}} | |t| - |z| |^{-N} \|\Upsilon\|_{\dot{B}_1^{\frac{n+1}{2}-N,1}} \right). \end{aligned} \quad (2.16)$$

Note that we do not work with Besov space with negative regularity index  $s$  (which would imply irrelevant conditions on  $\xi = 0$ ). Assuming  $N \leq (n+1)/2$ , we are led to

$$|U^\pm(t)\Upsilon(z)| \leq C_N \min \left( 1, |t|^{-\frac{n-1}{2}}, |t|^{-\frac{n-1}{2}} | |t| - |z| |^{-N} \right) \|\Upsilon\|_{B_1^{n,1}}. \quad (2.17)$$

We can now finish the proof of Lemma 2.1.3. Since  $p_c(t) = \frac{1}{c} (\int \sigma_2 W(ct) \sigma_2 dz)$ , we have  $|p_c(t)| \leq \frac{1}{c} \|\sigma_2\|_{L_z^1} \|W(ct)\sigma_2\|_{L_z^\infty}$ . By applying (a variant with an extra factor  $1/2^{j-1}$  of (2.12), we obtain

$$\|W(ct)\varphi_j \star \sigma_2\|_{L_z^\infty} \leq \frac{C}{2^{j-1}} \min \left( 2^{nj}, 2^{\frac{n+1}{2}j} |ct|^{-\frac{n-1}{2}} \right) \|\varphi_j \star \sigma_2\|_{L_z^1}.$$

Summing over  $j \in \mathbb{Z}$  yields

$$|p_c(t)| \leq \frac{K}{c \langle ct \rangle^{\frac{n-1}{2}}} \|\sigma_2\|_{L_z^1} \|\sigma_2\|_{B_1^{n-1,1}},$$

which proves (i). Estimate (ii) uses the refined estimate (2.13) which gives, for any  $N \in \mathbb{N}$ ,

$$\begin{aligned} & |W(ct)\varphi_j \star \sigma_2(z)| \\ & \leq \frac{C_N}{2^{j-1}} \min \left( 2^{nj}, 2^{\frac{n+1}{2}j} |ct|^{-\frac{n-1}{2}}, 2^{(\frac{n+1}{2}-N)j} |ct|^{-\frac{n-1}{2}} | |ct| - |z| |^{-N} \right) \|\varphi_j \star \sigma_2\|_{L_z^1}. \end{aligned}$$

With  $N = (n-1)/2$  and summing over  $j \in \mathbb{Z}$ , we get

$$|p_c(t)| \leq \frac{2C_N}{c} \left( \int_{\mathbb{R}^n} |\sigma_2(z)| \min \left( 1, |ct|^{-\frac{n-1}{2}}, |ct|^{-\frac{n-1}{2}} | |ct| - |z| |^{-\frac{n-1}{2}} \right) dz \right) \|\sigma_2\|_{B_1^{n-1,1}}.$$

We have

$$\begin{aligned} & \int_{\mathbb{R}^n} |\sigma_2(z)| \min \left( 1, |ct|^{-\frac{n-1}{2}}, |ct|^{-\frac{n-1}{2}} | |ct| - |z| |^{-\frac{n-1}{2}} \right) dz \\ & \lesssim \int_{\mathbb{R}^n} |\sigma_2(z)| \min \left( \langle ct \rangle^{-\frac{n-1}{2}}, \langle |ct| | |ct| - |z| | \rangle^{-\frac{n-1}{2}} \right) dz. \end{aligned}$$

We split the integration domain into the ball  $B(0, |ct|/2)$  and its complementary and we obtain

$$\begin{aligned} & \int_{\mathbb{R}^n} |\sigma_2(z)| \min \left( \langle ct \rangle^{-\frac{n-1}{2}}, \langle |ct| | |ct| - |z| | \rangle^{-\frac{n-1}{2}} \right) dz \\ & = \int_{B(0, \frac{|ct|}{2})} |\sigma_2(z)| \langle |ct| | |ct| - |z| | \rangle^{-\frac{n-1}{2}} dz + \int_{\mathbb{C}B(0, \frac{|ct|}{2})} |\sigma_2(z)| \langle ct \rangle^{-\frac{n-1}{2}} dz \\ & \leq \int_{B(0, \frac{|ct|}{2})} |\sigma_2| \left\langle \frac{|ct|^2}{2} \right\rangle^{-\frac{n-1}{2}} dz + \langle ct \rangle^{-\frac{n-1}{2}} \left( \int_{\mathbb{C}B(0, \frac{|ct|}{2})} |\sigma_2(z)| dz \right) \\ & \lesssim \left\langle \frac{|ct|}{2} \right\rangle^{-(n-1)} \|\sigma_2\|_{L_z^1} + \langle ct \rangle^{-\frac{n-1}{2}} \left\langle \frac{|ct|}{2} \right\rangle^{-\frac{n-1}{2}} \left( \int_{\mathbb{C}B(0, \frac{|ct|}{2})} |\sigma_2(z)| \langle z \rangle^{\frac{n-1}{2}} dz \right). \end{aligned}$$

The assumption on  $\sigma_2$  ensures that the last integral is finite

We turn to the specific case of odd dimensions. The role of the Huygens principle appears clearly with the estimate (v). Indeed the support assumption on  $\sigma_2$  implies, when  $n$  is odd, that

$$\text{if } ct \geq R_2 + |z| \text{ then } W(t)\sigma_2(z) = 0.$$

Therefore, when  $t \geq \frac{2R_2}{c}$ , the product  $\sigma_2(z)W(ct)\sigma_2(z)$  vanishes (see Fig. 2.1) and  $p_c(t) = 0$ . Bearing in mind that  $n \geq 3$ , Hölder inequality yields

$$|p_c(t)| \leq \frac{1}{c} \|\sigma_2\|_{L^{2n/(n+2)}} \|W(ct)\sigma_2\|_{L^{2n/(n-2)}}.$$

We conclude by combining the Sobolev embedding inequality, see e. g. [71, Lemma 8.3],  $\|W(ct)\sigma_2\|_{L^{2n/(n-2)}} \leq C_S \|\nabla_z W(ct)\sigma_2\|_{L^2}$ , and the energy conservation for the wave equation which implies

$$\|\nabla_z W(ct)\sigma_2\|_{L^2}^2 \leq \|\partial_s(W(s)\sigma_2)|_{s=ct}\|_{L^2}^2 + \|\nabla_z W(ct)\sigma_2\|_{L^2}^2 \leq \|\sigma_2\|_{L^2}^2.$$

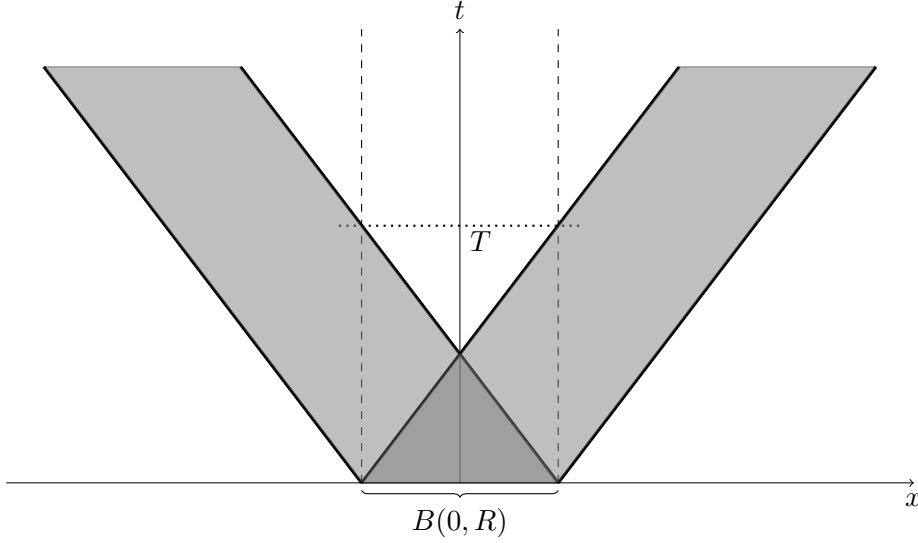

Figure 2.1: Propagation cone: the signal emanating from the ball  $B(0, R)$  cannot be felt in this ball after time  $T$

We turn to the proof of (iii). Consider  $t > 0$  and  $0 < R < ct$ . We split as follows

$$\sigma_2 = \sigma_2 \mathbf{1}_{|z| \leq R} + \sigma_2 \mathbf{1}_{|z| > R} := u_1 + u_2.$$

By linearity of the wave equation, we can write

$$p_c(t) = \frac{1}{c} \int_{\mathbb{R}^n} \sigma_2 W(ct) u_1 dz + \frac{1}{c} \int_{\mathbb{R}^n} \sigma_2 W(ct) u_2 dz.$$

Since  $u_1$  is supported in  $B(0, R)$ , the support of  $W(ct)u_1$  lies in  $\{z \mid ct - R \leq |z| \leq ct + R\}$ . Since  $ct - R > 0$ , the first integral is dominated as follows (we already know from the proof of (i) that  $\|W(ct)u_1\|_{L_z^\infty} \lesssim \|\sigma_2\|_{B_1^{n-1,1}}$ )

$$\begin{aligned} \left| \int_{\mathbb{R}^n} \sigma_2 W(ct) u_1 dz \right| &= \langle ct - R \rangle^{-\alpha} \left| \int_{\mathbb{C}B(0, ct-R)} \langle ct - R \rangle^\alpha \sigma_2(z) W(ct) u_1(z) dz \right| \\ &\lesssim \langle ct - R \rangle^{-\alpha} \left( \int_{\mathbb{C}B(0, ct-R)} \langle z \rangle^\alpha |\sigma_2(z)| dz \right) \|\sigma_2\|_{B_1^{n-1,1}}. \end{aligned}$$

By virtue of the assumptions on  $\sigma_2$ , the right hand side is finite. The integral with  $u_2$  can be estimated by using Plancherel's formula, which yields

$$\int_{\mathbb{R}^n} \sigma_2 W(ct) u_2 dz = \int_{\mathbb{R}^n} \widehat{\sigma}_2(\zeta) \frac{\sin(c|\zeta|t)}{|\zeta|} \widehat{u}_2(\zeta) d\zeta = \int_{\mathbb{R}^n} u_2 W(ct) \sigma_2 dz.$$

It leads to

$$\begin{aligned} \left| \int_{\mathbb{R}^n} \sigma_2 W(ct) u_2 dz \right| &= \left| \int_{\mathbb{R}^n} u_2 W(ct) \sigma_2 dz \right| \lesssim \left( \int_{\mathbb{R}^n} |\sigma_2(z)| \mathbf{1}_{|z|>R} dz \right) \|\sigma_2\|_{B_1^{n-1,1}} \\ &= \langle R \rangle^{-\alpha} \left( \int_{\mathbb{R}^n} \langle R \rangle^\alpha |\sigma_2(z)| \mathbf{1}_{|z|>R} dz \right) \|\sigma_2\|_{B_1^{n-1,1}} \\ &\leq \langle R \rangle^{-\alpha} \left( \int_{\mathbb{R}^n} \langle z \rangle^\alpha |\sigma_2(z)| dz \right) \|\sigma_2\|_{B_1^{n-1,1}}, \end{aligned}$$

which is finite too. We have proved that

$$|p_c(t)| \lesssim \frac{1}{c} (\langle ct - R \rangle^{-\alpha} + \langle R \rangle^{-\alpha})$$

and we conclude by setting  $R = ct/2$ . Item (iv) is justified similarly, just replacing the polynomial weights by exponential weights.  $\blacksquare$

Analogous conclusions apply to  $\mathcal{F}_I$  which can be cast as

$$\mathcal{F}_I(t, x) = \int_{\mathbb{R}^n} \sigma_2(z) \left( \dot{W}(ct) \Psi_0(x, z) + \frac{1}{c} W(ct) \Psi_1(x, z) \right) dz.$$

## 2.2 Linearized Landau damping

### 2.2.1 The linearized system

In the expansion (2.6), let us assume that the fluctuations  $f$  and  $\psi$  remain small, so that we neglect the quadratic term (with respect to the perturbations)  $\nabla_x \Phi[\psi] \cdot \nabla_v f$  in the evolution equations (note in particular that this assumes the smallness of the initial fluctuations  $(\psi_0, \psi_1)$ ). We are thus led to the following linearized system

$$\partial_t f + v \cdot \nabla_x f - \nabla_x \phi \cdot \nabla_v \mathcal{M} = 0, \quad t \geq 0, \quad x \in \mathbb{X}^d, \quad v \in \mathbb{R}^d, \quad (2.18a)$$

$$\phi(t, x) = \iint_{\mathbb{X}^d \times \mathbb{R}^n} \sigma_1(x - y) \psi(t, y, z) \sigma_2(z) dz dy, \quad t \geq 0, \quad x \in \mathbb{X}^d \quad (2.18b)$$

$$\partial_{tt}^2 \psi - c^2 \Delta_z \psi = -\sigma_2(z) \int_{\mathbb{X}^d} \sigma_1(x - y) \varrho(t, y) dy, \quad t \geq 0, \quad x \in \mathbb{X}^d, \quad z \in \mathbb{R}^n, \quad (2.18c)$$

$$\varrho(t, x) = \int_{\mathbb{R}^d} f(t, x, v) dv, \quad t \geq 0, \quad x \in \mathbb{X}^d. \quad (2.18d)$$

The system is completed by initial conditions

$$f|_{t=0} = f_0, \quad (\psi, \partial_t \psi)|_{t=0} = (\psi_0, \psi_1). \quad (2.19)$$

The expected result can be explained as follows: let us assume that the fluctuation does not provide additional mass:  $\iint f(0, x, v) dv dx = 0$ , and, to fix ideas,  $\psi_0 = 0$  and  $\psi_1 = 0$ . In such a case, linearized Landau damping asserts that  $\varrho$  converges strongly to 0, while  $f$  converges weakly to 0, as  $t \rightarrow \infty$ . Moreover, the potential  $\phi$  also vanishes for large times. We are going to establish that such a behavior holds for the system (2.18)–(2.19).

We start by applying the Fourier transform, with respect to  $x$  and  $v$  to (2.18a). It yields

$$(\partial_t - k \cdot \nabla_\xi) \widehat{f}(t, k, \xi) = -k \cdot \xi \widehat{\phi}(t, k) \widehat{\mathcal{M}}(\xi).$$

The equation can be integrated along characteristics, which leads to the following Duhamel formula

$$\widehat{f}(t, k, \xi) = \widehat{f}_0(k, \xi + tk) - \int_0^t (\xi + (t - \tau)k) \cdot k \widehat{\phi}(\tau, k) \widehat{\mathcal{M}}(\xi + (t - \tau)k) d\tau. \quad (2.20)$$

We turn to the expression of the Fourier coefficients of the potential. We remind the reader that we can split the potential into

$$\phi = \phi_I + \phi_S,$$

where  $\phi_I$  depends only on  $(\psi_0, \psi_1)$  as follows

$$\phi_I(t, x) = \iint_{\mathbb{X}^d \times \mathbb{R}^n} \sigma_1(x - y) \sigma_2(z) \underbrace{\left( \dot{W}(ct) \psi_0(y, z) + \frac{1}{c} W(ct) \psi_1(y, z) \right)}_{=\psi_I(t, y, z)} dy dz \quad (2.21)$$

and the coupling term reads

$$\phi_S(t, x) = - \int_0^t p_c(t - \tau) \Sigma \star \varrho(\tau, x) d\tau.$$

Plugging the expression of  $\phi = \phi_I + \phi_S$  into (2.20), we obtain

$$\begin{aligned} \widehat{f}(t, k, \xi) &= \widehat{f}_0(k, \xi + tk) - \int_0^t (\xi + (t - \tau)k) \cdot k \widehat{\phi}_I(\tau, k) \widehat{\mathcal{M}}(\xi + (t - \tau)k) d\tau \\ &\quad + |\widehat{\sigma}_1(k)|^2 \int_0^t (\xi + (t - \tau)k) \cdot k \left( \int_0^\tau p_c(\tau - s) \widehat{\varrho}(s, k) ds \right) \widehat{\mathcal{M}}(\xi + (t - \tau)k) d\tau \\ &= \widehat{f}_0(k, \xi + tk) - \int_0^t (\xi + (t - \tau)k) \cdot k \widehat{\phi}_I(\tau, k) \widehat{\mathcal{M}}(\xi + (t - \tau)k) d\tau \\ &\quad + |\widehat{\sigma}_1(k)|^2 \int_0^t \left( \int_s^t p_c(\tau - s) (\xi + k(t - \tau)) \cdot k \widehat{\mathcal{M}}(\xi + (t - \tau)k) d\tau \right) \widehat{\varrho}(s, k) ds \\ &= \widehat{f}_0(k, \xi + tk) - \int_0^t (\xi + (t - \tau)k) \cdot k \widehat{\phi}_I(\tau, k) \widehat{\mathcal{M}}(\xi + (t - \tau)k) d\tau \\ &\quad + |\widehat{\sigma}_1(k)|^2 \int_0^t \left( \int_0^{t-s} p_c(\tau) (\xi + (t - [\tau + s])k) \cdot k \widehat{\mathcal{M}}(\xi + (t - [\tau + s])k) d\tau \right) \widehat{\varrho}(s, k) ds. \end{aligned}$$

We are led to an integral equation for the (Fourier coefficients of) the macroscopic density by considering this relation for  $\xi = 0$ . Let us set

$$a(t, k) = \widehat{f}_0(k, tk) - |k|^2 \int_0^t \widehat{\phi}_I(\tau, k) (t - \tau) \widehat{\mathcal{M}}((t - \tau)k) d\tau \quad (2.22)$$

and

$$\mathcal{K}(t, k) = |k|^2 |\widehat{\sigma}_1(k)|^2 \int_0^t p_c(\tau) (t - \tau) \widehat{\mathcal{M}}((t - \tau)k) d\tau. \quad (2.23)$$

Then, we obtain an integral equation for the fluctuation of the macroscopic density

$$\widehat{\varrho}(t, k) = a(t, k) + \int_0^t \mathcal{K}(t - s, k) \widehat{\varrho}(s, k) ds. \quad (2.24)$$

The analysis of this relation makes use of the Laplace transform

$$\varphi : (0, \infty) \rightarrow \mathbb{C}, \quad \mathcal{L}\varphi(\omega) = \int_0^{+\infty} e^{-\omega t} \varphi(t) dt \text{ for } \omega \in \mathbb{C},$$

which is well defined for  $\text{Re}(\omega)$  large enough.

### 2.2.2 Linearized Landau damping in finite regularity

The linearized Landau damping holds with an algebraic rate provided the solution  $\varrho$  of (2.24) satisfies

$$|\widehat{\varrho}(t, k)| \leq C \langle tk \rangle^{-m} \quad (2.25)$$

(see for instance [87, section 3]) for a certain  $m > 0$ . For Volterra equations like (2.24) we can establish (see [12, Lemma 4.1], [13, Proposition 2.2]) mode-by-mode estimates in  $L_t^2$  norm: for any  $k$

$$\int_0^{+\infty} \langle tk \rangle^{2m} |\widehat{\varrho}(t, k)|^2 dt \leq C_{LD}^2 \int_0^{+\infty} \langle tk \rangle^{2m} |a(t, k)|^2 dt, \quad (2.26)$$

where  $C_{LD} > 0$  does not depend on  $k$ . From such an  $L_t^2$  estimate, we get an  $L_t^\infty$  estimate as follows

$$\begin{aligned} \langle tk \rangle^m |\widehat{\varrho}(t, k)| &\leq \langle tk \rangle^m |a(t, k)| + \left| \int_0^t \langle (t-\tau)k + \tau k \rangle^m \mathcal{K}_k(t-\tau, k) \widehat{\varrho}(\tau, k) d\tau \right| \\ &\leq \langle tk \rangle^m |a(t, k)| + \left( \int_0^t \langle \tau k \rangle^{2m} |\mathcal{K}(\tau, k)|^2 d\tau \right)^{1/2} \left( \int_0^t \langle \tau k \rangle^{2m} |\widehat{\varrho}(\tau, k)|^2 d\tau \right)^{1/2} \\ &\leq \langle tk \rangle^m |a(t, k)| + C_{LD} \left( \int_0^t \langle \tau k \rangle^{2m} |\mathcal{K}(\tau, k)|^2 d\tau \right)^{1/2} \left( \int_0^t \langle \tau k \rangle^{2m} |a(\tau, k)|^2 d\tau \right)^{1/2}, \end{aligned}$$

where we are left with the task of verifying that

$$\begin{cases} \sup_{\substack{t \geq 0 \\ k \in \mathbb{X}^{*d} \setminus \{0\}}} \langle tk \rangle^m |a(t, k)| < +\infty, \\ \sup_{k \in \mathbb{X}^{*d} \setminus \{0\}} \left( \int_0^{+\infty} \langle \tau k \rangle^{2m} |\mathcal{K}(\tau, k)|^2 d\tau \right) \left( \int_0^{+\infty} \langle \tau k \rangle^{2m} |a(\tau, k)|^2 d\tau \right) < +\infty \end{cases} \quad (2.27)$$

hold. We are going to identify conditions on  $a(t, k)$  and  $\mathcal{K}(t, k)$  such that (2.26) applies and to justify that (2.27) is satisfied. We refer the reader to [13, Proof of Proposition 2.2] for a proof of the following claim.

**Lemma 2.2.1** *Let  $\mathcal{K}$  satisfy*

$$\inf_{k \in \mathbb{X}^{*d} \setminus \{0\}} |1 - \mathcal{L}\mathcal{K}(\omega, k)| \geq \kappa > 0 \quad \text{for } \operatorname{Re}(\omega) \geq 0, \quad (\mathbf{L})$$

and for any  $0 \leq j \leq m$  :

$$\sup_{\substack{k \in \mathbb{X}^{*d} \setminus \{0\} \\ \operatorname{Re}(\omega) \geq 0}} \left( |k|^j \left| \partial_\omega^j \mathcal{L}\mathcal{K}(\omega, k) \right| \right) < +\infty.$$

Then there exists a constant  $C_{LD} > 0$ , which does not depend on  $k$ , such that the solutions of (2.24) satisfy (2.26).

Estimate (2.26) makes sense when  $t \mapsto \langle tk \rangle^m a(t, k)$  is square integrable, a property that needs to be carefully checked in the current framework.

Condition **(L)** gives rise to a stability criterion on the stationary profile  $\mathcal{M}$ . Since the operator  $\mathcal{K}$  involves the kernel  $p_c$  the detailed condition substantially differs from the usual Vlasov case. That this statement applies for our purpose relies on the following assumptions:



- (H1)  $n > m + \frac{5}{2}$ ,
- (H2)  $\sigma_2 \in B_1^{n-1,1}$  and  $|\sigma_2(z)| \leq C_2 \langle z \rangle^{-m_2}$  with  $m_2 > \frac{3n-1}{2}$ ,
- (H3)  $\sup_{k \in \mathbb{X}^{*d}} \left( \left\| \widehat{\psi}_0(k) \right\|_{B_{1,(z)}^{n,1}} + \left\| \widehat{\psi}_1(k) \right\|_{B_{1,(z)}^{n-1,1}} \right) < +\infty$ ,
- (H4)  $|\widehat{\sigma}_1(k)| \leq C_1 \langle k \rangle^{-m_1}$  with  $m_1 > m + 1$ ,
- (H5)  $|\widehat{\mathcal{M}}(\xi)| \leq C \langle \xi \rangle^{-\bar{m}}$  with  $\bar{m} > m + 2$  and  $|\widehat{f}_0(k, \xi)| \leq C_0 \langle \xi \rangle^{-m_0}$  with  $m_0 > m + \frac{1}{2}$ .

**Proposition 2.2.2** *Assume (H1)–(H5).*

(i) *There exists a constant  $A > 0$  such that for any  $0 \leq j \leq m$ ,  $k \in \mathbb{X}^{*d} \setminus \{0\}$  and  $\omega \in \mathbb{C}$  with  $\operatorname{Re}(\omega) \geq 0$ , we have*

$$|k|^j \left| \partial_\omega^j \mathcal{L} \mathcal{K}(\omega, k) \right| \leq A.$$

(ii) *For any  $k \in \mathbb{X}^{*d} \setminus \{0\}$ ,*

$$\int_0^{+\infty} |k| \langle tk \rangle^{2m} |a(t, k)|^2 dt < +\infty.$$

(iii) (2.27) *holds.*

The regularity of the data  $\sigma_1$ ,  $\mathcal{M}$  and  $f_0$  is controlled by assumptions (H4)–(H5): the higher the algebraic decay rate  $m$  requested on the Fourier modes of  $\varrho$ , see (2.25), the higher the regularity on the data. Assumption (H1) tunes the dimension  $n$  for the wave equation: the decay of the Fourier modes of  $\varrho$  is limited by the dispersion of the wave equation, which is stronger as  $n$  increases.

However, as indicated in Lemma 2.1.3, for odd  $n$  the Huygens principle and the decay of  $\sigma_2$  imply strengthened decay properties on  $p_c$ . Accordingly, Proposition 2.2.2 applies replacing (H1)–(H3) by

- (H1')  $n \geq 3$  is odd,
- (H2')  $\sigma_2 \in B_1^{n-1,1}$  and  $|\sigma_2(z)| \leq C_2 \langle z \rangle^{-m_2}$  with  $m_2 > n + m + \frac{3}{2}$
- (H3')  $\sup_{k \in \mathbb{X}^{*d}} \left( \left\| \widehat{\psi}_0(k) \right\|_{B_{1,(z)}^{n,1}} + \left\| \widehat{\psi}_1(k) \right\|_{B_{1,(z)}^{n-1,1}} \right) < +\infty$  and there exists  $C > 0$  such that
- $$\sup_{k \in \mathbb{X}^{*d}} \left( \left| \widehat{\psi}_0(k, z) \right| + \left| \widehat{\psi}_1(k, z) \right| \right) \leq C \langle z \rangle^{-m_2}.$$

Hypothesis (H2) or (H2') can be relaxed. Indeed, the decay imposed in (H2), (H2') on  $\sigma_2$  allows us to apply the refined dispersion estimates described in the proof of Lemma 2.1.3. Nevertheless, we can simply use the standard estimates as in Lemma 2.1.3-i). Then, the decay of  $p_c$  is slower and, as a counterpart, the dimension  $n$  in (H1) is more constrained. Proposition 2.2.2 applies replacing (H1)–(H2) by

- (H1'')  $n > 2m + 4$ ,
- (H2'')  $\sigma_2 \in B_1^{n-1,1}$ .

Before proving Proposition 2.2.2 let us detail a useful statement.

**Lemma 2.2.3** *Let  $\alpha > 1$  and  $\beta \geq 0$ . For any  $\gamma \geq 0$  such that  $\gamma \leq \beta$  et  $\gamma < \alpha - 1$ , we have*

$$\int_0^t \langle t - \tau \rangle^{-\alpha} \langle \tau k \rangle^{-\beta} d\tau \lesssim \langle k \rangle^\gamma \langle tk \rangle^{-\gamma}. \quad (2.28)$$

**Proof.** We split the integral

$$\begin{aligned} \int_0^t \langle t - \tau \rangle^{-\alpha} \langle \tau k \rangle^{-\beta} d\tau &= \int_0^{t/2} + \int_{t/2}^t \langle t - \tau \rangle^{-\alpha} \langle \tau k \rangle^{-\beta} d\tau \\ &\leq \int_0^{t/2} \langle t - \tau \rangle^{-\alpha} d\tau + \int_{t/2}^t \langle t - \tau \rangle^{-\alpha} \left\langle \frac{tk}{2} \right\rangle^{-\beta} d\tau. \end{aligned}$$

The second integral is dominated by

$$\int_{t/2}^t \langle t - \tau \rangle^{-\alpha} \left\langle \frac{tk}{2} \right\rangle^{-\beta} d\tau \lesssim \langle tk \rangle^{-\beta} \int_0^{+\infty} \langle u \rangle^{-\alpha} du$$

which is finite provided  $\alpha > 1$ . For the first integral we observe that, for any  $0 \leq \tau \leq t/2$ ,

$$\langle tk \rangle = \left\langle \frac{t}{k} 2k \right\rangle \leq \left\langle \frac{t}{2} \right\rangle \langle 2k \rangle \leq \langle t - \tau \rangle \langle 2k \rangle,$$

holds, and we infer that

$$\int_0^{t/2} \langle t - \tau \rangle^{-\alpha} d\tau \leq \frac{\langle 2k \rangle^\gamma}{\langle tk \rangle^\gamma} \int_0^{+\infty} \langle u \rangle^{\gamma-\alpha} du.$$

The right hand side is finite when  $\gamma < \alpha - 1$ , which finishes the proof.  $\blacksquare$

**Proof of Proposition 2.2.2.** (i) We start from

$$\partial_\omega^j \mathcal{L} \mathcal{K}(\omega, k) = |k| |\widehat{\sigma}_1(k)|^2 \int_0^{+\infty} (-t)^j e^{-\omega t} \left( \int_0^t p_c(\tau) |k| (t - \tau) \widehat{\mathcal{M}}([t - \tau]k) d\tau \right) dt.$$

Permuting integrals and with the change of variables  $u = t - \tau$ , we get

$$\begin{aligned} &|k|^j \left| \partial_\omega^j \mathcal{L} \mathcal{K}(\omega, k) \right| \\ &\leq |k| |\widehat{\sigma}_1(k)|^2 \int_0^{+\infty} \left( \int_0^{+\infty} |(u + \tau)k|^j |p_c(\tau)| |uk| \left| \widehat{\mathcal{M}}(uk) \right| du \right) d\tau \\ &\lesssim |\widehat{\sigma}_1(k)|^2 \left( \int_0^{+\infty} |\tau k|^j |p_c(\tau)| d\tau \right) \left( \int_0^{+\infty} |uk|^{j+1} \left| \widehat{\mathcal{M}}(uk) \right| du |k| \right) \\ &= |k|^j |\widehat{\sigma}_1(k)|^2 \left( \int_0^{+\infty} |\tau|^j |p_c(\tau)| d\tau \right) \left( \int_0^{+\infty} |s|^{j+1} \left| \widehat{\mathcal{M}}\left(\frac{k}{|k|}s\right) \right| ds \right). \end{aligned}$$

By **(H4)**,  $|k|^j |\widehat{\sigma}_1(k)|^2$  is bounded. Then **(H2)** allows us to apply Lemma 2.1.3 and we deduce that  $|p_c(t)| \lesssim \langle t \rangle^{-(n-1)}$ . Owing to **(H1)** the second factor is finite. Finally, **(H5)** implies that the last factor is finite too and remains uniformly bounded with respect to  $k$ . We point out that the mechanisms of this estimate differs substantially from the standard Vlasov case, where the decay rate improves with the mode. Here  $p_c$  does not not carry any frequency  $k$ , but the power of  $|k|$  are controlled by the decay assumptions on  $\widehat{\sigma}_1$ .

(ii) The term to be estimated can be cast as (we use  $\langle tk \rangle \lesssim \langle \tau k \rangle \langle (t - \tau)k \rangle$ ) :

$$\begin{aligned} & \int_0^{+\infty} \langle tk \rangle^2 |a(t, k)|^2 dt \\ & \lesssim \int_0^{+\infty} \langle tk \rangle^{2m} |\widehat{f}_0(k, tk)|^2 dt + \int_0^{+\infty} \langle tk \rangle^{-(1^+)} \left| \int_0^t \langle \tau k \rangle^{m+\frac{1}{2}^+} |k| \widehat{\phi}_I(\tau, k) \right. \\ & \quad \left. \times \langle (t - \tau)k \rangle^{m+\frac{1}{2}^+} (t - \tau) |k| \widehat{\mathcal{M}}([t - \tau]k) d\tau \right|^2 dt \\ & \lesssim \frac{1}{|k|} \int_0^{+\infty} \langle u \rangle^{2m} \left| \widehat{f}_0(k, \frac{k}{|k|}u) \right|^2 du + \frac{1}{|k|} \left( \int_0^{+\infty} \langle \tau k \rangle^{2m+1^+} |k| |\widehat{\phi}_I(\tau, k)|^2 d\tau \right) \\ & \quad \times \left( \int_0^{+\infty} \langle sk \rangle^{2m+3^+} |\widehat{\mathcal{M}}(sk)|^2 |k| ds \right) \left( \int_0^{+\infty} \langle u \rangle^{-(1^+)} du \right). \end{aligned}$$

Using **(H5)** we infer

$$\frac{1}{|k|} \int_0^{+\infty} \langle u \rangle^{2m} \left| \widehat{f}_0(k, \frac{k}{|k|}u) \right|^2 du \lesssim \frac{1}{|k|} \int_0^{+\infty} \langle u \rangle^{-1^+} dt \lesssim \frac{1}{|k|},$$

and

$$\int_0^{+\infty} \langle sk \rangle^{2m+3^+} |\widehat{\mathcal{M}}(sk)|^2 |k| ds \lesssim \int_0^{+\infty} \langle u \rangle^{-(1^+)} dt \lesssim 1,$$

It remains to justify that

$$\int_0^{+\infty} \langle \tau k \rangle^{2m+1^+} |k| |\widehat{\phi}_I(\tau, k)|^2 d\tau$$

is finite for any  $k \in \mathbb{X}^{*d} \setminus \{0\}$ . To this end we observe that the dispersion induced by the wave equation ensures

$$|\widehat{\phi}_I(\tau, k)| \lesssim |\widehat{\sigma}_1(k)| \left( \|\sigma_2\|_{L_z^1} + C_2 \right) \left( \|\widehat{\psi}_0(k)\|_{B_{1,(z)}^{n,1}} + \frac{1}{c} \|\widehat{\psi}_1(k)\|_{B_{1,(z)}^{n-1,1}} \right) \frac{1}{\langle c\tau \rangle^{n-1}}. \quad (2.29)$$

This follows from

$$\widehat{\phi}_I(\tau, k) = \widehat{\sigma}_1(k) \int_{\mathbb{R}^n} \sigma_2(z) \left( \dot{W}(c\tau)(\widehat{\psi}_0(k)) + \frac{1}{c} W(c\tau)(\widehat{\psi}_1(k)) \right) (z) dz$$

and reasoning as in the proof of Lemma 2.1.3-(ii). We conclude that

$$\begin{aligned} & \int_0^{+\infty} \langle \tau k \rangle^{2m+1^+} |k| |\widehat{\phi}_I(\tau, k)|^2 d\tau \\ & \lesssim |k| |\widehat{\sigma}_1(k)|^2 \left( \|\widehat{\psi}_0(k)\|_{B_{1,(z)}^{n,1}} + \frac{1}{c} \|\widehat{\psi}_1(k)\|_{B_{1,(z)}^{n-1,1}} \right) \int_0^{+\infty} \frac{\langle \tau \rangle^{2m+1^+} \langle k \rangle^{2m+1^+}}{\langle c\tau \rangle^{2(n-1)}} d\tau \\ & \lesssim \langle k \rangle^{2m+2^+} |\widehat{\sigma}_1(k)|^2 \left( \|\widehat{\psi}_0(k)\|_{B_{1,(z)}^{n,1}} + \frac{1}{c} \|\widehat{\psi}_1(k)\|_{B_{1,(z)}^{n-1,1}} \right) \int_0^{+\infty} \frac{\langle \tau \rangle^{2m+1^+}}{\langle c\tau \rangle^{2(n-1)}} d\tau. \end{aligned}$$

That this quantity is bounded uniformly with respect to  $k$  is a consequence of **(H1)**, **(H3)** and **(H4)**.

(iii) We have obtained

$$\int_0^{+\infty} \langle tk \rangle^{2m} |a(t, k)|^2 dt \lesssim \frac{1}{|k|},$$

where the factor  $1/|k|$  comes from a change of variables. We justify similarly that (there is

no factor  $1/|k|$  in this estimate)  $\sup_{t,k} \langle tk \rangle^m |a(t, k)| < \infty$ . It remains to study

$$\sup_k \left( \int_0^{+\infty} \langle tk \rangle^{2m} |\mathcal{K}(t, k)|^2 dt \right) \left( \int_0^{+\infty} \langle tk \rangle^{2m} |a(t, k)|^2 dt \right)$$

and to show that

$$\int_0^{+\infty} \langle tk \rangle^{2m} |\mathcal{K}(t, k)|^2 dt \lesssim |k|.$$

Observe that

$$\mathcal{K}(t, k) = |k| |\widehat{\sigma}_1(k)|^2 \int_0^t p_c(t - \tau) \tau |k| \widehat{\mathcal{M}}(\tau k) d\tau.$$

Based on **(H2)**, **(H5)** and Lemma 2.1.3, we write

$$\left| \int_0^t p_c(t - \tau) \tau |k| \widehat{\mathcal{M}}(\tau k) d\tau \right| \lesssim \int_0^t \langle t - \tau \rangle^{-(n-1)} \langle \tau k \rangle^{-(\bar{m}-1)} d\tau.$$

Lemma 2.2.3 allows us to dominate this quantity by  $\langle k \rangle^\gamma \langle tk \rangle^{-\gamma}$  for any  $\gamma \geq 0$  such that  $\gamma \leq \bar{m} - 1$  and  $\gamma < n - 2$ . In particular, with **(H1)** and **(H5)** it applies with  $\gamma = m + 1^+/2$ . We conclude that

$$\int_0^{+\infty} \langle tk \rangle^{2m} |\mathcal{K}(t, k)|^2 dt \lesssim |k| \left( \sup_k \langle k \rangle^{2m+1^+} |\widehat{\sigma}_1(k)|^4 \right) \int_0^{+\infty} \langle tk \rangle^{-(1^+)} |k| dt \lesssim |k|$$

which ends the proof.  $\blacksquare$

We can now state the results for linearized Landau damping in finite regularity on the torus or the whole space. For the sake of conciseness we only give a precise statement in the case of  $\mathbb{R}^d$  and make a remark on the torus case below.

**Proposition 2.2.4 (Linearized Landau damping on  $\mathbb{R}^d$  with finite regularity)** *Let  $\mathbb{X}^d = \mathbb{R}^d$  and  $m > 0$ . Let us assume **(H1)**–**(H5)** and **(L)**. There exists a constant  $C > 0$  such that for every  $k \in \mathbb{R}^d \setminus \{0\}$  and for every  $t \geq 0$ ,*

$$|\widehat{\rho}(t, k)| \leq C \langle tk \rangle^{-m}.$$

Moreover, if  $m$  is large enough, then, as  $t \rightarrow +\infty$ , the fluctuation of spatial density  $\rho(t)$ , the force term  $\nabla_x \phi$  and the fluctuation of media  $\psi(t)$  converge strongly to 0. To be more specific:

- If  $m > d/2$ , then for every  $r \in [0, m - \frac{d}{2})$  there exists a constant  $C_r > 0$  such that

$$\|\rho(t)\|_{H_x^r} \leq C_r \langle t \rangle^{-\frac{d}{2}}.$$

- If  $m > (d+2)/2$ , then for every  $r \in [0, m_1 - \frac{d+2}{2})$  there exists a constant  $\bar{C}_r > 0$  such that

$$\|\nabla_x \phi_I(t)\|_{H_x^r} \leq \bar{C}_r \langle t \rangle^{-(n-1)}$$

and for every  $r \in [0, 2m_1 - \frac{d+2}{2})$  there exists a constant  $\bar{C}'_r$  such that

$$\|\nabla_x \phi_S(t)\|_{H_x^r} \leq \bar{C}'_r \langle t \rangle^{-\frac{d+2}{2}}.$$

- If  $m > d/2$  and  $n > d+3$ , then for every  $r \in [0, m_1 - \frac{d}{2})$  there exists a constant  $\tilde{C}_r > 0$  such that

$$\left\| \psi(t) - \dot{W}(ct)\psi_0 - \frac{1}{c} W(ct)\psi_1 \right\|_{L_x^\infty H_x^r} \leq \tilde{C}_r \langle t \rangle^{-\frac{d}{2}}.$$

**Remark 2.2.5** *On the torus case the pointwise estimate of the Fourier transform of  $\varrho(t)$  is the same than in the free space case. However, there are several differences for the estimates of  $\varrho(t)$  and  $\nabla_x \phi_S(t)$  on the physical side. Indeed the spatial fluctuation  $\varrho(t)$  does not converge anymore to 0 but to the mean value of the initial fluctuation  $f_0$ :  $\varrho(t) \rightarrow_{t \rightarrow +\infty} \iint_{\mathbb{T}^d \times \mathbb{R}^d} f_0(x, v) dx dv$ . Moreover the convergence rates are not the same: if in the free space case even for very large value of  $m$  the convergence rates are limited by the space dimension  $d$  this is not the case when the torus case is considered. Indeed, thanks to the fact that the Fourier variable  $k$  takes its value in a discrete space ( $k \in \mathbb{Z}^d$ ),  $\inf_{k \neq 0} |k| > 0$  and one can use this gap in order to modify the proof of Proposition 2.2.4 and obtain convergence rates for  $\varrho(t)$  and  $\nabla_x \phi_S(t)$  which depend on  $m$  and are no more limited by the space dimension  $d$ .*

**Remark 2.2.6** *Let us detail a few examples:*

- (i) *For the density, with  $d = 3$ ,  $n \geq 5$ ,  $m = 2$ ,  $m_0 = 3$ ,  $m_1 = 4$ ,  $m_2 > (3n - 1)/2$  and  $\bar{m} = 5$ , we get*

$$\|\varrho(t)\|_{L_x^2} \lesssim \langle t \rangle^{-\frac{3}{2}}.$$

*Moreover, with  $d = 3$ ,  $n \geq 8$ ,  $m = 5$ ,  $m_0 = 6$ ,  $m_1 = 7$ ,  $m_2 > (3n - 1)/2$  and  $\bar{m} = 8$ , we obtain*

$$\|\varrho(t)\|_{L_x^\infty} \lesssim \|\varrho(t)\|_{H_x^3} \lesssim \langle t \rangle^{-\frac{3}{2}}.$$

- (ii) *For the force, with  $d = 3$ ,  $n \geq 6$ ,  $m = 3$ ,  $m_0 = 4$ ,  $m_1 = 5$ ,  $m_2 > (3n - 1)/2$  and  $\bar{m} = 6$ , we get*

$$\|\nabla_x \phi(t)\|_{L_x^2} \lesssim \langle t \rangle^{-\frac{5}{2}}.$$

*Moreover, with  $d = 3$ ,  $n \geq 6$ ,  $m = 3$ ,  $m_0 = 4$ ,  $m_1 = 6$ ,  $m_2 > (3n - 1)/2$  and  $\bar{m} = 6$ , we obtain*

$$\|\nabla_x \phi(t)\|_{L_x^\infty} \lesssim \|\nabla_x \phi(t)\|_{H_x^3} \lesssim \langle t \rangle^{-\frac{5}{2}}.$$

- (iii) *For the vibration field, with  $d = 3$ ,  $n \geq 7$ ,  $m = 2$ ,  $m_0 = 3$ ,  $m_1 = 4$ ,  $m_2 > (3n - 1)/2$  and  $\bar{m} = 5$ , we get*

$$\left\| \psi(t) - \dot{W}(ct)\psi_0 - \frac{1}{c} W(ct)\psi_1 \right\|_{L_z^\infty L_x^2} \lesssim \langle t \rangle^{-\frac{3}{2}}.$$

*Moreover, with  $d = 3$ ,  $n \geq 7$ ,  $m = 2$ ,  $m_0 = 3$ ,  $m_1 = 5$ ,  $m_2 > (3n - 1)/2$  and  $\bar{m} = 5$ , we have*

$$\begin{aligned} & \left\| \psi(t) - \dot{W}(ct)\psi_0 - \frac{1}{c} W(ct)\psi_1 \right\|_{L_z^\infty L_x^\infty} \\ & \lesssim \left\| \psi(t) - \dot{W}(ct)\psi_0 - \frac{1}{c} W(ct)\psi_1 \right\|_{L_z^\infty H_x^3} \lesssim \langle t \rangle^{-\frac{3}{2}}. \end{aligned}$$

**Remark 2.2.7** *As explained in Proposition 2.2.2, the decay of  $\widehat{\varrho}(t, k)$  is directly related to the dispersion of the wave equation, and thus on  $n$ . This explains the constraints on the dimension  $n$ . Nevertheless, when  $n \geq 3$  is odd, we can obtain the time decay of  $\widehat{\varrho}(t, k)$  without further restrictions on  $n$ . Accordingly, with **(H1')**–**(H3')** and **(H4)**–**(H5)** the convergence to 0 of the density fluctuation  $\varrho$  and the force  $\nabla_x \phi$  can be established. However, constraints appear when considering the fluctuation of the medium  $\psi$ : with the norms we are using, we need  $n > d + 3$ . In dimension  $d = 3$ , this excludes  $n = 3$  and  $n = 5$ . This restriction can be relaxed by considering instead the supremum over a ball  $B(0, R)$  of finite radius. For*

instance, in dimension  $d = 3$  with  $n = 3$ , assuming **(H1')**–**(H3')** and **(H4)**–**(H5)**, we can show that, for any  $0 < R < \infty$

$$\sup_{z \in B(0, R)} \left\| \psi(t, z) - \dot{W}(ct)\psi_0(z) - \frac{1}{c} W(ct)\psi_1(z) \right\|_{H_x^r} \leq C_R \langle t \rangle^{-1}.$$

where  $C_R > 0$  blows up as  $R \rightarrow +\infty$ . Further details on this issue can be found in the proof of Proposition 2.2.4.

**Proof of Proposition 2.2.4.** Owing to **(H1)**–**(H5)** we can apply Proposition 2.2.2 and Lemma 2.2.1. Proposition 2.2.2 ensures that (2.27) holds and from this, we can exhibit  $C > 0$ , independent of  $k$ , such that for any  $k \in \mathbb{R}^d \setminus \{0\}$ ,

$$\langle tk \rangle^m |\widehat{\varrho}(t, k)| \leq C.$$

That  $\varrho(t)$  converges to 0 is a consequence of

$$\begin{aligned} \|\varrho(t)\|_{H_x^r}^2 &\simeq \|\varrho(t)\|_{L_x^2}^2 + \|\varrho(t)\|_{\dot{H}_x^r}^2 = \int_{\mathbb{R}^d} |\widehat{\varrho}(t, k)|^2 dk + \int_{\mathbb{R}^d} |k|^{2r} |\widehat{\varrho}(t, k)|^2 dk \\ &\lesssim \frac{1}{t^d} \int_{\mathbb{R}^d} \langle tk \rangle^{-2m} t^d dk + \frac{1}{t^{d+2r}} \int_{\mathbb{R}^d} |tk|^{2r} \langle tk \rangle^{-2m} t^d dk \\ &= \frac{1}{t^d} \int_{\mathbb{R}^d} \langle x \rangle^{-2m} dx + \frac{1}{t^{d+2r}} \int_{\mathbb{R}^d} |x|^{2r} \langle x \rangle^{-2m} dx, \end{aligned}$$

where all integrals are finite provided  $2r - 2m < -d$ , that is  $r < m - d/2$ .

Next, we estimate both terms of  $\nabla_x \phi = \nabla_x \phi_I + \nabla_x \phi_S$ . We have

$$\|\nabla_x \phi_I(t)\|_{H_x^r}^2 \simeq \int_{\mathbb{R}^d} |k|^2 |\widehat{\phi}_I(t, k)|^2 dk + \int_{\mathbb{R}^d} |k|^{2r+2} |\widehat{\phi}_I(t, k)|^2 dk,$$

and, as noticed when proving Proposition 2.2.2,  $\widehat{\phi}_I(t, k)$  satisfies (2.29). It follows that

$$\|\nabla_x \phi_I(t)\|_{H_x^r}^2 \lesssim_c \left( \int_{\mathbb{R}^d} |k|^2 |\widehat{\sigma}_1(k)|^2 dk + \int_{\mathbb{R}^d} |k|^{2r+2} |\widehat{\sigma}_1(k)|^2 dk \right) \langle t \rangle^{-2(n-1)},$$

where the two integrals are finite, due to **(H4)**, when  $r < m_1 - 1 - d/2$ . Next, we apply Lemma 2.1.3-(ii):

$$\begin{aligned} \|\nabla_x \phi_S(t)\|_{H_x^r}^2 &\simeq \int_{\mathbb{R}^d} |k|^2 |\widehat{\phi}_S(t, k)|^2 dk + \int_{\mathbb{R}^d} |k|^{2r+2} |\widehat{\phi}_S(t, k)|^2 dk \\ &= \int_{\mathbb{R}^d} (|k|^2 + |k|^{2r+2}) |\widehat{\sigma}_1(k)|^4 \left| \int_0^t p_c(t-\tau) \widehat{\varrho}(\tau, k) d\tau \right|^2 dk \\ &\lesssim_c \int_{\mathbb{R}^d} (|k|^2 + |k|^{2r+2}) |\widehat{\sigma}_1(k)|^4 \left| \int_0^t \langle t-\tau \rangle^{-(n-1)} \langle \tau k \rangle^{-m} d\tau \right|^2 dk. \end{aligned}$$

By Lemma 2.2.3, for any  $\gamma \geq 0$  such that  $\gamma \leq m$  and  $\gamma < n - 2$ , we get

$$\int_0^t \langle t-\tau \rangle^{-(n-1)} \langle \tau k \rangle^{-m} d\tau \lesssim \langle k \rangle^\gamma \langle tk \rangle^{-\gamma},$$

and we conclude with

$$\begin{aligned} \|\nabla_x \phi_S(t)\|_{H_x}^2 &\lesssim_c \int_{\mathbb{R}^d} (|k|^2 + |k|^{2r+2}) |\widehat{\sigma}_1(k)|^4 \langle k \rangle^{2\gamma} \langle tk \rangle^{-2\gamma} dk \\ &\lesssim \left( \sup_k \langle k \rangle^{2r+2\gamma} |\widehat{\sigma}_1(k)|^4 \right) t^{-(d+2)} \int_{\mathbb{R}^d} |tk|^2 \langle tk \rangle^{-2\gamma} t^d dk \\ &= \left( \sup_k \langle k \rangle^{2r+2\gamma} |\widehat{\sigma}_1(k)|^4 \right) t^{-(d+2)} \int_{\mathbb{R}^d} |x|^2 \langle x \rangle^{-2\gamma} dx. \end{aligned}$$

The last integral is finite when  $2 - 2\gamma < -d$ , that is  $\gamma > (d+2)/2$  and the supremum over  $k$  is finite too provided  $2r + 2\gamma \leq 4m_1$ , that is  $r \leq 2m_1 - \gamma$ .

We turn to  $\psi$ . We have

$$\psi(t) - \dot{W}(ct)\psi_0 - \frac{1}{c} W(ct)\psi_1 = -\frac{1}{c} \int_0^t W(c[t-\tau])\sigma_2 \sigma_1 \star \varrho(\tau) d\tau.$$

Hence, for any  $z \in \mathbb{R}^n$ , we obtain

$$\begin{aligned} \|\psi(t, z) - \dot{W}(ct)\psi_0(z) - \frac{1}{c} W(ct)\psi_1(z)\|_{H_x}^2 \\ \simeq \int_{\mathbb{R}^d} \left(1 + |k|^{2r}\right) |\widehat{\sigma}_1(k)|^2 \left| \frac{1}{c} \int_0^t W(c[t-\tau])\sigma_2(z) \widehat{\varrho}(\tau, k) d\tau \right|^2 dk. \end{aligned}$$

We combine the dispersion estimate (2.15) to (2.25) and we arrive at

$$\left| \frac{1}{c} \int_0^t W(c[t-\tau])\sigma_2(z) \widehat{\varrho}(\tau, k) d\tau \right| \lesssim_c \int_0^t \langle t-\tau \rangle^{-\frac{n-1}{2}} \langle \tau k \rangle^{-m} d\tau.$$

Lemma 2.2.3 allows us to obtain, for any  $\gamma \geq 0$  such that  $\gamma \leq m$  and  $\gamma < (n-1)/2 - 1$ ,

$$\int_0^t \langle t-\tau \rangle^{-\frac{n-1}{2}} \langle \tau k \rangle^{-m} d\tau \lesssim \langle k \rangle^\gamma \langle tk \rangle^{-\gamma}.$$

We deduce that

$$\begin{aligned} \|\psi(t, z) - \dot{W}(ct)\psi_0(z) - \frac{1}{c} W(ct)\psi_1(z)\|_{H_x}^2 &\lesssim_c \int_{\mathbb{R}^d} \left(1 + |k|^{2r}\right) |\widehat{\sigma}_1(k)|^2 \langle k \rangle^{2\gamma} \langle tk \rangle^{-2\gamma} dk \\ &\lesssim \left( \sup_k \langle k \rangle^{2r+2\gamma} |\widehat{\sigma}_1(k)|^2 \right) t^{-d} \int_{\mathbb{R}^d} \langle tk \rangle^{-2\gamma} t^d dk = \left( \sup_k \langle k \rangle^{2r+2\gamma} |\widehat{\sigma}_1(k)|^2 \right) t^{-d} \int_{\mathbb{R}^d} \langle x \rangle^{-2\gamma} dx. \end{aligned}$$

The last integral is finite when  $\gamma > d/2$  (this imposes  $m > d/2$  and  $n > d+3$ ). The supremum over  $k$  is finite provided  $2r + 2\gamma \leq 2m_1$ , that is  $r \leq m_1 - \gamma$ .

The estimate in Remark 2.2.7 is obtained by restricting to the  $z$ 's in the ball  $B(0, |ct|/4)$ . We apply the refined estimate (2.17), gathered to (2.25). We get

$$\begin{aligned} \left| \frac{1}{c} \int_0^t W(c[t-\tau])\sigma_2(z) \widehat{\varrho}(\tau, k) d\tau \right| \\ \lesssim \frac{1}{c} |k|^{-\frac{1}{2}} \int_0^t \langle c|t-\tau| \cdot |c|t-\tau| - |z|| \rangle^{-\frac{n-1}{2}} \langle \tau k \rangle^{-m} d\tau. \end{aligned}$$

We proceed as for proving Lemma 2.2.3: for any  $\gamma \geq 0$  we obtain

$$\begin{aligned}
& \int_0^t \langle c|t - \tau| \cdot |c|t - \tau| - |z| \rangle^{-\frac{n-1}{2}} \langle \tau k \rangle^{-m} d\tau \\
& \lesssim \frac{\langle 2k \rangle^\gamma}{\langle tk \rangle^\gamma} \int_0^{t/2} \langle c|t - \tau| \cdot |c|t - \tau| - |z| \rangle^{-\frac{n-1}{2}} \langle t/2 \rangle^\gamma d\tau \\
& \quad + \int_{t/2}^t \langle c|t - \tau| \cdot |c|t - \tau| - |z| \rangle^{-\frac{n-1}{2}} \langle tk/2 \rangle^{-m} d\tau \\
& \leq \frac{\langle 2k \rangle^\gamma}{\langle tk \rangle^\gamma} \int_0^{t/2} \langle c|t - \tau| \cdot |c|t - \tau| - |z| \rangle^{-\frac{n-1}{2}} \langle t - \tau \rangle^\gamma d\tau \\
& \quad + \langle tk/2 \rangle^{-m} \int_{t/2}^t \langle c|t - \tau| \cdot |c|t - \tau| - |z| \rangle^{-\frac{n-1}{2}} d\tau \\
& = \frac{\langle 2k \rangle^\gamma}{\langle tk \rangle^\gamma} \int_{t/2}^t \langle cu \cdot |cu - |z| \rangle^{-\frac{n-1}{2}} \langle u \rangle^\gamma du \\
& \quad + \langle tk/2 \rangle^{-m} \int_0^{t/2} \langle cu \cdot |cu - |z| \rangle^{-\frac{n-1}{2}} du.
\end{aligned}$$

First,  $ct/2 \leq cu \leq ct$  and  $0 \leq |z| \leq ct/4$  imply  $|cu - |z| \rangle \geq ct/4 \geq cu/2$  so that

$$\langle cu \cdot |cu - |z| \rangle^{-1} \leq \left\langle \frac{c^2 u^2}{2} \right\rangle^{-1} \lesssim_c \langle u \rangle^{-2}.$$

We thus deduce that

$$\int_{t/2}^t \langle cu \cdot |cu - |z| \rangle^{-\frac{n-1}{2}} \langle u \rangle^\gamma du \lesssim \int_0^{+\infty} \langle u \rangle^{-(n-1)} \langle u \rangle^\gamma du$$

which is finite when  $\gamma < n - 2$ . Second, we have

$$\int_0^{t/2} \langle cu \cdot |cu - |z| \rangle^{-\frac{n-1}{2}} du \lesssim_c \int_{\mathbb{R}} \langle u \cdot |u - |z| \rangle^{-\frac{n-1}{2}} du.$$

As  $|u| \rightarrow +\infty$ , we have

$$\langle u \cdot |u - |z| \rangle^{-\frac{n-1}{2}} \simeq_{|z|} \langle u \rangle^{-(n-1)}$$

which is finite provided  $n \geq 3$ . However, we should make precise how it depends on  $|z|$ . To this end, we write

$$\begin{aligned}
\int_{\mathbb{R}} \langle u \cdot |u - |z| \rangle^{-\frac{n-1}{2}} du &= \int_{\mathbb{R}} \langle (u + |z|/2) \cdot (u - |z|/2) \rangle^{-\frac{n-1}{2}} du \\
&= \int_{\mathbb{R}} \langle u^2 - |z|^2/4 \rangle^{-\frac{n-1}{2}} du = \int_{\mathbb{R}} \left( \frac{\langle u^2 \rangle}{\langle u^2 - |z|^2/4 \rangle} \right)^{\frac{n-1}{2}} \langle u^2 \rangle^{-\frac{n-1}{2}} du.
\end{aligned}$$

A mere function analysis shows that, for any  $a \geq 0$ ,

$$x \mapsto \frac{\langle x \rangle^2}{\langle x - a \rangle^2}$$

reaches its maximum over  $[0, +\infty)$  for  $x = (a + \sqrt{a^2 + 4})/2$ , which leads to

$$\left( \frac{\langle u^2 \rangle}{\langle u^2 - |z|^2/4 \rangle} \right)^{\frac{n-1}{2}} \lesssim |z|^{n-1}.$$

It follows that

$$\int_{\mathbb{R}} \langle u \cdot |u - |z| \rangle^{-\frac{n-1}{2}} du \lesssim |z|^{n-1} \int_{\mathbb{R}} \langle u \rangle^{-(n-1)} du \lesssim |z|^{n-1}.$$



Therefore, when  $n \geq 3$ , for any  $\gamma \in [0, n-2)$  and  $z \in B(0, ct/4)$ , we have

$$\left| \frac{1}{c} \int_0^t W(c[t-\tau]) \sigma_2(z) \widehat{\varrho}(\tau, k) d\tau \right| \lesssim_c \langle k \rangle^\gamma \langle tk \rangle^{-\gamma} + |z|^{n-1} \langle tk \rangle^{-m}.$$

We infer that

$$\begin{aligned} & \|\psi(t, z) - \dot{W}(ct)\psi_0(z) - \frac{1}{c} W(ct)\psi_1(z)\|_{H_x^2}^2 \\ & \lesssim_c \int_{\mathbb{R}^d} (1 + |k|^{2r}) |\widehat{\sigma}_1(k)|^2 \left( \langle k \rangle^{2\gamma} \langle tk \rangle^{-2\gamma} + |z|^{2(n-1)} \langle tk \rangle^{-2m} \right) dk \\ & \lesssim \frac{\langle z \rangle^{2(n-1)}}{t^d} \left( \sup_k \langle k \rangle^{2r+2\gamma} |\widehat{\sigma}_1(k)|^2 \right) \int_{\mathbb{R}^d} \left( \langle tk \rangle^{-2\gamma} + \langle tk \rangle^{-2m} \right) t^d dk \\ & = \frac{\langle z \rangle^{2(n-1)}}{t^d} \left( \sup_k \langle k \rangle^{2r+2\gamma} |\widehat{\sigma}_1(k)|^2 \right) \int_{\mathbb{R}^d} \left( \langle x \rangle^{-2\gamma} + \langle x \rangle^{-2m} \right) dx \end{aligned}$$

where the last integral is finite when  $\gamma, m > d/2$ . When  $n$  is even, we can use **(H1')**–**(H3')** instead: the condition on  $m$  imposes regularity on the data but no further restriction on  $n$ . Such restriction arise from the condition on  $\gamma$ : we already have  $\gamma \in [0, n-2)$ . To be more specific, we have  $n > (d+4)/2$ . For  $d=1$  this holds for any  $n \geq 3$ ; but, for  $d=2$  or for the most relevant case  $d=3$ , we should assume  $n \geq 4$  and  $n \geq 5$ , respectively. Nonetheless, it is equally possible to make use of the decay of  $\widehat{\sigma}_1$  in order to obtain a singularity which remains integrable at 0 and gives more integrability at  $+\infty$ . The price to be paid is the strengthening of the regularity of  $\sigma_1$  and, more importantly, a reduced convergence rate for large times. To be specific, we get

$$\begin{aligned} & \|\psi(t, z) - \dot{W}(ct)\psi_0(z) - \frac{1}{c} W(ct)\psi_1(z)\|_{H_x^2}^2 \\ & \lesssim_c \int_{\mathbb{R}^d} (1 + |k|^{2r}) |\widehat{\sigma}_1(k)|^2 \left( \langle k \rangle^{2\gamma} \langle tk \rangle^{-2\gamma} + |z|^{2(n-1)} \langle tk \rangle^{-2m} \right) dk \\ & = \int_{\mathbb{R}^d} (|k|^{d-1} + |k|^{2r+d-1}) |k|^{-(d-1)} |\widehat{\sigma}_1(k)|^2 \left( \langle k \rangle^{2\gamma} \langle tk \rangle^{-2\gamma} + |z|^{2(n-1)} \langle tk \rangle^{-2m} \right) dk \\ & \lesssim \frac{\langle z \rangle^{2(n-1)}}{t} \left( \sup_k \langle k \rangle^{2r+2\gamma+d-1} |\widehat{\sigma}_1(k)|^2 \right) \int_{\mathbb{R}^d} |tk|^{-(d-1)} \left( \langle tk \rangle^{-2\gamma} + \langle tk \rangle^{-2m} \right) t^d dk \\ & = \frac{\langle z \rangle^{2(n-1)}}{t} \left( \sup_k \langle k \rangle^{2r+2\gamma+d-1} |\widehat{\sigma}_1(k)|^2 \right) \int_{\mathbb{R}^d} |x|^{-(d-1)} \left( \langle x \rangle^{-2\gamma} + \langle x \rangle^{-2m} \right) dx. \end{aligned}$$

The last integral is finite when  $\gamma > 1/2$ . This is compatible with the condition  $\gamma < n-2$  provided  $n \geq 3$ . It is possible to optimize this approach in order to find a sharp decay rate.  $\blacksquare$

### 2.2.3 Linearized Landau damping in analytic regularity

That the linearized Landau damping holds with an exponential rate relies, from (2.24), on an estimate on  $\varrho$  like

$$|\widehat{\varrho}(t, k)| \leq C e^{-\lambda|tk|} \quad (2.30)$$

(see [87, section 3]) for some  $\lambda > 0$ . To this end we shall use the analog in analytic regularity of Lemma 2.2.1.

**Lemma 2.2.8** *Suppose that  $\mathcal{L}\mathcal{K}(\omega|k|, k)$  is well-defined on  $k \in \mathbb{X}^{*d} \setminus \{0\}$  and  $\omega \in \{z \in \mathbb{C} \mid \operatorname{Re}(z) > -\Lambda\}$  for a certain  $\Lambda > 0$ . We also suppose that*

$$\inf_{k \in \mathbb{X}^{*d} \setminus \{0\}} |1 - \mathcal{L}\mathcal{K}(\omega|k|, k)| \geq \kappa > 0 \quad \text{for } \operatorname{Re}(\omega) > -\Lambda, \quad (\mathbf{L}')$$

is fulfilled. Then, for any  $0 < \lambda < \Lambda$  we can find  $C_{LD} > 0$ , which does not depend on  $k$ , such that any solution of (2.24) satisfies, for any  $k \in \mathbb{X}^{*d} \setminus \{0\}$ ,

$$\int_0^{+\infty} e^{2\lambda|tk|} |\widehat{\varrho}(t, k)|^2 dt \leq C_{LD}^2 \int_0^{+\infty} e^{2\lambda|tk|} |a(t, k)|^2 dt. \quad (2.31)$$

We refer the reader to [106, Proof of Lemma 3.5] or [12, Section 4] for details on this statement. It allows us to derive the following estimate in  $L_t^\infty$  norm

$$e^{\lambda|tk|} |\widehat{\varrho}(t, k)| \leq e^{\lambda|tk|} |a(t, k)| + C_{LD} \left( \int_0^{+\infty} e^{2\lambda|\tau k|} |\mathcal{K}(\tau, k)|^2 d\tau \right)^{1/2} \left( \int_0^{+\infty} e^{2\lambda|\tau k|} |a(\tau, k)|^2 d\tau \right)^{1/2}.$$

It remains to check that the data satisfy

$$\begin{cases} \sup_{\substack{t \geq 0 \\ k \in \mathbb{X}^{*d} \setminus \{0\}}} e^{\lambda|tk|} |a(t, k)| < +\infty, \\ \sup_{k \in \mathbb{X}^{*d} \setminus \{0\}} \left( \int_0^{+\infty} e^{2\lambda|\tau k|} |\mathcal{K}(\tau, k)|^2 d\tau \right) \left( \int_0^{+\infty} |k| e^{2\lambda|\tau k|} |a(\tau, k)|^2 d\tau \right) < +\infty. \end{cases} \quad (2.32)$$

In order to apply Lemma 2.2.8 and to check that (2.32) holds, we assume

- (K1)  $n \geq 3$  is odd,
- (K2)  $\sigma_2 \in C_c^0(\mathbb{R}^n)$  with  $\text{supp}(\sigma_2) \subset B(0, R_2)$ ,
- (K3) we have  $\text{supp}(\psi_0, \psi_1) \subset \mathbb{X}^d \times B(0, R_I)$ , for some  $0 < R_I < \infty$ , and

$$\sup_{k \in \mathbb{X}^{*d}} \left\{ \int_{\mathbb{R}^n} (|\widehat{\psi}_1(k, z)|^2 + c^2 |\nabla_z \widehat{\psi}_0(k, z)|^2) dz \right\} = \mathcal{E}_I < \infty,$$

- (K4) the function  $\sigma_1 : \mathbb{X}^d \rightarrow (0, \infty)$  is radially symmetric and real analytic, and in particular (see [106, Proposition 3.16]) there exists  $C_1, \lambda_1 > 0$  such that, for any  $k \in \mathbb{X}^{*d}$ ,  $|\widehat{\sigma}_1(k)| \leq C_1 e^{-\lambda_1|k|}$ .
- (K5) there exists  $C_0, \lambda_0 > 0$  such that for any  $\xi \in \mathbb{R}^d$ ,  $k \in \mathbb{X}^{*d}$  we have

$$|\widehat{\mathcal{M}}(\xi)| \leq C e^{-\bar{\lambda}|\xi|}, \quad |\widehat{f}_0(k, \xi)| \leq C_0 e^{-\lambda_0|\xi|}.$$

Namely, we assume analytic regularity on the data with (K4) and (K5). Note that (K4) is not a strong restriction in the present context, contrarily to what it could be for the Vlasov case, since for this model  $\sigma_1$  is naturally smooth. Moreover, physically the form function  $\sigma_1$  would naturally be compactly supported (the support being interpreted as the “domain of influence” of the particle), which does not make sense in the analytic framework. Thus, we should here think  $\sigma_1$  as a peaked bump function. We also bear in mind the fact that  $\sigma_1$  is radially symmetric: its Fourier coefficients are real and we have  $\widehat{\sigma_1 \star \sigma_1}(k) = |\widehat{\sigma}_1(k)|^2 \geq 0$ . These assumptions, together with the finite speed of propagation for the wave equation, allow us to control the “initial data” contribution in (2.22) and the kernel (2.23). Let us explain the role of (K3) for the associated contribution to (2.21) in (2.22). In (2.21),  $\psi_I$  is the solution of the wave equation on  $\mathbb{R}^n$ , starting from initial data  $(\psi_0, \psi_1)$ . The space variable  $x \in \mathbb{X}^d$  appears only as a parameter in this equation. Assumption (K3) means

that the Fourier transform (with respect to the parameter) of the initial data has finite and uniformly bounded energy. When  $\mathbb{X}^d = \mathbb{T}^d$ , **(K3)** holds under the condition

$$\iint_{\mathbb{X}^d \times \mathbb{R}^n} (|\psi_1(x, z)|^2 + c^2 |\nabla_z \psi_0(x, z)|^2) dz dx = \mathcal{E}_I < \infty,$$

which implies that the Fourier coefficients of the energy lies in  $\ell^2(\mathbb{Z}^d)$ , and thus in  $\ell^\infty(\mathbb{Z}^d)$ . This assumption is quite natural since this quantity is involved in the global energy balance for (2.2a)–(2.2d), see [25, 26, 103]. Working in  $\mathbb{R}^d$ , this has to be replaced by condition **(K3)**.

A naive intuition would relate the damping rate to the decay rate of  $p_c$ . In finite regularity, we indeed obtained a polynomial damping rate assuming the polynomial decay of  $p_c$ . The analytic framework is more demanding and it is not enough to assume the exponential decay of  $p_c$ . The proof of Lemma 2.2.10 below will make the role of the stronger assumptions **(K1)**–**(K2)** clear.

**Proposition 2.2.9** *Suppose **(K1)**–**(K5)**. The quantity  $\mathcal{L}\mathcal{K}(\omega|k|, k)$  is well-defined for any  $\omega \in \mathbb{C}$  such that  $\operatorname{Re}(\omega) > -\bar{\lambda}$  and (2.32) holds for any  $\lambda > 0$  such that*

$$\lambda < \min \left( \lambda_0, \bar{\lambda}, \frac{c\lambda_1}{R_2}, \frac{c\lambda_1}{R_I + R_2} \right).$$

The statement follows from a direct application of the following claim, and reproducing the computations of the proof of Proposition 2.2.2.

**Lemma 2.2.10** *Suppose **(K1)**–**(K5)**.*

(i) *Let  $a(t, k)$  be defined by (2.22). Then, there exists  $\alpha > 0$  such that for every  $0 < \lambda < \min(\lambda_0, \bar{\lambda}, c\lambda_1/(R_I + R_2))$ ,  $|a(t, k)| \leq \alpha e^{-\lambda|k|t}$  holds for any  $t \geq 0$ ,  $k \in \mathbb{X}^d$ .*

(ii) *Let  $\mathcal{K}(t, k)$  be defined by (2.23). Then, there exists  $C > 0$  such that for every  $0 < \lambda < \min(\bar{\lambda}, c\lambda_1/R_2)$ ,  $|\mathcal{K}(t, k)| \leq C e^{-\lambda|k|t}$  holds for any  $t \geq 0$ ,  $k \in \mathbb{X}^{*d}$ .*

**Proof.** We start with the proof of (i). First of all, assumption **(K5)** tells us that

$$|\widehat{f}_0(k, tk)| \leq C_0 e^{-\lambda_0 t|k|}$$

and since

$$|a(t, k)| \lesssim |\widehat{f}_0(k, tk)| + |k|^2 \int_0^t \left| \widehat{\phi}_I(\tau, k) \right| (t - \tau) \left| \widehat{\mathcal{M}}((t - \tau)k) \right| d\tau,$$

we only have to deal with second term. Then, relation (2.21) can be recast as

$$\phi_I(t, x) = \int_{\mathbb{X}^d} \sigma_1(x - y) \left( \int_{\mathbb{R}^n} \sigma_2(z) \psi_I(t, x, z) dz \right) dy$$

with  $\psi_I$  the solution of the free wave equation

$$\begin{aligned} (\partial_{tt}^2 - c^2 \Delta_z) \psi_I &= 0, \\ (\psi_I, \partial_t \psi_I)|_{t=0} &= (\psi_0, \psi_1). \end{aligned}$$

Assumptions **(K1)** and **(K3)** allow us to make use of Huygens' principle which tells us that

$$\operatorname{supp}(\psi_I(t, x, \cdot)) \subset \{z \in \mathbb{R}^n, ct - R_I \leq |z| \leq ct + R_I\}.$$

Therefore, by virtue of **(K2)**, the product  $\sigma_2(z)\psi_I(t, x, z)$  vanishes when  $t \geq \frac{R_1+R_2}{c} = S_0$  for any  $x \in \mathbb{X}^d$ ,  $z \in \mathbb{R}^n$  (see Fig. 2.1). Hence,  $\phi_I$  is supported in  $[0, S_0] \times \mathbb{X}^d$  and we can write

$$\widehat{\phi}_I(\tau, k) = \widehat{\sigma}_1(k) \left( \int_{\mathbb{R}^n} \sigma_2 \widehat{\psi}_I(\tau, k) dz \right) \mathbf{1}_{t \leq S_0}.$$

Moreover, thanks to Sobolev's embedding, energy conservation for the wave equation and assumption **(K3)**, we have

$$\begin{aligned} \left| \int_{\mathbb{R}^n} \sigma_2 \widehat{\psi}_I(\tau, k) dz \right| &\leq \|\sigma_2\|_{L_z^{\frac{2n}{n+2}}} \|\widehat{\psi}_I(\tau, k)\|_{L_z^{\frac{2n}{n-2}}} \\ &\lesssim \|\sigma_2\|_{L_z^{\frac{2n}{n+2}}} \|\nabla_z \widehat{\psi}_I(\tau, k)\|_{L_z^2} \leq \frac{1}{c} \|\sigma_2\|_{L_z^{\frac{2n}{n+2}}} \left( \|\partial_t \widehat{\psi}_I(\tau, k)\|_{L_z^2}^2 + c^2 \|\nabla_z \widehat{\psi}_I(\tau, k)\|_{L_z^2}^2 \right)^{\frac{1}{2}} \\ &= \frac{1}{c} \|\sigma_2\|_{L_z^{\frac{2n}{n+2}}} \left( \|\widehat{\psi}_1(k)\|_{L_z^2}^2 + c^2 \|\nabla_z \widehat{\psi}_0(k)\|_{L_z^2}^2 \right)^{\frac{1}{2}} \leq \frac{1}{c} \|\sigma_2\|_{L_z^{\frac{2n}{n+2}}} \sqrt{\mathcal{E}_I}. \end{aligned}$$

From these two facts, and thanks to **(K4)**–**(K5)**, we can eventually conclude as follows: for every  $0 < \lambda < \min(\bar{\lambda}, \lambda_1/S_0)$ ,

$$\begin{aligned} |k|^2 \int_0^t \left| \widehat{\Phi}_I(\tau, k) \right| (t-\tau) \left| \widehat{\mathcal{M}}((t-\tau)k) \right| d\tau &\lesssim |k|^2 e^{-\lambda_1|k|} \int_0^{S_0} |t-\tau| e^{-\bar{\lambda}(t-\tau)|k|} d\tau \\ &= |k|^2 e^{-\lambda_1|k|} \int_0^{S_0} |t-\tau| e^{-\lambda(t-\tau)|k|} e^{-(\bar{\lambda}-\lambda)(t-\tau)|k|} d\tau \leq S_0^2 \left( \sup_k |k|^2 e^{-(\lambda_1-\lambda S_0)|k|} \right) e^{-\lambda|tk|}. \end{aligned}$$

Accordingly,  $a(t, k)$  is dominated by  $\mathcal{O}(e^{-\lambda|k|t})$ , uniformly with respect to  $k$ , for  $0 < \lambda < \min(\lambda_0, \bar{\lambda}, \lambda_1/S_0)$ . (Note that  $S_0$  behaves like  $1/c$ ; as  $c$  becomes large, only  $\lambda_0$  and  $\bar{\lambda}$  are relevant in this condition.)

We turn now on the estimate on  $\mathcal{K}$ . With **(K4)**, **(K5)** and Lemma 2.1.3 (we use **(K1)** and **(K2)** in order to apply this lemma), we can estimate  $\mathcal{K}$  as follows: for every  $0 < \lambda < \min(\bar{\lambda}, c\lambda_1/R_2)$ ,

$$\begin{aligned} |\mathcal{K}(t, k)| &\leq |k|^2 |\widehat{\sigma}_1(k)|^2 \int_0^{\frac{2R_2}{c}} |p_c(\tau)| (t-\tau) \left| \widehat{\mathcal{M}}((t-\tau)k) \right| d\tau \\ &\lesssim |k|^2 e^{-2\lambda_1|k|} \int_0^{\frac{2R_2}{c}} (t-\tau) e^{-\lambda(t-\tau)|k|} e^{-(\bar{\lambda}-\lambda)|k|} d\tau \lesssim \left( \sup_k |k|^2 e^{-2(\lambda_1-\frac{R_2}{c}\lambda)|k|} \right) e^{-\lambda|tk|} \end{aligned}$$

which tells us that  $\mathcal{K}(t, k)$  is dominated by  $\mathcal{O}(e^{-\lambda|k|t})$ , uniformly with respect to  $k$ , provided  $0 < \lambda < \min(\bar{\lambda}, \frac{c\lambda_1}{R_2})$ .  $\blacksquare$

Hence, assuming **(K1)**–**(K5)** and **(L')**, the solution of (2.18)–(2.19) satisfies (2.30). We deduce the convergence of the fluctuation of density  $\varrho(t)$ , force  $\nabla_x \phi(t)$ , and medium  $\psi(t)$  (with exponential rate on the torus and polynomial rate for the free space problem), like in Proposition 2.2.4 and [87, Theorem 3.1].

## 2.2.4 Stability criterion for large wave speeds

We turn to investigate the “**(L)**-condition” made on the Laplace transform of  $\mathcal{K}$  (see **(L)** and **(L')**), where

$$\mathcal{L}\mathcal{K}(\omega, k) = |\widehat{\sigma}_1(k)|^2 \mathcal{L}p_c(\omega) \mathcal{L}(|k|^2 t \widehat{\mathcal{M}}(kt))(\omega).$$

In fact, for the Vlasov equation, such a property holds under a smallness assumption, see [87, Condition (a) in Proposition 2.1]. Here, this condition can be rephrased by means of a

condition on the wave speed  $c \gg 1$ . The latter confirms the intuition that the damping is related to the ability to evacuate the particles energy through the membranes, see [16]. (It also raises the issue to determine whether or not there exist stable equilibrium for  $c \ll 1$ .) A similar smallness condition on  $1/c$  appears in the asymptotic statements for a single particle [16, Theorem 2, 3 & 4], for the analysis of the relaxation to equilibrium for the Vlasov-Wave-Fokker-Planck model [4, Theorem 2.3], and the stability analysis in [26]. Moreover, as mentioned in the Introduction, up to a suitable  $c$ -dependent rescaling of the coupling, the regime  $c \rightarrow \infty$  leads to the usual Vlasov system [16], and it can be checked that the stability criterion for large  $c$ 's is consistent to the condition exhibited for the Vlasov equation. The role of the wave speed  $c$  on the damping phenomena is investigated on numerical grounds in the Next Chapter.

**Proposition 2.2.11 (Stability criterion for large  $c$ 's)** (i) Assume **(H1)**–**(H2)** and **(H4)**–**(H5)**. There exists  $c_0 > 0$  such that if  $c > c_0$  then condition **(L)** is fulfilled.  
(ii) Assume **(K1)**–**(K2)** and **(K4)**–**(K5)**. There exists  $c_0 > 0$  such that if  $c > c_0$  then condition **(L')** is fulfilled.

**Proof.** We only detail the proof of (ii), the former item being justified by a similar approach. Let  $0 < \Lambda < \min(\bar{\lambda}, c\lambda_1/R_2)$  and let  $\omega$  be a complex number such that  $\text{Re}(\omega) > -\Lambda$ . On the one hand, we have, for any  $k \neq 0$ ,

$$\left| \mathcal{L}(|k|^2 t \widehat{\mathcal{M}}(tk))(\omega|k|) \right| = \left| \int_0^\infty s \widehat{\mathcal{M}}\left(\frac{k}{|k|}s\right) e^{-\omega s} ds \right| \lesssim \int_0^\infty s e^{-\bar{\lambda}s} e^{\Lambda s} ds \lesssim 1.$$

On the other hand, Lemma 2.1.3 allows us to estimate the Laplace transform of the kernel  $p_c$  as follows

$$|\mathcal{L}p_c(\omega|k|)| \leq \|p_c\|_{L^\infty} \int_0^{2R_2/c} e^{\Lambda|k|s} ds \lesssim \frac{1}{c} \frac{e^{\frac{2R_2}{c}\Lambda|k|}}{c}.$$

Owing to **(K4)**, we obtain

$$|\widehat{\sigma}_1(k)|^2 |\mathcal{L}p_c(\omega|k|)| \lesssim \frac{1}{c^2} e^{-2(\lambda_1 - \frac{R_2}{c}\Lambda)|k|}.$$

We observe that the right hand side tends to 0 as  $c \rightarrow \infty$ . Therefore, for any  $\kappa \in (0, 1)$ , provided  $c$  is large enough, we have

$$\sup_{k \neq 0} |\mathcal{L}\mathcal{H}(\omega|k|, k)| \leq 1 - \kappa$$

for any  $\omega \in \mathbb{C}$  with  $\text{Re}(\omega) > -\Lambda$ , which implies  $\inf_{k \neq 0} |\mathcal{L}\mathcal{H}(\omega|k|, k) - 1| \geq \kappa > 0$ .  $\blacksquare$

Section 2.5 provides a thorough discussion of the stability criterion, beyond the mere assumption of large wave speeds  $c$ .

## 2.3 Non linear Landau damping: the free space problem

In this Section, we briefly explain how the non linear Landau damping can be justified, further details can be found in Appendix A. We shall see that the damping in  $\mathbb{R}^d$  occurs with a restriction on the space dimension: we should assume  $d \geq 3$ . As in [13], the analysis in the whole space relies on dispersive phenomena attached to the free transport operator; these effects are indeed strong enough to dominate the plasma echoes when  $d \geq 2$ , and a further technical restriction arises in the bootstrap argument, that leads to impose  $d \geq 3$ .

### 2.3.1 Functional framework

We shall make use of Sobolev-type spaces. For  $s \in \mathbb{R}$ ,  $m \in \mathbb{N} \setminus \{0\}$ , we denote

$$H^s(\mathbb{R}^m) = \left\{ u : \mathbb{R}^m \rightarrow \mathbb{R}, \int_{\mathbb{R}^m} \langle x \rangle^{2s} |\widehat{u}(x)|^2 dx \right\}.$$

Given  $x$  and  $y$  in  $\mathbb{R}^d$ ,  $\langle x, y \rangle$  stands for the vector in  $\mathbb{R}^{2d}$  that results from the concatenation of  $x$  and  $y$ . Consequently, we can set  $\langle x, y \rangle = (1 + |x|^2 + |y|^2)^{1/2}$ . With  $\alpha = (\alpha_1, \dots, \alpha_d) \in \mathbb{N}^d$ , we introduce the differential operator

$$D_\xi^\alpha = (-i\partial_{\xi_1}^{\alpha_1}) \cdots (-i\partial_{\xi_d}^{\alpha_d}).$$

For  $s \geq 0$ ,  $H^s$  stands for the standard Sobolev space. We shall make use of the norms introduced in [13]. We deal with functions  $f : (0, \infty) \times \mathbb{R}^d \times \mathbb{R}^d \rightarrow \mathbb{R}$ , and for  $P \in \mathbb{N}$ ,  $s \geq 0$ , we denote

$$\|f(t)\|_{H_P^s}^2 = \sum_{\substack{\alpha \in \mathbb{N}^d \\ |\alpha| \leq P}} \|(x, v) \mapsto v^\alpha f(t, x, v)\|_{H^s}^2 = \sum_{\substack{\alpha \in \mathbb{N}^d \\ |\alpha| \leq P}} \iint_{\mathbb{R}^d \times \mathbb{R}^d} \langle k, \xi \rangle^{2s} |D_\xi^\alpha \widehat{f}(t, k, \xi)|^2 dk d\xi. \quad (2.33)$$

It is also convenient to consider

$$\begin{aligned} \|\langle t\nabla_x, \nabla_v \rangle f(t)\|_{H_P^s}^2 &= \sum_{\substack{\alpha \in \mathbb{N}^d \\ |\alpha| \leq P}} \|(x, v) \mapsto \langle t\nabla_x, \nabla_v \rangle v^\alpha f(t, x, v)\|_{H^s}^2 \\ &= \sum_{\substack{\alpha \in \mathbb{N}^d \\ |\alpha| \leq P}} \iint_{\mathbb{R}^d \times \mathbb{R}^d} \langle tk, \xi \rangle^2 \langle k, \xi \rangle^{2s} |D_\xi^\alpha \widehat{f}(t, k, \xi)|^2 dk d\xi \end{aligned}$$

(there is a slight abuse of notation here since the right hand side is actually *equivalent* to the definition of  $\|\langle t\nabla_x, \nabla_v \rangle f(t)\|_{H_P^s}^2$  based on (2.33)) and

$$\begin{aligned} \|\nabla_x |^\delta f(t)\|_{H_P^s}^2 &= \sum_{\substack{\alpha \in \mathbb{N}^d \\ |\alpha| \leq P}} \|(x, v) \mapsto |\nabla_x|^\delta v^\alpha f(t, x, v)\|_{H^s}^2 \\ &= \sum_{\substack{\alpha \in \mathbb{N}^d \\ |\alpha| \leq P}} \iint_{\mathbb{R}^d \times \mathbb{R}^d} |k|^{2\delta} \langle k, \xi \rangle^{2s} |D_\xi^\alpha \widehat{f}(t, k, \xi)|^2 dk d\xi. \end{aligned}$$

We shall also use  $L^\infty$ -type estimate on Fourier transforms; we set

$$\left\| \widehat{\langle \nabla_{x,v} \rangle^s f} \right\|_{L_{(t)}^\infty L_{(k,\xi)}^\infty} = \sup_{t \in [0, T]} \left( \sup_{k, \xi \in \mathbb{R}^d} \left\{ \langle k, \xi \rangle^s |\widehat{f}(t, k, \xi)| \right\} \right).$$

For a function  $(t, x) \in (0, \infty) \times \mathbb{R}^d \mapsto \varrho(t, x) \in \mathbb{R}$  we introduce the modified Sobolev norm

$$\int_{\mathbb{R}^d} |k| \langle k, tk \rangle^{2s} |\widehat{\varrho}(t, k)|^2 dk = \|A_s(t) \widehat{\varrho}(t)\|_{L_{(k)}^2},$$

where we have set

$$A_s(t, k) = |k|^{1/2} \langle k, tk \rangle^s,$$

and we shall also use

$$\|A_s \widehat{\varrho}\|_{L_{(k,t)}^2} = \int_0^T \int_{\mathbb{R}^d} |k| \langle k, tk \rangle^{2s} |\widehat{\varrho}(t, k)|^2 dk dt,$$

and

$$\|A_s \widehat{\varrho}\|_{L^\infty_{(k)} L^2_{(t)}} = \sup_{k \in \mathbb{R}^d} \left( \int_0^T |k| \langle k, tk \rangle^{2s} |\widehat{\varrho}(t, k)|^2 \right)^{1/2}.$$

The norms defined on the macroscopic density  $\varrho$  equally apply to the kinetic quantity  $g$ , replacing  $\widehat{\varrho}(t, k)$  by  $\widehat{g}(t, k, tk)$ .

We go back to the formulation (2.9). Compared to the usual Vlasov equation, the expression of the potential  $\Phi[\psi]$  now involves the contribution of the initial data  $\mathcal{F}_I$ , and the self-consistent part  $\mathcal{G}_\varrho$  presents a memory effect, through the kernel  $p_c$ . It is convenient to think of the problem with some generality on these quantities. Thus, let us collect the hypothesis on the data of the problem:  $\mathcal{F}_I$ ,  $p_c$  and  $\sigma_1$ . We refer the reader to the previous section in order to translate these assumption on the original data  $\sigma_2$ ,  $\psi_0$  and  $\psi_1$ .

**(A1)** There exists an exponent  $\alpha_I > 0$  sufficiently large such that

$$\sup_{k \in \mathbb{R}^d} \left| \widehat{\mathcal{F}}_I(t, k) \right| \lesssim \langle t \rangle^{-\alpha_I},$$

**(A2)** There exists an exponent  $\alpha_c > 0$  sufficiently large such that

$$|p_c(t)| \lesssim \langle t \rangle^{-\alpha_c},$$

**(A3)**  $\sigma_1 \in \mathcal{S}(\mathbb{R}^d)$ : for any  $\alpha \geq 0$  we have

$$\lim_{|k| \rightarrow +\infty} \langle k \rangle^\alpha |\widehat{\sigma}_1(k)| = 0.$$

This formulation of the hypothesis has the advantage of pushing the generality of the result, both on the “linear” perturbation due to the data through  $\mathcal{F}_I$  and on the memory effects in the self-consistent potential through  $p_c$ . The following claims are crucial for our purposes: roughly speaking, they explain why the situation is not very different from the Vlasov case, once the role of  $\mathcal{F}_I(t)$  and  $p_c$  well understood, and it justifies that the approach of [13] is robust enough to be adapted. Note that **(A1)** is the assumption that makes the constants  $C_1(\mathcal{F}_I)$  and  $C_2(\mathcal{F}_I)$  below meaningful.

**Proposition 2.3.1** *Let **(A1)**–**(A3)** be fulfilled. Then for any  $0 < T < \infty$  and any  $s \geq 0$  such that  $s < \alpha_I - 1/2$  and  $s < (\alpha_c - 1)/2$ , the following three estimates hold*

$$\|A_s \widehat{\sigma}_1 \left( \widehat{\mathcal{F}}_I - \widehat{\sigma}_1 \widehat{\mathcal{G}}_\varrho \right)\|_{L^2_{(t)} L^2_{(k)}}^2 \lesssim C_1(\mathcal{F}_I) + \|A_s \widehat{\varrho}\|_{L^2_{(t)} L^2_{(k)}}^2, \quad (2.34a)$$

$$\|A_s \widehat{\sigma}_1 \left( \widehat{\mathcal{F}}_I - \widehat{\sigma}_1 \widehat{\mathcal{G}}_\varrho \right)\|_{L^\infty_{(k)} L^2_{(t)}}^2 \lesssim C_1(\mathcal{F}_I) + \|A_s \widehat{\varrho}\|_{L^\infty_{(k)} L^2_{(t)}}^2, \quad (2.34b)$$

$$\begin{aligned} \sup_{t \in [0, T]} \sup_{k \in \mathbb{R}^d} \langle k, tk \rangle^s |\widehat{\sigma}_1(k)| \left| \widehat{\mathcal{F}}_I(t, k) - \widehat{\sigma}_1(k) \widehat{\mathcal{G}}_\varrho(t, k) \right| \\ \lesssim C_2(\mathcal{F}_I) + \sup_{t \in [0, T]} \sup_{k \in \mathbb{R}^d} \langle k, tk \rangle^s |\widehat{\varrho}(t, k)|, \end{aligned} \quad (2.34c)$$

with

$$C_1(\mathcal{F}_I) = \int_0^{+\infty} \langle t \rangle^{2s} \sup_k \left| \widehat{\mathcal{F}}_I(t, k) \right|^2 dt \quad \text{and} \quad C_2(\mathcal{F}_I) = \sup_{t, k} \langle t \rangle^s \left| \widehat{\mathcal{F}}_I(t, k) \right|.$$

**Remark 2.3.2** We shall use the following variant of the statement : for any polynomial  $k \mapsto P(k)$ , we have

$$\left\| PA_s \widehat{\sigma}_1 \left( \widehat{\mathcal{F}}_I - \widehat{\sigma}_1 \widehat{\mathcal{G}}_\varrho \right) \right\|_{L^2(t) L^2(k)}^2 \lesssim C_1(\mathcal{F}_I) + \|A_s \widehat{\varrho}\|_{L^2(t) L^2(k)}^2, \quad (2.35a)$$

$$\left\| PA_s \widehat{\sigma}_1 \left( \widehat{\mathcal{F}}_I - \widehat{\sigma}_1 \widehat{\mathcal{G}}_\varrho \right) \right\|_{L^\infty(k) L^2(t)}^2 \lesssim C_1(\mathcal{F}_I) + \|A_s \widehat{\varrho}\|_{L^\infty(k) L^2(t)}^2, \quad (2.35b)$$

$$\begin{aligned} \sup_{t \in [0, T]} \sup_{k \in \mathbb{R}^d} \langle k, tk \rangle^s P(k) |\widehat{\sigma}_1(k)| \left| \widehat{\mathcal{F}}_I(t, k) - \widehat{\sigma}_1(k) \widehat{\mathcal{G}}_\varrho(t, k) \right| \\ \lesssim C_2(\mathcal{F}_I) + \sup_{t \in [0, T]} \sup_{k \in \mathbb{R}^d} \langle k, tk \rangle^s |\widehat{\varrho}(t, k)|, \end{aligned} \quad (2.35c)$$

These estimates can be justified since  $\sigma_1$  lies in the Schwartz class and thus  $P(k)\widehat{\sigma}_1(k)$  remains a function with fast decay.

**Proof.** In order to prove (2.34a), we analyse separately the contribution from  $\widehat{\mathcal{F}}_I$  and  $\widehat{\mathcal{G}}_\varrho$  as follows

$$\begin{aligned} \left\| A_s \widehat{\sigma}_1 \left( \widehat{\mathcal{F}}_I - \widehat{\sigma}_1 \widehat{\mathcal{G}}_\varrho \right) \right\|_{L^2(t) L^2_k}^2 &\lesssim \underbrace{\int_0^T \int_{\mathbb{R}_k^d} |k| \langle k, tk \rangle^{2s} |\widehat{\sigma}_1(k)|^2 |\widehat{\mathcal{F}}_I(t, k)|^2 dk dt}_{=I} \\ &\quad + \underbrace{\int_0^T \int_{\mathbb{R}_k^d} |k| \langle k, tk \rangle^{2s} |\widehat{\sigma}_1(k)|^4 |\widehat{\mathcal{G}}_\varrho(t, k)|^2 dk dt}_{=II}. \end{aligned}$$

For I, by using  $\langle k, tk \rangle^2 \leq \langle k \rangle^2 \langle t \rangle^2$ , we readily obtain

$$I \leq \left( \int_{\mathbb{R}_k^d} |k| \langle k \rangle^{2s} |\widehat{\sigma}_1(k)|^2 dk \right) \left( \int_0^{+\infty} \langle t \rangle^{2s} \sup_k |\widehat{\mathcal{F}}_I(t, k)|^2 dt \right).$$

For II we start by applying Cauchy-Schwarz' inequality

$$\begin{aligned} |\widehat{\mathcal{G}}_\varrho(t, k)|^2 &= \left| \int_0^t p_c(t - \tau) \varrho(\tau, k) d\tau \right|^2 \\ &\leq \left( \int_0^t |p_c(t - \tau)| d\tau \right) \left( \int_0^t |p_c(t - \tau)| |\widehat{\varrho}(\tau, k)|^2 d\tau \right). \end{aligned}$$

Going back to II, we are led to

$$II \leq \|p_c\|_{L^1} \int_0^T \int_0^t |p_c(t - \tau)| \left( \int_{\mathbb{R}_k^d} |k| \langle k, \tau k \rangle^{2s} \frac{\langle k, tk \rangle^{2s}}{\langle k, \tau k \rangle^{2s}} |\widehat{\sigma}_1(k)|^4 |\widehat{\varrho}(\tau, k)|^2 dk \right) d\tau dt.$$

A simple study of function shows that (for  $t \geq \tau$ )

$$\sup_{k \in \mathbb{R}^d} \frac{\langle k, tk \rangle^{2s}}{\langle k, \tau k \rangle^{2s}} \leq \frac{\langle t \rangle^{2s}}{\langle \tau \rangle^{2s}}.$$

Since  $|\widehat{\sigma}_1(k)| \leq \|\sigma_1\|_{L^1} \lesssim 1$ , and using Fubini's theorem, we obtain

$$\begin{aligned} II &\lesssim \|p_c\|_{L^1} \int_0^T \left( \int_\tau^T |p_c(t - \tau)| \frac{\langle t \rangle^{2s}}{\langle \tau \rangle^{2s}} \|A_s \widehat{\varrho}(\tau)\|_{L^2(k)}^2 dt \right) d\tau \\ &\lesssim \|p_c\|_{L^1} \int_0^T \|A_s \widehat{\varrho}(\tau)\|_{L^2(k)}^2 \left( \int_0^{T-\tau} |p_c(u)| \frac{\langle u + \tau \rangle^{2s}}{\langle \tau \rangle^{2s}} du \right) d\tau. \end{aligned}$$



Since  $\langle u + \tau \rangle^{2s} \lesssim \langle u \rangle^{2s} \langle \tau \rangle^{2s}$ , we arrive at

$$\Pi \lesssim \|p_c\|_{L^1} \left( \int_0^{+\infty} \langle u \rangle^{2s} |p_c(u)| \, du \right) \|A_s \widehat{\varrho}\|_{L^2_t L^2_k}^2.$$

It ends the proof of (2.34a).

Estimate (2.34b) follows the same strategy: for  $k \in \mathbb{R}^d$ , we split as follows

$$\begin{aligned} & \int_0^T |k| \langle k, tk \rangle^{2s} |\widehat{\sigma}_1(k)|^2 \left| \widehat{\mathcal{F}}_I(t, k) - \widehat{\sigma}_1(k) \widehat{\mathcal{G}}_\varrho(t, k) \right|^2 dt \\ & \leq \underbrace{\int_0^T |k| \langle k, tk \rangle^{2s} |\widehat{\sigma}_1(k)|^2 |\widehat{\mathcal{F}}_I(t, k)|^2 dt}_{=J} + \underbrace{\int_0^T |k| \langle k, tk \rangle^{2s} |\widehat{\sigma}_1(k)|^4 |\widehat{\mathcal{G}}_\varrho(t, k)|^2 dt}_{=JJ}. \end{aligned}$$

Proceeding as above, we obtain

$$J \leq \left( \sup_{k \in \mathbb{R}^d} |k| \langle k \rangle^{2s} |\widehat{\sigma}_1(k)|^2 \right) \left( \int_0^{+\infty} \langle t \rangle^{2s} \sup_k |\widehat{\mathcal{F}}_I(t, k)|^2 dt \right)$$

and

$$\begin{aligned} JJ & \lesssim \|p_c\|_{L^1} \int_0^T \left( \int_\tau^T |p_c(t - \tau)| \frac{\langle t \rangle^{2s}}{\langle \tau \rangle^{2s}} |k| \langle k, \tau k \rangle^{2s} |\widehat{\varrho}(\tau, k)|^2 dt \right) d\tau \\ & \lesssim \|p_c\|_{L^1} \left( \int_0^{+\infty} \langle u \rangle^{2s} |p_c(u)| \, du \right) \left( \int_0^T |k| \langle k, \tau k \rangle^{2s} |\widehat{\varrho}(\tau, k)|^2 d\tau \right). \end{aligned}$$

We proceed with a slightly different approach for (2.34c) when dealing with the contribution involving  $\widehat{\mathcal{G}}_\varrho$ . For any  $t \in [0, T]$  and  $k \in \mathbb{R}^d$ , we write

$$\begin{aligned} & \langle k, tk \rangle^s |\widehat{\sigma}_1(k)| \left| \widehat{\mathcal{F}}_I(t, k) - \widehat{\sigma}_1(k) \widehat{\mathcal{G}}_\varrho(t, k) \right| \\ & \lesssim \left( \sup_{k \in \mathbb{R}^d} \langle k \rangle^s |\widehat{\sigma}_1(k)| \right) \left( \sup_{t \in [0, T]} \langle t \rangle^s \sup_k |\widehat{\mathcal{F}}_I(t, k)| \right) + \langle k, tk \rangle^s |\widehat{\mathcal{G}}_\varrho(t, k)|. \end{aligned}$$

Since

$$\begin{aligned} \langle k, tk \rangle^s |\widehat{\mathcal{G}}_\varrho(t, k)| & \leq \int_0^t |p_c(t - \tau)| \frac{\langle k, tk \rangle^s}{\langle k, \tau k \rangle^s} \langle k, \tau k \rangle^s |\widehat{\varrho}(\tau, k)| \, d\tau \\ & \lesssim \left( \int_0^t |p_c(t - \tau)| \frac{\langle t \rangle^s}{\langle \tau \rangle^s} \, d\tau \right) \left( \sup_{\tau \in [0, T]} \sup_{k \in \mathbb{R}^d} \langle k, \tau k \rangle^s |\widehat{\varrho}(\tau, k)| \right), \end{aligned}$$

it suffices to observe that

$$\int_0^t |p_c(t - \tau)| \frac{\langle t \rangle^s}{\langle \tau \rangle^s} \, d\tau < \infty$$

by virtue of **(A2)**. ■

**Proposition 2.3.3** *Let **(A1)**–**(A3)** be fulfilled. Assume that  $\mathcal{M} \in H_P^{\frac{s}{2}}$  with  $P > d/2$  and*

$\tilde{s} \geq 0$ . Then for any  $s \geq 0$  such that  $s < \tilde{s} - 2d$  and  $s < \alpha_I - 1$ , we have

$$\left\| (t, k) \mapsto A_s(t, k) \int_0^t \widehat{\nabla_x \sigma_1}(k) \widehat{\mathcal{F}}_I(\tau, k) \widehat{\nabla_v \mathcal{M}}((t - \tau)k) d\tau \right\|_{L_{(t)}^2 L_{(k)}^2} \quad (2.36a)$$

$$\lesssim \int_0^{+\infty} \langle t \rangle^{2s+1+} \sup_k \left| \widehat{\mathcal{F}}_I(t, k) \right|^2 dt$$

$$\left\| (t, k) \mapsto A_s(t, k) \int_0^t \widehat{\nabla_x \sigma_1}(k) \widehat{\mathcal{F}}_I(\tau, k) \widehat{\nabla_v \mathcal{M}}((t - \tau)k) d\tau \right\|_{L_{(k)}^\infty L_{(t)}^2} \quad (2.36b)$$

$$\lesssim \int_0^{+\infty} \langle t \rangle^{2s+1+} \sup_k \left| \widehat{\mathcal{F}}_I(t, k) \right|^2 dt$$

**Proof.** First, let us introduce the following notation

$$I(t, k) = A_s(t, k) \int_0^t \widehat{\nabla_x \sigma_1}(k) \widehat{\mathcal{F}}_I(\tau, k) \widehat{\nabla_v \mathcal{M}}((t - \tau)k) d\tau$$

and estimate for every  $k \in \mathbb{R}^d$  the  $L_{(t)}^2$  norm of  $t \mapsto I(t, k)$ . By using the relations  $\langle k, tk \rangle \lesssim \langle k, \tau k \rangle \langle [t - \tau]k \rangle$  and  $\langle k, \tau k \rangle \leq \langle k \rangle \langle \tau \rangle$ , we obtain

$$\begin{aligned} \int_0^T |I(t, k)|^2 dt &\lesssim |k|^3 |\widehat{\sigma}_1(k)|^2 \int_0^T \langle tk \rangle^{-(1+)} \\ &\quad \times \left( \int_0^t \langle \tau k \rangle^{\frac{1}{2}+} \langle k, \tau k \rangle^s \left| \widehat{\mathcal{F}}_I(\tau, k) \right| \langle (t - \tau)k \rangle^{s+\frac{1}{2}+} \left| \widehat{\nabla_v \mathcal{M}}((t - \tau)k) \right| \right)^2 dt \\ &\lesssim |k| |\widehat{\sigma}_1(k)|^2 \int_0^T \langle tk \rangle^{-(1+)} \left( \int_0^{+\infty} \langle \tau k \rangle^{1+} \langle k, \tau k \rangle^{2s} \left| \widehat{\mathcal{F}}_I(\tau, k) \right|^2 d\tau \right) \\ &\quad \times \left( \int_0^{+\infty} \langle (t - \tau)k \rangle^{2s+1+} \left| \widehat{\nabla_v \mathcal{M}}((t - \tau)k) \right|^2 |k| d\tau \right) |k| dt \\ &\lesssim |k| \langle k \rangle^{2s+1+} |\widehat{\sigma}_1(k)|^2 \left( \int_0^{+\infty} \langle \tau \rangle^{2s+1+} \sup_k \left| \widehat{\mathcal{F}}_I(\tau, k) \right|^2 d\tau \right) \\ &\quad \times \left( \int_0^{+\infty} \langle u \rangle^{2s+1+} \left| \widehat{\nabla_v \mathcal{M}}\left(u \frac{k}{|k|}\right) \right|^2 du \right) \int_0^T \langle u \rangle^{-(1+)} du. \end{aligned}$$

Since  $\mathcal{M} \in H_P^{\tilde{s}}$ , we have  $\xi \mapsto \langle \xi \rangle^{\tilde{s}} \widehat{\mathcal{M}}(\xi) \in H^P$ , where  $P > d/2$ , and Sobolev's embedding yields  $|\widehat{\mathcal{M}}(\xi)| \lesssim \|\widehat{\mathcal{M}}\|_{H^P} \langle \xi \rangle^{-\tilde{s}}$ . Then, as soon as  $s < \tilde{s} - (1+)$ , this ensures that the integral involving  $\mathcal{M}$  is uniformly bounded with respect to  $k$ . Eventually **(A3)** ensures that both  $L_{(k)}^2 L_{(t)}^2$  and  $L_{(k)}^\infty L_{(t)}^2$ -norm of  $I(t, k)$  are dominated as asserted.  $\blacksquare$

Let us now collect a few technical results, more or less extracted from [13], which will be useful for the proof of the Landau damping.

**Lemma 2.3.4 (Trace Lemma)** *Let  $f \in H^s(\mathbb{R}^d)$  with  $s > \frac{d-1}{2}$ . Let  $\mathcal{C} \subset \mathbb{R}^d$  be a submanifold with dimension larger or equal to 1. We have*

$$\|f\|_{L^2(\mathcal{C})} \lesssim \|f\|_{H^s}.$$

This claim, which will be further used in the sequel, allows us to obtain the following estimates.

**Lemma 2.3.5** *Let  $f_0$  be in  $H_P^s$  with  $P > d/2$ . Then,*

1. *we have*

$$\int_0^T \int_{\mathbb{R}^d} |A_s \widehat{f_0}(k, tk)|^2 dk dt = \int_0^T \int_{\mathbb{R}^d} |k| \langle k, tk \rangle^{2s} |\widehat{f_0}(k, tk)|^2 dk dt \lesssim \|f_0\|_{H_P^s}^2. \quad (2.37)$$

2. *if, moreover,  $(x, v) \mapsto x^\alpha f_0(x, v) \in H_P^s$ , for any  $\alpha \in \mathbb{N}^d$  with  $|\alpha| \leq P$ , we have*

$$\sup_{k, \xi} \left( \langle k, \xi \rangle^s |\widehat{f}(k, \xi)| \right) \lesssim \sum_{|\alpha| \leq P} \|x^\alpha f_0(x, v)\|_{H_P^s}. \quad (2.38)$$

3. *if, moreover  $(x, v) \mapsto x^\alpha f_0(x, v) \in H_P^{s+1}$  for any  $\alpha \in \mathbb{N}^d$  with  $|\alpha| \leq P$ , we have*

$$\sup_{k \in \mathbb{R}^d} \int_0^T |k| \langle k, tk \rangle^{2s} |\widehat{f_0}(k, tk)|^2 dt \lesssim \sum_{\substack{\alpha \in \mathbb{N}^d \\ |\alpha| \leq P}} \|x^\alpha f_0(x, v)\|_{H_P^{s+1}}. \quad (2.39)$$

**Proof.** Since  $f_0 \in H_P^s$ , we have

$$(k, \xi) \mapsto \langle k, \xi \rangle^s \widehat{f_0}(k, \xi) \in L_{(k)}^2 H_{(\xi)}^P.$$

Indeed,

$$\begin{aligned} \left| D_\xi^\alpha \left( \xi \mapsto \langle k, \xi \rangle^s \widehat{f_0}(k, \xi) \right) \right| &= \left| \sum_{\substack{j \in \mathbb{N}^d \\ j \leq \alpha}} \binom{\alpha}{j} D_\xi^{\alpha-j} \left( \xi \mapsto \langle k, \xi \rangle^s \right) D_\xi^j \widehat{f_0}(k, \xi) \right| \\ &\lesssim \sum_{\substack{j \in \mathbb{N}^d \\ j \leq \alpha}} \langle k, \xi \rangle^s \left| D_\xi^j \widehat{f_0}(k, \xi) \right| \end{aligned}$$

yields

$$\begin{aligned} \underbrace{\left\| \xi \mapsto \langle k, \xi \rangle^s \widehat{f_0}(k, \xi) \right\|_{L_{(k)}^2 H_{(\xi)}^P}^2}_{=} &\lesssim \sum_{\substack{\alpha \in \mathbb{N}^d \\ |\alpha| \leq P}} \int_{\mathbb{R}_k^d \times \mathbb{R}_\xi^d} \langle k, \xi \rangle^{2s} \left| D_\xi^\alpha \widehat{f_0}(k, \xi) \right|^2 dk d\xi = \|f_0\|_{H_P^s}^2. \\ &= \int_{\mathbb{R}_k^d} \left\| \xi \mapsto \langle k, \xi \rangle^s \widehat{f_0}(k, \xi) \right\|_{H_{(\xi)}^P}^2 dk \end{aligned} \quad (2.40)$$

Next, we observe that

$$\begin{aligned} \int_0^T \|A_s \widehat{f_0}(\cdot, t)\|_{L_{(k)}^2}^2 dt &= \int_{\mathbb{R}_k^d} \left( \int_0^T \langle k, tk \rangle^{2s} |\widehat{f_0}(k, tk)|^2 |k| dt \right) dk \\ &= \int_{\mathbb{R}_k^d} \left( \int_0^{|k|T} \langle k, uk/|k| \rangle^{2s} |\widehat{f_0}(k, uk/|k|)|^2 du \right) dk \\ &\leq \int_{\mathbb{R}_k^d} \left( \sup_{\omega \in \mathbb{S}^{d-1}} \int_{-\infty}^{+\infty} \langle k, u\omega \rangle^{2s} |f_0(k, u\omega)|^2 du \right) dk. \end{aligned}$$

Therefore coming back to (2.40), with  $P > d/2$ , we deduce that

$$\left\| \xi \mapsto \langle k, \xi \rangle^s \widehat{f_0}(k, \xi) \right\|_{H_{(\xi)}^P}^2$$

is finite for almost every  $k \in \mathbb{R}^d$ . We can apply the Trace Lemma 2.3.4 for almost every  $k \in \mathbb{R}^d$ , which leads to

$$\int_{-\infty}^{+\infty} \langle k, u\omega \rangle^{2s} |\widehat{f}_0(k, u\omega)|^2 du \lesssim \|\xi \mapsto \langle k, \xi \rangle^s \widehat{f}_0(k, \xi)\|_{H_{(\xi)}^P}^2.$$

(Note that the constant in the estimate of the Trace Lemma 2.3.4 only depends on the submanifold  $\mathcal{C}$ , and the estimate does not involve the parameter  $k$ .) Integrating over  $k$  we conclude that

$$\int_0^T \|A_s \widehat{f}_0(\cdot, t)\|_{L_{(k)}^2}^2 dt \lesssim \|f_0\|_{H_P^s}^2.$$

For the second estimate, we remark that  $(x, v) \mapsto x^\alpha f_0(x, v) \in H_P^s$  implies that  $\langle k, \xi \rangle^{s+1} \widehat{f}_0(k, \xi)$  lies in  $H_{(k)}^P H_{(\xi)}^P$ , which embeds into the space of continuous functions; the third estimate then follows immediately, see [13, Lemma 2.6].  $\blacksquare$

The following statement will be repeatedly used for proving Proposition 2.3.9, see [13, Lemma 2.9].

**Lemma 2.3.6** *Let  $g_1$  et  $g_2$  be in  $L^2(\mathbb{R}_k^d \times \mathbb{R}_\xi^d)$  and let  $r \in L^1(\mathbb{R}_n^d)$ . Then, we have*

$$\left| \int_{\mathbb{R}_{k,\xi,n}^{3d}} g_1(k, \xi) r(n) g_2(k-n, \xi-tn) dn dk d\xi \right| \lesssim \|g_1\|_{L_{(k,\xi)}^2} \|g_2\|_{L_{(k,\xi)}^2} \|r\|_{L_{(n)}^1}. \quad (2.41)$$

Let  $g_1 \in L^2(\mathbb{R}_k^d \times \mathbb{R}_\xi^d)$ ,  $g_2 \in L^1(\mathbb{R}_k^d; L^2(\mathbb{R}_\xi^d))$  and  $r \in L^2(\mathbb{R}_n^d)$ . Then, we have

$$\left| \int_{\mathbb{R}_{k,\xi,n}^{3d}} g_1(k, \xi) r(n) g_2(k-n, \xi-tn) dn dk d\xi \right| \lesssim \|g_1\|_{L_{(k,\xi)}^2} \|g_2\|_{L^1(\mathbb{R}_k^d; L^2(\mathbb{R}_\xi^d))} \|r\|_{L_{(n)}^2}. \quad (2.42)$$

The analysis of the Landau Damping, as it is already clear for the linearized problem, relies heavily on the formulation of the problem by means of the Fourier variables. Let us collect the useful formula from which the reasoning starts. Integrating (2.10a)–(2.10b) over  $[0, t]$ , we get

$$g(t, x, v) = f_0(x, v) + \int_0^t \nabla_x \sigma_1 \star (\mathcal{F}_I - \sigma_1 \star \mathcal{G}_\rho)(\tau, x + \tau v) \cdot (\nabla_v - \tau \nabla_x) (\mathcal{M}(v) + g(\tau, x, v)) d\tau.$$

We check that

$$\int_{\mathbb{R}^{2d}} u(x + \tau v, v) e^{-ik \cdot x} e^{-i\xi \cdot v} dv dx = \int_{\mathbb{R}^{2d}} u(y, v) e^{-ik \cdot y} e^{-i(\xi - \tau k) \cdot v} dv dx = \widehat{u}(k, \xi - \tau k).$$

We also bear in mind that  $\mathbf{1}(\widehat{v})(\xi) = \delta(\xi = 0)$  and  $\mathbf{1}(\widehat{x})(k) = \delta(k = 0)$ . We thus obtain

$$\begin{aligned} \widehat{g}(t, k, \xi) &= \widehat{f}_0(k, \xi) \\ &\quad - \int_0^t \int_{\mathbb{R}^{2d}} n \widehat{\sigma}_1(n) (\widehat{\mathcal{F}}_I - \widehat{\sigma}_1 \widehat{\mathcal{G}}_\rho)(\tau, n) \delta(\zeta = \tau n) \cdot (\xi - \zeta) \widehat{\mathcal{M}}(\xi - \zeta) \delta(n = k) dn d\zeta d\tau \\ &\quad - \int_0^t \int_{\mathbb{R}^{2d}} n \widehat{\sigma}_1(n) (\widehat{\mathcal{F}}_I - \widehat{\sigma}_1 \widehat{\mathcal{G}}_\rho)(\tau, n) \delta(\zeta = \tau n) \\ &\quad \quad \quad \cdot (\xi - \zeta - \tau(k - n)) \widehat{g}(\tau, k - n, \xi - \zeta) dn d\zeta d\tau \\ &= \widehat{f}_0(k, \xi) - \int_0^t k \widehat{\sigma}_1(k) (\widehat{\mathcal{F}}_I - \widehat{\sigma}_1 \widehat{\mathcal{G}}_\rho)(\tau, \tau k) \cdot (\xi - \tau k) \widehat{\mathcal{M}}(\xi - \tau k) d\tau \\ &\quad - \int_0^t \int_{\mathbb{R}^d} n \widehat{\sigma}_1(n) (\widehat{\mathcal{F}}_I - \widehat{\sigma}_1 \widehat{\mathcal{G}}_\rho)(\tau, n) \cdot (\xi - \tau k) \widehat{g}(\tau, k - n, \xi - \tau n) dn d\tau. \end{aligned} \quad (2.43)$$

Eventually, the macroscopic density is evaluated by

$$\begin{aligned}\widehat{\varrho}(t, k) &= \int_{\mathbb{R}^{2d}} f(t, x, v) e^{-ik \cdot x} dv dx = \int_{\mathbb{R}^{2d}} g(t, x - tv, v) e^{-ik \cdot x} dv dx \\ &= \int_{\mathbb{R}^{2d}} g(t, y, v) e^{-ik \cdot y} e^{-itk \cdot v} dv dy = \widehat{g}(t, k, tk).\end{aligned}$$

Going back to (2.43) with  $\xi = tk$ , we arrive at

$$\begin{aligned}\widehat{\varrho}(t, k) &= \widehat{f}_0(k, tk) - \int_0^t k \widehat{\sigma}_1(k) (\widehat{\mathcal{F}}_I - \widehat{\sigma}_1 \widehat{\mathcal{G}}_\varrho)(\tau, \tau k) \cdot (t - \tau) k \widehat{\mathcal{M}}((t - \tau)k) d\tau \\ &\quad - \int_0^t \int_{\mathbb{R}^d} n \widehat{\sigma}_1(n) (\widehat{\mathcal{F}}_I - \widehat{\sigma}_1 \widehat{\mathcal{G}}_\varrho)(\tau, n) \cdot ((t - \tau)k) \widehat{g}(\tau, k - n, tk - \tau n) dn d\tau \quad (2.44)\end{aligned}$$

### 2.3.2 Main result

We are ready now to state the main result about the non linear Landau damping. As said above, the proof makes the constraint  $d \geq 3$  on the space dimension appear.

**Theorem 2.3.7 (Landau damping in  $\mathbb{R}^d$ )** *Let  $d \geq 3$ . Suppose (A1)–(A3). There exists universal constants  $\varepsilon_0, R_0 > 0$  and  $r \in (0, R_0)$  such that if  $s > R_0$ ,*

$$\sum_{\substack{\alpha \in \mathbb{N}^d \\ |\alpha| \leq P}} \|x^\alpha f_0\|_{H_P^{\tilde{s}}}^2 \leq \varepsilon_0^2 \quad \int_0^{+\infty} \langle t \rangle^{2s} \sup_k \left| \widehat{\mathcal{F}}_I(t, k) \right|^2 dt \leq \varepsilon_0^2, \quad \sup_{t, k} \langle t \rangle^s \left| \widehat{\mathcal{F}}_I(t, k) \right| \leq \varepsilon_0,$$

and  $\mathcal{M} \in H_P^{\tilde{s}}(\mathbb{R}_v^d)$  with  $P > d/2$  and  $\tilde{s} \geq s + 2d$  satisfies (L), then, the unique solution  $g$  of (2.10a)–(2.10b) is globally defined. Moreover, there exists  $g^\infty \in H_P^r$  such that

$$\|g(t) - g^\infty\|_{H_P^\sigma} \lesssim \varepsilon_0 \langle t \rangle^{-\frac{d}{2}} \quad \text{for } 0 \leq \sigma \leq r, \quad (2.45a)$$

$$|\widehat{g}(t, k, tk)| \lesssim \varepsilon_0 \langle k, tk \rangle^{-(r+d+2)} \quad (2.45b)$$

$$\|\langle \nabla_x \rangle^\sigma \nabla \sigma_1 \star (\mathcal{F}_I(t) - \sigma_1 \star \mathcal{G}_g(t))\|_{L^\infty(dx)} \lesssim \varepsilon_0 \langle t \rangle^{-d-1} \quad \text{for } \sigma \geq 0 \quad (2.45c)$$

holds.

**Remark 2.3.8** i) Estimate (2.45c) holds because  $\sigma_1$  is assumed to be in the Schwartz class; this assumption can be relaxed at the price of introducing constraints on the regularity exponent  $\sigma$ .

ii) Estimate (2.45b) provides a decay of  $\widehat{\varrho}(t, k)$  with rate  $\langle k, tk \rangle^{-(r+d+2)}$ ; the statement can be completed by the convergence to 0 of the fluctuations  $\psi$  of the medium state, see Proposition 2.2.4.

The proof of the Landau Damping in fact relies on a bootstrap estimate, see [13, Proposition 2.5], which states as follows.

**Proposition 2.3.9 (Bootstrap)** *Let the hypothesis of Theorem 2.3.7 be fulfilled and let  $0 < \delta < 1/2$ . There exists real numbers  $2(d+1) + 1 < s_1 < s_2 < s_3 < s_4 < s$  and  $K_1, \dots, K_5 \geq 1$  such that, for any  $g \in C^0([0, T], H_P^s)$  solution of (2.10a)–(2.10b) on the time*

interval  $[0, T]$  verifying

$$\|\langle t \nabla_x, \nabla_v \rangle g(t)\|_{H_P^{s_4}}^2 \leq 4K_1 \varepsilon^2 \langle t \rangle^5, \quad (2.46a)$$

$$\|A_{s_4} \widehat{\varrho}\|_{L_{(t)}^2 L_{(k)}^2}^2 \leq 4K_2 \varepsilon^2, \quad (2.46b)$$

$$\| |\nabla_x|^\delta g(t) \|_{H_P^{s_3}}^2 \leq 4K_3 \varepsilon^2, \quad (2.46c)$$

$$\|A_{s_2} \widehat{\varrho}\|_{L_{(k)}^\infty L_{(t)}^2}^2 \leq 4K_4 \varepsilon^2, \quad (2.46d)$$

$$\|\langle \widehat{\nabla_{x,v}}^{s_1} g(t) \rangle\|_{L_{(k,\varepsilon)}^\infty} \leq 4K_5 \varepsilon, \quad (2.46e)$$

for  $0 < \varepsilon \leq \varepsilon_0$  small enough, the following estimates hold on  $[0, T]$

$$\|\langle t \nabla_x, \nabla_v \rangle g(t)\|_{H_P^{s_4}}^2 \leq 2K_1 \varepsilon^2 \langle t \rangle^5, \quad (2.47a)$$

$$\|A_{s_4} \widehat{\varrho}\|_{L_{(t)}^2 L_{(k)}^2}^2 \leq 2K_2 \varepsilon^2, \quad (2.47b)$$

$$\| |\nabla_x|^\delta g(t) \|_{H_P^{s_3}}^2 \leq 2K_3 \varepsilon^2, \quad (2.47c)$$

$$\|A_{s_2} \widehat{\varrho}\|_{L_{(k)}^\infty L_{(t)}^2}^2 \leq 2K_4 \varepsilon^2, \quad (2.47d)$$

$$\|\langle \widehat{\nabla_{x,v}}^{s_1} g(t) \rangle\|_{L_{(k,\varepsilon)}^\infty} \leq 2K_5 \varepsilon. \quad (2.47e)$$

**Remark 2.3.10** We shall see within the proof how the  $s_i$ 's are chosen, according to some compatibility conditions. This choice determines the possible value for  $R_0$  that arises in Theorem 2.3.7 as a threshold for the Sobolev regularity in which the damping is evaluated. To be specific, Proposition 2.3.9 holds for  $s > s_4 + 2d$  and  $s_i > s_{i-1} + 2d$  and in Theorem 2.3.7, we can set

$$R_0 = s_4 + 2d, \quad r = s_1 - d - 2.$$

The condition on  $\varepsilon_0$  imposes a smallness constraint on the initial perturbation.

**Remark 2.3.11** It might be surprising that the half-convolution with respect to time plays a relatively weak role in this statement, compared to the Vlasov case. At first sight, we would suspect that the memory effect changes a lot the control of the force terms, or that it imposes further restrictions. In fact, the heart of the proof relies on the estimates in Proposition 2.3.1, and the main impact of the memory term is rather on the stability condition, where it completely modifies, in a quite intricate way, the expression of the symbol  $\mathcal{L}\mathcal{H}$ . This can be seen as a confirmation of the robustness of the approach designed in [87, 12, 13].

Having at hand the bootstrap statement, let us prove Theorem 2.3.7. This proof follows closely [13].

**Proof of Landau damping.** If we have the a priori knowledge that with initial data such that

$$\sum_{\substack{\alpha \in \mathbb{N}^d \\ |\alpha| \leq P}} \|x^\alpha f_0\|_{H_P^s}^2 < +\infty, \quad \int_0^{+\infty} \langle t \rangle^{2s} \sup_k \left| \widehat{\mathcal{F}}_I(t, k) \right|^2 dt < +\infty, \quad \sup_{t,k} \langle t \rangle^s \left| \widehat{\mathcal{F}}_I(t, k) \right| < +\infty,$$

the equation (2.10a)–(2.10b) admits a local solution continuous in time with respect to the bootstrap's norms, then, under the assumption of Theorem 2.3.7, the bootstrap statement implies that this solution is indeed global in time and satisfies (2.47a)–(2.47e) over  $[0, \infty)$ . We use these estimates to analyze the Landau Damping. In regard to the continuity of the solution with respect to the bootstrap's norms, we refer the reader to Appendix A where we briefly explain how to obtain it.

From this, (2.47e) implies (2.45b): for every  $t \geq 0$ ,  $|\widehat{\varrho}(t, k)| \lesssim \varepsilon \langle k, tk \rangle^{-s_1}$ . For the force term, we shall use the general estimate, for  $\sigma \geq 0$ ,

$$\|\langle \nabla_x \rangle^\sigma F(t, \cdot)\|_{L^\infty(dx)} \leq \int_{\mathbb{R}^d} \langle k \rangle^\sigma |\widehat{F}(t, k)| dk.$$

Next, we apply successively (2.34c) and (2.47e); we obtain

$$\begin{aligned} \|\langle \nabla_x \rangle^\sigma \nabla_x \Phi[\psi](t, \cdot)\|_{L^\infty(dx)} &\leq \int_{\mathbb{R}^d} \langle k \rangle^\sigma |k| |\widehat{\sigma}_1(k)| \left| \widehat{\mathcal{F}}_I(t, k) - \widehat{\sigma}_1(k) \widehat{\mathcal{G}}_\varrho(t, k) \right| dk \\ &\lesssim \int_{\mathbb{R}^d} \langle k, tk \rangle^{-s_1} |k| \varepsilon dk \lesssim \varepsilon \langle t \rangle^{-1} \int_{\mathbb{R}^d} \langle k, tk \rangle^{1-s_1} dk \lesssim \varepsilon \langle t \rangle^{-d-1} \end{aligned}$$

where we used **(A3)** to incorporate  $\langle k \rangle^\sigma$  with  $|\widehat{\sigma}_1(k)|$  and the elementary inequality  $|k| \langle t \rangle \leq \langle k, tk \rangle$ .

It remains to show that the behavior of  $g(t, x, v)$  is driven by free transport. To this end, we are going to define  $g^\infty$  as the solution of

$$\begin{aligned} g^\infty(x, v) &= f_0(x, v) \\ &+ \int_0^{+\infty} \nabla \sigma_1 \star (\mathcal{F}_I(t) - \sigma_1 \star \mathcal{G}_\varrho(t)) (x + tv) \cdot (\nabla_v \mathcal{M}(v) + (\nabla_v - t \nabla_x) g(t, x, v)) dt, \end{aligned}$$

which, indeed, lies in some  $H_P^r$ . From this, we can establish the convergence of  $g$  to  $g^\infty$  in  $H_P^\sigma$ -norm, with  $0 \leq \sigma \leq r = s_1 - d - 2$ . To this aim, we go back to (2.43) and we get

$$\begin{aligned} \langle k, \xi \rangle^\sigma D_\xi^\alpha \widehat{g}(t, k, \xi) &= \langle k, \xi \rangle^\sigma D_\xi^\alpha \widehat{f}_0(k, \xi) \\ &- \int_0^t \underbrace{\langle k, \xi \rangle^\sigma k \widehat{\sigma}_1(k) \left( \widehat{\mathcal{F}}_I(\tau, k) - \widehat{\sigma}_1(k) \widehat{\mathcal{G}}_\varrho(\tau, k) \right) \cdot D_\xi^\alpha (\xi - \tau k) \widehat{\mathcal{M}}(\xi - \tau k)}_{L(\tau, k, \xi)} d\tau \\ &- \int_0^t \underbrace{\int_{\mathbb{R}_n^d} \langle k, \xi \rangle^\sigma n \widehat{\sigma}_1(n) \left( \widehat{\mathcal{F}}_I(\tau, n) - \widehat{\sigma}_n \widehat{\mathcal{G}}_\varrho(\tau, n) \right) \cdot D_\xi^\alpha (\xi - tk) \widehat{g}(\tau, k - n, \xi - \tau n)}_{NL(\tau, k, \xi)} dn d\tau. \end{aligned}$$

For the linear term, we combine (2.34c), (2.47e), together with the elementary inequalities  $\langle k, \xi \rangle^{2\sigma} \lesssim \langle k, \tau k \rangle^{2\sigma} \langle \xi - \tau k \rangle^{2\sigma}$  and  $|k| \langle \tau \rangle \leq \langle k, \tau k \rangle$ ; we are led to

$$\begin{aligned} \|L(\tau)\|_{L^2_{(k, \xi)}}^2 &\lesssim \int_{\mathbb{R}_{k, \xi}^{2d}} \langle k, \tau k \rangle^{2\sigma} |k|^2 |\widehat{\sigma}_1(k)|^2 \left| \widehat{\mathcal{F}}_I(\tau, k) - \widehat{\sigma}_1(k) \widehat{\mathcal{G}}_\varrho(\tau, k) \right|^2 \\ &\quad \times \langle \xi - \tau k \rangle^{2\sigma} \left| D_\xi^\alpha (\xi - \tau k) \widehat{\mathcal{M}}(\xi - \tau k) \right|^2 dk d\xi \\ &\lesssim \left( \int_{\mathbb{R}_k^d} \langle k, \tau k \rangle^{2\sigma} |k|^2 \langle k, \tau k \rangle^{-2s_1} \varepsilon^2 dk \right) \left( \int_{\mathbb{R}_\xi^d} \langle \xi \rangle^{2\sigma} \left| \widehat{\nabla_v \mathcal{M}}(\xi) \right|^2 d\xi \right) \\ &\lesssim \varepsilon^2 \langle \tau \rangle^{-2} \int_{\mathbb{R}_k^d} \langle k, \tau k \rangle^{2\sigma+2-2s_1} dk \lesssim \varepsilon^2 \langle \tau \rangle^{-d-2}, \end{aligned}$$

where we used the assumption  $\mathcal{M} \in H_P^{\tilde{s}}$  with  $\tilde{s} > \sigma$ ; the last estimate holds provided  $2\sigma + 2 - 2s_1 < -d$ , that is  $\sigma < s_1 - d/2 - 1$ . For the non linear term, the Cauchy-Schwarz

inequality, with  $\langle k, \xi \rangle \leq \langle n, \tau n \rangle \langle k - n, \xi - \tau n \rangle$ , yields

$$\begin{aligned} & \int_{\mathbb{R}_n^d} \langle k, \xi \rangle^\sigma |n| |\widehat{\sigma}_1(n)| \left| \widehat{\mathcal{F}}_I(\tau, n) - \widehat{\sigma}_1(n) \widehat{\mathcal{G}}_\rho(\tau, n) \right| \left| D_\xi^\alpha \widehat{\nabla}_v g(\tau, k - n, \xi - \tau n) \right| dn \\ & \leq \left( \int_{\mathbb{R}_n^d} \frac{\langle n, \tau n \rangle^\sigma}{|k - n|^{2\delta}} |n| |\widehat{\sigma}_1(n)| \left| \widehat{\mathcal{F}}_I(\tau, n) - \widehat{\sigma}_1(n) \widehat{\mathcal{G}}_\rho(\tau, n) \right| dn \right)^{1/2} \\ & \quad \times \left( \int_{\mathbb{R}_n^d} \langle n, \tau n \rangle^\sigma |n| |\widehat{\sigma}_1(n)| \left| \widehat{\mathcal{F}}_I(\tau, n) - \widehat{\sigma}_1(n) \widehat{\mathcal{G}}_\rho(\tau, n) \right| \right. \\ & \quad \left. \times |k - n|^{2\delta} \langle k - n, \xi - \tau n \rangle^{2\sigma} \left| D_\xi^\alpha \widehat{\nabla}_v g(\tau, k - n, \xi - \tau n) \right|^2 dn \right)^{1/2}. \end{aligned}$$

Next, combining (2.34c), (2.47e), (2.47c) and  $|n| \langle \tau \rangle \leq \langle n, \tau n \rangle$ , leads to

$$\begin{aligned} & \|\text{NL}(\tau)\|_{L_{(k,\xi)}^2}^2 \\ & \lesssim \int_{\mathbb{R}_{k,\xi}^{2d}} \left( \int_{\mathbb{R}_n^d} \frac{\langle n, \tau n \rangle^\sigma}{|k - n|^{2\delta}} |n| |\widehat{\sigma}_1(n)| \left| \widehat{\mathcal{F}}_I(\tau, n) - \widehat{\sigma}_1(n) \widehat{\mathcal{G}}_\rho(\tau, n) \right| dn \right) \\ & \quad \times \left( \int_{\mathbb{R}_n^d} \langle n, \tau n \rangle^\sigma |n| |\widehat{\sigma}_1(n)| \left| \widehat{\mathcal{F}}_I(\tau, n) - \widehat{\sigma}_1(n) \widehat{\mathcal{G}}_\rho(\tau, n) \right| \right. \\ & \quad \left. \times |k - n|^{2\delta} \langle k - n, \xi - \tau n \rangle^{2\sigma} \left| D_\xi^\alpha \widehat{\nabla}_v g(t)(k - n, \xi - \tau n) \right|^2 dn \right) dk d\xi \\ & \lesssim \left( \sup_{k \in \mathbb{R}^d} \int_{\mathbb{R}_n^d} \frac{\langle n, \tau n \rangle^\sigma}{|k - n|^{2\delta}} |n| |\widehat{\sigma}_1(n)| \left| \widehat{\mathcal{F}}_I(\tau, n) - \widehat{\sigma}_1(n) \widehat{\mathcal{G}}_\rho(\tau, n) \right| dn \right) \\ & \quad \times \left( \int_{\mathbb{R}_n^d} \langle n, \tau n \rangle^\sigma |n| |\widehat{\sigma}_1(n)| \left| \widehat{\mathcal{F}}_I(\tau, n) - \widehat{\sigma}_1(n) \widehat{\mathcal{G}}_\rho(\tau, n) \right| dn \right) \left\| |\nabla_x|^\delta \nabla_v g(\tau) \right\|_{H_P^\sigma}^2 \\ & \lesssim \left( \sup_{k \in \mathbb{R}^d} \int_{\mathbb{R}_n^d} \frac{\langle n, \tau n \rangle^\sigma}{|k - n|^{2\delta}} |n| \langle n, \tau n \rangle^{-s_1} \varepsilon dn \right) \\ & \quad \times \left( \int_{\mathbb{R}_n^d} \langle n, \tau n \rangle^\sigma |n| \langle n, \tau n \rangle^{-s_1} \varepsilon dn \right) \left\| |\nabla_x|^\delta g(\tau) \right\|_{H_P^{s_3}}^2 \\ & \lesssim \varepsilon^4 \langle \tau \rangle^{-2} \left( \sup_{k \in \mathbb{R}^d} \int_{\mathbb{R}_n^d} \frac{\langle n, \tau n \rangle^{\sigma+1-s_1}}{|k - n|^{2\delta}} dn \right) \left( \int_{\mathbb{R}_n^d} \langle n, \tau n \rangle^{\sigma+1-s_1} dn \right) \end{aligned}$$

where we have used the condition  $s_3 \geq \sigma + 1$ . Remarking that  $\langle n, \tau n \rangle^2 = 1 + \langle \tau \rangle^2 |n|^2 = \langle \langle \tau \rangle n \rangle^2$ , a simple change of variable yields

$$\int_{\mathbb{R}_n^d} \langle n, \tau n \rangle^{\sigma+1-s_1} dn = \langle \tau \rangle^{-d} \int_{\mathbb{R}_n^d} \langle n \rangle^{\sigma+1-s_1} dn \lesssim \langle \tau \rangle^{-d}$$

provided  $\sigma + 1 - s_1 < -d$ , that is  $\sigma < s_1 - d - 1$ . Proceeding with the same change of variable, since  $\delta < d$  we obtain, for any  $k \in \mathbb{R}^d$ ,

$$\begin{aligned} & \int_{\mathbb{R}_n^d} \frac{\langle n, \tau n \rangle^{\sigma+1-s_1}}{|k - n|^{2\delta}} dn = \langle \tau \rangle^{-d+2\delta} \int_{\mathbb{R}_n^d} \frac{\langle n \rangle^{\sigma+1-s_1}}{|\langle \tau \rangle k - n|^{2\delta}} dn \\ & = \langle \tau \rangle^{-d+2\delta} \left( \int_{B(\langle \tau \rangle k, 1)} + \int_{\mathbb{C}B(\langle \tau \rangle k, 1)} \frac{\langle n \rangle^{\sigma+1-s_1}}{|\langle \tau \rangle k - n|^{2\delta}} dn \right) \\ & \leq \langle \tau \rangle^{-d+2\delta} \left( \int_{B(0,1)} \frac{1}{|n|^{2\delta}} dn + \int_{\mathbb{R}_n^d} \langle n, \tau n \rangle^{\sigma+1-s_1} dn \right) \lesssim \langle \tau \rangle^{-d+2\delta}. \end{aligned}$$



which is indeed a uniform estimate with respect to  $k$ . Eventually, we arrive at

$$\|\text{NL}(\tau)\|_{L^2_{(k,\varepsilon)}}^2 \lesssim \varepsilon^4 \langle \tau \rangle^{-2d-2+2\delta}.$$

The conclusion is two-fold: on the one hand, the definition of  $g^\infty$  is meaningful, and it gives an element of  $H^{\sigma}_p$  for any  $0 \leq \sigma \leq r = s_1 - d - 2$ ; on the other hand, for any  $\sigma \in [0, s_1 - d - 1)$ , we have

$$\begin{aligned} \|g(t) - g^\infty\|_{H^{\sigma}_p}^2 &\lesssim \varepsilon^2 \int_t^{+\infty} \langle \tau \rangle^{-d-2} d\tau + \varepsilon^4 \int_t^{+\infty} \langle \tau \rangle^{-2d-2+2\delta} d\tau \lesssim \varepsilon^2 \langle t \rangle^{-d-1+} + \varepsilon^4 \langle t \rangle^{-2d-1+2\delta+}. \end{aligned}$$

This ends the proof.  $\blacksquare$

The bootstrap argument in itself is adapted from [13] by taking advantage of the analogies with the Vlasov equation. There are two main differences that require some care: the additional term  $\mathcal{F}_I(t)$  should be controlled with the bootstrap norms and all quantities where  $\|\varrho(t)\|$  arises in [13] should be controlled here by  $\|\mathcal{G}_\varrho\|$ . Both  $\|\mathcal{F}_I(t)\|$  and the estimates of  $\|\mathcal{G}_\varrho\|$  by  $\|\varrho(t)\|$  should be evaluated by using the norms involved in Proposition 2.3.9. These issues are the motivation for Proposition 2.3.1 and Proposition 2.3.3. For instance, let us detail this strategy for the estimate of  $A_{s_4} \widehat{\varrho}$  in the  $L^2_{(k)} L^2_{(t)}$  norm. The other estimates proceed similarly, by combining the arguments of [13] to Propositions 2.3.1 and 2.3.3. They are performed in details in Appendix A.

### 2.3.3 Estimate of the $L^2_{(k)} L^2_{(t)}$ norm of $A_{s_4} \widehat{\varrho}$ .

The estimate of  $A_{s_4} \widehat{\varrho}$  is a consequence of the following two claims, for which we refer the reader to [13, Section 2.3 and 3]. The former is a version of Lemma 2.2.1 adapted to the norms of the bootstrap.

**Proposition 2.3.12 (Linearized damping on  $\mathbb{R}^d$ )** *Let the assumptions of Theorem 2.3.7 be fulfilled. We consider a family of functions  $\{t \in [0, T] \mapsto a(t, k), k \in \mathbb{R}^d\}$ . We suppose that, for any  $k \in \mathbb{R}^d$ ,*

$$\int_0^T |k| \langle k, tk \rangle^{2s} |a(t, k)|^2 dt < +\infty,$$

*holds. Then, we can find a constant  $C_{LD}$  (which does not depend on  $k$  and  $T$ ) such that any solution  $(t, k) \mapsto \phi(t, k)$  of the system*

$$\begin{aligned} \phi(t, k) &= a(t, k) + \int_0^t \mathcal{K}(t - \tau, k) \phi(\tau, k) d\tau \\ &= a(t, k) + \int_0^t |\widehat{\sigma}_1(k)|^2 |k|^2 (t - \tau) \cdot \widehat{\mathcal{M}}([t - \tau]k) \left( \int_0^\tau p_c(\tau - \sigma) \phi(\sigma, k) d\sigma \right) d\tau, \end{aligned}$$

*on  $[0, T]$  satisfies the following estimate: for any  $k \in \mathbb{R}^d$*

$$\int_0^T |k| \langle k, tk \rangle^{2s} |\phi(t, k)|^2 dt \leq C_{LD} \int_0^T |k| \langle k, tk \rangle^{2s} |a(t, k)|^2 dt.$$

The second estimate is concerned with the time-response kernel

$$\bar{K}(t, \tau, k, n) = \frac{|k|^{1/2} |n|^{1/2} |k(t - \tau)|}{\langle n \rangle^2} |\widehat{g}(t, k - n, tk - \tau n)|.$$

which is a crucial quantity for the analysis of the echo phenomena. It leads to the constraint on  $s_1$  involved in Proposition 2.3.9. Technically, this statement is substantially different when  $\mathbb{X}^d = \mathbb{T}^d$  or when  $\mathbb{X}^d = \mathbb{R}^d$ . In the torus, the proof needs analytic regularity but is free of constraint on the space dimension  $d$  (see [12, Section 6]). For the free space problem, the argument relies on dispersion mechanisms of the transport operator which are strong enough only when  $d \geq 2$ ; in this situation it is thus possible to work in finite regularity.

**Proposition 2.3.13** *Let  $0 < T < \infty$ . Let  $s_1 > 2(d + 1) + 1$ . The following two estimates hold*

$$\sup_{t \in [0, T]} \sup_{k \in \mathbb{R}^d} \int_0^t \int_{\mathbb{R}^d} \bar{K}(t, \tau, k, n) \, dn \, d\tau \lesssim \sup_{\tau \in [0, T]} \sup_{k, \xi \in \mathbb{R}^d} \langle k, \xi \rangle^{s_1} |\widehat{g}(\tau, k, \xi)|$$

and

$$\sup_{\tau \in [0, T]} \sup_{n \in \mathbb{R}^d} \int_\tau^T \int_{\mathbb{R}^d} \bar{K}(t, \tau, k, n) \, dk \, dt \lesssim \sup_{\tau \in [0, T]} \sup_{k, \xi \in \mathbb{R}^d} \langle k, \xi \rangle^{s_1} |\widehat{g}(\tau, k, \xi)|.$$

**Remark 2.3.14** *The factor  $1/\langle n \rangle^2$  in the kernel  $\bar{K}$  comes from the convolution kernel used in [13]. Here, since  $\sigma_1$  is Schwartz class, this factor can be replaced by  $1/\langle n \rangle^m$  with  $m \in \mathbb{N}$  as large as we wish.*

We follow closely the arguments of [13], up to the perturbation due to  $\mathcal{F}_I$  and  $\mathcal{G}_g$ ; as pointed out above, these perturbations do not substantially modify the analysis, owing to Proposition 2.3.1 and Proposition 2.3.3.

We start from the expression of  $\widehat{\varrho}(t, k)$  in (2.44) and we apply Proposition 2.3.12 in order to estimate the  $L^2_{(t)}$  norm of  $A_{s_i} \widehat{\varrho}$  (with  $i \in \{2, 4\}$ ). We get

$$\begin{aligned} \|A_{s_i} \widehat{\varrho}(\cdot, k)\|_{L^2_{(t)}}^2 &\lesssim \int_0^T |k| \langle k, tk \rangle^{2s_i} |\widehat{f}_0(k, tk)|^2 \, dt \\ &+ \int_0^T \left| \int_0^t |k|^{1/2} \langle k, tk \rangle^{s_4} k \widehat{\sigma}_1(k) \widehat{\mathcal{F}}_I(\tau, k) \cdot [t - \tau] k \widehat{\mathcal{M}}([t - \tau]k) \, d\tau \right|^2 \, dt \\ &+ \int_0^T \left| \int_0^t \int_{\mathbb{R}^d_n} |k|^{1/2} \langle k, tk \rangle^{s_4} n \widehat{\sigma}_1(n) \left( \widehat{\mathcal{F}}_I(\tau, n) - \widehat{\sigma}_1(n) \widehat{\mathcal{G}}_\varrho(\tau, n) \right) \right. \\ &\quad \left. \times [t - \tau] k \widehat{g}(\tau, k - n, tk - \tau n) \, d\tau \, dn \right|^2 \, dt. \end{aligned} \quad (2.48)$$

Integrating (2.48) with respect to  $k$  yields

$$\begin{aligned} \|A_{s_4} \widehat{\varrho}\|_{L^2_{(k)} L^2_{(t)}}^2 &\lesssim \int_{\mathbb{R}^d} \int_0^T |k| \langle k, tk \rangle^{2s_4} |\widehat{f}_0(k, tk)|^2 \, dk \, dt \\ &+ \int_{\mathbb{R}^d} \int_0^t \left| \int_0^t |k|^{1/2} \langle k, tk \rangle^{s_4} k \widehat{\sigma}_1(k) \widehat{\mathcal{F}}_I(\tau, k) \cdot (t - \tau) k \widehat{f}^0([t - \tau]k) \, d\tau \right|^2 \, dk \, dt \\ &+ \int_{\mathbb{R}^d} \int_0^T \left| \int_0^t \int_{\mathbb{R}^d} |k|^{1/2} \langle k, tk \rangle^{s_4} n \widehat{\sigma}_1(n) \left( \widehat{\mathcal{F}}_I(\tau, n) - \widehat{\sigma}_1(n) \widehat{\mathcal{G}}_\varrho(\tau, n) \right) \right. \\ &\quad \left. \times (t - \tau) k \widehat{g}(\tau, k - n, tk - \tau n) \, d\tau \, dn \right|^2 \, dk \, dt. \end{aligned}$$

We denote the three terms in the right hand side as CT1, CT2 and NLT, respectively (for “constant term 1 and 2, non linear term”). In what follows, we are going to split the discussion according to the estimate  $\text{NLT} \lesssim \text{NLTT} + \text{NLTR}$ , where NLTT (for transport) and NLTR (for reaction) stand for the contributions that arise from the following decomposition

$$\langle k, tk \rangle^{s_4} \lesssim \langle k - n, tk - \tau n \rangle^{s_4} + \langle n, \tau n \rangle^{s_4}.$$

**Estimate on CT1 and CT2.** Thanks to the first point of Lemma 2.3.5 we get

$$\text{CT1} \lesssim \sum_{\substack{\alpha \in \mathbb{N}^d \\ |\alpha| \leq P}} \|(x, v) \mapsto x^\alpha f_0(x, v)\|_{H_P^s}^2 \leq \varepsilon^2,$$

while Proposition 2.3.3 implies  $\text{CT2} \lesssim \varepsilon^2$ .

**Estimate on NLTT.** As said above, having Proposition 2.3.1 at hand permits us to readily adapt the arguments of [13]. The Cauchy-Schwarz inequality yields

$$\begin{aligned} \text{NLTT} &\leq \int_{\mathbb{R}^d} \int_0^T \left( \int_0^t \int_{\mathbb{R}^d} \langle \tau \rangle^{5/2} |n| |\widehat{\sigma}_1(n)| |\widehat{\mathcal{F}}_I(\tau, n) - \widehat{\sigma}_1(n) \widehat{\mathcal{G}}_\rho(\tau, n)| \, d\tau \, dn \right) \\ &\quad \times \left( \int_0^t \int_{\mathbb{R}^d} \langle \tau \rangle^{-5/2} |n| |\widehat{\sigma}_1(n)| \left| \widehat{\mathcal{F}}_I(\tau, n) - \widehat{\sigma}_1(n) \widehat{\mathcal{G}}_\rho(\tau, n) \right| |k| \langle k - n, tk - \tau n \rangle^{2s_4} \right. \\ &\quad \left. \times |(t - \tau)k|^2 |\widehat{g}(\tau, k - n, tk - \tau n)|^2 \, d\tau \, dn \right) \, dk \, dt. \end{aligned}$$

Now, (2.34c) and (2.46e) ensure that

$$\langle n, \tau n \rangle^{s_1} |\widehat{\sigma}_1(n)| |\widehat{\mathcal{F}}_I(\tau, n) - \widehat{\sigma}_1(n) \widehat{\mathcal{G}}_\rho(\tau, n)| \lesssim (1 + K_5) \varepsilon.$$

Since  $|n| \langle \tau \rangle \leq \langle n, \tau n \rangle$ , we get

$$\begin{aligned} &\int_0^t \int_{\mathbb{R}^d} \langle \tau \rangle^{5/2} |n| |\widehat{\sigma}_1(n)| |\widehat{\mathcal{F}}_I(\tau, n) - \widehat{\sigma}_1(n) \widehat{\mathcal{G}}_\rho(\tau, n)| \, d\tau \, dn \\ &\quad \lesssim \left( \int_0^t \langle \tau \rangle^{5/2} \int_{\mathbb{R}_n^d} |n| \langle n, \tau n \rangle^{-s_1} \, dn \, d\tau \right) (1 + K_5) \varepsilon \\ &\quad \lesssim \left( \int_0^{+\infty} \langle \tau \rangle^{5/2-d-1} \, d\tau \right) (1 + K_5) \varepsilon \lesssim (1 + K_5) \varepsilon \end{aligned}$$

where the last estimate assumes the condition  $5/2 - d - 1 < -1$ , that is  $d > 5/2$ . This is one of the constraints on the space dimension  $d$  which imply that the analysis applies only when  $d \geq 3$ .

Going back to NLTT we are led to (by using  $(|t - \tau)k| \leq \langle \tau(k - n), tk - \tau n \rangle$ )

$$\begin{aligned}
\text{NLTT} &\lesssim (1 + K_5)\varepsilon \int_{\mathbb{R}^d} \int_0^T \left( \int_0^t \int_{\mathbb{R}^d} \langle \tau \rangle^{+5/2} |n| |\widehat{\sigma}_1(n)| \left| \widehat{\mathcal{F}}_I(\tau, n) - \widehat{\sigma}_1(n) \widehat{\mathcal{G}}_\rho(\tau, n) \right| \right. \\
&\quad \left. \times \langle \tau \rangle^{-5} |k| \langle k - n, tk - \tau n \rangle^{2s_4} \langle \tau(k - n), tk - \tau n \rangle^2 |\widehat{g}(\tau, k - n, tk - \tau n)|^2 d\tau dn \right) dk dt \\
&\lesssim (1 + K_5)\varepsilon \int_{\mathbb{R}^d} \int_0^T \langle \tau \rangle^{+5/2} |n| |\widehat{\sigma}_1(n)| \left| \widehat{\mathcal{F}}_I(\tau, n) - \widehat{\sigma}_1(n) \widehat{\mathcal{G}}_\rho(\tau, n) \right| \\
&\quad \times \left( \int_\tau^T \int_{\mathbb{R}^d} \langle \tau \rangle^{-5} |k| \langle k - n, tk - \tau n \rangle^{2s_4} \langle \tau(k - n), tk - \tau n \rangle^2 \right. \\
&\quad \left. \times |\widehat{g}(\tau, k - n, tk - \tau n)|^2 dt dk \right) dn d\tau \\
&\lesssim (1 + K_5)\varepsilon \left( \int_{\mathbb{R}^d} \int_0^T \langle \tau \rangle^{+5/2} |n| |\widehat{\sigma}_1(n)| \left| \widehat{\mathcal{F}}_I(\tau, n) - \widehat{\sigma}_1(n) \widehat{\mathcal{G}}_\rho(\tau, n) \right| dn d\tau \right) \\
&\quad \times \left( \sup_{0 \leq \tau \leq T} \sup_{n \in \mathbb{R}^d} \langle \tau \rangle^{-5} \int_{\mathbb{R}^d} \int_{-\infty}^{+\infty} \langle k - n, tk - \tau n \rangle^{2s_4} \langle \tau(k - n), tk - \tau n \rangle^2 \right. \\
&\quad \left. \times |\widehat{g}(\tau, k - n, tk - \tau n)|^2 |k| dt dk \right) \\
&\lesssim (1 + K_5)^2 \varepsilon^2 \left( \sup_{0 \leq \tau \leq T} \sup_{n \in \mathbb{R}^d} \langle \tau \rangle^{-5} \int_{\mathbb{R}^d} |k| \int_{-\infty}^{+\infty} |\langle \tau(k - n), tk - \tau n \rangle \langle k - n, tk - \tau n \rangle^{s_4} \right. \\
&\quad \left. \times \widehat{g}(\tau, k - n, tk - \tau n)|^2 dt dk \right).
\end{aligned}$$

With two changes of variables and by applying the Trace Lemma 2.3.4, we obtain

$$\begin{aligned}
&\int_{\mathbb{R}^d} |k| \int_{-\infty}^{+\infty} |\langle \tau(k - n), tk - \tau n \rangle \langle k - n, tk - \tau n \rangle^{s_4} \widehat{g}(\tau, k - n, tk - \tau n)|^2 dt dk \\
&= \int_{\mathbb{R}^d} \int_{-\infty}^{+\infty} \left| \langle \tau(k - n), t \frac{k}{|k|} - \tau n \rangle \langle k - n, t \frac{k}{|k|} - \tau n \rangle^{s_4} \widehat{g}(\tau, k - n, tk - \tau n) \right|^2 dt dk \\
&\leq \sup_{\omega \in \mathbb{S}^{d-1}} \sup_{x \in \mathbb{R}^d} \int_{\mathbb{R}^d} \int_{-\infty}^{+\infty} |\langle \tau(k - n), t\omega + x \rangle \langle k - n, t\omega + x \rangle^{s_4} \widehat{g}(\tau, k - n, t\omega + x)|^2 dt dk \\
&\leq \sup_{\omega \in \mathbb{S}^{d-1}} \sup_{x \in \mathbb{R}^d} \int_{\mathbb{R}^d} \int_{-\infty}^{+\infty} |\langle \tau k, t\omega + x \rangle \langle k, t\omega + x \rangle^{s_4} \widehat{g}(\tau, k - n, t\omega + x)|^2 dt dk \\
&\lesssim \|\langle \tau \nabla_x, \nabla_v \rangle g(\tau)\|_{H_P^{s_4}}^2.
\end{aligned}$$

Finally, combining this with (2.46a) we obtain

$$\text{NLTT} \lesssim (1 + K_5)^2 K_1 \varepsilon^4.$$

**Estimate on NLTR.** We make the time-response kernel  $\bar{K}$  appear:

$$\begin{aligned}
\text{NLTR} &= \int_{\mathbb{R}^d} \int_0^T \left( \int_0^t \int_{\mathbb{R}^d} \bar{K}(t, \tau, k, n) \langle n, \tau n \rangle^{s_4} |n|^{1/2} \langle n \rangle^2 |\widehat{\sigma}_1(n)| \right. \\
&\quad \left. \times \left| \widehat{\mathcal{F}}_I(\tau, n) - \widehat{\sigma}_1(n) \widehat{\mathcal{G}}_\rho(\tau, n) \right| d\tau dn \right)^2 dk dt.
\end{aligned}$$

Then, Cauchy-Schwarz' inequality and Fubini's theorem allow us to obtain

$$\begin{aligned}
\text{NLTR} &\lesssim \int_{\mathbb{R}^d} \int_0^T \left( \int_0^t \int_{\mathbb{R}^d} \bar{K}(t, \tau, k, n) \, d\tau \, dn \right) \left( \int_0^t \int_{\mathbb{R}^d} \bar{K}(t, \tau, k, n) \right. \\
&\quad \left. \times \langle n, \tau n \rangle^{2s_4} |n| \langle n \rangle^4 |\hat{\sigma}_1(n)|^2 \left| \widehat{\mathcal{F}}_I(\tau, n) - \hat{\sigma}_1(n) \widehat{\mathcal{G}}_\varrho(\tau, n) \right|^2 \, d\tau \, dn \right) \, dk \, dt \\
&\lesssim \left( \sup_{t \in [0, T]} \sup_{k \in \mathbb{R}^d} \int_0^t \int_{\mathbb{R}^d} \bar{K}(t, \tau, k, n) \, d\tau \, dn \right) \int_0^T \int_{\mathbb{R}^d} \left( \int_\tau^T \int_{\mathbb{R}^d} \bar{K}(t, \tau, k, n) \, dt \, dk \right) \\
&\quad \times \langle n, \tau n \rangle^{2s_4} |n| \langle n \rangle^4 |\hat{\sigma}_1(n)|^2 \left| \widehat{\mathcal{F}}_I(\tau, n) - \hat{\sigma}_1(n) \widehat{\mathcal{G}}_\varrho(\tau, n) \right|^2 \, d\tau \, dn \\
&\lesssim \left( \sup_{t \in [0, T]} \sup_{k \in \mathbb{R}^d} \int_0^t \int_{\mathbb{R}^d} \bar{K}(t, \tau, k, n) \, d\tau \, dn \right) \left( \sup_{\tau \in [0, T]} \sup_{n \in \mathbb{R}^d} \int_\tau^T \int_{\mathbb{R}^d} \bar{K}(t, \tau, k, n) \, dt \, dk \right) \\
&\quad \times \int_0^T \int_{\mathbb{R}^d} \langle n, \tau n \rangle^{2s_4} |n| \langle n \rangle^4 |\hat{\sigma}_1(n)|^2 \left| \widehat{\mathcal{F}}_I(\tau, n) - \hat{\sigma}_1(n) \widehat{\mathcal{G}}_\varrho(\tau, n) \right|^2 \, d\tau \, dn.
\end{aligned}$$

By using (2.34a) and (2.46b), we obtain

$$\int_0^T \int_{\mathbb{R}^d} \langle n, \tau n \rangle^{2s_4} |n| \langle n \rangle^4 |\hat{\sigma}_1(n)|^2 \left| \widehat{\mathcal{F}}_I(\tau, n) - \hat{\sigma}_1(n) \widehat{\mathcal{G}}_\varrho(\tau, n) \right|^2 \, d\tau \, dn \lesssim (1 + K_2) \varepsilon^2.$$

Gathering this with Lemma 2.3.13 and (2.46e), we are led to

$$\text{NLTR} \lesssim (1 + K_2) K_5^2 \varepsilon^4.$$

**Recap.** We have shown that, if  $g$  is a solution of (2.10a)–(2.10b) satisfying (2.46a)–(2.46e) on  $[0, T]$ , then

$$\|A_{s_4} \widehat{\varrho}\|_{L^2_{(k)} L^2_{(t)}}^2 \lesssim \left( 1 + (1 + K_5)^2 K_1 \varepsilon^2 + (1 + K_2) K_5^2 \varepsilon^2 \right) \varepsilon^2.$$

Let us denote  $C_1$  the constant hidden in the symbol  $\lesssim$  of this estimate. Choosing  $K_2 \geq C_1$  and  $\varepsilon \ll 1$  so that

$$(1 + K_5)^2 K_1 \varepsilon^2 + (1 + K_2) K_5^2 \varepsilon^2 \leq 1$$

allows us to conclude that (2.47b) holds.

## 2.4 Non linear Landau damping: periodic framework

The dispersive effect which has been used for proving the Landau damping on  $\mathbb{R}^d$  does not exist on the torus. For this reason, in order to control the echoes, we shall work in the (sub-)analytic framework, following [12]. For the Vlasov-Poisson problem, the analysis of [10] is a hint that this regularity could be necessary. As a counterpart of this regularity, there is no restriction on the space dimension  $d$ .

The proof still relies on a bootstrap argument, see [12]. There are two main arguments, like on  $\mathbb{R}^d$ , in order to adapt the proof of [12] to the context of the Vlasov-Wave system: firstly, the force term  $\nabla \sigma_1 \star (\mathcal{F}_I(t) - \sigma_1 \star \mathcal{G}_\varrho(t))$  can be controlled, in suitable norms, by the macroscopic density  $\varrho(t)$ , and, secondly, the contribution associated to the initial data  $\int_0^t \nabla \sigma_1 \star \mathcal{F}_I(\tau, x + \tau v) \cdot \nabla_v \mathcal{M}(v) \, d\tau$  does not perturb too much the bootstrap property (here, we refer the reader to the remarks made when analyzing the whole space problem).

### 2.4.1 Functional framework

We start by introducing several Gevrey norms. Let  $g : (0, \infty)_t \times \mathbb{T}_x^d \times \mathbb{R}_v^d \rightarrow \mathbb{R}$ . The Gevrey norm  $\|\cdot\|_{\mathcal{G}^{\lambda,\sigma;s}}$  is defined by

$$\|g(t)\|_{\mathcal{G}^{\lambda,\sigma;s}}^2 = \sum_{k \in \mathbb{Z}^d} \int_{\mathbb{R}_\xi^d} \langle k, \xi \rangle^{2\sigma} e^{2\lambda \langle k, \xi \rangle^s} |\widehat{g}(t, k, \xi)|^2 d\xi$$

and we also need the Gevrey norm  $\|\cdot\|_{\mathcal{F}^{\lambda,\sigma;s}}$  given by

$$\|g(t)\|_{\mathcal{F}^{\lambda,\sigma;s}}^2 = \sum_{k \in \mathbb{Z}^d} \langle k, tk \rangle^{2\sigma} e^{2\lambda \langle k, tk \rangle^s} |\widehat{g}(t, k, tk)|^2.$$

Let  $\varrho : \mathbb{R}_t \times \mathbb{T}_x^d \rightarrow \mathbb{R}$ . The Gevrey norm  $\|\cdot\|_{\mathcal{F}^{\lambda,\sigma;s}}$  reads

$$\|\varrho(t)\|_{\mathcal{F}^{\lambda,\sigma;s}}^2 = \sum_{k \in \mathbb{Z}^d} \langle k, tk \rangle^{2\sigma} e^{2\lambda \langle k, tk \rangle^s} |\widehat{\varrho}(t, k)|^2.$$

In what follows, we always assume  $\lambda, \sigma \geq 0$  and  $0 < s \leq 1$ .

As a warm-up, we observe that, with  $g(t, x, v) = f(t, x+tv, v)$  and  $\varrho(t, x) = \int f(t, x, v) dv$ , we have

$$\|\varrho(t)\|_{\mathcal{F}^{\lambda,\sigma;s}} = \|g(t)\|_{\mathcal{F}^{\lambda,\sigma;s}}.$$

Moreover, assuming  $\sigma > d/2$  we have a  $\sigma$ -ring property: with  $h(t, x, v) = \varrho(t, x+tv)g(t, x, v)$ , we have

$$\|h(t)\|_{\mathcal{G}^{\lambda,\sigma;s}} \lesssim \|\varrho(t)\|_{\mathcal{F}^{\lambda,\sigma;s}} \|g(t)\|_{\mathcal{G}^{\lambda,\sigma;s}}.$$

Finally, we shall also need the following Gevrey norm: for  $P \in \mathbb{N}$ , we define the norm  $\|\cdot\|_{\mathcal{G}_P^{\lambda,\sigma;s}}$  of a function  $(t, x, v) \mapsto g(t, x, v)$  by

$$\begin{aligned} \|g(t)\|_{\mathcal{G}_P^{\lambda,\sigma;s}}^2 &= \sum_{\substack{\alpha \in \mathbb{N}^d \\ |\alpha| \leq P}} \|(x, v) \mapsto v^\alpha g(t, x, v)\|_{\mathcal{G}^{\lambda,\sigma;s}}^2 \\ &= \sum_{\substack{\alpha \in \mathbb{N}^d \\ |\alpha| \leq P}} \sum_{k \in \mathbb{Z}^d} \int_{\mathbb{R}_\xi^d} \langle k, \xi \rangle^{2\sigma} e^{2\lambda \langle k, \xi \rangle^s} \left| D_\xi^\alpha \widehat{g}(t, k, \xi) \right|^2 d\xi. \end{aligned}$$

The  $\sigma$ -ring estimate equally applies to this norm. Note that the weight in the exponential is  $\langle k, \xi \rangle$ , instead of  $|k, \xi|$ ; this is useful to establish the following embedding property.

**Proposition 2.4.1** *Let  $\lambda > 0$ ,  $0 < s \leq 1$  and  $P \in \mathbb{N}$ .*

*i) ( $\sigma$ -ring estimate) Let  $\sigma > d/2$ , and set  $h(t, x, v) = \varrho(t, x+tv)g(t, x, v)$ . Then, we have*

$$\|h(t)\|_{\mathcal{G}_P^{\lambda,\sigma;s}} \lesssim \|\varrho(t)\|_{\mathcal{F}^{\lambda,\sigma;s}} \|g(t)\|_{\mathcal{G}_P^{\lambda,\sigma;s}}. \quad (2.49)$$

*ii) (embedding) Let  $\sigma \geq 0$ , and suppose  $P > d/2$ . Then, there exists  $C > 0$  such that for any  $(t, x, v) \mapsto g(t, x, v) \in \mathcal{G}_P^{\lambda,\sigma;s}$ , we have*

$$\|g(t)\|_{\mathcal{F}^{\lambda,\sigma;s}} \leq C \|g(t)\|_{\mathcal{G}_P^{\lambda,\sigma;s}} \quad (2.50)$$

**Proof.** Let  $\alpha \in \mathbb{N}^d$ . We remark that

$$\langle k, \xi \rangle^\sigma e^{\lambda \langle k, \xi \rangle} \lesssim (\langle n, tn \rangle^\sigma + \langle k - n, \xi - tn \rangle^\sigma) e^{\lambda \langle n, tn \rangle} e^{\lambda \langle k - n, \xi - tn \rangle}.$$

Then, by using the Cauchy-Schwarz inequality, we get

$$\begin{aligned} & \| (t, x, v) \mapsto v^\alpha \varrho(t, x + tv) g(t, x, v) \|_{\mathcal{G}_P^{\lambda, \sigma; s}}^2 \\ &= \sum_{k \in \mathbb{Z}^d} \int_{\mathbb{R}_\xi^d} \left| \sum_{n \in \mathbb{Z}^d} \langle k, \xi \rangle^\sigma e^{\lambda \langle k, \xi \rangle} \widehat{\varrho}(t, n) D_\xi^\alpha \widehat{g}(t, k - n, \xi - tn) \right|^2 d\xi \\ &= \sum_{k \in \mathbb{Z}^d} \int_{\mathbb{R}_\xi^d} \left| \sum_{n \in \mathbb{Z}^d} \langle n, tn \rangle^\sigma e^{\lambda \langle n, tn \rangle} \widehat{\varrho}(t, n) e^{\lambda \langle k - n, \xi - tn \rangle} D_\xi^\alpha \widehat{g}(t, k - n, \xi - tn) \right|^2 d\xi \\ &\quad + \sum_{k \in \mathbb{Z}^d} \int_{\mathbb{R}_\xi^d} \left| \sum_{n \in \mathbb{Z}^d} e^{\lambda \langle n, tn \rangle} \widehat{\varrho}(t, n) \langle k - n, \xi - tn \rangle^\sigma e^{\lambda \langle k - n, \xi - tn \rangle} D_\xi^\alpha \widehat{g}(t, k - n, \xi - tn) \right|^2 d\xi \\ &\lesssim \sum_{k \in \mathbb{Z}^d} \int_{\mathbb{R}_\xi^d} \left( \sum_{n \in \mathbb{Z}^d} \langle k - n \rangle^{-2\sigma} \langle n, tn \rangle^{2\sigma} e^{2\lambda \langle n, tn \rangle} |\widehat{\varrho}(t, n)|^2 \right) \\ &\quad \times \left( \sum_{n \in \mathbb{Z}^d} \langle k - n, \xi - tn \rangle^{2\sigma} e^{2\lambda \langle k - n, \xi - tn \rangle} \left| D_\xi^\alpha \widehat{g}(t, k - n, \xi - tn) \right|^2 \right) d\xi \\ &\quad + \sum_{k \in \mathbb{Z}^d} \int_{\mathbb{R}_\xi^d} \left( \sum_{n \in \mathbb{Z}^d} \langle n, tn \rangle^{2\sigma} e^{2\lambda \langle n, tn \rangle} |\widehat{\varrho}(t, n)|^2 \right) \\ &\quad \times \left( \sum_{n \in \mathbb{Z}^d} \langle n \rangle^{-2\sigma} \langle k - n, \xi - tn \rangle^{2\sigma} e^{2\lambda \langle k - n, \xi - tn \rangle} \left| D_\xi^\alpha \widehat{g}(t, k - n, \xi - tn) \right|^2 \right) d\xi. \end{aligned}$$

We conclude that i) holds since the condition  $\sigma > d/2$  implies that the series  $\sum_k \langle k - n \rangle^{-2\sigma}$  and  $\sum_n \langle n \rangle^{-2\sigma}$  are finite.

We turn to the proof of ii). For  $0 < s \leq 1$ , we get

$$\sum_{\substack{\alpha \in \mathbb{N}^d \\ |\alpha| \leq P}} \sum_{k \in \mathbb{Z}^d} \int_{\mathbb{R}_\xi^d} \left| D_\xi^\alpha (\xi \mapsto \langle k, \xi \rangle^\sigma e^{\lambda \langle k, \xi \rangle} \widehat{g}(t, k, \xi)) \right|^2 d\xi \lesssim \|g(t)\|_{\mathcal{G}_P^{\lambda, \sigma; s}}^2. \quad (2.51)$$

Indeed, since  $|\partial_{\xi_i} \langle k, \xi \rangle| = |\xi_i / \langle k, \xi \rangle| \leq 1$ , we have

$$\left| \partial_{\xi_i} [\xi \mapsto \langle k, \xi \rangle^\sigma e^{\lambda \langle k, \xi \rangle} \widehat{g}(t, k, \xi)] \right| \lesssim \langle k, \xi \rangle^\sigma e^{\lambda \langle k, \xi \rangle} |\widehat{g}(t, k, \xi)| + \langle k, \xi \rangle^\sigma e^{\lambda \langle k, \xi \rangle} |\partial_{\xi_i} \widehat{g}(t, k, \xi)|.$$

Repeating the argument, we establish that, for any multi-index  $\alpha$ ,

$$\left| D_\xi^\alpha [\xi \mapsto \langle k, \xi \rangle^\sigma e^{\lambda \langle k, \xi \rangle} \widehat{g}(t, k, \xi)] \right| \lesssim \sum_{j \leq \alpha} \langle k, \xi \rangle^\sigma e^{\lambda \langle k, \xi \rangle} |D_\xi^j \widehat{g}(t, k, \xi)|.$$

Going back to (2.51) shows that,  $g(t)$  being an element of  $\mathcal{G}_P^{\lambda, \sigma; s}$ , for any  $k \in \mathbb{Z}^d$ , we have

$$\sum_{\substack{\alpha \in \mathbb{N}^d \\ |\alpha| \leq P}} \int_{\mathbb{R}_\xi^d} \left| D_\xi^\alpha (\xi \mapsto \langle k, \xi \rangle^\sigma e^{\lambda \langle k, \xi \rangle} \widehat{g}(t, k, \xi)) \right|^2 d\xi < +\infty.$$

In other words,  $\xi \mapsto \langle k, \xi \rangle^\sigma e^{\lambda \langle k, \xi \rangle} \widehat{g}(t, k, \xi)$  belongs to  $H^P(\mathbb{R}_\xi^d)$ . Since  $P > d/2$ , Sobolev's embedding applies: this function is continuous, and, for any  $k \in \mathbb{Z}^d$  and  $\xi \in \mathbb{R}^d$ , we get

$$\left| \langle k, \xi \rangle^\sigma e^{\lambda \langle k, \xi \rangle} \widehat{g}(t, k, \xi) \right| \lesssim \left( \sum_{\substack{\alpha \in \mathbb{N}^d \\ |\alpha| \leq P}} \int_{\mathbb{R}_\zeta^d} \left| D_\zeta^\alpha [\zeta \mapsto \langle k, \zeta \rangle^\sigma e^{\lambda \langle k, \zeta \rangle} \widehat{g}(t, k, \zeta)] \right|^2 d\zeta \right)^{1/2}.$$

It follows that

$$\begin{aligned} \|g(t)\|_{\mathcal{F}^{\lambda, \sigma; s}}^2 &= \sum_{k \in \mathbb{Z}^d} \left| \langle k, tk \rangle^\sigma e^{\lambda(k, tk)^s} \widehat{g}(t, k, tk) \right|^2 \\ &\lesssim \sum_{k \in \mathbb{Z}^d} \sum_{\substack{\alpha \in \mathbb{N}^d \\ |\alpha| \leq P}} \int_{\mathbb{R}_\xi^d} \left| D_\xi^\alpha (\xi \mapsto \langle k, \xi \rangle^\sigma e^{\lambda(k, \xi)^s} \widehat{g}(t, k, \xi)) \right|^2 d\xi \lesssim \|g(t)\|_{\mathcal{G}_P^{\lambda, \sigma; s}}^2. \end{aligned}$$

■

From now on, we assume that

$$\sigma > d/2, \quad P > d/2, \quad 0 < s \leq 1.$$

We shall consider the parameter  $\lambda$  as a function of the time variable  $\lambda : t \mapsto \lambda(t) \in (0, \infty)$ , continuous and decreasing. The estimates (2.49) and (2.50) adapt to this context.

In contrast to what we did for the problem on  $\mathbb{R}^d$ , we do not express general conditions on  $\mathcal{F}_I$  and  $p_c$ . Instead, we shall use the same assumptions as in the case of the linearized Landau damping. For the sake of convenience, let us recall them here.

**(K1)**  $n \geq 3$  is odd,

**(K2)**  $\sigma_2 \in C_c^0(\mathbb{R}^n)$  with  $\text{supp}(\sigma_2) \subset B(0, R_2)$ .

**(K3)**  $\text{supp}(\psi_i) \subset \mathbb{T}^d \times B(0, R_I)$ ,  $i = 1, 2$  and

$$\mathcal{E}_I = \iint_{\mathbb{T}^d \times \mathbb{R}^n} \left( |\psi_1(x, z)|^2 + c^2 |\nabla_z \psi_0(x, z)| \right) dx dz < +\infty.$$

**(K4)**  $\sigma_1 : \mathbb{T}^d \rightarrow \mathbb{R}_+$  is radially symmetry and analytic; in particular there exist  $C_1, \lambda_1 > 0$  such that  $|\widehat{\sigma}_1(k)| \leq C_1 \exp(-\lambda_1 |k|)$  holds for any  $k \in \mathbb{Z}^d$ .

Note that assumption **(K5)** on  $\mathcal{M}$  and  $f_0$  will be replaced by  $\mathcal{M} \in \mathcal{G}_P^{\nu_0, 0; 1}$  and  $f_0 \in \mathcal{G}_P^{\nu_0, 0; s}$ .

As a consequence of **(K1)** and **(K2)** the kernel  $p_c$  has a compact support:  $\text{supp}(p_c) \subset [0, 2R_2/c]$ , see Lemma 2.1.3. By virtue of **(K2)** and **(K3)**,  $\mathcal{F}_I$  is compactly supported too:  $\text{supp}(\mathcal{F}_I) \subset [0, (R_I + R_2)/c]$ , as pointed out in the proof of Lemma 2.2.10. In what follows, the following parameters will play an important role

$$2R_2/c, \quad S_0 = (R_I + R_2)/c.$$

The following statement, analog for the torus of Proposition 2.3.1, is a crucial ingredient to justify the bootstrap property.

**Proposition 2.4.2** *Let **(K1)**–**(K4)** be fulfilled. Let  $t \mapsto \lambda(t) > 0$  be a continuous and decreasing function. For any  $\sigma \geq 0$  and  $0 < s \leq 1$ , we get*

$$\begin{aligned} \|\nabla \sigma_1 \star (\mathcal{F}_I(t) - \sigma_1 \star \mathcal{G}_\varrho(t))\|_{\mathcal{F}^{\lambda(t), \sigma; s}}^2 &\lesssim \mathcal{E}_I \mathbf{1}_{0 \leq t \leq S_0} + \int_0^t |p_c(t - \tau)| \|\varrho(\tau)\|_{\mathcal{F}^{\lambda(\tau), \sigma; s}}^2 d\tau, \end{aligned} \quad (2.52)$$

Consequently, the following estimates hold

$$\|\nabla \sigma_1 \star (\mathcal{F}_I(t) - \sigma_1 \star \mathcal{G}_\varrho(t))\|_{\mathcal{F}^{\lambda(t), \sigma; s}}^2 \lesssim \mathcal{E}_I + \int_0^t \|\varrho(\tau)\|_{\mathcal{F}^{\lambda(\tau), \sigma; s}}^2 d\tau, \quad (2.53a)$$

$$\sup_{\tau \in [0, t]} \|\nabla \sigma_1 \star (\mathcal{F}_I(\tau) - \sigma_1 \star \mathcal{G}_\varrho(\tau))\|_{\mathcal{F}^{\lambda(\tau), \sigma; s}}^2 \lesssim \mathcal{E}_I + \sup_{\tau \in [0, t]} \|\varrho(\tau)\|_{\mathcal{F}^{\lambda(\tau), \sigma; s}}^2, \quad (2.53b)$$

$$\int_0^t \|\nabla \sigma_1 \star (\mathcal{F}_I(\tau) - \sigma_1 \star \mathcal{G}_\varrho(\tau))\|_{\mathcal{F}^{\lambda(\tau), \sigma; s}}^2 d\tau \lesssim \mathcal{E}_I + \int_0^t \|\varrho(\tau)\|_{\mathcal{F}^{\lambda(\tau), \sigma; s}}^2 d\tau. \quad (2.53c)$$



**Remark 2.4.3** *The following observations will be useful:*

- i) *In the specific case  $s = 1$  we shall need a further assumption on  $\lambda(0)$ : for this situation, we assume  $\lambda(0) < C(\lambda_1, 2R_2/c, S_0) = \min(\lambda_1/\langle S_0 \rangle, 2\lambda_1/\langle 2R_2/c \rangle)$ .*
- ii) *In contrast to the analysis of the Vlasov-Poisson problem, a control of  $\int \|\varrho\| \, d\tau$  ensures a pointwise control of the force term. This fact, which can be seen as a kind of regularizing effect of the half-time-convolution, simplifies slightly the proof of the bootstrap property.*
- iii) *Like for the whole space problem, the exponential decay of  $\widehat{\sigma}_1(k)$  can be used to absorb any polynomial with respect to  $k$  that arises in the estimates, see Remark 2.3.2.*

**Proof.** We estimate separately the contributions from  $\mathcal{F}_I$  and  $\mathcal{G}_\varrho$ :

$$\|\nabla\sigma_1 \star (\mathcal{F}_I(t) - \sigma_1 \star \mathcal{G}_\varrho(t))\|_{\mathcal{F}^{\lambda(t), \sigma; s}}^2 \lesssim \|\nabla\sigma_1 \star \mathcal{F}_I(t)\|_{\mathcal{F}^{\lambda(t), \sigma; s}}^2 + \|\nabla\Sigma \star \mathcal{G}_\varrho(t)\|_{\mathcal{F}^{\lambda(t), \sigma; s}}^2.$$

For the former, we use  $\text{supp}(\mathcal{F}_I) \subset [0, S_0] \times \mathbb{T}^d$  and the estimate (see the proof of Lemma 2.2.10)

$$|k| |\widehat{\sigma}_1(k)| |\widehat{\mathcal{F}}_I(t, k)| \leq C_1 |k| e^{-\lambda_1 |k|} \|\sigma_2\|_{L^{2n/(n+2)}} \sqrt{\mathcal{E}_I} \mathbf{1}_{0 \leq t \leq S_0}. \quad (2.54)$$

We obtain

$$\begin{aligned} \|\nabla\sigma_1 \star \mathcal{F}_I(t)\|_{\mathcal{F}^{\lambda(t), \sigma; s}}^2 &\lesssim \left( \sum_{k \in \mathbb{Z}^d} \langle k, tk \rangle^{2\sigma} e^{2\lambda(t)\langle k, tk \rangle^s} |k|^2 e^{-2\lambda_1 |k|^2} \right) \mathcal{E}_I \mathbf{1}_{0 \leq t \leq S_0} \\ &\lesssim \left( \sum_{k \in \mathbb{Z}^d} \langle k \rangle^{2\sigma} \langle S_0 \rangle^{2\sigma} e^{2\lambda(0)\langle k \rangle^s \langle S_0 \rangle^s} |k|^2 e^{-2\lambda_1 |k|^2} \right) \mathcal{E}_I \mathbf{1}_{0 \leq t \leq S_0}. \end{aligned}$$

When  $0 < s < 1$  the sum is finite; when  $s = 1$  we should impose the additional condition  $\lambda_1 > \lambda(0)\langle S_0 \rangle$ .

For the latter, we apply the Cauchy-Schwarz inequality, so that

$$\begin{aligned} \|\nabla\Sigma \star \mathcal{G}_\varrho(t)\|_{\mathcal{F}^{\lambda(t), \sigma; s}}^2 &= \sum_{k \in \mathbb{Z}^d} \langle k, tk \rangle^{2\sigma} e^{2\lambda(t)\langle k, tk \rangle^s} |k|^2 |\widehat{\sigma}_1(k)|^4 \left| \int_0^t p_c(t-\tau) \widehat{\varrho}(\tau, k) \, d\tau \right|^2 \\ &\leq \|p_c\|_{L^1} \int_0^t |p_c(t-\tau)| \left( \sum_{k \in \mathbb{Z}^d} \langle k, tk \rangle^{2\sigma} e^{2\lambda(t)\langle k, tk \rangle^s} |k|^2 |\widehat{\sigma}_1(k)|^4 |\widehat{\varrho}(\tau, k)|^2 \right) \, d\tau \\ &= \|p_c\|_{L^1} \int_0^t |p_c(t-\tau)| \left( \sum_{k \in \mathbb{Z}^d} I_k(t, \tau) \langle k, \tau k \rangle^{2\sigma} e^{2\lambda(t)\langle k, \tau k \rangle^s} |\widehat{\varrho}(\tau, k)|^2 \right) \, d\tau. \end{aligned}$$

It follows that

$$I_k(t, \tau) = |k|^2 |\widehat{\sigma}_1(k)|^4 \frac{\langle k, tk \rangle^{2\sigma}}{\langle k, \tau k \rangle^{2\sigma}} e^{2(\lambda(t) - \lambda(\tau))\langle k, tk \rangle^s} e^{\lambda(\tau)(\langle k, tk \rangle^s - \langle k, \tau k \rangle^s)}.$$

Therefore if  $I_k(t, \tau)$  is bounded uniformly with respect to  $k$ ,  $t$  and  $\tau$ , then we get

$$\|\nabla\Sigma \star \mathcal{G}_\varrho(t)\|_{\mathcal{F}^{\lambda(t), \sigma; s}}^2 \lesssim \int_0^t |p_c(t-\tau)| \|\varrho(\tau)\|_{\mathcal{F}^{\lambda(\tau), \sigma; s}}^2 \, d\tau.$$

We are left with the task of justify a uniform bound on  $I_k(t, \tau)$ . To this end, we remember that  $p_c$  has a compact support: we can restrict the time integration to  $0 \leq t - \tau \leq 2R_2/c$ . For  $t \geq \tau$ , a simple analysis of function shows that

$$\sup_{k \in \mathbb{Z}^d} \frac{\langle k, tk \rangle^{2\sigma}}{\langle k, \tau k \rangle^{2\sigma}} \leq \frac{\langle t \rangle^{2\sigma}}{\langle \tau \rangle^{2\sigma}} \leq \langle t - \tau \rangle^{2\sigma} \leq \langle 2R_2/c \rangle^{2\sigma}.$$

Since  $t \mapsto \lambda(t)$  is decreasing, we have  $\exp(2(\lambda(t) - \lambda(\tau))\langle k, tk \rangle^s) \leq 1$ . Finally, with  $0 < s \leq 1$ ,

we have (see [12, Lemma 3.2])

$$|\langle x \rangle^s - \langle y \rangle^s| \leq \langle x - y \rangle^s,$$

so that  $\langle k, tk \rangle^s - \langle k, \tau k \rangle^s \leq \langle (t - \tau)k \rangle^s \leq \langle \frac{2R_2}{c}k \rangle^s$  and  $\exp(2\lambda(\tau)(\langle k, tk \rangle^s - \langle k, \tau k \rangle^s)) \leq \exp(2\lambda(0)\langle \frac{2R_2}{c} \rangle^s \langle k \rangle^s)$ . We conclude with

$$I_k(t, \tau) \leq C_1^4 |k|^2 e^{-4\lambda_1 |k|} \langle 2R_2/c \rangle^{2\sigma} e^{2\lambda(0)\langle \frac{2R_2}{c} \rangle^s \langle k \rangle^s},$$

when  $0 < s < 1$ , while for  $s = 1$  we further assume  $4\lambda_1 > 2\lambda(0)\langle 2R_2/c \rangle$ .  $\blacksquare$

We turn to the estimate of the force term  $\int_0^t \nabla \sigma_1 \star \mathcal{F}_I(\tau, x + \tau v) \cdot \nabla_v \mathcal{M}(v) \, d\tau$  by means of the norms involved in the bootstrap.

**Proposition 2.4.4** *Let (K1)–(K4). Assume that  $\mathcal{M} \in \mathcal{G}_P^{\nu_0, 0; s}$  for some integer  $P > d/2$ . Let  $t \mapsto \lambda(t) > 0$  be continuous, decreasing, and such that  $\lambda(0) < \nu_0$ . Then for any  $\sigma \geq 0$  and  $0 < s \leq 1$ , we have*

$$\int_0^T \left\| \int_0^t \nabla \sigma_1 \star \mathcal{F}_I(\tau, x + \tau v) \cdot \nabla_v \mathcal{M}(v) \, d\tau \right\|_{\mathcal{F}^{\lambda(t), \sigma; s}}^2 \, dt \lesssim \mathcal{E}_I. \quad (2.55)$$

**Remark 2.4.5** *Again, when  $s = 1$  a constraint on  $\lambda(0)$  like  $\lambda(0) < C'(\lambda_1, S_0) = \lambda_1 / \langle S_0 \rangle$  should be imposed.*

**Proof.** We start with

$$\int_0^T \left\| \int_0^t \nabla \sigma_1 \star \mathcal{F}_I(\tau, x + \tau v) \cdot \nabla_v \mathcal{M}(v) \, d\tau \right\|_{\mathcal{F}^{\lambda(t), \sigma; s}}^2 \, dt \leq \int_0^T \sum_{k \in \mathbb{Z}^d \setminus \{0\}} I(t, k)^2 \, dt,$$

where  $I(t, k)$  is defined by

$$I(t, k) = \int_0^t \langle k, tk \rangle^\sigma e^{\lambda(t)\langle k, tk \rangle^s} |k| |\widehat{\sigma}_1(k)| \left| \widehat{\mathcal{F}}_I(\tau, k) \right| |(t - \tau)k| \left| \widehat{\mathcal{M}}([t - \tau]k) \right| \, d\tau.$$

For any  $k \neq 0$ , we have  $\langle t \rangle \leq \langle k, tk \rangle$ , and since  $\lambda$  is decreasing, we obtain

$$\begin{aligned} I(t, k) &\leq \langle t \rangle^{-1} \int_0^t \langle k, \tau k \rangle^{\sigma+1} e^{\lambda(\tau)\langle k, \tau k \rangle^s} |k| |\widehat{\sigma}_1(k)| \left| \widehat{\mathcal{F}}_I(\tau, k) \right| \\ &\quad \times \langle [t - \tau]k \rangle^{\sigma+1} e^{\lambda(\tau)\langle [t - \tau]k \rangle^s} |t - \tau| |k| \left| \widehat{\mathcal{M}}([t - \tau]k) \right| \, d\tau. \end{aligned}$$

Since  $\|\xi \mapsto \exp(\nu_0 \langle \xi \rangle^s) \cdot \widehat{\mathcal{M}}(\xi)\|_{H^P} \lesssim \|\mathcal{M}\|_{\mathcal{G}_P^{\nu_0, 0; s}}$  and  $P > d/2$ , the Sobolev embedding  $H^P \hookrightarrow C^0$  ensures that

$$|\widehat{\mathcal{M}}(\xi)| \lesssim e^{-\nu_0 \langle \xi \rangle^s}.$$

Then, by using (2.54), we arrive at

$$\begin{aligned} I(t, k) &\lesssim \langle t \rangle^{-1} \langle k \rangle^{\sigma+1} \langle S_0 \rangle^{\sigma+1} e^{\lambda(0)\langle k \rangle^s \langle S_0 \rangle^s} |k| e^{-\lambda_1 |k|} \\ &\quad \times \left( \int_0^t \langle [t - \tau]k \rangle^{\sigma+1} e^{\lambda(0)\langle [t - \tau]k \rangle^s} |t - \tau| |k| e^{-\nu_0 \langle [t - \tau]k \rangle^s} \, d\tau \right) \sqrt{\mathcal{E}_I}. \end{aligned}$$

Since  $\lambda(0) < \nu_0$  we have

$$\int_0^t \langle [t - \tau]k \rangle^{\sigma+1} e^{\lambda(0)\langle [t - \tau]k \rangle^s} |t - \tau| |k| e^{-\nu_0 \langle [t - \tau]k \rangle^s} \, d\tau \leq \int_{\mathbb{R}} \langle u \rangle^{\sigma+2} e^{-(\nu_0 - \lambda(0))\langle u \rangle^s} \, du \lesssim 1.$$

Therefore, when  $0 < s < 1$  we obtain  $\int_0^T \sum_k I(t, k)^2 \, dt \lesssim \mathcal{E}_I$  and for  $s = 1$  we conclude similarly at the price of a constraint like  $\lambda_1 > \lambda(0)\langle S_0 \rangle$ .  $\blacksquare$

We now state an existence-uniqueness result for the Cauchy problem (2.10a)–(2.10b), in the functional spaces of interest. We will give a complete proof of this theorem and make additional remarks in Appendix B.

**Proposition 2.4.6** *Let  $P > d/2$  be an integer and  $\sigma > d/2$  be a real number. Let  $\mathcal{M}, f_0 \in \mathcal{G}_P^{\nu_0, 0; 1}$  with  $\nu_0 > 0$ . Then, there exists  $T^* > 0$  and a continuous decreasing function  $0 < \nu(t) < \min(\nu_0, \lambda_1/\langle S_0 \rangle, 2\lambda_1\langle 2R_2/c \rangle)$  such that the problem (2.10a)–(2.10b) admits a unique solution  $g \in C^0([0, T^*]; \mathcal{G}_P^{\nu(t), \sigma; 1})$  on  $[0, T^*]$ . Moreover, if for some  $T \leq T^*$ , we have*

$$\limsup_{t \nearrow T} \|g(t)\|_{H_P^\sigma} < +\infty$$

then, actually,  $T < T^*$ .

**Remark 2.4.7** *The constraint  $\nu(0) < \min(\nu_0, \lambda_1/\langle S_0 \rangle, 2\lambda_1\langle 2R_2/c \rangle)$  comes from the fact that the proof uses Proposition 2.4.2.*

**Remark 2.4.8** *The fact that the boundedness of the  $H_P^\sigma$ -norm of the solution implies that the solution can be continued on a larger time interval and still be analytic on this time interval might be surprising. Indeed, from the proof of this statement, we can see that the decay rate of the analyticity radius  $\nu(t)$  of a solution of (2.10a)–(2.10b) can be estimated in term of the  $H_P^\sigma$ -norm of the solution itself: see (B.8a)–(B.8c). Then, since this decay is exponential, as soon as the  $H_P^\sigma$ -norm of the solution is finite, the analyticity radius of the solution does not shrink to 0. The complete proof of this statement and appropriate references can be found in Appendix B.*

The analysis of the Landau Damping, as it is already clear for the linearized problem, relies heavily on the formulation of the problem by means of the Fourier variables. Let us collect the useful formula from which the reasoning starts. Integrating (2.10a)–(2.10b) over  $[0, t]$ , we get

$$g(t, x, v) = f_0(x, v) + \int_0^t \nabla_x \sigma_1 \star (\mathcal{F}_I - \sigma_1 \star \mathcal{G}_Q)(\tau, x + \tau v) \cdot (\nabla_v - \tau \nabla_x)(\mathcal{M}(v) + g(\tau, x, v)) \, d\tau.$$

Thus, we obtain

$$\begin{aligned} \widehat{g}(t, k, \xi) &= \widehat{f}_0(k, \xi) - \int_0^t k \widehat{\sigma}_1(k) (\widehat{\mathcal{F}}_I - \widehat{\sigma}_1 \widehat{\mathcal{G}}_Q)(\tau, k) \cdot (\xi - \tau k) \widehat{\mathcal{M}}(\xi - \tau k) \, d\tau \\ &\quad - \sum_{n \in \mathbb{Z}^d} \int_0^t n \widehat{\sigma}_1(n) (\widehat{\mathcal{F}}_I - \widehat{\sigma}_1 \widehat{\mathcal{G}}_Q)(\tau, n) \cdot (\xi - \tau k) \widehat{g}(\tau, k - n, \xi - \tau n) \, d\tau \end{aligned}$$

and

$$\begin{aligned} \widehat{q}(t, k) &= \widehat{f}_0(k, tk) - \int_0^t k \widehat{\sigma}_1(k) (\widehat{\mathcal{F}}_I - \widehat{\sigma}_1 \widehat{\mathcal{G}}_Q)(\tau, k) \cdot (t - \tau) k \widehat{M}((t - \tau)k) \, d\tau \\ &\quad - \sum_{n \in \mathbb{Z}^d} \int_0^t n \widehat{\sigma}_1(n) (\widehat{\mathcal{F}}_I - \widehat{\sigma}_1 \widehat{\mathcal{G}}_Q)(\tau, n) \cdot (t - \tau) k \widehat{g}(\tau, k - n, tk - \tau n) \, d\tau. \end{aligned}$$

### 2.4.2 Main result

That the Landau damping holds on the torus can be formulated as follows.

**Theorem 2.4.9 (Landau damping in  $\mathbb{T}^d$ )** *Let  $(\mathbf{K1})$ – $(\mathbf{K4})$  be fulfilled. Let  $P > d/2$  be an integer,  $0 < s \leq 1$  be a real number,  $\mathcal{M} \in \mathcal{G}_P^{\nu_0,0;1}$  and  $f_0 \in \mathcal{G}_P^{\nu_0,0;s}$  with  $\nu_0 > 0$ . We also assume (without any loss of generality) that  $\iint f_0 dx dv = 0$ . There exists a universal constant  $\varepsilon_0$ , such that if*

$$\|f_0\|_{\mathcal{G}_P^{\nu_0,\sigma;s}} \leq \varepsilon_0 \quad ; \quad \mathcal{E}_I \leq \varepsilon_0^2$$

and  $\mathcal{M}$  satisfies  $(\mathbf{L})$ , then, the unique solution  $g$  of (2.10a)–(2.10b) is globally defined. To be more specific, for any  $0 < \lambda' < \nu_0$ , we have  $g \in C^0(\mathbb{R}_+; \mathcal{G}^{\lambda',0;s})$  and there exists an asymptotic density  $g^\infty \in \mathcal{G}^{\lambda',0;s}$ , the space average of which vanishes, such that

$$\|g(t) - g^\infty\|_{\mathcal{G}^{\lambda',0;s}} \lesssim \varepsilon_0 e^{-\frac{1}{2}(\nu_0 - \lambda')(t)^s}, \quad (2.56a)$$

$$\|\varrho(t)\|_{\mathcal{F}^{\lambda',0;s}} \lesssim \varepsilon_0 e^{-\frac{1}{2}(\nu_0 - \lambda')(t)^s}, \quad (2.56b)$$

$$\|\nabla \sigma_1 \star (\mathcal{F}_I(t) - \sigma_1 \star \mathcal{G}_\varrho(t))\|_{\mathcal{F}^{\lambda',0;s}} \lesssim \varepsilon_0 e^{-\frac{1}{2}(\nu_0 - \lambda')(t)^s}. \quad (2.56c)$$

**Remark 2.4.10** *When  $s = 1$  the constraint on  $\lambda'$  becomes*

$$\lambda' < \min\left(\nu_0, \frac{\lambda_1}{\langle S_0 \rangle}, \frac{2\lambda_1}{\langle 2R_2/c \rangle}\right).$$

**Remark 2.4.11** *Estimate (2.56b) can be rephrased as a decay of  $\widehat{\varrho}(t, k)$  like  $\exp(-\lambda' \langle tk \rangle^s)$ . This can be used to establish also that fluctuation of the medium  $\psi$  tends to 0, see Proposition 2.2.4).*

Like for the problem set on  $\mathbb{R}^d$ , the proof relies on a bootstrap argument, which, in this context, states as follows.

**Proposition 2.4.12 (Bootstrap)** *Let the assumptions of Theorem 2.4.9 be fulfilled. Let  $\alpha_0 = (\nu_0 + \lambda')/2$  and  $\sigma > d/2 + 6$ . There exists a function  $\lambda : \mathbb{R}_+ \rightarrow (\alpha_0, \nu_0)$ , continuous and decreasing, a real  $\beta > 2$  and constants  $K_1, K_2, K_3, K_4 > 0$  such that if  $g$  is a solution of (2.10a)–(2.10b) on the time interval  $[0, T]$  verifying*

$$\|g(t)\|_{\mathcal{G}_P^{\lambda(t),\sigma+1;s}}^2 \leq 4K_1 \langle t \rangle^7 \varepsilon^2 \quad (2.57a)$$

$$\|g(t)\|_{\mathcal{G}_P^{\lambda(t),\sigma-\beta;s}}^2 \leq 4K_2 \varepsilon^2 \quad (2.57b)$$

$$\int_0^T \|\varrho(t)\|_{\mathcal{F}^{\lambda(t),\sigma;s}}^2 dt \leq 4K_3 \varepsilon^2 \quad (2.57c)$$

for  $0 < \varepsilon \leq \varepsilon_0$  small enough, then  $g$  also satisfies, on  $[0, T]$ , the estimates

$$\|g(t)\|_{\mathcal{G}_P^{\lambda(t),\sigma+1;s}}^2 \leq 2K_1 \langle t \rangle^7 \varepsilon^2 \quad (2.58a)$$

$$\|g(t)\|_{\mathcal{G}_P^{\lambda(t),\sigma-\beta;s}}^2 \leq 2K_2 \varepsilon^2 \quad (2.58b)$$

$$\int_0^T \|\varrho(t)\|_{\mathcal{F}^{\lambda(t),\sigma;s}}^2 dt \leq 2K_3 \varepsilon^2 \quad (2.58c)$$

$$\|\varrho(t)\|_{\mathcal{F}^{\lambda(t),\sigma;s}}^2 \leq 2K_4 \langle t \rangle \varepsilon^2 \quad (2.58d)$$

**Remark 2.4.13** *The role of (2.58d) is a bit different from its analog for the Vlasov-Poisson problem. Indeed, the interest of this estimate is to provide a pointwise control on the force term. However, here, as said above, such a control can be obtained by estimating  $\int \|\varrho(t)\|_{\mathcal{F}^{\lambda(t),\sigma;s}}^2 dt$ . Consequently (2.58c) is enough to finish the proof, without using (2.58d) and the proof slightly simplifies. Nevertheless, we keep (2.58d) in the statement since it is useful to justify (2.56b).*

We now explain how the Landau damping can be justified, having at hand the bootstrap statement.

**Proof of Landau damping.** We only detail the case  $0 < s < 1$  and  $\mathcal{M}, f_0 \in \mathcal{G}_P^{\nu_0,0;1}$ , and we refer the reader to Remark 2.4.14 below for further information.

*Step 1 : Global well-posedness.* Since  $\mathcal{M}, f_0 \in \mathcal{G}_P^{\nu_0,0;1}$ , Proposition 2.4.6 ensures that we can find  $T^* > 0$  and a continuously decreasing function  $0 < \nu(t) < \min(\nu_0, \lambda_1/\langle S_0 \rangle, 2\lambda_1\langle 2R_2/c \rangle)$  such that (2.10a)–(2.10b) has a unique solution  $g \in C^0([0, T^*]; \mathcal{G}_P^{\nu(t),\sigma+1;1})$  on  $[0, T^*]$ . Moreover, since  $0 < s < 1$ , this solution equally lies in  $C^0([0, T^*]; \mathcal{G}_P^{\lambda(t),\sigma+1;s})$ , where now  $\lambda(t)$  stands for the function arising from Proposition 2.4.12. It is still possible to fix the constants so that the estimates (2.58a)–(2.58c) hold at  $T = 0$ , and  $g$  is continuous for the corresponding norms. Therefore, we already know that we can find  $T > 0$  such that (2.57a)–(2.57c) hold on  $[0, T]$ . Proposition 2.4.12 together with a reasoning by connectivity ensures that (2.58a)–(2.58d) hold on  $[0, T^*]$ . Finally, (2.58a) tells us that

$$\limsup_{t \nearrow T^*} \|g(t)\|_{H_P^{\sigma+1}} \leq \limsup_{t \nearrow T^*} \|g(t)\|_{\mathcal{G}_P^{\lambda(t),\sigma+1;s}} \leq 2K_1 \langle T^* \rangle^7 \varepsilon^2$$

holds, and thus we can go back to the extension argument in Proposition 2.4.6, and we conclude that  $T^* = +\infty$ .

*Step 2 : Convergence to 0 of  $\varrho$ .* Since the space average of  $g(t)$  vanishes:  $\widehat{\varrho}(t, 0) = \widehat{g}(t, 0) = 0$ , we get

$$\|\varrho(t)\|_{\mathcal{F}^{\lambda',0;s}}^2 \leq \|\varrho\|_{\mathcal{F}^{\alpha_0,0;s}}^2 e^{-2(\alpha_0 - \lambda')(t)^s}.$$

Next (2.58d) (with  $\sigma > 1/2$ ) ensures that

$$\begin{aligned} \|\varrho(t)\|_{\mathcal{F}^{\alpha_0,0;s}}^2 &= \sum_{k \in \mathbb{Z}_*^d} e^{2\alpha_0 \langle k, tk \rangle^s} |\widehat{\varrho}(t, k)|^2 \\ &\leq \sum_{k \in \mathbb{Z}_*^d} \frac{\langle t \rangle^{2\sigma}}{\langle t \rangle} e^{2\lambda(t) \langle k, tk \rangle^s} |\widehat{\varrho}(t, k)|^2 \leq \frac{1}{\langle t \rangle} \|\varrho(t)\|_{\mathcal{F}^{\lambda(t),\sigma;s}}^2 \leq K_4 \varepsilon^2. \end{aligned}$$

Since  $\alpha_0 = (\nu_0 + \lambda')/2$ , we have proved

$$\|\varrho(t)\|_{\mathcal{F}^{\lambda',0;s}} \leq \sqrt{K_4 \varepsilon} e^{-\frac{1}{2}(\lambda_0 - \lambda')(t)^s}.$$

*Step 3 : Convergence to 0 of the force.* This result follows similar arguments. Since the average of the force term vanishes, we have

$$\|\nabla \sigma_1 \star (\mathcal{F}_I(t) - \sigma_1 \star \mathcal{G}_\varrho(t))\|_{\mathcal{F}^{\lambda',0;s}}^2 \leq \|\nabla \sigma_1 \star (\mathcal{F}_I(t) - \sigma_1 \star \mathcal{G}_\varrho(t))\|_{\mathcal{F}^{\alpha_0,0;s}}^2 e^{-2(\alpha_0 - \lambda')(t)^s}.$$

By using (2.53a) and (2.58c), we get

$$\|\nabla \sigma_1 \star (\mathcal{F}_I(t) - \sigma_1 \star \mathcal{G}_\varrho(t))\|_{\mathcal{F}^{\alpha_0,0;s}}^2 \lesssim \mathcal{E}_I \mathbf{1}_{0 \leq t \leq S_0} + \int_0^t \|\varrho\|_{\mathcal{F}^{\lambda(t),\sigma;s}}^2 d\tau \lesssim \varepsilon^2.$$

we conclude by using  $\alpha_0 = (\nu_0 + \lambda')/2$ , again.

*Step 4 : Existence of the asymptotic profile.* We wish to define the quantity

$$g^\infty : (x, v) \longmapsto f_0(x, v) + \int_0^{+\infty} \mathcal{N}(g)(\tau) d\tau$$

where  $\mathcal{N}(g)$  stands for the right hand side of (2.10a):

$$\mathcal{N}(g)(t, x, v) = \nabla_x \sigma_1 \star (\mathcal{F}_I + \sigma_1 \star \mathcal{G}_\varrho)(t, x + tv) \cdot (\nabla_v - t \nabla_x)(\mathcal{M} + g)(t, x, v).$$

Let us check that this makes sense as an element of  $\mathcal{G}^{\lambda', 0; s}$ . Next, we will show that  $g(t)$  converges to  $g^\infty$  for large times. We start by estimating  $\int_0^t \|\mathcal{N}(g)(\tau)\|_{\mathcal{G}^{\lambda', 0; s}} d\tau$ . With (2.49), we get

$$\begin{aligned} \int_0^t \|\mathcal{N}(g)(\tau)\|_{\mathcal{G}^{\lambda', 0; s}} d\tau &\leq \int_0^t \|\mathcal{N}(g)(\tau)\|_{\mathcal{G}^{\lambda', d/2+1; s}} d\tau \\ &\lesssim \int_0^t \|\nabla \sigma_1 \star (\mathcal{F}_I(\tau) - \sigma_1 \star \mathcal{G}_\varrho(\tau))\|_{\mathcal{F}^{\lambda', d/2+1; s}} \|(\nabla_v - \tau \nabla_x)(\mathcal{M} + g(\tau))\|_{\mathcal{G}_P^{\lambda', d/2+1; s}} d\tau. \end{aligned}$$

Since  $\sigma > d/2 + 6$ , we have

$$\begin{aligned} \|(\nabla_v - \tau \nabla_x)(\mathcal{M} + g(\tau))\|_{\mathcal{G}_P^{\lambda', d/2+1; s}} \\ \lesssim \langle \tau \rangle \|\mathcal{M} + g(\tau)\|_{\mathcal{G}_P^{\lambda', d/2+2; s}} \leq \langle \tau \rangle \|\mathcal{M} + g(\tau)\|_{\mathcal{G}_P^{\lambda(\tau), \sigma+1; s}}. \end{aligned}$$

Moreover, the average of the force term vanishes so that

$$\begin{aligned} \|\nabla \sigma_1 \star (\mathcal{F}_I(\tau) - \sigma_1 \star \mathcal{G}_\varrho(\tau))\|_{\mathcal{F}^{\lambda', d/2+1; s}} \\ \leq \langle \tau \rangle^{-\sigma+d/2+1} \|\nabla \sigma_1 \star (\mathcal{F}_I(\tau) - \sigma_1 \star \mathcal{G}_\varrho(\tau))\|_{\mathcal{F}^{\lambda', \sigma; s}} \\ \lesssim \langle \tau \rangle^{-\sigma+d/2+1} \|\nabla \sigma_1 \star (\mathcal{F}_I(\tau) - \sigma_1 \star \mathcal{G}_\varrho(\tau))\|_{\mathcal{F}^{\lambda(\tau), \sigma; s}} \end{aligned}$$

and applying (2.58a) with the Cauchy-Schwarz inequality yields

$$\begin{aligned} \int_0^t \|\mathcal{N}(g)(\tau)\|_{\mathcal{G}^{\lambda', 0; s}} d\tau \\ \lesssim \int_0^t \langle \tau \rangle^{-\sigma+d/2+2} \|\nabla \sigma_1 \star (\mathcal{F}_I(\tau) - \sigma_1 \star \mathcal{G}_\varrho(\tau))\|_{\mathcal{F}^{\lambda(\tau), \sigma; s}} \left( \|\mathcal{M}\|_{\mathcal{G}_P^{\lambda_0, 0; s}} + \sqrt{K_1} \langle \tau \rangle^{7/2} \varepsilon \right) d\tau \\ \lesssim \left( \int_0^t \|\nabla \sigma_1 \star (\mathcal{F}_I(\tau) - \sigma_1 \star \mathcal{G}_\varrho(\tau))\|_{\mathcal{F}^{\lambda(\tau), \sigma; s}}^2 d\tau \right)^{1/2} \\ \times \left( \int_0^t \langle \tau \rangle^{-2\sigma+d+11} \left( \|\mathcal{M}\|_{\mathcal{G}_P^{\lambda_0, 0; s}}^2 + K_1 \varepsilon^2 \right) d\tau \right)^{1/2}. \end{aligned}$$

By using (2.53a) and (2.58c) we see that the first factor of the right hand side is bounded uniformly with respect to  $t$  while the condition  $\sigma > d/2 + 6$  implies that the second factor is also bounded uniformly with respect to  $t$ . Thus  $g^\infty$  is well defined in  $\mathcal{G}^{\lambda', 0; s}$ . To be more specific, we have shown that

$$\|g^\infty - f_0\|_{\mathcal{G}^{\lambda', 0; s}}^2 \lesssim (\mathcal{E}_I + K_3 \varepsilon^2)(1 + K_1 \varepsilon^2).$$

Since  $\mathcal{E}_I \leq \varepsilon^2$  it says that  $g^\infty$  is at a distance at most  $\varepsilon$  from  $f_0$ .

The convergence of  $g(t)$  towards  $g^\infty$  relies on the same manipulations. The noticeable difference is in Step 3; using again the fact that the space average of the force term vanishes, we get

$$\begin{aligned} \|\nabla \sigma_1 \star (\mathcal{F}_I(\tau) - \sigma_1 \star \mathcal{G}_\varrho(\tau))\|_{\mathcal{F}^{\lambda', d/2+1; s}} \\ \leq \langle \tau \rangle^{-\sigma+d/2+1} e^{-(\alpha_0 - \lambda') \langle \tau \rangle} \|\nabla \sigma_1 \star (\mathcal{F}_I(\tau) - \sigma_1 \star \mathcal{G}_\varrho(\tau))\|_{\mathcal{F}^{\alpha_0, \sigma; s}} \\ \leq \langle \tau \rangle^{-\sigma+d/2+1} e^{-(\alpha_0 - \lambda') \langle \tau \rangle} \|\nabla \sigma_1 \star (\mathcal{F}_I(\tau) - \sigma_1 \star \mathcal{G}_\varrho(\tau))\|_{\mathcal{F}^{\lambda(\tau), \sigma; s}}, \end{aligned}$$

It follows that

$$\begin{aligned} \|g(t) - g^\infty\|_{\mathcal{G}^{\lambda',0;s}} &\leq \int_t^{+\infty} \|\mathcal{N}(g)(\tau)\|_{\mathcal{G}^{\lambda',0;s}} d\tau \\ &\lesssim e^{-(\alpha_0 - \lambda')(t)^s} \left( \int_t^{+\infty} \langle \tau \rangle^{-\sigma+d/2+2} \|\nabla \sigma_1 \star (\mathcal{F}_I(\tau) - \sigma_1 \star \mathcal{G}_g(\tau))\|_{\mathcal{F}^{\lambda(\tau),\sigma;s}} \right. \\ &\quad \left. \times \|\mathcal{M} + g(\tau)\|_{\mathcal{G}_P^{\lambda(\tau),\sigma+1;s}} d\tau \right) \\ &\lesssim \varepsilon e^{-(\alpha_0 - \lambda')(t)^s}, \end{aligned}$$

and we conclude by using  $\alpha_0 = (\nu_0 + \lambda')/2$ .  $\blacksquare$

**Remark 2.4.14** *We conclude the proof with a couple of remarks.*

- When the data  $f_0$  belong to  $\mathcal{G}_P^{\nu_0,0;s}$ , with  $0 < s < 1$ , Step 1 is critical since it relies on Proposition 2.4.6 which applies for analytic data only. We use a regularization argument: we introduce a sequence  $(f_0^\eta)_{\eta>0}$  of data that belong to  $\mathcal{G}_P^{\nu_0,0;1}$  and that converge to  $f_0$  in  $\mathcal{G}_P^{\nu_0,0;s}$  as  $\eta \rightarrow 0$ . For any  $\eta > 0$ , the associated solution  $g^\eta$  is globally defined and it satisfies (2.58a)–(2.58d) on  $[0, +\infty)$ . We can also check that the constants  $K_1, \dots, K_4$  can be defined independently of  $\eta$  and that  $g^\eta$  converges in  $C^0([0, +\infty); L^1(\mathbb{R}^d \times \mathbb{R}^d))$  to a certain function  $g$ , which is still a solution of (2.10a)–(2.10b), see [103] and [25, Theorem 4 & Lemma 8]. Moreover, for any  $t \geq 0$ , we have

$$\|g(t)\|_{\mathcal{G}_P^{\lambda(t),\sigma+1;s}}^2 \leq \liminf_{\eta \rightarrow 0^+} \|g^\eta(t)\|_{\mathcal{G}_P^{\lambda(t),\sigma+1;s}}^2$$

and

$$\|g(t)\|_{\mathcal{G}_P^{\lambda(t),\sigma-\beta;s}}^2 \leq \liminf_{\eta \rightarrow 0^+} \|g^\eta(t)\|_{\mathcal{G}_P^{\lambda(t),\sigma-\beta;s}}^2.$$

Indeed, for any fixed  $t$ , the sequence  $(g^\eta(t))_{\eta>0}$  is bounded in  $\mathcal{G}_P^{\lambda(t),\sigma+1;s}$  and  $\mathcal{G}_P^{\lambda(t),\sigma-\beta;s}$  (owing to (2.58a) to (2.58b)); thus, extracting a subsequence (which might depend on  $t$ , but this is not an issue here), there exists  $\bar{g}_t$  and  $\tilde{g}_t$  such  $g^\eta(t)$  converges weakly to  $\bar{g}_t$  in  $\mathcal{G}_P^{\lambda(t),\sigma+1;s}$  (resp. to  $\tilde{g}_t$  in  $\mathcal{G}_P^{\lambda(t),\sigma-\beta;s}$ ). By lower-semi-continuity of the norm for the weak topology, we get

$$\|\bar{g}_t\|_{\mathcal{G}_P^{\lambda(t),\sigma+1;s}}^2 \leq \liminf_{\eta \rightarrow 0^+} \|g^\eta(t)\|_{\mathcal{G}_P^{\lambda(t),\sigma+1;s}}^2$$

and

$$\|\tilde{g}_t\|_{\mathcal{G}_P^{\lambda(t),\sigma-\beta;s}}^2 \leq \liminf_{\eta \rightarrow 0^+} \|g^\eta(t)\|_{\mathcal{G}_P^{\lambda(t),\sigma-\beta;s}}^2.$$

Since  $g(t) = \bar{g}_t = \tilde{g}_t$  (by uniqueness of the limit in  $L^1$ ) almost everywhere, (2.58a) and (2.58b) still apply for  $g$ . In order to justify that (2.58c) and (2.58d) apply to  $g$ , we use the fact that, for any  $t, k, \xi$

$$\widehat{g}^\eta(t, k, \xi) \xrightarrow{\eta \rightarrow 0^+} \widehat{g}(t, k, \xi).$$

Fatou's lemma then yields

$$\|g(t)\|_{\mathcal{F}^{\lambda(t),\sigma;s}}^2 = \sum_{k \in \mathbb{Z}^d} \langle k, tk \rangle^{2\sigma} e^{2\lambda(t)\langle k, tk \rangle^s} \liminf_{\eta \rightarrow 0^+} |\widehat{g}^\eta(t, k, tk)|^2 \leq \liminf_{\eta \rightarrow 0^+} \|g^\eta(t)\|_{\mathcal{F}^{\lambda(t),\sigma;s}}^2.$$

- When  $s = 1$  this is still Step 1 that contains some difficulty. We can apply Proposition 2.4.6, but we should check the interaction between the function  $\lambda$  given by the bootstrap statement and the function  $\nu$  arising from Proposition 2.4.6. Indeed, it is not a priori excluded that  $\nu(t) < \lambda(t)$  at a certain time  $t > 0$ , which would prevent us from extending the solution in  $\mathcal{G}_P^{\lambda(t),\sigma+1;1}$ , see [12].

### 2.4.3 Bootstrap analysis: sketch of proof of Proposition 2.4.12

To start with, let us make a few observations:

- Like for the problem in  $\mathbb{R}^d$ , the main difficulty relies on the treatment of the echoes. In  $\mathbb{R}^d$ , the dispersive effect of the transport operator allows us to obtain a control by means of Sobolev norms, at the price of restrictions on the space dimension  $d$ , though: in finite regularity we need to assume  $d \geq 2$  (the case  $d = 2$  being critical for a different reason). On the torus, the dispersive effect does not hold, which motivates the analytic framework. As a consequence of working in such a high regularity, we get rid of the restriction on  $d$ .
- The justification of the bootstrap follows the same approach than for the problem on  $\mathbb{R}^d$ . Since the structure of the Vlasov-Wave equation is close to the structure of the Vlasov-Poisson equation, we can perform the same estimates than in [12]. The price to be paid is to replace terms of the form  $\|\varrho(t)\|_{\mathcal{F}}$  by

$$\|\nabla\sigma_1 \star (\mathcal{F}_I(t) - \sigma_1 \star \mathcal{G}_\varrho(t))\|_{\mathcal{F}}. \quad (2.59)$$

Then all the difficulty consists in controlling (2.59) by means of  $\|\varrho(t)\|_{\mathcal{F}}$ . Since Proposition 2.4.2 and Proposition 2.4.4 allow us to perform this kind of estimate, we have a complete proof of the Proposition 2.4.12 by applying this strategy.

For the sake of brevity, let us just sketch how apply this strategy to obtain the estimate (2.58c) from (2.57a)–(2.57c), having, on the one hand, the estimates of [12] and, on the other hand, the estimates from Propositions 2.4.2 and 2.4.4. As in the free space case, we first need a version of Lemma 2.2.8 adapted to the norms of the bootstrap statement. Here we need to adapt this Lemma to the case of fractional exponential weights. This was performed in [12, Lemma 4.1]. We can adapted the proof to the context of the Vlasov-Wave system and obtain the following result.

**Proposition 2.4.15 (Linearized damping on  $\mathbb{T}^d$ )** *Let the assumptions of Theorem 2.4.9 and Proposition 2.4.12 be fulfilled. We consider a family of functions  $\{t \in [0, T] \mapsto a(t, k), k \in \mathbb{Z}^d\}$ . We suppose that*

$$\sum_{k \in \mathbb{Z}^d} \int_0^T \langle k, tk \rangle^{2\sigma} e^{2\lambda(t)\langle k, tk \rangle^s} |a(t, k)|^2 dt < +\infty,$$

*holds. Then, we can find a constant  $C_{LD}$  (which does not depend on  $k$  and  $T$ ) such that any solution  $(t, k) \mapsto \phi(t, k)$  of the system*

$$\begin{aligned} \phi(t, k) &= a(t, k) + \int_0^t \mathcal{K}(t - \tau, k) \phi(\tau, k) d\tau \\ &= a(t, k) + \int_0^t |\hat{\sigma}_1(k)|^2 |k|^2 (t - \tau) \widehat{\mathcal{M}}([t - \tau]k) \left( \int_0^\tau p_c(\tau - \sigma) \phi(\sigma, k) d\sigma \right) d\tau, \end{aligned}$$

*on  $[0, T]$  satisfies the following estimate: for any  $k \in \mathbb{Z}^d$*

$$\int_0^T \langle k, tk \rangle^{2\sigma} e^{2\lambda(t)\langle k, tk \rangle^s} |\phi(t, k)|^2 dt \leq C_{LD} \int_0^T \langle k, tk \rangle^{2\sigma} e^{2\lambda(t)\langle k, tk \rangle^s} |a(t, k)|^2 dt.$$



Then we introduce the time response kernel which contains all the difficulties concerning the control of echos terms: let

$$\bar{K}(t, \tau, k, n) = \frac{1}{\langle n \rangle^\gamma} e^{(\lambda(t) - \lambda(\tau)) \langle k, tk \rangle^s} e^{c\lambda(\tau) \langle k-n, tk-\tau n \rangle^s} |(t-\tau)k \widehat{g}(\tau, k-n, tk-\tau n)| \mathbf{1}_{n \neq 0}$$

where  $c = c(s) \in (0, 1)$  is determined by the proof.

**Remark 2.4.16** *i) Since in our case the kernel  $\sigma_1$  is analytic we can choose  $\gamma$  as large as we wish. In practice, since we use the arguments of [12], for proving a result in Gevrey regularity class  $s \in (0, 1)$ , we should take  $\gamma$  such that  $s > 1/(2 + \gamma)$  (so the smaller  $s$ , the larger  $\gamma$ ).*

*ii) Note also that the analyticity of  $\sigma_1$  allows us to replace the term  $\langle n \rangle^{-\gamma}$  in the time response kernel by  $\exp(-\gamma \langle n \rangle)$ . According to [87, Section 7.1.1], this permits us to obtain better estimates on  $\bar{K}$ , but it is not obvious that these improvements lead to a Landau damping effect in finite regularity on the torus. Since in our context the regularity of  $\sigma_1$  is also needed to obtain the crucial estimates of Propositions 2.4.2 and 2.4.4, and since replacing  $\langle n \rangle^{-\gamma}$  by  $\exp(-\gamma \langle n \rangle)$  does not improve the result, we chose the definition of the time response kernel with the  $\langle n \rangle^{-\gamma}$  factor.*

For this time response kernel we will use the followings estimates (see [12, Section 6], which are the analog in the torus of Lemma 2.3.13.

**Lemma 2.4.17** *Under the assumptions of Proposition 2.4.12 the following two estimates hold*

$$\sup_{t \in [0, T]} \sup_{k \in \mathbb{Z}^d \setminus \{0\}} \int_0^t \sum_{n \in \mathbb{Z}^d \setminus \{0\}} \bar{K}(t, \tau, k, n) d\tau \lesssim \sqrt{K_2} \varepsilon$$

and

$$\sup_{\tau \in [0, T]} \sup_{n \in \mathbb{Z}^d \setminus \{0\}} \int_\tau^T \sum_{k \in \mathbb{Z}^d \setminus \{0\}} \bar{K}(t, \tau, k, n) dt \lesssim \sqrt{K_2} \varepsilon.$$

We now get all the required definitions and propositions. We follow closely the arguments of [12]. We start from

$$\begin{aligned} \widehat{\varrho}(t, k) &= \widehat{f}_0(k, tk) - \int_0^t k \widehat{\sigma}_1(k) \widehat{\mathcal{F}}_I(\tau, k) \cdot (t-\tau)k \widehat{\mathcal{M}}((t-\tau)k) d\tau \\ &\quad + \int_0^t k |\widehat{\sigma}_1(k)|^2 \widehat{\mathcal{G}}_\varrho(\tau, k) \cdot (t-\tau)k \widehat{\mathcal{M}}((t-\tau)k) d\tau \\ &\quad - \sum_{n \in \mathbb{Z}^d} \int_0^t n \widehat{\sigma}_1(n) (\widehat{\mathcal{F}}_I - \widehat{\sigma}_1 \widehat{\mathcal{G}}_\varrho)(\tau, n) \cdot (t-\tau)k \widehat{g}(\tau, k-n, tk-\tau n) d\tau \\ &= \text{CT1}(t, k) + \text{CT2}(t, k) \\ &\quad + \int_0^t k |\widehat{\sigma}_1(k)|^2 \widehat{\mathcal{G}}_\varrho(\tau, k) \cdot (t-\tau)k \widehat{\mathcal{M}}((t-\tau)k) d\tau + \text{NLT}(t, k). \end{aligned}$$

As in the free space problem (see Section 2.3.3), for estimating the non linear term NLT we start by splitting it into several parts. Here this decomposition is slightly more precise than in Section 2.3.3 but the main idea is the same: we consider separately contributions from high and low frequencies coming from  $\varrho$  and  $g$ :  $\text{NLT} = \text{T} + \text{R} + \mathcal{R}$ . The transport term T contains  $\varrho$ 's low frequency terms and  $g$ 's high frequency terms; the reaction term R contains  $\varrho$ 's high frequency terms and  $g$ 's low frequency terms and the remainder term  $\mathcal{R}$  contains the other terms, those where  $\varrho$  and  $g$  have almost the same frequency. The

precise decomposition needs the introduction of the Littlewood-Paley decomposition and the paradifferential formalism. We prefer not to detail this aspect here. Then, we apply Proposition 2.4.15 to obtain (by summing over  $k \in \mathbb{Z}^d \setminus \{0\}$ )

$$\begin{aligned} \int_0^T \|\varrho(t)\|_{\mathcal{F}^{\lambda(t),\sigma;s}}^2 dt &\lesssim \int_0^T \|\text{CT1}(t)\|_{\mathcal{F}^{\lambda(t),\sigma;s}}^2 dt + \int_0^T \|\text{CT2}(t)\|_{\mathcal{F}^{\lambda(t),\sigma;s}}^2 dt \\ &+ \int_0^T \|\text{T}(t)\|_{\mathcal{F}^{\lambda(t),\sigma;s}}^2 dt + \int_0^T \|\text{R}(t)\|_{\mathcal{F}^{\lambda(t),\sigma;s}}^2 dt + \int_0^T \|\mathcal{R}(t)\|_{\mathcal{F}^{\lambda(t),\sigma;s}}^2 dt. \end{aligned}$$

**Constant terms.** We estimate the first constant term CT1 as in [12] and we obtain

$$\int_0^T \|\text{CT1}(t)\|_{\mathcal{F}^{\lambda(t),\sigma;s}}^2 dt \lesssim \varepsilon^2.$$

For the second constant term CT2 we use the Proposition 2.4.4 to obtain

$$\int_0^T \|\text{CT2}(t)\|_{\mathcal{F}^{\lambda(t),\sigma;s}}^2 dt \lesssim \mathcal{E}_I.$$

**Reaction term.** Following closely the argument from [12, Section 5.1.1], we are led to the following estimate on R:

$$\begin{aligned} \int_0^T \|\text{R}(t)\|_{\mathcal{F}^{\lambda(t),\sigma;s}}^2 dt &\lesssim \left( \sup_{t \in [0,T]} \sup_{k \in \mathbb{Z}_*^d} \int_0^t \sum_{n \in \mathbb{Z}_*^d} \bar{K}(t, \tau, k, n) d\tau \right) \\ &\times \left( \sup_{\tau \in [0,T]} \sup_{n \in \mathbb{Z}_*^d} \int_\tau^T \sum_{k \in \mathbb{Z}_*^d} \bar{K}(t, \tau, k, n) dt \right) \\ &\times \left( \int_0^T \|\nabla \sigma_1 \star (\mathcal{F}_I(\tau) - \sigma_1 \star \mathcal{G}_\varrho(\tau))\|_{\mathcal{F}^{\lambda(\tau),\sigma;s}}^2 d\tau \right). \end{aligned}$$

Note that in order to make the kernel  $\bar{K}$  appear, we have to multiply and divide by  $\langle n \rangle^\gamma$ . Then the correct estimate is the same but replacing

$$\begin{aligned} &\|\nabla \sigma_1 \star (\mathcal{F}_I(\tau) - \sigma_1 \star \mathcal{G}_\varrho(\tau))\|_{\mathcal{F}^{\lambda(\tau),\sigma;s}}^2 \\ &= \sum_{n \in \mathbb{Z}_*^d} \langle n, \tau n \rangle^{2\sigma} e^{2\lambda(\tau)\langle n, \tau n \rangle^s} |n|^2 |\hat{\sigma}_1(n)|^2 \left| \widehat{\mathcal{F}}_I(\tau, n) - \hat{\sigma}_1(n) \widehat{\mathcal{G}}_\varrho(\tau, n) \right|^2 \end{aligned}$$

by

$$\sum_{n \in \mathbb{Z}_*^d} \langle n, \tau n \rangle^{2\sigma} e^{2\lambda(\tau)\langle n, \tau n \rangle^s} \langle n \rangle^{2\gamma} |n|^2 |\hat{\sigma}_1(n)|^2 \left| \widehat{\mathcal{F}}_I(\tau, n) - \hat{\sigma}_1(n) \widehat{\mathcal{G}}_\varrho(\tau, n) \right|^2.$$

Since  $\sigma_1$  is analytic we can always use, without any bad consequences, a small part of the exponential decay of its Fourier transform to absorb the  $\langle k \rangle^\gamma$ -term (we already dealt with this difficulty in the free space problem, see Remark 2.3.2). From now on, we always omit this minor detail in the estimates. Then, applying Lemma 2.4.17 and Proposition 2.4.2 with (2.57a), we get

$$\int_0^T \|\text{R}(t)\|_{\mathcal{F}^{\lambda(t),\sigma;s}}^2 dt \lesssim K_2 \varepsilon^2 \left( \mathcal{E}_I + K_3 \varepsilon^2 \right).$$

**Transport term.** We follow line by line the estimate of [12, Section 5.1.2], and we are led to

$$\begin{aligned} \int_0^T \|\mathbb{T}(t)\|_{\mathcal{F}^{\lambda(t),\sigma;s}}^2 dt &\lesssim \left( \int_0^T \|\nabla \sigma_1 \star (\mathcal{F}_I(\tau) - \sigma_1 \star \mathcal{G}_\varrho(\tau))\|_{\mathcal{F}^{\lambda(\tau),\sigma;s}}^2 d\tau \right) \\ &\times \left( \sup_{\tau \geq 0} e^{(c-1)\alpha_0 \langle \tau \rangle^s} \sum_{k \in \mathbb{Z}_*^d} \sup_{\omega \in \mathbb{Z}_*^d} \sup_{x \in \mathbb{R}^d} \int_{-\infty}^{+\infty} \left\langle k, \frac{\omega}{|\omega|} \zeta - x \right\rangle^{2\sigma+2} \right. \\ &\quad \left. \times e^{2\lambda(\tau) \langle k, \frac{\omega}{|\omega|} \zeta - x \rangle^s} \left| \widehat{g} \left( \tau, k, \frac{\omega}{|\omega|} \zeta - x \right) \right|^2 d\zeta \right) \end{aligned}$$

where  $c = c(s) \in (0, 1)$ . Then, applying Proposition 2.4.2 with (2.57c) and the Trace Lemma 2.3.4 with (2.57a) (see in Section 2.3.3 the paragraph **Estimate on NLTT** for a similar reasoning) yields

$$\int_0^T \|\mathbb{T}(t)\|_{\mathcal{F}^{\lambda(t),\sigma;s}}^2 dt \lesssim (\mathcal{E}_I + K_3 \varepsilon^2) K_1 \varepsilon^2.$$

**Remainders term.** The arguments of [12, Section 5.1.3] allow us to obtain the estimate

$$\begin{aligned} \int_0^T \|\mathcal{R}(t)\|_{\mathcal{F}^{\lambda(t),\sigma;s}}^2 dt &\lesssim K_1 \varepsilon^2 \left( \int_0^T \|\nabla \sigma_1 \star (\mathcal{F}_I(\tau) - \sigma_1 \star \mathcal{G}_\varrho(\tau))\|_{\mathcal{F}^{\lambda(\tau),\sigma;s}}^2 d\tau \right) \\ &\quad \times \left( \int_0^T \sum_{n \in \mathbb{Z}_*^d} e^{2(c'-1)\lambda(\tau) \langle n, \tau n \rangle^s} \langle \tau \rangle^7 d\tau \right) \end{aligned}$$

where  $c' \in (0, 1)$ . We conclude by applying Proposition 2.4.2 with (2.57c) to obtain

$$\int_0^T \|\mathcal{R}(t)\|_{\mathcal{F}^{\lambda(t),\sigma;s}}^2 dt \lesssim K_1 \varepsilon^2 (\mathcal{E}_I + K_3 \varepsilon^2).$$

**Recap.** We have shown that, if  $g$  is a solution of (2.10a)–(2.10b) satisfying (2.57a)–(2.57c) on  $[0, T]$ , then

$$\int_0^T \|\varrho(t)\|_{\mathcal{F}^{\lambda(t),\sigma;s}}^2 dt \lesssim \varepsilon^2 + \mathcal{E}_I + K_2 \varepsilon^2 (\mathcal{E}_I + K_3 \varepsilon^2) + (\mathcal{E}_I + K_3 \varepsilon^2) K_1 \varepsilon^2 + K_1 \varepsilon^2 (\mathcal{E}_I + K_3 \varepsilon^2).$$

Since in Theorem 2.4.9 the smallness assumption on the fluctuation of the media is  $\mathcal{E}_I \leq \varepsilon^2$ , this estimate can be rewritten as

$$\int_0^T \|\varrho(t)\|_{\mathcal{F}^{\lambda(t),\sigma;s}}^2 dt \lesssim (1 + K_2(1 + K_3)\varepsilon^2 + K_1(1 + K_3)\varepsilon^2) \varepsilon^2.$$

Let us denote  $C_1$  the constant hidden in the symbol  $\lesssim$  of this estimate. Choosing  $K_3 \geq C_1$  and  $\varepsilon \ll 1$  so that

$$(K_1 + K_2)(1 + K_3)\varepsilon^2 \leq 1$$

allows us to conclude that (2.58c) holds.

## 2.5 Discussion of the stability criterion

In this section we come back to the stability criteria **(L)** and **(L')** which are absolutely crucial for justifying the Landau damping. We already know that a large wave speed guarantees the damping, see Proposition 2.2.11. Nevertheless, we may also wonder, for a given wave speed  $c$ , whether or not an equilibrium  $\mathcal{M}$  is stable or unstable.

### 2.5.1 Towards a Landau-Penrose criterion

For the usual Vlasov equation, a “practical” condition on the equilibrium  $\mathcal{M}$  — the Penrose criterion, see [87, Condition (c) in Proposition 2.1] — can be exhibited to ensure the linearized stability. By following a similar approach we expect to find a criterion with the same flavor for the Vlasov-Wave problem. However we shall see that the half-convolution with respect to time that defines  $p_c$  makes the criterion much more intricate.

Throughout this section we assume that

$$\sigma_1 \text{ and } \sigma_2 \text{ are radially symmetric,}$$

which makes the computation more explicit. With a slight abuse, we shall use the same notation for radially symmetric functions and their radial representation. As a warm-up, let us briefly recall why it suffices to check that  $\omega \in i\mathbb{R} \mapsto \mathcal{L}\mathcal{K}(\omega|k|, k) \in \mathbb{C}$  never crosses the real-axis beyond 1.

The first step of the reasoning consists in showing that it is sufficient to check that  $\mathcal{L}\mathcal{K}(\omega|k|, k) \neq 1$  for every  $k$  and  $\omega \in \mathbb{C}$  with  $\operatorname{Re}(\omega) \geq 0$ . Let us distinguish four different cases, depending if  $\mathbb{X}^d = \mathbb{T}^d$  or  $\mathbb{R}^d$  and depending if we are considering  $(\mathbf{L})$  or  $(\mathbf{L}')$ .

**First case:  $\mathbb{X}^d = \mathbb{T}^d$  and  $(\mathbf{L})$ .** In this case, thanks to the expression

$$\mathcal{L}\mathcal{K}((\alpha + i\beta)|k|, k) = |\hat{\sigma}_1(k)|^2 \left( \int_0^{+\infty} e^{-(\alpha+i\beta)|k|t} p_c(t) dt \right) \left( \int_0^{+\infty} e^{-(\alpha+i\beta)u} u \widetilde{\mathcal{M}}\left(u \frac{k}{|k|}\right) du \right)$$

we check that  $\mathcal{L}\mathcal{K}((\alpha + i\beta)|k|, k)$  converges to 0 when  $|k| \rightarrow +\infty$ , uniformly with respect to  $\alpha + i\beta$  and it converges to 0 when  $\alpha \rightarrow +\infty$ , uniformly with respect to  $k$  and  $\beta$ . Moreover, thanks to the Riemann-Lebesgue Lemma, we can also prove that  $\mathcal{L}\mathcal{K}((\alpha + i\beta)|k|, k)$  converges to 0 when  $|\beta| \rightarrow +\infty$ :

$$\left| \mathcal{L}\mathcal{K}((\alpha + i\beta)|k|, k) \right| \leq \|\sigma_1\|_{L_x^2}^2 \|p_c\|_{L_t^1} \left| \int_0^{+\infty} e^{-i\beta u} e^{-\alpha u} u \widetilde{\mathcal{M}}\left(u \frac{k}{|k|}\right) du \right| \xrightarrow{|\beta| \rightarrow +\infty} 0.$$

There is *a priori* no reason for the latter convergence to be uniform with respect to  $k$  and  $\alpha$ . However, since we consider an infimum over all  $k \in \mathbb{Z}^d \setminus \{0\}$ , the first convergence ensures us that we can restrict to a finite number of modes  $k$  and the convergence when  $|\beta| \rightarrow +\infty$  is indeed uniform with respect to  $k$ . We can also justify that this convergence is uniform with respect to  $\alpha$ . To this end, we show that

$$\alpha \mapsto \int_0^{+\infty} e^{-i\beta u} e^{-\alpha u} u \widetilde{\mathcal{M}}\left(u \frac{k}{|k|}\right) du$$

is uniformly continuous with respect to  $k$  and  $\beta$ :

$$\begin{aligned} & \left| \int_0^{+\infty} e^{-i\beta u} e^{-\alpha_1 u} u \widetilde{\mathcal{M}}\left(u \frac{k}{|k|}\right) du - \int_0^{+\infty} e^{-i\beta u} e^{-\alpha_2 u} u \widetilde{\mathcal{M}}\left(u \frac{k}{|k|}\right) du \right| \\ & \leq \int_0^{+\infty} |e^{-\alpha_1 u} - e^{-\alpha_2 u}| |u \widetilde{\mathcal{M}}\left(u \frac{k}{|k|}\right)| du \xrightarrow{|\alpha_1 - \alpha_2| \rightarrow 0} 0, \end{aligned}$$

where the convergence is obviously uniform with respect to  $\beta$  and where the assumption  $\mathcal{M} \in H_P^\sigma$  (resp.  $\mathcal{M} \in \mathcal{G}_P^{\nu_0, 0; 1}$ ) implies  $|\widetilde{\mathcal{M}}(\xi)| \lesssim \langle \xi \rangle^{-\sigma}$  (resp.  $|\widetilde{\mathcal{M}}(\xi)| \lesssim e^{-\nu_0 \langle \xi \rangle}$ ) and thus the uniform convergence with respect to  $k$ . Since the convergence of  $\mathcal{L}\mathcal{K}$  to 0 when

$\alpha \rightarrow +\infty$  is uniform with respect to  $\beta$ , we can consider  $\alpha$  in a compact subset of  $(0, \infty)$  and then (by uniform continuity) only a finite number of  $\alpha$ 's. The convergence of  $\mathcal{L}\mathcal{K}$  to 0 when  $|\beta| \rightarrow +\infty$  is then also uniform in  $\alpha$ . Now, we know that outside of a compact of  $\{\omega \in \mathbb{C}, \operatorname{Re}(\omega) \geq 0\} \times \mathbb{Z}^d \setminus \{0\}$  the application  $(\omega, k) \mapsto \mathcal{L}\mathcal{K}(\omega|k|, k)$  is far from 1. Since in a compact of this set there is a finite number of modes  $k$  and since the application  $\omega \mapsto \mathcal{L}\mathcal{K}(\omega|k|, k)$  is continuous, condition **(L)** is satisfied if and only if  $\mathcal{L}\mathcal{K}(\omega|k|, k) \neq 1$  for every  $k \in \mathbb{Z}^d \setminus \{0\}$  and every  $\omega \in \mathbb{C}$  such that  $\operatorname{Re}(\omega) \geq 0$ .

**Second case:  $\mathbb{X}^d = \mathbb{R}^d$  and **(L)**.** This case is not far from the previous one, we only have to understand what happens when  $k$  lives in a *continuum space* like  $\mathbb{R}^d \setminus \{0\}$ . If we fix some  $\delta > 0$  arbitrarily small and if we only consider the infimum over  $\{|k| \geq \delta\}$ , then we can follow the same strategy, up to the fact that we have now to justify the uniform continuity of

$$k \mapsto \int_0^{+\infty} e^{-i\beta u} e^{-\alpha u} u \widehat{\mathcal{M}}\left(u \frac{k}{|k|}\right) du$$

with respect to  $\beta$ . Since  $\mathcal{M} \in H_P^g$  (resp.  $\mathcal{M} \in \mathcal{G}_P^{\nu_0, 0; 1}$ ) implies  $\xi \mapsto \widehat{\mathcal{M}}(\xi)$  is continuous and since  $|e^{-i\beta u}| \leq 1$ , this is obviously the case.

Next, we study what happens when  $k$  goes to 0 (this point is irrelevant for the usual Vlasov case: since the potential is singular at 0 the symbol  $\mathcal{L}\mathcal{K}$  can not reach 1 when  $k \rightarrow 0$ ). It is not possible to extend  $k \mapsto \mathcal{L}\mathcal{K}(\omega|k|, k)$  by continuity at 0, but for every sequence  $(k_n)_{n \in \mathbb{N}}$  such that  $k_n \rightarrow 0$ , up to a sub-sequence, we can assume that  $(k_n/|k_n|)_{n \in \mathbb{N}}$  converges to a certain  $\sigma^\infty$ . Then we are led to

$$\lim_{n \rightarrow +\infty} \mathcal{L}\mathcal{K}(\omega|k_n|, k_n) = |\widehat{\sigma}_1(0)|^2 \left( \int_0^{+\infty} p_c(t) dt \right) \left( \int_0^{+\infty} e^{-\omega u} u \widehat{\mathcal{M}}(u\sigma^\infty) du \right).$$

Since  $\int_0^\infty p_c dt = \kappa/c^2$ , we conclude that **(L)** is satisfied if and only if for every  $k \in \mathbb{R}^d \setminus \{0\}$ ,  $\sigma \in \mathbb{S}^{d-1}$ ,  $\omega \in \mathbb{C}$  with  $\operatorname{Re}(\omega) \geq 0$ ,

$$\mathcal{L}\mathcal{K}(\omega|k|, k) \neq 1 \quad \text{and} \quad \mathcal{L}(\omega, \sigma) = \frac{\kappa}{c^2} |\widehat{\sigma}_1(0)|^2 \left( \int_0^{+\infty} e^{-\omega u} u \widehat{\mathcal{M}}(u\sigma) du \right) \neq 1.$$

**Third case:  $\mathbb{X}^d = \mathbb{T}^d$  and **(L')**.** In this case we first prove that if the criterion **(L')** is satisfied for a certain  $\kappa > 0$  for all  $\omega = \alpha + i\beta$  with  $\alpha \geq 0$ , we can find  $\Lambda > 0$  such that (possibly replacing  $\kappa$  by  $\kappa/2$ ) criterion **(L')** is satisfied for all  $\omega = \alpha + i\beta$  with  $\alpha > -\Lambda$ . From that point we can then apply the arguments of the first case in order to conclude that **(L')** is satisfied if and only if  $\mathcal{L}\mathcal{K}(\omega|k|, k) \neq 1$  for every  $k \in \mathbb{Z}^d \setminus \{0\}$  and  $\omega \in \mathbb{C}$  with  $\operatorname{Re}(\omega) \geq 0$ . Let us justify the first point. Thanks to the uniform convergence to 0 with respect to  $\alpha$  and  $\beta$  of  $\mathcal{L}\mathcal{K}$  when  $|k| \rightarrow +\infty$ , we can restrict ourselves to the case of bounded Fourier modes  $k$ . Then we show the uniform continuity with respect to  $k$  (with  $|k|$  bounded) and  $\beta$  of  $\alpha \mapsto \mathcal{L}\mathcal{K}((\alpha + i\beta)|k|, k)$  which implies the required conclusion. Since we have already seen that

$$\alpha \mapsto \int_0^{+\infty} e^{-(\alpha+i\beta)u} u \widehat{\mathcal{M}}\left(u \frac{k}{|k|}\right) du$$

is uniformly continuous with respect to  $k$  and  $\beta$  it only remains to prove that

$$\alpha \mapsto \int_0^{+\infty} e^{-(\alpha+i\beta)|k|t} p_c(t) dt$$

is uniformly continuous with respect to  $k$  and  $\beta$ :

$$\left| \int_0^{+\infty} e^{-(\alpha_1+i\beta)|k|t} p_c(t) dt - \int_0^{+\infty} e^{-(\alpha_2+i\beta)|k|t} p_c(t) dt \right| \leq \int_0^{+\infty} |e^{-\alpha_1|k|t} - e^{-\alpha_2|k|t}| |p_c(t)| dt$$

This convergence is obviously uniform with respect to  $\beta$  and the uniformity with respect to  $k$  is only possible when  $|k|$  is bounded.

**Fourth case:**  $\mathbb{X}^d = \mathbb{R}^d$  **and**  $(\mathbf{L}')$ . By combining the arguments of the third and second cases we obtain that  $(\mathbf{L}')$  is satisfied if and only if for every  $k \in \mathbb{R}^d \setminus \{0\}$ ,  $\sigma \in \mathbb{S}^{d-1}$ ,  $\omega \in \mathbb{C}$  with  $\operatorname{Re}(\omega) \geq 0$ ,

$$\mathcal{L}\mathcal{K}(\omega|k|, k) \neq 1 \quad \text{and} \quad \mathcal{L}(\omega, \sigma) \neq 1.$$

The second step of the argument consists in applying Rouché's theorem in order to compute the number of zeros of  $\omega \mapsto \mathcal{L}\mathcal{K}(\omega|k|, k) - 1$  in a certain compact of  $\{\omega \in \mathbb{C}, \operatorname{Re}(\omega) \geq 0\}$  (note that is possible to justify that  $\omega \mapsto \mathcal{L}\mathcal{K}(\omega|k|, k)$  is holomorphic). To be more specific, the previous step allows us to find a radius  $\Omega > 0$  such that  $\mathcal{L}\mathcal{K}$  is far from 1 for every  $k$  and  $\omega \in \mathbb{C}$  with  $\operatorname{Re}(\omega) \geq 0$  and  $|\omega| \geq \Omega$ . If we assume, for every  $k$ , that  $\omega \mapsto \mathcal{L}\mathcal{K}(\omega|k|, k)$  never achieves the value 1 on the imaginary axis, then Rouché's theorem tells us that the number of zeros of  $\omega \mapsto \mathcal{L}\mathcal{K}(\omega|k|, k) - 1$  is equal to

$$N = \frac{1}{2i\pi} \int_{\Gamma_\Omega} \frac{\partial_\omega \mathcal{L}\mathcal{K}(\omega|k|, k)}{\mathcal{L}\mathcal{K}(\omega|k|, k) - 1} d\omega \quad (2.60)$$

where  $\Gamma_\Omega = C_\Omega \cup [-i\Omega, i\Omega]$  with  $C_\Omega = \{\Omega e^{i\theta}, \theta \in [\pi/2, 3\pi/2]\}$  (depending on the case, we have to be cautious when we apply Rouché's theorem, see Remark 2.5.2 below). We split the integral over the path  $\Gamma_\Omega$  into a contribution over  $C_\Omega$  and an other contribution over  $[-i\Omega, i\Omega]$  and we let  $\Omega$  go to  $+\infty$ : we can justify (see Remark 2.5.3 below) that the integral over  $C_\Omega$  goes to 0 and we eventually obtain

$$N = \frac{1}{2i\pi} \int_{\mathcal{L}\mathcal{K}(i|k|\mathbb{R}, k)} \frac{1}{z - 1} dz.$$

Since  $\mathcal{L}\mathcal{K}(i\beta|k|, k) \rightarrow 0$  when  $\beta \rightarrow \pm\infty$ ,  $\mathcal{L}\mathcal{K}(i|k|\mathbb{R}, k) \cup \{0\}$  is a closed path in  $\mathbb{C}$  (which does not cross 1) and we deduce that  $\mathcal{L}\mathcal{K}(i\omega|k|, k) \neq 1$  for every  $k$  and  $\omega \in \mathbb{C}$  with  $\operatorname{Re}(\omega) \geq 0$  if and only if  $\mathcal{L}\mathcal{K}(i\beta|k|, k) \neq 1$  for every  $k$  and  $\beta \in \mathbb{R}$  **and** the winding number of the path  $\mathcal{L}\mathcal{K}(i|k|\mathbb{R}, k) \cup \{0\}$  around 1 is equal to 0. This formulation eventually allows us to obtain the announced sufficient (but not necessary) criterion: if for every  $k$  and  $\beta \in \mathbb{R}$

$$\operatorname{Im}(\mathcal{L}\mathcal{K}(i\beta|k|, k)) = 0 \quad \implies \quad \operatorname{Re}(\mathcal{L}\mathcal{K}(i\beta|k|, k)) < 1,$$

then the linear stability criterion is satisfied.

**Remark 2.5.1** For  $\mathbb{X}^d = \mathbb{R}^d$  the second step has to be performed also on the symbol  $\mathcal{L}$ . Then the complete sufficient condition is: if for every  $k \in \mathbb{R}^d \setminus \{0\}$  and  $\sigma \in \mathbb{S}^{d-1}$ ,  $\beta \in \mathbb{R} \mapsto \mathcal{L}\mathcal{K}(i\beta|k|, k)$  **and**  $\beta \in \mathbb{R} \mapsto \mathcal{L}(i\beta, \sigma)$  never crosses the real-axis beyond 1, then the linear stability criterion is satisfied.

**Remark 2.5.2** (i) In the case  $\mathcal{M} \in \mathcal{G}_P^{\nu_0, 0; 1}$  and  $p_c$  compactly supported, one can justify that  $\omega \mapsto \mathcal{L}\mathcal{K}(\omega|k|, k)$  is holomorphic on a set of the form  $\{\omega \in \mathbb{C} \text{ s.t. } \operatorname{Re}(\omega) > -\Lambda\}$  with  $\Lambda > 0$  and Rouché's theorem can be applied without any additional difficulties.

(ii) In the case  $\mathcal{M} \in H_P^\sigma$  and  $p_c$  has a polynomial decay,  $\omega \mapsto \mathcal{L}\mathcal{K}(\omega|k|, k)$  is holomorphic on the set  $\{\omega \in \mathbb{C} \text{ s.t. } \operatorname{Re}(\omega) > 0\}$  which does not contain the imaginary line and we have thus to be cautious when we apply Rouché's theorem. We overcome this difficulty as follow:

- We first chose  $\Omega > 0$  sufficiently large in order to insure that all the zeros of  $\omega \mapsto \mathcal{L}\mathcal{K}(\omega|k|, k) - 1$  are on the interior of the bounded domain with boundary  $\Gamma_\Omega$ . We consider then a sequence of closed path  $(\Gamma_\varepsilon)_\varepsilon$  included in  $\{\omega \in \mathbb{C} \text{ s.t } \text{Re}(\omega) > 0\}$  and converging to  $\Gamma_\Omega$ .
- Then, the uniform continuity of  $\alpha \in \mathbb{R}_+ \mapsto \mathcal{L}\mathcal{K}((\alpha + i\beta)|k|, k)$  with respect to  $\beta$  and  $k$  insures that for  $\varepsilon > 0$  sufficiently small all the zeros of  $\omega \mapsto \mathcal{L}\mathcal{K}(\omega|k|, k) - 1$  are on the interior of the bounded domains with boundary  $\Gamma_\varepsilon$ . We can thus apply Rouché's theorem on these closed paths:

$$N = \frac{1}{2i\pi} \int_{\Gamma_\varepsilon} \frac{\partial_\omega \mathcal{L}\mathcal{K}(\omega|k|, k)}{\mathcal{L}\mathcal{K}(\omega|k|, k) - 1} d\omega.$$

- We conclude by remarking that on these paths, since  $\mathcal{L}\mathcal{K}(\omega|k|, k)$  is far from 1,

$$\omega \mapsto \frac{\partial_\omega \mathcal{L}\mathcal{K}(\omega|k|, k)}{\mathcal{L}\mathcal{K}(\omega|k|, k) - 1}$$

is continuous and then, since these closed paths are bounded we get

$$N = \frac{1}{2i\pi} \int_{\Gamma_\varepsilon} \frac{\partial_\omega \mathcal{L}\mathcal{K}(\omega|k|, k)}{\mathcal{L}\mathcal{K}(\omega|k|, k) - 1} d\omega \xrightarrow{\varepsilon \rightarrow 0} \frac{1}{2i\pi} \int_{\Gamma_\Omega} \frac{\partial_\omega \mathcal{L}\mathcal{K}(\omega|k|, k)}{\mathcal{L}\mathcal{K}(\omega|k|, k) - 1} d\omega.$$

**Remark 2.5.3** In order to justify the limit  $\Omega \rightarrow +\infty$  in (2.60) it is sufficient to prove that  $|\partial_\omega \mathcal{L}\mathcal{K}(\omega|k|, k)| \lesssim \langle \omega \rangle^{-2}$ . For example, in that case we get

$$\left| \frac{1}{2i\pi} \int_{C_\Omega} \frac{\partial_\omega \mathcal{L}\mathcal{K}(\omega|k|, k)}{\mathcal{L}\mathcal{K}(\omega|k|, k) - 1} d\omega \right| \leq \frac{\Omega}{2\pi\kappa} \int_{\pi/2}^{3\pi/2} |\partial_\omega \mathcal{L}\mathcal{K}(\Omega e^{i\theta}|k|, k)| d\theta \leq \frac{\Omega}{2\kappa} \langle \Omega \rangle^{-2} \xrightarrow{\Omega \rightarrow +\infty} 0.$$

Since

$$\begin{aligned} \partial_\omega \mathcal{L}\mathcal{K}(\omega|k|, k) &= |\hat{\sigma}_1(k)|^2 \left( \int_0^{+\infty} -i|k|te^{-i\omega|k|t} p_c(t) dt \right) \left( \int_0^{+\infty} e^{-i\omega u} u \widetilde{\mathcal{M}}\left(u \frac{k}{|k|}\right) du \right) \\ &\quad + |\hat{\sigma}_1(k)|^2 \left( \int_0^{+\infty} e^{-i\omega|k|t} p_c(t) dt \right) \left( \int_0^{+\infty} -iue^{-i\omega u} u \widetilde{\mathcal{M}}\left(u \frac{k}{|k|}\right) du \right), \end{aligned}$$

we get

$$\begin{aligned} |\partial_\omega \mathcal{L}\mathcal{K}(\omega|k|, k)| &\leq \left( \sup_k |k| |\hat{\sigma}_1(k)|^2 \right) \|t \mapsto tp_c(t)\|_{L_t^1} \left| \int_0^{+\infty} e^{-i\omega u} u \widetilde{\mathcal{M}}\left(u \frac{k}{|k|}\right) du \right| \\ &\quad + \|\sigma_1\|_{L_x^1}^2 \|p_c\|_{L_t^1} \left| \int_0^{+\infty} e^{-i\omega u} u^2 \widetilde{\mathcal{M}}\left(u \frac{k}{|k|}\right) du \right|. \end{aligned}$$

Moreover

$$\left| \int_0^{+\infty} e^{-i\omega u} u^2 \widetilde{\mathcal{M}}\left(u \frac{k}{|k|}\right) du \right| = \left| \int_0^{+\infty} \frac{e^{-i\omega u}}{\omega^2} \frac{d^2}{du^2} \left\{ u \mapsto u^2 \widetilde{\mathcal{M}}\left(u \frac{k}{|k|}\right) \right\} du \right|$$

which will give us the right estimation if we are able to justify that

$$\frac{d^2}{du^2} \left\{ u \mapsto u^2 \widetilde{\mathcal{M}}\left(u \frac{k}{|k|}\right) \right\}$$

is integrable. As we have already seen it (see Lemma 2.3.5),  $\mathcal{M} \in H_P^\sigma$  with  $P > d/2$  implies that

$$\|\xi \mapsto \langle \xi \rangle^\sigma \widehat{\mathcal{M}}(\xi)\|_{C^0} \lesssim \|\mathcal{M}\|_{H_P^\sigma},$$

and the same reasoning shows that  $\mathcal{M} \in H_P^\sigma$  with  $P > d/2 + 2$  implies

$$\|\xi \mapsto \langle \xi \rangle^\sigma \widehat{\mathcal{M}}(\xi)\|_{C^2} \lesssim \|\mathcal{M}\|_{H_P^\sigma}$$

which gives us the required estimation when  $\sigma > 0$  is sufficiently large.

### 2.5.2 Computations of Laplace transforms for the Penrose criterion

In order to find an expression for the stability criterion, we compute  $\mathcal{L}\mathcal{K}(\omega|k|, k)$  on the imaginary axis: namely, with  $\beta \in \mathbb{R}$ , we consider

$$\begin{aligned} \mathcal{L}\mathcal{K}(i\beta|k|, k) &= \lim_{\substack{\alpha \rightarrow 0 \\ \alpha > 0}} \mathcal{L}\mathcal{K}((\alpha + i\beta)|k|, k) \\ &= \rho_0 |\widehat{\sigma}_1(k)|^2 \left\{ \lim_{\substack{\alpha \rightarrow 0 \\ \alpha > 0}} \mathcal{L}p_c((\alpha + i\beta)|k|) \right\} \left\{ \lim_{\substack{\alpha \rightarrow 0 \\ \alpha > 0}} \mathcal{L}(t|k|^2 \widehat{M}(tk))((\alpha + i\beta)|k|) \right\}. \end{aligned}$$

where

$$v \mapsto \mathcal{M}(v) = \rho_0 M(v), \quad \rho_0 > 0, \quad \int M(v) dv = 1.$$

The computation of the Laplace transform of  $t \mapsto t|k|^2 \widehat{M}(tk)$  is based on the Plemelj formula; see [33, Example 5.2], which leads to (see [87, Proposition 2.1])

$$\lim_{\substack{\alpha \rightarrow 0 \\ \alpha > 0}} \mathcal{L}(t|k|^2 \widehat{M}(kt))((\alpha + i\beta)|k|, k) = -\text{P.V.} \int_{\mathbb{R}} \frac{\mu'_{k/|k|}(r)}{r + \beta} dr - i\pi \mu'_{k/|k|}(-\beta),$$

where P.V. denotes the usual *principal value operator* and where  $\mu_{k/|k|}$  is the one-dimensional marginal of  $M$  defined by

$$\mu_{k/|k|}(r) = \int_{v_\perp \cdot k = 0} M\left(r \frac{k}{|k|} + v_\perp\right) dv_\perp.$$

Next, the Laplace transform of  $p_c$  can be determined by using the classical result [95, Formula (VI,2;13)]

$$\mathcal{L}(\mathbf{1}_{t \geq 0} \sin(\theta t))(\omega) = \frac{\theta}{\omega^2 + \theta^2}, \quad \text{for } \text{Re}(\omega) > 0.$$

For  $\alpha > 0$ ,  $\beta \in \mathbb{R}$ , we thus get (we recall that  $p_c$  is defined by (2.5))

$$\mathcal{L}p_c((\alpha + i\beta)|k|) = \frac{1}{(2\pi)^n} \int_{\mathbb{R}^n} \frac{|\widehat{\sigma}_2(\zeta)|^2}{(\alpha + i\beta)^2 |k|^2 + c^2 |\zeta|^2} d\zeta.$$

Since  $\sigma_2$  is radially symmetric, its Fourier transform is radially symmetric too and we can write

$$\mathcal{L}p_c((\alpha + i\beta)|k|) = \frac{|\mathbb{S}^{n-1}|}{(2\pi)^n} \int_0^{+\infty} \frac{r^{n-1} |\widehat{\sigma}_2(r)|^2}{(\alpha^2 - \beta^2) |k|^2 + c^2 r^2 + 2i\alpha\beta |k|^2} dr.$$

In order to compute this integral we will apply the following Plemelj-like formula.



**Lemma 2.5.4** *Let  $n \geq 3$ . Let  $f : \mathbb{R} \rightarrow \mathbb{R}$  be Schwartz class. We have for any  $\kappa \neq 0$ ,*

$$\lim_{\substack{\lambda \rightarrow 0 \\ \lambda > 0}} \int_0^{+\infty} \frac{r^{n-1} f(r)}{r^2 - \kappa^2 + \lambda^2 + 2i\kappa\lambda} dr = \text{P.V.} \int_0^{+\infty} \frac{r^{n-1} f(r)}{r^2 - \kappa^2} dr - \text{sgn}(\kappa) \frac{i\pi}{2} \kappa^{n-2} f(|\kappa|).$$

We postpone the proof of this claim at the end of the section. We apply this formula with  $f(r) = |\widehat{\sigma}_2(r)|^2$ ,  $\lambda = \alpha|k|/c$  and  $\kappa = \beta|k|/c$  in order to obtain

$$\begin{aligned} & \lim_{\substack{\alpha \rightarrow 0 \\ \alpha > 0}} \mathcal{L}p_c((\alpha + i\beta)|k|) \\ &= \frac{1}{c^2} \frac{|\mathbb{S}^{n-1}|}{(2\pi)^n} \left( \text{P.V.} \int_0^{+\infty} \frac{r^{n-1} |\widehat{\sigma}_2(r)|^2}{r^2 - \frac{\beta^2|k|^2}{c^2}} dr - \text{sgn}(\beta) \frac{i\pi}{2} \left(\frac{\beta|k|}{c}\right)^{n-2} \left| \widehat{\sigma}_2\left(\frac{|\beta k|}{c}\right) \right|^2 \right). \end{aligned}$$

We point out that Lemma 2.5.4 cannot be applied with  $\beta = 0$ , nevertheless the previous formula makes sense even when  $\beta = 0$ : in this case a direct application of the dominated convergence theorem allows us to obtain

$$\lim_{\substack{\alpha \rightarrow 0 \\ \alpha > 0}} \mathcal{L}p_c(\alpha|k|) = \frac{1}{(2\pi)^n} \int_{\mathbb{R}^n} \frac{|\widehat{\sigma}_2(\zeta)|^2}{c^2 |\zeta|^2} d\zeta = \frac{\kappa}{c^2}.$$

which is consistent with the general formula.

Therefore, we obtain the following expression for  $\mathcal{L}\mathcal{H}(i\beta|k|, k)$  which identifies the real and imaginary parts

$$\mathcal{L}\mathcal{H}(i\beta|k|, k) = \frac{\rho_0}{c^2} \frac{|\mathbb{S}^{n-1}|}{(2\pi)^n} |\widehat{\sigma}_1(k)|^2 (\mathcal{R}(\beta|k|, k) + i\mathcal{I}(\beta|k|, k)),$$

where

$$\begin{aligned} \mathcal{R}(\beta|k|, k) &= - \left( \text{P.V.} \int_0^{+\infty} \frac{r^{n-1} |\widehat{\sigma}_2(r)|^2}{r^2 - \frac{\beta^2|k|^2}{c^2}} dr \right) \left( \text{P.V.} \int_{\mathbb{R}} \frac{\mu'_{k/|k|}(r)}{r + \beta} dr \right) \\ &\quad - \text{sgn}(\beta) \frac{\pi^2}{2} \left(\frac{\beta|k|}{c}\right)^{n-2} \left| \widehat{\sigma}_2\left(\frac{|\beta k|}{c}\right) \right|^2 \mu'_{k/|k|}(-\beta), \end{aligned}$$

and

$$\begin{aligned} \mathcal{I}(\beta|k|, k) &= -\pi \mu'_{k/|k|}(-\beta) \left( \text{P.V.} \int_0^{+\infty} \frac{r^{n-1} |\widehat{\sigma}_2(r)|^2}{r^2 - \frac{\beta^2|k|^2}{c^2}} dr \right) \\ &\quad + \text{sgn}(\beta) \frac{\pi}{2} \left(\frac{\beta|k|}{c}\right)^{n-2} \left| \widehat{\sigma}_2\left(\frac{|\beta k|}{c}\right) \right|^2 \left( \text{P.V.} \int_{\mathbb{R}} \frac{\mu'_{k/|k|}(r)}{r + \beta} dr \right). \end{aligned}$$

It leads to the *Penrose stability criterion*, hereafter denoted **(P)**:

<p>If</p> $\frac{\operatorname{sgn}(\beta)}{2} \left(\frac{\beta k }{c}\right)^{n-2} \left \widehat{\sigma}_2\left(\frac{ \beta k }{c}\right)\right ^2 \left(\text{P.V.} \int_{\mathbb{R}} \frac{\mu'_{k/ k }(r)}{r + \beta} dr\right)$ $= \mu'_{k/ k }(-\beta) \left(\text{P.V.} \int_0^{+\infty} \frac{r^{n-1}  \widehat{\sigma}_2(r) ^2}{r^2 - \frac{\beta^2  k ^2}{c^2}} dr\right),$ <p>then</p> $-\frac{\rho_0}{c^2} \frac{ \mathbb{S}^{n-1} }{(2\pi)^n}  \widehat{\sigma}_1(k) ^2 \left\{ \left(\text{P.V.} \int_0^{+\infty} \frac{r^{n-1}  \widehat{\sigma}_2(r) ^2}{r^2 - \frac{\beta^2  k ^2}{c^2}} dr\right) \left(\text{P.V.} \int_{\mathbb{R}} \frac{\mu'_{k/ k }(r)}{r + \beta} dr\right) \right.$ $\left. + \operatorname{sgn}(\beta) \frac{\pi^2}{2} \left(\frac{\beta k }{c}\right)^{n-2} \left \widehat{\sigma}_2\left(\frac{ \beta k }{c}\right)\right ^2 \mu'_{k/ k }(-\beta) \right\} < 1.$
---

When  $\mathbb{X}^d = \mathbb{R}^d$ , the Penrose criterion **(P)** has to be completed with the following criterion (hereafter denoted **(P')**): for all  $\omega \in \mathbb{S}^d$

$$\text{if } \mu'_{\omega}(-\beta) = 0 \text{ then } -\frac{\rho_0 \kappa}{c^2} |\widehat{\sigma}_1(0)|^2 \left(\text{P.V.} \int_{\mathbb{R}} \frac{\mu'_{\omega}(r)}{r + \beta} dr\right) < 1,$$

We conclude that, when **(P)** (resp. **(P)** and **(P')**) is satisfied, then **(L)** holds. This criterion is much more involved than the Penrose criterion for the Vlasov equation, because the memory term  $p_c$  completely changes the evaluation of the symbol  $\mathcal{L}\mathcal{K}$  and does not keep a simple separation between the real and imaginary parts.

**Remark 2.5.5** *Let us rescale the problem as in [25]: roughly speaking, it amounts to replace the wave equation by*

$$\partial_{tt}^2 \psi - c^2 \Delta_z \psi = -c^2 \sigma_2 \sigma_1 \star \rho.$$

*Letting  $c$  run to  $+\infty$ , the problem looks like the Vlasov equation where the self-consistent potential is defined by the convolution  $-\kappa \sigma_1 \star \sigma_1 \star \rho$ . According to [87], the stability criterion for this limiting problem reads*

$$\text{if } \mu'_{k/|k|}(-\beta) = 0, \text{ then } -\rho_0 \kappa |\widehat{\sigma}_1(k)|^2 \left(\text{P.V.} \int_{\mathbb{R}} \frac{\mu'_{k/|k|}(r)}{r + \beta} dr\right) < 1,$$

*which corresponds to the limit  $c \rightarrow +\infty$  in the rescaled version of **(P)** (note that in this scaling the symbol  $\mathcal{L}\mathcal{K}$  is multiplied by  $c^2$ ). In particular, mind the minus sign in front of the coefficient  $\rho_0 |\widehat{\sigma}_1(k)|^2$ : it makes the situation very similar to those of the attractive Vlasov-system.*

We finish this section with the proof of the Plemelj like formula that we used in order to compute the Laplace transform of  $p_c$ .

**Proof of Lemma 2.5.4.** Let us denote by  $I(\lambda)$  the quantity under consideration and  $f(r) = g(r^2)$ ; with the change of variable  $u = r^2$  we get

$$I(\lambda) = \frac{1}{2} \int_0^{+\infty} \frac{\gamma(u)}{u - \kappa^2 + \lambda^2 + 2i\kappa\lambda} du,$$

where  $\gamma(u) = u^{n/2-1} g(u)$ . We adapt the computations that lead to Plemelj's formula. It is crucial to remark that

$$\gamma' \in L^p((0, \infty)) \text{ for some } 1 < p < 2. \quad (2.61)$$

(At worst,  $\gamma'(u)$  has the same singularity as  $1/\sqrt{u}$  as  $u \rightarrow 0$ .) We start with

$$I(\lambda) = \frac{1}{2} \int_0^{+\infty} \frac{\gamma(u)}{(u - \kappa^2 + \lambda^2)^2 + 4\kappa^2\lambda^2} (u - \kappa^2 + \lambda^2) du - \frac{2i\kappa\lambda}{2} \int_0^{+\infty} \frac{\gamma(u)}{(u - \kappa^2 + \lambda^2)^2 + 4\kappa^2\lambda^2} du.$$

Setting  $v = u - \kappa^2 + \lambda^2$ , and  $w = v/(2|\kappa|\lambda)$ , the second term recasts as

$$-\frac{i}{2} \frac{\kappa}{|\kappa|} \int_{-\kappa^2+\lambda^2}^{+\infty} \frac{\gamma(v + \kappa^2 - \lambda^2)}{\left(\frac{v}{2|\kappa|\lambda}\right)^2 + 1} \frac{dv}{2|\kappa|\lambda} = -\text{sgn}(\kappa) \frac{i}{2} \int_{-\frac{1}{2}\left(\frac{\lambda}{|\kappa|} - \frac{|\kappa|}{\lambda}\right)}^{+\infty} \frac{\gamma(2|\kappa|\lambda w + \kappa^2 - \lambda^2)}{w^2 + 1} dw$$

which tends to  $-i \text{sgn}(\kappa) \pi \gamma(\kappa^2)/2$  as  $\lambda \rightarrow 0$ . Similarly, we consider

$$J(\lambda) = \int_{-\kappa^2+\lambda^2}^{+\infty} \frac{v}{v^2 + 4\kappa^2\lambda^2} \gamma(v + \kappa^2 - \lambda^2) dv.$$

Since  $\lambda$  is intended to tend to 0, we can consider  $\kappa^2 \gg \lambda^2 > 0$ . Given  $0 < \delta < \kappa^2 - \lambda^2$ , we split into 2 parts

$$J(\lambda) = \int_{|v|>\delta} \dots dv + \int_{-\delta}^{+\delta} \dots dv = J^\delta(\lambda) + J_\delta(\lambda).$$

First, we show that  $J_\delta(\lambda)$  tends to 0 as  $\delta \rightarrow 0$ , uniformly with respect to  $\lambda$ . Indeed, since  $v \mapsto v/(v^2 + \lambda^2)$  is odd and thanks to (2.61), we have

$$|J_\delta(\lambda)| = \left| \int_{-\delta}^{+\delta} \frac{v}{v^2 + 4\kappa^2\lambda^2} [\gamma(v + \kappa^2 - \lambda^2) - \gamma(\kappa^2 - \lambda^2)] dv \right| \leq \|\gamma'\|_{L^p} \int_{-\delta}^{+\delta} \frac{1}{|v|^{1/p}} dv \xrightarrow{\delta \rightarrow 0} 0.$$

By dominated convergence, we get (owing to the fast decay at infinity of  $\gamma'$ )

$$\begin{aligned} \lim_{\lambda \rightarrow 0} J^\delta(\lambda) &= \int_{|v|>\delta} \mathbf{1}_{v \geq -\kappa^2} \frac{\gamma(v + \kappa^2)}{v} dv \\ &= \int_{-\kappa^2}^{-\delta} \frac{\gamma(v + \kappa^2) - \gamma(\kappa^2)}{v} dv + \int_{\delta}^{\kappa^2} \frac{\gamma(v + \kappa^2) - \gamma(\kappa^2)}{v} dv + \int_{\kappa^2}^{+\infty} \frac{\gamma(v + \kappa^2)}{v} dv. \end{aligned}$$

The same reasoning shows that this quantity admits a limit as  $\delta$  goes 0, that we write with the shorthand notation

$$\lim_{\delta \rightarrow 0} \lim_{\lambda \rightarrow 0} J^\delta(\lambda) = \text{P.V.} \int_{-\kappa^2}^{\infty} \frac{\gamma(v + \kappa^2)}{v} dv. \quad \blacksquare$$

### 2.5.3 Stable and unstable states

The criterion **(P)** is a bit ugly and not that practical. Nevertheless, some relevant information can be extracted from the formula, showing again the similarity with the attractive Vlasov-Poisson equation.

**Proposition 2.5.6** *Let  $\mathbb{X}^d = \mathbb{R}^d$  with  $d \geq 3$ . Let  $\mathcal{M}$  be a spatially homogeneous and radially symmetric equilibrium. Then, there exists a threshold for the wave speed  $c_0(\mathcal{M}, \sigma_1, \sigma_2) > 0$  such that for any  $0 < c < c_0(\mathcal{M}, \sigma_1, \sigma_2)$ ,  $\mathcal{M}$  is an unstable equilibrium state.*

**Proof.** We find  $k$  and  $\beta$  such that  $\mathcal{L}\mathcal{K}(i\beta|k|, k) = 1$ . To this end, we use the fact that  $\mathcal{L}p_c(i\beta|k|)$  belongs to  $\mathbb{R}$  for  $\beta = 0$  and the radial symmetry of  $\mathcal{M}$  which implies that  $\mathcal{L}(|k|^2 t\bar{M}(tk))(i\beta|k|, k)$  is real too when  $\beta = 0$ :

$$\mathcal{L}\mathcal{K}(0, k) = -\rho_0 |\hat{\sigma}_1(k)|^2 \left( \text{P.V.} \int_{\mathbb{R}} \frac{\mu'_{k/|k|}(r)}{r} dr \right) \frac{\kappa}{c^2}. \quad (2.62)$$

Moreover, the symmetry of  $\mathcal{M}$  (and the condition on the dimension  $d$ , see Remark 2.5.7 below) also ensures (except for  $\mathcal{M} = 0$ , but 0 is obviously a stable state)

$$- \left( \text{P.V.} \int_{\mathbb{R}} \frac{\mu'_{k/|k|}(r)}{r} dr \right) > 0.$$

Now let us pick a vector  $k_0$  such that  $\hat{\sigma}_1(k_0) \neq 0$ . As far as  $c$  is small enough, we have  $\mathcal{L}\mathcal{K}(0, k_0) > 1$ . Next,

$$\mathcal{L}\mathcal{K}(0, \lambda k_0) \xrightarrow{\lambda \rightarrow +\infty} 0$$

and the continuity of  $\lambda \in \mathbb{R} \mapsto \hat{\sigma}_1(\lambda k_0)$  (observe that  $\lambda k_0/|\lambda k_0|$  does not depend on  $\lambda$  and thus only  $\hat{\sigma}_1$  depends on  $\lambda$  in the expression of  $\mathcal{L}\mathcal{K}(0, \lambda k_0)$ ), allow us to exhibit a  $\lambda_0 \in \mathbb{R}$  such that  $\mathcal{L}\mathcal{K}(0, \lambda_0 k_0) = 1$ . ■

**Remark 2.5.7** *The condition  $d \geq 3$  ensures that all marginals of a non negative radially symmetric function  $\mathcal{M}$  are non increasing function of  $|v|$ , see [87, Remark 2.2], which yields*

$$- \left( \text{P.V.} \int_{\mathbb{R}} \frac{\mu'_{k/|k|}(r)}{r} dr \right) \geq 0. \quad (2.63)$$

*When  $d = 1$  or  $d = 2$  this does not hold in full generality. Nevertheless, Proposition 2.5.6 still holds provided (2.63) is fulfilled.*

**Remark 2.5.8** *When  $\mathbb{X}^d = \mathbb{T}^d$ , the same proof shows that, for any spatially homogeneous and radially symmetric equilibrium, we can find some wave speed  $c$  such that  $\mathcal{M}$  is unstable. However, since  $k \in \mathbb{Z}^d$ , it is not clear that we can exhibit a non trivial interval  $[0, c_0(\mathcal{M})]$  such that instability occurs.*

*To identify a threshold on  $c$  determining whether or not the stability criterion holds can be interpreted by means of Jeans' criterion, a standard criterion for the Vlasov-Poisson system, see [87, Proposition 2.1 & Remark 2.2]). To be more specific, let us consider a form function  $\sigma_1$  defined on  $\mathbb{R}^d$ , the Fourier transform of which has a singularity at  $\xi = 0$ : typically  $\hat{\sigma}_1(k) = |k|^{-\alpha}$  for some  $\alpha > 1$ . Of course, such singular potential is beyond the analysis detailed in this paper; we only use this assumption to establish a parallel with the usual Jeans' criterion. Let  $\sigma_1^{(L)}$  be the periodic potential defined on  $\mathbb{T}_L^d = (\mathbb{R}/(2\pi L\mathbb{Z}))^d$  by*

$$\sigma_1^{(L)}(x) = \sum_{k \in \mathbb{Z}^d} \sigma_1(x + 2\pi L k).$$

*Observing that  $\widehat{\sigma_1^{(L)}}(k) = \hat{\sigma}_1(k/L)$ , (2.62) becomes*

$$\mathcal{L}\mathcal{K}(0, k) = -\rho_0 \frac{L^{2\alpha}}{|k|^{2\alpha}} \left( \text{P.V.} \int_{\mathbb{R}} \frac{\mu'_{k/|k|}(r)}{r} dr \right) \frac{\kappa}{c^2},$$

*where  $L$  has a role similar to  $1/c$ . In particular, for any spatially homogeneous equilibrium  $\mathcal{M}$ , there exists a critical length  $L_J$  beyond which the equilibrium can be unstable, this defines Jeans' length.*

**Remark 2.5.9** Denoting  $\mathcal{M} = \rho_0 M$ , with  $M$  being normalized, we can equally say (with the same arguments) that, for any fixed wave speed  $c$  we can find a mass threshold  $m_0 = m_0(M, c, \sigma_1, \sigma_2) > 0$  such that for any  $\rho_0 > m_0(M, c, \sigma_1, \sigma_2)$ ,  $\mathcal{M}$  is unstable. Nevertheless we point out that, for  $c$  fixed, the mass  $\rho_0$  of the profile  $\mathcal{M}$  is not the unique quantity that governs the stability of  $\mathcal{M}$ , as indicated by the following claim

**Proposition 2.5.10** Let  $\mathcal{M}$  be a spatially homogeneous equilibrium. We can find two positive constants  $C_1 = C_1(c, \sigma_1, \sigma_2)$  and  $C_2 = C_2(c, \sigma_1, \sigma_2)$  such that

if, for any  $\omega \in \mathbb{S}^d$ , we have  $\int_0^{+\infty} u |\widehat{\mathcal{M}}(u\omega)| du \leq C_1(c, \sigma_1, \sigma_2)$ , then  $\mathcal{M}$  is stable,

if there exists  $\omega \in \mathbb{S}^d$  such that  $\int_0^{+\infty} u \widehat{\mathcal{M}}(u\omega) du \geq C_2(c, \sigma_1, \sigma_2)$ , then  $\mathcal{M}$  is unstable .

This statement can be interpreted as follows. For fixed  $c$ ,  $\sigma_1$  and  $\sigma_2$  there always exist stable spatially homogeneous equilibria with an arbitrarily large mass (resp. kinetic energy), and there always exist unstable spatially homogeneous equilibria with an arbitrarily small mass (resp. kinetic energy). This comes from the fact that the constant  $C_1$  and  $C_2$  in Proposition 2.5.10 are left invariant by the rescaling  $M \rightarrow M_\lambda(v) = \lambda^{d-2} \mathcal{M}(\lambda v)$ , while the associated mass (resp. kinetic energy) is invariant for the scaling  $M \rightarrow \lambda^d \mathcal{M}(\lambda v)$  (resp.  $M \rightarrow \lambda^{d+2} \mathcal{M}(\lambda v)$ ). These findings are investigated on numerical grounds in the next Chapter.

**Proof.** The first part of the statement is a direct consequence of Proposition 2.2.11, which tells us that a given profile  $\mathcal{M}$  is stable provided  $c$  is large enough. The second part of the statement is a direct consequence of Proposition 2.5.6 and it comes from the formula

$$\mathcal{L}(|k|^2 t \widehat{\mathcal{M}}(tk))(0, k) = \rho_0 \left( \text{P.V.} \int_{\mathbb{R}} \frac{\mu'_{k/|k|}(r)}{r} dr \right) = \int_0^{+\infty} u \widehat{\mathcal{M}}(u\omega) du.$$

■





---

 Numerical investigation of Landau damping in dynamical Lorentz gases
 

---

In this Chapter we continue the analysis of the Landau damping effect on the Vlasov-Wave system, but on numerical ground. At the end of the previous Chapter there were left two main questions: when  $c \sim 1$  is it "easy" in practice to obtain a stable homogeneous equilibrium ? and what happens in the case  $n = 1$  ? Since we will perform simulations on large time interval we need a numerical scheme which preserves as much as possible the structure of the Vlasov-Wave system. To be more specific, since the main physical interest of this system is that it describes the energy exchanges between particles and the environment, we took care to preserve this property at the discrete level. This strategy is quite general since we can apply it to the  $N$ -particles model. We performed several simulations in that case too in order to precise our insight on the influence of the physical quantity  $c$  (the wave speed) and  $n$  (the membrane's dimension).

The results of this Chapter are the content of the article [P2] jointly with T. Goudon. Note that the schemes are presented here in a slightly simpler (but equivalent) way than in [P2].

### 3.1 Introduction

This work is devoted to the numerical investigation of equations modeling the interaction of particles with their environment, according to a description originally introduced by L. Bruneau & S. de Bièvre [16]. We refer the reader to Fig. 3.1 for a rough picture that can guide the intuition on this description. Particles evolve in the physical space  $\mathbb{R}^d$ , and the behavior of the environment is embodied into a vibration field which waves in the transverse direction  $\mathbb{R}^n$ . The motion space and the vibration space are distincts and there is no a priori relation between  $n$  and  $d$ . The environment can be thought of as a (continuum) set of membranes, activated by the passage of the particles, as depicted in Fig. 3.1, and on each position  $x \in \mathbb{R}^d$ , the particles can exchange momentum and energy with the membranes.

The interaction is thus driven by the following parameters:

- two form functions  $x \in \mathbb{R}^d \mapsto \sigma_1(x)$  and  $z \in \mathbb{R}^n \mapsto \sigma_2(z)$  determine the interaction domain, in the physical and the transverse directions respectively, between the particles and the waves; they are both non negative, spherically symmetric, infinitely smooth and compactly supported;
- the vibration field is characterized by the (uniform) wave speed  $c > 0$ .



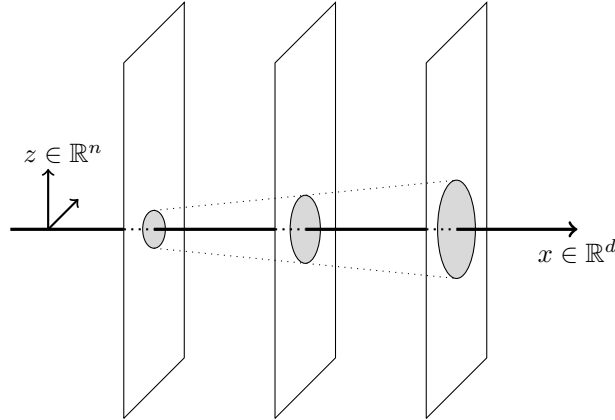

Figure 3.1: Particle-wave interactions

As we shall see below, the dimension  $n$  of the vibrational direction plays also a fundamental role.

The behavior of a *single particle* governed by this dynamics is discussed in [16]: with  $q(t)$  denoting the position of the particle, and  $\psi(t, x, z)$  describing the environment, one considers the system

$$\ddot{q}(t) = -\nabla W(q(t)) - \iint_{\mathbb{R}^d \times \mathbb{R}^n} \sigma_1(q(t) - y)\sigma_2(z)\nabla_y \psi(t, y, z) \, dy \, dz, \tag{3.1a}$$

$$\partial_{tt}^2 \psi - c^2 \Delta_z \psi = -\sigma_2(z)\sigma_1(x - q(t)), \tag{3.1b}$$

for  $t \geq 0$ ,  $x \in \mathbb{R}^d$ ,  $z \in \mathbb{R}^n$ . Equation (3.1a) also takes into account the effect of an external potential  $x \mapsto W(x)$ . The system (3.1a)–(3.1b) is completed by initial data

$$(q(0), \dot{q}(0)) = (q_0, p_0), \quad (\psi(0, x, z), \partial_t \psi(0, x, z)) = (\psi_0(x, z), \psi_1(x, z)). \tag{3.2}$$

A fundamental feature of the model is the conservation of the total energy. Let

$$E_{\text{particle}}(t) = \frac{1}{2} \dot{q}(t)^2 + W(q(t)) + \iint_{\mathbb{R}^d \times \mathbb{R}^n} \sigma_1(q(t) - y)\sigma_2(z)\psi(t, y, z) \, dy \, dz \tag{3.3}$$

and

$$E_{\text{wave}}(t) = \frac{1}{2} \iint_{\mathbb{R}^d \times \mathbb{R}^n} |\partial_t \psi(t, x, z)|^2 \, dx \, dz + \frac{c^2}{2} \iint_{\mathbb{R}^d \times \mathbb{R}^n} |\nabla_z \psi(t, x, z)|^2 \, dx \, dz. \tag{3.4}$$

Then, we have

$$E(t) = E_{\text{particle}}(t) + E_{\text{wave}}(t) = E(0). \tag{3.5}$$

As time becomes large, the remarkable fact brought out in [16] is that the membranes eventually act as a friction force on the particle. To be more specific, the flavor of the large time asymptotics of the particle can be recapped in the following statement (for precise statements and detailed assumptions, we refer the reader to [16, Theorems 2 & 4]).

**Theorem 3.1.1** *Let  $n = 3$ . For any  $\eta \in (0, 1)$  there exists a critical wave speed  $c_0 = c_0(\eta) > 0$  and constants  $\gamma, K > 0$  (which do not depend on  $\eta$ ) such that the following assertions hold*

- Constant force, [16, Theorem 2]: *if  $W(x) = \mathcal{F} \cdot x$  for a certain  $\mathcal{F} \in \mathbb{R}^d$  constant and small enough compared to  $c^{-1}$ , then, there exists  $q_\infty \in \mathbb{R}^d$  and  $v(\mathcal{F}) \in \mathbb{R}^d$  such that, for any  $c \geq c_0$ , we have*

$$|q_\infty + t v(\mathcal{F}) - q(t)| \leq K e^{-\frac{\gamma(1-\eta)}{c^3} t};$$

- Confining potential, [16, Theorem 4]: if  $W(x) \rightarrow_{|x| \rightarrow +\infty} +\infty$ , then as time tends to  $\infty$ ,  $\dot{q}(t)$  converges to 0 and  $q(t)$  converges to a critical point  $q^*$  of the potential  $W$ . If  $q^*$  is a non degenerate minimum of  $W$ , then, for any  $c \geq c_0$ , we have

$$|q(t) - q^*| \leq K e^{-\frac{\gamma(1-\eta)}{2c^3} t}.$$

**Remark 3.1.2** *The following comments are worthwhile:*

- We point out the role of the assumptions “the wave speed  $c$  is large enough” and on the dimension  $n$  for the wave propagation. That  $c$  is large can be interpreted as a condition ensuring that the energy is quickly evacuated in the membrane, when the particle hits this membrane. The following two intuitive arguments for choosing the dimension  $n = 3$  can be given: first, it ensures a strong enough dispersion effect, which would be too weak in lower dimensions; second, the Huygens principle implies that the energy transferred to the membrane is really evacuated and cannot be felt at the hitting point after a while.
- When the particle is subjected to a constant external force, asymptotically as time becomes large it has a uniform rectilinear motion. Assuming  $n = 3$  also allows us to identify the asymptotic action of the vibrations as a friction force proportional to the velocity of the particle (see [16, Eq. (2.9)]).
- When the particle is subjected to a confining potential, it stops exponentially fast at a critical point of the potential.

This statement tells us that, in certain circumstances, the interaction with the environment acts on the particle as a drag force: the large time behavior looks like the one of the system

$$\dot{q}(t) = p(t), \quad \dot{p}(t) = -\nabla W(q(t)) - \lambda p(t),$$

with an effective friction coefficient  $\lambda > 0$ . This is precisely the motivation presented in [16] to shed some light on the conditions driving to such a friction effect, by coming back to a more microscopic and detailed description of the interaction, that takes into account the dynamics of the environment, here represented by a scalar vibration field.

Therefore, this work fits in the framework of open systems theory where a classical, or quantum, system is coupled to its environment through exchanges of mass, momentum or energy. In turn, the environment has a dissipative action on the system, an idea that dates back to the seminal works of Caldeira-Leggett [19, 20]. We refer the reader to [66] for an overview on such models for classical particles, and the presentation of a quite general framework that encompasses many physical situations of interest. In particular, it is worth mentioning the related attempts to model frictional damping from the interaction with a wave field coupled to the moving particle [62, 64] and [42], where the environment is described as a Bose gas, and the slowing down of the particle is interpreted in terms of Cherenkov radiation effects. The originality of the model introduced in [16] is to model the environment as a vibrational field that can evacuate energy in directions transverse to the particle’s motion. Then, the wish is to derive an effective formula, depending on the interaction parameters (here  $\sigma_1, \sigma_2, c, \dots$ ) for the drag coefficient  $\lambda$ . One also expects, for small applied force  $\mathcal{F}$ , that the limiting velocity  $v(\mathcal{F})$  becomes proportional to the force:  $v(\mathcal{F}) \sim_{\mathcal{F} \rightarrow 0} \mu \mathcal{F}$ , in the spirit of Ohm’s law, and one is interested in identifying the corresponding mobility  $\mu$ . Complementary studies of the model (3.1a)–(3.1b) can be found in [2, 27, 28, 29, 66, 96], with connections to stochastic homogenization and to the classical

Lorentz problems. We also refer to [24] for a quantum version of the model, and further connection to the Cherenkov radiation.

It is natural to extend the model (3.1a)–(3.1b) by considering a set of  $N$  particles which all interact with the membranes. Let  $q_i$  stand for the position of the  $i$ th particle. The system is now governed by the system

$$\ddot{q}_i(t) = -\nabla W(q_i(t)) - \iint_{\mathbb{R}^d \times \mathbb{R}^n} \sigma_1(q_i(t) - y)\sigma_2(z)\nabla_y \psi(t, y, z) \, dy \, dz, \quad (3.6a)$$

$$\partial_{tt}^2 \psi - c^2 \Delta_z \psi = -\sigma_2(z) \left( \sum_{i=1}^N \sigma_1(x - q_i(t)) \right), \quad (3.6b)$$

for  $t \geq 0$ ,  $x \in \mathbb{R}^d$ ,  $z \in \mathbb{R}^n$ . Considering the mean field regime of this system (which amounts to deal with the limit  $N \rightarrow \infty$ , assuming that the strength of the force on a given particle scales like  $1/N$ ), one is led to a kinetic equation

$$\partial_t F + v \cdot \nabla_x F - \nabla_x \left( W + \sigma_1 \star_x \int \sigma_2 \psi \, dz \right) \cdot \nabla_v F = 0, \quad (3.7a)$$

$$\partial_{tt}^2 \psi - c^2 \Delta_z \psi = -\sigma_2(z) \left( \sigma_1 \star_x \int F \, dv \right), \quad (3.7b)$$

for  $t \geq 0$ ,  $x \in \mathbb{R}^d$ ,  $v \in \mathbb{R}^d$ ,  $z \in \mathbb{R}^n$ , where the unknown  $F$  stands for the particles distribution function in phase space, see [52]. These systems still satisfy the energy conservation property (3.5), just adapting the definition of the energy associated to the particles as follows:

$$E_{\text{particles}}(t) = \sum_{i=1}^N \left( \frac{1}{2} \dot{q}_i(t)^2 + W(q_i(t)) + \iint_{\mathbb{R}^d \times \mathbb{R}^n} \sigma_1(q_i(t) - y)\sigma_2(z)\psi(t, y, z) \, dy \, dz \right) \quad (3.8)$$

for (3.6a)–(3.6b) and

$$E_{\text{particles}}(t) = \iint_{\mathbb{R}^d \times \mathbb{R}^d} F(t, x, v) \left( \frac{v^2}{2} + W(x) + \iint_{\mathbb{R}^d \times \mathbb{R}^n} \sigma_1(x - y)\sigma_2(z)\psi(t, y, z) \, dy \, dz \right) \, dx \, dv \quad (3.9)$$

for (3.7a)–(3.7b). We refer the reader to [25] for the well-posedness analysis of the Vlasov-Wave system (3.7a)–(3.7b). As a matter of fact, we point out that  $F$  naturally remains non-negative, all  $L^p$  ( $1 \leq p \leq +\infty$ ) norms are conserved as well as the entropy functional

$$H(t) = \iint_{\mathbb{R}^d \times \mathbb{R}^d} F(t) \log(F(t)) \, dx \, dv.$$

More generally, for any  $A : \mathbb{R}_+ \rightarrow \mathbb{R}$  the integral (Casimir functionals)

$$\iint_{\mathbb{R}^d \times \mathbb{R}^d} A(F(t)) \, dx \, dv$$

is conserved. These fundamental properties are consequences of the fact that the flow

$$\varphi_t : (x_0, v_0) \mapsto (\mathcal{X}(t), \mathcal{V}(t))$$

defined by the ODE system

$$\begin{aligned} \frac{d}{dt} \mathcal{X}(t) &= \mathcal{V}(t), & \mathcal{X}(0) &= x_0, \\ \frac{d}{dt} \mathcal{V}(t) &= -\nabla_x W(\mathcal{X}(t)) - \nabla_x \phi(t, \mathcal{X}(t)), & \mathcal{V}(0) &= v_0 \end{aligned} \quad (3.10)$$

where

$$\phi(t, x) = \iint_{\mathbb{R}^d \times \mathbb{R}^n} \sigma_1(x - y) \sigma_2(z) \psi(t, y, z) \, dz \, dy, \quad (3.11)$$

is symplectic. Indeed, denoting

$$J = \begin{pmatrix} 0_d & I_d \\ -I_d & 0_d \end{pmatrix},$$

we have

$$(\text{Jac } \varphi_t)^T J (\text{Jac } \varphi_t) = J.$$

In particular,  $\det(\text{Jac } \varphi_t)^2 = 1$  and volumes are conserved by the flow. We deduce the asserted conservation properties since the distribution function  $F$  is constant along the flow  $\varphi_t$ : for any  $t \geq 0$ ,  $F(t, x, v) = F_0(\varphi_{-t}(x, v))$ .

**Remark 3.1.3** *The construction of the numerical method will use this property, which equally applies to the particulate systems as follows. Given a solution of (3.1a)–(3.1b), associated to the initial data  $(q_0, p_0, \Psi_0, \Psi_1)$ , we have at hand the potential defined by the formula (3.11), and it makes sense to consider the differential system (3.10) (where a priori  $(x_0, v_0) \neq (q_0, p_0)$ ; when the equality holds the trajectories coincide  $(q(t), p(t)) = (\mathcal{X}(t), \mathcal{V}(t))$ ). It describes the motion of a “fictitious particle”, governed by the potential  $\phi$ . This system is still symplectic. A similar conclusion applies when starting from (3.6a)–(3.6b). However, we warn the reader not to be confused: the differential system (3.1a)–(3.1b), or (3.6a)–(3.6b), itself is by no means symplectic (which would be contradictory with Theorem 3.1.1 and the numerical experiments). This observation will be crucial for the construction of the numerical scheme: on a given time step, one has to solve the ODE system with  $\psi$  considered as given, which motivates the use of a symplectic method in order to preserve accurately the energetic properties of the model.*

**Remark 3.1.4** *Contrarily to a common practice, we have incorporated the interaction potential in definition (3.3), and its counterparts for the many-particles frameworks. It is seen as the potential exerted by the wave on the particle, consistently with the viewpoint developed in [25]. This formulation will be also natural for discussing the numerical strategy and the preservation of the energy exchanges.*

One might wonder what the friction effect observed on a single particle becomes when one deals with a large number of particles, either with the discrete model (3.6a)–(3.6b) or the kinetic model (3.7a)–(3.7b). Surprisingly, the conclusion might substantially differ (see also the recent results in [104] which gives interesting hints on the large time behavior for the  $N$  particles system and comments on the loss of convergence rate in mean field regime  $N \rightarrow \infty$ ). In fact the analysis performed in [25] establishes an unexpected connection between (3.7a)–(3.7b) and the *attractive* Vlasov–Poisson system, which can be obtained in a certain asymptotic regime as  $c \rightarrow \infty$ . In the same spirit, several stationary solutions of (3.7a)–(3.7b) can be identified, by means of free energy minimization, and their stability has been established [26]. Moreover, still based on the analogies with the Vlasov–Poisson system, it has been shown that the Vlasov–Wave system (3.7a)–(3.7b) can lead to a Landau damping effect, as summarized in the following statement (see the previous Chapter for further details).

**Theorem 3.1.5** *Let  $W = 0$ ,  $n = 3$  and suppose that  $x \in \mathbb{T}^d$ . If the initial data  $(F_0, \psi_0, \psi_1)$  are homogeneous with respect to  $x$ , then the unique solution  $(F(t), \psi(t))$  of (3.7a)–(3.7b) satisfies  $F(t) = F_0$  for any  $t$ . If  $F_0$  satisfies a certain criterion of linear stability and considering  $(\tilde{F}_0, \tilde{\psi}_0, \tilde{\psi}_1)$  small enough perturbations of  $(F_0, \psi_0, \psi_1)$ , then, the associated solution  $(\tilde{F}(t), \tilde{\psi}(t))$  of (3.7a)–(3.7b) satisfies the following properties:*

- the force term  $-\nabla_x \left( \sigma_1 \star_x \int \sigma_2 \tilde{\psi} dz \right)$  converges (strongly) to 0,
- if, moreover,  $\tilde{F}_0$  has the same mass as  $F_0$ , the macroscopic density  $\int \tilde{F} dv$  converges (strongly) to  $\int F_0 dv$ .

**Remark 3.1.6** *Let us make the following comments:*

- The analysis follows arguments for the Vlasov-Poisson system, see [87] and [12]; it adapts also when dealing for the problem set on  $\mathbb{R}^d$ , following [13]. The decay rate can be explicitated, depending on the functional framework for the perturbation  $\tilde{F}_0$ .
- Given a spatially homogeneous profile  $F_0$ , the criterion ensuring the linear stability holds provided  $c$  is large enough.
- Again, the role of the dimension  $n = 3$  (in fact  $n$  odd and  $n \geq 3$ ) is crucial for establishing the Landau damping.

We wish to investigate these questions on numerical grounds. In particular, we address the following issues:

- for the single particle model (3.1a)–(3.1b), to illustrate the validity of Theorem 3.1.1 and observe the friction effect, for both a confining potential or a constant force, in which case we discuss the behavior of the asymptotic speed.
- for (3.6a)–(3.6b), to investigate the  $N$ -particles large time dynamics. When  $N > 1$  particles interact, the situation looks much more intricate and several scenarios emerge. Roughly speaking either the particles ignore each other, possibly after a very short time of interaction, and they behave as they were alone, or they form clusters that create their own confining potential. Such cluster may move or stop, even if, individually, each particle in the cluster keeps moving. (Further results on the large time asymptotics for  $N$  particles in a confining potential can be found in [104].)
- For the kinetic model (3.7a)–(3.7b), to illustrate the Landau damping phenomena.

We will pay a specific attention to discuss the role of the assumptions of the wave-space dimension  $n$ , and on the wave-speed  $c$ . The numerical investigation of these questions require to take into consideration the specific features of the models in order to construct the numerical method:

- as said above, the friction/damping phenomena depend on the wave-space dimension  $n$ , and the case  $n = 3$  definitely has a specific role. Moreover, these phenomena are, more or less, related to the ability to evacuate the energy through the membranes. Hence, one has to simulate the free space wave equation, in dimension  $n = 3$ . This requires to pay attention to the conditions imposed at the boundaries of the wave-computational domain, in order not to perturb the necessary dispersion effects, which are essential for the asymptotic properties.
- the energy balance, and in particular the exchanges between the kinetic energy of the particles and the vibrational energy of the membranes, are also crucial features of the models, and the discrete version of the problem should preserve as far as possible the dynamics of these exchanges.

These considerations will guide the technical choices to design the numerical scheme. The Chapter is organized as follows. In Section 3.2, we describe how we can take advantage of spherical symmetries to set up transparent boundary conditions for the wave equation in dimension  $n = 3$ . Sections 3.3 and 3.4 are devoted to the discretization of the equations, in the  $N$  particles and in the kinetic frameworks, respectively. In Section 3.5, we discuss in details the energetic properties of the schemes. We present the numerical results in Section 3.6.

## 3.2 Discretization of the wave equation with a transparent boundary condition

In dimension  $n = 1$ , the wave equation propagates the information to the right and to the left with velocities  $\pm c$ , and considering the expression of the solution given by D'Alembert's formula, we find that

$$(\partial_t + c\partial_x)\psi(t, R_{\max}) = 0 = (\partial_t - c\partial_x)\psi(t, -R_{\max})$$

constitutes transparent boundary conditions that can be used when truncating the computational domain to the interval  $(-R_{\max}, +R_{\max})$ . Furthermore, these conditions can be easily implemented. Unfortunately, finding relevant boundary conditions in higher dimensions is far more challenging and leads to non local formula, see [31]. Nevertheless, in the particular case of the dimension  $n = 3$  (note that Theorems 3.1.1 and 3.1.5 use this assumption) and for radially symmetric data, there exists a transformation that allows us to go back to the classical wave equation in dimension  $n = 1$ , see e.g. [105].

### 3.2.1 Radially symmetric wave equation

Consider the wave equation in dimension  $n = 3$

$$\partial_{tt}^2\psi - c^2\Delta_z\psi = -\sigma_2(z)S(t, x). \quad (3.12)$$

We suppose that

$$\sigma_2(z) = \tilde{\sigma}_2(|z|)$$

is radially symmetric. If, furthermore, the initial condition

$$(\psi_0(x, z), \psi_1(x, z)) = (\Psi_0(x, |z|), \Psi_1(x, |z|))$$

is radially symmetric too, then the unique solution  $\psi$  of (3.12) is radially symmetric. We have  $\psi(t, x, z) = \Psi(t, x, |z|)$  and  $\Psi$  satisfies

$$\partial_{tt}^2\Psi - c^2\left(\partial_{rr}^2\Psi + \frac{n-1}{r}\partial_r\Psi\right) = -\tilde{\sigma}_2(r)S(t, x).$$

We set

$$u(t, x, r) = r\Psi(t, x, r). \quad (3.13)$$

Using that  $n = 3$ , we check that  $u$  is a solution of the classical wave equation in dimension one

$$\partial_{tt}^2u - c^2\partial_{rr}^2u = r\left(\partial_{tt}^2\Psi - c^2\partial_{rr}^2\Psi - c^2\frac{2}{r}\partial_r\Psi\right) = -r\tilde{\sigma}_2(r)S(t, x).$$

Therefore, truncating the domain to  $|z| \leq R_{\max}$ , we can use

$$\partial_t u + c\partial_r u = 0$$

as a (simple and exact) transparent boundary condition for  $r = R_{\max}$ . Eventually, we have to solve numerically the following system, for  $t \geq 0$  and  $0 < r < R_{\max}$ ,

$$\partial_{tt}^2 u - c^2 \partial_{rr}^2 u = -r\tilde{\sigma}_2(r)S(t, x), \tag{3.14a}$$

$$(u(0, x, r), \partial_t u(0, x, r)) = (r\Psi_0(x, r), r\Psi_1(x, r)), \tag{3.14b}$$

$$u(t, x, 0) = 0, \quad \partial_t u(t, x, R_{\max}) + c\partial_r u(t, x, R_{\max}) = 0. \tag{3.14c}$$

We remind the reader that  $x$  appears here as a parameter. In practice, we shall discretize the physical space, and thus we shall deal with this system for a finite number of grid points  $x$ . Once  $u$  determined by solving (3.14a)–(3.14c), we can come back to the original unknown  $\Psi$  (and then  $\psi$ ): for any  $r \neq 0$ , we have  $\Psi(t, x, r) = u(t, x, r)/r$  and for  $r = 0$ , we derive (3.13) to get

$$\partial_r u(t, x, r) = \Psi(t, x, r) + r\partial_r \Psi(t, x, r).$$

Since for any smooth solution of (3.12),  $\partial_r \Psi(t, x, 0)$  is bounded (in fact for these solutions  $\partial_r \Psi(t, x, 0) = 0$ ), we eventually get  $\Psi(t, x, 0) = \partial_r u(t, x, 0)$ . Nevertheless, for our purposes, it is not necessary to reconstruct  $\psi$  to solve (3.1a), (3.6a) or (3.7a). Indeed, for these three equations we can write the potential

$$\phi(t, x) = \iint_{\mathbb{R}^d \times \mathbb{R}^n} \sigma_1(x - y)\sigma_2(z)\psi(t, y, z) dy dz$$

by means of  $u$ :

$$\phi(t, x) = 4\pi \int_{\mathbb{R}^d} \sigma_1(x - y) \left( \int_0^{R_{\max}} r\tilde{\sigma}_2(r)u(t, y, r) dr \right) dy. \tag{3.15}$$

This equality (3.15) holds true as far as

$$\text{supp}(\tilde{\sigma}_2) \subset [0, R_{\max}],$$

a condition that we shall use to choose the cut-off parameter  $R_{\max}$ .

### 3.2.2 Discretization of the radial wave equation (3.14a)–(3.14c).

Let us explain the discretization method for the wave equation; we use quite classical approaches and further information about the schemes can be found in e. g. [3, 110].

**Radial discretization.** We use a Finite Element Method (FEM). To this end, we introduce a subdivision

$$0 = r_1 < r_2 < \dots < r_K = R_{\max}$$

of  $[0, R_{\max}]$  and a basis  $(\varphi_1, \dots, \varphi_{\mathcal{K}_K})$  (with  $\mathcal{K}_K \geq K$ ) of polynomial functions associated to this partition and the choice of the family of finite elements. The approached solution reads  $u_h(t, x, r) = \sum_{k=1}^{\mathcal{K}_K} u_k(t, x)\varphi_k(r)$  where the numerical unknowns are collected in  $U(t, x) = (u_1, \dots, u_{\mathcal{K}_K})(t, x)$ , the vector determined by the system

$$\mathcal{M} \frac{d^2}{dt^2} U(t, x) + \mathcal{C} \frac{d}{dt} U(t, x) + \mathcal{R}U(t, x) = G(t, x). \tag{3.16}$$

In (3.16),  $\mathcal{M}$  is the mass matrix,  $\mathcal{C}$  the diffusion matrix,  $\mathcal{R}$  the rigidity matrix and the components of  $G(t, x)$  are given by

$$-S(t, x) \int_0^{R_{\max}} r \tilde{\sigma}_2(r) \varphi_k(r) dr, \quad \text{for } k \in \{1, \dots, \mathcal{K}_K\}.$$

Note that Dirichlet boundary conditions are encoded in the mass matrix  $\mathcal{M}$  whereas the transparent boundary condition is encoded in the diffusion matrix  $\mathcal{C}$ .

**Time discretization.** Next, we make use of Newmark scheme for treating the time derivatives in (3.16). Let  $\delta t > 0$  stand for the time step and set  $t^n = n\Delta t$ . Then, the approximation of the solution  $u$  at time  $t^n$  is  $u^n(x, r) = \sum_{k=1}^{\mathcal{K}_K} u_k^n(x) \varphi_k(r)$ . We denote  $U_x^n$  the vector with components  $u_k^n(x)$ . For  $G(t, x) = 0$ , the Newmark scheme reads

$$\begin{aligned} \mathcal{M} \frac{U_x^{n+1} - 2U_x^n + U_x^{n-1}}{\Delta t^2} + \mathcal{C} \frac{dU_x^{n+1} + (1-2d)U_x^n + (d-1)U_x^{n-1}}{\Delta t} \\ + \mathcal{R} \left( \theta U_x^{n+1} + (1/2 + d - 2\theta)U_x^n + (1/2 - d + \theta)U_x^{n-1} \right) = 0 \end{aligned} \quad (3.17)$$

where  $0 \leq d \leq 1$  and  $0 \leq \theta \leq 1/2$  are parameters of the scheme. Of course, in our situation,  $G(t, x) \neq 0$  and the choice of the time discretization of  $G$  will depend on the coupling with (3.1a) (resp. (3.6a) or (3.7a)). This will be detailed later on. In practice we will only use this scheme with  $(d, \theta) = (1/2, 1/4)$ . For these parameters the scheme is second order accurate in time and  $k$ th order in space, where  $k$  depends of the choice of the FEM basis. Moreover, for these parameters, as far as the support of the wave remains included in the computational domain, the scheme conserves the discrete energy of the homogeneous wave equation. More precisely, as far as  $\mathcal{C}U_x^m = 0$  for  $m \in \{n-1, n, n+1\}$ , we have

$$\begin{aligned} \left\langle \mathcal{M} \frac{U_x^{n+1} - U_x^n}{\Delta t}, \frac{U_x^{n+1} - U_x^n}{\Delta t} \right\rangle + \left\langle \mathcal{R} \frac{U_x^{n+1} + U_x^n}{2}, \frac{U_x^{n+1} + U_x^n}{2} \right\rangle \\ = \left\langle \mathcal{M} \frac{U_x^n - U_x^{n-1}}{\Delta t}, \frac{U_x^n - U_x^{n-1}}{\Delta t} \right\rangle + \left\langle \mathcal{R} \frac{U_x^n + U_x^{n-1}}{2}, \frac{U_x^n + U_x^{n-1}}{2} \right\rangle. \end{aligned} \quad (3.18)$$

### 3.3 Discretization of (3.1a)–(3.1b)

We restrict ourselves to the case where the particles evolve in the one-dimensional torus:  $d = 1$  and  $x \in \mathbb{T}_L := \mathbb{R}/(L\mathbb{Z})$  (where  $L > 0$ ). For (3.1a), we thus impose  $q(t) \in \mathbb{T}_L$ . Then we are led to discretize the following system

$$\begin{cases} \dot{q}(t) = p(t), \\ \dot{p}(t) = -\partial_x W(q(t)) - \partial_x \phi(t, q(t)), \\ (q(0), \dot{q}(0)) = (q_0, p_0), \quad q(t) \in \mathbb{T}_L, \end{cases} \quad \begin{cases} \partial_{tt}^2 u - c^2 \partial_{rr}^2 u = -r \tilde{\sigma}_2(r) \sigma_1(x - q(t)), \\ (u(0, x, r), \partial_t u(0, x, r)) = (r \Psi_0(x, r), r \Psi_1(x, r)), \\ u(t, x, 0) = 0, \\ \partial_t u(t, x, R_{\max}) + c \partial_r u(t, x, R_{\max}) = 0, \end{cases}$$

where the potential  $\phi$  is defined by (3.15).

As said in the previous section, we solve the wave equation with a classical Newmark scheme with parameters  $(d, \theta) = (1/2, 1/4)$ . This ensures second order accuracy in time,



and  $k$ th order with respect to the wave direction (depending on the choice of the FEM; in practice we shall work with the Lagrange  $\mathbb{P}_2$  elements, which reaches second order accuracy). The symplectic property of the flow is a fundamental feature of the model. Hence, we make use of the Stormer-Verlet scheme (see (3.23) below) which is a second order accurate symplectic scheme: the discrete flow  $\varphi_n : (q_0, p_0) \mapsto (q^n, p^n)$  is symplectic, where  $q^n$  and  $p^n$  stand for the approximation of  $q$  and  $p$  at time  $t^n$ , respectively. Further details about symplectic schemes can be found e. g. in [48, Section 1.3.2] and [58, 94].

We are left with the question of handling the coupling between the two evolution equations. To this end, we pay attention to the energy exchanges. We have already introduced the subdivision  $(r_1, \dots, r_K)$  and the basis functions  $(\varphi_1, \dots, \varphi_{\mathcal{K}_k})$ . Let  $\Delta t > 0$  be the time step. We have set  $t^n = n\Delta t$ . Next, we also define a subdivision of the physical domain

$$0 = x_1 < \dots < x_i = i\Delta x < \dots < x_N = L$$

characterized by the (uniform) space step  $\Delta x$ . We denote  $[x_{i-\frac{1}{2}}, x_{i+\frac{1}{2}}]$  the cell centered at  $x_i$ . Therefore the numerical unknowns for the wave equation are denoted  $u_{i,k}^n$ ; they define the following approximation  $u^n$  of the wave at time  $t^n$

$$u^n(x, r) = \sum_{i=1}^N \sum_{k=1}^{\mathcal{K}_k} u_{i,k}^n \mathbf{1}_{[x_{i-\frac{1}{2}}, x_{i+\frac{1}{2}}]}(x) \varphi_k(r).$$

It is also convenient to introduce

$$u_k^n(x) = \sum_{i=1}^N u_{i,k}^n \mathbf{1}_{[x_{i-\frac{1}{2}}, x_{i+\frac{1}{2}}]}(x),$$

so that

$$u_{i,k}^n = \frac{1}{\Delta x} \int_{x_{i-\frac{1}{2}}}^{x_{i+\frac{1}{2}}} u_k^n(x) dx.$$

We shall denote  $U_x^n$  and  $U_i^n$  the vector in  $\mathbb{R}^{\mathcal{K}_K}$  with components  $u_k^n(x)$  and  $u_{i,k}^n$ , respectively. Hence, the potential  $\phi$  at time  $t^n$  can be approached by

$$\begin{aligned} \phi^n(x) &= 4\pi \int_0^L \sigma_1(x-y) \left( \int_0^{R_{\max}} r \tilde{\sigma}_2(r) u^n(y, r) dr \right) dy \\ &= 4\pi \sum_{i=1}^N \sum_{k=1}^{\mathcal{K}_K} u_{i,k}^n \left( \int_{x_{i-\frac{1}{2}}}^{x_{i+\frac{1}{2}}} \sigma_1(x-y) dy \right) \left( \int_0^{R_{\max}} r \tilde{\sigma}_2(r) \varphi_k(r) dr \right). \end{aligned} \quad (3.19)$$

Accordingly, we have

$$\begin{aligned} (\partial_x \phi)^n(x) &= \partial_x \phi^n(x) = 4\pi \sum_{i=1}^N \sum_{k=1}^{\mathcal{K}_K} u_{i,k}^n \left( \int_{x_{i-\frac{1}{2}}}^{x_{i+\frac{1}{2}}} \partial_x \sigma_1(x-y) dy \right) \left( \int_0^{R_{\max}} r \tilde{\sigma}_2(r) \varphi_k(r) dr \right) \\ &= 4\pi \sum_{i=1}^N \sum_{k=1}^{\mathcal{K}_K} u_{i,k}^n \left( -\sigma_1(x-x_{i+\frac{1}{2}}) + \sigma_1(x-x_{i-\frac{1}{2}}) \right) \left( \int_0^{R_{\max}} r \tilde{\sigma}_2(r) \varphi_k(r) dr \right). \end{aligned} \quad (3.20)$$

Eventually, we set

$$\phi^{n+\frac{1}{2}} = \frac{\phi^{n+1} + \phi^n}{2} \quad \text{and} \quad \partial_x \phi^{n+\frac{1}{2}} = \frac{\partial_x \phi^{n+1} + \partial_x \phi^n}{2}.$$

**Time-discretization.** Suppose that we have computed  $q^n, p^n, u^{n-1}$  and  $u^n$ . We are going to update these quantities and define  $q^{n+1}, p^{n+1/2}, p^{n+1}$  and  $u^{n+1}$ . To this end, we solve numerically the following two equations on the time interval  $[t^n, t^{n+1}]$ .

$$\begin{cases} \partial_{tt}^2 u - c^2 \partial_{rr}^2 u = -r\tilde{\sigma}_2(r)\sigma_1(x - q^n) \\ u(t^{n-1}) = u^{n-1}; u(t^n) = u^n \end{cases} \quad \begin{cases} \dot{q}(t) = p(t) \\ \dot{p}(t) = -\partial_x W(q(t)) - \partial_x \phi^{n+\frac{1}{2}}(q(t)) \\ q(t^n) = q^n; p(t^n) = p^n \end{cases}$$

The approximation  $q^n$  allows us to compute an approximation of the right hand side of the wave equation:  $r\tilde{\sigma}_2(r)\sigma_1(x - q^n)$ , that can be used on all the interval  $[t^n, t^{n+1}]$ . Then, we compute  $u^{n+1}$  by applying the Newmark scheme. More precisely, we apply (3.17) and we average over the cell  $(x_{i-1/2}, x_{i+1/2})$ . It leads to the following scheme:

$$\mathcal{M} \frac{U_i^{n+1} - 2U_i^n + U_i^{n-1}}{\Delta t^2} + \mathcal{C} \frac{U_i^{n+1} + U_i^{n-1}}{\Delta t} + \mathcal{R} \left( \frac{1}{4}U_i^{n+1} + \frac{1}{2}U_i^n + \frac{1}{4}U_i^{n-1} \right) = G_i^n \quad (3.21)$$

where  $G_i^n$  stands for the vector in  $\mathbb{R}^{\mathcal{K}_K}$  with components

$$- \left( \frac{1}{\Delta x} \int_{x_{i-\frac{1}{2}}}^{x_{i+\frac{1}{2}}} \sigma_1(x - q^n) dx \right) \left( \int_0^{R_{\max}} r\tilde{\sigma}_2(r)\varphi_k(r) dr \right). \quad (3.22)$$

We turn to the equation for the particle. With the obtained approximations of  $u$ , we define  $\partial_x \phi^{n+1}$  and  $\partial_x \phi^{n+1/2} = (\partial_x \phi^{n+1} + \partial_x \phi^n)/2$ . Then we use on all the interval  $[t^n, t^{n+1}]$  this approximation of the force term. Since the force term  $-\partial_x W(x) - \partial_x \phi^{n+1/2}(x)$  is constant in time, applying the Stormer-Verlet scheme eventually leads to the following scheme:

$$\begin{cases} p^{n+\frac{1}{2}} = p^n - \frac{\Delta t}{2} \partial_x W(q^n) - \frac{\Delta t}{2} \partial_x \phi^{n+\frac{1}{2}}(q^n) \\ q^{n+1} = q^n + \Delta t p^{n+\frac{1}{2}} \\ p^{n+1} = p^{n+\frac{1}{2}} - \frac{\Delta t}{2} \partial_x W(q^{n+1}) - \frac{\Delta t}{2} \partial_x \phi^{n+\frac{1}{2}}(q^{n+1}). \end{cases} \quad (3.23)$$

The full scheme is obtained by combining (3.21) and (3.23). We will justify this time discretization in terms of energy balance in Section 3.5.

### 3.4 Discretization of (3.7a)–(3.7b)

Again, we restrict the discussion to the case  $x \in \mathbb{T}_L$ . Moreover we should also deal with a truncated velocity domain  $[-V_{\max}, V_{\max}]$ , where  $V_{\max}$  is chosen large enough so that it is reasonable to impose

$$F(t, x, -V_{\max}) = 0 = F(t, x, V_{\max}),$$

considering initial data such that  $\text{supp}(F_0) \subset \mathbb{T}_L \times [-V_{\max}, V_{\max}]$ . We are thus concerned with the simulation of (adding an external potential does not add any difficulty, and we take  $W = 0$  in this presentation for the sake of clarity):

$$\begin{cases} \partial_t F + v \partial_x F - \partial_x \phi \partial_v F = 0 \\ F(0, x, v) = F_0(x, v) \\ F(t, 0, v) = F(t, L, v) \\ F(t, x, -V_{\max}) = F(t, x, V_{\max}) = 0 \end{cases} \quad \begin{cases} \partial_{tt}^2 u - c^2 \partial_{rr}^2 u = -r\tilde{\sigma}_2(r)\sigma_1(x - q(t)) \\ (u(0, x, r), \partial_t u(0, x, r)) = (r\Psi_0(x, r), r\Psi_1(x, r)) \\ u(t, x, 0) = 0 \\ \partial_t u(t, x, R_{\max}) + c\partial_r u(t, x, R_{\max}) = 0 \end{cases}$$

where the potential  $\phi$  is defined by (3.15).

The wave equation is treated by using the Newmark scheme and the FEM as described above. For the kinetic equation, we use a Semi-Lagrangian finite volume scheme: the Positive and Flux Conservative (PFC) method that guarantees at the discrete level the conservation of mass, positivity of the solution and a maximum principle. Details and comments about this scheme can be found e. g. in [39, 37, 38] and the references therein. Note that other approaches, based on DG or WENO approximations could be used as well, see [55, 92, 93] for details on such approaches for Vlasov’s equations.

We adapt the time discretization described for (3.1a)–(3.1b) in order to care of the energy balance. With the time step  $\Delta t > 0$  we still denote  $t^n = n\Delta t$ . We construct a grid of the phase space with space and velocity steps  $\Delta x > 0$  and  $\Delta v > 0$  respectively. Let  $x_{i+1/2} = (i+1/2)\Delta x$ , for  $i \in \{1, \dots, N\}$ , and  $v_{j+1/2} = (j+1/2)\Delta v$ , for  $j \in \{-M, \dots, M\}$ , with  $N\Delta x = L$  and  $M\Delta v = V_{\max}$ . We denote by  $C_{i,j}$  the cell  $[x_{i-1/2}, x_{i+1/2}] \times [v_{j-1/2}, v_{j+1/2}]$ , with center  $(x_i, v_j)$ . From the discrete quantities  $u_{i,k}^n$ , we construct the approximation  $(x, r) \mapsto u^n(x, r)$  as above. The potential  $\phi^n$  and  $\partial_x \phi^n$  are still defined by (3.19) and (3.20). From the numerical unknowns  $F_{i,j}^n$ , we define the approximated distribution function

$$F^n(x, v) = \sum_{i=1}^N \sum_{j=-M}^M F_{i,j}^n \mathbf{1}_{C_{i,j}}(x, v).$$

The macroscopic density  $\rho$  at time  $t^n$  is thus given by

$$\rho^n(x) = \int_{-V_{\max}}^{V_{\max}} F_h(t, x, v) dv = \sum_{i=1}^N \left( \Delta v \sum_{j=-M}^M F_{i,j}^n \right) \mathbf{1}_{\left[ x_{i-\frac{1}{2}}, x_{i+\frac{1}{2}} \right]}(x). \tag{3.24}$$

The convolution  $\sigma_1 \star \rho$  at time  $t^n$  becomes

$$(\sigma_1 \star \rho)^n(x) = \sigma_1 \star \rho^n(x) = \Delta v \sum_{i=1}^N \sum_{j=-M}^M F_{i,j}^n \left( \int_{x_{i-\frac{1}{2}}}^{x_{i+\frac{1}{2}}} \sigma_1(x-y) dy \right). \tag{3.25}$$

### 3.4.1 Time-discretisation

Knowing the approximations of  $F$  and  $u$  up to  $t^n$ , we obtain the updated quantities  $u^{n+1}$  and  $F^{n+1}$  by solving the following equations on  $[t^n, t^{n+1}]$ :

$$\begin{cases} \partial_{tt}^2 u - c^2 \partial_{rr}^2 u = -r \tilde{\sigma}_2(r) (\sigma_1 \star \rho)^n, & \begin{cases} \partial_t F + v \partial_x F - \partial_x \phi^{n+\frac{1}{2}} \partial_v F = 0. \\ F(t^n) = F^n \end{cases} \\ u(t^{n-1}) = u^{n-1}; u(t^n) = u^n, \end{cases}$$

With  $F^n$  we determine  $(\sigma_1 \star \rho)^n$ , which is used to evaluate the source  $\rho$  term for the wave equation. Applying the Newmark scheme (3.17) with this right hand side we get  $u^{n+1}$ :

$$\mathcal{M} \frac{U_i^{n+1} - 2U_i^n + U_i^{n-1}}{\Delta t^2} + \mathcal{C} \frac{U_i^{n+1} + U_i^{n-1}}{\Delta t} + \mathcal{R} \left( \frac{1}{4} U_i^{n+1} + \frac{1}{2} U_i^n + \frac{1}{4} U_i^{n-1} \right) = G_i^n \tag{3.26}$$

where  $U_i^n = (u_{i,1}^n, \dots, u_{i,\mathcal{K}_K}^n)$  and the components  $G_{i,k}^n$  are defined by

$$- \left( \frac{1}{\Delta x} \int_{x_{i-\frac{1}{2}}}^{x_{i+\frac{1}{2}}} (\sigma_1 \star \rho)^n(x) dx \right) \left( \int_0^{R_{\max}} r \tilde{\sigma}_2(r) \varphi_k(r) dr \right). \tag{3.27}$$

Having disposed of the wave equation, we compute the force terms  $\partial_x \phi^{n+1}$ , as well as

$$\partial_x \phi^{n+\frac{1}{2}} = \frac{\partial_x \phi^{n+1} + \partial_x \phi^n}{2}.$$

Replacing the force by this constant quantity over the time interval, we obtain  $F^{n+1}$  by solving the corresponding Liouville equation with the PFC scheme.

### 3.4.2 Discretisation of the kinetic equation with the PFC scheme

We start with the time-splitting

$$\begin{cases} \partial_t F^* + v \partial_x F^* = 0, & t \in [t^n, t^{n+1}] \\ F^*(t^n) = F(t^n) = F^n \end{cases} \quad \begin{cases} \partial_t F^{**} - \partial_x \phi^{n+\frac{1}{2}} \partial_v F^{**} = 0, & t \in [t^n, t^{n+1}] \\ F^{**}(t^n) = F^*(t^{n+1}). \end{cases}$$

The consistency analysis of such time splitting methods with Landau damping is considered in [35]. The solutions of these equations at the final time  $t^{n+1}$  are obtained by integrating along characteristics:

$$\begin{cases} F^*(t^{n+1}, x, v) = F^*(t^n, X(t^n, t^{n+1}, x, v), v) = F^*(t^n, x - \Delta t v, v), \\ F^{**}(t^{n+1}, x, v) = F^{**}(t^n, x, V(t^n, t^{n+1}, x, v)) = F^{**}(t^n, x, v + \Delta t \partial_x \phi^{n+\frac{1}{2}}(x)). \end{cases}$$

Let us set

$$F_{i,j}^{*,n} = \frac{1}{\Delta x} \int_{x_{i-\frac{1}{2}}}^{x_{i+\frac{1}{2}}} F^*(t^n, x, v_j) dx \quad \text{and} \quad F_{i,j}^{**,n} = \frac{1}{\Delta v} \int_{v_{j-\frac{1}{2}}}^{v_{j+\frac{1}{2}}} F^{**}(t^n, x_i, v) dv.$$

On the one hand, we obtain

$$F_{i,j}^{*,n+1} = \frac{1}{\Delta x} \int_{x_{i-\frac{1}{2}-\Delta t v_j}}^{x_{i-\frac{1}{2}}} F^*(t^n, x, v_j) dx + F_{i,j}^{*,n} - \frac{1}{\Delta x} \int_{x_{i+\frac{1}{2}-\Delta t v_j}}^{x_{i+\frac{1}{2}}} F^*(t^n, x, v_j) dx,$$

and, on the other hand, we get

$$\begin{aligned} F_{i,j}^{**,n+1} &= \frac{1}{\Delta v} \int_{v_{j-\frac{1}{2}+\Delta t \partial_x \phi_i^{n+\frac{1}{2}}}}^{v_{j-\frac{1}{2}}} F^{**}(t^n, x_i, v) dv \\ &\quad + F_{i,j}^{**,n} - \frac{1}{\Delta v} \int_{v_{j+\frac{1}{2}+\Delta t \partial_x \phi_i^{n+\frac{1}{2}}}}^{v_{j+\frac{1}{2}}} F^{**}(t^n, x_i, v) dv, \end{aligned}$$

where we denote  $\partial_x \phi_i^{n+1/2} = \partial_x \phi^{n+1/2}(x_i)$ . The scheme relies on relevant approximations, denoted  $\Psi_{i+1/2,j}^{*,n}$  and  $\Psi_{i,j+1/2}^{**,n}$  respectively, of the integrals

$$\frac{1}{\Delta x} \int_{x_{i+\frac{1}{2}-\Delta t v_j}}^{x_{i+\frac{1}{2}}} F^*(t^n, x, v_j) dx \quad \text{and} \quad \frac{1}{\Delta v} \int_{v_{j+\frac{1}{2}+\Delta t \partial_x \phi_i^{n+\frac{1}{2}}}}^{v_{j+\frac{1}{2}}} F^{**}(t^n, x_i, v) dv.$$

The scheme thus reads

$$\begin{cases} F_{i,j}^{*,n} = F_{i,j}^n \\ F_{i,j}^{*,n+1} = F_{i,j}^{*,n} + \frac{1}{\Delta x} (\Psi_{i-1/2,j}^{*,n} - \Psi_{i+1/2,j}^{*,n}) \\ F_{i,j}^{**,n} = F_{i,j}^{*,n+1} \\ F_{i,j}^{**,n+1} = F_{i,j}^{**,n} + \frac{1}{\Delta v} (\Psi_{i,j-1/2}^{**,n} - \Psi_{i,j+1/2}^{**,n}) \\ F_{i,j}^{n+1} = F_{i,j}^{**,n+1} \end{cases} \quad (3.28)$$

**Definition of  $\Psi_{i+1/2,j}^{*,n}$  and  $\Psi_{i,j+1/2}^{**,n}$ .** We construct a polynomial approximation  $F_h^n(x, v)$  of  $F^n(x, v)$  by using the values  $F_{i,j}^n$ . Then,  $\Psi_{i+1/2,j}^{*,n}$  and  $\Psi_{i,j+1/2}^{**,n}$  are simply deduced by computing the primitive of the polynomial  $F_h^n(x, v)$ . In order to satisfy the fundamental properties of positivity, maximum principle and mass conservation, this reconstruction should incorporate slope limiters that control the effects of too high gradients, due in particular to filamentation effects in phase space. We refer the reader to [37, 38, 39, 101, 102] for further details on the pros and cons of the reconstruction techniques. Here, we make use of a reconstruction based on third order polynomials (thus third order accurate when the gradients remain moderate).

### 3.5 Discrete energy balance

In this Section, we motivate the construction of the scheme (3.21)–(3.23) and (3.26)–(3.28) by discussing the discrete energy balance. We point out that it could be misleading to conserve the discrete *total* energy. It is much more important to reproduce well the energy *exchanges* between the particles and the waves. Indeed, it might be possible to conserve exactly the total energy, but with particles and wave energies far from their expected values. For this reason, we focus our attention on the energy exchanges, possibly at the price of sacrificing the exact conservation of the total energy.

Let us go back to the basic energetic properties of the equations under consideration. If  $u$  is the solution of the wave equation

$$\partial_{tt}^2 u - c^2 \partial_{rr}^2 u = f,$$

then  $E_{\text{wave}}$  defined by (3.4) satisfies

$$\frac{d}{dt} E_{\text{wave}}(t) = \iint \partial_t u(t) f(t) \, dx \, dr,$$

and this energy is conserved when  $f = 0$ . If  $q$  is solution of the ODE

$$\ddot{q}(t) = -\nabla_x W(q(t)) - \nabla_x \phi(t, q(t)),$$

then  $E_{\text{particle}}$  defined by (3.3) satisfies

$$\frac{d}{dt} E_{\text{particle}}(t) = (\partial_t \phi)(t, q(t)).$$

In particular  $E_{\text{particle}}(t)$  is conserved when the potential  $\phi$  does not depend on the time variable. Going back to the coupled system (3.1a)–(3.1b), the total energy  $E = E_{\text{wave}} + E_{\text{particle}}$  is conserved because the source term  $f$  of the wave equation and the time-dependent potential  $\phi$  fulfil the cancellation property

$$\iint \partial_t u(t) f(t) \, dx \, dr + \partial_t \phi(t, q(t)) = 0.$$

Therefore, the guidelines for constructing a energetically relevant scheme for (3.1a)–(3.1b) should be:

- (i) the scheme for the wave equation conserves the discrete analog of  $E_{\text{wave}}$  when the source term  $f$  vanishes,

- (ii) the scheme for the particle equation conserves the discrete analog of  $E_{\text{particle}}$  when the potential  $\phi$  does not depend on time,
- (iii) the discrete coupling is such that the contributions from the analog of  $\iint \partial_t u(t) f(t) dx dr$  and  $\partial_t \phi(t, q(t))$  cancel out.

Criterion (i) is a standard requirement for a scheme for the wave equation; by the way it is fulfilled by (3.21). Item (ii) is more delicate; having a symplectic scheme usually guarantees it is satisfied approximately, the discrete energy oscillates about the expected value, and energy conservation holds only in average. The coupling strategy devised above, see (3.21)–(3.23), is precisely intended to satisfy (iii). The constructed scheme is satisfactory in this sense: the energy exchange is exactly treated and the error on the total energy is controlled by the error produced by the symplectic scheme designed for a hamiltonian system.

We follow the same reasoning for the system (3.7a)–(3.7b). We are dealing with a kinetic equation

$$\partial_t F + v \cdot \nabla_x F - \nabla_x \phi(t) \cdot \nabla_v F = 0$$

and the energy  $E_{\text{particles}}$  defined by (3.9) satisfies

$$\frac{d}{dt} E_{\text{particles}}(t) = \iint F(t) \partial_t \phi(t) dx dv.$$

Like for the ODE describing a single particle, when the potential  $\phi$  does not depend on the time variable, the energy  $E_{\text{particles}}$  is conserved. Going back to the coupled system (3.7a)–(3.7b), the conservation of  $E = E_{\text{wave}} + E_{\text{particles}}$  relies on the cancellation of the coupling terms

$$\iint \partial_t u(t) f(t) dx dr + \iint F(t) \partial_t \phi(t) dx dv = 0.$$

Therefore, the numerical strategy is based on the following requirements

- (i) the scheme for the wave equation conserves the discrete analog of  $E_{\text{wave}}$  when the source term  $f$  vanishes,
- (ii) the scheme for the kinetic equation conserves the discrete analog  $E_{\text{particles}}$  when the potential  $\phi$  does not depend on time,
- (iii) the discrete coupling is such that the contributions from the analog of  $\iint \partial_t u(t) f(t) dx dr$  and  $\iint F(t) \partial_t \phi(t) dx dv$  cancel out.

Again, (ii) is not exactly satisfied by the discretization techniques, which, nevertheless, conserve positivity,  $L^1$  and  $L^\infty$  estimates. The coupling requirement (iii) is specifically addressed by (3.26)–(3.28): the energy exchange is exactly handled by the scheme, and the error on the total energy is controlled by the error made on the Vlasov equation.

Let us now explain how (iii) is satisfied by the scheme (3.21)–(3.23) and (3.26)–(3.28).

### 3.5.1 The one-particle model

Let  $D$  be the operator which associates to a real valued sequence  $(a^n)_{n \in \mathbb{N}}$  the finite difference sequence defined by

$$(Da^n) = (a^{n+1} - a^n).$$

We remind the reader that  $u^n$  comes from (3.21),  $\phi^n$  is defined by (3.19), and we have set  $\phi^{n-1/2} = (\phi^n + \phi^{n-1})/2$ . We also set

$$u^{n-1/2} = \frac{u^n + u^{n-1}}{2} \quad \text{and} \quad \partial_t u^{n-1/2} = \frac{u^n - u^{n-1}}{\Delta t}.$$

We define the following discrete energies at time  $t^n$ :

$$E_{\text{wave}}^n = 4\pi \iint \frac{1}{2} \left| \partial_t u^{n-1/2}(x, r) \right|^2 + \frac{c^2}{2} \left| \partial_r u^{n-1/2}(x, r) \right|^2 dx dr,$$

and

$$E_{\text{particle}}^n = \frac{1}{2} |p^n|^2 + W(q^n) + \phi^{n-1/2}(q^n).$$

Observe that

$$E_{\text{wave}}^n = 2\pi \Delta x \sum_{i=1}^N \left\langle \mathcal{M} \frac{U_i^n - U_i^{n-1}}{\Delta t}, \frac{U_i^n - U_i^{n-1}}{\Delta t} \right\rangle + 2\pi \Delta x \sum_{i=1}^N \left\langle \mathcal{R} \frac{U_i^n + U_i^{n-1}}{2}, \frac{U_i^n + U_i^{n-1}}{2} \right\rangle.$$

Owing to (3.18), we get

$$D E_{\text{wave}}^n = 2\pi \Delta x \sum_{i=1}^N \left\langle G_i^n, U_i^{n+1} - U_i^{n-1} \right\rangle,$$

where  $G_i^n$  is given by (3.22). Next, we have

$$\begin{aligned} D E_{\text{particle}}^n &= \frac{1}{2} |p^{n+1}|^2 + W(q^{n+1}) + \phi^{n+1/2}(q^{n+1}) \\ &\quad - \left( \frac{1}{2} |p^n|^2 + W(q^n) + \phi^{n+1/2}(q^n) \right) + D \phi^{n-1/2}(q^n). \end{aligned}$$

We arrive at the following claim.

**Theorem 3.5.1** *The scheme (3.21)–(3.23) is consistent for the energy exchange, which means that, for any  $n \in \mathbb{N}$ ,*

$$2\pi \Delta x \sum_{i=1}^N \left\langle G_i^n, U_i^{n+1} - U_i^{n-1} \right\rangle + D \phi^{n-1/2}(q^n) = 0.$$

Then, with the notation  $E^n = E_{\text{wave}}^n + E_{\text{particle}}^n$ , we have

$$D E^n = \frac{1}{2} |p^{n+1}|^2 + W(q^{n+1}) + \phi^{n+1/2}(q^{n+1}) - \left( \frac{1}{2} |p^n|^2 + W(q^n) + \phi^{n+1/2}(q^n) \right). \quad (3.29)$$

This statement means that the error on the total discrete energy corresponds exactly to the error made on  $E_{\text{particle}}$  by the symplectic scheme. Note that (3.29) holds as far as (3.18) is satisfied, which itself relies on the assumption that the wave has not crossed the boundary of the computational domain (this is expressed through the assumption that  $\mathcal{C}U_x^m = 0$  for  $m \in \{n-1, n, n+1\}$ ). This is not an issue since the energy that leaves the computational domain can be explicitly computed and incorporated in the energy balance.

**Proof.** On the one hand, we have

$$\begin{aligned} 2\pi\Delta x \sum_{i=1}^N \langle G_i^n, U_i^{n+1} - U_i^{n-1} \rangle &= 2\pi\Delta x \sum_{i=1}^N \sum_{k=1}^{\mathcal{K}_K} G_{i,k}^n (u_{i,k}^{n+1} - u_{i,k}^{n-1}) \\ &= -2\pi \sum_{i=1}^N \sum_{k=1}^{\mathcal{K}_K} \left( \int_{x_{i-\frac{1}{2}}}^{x_{i+\frac{1}{2}}} \sigma_1(x - q^n) dx \right) \left( \int_0^{R_{\max}} r \tilde{\sigma}_2(r) \varphi_k(r) dr \right) (u_{i,k}^{n+1} - u_{i,k}^{n-1}). \end{aligned}$$

On the other hand, we get

$$\begin{aligned} D\phi^{n-\frac{1}{2}}(q^n) &= 4\pi \sum_{i=1}^N \sum_{k=1}^{\mathcal{K}_K} Du_{i,k}^{n-\frac{1}{2}} \left( \int_{x_{i-\frac{1}{2}}}^{x_{i+\frac{1}{2}}} \sigma_1(q^n - y) dy \right) \left( \int_0^{R_{\max}} r \tilde{\sigma}_2(r) \varphi_k(r) dr \right) \\ &= 2\pi \sum_{i=1}^N \sum_{k=1}^{\mathcal{K}_K} \left( \int_{x_{i-\frac{1}{2}}}^{x_{i+\frac{1}{2}}} \sigma_1(q^n - y) dy \right) \left( \int_0^{R_{\max}} r \tilde{\sigma}_2(r) \varphi_k(r) dr \right) ([u_{i,k}^{n+1} + u_{i,k}^n] - [u_{i,k}^n + u_{i,k}^{n-1}]). \end{aligned}$$

That the two quantities compensate is a consequence of the fact that  $\sigma_1$  is even. This ends the proof.  $\blacksquare$

### 3.5.2 The kinetic model

The relation

$$D E_{\text{wave}}^n = 2\pi\Delta x \sum_{i=1}^N \langle G_i^n, U_i^{n+1} - U_i^{n-1} \rangle,$$

still holds, with now  $G_i^n$  defined in (3.27). With  $F^n$  given by (3.28) we set

$$E_{\text{particles}}^n = \iint F^n(x, v) \left( \frac{v^2}{2} + \phi^{n-\frac{1}{2}}(x) \right) dx dv.$$

We obtain

$$D E_{\text{particles}}^n = \iint D F^n(x, v) \left( \frac{v^2}{2} + \phi^{n-\frac{1}{2}}(x) \right) dx dv + \iint F^n(x, v) D \phi^{n-\frac{1}{2}}(x) dx dv.$$

**Theorem 3.5.2** *The scheme (3.26)–(3.28) is consistent for the energy exchange, which means that, for any  $n \in \mathbb{N}$ ,*

$$2\pi\Delta x \sum_{i=1}^N \langle G_i^n, U_i^{n+1} - U_i^{n-1} \rangle + \iint F^n(x, v) D \phi^{n-\frac{1}{2}}(x) dx dv = 0.$$

Then, with the notation  $E^n = E_{\text{wave}}^n + E_{\text{particles}}^n$ , we have

$$D E^n = \iint D F^n(x, v) \left( \frac{v^2}{2} + \phi^{n-\frac{1}{2}}(x) \right) dx dv.$$

As a consequence, the error on the total energy only comes from the error on the particles kinetic energy, as produced by the Semi-Lagrangian method (or the alternative method that could be used for the Vlasov equation).



**Proof.** We have

$$\begin{aligned} 2\pi\Delta x \sum_{i=1}^N \langle G_i^n, U_i^{n+1} - U_i^{n-1} \rangle &= 2\pi\Delta x \sum_{i=1}^N \sum_{k=1}^{\mathcal{K}_K} G_{i,k}^n (u_{i,k}^{n+1} - u_{i,k}^{n-1}) \\ &= -2\pi \sum_{i=1}^N \sum_{k=1}^{\mathcal{K}_K} \left( \int_{x_{i-\frac{1}{2}}}^{x_{i+\frac{1}{2}}} \sigma_1 \star \rho^n(x) dx \right) \left( \int_0^{R_{\max}} r \tilde{\sigma}_2(r) \varphi_k(r) dr \right) (u_{i,k}^{n+1} - u_{i,k}^{n-1}), \end{aligned}$$

with  $\sigma \star \rho^n$  defined in (3.25). It recasts as

$$\begin{aligned} 2\pi\Delta x \sum_{i=1}^N \langle G_i^n, D U_i^n + D U_i^{n-\frac{1}{2}} \rangle \\ = -2\pi\Delta v \sum_{i=1}^N \sum_{k=1}^{\mathcal{K}_K} \sum_{i'=1}^N \sum_{j=-M}^M F_{i',j}^n \left( \int_{x_{i-\frac{1}{2}}}^{x_{i+\frac{1}{2}}} \int_{x_{i'-\frac{1}{2}}}^{x_{i'+\frac{1}{2}}} \sigma_1(x-y) dx dy \right) \\ \times \left( \int_0^{R_{\max}} r \tilde{\sigma}_2(r) \varphi_k(r) dr \right) (u_{i,k}^{n+1} - u_{i,k}^{n-1}). \end{aligned}$$

Next, we have

$$\begin{aligned} \iint F^n(x, v) D \phi^{n-\frac{1}{2}}(x) dx dv &= \Delta v \sum_{i=1}^N \sum_{j=-M}^M F_{i,j}^n \left( \int_{x_{i-\frac{1}{2}}}^{x_{i+\frac{1}{2}}} D \phi^{n-\frac{1}{2}}(x) dx \right) \\ &= 4\pi\Delta v \sum_{i=1}^N \sum_{j=-M}^M \sum_{i'=1}^N \sum_{k=1}^{\mathcal{K}_K} F_{i',j}^n \left( \int_{x_{i-\frac{1}{2}}}^{x_{i+\frac{1}{2}}} \int_{x_{i'-\frac{1}{2}}}^{x_{i'+\frac{1}{2}}} \sigma_1(x-y) dx dy \right) \\ &\quad \times \left( \int_0^{R_{\max}} r \tilde{\sigma}_2(r) \varphi_k(r) dr \right) D u_{i',k}^{n-\frac{1}{2}} \\ &= 2\pi\Delta v \sum_{i=1}^N \sum_{j=-M}^M \sum_{i'=1}^N \sum_{k=1}^{\mathcal{K}_K} F_{i',j}^n \left( \int_{x_{i-\frac{1}{2}}}^{x_{i+\frac{1}{2}}} \int_{x_{i'-\frac{1}{2}}}^{x_{i'+\frac{1}{2}}} \sigma_1(x-y) dx dy \right) \\ &\quad \times \left( \int_0^{R_{\max}} r \tilde{\sigma}_2(r) \varphi_k(r) dr \right) ([u_{i',k}^{n+1} + u_{i',k}^n] - [u_{i',k}^n + u_{i',k}^{n-1}]). \end{aligned}$$

Again, since  $\sigma_1$  is even, the two quantities compensate, which concludes the proof.

Like for the one-particle model, the statement holds as far as (3.18) holds. Otherwise, the energy which goes away the computational domain for the wave equation should be taken into account in the energy balance.  $\blacksquare$

### 3.6 Numerical results

In this Section we perform several numerical simulations. Our purpose is two-fold: on the one hand, we check the ability of the scheme in reproducing the expected behavior of the system as asserted in Theorems 3.1.1 and 3.1.5, in particular concerning the energy exchanges, and in capturing the rate of convergence; on the other hand, we also discuss the physical effects and the role of the assumptions in Theorems 3.1.1 and 3.1.5. We consider the following situations:

- *Single particle.* We wish to illustrate the statements in Theorem 3.1.1: the particle

stops at the critical point of a confining potential; in the free-force case, the particle slows down due to the interaction with the environment; with a constant force, the particle asymptotically moves at a constant speed, that depends linearly on the applied force. These findings however assumes that the wave speed  $c$  is large enough; we shall see on numerical grounds that the behavior is indeed different from the conclusions of Theorem 3.1.1 when  $c$  is small.

- *N-particles.* The theory is far less advanced for this situation, which leads to quite intricate indirect interactions between the particles. The simulations reveal that several scenario can occur and they provide ground for conjectures about the stability of specific states.
- *Kinetic model.* We wish to illustrate the statements in Theorem 3.1.5. In particular, the proof of the Landau damping requires a stability condition which involves the wave speed  $c$  and the spreading of the initial condition. We shall discuss on numerical grounds the effects of these conditions. We will also briefly show that the dimension  $n$  of the vibrational space is crucial; in particular the damping does not hold when  $n = 1$ .

For all the simulations discussed below, we work with the compactly supported form functions:

$$\sigma_1(x) = \exp\left(-\frac{1}{\epsilon^2 - x^2}\right) \mathbf{1}_{-\epsilon \leq x \leq \epsilon},$$

and

$$\sigma_2(z) = \tilde{\sigma}_2(|z|), \quad \tilde{\sigma}_2(r) = \exp\left(-\frac{1}{R^2 - r^2}\right) \mathbf{1}_{0 \leq r \leq R}.$$

Of course, the shape of the solutions is influenced by  $\sigma_1, \sigma_2$ . In particular it changes the depth and the width of the potential wells, but the general features are well represented with these functions. The regularity of  $\sigma_1$  is quite important in the analysis of the equations, but it is not clear in the experiments the dealing with less regular form functions has a significant role. The simulations are performed on the slab  $(-L, L)$ , with periodic boundary conditions. For the Vlasov case, the initial data for the particle distribution function is given by

$$F_0(x, v) = Z \left(1 + a \cos\left(\frac{2\pi}{L}x\right)\right) \exp(-v^2/2),$$

with  $a > 0$  and  $Z$  the normalizing constant (so that  $F_0$  is normalized:  $\iint F_0 dv dx = 1$ ). For the wave equation, we simply set  $(\Psi_0, \Psi_1) = 0$ .

For the particle simulations, the initial data for the wave equation is given by  $\Psi_1 = 0$  and  $\Psi_0$  solution of the stationary equation  $-c^2 \Delta_z \Psi_0(z) = -\sigma_2(z) \sigma_1(x - q_0)$ , with  $q_0$  the initial data of the particle. This quantity is determined numerically by working with the radial coordinate  $r = |z|$ , and by using a suitable approximation of stationary solutions based on infinite elements.

Table 3.1 collects the parameters used in the simulations. The other parameters depend on the considered situation.

$\epsilon$	$R$	$R_{\max}$	$a$	$V_{\max}$
1	1	$2R$	.1	7

Table 3.1: General data for the numerical simulations

### 3.6.1 Simulations for a single particle

**Confining potential.** We start with the case of the confining potential in (3.1a)–(3.1b). We have used the data collected in Table 3.2. The simulations illustrate the second item of Theorem 3.1.1: the particle is trapped by the bottom of the well of the confining potential. It goes back and forth and slows down in the well of the potential.

$W(x)$	$c$	$T$	$L$	$\Delta t$	$\Delta x$	$\Delta r$
$.3x^2$	.5	40	3	$2 \cdot 10^{-2}$	3/128	2/128

Table 3.2: Data for the simulations with a confining potential

The phase portraits depicted in Fig. 3.2 with different initial data illustrate this effect. Fig. 3.2 also shows the evolution of the total energy and of the energy balance. On the one hand, the total energy is not exactly preserved, but the error remains of order  $10^{-4}$  on the time scale of observation, thus confirming the robustness of the scheme. Similar observations apply to all the simulations. On the other hand, for the energy balance, we observe that the particle loses its kinetic energy, which is gained by the membranes. We warn the reader that with the adopted definition (3.3),  $E_{\text{particle}}$  contains asymptotically only the interaction energy, since the kinetic energy of the particle and the energy associated to the external potential tend to 0. Fig. 3.3 illustrates the role of the wave speed  $c$ : while the velocity of the particle clearly tends to 0 (exponentially fast, Fig. 3.3-left) when  $c$  is large, the damping is less visible with small  $c$ 's on Fig. 3.3-right.

**No external force.** Next, we consider the case where there is no external force. The data for these simulations are collected in Table 3.3.

We start with the situation where  $c$  is large enough (Test 1). The interaction with the waves acts as a drag on the particle, which makes it slow down. Note on the figure that the well of the potential created by the vibrating field is slightly delayed compared to the position of the particle, see Fig. 3.4.

	$W(x)$	$c$	$T$	$L$	$\Delta t$	$\Delta x$	$\Delta r$
Test 1	0	.5	20	20	$2 \cdot 10^{-2}$	20/512	2/128
Test 2	0	.25	20	10	$2 \cdot 10^{-2}$	10/256	2/128

Table 3.3: Data for the force-free simulations

It can be observed that the larger  $c$ , the smaller the delay. (More precisely, the leading quantity is the ratio  $c/\dot{q}(0)$ .) For such large  $c$ 's, the particle eventually stops, as announced in [16], see Theorem 3.1.1: this is illustrated by the phase portraits and the velocity evolution in Fig. 3.5 (top). However, when  $c$  is smaller (Test 2), we observe oscillations: the position of the well of the self-consistent potential oscillates, and the particle itself oscillates in the well of this potential. The phase portrait contrasts significantly with the case where  $c$  is large, exhibiting spirals, instead of a neat stop, see Fig. 3.5 (bottom). It is difficult to predict whether this situation leads to a limit cycle or a full stop; anyway if the latter occurs it would be with a far smaller rate.

**Constant force.** Finally, we deal with the case of a constant external force, which is specifically studied in [16], see the first item in Theorem 3.1.1. The data for these simulations are given in Table 3.4.

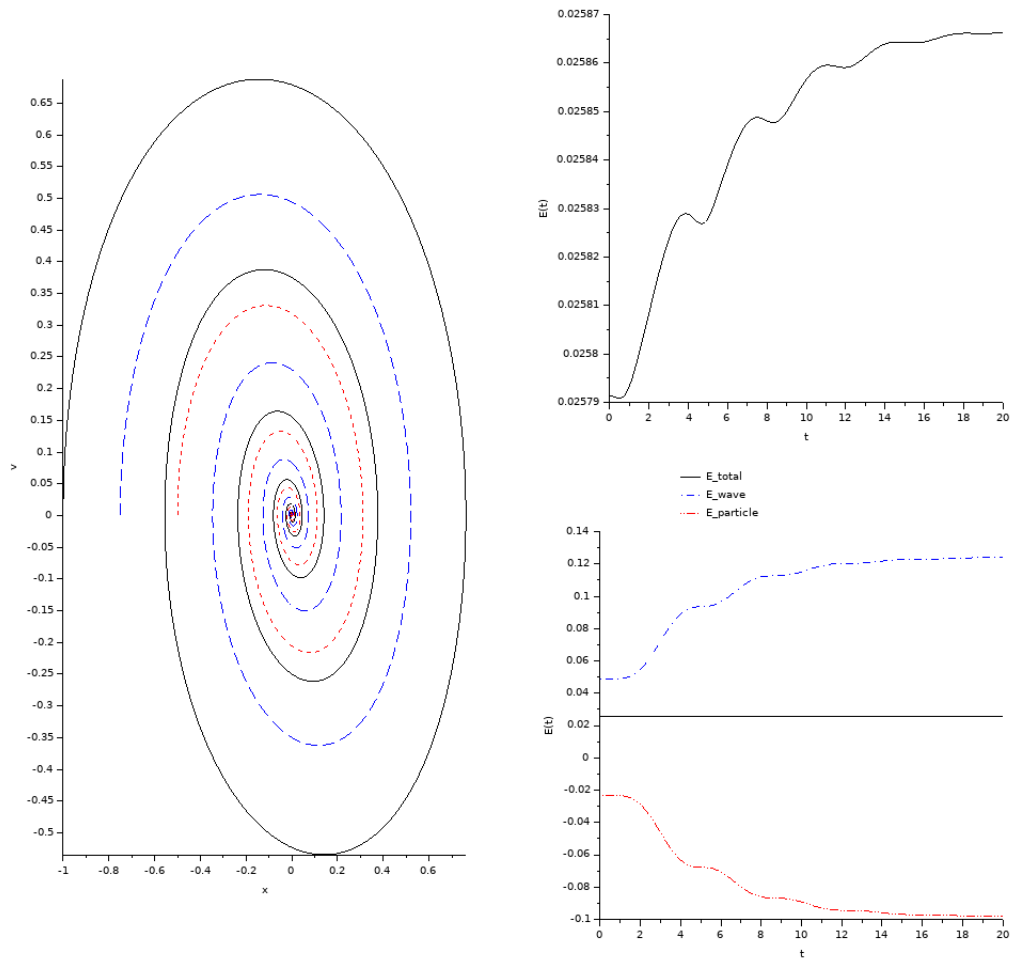

Figure 3.2: Single particle with a confining potential (Table 3.2): phase portrait (left) and evolution of the energy (right)

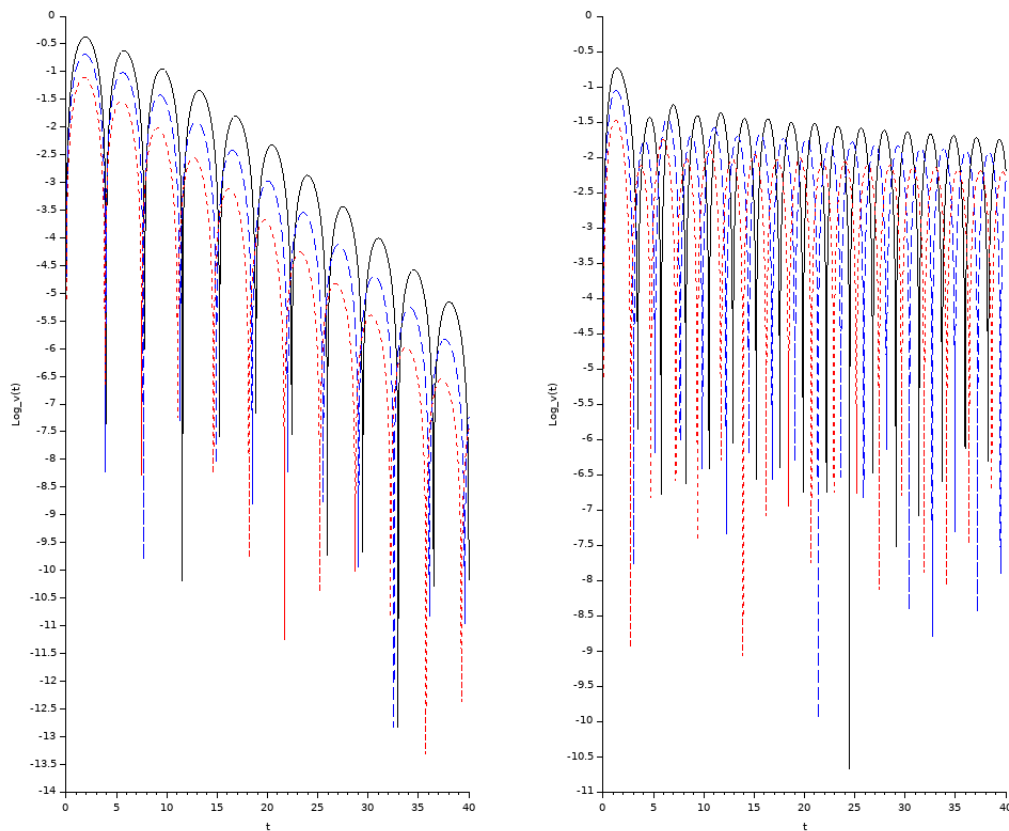

Figure 3.3: Single particle with a confining potential (Table 3.2): evolution of the particle velocity for several initial data (left:  $c = .5$ , right  $c = .25$ )

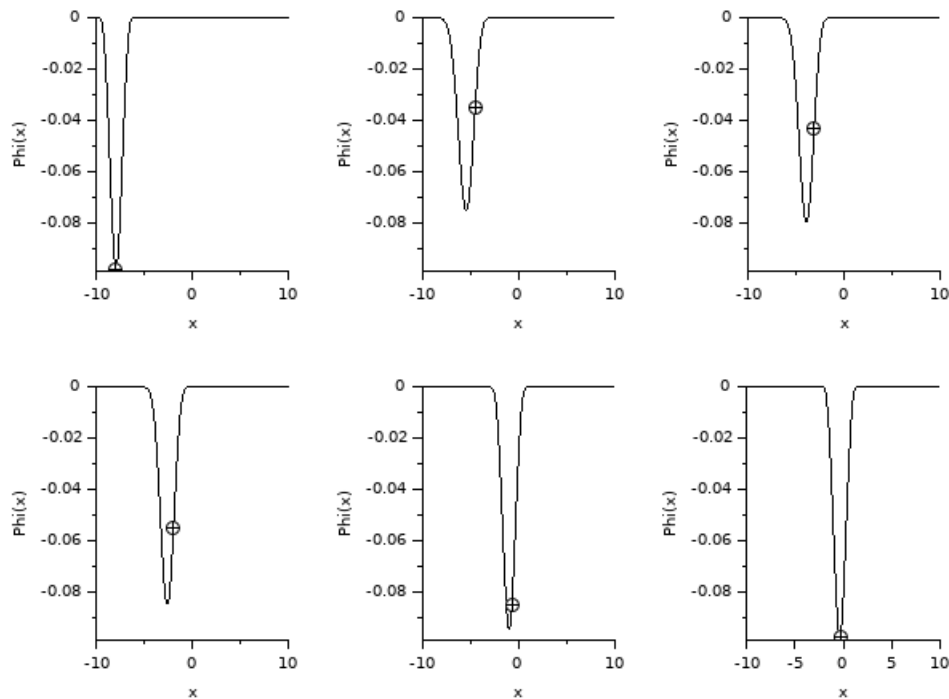

Figure 3.4: Single particle without external force (Table 3.3): delay between the particle position and the potential created by the vibrating field

	$\mathcal{F}$	$c$	$T$	$L$	$\Delta t$	$\Delta x$	$\Delta r$
Test 1	-.1	.5	40	20	$2 \cdot 10^{-2}$	20/512	2/128
Test 2	-.065	.5	40	10	$2 \cdot 10^{-2}$	10/256	2/128

Table 3.4: Data for the simulation with a constant force

We start with the situation where the strength of  $\mathcal{F}$  is not small enough compared to  $1/c$  (Test 1); the statement in Theorem 3.1.1 does not apply. This is indeed what we observe in the simulation: the damping effect is too weak and the speed of the particle keeps growing (see Fig. 3.6-bottom-left). For the same value of  $c$ , we choose a smaller value of  $\mathcal{F}$  (Test 2), so that the conditions of Theorem 3.1.1 are satisfied. We see in Fig. 3.6-top-right that the well of the potential is deeper (see Remark 3.6.1 below), and the damping effect exerted by the wave is indeed stronger. We clearly observe on Fig. 3.6-bottom-right that the speed of the particle tends to a limit value, and for large times the particle has a rectilinear motion with this speed.

We perform the same simulation by making the applied force  $\mathcal{F}$  vary: the behavior of the asymptotic speed  $v(\mathcal{F})$  is depicted in Fig. 3.7, where the expected linear behavior can be observed for small  $\mathcal{F}$ 's, with a slope  $\simeq 2.6$ .

**Remark 3.6.1** *It makes sense to rescale the equations so that the coupling term in the wave equation behaves like  $c^2$ . This is the scaling adopted in [25] in order to derive from (3.7a)–(3.7b) an attractive Vlasov equation. This scaling might be also motivated by the following considerations. With this rescaling the damping rate in Theorem 3.1.1 behaves like  $1/c$  instead of  $1/c^3$ . If we work with this rescaled version of the equation, the depth of*

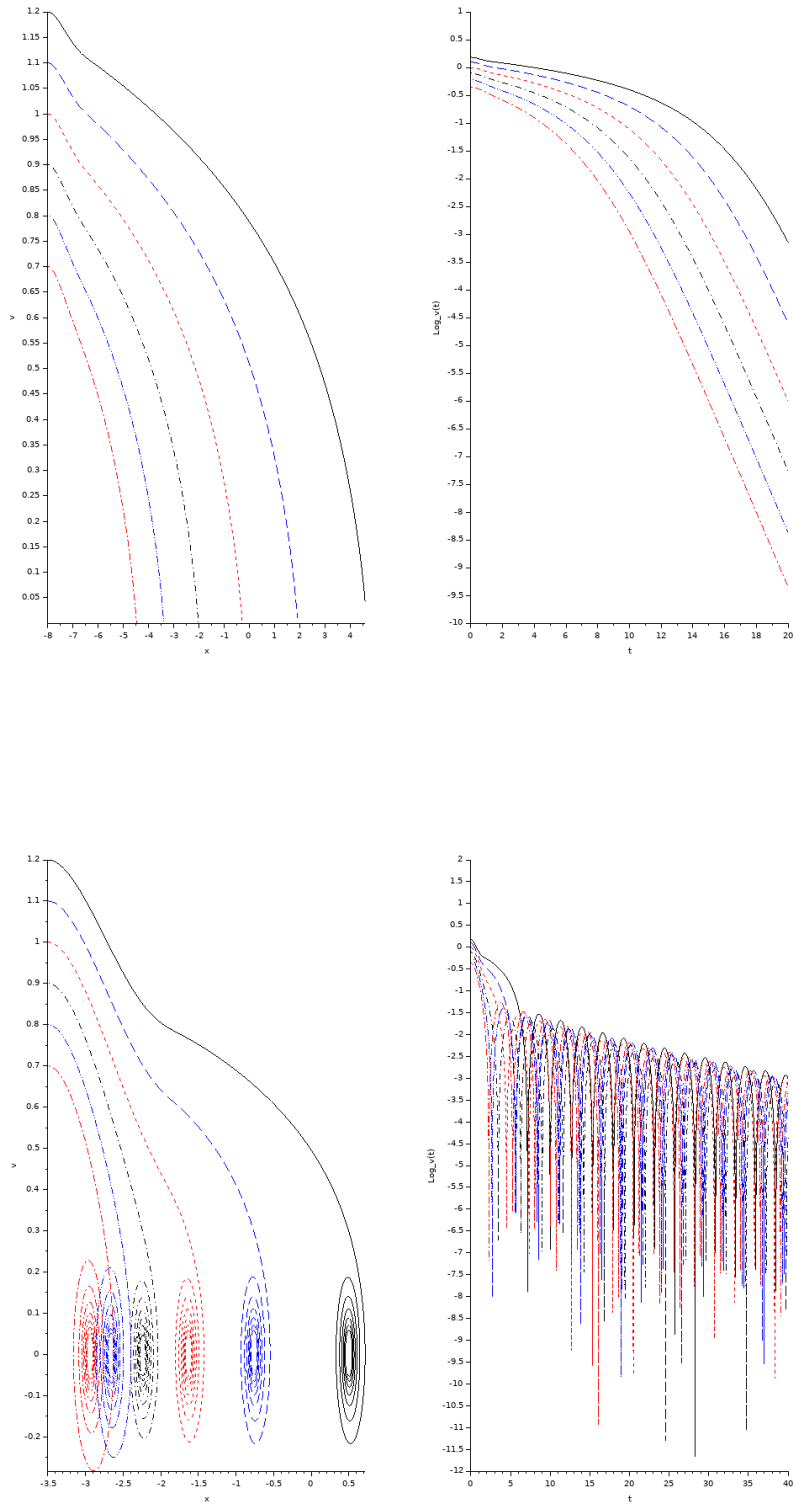

Figure 3.5: Single particle without external force (Table 3.3): phase portrait (left) and velocity evolution (right) for Test 1 (top,  $c$  large) and Test 2 (bottom,  $c$  small) and for several initial data

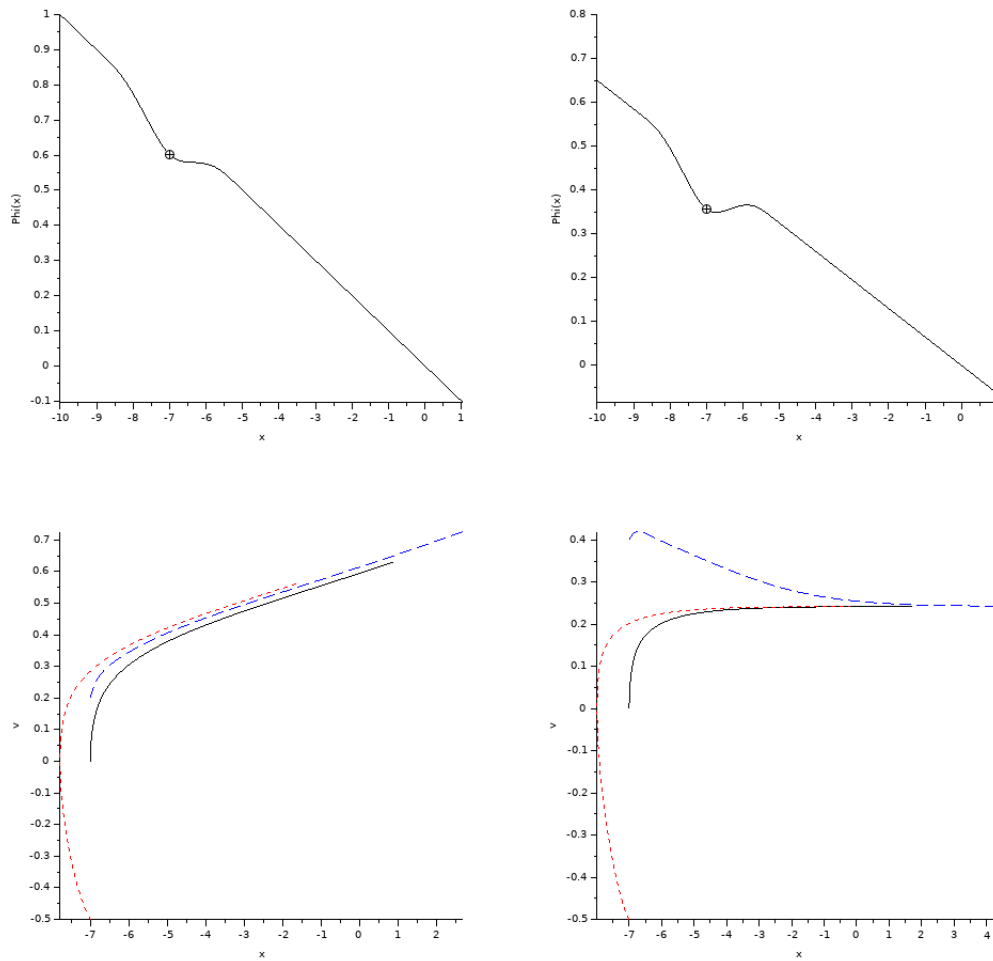

Figure 3.6: Left: Single particle with a constant force  $\mathcal{F}$  not small enough compared to  $1/c$  (Table 3.4, Test 1). Right: Single particle with a constant force  $\mathcal{F}$  small enough compared to  $1/c$  (Table 3.4, Test 2) Top: self-consistent potential at a certain time, and position of the particle; bottom: phase portrait for several initial data



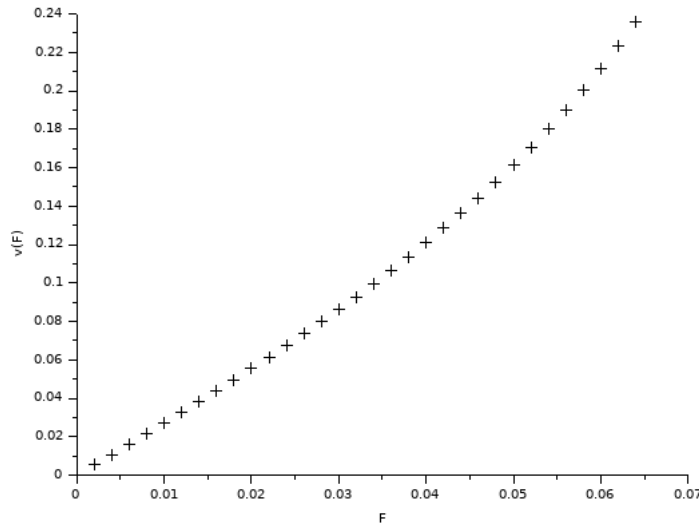

Figure 3.7: Asymptotic speed versus strength of the external force (Table 3.4, Test 2)

*the potential remains unchanged by making  $c$  vary, but the faster evacuation of the energy through the membranes reduces the delay between particle’s and potential well positions. With this re-scaling, the smallness condition on the force  $\mathcal{F}$  becomes uniform with respect to  $c$ .*

### 3.6.2 Simulations for $N$ particles

When dealing with  $N > 1$  particles, see (3.6a)–(3.6b), few rigorous results are known and the asymptotic behavior of the system is certainly quite involved. When the particles are subjected to a confining potential, we observe that they are all just trapped in the well of the potential, and we can infer from the analysis in [104] that they eventually stop in the bottom of that well. However, the statements in [104] involve technical assumptions on the form functions which are not easy to check in practice, and the proof relies on compactness arguments that do not provide any convergence rate, which likely depends, at least, on the number of particles. Fig. 3.8 and Fig. 3.9 present the results of simulations with 2 particles. A remarkable observation is that the two particles seem to self-organize in opposition of phase. The mean velocity tends to 0, exponentially fast (see Fig. 3.10), but it is not clear at all that the individual velocities vanish for large time, see in particular Fig. 3.9. At least, the observed rate of convergence is not exponential and it can become very slow, see Fig. 3.8 and Fig. 3.9, compared to Fig. 3.3. The data for this simulation are collected in Table 3.5.

	$W(x)$	$c$	$T$	$L$	$\Delta t$	$\Delta x$	$\Delta r$	$q_0^1$	$p_0^1$	$q_0^2$	$p_0^2$
Test 1	$.3x^2$	.5	160	3	$2.10^{-2}$	3/128	2/128	-1	0	1	0
Test 2	$.3x^2$	.5	160	3	$2.10^{-2}$	3/128	2/128	-1	0	-0.75	0

Table 3.5: Data for the 2-particles simulations with a confining potential

When there is no external potential, we observe a large variety of scenario. Again, this

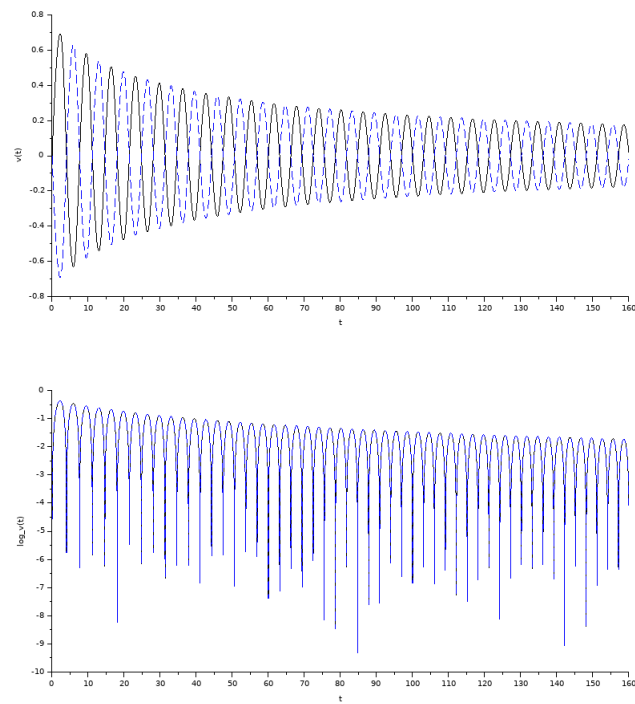

Figure 3.8: Two particles in a confining potential, evolution of the velocities I (Table 3.5-Test 1)

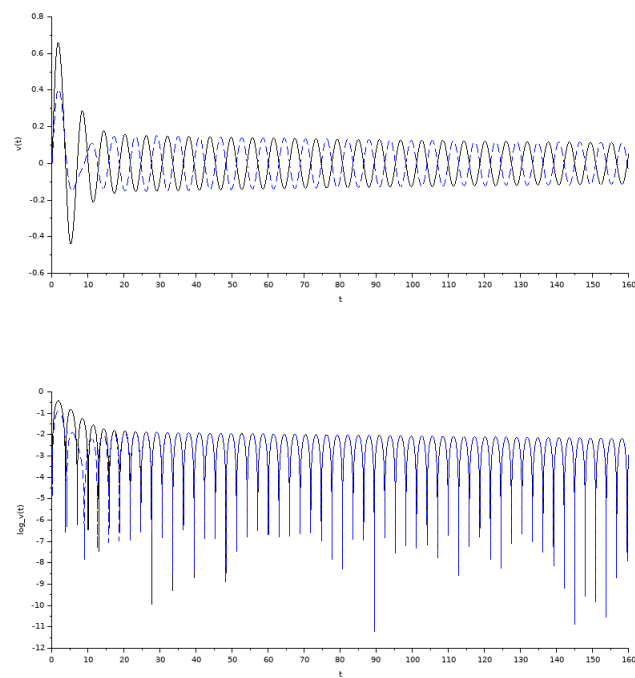

Figure 3.9: Two particles in a confining potential, evolution of the velocities II (Table 3.5-Test 2)

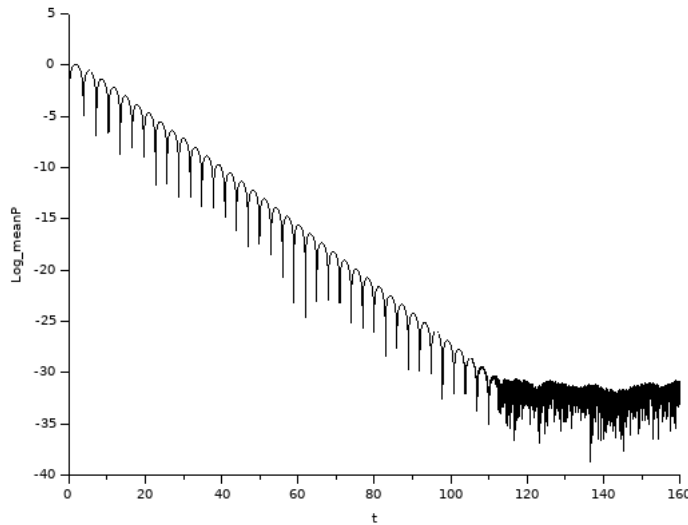

Figure 3.10: Two particles in a confining potential, evolution of the mean velocity (Table 3.5-Test 2)

can already be understood by considering only 2 particles. In Fig. 3.11, we show the situation where two particles meet at some point, but the potential created by their interaction is not strong enough compared to their kinetic energy so that they just cross, and they continue their motion as if they were alone, being stopped by the damping far away from the meeting point. In this situation, their large time behavior looks like as if each particle were alone, with velocities tending exponentially fast to 0, see Fig. 3.12. We repeat the same simulation, just changing the kinetic energy of the two particles into a far smaller value, see Fig. 3.13: now, the two particles stay confined in the same neighborhood. They are going back and forth in the common well they are creating themselves; they cross each other, going in opposite directions, with one particle in each side of the potential well. Note that according to the phase portrait in Fig. 3.15 and the evolution of the velocities in Fig. 3.14, it is not clear at all, on the time scale of observation, whether the damping effect leads to the full stop at the same point of the two particles or the dynamic tends to a periodic solution. The data for this simulation are collected in Table 3.6.

	$W(x)$	$c$	$T$	$L$	$\Delta t$	$\Delta x$	$\Delta r$	$q_0^1$	$p_0^1$	$q_0^2$	$p_0^2$
Test 1	0	.5	40	20	$2 \cdot 10^{-2}$	20/512	2/128	-4	1	4	-1
Test 2	0	.5	80	20	$2 \cdot 10^{-2}$	20/512	2/128	-4	.8	4	-.8

Table 3.6: Data for the 2-particles simulations with no external force

The complexity of the possible large time scenario increases for larger  $N$ 's. The space-repartition of the  $N$  particles can be complicated and highly depend on the initial state; nonetheless, it is still reasonable to expect that the velocities vanish for large times. However, the rate of convergence to zero is not exponential. Again, we refer the reader to [104] for an attempt identifying conditions (for the free-space problem) that lead to a final stop of all particles, with a rate which gets slower as  $N$  becomes larger. In particular, exploring

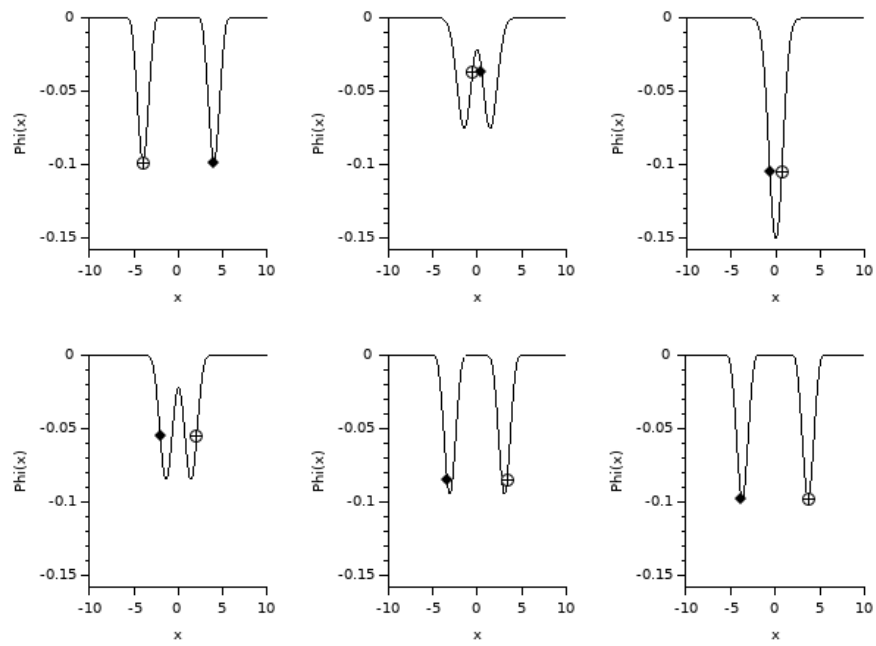

Figure 3.11: Two particles: weak interaction (Table 3.6-Test 1)

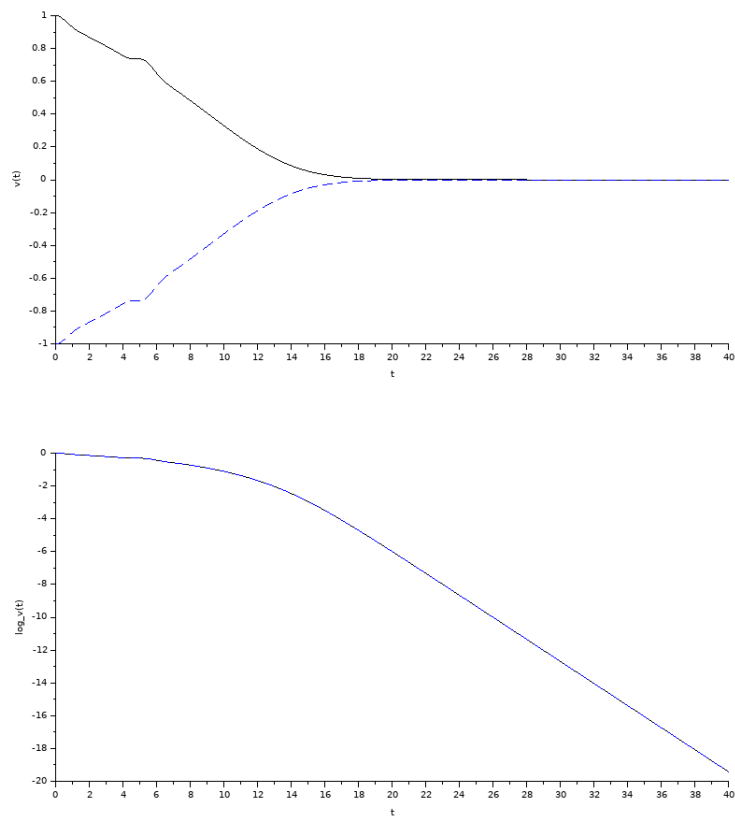

Figure 3.12: Two particles: weak interaction (Table 3.6-Test 1), evolution of the velocities

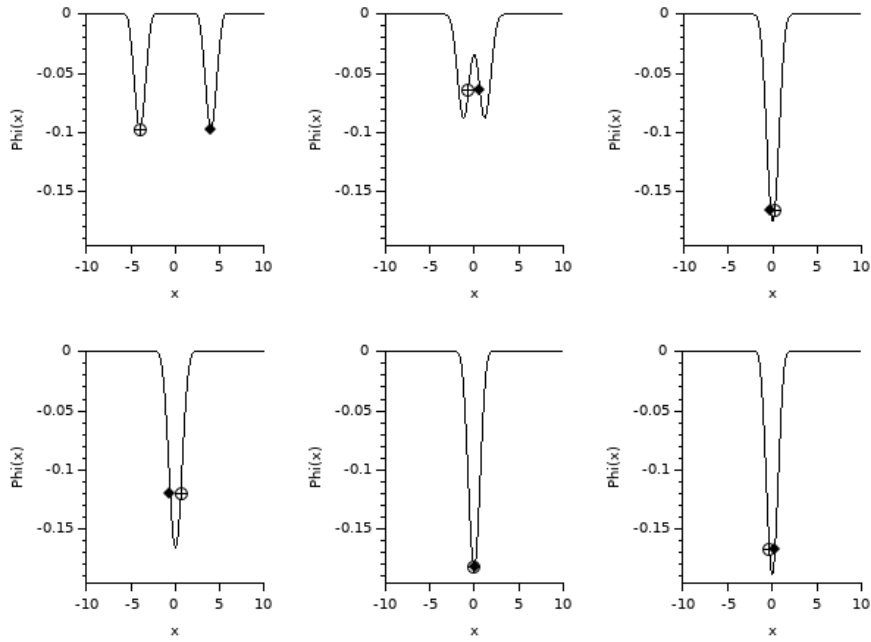

Figure 3.13: Two particles: strong interaction (Table 3.6-Test 2)

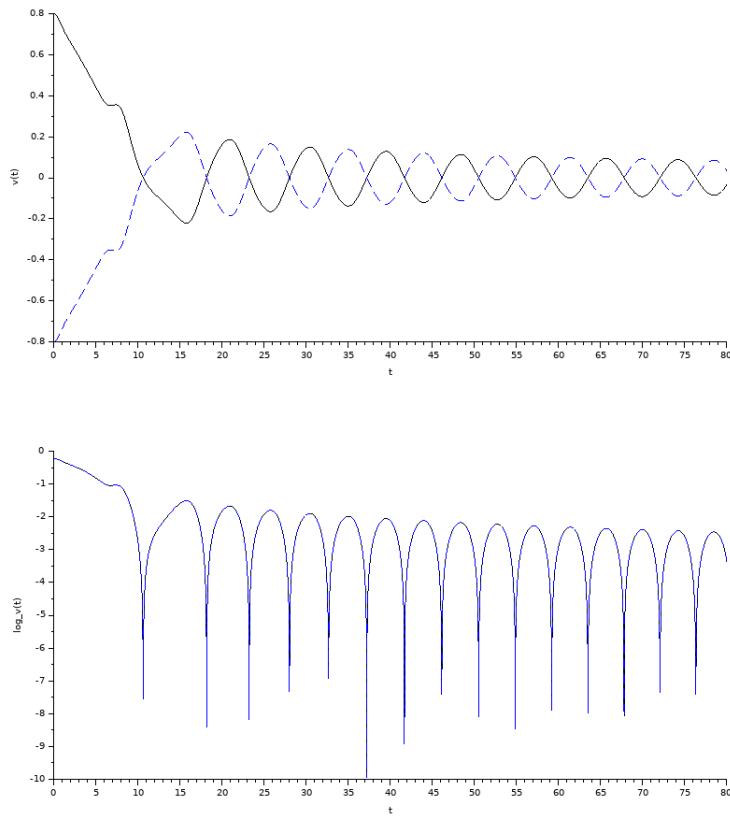

Figure 3.14: Two particles: strong interaction (Table 3.6-Test 2), evolution of the velocities

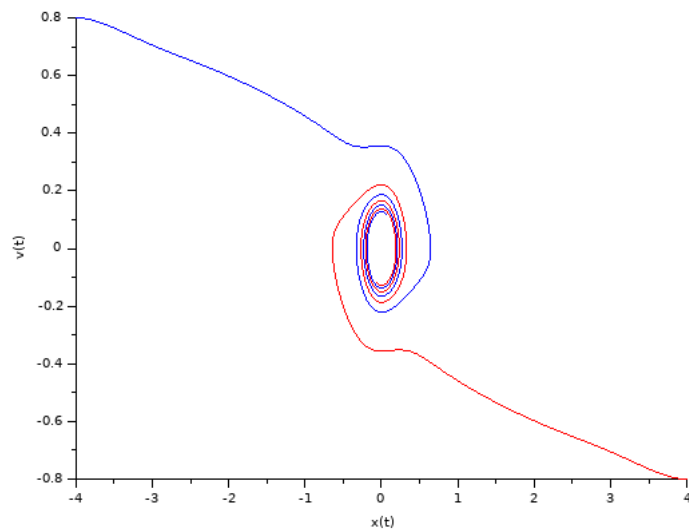

Figure 3.15: Two particles: strong interaction, phase portrait (Table 3.6-Test 2)

$W(x)$	$c$	$T$	$L$	$\Delta t$	$\Delta x$	$\Delta r$	$N$
0	2	40	20	$2 \cdot 10^{-2}$	20/512	2/128	100

Table 3.7: Data for the  $N$ -particles simulations

the large time behavior for the  $N$ -particles system becomes numerically demanding, since it requires a long time to establish. Fig. 3.16 illustrates a case with the creation of a common well: the particles keep moving back and forth along the walls of the well, and the well itself move. Like with one particle, we observe that the medium acts as a friction on the particles cloud, but, considering the particles individually, it is not clear at all whether they will be stopped or kept moving in the common well. In Fig. 3.17 we see the exponential decay of the mean velocity of the particles until the cloud is stopped. Again, it is not clear whether or not particles will be individually stopped. In contrast to the 2 particles case, we do not observe self-organization of the particles in phase opposition patterns; and after the rapid transient stage, the decay is not anymore exponential. For the presented simulation, we have set the parameters as in Table 3.7.

We have performed a few simulations adopting the mean-field rescaling, but we do not observe significantly different results.

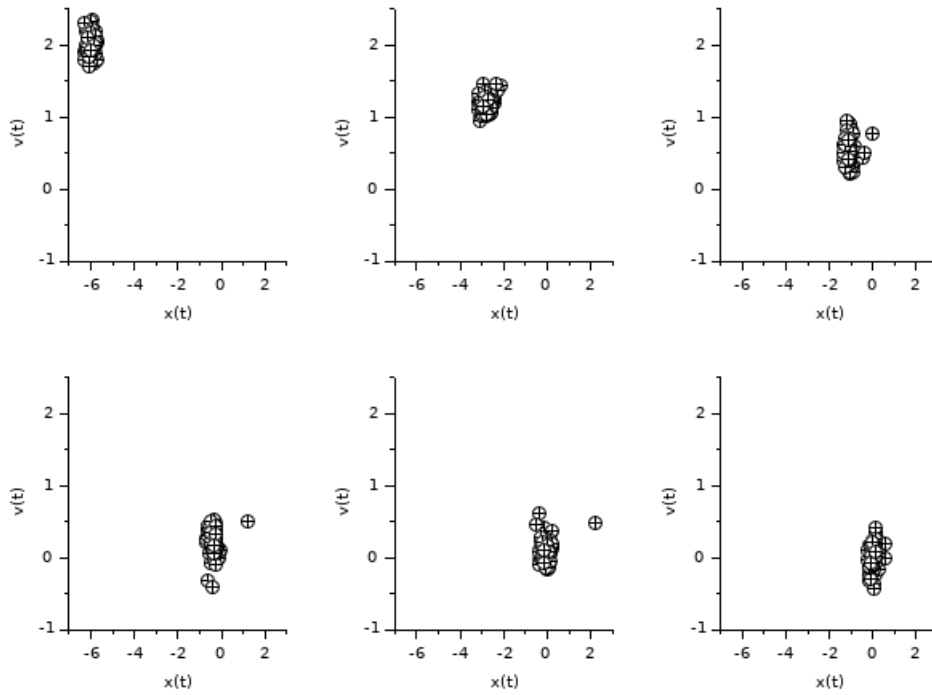

Figure 3.16:  $N$ -particles, evolution of a cloud (Table 3.7)

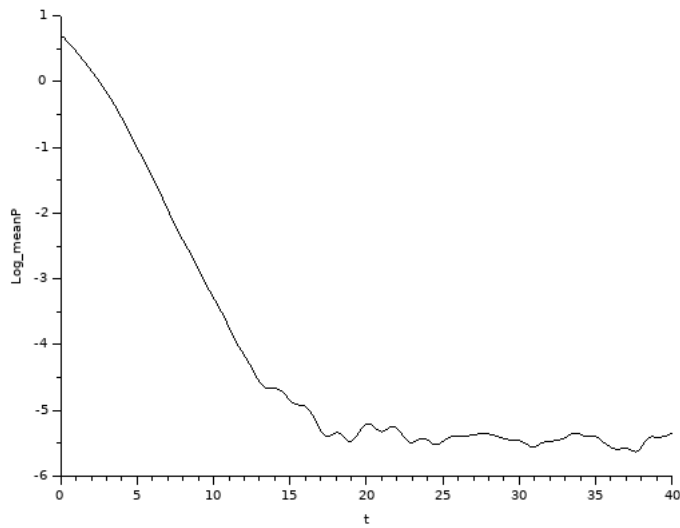

Figure 3.17:  $N$ -particles, evolution of the mean velocity (Table 3.7)

### 3.6.3 Simulations for the Vlasov equation

We turn to (3.7a)–(3.7b) and we wish to illustrate numerically Theorem 3.1.5. We make use of the parameters in Table 3.8.

In Fig. 3.18-left this is the case where  $c$  is large enough (Test 1), and Landau damping holds: we see the exponential decay of the macroscopic density and of the self-consistent force. We also observe that the behavior of the particle distribution function is driven for large times by free transport. In Fig. 3.18-right and Fig. 3.19,  $c$  is smaller and the Landau damping does not hold (Test 2). We refer the reader to [52] for a link between the wave speed threshold and Jean’s length in the attractive Vlasov-Poisson case.

We also illustrate the role of the dimension  $n$  for the wave equation. The results depicted in Fig. 3.20 and Fig. 3.21 have been obtained with the one-dimensional wave equation (Test 3). There is no damping at all, even increasing the value of  $c$ : the particles aggregate, with increased velocities, in a well which is going deeper and deeper. The amplitudes of both the potential and its gradient become larger as time grows. We refer the reader to the end of this Section for an explanation of the difference between the cases  $n = 1$  and  $n = 3$ .

	$W(x)$	$c$	$n$	$T$	$L$	$\Delta t$	$\Delta x$	$\Delta r$	$\Delta v$
Test 1	0	0.5	3	60	4	$2 \cdot 10^{-2}$	4/256	2/128	7/256
Test 2	0	0.05	3	60	4	$2 \cdot 10^{-2}$	4/256	2/128	7/256
Test 3	0	0.5	1	60	4	$2 \cdot 10^{-2}$	4/256	2/128	7/256

Table 3.8: Data for the kinetic simulations, I

The linear stability criterion mentioned in Theorem 3.1.5 is not very explicit; one may wonder what is meant in practical terms by this condition and how we can decide easily whether or not a given equilibrium is stable. We have already seen that the answer depends of the value of the parameter  $c$ : for a given profile, if  $c$  is large enough there is damping (Test 1) whereas for  $c$  small enough there is not (Test 2). The question can be addressed the other way around, keeping the value of  $c$  fixed. In [52] we have shown that for any given velocity profile  $v \mapsto \mathcal{M}(v)$ , if the mass of this profile is spread enough, then the linear stability criterion is satisfied. This can be understood by introducing the following rescaling:  $\mathcal{M}_\lambda(v) = \lambda^d \mathcal{M}(\lambda v)$ . For  $\lambda$  small enough this equilibrium is stable and if  $\lambda$  is large enough the equilibrium is no more stable. Since this rescaling is mass invariant, this result shows that any profile  $\mathcal{M}$  of arbitrary large  $L^1$ -norm is stable as soon as its mass is spread enough. We can investigate this result at the numerical level as well. We perform several simulations, by making the rescaling parameter  $\lambda$  vary, with the following rescaled initial data

$$F_0^\lambda(x, v) = \lambda Z \left( 1 + a \cos \left( \frac{2\pi}{L} x \right) \right) \exp(-\lambda^2 v^2 / 2).$$

and using the data in Table 3.9.

	$W(x)$	$c$	$\lambda$	$n$	$T$	$L$	$\Delta t$	$\Delta x$	$\Delta r$	$\Delta v$
Test 4	0	1	10	3	60	4	$2 \cdot 10^{-2}$	4/256	2/128	0.7/256
Test 5	0	0.1	1	3	60	4	$2 \cdot 10^{-2}$	4/256	2/128	7/256
Test 6	0	0.1	0.25	3	60	4	$2 \cdot 10^{-2}$	4/256	2/128	14/512

Table 3.9: Data for the kinetic simulations, II



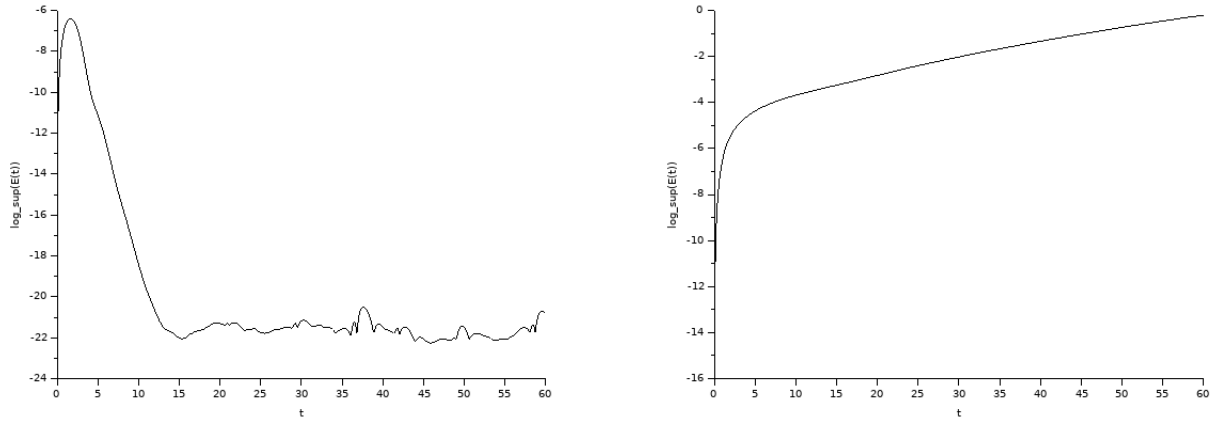

Figure 3.18: Kinetic model, evolution of the force field (Table 3.8): the case with  $c$  large enough (Test 1: left), and the case  $c \ll 1$  (Test 2: right)

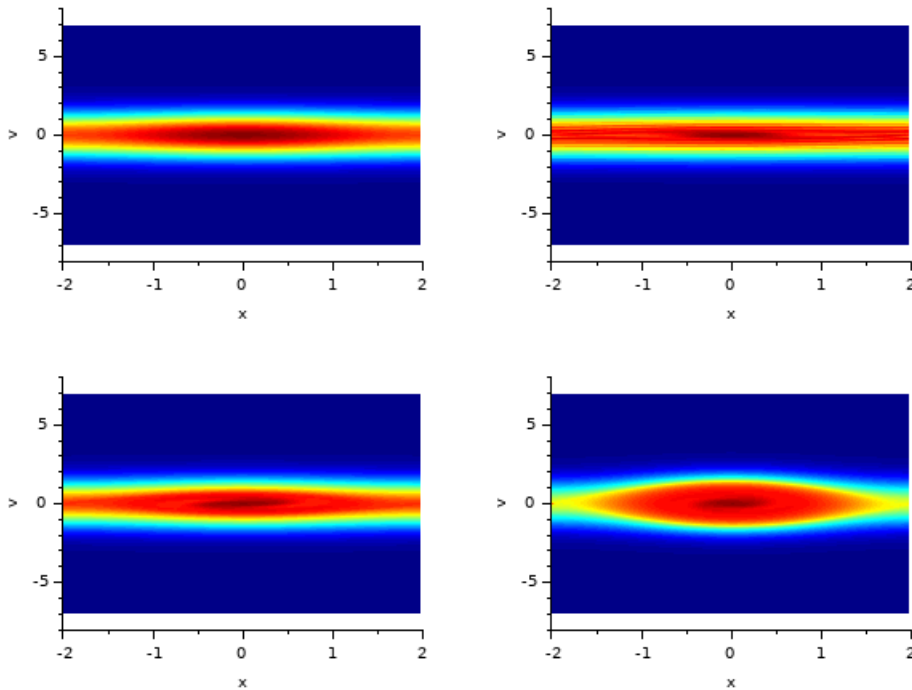

Figure 3.19: Kinetic model: the case  $c \ll 1$  (Table 3.8, Test 2), the particles distribution function  $F$  at several times (top left: initial condition)

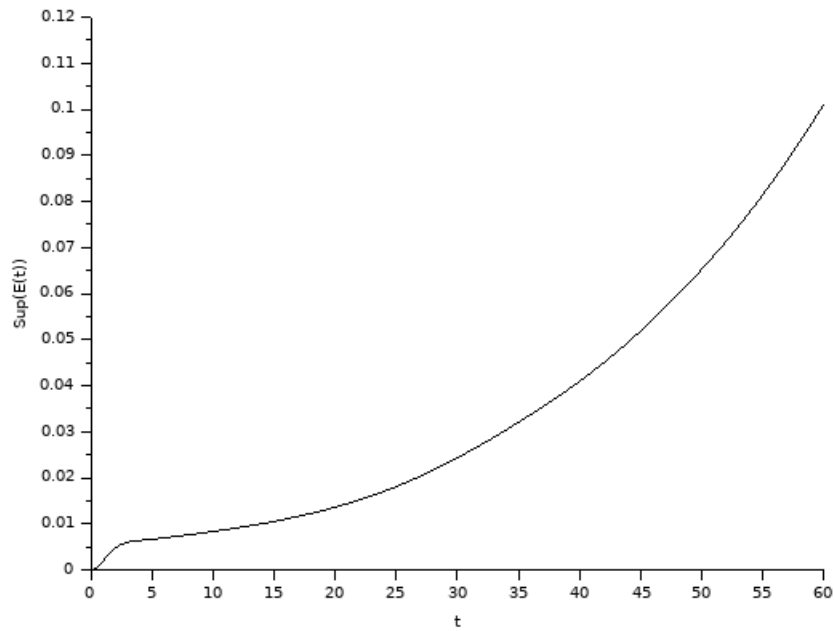

Figure 3.20: The case  $n = 1$  (Table 3.8, Test 3): the force field

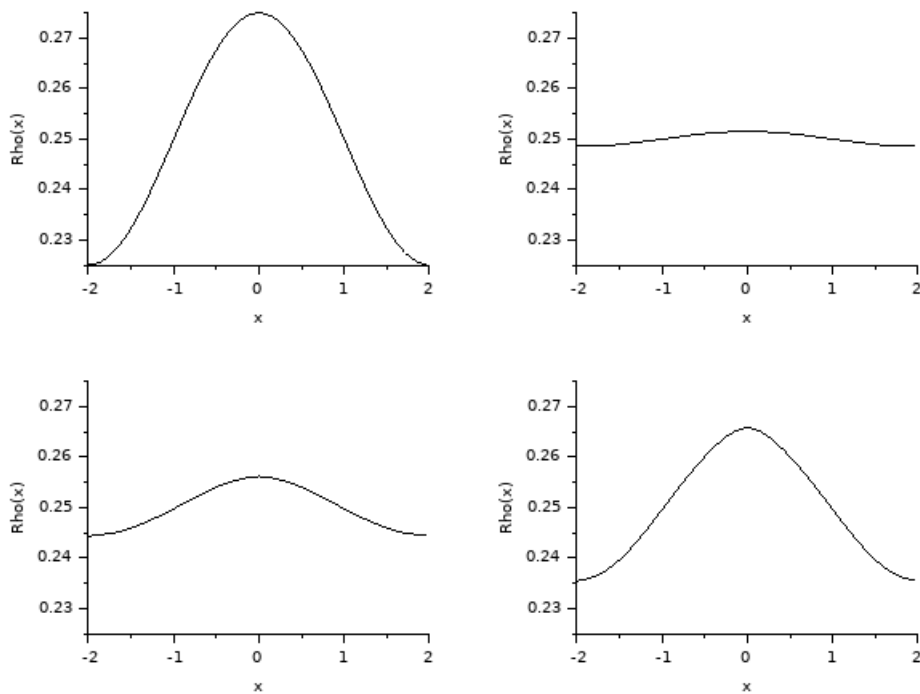

Figure 3.21: The case  $n = 1$  (Table 3.8, Test 3): the macroscopic density  $\rho$  at several time (top left: initial condition)

Since the parameter  $\lambda$  dilates in velocity the initial data, we can use for the fourth test a smaller computational domain ( $V_{\max} = 0.7$ ) whereas in the sixth test we have to use a larger domain ( $V_{\max} = 14$ ).

In Fig. 3.22 this is the case where from a stable state (Test 1) we pass to an unstable state by contracting the mass of the velocity profile (Test 4). We see that, since almost all the mass is now concentrated near 0, any spatial perturbation (even small) of this profile creates spatial region where particles are trapped. Conversely, starting from an unstable state (Test 5 and Fig. 3.23-left) it is possible to obtain a stable state by dilating the velocity profile (Test 6 and Fig. 3.23-right). In particular this procedure allows us to obtain numerically the Landau damping effect for an arbitrarily small value of  $c$ . Nevertheless, this procedure leads to numerical difficulties. On the one hand, for  $c$  small the dispersion in the membranes is really slow and the damping rate is small (compare Fig. 3.18 and Fig. 3.23-right). Therefore, in order to observe the damping numerically we have to perform computations on a large time interval, which becomes demanding. On the other hand, this procedure dilates in velocity the initial data which thus requires to compute on a larger domain in velocity and increases the computational cost. These two difficulties combine and lead to really heavy simulation. (This is the reason why we perform simulations with  $c = 0.1$  and not  $c = 0.05$ .)

**A remark in the case  $n = 1$ .** According to [25], the system (3.7a)–(3.7b) can be rewritten as a Vlasov equation with a memory term in the force field

$$\partial_t F + v \cdot \nabla_x F - \nabla_x \left( \Phi_0 - \int_0^t p_c(t - \tau) \Sigma \star \rho(\tau) d\tau \right) \cdot \nabla_v F = 0. \quad (3.30)$$

In (3.30), we have  $p_c(t) = \int \sigma_2(z) \Upsilon(t, z) dz$  where  $\Upsilon$  is the unique solution of the wave equation with initial impulsion  $\sigma_2$ :

$$\begin{aligned} (\partial_{tt}^2 - c^2 \Delta_z) \Upsilon(t, z) &= 0, \\ (\Upsilon, \partial_t \Upsilon)|_{t=0} &= (0, \sigma_2). \end{aligned}$$

In [25, Lemma 14] and in Lemma 2.1.3 of the previous Chapter it is shown that the kernel  $p_c$  satisfies the following properties.

**Proposition 3.6.2** *For  $n \geq 3$ ,  $p_c \in L^1(0, +\infty)$  and*

$$\int_0^{+\infty} p_c(t) dt = \frac{\kappa}{c^2} \quad ; \quad \kappa = \int \frac{|\widehat{\sigma}_2(\zeta)|^2}{|\zeta|^2} d\zeta.$$

*If, moreover,  $n$  is odd, then  $p_c$  has a compact support included in  $[0, 2R_2/c]$  (with  $\text{supp}(\sigma_2) = B(0, R_2)$ ) and*

$$|p_c(t)| \lesssim \frac{\|\sigma_2\|_{L_z^{2n/(n+2)}} \|\sigma_2\|_{L_z^2}}{c}.$$

That  $\kappa$  is finite clearly relies on the assumption  $n \geq 3$ . This statement means that there is a loss of memory effect in the force field of (3.30). This loss of memory effect is an important mechanism in the analysis of the Landau damping for (3.7a)–(3.7b) (*cf* the previous Chapter). In dimension  $n = 1$  there is no such a loss of memory effect in the kernel  $p_c$ . In turn, if the initial data has a spatial inhomogeneity, then the force field created by the medium cannot be damped and the force field eventually grows in the spatial region where the force field acted initially as an attractive force.

**Proposition 3.6.3** *If  $n = 1$ , then  $p_c(t) \geq 0$  and  $\lim_{t \rightarrow \infty} p_c(t) = \frac{1}{2c} \|\sigma_2\|_{L_z^1}^2$ .*

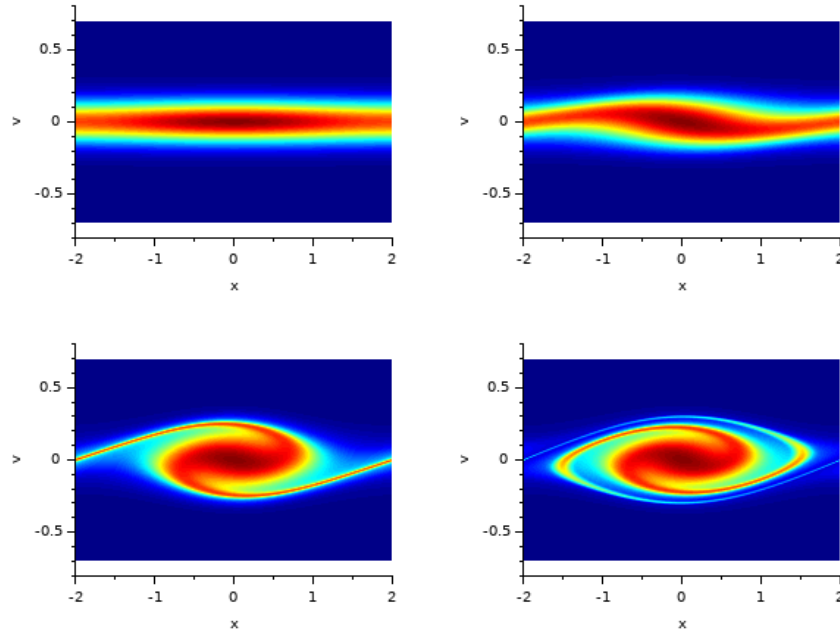

Figure 3.22: Kinetic model: the case  $c = 1$  and  $\lambda = 10$  (Table 3.9, Test 4)

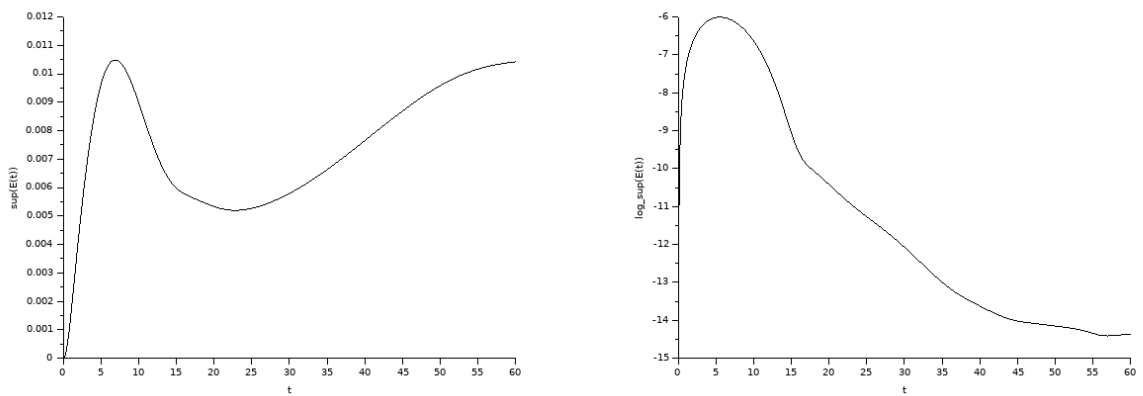

Figure 3.23: Kinetic model, evolution of the force field: with  $c = 0.1$  and  $\lambda = 1$  (Table 3.9, Test 5: left) and  $c = 0.1$  and  $\lambda = 0.25$  (Table 3.9, Test 6: right)

This proposition is a direct application of the d'Alembert formula:

$$\Upsilon(t, z) = \frac{1}{2c} \int_{z-ct}^{z+ct} \sigma_2(s) ds$$

which allows us to obtain

$$p_c(t) = \frac{1}{2c} \int_{-\infty}^{+\infty} \sigma_2(z) \left( \int_{z-ct}^{z+ct} \sigma_2(s) ds \right) dz.$$

This is precisely the effect illustrated in Fig. 3.20 and 3.21: assuming  $n \geq 3$  is not a matter of technical difficulty, but is deeply related to the physical mechanisms described by the model.

### 3.7 Conclusion

In this Chapter, we set up a numerical strategy that preserves accurately the dynamics of energy exchanges for open systems where particles transfer energy to their environment, represented as a transverse vibrational field. The method applies for  $N$ -particles model as well as for statistical description based on kinetic equations. As we will see it in Chapter 5, the strategy behind these numerical schemes can be applied to quantum particles as well.

The simulations illustrate the theoretical results obtained when considering a single particle [16], interpreted as a friction effect of the environment on the particle, or many particles, where the interaction leads to Landau damping effects (see the previous Chapter). The numerical investigation also sheds light on the role of the parameters of the model; in particular the wave speed  $c$  and the dimension  $n$  of the vibrational space should satisfy conditions for the damping to occur.





---

On quantum dissipative systems: ground states and orbital stability

---

This chapter is devoted to the analysis of the Schrödinger-Wave system. More precisely, we study the existence of ground states and their orbital stability. This work is the purpose of the article [P4]. This is a first step in order to investigate some dissipative behaviors on this system. We refer the reader to the next Chapter for a numerical study in this direction.

## 4.1 Introduction

This work is concerned with the study of the following system of PDEs, hereafter referred to as the *Schrödinger-Wave equation*

$$i\partial_t u + \frac{1}{2}\Delta_x u = \left( \sigma_1 \star_x \int_{\mathbb{R}^n} \sigma_2 \psi \, dz \right) u, \quad t \in \mathbb{R}, \, x \in \mathbb{R}^d \quad (4.1a)$$

$$(\partial_{tt}^2 \psi - c^2 \Delta_z \psi)(t, x, z) = -c^2 \sigma_2(z) \sigma_1 \star_x |u|^2(t, x), \quad t \in \mathbb{R}, \, x \in \mathbb{R}^d, \, z \in \mathbb{R}^n \quad (4.1b)$$

endowed with the initial data

$$u(0, x) = u_0(x), \quad (\psi(0, x, z), \partial_t \psi(0, x, z)) = (\psi_0(x, z), \psi_1(x, z)). \quad (4.2)$$

Here  $u$  represents the wave function of a quantum particle, which interacts with the vibrational field  $\psi$ , and  $c > 0$  is a fixed parameter. A key feature of the model is the fact that the particle motion holds in the space  $\mathbb{R}^d$ , but the vibrations hold in a *transverse direction*  $\mathbb{R}^n$ . We are mainly interested in finding particular *solitary wave* solutions of the system, with the specific form

$$u(t, x) = e^{i\omega t} Q(x), \quad \psi(t, x, z) = \Psi(x, z) \quad (4.3)$$

where  $\omega \in \mathbb{R}$ , and  $Q, \Psi$  are real valued, and to investigate the stability of such solutions.

### 4.1.1 Motivation

This work is motivated by the modeling of dissipative systems. As suggested by A. Caldeira and A. Legget [19] the dissipation arising on a physical system might come from a coupling with a complex environment. In this approach, dissipation is interpreted as the transfer



of energy from the single degree of freedom characterising the system to the more complex set of degrees of freedom describing the environment; the energy is then evacuated into the environment and does not come back to the system. There are many possible descriptions of the environment: the case in which the environmental variables are vibrational degrees of freedom is particularly appealing. The system (4.1a)-(4.1b) belongs to this class of models.

This system is nothing but a quantum version of a model introduced by L. Bruneau and S. de Bièvre in [16] for describing a classical particle interacting with its environment seen as a bath of oscillators. Roughly speaking in each space position  $x \in \mathbb{R}^d$  there is a membrane oscillating on a transverse direction  $z \in \mathbb{R}^n$ . When the particle hits a membrane, its kinetic energy activates vibrations and the energy is evacuated at infinity in the  $\mathbb{R}^n$  directions. In particular, the coordinates  $(z_1, \dots, z_n) \in \mathbb{R}^n$  need not have the specific dimension of a length (but adopting this language might definitely help the intuition). These energy transfer mechanisms eventually act as a sort of friction force on the particle, an intuition rigorously justified in [16, Theorem 2 and Theorem 4]. The system for the position of the particle  $t \mapsto q(t)$  and the state of the vibrational environment  $(t, z) \mapsto \psi(t, z)$  reads

$$\ddot{q}(t) = - \int \nabla \sigma_1(q(t) - y) \sigma_2(z) \psi(t, y, z) dz dy, \quad t \in \mathbb{R} \quad (4.4a)$$

$$(\partial_{tt}^2 \psi - c^2 \Delta_z \psi)(t, x, z) = -\sigma_2(z) \sigma_1(x - q(t)), \quad t \in \mathbb{R}, x \in \mathbb{R}^d, z \in \mathbb{R}^n \quad (4.4b)$$

completed by the initial data

$$(q(0), \dot{q}(0)) = (q_0, p_0), \quad (\psi(0, x, z), \partial_t \psi(0, x, z)) = (\psi_0(x, z), \psi_1(x, z)). \quad (4.5)$$

The functions  $\sigma_1 : \mathbb{R}^d \rightarrow [0, \infty)$  and  $\sigma_2 : \mathbb{R}^n \rightarrow [0, \infty)$  are form functions encoding the interaction domain between the particle and the environment. The model can be extended by considering  $P$ -interacting particles, and the mean-field regime  $P \rightarrow \infty$  leads to the following Vlasov-Wave system [52]

$$\partial_t f + v \cdot \nabla_x f - \nabla_x \left( \sigma_1 \star_x \int \sigma_2 \psi dz \right) \cdot \nabla_v f = 0, \quad t \in \mathbb{R}, x \in \mathbb{R}^d, v \in \mathbb{R}^d \quad (4.6a)$$

$$\partial_{tt}^2 \psi - c^2 \Delta_z \psi = -\sigma_2(z) \left( \sigma_1 \star_x \int f dv \right), \quad t \in \mathbb{R}, x \in \mathbb{R}^d, z \in \mathbb{R}^n, \quad (4.6b)$$

$$f(0, x, v) = f_0(x, v), \quad (\psi(0, x, z), \partial_t \psi(0, x, z)) = (\psi_0(x, z), \psi_1(x, z)), \quad (4.6c)$$

where  $f$  stands for the particle distribution function in phase space. This system is thoroughly investigated in [4, 26, 103]. In [25], it is proposed to rescale the wave equation (4.6b) as follows

$$\partial_{tt}^2 \psi - c^2 \Delta_z \psi = -c^2 \sigma_2 \left( \sigma_1 \star_x \int f dv \right). \quad (4.7)$$

As  $c$  goes to  $+\infty$ , the solutions of the rescaled system (4.6a), (4.7) tend to solutions of

$$\partial_t \tilde{f} + v \cdot \nabla_x \tilde{f} - \nabla_x \left( \sigma_1 \star_x \int \sigma_2 \tilde{\psi} dz \right) \cdot \nabla_v \tilde{f} = 0, \quad t \in \mathbb{R}, x \in \mathbb{R}^d, v \in \mathbb{R}^d \quad (4.8a)$$

$$- \Delta_z \tilde{\psi} = -\sigma_2 \left( \sigma_1 \star_x \int \tilde{f} dv \right), \quad t \in \mathbb{R}, x \in \mathbb{R}^d, z \in \mathbb{R}^n \quad (4.8b)$$

(Without the rescaling the regime  $c \rightarrow \infty$  would simply lead to the free transport equation for the particle distribution function  $\tilde{f}$ .) We can write

$$\tilde{\psi}(t, x, z) = \Gamma(z) \left( \sigma_1 \star \int \tilde{f} dv \right) (x)$$

where  $\Gamma$  denotes the unique solution of

$$-\Delta_z \Gamma = -\sigma_2, \quad \Gamma \in \dot{H}^1(\mathbb{R}_z^n). \quad (4.9)$$

This observation allows us to express (4.8a)-(4.8b) as a standard Vlasov equation

$$\partial_t \tilde{f} + v \cdot \nabla_x \tilde{f} + \kappa \nabla_x \left( \Sigma \star_x \int \tilde{f} dv \right) \cdot \nabla_v \tilde{f} = 0, \quad t \in \mathbb{R}, x \in \mathbb{R}^d, v \in \mathbb{R}^d, \quad (4.10)$$

where the potential is defined by a convolution with the macroscopic density, with

$$\kappa = \|\nabla_z \Gamma\|_{L^2}^2, \quad \Sigma = \sigma_1 \star \sigma_1. \quad (4.11)$$

Quite surprisingly – mind the sign  $\kappa > 0$  – this corresponds to an attractive dynamics. This unexpected connection guides the intuition to establish further features of the solutions of the Vlasov-Wave system; in particular, they exhibit Landau damping phenomena [P1, P2]. The analysis of these models, either for a single particle or the kinetic description, brings out the critical role of the wave speed  $c > 0$  and the dimension  $n$  of the space for the wave equation.

The system (4.1a)-(4.1b) then appears as a quantum version of the L. Bruneau and S. de Bièvre model. This intuition can be justified by the semi-classical analysis *à la* P.-L. Lions-T. Paul [76], which makes a natural connection between the Vlasov-Wave system and (4.1a)-(4.1b), see Appendix D. Another quantum version of (4.4a)–(4.4b) can be obtained by applying the second quantization approach [15, 24]. With this approach the environment  $\psi$  is also quantized. Here we restrict ourselves to the model (4.1a)–(4.1b).

Note that here we have adopted from the beginning the rescaling where the coupling term in the wave equation (4.1b) is of the order of  $c^2$ . We will motivate this choice below. According to the framework introduced in [16], throughout this article we assume:

**(H1)**  $n \geq 3$ ,

**(H2)** The form functions  $\sigma_1$  and  $\sigma_2$  are non-negative, smooth, compactly supported and radially symmetric.

As said above the role of the dimension  $n$  for the wave equation is critical in these models. Indeed, the evacuation of energy in the environment relies on the dispersion properties of the wave equation, which are strong enough when  $n$  is sufficiently large [P1]. By the way, notice that the definition of  $\kappa$  in (4.11) makes sense when assuming  $n \geq 3$ . The case  $n = 3$  also plays a specific role in the theory presented in [16]. The assumptions **(H1)** and **(H2)** on the form functions are very natural in the modeling framework of [16]. In what follows, we use the abuse of notation to mix up a radially symmetric function of  $x \in \mathbb{R}^d$  with the underlying function of the scalar quantity  $|x|$ , and we will equally refer to the monotonicity of this function.

Following the observations made for classical particles, it is instructive to consider the regime where  $c$  goes to  $+\infty$  in (4.1a)–(4.1b). We are led to

$$i\partial_t \tilde{u} + \frac{1}{2} \Delta_x \tilde{u} = \left( \sigma_1 \star_x \int \sigma_2 \tilde{\psi} dz \right) \tilde{u}, \quad t \in \mathbb{R}, x \in \mathbb{R}^d, \quad (4.12a)$$

$$-\Delta_z \tilde{\psi} = -\sigma_2(z) \left( \sigma_1 \star_x |\tilde{u}|^2 \right) (x), \quad t \in \mathbb{R}, x \in \mathbb{R}^d, z \in \mathbb{R}^n \quad (4.12b)$$

which can be cast in the usual form of an Hartree type equation

$$i\partial_t \tilde{u} + \frac{1}{2} \Delta_x \tilde{u} = -\kappa \left( \Sigma \star_x |\tilde{u}|^2 \right) \tilde{u}, \quad t \in \mathbb{R}, x \in \mathbb{R}^d. \quad (4.13)$$

This remark will be helpful for the analysis.

The conservation of the total energy is a remarkable property of all these models. For the particle equation (4.4a)–(4.4b), we set

$$\mathcal{E}_{\text{part}}(t) = \frac{|\dot{q}(t)|^2}{2} + \iint \sigma_1(q(t) - y)\sigma_2(z)\psi(t, y, z) dy dz + \frac{1}{2} \iint (|\partial_t \psi(t)|^2 + c^2 |\nabla_z \psi(t)|^2) dz dx$$

and for the kinetic equation (4.6a), with (4.7) (mind the rescaling for the wave equation), we set

$$\mathcal{E}_{\text{kin}}(t) = \iint \left( \frac{v^2}{2} + \sigma_1 \star \int \sigma_2 \psi(t) dz \right) f(t) dx dv + \frac{1}{2} \iint \left( \frac{1}{c^2} |\partial_t \psi(t)|^2 + |\nabla_z \psi(t)|^2 \right) dx dz.$$

Then, we have

$$\mathcal{E}_{\text{part}}(t) = \mathcal{E}_{\text{part}}(0), \quad \mathcal{E}_{\text{kin}}(t) = \mathcal{E}_{\text{kin}}(0).$$

For the quantum model, (4.1a)–(4.1b), it becomes

$$\begin{aligned} \mathcal{E}_{\text{Schr}}(t) &= \frac{1}{2} \int |\nabla_x u(t)|^2 dx + \int \left( \sigma_1 \star \int \sigma_2 \psi(t) dz \right) |u(t)|^2 dx \\ &\quad + \frac{1}{2} \iint \left( \frac{1}{c^2} |\partial_t \psi(t)|^2 + |\nabla_z \psi(t)|^2 \right) dx dz = \mathcal{E}_{\text{Schr}}(0). \end{aligned} \quad (4.14)$$

For the asymptotic Hartree equation (4.13), we get similarly

$$\mathcal{H}(t) = \frac{1}{2} \int |\nabla_x \tilde{u}(t)|^2 dx - \frac{\kappa}{2} \int |\tilde{u}(t, x)|^2 \Sigma(x - y) |\tilde{u}(t, y)|^2 dx dy = \mathcal{H}(0). \quad (4.15)$$

Moreover, both quantum equations are invariant by translation and phase and conserve the mass of the wave function:

$$\mathcal{M}(t) = \int |u(t, x)|^2 dx = \mathcal{M}(0), \quad \tilde{\mathcal{M}}(t) = \int |\tilde{u}(t, x)|^2 dx = \tilde{\mathcal{M}}(0). \quad (4.16)$$

However, there are fundamental differences between the two equations. Let

$$p(t) = \text{Im} \int \nabla_x u(t, x) \bar{u}(t, x) dx, \quad \tilde{p}(t) = \text{Im} \int \nabla_x \tilde{u}(t, x) \bar{\tilde{u}}(t, x) dx$$

be the momentum associated to (4.1a)–(4.1b) and (4.13), respectively. We have momentum conservation for (4.13)

$$\frac{d}{dt} \tilde{p} = 0,$$

but

$$\frac{d}{dt} p(t) = - \int_{\mathbb{R}^d} \nabla_x \left( \sigma_1 \star \int_{\mathbb{R}^n} \sigma_2(z) \psi(t, x, z) dz \right) |u(t, x)|^2 dx$$

for (4.1a)–(4.1b). This expression can be rewritten as the conservation of the total momentum of the system

$$\mathcal{P}(t) = p(t) - \frac{1}{c^2} \iint \partial_t \psi(t) \nabla_x \psi(t) dx dz = \mathcal{P}(0). \quad (4.17)$$

We also introduce the center of mass

$$q(t) = \frac{\int_{\mathbb{R}^d} x |u(t, x)|^2 dx}{\int_{\mathbb{R}^d} |u(t, x)|^2 dx} = \frac{1}{\mathcal{M}(0)} \int_{\mathbb{R}^d} x |u(t, x)|^2 dx$$

associated to (4.1a)–(4.1b) and a similar definition  $\tilde{q}(t)$  for (4.13). We have

$$\mathcal{M}(0) \frac{d}{dt} q(t) = p(t), \quad \tilde{\mathcal{M}}(0) \frac{d}{dt} \tilde{q}(t) = \tilde{p}(t).$$

Therefore, the momentum conservation for (4.13) implies that the center of mass follows a straight line at constant speed. For (4.1a)–(4.1b), the analogy with the case of a single classical particle would lead to conjecture that the center of mass will stop exponentially fast. Numerical experiments shed some light on this issue. We refer the reader to Chapter 5 for a study in this direction. Finally, we note that (4.13) is also Galilean invariant: if  $\tilde{u}$  is a solution of (4.13), then

$$v(t, x) = \tilde{u}(t, x - tp_0) e^{ip_0 \cdot (x - tp_0)} e^{i \frac{|p_0|^2}{2} t}$$

still is a solution of (4.13). This property is not fulfilled by the system (4.1a)–(4.1b), which leads to a specific behavior of the solutions, consistently with the previous remark.

### 4.1.2 Solitary waves

The system (4.1a)–(4.1b) can be shown to be well-posed, in natural functional spaces associated to the energy conservation.

**Theorem 4.1.1** *Let (H1)–(H2) be fulfilled. For all  $u_0 \in H^1(\mathbb{R}_x^d)$ ,  $\psi_0 \in L^2(\mathbb{R}_x^d; \dot{H}^1(\mathbb{R}_z^n))$  and  $\psi_1 \in L^2(\mathbb{R}_x^d; L^2(\mathbb{R}_z^n))$ , the system (4.1a)–(4.1b) and (4.2) admits a unique global solution  $(u, \psi)$  such that  $u \in C^0([0, +\infty); H^1(\mathbb{R}_x^d))$  and*

$$\psi \in C^0([0, +\infty); L^2(\mathbb{R}_x^d; \dot{H}^1(\mathbb{R}_z^n))) \cap C^1([0, +\infty); L^2(\mathbb{R}_x^d; L^2(\mathbb{R}_z^n))).$$

The proof is detailed in Appendix C. The local well-posedness is based on Strichartz' estimates, which rely on the dispersive properties of the Schrödinger and the wave equations in the coupling. The difficulty comes from the fact that Strichartz' estimates for (4.1a) lead to estimates of  $u$  in  $L_t^q L_x^r$  norms whereas Strichartz' estimates for (4.1b) lead to estimates on  $\psi$  in  $L_x^r L_t^q L_z^p$  norms. Then, in order to gather these estimates, it is necessary to manage with permutations of Lebesgue-norms in time and space. For this purpose, assumption (H2) allows us to apply Hölder and Young inequalities in order to always obtain estimates in  $L_t^q L_x^q$ -norms. Eventually, that solutions are globally defined comes from the Hamiltonian structure of the system.

The main purpose of this Chapter is to show the existence and the orbital stability of solitary waves for the Schrödinger-Wave system. Namely, we are going to study solutions of (4.1a)–(4.1b) with the form (4.3). The existence of such non dispersive solutions is the translation of the presence of some attractive dynamics induced by the model. The rescaling (4.7) is important in the discussion. We start by observing that if  $(u, \psi) = (Q(x)e^{i\omega t}, \Psi(x, z))$  is a solution of (4.1a)–(4.1b), then  $(Q, \Psi)$  is a solution of

$$-\frac{1}{2}\Delta_x Q + \omega Q + \left( \sigma_1 \star_x \int \sigma_2 \Psi dz \right) Q = 0, \quad x \in \mathbb{R}^d \quad (4.18a)$$

$$-c^2 \Delta_z \Psi = -c^2 \sigma_2(z) \left( \sigma_1 \star_x Q^2 \right) (x), \quad x \in \mathbb{R}^d, z \in \mathbb{R}^n, \quad (4.18b)$$

which is in fact independent of the parameter  $c$ . In turn, the profiles  $(Q, \Psi)$  do not depend on  $c$ . Moreover these particular solutions  $(Q(x)e^{i\omega t}, \Psi(x, z))$  are also solutions of the asymptotic

system (4.12a)–(4.12b). It is therefore relevant to compare the behavior of the solutions of (4.1a)–(4.1b) and the solutions of (4.12a)–(4.12b) around the state  $(Q(x)e^{i\omega t}, \Psi(x, z))$ : this comparison provides information on the action of the environment on the quantum particle.

According to the previous discussion, the expected behavior for the Schrödinger wave system can be summarized as follows.

**Conjecture 4.1.2** *Let  $(Q, \Psi)$  be a solution of (4.18a)–(4.18b) orbitally stable under the dynamic (4.1a)–(4.1b). If  $u_0(x) = Q(x)e^{i\frac{p_0}{2}\cdot x}$  for some sufficiently small  $p_0$  and if  $(\psi_0, \psi_1) = (\Psi, 0)$ , then there exists two functions  $x = x(t)$  and  $\gamma = \gamma(t)$  such that*

- *the unique solution  $(u, \psi)$  of (4.1a)–(4.1b) associated to these initial conditions remains close (uniformly in time in some norms that have to be precised) to  $(Q(\cdot - x(t))e^{i\gamma(t)}, \Psi(\cdot - x(t), \cdot))$ ;*
- *$|\dot{x}(t)| \leq Ce^{-\lambda\frac{t}{c}}$  and  $|x(t) - \bar{x}| \leq Ce^{-\lambda\frac{t}{c}}$ .*

Even if the orbital stability of solitary waves of non linear Schrödinger equations is a classical result for many years, see for instance [22, 107, 108], there are several difficulties to justify it in the present context. Firstly, we are dealing with a system and not with a mere scalar equation. Secondly, the nonlinearity is non local. Nevertheless, we can expect that structure properties of the simpler problem (4.13) still apply to the system (4.1a)–(4.1b). At first sight, assumption **(H2)** can be expected to make the problem easier than the case where  $\Sigma$  is replaced by the kernel of the Poisson equation in dimension  $d = 3$ , that is  $\Sigma^0(x) = \frac{1}{|x|}$ . This specific case (4.13) – the Schrödinger-Newton equation – has been investigated in details by E. Lenzmann [68]. However, while  $\Sigma = \sigma_1 \star \sigma_1$  has better regularity and support properties, it does not satisfy any scale invariance. It turns out that the analysis of the Schrödinger-Newton equation exploits, in a quite crucial way, either explicit formula or the scale invariance which are very specific to the kernel  $\frac{1}{|x|}$ . For this reason, we shall use a quite indirect approach, that relies on the perturbative arguments developped in [68] for establishing spectral properties for the non relativistic Hartree equation. The second part of the conjecture means that the environment acts on the quantum particle as a friction force and is the object, through a numerical investigation, of the next Chapter.

## 4.2 Main results

As said above, the main objective is to discuss the existence and the stability of non trivial solutions (with finite mass and energy) of (4.1a)–(4.1b) with the form (4.3). In order to establish the existence, we start by observing that  $(Q, \Psi)$  has to be a solution of (4.18a)–(4.18b). Then we can express  $\Psi$  in term of  $Q$  as follows:

$$\Psi(x, z) = \Gamma(z) \sigma_1 \star Q^2(x),$$

where  $\Gamma$  stands for the unique solution of (4.9). Coming back to (4.18a), we deduce that  $Q$  satisfies

$$-\frac{1}{2}\Delta_x Q + \omega Q - \kappa(\Sigma \star Q^2)Q = 0 \quad (4.19)$$

with the definition (4.11). This equation is known as the *Choquard equation* and it has been intensively studied (see for example [77], [70] or [68] and the references therein). In particular, we already know from [77] that there exists infinitely many solitary waves.

### 4.2.1 Ground states

Nevertheless, we are only interested in *stable* solitary waves: for this reason, we consider solitary waves that minimize the energy of the system under a mass constraint, a quantity conserved by the evolution equation. Such solitary waves are called *ground states*. The specific case of the Newtonian potential  $\Sigma^0(x) = \frac{1}{|x|}$  in dimension  $d = 3$  has been studied in [70] which establishes the existence and uniqueness (up a change of phase and translation) of ground states for (4.13). The existence part of [70] still applies in the case where  $\Sigma$  is a smooth, compactly supported, radially symmetric, non increasing and non negative function. However, the arguments for proving the uniqueness part of the statement rely strongly on the specific form of the Newtonian potential. Besides, the definition of the energy functional for the system (4.1a)–(4.1b) differs from those of (4.13). Therefore, one has to check that (4.1a)–(4.1b) admits ground states. For that purpose we will need the following additional assumption on the form function  $\sigma_1$ .

**(H3)** The form function  $\sigma_1$  is non increasing.

We interpret the energy functional (4.14) as depending on  $u$ ,  $\psi$  and  $\chi = \partial_t \psi$ . Namely, for  $u : \mathbb{R}^d \rightarrow \mathbb{C}$ ,  $\psi, \chi : \mathbb{R}^d \times \mathbb{R}^n \rightarrow \mathbb{R}$ , we set

$$E(u, \psi, \chi) = \frac{1}{2} \int |\nabla_x u|^2 dx + \int (\sigma_1 \star \int \sigma_2 \psi dz) |u|^2 dx + \frac{1}{2} \iint \left( \frac{1}{c^2} |\chi|^2 + |\nabla_z \psi|^2 \right) dx dz$$

so that  $\mathcal{E}_{\text{Sch}}(t) = E(u, \psi, \partial_t \psi)(t)$ . Similarly, we set

$$H(u) = \frac{1}{2} \int |\nabla_x u|^2 dx - \frac{\kappa}{2} \int |u(x)|^2 \Sigma(x-y) |u(y)|^2 dx dy, \quad (4.20)$$

see (4.15). In order to establish the existence of ground states we will study the following three minimization problems.

$$I_M := \inf \left\{ E(u, \psi, \chi) \text{ s.t. } (u, \psi, \chi) \in H_x^1 \times L_x^2 \dot{H}_z^1 \times L_x^2 L_z^2 \text{ and } \|u\|_{L_x^2}^2 \leq M \right\}, \quad (4.21a)$$

$$J_M := \inf \left\{ E(u, \psi, \chi) \text{ s.t. } (u, \psi, \chi) \in H_x^1 \times L_x^2 \dot{H}_z^1 \times L_x^2 L_z^2 \text{ and } \|u\|_{L_x^2}^2 = M \right\}, \quad (4.21b)$$

$$K_M := \inf \left\{ E(u, \Gamma \sigma_1 \star |u|^2, 0) \text{ s.t. } u \in H_x^1 \text{ and } \|u\|_{L_x^2}^2 = M \right\}. \quad (4.21c)$$

The interest of (4.21c) comes from the fact that  $E(u, \Gamma \sigma_1 \star |u|^2, 0) = H(u)$  since  $\sigma_1$  is odd and therefore  $\|\sigma_1 \star |u|^2\|_{L_x^2}^2 = \iint |u|^2(x) \Sigma(x-y) |u|^2(y) dx dy$ . Then, if  $K_M$  is reached at  $u$ ,  $u$  is a ground state of (4.13) too and we will be able to compare ground states of (4.1a)–(4.1b) with ground states of (4.13). Section 4.3 is devoted to the proof of the following theorem.

**Theorem 4.2.1** *Let (H1)–(H3) be fulfilled.*

(i) *For every  $M \geq 0$ ,  $I_M$  is reached.*

(ii) *There exists a mass threshold  $M_0 \geq 0$  such that for every  $M > M_0$ ,  $J_M < 0$  is reached on  $(u, \psi, \chi) = (u, \psi, 0)$  with  $u$  non negative, radially symmetric and non increasing. Moreover  $(u, \psi)$  is a solution of (4.18a)–(4.18b) for a certain  $\omega > 0$ . In particular  $\psi = \Gamma \sigma_1 \star |u|^2$  is non positive,  $u$  is an element of the Schwartz class  $\mathcal{S}(\mathbb{R}^d)$  and  $K_M = J_M$  is reached at  $u$ .*

(iii) *If  $d \geq 3$ , then  $M_0 > 0$ .*

Note that we do not know whether the minimizer in item (ii) is uniquely defined, up to a possible change of phase and translation. Applying Lieb's method [70], we cannot even conclude whether or not the minimizer of  $J_M$  are radially symmetric, a preliminary step to

establish uniqueness, and strictly positive. The alternative approach of L. Ma and L. Zhao [82, Section 5] provides a positive answer to the strict positivity and radial symmetry of the minimizer, though. Note also that the third item of this theorem is reminiscent to the fact that (4.1a)–(4.1b) does not have a scale invariance.

### 4.2.2 Orbital stability

The variational characterization will be used in Section 4.4 to establish the following orbital stability result for these ground states. In this statement, for a given mass  $M > 0$ , we denote by  $S_M$  the space of all possible ground states

$$S_M = \left\{ (\tilde{Q}, \tilde{\Psi}) \in H_x^1 \times L_x^2 \dot{H}_z^1 \text{ such that } \|\tilde{Q}\|_{L_x^2}^2 = M \text{ and } E(\tilde{Q}, \tilde{\Psi}, 0) = J_M \right\}.$$

**Theorem 4.2.2** *Let  $M \in (M_0, 2M_0)$  and  $(Q, \Psi)$  be in  $S_M$ . For every  $\varepsilon > 0$  there exists  $\delta_\varepsilon > 0$  such that if  $u_0 \in H_x^1$ ,  $\psi_0 \in L_x^2 \dot{H}_z^1$  and  $\chi_0 \in L_x^2 L_z^2$  with  $\|u_0\|_{L_x^2}^2 = M$  and*

$$\|u_0 - Q\|_{H_x^1}^2 + \|\psi_0 - \Psi\|_{L_x^2 \dot{H}_z^1}^2 + \|\chi_0\|_{L_x^2 L_z^2}^2 < \delta_\varepsilon,$$

*then the unique solution  $(u, \psi, \chi = \partial_t \psi)$  of (4.1a)–(4.1b) with initial data  $(u_0, \psi_0, \chi_0)$  satisfies*

$$\sup_{t \geq 0} \inf_{(\tilde{Q}, \tilde{\Psi}) \in S_M} \left( \|u(t) - \tilde{Q}\|_{H_x^1}^2 + \|\psi(t) - \tilde{\Psi}\|_{L_x^2 \dot{H}_z^1}^2 + \|\chi(t)\|_{L_x^2 L_z^2}^2 \right) < \varepsilon.$$

The proof is classical and based on the concentration-compactness lemma, see for instance [22, 73, 74] and the references therein. However, the lack of a scale invariance has two negative consequences. First, when applying the concentration-compactness lemma, the discussion on the *dichotomy* scenario relies on a sub-additivity property on  $J_M$ : for every  $\alpha \in (0, 1)$ ,  $J_M < J_{\alpha M} + J_{(1-\alpha)M}$  (see [22, Section I, case 1]). Usually, such sub-additivity property comes from the scale invariance of the equation. In our case we justify such property only for  $M \in (M_0, 2M_0)$ , which leads to the first assumption of the statement, see (4.35) below. Second, since we do not know whether the ground states are unique (up to the equation invariants), the statement only tells us that a perturbation of a ground state stay close (uniformly in time) to *the manifold of all the possible ground states*. This is weaker than the expected conclusion which would assert that “a perturbation of a given ground state stay close (uniformly in time) to *the manifold generated by this ground state and the equation invariants (phase and translation)*”.

### 4.2.3 Strengthened orbital stability

A strengthened result can be obtained by using an alternative approach, based on the study of the linearization of the energy around a ground state (see [85, 107, 108]; we also refer the reader to the lecture notes [84, Section 2.6] and the references therein). To be more specific, we fix  $M > M_0$  and we consider a ground state  $(Q, \Psi)$  of  $J_M$  such that  $Q$  is positive, radially symmetric and decreasing and such that  $\|Q\|_{L_x^2}^2 = M$ . We introduce

$$W(u, \psi, \chi) = E(u, \psi, \chi) + \omega \|u\|_{L_x^2}^2.$$

Next, we linearize this quantity around  $(Q, \Psi, 0)$ : for every  $u \in H_x^1$ ,  $\psi \in L_x^2 \dot{H}_z^1$  and  $\chi \in L_x^2 L_z^2$ , we have

$$\begin{aligned}
W(Q + u, \Psi + \psi, \chi) &= W(Q, \Psi, 0) \\
&+ \frac{1}{2} \int_{\mathbb{R}^d} \nabla_x Q \cdot (\nabla_x u + \nabla_x \bar{u}) \, dx + \omega \int_{\mathbb{R}^d} Q(u + \bar{u}) \, dx + \int_{\mathbb{R}^d} \left( \sigma_1 \star \int_{\mathbb{R}^n} \sigma_2 \Psi \, dz \right) Q(u + \bar{u}) \, dx \\
&+ \int_{\mathbb{R}^d} \left( \sigma_1 \star \int_{\mathbb{R}^n} \sigma_2 \psi \, dz \right) Q^2 \, dx + \frac{1}{2} \iint_{\mathbb{R}^d \times \mathbb{R}^n} \nabla_z \Psi \cdot \nabla_z \psi \, dx \, dz \\
&+ \frac{1}{2} \int_{\mathbb{R}^d} |\nabla_x u|^2 \, dx + \omega \int_{\mathbb{R}^d} |u|^2 \, dx + \int_{\mathbb{R}^d} \left( \sigma_1 \star \int_{\mathbb{R}^n} \sigma_2 \Psi \, dz \right) |u|^2 \, dx \\
&+ \int_{\mathbb{R}^d} \left( \sigma_1 \star \int_{\mathbb{R}^n} \sigma_2 \psi \, dz \right) Q(u + \bar{u}) \, dx + \frac{1}{2c^2} \iint_{\mathbb{R}^d \times \mathbb{R}^n} |\chi|^2 \, dx \, dz + \frac{1}{2} \iint_{\mathbb{R}^d \times \mathbb{R}^n} |\nabla_z \psi|^2 \, dx \, dz \\
&+ \int_{\mathbb{R}^d} \left( \sigma_1 \star \int_{\mathbb{R}^n} \sigma_2 \psi \, dz \right) |u|^2 \, dx.
\end{aligned}$$

We write this as  $W(Q + u, \Psi + \psi, \chi) = W(Q, \Psi, 0) + I_1 + \dots + I_{12}$ . Thanks to (4.18a),  $I_1 + I_2 + I_3 = 0$  and thanks to (4.18b),  $I_4 + I_5 = 0$ . Let us denote

$$u = f + ig, \quad f, g \in \mathbb{R}.$$

We can rewrite

$$I_6 + \dots + I_{11} = \left\langle \mathcal{L}_+ \begin{pmatrix} f \\ \psi \end{pmatrix}, \begin{pmatrix} f \\ \psi \end{pmatrix} \right\rangle_{L_x^2 \times L_x^2 L_z^2} + \langle L_- g, g \rangle_{L_x^2} + \frac{1}{2c^2} \|\chi\|_{L_x^2 L_z^2}^2$$

where

$$\mathcal{L}_+ = \begin{pmatrix} -\frac{1}{2} \Delta_x + \omega + \left( \sigma_1 \star \int_{\mathbb{R}^n} \sigma_2 \Psi \, dz \right) & M_1 \\ M_2 & -\frac{1}{2} \Delta_z \end{pmatrix} \quad (4.22)$$

with

$$M_1 \psi = \left( \sigma_1 \star \int_{\mathbb{R}^n} \sigma_2 \psi \, dz \right) Q, \quad M_2 f = \sigma_2 (\sigma_1 \star Q f),$$

and

$$L_- = -\frac{1}{2} \Delta_x + \omega + \left( \sigma_1 \star \int_{\mathbb{R}^n} \sigma_2 \Psi \, dz \right). \quad (4.23)$$

Let us also introduce the operator  $L_+$  defined by

$$L_+ f = -\frac{1}{2} \Delta_x f + \omega f - \kappa (\Sigma \star Q^2) f - 2\kappa (\Sigma \star Q f) Q, \quad (4.24)$$

which will have an important role in the sequel: it is the analog to  $\mathcal{L}_+$  for  $\widetilde{W}(u) = H(u) + \omega \|u\|_{L_x^2}^2$ . We eventually obtain the following decomposition

$$\begin{aligned}
W(Q + u, \Psi + \psi, \chi) &= W(Q, \Psi, 0) + \left\langle \mathcal{L}_+ \begin{pmatrix} f \\ \psi \end{pmatrix}, \begin{pmatrix} f \\ \psi \end{pmatrix} \right\rangle_{L_x^2 \times L_x^2 L_z^2} + \langle L_- g, g \rangle_{L_x^2} \\
&+ \frac{1}{2c^2} \|\chi\|_{L_x^2 L_z^2}^2 + \int_{\mathbb{R}^d} \left( \sigma_1 \star \int_{\mathbb{R}^n} \sigma_2 \psi \, dz \right) |u|^2 \, dx. \quad (4.25)
\end{aligned}$$



**Remark 4.2.3** Relation (4.25) holds true when replacing, for some  $\alpha \in \mathbb{R}$ ,  $M_1$  and  $M_2$  in the definition of  $\mathcal{L}_+$  by  $\alpha M_1$  and  $(2 - \alpha)M_2$ . However,  $\mathcal{L}_+$  is self-adjoint only in the particular case  $\alpha = 1$ .

The key argument to prove an orbital stability result is to characterize the kernel of  $L_-$  and  $\mathcal{L}_+$  and to prove that these operators are coercive under some orthogonality conditions. The operator  $L_-$  is a local operator, and we already have at hand the following statement, see for example [107].

**Lemma 4.2.4** *We have  $\text{Ker}(L_-) = \text{Span}\{Q\}$  and there exists a universal constant  $\mu > 0$  such that for every  $g \in H_x^1$ ,*

$$\langle L_- g, g \rangle_{L_x^2} \geq \mu \|g\|_{H_x^1}^2 - \frac{1}{\mu} |\langle g, Q \rangle_{H_x^1}|^2. \quad (4.26)$$

The difficult part is to obtain an analogous statement for  $\mathcal{L}_+$ . The method consists in working on the operator  $L_+$ : the knowledge of the kernel of  $L_+$  will allow us to identify the kernel of  $\mathcal{L}_+$  and a coercivity property for  $L_+$  will provide a coercivity property for  $\mathcal{L}_+$  too. By direct inspection, it can be checked that  $\text{Span}\{\partial_{x_j} Q, j = 1, \dots, d\} \subset \text{Ker}(L_+)$ ; we shall work further to establish the reverse inclusion and characterize  $\text{Ker}(L_+)$ . Since  $L_+$  is a non-local operator, classical arguments based on Sturm-Liouville theory are not applicable. We shall need to develop alternative approaches and perturbative arguments, inspired from [68].

From now on we stick to the case  $d = 3$ ; we are going to exploit results known for the Newtonian potential

$$\Sigma^0(x) = \frac{1}{|x|}. \quad (4.27)$$

Indeed, for this specific situation E. Lenzmann succeeded in proving that  $\text{Ker}(L_+) = \text{Span}\{\partial_{x_j} Q\}$ , see [68]. Based on this characterization, P. D'Avenia and M. Squassina established the coercivity of  $L_+$  under some orthogonality conditions [23]. The following lemma summarizes these results for the Newtonian potential.

**Lemma 4.2.5** *Let  $d = 3$  and consider the potential (4.27). We have  $\text{Ker}(L_+) = \text{Span}\{\partial_{x_j} Q, j = 1, \dots, d\}$ . Moreover, there exists a universal constant  $\nu > 0$  such that for every  $f \in H_x^1$ ,*

$$\langle L_+ f, f \rangle_{L_x^2} \geq \nu \|f\|_{H_x^1}^2 - \frac{1}{\nu} \left( |\langle f, Q \rangle_{L_x^2}|^2 + \sum_{j=1}^d |\langle f, \partial_{x_j} Q \rangle_{L_x^2}|^2 \right). \quad (4.28)$$

We need to extend such a property to potentials with the form  $\Sigma = \sigma_1 \star \sigma_1$ : we denote by  $\mathcal{A}$  the set of *admissible* form functions  $\sigma_1$  such that Lemma 4.2.5 applies when  $\Sigma = \sigma_1 \star \sigma_1$ . This is made clear by the following Definition.

**Definition 4.2.6** *We say that  $\sigma_1$  is an admissible form function if it satisfies (H2)–(H3) and if there exists a mass interval  $I$  of non empty interior such that for every  $M \in I$  and every positive and radially symmetric minimizer  $Q_M$  of  $K_M$ , Lemma 4.2.5 applies.*

That  $\mathcal{A}$  is non empty is highly non trivial: in [68] the characterization in Lemma 4.2.5 relies strongly on the specific form of the Newtonian potential and the scale invariance property of equation (4.19) in this specific case. Section 4.9 is devoted to the construction of admissible form functions  $\sigma_1$ . The difficulty in identifying the class of admissible form functions  $\sigma_1$  is a weakness of the method compared to the approach by concentration-compactness. Nevertheless this additional restriction will allow us to obtain a more precise

orbital stability result and we shall see in Section 4.9 that we can find many form functions  $\sigma_1$  that fits the physical framework introduced in [16]. We proceed in two steps. The idea is to boil down a perturbative approach for potentials  $\Sigma$  close, in an appropriate sense, to  $\frac{1}{|x|}$  and then to push this result by suitable rescalings which allow us to identify physically relevant potentials  $\Sigma = \sigma_1 \star \sigma_1$  not necessarily close to  $\frac{1}{|x|}$ . An important issue in this approach is to clarify the role of the mass constraint: Theorem 4.2.2 applies to any ground state of mass  $M \in (M_0, 2M_0)$ . Hence, we expect stability results that apply to a continuum of possible masses  $M$ , as stated in Definition 4.2.6.

**Proposition 4.2.7** *The set  $\mathcal{A}$  of admissible form functions is non empty.*

We give below additional comments on the strategy to justify this proposition.

From now on we denote

$$\mathcal{H} = \{(u, \psi) \in H_x^1 \times L_x^2 \dot{H}_z^1\}$$

which is a Hilbert space when endowed with the norm defined by

$$\|(u, \psi)\|_{\mathcal{H}}^2 = \|u\|_{H_x^1}^2 + \|\psi\|_{L_x^2 \dot{H}_z^1}^2.$$

The following lemma, proved in section 4.7, gives the required coercivity property on  $\mathcal{L}_+$ .

**Lemma 4.2.8** *Assume (H1)–(H3), with  $d = 3$  and let  $\sigma_1$  be an admissible form function. Then  $\text{Ker}(\mathcal{L}_+) = \text{Span}\{(\partial_{x_j} Q, \partial_{x_j} \Psi)^t, j = 1, \dots, d\}$  and there exists a universal constant  $\tilde{\nu} > 0$  such that for every  $(f, \psi) \in \mathcal{H}$ ,*

$$\left\langle \mathcal{L}_+ \begin{pmatrix} f \\ \psi \end{pmatrix}, \begin{pmatrix} f \\ \psi \end{pmatrix} \right\rangle_{L_x^2 \times L_x^2 L_z^2} \geq \tilde{\nu} \|f, \psi\|_{\mathcal{H}}^2 - \frac{1}{\tilde{\nu}} \left( \left| \langle f, Q \rangle_{L_x^2} \right|^2 + \sum_{j=1}^d \left| \langle f, \partial_{x_j} Q \rangle_{L_x^2} \right|^2 \right). \quad (4.29)$$

This lemma is the key ingredient to prove the following orbital stability theorem that strengthens Theorem 4.2.2. The proof is detailed in Section 4.5.

**Theorem 4.2.9** *Assume (H1)–(H3), with  $d = 3$  and let  $\sigma_1$  be an admissible form function. For every  $(u_0, \psi_0, \chi_0) \in H_x^1 \times L_x^2 \dot{H}_z^1 \times L_x^2 L_z^2$  let us denote by  $(u, \psi, \chi = \partial_t \psi)$  the unique solution of (4.1a) and (4.1b) associated to the initial data  $(u_0, \psi_0, \chi_0)$ . Let us assume  $\|u_0\|_{L_x^2} = \|Q\|_{L_x^2}$ . There exists  $\varepsilon_0 > 0$  such that for every  $\varepsilon \in (0, \varepsilon_0)$  we can find  $\eta(\varepsilon) > 0$  and  $\delta(\varepsilon) > 0$  such that, if*

$$\|u_0 - Q, \psi_0 - \Psi\|_{\mathcal{H}}^2 + \frac{1}{c^2} \|\chi_0\|_{L_x^2 L_z^2}^2 \leq \eta(\varepsilon)^2 \quad \text{and} \quad W(u_0, \psi_0, \chi_0) - W(Q, \Psi, 0) \leq \delta(\varepsilon),$$

*then there exists two functions  $x(t)$  and  $\gamma(t)$ , continuous in time, such that for every  $t \geq 0$ ,  $v = e^{-i\gamma(t)} u(t, \cdot + x(t))$  satisfies the following orthogonality conditions*

$$\left\langle \text{Re } v, \partial_{x_j} Q \right\rangle_{L_x^2} = 0, \quad j = 1, \dots, d, \quad (4.30a)$$

$$\langle \text{Im } v, Q \rangle_{H_x^1} = 0 \quad (4.30b)$$

and

$$\sup_{t \geq 0} \left\| u(t) - e^{i\gamma(t)} Q(\cdot - x(t)), \psi(t) - \Psi(\cdot - x(t)) \right\|_{\mathcal{H}}^2 + \frac{1}{c^2} \|\chi(t)\|_{L_x^2 L_z^2}^2 \leq \varepsilon^2.$$

**Remark 4.2.10** *Note that in the regime  $c \gg 1/\varepsilon^2$ , the theorem still applies if the perturbation  $\chi_0$  is not close to zero. It is also worth remarking that  $\eta(\varepsilon)$  and  $\delta(\varepsilon)$  are uniform with respect to  $c$ .*

A similar result can be obtained for the asymptotic system (4.13). Then, thanks to its Galilean invariance, the orbital stability can be extended to initial data  $\tilde{u}_0$  with arbitrarily high initial momentum. In that state, Theorem 4.2.9 does not provide such a result for the Schrödinger-Wave system and one can ask if, at least in the regime  $c \gg 1$ , it is possible to consider initial data  $u_0$  with high initial momentum and still get an orbital stability statement. Section 4.6 is devoted to prove the following theorem which provides an orbital stability result on a finite time interval  $[0, T_f]$ , where  $T_f$  depends, among other quantities, on  $c$  and goes to  $+\infty$  when  $c \rightarrow +\infty$ . In this statement  $p_0$  stands for the momentum of the initial data  $u_0$ ,  $p_0 = \text{Im} \int \nabla_x u_0 \bar{u}_0 dx$  and  $p(t)$  for the momentum of the wave function  $u$  at time  $t$ . We also use the notation  $\langle x \rangle := \sqrt{1 + |x|^2}$ .

**Theorem 4.2.11** *Under the assumptions of Theorem 4.2.9. Let  $n \geq 4$  and  $\alpha \in [1, 2]$  or  $n = 3$  and  $\alpha \in [1, 2)$ . There exists  $\varepsilon_0 = \varepsilon_0(\alpha) > 0$  such that for every  $\varepsilon \in (0, \varepsilon_0)$  and  $c \geq \langle p_0 \rangle \varepsilon^{-2}$  we can find  $\eta(\varepsilon) > 0$  and  $\delta(\varepsilon) > 0$  such that, if*

- $\|u_0 e^{-i\frac{p_0}{M}x} - Q, \psi_0 - \Psi\|_{\mathcal{H}}^2 + \frac{1}{c^2} \|\chi_0\|_{L_x^2 L_z^2}^2 \leq \eta(\varepsilon)^2,$
- $W(u_0 e^{-i\frac{p_0}{M}x}, \psi_0, \chi_0) - W(Q, \Psi, 0) \leq \delta(\varepsilon),$
- and  $\frac{1}{c} \|\nabla_x \psi_0\|_{L_x^2 L_z^2} + \frac{1}{c^2} \|\nabla_x \chi_0\|_{L_x^2 \dot{H}_z^{-1}} \leq \frac{\varepsilon^2}{\langle p_0 \rangle},$

then there exists two functions  $x(t)$  and  $\gamma(t)$ , continuous in time, such that for every  $0 \leq t \leq T_f(\alpha, n, \varepsilon^2, p_0, c)$  where

$$T_f(\alpha, n, \varepsilon, p_0, c) = K(\alpha, n) \frac{\varepsilon^\alpha c^{\alpha-1}}{\langle p_0 \rangle^\alpha}, \quad K(\alpha, n) > 0, \quad (4.31)$$

the function

$$v(t, x) = u(t, x + x(t)) e^{-i\frac{p(t)}{M}(x+x(t))} e^{-i\gamma(t)}$$

satisfies the following orthogonality conditions

$$\langle \text{Re } v(t), \partial_{x_j} Q \rangle_{L_x^2} = 0, \quad j = 1, \dots, d, \quad (4.32a)$$

$$\langle \text{Im } v(t), Q \rangle_{H_x^1} = 0 \quad (4.32b)$$

and the estimate

$$\sup_{0 \leq t \leq T_f} \|v(t) - Q, \psi(t, \cdot + x(t)) - \Psi\|_{\mathcal{H}}^2 + \frac{1}{c^2} \|\chi(t)\|_{L_x^2 L_z^2}^2 \leq \varepsilon^2.$$

**Remark 4.2.12** i) Since  $(\psi_0, \chi_0)$  is close to  $(\Psi, 0)$ , the assumption

$$\frac{1}{c} \|\nabla_x \psi_0\|_{L_x^2 L_z^2} + \frac{1}{c^2} \|\nabla_x \chi_0\|_{L_x^2 \dot{H}_z^{-1}} \leq \frac{\varepsilon^2}{\langle p_0 \rangle}$$

is not a strong assumption in the regime  $c \geq \langle p_0 \rangle \varepsilon^{-2}$ . Note that  $\dot{H}_z^{-1}$  simply denotes the space of functions  $f$  such that  $\zeta \mapsto |\zeta|^{-2} |\hat{f}(\zeta)|^2 \in L_\zeta^1$ . Then, in dimension  $n \geq 3$  any function in  $L_z^2$  with a Fourier transform bounded near the origin defines an element of  $\dot{H}_z^{-1}$ .

ii) The most interesting case is  $\alpha = 2$  for which  $T_f$  growth linearly with respect to  $c$ . However, in the case  $n = 3$ , the constant  $K(\alpha, n)$  goes to 0 when  $\alpha \rightarrow 2$ .

One may ask which additional information this result provides compared to a rigorous proof of the asymptotic (4.1a)–(4.1b) to (4.13) when  $c \rightarrow +\infty$ . Indeed, thanks to such asymptotic result we know that on a finite time interval  $[0, T]$ , a solution of (4.1a)–(4.1b) converges to a solution of (4.13) (see [25, Theorem 10] for an analogous result in the Vlasov-Wave case). Then, thanks to the orbital stability of the asymptotic system, when  $c \gg 1$  one can obtain the orbital stability on finite time interval for (4.1a)–(4.1b) with an initial data with a possible high momentum. Nevertheless, since this approach is based on compactness arguments, it does not give a relation between the momentum  $p_0$  of the initial data, the wave speed  $c$ , the final time  $T$  and the size  $\epsilon$  of the error. We refer the reader to [34] for an example, in a different context, of an orbital stability result on large time interval. To be more precise, in this article the authors shown that plane waves of the cubic non linear Schrödinger equation are orbitally stable on large time interval when their perturbations are small in high-order Sobolev norms (whereas it is known that rough perturbations are not stable, see references therein).

The strategy to prove Theorem 4.2.11 is the following. If the Schrödinger-Wave system does not conserve the momentum of the wave function  $u$ , it conserves the total momentum  $\mathcal{P}(t)$  of the system (4.17). Then, this formula suggests, when  $c \gg 1$ , that the variations of  $p(t)$  are small. The time interval  $[0, T_f]$  is exactly, depending on  $p_0$ , the larger time interval on which we are able to justify that

$$\sup_{0 \leq t \leq T_f} ||p_0|^2 - |p(t)|^2| \leq \epsilon,$$

see Lemma 4.6.1. Then, since on this time interval the momentum of the wave function  $u$  is almost conserved, we can use it as we did with the conserved momentum of the asymptotic system (4.13).

As explained above, our strategy to identify admissible form functions and to establish the orbital stability for the Schrödinger-Wave system is based on a perturbative analysis from  $\Sigma^0$ . For this purpose let us introduce the following more precise notations.

**Definition 4.2.13** *For a given potential  $\Sigma$  we denote  $H^\Sigma$  and  $K_M^\Sigma$  the corresponding energy defined by (4.20), and the minimization problem (4.21c), respectively. Then we denote by  $Q_M^\Sigma$  a positive and radially symmetric minimizer of  $K_M^\Sigma$  and by  $\omega(\Sigma, Q_M^\Sigma)$  the constant  $\omega > 0$  such that  $Q_M^\Sigma$  is a solution of (4.19) with  $\Sigma$  and  $\omega = \omega(\Sigma, Q_M^\Sigma)$ . Note that the notation  $Q_M^\Sigma$  could design several minimizers since a priori we do not get the uniqueness of the minimizers of  $K_M^\Sigma$ . Moreover we make precise how the operator  $L_+$  defined by (4.22) depends on  $\Sigma$ ,  $Q$  and  $\omega$ . Since we will only consider cases where  $\omega = \omega(\Sigma, Q)$  we will use the notation  $L_+ = L_+(\Sigma, Q)$ .*

We consider a sequence  $(\Sigma^\varepsilon)_{\varepsilon > 0}$  of smooth potentials satisfying the following assumption:

**(H4)** For every  $\varepsilon$  there exists  $\sigma_1^\varepsilon$  satisfying **(H2)**–**(H3)** such that  $\Sigma^\varepsilon = \sigma_1^\varepsilon \star \sigma_1^\varepsilon$  and the sequence  $(\Sigma^\varepsilon)_{\varepsilon > 0}$  converges to  $\Sigma^0$  in the following sense: for every  $R > 0$ ,

$$\|(\Sigma^\varepsilon - \Sigma^0)\mathbf{1}_{|x| \leq R}\|_{L_x^{3/2}} + \|(\Sigma^\varepsilon - \Sigma^0)\mathbf{1}_{|x| > R}\|_{L_x^\infty} \xrightarrow{\varepsilon \rightarrow 0} 0. \quad (4.33)$$

For such family we know that for each  $\varepsilon > 0$ , there exists a mass threshold  $M_0^\varepsilon > 0$  such that  $K_M^{\Sigma^\varepsilon}$  is achieved for every  $M > M_0^\varepsilon$ . In order to work with a fixed mass  $M > 0$  we will also assume that  $\sup(M_0^\varepsilon) < +\infty$  and we will consider a mass  $M$  such that  $M > \sup(M_0^\varepsilon)$ . This assumption is quite reasonable since  $\Sigma^\varepsilon \rightarrow \Sigma^0$  and there is no mass threshold in the

case  $\Sigma = \Sigma^0$ . We refer the reader to Lemma 4.8.1 which insures that this assumption is indeed always valid in the previous context.

Then we consider a sequence  $(Q^\varepsilon)_{\varepsilon>0}$  of smooth, positive, radially symmetric and decreasing functions and a sequence  $(\omega^\varepsilon)_{\varepsilon>0}$  of positive numbers such that  $Q^\varepsilon = Q_M^{\Sigma^\varepsilon}$  and  $\omega^\varepsilon = \omega(\Sigma^\varepsilon, Q_M^{\Sigma^\varepsilon})$ . In particular each  $Q^\varepsilon$  is a solution of (4.19) with  $\Sigma = \Sigma^\varepsilon$  and  $\omega = \omega^\varepsilon$ . We also consider  $Q^0$ , the unique positive and radially symmetric minimizer of  $K_M^{\Sigma^0}$ . Note that  $Q^0$  is also decreasing and we can find  $\omega^0 > 0$  such that  $Q^0$  is a solution of (4.19) with  $\Sigma = \Sigma^0$  and  $\omega = \omega^0$ . Hence, the cornerstone of the analysis is given by the following result, established in Section 4.8.

**Proposition 4.2.14** *With the previous notations and assuming (H4), the following properties hold.*

(i) Convergence. *For every  $\delta > 0$  there exists  $\varepsilon_0 > 0$  such that for every  $0 < \varepsilon < \varepsilon_0$ ,*

$$\|Q^\varepsilon - Q^0\|_{H_x^1} + |\omega^\varepsilon - \omega^0| < \delta.$$

(ii) Coercivity. *There exists  $\bar{\varepsilon}_0 > 0$  such that for every  $\varepsilon \in (0, \bar{\varepsilon}_0)$ ,  $Q^\varepsilon = Q_M^{\Sigma^\varepsilon}$  and  $\omega^\varepsilon = \omega(\Sigma^\varepsilon, Q_M^{\Sigma^\varepsilon})$  there exists  $\nu(\Sigma^\varepsilon, Q^\varepsilon, \omega^\varepsilon) > 0$  satisfying, for every  $f \in H_x^1$ ,*

$$\langle L_+(\Sigma^\varepsilon, Q^\varepsilon, \omega^\varepsilon)f, f \rangle_{L_x^2} \geq \nu(\Sigma^\varepsilon, Q^\varepsilon, \omega^\varepsilon) \|f\|_{H_x^1}^2 - \frac{1}{\nu^0} \left( |\langle f, Q^\varepsilon \rangle_{L_x^2}|^2 + \sum_{j=1}^3 |\langle f, \partial_{x_j} Q^\varepsilon \rangle_{L_x^2}|^2 \right),$$

where  $\nu^0$  is the best constant possible in Lemma 4.2.5. Moreover,  $\nu(\Sigma^\varepsilon, Q^\varepsilon, \omega^\varepsilon) \nearrow \nu^0$  when  $\varepsilon \rightarrow 0$ . This coercivity inequality insures that the kernel of  $L_+(\Sigma^\varepsilon, Q^\varepsilon, \omega^\varepsilon)$  is spanned by the  $\partial_{x_j} Q^\varepsilon$  and Lemma 4.2.5 applies to the kernel  $\Sigma^\varepsilon$  as well.

**Remark 4.2.15** *In point (i),  $\varepsilon_0$  depends on the chosen sequence  $(Q^\varepsilon)_{\varepsilon>0}$  whereas in point (ii),  $\bar{\varepsilon}_0$  is the same for every sequence  $(Q^\varepsilon)_{\varepsilon>0}$ . However, how the coercivity constant  $\nu(\Sigma^\varepsilon, Q^\varepsilon, \omega^\varepsilon)$  converges to  $\nu^0$  depends on the considered sequence.*

In this proposition, how  $\bar{\varepsilon}_0$  has to be small depends on  $M$ ; hence the result cannot be extended to consider, for a fixed potential  $\Sigma^\varepsilon$  close to  $\Sigma^0$ , a continuum of possible masses  $M$ . The statement applies for a given mass  $M$  but it is not sufficient to justify that  $\mathcal{A}$  is non empty. This issue is addressed in Section 4.9.

**Remark 4.2.16** *Our approach can be adapted to treat many problems involving a non local definition of the potential, without scale invariance. A relevant example is the case of the Hartree equation with the Yukawa potential  $\Sigma(x) = \frac{e^{-\mu|x|}}{|x|}$ , which corresponds to a coupling between the Schrödinger equation and the screened Poisson equation  $\mu^2\Phi - \Delta_x\Phi = |u|^2$  for the potential. The stability analysis for this problem is performed by a variational approach in [111] and an improved statement has been obtained in [61] by using a perturbative approach next to  $\mu = 0$ .*

### 4.3 Existence of ground states: proof of Theorem 4.2.1

Let us gather the basic properties of  $I_M$ ,  $J_M$  and  $K_M$  in the following lemma, which is further illustrated by Fig. 4.1.

**Lemma 4.3.1** *Let (H1)–(H2) be fulfilled. The following assertions hold:*

a)  $M \mapsto I_M$  is non increasing.

- b)  $I_0 = J_0 = 0$  are reached at  $(u, \psi, \chi) = (0, 0, 0)$  and  $K_0 = 0$  is reached at  $u = 0$ .  
c) For every  $M \geq 0$ ,  $-\infty < I_M \leq J_M \leq K_M$ .  
d) For every  $M \geq 0$ ,  $J_M \leq 0$ .  
e) There exists a mass threshold  $M_0 \geq 0$  such that  $I_M = 0$  for  $M \in [0, M_0]$  and  $I_M < 0$  for  $M > M_0$ .  
f) If  $I_M < 0$  is reached at  $(u, \psi, \chi)$ , then  $\|u\|_{L_x^2}^2 = M$  and  $J_M = I_M$  is reached at  $(u, \psi, \chi)$ . Moreover  $\chi = 0$ ,  $\psi = \Gamma \sigma_1 \star |u|^2$  and  $u \in \mathcal{S}(\mathbb{R}^d)$  is a solution of (4.19) for a certain  $\omega > 0$ . In particular  $K_M = J_M$  is reached at  $u$ .  
g) If  $d \geq 3$  there exists a mass threshold  $M_1 > 0$  such that  $K_M > 0$  for every  $M \in (0, M_1)$ .

Before to prove this lemma let us make several remarks

- Points d) and f) coupled with Theorem 4.2.1-(i) imply  $J_M = I_M$  for every  $M \geq 0$ .
- Points e) and f) coupled with Theorem 4.2.1-(i) imply that  $J_M$  is reached for  $M > M_0$  and improve also point a):  $I_M = 0$  for  $M \in [0, M_0]$  and  $M \mapsto I_M$  is decreasing on  $(M_0, +\infty)$ .
- Points e), f) and g) coupled with Theorem 4.2.1-(i) imply that  $M_0 \geq M_1 > 0$  is indeed a positive number. The proof of point g) will give us the following additional information

$$0 < \frac{1}{\kappa C^2 \|\Sigma\|_{L_x^{\frac{d}{2}}}} \leq M_1 \leq M_0. \quad (4.34)$$

- The improvement of point a) coupled with  $M_0 > 0$  in the case  $d \geq 3$  implies that  $J_M$  satisfies the following sub-additivity property which will be at the heart of the proof of Theorem 4.2.2: for every  $M \in (M_0, 2M_0)$  and for every  $\alpha \in (0, 1)$ ,

$$J_M < J_{\alpha M} + J_{(1-\alpha)M}. \quad (4.35)$$

Indeed, either  $\alpha$  or  $1 - \alpha$  belongs to  $(0, 1/2)$ . Let us suppose  $0 < \alpha < 1/2$  (Fig. 4.1 might help to check the argument): we have  $\alpha M < M_0$ , so that  $J_{\alpha M} = 0$ . Besides, by monotonicity, we also have  $J_M < J_{(1-\alpha)M} < 0$ . Combining the two observations proves the sub-additivity inequality.

**Proof.** *Items a) and b)* are direct consequences of the definition of  $I_M$ ,  $J_M$  and  $K_M$ . The non trivial part of c) is to prove that  $E(u, \psi, \chi)$  is bounded from below under the mass constrain  $\|u\|_{L_x^2}^2 = M$ . Since for every  $(u, \psi, \chi)$ ,

$$\begin{aligned} E(u, \psi, \chi) &\geq \frac{1}{2} \|\nabla_x u\|_{L_x^2}^2 - \left| \int_{\mathbb{R}^d} \left( \sigma_1 \star \int_{\mathbb{R}^n} \sigma_2 \psi \, dz \right) |u|^2 \, dx \right| + \frac{1}{2} \|\nabla_z \psi\|_{L_x^2 L_z^2}^2 + \frac{1}{2c^2} \|\chi\|_{L_x^2 L_z^2}^2 \\ &\geq \frac{1}{2} \|\nabla_x u\|_{L_x^2}^2 - M \|\sigma_1\|_{L_x^2} \|\sigma_2\|_{L_z^{2n/(n+2)}} \|\psi\|_{L_x^2 L_z^{2n/(n-2)}} + \frac{1}{2} \|\nabla_z \psi\|_{L_x^2 L_z^2}^2 + \frac{1}{2c^2} \|\chi\|_{L_x^2 L_z^2}^2, \end{aligned} \quad (4.36)$$

the Sobolev inequality  $\|f\|_{L_z^{2n/(n-2)}} \lesssim \|\nabla_z f\|_{L_z^2}$ , see e.g. [88, Theorem, p. 125] allows us to conclude.

*Item d).* Let  $u \in H_x^1$ . For  $\lambda > 0$ , we set  $u_\lambda(x) = \lambda^{d/2} u(\lambda x)$ . Then  $\|u_\lambda\|_{L_x^2}^2 = M$  and  $E(u_\lambda, 0, 0) = \lambda^2 \|\nabla_x u\|_{L_x^2}^2 \rightarrow_{\lambda \rightarrow 0} 0$ , which justifies the claim.

*Item e).* For every  $(u, \psi)$  and  $a \in \mathbb{R}$ , we have

$$\begin{aligned} E(au, a|\psi|, 0) \\ = a^2 \left( \frac{1}{2} \|\nabla_x u\|_{L_x^2}^2 - a \int \left( \sigma_1 \star \int \sigma_2 |\psi| \, dz \right) |u|^2 \, dx + \frac{1}{2} \|\nabla_z |\psi|\|_{L_x^2 L_z^2}^2 \right) \xrightarrow{a \rightarrow +\infty} -\infty \end{aligned}$$

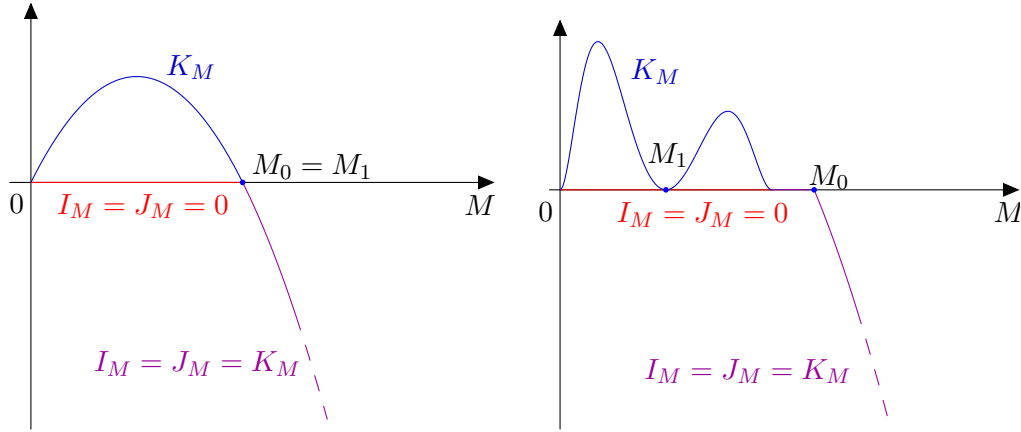

Figure 4.1: Two possible graphs representing  $I_M, J_M, K_M$  as a function of the mass  $M$ . Note that nothing ensures that these functions are differentiable as the picture might indicate. The right picture corresponds to the case where  $M_1 < M_0$ , while  $M_1$  joins  $M_0$  on the left, which could be the expected situation.

and  $\|au\|_{L_x^2}^2 = a^2\|u\|_{L_x^2}^2$ . We conclude by using that  $I_M \leq 0$  and  $M \mapsto I_M$  is non increasing.

*Item f).* We argue by contradiction: we suppose that  $E(u, \psi, \chi) = I_M$  with  $\|u\|_{L_x^2}^2 = m$  and  $0 < m < M$  (note that  $I_M < 0$  implies  $m \neq 0$ ). We first remark that  $I_M < 0$  implies

$$\int \left( \sigma_1 \star \int \sigma_2 \psi \, dz \right) |u|^2 \, dx < 0.$$

Then, by considering  $v = (M/m)^{1/2}u$ ,  $\varphi = (M/m)^{1/2}\psi$  and  $\zeta = (M/m)^{1/2}\chi$  we get

$$\begin{aligned} I_M &\leq E(v, \varphi, \zeta) \\ &= \frac{M}{m} \left( \frac{1}{2} \|\nabla_x u\|_{L_x^2}^2 + \underbrace{\sqrt{\frac{M}{m}} \int \left( \sigma_1 \star \int \sigma_2 \psi \, dz \right) |u|^2 \, dx}_{>1} + \frac{1}{2c^2} \|\chi\|_{L_x^2 L_z^2}^2 + \frac{1}{2} \|\nabla_z \psi\|_{L_x^2 L_z^2}^2 \right) \\ &< \frac{M}{m} E(u, \psi, \chi) = \frac{M}{m} I_M < I_M, \end{aligned}$$

which is a contradiction. Since  $(u, \psi, \chi)$  is a minimizer of  $J_M$ , the Euler-Lagrange relations imply the existence of a Lagrange multiplier  $\lambda_{u,\psi,\chi}$  such that  $\nabla_{u,\psi,\chi} E(u, \psi, \chi) = \lambda_{u,\psi,\chi} \nabla_{u,\psi,\chi} (u \mapsto \|u\|_{L_x^2}^2) = 2\lambda_{u,\psi,\chi}(u, 0, 0)^t$ . The first two components of this vectorial relation imply that  $(u, \psi)$  is a solution of (4.18a)–(4.18b) with  $\omega = -\lambda_{u,\psi,\chi}$  and the third component implies that  $\chi = 0$ . Then  $\psi = \Gamma \sigma_1 \star |u|^2$  (which implies that  $K_M = J_M$  is reached at  $u$ ) and  $u$  is a solution of (4.19) with  $\omega = -\lambda_{u,\psi,\chi}$ . Moreover, by multiplying (4.19) by  $u$  and integrating over  $\mathbb{R}^d$  we get

$$\frac{1}{2} \|\nabla_x u\|_{L_x^2}^2 + \omega \|u\|_{L_x^2}^2 - \kappa \iint |u|^2(x) \Sigma(x-y) |u|^2(y) \, dx \, dy = 0.$$

It follows that

$$\begin{aligned} 0 > J_M = K_M &= \frac{1}{2} \|\nabla_x u\|_{L_x^2}^2 - \frac{\kappa}{2} \iint |u|^2(x) \Sigma(x-y) |u|^2(y) \, dx \, dy \\ &= -\omega \|u\|_{L_x^2}^2 + \frac{\kappa}{2} \iint |u|^2(x) \Sigma(x-y) |u|^2(y) \, dx \, dy \end{aligned}$$

and thus  $\omega > 0$ . Eventually, thanks to the fact that  $\omega$  is a positive number, one can prove by standard arguments that  $u$  is in the Schwartz class (we refer the reader to [70, Theorem 8] and its proof in [77, Remark 1]).

*Item g).* Let us denote by  $C$  the optimal constant of the homogeneous Sobolev embedding  $\|f\|_{L_x^{2d/(d-2)}} \leq C\|\nabla_x f\|_{L_x^2}$  (note that this estimate requires  $d \geq 3$ ). Since  $E(u, \Gamma \sigma_1 \star |u|^2, 0) = H(u)$  and by using the estimate

$$\begin{aligned} \iint |u|^2(x)\Sigma(x-y)|u|^2(y) dx dy &\leq \|\Sigma \star |u|^2\|_{L_x^\infty} \|u\|_{L_x^2}^2 \\ &\leq \|\Sigma\|_{L_x^{\frac{d}{2}}} \| |u|^2 \|_{L_x^{\frac{d}{d-2}}} \|u\|_{L_x^2}^2 = \|\Sigma\|_{L_x^{\frac{d}{2}}} \|u\|_{L_x^{\frac{2d}{d-2}}}^2 \|u\|_{L_x^2}^2 \leq C^2 \|\Sigma\|_{L_x^{\frac{d}{2}}} \|\nabla_x u\|_{L_x^2}^2 \|u\|_{L_x^2}^2, \end{aligned}$$

we eventually obtain

$$E(u, \Gamma \sigma_1 \star |u|^2, 0) \geq \frac{1}{2} \left( 1 - \kappa C^2 \|\Sigma\|_{L_x^{\frac{d}{2}}} \|u\|_{L_x^2}^2 \right) \|\nabla_x u\|_{L_x^2}^2,$$

and  $K_M$  is positive as soon as  $1 - \kappa C^2 \|\Sigma\|_{L_x^{d/2}} M > 0$ .  $\blacksquare$

Thanks to the previous arguments, Theorem 4.2.1-(ii) follows from Theorem 4.2.1-(i): in the proof we will construct a minimizer such that  $u$  is non negative, radially symmetric and non increasing. We are thus left with the task of proving Theorem 4.2.1-(i).

**Proof of Theorem 4.2.1-(i).** We fix  $M > 0$  and we consider a minimizing sequence  $(u_\nu, \psi_\nu, \chi_\nu)_{\nu \in \mathbb{N}}$  of  $I_M$ . We start by constructing from this sequence another minimizing sequence with specific properties. Since  $E(u_\nu, \psi_\nu, 0) \leq E(u_\nu, \psi_\nu, \chi_\nu)$ , we can take  $\chi_\nu = 0$  for every  $\nu$ . Moreover, owing to convexity properties, we have  $E(|u_\nu|, -|\psi_\nu|, 0) \leq E(u_\nu, \psi_\nu, 0)$  and we can suppose  $u_\nu \geq 0$  and  $\psi_\nu \leq 0$ . Finally, the density of linear combinations of tensor product in  $L_x^2 \dot{H}_z^1$  allows us to assume that every  $\psi_\nu$  can be written as

$$\psi_\nu(x, z) = - \sum_{i=0}^{N_\nu} f_i^\nu(x) g_i^\nu(z),$$

where  $f_i^\nu \in L_x^2$  and  $g_i^\nu \in \dot{H}_z^1$  are positive functions. Possibly at the price of decomposing the  $g_i^\nu$ 's on a Hilbert basis of  $\dot{H}_z^1$ , we can suppose that for each  $\nu$ ,  $(g_i^\nu)_{i \in \mathbb{N}}$  forms an orthogonal family and we obtain

$$\begin{aligned} E(u_\nu, \psi_\nu, 0) &= \frac{1}{2} \|\nabla_x u_\nu\|_{L_x^2}^2 \\ &- \sum_{i=0}^{N_\nu} \left( \int_{\mathbb{R}^n} \sigma_2(z) g_i^\nu(z) dz \right) \left( \iint_{\mathbb{R}^d \times \mathbb{R}^d} |u_\nu(x)|^2 \sigma_1(x-y) f_i^\nu(y) dx dy \right) + \sum_{i=0}^{N_\nu} \|f_i^\nu\|_{L_x^2}^2 \|g_i^\nu\|_{\dot{H}_z^1}^2. \end{aligned}$$

From here we can apply the symmetric decreasing rearrangement theory in order to obtain, see [71, chapter 3],  $\|u_\nu^*\|_{L_x^2}^2 = \|u_\nu\|_{L_x^2}^2$ ,  $\|\nabla_x u_\nu^*\|_{L_x^2}^2 \leq \|\nabla_x u_\nu\|_{L_x^2}^2$ ,  $\|f_i^{\nu,*}\|_{L_x^2}^2 = \|f_i^\nu\|_{L_x^2}^2$  and

$$\iint_{\mathbb{R}^d \times \mathbb{R}^d} |u_\nu(x)|^2 \sigma_1(x-y) f_i^\nu(y) dx dy \leq \iint_{\mathbb{R}^d \times \mathbb{R}^d} |u_\nu^*(x)|^2 \sigma_1^*(x-y) f_i^{\nu,*}(y) dx dy,$$

where  $\cdot^*$  stands for the symmetric decreasing rearrangement of a given function. Since  $\sigma_1$  is assumed non negative, radially symmetric and non increasing,  $\sigma_1^* = \sigma_1$  and since

$$\sum_{i=0}^{N_\nu} \|f_i^{\nu,*}\|_{L_x^2}^2 \|g_i^\nu\|_{\dot{H}_z^1}^2 = \left\| \sum_{i=0}^{N_\nu} f_i^{\nu,*} g_i^\nu \right\|_{L_x^2 \dot{H}_z^1}^2,$$

we eventually obtain  $E(u_\nu^*, \tilde{\psi}_\nu, 0) \leq E(u_\nu, \psi_\nu, 0)$ , where  $\tilde{\psi}_\nu = \sum_{i=0}^{N_\nu} f_i^{\nu,*} g_i^\nu$ . From now on,



we will use the abuse of notation  $u_\nu = u_\nu^*$  and  $\psi_\nu = \tilde{\psi}_\nu$ .

Having disposed of these preliminaries, we enter into the heart of the proof. Thanks to (4.36) we know that  $(u_\nu)_{\nu \in \mathbb{N}}$  is bounded in  $H_x^1$  and  $(\psi_\nu)_{\nu \in \mathbb{N}}$  is bounded in  $L_x^2 \dot{H}_z^1$ . Hence we can suppose, possibly at the price of extracting subsequences, that  $(u_\nu)_{\nu \in \mathbb{N}}$  converges weakly to  $u$  in  $H_x^1$ ,  $(\psi_\nu)_{\nu \in \mathbb{N}}$  converges weakly to  $\psi$  in  $L_x^2 \dot{H}_z^1$ . We have  $\|u\|_{L_x^2}^2 \leq M$ ,  $\|\nabla_x u\|_{L_x^2}^2 \leq \liminf_{\nu \rightarrow \infty} \|\nabla_x u_\nu\|_{L_x^2}^2$  and  $\|\psi\|_{L_x^2 \dot{H}_z^1}^2 \leq \liminf_{\nu \rightarrow \infty} \|\psi_\nu\|_{L_x^2 \dot{H}_z^1}^2$ . In order to conclude the proof it only remains to prove that

$$\int_{\mathbb{R}^d} \left( \sigma_1 \star \int_{\mathbb{R}^n} \sigma_2 \psi_\nu dz \right) |u_\nu(x)|^2 dx \xrightarrow{\nu \rightarrow +\infty} \int_{\mathbb{R}^d} \left( \sigma_1 \star \int_{\mathbb{R}^n} \sigma_2 \psi dz \right) |u(x)|^2 dx. \quad (4.37)$$

Indeed, (4.37) now implies  $E(u, \psi, 0) \leq \liminf_{\nu \rightarrow \infty} E(u_\nu, \psi_\nu, 0) = I_M$  and we eventually conclude that  $I_M$  is reached at  $(u, \psi, 0)$ .

We turn to (4.37). On the one hand, by using a diagonal argument and extracting further subsequences if necessary, we know that  $(u_\nu)_{\nu \in \mathbb{N}}$  converges also pointwise to  $u$ . Since for every  $\nu$ ,  $u_\nu$  is non negative, radially symmetric and non increasing, for almost every  $x \in \mathbb{R}^d$  we get

$$|u_\nu(x)|^2 \text{meas}(B(0, |x|)) \leq \int_{B(0, |x|)} |u_\nu(y)|^2 dy \leq M$$

and then

$$|u_\nu(x)| \leq \sqrt{\frac{M}{\text{meas}(B(0, |x|))}} \lesssim \frac{1}{|x|^{\frac{d}{2}}}.$$

Moreover, for almost every  $x \in \mathbb{R}^d$  we also have

$$|u_\nu(x)|^{\frac{2d}{d-2}} \text{meas}(B(0, |x|)) \leq \|u_\nu\|_{L_x^{\frac{2d}{d-2}}}^{\frac{2d}{d-2}} \lesssim \|\nabla_x u_\nu\|_{L_x^2}^{\frac{2d}{d-2}},$$

and since  $(u_\nu)_{\nu \in \mathbb{N}}$  is bounded in  $H_x^1$  we obtain  $|u_\nu(x)| \lesssim |x|^{-(d-2)/2}$ . We conclude that  $0 \leq u_\nu \leq f$  holds, where  $f$  is defined by

$$f(x) = \begin{cases} A |x|^{-\frac{d-2}{2}} & \text{if } |x| \leq 1, \\ A |x|^{-\frac{d}{2}} & \text{else.} \end{cases}$$

On the other hand, the weak convergence of  $\psi_\nu$  to  $\psi$  in  $L_x^2 \dot{H}_z^1$  implies the pointwise convergence of  $(\sigma_1 \star \int \sigma_2 \psi_\nu dz) |u_\nu|^2$  to  $(\sigma_1 \star \int \sigma_2 \psi dz) |u|^2$ . It remains to dominate this quantity by an integrable function. Indeed, the inverse Fourier transform of  $\zeta \mapsto \hat{\sigma}_2(\zeta)/|\zeta|^2$  defines an element of  $\dot{H}_z^1$ , and we get

$$\begin{aligned} \left( \sigma_1 \star \int_{\mathbb{R}^n} \sigma_2 \psi_\nu dz \right) (x) &= \iint_{\mathbb{R}^d \times \mathbb{R}^n} |\zeta| \sigma_1(x-y) \frac{\hat{\sigma}_2(\zeta)}{|\zeta|^2} |\zeta| \overline{\hat{\psi}_\nu(y, \zeta)} dy d\zeta \\ &\xrightarrow{\nu \rightarrow +\infty} \iint_{\mathbb{R}^d \times \mathbb{R}^n} |\zeta| \sigma_1(x-y) \frac{\hat{\sigma}_2(\zeta)}{|\zeta|^2} |\zeta| \overline{\hat{\psi}(y, \zeta)} dy d\zeta = \left( \sigma_1 \star \int_{\mathbb{R}^n} \sigma_2 \psi dz \right) (x). \end{aligned} \quad (4.38)$$

A rough estimate leads to

$$\left| \left( \sigma_1 \star \int_{\mathbb{R}^n} \sigma_2 \psi_\nu dz \right) |u_\nu|^2 \right| \leq \|\sigma_1\|_{L_x^2} \|\sigma_2\|_{L_z^{2n/(n+2)}} \|\psi_\nu\|_{L_x^2 L_z^{2n/(n-2)}} f^2 \lesssim \|\psi_\nu\|_{L_x^2 \dot{H}_z^1} f^2 \lesssim f^2,$$

which is locally integrable on  $\mathbb{R}^d$  but not integrable ( $f^2$  behaves like  $|x|^{-d}$  at infinity). We need to refine the estimates for large  $|x|$ 's: we are going to show that  $\sigma_1 \star \int \sigma_2 \psi_\nu dz$  is dominated when  $|x| \geq 1$  by a function which tends to 0 at  $\infty$ . We first remark that, like for

$u_\nu$ , the following estimate holds for each  $f_i^\nu$ :

$$|f_i^\nu(x)| \leq \frac{\|f_i^\nu\|_{L_x^2}}{\sqrt{\text{meas}(B(0,|x|))}},$$

which yields the refined estimate

$$\begin{aligned} \left| \sigma_1 \star \int_{\mathbb{R}^n} \sigma_2 \psi_\nu \, dz \right| (x) &= \left| \sum_{i=0}^{N_\nu} \left( \int_{\mathbb{R}^n} \sigma_2(z) g_i^\nu(z) \, dz \right) \left( \int_{\mathbb{R}^d} \sigma_1(x-y) f_i^\nu(y) \, dy \right) \right| \\ &\leq \sum_{i=0}^{N_\nu} \|\sigma_2\|_{L_z^{2n/(n+2)}} \|g_i^\nu\|_{L_z^{2n/(n-2)}} \int_{\mathbb{R}^d} \sigma_1(x-y) \frac{\|f_i^\nu\|_{L_x^2}}{\sqrt{\text{meas}(B(0,|y|))}} \, dy \\ &\lesssim \left( \int_{\mathbb{R}^d} \sigma_1(x-y) \frac{1}{|y|^{d/2}} \, dy \right) \sum_{i=0}^{N_\nu} \|f_i^\nu\|_{L_x^2} \|g_i^\nu\|_{\dot{H}_z^1}. \end{aligned}$$

Then, since  $\sum_{i=0}^{N_\nu} \|f_i^\nu\|_{L_x^2} \|g_i^\nu\|_{\dot{H}_z^1} = \|\psi_\nu\|_{L_x^2 \dot{H}_z^1}$  is uniformly bounded with respect to  $\nu$ , we can conclude owing to weak decay assumptions on  $\sigma_1$ . For example, if  $\sigma_1 \in L_x^\infty \cap L_x^1$  and if for some  $0 < \varepsilon \leq d/2$ ,  $x \mapsto |x|^\varepsilon \sigma_1(x)$  lies in  $L_x^\infty \cap L_x^1$  (which is a consequence of **(H2)**), then

$$\begin{aligned} \frac{1}{|x|^\varepsilon} \int_{\mathbb{R}^d} \sigma_1(x-y) \frac{|x|^\varepsilon}{|y|^{d/2}} \, dy &\lesssim \frac{1}{|x|^\varepsilon} \int_{\mathbb{R}^d} \sigma_1(x-y) \frac{|x-y|^\varepsilon + |y|^\varepsilon}{|y|^{d/2}} \, dy \\ &\lesssim \frac{1}{|x|^\varepsilon} \left( \|x \mapsto |x|^\varepsilon \sigma_1(x)\|_{L_x^\infty} \int_{B(0,1)} |y|^{-d/2} \, dy + \int_{\mathbb{C}B(0,1)} \sigma_1(y) |y|^\varepsilon \, dy \right. \\ &\quad \left. + \|\sigma_1\|_{L_x^\infty} \int_{B(0,1)} |y|^{\varepsilon-d/2} \, dy + \int_{\mathbb{C}B(0,1)} \sigma_1(y) \, dy \right) \lesssim \frac{1}{|x|^\varepsilon}. \end{aligned}$$

This ends the proof.  $\blacksquare$

Let us complete this Section with some comments on the uniqueness issue for the minimization problem  $J_M$  and complementary properties of the solutions. As soon as  $J_M$  is reached at  $(u, \psi, \chi)$ , we have  $\chi = 0$ ,  $\psi = \Gamma \sigma_1 \star |u|^2$  and  $K_M = J_M$  is reached at  $u$ . Hence  $J_M$  admits a unique minimizer if and only if  $K_M$  admits a unique minimizer. In [70] E. Lieb fully answers the question of the uniqueness of the minimizer of  $K_M$  for the Newtonian kernel  $\Sigma^0(x) = \frac{1}{|x|}$  in dimension  $d = 3$ . A first step of the proof consists in proving that if  $K_M$  is reached at  $u$  then, up to a translation and a change of phase,  $u$  is positive, radially symmetric and decreasing. The proof uses the fact that  $r \mapsto 1/r$  is decreasing, see [70, Lemma 3 and Corollary 4]. Here, we suppose that  $\sigma_1$  is non increasing ( $\sigma_1$  strictly decreasing is not compatible with  $\sigma_1$  compactly supported) and we cannot apply this reasoning. Nevertheless, the recent result of L. Ma-L. Zhao [82, Section 5] tells us that any non negative solution of (4.19) is strictly positive, radially symmetric and decreasing. This justifies that, if  $K_M$  is reached at  $u$  then, up to a translation and a change of phase,  $u$  is positive, radially symmetric and decreasing. The idea in [82] consists in writing (4.19) as a system

$$\left(\omega - \frac{1}{2}\Delta\right)Q = QX, \quad X = \kappa\Sigma \star Q^2.$$

The operator  $(\omega - \frac{1}{2}\Delta)$  is indeed invertible, and its inverse can be expressed by means of a convolution with the Bessel potential [97, Chapter V, Sect. 3]

$$\mathcal{J}(x) = \frac{1}{4\pi} \int_0^\infty e^{-\pi x^2/t} e^{-t/(4\pi)} t^{-(d-2)/2} \frac{dt}{t}$$

(this kernel corresponds to the operator  $(\mathbb{I} - \Delta)$ ). Therefore  $Q$  appears as the solution of an integral equation

$$Q = \mathcal{J} \star (QX), \quad X = \kappa \Sigma \star Q^2.$$

The operator  $(\omega - \frac{1}{2}\Delta)^{-1}$  is positive in the sense that the solution  $u$  of  $(\omega - \frac{1}{2}\Delta)u = f$ , with  $f \geq 0$ ,  $f \not\equiv 0$  is strictly positive. This reflects in the fact that  $\mathcal{J}(x) > 0$  for any  $x \in \mathbb{R}^d$ . Since we already know that  $Q$  is non negative, we deduce that actually  $Q$  is positive. Moreover  $\mathcal{J}$  is decreasing,  $\Sigma$  is non increasing, which allows us to adapt the moving plane strategy of [82]: we conclude that  $Q$  is radially symmetric, and monotone decreasing in the radial direction. The second step in Lieb's approach shows that  $K_M$  admits a unique positive, radially symmetric and decreasing minimizer [70, Theorem 10]. However, the proof relies strongly on the specific properties of the kernel  $\Sigma^0(x) = 1/|x|$ ; the proof cannot be adapted to the present framework. Two other questions are left open, though not essential for the sequel: does (4.13) admit ground state of mass  $M \in (0, M_0]$ ? and does  $M_1$  equal to  $M_0$ ?

## 4.4 Orbital stability: concentration-compactness approach

Theorem 4.2.2 is a consequence of the following lemma.

**Lemma 4.4.1** *Let  $M \in (M_0, 2M_0)$ . If  $(u_\nu, \psi_\nu, \chi_\nu)_{\nu \in \mathbb{N}} \subset H_x^1 \times L_x^2 \dot{H}_z^1 \times L_x^2 L_z^2$  is a minimizing sequence of  $J_M$  such that  $\|u_\nu\|_{L_x^2}^2 = M$ , then there exists a sequence  $(x_\nu)_{\nu \in \mathbb{N}}$  of elements of  $\mathbb{R}^d$  and  $(\tilde{Q}, \tilde{\Psi}) \in S_M$  such that, up to a sub-sequence,*

$$\|u_\nu(\cdot - x_\nu) - \tilde{Q}\|_{H_x^1}^2 + \|\psi_\nu(\cdot - x_\nu, \cdot) - \tilde{\Psi}\|_{L_x^2 \dot{H}_z^1}^2 + \|\chi_\nu\|_{L_x^2 L_z^2}^2 \xrightarrow{\nu \rightarrow +\infty} 0.$$

Let us first explain how this lemma implies Theorem 4.2.2. We argue by contradiction. Let us assume the existence of  $\varepsilon > 0$  and a sequence of initial data  $(u_0^\nu, \psi_0^\nu, \chi_0^\nu)_{\nu \in \mathbb{N}}$  satisfying  $\|u_0^\nu\|_{L_x^2}^2 = M$ ,

$$\|u_0^\nu - Q\|_{H_x^1}^2 + \|\psi_0^\nu - \Psi\|_{L_x^2 \dot{H}_z^1}^2 + \|\chi_0^\nu\|_{L_x^2 L_z^2}^2 \xrightarrow{\nu \rightarrow +\infty} 0,$$

and such that for any  $\nu \in \mathbb{N}$ , the unique solution  $(u^\nu, \psi^\nu, \chi^\nu)$  of (4.1a)-(4.1b) with initial data  $(u_0^\nu, \psi_0^\nu, \chi_0^\nu)$  satisfies for some  $t_\nu > 0$ ,

$$\inf_{(\tilde{Q}, \tilde{\Psi}) \in S_M} \left( \|u^\nu(t_\nu) - \tilde{Q}\|_{H_x^1}^2 + \|\psi^\nu(t_\nu) - \tilde{\Psi}\|_{L_x^2 \dot{H}_z^1}^2 + \|\chi^\nu(t_\nu)\|_{L_x^2 L_z^2}^2 \right) > \varepsilon.$$

The energy functional  $E$  is continuous with respect to  $u \in H_x^1$ ,  $\psi \in L_x^2 \dot{H}_z^1$  and  $\chi \in L_x^2 L_z^2$  so that

$$E(u_0^\nu, \psi_0^\nu, \chi_0^\nu) \xrightarrow{\nu \rightarrow +\infty} E(Q, \Psi, 0) = J_M.$$

By using the mass and energy conservations we check that the sequence  $(u^\nu(t_\nu), \psi^\nu(t_\nu), \chi^\nu(t_\nu))_{\nu \in \mathbb{N}}$  fulfils the assumptions of Lemma 4.4.1 and we eventually obtain the required contradiction.

**Proof of Lemma 4.4.1.** First of all, since  $J_M \leq E(u_\nu, \psi_\nu, 0) \leq E(u_\nu, \psi_\nu, \chi_\nu)$  and  $E(u_\nu, \psi_\nu, \chi_\nu) \rightarrow J_M$  when  $\nu \rightarrow +\infty$  we obtain

$$\frac{1}{2c} \|\chi_\nu\|_{L_x^2 L_z^2}^2 = E(u_\nu, \psi_\nu, \chi_\nu) - E(u_\nu, \psi_\nu, 0) \xrightarrow{\nu \rightarrow +\infty} 0.$$

Then, owing to (4.36),  $(u_\nu)_{\nu \in \mathbb{N}}$  is bounded in  $H_x^1$  and  $(\psi_\nu)_{\nu \in \mathbb{N}}$  is bounded in  $L_x^2 \dot{H}_z^1$ . The concentration compactness lemma [73, 74] — here we use the version that can be found

in [21, Prop. 1.7.6] — insures that there are only three different possible scenarii for the behavior of the sequence  $(u_\nu)_{\nu \in \mathbb{N}}$ .

*Scenario 1: Evanescence.* Up to a sub-sequence, for every  $2 < q < 2^*$ ,  $(u_\nu)_{\nu \in \mathbb{N}}$  converges strongly to 0 in  $L_x^q$ , where  $2^* = +\infty$  if  $d = 1$  or  $2$  and  $2^* = 2d/(d-2)$  if  $d \geq 3$ ). Let us assume  $d \geq 3$ ; we have

$$\begin{aligned} \left| \int_{\mathbb{R}^d} \left( \sigma_1 \star \int_{\mathbb{R}^n} \sigma_2 \psi_\nu \, dz \right) |u_\nu|^2 \, dx \right| &\leq \left\| \sigma_1 \star \int_{\mathbb{R}^n} \sigma_2 \psi_\nu \, dz \right\|_{L_x^{d-1}} \| |u_\nu|^2 \|_{L_x^{(d-1)/(d-2)}} \\ &\leq \|\sigma_1\|_{L_x^{2(d-1)/(d+1)}} \|\sigma_2\|_{L_z^{2n/(n+2)}} \|\psi_\nu\|_{L_x^2 L_z^{2n/(n-2)}} \lesssim \|\psi_\nu\|_{L_x^2 \dot{H}_z^1} \|u_\nu\|_{L_x^{2(d-1)/(d-2)}}^2. \end{aligned}$$

Since  $(\psi_\nu)_{\nu \in \mathbb{N}}$  is bounded in  $L_x^2 \dot{H}_z^1$  and  $2 < 2(d-1)/(d-2) < 2^*$ , we eventually obtain

$$\int_{\mathbb{R}^d} \left( \sigma_1 \star \int_{\mathbb{R}^n} \sigma_2 \psi_\nu \, dz \right) |u_\nu|^2 \, dx \xrightarrow{\nu \rightarrow +\infty} 0.$$

Then

$$J_M = \lim_{\nu \rightarrow +\infty} E(u_\nu, \psi_\nu, 0) = \lim_{\nu \rightarrow +\infty} \left( \frac{1}{2} \|\nabla_x u_\nu\|_{L_x^2}^2 + \frac{1}{2} \|\nabla_z \psi_\nu\|_{L_x^2 L_z^2}^2 \right) \geq 0,$$

which contradicts  $J_M < 0$ .

*Scenario 2: Dichotomy.* Up to possible extraction, there exists two sequences  $(v_\nu)_{\nu \in \mathbb{N}}$  and  $(w_\nu)_{\nu \in \mathbb{N}}$ , bounded in  $H_x^1$  and such that the following assertions hold

$$(i) \quad \exists \alpha \in (0, 1) \text{ such that } \|v_\nu\|_{L_x^2}^2 \xrightarrow{\nu \rightarrow +\infty} \alpha M \text{ and } \|w_\nu\|_{L_x^2}^2 \xrightarrow{\nu \rightarrow +\infty} (1 - \alpha)M,$$

$$(ii) \quad \forall 2 \leq q < 2^*, \quad \|u_\nu\|_{L_x^q}^q - \|v_\nu\|_{L_x^q}^q - \|w_\nu\|_{L_x^q}^q \xrightarrow{\nu \rightarrow +\infty} 0,$$

$$(iii) \quad \liminf_{\nu \rightarrow +\infty} \left( \|\nabla_x u_\nu\|_{L_x^2}^2 - \|\nabla_x v_\nu\|_{L_x^2}^2 - \|\nabla_x w_\nu\|_{L_x^2}^2 \right) \geq 0.$$

With (ii), we infer

$$\begin{aligned} &\left| \int_{\mathbb{R}^d} \left( \sigma_1 \star \int_{\mathbb{R}^n} \sigma_2 \psi_\nu \, dz \right) (|u_\nu|^2 - |v_\nu|^2 - |w_\nu|^2) \, dx \right| \\ &\leq \|\sigma_1\|_{L_x^2} \|\sigma_2\|_{L_z^{2n/(n+2)}} \|\psi_\nu\|_{L_x^2 \dot{H}_z^1} \left( \int_{\mathbb{R}^d} | |u_\nu|^2 - |v_\nu|^2 - |w_\nu|^2 | \, dx \right) \xrightarrow{\nu \rightarrow +\infty} 0. \end{aligned} \quad (4.39)$$

Note that we can apply (ii) because in the proof of the concentration compactness lemma [21]  $v_\nu$  and  $w_\nu$  are built in such way that  $|u_\nu|^2 - |v_\nu|^2 - |w_\nu|^2 \geq 0$ . Since

$$\begin{aligned} E(u_\nu, \psi_\nu, 0) &= \frac{1}{2} \left( \|\nabla_x u_\nu\|_{L_x^2}^2 - \|\nabla_x v_\nu\|_{L_x^2}^2 - \|\nabla_x w_\nu\|_{L_x^2}^2 \right) \\ &\quad + \int_{\mathbb{R}^d} \left( \sigma_1 \star \int_{\mathbb{R}^n} \sigma_2 \psi_\nu \, dz \right) (|u_\nu|^2 - |v_\nu|^2 - |w_\nu|^2) \, dx + E(v_\nu, \psi_\nu, 0) + E(w_\nu, \psi_\nu, 0), \end{aligned}$$

combining (4.39), (iii) and (i) yields

$$\begin{aligned} J_M = \lim_{\nu \rightarrow +\infty} E(u_\nu, \psi_\nu, 0) &\geq \liminf_{\nu \rightarrow +\infty} (E(v_\nu, \psi_\nu, 0) + E(w_\nu, \psi_\nu, 0)) \\ &\geq \liminf_{\nu \rightarrow +\infty} E(v_\nu, \psi_\nu, 0) + \liminf_{\nu \rightarrow +\infty} E(w_\nu, \psi_\nu, 0) \geq J_{\alpha M} + J_{(1-\alpha)M}, \end{aligned}$$

which is a contradiction with (4.35), satisfied for  $M \in (M_0, 2M_0)$ .

*Scenario 3: Compactness.* Up to a sub-sequence, there exists a sequence  $(x_\nu)_{\nu \in \mathbb{N}}$  in  $\mathbb{R}^d$  such that  $v_\nu(x) = u_\nu(x - x_\nu)$  converges weakly to  $u$  in  $H_x^1$  and strongly to  $u$  in  $L_x^q$  for any  $2 \leq q < 2^*$ . The sequence  $\varphi_\nu(x, z) = \psi_\nu(x - x_\nu, z)$  is bounded in  $L_x^2 \dot{H}_z^1$  (note that  $\|\varphi_\nu\|_{L_x^2 \dot{H}_z^1} = \|\psi_\nu\|_{L_x^2 \dot{H}_z^1}$ ). Up to a subsequence,  $(\varphi_\nu)_{\nu \in \mathbb{N}}$  converges weakly to  $\psi$  in  $L_x^2 \dot{H}_z^1$ .

Since  $(v_\nu)_{\nu \in \mathbb{N}}$  converges strongly to  $u$  in  $L_x^2$  we have  $\|u\|_{L_x^2}^2 = M$  and then  $E(u, \psi, 0) \geq J_M$ . Let us now prove that

$$\int_{\mathbb{R}^d} \left( \sigma_1 \star \int_{\mathbb{R}^n} \sigma_2 \varphi_\nu dz \right) |v_\nu|^2 dx \xrightarrow{\nu \rightarrow +\infty} \int_{\mathbb{R}^d} \left( \sigma_1 \star \int_{\mathbb{R}^n} \sigma_2 \psi dz \right) |u|^2 dx \quad (4.40)$$

holds. We have

$$\begin{aligned} \int_{\mathbb{R}^d} \left( \sigma_1 \star \int_{\mathbb{R}^n} \sigma_2 \varphi_\nu dz \right) |v_\nu|^2 dx &= \int_{\mathbb{R}^d} (\sigma_1 \star |v_\nu|^2) \left( \int_{\mathbb{R}^n} \sigma_2 \varphi_\nu dz \right) dx \\ &= \int_{\mathbb{R}^d} \left[ (\sigma_1 \star |v_\nu|^2) - (\sigma_1 \star |u|^2) \right] \left( \int_{\mathbb{R}^n} \sigma_2 \varphi_\nu dz \right) dx + \int_{\mathbb{R}^d} (\sigma_1 \star |u|^2) \left( \int_{\mathbb{R}^n} \sigma_2 \varphi_\nu dz \right) dx, \end{aligned}$$

where

$$\begin{aligned} \left| \int_{\mathbb{R}^d} \left[ (\sigma_1 \star |v_\nu|^2) - (\sigma_1 \star |u|^2) \right] \left( \int_{\mathbb{R}^n} \sigma_2 \varphi_\nu dz \right) dx \right| \\ \lesssim \left\| (\sigma_1 \star |v_\nu|^2) - (\sigma_1 \star |u|^2) \right\|_{L_x^2} \|\varphi_\nu\|_{L_x^2 \dot{H}_z^1}, \end{aligned}$$

Moreover, reasoning as in (4.38), we get

$$\begin{aligned} \int_{\mathbb{R}^d} (\sigma_1 \star |u|^2) \left( \int_{\mathbb{R}^n} \sigma_2 \varphi_\nu dz \right) dx &= \iint_{\mathbb{R}^d \times \mathbb{R}^n} (\sigma_1 \star |u|^2) \sigma_2 \varphi_\nu dx dz \\ &\xrightarrow{\nu \rightarrow +\infty} \iint_{\mathbb{R}^d \times \mathbb{R}^n} (\sigma_1 \star |u|^2) \sigma_2 \psi dx dz = \int_{\mathbb{R}^d} \left( \sigma_1 \star \int_{\mathbb{R}^n} \sigma_2 \psi dz \right) |u|^2 dx. \end{aligned}$$

It remains to prove that  $\sigma_1 \star |v_\nu|^2$  converges strongly to  $\sigma_1 \star |u|^2$  in  $L_x^2$ . To this end, we remark that

$$\sigma_1 \star |v_\nu|^2 - \sigma_1 \star |u|^2 = \sigma_1 \star (|v_\nu - u + u|^2 - |u|^2) = \sigma_1 \star (|v_\nu - u|^2 + 2\operatorname{Re}(v_\nu - u)\bar{u}).$$

By using Young's inequalities and the strong convergence in  $L_x^2$  of  $(v_\nu)_{\nu \in \mathbb{N}}$  to  $u$ , we obtain

$$\begin{aligned} \left\| (\sigma_1 \star |v_\nu|^2) - (\sigma_1 \star |u|^2) \right\|_{L_x^2} &\leq \|\sigma_1\|_{L_x^2} \left\| |v_\nu - u|^2 + 2\operatorname{Re}(v_\nu - u)\bar{u} \right\|_{L_x^1} \\ &\leq \|\sigma_1\|_{L_x^2} \left( \|v_\nu - u\|_{L_x^2}^2 + 2\|v_\nu - u\|_{L_x^2} \|u\|_{L_x^2} \right) \xrightarrow{\nu \rightarrow +\infty} 0. \end{aligned}$$

With (4.40) we can now justify that  $(u, \psi)$  lies in  $S_M$ :

$$\begin{aligned} J_M &= \lim_{\nu \rightarrow +\infty} E(v_\nu, \varphi_\nu, 0) \geq \liminf_{\nu \rightarrow +\infty} \left( \frac{1}{2} \|\nabla_x v_\nu\|_{L_x^2}^2 \right) \\ &\quad + \liminf_{\nu \rightarrow +\infty} \left( \int_{\mathbb{R}^d} \left( \sigma_1 \star \int_{\mathbb{R}^n} \sigma_2 \varphi_\nu dz \right) |v_\nu|^2 dx \right) + \liminf_{\nu \rightarrow +\infty} \left( \frac{1}{2} \|\nabla_z \varphi_\nu\|_{L_x^2 L_z^2}^2 \right) \geq E(u, \psi, 0). \end{aligned}$$

In order to conclude the proof it only remains to justify the strong convergence of  $(v_\nu, \varphi_\nu)_{\nu \in \mathbb{N}}$  to  $(u, \psi)$  in  $H_x^1 \times L_x^2 \dot{H}_z^1$ . We already know that this convergence holds weakly. We combine

$$E(u, \psi, 0) = J_M = \lim_{\nu \rightarrow +\infty} E(v_\nu, \varphi_\nu, 0)$$

and (4.40) to deduce that

$$\frac{1}{2} \|\nabla_x v_\nu\|_{L_x^2}^2 + \frac{1}{2} \|\nabla_z \varphi_\nu\|_{L_x^2 L_z^2}^2 \xrightarrow{\nu \rightarrow +\infty} \frac{1}{2} \|\nabla_x u\|_{L_x^2}^2 + \frac{1}{2} \|\nabla_z \psi\|_{L_x^2 L_z^2}^2,$$

holds, which allows us to conclude.  $\blacksquare$

## 4.5 Strengthened orbital stability: approach by linearization

In this Section, we explain how Lemma 4.2.4 and Lemma 4.2.8 imply Theorem 4.2.9.

**Step 1.** The first step of the proof consists in checking that, up to the invariants of the equation, any  $v \in H_x^1$  close enough to  $Q$  satisfies the orthogonality conditions (4.30a)–(4.30b). For that purpose, let us introduce the function  $F : H_x^1 \times \mathbb{R}^{d+1} \rightarrow \mathbb{R}^{d+1}$  defined by

$$\begin{aligned} F_j(v, (y, \theta)) &= \left\langle \operatorname{Re} e^{-i\theta} v(\cdot + y), \partial_{x_j} Q \right\rangle_{L_x^2}, \quad j = 1, \dots, d \\ F_{d+1}(v, (y, \theta)) &= \left\langle \operatorname{Im} e^{-i\theta} v(\cdot + y), Q \right\rangle_{H_x^1}. \end{aligned}$$

Direct computations show that  $F(Q, (0, 0)) = 0$  and  $D_{y, \theta} F(Q, (0, 0))$  is an invertible diagonal matrix (indeed  $\partial_{y_j} F_j(Q, (0, 0)) = \|\partial_{x_j} Q\|_{L_x^2}^2$  and  $\partial_\theta F_{d+1}(Q, (0, 0)) = -\|Q\|_{H_x^1}^2$ ). The implicit function theorem provides the existence of  $\varepsilon_0 > 0$  and a  $C^1$ -diffeomorphism  $G : B_{H_x^1}(Q, 2\varepsilon_0) \rightarrow U_{\varepsilon_0} \subset \mathbb{R}^{d+1}$ ,  $G(v) = (x, \gamma)$  such that for every  $v \in B_{H_x^1}(Q, 2\varepsilon_0)$  and every  $(y, \theta) \in U_{\varepsilon_0}$ ,  $F(v, (y, \theta)) = 0$  if and only if  $(y, \theta) = G(v)$ . Moreover, since

$$|(x, \gamma)| = |G(v) - G(Q)| \leq (\sup \|D_v G\|) \|v - Q\|_{H_x^1},$$

for every  $\varepsilon \in (0, \varepsilon_0)$  there exists  $\eta(\varepsilon) > 0$  such that

$$\|v - Q, \varphi - \Psi\|_{\mathcal{H}}^2 + \frac{1}{c^2} \|\chi\|_{L_x^2 L_z^2}^2 \leq \eta(\varepsilon)^2$$

implies for  $(x, \gamma) = G(v)$ ,

$$\|e^{-i\gamma} v(\cdot + x) - Q, \varphi(\cdot + x) - \Psi\|_{\mathcal{H}}^2 + \frac{1}{c^2} \|\chi\|_{L_x^2 L_z^2}^2 \leq \varepsilon^2.$$

**Step 2.** In this second step we show that, if for a given time  $t_0 \in [0, +\infty)$ , there exists  $(x_0, \gamma_0) \in \mathbb{R}^{d+1}$  such that  $v = e^{-i\gamma_0} u(t_0, \cdot + x_0)$  satisfies the orthogonality conditions (4.30a)–(4.30b) and the estimate

$$\|e^{-i\gamma_0} u(t_0, \cdot + x_0) - Q, \psi(t_0, \cdot + x_0) - \Psi\|_{\mathcal{H}}^2 + \frac{1}{c^2} \|\chi(t_0)\|_{L_x^2 L_z^2}^2 \leq \varepsilon^2 < \varepsilon_0^2,$$

then there exists a time  $T^* > t_0$  and two functions  $x(t)$  and  $\gamma(t)$  continuous in time such that  $(x(t_0), \gamma(t_0)) = (x_0, \gamma_0)$  and, for every  $t \in [t_0, T^*)$ ,

- i)  $(x(t) - x_0, \gamma(t) - \gamma_0) \in U_{\varepsilon_0}$ ,
- ii)  $v = e^{-i\gamma(t)} u(t, \cdot + x(t))$  satisfies the orthogonality conditions (4.30a)–(4.30b),
- iii)  $\|e^{-i\gamma(t)} u(t, \cdot + x(t)) - Q, \psi(t, \cdot + x(t)) - \Psi\|_{\mathcal{H}}^2 + \frac{1}{c^2} \|\chi(t)\|_{L_x^2 L_z^2}^2 \leq \varepsilon^2$ .

First, thanks to the time continuity of  $t \mapsto (e^{-i\gamma_0} u(t, \cdot + x_0), \psi(t, \cdot + x_0)) \in \mathcal{H}$ , there exists a time  $T^* > t_0$  such that for every  $t \in [t_0, T^*)$

$$\|e^{-i\gamma_0} u(t, \cdot + x_0) - Q, \psi(t, \cdot + x_0) - \Psi\|_{\mathcal{H}}^2 \leq 4\varepsilon^2 < 4\varepsilon_0^2.$$

Next, for every  $t \in [t_0, T^*)$  we can apply the first step to  $v = e^{-i\gamma_0} u(t, \cdot + x_0)$  and we obtain the existence of  $x(t)$  and  $\gamma(t)$  such that  $(x(t_0), \gamma(t_0)) = (x_0, \gamma_0)$  and such that i) and ii) hold. Moreover the continuity of  $t \mapsto e^{-i\gamma_0} u(t, \cdot + x_0)$  implies the continuity of  $t \mapsto x(t)$  and  $t \mapsto \gamma(t)$ . We notice also that we can extend by continuity  $x(t)$  and  $\gamma(t)$  at time  $T^*$  and this

extension is such that  $v = e^{-i\gamma(T^*)}u(T^*, \cdot + x(T^*))$  still satisfies the orthogonality conditions (4.30a)–(4.30b).

We can now apply Lemma 4.2.4 and 4.2.8 as follows. Thanks to the conservation of mass and energy and to the invariance by translation and phase of these quantities we get

$$\begin{aligned} W(u_0, \psi_0, \chi_0) &= W(u(t), \psi(t), \chi(t)) \\ &= W\left(e^{-i\gamma(t)}u(t, \cdot + x(t)), \psi(t, \cdot + x(t)), \chi(t)\right) = W(Q + u^\varepsilon(t), \Psi + \psi^\varepsilon(t), \chi(t)), \end{aligned}$$

where

$$u^\varepsilon(t) = e^{-i\gamma(t)}u(t, \cdot + x(t)) - Q \quad \text{and} \quad \psi^\varepsilon(t) = \psi(t, \cdot + x(t)) - \Psi.$$

We make use of the decomposition (4.25) combined with Lemma 4.2.4 and 4.2.8; we obtain

$$\begin{aligned} \bar{\nu} \|\operatorname{Re} u^\varepsilon, \psi^\varepsilon\|_{\mathcal{H}}^2 + \mu \|\operatorname{Im} u^\varepsilon\|_{H_x^1}^2 + \frac{1}{2c^2} \|\chi(t)\|_{L_x^2 L_z^2}^2 \\ \leq W(u_0, \psi_0, \chi_0) - W(Q, \Psi, 0) + \frac{1}{\bar{\nu}} \left( \left| \langle \operatorname{Re} u^\varepsilon, Q \rangle_{L_x^2} \right|^2 + \sum_{j=1}^d \left| \langle \operatorname{Re} u^\varepsilon, \partial_{x_j} Q \rangle_{L_x^2} \right|^2 \right) \\ + \frac{1}{\mu} \left| \langle \operatorname{Im} u^\varepsilon, Q \rangle_{H_x^1} \right|^2 - \int_{\mathbb{R}^d} \left( \sigma_1 \star \int_{\mathbb{R}^n} \sigma_2 \psi^\varepsilon(t) dz \right) |u^\varepsilon(t)|^2 dx. \end{aligned}$$

Since  $e^{-i\gamma(t)}u(t, \cdot + x(t))$  and  $Q$  satisfy the orthogonality conditions (4.30a)–(4.30b) we know that  $u^\varepsilon$  also satisfies these conditions. Moreover  $\|Q\|_{L_x^2} = \|u(t)\|_{L_x^2} = \|u^\varepsilon + Q\|_{L_x^2}$  leads to

$$\|Q\|_{L_x^2}^2 = \|u^\varepsilon\|_{L_x^2}^2 + \|Q\|_{L_x^2}^2 + 2\langle \operatorname{Re} u^\varepsilon, Q \rangle_{L_x^2} \quad \text{and then} \quad \langle \operatorname{Re} u^\varepsilon, Q \rangle_{L_x^2} = -\frac{1}{2} \|u^\varepsilon\|_{L_x^2}^2,$$

which implies

$$\left| \langle \operatorname{Re} u^\varepsilon, Q \rangle_{L_x^2} \right|^2 \leq \frac{1}{4} \|u^\varepsilon\|_{L_x^2}^4 \leq 4\varepsilon^4.$$

We also get

$$\begin{aligned} \left| \int_{\mathbb{R}^d} \left( \sigma_1 \star \int_{\mathbb{R}^n} \sigma_2 \psi^\varepsilon(t) dz \right) |u^\varepsilon(t)|^2 dx \right| &\leq \|\sigma_1\|_{L_x^2} \|\sigma_2\|_{L_z^{2n/(n+2)}} \|\psi^\varepsilon(t)\|_{L_x^2 \dot{H}_z^1} \|u^\varepsilon(t)\|_{L_x^2}^2 \\ &\leq \|\sigma_1\|_{L_x^2} \|\sigma_2\|_{L_z^{2n/(n+2)}} \|u^\varepsilon(t), \psi^\varepsilon(t)\|_{\mathcal{H}}^3 \leq 8 \|\sigma_1\|_{L_x^2} \|\sigma_2\|_{L_z^{2n/(n+2)}} \varepsilon^3. \end{aligned}$$

Gathering these estimates leads eventually to (we recall that  $W(u_0, \psi_0, \chi_0) - W(Q, \Psi, 0) \leq \delta(\varepsilon)$ )

$$\begin{aligned} \|\operatorname{Re} u^\varepsilon, \psi^\varepsilon\|_{\mathcal{H}}^2 + \|\operatorname{Im} u^\varepsilon\|_{H_x^1}^2 + \frac{1}{c^2} \|\chi(t)\|_{L_x^2 L_z^2}^2 \\ \leq \frac{1}{\min(\bar{\nu}, \mu, \frac{1}{2})} \left( \delta(\varepsilon) + \frac{4}{\bar{\nu}} \varepsilon^4 + 8 \|\sigma_1\|_{L_x^2} \|\sigma_2\|_{L_z^{2n/(n+2)}} \varepsilon^3 \right). \end{aligned}$$

By taking

$$\delta(\varepsilon) = \min\left(\bar{\nu}, \mu, \frac{1}{2}\right) \frac{\varepsilon^2}{2},$$

and possibly at the price of picking a smaller  $\varepsilon_0$ , we eventually obtain iii) for every  $t \in [t_0, T^*]$ .

**Conclusion.** We apply the first step with  $v = u_0$ , which insures the existence of  $x(0)$  and  $\gamma(0)$  such that we can apply the second step at time  $t = 0$ . Thus, since  $T^* > 0$  and since we took care to justify that the conclusions of second step is also valid at time  $t = T^*$ , a classical argument on connected space allows us to conclude that  $T^* = +\infty$ .

## 4.6 Orbital stability on finite time for data with a high initial momentum

In this section we give the proof of Theorem 4.2.11 which provides a result of orbital stability on a finite time interval but with an initial data  $u_0$  which might have a high momentum  $p_0$ . As explained in the introduction, a first step in order to obtain this result consists in obtaining the larger time interval  $[0, T_f]$  on which we are able to justify that

$$\sup_{0 \leq t \leq T_f} \left| |p_0|^2 - |p(t)|^2 \right| \leq \epsilon. \quad (4.41)$$

The following Lemma, based on the conservation of the total momentum of the system (4.17) and Strichartz' estimates justifies that (4.41) holds with  $T_f$  defined by (4.31).

**Lemma 4.6.1** *We fix  $\epsilon > 0$  and  $p_0 \in \mathbb{R}^d$  and we consider the regime  $c \geq \langle p_0 \rangle \epsilon^{-1}$ . Let  $\nabla_x \psi_0 \in L_x^2 L_z^2$  and  $\nabla_x \chi_0 \in L_x^2 \dot{H}_z^{-1}$  be such that*

$$\frac{1}{c} \|\nabla_x \psi_0\|_{L_x^2 L_z^2} + \frac{1}{c^2} \|\nabla_x \chi_0\|_{L_x^2 \dot{H}_z^{-1}} \leq \frac{\epsilon}{\langle p_0 \rangle}.$$

*Then, for any  $n \geq 4$  and  $\alpha \in [1, 2]$  or  $n = 3$  and  $\alpha \in [1, 2)$ , there exists two constants  $C = C(\alpha, n) > 0$  and  $K = K(\alpha, n) > 0$  independent of  $\epsilon$ ,  $p_0$  and  $c$ , such that*

$$\sup_{0 \leq t \leq T_f} \left| |p_0|^2 - |p(t)|^2 \right| \leq C\epsilon \left( \sup_{0 \leq t \leq T_f} \frac{1}{c} \|\chi(t)\|_{L_x^2 L_z^2} \right) + C\epsilon^2 \left( \sup_{0 \leq t \leq T_f} \frac{1}{c} \|\chi(t)\|_{L_x^2 L_z^2} \right)^2,$$

*where the time  $T_f = T_f(\alpha, n, \epsilon, p_0, c)$  is defined by*

$$T_f(\alpha, \epsilon, p_0, c) = K(\alpha, n) \frac{\epsilon^\alpha c^{\alpha-1}}{\langle p_0 \rangle^\alpha}.$$

**Remark 4.6.2** i) *The assumption  $\nabla_x \chi_0 \in L_x^2 \dot{H}_z^{-1}$  is not a strong restriction for us since in the case  $n \geq 3$ ,  $\zeta \mapsto |\zeta|^{-2}$  is locally integrable around 0. Then any function  $\nabla_x \chi_0 \in L_x^2 L_z^2$  such that its Fourier transform in the  $z$ -variable is continuous around 0 defines an element of  $L_x^2 \dot{H}_z^{-1}$ . Moreover, the smallness assumption on the initial data is neither a restriction in our study since we start with initial data  $(\psi_0, \chi_0)$  close to  $(\Psi, 0)$  where  $\Psi$  is of order 1.*  
 ii) *The case  $\alpha = 1$  is allowed but has no interest for us since in that case the time  $T_f$  is independent of  $c$ . The most interesting case is when  $\alpha = 2$  for which the time  $T_f$  growth linearly with  $c$ . However, when  $n = 3$  the constant  $C(\alpha, n)$  blows up when  $\alpha$  goes to 2.*  
 iii) *In practice we will start with  $\chi_0/c$  of size  $\epsilon$  in  $L_x^2 L_z^2$  and we will propagate this estimate to  $\chi(t)$  for any  $t \in [0, T_f]$ . In that case we get*

$$\sup_{0 \leq t \leq T_f} \left| |p_0|^2 - |p(t)|^2 \right| \lesssim \epsilon^2.$$

iv) *Since in the classical version of the Schrödinger-Wave system the media acts on the particle as a linear friction force with friction coefficient  $\gamma/c$  when  $n = 3$ , and since we expect that it is still the case at the quantum level, it is interesting to consider the case of a classical particle only submitted to an external linear friction force with friction coefficient  $\gamma/c$  and to investigate on which time interval we get*

$$\left| |p_0|^2 - |p(t)|^2 \right| \leq \epsilon^2.$$



Since  $\dot{p}(t) = -\gamma p(t)/c$  implies  $p(t) = p_0 \exp(-\gamma t/c)$  we get

$$\left| |p_0|^2 - |p(t)|^2 \right| = |p_0|^2 \left( 1 - e^{-\frac{2\gamma}{c}t} \right) \leq \epsilon^2 \iff t \leq -\frac{c}{2\gamma} \log \left( 1 - \frac{\epsilon^2}{|p_0|^2} \right) \sim \frac{c \epsilon^2}{2\gamma |p_0|^2},$$

which exactly correspond to the case  $\alpha = 2$  in the definition of  $T_f$ . The case  $\alpha = 2$  is not covered when  $n = 3$  but our rough estimation seems to be not that far from optimal.

v) However, when  $n \geq 4$ , at the classical level the environment acts on the particle as a non linear friction force with exponent  $n - 2$  and friction coefficient  $\gamma/c^{n-2}$  (see [16, Section 2]). In that case

$$\dot{p}(t) = -\gamma \left( \frac{|p(t)|}{c} \right)^{n-2} \frac{p(t)}{|p(t)|} \quad ; \quad |p(t)|^2 = |p_0|^2 \left( 1 + \frac{(n-3)\gamma}{c^{n-2}} |p_0|^{n-3} t \right)^{-\frac{2}{n-3}}$$

which leads to

$$\begin{aligned} |p_0|^2 - |p(t)|^2 &= |p_0|^2 \left( 1 - \left( 1 + \frac{(n-3)\gamma}{c^{n-2}} |p_0|^{n-3} t \right)^{-\frac{2}{n-3}} \right) \leq \epsilon^2 \\ \iff t &\leq \frac{c^{n-2}}{(n-3)\gamma |p_0|^{n-3}} \left( \left( 1 - \frac{\epsilon^2}{|p_0|^2} \right)^{-\frac{n-3}{2}} - 1 \right) \sim \frac{c^{n-2} \epsilon^2}{2\gamma |p_0|^{n-1}} \end{aligned}$$

and our estimation of the minimal time is not sharp at all in the case  $n \geq 4$ .

vi) The fact that our result is not close to the classical case has two different explanations. The first one is that our result is based on a rough estimate which is far from optimal. The second is that at the classical level the fact that the media acts on the particle as a linear (resp. non linear) friction force is an asymptotic result which is only valid when the momentum of the particle is small. Since our result works for any value of  $p_0$  we cannot expect it to be close to this asymptotic case.

**Proof.** For the sake of simplicity we only make the proof in the case where  $\chi_0 \equiv 0$ , straightforward modifications allow us to obtain the general case. In this case, thanks to the conservation of the total momentum (4.17)

$$\mathcal{P}(t) = p(t) - \frac{1}{c^2} \iint \chi(t) \nabla_x \psi(t) \, dx \, dz = \mathcal{P}(0),$$

we get

$$p(t) = \mathcal{P}(0) + \frac{1}{c^2} \iint \chi(t) \nabla_x \psi(t) \, dx \, dz = p_0 + \frac{1}{c^2} \iint \chi(t) \nabla_x \psi(t) \, dx \, dz = p_0 + f(t).$$

Then

$$\left| |p_0|^2 - |p(t)|^2 \right| = \left| 2p_0 f(t) + |f(t)|^2 \right| \leq \left( 2|p_0| |f(t)| + |f(t)|^2 \right) \quad (4.42)$$

and we only have to estimate  $f(t)$ . Thanks to the Cauchy-Schwarz inequality we get

$$\sup_{0 \leq t \leq T} |f(t)| \leq \frac{1}{c} \|\nabla_x \psi\|_{L_x^2 L_t^\infty L_z^2} \left( \sup_{0 \leq t \leq T} \frac{1}{c} \|\chi(t)\|_{L_x^2 L_z^2} \right)$$

and we will apply some Strichartz' estimates to the term involving  $\nabla_x \psi$  (see for example [60], [46] and references therein or the proof of the well-posedness of the Schrödinger-Wave system that we performed in Appendix C):

$$\begin{aligned} \|\nabla_x \psi\|_{L_x^2 L_t^\infty \dot{H}_z^s} &\leq c^{-s+\frac{n}{2}} K(\bar{p}', \bar{q}') \left( c^{s-\frac{n}{2}} \|\nabla_x \psi_0\|_{L_x^2 \dot{H}_z^s} \right. \\ &\quad \left. + c^{(s-1)-\frac{n}{2}} \|\nabla_x \chi_0\|_{L_x^2 \dot{H}_z^{s-1}} + c^{-\frac{n}{2}} \|\nabla_x \chi_0\|_{L_x^2 \dot{H}_z^{s-1}} + c^{-\frac{n}{2}} \|\nabla_x \chi_0\|_{L_x^2 \dot{H}_z^{s-1}} \right), \quad (4.43) \end{aligned}$$

where the exponent pair  $(\bar{q}, \bar{p})$  is such that  $2 \leq \bar{q} \leq +\infty$ ,  $2 \leq \bar{p} < +\infty$ ,  $(\bar{q}, \bar{p}, n) \neq (2, \infty, 3)$  and has to satisfy the following two relations

$$\frac{1}{\bar{q}} + \frac{n-1}{2\bar{p}} \leq \frac{n-1}{4} \quad \text{and} \quad \frac{1}{\bar{q}} + \frac{n}{\bar{p}} = \frac{n}{2} + s - 1.$$

Note that here, since we want to study the asymptotic regime  $c \rightarrow +\infty$  we make explicitly appear how Strichartz' estimates depend on the wave speed  $c$  (it can be obtained by a simple scaling argument). The range of possible values for  $\bar{p}$  is  $\bar{p} \in [2n/(n-2), 2n/(n-3)]$ . For these value of  $\bar{p}$ , the exponent  $\bar{q}$  takes its values in  $[2, +\infty]$  except in the case  $n = 3$  where the limiting case  $\bar{p} = +\infty$  and  $\bar{q} = 2$  is not allowed. Applying (4.43) with  $s = 0$  leads to

$$\|\nabla_x \psi\|_{L_x^2 L_t^\infty L_z^2} \lesssim \|\nabla_x \psi_0\|_{L_x^2 L_z^2} + c^{-1} \|\nabla_x \chi_0\|_{L_x^2 \dot{H}_z^{-1}} + c^{\frac{n}{2} - \frac{n}{\bar{p}'} + 2} \|\sigma_2 \nabla_x \sigma_1 \star |u|^2\|_{L_x^2 L_t^{\bar{q}'} L_z^{\bar{p}'}}$$

where

$$\frac{n}{2} - \frac{n}{\bar{p}'} + 2 = \frac{1}{\bar{q}'}$$

Since  $\bar{q} \in [2, +\infty]$  implies  $\bar{q}' \in [1, 2]$  we get for every  $\bar{q}' \in [1, 2]$  (in the case  $n = 3$  the value  $\bar{q}' = 2$  is excluded since  $\bar{q} = 2$  is not allowed)

$$\|\nabla_x \psi\|_{L_x^2 L_t^\infty L_z^2} \lesssim \|\nabla_x \psi_0\|_{L_x^2 L_z^2} + c^{-1} \|\nabla_x \chi_0\|_{L_x^2 \dot{H}_z^{-1}} + c^{\frac{1}{\bar{q}'}} \|\sigma_2 \nabla_x \sigma_1 \star |u|^2\|_{L_x^2 L_t^{\bar{q}'} L_z^{\bar{p}'}}.$$

Then, standard inequalities lead to

$$\begin{aligned} \|\sigma_2 \nabla_x \sigma_1 \star |u|^2\|_{L_x^2 L_t^{\bar{q}'} L_z^{\bar{p}'}} &\leq \|\sigma_2\|_{L_z^{\bar{p}'}} \|\nabla_x \sigma_1 \star |u|^2\|_{L_x^2 L_t^{\bar{q}'}} \\ &\leq |T|^{\frac{1}{\bar{q}'}} \|\sigma_2\|_{L_z^{\bar{p}'}} \left( \sup_{0 \leq t \leq T} \|\nabla_x \sigma_1 \star |u(t)|^2\|_{L_x^2} \right) \leq |T|^{\frac{1}{\bar{q}'}} \|\sigma_2\|_{L_z^{\bar{p}'}} \|\nabla_x \sigma_1\|_{L_x^2} \left( \sup_{0 \leq t \leq T} \| |u(t)|^2 \|_{L_x^1} \right) \\ &\leq |T|^{\frac{1}{\bar{q}'}} \|\sigma_2\|_{L_z^{\bar{p}'}} \|\nabla_x \sigma_1\|_{L_x^2} M. \end{aligned}$$

and we eventually obtain

$$\sup_{0 \leq t \leq T} |f(t)| \lesssim \frac{1}{c} \left( \|\nabla_x \psi_0\|_{L_x^2 L_z^2} + c^{-1} \|\nabla_x \chi_0\|_{L_x^2 \dot{H}_z^{-1}} + |cT|^{\frac{1}{\bar{q}'}} M \right) \left( \sup_{0 \leq t \leq T} \frac{1}{c} \|\chi(t)\|_{L_x^2 L_z^2} \right).$$

Coming back to (4.42) and applying the previous estimate with  $\alpha = \bar{q}'$  and  $T = T_f$  conclude the proof.  $\blacksquare$

Let us now give the proof of Theorem 4.2.11. As before, for the sake of simplicity we only consider the case

$$(u_0(x), \psi_0(x, z), \chi_0(x, z)) = \left( Q(x) e^{i \frac{p_0}{M} \cdot x}, \Psi(x, z), 0 \right), \quad (4.44)$$

where  $|p_0|$  might be arbitrarily large. The general case can be obtained by straightforward modifications. The following simple relation will give us several useful information and is the key which will allow us to adapt the proof of Theorem 4.2.9: if

$$v(t, x) = u(t, x) e^{-i \frac{p(t)}{M} \cdot x}$$

where  $p(t) = \text{Im} \int \nabla_x u(t) \overline{u(t)} dx$  denotes the momentum of  $u(t)$  and  $M = \|u(t)\|_{L_x^2}^2$  its mass, then

$$\int |\nabla_x v(t)|^2 dx = \int |\nabla_x u(t)|^2 dx - \frac{|p(t)|^2}{M}.$$

As a consequence we get

$$W\left(u(t) e^{-i \frac{p(t)}{M} \cdot x}, \psi(t), \chi(t)\right) = W(u(t), \psi(t), \chi(t)) - \frac{|p(t)|^2}{2M},$$

end then, thanks to the mass and energy conservation and since  $(Q, \Psi)$  is a minimizer of the energy under the mass constraint  $\|Q\|_{L_x^2}^2 = M$ , we have the relation

$$\begin{aligned} 0 &\leq W\left(u(t)e^{-i\frac{p(t)}{M}\cdot x}, \psi(t), \chi(t)\right) - W(Q, \Psi, 0) \\ &= W\left(u_0e^{-i\frac{p_0}{M}\cdot x}, \psi_0, \chi_0\right) - W(Q, \Psi, 0) + \frac{|p_0|^2 - |p(t)|^2}{M}. \end{aligned} \quad (4.45)$$

**Remark 4.6.3** Relation 4.45 gives us for free that the momentum of the function  $u(t)$  is uniformly bounded in time

$$|p(t)|^2 \leq |p_0|^2 + M \left( W(u_0e^{-i\frac{p_0}{M}\cdot x}, \psi_0, \chi_0) - W(Q, \Psi, 0) \right).$$

In the particular case of an initial data of the form (4.44), this estimate becomes  $|p(t)| \leq |p_0|$ .

We have now all the required materials in order to adapt the proof of Theorem 4.2.9.

**Proof of Theorem 4.2.11.** Let us assume that the function  $x(t)$  and  $\gamma(t)$  are well defined on a time interval  $[0, T]$  (where  $T \geq 0$  might be equal to 0). In particular, on this time interval the orthogonality conditions (4.32a)–(4.32b) are satisfied and

$$\|v(t) - Q, \psi(t, \cdot + x(t)) - \Psi\|_{\mathcal{H}}^2 + \frac{1}{c^2} \|\chi(t)\|_{L_x^2 L_z^2}^2 \leq \varepsilon^2.$$

Then, thanks to the continuity of  $u(t)$ ,  $\psi(t)$ ,  $\chi(t)$  and  $p(t)$  there exists a larger time  $T^* > T$ , such that for every  $t \in [T, T^*]$

$$\left\| u(t, \cdot + x(T))e^{-i\frac{p(t)}{M}\cdot(x+x(T))}e^{-i\gamma(T)} - Q, \psi(t, \cdot + x(T)) - \Psi \right\|_{\mathcal{H}}^2 + \frac{1}{c^2} \|\chi(t)\|_{L_x^2 L_z^2}^2 \leq 4\varepsilon^2.$$

This estimation implies that

$$\frac{1}{c} \|\chi(t)\|_{L_x^2 L_z^2} \leq 2\varepsilon$$

is of order  $\varepsilon$  on this larger time interval. Moreover, as in the proof of Theorem 4.2.9, it implies that the implicit function theorem can be applied in order to extend continuously the modulation parameters  $x(t)$  and  $\gamma(t)$  on  $[T, T^*]$  in a way that the orthogonality conditions (4.32a)–(4.32b) still hold on it. Let us now prove that for every  $t \in [T, T^*]$  we get

$$\|v(t) - Q, \psi(t, \cdot + x(t)) - \Psi\|_{\mathcal{H}}^2 + \frac{1}{c^2} \|\chi(t)\|_{L_x^2 L_z^2}^2 \leq \varepsilon^2.$$

Thanks to (4.45) and in the particular case where  $(u_0, \psi_0, \chi_0) = (Qe^{i\frac{p_0}{M}\cdot x}, \Psi, 0)$  we get

$$0 \leq W\left(u(t)e^{-i\frac{p(t)}{M}\cdot x}, \psi(t), \chi(t)\right) - W(Q, \Psi, 0) = \frac{|p_0|^2 - |p(t)|^2}{M}.$$

Then, since we already know that  $\|\chi(t)\|_{L_x^2 L_z^2}/c$  is of order  $\varepsilon$  on the time interval  $[T, T^*]$ , Lemma 4.6.1 (applied with  $\epsilon = \varepsilon^2$ ) implies that as long as  $T^* \leq T_f$ ,

$$W\left(u(t)e^{-i\frac{p(t)}{M}\cdot x}, \psi(t), \chi(t)\right) - W(Q, \Psi, 0) \lesssim \varepsilon^3.$$

On the other hand, the invariance by change of phase and translation of  $W$  coupled with

the relation (4.25) and the coercivity results of Lemmas 4.2.4 and 4.2.8 leads to

$$\begin{aligned} & \mu \|\operatorname{Im} u^\varepsilon(t)\|_{H_x^1}^2 + \bar{\nu} \|\operatorname{Re} u^\varepsilon(t), \psi^\varepsilon(t)\|_{\mathcal{H}}^2 + \frac{1}{2c^2} \|\chi(t)\|_{L_x^2 L_z^2}^2 \\ & \leq W\left(u(t)e^{-i\frac{p(t)}{M}\cdot x}, \psi(t), \chi(t)\right) - W(Q, \Psi, 0) + \frac{1}{\mu} \left| \langle \operatorname{Im} u^\varepsilon(t), Q \rangle_{H_x^1} \right|^2 + \frac{1}{\bar{\nu}} \left| \langle \operatorname{Re} u^\varepsilon(t), Q \rangle_{L_x^2} \right|^2 \\ & \quad + \frac{1}{\bar{\nu}} \sum_{j=1}^d \left| \langle \operatorname{Re} u^\varepsilon(t), \partial_{x_j} Q \rangle_{L_x^2} \right|^2 - \int \left( \sigma_1 \star \int \sigma_2 \psi^\varepsilon(t) dz \right) |u^\varepsilon(t)|^2 dx, \end{aligned}$$

where

$$u^\varepsilon(t) = v(t) - Q \quad \text{and} \quad \psi^\varepsilon(t, x, z) = \psi(t, x + x(t), z) - \Psi(x, z).$$

Eventually, thanks to the orthogonality conditions (4.32a)–(4.32b) we get

$$\begin{aligned} & \mu \|\operatorname{Im} u^\varepsilon(t)\|_{H_x^1}^2 + \bar{\nu} \|\operatorname{Re} u^\varepsilon(t), \psi^\varepsilon(t)\|_{\mathcal{H}}^2 + \frac{1}{2c^2} \|\chi(t)\|_{L_x^2 L_z^2}^2 \\ & \lesssim \varepsilon^3 + \left| \langle \operatorname{Re} u^\varepsilon(t), Q \rangle_{L_x^2} \right|^2 + \left| \int \left( \sigma_1 \star \int \sigma_2 \psi^\varepsilon(t) dz \right) |u^\varepsilon(t)|^2 dx \right| \end{aligned}$$

where the condition  $\|u_0\|_{L_x^2} = \|Q\|_{L_x^2}$  implies that  $\langle \operatorname{Re} u^\varepsilon, Q \rangle_{L_x^2}$  is of order  $\varepsilon^2$  and where the term  $|\int (\sigma_1 \star \int \sigma_2 \psi^\varepsilon dz) |u^\varepsilon|^2 dx|$  is of order  $\varepsilon^3$ . Making explicitly appear the constant  $C > 0$  in front of the previous inequality and using the extra  $\varepsilon$ -factor in order to get

$$\frac{C\varepsilon(2 + \varepsilon)}{\min(\mu, \bar{\nu}, \frac{1}{2})} \leq 1$$

when  $\varepsilon \leq \varepsilon_0$  leads to the require conclusion. We finish the proof with a classical argument on connected space which insures that this conclusion is true on any time interval  $[0, T^*]$  such that  $T^* \leq T_f$ .  $\blacksquare$

## 4.7 Coercivity of $\mathcal{L}_+$ : proof of Lemma 4.2.8

This section is dedicated to the proof of Lemma 4.2.8, which is a key ingredient of the proof of Theorem 4.2.9. The kernel of  $\mathcal{L}_+$  can be identified by using Lemma 4.2.5. Indeed, since  $(f, \psi)^t \in \operatorname{Ker}(\mathcal{L}_+)$  implies

$$-\frac{1}{2} \Delta_z \psi + \sigma_2 (\sigma_1 \star Q f) = 0,$$

we can express  $\psi$  in term of  $f$  as follows:  $\psi = 2\Gamma(\sigma_1 \star Q f)$ . Moreover the relation

$$\mathcal{L}_+ \begin{pmatrix} f \\ 2\Gamma(\sigma_1 \star Q f) \end{pmatrix} = \begin{pmatrix} L_+ f \\ 0 \end{pmatrix} \quad (4.46)$$

allows us to identify the kernel of  $\mathcal{L}_+$  to the kernel of  $L_+$ : we eventually get

$$\operatorname{Ker}(\mathcal{L}_+) = \operatorname{Span}\{(\partial_{x_j} Q, \partial_{x_j} \Psi)^t, j = 1, \dots, d\}.$$

In order to prove the coercivity relations (4.29), we need the following two lemmas.

**Lemma 4.7.1** *For every  $(f, \psi) \in \mathcal{H}$  such that  $\langle f, Q \rangle_{L_x^2} = 0$ , we have*

$$\left\langle \mathcal{L}_+ \begin{pmatrix} f \\ \psi \end{pmatrix}, \begin{pmatrix} f \\ \psi \end{pmatrix} \right\rangle_{L_x^2 \times L_x^2 L_z^2} \geq 0.$$

Moreover, since  $\operatorname{Ker}(\mathcal{L}_+) = \{(\partial_{x_j} Q, \partial_{x_j} \Psi)^t, j = 1, \dots, d\}$  and  $\langle \partial_{x_j} Q, Q \rangle_{L_x^2} = 0$ , we know that this inequality cannot be strict.

**Lemma 4.7.2** *Let  $(f_\nu, \psi_\nu)_{\nu \in \mathbb{N}}$  be a bounded sequence of  $\mathcal{H}$  which converges weakly to  $(\bar{f}, \bar{\psi})$  in  $\mathcal{H}$ . Then, up to a sub-sequence if needed, we have the following two convergences:*

$$\int_{\mathbb{R}^d} \left( \sigma_1 \star \int_{\mathbb{R}^n} \sigma_2 \Psi dz \right) |f_\nu|^2 dx \xrightarrow{\nu \rightarrow +\infty} \int_{\mathbb{R}^d} \left( \sigma_1 \star \int_{\mathbb{R}^n} \sigma_2 \Psi dz \right) |\bar{f}|^2 dx \quad (4.47)$$

and

$$\int_{\mathbb{R}^d} \left( \sigma_1 \star \int_{\mathbb{R}^n} \sigma_2 \psi_\nu dz \right) Q f_\nu dx \xrightarrow{\nu \rightarrow +\infty} \int_{\mathbb{R}^d} \left( \sigma_1 \star \int_{\mathbb{R}^n} \sigma_2 \bar{\psi} dz \right) Q \bar{f} dx. \quad (4.48)$$

**Proof of Lemma 4.7.1.** Let  $f$  be a real valued function of  $H_x^1$  such that  $\langle f, Q \rangle_{L_x^2} = 0$ , let  $\psi$  be a function of  $L_x^2 \dot{H}_z^1$  and let  $u$  be the function defined on  $\mathbb{R}$  by

$$u(s) = \frac{\|Q\|_{L_x^2}}{\|Q + sf\|_{L_x^2}} (Q + sf).$$

One can check that  $u(s)$  is a real valued function of  $H_x^1$  and  $\|u(s)\|_{L_x^2} = \|Q\|_{L_x^2}$  for every  $s \in \mathbb{R}$ ,  $u$  is smooth,  $u(0) = Q$  and

$$u'(0) = f - \frac{\langle f, Q \rangle_{L_x^2}}{\|Q\|_{L_x^2}^2} Q = f.$$

Since  $(Q, \Psi, 0)$  is a minimizer of  $J_M$ , we know that for every  $s \in \mathbb{R}$ ,  $W(Q, \Psi, 0) \leq W(u(s), \Psi + s\psi, 0)$ . Moreover (4.25) leads to

$$\begin{aligned} 0 \leq W(u(s), \Psi + s\psi, 0) - W(Q, \Psi, 0) &= \left\langle \mathcal{L}_+ \begin{pmatrix} u(s) - Q \\ s\psi \end{pmatrix}, \begin{pmatrix} u(s) - Q \\ s\psi \end{pmatrix} \right\rangle_{L_x^2 \times L_x^2 L_z^2} \\ &\quad + \int_{\mathbb{R}^d} \left( \sigma_1 \star \int_{\mathbb{R}^n} \sigma_2 s\psi dz \right) |u(s) - Q|^2 dx. \end{aligned}$$

Since  $u(s) - Q = u(s) - u(0) = sf + o(s)$  (when  $s$  goes to 0), we eventually obtain

$$0 \leq s^2 \left\langle \mathcal{L}_+ \begin{pmatrix} f \\ \psi \end{pmatrix}, \begin{pmatrix} f \\ \psi \end{pmatrix} \right\rangle_{L_x^2 \times L_x^2 L_z^2} + o(s^2),$$

which concludes the proof. ■

**Proof of Lemma 4.7.2.** The proof uses in several places a basic result of integration theory, consequence of Egoroff's theorem [100, Proposition 3.9]: if a sequence  $(g_\nu)_{\nu \in \mathbb{N}} \subset L^p(\mathbb{R}^d)$  converges weakly to some  $\bar{g}$  in  $L^p(\mathbb{R}^d)$  where  $1 \leq p < +\infty$  and if this sequence converges also a.e. to some  $g$ , then  $\bar{g} = g$ .

Here, the sequence  $(f_\nu)_{\nu \in \mathbb{N}}$  is bounded in  $H^1(\mathbb{R}^d)$  and the compact embedding  $H^1(\Omega) \rightarrow L^2(\Omega)$  which holds for any bounded open set  $\Omega \subset \mathbb{R}^d$  implies that, up to a sub-sequence,  $(f_\nu)_{\nu \in \mathbb{N}}$  converges strongly to  $\bar{f}$  in  $L^2(\Omega)$  and thus converges, up to a further sub-sequence, a.e. in  $\Omega$  to  $\bar{f}$ . A diagonal argument yields the a.e. convergence of  $(f_\nu)_{\nu \in \mathbb{N}}$  to  $\bar{f}$  in  $\mathbb{R}^d$ . Moreover, by using the homogeneous Sobolev embedding in dimension  $d = 3$ , the boundedness of  $(f_\nu)_{\nu \in \mathbb{N}}$  in  $H_x^1$  implies its boundedness in  $L_x^2$  and  $L_x^6$  and, by interpolation, in any  $L_x^p$  with  $2 \leq p \leq 6$ . Consequently, the sequence  $(|f_\nu|^2)_{\nu \in \mathbb{N}}$  is bounded in  $L_x^3$  and, up to a sub-sequence, converges weakly in  $L_x^3$  to some  $g$ . Since this sequence converges also a.e. to  $|f|^2$ , we have indeed  $g = |f|^2$ .

To prove (4.47) we proceed as follows. Since  $\Psi = \Gamma \sigma_1 \star Q^2$  with  $Q$  lying in the Schwartz

class, the weak convergence of  $(|f_\nu|^2)_{\nu \in \mathbb{N}}$  to  $|f|^2$  in  $L_x^3$  yields

$$\begin{aligned} \int \left( \sigma_1 \star \int \sigma_2 \Psi \, dz \right) |f_\nu|^2 \, dx &= -\kappa \int \left( \Sigma \star Q^2 \right) |f_\nu|^2 \, dx \\ &\xrightarrow{\nu \rightarrow +\infty} -\kappa \int \left( \Sigma \star Q^2 \right) |\bar{f}|^2 \, dx = \int \left( \sigma_1 \star \int \sigma_2 \Psi \, dz \right) |\bar{f}|^2 \, dx. \end{aligned}$$

We turn to (4.48). We split

$$\begin{aligned} \int \left( \sigma_1 \star \int \sigma_2 \psi_\nu \, dz \right) Q f_\nu \, dx &= \iint \sigma_2 (\sigma_1 \star Q f_\nu) \psi_\nu \, dx \, dz \\ &= \iint \sigma_2 (\sigma_1 \star Q (f_\nu - \bar{f})) \psi_\nu \, dx \, dz + \iint \sigma_2 (\sigma_1 \star Q \bar{f}) \psi_\nu \, dx \, dz. \end{aligned}$$

The weak convergence of  $(\psi_\nu)_{\nu \in \mathbb{N}}$  to  $\bar{\psi}$  in  $L_x^2 \dot{H}_z^1$  (note that  $\sigma_2$  smooth and  $n \geq 3$  imply  $\sigma_2 \in \dot{H}_z^{-1}$ ) directly implies that the second term of the right hand side converges to  $\int (\sigma_1 \star \int \sigma_2 \bar{\psi} \, dz) Q \bar{f} \, dx$ . It only remains to prove that the first term of the right hand side converges to 0. To this end, we are going to show that  $(Q f_\nu)_{\nu \in \mathbb{N}}$  converges strongly to  $Q \bar{f}$  in  $L_x^{3/2}$ . Indeed,  $(|f_\nu|^{3/2})_{\nu \in \mathbb{N}}$  is bounded in  $L_x^2$  and, up to a sub-sequence it converges weakly to  $g = |\bar{f}|^{3/2}$  in  $L_x^2$ . Since  $Q^{3/2} \in L_x^2$ , we get  $\|Q f_\nu\|_{L_x^{3/2}} \rightarrow \|Q \bar{f}\|_{L_x^{3/2}}$  as  $\nu \rightarrow \infty$ . Moreover the sequence  $(Q f_\nu)_{\nu \in \mathbb{N}}$  is also bounded in  $L_x^{3/2}$  and, up to a further sub-sequence if needed, it converges weakly to  $Q \bar{f}$  in  $L_x^{3/2}$ . Thus we get the announced strong convergence. We combine this strong convergence with the boundedness of  $(\psi_\nu)_{\nu \in \mathbb{N}}$  in  $L_x^2 \dot{H}_z^1$  and we conclude as follows:

$$\begin{aligned} \left| \iint \sigma_2 (\sigma_1 \star Q (f_\nu - \bar{f})) \psi_\nu \, dx \, dz \right| &\leq \|\sigma_2\|_{L_x^{2n/(n+2)}} \|\psi_\nu\|_{L_x^2 \dot{H}_z^1} \|\sigma_1 \star Q (f_\nu - \bar{f})\|_{L_x^2} \\ &\leq \|\sigma_2\|_{L_x^{2n/(n+2)}} \|\psi_\nu\|_{L_x^2 \dot{H}_z^1} \|\sigma_1\|_{L_x^{6/5}} \|Q f_\nu - Q \bar{f}\|_{L_x^{3/2}} \xrightarrow{\nu \rightarrow +\infty} 0. \end{aligned}$$

■

We are now able to prove the coercivity relation (4.29).

**Proof of (4.29).** We argue by contradiction, assuming the existence of a sequence of positive numbers  $(\tilde{\nu}_k)_{k \in \mathbb{N}}$  which converges to 0 and the existence of a sequence  $(f_k, \psi_k)_{k \in \mathbb{N}}$  in  $\mathcal{H}$  such that for every  $k$ ,

$$\left\langle \mathcal{L}_+ \begin{pmatrix} f_k \\ \psi_k \end{pmatrix}, \begin{pmatrix} f_k \\ \psi_k \end{pmatrix} \right\rangle_{L_x^2 \times L_x^2 L_z^2} < \tilde{\nu}_k \|f_k, \psi_k\|_{\mathcal{H}}^2 - \frac{1}{\tilde{\nu}_k} \left( \left| \langle f_k, Q \rangle_{L_x^2} \right|^2 + \sum_{j=1}^d \left| \langle f_k, \partial_{x_j} Q \rangle_{L_x^2} \right|^2 \right). \quad (4.49)$$

We can assume that  $\|(f_k, \psi_k)\|_{\mathcal{H}} = 1$  and thus, that there exists  $\bar{f} \in H_x^1$  and  $\bar{\psi} \in L_x^2 \dot{H}_z^1$  such that  $(f_k)_{k \in \mathbb{N}}$  converges weakly to  $\bar{f}$  in  $H_x^1$  and  $(\psi_k)_{k \in \mathbb{N}}$  converges weakly to  $\bar{\psi}$  in  $L_x^2 \dot{H}_z^1$ . On the one hand, thanks to the weak convergence of  $(f_k)_{k \in \mathbb{N}}$ , we get

$$\langle f_k, Q \rangle_{L_x^2} \xrightarrow{k \rightarrow +\infty} \langle \bar{f}, Q \rangle_{L_x^2} \quad \text{and} \quad \langle f_k, \partial_{x_j} Q \rangle_{L_x^2} \xrightarrow{k \rightarrow +\infty} \langle \bar{f}, \partial_{x_j} Q \rangle_{L_x^2},$$

while on the other hand (4.49) implies

$$0 \leq \left| \langle f_k, Q \rangle_{L_x^2} \right|^2 + \sum_{j=1}^d \left| \langle f_k, \partial_{x_j} Q \rangle_{L_x^2} \right|^2 < \tilde{\nu}_k^2 - \tilde{\nu}_k \left\langle \mathcal{L}_+ \begin{pmatrix} f_k \\ \psi_k \end{pmatrix}, \begin{pmatrix} f_k \\ \psi_k \end{pmatrix} \right\rangle_{L_x^2 \times L_x^2 L_z^2} \xrightarrow{k \rightarrow +\infty} 0,$$

bearing in mind that  $\langle \mathcal{L}_+ h, h \rangle \leq K \|h\|_{\mathcal{H}}^2$ . We eventually obtain  $\langle \bar{f}, Q \rangle_{L_x^2} = 0$  and  $\langle \bar{f}, \partial_{x_j} Q \rangle_{L_x^2} = 0$ . Knowing that  $\bar{f}$  is orthogonal to  $Q$ , we can apply Lemma 4.7.1 in order to

obtain

$$\left\langle \mathcal{L}_+ \begin{pmatrix} \bar{f} \\ \bar{\psi} \end{pmatrix}, \begin{pmatrix} \bar{f} \\ \bar{\psi} \end{pmatrix} \right\rangle_{L_x^2 \times L_x^2 L_z^2} \geq 0.$$

On the other hand, the relation

$$\begin{aligned} \left\langle \mathcal{L}_+ \begin{pmatrix} f_k \\ \psi_k \end{pmatrix}, \begin{pmatrix} f_k \\ \psi_k \end{pmatrix} \right\rangle_{L_x^2 \times L_x^2 L_z^2} &= \frac{1}{2} \|\nabla_x f_k\|_{L_x^2}^2 + \omega \|f_k\|_{L_x^2}^2 + \int (\sigma_1 \star \int \sigma_2 \Psi \, dz) |f_k|^2 \, dx \\ &\quad + 2 \int (\sigma_1 \star \int \sigma_2 \psi_k \, dz) Q f_k \, dx + \frac{1}{2} \|\nabla_z \psi_k\|_{L_x^2 L_z^2}^2, \end{aligned}$$

coupled with Lemma 4.7.2 and (4.49) leads to

$$\begin{aligned} &\left\langle \mathcal{L}_+ \begin{pmatrix} \bar{f} \\ \bar{\psi} \end{pmatrix}, \begin{pmatrix} \bar{f} \\ \bar{\psi} \end{pmatrix} \right\rangle_{L_x^2 \times L_x^2 L_z^2} \\ &\leq \liminf_{k \rightarrow +\infty} \left\langle \mathcal{L}_+ \begin{pmatrix} f_k \\ \psi_k \end{pmatrix}, \begin{pmatrix} f_k \\ \psi_k \end{pmatrix} \right\rangle_{L_x^2 \times L_x^2 L_z^2} \leq \limsup_{k \rightarrow +\infty} \left\langle \mathcal{L}_+ \begin{pmatrix} f_k \\ \psi_k \end{pmatrix}, \begin{pmatrix} f_k \\ \psi_k \end{pmatrix} \right\rangle_{L_x^2 \times L_x^2 L_z^2} \\ &\leq \limsup_{k \rightarrow +\infty} \left\{ \frac{1}{\bar{\nu}_k} \left( |\langle f_k, Q \rangle_{L_x^2}|^2 + \sum_{j=1}^d |\langle f_k, \partial_{x_j} Q \rangle_{L_x^2}|^2 \right) + \left\langle \mathcal{L}_+ \begin{pmatrix} f_k \\ \psi_k \end{pmatrix}, \begin{pmatrix} f_k \\ \psi_k \end{pmatrix} \right\rangle_{L_x^2 \times L_x^2 L_z^2} \right\} \\ &\leq \limsup_{k \rightarrow +\infty} \bar{\nu}_k = 0. \end{aligned}$$

We eventually deduce

$$\lim_{k \rightarrow +\infty} \left\langle \mathcal{L}_+ \begin{pmatrix} f_k \\ \psi_k \end{pmatrix}, \begin{pmatrix} f_k \\ \psi_k \end{pmatrix} \right\rangle_{L_x^2 \times L_x^2 L_z^2} = \left\langle \mathcal{L}_+ \begin{pmatrix} \bar{f} \\ \bar{\psi} \end{pmatrix}, \begin{pmatrix} \bar{f} \\ \bar{\psi} \end{pmatrix} \right\rangle_{L_x^2 \times L_x^2 L_z^2} = 0 \quad (4.50)$$

and thus  $(\bar{f}, \bar{\psi})$  is a minimizer of

$$\inf_{\langle f, Q \rangle_{L_x^2} = 0} \left\langle \mathcal{L}_+ \begin{pmatrix} f \\ \psi \end{pmatrix}, \begin{pmatrix} f \\ \psi \end{pmatrix} \right\rangle_{L_x^2 \times L_x^2 L_z^2}. \quad (4.51)$$

We can now conclude as follows. First of all, the relation (4.50) coupled with Lemma 4.7.2 leads to the norm convergence

$$\frac{1}{2} \|\nabla_x f_k\|_{L_x^2}^2 + \omega \|f_k\|_{L_x^2}^2 + \frac{1}{2} \|\psi_k\|_{L_x^2 \dot{H}_z^1}^2 \xrightarrow{k \rightarrow +\infty} \frac{1}{2} \|\nabla_x \bar{f}\|_{L_x^2}^2 + \omega \|\bar{f}\|_{L_x^2}^2 + \frac{1}{2} \|\bar{\psi}\|_{L_x^2 \dot{H}_z^1}^2.$$

It implies the strong convergence of  $(f_k, \psi_k)_{k \in \mathbb{N}}$  to  $(\bar{f}, \bar{\psi})$  in  $\mathcal{H}$ . In particular we know that  $\|(\bar{f}, \bar{\psi})\|_{\mathcal{H}} = 1$ . Second of all,  $(\bar{f}, \bar{\psi})$  is a minimizer of (4.51) and the Euler Lagrange relation insures the existence of a real number  $\lambda$  such that

$$\mathcal{L}_+ \begin{pmatrix} \bar{f} \\ \bar{\psi} \end{pmatrix} = \lambda \begin{pmatrix} Q \\ 0 \end{pmatrix}.$$

The second component of this vectorial relation leads to  $\bar{\psi} = 2\Gamma(\sigma_1 \star Q \bar{f})$ . From this relation we obtain the contradiction as follows: owing to (4.46), Lemma 4.2.5 and since  $\bar{f}$  is orthogonal to  $Q$  and  $\partial_{x_j} Q$ , we get

$$\begin{aligned} 0 &= \left\langle \mathcal{L}_+ \begin{pmatrix} \bar{f} \\ \bar{\psi} \end{pmatrix}, \begin{pmatrix} \bar{f} \\ \bar{\psi} \end{pmatrix} \right\rangle_{L_x^2 \times L_x^2 L_z^2} = \left\langle \begin{pmatrix} L_+ \bar{f} \\ 0 \end{pmatrix}, \begin{pmatrix} \bar{f} \\ \bar{\psi} \end{pmatrix} \right\rangle_{L_x^2 \times L_x^2 L_z^2} \\ &= \langle L_+ \bar{f}, \bar{f} \rangle_{L_x^2} \geq \nu \|\bar{f}\|_{H_x^1}^2 - \frac{1}{\nu} \left( |\langle \bar{f}, Q \rangle_{L_x^2}|^2 + \sum_{j=1}^d |\langle \bar{f}, \partial_{x_j} Q \rangle_{L_x^2}|^2 \right) = \nu \|\bar{f}\|_{H_x^1}^2. \end{aligned}$$

Thus  $(\bar{f}, \bar{\psi}) = (0, 0)$ , which contradicts  $\|\bar{f}, \bar{\psi}\|_{\mathcal{H}} = 1$ .  $\blacksquare$

## 4.8 Perturbation analysis: proof of Proposition 4.2.14

In this section, since there is no ambiguity, we will use the following shorthand notations, see Definition 4.2.13,  $H^\varepsilon = H^{\Sigma^\varepsilon}$ ,  $K_M^\varepsilon = K_M^{\Sigma^\varepsilon}$ ,  $L_+^\varepsilon = L_+(\Sigma^\varepsilon, Q^\varepsilon)$ ,  $H^0 = H^{\Sigma^0}$ ,  $K_M^0 = K_M^{\Sigma^0}$  and  $L_+^0 = L_+(\Sigma^0, Q^0)$ . Before proving Proposition 4.2.14 let us check that  $\sup(M_0^\varepsilon) < +\infty$ . We remind the reader that the sequence of ground states  $(Q^\varepsilon)_{\varepsilon>0}$  is well defined only if this supremum is finite.

**Lemma 4.8.1** *Let (H4) be fulfilled. For every  $M > 0$  there exists  $\varepsilon_0 > 0$  such that for every  $\varepsilon \in (0, \varepsilon_0)$ ,  $M_0^\varepsilon < M$ .*

**Proof.** We start by showing that for every  $u \in H_x^1$ ,

$$H^\varepsilon(u) \xrightarrow{\varepsilon \rightarrow 0} H^0(u).$$

Indeed, thanks to the Cauchy-Schwarz inequality we have

$$\left| H^\varepsilon(u) - H^0(u) \right| = \left| \int |u|^2 \star (\Sigma^\varepsilon - \Sigma^0)(x) |u|^2(x) dx \right| \leq \| |u|^2 \star (\Sigma^\varepsilon - \Sigma^0) \|_{L_x^\infty} \|u\|_{L_x^2}^2,$$

and thanks to the homogeneous Sobolev embedding in dimension  $d = 3$  we get

$$\begin{aligned} \| |u|^2 \star (\Sigma^\varepsilon - \Sigma^0) \|_{L_x^\infty} &\leq \| (\Sigma^\varepsilon - \Sigma^0) \mathbf{1}_{|x| \leq R} \|_{L_x^{3/2}} \| |u|^2 \|_{L_x^3} + \| (\Sigma^\varepsilon - \Sigma^0) \mathbf{1}_{|x| > R} \|_{L_x^\infty} \| |u|^2 \|_{L_x^1} \\ &\leq C \| (\Sigma^\varepsilon - \Sigma^0) \mathbf{1}_{|x| \leq R} \|_{L_x^{3/2}} \| \nabla_x u \|_{L_x^2}^2 + \| (\Sigma^\varepsilon - \Sigma^0) \mathbf{1}_{|x| > R} \|_{L_x^\infty} \|u\|_{L_x^2}^2. \end{aligned}$$

Thus, assumption (4.33) leads to the required convergence. We conclude as follows. By using the results of E. Lieb in [70] we know that  $K_M^0 < 0$  is achieved at a unique positive and radially symmetric function  $Q^0$ . Then  $H^\varepsilon(Q^0) \rightarrow H^0(Q^0) = K_M^0 < 0$  implies  $K_M^\varepsilon < 0$  as soon as  $\varepsilon$  is sufficiently small. Eventually Lemma 4.3.1-(e) and (f) allows us to conclude.  $\blacksquare$

We turn to the proof of Proposition 4.2.14.

**Proof of (i) Convergence.** *Step 1.* We prove that for every  $u \in H_x^1$  and for every  $\delta, R > 0$ , there exists  $\varepsilon_0 > 0$  such that for every  $0 < \varepsilon < \varepsilon_0$ ,

$$H^\varepsilon(u) \geq \frac{1}{2} \|\nabla_x u\|_{L_x^2}^2 - \frac{\kappa C}{2} (\delta + cR) \|u\|_{L_x^2}^2 \|\nabla_x u\|_{L_x^2}^2 - \frac{\kappa}{2} \left( \delta + \frac{1}{R} \right) \|u\|_{L_x^2}^4 \quad (4.52)$$

where  $C$  denotes the best constant in the homogeneous Sobolev embedding in dimension  $d = 3$  and  $c > 0$  is a constant. Since

$$\begin{aligned} H^\varepsilon(u) &= \frac{1}{2} \|\nabla_x u\|_{L_x^2}^2 - \frac{\kappa}{2} \iint |u|^2(x) \Sigma^\varepsilon(x-y) |u|^2(y) dx dy \\ &\geq \frac{1}{2} \|\nabla_x u\|_{L_x^2}^2 - \frac{\kappa}{2} \left| \iint |u|^2(x) \Sigma^\varepsilon(x-y) |u|^2(y) dx dy \right| \end{aligned}$$

we only have to estimate the last term of the right hand side. Again, we use the Cauchy-



Schwarz inequality and the homogeneous Sobolev embedding and we obtain

$$\begin{aligned} \left| \iint |u|^2(x) \Sigma^\varepsilon(x-y) |u|^2(y) \, dx \, dy \right| &\leq C \|\Sigma^\varepsilon \mathbf{1}_{|x| \leq R}\|_{L_x^{3/2}} \|u\|_{L_x^2}^2 \|\nabla_x u\|_{L_x^2}^2 + \|\Sigma^\varepsilon \mathbf{1}_{|x| > R}\|_{L_x^\infty} \|u\|_{L_x^2}^4 \\ &\leq C \left( \|(\Sigma^\varepsilon - \Sigma^0) \mathbf{1}_{|x| \leq R}\|_{L_x^{3/2}} + \|\Sigma^0 \mathbf{1}_{|x| \leq R}\|_{L_x^{3/2}} \right) \|u\|_{L_x^2}^2 \|\nabla_x u\|_{L_x^2}^2 \\ &\quad + \left( \|(\Sigma^\varepsilon - \Sigma^0) \mathbf{1}_{|x| > R}\|_{L_x^\infty} + \|\Sigma^0 \mathbf{1}_{|x| > R}\|_{L_x^\infty} \right) \|u\|_{L_x^2}^4. \end{aligned}$$

The quantities  $\|\Sigma^0 \mathbf{1}_{|x| \leq R}\|_{L_x^{3/2}}$  and  $\|\Sigma^0 \mathbf{1}_{|x| > R}\|_{L_x^\infty}$  can be evaluated explicitly. Combined with the convergence (4.33), it allows us to obtain (4.52) for every  $\delta > 0$  provided  $\varepsilon > 0$  is sufficiently small.

*Step 2.* Estimate (4.52) has two consequences: firstly, the sequence  $(Q^\varepsilon)_{\varepsilon > 0}$  is bounded in  $H_x^1$  and, secondly, the sequence  $(K_M^\varepsilon)_{\varepsilon > 0}$  is bounded from below (at least for  $\varepsilon > 0$  sufficiently small) by  $-\kappa(\delta + 1/R)M^2/2$ . Indeed we already know that  $\|Q^\varepsilon\|_{L_x^2}^2 = M$  and for  $\delta + cR > 0$  sufficiently small (that means  $\varepsilon > 0$  is also sufficiently small), we have  $\kappa C(\delta + cR)M/2 \leq 1/4$ . Hence, (4.52) with  $u = Q^\varepsilon$  becomes

$$H^\varepsilon(Q^\varepsilon) \geq \frac{1}{4} \|\nabla_x Q^\varepsilon\|_{L_x^2}^2 - \frac{\kappa}{2} \left( \delta + \frac{1}{R} \right) M^2.$$

Since  $H^\varepsilon(Q^\varepsilon) = K_M^\varepsilon < 0$  is negative for every  $\varepsilon > 0$  we eventually deduce that  $\|\nabla_x Q^\varepsilon\|_{L_x^2}$  is bounded. Moreover, it is clear that the sequence  $(K_M^\varepsilon)_{\varepsilon > 0}$  is bounded from below by  $-\kappa(\delta + 1/R)M^2/2$ , as soon as  $\varepsilon > 0$  is sufficiently small.

Therefore, we know that  $(Q^\varepsilon)_{\varepsilon > 0}$  is bounded in  $H_x^1$ , and we also know the existence of two constant  $a, A > 0$  such that for every  $\varepsilon > 0$  sufficiently small,  $-A \leq J_M^\varepsilon \leq -a$  (the existence of  $a$  comes from the proof of Lemma 4.8.1 where we proved that  $K_M^\varepsilon \leq H^\varepsilon(Q^0) \rightarrow H^0(Q^0) = K_M^0 < 0$ ). Moreover, since  $Q^\varepsilon$  is a solution of (4.19) with  $\Sigma = \Sigma^\varepsilon$  and  $\omega = \omega^\varepsilon$ , by multiplying this equation by  $Q^\varepsilon$  and integrating over  $\mathbb{R}^3$  we get

$$\omega^\varepsilon M = -\frac{1}{2} \|\nabla_x Q^\varepsilon\|_{L_x^2}^2 + \kappa \iint |Q^\varepsilon|^2(x) \Sigma^\varepsilon(x-y) |Q^\varepsilon|^2(y) \, dx \, dy.$$

In turn, the sequence  $(\omega^\varepsilon)_{\varepsilon > 0}$  is bounded:

$$\begin{aligned} 0 < \frac{a}{M} \leq \omega^\varepsilon &= -\frac{K_M^\varepsilon}{M} + \frac{\kappa}{2M} \iint |Q^\varepsilon|^2(x) \Sigma^\varepsilon(x-y) |Q^\varepsilon|^2(y) \, dx \, dy \\ &\leq \frac{A}{M} + \frac{\kappa C}{2M} (\delta + cR) \|Q^\varepsilon\|_{L_x^2}^2 \|\nabla_x Q^\varepsilon\|_{L_x^2}^2 + \frac{\kappa}{2M} \left( \delta + \frac{1}{R} \right) \|Q^\varepsilon\|_{L_x^2}^4. \end{aligned}$$

There exists  $\tilde{Q} \in H_x^1$  and  $\tilde{\omega} > 0$  such that, up to a subsequence,  $(Q^\varepsilon)_{\varepsilon > 0}$  converges weakly to  $\tilde{Q}$  in  $H_x^1$  and  $(\omega^\varepsilon)_{\varepsilon > 0}$  converges to  $\tilde{\omega}$ . Since the functions  $Q^\varepsilon$  are positive and radially symmetric, we also know that  $\tilde{Q}$  is positive and radially symmetric, and  $(Q^\varepsilon)_{\varepsilon > 0}$  converges strongly to  $\tilde{Q}$  in  $L_x^p$  for  $2 < p < 6$ , see [72, 98] for such compactness statements based on symmetry properties.

*Step 3.* We are going to prove that  $\tilde{Q} = Q^0$  and  $\tilde{\omega} = \omega^0$ . To this end, it is sufficient to prove that  $\tilde{Q}$  is a solution of the Choquard equation (4.19) with  $\Sigma = \Sigma^0$ ,  $\omega = \tilde{\omega}$  and  $\|\tilde{Q}\|_{L_x^2}^2 = M$ . Indeed, we know that the Choquard equation with  $\Sigma = \Sigma^0$  admits a unique positive, radially symmetric solution for  $\omega = 1$  (see for instance [70] or [68]). This result can be extended by a scaling argument for every  $\omega > 0$ . Hence, we can justify the following assertion: if two positive and radially symmetric solutions  $Q_1$  and  $Q_2$  of (4.19) with  $\Sigma = \Sigma^0$ ,  $\omega = \omega_1$  and  $\omega = \omega_2$  have the same mass, then  $Q_1 = Q_2$  and  $\lambda_1 = \lambda_2$ .

For every  $\varepsilon > 0$  and for every  $\varphi \in C_c^\infty(\mathbb{R}_x^3)$ , we have

$$\frac{1}{2} \int \nabla_x Q^\varepsilon \cdot \nabla_x \varphi \, dx + \omega^\varepsilon \int Q^\varepsilon \varphi \, dx - \kappa \iint Q^\varepsilon \varphi(x) \Sigma^\varepsilon(x-y) |Q^\varepsilon|^2(y) \, dx \, dy = 0.$$

It is obvious that the first two terms converge respectively to  $(\int \nabla_x \tilde{Q} \cdot \nabla_x \varphi \, dx)/2$  and  $\tilde{\omega} \int \tilde{Q} \varphi \, dx$  (note that for the second term we use the fact that  $\|Q^\varepsilon\|_{L_x^2}$  is bounded with respect to  $\varepsilon$ ). Let us now show that the third term converges to  $-\kappa \iint \tilde{Q} \varphi(x) \Sigma^0(x-y) |\tilde{Q}|^2(y) \, dx \, dy$ . For that purpose we decompose the difference as follows

$$\left| \iint Q^\varepsilon \varphi(x) \Sigma^\varepsilon(x-y) |Q^\varepsilon|^2(y) \, dx \, dy - \iint \tilde{Q} \varphi(x) \Sigma^0(x-y) |\tilde{Q}|^2(y) \, dx \, dy \right| \leq I_1 + I_2 + I_3,$$

where

$$I_1 = \left| \iint Q^\varepsilon \varphi(x) \left( \Sigma^\varepsilon(x-y) - \Sigma^0(x-y) \right) |Q^\varepsilon|^2(y) \, dx \, dy \right|,$$

$$I_2 = \left| \iint \left( Q^\varepsilon(x) - \tilde{Q}(x) \right) \varphi(x) \Sigma^0(x-y) |Q^\varepsilon|^2(y) \, dx \, dy \right|,$$

$$I_3 = \left| \iint \tilde{Q} \varphi(x) \Sigma^0(x-y) \left( |Q^\varepsilon|^2 - |\tilde{Q}|^2 \right) (y) \, dx \, dy \right|.$$

The convergence of  $I_1$  follows from the boundedness of  $(Q^\varepsilon)_{\varepsilon>0}$  in  $H_x^1$  together with the convergence (4.33):

$$\begin{aligned} I_1 &\leq \|Q^\varepsilon \varphi\|_{L_x^1} \|(\Sigma^\varepsilon - \Sigma^0) \star |Q^\varepsilon|^2\|_{L_x^\infty} \\ &\leq \|Q^\varepsilon\|_{L_x^2} \|\varphi\|_{L_x^2} \left( C \|(\Sigma^\varepsilon - \Sigma^0) \mathbf{1}_{|x| \leq R}\|_{L_x^{3/2}} \|\nabla_x Q^\varepsilon\|_{L_x^2}^2 + \|(\Sigma^\varepsilon - \Sigma^0) \mathbf{1}_{|x| > R}\|_{L_x^\infty} \|Q^\varepsilon\|_{L_x^2}^2 \right). \end{aligned}$$

The boundedness of  $(Q^\varepsilon)_{\varepsilon>0}$  in  $L_x^2$  and the strong convergence of  $Q^\varepsilon$  to  $\tilde{Q}$  in  $L_x^p$  for  $2 < p < 8$  with  $p = 4$  and  $p = 8/3$  imply the convergence of  $I_2$  (we use that  $\Sigma^0 \mathbf{1}_{|x| \leq R}$  lies in  $L_x^q$  for  $1 \leq q < 3$  and  $\Sigma^0 \mathbf{1}_{|x| > R}$  lies in  $L_x^q$  for  $q > 3$ ):

$$\begin{aligned} I_2 &\leq \|\Sigma^0 \star (Q^\varepsilon - \tilde{Q}) \varphi\|_{L_x^\infty} \|Q^\varepsilon\|_{L_x^2}^2 \\ &\leq \left( \|\Sigma^0 \mathbf{1}_{|x| \leq R}\|_{L_x^2} \|(Q^\varepsilon - \tilde{Q}) \varphi\|_{L_x^2} + \|\Sigma^0 \mathbf{1}_{|x| > R}\|_{L_x^4} \|(Q^\varepsilon - \tilde{Q}) \varphi\|_{L_x^{4/3}} \right) \|Q^\varepsilon\|_{L_x^2}^2 \\ &\leq \left( \|\Sigma^0 \mathbf{1}_{|x| \leq R}\|_{L_x^2} \|Q^\varepsilon - \tilde{Q}\|_{L_x^4} \|\varphi\|_{L_x^4} + \|\Sigma^0 \mathbf{1}_{|x| > R}\|_{L_x^4} \|Q^\varepsilon - \tilde{Q}\|_{L_x^{8/3}} \|\varphi\|_{L_x^{8/3}} \right) \|Q^\varepsilon\|_{L_x^2}^2. \end{aligned}$$

For the last term we use almost the same strategy than for  $I_2$ . We write

$$\begin{aligned} I_3 &\leq \|\tilde{Q} \varphi\|_{L_x^1} \|\Sigma^0 \star (|Q^\varepsilon|^2 - |\tilde{Q}|^2)\|_{L_x^\infty} \\ &\leq \|\tilde{Q}\|_{L_x^2} \|\varphi\|_{L_x^2} \left( \|\Sigma^0 \mathbf{1}_{|x| \leq R}\|_{L_x^2} \||Q^\varepsilon|^2 - |\tilde{Q}|^2\|_{L_x^2} + \|\Sigma^0 \mathbf{1}_{|x| > R}\|_{L_x^4} \||Q^\varepsilon|^2 - |\tilde{Q}|^2\|_{L_x^{4/3}} \right). \end{aligned}$$

Since  $|Q^\varepsilon|^2 - |\tilde{Q}|^2 = |Q^\varepsilon - \tilde{Q}|^2 + 2(Q^\varepsilon - \tilde{Q})\tilde{Q}$  we eventually obtain

$$\begin{aligned} \||Q^\varepsilon|^2 - |\tilde{Q}|^2\|_{L_x^2} &\leq \||Q^\varepsilon - \tilde{Q}|^2\|_{L_x^2} + 2\|(Q^\varepsilon - \tilde{Q})\tilde{Q}\|_{L_x^2} \\ &\leq \|Q^\varepsilon - \tilde{Q}\|_{L_x^4}^2 + 2\|Q^\varepsilon - \tilde{Q}\|_{L_x^4} \|\tilde{Q}\|_{L_x^4} \end{aligned}$$

and

$$\begin{aligned} \||Q^\varepsilon|^2 - |\tilde{Q}|^2\|_{L_x^{4/3}} &\leq \||Q^\varepsilon - \tilde{Q}|^2\|_{L_x^{4/3}} + 2\|(Q^\varepsilon - \tilde{Q})\tilde{Q}\|_{L_x^{4/3}} \\ &\leq \|Q^\varepsilon - \tilde{Q}\|_{L_x^{8/3}}^2 + 2\|Q^\varepsilon - \tilde{Q}\|_{L_x^{8/3}} \|\tilde{Q}\|_{L_x^{8/3}}. \end{aligned}$$

These convergences allow us to obtain that  $\tilde{Q}$  is a solution of (4.19) with  $\Sigma = \Sigma^0$  and  $\omega = \tilde{\omega}$ . It only remains to prove that  $\|\tilde{Q}\|_{L_x^2}^2 = M$ : the weak- $L_x^2$  convergence of  $Q^\varepsilon$  already implies  $\|\tilde{Q}\|_{L_x^2}^2 \leq M$ .

We multiply by  $Q^\varepsilon$  the Choquard equation satisfied by  $Q^\varepsilon$  and we integrate over  $\mathbb{R}_x^3$ ; it yields

$$-\omega^\varepsilon M = \frac{1}{2} \|\nabla_x Q^\varepsilon\|_{L_x^2}^2 - \kappa \iint |Q^\varepsilon|^2(x) \Sigma^\varepsilon(x-y) |Q^\varepsilon|^2(y) dx dy.$$

Taking  $\liminf_{\varepsilon \rightarrow 0}$  leads to

$$-\tilde{\omega} M \geq \frac{1}{2} \|\nabla_x \tilde{Q}\|_{L_x^2}^2 - \kappa \limsup_{\varepsilon \rightarrow 0} \iint |Q^\varepsilon|^2(x) \Sigma^\varepsilon(x-y) |Q^\varepsilon|^2(y) dx dy.$$

We justify as before that the last term converges to  $\iint |\tilde{Q}|^2(x) \Sigma^0(x-y) |\tilde{Q}|^2(y) dx dy$ . Since  $\tilde{Q}$  is a solution of (4.19) with  $\Sigma = \Sigma^0$  and  $\omega = \tilde{\omega}$  we obtain

$$-\tilde{\omega} M \geq \frac{1}{2} \|\nabla_x \tilde{Q}\|_{L_x^2}^2 - \kappa \iint |\tilde{Q}|^2(x) \Sigma^0(x-y) |\tilde{Q}|^2(y) dx dy = -\tilde{\omega} \|\tilde{Q}\|_{L_x^2}^2.$$

Since  $\tilde{\omega} > 0$ , we eventually obtain  $M \leq \|\tilde{Q}\|_{L_x^2}^2$  and thus  $\tilde{Q} = Q^0$  and  $\tilde{\omega} = \omega^0$ .

*Step 5.* In order to conclude the proof it only remains to justify that the weak convergence of (a sub-sequence of)  $(Q^\varepsilon)_{\varepsilon > 0}$  to  $Q^0$  in  $H_x^1$  actually holds strongly (then, thanks to the uniqueness of  $Q^0$ , one can extend this convergence to the entire sequence). We already know that  $\|Q^0\|_{L_x^2}^2 = M = \|Q^\varepsilon\|_{L_x^2}^2$ , which implies the strong convergence of  $(Q^\varepsilon)_{\varepsilon > 0}$  in  $L_x^2$ . We turn to the strong convergence of  $(\nabla_x Q^\varepsilon)_{\varepsilon > 0}$  in  $L_x^2$ . Thanks to the end of the previous step we have

$$\lim_{\varepsilon \rightarrow 0} \|\nabla_x Q^\varepsilon\|_{L_x^2}^2 = 2 \left( -\omega^0 M + \kappa \iint |Q^0|^2(x) \Sigma^0(x-y) |Q^0|^2(y) dx dy \right) = \|\nabla_x Q^0\|_{L_x^2}^2,$$

which finishes the proof.  $\blacksquare$

**Proof of (ii) Coercivity.** We fix  $\varepsilon > 0$  and we consider a positive and radially symmetric minimizer  $Q^\varepsilon$  of  $K_M^\varepsilon$ . Proposition 4.2.5 gives

$$\langle L_+^0 f, f \rangle_{L_x^2} \geq \nu^0 \|f\|_{H_x^1}^2 - \frac{1}{\nu^0} \left( \left| \langle f, Q^0 \rangle_{L_x^2} \right|^2 + \sum_{j=1}^d \left| \langle f, \partial_{x_j} Q^0 \rangle_{L_x^2} \right|^2 \right).$$

Next, we compute  $\langle L_+^\varepsilon f, f \rangle$  as follows:

$$\begin{aligned} \langle L_+^\varepsilon f, f \rangle_{L_x^2} &= \langle L_+^0 f, f \rangle_{L_x^2} + \langle (L_+^\varepsilon - L_+^0) f, f \rangle_{L_x^2} \\ &\geq \nu^0 \|f\|_{H_x^1}^2 - \frac{1}{\nu^0} \left( \left| \langle f, Q^0 \rangle_{L_x^2} \right|^2 + \sum_{j=1}^d \left| \langle f, \partial_{x_j} Q^0 \rangle_{L_x^2} \right|^2 \right) - \left| \langle (L_+^\varepsilon - L_+^0) f, f \rangle_{L_x^2} \right| \\ &\geq \nu^0 \|f\|_{H_x^1}^2 - \frac{1}{\nu^0} \left( \left| \langle f, Q^\varepsilon \rangle_{L_x^2} \right|^2 + \sum_{j=1}^d \left| \langle f, \partial_{x_j} Q^\varepsilon \rangle_{L_x^2} \right|^2 \right) - \frac{1}{\nu^0} R^\varepsilon - \left| \langle (L_+^\varepsilon - L_+^0) f, f \rangle_{L_x^2} \right|, \end{aligned}$$

where

$$\begin{aligned} R^\varepsilon &= \left| \langle f, Q^0 - Q^\varepsilon \rangle_{L_x^2} \right|^2 + \sum_{j=1}^d \left| \langle f, \partial_{x_j} Q^0 - \partial_{x_j} Q^\varepsilon \rangle_{L_x^2} \right|^2 \\ &\quad + 2 \left| \langle f, Q^0 - Q^\varepsilon \rangle_{L_x^2} \right| \left| \langle f, Q^\varepsilon \rangle_{L_x^2} \right| + 2 \sum_{j=1}^d \left| \langle f, \partial_{x_j} Q^0 - \partial_{x_j} Q^\varepsilon \rangle_{L_x^2} \right| \left| \langle f, \partial_{x_j} Q^\varepsilon \rangle_{L_x^2} \right|. \end{aligned}$$

Then we infer the following estimate:  $R^\varepsilon \leq \alpha(Q^\varepsilon)\|f\|_{H_x^1}^2$  where  $\alpha(Q) > 0$  and  $\alpha(Q) \rightarrow 0$  when  $\|Q - Q^0\|_{H_x^1} \rightarrow 0$ . Moreover

$$\begin{aligned} \langle (L_+^\varepsilon - L_+^0)f, f \rangle_{L_x^2} &= (\omega^\varepsilon - \omega^0) \|f\|_{L_x^2}^2 - \kappa \int (\Sigma^\varepsilon \star |Q^\varepsilon|^2 - \Sigma^0 \star |Q^0|^2) |f|^2 dx \\ &\quad - 2\kappa \iint (Q^\varepsilon f(x)\Sigma^\varepsilon(x-y)Q^\varepsilon f(y) - Q^0 f(x)\Sigma^0(x-y)Q^0 f(y)) dx dy, \end{aligned}$$

and from this expression we can obtain (thanks to a similar reasoning than in the proof of point (i)) the following estimate

$$\left| \langle (L_+^\varepsilon - L_+^0)f, f \rangle_{L_x^2} \right| \leq \beta(\Sigma^\varepsilon, Q^\varepsilon, \omega^\varepsilon) \|f\|_{H_x^1}^2,$$

where  $\beta(\Sigma, Q, \omega) > 0$  and  $\beta(\Sigma, Q, \omega) \rightarrow 0$  when

$$\|(\Sigma - \Sigma^0)\mathbf{1}_{|x| \leq R}\|_{L_x^{3/2}} + \|(\Sigma - \Sigma^0)\mathbf{1}_{|x| > R}\|_{L_x^\infty} + \|Q - Q^0\|_{H_x^1} + |\omega - \omega^0| \rightarrow 0.$$

This assertion applies for any  $R > 0$ ; here  $R$  is fixed once for all (not necessarily small as in the proof of convergence). Gathering these two estimates leads to

$$\begin{aligned} \langle L_+^\varepsilon f, f \rangle_{L_x^2} &\geq \left( \nu^0 - \frac{\alpha(Q^\varepsilon)}{\nu^0} - \beta(\Sigma^\varepsilon, Q^\varepsilon, \omega^\varepsilon) \right) \|f\|_{H_x^1}^2 \\ &\quad - \frac{1}{\nu^0} \left( \left| \langle f, Q^\varepsilon \rangle_{L_x^2} \right|^2 + \sum_{j=1}^d \left| \langle f, \partial_{x_j} Q^\varepsilon \rangle_{L_x^2} \right|^2 \right). \end{aligned}$$

The announced coercivity property holds for the ground state  $Q^\varepsilon$  provided

$$\frac{\alpha(Q^\varepsilon)}{\nu^0} + \beta(\Sigma^\varepsilon, Q^\varepsilon, \omega^\varepsilon) < \nu^0. \quad (4.53)$$

Since  $\alpha(Q)$  and  $\beta(\Sigma, Q, \omega)$  converge to zero when

$$\|(\Sigma - \Sigma^0)\mathbf{1}_{|x| \leq R}\|_{L_x^{3/2}} + \|(\Sigma - \Sigma^0)\mathbf{1}_{|x| > R}\|_{L_x^\infty} + \|Q - Q^0\|_{H_x^1} + |\omega - \omega^0| \rightarrow 0,$$

there exists  $\delta > 0$  such that

$$\|(\Sigma - \Sigma^0)\mathbf{1}_{|x| \leq R}\|_{L_x^{3/2}} + \|(\Sigma - \Sigma^0)\mathbf{1}_{|x| > R}\|_{L_x^\infty} + \|Q - Q^0\|_{H_x^1} + |\omega - \omega^0| < \delta$$

implies (4.53). Thanks to **(H4)** we can find  $\bar{\varepsilon}_0 > 0$  such that for every  $\varepsilon \in (0, \bar{\varepsilon}_0)$ ,

$$\|(\Sigma - \Sigma^0)\mathbf{1}_{|x| \leq R}\|_{L_x^{3/2}} + \|(\Sigma - \Sigma^0)\mathbf{1}_{|x| > R}\|_{L_x^\infty} < \frac{\delta}{2}.$$

Therefore, possibly by choosing a smaller  $\bar{\varepsilon}_0$  if necessary, for every  $\varepsilon \in (0, \bar{\varepsilon}_0)$  and every positive and radially symmetric minimizer  $Q^\varepsilon$  of  $K_M^\varepsilon$ , we get

$$\|Q^\varepsilon - Q^0\|_{H_x^1} + |\omega^\varepsilon - \omega^0| < \frac{\delta}{2}.$$

We argue by contradiction to justify this. If it were not the case then there exists a sequence  $\varepsilon_k \rightarrow 0$  and a sequence of positive and radially symmetric minimizer  $(Q^{\varepsilon_k})_{k \in \mathbb{N}}$  such that for every  $k$ ,

$$\|Q^{\varepsilon_k} - Q^0\|_{H_x^1} + |\omega^{\varepsilon_k} - \omega^0| \geq \frac{\delta}{2}.$$

However we can apply point (i) to this sequence which insures that

$$\|Q^{\varepsilon_k} - Q^0\|_{H_x^1} + |\omega^{\varepsilon_k} - \omega^0| \xrightarrow[k \rightarrow +\infty]{} 0,$$

a contradiction. ■

## 4.9 Admissible form functions: proof of Proposition 4.2.7

The general strategy relies on the application of Proposition 4.2.14; hence we have to construct a sequence of potentials  $(\Sigma^\varepsilon)_{\varepsilon>0}$ , with the specific form  $\Sigma^\varepsilon = \sigma_1^\varepsilon \star \sigma_1^\varepsilon$ , which converges to  $\Sigma^0$  in the sense of (4.33). This requires some care beyond the classical “regularization and truncature” approach. A similar difficulty arises, but in a different manner, when justifying the asymptotic regime of the Vlasov-Wave system (4.6a), (4.7) towards the Vlasov-Poisson equation [25]. The following simple examples are quite illuminating on the strategy.

**Toy example 1.** Let  $\chi : \mathbb{R}^d \rightarrow [0, 1]$  be a  $C_c^\infty$  function which satisfies  $\chi(x) = 1$  for  $|x| \leq 1$  and  $\chi(x) = 0$  for  $|x| \geq 2$ . Let

$$\Sigma^\varepsilon(x) = \frac{\chi(\varepsilon x)}{|x|}.$$

The analysis of this kernel is simple: due to the scale invariance of  $\frac{1}{|x|}$ , we have

$$\Sigma^\varepsilon(x) = \varepsilon \frac{\chi(\varepsilon x)}{|\varepsilon x|} = \varepsilon \Sigma^1(\varepsilon x).$$

As a matter of fact, we have

- i)  $H^{\Sigma^\varepsilon}(u) = \varepsilon^3 H^{\Sigma^1}(u^\varepsilon)$  where  $u^\varepsilon(x) = \varepsilon^{-2} u(\varepsilon^{-1}x)$ ,
- ii)  $Q^\varepsilon$  is a minimizer of  $K_M^{\Sigma^\varepsilon} \iff Q(x) = \varepsilon^{-2} Q^\varepsilon(\varepsilon^{-1}x)$  is a minimizer of  $K_{\varepsilon^{-1}M}^{\Sigma^1}$ ,
- iii)  $K_M^{\Sigma^\varepsilon} = \varepsilon^3 K_{\varepsilon^{-1}M}^{\Sigma^1}$ ,
- iv) if  $Q^\varepsilon$  is a minimizer of  $K_M^{\Sigma^\varepsilon}$ , then  $\omega(\Sigma^\varepsilon, Q^\varepsilon) = \varepsilon^2 \omega(\Sigma^1, Q)$  where  $Q(x) = \varepsilon^{-2} Q^\varepsilon(\varepsilon^{-1}x)$ ,
- v)  $\langle L_+(\Sigma^\varepsilon, Q^\varepsilon) f^\varepsilon, f^\varepsilon \rangle_{L_x^2} = \varepsilon^3 \langle L_+(\Sigma^1, Q) f, f \rangle_{L_x^2}$  where  $f(x) = \varepsilon^{-2} f^\varepsilon(\varepsilon^{-1}x)$  and still  $Q(x) = \varepsilon^{-2} Q^\varepsilon(\varepsilon^{-1}x)$ .

These relations provide several useful information. For example, since for any fixed  $\varepsilon > 0$ ,  $\Sigma^\varepsilon$  lies in  $L_x^{3/2}$ , Lemma 4.3.1 applies and justifies the existence of the mass threshold  $M_0^{\Sigma^\varepsilon}$ , which, in turn, can be expressed by means of  $M_0^{\Sigma^1}$ :  $M_0^{\Sigma^\varepsilon} = \varepsilon M_0^{\Sigma^1} \rightarrow 0$ . Furthermore,  $\Sigma^\varepsilon$  converges to  $\Sigma^0$  in the sense of (4.33), and the conclusions of Proposition 4.2.14 hold. Then, relation v) allows us to extend the coercivity estimate to any radially symmetric minimizer of  $K_m^{\Sigma^1}$  associated to a mass  $m$  larger than  $M/\varepsilon_0$ , as illustrated by Fig. 4.2. Indeed ii), v) and Proposition 4.2.14-(ii) yield

$$\begin{aligned} \langle L_+(\Sigma^1, Q) f, f \rangle_{L_x^2} &= \varepsilon^{-3} \langle L_+(\Sigma^\varepsilon, Q^\varepsilon) f^\varepsilon, f^\varepsilon \rangle_{L_x^2} \\ &\geq \varepsilon^{-3} \nu^\varepsilon \|f^\varepsilon\|_{H_x^1}^2 - \frac{\varepsilon^{-3}}{\nu^0} \left( \left| \langle f^\varepsilon, Q^\varepsilon \rangle_{L_x^2} \right|^2 + \sum_{j=1}^3 \left| \langle f^\varepsilon, \partial_{x_j} Q^\varepsilon \rangle_{L_x^2} \right|^2 \right) \\ &= \nu^\varepsilon \|\nabla_x f\|_{L_x^2}^2 + \varepsilon^{-2} \nu^\varepsilon \|f\|_{L_x^2}^2 - \frac{1}{\nu^0} \left( \varepsilon^{-2} \left| \langle f, Q \rangle_{L_x^2} \right|^2 + \varepsilon^{-1} \sum_{j=1}^3 \left| \langle f^\varepsilon, \partial_{x_j} Q^\varepsilon \rangle_{L_x^2} \right|^2 \right) \end{aligned}$$

which implies the announced coercivity property.

This example can be compared to the case of the Yukawa potential seen as a perturbation of the Newtonian potential in [61].

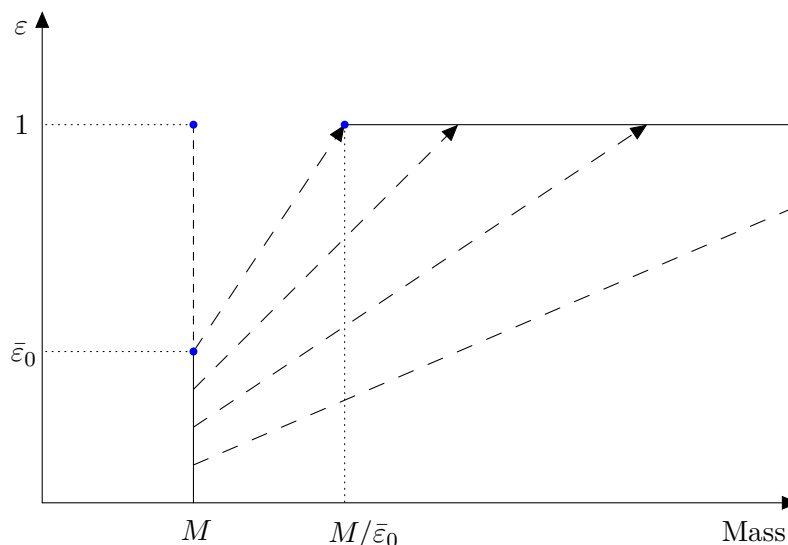

Figure 4.2: Illustration of the strategy: for the given mass  $M$ , the stability of the ground states is proved for the potentials  $\Sigma^\varepsilon$ , with  $0 \leq \varepsilon < \bar{\varepsilon}_0$ . By rescaling, we can go back to the potentials  $\Sigma^1$ , and ground states with a mass larger than  $M/\bar{\varepsilon}_0$  are stable.

**Toy example 2.** Let  $\alpha : \mathbb{R}^d \rightarrow [0, \infty)$  be a  $C^\infty$  function such that  $\int \alpha \, dx = 1$ . We consider

$$\Sigma^\varepsilon(x) = \varepsilon^{-3} \int \frac{\alpha(\varepsilon^{-1}y)}{|x-y|} \, dy.$$

Now, we have the scaling relation:  $\Sigma^\varepsilon(x) = \varepsilon^{-1} \Sigma^1(\varepsilon^{-1}x)$ , where

$$\Sigma^1(x) = \int \frac{\alpha(y)}{|x-y|} \, dy.$$

We deduce that

$$Q^\varepsilon \text{ is a minimizer of } K_M^{\Sigma^\varepsilon} \iff Q(x) = \varepsilon^2 Q^\varepsilon(\varepsilon x) \text{ is a minimizer of } K_{\varepsilon M}^{\Sigma^1}.$$

Reasoning as in the previous example, we obtain that, for  $M$  sufficiently small, every positive and radially symmetric minimizer of  $K_M^{\Sigma^1}$  satisfies the coercivity relation (4.28). In particular there is no mass threshold:  $M_0^{\Sigma^1} = 0$ . Since  $\Sigma^1 \notin L_x^{3/2}$ , this is not a contradiction with Lemma 4.3.1.

**Main strategy.** The two previous examples do not fit with our framework, where we are dealing with smooth and compactly supported potentials  $\Sigma$ . Then, in order to handle such a potential, the idea is (as usual) to combine the truncature and the regularization by setting

$$\Sigma^\varepsilon(x) = \varepsilon^{-3} \chi(\varepsilon x) \int \frac{\alpha(\varepsilon^{-1}y)}{|x-y|} \, dy.$$

However, the scaling for the truncature and for the regularization are not the same, and the properties deduced from the scale invariance of  $\frac{1}{|x|}$  break down. Instead, we consider a doubly indexed sequence of potentials

$$\Sigma^{\lambda,\mu}(x) = \lambda^{-3} \chi(\mu x) \int \frac{\alpha(\lambda^{-1}y)}{|x-y|} \, dy$$

with  $\lambda, \mu > 0$ . We also introduce

$$\tilde{\Sigma}^\epsilon(x) = \epsilon^{-3} \chi(x) \int \frac{\alpha(\epsilon^{-1}y)}{|x-y|} dy.$$

We have the scaling relation  $\Sigma^{\lambda,\mu}(x) = \mu \tilde{\Sigma}^{\lambda\mu}(\mu x)$  which leads to the following lemma.

**Lemma 4.9.1** *The following assertions hold:*

- i)  $H^{\Sigma^{\lambda,\mu}}(u) = \mu^3 H^{\tilde{\Sigma}^\epsilon}(u^\mu)$  where  $u^\mu(x) = \mu^{-2} u(\mu^{-1}x)$  and  $\epsilon = \lambda\mu$ ,
- ii)  $Q^{\lambda,\mu}$  is a minimizer of  $K_M^{\tilde{\Sigma}^{\lambda,\mu}}$   $\iff$   $Q(x) = \mu^{-2} Q^{\lambda,\mu}(\mu^{-1}x)$  is a minimizer of  $K_{\mu^{-1}M}^{\tilde{\Sigma}^\epsilon}$  with  $\epsilon = \lambda\mu$ ,
- iii)  $K_M^{\Sigma^{\lambda,\mu}} = \mu^3 K_{\mu^{-1}M}^{\tilde{\Sigma}^\epsilon}$  with  $\epsilon = \lambda\mu$ ,
- iv) if  $Q^{\lambda,\mu}$  is a minimizer of  $K_M^{\Sigma^{\lambda,\mu}}$ , then  $\omega(\Sigma^{\lambda,\mu}, Q^{\lambda,\mu}) = \mu^2 \omega(\tilde{\Sigma}^\epsilon, Q)$  where  $Q(x) = \mu^{-2} Q^{\lambda,\mu}(\mu^{-1}x)$  and  $\epsilon = \lambda\mu$ ,
- v)  $\langle L_+(\Sigma^{\lambda,\mu}, Q^{\lambda,\mu}) f^{\lambda,\mu}, f^{\lambda,\mu} \rangle_{L_x^2} = \mu^3 \langle L_+(\tilde{\Sigma}^\epsilon, Q) f, f \rangle_{L_x^2}$  where  $Q(x) = \mu^{-2} Q^{\lambda,\mu}(\mu^{-1}x)$ ,  $f(x) = \mu^{-2} f^{\lambda,\mu}(\mu^{-1}x)$  and  $\epsilon = \lambda\mu$ .

Let us suppose for a while that the sequence  $(\Sigma^{\lambda,\mu})_{\lambda,\mu>0}$  converges to  $\Sigma^0$  in the sense of (4.33) as  $\lambda$  and  $\mu$  tend to 0. Then there exists  $\lambda_0 > 0$  and  $\mu_0 > 0$  such that for any  $(\lambda, \mu) \in (0, \lambda_0) \times (0, \mu_0)$ , the conclusions of Proposition 4.2.14 hold. Based on Lemma 4.9.1, we infer the following statement.

**Proposition 4.9.2** (i) *For every  $(\lambda, \mu) \in (0, \lambda_0) \times (0, \mu_0)$  and for every positive and radially symmetric minimizer  $Q$  of  $K_{\mu^{-1}M}^{\tilde{\Sigma}^\epsilon}$  with  $\epsilon = \lambda\mu$ , the operator  $L_+(\tilde{\Sigma}^\epsilon, Q)$  satisfies Lemma 4.2.5.*

(ii) *In particular, for  $\epsilon \in (0, \lambda_0 \mu_0)$  fixed, applying (i) to any  $(\lambda, \mu) \in (0, \lambda_0) \times (0, \mu_0)$  such that  $\lambda\mu = \epsilon$  implies that for any  $m \in (\mu_0^{-1}M, \lambda_0 \epsilon^{-1}M)$  and any positive and radially symmetric minimizer  $Q$  of  $K_m^{\tilde{\Sigma}^\epsilon}$ , the operator  $L_+(\tilde{\Sigma}^\epsilon, Q)$  satisfies Lemma 4.2.5.*

Item (ii) implies, up to the fact that  $\tilde{\Sigma}^\epsilon$  can be cast under the form  $\tilde{\Sigma}^\epsilon = \tilde{\sigma}_1^\epsilon \star \tilde{\sigma}_1^\epsilon$ , that the set of admissible form function  $\mathcal{A}$  is non empty. Then, to conclude the proof it only remains to slightly adapt the previous construction in order to obtain a sequence  $\Sigma^{\lambda,\mu}$  satisfying **(H4)**. We proceed as follows. Let  $\alpha, \chi$  be two  $C_c^\infty(\mathbb{R}^3)$ , non negative, radially symmetric, compactly supported and non increasing functions, with  $\chi(x) = 1$  in a neighborhood of the origin. Let us set

$$\sigma_1^{\lambda,\mu}(x) = \lambda^{-3} \int_{\mathbb{R}^3} \alpha(\lambda^{-1}y) \frac{\chi(\mu[x-y])}{|x-y|^2} dy = \alpha^\lambda \star \left( \frac{\chi^\mu}{|\cdot|^2} \right)(x) \quad \text{and} \quad \Sigma^{\lambda,\mu} = \sigma_1^{\lambda,\mu} \star \sigma_1^{\lambda,\mu},$$

where

$$\alpha^\lambda(x) = \lambda^{-3} \alpha(\lambda^{-1}x) \quad \text{and} \quad \chi^\mu(x) = \chi(\mu x).$$

Then each  $\sigma_1^{\lambda,\mu}$  satisfies **(H2)**–**(H3)**. Moreover we can check that

$$\sigma_1^{\lambda,\mu}(x) = \mu^2 \tilde{\sigma}_1^{\lambda\mu}(\mu x), \quad \Sigma^{\lambda,\mu}(x) = \mu \tilde{\Sigma}^{\lambda\mu}(\mu x),$$

where

$$\tilde{\sigma}_1^\epsilon(x) = \int \alpha^\epsilon(x-y) \frac{\chi(y)}{|y|^2} dy, \quad \tilde{\Sigma}^\epsilon = \tilde{\sigma}_1^\epsilon \star \tilde{\sigma}_1^\epsilon.$$

Then Lemma 4.9.1 applies to this new sequence as well and Proposition 4.9.2 holds provided we can show that it converges to  $\Sigma^0$  in the sense of (4.33). Such a form function appeared in [25]. The construction is based on the following two observations:

$$\frac{1}{|\cdot|^2} \star \frac{1}{|\cdot|^2}(x) = \frac{C}{|x|} = C \Sigma^0(x) \quad \text{where } C = \int_{\mathbb{R}^3} \frac{dy}{|y|^2 |e_1 - y|^2}$$

( $e_1$  being the first vector of the canonical basis), and

$$\Sigma^{\lambda,\mu} = (\alpha^\lambda \star \alpha^\lambda) \star \left( \frac{\chi^\mu}{|\cdot|^2} \star \frac{\chi^\mu}{|\cdot|^2} \right).$$

Then, at least formally,  $\alpha^\lambda \star \alpha^\lambda \rightarrow (\int \alpha \star \alpha dx) \delta_0$  when  $\lambda \rightarrow 0$  and  $(\chi^\mu/|\cdot|^2) \star (\chi^\mu/|\cdot|^2) \rightarrow (1/|\cdot|^2) \star (1/|\cdot|^2) = C \Sigma^0$  when  $\mu \rightarrow 0$  and we can expect that  $\Sigma^{\lambda,\mu}$  looks like  $\Sigma^0$  when  $\lambda, \mu \rightarrow 0$  provided  $\int \alpha dx = 1/\sqrt{C}$ . The intuition is confirmed by the following claim.

**Lemma 4.9.3** *If  $\int \alpha dx = 1/\sqrt{C}$ , then the sequence  $(\Sigma^{\lambda,\mu})_{\lambda,\mu>0}$  converges to  $\Sigma^0$  in the sense of (4.33) when  $(\lambda, \mu) \rightarrow (0, 0)$ .*

This approach allows us to construct a large class of admissible form functions, not necessarily close de  $\Sigma^0$  in the sense of (4.33), by using suitable rescalings that preserve the coercivity estimate as we did with the toy example 1. Indeed, for any  $\alpha$  and  $\chi$  defined as before, if the form function  $\sigma_1 = \alpha \star (\chi/|\cdot|^2)$  is not in  $\mathcal{A}$  we know, at least that up to rescaling  $\alpha$  into  $\alpha^\epsilon(x) = \epsilon^{-3} \alpha(\epsilon^{-1}x)$ , that the form functions  $\tilde{\sigma}_1^\epsilon = \alpha^\epsilon \star (\chi/|\cdot|^2)$  belong to  $\mathcal{A}$  provided  $\epsilon$  is sufficiently small. With the previous notation the non empty mass interval  $I$  associated to the form function  $\tilde{\sigma}_1^\epsilon$  is given by  $I = (\mu_0^{-1}M, \lambda_0 \epsilon^{-1}M)$ . It is also possible to rescale  $\chi$  into  $\chi^\epsilon(x) = \chi(\epsilon x)$  and obtain that form functions  $\check{\sigma}_1^\epsilon = \alpha \star (\chi^\epsilon/|\cdot|^2)$  equally belong to  $\mathcal{A}$  provided  $\epsilon$  is sufficiently small (this second example uses the scaling relation  $\sigma_1^{\lambda,\mu}(x) = \lambda^{-2} \check{\sigma}_1^{\lambda\mu}(\lambda^{-1}x)$ ). Moreover given an admissible function  $\sigma_1$ , we observe that  $\sigma_1^{\lambda,\mu}(x) = \lambda \sigma_1(\mu x)$  is admissible too. We obtain this way form functions with arbitrary support size and  $L_x^\infty$ -norm, which are non negative, non increasing, radially symmetric and concentrated around the origin. Such form functions are physically meaningful in the framework defined in [16]. Since they are simply derived by rescaling, we can check that the necessary coercivity estimate still holds, with constants that keep track of the rescaling, and they also provide stable ground states.

**Proof of Lemma 4.9.3.** Let  $0 < R < \infty$  be fixed once for all. We decompose the difference  $\Sigma^{\lambda,\mu} - \Sigma^0$  as follows

$$\begin{aligned} \Sigma^{\lambda,\mu}(x) - \Sigma^0(x) &= (\alpha^\lambda \star \alpha^\lambda) \star \left( \frac{\chi^\mu}{|\cdot|^2} \star \frac{\chi^\mu}{|\cdot|^2} - \frac{1}{|\cdot|^2} \star \frac{1}{|\cdot|^2} \right)(x) \\ &\quad + C \int (\alpha^\lambda \star \alpha^\lambda)(y) \left( \Sigma^0(x-y) - \Sigma^0(x) \right) dy = I_1(x) + I_2(x). \end{aligned}$$

Bearing in mind that  $\alpha^\lambda \star \alpha^\lambda(x) = \lambda^{-3} \alpha \star \alpha(\lambda^{-1}x)$ , we readily obtain the convergence of  $I_2 \mathbf{1}_{|x| \leq R}$  to 0 in the  $L_x^{3/2}$ -norm. Moreover, since the support of  $\alpha^\lambda \star \alpha^\lambda$  shrinks to  $\{0\}$  when  $\lambda \rightarrow 0$  and since the function  $x \mapsto 1/|x|$  is a Lipschitz function on every set of the form  $\mathbb{C}B(0, R)$  (with a Lipschitz constant  $L(R)$  which blows up when  $R \rightarrow 0$ ) we get

$$\|I_2 \mathbf{1}_{|x| > R}\|_{L_x^\infty} \lesssim \text{meas} \left( \text{supp} \left( \alpha^\lambda \star \alpha^\lambda \right) \right) \xrightarrow{\lambda \rightarrow 0} 0.$$



Next, for  $y \in \text{supp}(\alpha^\lambda \star \alpha^\lambda)$  with  $\lambda$  sufficiently small,  $|x| > R$  implies  $|x - y| > R/2$ ; it follows that

$$\begin{aligned} & \|I_1 \mathbf{1}_{|x|>R}\|_{L_x^\infty} \\ & \leq \left\| \left( \frac{\chi^\mu}{|\cdot|^2} \star \frac{\chi^\mu}{|\cdot|^2} - \frac{1}{|\cdot|^2} \star \frac{1}{|\cdot|^2} \right) \mathbf{1}_{|x|>R/2} \right\|_{L_x^\infty} = \sup_{|x|>R/2} \left| \int \frac{\chi^\mu(x-y)\chi^\mu(y) - 1}{|x-y|^2|y|^2} dy \right| \\ & \leq \sup_{|x|>R/2} \left| \int \frac{\chi^\mu(x-y)(\chi^\mu(y) - 1)}{|x-y|^2|y|^2} dy \right| + \sup_{|x|>R/2} \left| \int \frac{\chi^\mu(z) - 1}{|z|^2|x+z|^2} dz \right|. \end{aligned}$$

Since  $0 \leq \chi \leq 1$  and  $\chi^\mu(x) = 1$  when  $|x| \leq \mu^{-1}$  this estimate yields

$$\|I_1 \mathbf{1}_{|x|>R}\|_{L_x^\infty} \leq 4 \sup_{|x|>R/2} \int_{\mathbb{C}B(0, \mu^{-1})} \frac{1}{|x-y|^2|y|^2} dy \xrightarrow{\mu \rightarrow 0} 0.$$

It remains to prove that  $I_1 \mathbf{1}_{|x| \leq R}$  converges to 0 in  $L_x^{3/2}$ -norm as  $\lambda, \mu \rightarrow 0$ . For  $r \in (0, R)$  we split this quantity as follows

$$\|I_1 \mathbf{1}_{|x| \leq R}\|_{L_x^{3/2}} \leq \|I_1 \mathbf{1}_{|x| \geq r}\|_{L_x^{3/2}} + \|I_1 \mathbf{1}_{r < |x| \leq R}\|_{L_x^{3/2}}.$$

We have

$$\left| (\alpha^\lambda \star \alpha^\lambda) \star \left( \frac{\chi^\mu}{|\cdot|^2} \star \frac{\chi^\mu}{|\cdot|^2} - \frac{1}{|\cdot|^2} \star \frac{1}{|\cdot|^2} \right) \mathbf{1}_{|x| \leq r} \right| \leq 2C (\alpha^\lambda \star \alpha^\lambda) \star \Sigma^0 \mathbf{1}_{|x| \leq r}$$

and we have already seen that  $C(\alpha^\lambda \star \alpha^\lambda) \star \Sigma^0 \mathbf{1}_{|x| \leq r}$  converges to  $\Sigma^0 \mathbf{1}_{|x| \leq r}$  in the  $L_x^{3/2}$ -norm for any  $0 < r < \infty$ . Let  $\eta > 0$ . We can choose  $r = r(\eta) > 0$  small enough and, next, find  $\lambda(\eta)$  small enough so that for any  $0 < \lambda < \lambda(\eta)$ , we get

$$\|I_1 \mathbf{1}_{|x| \leq r}\|_{L_x^{3/2}} \leq 2\|(C(\alpha^\lambda \star \alpha^\lambda) \star \Sigma^0 - \Sigma^0) \mathbf{1}_{|x| \leq r}\|_{L_x^{3/2}} + 2\|\Sigma^0 \mathbf{1}_{|x| \leq r}\|_{L_x^{3/2}} \leq \eta.$$

Finally, the  $L_x^{3/2}$ -norm of  $I_1 \mathbf{1}_{r < |x| \leq R}$  can be estimated as we did for the  $L_x^\infty$ -norm of  $I_1 \mathbf{1}_{|x| > R}$ . Possibly at the price of taking  $\lambda(\eta)$  smaller, if  $|x| > r$  we have  $|x - y| > r/2$  for any  $y \in \text{supp}(\alpha^\lambda \star \alpha^\lambda)$ . It follows that

$$\|I_1 \mathbf{1}_{r < |x| \leq R}\|_{L_x^{3/2}} \leq \text{meas}(B(0, R))^{2/3} \sup_{r/2 < |x| \leq R} \int_{\mathbb{C}B(0, \mu^{-1})} \frac{1}{|x-y|^2|y|^2} dy,$$

which can be made  $\leq \eta$  for  $0 < \mu < \mu(\eta)$ , with  $\mu(\eta)$  small enough. This ends the proof. ■





---

Numerical investigation of solitary waves stability for quantum dissipative systems

---

In this Chapter we continue on numerical grounds the study of the Schrödinger-Wave system begun in Chapter 4. In the previous Chapter we justified the existence and the orbital stability of ground states for this system. Here we study numerically these particular solutions. More precisely, through this study, we want to understand how the environment acts on a solitary wave. Indeed, by analogy with the classical model of L. Bruneau and S. De Bièvre, we expect that the possible translation of the ground state that allows the orbital stability result of the previous Chapter is bounded and converges exponentially fast to an asymptotic position. The results of this Chapter are the purpose of the article [P3].

The time discretization that we use for the Schrödinger-Wave system follows the same strategy than in Chapter 3 where we discretized the Vlasov-Wave system. To be more specific, we make a special effort in order to insure that the energy exchanges between the quantum particle and the environment for the discrete system are consistent with those for the continuous system.

### 5.1 Introduction

In this work we investigate on numerical grounds the dynamics of the following system, hereafter referred to as the *Schrödinger-Wave equation*

$$i\partial_t u + \frac{1}{2}\Delta_x u = \left( \sigma_1 \star_x \int_{\mathbb{R}^n} \sigma_2 \psi \, dz \right) u, \quad t \in \mathbb{R}, \, x \in \mathbb{R}^d \quad (5.1a)$$

$$(\partial_{tt}^2 \psi - c^2 \Delta_z \psi)(t, x, z) = -c^2 \sigma_2(z) \sigma_1 \star_x |u|^2(t, x), \quad t \in \mathbb{R}, \, x \in \mathbb{R}^d, \, z \in \mathbb{R}^n \quad (5.1b)$$

endowed with the initial data

$$u(0, x) = u_0(x), \quad (\psi(0, x, z), \partial_t \psi(0, x, z)) = (\psi_0(x, z), \psi_1(x, z)). \quad (5.2)$$

This model has been introduced in [P4] and it is intended to describe the behavior of a quantum particle interacting with its environment:  $u$  stands for the wave function of the quantum particle, which interacts with the vibrational field  $\psi$ , representing the environment. Here  $c > 0$  is a fixed parameter, and  $\sigma_1, \sigma_2$  are some God-given form functions which are

supposed non-negative, infinitely smooth, radially symmetric and compactly supported. A key feature of the model is the fact that the particle motion holds in the space  $\mathbb{R}^d$ , but the vibrations hold in a *transverse direction*  $\mathbb{R}^n$ .

Several quantities are conserved by the dynamics: the mass of the wave function  $u$

$$\mathcal{M}(t) = \int |u(t)|^2 dx,$$

and, denoting  $\chi = \partial_t \psi$ , the total energy of the system

$$E(u, \psi, \chi) = \frac{1}{2} \int |\nabla_x u|^2 dx + \int \left( \sigma_1 \star \int \sigma_2 \psi dz \right) |u|^2 dx + \frac{1}{2} \int \left( \frac{1}{c^2} |\chi|^2 + |\nabla_z \psi|^2 \right) dx dz, \quad (5.3)$$

and the total momentum

$$P(u, \psi, \chi) = \text{Im} \int \nabla_x u(x) \overline{u(x)} dx - \frac{1}{c^2} \iint \chi(x, z) \nabla_x \psi(x, z) dx dz \quad (5.4)$$

are conserved too. These conservation laws define a natural functional framework, in which a well-posedness theory can be established, see Appendix C.

We are particularly interested in the stability of some specific solutions of the system (5.1a)–(5.1b). To this end, it is relevant to consider the regime  $c \rightarrow +\infty$ , which reveals the attractive dynamics of the system. Indeed, passing to the limit  $c \rightarrow +\infty$  in (5.1a)–(5.1b) leads (at least formally) to the following system

$$i\partial_t \tilde{u} + \frac{1}{2} \Delta_x \tilde{u} = \left( \sigma_1 \star_x \int \sigma_2 \tilde{\psi} dz \right) \tilde{u}, \quad t \in \mathbb{R}, x \in \mathbb{R}^d, \quad (5.5a)$$

$$- \Delta_z \tilde{\psi} = -\sigma_2(z) \left( \sigma_1 \star_x |\tilde{u}|^2 \right) (x), \quad t \in \mathbb{R}, x \in \mathbb{R}^d, z \in \mathbb{R}^n. \quad (5.5b)$$

Let us denote  $z \mapsto \Gamma(z)$  the solution of the auxilliary equation

$$\Delta_z \Gamma = \sigma_2.$$

Then, the solution of (5.5b) reads  $\tilde{\psi}(x, z) = \Gamma(z) (\sigma_1 \star |\tilde{u}|^2)(x)$ . Accordingly, (5.5a)–(5.5b) can be cast in the usual form of an Hartree type equation

$$i\partial_t \tilde{u} + \frac{1}{2} \Delta_x \tilde{u} = -\kappa \left( \Sigma \star_x |\tilde{u}|^2 \right) \tilde{u}, \quad t \in \mathbb{R}, x \in \mathbb{R}^d, \quad (5.6)$$

where  $\kappa = \|\nabla_z \Gamma\|_{L^2_z}^2$  and  $\Sigma = \sigma_1 \star \sigma_1$ . Since  $\kappa > 0$  and  $\sigma_1$  is non negative, this Hartree type equation looks like the Newton-Hartree equation, where the self-consistent potential is focusing. This observation motivates the study of solitary waves, particular solutions of the form  $(u(t, x), \psi(x, z)) = (Q(x)e^{i\omega t}, \Psi(x, z))$ . For such solutions, the natural dispersion of the linear Schrödinger equation is compensated by the non linear term. As a matter of fact, we check that  $(u(t, x), \psi(x, z)) = (Q(x)e^{i\omega t}, \Psi(x, z))$  is a solution of (5.1a)–(5.1b) if and only if  $\Psi(x, z) = \Gamma(z) \sigma_1 \star Q^2(x)$  and  $Q$  is a solution of the following Choquard equation

$$-\frac{1}{2} \Delta_x Q + \omega Q - \kappa (\Sigma \star Q^2) Q = 0. \quad (5.7)$$

The Choquard equation (5.7) has been intensively studied: see for example [70, 77], and the references therein. In particular, with the assumptions made on  $\sigma_1$ , we know that equation

(5.7) has infinitely many non trivial solutions, and thus the Schrödinger-Wave system admits many solitary waves. It is worth pointing out that neither  $\Psi$ , nor the Choquard equation (5.7), depend on the wave speed  $c$ . This means that if  $(u(t, x), \psi(x, z)) = (Q(x)e^{i\omega t}, \Psi(x, z))$  is a solitary wave of the Schrödinger-Wave system for some  $c_0 > 0$ , then  $(u, \psi)$  is a solitary wave of the Schrödinger-Wave equation for every wave speed  $c > 0$ . This property equally applies for the asymptotic system (5.5a)–(5.5b). To be more specific, if  $(u(t, x), \psi(x, z)) = (Q(x)e^{i\omega t}, \Psi(x, z))$  is a solution of the Schrödinger-Wave system, then  $(u, \psi)$  (resp.  $u$ ) is also a solution of (5.5a)–(5.5b) (resp. (5.6)).

The analysis of the Hartree system (5.5a)–(5.5b) provides some useful hints to understand the dynamics for finite  $c$ 's. However the complex interactions between the particle and the environment are certainly poorly described by the asymptotic system — where the wave function is the only unknown, see (5.6) — and it is important to understand how the dynamics do differ. A crucial difference is that (5.6) is Galilean invariant while the Schrödinger-Wave system (5.1a)–(5.1b) is not. Hence, let  $Q$  be a solution of (5.7) with  $M = \|Q\|_{L_x^2}^2$ ; we shall work with initial data

$$\tilde{u}_0(x) = Q(x)e^{i\frac{p_0}{M}\cdot x}.$$

Owing to Galilean invariance for (5.6), we find

$$\tilde{u}(t, x) = Q\left(x - t\frac{p_0}{M}\right) \cdot \exp\left(i\frac{p_0}{M} \cdot \left(x - t\frac{p_0}{M}\right)\right) \cdot \exp\left(i\omega t + i\frac{|p_0|^2}{2M^2}t\right). \quad (5.8)$$

In other words, if an impulsion  $p_0$  is given to a solitary wave of mass  $M$ , then the solitary wave for (5.6) moves on a straight line with a uniform momentum  $p_0/M$ . We are going to compare this solution to the solution of (5.1a)–(5.1b), starting from the same initial data: we wish to investigate how the lack of Galilean invariance for the Schrödinger-Wave system modifies the *movement* of a solitary wave when this solitary wave is initially submitted to an impulsion  $p_0$ .

As we shall discuss in details below, this question has to be made more precise because, due to the lack of Galilean invariance, the solitary wave perturbed by an impulsion  $p_0$  can be *deformed* during the time evolution of (5.1a)–(5.1b). That the discussion makes sense relies on a stability property of the system which asserts that the solution remains close to the original solitary wave. Such a stability property holds for the ground states of (5.1a)–(5.1b), the solitary waves which minimize the energy (5.3) under a mass constraint. The orbital stability results established in the previous Chapter precisely insure that for a small enough impulsion  $p_0$ , the solution remains, up to a translation and a change of phase, close to the original solitary wave, uniformly in time. The present study is based on the following statement (see Theorem 4.2.9).

**Theorem 5.1.1** (i) Existence of ground states. *There exists  $M_0 > 0$  such that for every  $M \in (M_0, +\infty)$*

$$J_M = \inf \left\{ E(u, \psi, \chi) \text{ s.t. } (u, \psi, \chi) \in H_x^1 \times L_x^2 \dot{H}_z^1 \times L_x^2 L_z^2 \text{ and } \|u\|_{L_x^2}^2 = M \right\}$$

*is strictly negative and achieved at  $(u, \psi, \chi) = (Q, \Psi, 0)$  where  $\Psi(x, z) = \Gamma(z)\sigma_1 \star Q^2(x)$  and  $Q$  is a solution of the Choquard equation (5.7) for some  $\omega > 0$ . Moreover,  $Q$  is a positive, radially symmetric, function which belongs to the Schwartz class, and its radial profile is decreasing. Such minimizer  $(Q, \Psi)$  of  $J_M$  is called a ground state.*

(ii) Orbital stability. *For every  $(u_0, \psi_0, \chi_0) \in H_x^1 \times L_x^2 \dot{H}_z^1 \times L_x^2 L_z^2$  let us denote by  $(u, \psi, \chi =$*

$\partial_t \psi$ ) the unique solution of (5.1a)–(5.1b) associated to the initial data  $(u_0, \psi_0, \chi_0)$ . Let  $M > M_0$ ,  $(Q, \Psi, 0)$  be a ground state of  $J_M$  and let us assume that  $\|u_0\|_{L_x^2} = \|Q\|_{L_x^2}$ . For every  $\varepsilon > 0$  sufficiently small, there exists  $\eta(\varepsilon) > 0$  and  $\delta(\varepsilon) > 0$  such that the following condition on the initial data

$$\|u_0 - Q\|_{H_x^1}^2 + \|\psi_0 - \Psi\|_{L_x^2 \dot{H}_z^1}^2 + \frac{1}{c^2} \|\chi_0\|_{L_x^2 L_z^2}^2 \leq \eta(\varepsilon)^2 \quad \text{and} \quad W(u_0, \psi_0, \chi_0) - W(Q, \Psi, 0) \leq \delta(\varepsilon),$$

implies the existence of two continuous functions  $t \mapsto x(t) \in \mathbb{R}^d$  and  $t \mapsto \gamma(t) \in \mathbb{R}$  such that

$$\sup_{t \geq 0} \left\| u(t) - e^{i\gamma(t)} Q(\cdot - x(t)) \right\|_{H_x^1}^2 + \|\psi(t) - \Psi(\cdot - x(t))\|_{L_x^2 \dot{H}_z^1}^2 + \frac{1}{c^2} \|\chi(t)\|_{L_x^2 L_z^2}^2 \leq \varepsilon^2. \quad (5.9)$$

Assuming  $|p_0| \ll 1$ , we can apply Theorem 5.1.1-ii) with  $u_0(x) = Q(x)e^{i\frac{p_0}{M} \cdot x}$  and  $(\psi_0, \psi_1) = (\Psi, 0)$ . The modulation parameter  $x(t)$  seems to be a natural candidate for the *position* of the ground state and we can thus study its *movement*. Nevertheless, although the modulation parameters  $x(t)$  and  $\gamma(t)$  are uniquely determined (thanks to some orthogonality conditions, see Theorem 4.2.9), the continuity of the translation operator on  $H_x^1$  implies that the stability estimate (5.9) equally applies when  $x(t)$  is replaced by a function  $y(t)$  such that  $\|y - x\|_{L_t^\infty} \ll 1$ . Thus the notion of *position* of a ground state along time is not absolute (the function  $y(t)$  could also be a definition of the position) but only defined up to a small translation. This remark raises the issue of clarifying the quantities of interest to study numerically the *movement* of a ground state.

### 5.1.1 Motivation

In order to motivate our study and to have some insight on what could be the dynamic of the position of a ground state, let us briefly recall the physical motivation of the Schrödinger-Wave equation. This system belongs to the large class of open systems modeling dissipative effects. Indeed, as suggested by A. Caldeira and A. Legget in [20, 19] the dissipation arising on a physical system might come from a coupling with a complex environment. In this approach, dissipation is interpreted as the transfer of energy from the single degree of freedom characterizing the system to the more complex set of degrees of freedom describing the environment; the energy is evacuated into the environment and does not come back to the system. To be more specific, the Schrödinger-Wave system is the quantum version of the classical model introduced by L. Bruneau and S. De Bièvre in [16]:

$$\ddot{q}(t) = - \iint \nabla \sigma_1(q(t) - y) \sigma_2(z) \psi(t, y, z) \, dz \, dy, \quad t \in \mathbb{R} \quad (5.10a)$$

$$(\partial_{tt}^2 \psi - c^2 \Delta_z \psi)(t, x, z) = -c^2 \sigma_2(z) \sigma_1(x - q(t)), \quad t \in \mathbb{R}, \, x \in \mathbb{R}^d, \, z \in \mathbb{R}^n \quad (5.10b)$$

completed by the initial data

$$(q(0), \dot{q}(0)) = (q_0, p_0), \quad (\psi(0, x, z), \partial_t \psi(0, x, z)) = (\psi_0(x, z), \psi_1(x, z)). \quad (5.11)$$

In this system,  $q(t)$  denotes the position of the classical particle and  $\psi(t, x, z)$  still describes the state of the vibrational environment. Roughly speaking the environment can be thought of as a (continuum) set of membranes, activated by the passage of the particle. On each position  $x \in \mathbb{R}^d$ , the particle exchanges momentum and energy with the membranes. The evacuation of energy through the membranes eventually leads to a sort of friction effect. In (5.1a)–(5.1b), the position-velocity pair  $(q, p)$  of the classical modeling is replaced by the wave function  $u$  governed by the Schrödinger equation. A fully quantized model is discussed

in [15, 24]. We point out that here the wave equation is scaled differently than in the seminal paper [16], with an extra  $c^2$ -factor on the right hand side of (5.10b). We refer the reader to the previous Chapter for the justification of this rescaling. The main finding in [16] is precisely to exhibit the friction effects in the dynamics of (5.10a)–(5.10b), as illustrated by the following statement (see [16, Theorems 2 & 4] for further details).

**Theorem 5.1.2** *Let  $n = 3$ . For any  $\eta \in (0, 1)$  there exists a critical wave speed  $c_0 = c_0(\eta) > 0$  and constants  $\gamma, K > 0$  (which do not depend on  $\eta$ ) such that for any  $c \geq c_0$  there exists  $q_\infty = q_\infty(c) \in \mathbb{R}^d$  such that*

$$|\dot{q}(t)| + |q(t) - q_\infty| \leq K e^{-\frac{\gamma(1-\eta)}{c}t}.$$

**Remark 5.1.3** *As explained above, we have adopted a different scaling of the wave equation: this is the reason why the corresponding result in [16] appears with a factor  $c^{-3}$  in the convergence rate instead of  $c^{-1}$  here.*

This result makes it concrete the dissipation mechanism of the interaction with the environment. The conditions on the dimension  $n$  of the vibrational field and on the wave speed  $c$  are quite critical, as confirmed by the numerical experiments of Chapter 3. Indeed, the dissipative effect comes from the capability of evacuating the kinetic energy of the particle through the vibrations in the transverse directions: the condition  $n \geq 3$  can be seen as a condition insuring a strong enough dispersion effect in the membranes. It implies that the energy given by the particle to the environment does not entirely come back to the particle. Of course, the shape of the form function  $\sigma_2$ , and the fact it is compactly supported, are crucial in this mechanism. Moreover, requesting  $c$  large enough can be interpreted as a condition ensuring that the energy is quickly evacuated in the membrane, out of the support of  $\sigma_2$ . Since the dispersion rate of the wave equation depends on the dimension  $n$ , the friction effect of the environment on the particle depends on  $n$ . The specific case  $n = 3$  makes a linear relation appear between the asymptotic velocity of the particle and the resulting friction force (and thus an exponential convergence rate), as pointed out in [16, Section 2], see also Remark 5.1.9 below.

The stability of the ground states can be seen as a natural analog of these properties for the quantum model (5.1a)–(5.1b): we still expect that the vibrational field  $\psi$  produces a friction effect on the wave function  $u$ . The orbital stability result in Theorem 5.1.1 insures that, up to an error term of size  $\varepsilon$ , the solution associated to a small initial perturbation of the ground state stays close to  $(Q(x - x(t))e^{i\gamma(t)}, \Psi(x - x(t), z))$ . Then, if the environment  $\psi$  acts on the wave function  $u$  as a friction force, one can expect that the wave function  $u$  remains at a bounded distance of the original ground state  $(Q(x), \Psi(x, z))$ , which means that  $t \mapsto x(t)$  is bounded. These are the issues we wish to numerically investigate.

### 5.1.2 Conjectures and main results

From now on, we fix a mass  $M > M_0$ , a ground state  $(Q, \Psi)$  such that  $\|Q\|_{L_x^2}^2 = M$  and an initial impulsion  $p_0$ . We consider an initial data for (5.1a)–(5.1b) of the form

$$u_0(x) = Q(x)e^{i\frac{p_0}{M}x} \quad (\psi_0, \psi_1) = (\Psi, 0).$$

We denote by  $(u, \psi)$  the unique solution of (5.1a)–(5.1b) associated to this initial data. We assume that  $p_0$  is small enough so that Theorem 5.1.1 applies. Thus there exists four functions  $(t, x) \mapsto u^\varepsilon(t, x)$ ,  $(t, x, z) \mapsto \psi^\varepsilon(t, x, z)$ ,  $t \mapsto x(t)$  and  $t \mapsto \gamma(t)$  such that

$$u(t, x) = Q(x - x(t))e^{i\gamma(t)} + u^\varepsilon(t, x) \quad \psi(t, x, z) = \Psi(x - x(t), z) + \psi^\varepsilon(t, x, z)$$



and

$$\sup_{t \geq 0} \left( \|u^\varepsilon(t)\|_{H_x^1} + \|\psi^\varepsilon(t)\|_{L_x^2 \dot{H}_z^1} + \frac{1}{c^2} \|\partial_t \psi^\varepsilon(t)\|_{L_x^2 L_z^2} \right) \leq \varepsilon^2.$$

We wish to challenge on numerical grounds this stability result, the intuition on the problem and the analogy with the model for a single classical particle. To this end, we shall produce numerical approximations of the solutions: hereafter, we denote with a subscript  $h$  the numerical solution, where  $h > 0$  refers to the discretization parameters. The following conjecture would be the analog of Theorem 5.1.2 for the quantum model.

**Conjecture 5.1.4** *Let  $n = 3$  and  $c > 0$ . There exists constants  $\lambda, C > 0$  such that for any  $p_0$  sufficiently small we can find a function  $t \mapsto y(t) \in \mathbb{R}^d$  and  $y_\infty \in \mathbb{R}^d$  such that the conclusion (5.9) of Theorem 5.1.1 still applies when the modulation parameter  $x(t)$  is replaced by  $y(t)$  and*

$$|\dot{y}(t)| + |y(t) - y_\infty| \leq C e^{-\frac{\lambda}{c}t}.$$

**Remark 5.1.5** *The conjecture is stated only when the conclusion of Theorem 5.1.1 is valid, and how  $p_0$  has to be small depends on the assumptions of this theorem. However, in the regime  $c \gg 1$  we believe that the assumptions can be weakened. To be more specific, since for  $c \rightarrow +\infty$  the asymptotic system is Galilean invariant, we believe that the smallness assumption on  $u_0 - Q$  can be relaxed in the direction  $\exp(ip_0 \cdot x/M)$  when  $c \gg |p_0|$ . We will investigate numerically how  $p_0$  has to be small depending on the value of  $c$ .*

We warn the reader that this conjecture involves a function  $t \mapsto y(t)$  which could differ from the modulation parameter  $x(t)$ . This is related to the fact, mentioned above, that the position of a ground state for (5.1a)–(5.1b) along time is not absolute due to the possible deformation of the ground state. From the function  $y$  one can easily construct another smooth function  $\bar{y}$  such that  $\|\bar{y} - y\|_{L_t^\infty} \ll 1$  (and then such that (5.9) applies with  $\bar{y}(t)$  replacing  $x(t)$ ) and such that  $\bar{y}(t)$  is rapidly oscillating around  $y_\infty$  without converging to it as  $t \rightarrow +\infty$ . For this function there exists  $C > 0$  such that for every  $\bar{y}_\infty \in \mathbb{R}^d$

$$\limsup_{t \rightarrow +\infty} |\dot{\bar{y}}(t)| + |\bar{y}(t) - \bar{y}_\infty| > C$$

and then Conjecture 5.1.4 fails with  $\bar{y}(t)$ . In particular, there is no reason to believe *a priori* that the conjecture applies with  $y = x$ .

This discussion raises the issue of the definition and computation of the *position* of a ground state along time. The definition of  $x$  relies on orthogonality relations, see Theorem 4.2.9, which can indeed be used to compute the modulation parameter  $x(t)$ . However, we shall introduce another quantity, which is more physical and which will allow us to perform finer predictions: the center of mass of the solution, which is given by

$$q(t) = \frac{\int x |u(t, x)|^2 dx}{\int |u(t, x)|^2 dx} = \frac{1}{M} \int x |u(t, x)|^2 dx.$$

In order to investigate the validity of the conjecture we have first to check that  $q(t)$  stays close to  $x(t)$ , uniformly in time. The following computation shows that this is formally the

case:

$$\begin{aligned}
Mq(t) &= x(t) \int |u(t, x)|^2 dx + \int (x - x(t)) |u(t, x)|^2 dx \\
&= Mx(t) + \int (x - x(t)) |Q(x - x(t))|^2 dx \\
&\quad + 2\operatorname{Re} \int (x - x(t)) Q(x - x(t)) e^{-i\gamma(t)} u^\varepsilon(t, x) dx + \int (x - x(t)) |u^\varepsilon(t, x)|^2 dx \\
&= Mx(t) + 0 + 2\operatorname{Re} \int (x - x(t)) Q(x - x(t)) e^{-i\gamma(t)} u^\varepsilon(t, x) dx \\
&\quad + \int (x - x(t)) |u^\varepsilon(t, x)|^2 dx,
\end{aligned}$$

where the second term is equal to zero because  $Q$  is radially symmetric. We thus get

$$|q(t) - x(t)| \leq \frac{2}{M} \|xQ\|_{L_x^2} \|u^\varepsilon(t)\|_{L_x^2} + \frac{1}{M} \int |x - x(t)| |u^\varepsilon(t, x)|^2 dx.$$

Theorem 5.1.1 insures that  $\|u^\varepsilon(t)\|_{H_x^1}$  is dominated by  $\varepsilon$ , uniformly in time. Thus the first term of the estimate is of order  $\mathcal{O}(\varepsilon)$ . However, we have no information on the boundedness of  $\int |x - x(t)| |u^\varepsilon(t)|^2 dx$  along time, and the second term is only formally of order  $\mathcal{O}(\varepsilon^2)$ . Nevertheless it will be easy to check whether or not this behavior is confirmed numerically. Indeed, once the numerical approximation  $u_h$  of the wave function is computed, we will be able to compute its center of mass  $q_h$  and then to compute in some discrete norm the difference

$$\epsilon_h^1 = |u_h| - Q_h(x - q_h). \quad (5.12)$$

This is the purpose of our first numerical investigation and we obtain the following conclusion.

**Observation 5.1.6** *The quantity  $\epsilon_h^1$  remains small, uniformly on the simulation time, in discrete  $L_x^2$ ,  $H_x^1$  and  $L_x^\infty$ -norms.*

This fact confirms the formal computation. From now on we will assume that the following decomposition is valid

$$u(t, x) = Q(x - q(t)) e^{i\gamma(t)} + \widetilde{u}^\varepsilon(t, x) \quad (5.13)$$

where  $\widetilde{u}^\varepsilon$  is of order  $\mathcal{O}(\varepsilon)$ .

It would be tempting to investigate the validity of the conjecture with  $y(t) = q(t)$ . Indeed, this quantity has a physical meaning and it is easier to compute than the modulation parameter  $x(t)$ . However, the computation of the center of mass requires the computation of the wave function  $u$  itself. Furthermore, a priori we have no information on the damping of this quantity and we cannot exclude that  $q(t)$  does not converge exponentially fast to some asymptotic position but instead oscillates around it. Such oscillations can come from the part  $\widetilde{u}^\varepsilon$  of the wave function which is not damped. Another (more optimistic) possible scenario is that  $\widetilde{u}^\varepsilon$  is damped but with a rate slower than exponential: the possible oscillations of  $q(t)$  can be damped but not with the expected exponential rate. For this reason, we decide to work with another relevant function  $y$  which is robust with respect to the small perturbations of the wave function. To this end, let us observe that the evolution of the center of mass is governed by

$$M\dot{q}(t) = p(t) \quad \text{with } p(t) = \operatorname{Im} \int \nabla_x u(t) \bar{u}(t) dx, \quad (5.14a)$$

$$\dot{p}(t) = - \int \nabla_x \left( \sigma_1 \star \int \sigma_2 \psi(t) dz \right) |u(t)|^2 dx, \quad (5.14b)$$

$$\partial_{tt}^2 \psi - c^2 \Delta_z \psi = -c^2 \sigma_2(z) \sigma_1 \star |u(t)|^2, \quad (5.14c)$$

endowed with the initial data

$$(q(0), p(0)) = \left( \frac{1}{M} \int x |u_0|^2 dx, \operatorname{Im} \int \nabla_x u_0 \bar{u}_0 dx \right), \quad (\psi_0, \psi_1) = (\Psi, 0).$$

With the specific choice of initial data  $u_0$  we have  $q(0) = 0$  and  $p(0) = p_0$ . Neglecting the fluctuation term  $\widetilde{u}^\varepsilon$  in (5.13), we obtain the following simplified system

$$M \frac{d}{dt} q^a(t) = p^a(t) \tag{5.15a}$$

$$\frac{d}{dt} p^a(t) = - \int \nabla_x \left( \sigma_1 \star \int \sigma_2 \psi^a(t) dz \right) Q^2(x - q^a(t)) dx, \tag{5.15b}$$

$$\partial_{tt}^2 \psi^a - c^2 \Delta_z \psi^a = -c^2 \sigma_2(z) \sigma_1 \star Q^2(\cdot - q^a(t)), \tag{5.15c}$$

endowed with the initial data

$$(q^a(0), p^a(0)) = (0, p_0), \quad (\psi_0^a, \psi_1^a) = (\Psi, 0).$$

This closed system is similar to the model for a classical particle (5.10a)–(5.10b). Indeed, using the fact that  $\sigma_1$  and  $Q^2$  are radially symmetric one can check that the right hand side of (5.15b) is exactly the right hand side of (5.10a) when  $\sigma_1$  is replaced by  $\sigma_1 \star Q^2$ :

$$- \int \nabla_x \left( \sigma_1 \star \int \sigma_2 \psi^a(t) dz \right) Q^2(x - q^a(t)) dx = - \nabla_x \left( (\sigma_1 \star Q^2) \star \int \sigma_2 \psi^a(t) dz \right) (q^a(t)).$$

Then (5.15a)–(5.15c) is exactly (5.10a)–(5.10b) with a particle of mass  $M$  instead of mass 1 and with the form function  $\sigma_1 \star Q^2$  instead of  $\sigma_1$ .

By construction  $q^a$  does not depend on the fluctuations of the wave function  $u$  as we would like it to be. Using the decomposition given by the orbital stability result of Theorem 5.1.1 shows that the force term acting on the center of mass  $q(t)$  in (5.14b) is of order  $\mathcal{O}(\varepsilon)$ :

$$\begin{aligned} \int \nabla_x \left( \sigma_1 \star \int \sigma_2 \psi(t) dz \right) |u(t)|^2 dx &= \int \nabla_x \left( \sigma_1 \star \int \sigma_2 \Psi(\cdot - x(t), z) dz \right) |Q(x - x(t))|^2 dx \\ &+ 2\operatorname{Re} \int \nabla_x \left( \sigma_1 \star \int \sigma_2 \Psi(\cdot - x(t), z) dz \right) Q(x - x(t)) e^{-i\gamma(t)} u^\varepsilon(t, x) dx \\ &\quad + \int \nabla_x \left( \sigma_1 \star \int \sigma_2 \psi^\varepsilon(t) dz \right) |Q(x - x(t))|^2 dx \\ &+ \int \nabla_x \left( \sigma_1 \star \int \sigma_2 \Psi(\cdot - x(t), z) dz \right) |u^\varepsilon(t, x)|^2 dx \\ &\quad + 2\operatorname{Re} \int \nabla_x \left( \sigma_1 \star \int \sigma_2 \psi^\varepsilon(t) dz \right) Q(x - x(t)) e^{-i\gamma(t)} u^\varepsilon(t, x) dx \\ &+ \int \nabla_x \left( \sigma_1 \star \int \sigma_2 \psi^\varepsilon(t) dz \right) |u^\varepsilon(t, x)|^2 dx. \end{aligned}$$

Every element of this decomposition is at least of order  $\mathcal{O}(\varepsilon)$  except the first one which at first sight is of order  $\mathcal{O}(1)$ . But actually this term vanishes since

$$\begin{aligned} \int \nabla_x \left( \sigma_1 \star \int \sigma_2 \Psi(\cdot - x(t), z) dz \right) |Q(x - x(t))|^2 dx \\ = -\kappa \int \nabla_x \left( \sigma_1 \star Q^2(\cdot - x(t)) \right) Q^2(x - x(t)) dx = 0. \end{aligned}$$

Therefore, the force term in (5.14b) is of order  $\mathcal{O}(\varepsilon)$ . The terms neglected in (5.14a)–(5.14c) are of the same order  $\mathcal{O}(\varepsilon)$  and their effects on the dynamics, with possible deformations of the wave function  $u$  due to the nonlinear terms, cannot be considered as negligible, even on short time intervals. In particular, we do not know whether or not  $q^a(t)$  remains close to the center of mass  $q(t)$ . We address this question numerically and we obtain the following conclusion.

**Observation 5.1.7** *We observe numerically that  $\epsilon_h^2 = |q_h^a - q_h| + |p_h^a - p_h|$  remains small along time.*

The numerical simulations indicate that, for the considered initial data,  $q^a(t)$  can be used to define the *position* of the ground state. This quantity does not depend on the small perturbations of the wave function around the moving ground state, and we have investigated the conjecture with  $y(t) = q^a(t)$ .

**Observation 5.1.8** *We observe numerically that the momentum of the moving ground state converges exponentially fast to zero and its position converges to an asymptotic point with the same exponential rate. Moreover the exponential rate is proportional to  $c^{-1}$  and depends on the considering ground state  $Q$ . To be more precise there exists an asymptotic position  $q^\infty$  such that*

$$|p_h^a(t^n)| + |q_h^a(t^n) - q^\infty| \leq e^{-\frac{\lambda}{c}t^n}$$

where  $\lambda = \lambda(Q)$  depends on  $Q$ .

**Remark 5.1.9** *Let us discuss further the analogy between the classical and the quantum models. According to [16, Section 2], the force exerted by the environment when the particle has a uniform rectilinear motion can be explicitly computed, as a function of the particle's speed  $v$ . We get*

$$f(v) = - \iint_{\mathbb{R}^d \times \mathbb{R}^n} |\hat{\sigma}_2(\zeta)|^2 \left( \int_0^{+\infty} \frac{\sin(c|\zeta|\tau)}{c|\zeta|} \sigma_1(x + \tau v) d\tau \right) \nabla_x \sigma_1(x) dx d\zeta.$$

It can be recast as

$$f(v) = f_r(|v|) \frac{v}{|v|}, \quad f_r(|v|) < 0$$

which makes the fact that the environment acts against the particle motion appear. Moreover,  $f_r$  vanishes when  $v = 0$ , and, more precisely it has the following behavior as  $v \rightarrow 0$

$$f_r(|v|) = -\gamma \left( \frac{|v|}{c} \right)^{n-2} + o \left( \frac{|v|}{c} \right)^{n-2},$$

(this formula takes into account the rescaling of the current paper) where  $\gamma > 0$  depends on the form functions  $\sigma_1$  and  $\sigma_2$ :

$$\gamma = |\hat{\sigma}_2(0)|^2 \iint_{\mathbb{R}^d \times \mathbb{R}^n} \left( \int_0^{+\infty} \frac{\sin(\tau|\zeta|)}{|\zeta|} \sigma_1(x_1 + \tau, x_\perp) d\tau \right) \partial_{x_1} \sigma_1(x) dx d\zeta.$$

This formula shows the critical role of the dimension  $n = 3$ : when  $n = 3$  it corresponds to a linear friction, with coefficient  $\gamma/c$ , when  $n \geq 4$  the friction law becomes non linear with exponent  $n - 2$  (when  $n = 1, 2$  the previous computations are meaningless; for instance the formula which defines  $\gamma$  is well defined only when  $n \geq 3$ ).

Going back to the quantum model, this discussion can be adapted to make how  $\lambda$  depends on  $Q$  explicit. We assume that the soliton  $Q$  has a rectilinear uniform motion, at speed  $v$ ,

without deformation. We have already seen that in this case, replacing  $\sigma_1$  by  $\sigma_1 \star Q^2$ , the systems (5.15a)–(5.15c) and (5.10a)–(5.10b) are similar. Therefore  $\lambda(Q)$  can be computed like  $\gamma$ , up to changing  $\sigma_1$  into  $\sigma_1 \star Q^2$ ; it leads to

$$\lambda(Q) = |\hat{\sigma}_2(0)|^2 \iint_{\mathbb{R}^d \times \mathbb{R}^n} \left( \int_0^{+\infty} \frac{\sin(\tau|\zeta|)}{|\zeta|} \sigma_1 \star Q^2(x_1 + \tau, x_\perp) d\tau \right) \partial_{x_1}(\sigma_1 \star Q^2)(x) dx d\zeta.$$

Up to now, we have focused the discussion on the translation of the ground state and neglected the change of phase. Let us go back to this issue now. To this end, we consider the asymptotic system (5.6) for which the Galilean invariance gives the explicit formula (5.8) and thus an exact knowledge of the phase of the solution. This formula can be rewritten by means of the center of mass of the solution: if we denote by  $\tilde{q}(t)$  the center of mass of  $\tilde{u}(t)$ :

$$\tilde{q}(t) = \frac{1}{M} \int x |\tilde{u}(t, x)|^2 dx,$$

then

$$M \frac{d}{dt} \tilde{q}(t) = \tilde{p}(t) \quad \text{with } \tilde{p}(t) = \text{Im} \int \nabla_x \tilde{u}(t) \overline{\tilde{u}(t)} dx, \tag{5.16a}$$

$$\frac{d}{dt} \tilde{p}(t) = 0, \tag{5.16b}$$

and we eventually obtain

$$\tilde{u}(t, x) = Q(x - \tilde{q}(t)) \cdot \exp\left(i \frac{\tilde{p}(t)}{M} \cdot (x - \tilde{q}(t))\right) \cdot \exp\left(i\omega t + \frac{i}{2M^2} \int_0^t |\tilde{p}(s)|^2 ds\right).$$

We already know that  $|u(t)| - Q(x - q^a(t))$  remains small along time, and (5.15a)–(5.15c) is asymptotic to (5.16a)–(5.16b). By analogy with the previous formula we expect that

$$\left\| u(t, x) - Q(x - q^a(t)) \cdot \exp\left(i \frac{p^a(t)}{M} \cdot (x - q^a(t))\right) \cdot \exp\left(i\omega t + \frac{i}{2M} \int_0^t |p^a(s)|^2 ds\right) \right\|$$

is uniformly small for all time. This conjecture is the purpose of our fourth numerical investigation.

**Observation 5.1.10** *We observe numerically that the discrete quantity*

$$\epsilon_h^3 = u_h(t^n) - Q_h(x - q_h^a(t^n)) \cdot \exp\left(i \frac{p_h^a(t^n)}{M} \cdot (x - q_h^a(t^n))\right) \cdot \exp(i\omega_h t^n + i\gamma_h^a(t^n)) \tag{5.17}$$

where  $\gamma_h^a$  stands for the discrete equivalent of

$$\gamma^a(t) = \frac{1}{2M^2} \int_0^t |p^a(s)|^2 ds,$$

remains small for every  $t^n$  in discrete  $L_x^2$ ,  $H_x^1$  and  $L_x^\infty$ -norms.

The sequel of this Chapter is organized as follows. In Section 5.2 we detail the numerical results and discuss on numerical grounds Observations 5.1.6-5.1.10 stated before. Section 5.3 describes the construction of the numerical method: we need a scheme for the Schrödinger-Wave system (5.1a)–(5.1b) and another one for solving the Choquard equation (5.7) in order to compute an approximation of a ground state. In Section 5.4 we investigate the energetic properties of the scheme discretizing (5.1a)–(5.1b).

## 5.2 Numerical results

For all the simulations discussed below we work with the form functions

$$\sigma_1(x) = K_1 \exp\left(-\frac{1}{R_1^2 - x^2}\right) \mathbf{1}_{|x| \leq R_1}$$

and

$$\sigma_2(z) = \tilde{\sigma}_2(|z|), \quad \tilde{\sigma}_2(r) = K_2 \exp\left(-\frac{1}{R_2^2 - r^2}\right) \mathbf{1}_{r \leq R_2}.$$

The parameters used for the computational domain and the form functions are collected in Table 5.1. We refer the reader to the next Section for details on the numerical scheme. The wave equation is solved with the  $\mathbb{P}_2$  Lagrange elements and we perform the simulations with a solitary wave of mass  $M = 2$  (we did not take a mass  $M = 1$  in order to test the validity of the mass dependence in (5.17)).

$K_1$	$R_1$	$K_2$	$R_2$	$L$	$R_{max}$	$N_x$	$N_r$	$\Delta x$	$\Delta r$	$\Delta t$
3	1	3	1	$8\pi$	$2R_2$	1024	512	$8\pi/1024$	$2/1024$	$1/256$

Table 5.1: General data for the numerical simulations.

The solitary wave  $Q_h$  and  $\Upsilon_h$  are represented in Figure 5.1. The solitary wave is com-

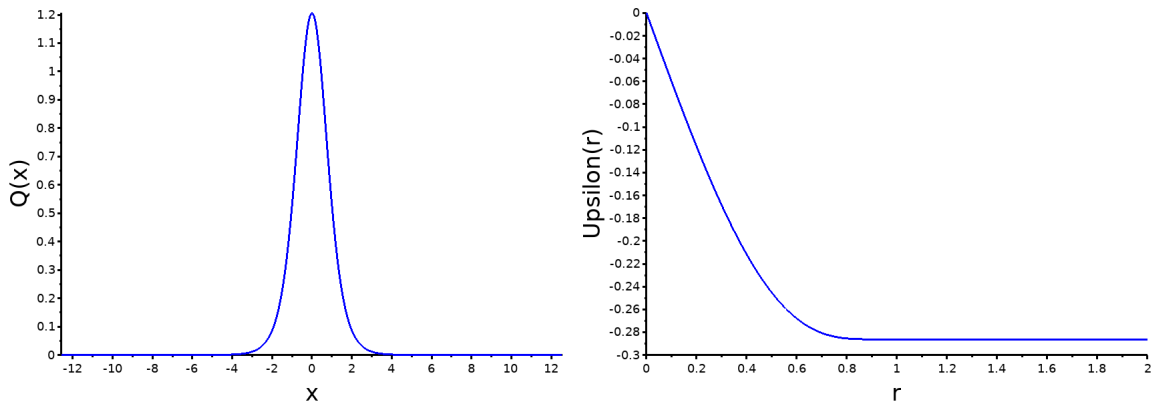

Figure 5.1: The solitary wave  $Q_h$  of mass  $M = 2$  (left) and the solution  $\Upsilon_h$  of  $\partial_{rr}^2 \Upsilon = \tilde{\sigma}_2$  (right). From these approximations we get  $\omega_h \simeq 2.006$  and  $\kappa_h \simeq 1.664$ .

puted by using the imaginary time method described in Section 5.3.2. We proceed in two steps. We first apply the imaginary time method with the initial data

$$v_0(x) = \frac{e^{-x^2}}{\|x \mapsto e^{-x^2}\|_{L_x^2}}.$$

It provides a solitary wave of mass  $M = 1$ . Then, we re-normalize this solitary wave in order to have a function of mass  $M = 2$  and we apply again the imaginary time method with this new initial data. In Figure 5.2, we have represented the evolution of the energy (5.25) when the imaginary time method is applied. In particular we observe, as at the continuous level, that this quantity is decreasing.

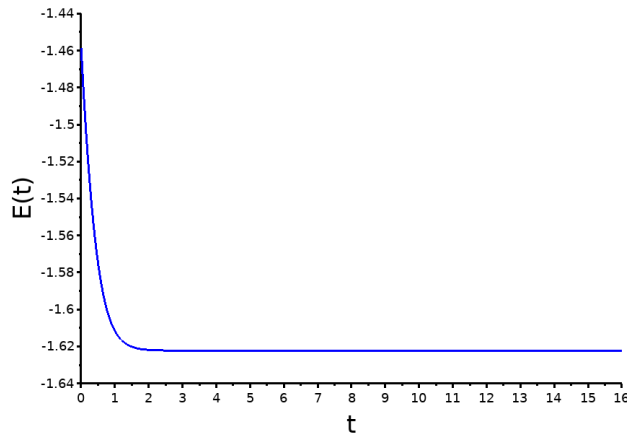

Figure 5.2: Evolution of the energy (5.25) when the imaginary time method is applied.

Having the solitary wave at hand, we perform simulations with several values for  $p_0$  and  $c$ , see Table 5.2, in order to see how the errors  $\epsilon_h^1$ ,  $\epsilon_h^2$  and  $\epsilon_h^3$ , introduced in Observations 5.1.6, 5.1.7 and 5.1.10, are influenced by these parameters. Test 3 is the most challenging since it combines a large value of the initial impulsion  $p_0$  and a moderate value of the wave speed  $c$ . The results are depicted in Figure 5.3–5.5.

	Test 1	Test 2	Test 3	Test 4
$p_0$	0.05	0.05	1.6	1.6
$c$	5	20	5	20
$T$	16	32	32	16

Table 5.2: Data for the study of the error terms  $\epsilon_h^1$ ,  $\epsilon_h^2$  and  $\epsilon_h^3$ .

In particular, we see that these errors stay small along time. We also see that the smaller  $p_0$ , the smaller the errors and the larger  $c$ , the larger  $p_0$  can be taken. Concerning Observation 5.1.10, note that the results are very sensitive to the accuracy of the evaluation of the Lagrange multiplier  $\omega$  of the soliton: the errors on  $\omega$  naturally produce an error on the phase, which grows linearly with time, as it can be observed in Figure 5.5. We also illustrate the dynamic of these solutions in Figure 5.6–5.7. In order to see on figures the differences between  $u_h(t^n, x)$  and

$$u_h^a(t^n, x) = Q_h(x - q_h^a(t^n)) \cdot \exp\left(i \frac{p_h^a(t^n)}{M} \cdot (x - q_h^a(t^n))\right) \cdot \exp(i\omega_h t^n + i\gamma_h^a(t^n))$$

we make this illustration in the case of Test 3 where errors are the largest.

Then we investigate how the environment acts on the solitary wave. For that purpose, for a given value of  $p_0$  and depending on the value of  $c$  (see Table 5.3) we check that, as asserted in Observation 5.1.8,  $p_h^a$  converges exponentially fast to zero and that the convergence rate is proportional to  $1/c$ : see Figure 5.8–5.9.

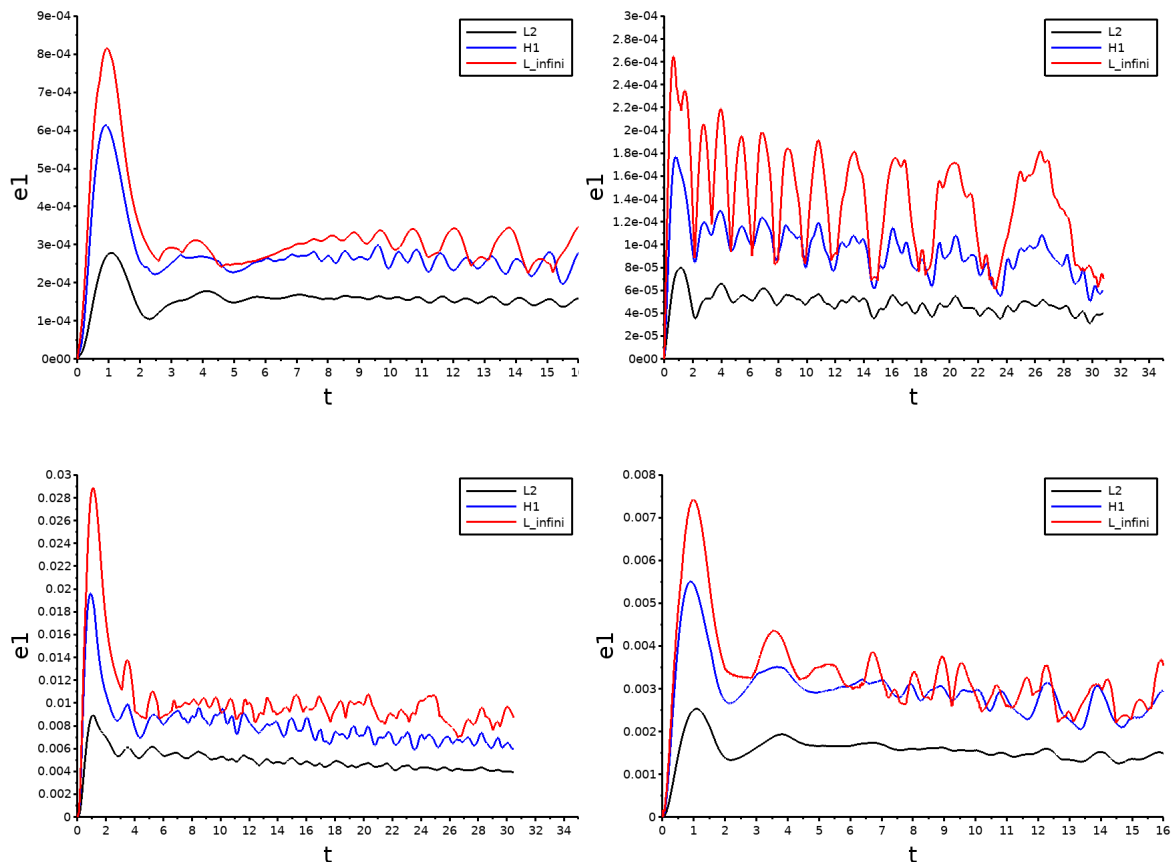

Figure 5.3: Evolution of the error term  $\epsilon_h^1$  along time (from left to right and top to bottom, Test 1 to 4, see Table 5.2).

	Test 1	Test 2	Test 3	Test 4
$p_0$	0.05	0.05	0.05	0.05
$c$	5	10	20	40
$T$	16	32	32	32

Table 5.3: Data for the study of the convergence rate to 0 of  $p_h^a$  (dependency on  $c$ ).

## 5.3 Numerical schemes

The numerical issues split into two parts: first, we explain how the Schrödinger-Wave system (5.1a)–(5.1b) is discretized and, second, we detail how we compute an approximation of a ground state  $(Q, \Psi)$ . The latter step is crucial since this ground state is used to define the initial data for the simulation of the Cauchy problem.

### 5.3.1 Discretization of the Schrödinger-Wave system

We restrict ourselves to the case where the wave function  $u$  evolves on the one-dimensional torus:  $d = 1$  and  $x \in \mathbb{T}_L := \mathbb{R}/(L\mathbb{Z})$ . Of course,  $L > 0$  is chosen at least larger than the diameter of the support of  $\sigma_1$ . The ground states  $Q$  decay exponentially fast, and we



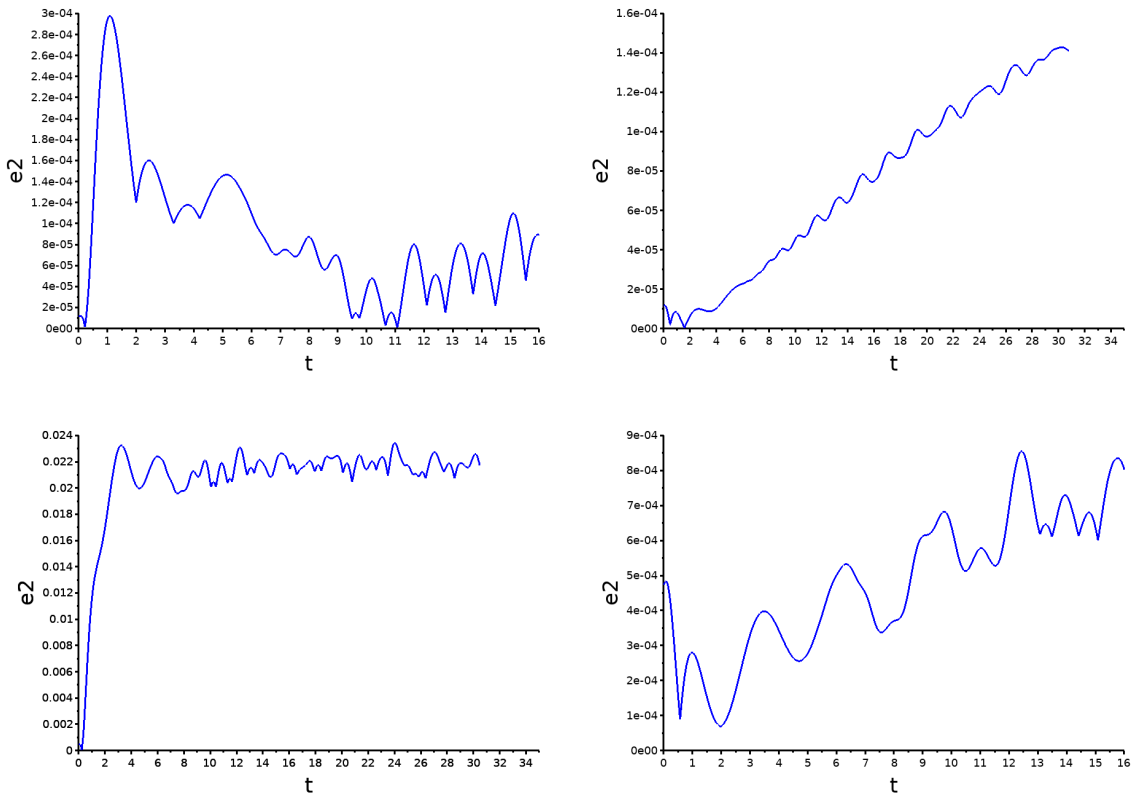

Figure 5.4: Evolution of the error term  $\epsilon_h^2$  along time (from left to right and top to bottom, Test 1 to 4, see Table 5.2).

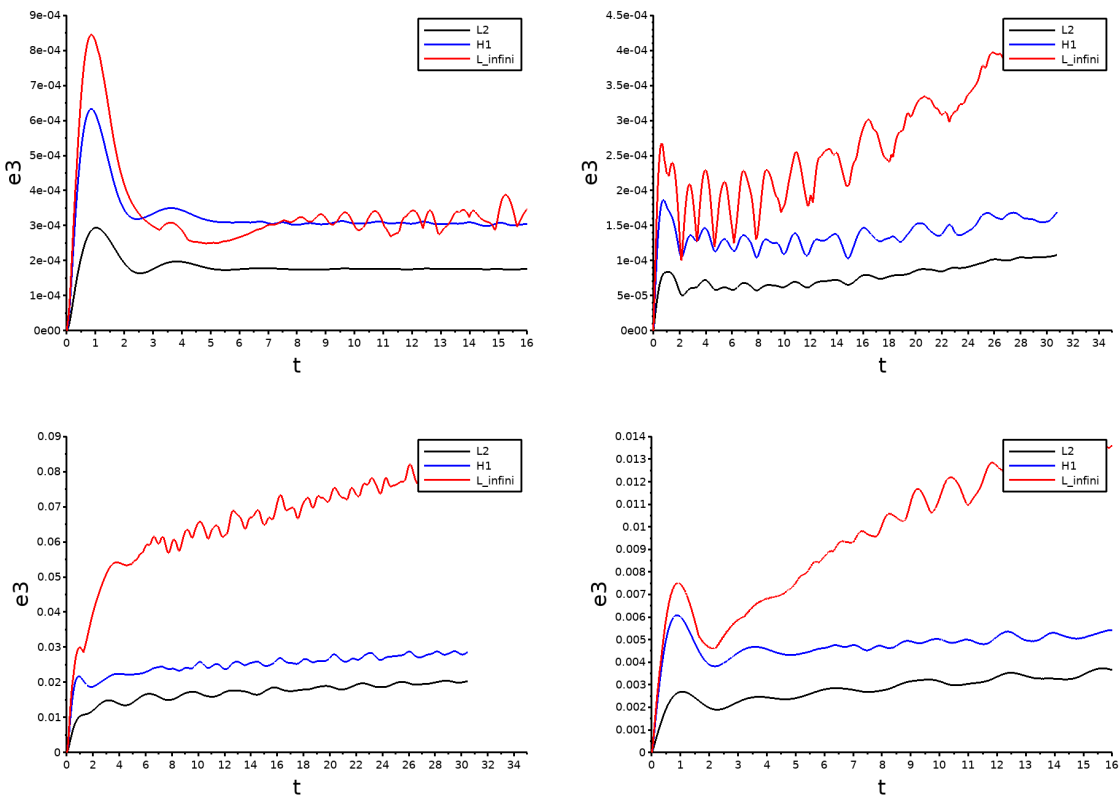

Figure 5.5: Evolution of the error term  $\epsilon_h^3$  along time (from left to right and top to bottom, Test 1 to 4, see Table 5.2).

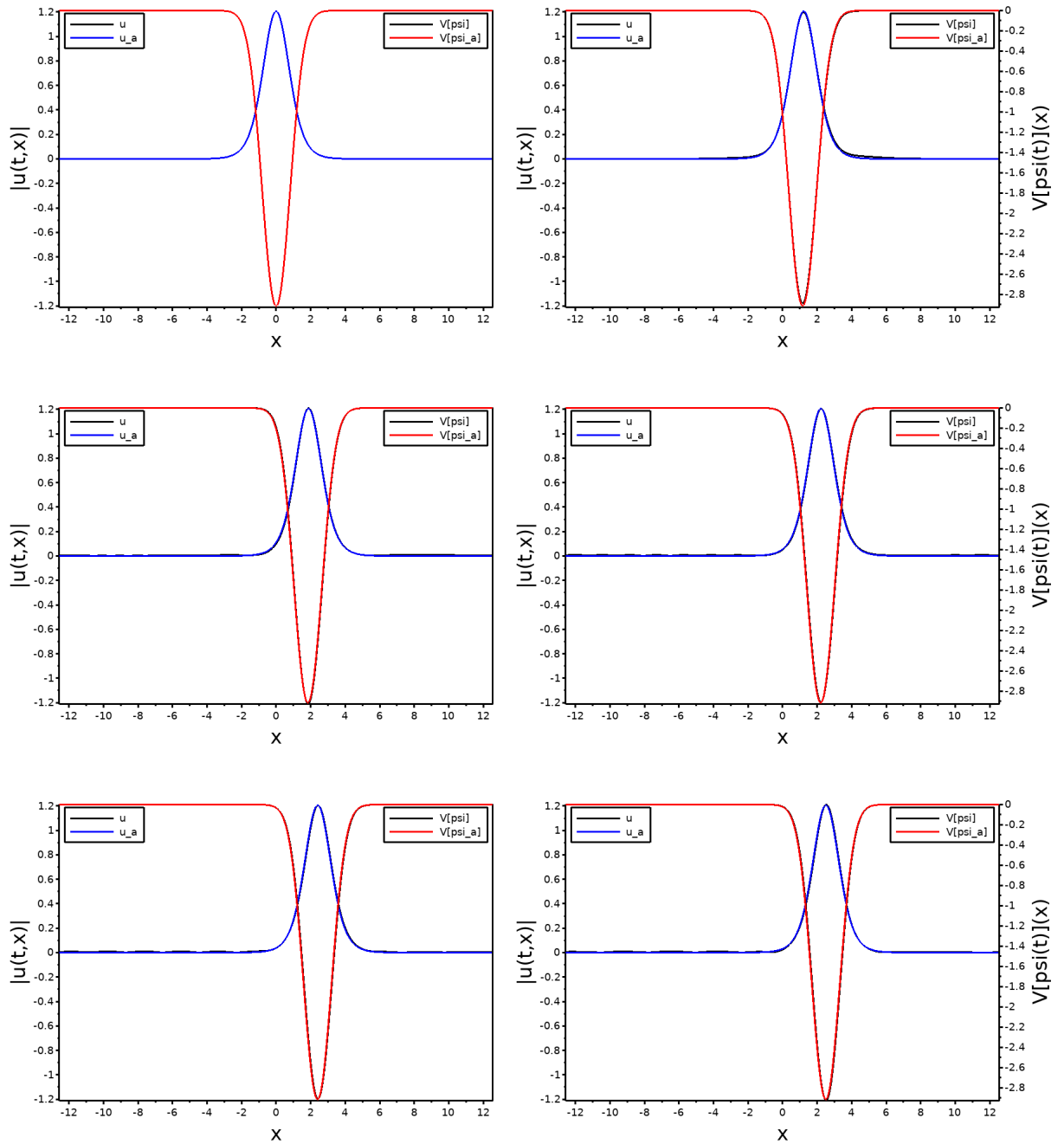

Figure 5.6: Evolution of the modulus of the wave function and of the potential created by the environment and acting on the wave function. From left to right and top to bottom  $t^n = 0, 2, 4, \dots, 10$ .

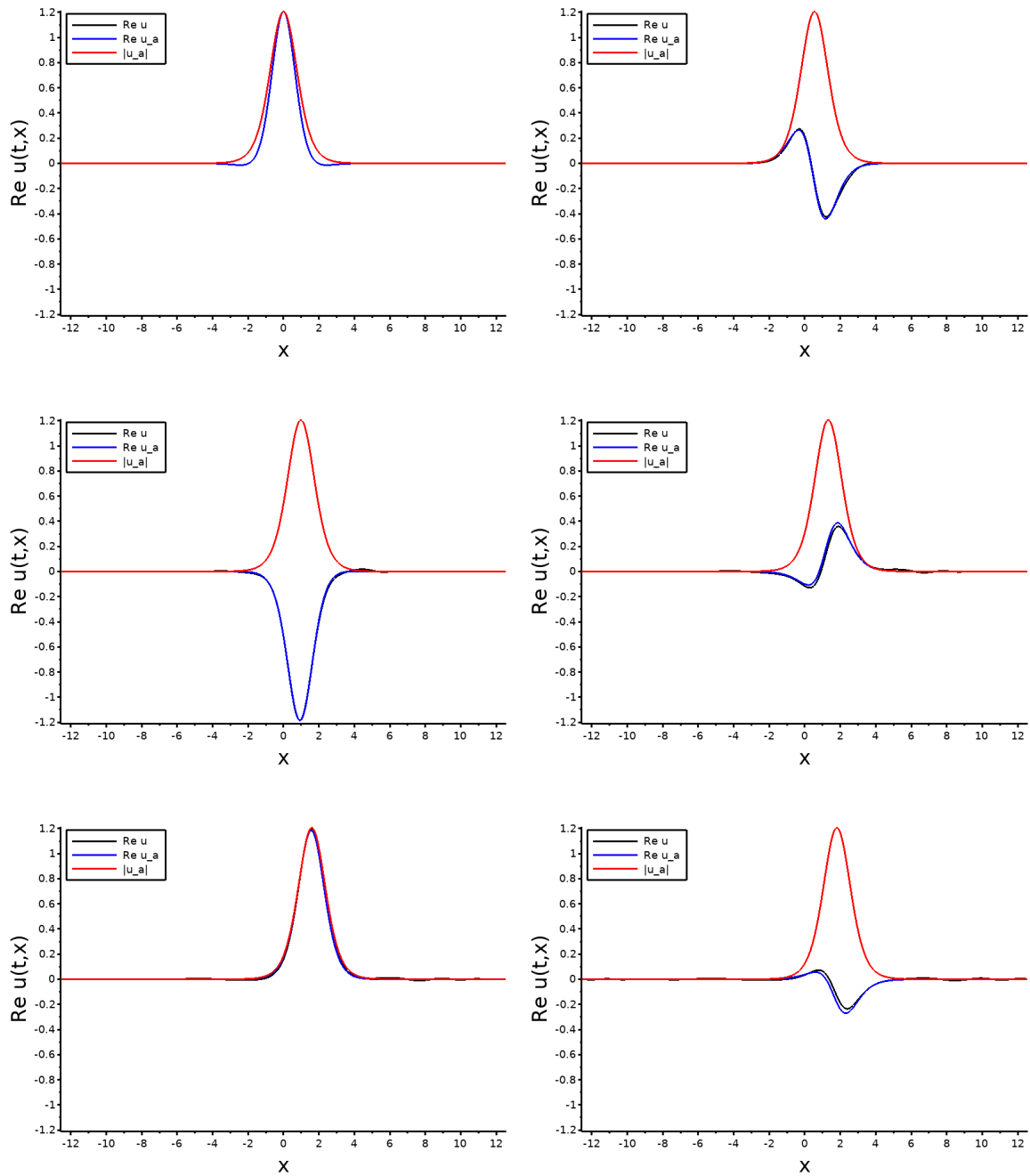

Figure 5.7: Evolution of the real part of the wave function. From left to right and top to bottom  $t^n = 0, 0.75, 1.5, \dots, 3.75$ .

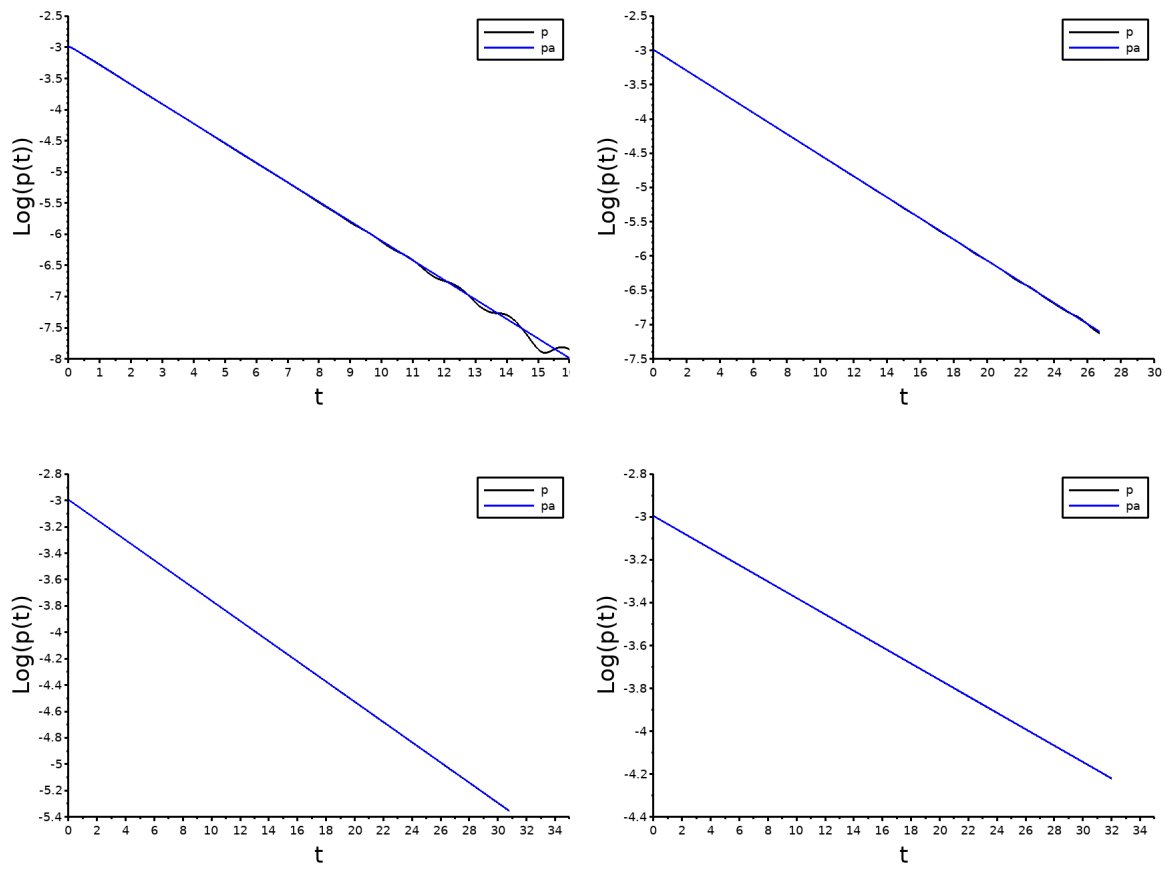

Figure 5.8: Exponential decay of  $p_h^a(t)$  depending on  $c$  and comparison with the exponential decay of  $p_h(t)$  (from left to right and top to bottom, Test 1 to 4, see Table 5.3). Top left we observe that when the ground state is almost stopped the exponential decay of the impulsion  $p_h$  oscillates while the exponential decreasing of  $p_h^a$  does not.

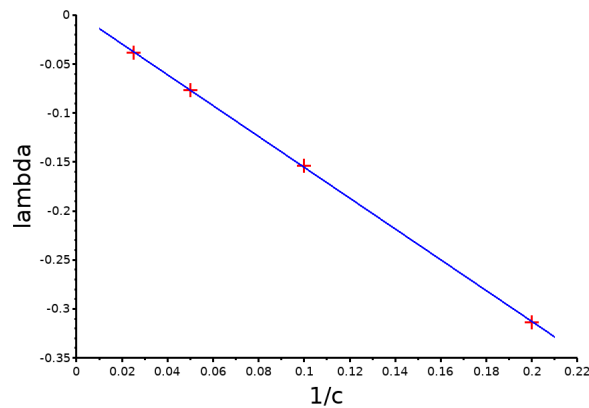

Figure 5.9: Investigation of the proportionality between the exponential decay to zero of  $p_h^a$  and  $1/c$ .

expect that by choosing  $L > 0$  large enough the periodic boundary condition will induce a negligible effect on the computed solutions. This intuition is easily verifiable numerically by performing several numerical simulations with different values of  $L$  and comparing the solutions. Another approach could be to use some transparent boundary conditions [5]. For the Schrödinger equation, even in dimension  $d = 1$ , an exact formula for transparent boundary condition requires the computation of a non local operator; for the sake of simplicity we prefer to work on a sufficiently large computational domain with periodic boundary conditions.

As explained above, it is crucial to consider the wave equation in the three dimensional free space. Thus, we have to take  $n = 3$  and we should pay attention to use transparent or absorbing conditions on the boundaries of the computational domain, in order to reproduce the necessary energy evacuation. In dimension  $n = 1$ , the transparent boundary conditions can be easily identified and computed, but in dimension  $n \geq 2$  exact transparent boundary conditions are more involved and lead to some non local formula. The evaluation of the underlying non local operator is numerically costly [31]. Nevertheless in dimension  $n = 3$ , and for radially symmetric data, there exists a suitable transformation that allows us to reduce the problem to the classical wave equation in dimension  $n = 1$  on the domain  $[0, +\infty)$  with a Dirichlet boundary condition at  $r = 0$ , see e.g. [105]. This is the framework we adopt for the simulations. The form function  $\sigma_2(z) = \tilde{\sigma}_2(|z|)$  is assumed radially symmetric, the initial data  $(\psi_0, \psi_1) = (\Psi, 0)$  where  $\Psi(x, z) = \Gamma(z)(\sigma_1 \star Q^2)(x)$  with  $\Delta_z \Gamma = \sigma_2$  are radially symmetric too. In what follows, we denote  $\Gamma(z) = \tilde{\Gamma}(|z|)$ . Then, the solution  $\psi$  of (5.1b) is radially symmetric with respect to the  $z$ -variable:  $\psi(t, x, z) = \tilde{\psi}(t, x, |z|)$ . Setting  $\chi(t, x, r) = r\tilde{\psi}(t, x, r)$  and using that  $n = 3$  allow us to obtain that  $\chi$  is a solution of the wave equation in dimension one

$$\partial_{tt}^2 \chi - c^2 \partial_{rr}^2 \chi = -c^2 r \tilde{\sigma}_2(r) (\sigma_1 \star |u|^2)(x), \quad t \geq 0, x \in [-L/2, L/2], r \in [0, +\infty), \tag{5.18a}$$

$$(\chi(0, x, r), \partial_t \chi(0, x, r)) = (r \tilde{\Gamma}(r) (\sigma_1 \star Q^2)(x), 0), \tag{5.18b}$$

$$\chi(t, x, 0) = 0. \tag{5.18c}$$

Note that the coupling potential in (5.1a) can be expressed only by means of the new unknown  $\chi$ :

$$\begin{aligned} \phi(t, x) &= \int_{-L/2}^{L/2} \sigma_1(x - y) \left( \int_{\mathbb{R}^3} \psi(t, y, z) dz \right) dy \\ &= 4\pi \int_{-L/2}^{L/2} \sigma_1(x - y) \left( \int_0^{+\infty} r \tilde{\sigma}_2(r) \chi(t, y, r) \right) dy. \end{aligned}$$

Moreover, the potential depends on  $\chi$  only on the support of the function  $\tilde{\sigma}_2$ . Therefore, we have only to compute  $\chi$  on a bounded domain  $[0, R_{max}]$  with  $\text{supp}(\tilde{\sigma}_2) \subset [0, R_{max}]$  and to implement the exact transparent boundary condition on  $r = R_{max}$

$$\partial_t \chi(t, x, R_{max}) + c \partial_r \chi(t, x, R_{max}) = 0.$$

We are thus led to discretize the following system: for every  $t \geq 0, x \in [-L/2, L/2], r \in [0, R_{max}]$

$$i \partial_t u + \frac{1}{2} \Delta_x u = 4\pi \left( \int_{-L/2}^{L/2} \int_0^{R_{max}} \sigma_1(x - y) \tilde{\sigma}_2(r) \chi(t, y, r) dy dr \right) u(t, x), \tag{5.19a}$$

$$u(0, x) = Q(x) \cdot \exp(ip_0 \cdot x/M), \tag{5.19b}$$

$$u(t, -L/2) = u(t, L/2), \tag{5.19c}$$

coupled with

$$\partial_{tt}^2 \chi - c^2 \partial_{rr}^2 \chi = -c^2 r \tilde{\sigma}_2(r) (\sigma_1 \star |u(t)|^2)(x), \quad (5.20a)$$

$$(\chi(0, x, r), \partial_t \chi(0, x, r)) = (r \tilde{\Gamma}(r) (\sigma_1 \star Q^2)(x), 0), \quad (5.20b)$$

$$\chi(t, x, 0) = 0, \quad \partial_t \chi(t, x, R_{max}) + c \partial_r \chi(t, x, R_{max}) = 0. \quad (5.20c)$$

**Remark 5.3.1** (i) *In dimension  $n = 1$ , the D'Alembert formula shows that a solution of the free wave equation is the sum of two profiles, one moving from right to left and another moving from left to right, both at velocity  $c$ . Thus, the part of the wave which goes out the domain  $[-R_{max}, R_{max}]$  satisfies the transport equation  $\partial_t \chi \pm c \partial_r \chi$  at  $r = \pm R_{max}$ . For the equation set on  $[0, +\infty)$  with Dirichlet boundary condition at  $r = 0$ , the part of the wave moving from right to left is reflected at  $r = 0$  and move then from left to right; the part of the wave which travels from left to right goes out the domain at  $r = R_{max}$  where it satisfies the transport equation  $\partial_t \chi + c \partial_x \chi = 0$ . This short argument can be used as an heuristic to justify the boundary condition (5.20c).*

(ii) *However this argument takes only into account the part of the wave which goes out the domain but not the part which goes from the outside to the inside. If the support of the moving profile from right to left is not included in the domain  $[0, R_{max}]$ , then after some time this part of the profile enters in the domain  $[0, R_{max}]$  and modifies the solution. Such an effect cannot be taken into account in a simple way. Indeed the correct boundary condition at  $r = R_{max}$  is  $\partial_t \chi + c \partial_x \chi = f(t)$  where  $f(t)$  is exactly the part of the wave coming from the outside of the domain and entering in it at time  $t$ . Such a boundary condition requires the knowledge of what happens outside of the computational domain, which is precisely disregarded at a numerical level.*

(iii) *This issue disappears when the support of the moving profile is bounded and the computational domain is larger than the support. One can apply the D'Alembert formula in order to prove this condition is fulfilled when the right hand side of the wave equation and the data  $(\chi(0), \partial_t \chi(0))$  have a bounded support. In this case, if the support are included in  $[0, R_{max}]$ , then there is no incoming wave on  $[0, R_{max}]$  and thus  $f(t) = 0$ .*

(iv) *Therefore, we take  $R_{max}$  such that the support of  $\tilde{\sigma}_2$  is included in  $[0, R_{max}]$ : the right hand side of (5.20a) is included in  $[0, R_{max}]$  and does not generate incoming waves. This is also the case for  $\partial_t \chi(0) \equiv 0$  but not for  $\chi(0, x, r) = r \tilde{\Gamma}(r) (\sigma_1 \star Q^2)(x)$ . Indeed since  $\Gamma$  is defined as the solution of  $\Delta_z \Gamma = \sigma_2$  where  $\sigma_2$  is non negative, we know that the support of  $\Gamma$  spreads on the whole space  $\mathbb{R}_z^3$  and the profile  $\tilde{\Gamma}$  decays as  $1/r$ . Thus the coupling of (5.19a)–(5.19c) with (5.20a)–(5.20c) is not equivalent with the coupling of (5.19a)–(5.19c) with (5.18a)–(5.18c).*

(v) *This difficulty is handled as follows. The orbital stability result of Theorem 5.1.1 applies to any initial data close to  $(Q, \Psi, 0)$ . Hence, we can consider an initial data with a small perturbation added to  $\Psi$ . We remark that  $\Psi \in L_x^2 \dot{H}_z^1$  implies*

$$\|\Psi \mathbf{1}_{|z| > R}\|_{L_x^2 \dot{H}_z^1} \xrightarrow{R \rightarrow +\infty} 0.$$

*Thus, for  $R > 0$  sufficiently large,  $\Psi(x, z) \mathbf{1}_{|z| \leq R}$  is a possible initial data. With this initial data the support of  $\chi(0)$  is included in  $[0, R]$ , and there is no incoming wave on the domain  $[0, R]$ . Finally, we can consider the coupling of (5.19a)–(5.19c) and (5.20a)–(5.20c) with  $R_{max} \geq R$ .*

(vi) *As a recap, at the numerical level we have to choose a sufficiently large computational domain for the wave equation in order to be sure that the incoming waves which are not computable have only a small influence on the solution.*

We discretize the system (5.19a)–(5.19c), (5.20a)–(5.20c) as follows. We use the classical Crank-Nicolson scheme to solve the Schrödinger equation. The wave equation is handled with a Finite Element Method (FEM) and the Newmark scheme in time (with parameter  $(d, \theta) = (1/2, 1/4)$ ). We pay attention to the coupling in order to preserve at the discrete level the energy exchange dynamics. Let  $\Delta t > 0$  be the time step. We set  $t^n = n\Delta t$ . We introduce a subdivision

$$0 = r_1 < r_2 < \dots < r_K = R_{\max}$$

of  $[0, R_{\max}]$  and a basis  $(\varphi_1, \dots, \varphi_{\mathcal{K}_K})$  (with  $\mathcal{K}_K \geq K$ ) of polynomial functions associated to this partition and the choice of the family of finite elements. Next, we also define a subdivision of the physical domain

$$-\frac{L}{2} + \frac{\Delta x}{2} = x_1 < \dots < x_i = -\frac{L}{2} + i\frac{\Delta x}{2} < \dots < x_N = \frac{L}{2} - \frac{\Delta x}{2}$$

characterized by the (uniform) space step  $\Delta x$ . We denote  $[x_{i-\frac{1}{2}}, x_{i+\frac{1}{2}}]$  the cell centered at  $x_i$ . The numerical unknowns for the wave equation are denoted  $\chi_{j,k}^n$ ; they define the following approximation  $\chi^n$  of the wave at time  $t^n$

$$\chi^n(x, r) = \sum_{j=1}^N \sum_{k=1}^{\mathcal{K}_k} \chi_{j,k}^n \mathbf{1}_{[x_{j-\frac{1}{2}}, x_{j+\frac{1}{2}}]}(x) \varphi_k(r).$$

It is also convenient to introduce

$$\chi_k^n(x) = \sum_{j=1}^N \chi_{j,k}^n \mathbf{1}_{[x_{j-\frac{1}{2}}, x_{j+\frac{1}{2}}]}(x),$$

so that

$$\chi_{j,k}^n = \frac{1}{\Delta x} \int_{x_{j-\frac{1}{2}}}^{x_{j+\frac{1}{2}}} \chi_k^n(x) dx.$$

We shall denote  $X_x^n$  and  $X_i^n$  the vector in  $\mathbb{R}^{\mathcal{K}_K}$  with components  $\chi_k^n(x)$  and  $\chi_{i,k}^n$ , respectively. Hence, the potential  $\phi$  at time  $t^n$  can be approached by

$$\begin{aligned} \phi^n(x) &= 4\pi \int_{-L/2}^{L/2} \sigma_1(x-y) \left( \int_0^{R_{\max}} r \tilde{\sigma}_2(r) \chi^n(y, r) dr \right) dy \\ &= 4\pi \sum_{j=1}^N \sum_{k=1}^{\mathcal{K}_K} \chi_{j,k}^n \left( \int_{x_{j-\frac{1}{2}}}^{x_{j+\frac{1}{2}}} \sigma_1(x-y) dy \right) \left( \int_0^{R_{\max}} r \tilde{\sigma}_2(r) \varphi_k(r) dr \right), \end{aligned}$$

and we set

$$\phi_j^n = \frac{1}{\Delta x} \int_{x_{j-\frac{1}{2}}}^{x_{j+\frac{1}{2}}} \phi^n(x) dx.$$

Eventually we define the potential  $\phi$  at time  $t^{n+1/2}$  by

$$\phi^{n+\frac{1}{2}} = \frac{\phi^{n+1} + \phi^n}{2}.$$

The numerical unknowns for the Schrödinger equation are denoted  $u_j^n$ ; they define the following approximation  $u^n$  of the wave function at time  $t^n$

$$u^n(x) = \sum_{j=1}^N u_j^n \mathbf{1}_{[x_{j-\frac{1}{2}}, x_{j+\frac{1}{2}}]}(x).$$

We set

$$(|u|^2)^n(x) = u^n(x)\overline{u^n}(x) = \sum_{j=1}^N u_j^n \overline{u_j^n} \mathbf{1}_{[x_{j-\frac{1}{2}}, x_{j+\frac{1}{2}}]}(x),$$

and the approximation of the convolution  $\sigma_1 \star |u|^2$  at time  $t^n$  becomes

$$\left(\sigma_1 \star |u|^2\right)^n(x) = \sigma_1 \star (|u|^2)^n(x) = \sum_{j=1}^N u_j^n \overline{u_j^n} \left( \int_{x_{j-\frac{1}{2}}}^{x_{j+\frac{1}{2}}} \sigma_1(x-y) dy \right).$$

We eventually define the vectors  $G^n(x) = (G_k^n(x))_k$  and  $G_j^n = (G_{j,k}^n)_k \in \mathbb{R}^{\mathcal{K}_K}$  by

$$G_k^n(x) = -c^2 \left(\sigma_1 \star |u|^2\right)^n(x) \left( \int_0^{R_{\max}} r \tilde{\sigma}_2(r) \varphi_k(r) dr \right) \quad \text{and} \quad G_j^n = \frac{1}{\Delta x} \int_{x_{j-\frac{1}{2}}}^{x_{j+\frac{1}{2}}} G^n(x) dx.$$

We are now able to give the discretization of (5.19a)–(5.19c), (5.20a)–(5.20c). Assuming that the quantities  $(\chi_{j,k}^{n-1})_{j,k}$ ,  $(\chi_{j,k}^n)_{j,k}$  and  $(u_j^n)_j$  are already known, we compute  $(\chi_{j,k}^{n+1})_{j,k}$  and  $(u_j^{n+1})_j$  as follows: for every  $j \in \{1, \dots, N\}$

$$\mathcal{M} \frac{X_j^{n+1} - 2X_j^n + X_j^{n-1}}{\Delta t^2} + \mathcal{C} \frac{X_j^{n+1} + X_j^{n-1}}{\Delta t} + \mathcal{R} \left( \frac{1}{4} X_j^{n+1} + \frac{1}{2} X_j^n + \frac{1}{4} X_j^{n-1} \right) = G_j^n, \quad (5.21a)$$

$$i \frac{u_j^{n+1} - u_j^n}{\Delta t} + \frac{1}{4} \frac{u_{j+1}^{n+1} - 2u_j^{n+1} + u_{j-1}^{n+1}}{\Delta x^2} + \frac{1}{4} \frac{u_{j+1}^n - 2u_j^n + u_{j-1}^n}{\Delta x^2} = \phi_j^{n+\frac{1}{2}} \frac{u_j^{n+1} + u_j^n}{2}, \quad (5.21b)$$

where  $\mathcal{M}$ ,  $\mathcal{C}$  and  $\mathcal{R}$  are respectively the mass matrix, the diffusion matrix and the rigidity matrix associated to the chosen FEM. The Dirichlet boundary condition at  $r = 0$  is embodied in the mass matrix whereas the transparent boundary condition at  $r = R_{\max}$  is encoded in the diffusion matrix (the only non zero coefficients of  $\mathcal{C}$  are indeed coming from this boundary condition). The scheme (5.21b) is completed by the periodic boundary condition  $u_0^{n+1} = u_N^{n+1}$  and  $u_{N+1}^{n+1} = u_1^{n+1}$ .

### 5.3.2 Computation of a ground state $(Q, \Psi)$

Let  $H : H_x^1 \rightarrow \mathbb{R}$  be the functional defined by

$$H(u) = \frac{1}{2} \int |\nabla_x u|^2 dx - \frac{\kappa}{2} \iint |u|^2(x) \Sigma(x-y) |u|^2(y) dx dy$$

where  $\Sigma = \sigma_1 \star \sigma_1$  and  $\kappa = \|\nabla_z \Gamma\|_{L_z^2}^2$  (with  $\Delta_z \Gamma = \sigma_2$ ) and let  $K_M$  be the following minimization problem:

$$K_M = \inf \{ H(u) \text{ s.t. } u \in H_x^1 \text{ and } \|u\|_{L_x^2}^2 = M \}.$$

One can prove that  $E(u, \Gamma \sigma_1 \star |u|^2, 0) = H(u)$  (cf the previous Chapter). Thanks to Theorem 5.1.1-i), if  $J_M < 0$  we then get  $K_M = J_M$  and if  $(Q, \Psi)$  is a minimizer of  $J_M$ , then  $K_M = H(Q) = E(Q, \Psi, 0) = J_M$ . Thus, instead of computing a minimizer of  $J_M$  we are going to compute a minimizer of  $K_M$ . To this end, we start by solving the Laplace equation  $\Delta_z \Gamma = \sigma_2$  in order to have an approximation of the parameter  $\kappa$ . Next, we compute an approximation of a minimizer of  $K_M$  and eventually the formula  $\Psi(x, z) = \Gamma(z) \sigma_1 \star Q^2(x)$  provides an approximation of  $\Psi$ .



**Computation of  $\kappa$**

Reasoning as for the wave equation, with the radial symmetry, we set  $\Upsilon(r) = r\tilde{\Gamma}(r)$ . Then, instead of solving the 3d-Laplace equation  $\Delta_z \Gamma = \sigma_2$  it suffices to consider the following 1d-Laplace equation on  $[0, +\infty)$

$$\partial_{rr}^2 \Upsilon(r) = r\tilde{\sigma}_2 r, \quad \Upsilon(0) = 0, \quad \Upsilon(r) \xrightarrow[r \rightarrow +\infty]{} 0. \tag{5.22}$$

One possible strategy to solve numerically this equation is to mix a FEM on a bounded domain  $[0, R_{max}]$  with an Infinite Element Method on the unbounded domain  $[R_{max}, +\infty)$ , see for example [44] and [45]. However, this equation has to be solved only once and instead we exploit the solver for the wave equation in dimension one endowed with the Dirichlet boundary condition at  $r = 0$  and an exact transparent boundary condition at  $r = R_{max}$ . Namely, we solve the wave equation

$$\partial_{tt}^2 \chi - c^2 \partial_{rr}^2 \chi = -c^2 r \tilde{\sigma}_2(r), \quad t \geq 0, r \in [0, R_{max}], \tag{5.23a}$$

$$(\chi(0, r), \partial_t \chi(0, r)) = (0, 0), \quad r \in [0, R_{max}] \tag{5.23b}$$

$$\chi(t, 0) = 0, \quad \partial_t \chi(t, R_{max}) + c \partial_r \chi(t, R_{max}) = 0, \quad t \geq 0. \tag{5.23c}$$

on a time interval  $[0, T_f]$  sufficiently large so that the final solution  $\chi(T_f, r)$  is a good approximation of  $\Upsilon(r)$  for  $r \in [0, R_{max}]$ , since we know that  $\chi(t) \rightarrow \Upsilon$  as  $t \rightarrow +\infty$ . We solve (5.23a)–(5.23c) with the classical Newmark scheme (5.21a). Here the unknown  $X^n$  does not depend on the index  $j$  since the considered wave equation does not depend on  $x$  and the right hand side is the constant vector  $G = (G_k)_k \in \mathbb{R}^{\mathcal{K}_K}$  defined by

$$G_k = \int_0^{R_{max}} r \tilde{\sigma}_2(r) \varphi_k(r) dr.$$

Let

$$\Upsilon_h(r) = \sum_{k=1}^{\mathcal{K}_K} \Upsilon_k \varphi_k(r)$$

be the computed approximation of  $\Upsilon(r)$  on  $[0, R_{max}]$  and  $V$  be the vector with component  $(\Upsilon_k)_k$ . Since  $\kappa = 4\pi \int_0^{+\infty} |\partial_r \Upsilon(r)|^2 dr$  we obtain the following approximation of  $\kappa$ :

$$\kappa_h = 4\pi \int_0^{R_{max}} |\partial_r \Upsilon_h(r)|^2 dr = \frac{4\pi}{c^2} \langle \mathcal{R}V, V \rangle.$$

The accuracy of the approximation of  $\kappa$  is quite sensitive to the size of the computational domain:  $R_{max}$  should be chosen sufficiently large. In practice we compute  $\kappa_h$  for an increasing sequence of  $R_{max}^i$  and we consider the criterion  $|\kappa_h^{i+1} - \kappa_h^i| \ll 1$  in order to detect when the size of the computational domain is sufficiently large.

**Computation of  $Q$**

In order to compute a minimizer of  $K_M$  we appeal to the *imaginary time* method (see for example [6, 8] and the references therein). It consists in solving the following heat equation

$$\partial_t v - \frac{1}{2} \Delta_x v + \omega(v)v - \kappa(\Sigma \star |v|^2)v = 0, \quad t \geq 0, x \in \mathbb{R}^d, \tag{5.24a}$$

$$\omega(v) = -\frac{1}{\|v\|_{L_x^2}^2} \left( \frac{1}{2} \int |\nabla_x v|^2 dx - \kappa \iint |v|^2(x) \Sigma(x-y) |v|^2(y) dx dy \right), \tag{5.24b}$$

$$v(0, x) = v_0(x), \quad \|v_0\|_{L_x^2}^2 = M, \quad x \in \mathbb{R}^d. \tag{5.24c}$$

A stationary solution of (5.24a) is a solution of the Choquard equation (5.7) and a direct computation shows that

$$\frac{d}{dt} \|v(t)\|_{L_x^2}^2 = 0 \quad \text{and} \quad \frac{d}{dt} H(v(t)) = -2 \|\partial_t v(t)\|_{L_x^2}^2 \leq 0.$$

Thus, when  $t$  goes to  $+\infty$  the solution  $v(t)$  converges to a (at least local) minimizer of  $K_M$ . We solve numerically (5.24a)–(5.24c) in dimension  $d = 1$  and on a bounded domain  $[-L/2, L/2]$  endowed with Dirichlet boundary conditions. Since a ground state  $Q$  of  $K_M$  decays exponentially fast, if  $L$  is chosen sufficiently large, this leads to small errors on the computed ground state  $Q_h$ . We solve the heat equation with a semi-Crank-Nicolson scheme: for every  $j \in \{1, \dots, N\}$

$$\begin{aligned} \frac{\widetilde{v_j^{n+1}} - v_j^n}{\Delta t} - \frac{1}{4} \frac{\widetilde{v_{j+1}^{n+1}} - 2\widetilde{v_j^{n+1}} + \widetilde{v_{j-1}^{n+1}}}{\Delta x^2} - \frac{1}{4} \frac{v_{j+1}^n - 2v_j^n + v_{j-1}^n}{\Delta x^2} \\ + \omega^n \frac{\widetilde{v_j^{n+1}} + v_j^n}{2} - \kappa \Phi_j^n \frac{\widetilde{v_j^{n+1}} + v_j^n}{2} = 0, \end{aligned}$$

with the Dirichlet boundary condition  $v_0^n = 0 = v_{N+1}^n$  and where

$$\Phi_j^n = \frac{1}{\Delta x} \sum_{j'=1}^N v_{j'}^n v_j^n \left( \int_{x_{j-\frac{1}{2}}}^{x_{j+\frac{1}{2}}} \int_{x_{j'-\frac{1}{2}}}^{x_{j'+\frac{1}{2}}} \Sigma(x-y) dx dy \right).$$

Since this scheme does not preserve the discrete mass we renormalize

$$v_j^{n+1} = \frac{\sqrt{M}}{\sqrt{\Delta x \sum_{i=1}^N \widetilde{v_i^{n+1}} v_i^{n+1}}} \widetilde{v_j^{n+1}},$$

and we eventually compute the new Lagrange multiplier  $\omega^{n+1}$ :

$$\omega^{n+1} = -\frac{1}{M} \left( \frac{\Delta x}{2} \sum_{j=1}^N \frac{v_{j+1}^{n+1} - v_j^{n+1}}{\Delta x} \cdot \frac{v_{j+1}^{n+1} - v_j^{n+1}}{\Delta x} - \kappa \Delta x \sum_{j=1}^N \Phi_j^{n+1} v_j^{n+1} v_j^{n+1} \right).$$

As in the continuous case, we observe numerically (see Figure 5.2) that the discrete energy

$$H^n = \frac{\Delta x}{2} \sum_{j=1}^N \frac{v_{j+1}^{n+1} - v_j^{n+1}}{\Delta x} \cdot \frac{v_{j+1}^{n+1} - v_j^{n+1}}{\Delta x} - \kappa \frac{\Delta x}{2} \sum_{j=1}^N \Phi_j^n v_j^n v_j^n \quad (5.25)$$

decays along time.

## 5.4 Discrete properties of the scheme

As stated in the introduction the Schrödinger-Wave system conserves the mass of the wave function, the total energy (5.3) and the total momentum of the system (5.4). It is then natural to ask that the scheme preserves the same discrete quantities. However the Schrödinger-Wave equation is a system where the wave function  $u$  exchanges energy with the environment  $\psi$  and it might be possible that at the discrete level a scheme preserves the discrete energy of the total system but such that the energy exchanges between the wave function and the

environment are not consistent with the energy exchanges at the continuum level. Thus, first and foremost, a good scheme should be consistent with the energy exchanges. It can be difficult to construct a scheme which is consistent with both the energy and momentum exchanges. As we shall see below, the scheme we propose, primarily targeted on the energy balance, does not conserve the total momentum.

In order to specify what we mean by *consistency with the energy exchanges*, let us go back to the basic energetic properties of the Schrödinger-Wave system. If  $\chi$  is the solution of a wave equation of the form

$$\partial_{tt}^2 \chi - c^2 \partial_{rr}^2 \chi = c^2 f,$$

then the energy of  $\chi$  defined by

$$E_{\text{wave}}(t) = 4\pi \iint \left( \frac{1}{2c^2} |\partial_t \chi(t, x, r)|^2 + \frac{1}{2} |\partial_r \chi(t, x, r)|^2 \right) dx dr,$$

satisfies

$$\frac{d}{dt} E_{\text{wave}}(t) = 4\pi \iint \partial_t \chi(t, x, r) f(t, x, r) dx dr.$$

In particular the energy is conserved when  $f = 0$ . If  $u$  is a solution of a Schrödinger equation of the form

$$i\partial_t u + \frac{1}{2} \Delta_x u = \phi u,$$

(where  $\phi$  is a real-valued potential) then the energy of  $u$  defined by

$$E_{\text{schro}}(t) = \frac{1}{2} \int |\nabla_x u(t, x)|^2 dx + \int \phi(t, x) |u(t, x)|^2 dx$$

satisfies

$$\frac{d}{dt} E_{\text{schro}}(t) = \int \partial_t \phi(t, x) |u(t, x)|^2 dx.$$

In particular the energy is conserved when  $\phi$  is a stationary potential. Going back to the Schrödinger-Wave system, the total energy  $E_{\text{tot}} = E_{\text{wave}} + E_{\text{schro}}$  is conserved because the source term  $f$  of the wave equation and the time-dependent potential  $\phi$  fulfil the cancellation property

$$4\pi \iint \partial_t \chi(t, x, r) f(t, x, r) dx dr + \int \partial_t \phi(t, x) |u(t, x)|^2 dx = 0.$$

Therefore an energetically relevant scheme for the Schrödinger-Wave equation should satisfy the following basic requirements:

- (i) the scheme for the wave equation conserves the analog of  $E_{\text{wave}}$  when the source term  $f$  vanishes,
- (ii) the scheme for the Schrödinger equation conserves the discrete mass when the potential  $\phi$  is real-valued and the discrete analog of  $E_{\text{schro}}$  when the potential  $\phi$  does not depend on time,
- (iii) the discrete coupling is such that the contributions from the analog of  $\int \partial_t \phi(t) |u(t)|^2 dx$  and  $4\pi \iint \partial_t \chi(t) f(t) dx dr$  cancel out.

We are going to check that the scheme (5.21a)–(5.21b) satisfies these three requirements. To this end, let us introduce a few notations. Let  $D$  be the discrete time derivative operator

$$(Da^n) = \frac{a^{n+1} - a^n}{\Delta t}$$

and let  $\nabla^d$  be the discrete periodic gradient operator which associates to a real valued sequence  $(b_j)_{1 \leq j \leq N}$  the sequence defined by

$$\left(\nabla^d b\right)_{j+1/2} = \frac{b_{j+1} - b_j}{\Delta x}, \quad b_0 = b_N \quad \text{and} \quad b_{N+1} = b_1.$$

In the sequel we will repeatedly use the following discrete integration by part formula

$$\sum_{j=1}^N \left(\nabla^d a\right)_{j-1/2} b_j = - \sum_{j=1}^N a_j \left(\nabla^d b\right)_{j+1/2}. \quad (5.26)$$

The discrete mass of the wave function  $u$  at time  $t^n$  is given by

$$M^n = \int_{-L/2}^{L/2} |u^n(x)|^2 dx = \Delta x \sum_{j=1}^N u_j^n \overline{u_j^n}.$$

We define the following discrete energies at time  $t^n$ :

$$E_{\text{schro}}^n = \frac{\Delta x}{2} \sum_{j=1}^N (\nabla^d u^n)_{j+1/2} (\nabla^d \overline{u^n})_{j+1/2} + \Delta x \sum_{j=1}^N \phi_j^{n+\frac{1}{2}} u_j^n \overline{u_j^n}$$

and

$$\begin{aligned} E_{\text{wave}}^n &= \frac{4\pi}{2c^2} \int_{-L/2}^{L/2} \int_0^{R_{\text{max}}} |D\chi^n(x, r)|^2 dx dr + \frac{4\pi}{2} \int_{-L/2}^{L/2} \int_0^{R_{\text{max}}} \left| \partial_r \chi^{n+\frac{1}{2}}(x, r) \right|^2 dx dr \\ &= \frac{2\pi\Delta x}{c^2} \sum_{j=1}^N \left\langle \mathcal{M} \frac{X_j^{n+1} - X_j^n}{\Delta t}, \frac{X_j^{n+1} - X_j^n}{\Delta t} \right\rangle + \frac{2\pi\Delta x}{c^2} \sum_{j=1}^N \left\langle \mathcal{R} \frac{X_j^{n+1} + X_j^n}{2}, \frac{X_j^{n+1} + X_j^n}{2} \right\rangle, \end{aligned}$$

where  $\chi^{n+\frac{1}{2}} = (\chi^{n+1} + \chi^n)/2$ .

**Theorem 5.4.1** *Assume that for every  $m \in \mathbb{N}$ ,  $\mathcal{C}X_j^m = 0$ . Then, the scheme (5.21a)–(5.21b) conserves the discrete mass  $M^n$  and the discrete total energy  $E_{\text{tot}}^n = E_{\text{schro}}^n + E_{\text{wave}}^n$ . Moreover the scheme is consistent for the energy exchange, that means*

$$\int_{-L/2}^{L/2} D\phi^{n+\frac{1}{2}}(x) |u^{n+1}(x)|^2 dx + DE_{\text{wave}}^n = 0.$$

**Remark 5.4.2** *The assumption  $\mathcal{C}X_j^m = 0$  means that the wave does not cross the boundary of the computational domain. We have to make this assumption since the part of the wave which goes out of the computational domain does not contribute anymore to the total energy (see the definition of  $E_{\text{wave}}^n$ ), and thus the discrete energy cannot be conserved. In practice this is not an issue since the energy that goes away the computational domain can be explicitly computed and incorporated in the energy balance.*

Before we detail the proof of this statement, let us say a few words on the discrete mass center and impulsion of the wave function  $u$ . The discrete mass of the wave function  $u$  is conserved and we denote by  $M = M^n$  its value. Then the discrete center of mass of the wave function is defined by

$$q^n = \frac{1}{M} \int_{-L/2}^{L/2} x |u^n(x)|^2 dx = \frac{\Delta x}{M} \sum_{j=1}^N x_j u_j^n \overline{u_j^n}.$$

In order to define the discrete impulsion of the wave function we need to define its discrete gradient. To this end, we bear in mind that we have adopted a Finite Volume approach to discretize (5.1a), with a numerical unknown constant over the cells  $C_j = [x_{j-\frac{1}{2}}, x_{j+\frac{1}{2}}]$ . Hence, the discrete gradient is naturally thought of as the piecewise constant function on the staggered grid  $C_{j+1/2} = [x_j, x_{j+1}]$ :

$$(\partial_x u)^n(x) = \sum_{j=1}^N (\nabla^d u^n)_{j+1/2} \mathbf{1}_{[x_j, x_{j+1}]}(x), \quad (\nabla^d u^n)_{j+1/2} = \frac{u_{j+1}^n - u_j^n}{\Delta x}.$$

This definition is consistent with the discrete Laplacian on  $C_j$ , with  $(\Delta^d u)_j = \frac{1}{\Delta x}(\nabla^d u_{j+1/2} - \nabla^d u_{j-1/2})$ , which can be seen as a combination of  $\nabla^d$ 's operators defined on the twin grids. Accordingly, the discrete impulsion of the wave function is defined by

$$p^n = \text{Im} \int_{-L/2}^{L/2} (\partial_x u)^n(x) \overline{u^n(x)} dx = \Delta x \text{Im} \sum_{j=1}^N (\nabla^c u^n)_j \overline{u_j^n}$$

where  $(\nabla^c b)_j = \frac{1}{2}[(\nabla^d b)_{j-1/2} + (\nabla^d b)_{j+1/2}]$  is the discrete periodic centered-gradient operator at  $x_j$ . Another justification for this definition is that at the continuous level the quantity  $\int \nabla_x u \bar{u} dx$  is purely imaginary. This property is conserved at the discrete level when the periodic centered-gradient operator is taken but it fails with the periodic right or left-gradient operators. It is also worth remarking that the energy  $E_{\text{schro}}^n$  can be rewritten as

$$E_{\text{schro}}^n = \frac{1}{2} \int_{-L/2}^{L/2} |(\partial_x u)^n(x)|^2 dx + \int_{-L/2}^{L/2} \phi^{n+\frac{1}{2}}(x) |u^n(x)|^2 dx.$$

The discrete center of mass satisfies the following relation

$$M \frac{q^{n+1} - q^n}{\Delta t} = \Delta x \text{Im} \sum_{j=1}^N \left( \nabla^d \frac{u^{n+1} + u^n}{2} \right)_{j+1/2} \frac{\overline{u_{j+1}^{n+1}} + \overline{u_{j+1}^n}}{2}.$$

The right hand side depends on both  $u^n$  and  $u^{n+1}$ , the latter being computed from  $u^n$  by (5.21b). We observe that

$$\begin{aligned} & \text{Im} \left\{ \sum_{j=1}^N \left( \nabla^d \frac{u^{n+1} + u^n}{2} \right)_{j+1/2} \frac{\overline{u_{j+1}^{n+1}} + \overline{u_{j+1}^n}}{2} \right\} \\ &= \frac{1}{4\Delta x} \text{Im} \left\{ \sum_{j=1}^N (u_{j+1}^{n+1} + u_{j+1}^n - u_j^{n+1} - u_j^n) (\overline{u_{j+1}^{n+1}} + \overline{u_{j+1}^n}) \right\} \\ &= -\frac{1}{4\Delta x} \text{Im} \left\{ \sum_{j=1}^N (u_j^{n+1} + u_j^n) (\overline{u_{j+1}^{n+1}} + \overline{u_{j+1}^n}) \right\} \\ &= +\frac{1}{4\Delta x} \text{Im} \left\{ \sum_{j=1}^N (\overline{u_j^{n+1}} + \overline{u_j^n}) (u_{j+1}^{n+1} + u_{j+1}^n) \right\} \\ &= +\frac{1}{4\Delta x} \text{Im} \left\{ \sum_{j=1}^N (\overline{u_j^{n+1}} + \overline{u_j^n}) (u_{j+1}^{n+1} + u_{j+1}^n - u_j^{n+1} - u_j^n) \right\} \\ &= \text{Im} \sum_{j=1}^N \left( \nabla^d \frac{u^{n+1} + u^n}{2} \right)_{j+1/2} \frac{\overline{u_j^{n+1}} + \overline{u_j^n}}{2} = \text{Im} \sum_{j=1}^N \left( \nabla^c \frac{u^{n+1} + u^n}{2} \right)_j \frac{\overline{u_j^{n+1}} + \overline{u_j^n}}{2} \end{aligned}$$

and the evolution of the center of mass can be recast as follows:

$$M \frac{q^{n+1} - q^n}{\Delta t} = \text{Im} \int_{L/2}^{L/2} \frac{(\partial_x u)^{n+1}(x) + (\partial_x u)^n(x) \overline{u^{n+1}(x)} + \overline{u^n(x)}}{2} dx.$$

For the discrete impulsion, we have

$$\frac{p^{n+1} - p^n}{\Delta t} = -\Delta_x \text{Re} \sum_{j=1}^N (\nabla^d \phi^{n+\frac{1}{2}})_{j+1/2} \frac{u_{j+1}^{n+1} + u_{j+1}^n}{2} \frac{\overline{u_j^{n+1}} + \overline{u_j^n}}{2}.$$

**Remark 5.4.3** *The shift index comes from the fact that at the discrete level the Leibniz formula for the derivative of a product is not satisfied. Moreover the time discretization of the wave equation seems not to be adapted to the conservation of the discrete total momentum of the system. This is not due to the choice of the space discretization, but to the choice of time discretization. The time discretization of both equations and the treatment of the coupling are constructed in order to ensure the conservation of the discrete total energy of the system, which is hardly compatible with the conservation of the discrete total momentum.*

**Proof of Theorem 5.4.1.** We begin with the mass conservation:

$$DM^n = \frac{M^{n+1} - M^n}{\Delta t} = \Delta x \sum_{j=1}^N \frac{u_j^{n+1} - u_j^n}{\Delta t} \frac{\overline{u_j^{n+1}}}{u_j^{n+1}} + \Delta x \sum_{j=1}^N u_j^n \frac{\overline{u_j^{n+1}} - \overline{u_j^n}}{\Delta t}.$$

Coming back to (5.21b) we have on the one hand

$$\frac{u_j^{n+1} - u_j^n}{\Delta t} = \frac{i}{2} (\Delta^d u^{n+1})_j + \frac{i}{2} (\Delta^d u^n)_j - i \phi_j^{n+\frac{1}{2}} \frac{u_j^{n+1} + u_j^n}{2}$$

and on the other hand

$$\frac{\overline{u_j^{n+1}} - \overline{u_j^n}}{\Delta t} = -\frac{i}{2} (\Delta^d \overline{u^{n+1}})_j - \frac{i}{2} (\Delta^d \overline{u^n})_j + i \phi_j^{n+\frac{1}{2}} \frac{\overline{u_j^{n+1}} + \overline{u_j^n}}{2}.$$

Then, thanks to the discrete integration by part property (5.26) we get

$$\begin{aligned} \Delta x \sum_{j=1}^N \frac{u_j^{n+1} - u_j^n}{\Delta t} \frac{\overline{u_j^{n+1}}}{u_j^{n+1}} \\ = -\frac{i\Delta x}{2} \sum_{j=1}^N \left[ (\nabla^d u^{n+1})_{j+1/2} (\nabla^d \overline{u^{n+1}})_{j+1/2} + (\nabla^d u^n)_{j+1/2} (\nabla^d \overline{u^{n+1}})_{j+1/2} \right] \\ - \frac{i\Delta x}{2} \sum_{j=1}^N \phi_j^{n+\frac{1}{2}} (u_j^{n+1} \overline{u_j^{n+1}} + u_j^n \overline{u_j^{n+1}}) \end{aligned}$$

and

$$\begin{aligned} \Delta x \sum_{j=1}^N u_j^n \frac{\overline{u_j^{n+1}} - \overline{u_j^n}}{\Delta t} \\ = \frac{i\Delta x}{2} \sum_{j=1}^N \left[ (\nabla^d u^n)_{j+1/2} (\nabla^d \overline{u^{n+1}})_{j+1/2} + (\nabla^d u^n)_{j+1/2} (\nabla^d \overline{u^n})_{j+1/2} \right] \\ + \frac{i\Delta x}{2} \sum_{j=1}^N \phi_j^{n+\frac{1}{2}} (u_j^n \overline{u_j^{n+1}} + u_j^n \overline{u_j^n}) \end{aligned}$$

Eventually, gathering these two identities leads to

$$DM^n = -\frac{i\Delta x}{2} \sum_{j=1}^N \left[ \left( \nabla^d u^{n+1} \right)_{j+1/2} \left( \nabla^d \overline{u^{n+1}} \right)_{j+1/2} - \left( \nabla^d u^n \right)_{j+1/2} \left( \nabla^d \overline{u^n} \right)_{j+1/2} \right] - \frac{i\Delta x}{2} \sum_{j=1}^N \phi_j^{n+\frac{1}{2}} \left( u_j^{n+1} \overline{u_j^{n+1}} - u_j^n \overline{u_j^n} \right).$$

From here, since  $DM^n$  is a real number, we directly get the discrete mass conservation and we get for free that the discrete quantity

$$\begin{aligned} & \int_{-L/2}^{L/2} D |(\partial_x u^n)(x)|^2 + \phi^{n+\frac{1}{2}}(x) D |u^n(x)|^2 dx \\ &= \frac{\Delta x}{\Delta t} \sum_{j=1}^N \left[ \left( \nabla^d u^{n+1} \right)_{j+1/2} \left( \nabla^d \overline{u^{n+1}} \right)_{j+1/2} + \phi_j^{n+\frac{1}{2}} u_j^{n+1} \overline{u_j^{n+1}} \right] \\ & - \frac{\Delta x}{\Delta t} \sum_{j=1}^N \left[ \left( \nabla^d u^n \right)_{j+1/2} \left( \nabla^d \overline{u^n} \right)_{j+1/2} + \phi_j^{n+\frac{1}{2}} u_j^n \overline{u_j^n} \right] = -\frac{2}{\Delta t} \text{Im}(DM^n) = 0 \end{aligned}$$

is conserved by the scheme. This exactly means that the Crank-Nicolson scheme preserves the discrete mass and energy of any Schrödinger equation with a real and constant in time potential  $\phi = \phi(x)$ . Since

$$DE_{\text{schro}}^n = \int_{-L/2}^{L/2} D |(\partial_x u^n)(x)|^2 + \phi^{n+\frac{1}{2}}(x) D |u^n(x)|^2 dx + \int_{-L/2}^{L/2} D \phi^{n+\frac{1}{2}}(x) |u^{n+1}(x)|^2 dx,$$

the scheme preserves the discrete total energy  $E_{\text{tot}}^n$  if and only if it is consistent with the discrete energy exchange, that means

$$\int_{-L/2}^{L/2} D \phi^{n+\frac{1}{2}}(x) |u^{n+1}(x)|^2 dx + D E_{\text{wave}}^n = 0.$$

Let us compute the discrete time derivative of  $E_{\text{wave}}^n$ . For that purpose we rewrite (5.21a) as follows (the assumptions insure that the term of the form  $\mathcal{C}X_j^m$  are equal to zero)

$$\mathcal{M} \frac{X_j^{n+1} - X_j^n}{\Delta t^2} = \mathcal{M} \frac{X_j^n - X_j^{n-1}}{\Delta t^2} - \mathcal{R} \left( \frac{1}{4} X_j^{n+1} + \frac{1}{2} X_j^n + \frac{1}{4} X_j^{n-1} \right) + G_j^n$$

and we take the scalar product of this quantity against the vector  $X_j^{n+1} - X_j^n$

$$\begin{aligned} \left\langle \mathcal{M} \frac{X_j^{n+1} - X_j^n}{\Delta t}, \frac{X_j^{n+1} - X_j^n}{\Delta t} \right\rangle &= \left\langle \mathcal{M} \frac{X_j^n - X_j^{n-1}}{\Delta t}, \frac{X_j^{n+1} - X_j^n}{\Delta t} \right\rangle \\ & - \left\langle \mathcal{R} \left( \frac{1}{4} X_j^{n+1} + \frac{1}{2} X_j^n + \frac{1}{4} X_j^{n-1} \right), X_j^{n+1} - X_j^n \right\rangle + \langle G_j^n, X_j^{n+1} - X_j^n \rangle. \end{aligned}$$

Besides, since the mass matrix  $\mathcal{M}$  is symmetric

$$\left\langle \mathcal{M} \frac{X_j^n - X_j^{n-1}}{\Delta t}, \frac{X_j^{n+1} - X_j^n}{\Delta t} \right\rangle = \left\langle \mathcal{M} \frac{X_j^{n+1} - X_j^n}{\Delta t^2}, X_j^n - X_j^{n-1} \right\rangle,$$

we also get (by taking the scalar product against the vector  $X_j^n - X_j^{n-1}$ )

$$\begin{aligned} \left\langle \mathcal{M} \frac{X_j^n - X_j^{n-1}}{\Delta t}, \frac{X_j^{n+1} - X_j^n}{\Delta t} \right\rangle &= \left\langle \mathcal{M} \frac{X_j^n - X_j^{n-1}}{\Delta t}, \frac{X_j^n - X_j^{n-1}}{\Delta t} \right\rangle \\ &\quad - \left\langle \mathcal{R} \left( \frac{1}{4} X_j^{n+1} + \frac{1}{2} X_j^n + \frac{1}{4} X_j^{n-1} \right), X_j^n - X_j^{n-1} \right\rangle + \langle G_j^n, X_j^n - X_j^{n-1} \rangle. \end{aligned}$$

Gathering these two identities leads to

$$\begin{aligned} \left\langle \mathcal{M} \frac{X_j^{n+1} - X_j^n}{\Delta t}, \frac{X_j^{n+1} - X_j^n}{\Delta t} \right\rangle &= \left\langle \mathcal{M} \frac{X_j^n - X_j^{n-1}}{\Delta t}, \frac{X_j^n - X_j^{n-1}}{\Delta t} \right\rangle \\ &\quad - \left\langle \mathcal{R} \left( \frac{1}{4} X_j^{n+1} + \frac{1}{2} X_j^n + \frac{1}{4} X_j^{n-1} \right), X_j^{n+1} - X_j^{n-1} \right\rangle + \langle G_j^n, X_j^{n+1} - X_j^{n-1} \rangle. \end{aligned}$$

Since

$$\begin{aligned} &\left\langle \mathcal{R} \left( \frac{1}{4} X_j^{n+1} + \frac{1}{2} X_j^n + \frac{1}{4} X_j^{n-1} \right), X_j^{n+1} - X_j^{n-1} \right\rangle \\ &= \left\langle \mathcal{R} \left( \frac{X_j^{n+1} + X_j^n}{2} + \frac{X_j^n + X_j^{n-1}}{2} \right), \frac{X_j^{n+1} - X_j^n}{2} - \frac{X_j^n + X_j^{n-1}}{2} \right\rangle \\ &= \left\langle \mathcal{R} \frac{X_j^{n+1} + X_j^n}{2}, \frac{X_j^{n+1} + X_j^n}{2} \right\rangle - \left\langle \mathcal{R} \frac{X_j^n + X_j^{n-1}}{2}, \frac{X_j^n + X_j^{n-1}}{2} \right\rangle \end{aligned}$$

we eventually obtain the following relation

$$\begin{aligned} &\left\langle \mathcal{M} \frac{X_j^{n+1} - X_j^n}{\Delta t}, \frac{X_j^{n+1} - X_j^n}{\Delta t} \right\rangle + \left\langle \mathcal{R} \frac{X_j^{n+1} + X_j^n}{2}, \frac{X_j^{n+1} + X_j^n}{2} \right\rangle \\ &= \left\langle \mathcal{M} \frac{X_j^n - X_j^{n-1}}{\Delta t}, \frac{X_j^n - X_j^{n-1}}{\Delta t} \right\rangle + \left\langle \mathcal{R} \frac{X_j^n + X_j^{n-1}}{2}, \frac{X_j^n + X_j^{n-1}}{2} \right\rangle + \langle G_j^n, X_j^{n+1} - X_j^{n-1} \rangle \end{aligned}$$

which implies that

$$DE_{\text{wave}}^n = \frac{2\pi\Delta x}{c^2\Delta t} \sum_{j=1}^N \langle G_j^{n+1}, X_j^{n+2} - X_j^n \rangle.$$

In particular this equality implies that the Newmark scheme conserves the energy of the free wave equation. We are left with the task to prove that

$$\Delta x \sum_{j=1}^N \frac{\phi_j^{n+1+\frac{1}{2}} - \phi_j^{n+\frac{1}{2}}}{\Delta t} u_j^{n+1} \overline{u_j^{n+1}} + \frac{2\pi\Delta x}{c^2\Delta t} \sum_{j=1}^N \langle G_j^{n+1}, X_j^{n+2} - X_j^n \rangle = 0.$$

On the one hand we get

$$\begin{aligned} \Delta x \sum_{j=1}^N \frac{\phi_j^{n+1+\frac{1}{2}} - \phi_j^{n+\frac{1}{2}}}{\Delta t} u_j^{n+1} \overline{u_j^{n+1}} &= \frac{\Delta x}{2\Delta t} \sum_{j=1}^N (\phi_j^{n+2} - \phi_j^n) u_j^{n+1} \overline{u_j^{n+1}} \\ &= \frac{2\pi}{\Delta t} \sum_{j,j'=1}^N \sum_{k=1}^{\mathcal{K}_K} (\chi_{j',k}^{n+2} - \chi_{j',k}^n) \left( \int_{x_{j-\frac{1}{2}}}^{x_{j+\frac{1}{2}}} \int_{x_{j'-\frac{1}{2}}}^{x_{j'+\frac{1}{2}}} \sigma_1(x-y) dx dy \right) \\ &\quad \times \left( \int_0^{R_{\max}} r \tilde{\sigma}_2(r) \varphi_k(r) dr \right) u_j^{n+1} \overline{u_{j'}^{n+1}} \end{aligned}$$



while on the other hand we have

$$\begin{aligned} & \frac{2\pi\Delta x}{c^2\Delta t} \sum_{j=1}^N \langle G_j^{n+1}, X_j^{n+2} - X_j^n \rangle \\ &= -\frac{2\pi}{\Delta t} \sum_{j,j'=1}^N \sum_{k=1}^{\mathcal{K}_K} u_{j'}^{n+1} \overline{u_{j'}^{n+1}} \left( \int_{x_{j-\frac{1}{2}}}^{x_{j+\frac{1}{2}}} \int_{x_{j'-\frac{1}{2}}}^{x_{j'+\frac{1}{2}}} \sigma_1(x-y) \, dx \, dy \right) \\ & \quad \times \left( \int_0^{R_{max}} r \tilde{\sigma}_2(r) \varphi_k(r) \, dr \right) (\chi_{j,k}^{n+2} - \chi_{j,k}^n) \end{aligned}$$

Since  $\sigma_1$  is even, we have

$$\int_{x_{j-\frac{1}{2}}}^{x_{j+\frac{1}{2}}} \int_{x_{j'-\frac{1}{2}}}^{x_{j'+\frac{1}{2}}} \sigma_1(x-y) \, dx \, dy = \int_{x_{j'-\frac{1}{2}}}^{x_{j'+\frac{1}{2}}} \int_{x_{j-\frac{1}{2}}}^{x_{j+\frac{1}{2}}} \sigma_1(x-y) \, dx \, dy,$$

and we conclude that the scheme is consistent with the energy exchanges. Note that in practice the convolution with  $\sigma_1$  in the definition of  $G_j^n$  and  $\phi_j^n$  is computed with an numerical integration method. This numerical integration has to be consistent with the previous formula in order to insure that the scheme conserves the total energy of the system. ■





---

## Particles subjected to a high random acceleration

---

This Chapter is the result of a collaboration with A. Vasseur. If this work is almost uncorrelated with the rest of this thesis, we can at least make the following link. The Vlasov-Wave system introduced in Chapter 2 can be seen as a model of Lorentz gas. Indeed, in this model, each membrane can be seen as an obstacle through which particles of the gas move. This model is a non linear model of Lorentz gas: the obstacles influence the movement of particles and, as a response, particles have also an influence on the obstacles. In this Chapter we consider a linear model of Lorentz gas: the obstacles modify the trajectory of particles but particles have no more influence on obstacles. Then, the difficulty arise from our knowledge of the obstacles' states : in practice we do not know them precisely. The obstacles are thus modeled by a random external force field and the new question is: what can we say on the dynamic of the particle's density ? More precisely, since now the particles' density is also a random process, we want first to understand the dynamic of its expectation and then, how far from this *mean* dynamic a given particle's density realization is. These questions are addressed through a rescaling of the considered system and when the scaling parameter  $\epsilon$  converges to 0.

This strategy of rescaling has been the object of numerous works and is not restricted to the case of a random media. As an example, one can consider the case of particles moving through obstacles modeled as hard spheres distributed periodically on a lattice of size  $\epsilon$  and study this system in the regime  $\epsilon \rightarrow 0$  [47]. We can also mention the case of the homogenization theory which is not concerned by the dynamic of particles in an heterogeneous media but by the intrinsic properties of the media when the scaling parameter  $\epsilon$  converges to 0.

In the context of particles submitted to a high random force field, F. Poupaud and A. Vasseur developed a straightforward PDE approach in order to study this problem [91]. Their approach, hereafter mentioned as the (PV) strategy, is the cornerstone of several other articles [78, 9, 49, 50] but has one main weakness: it requires a time decorrelation assumption on the random force field. As a consequence, the (PV) strategy does not cover the case of stationary (random) potentials. The goal of this work with A. Vasseur was to extend, at the price of an extra assumption on the momentum of particles, the (PV) strategy to these cases. In the case of particles with a privileged direction of displacement we succeed to implement the (PV) strategy, the main idea being to use this direction as a time variable in order to obtain from a spatial decorrelation assumption on this direction a sort of time

decorrelation property. This analysis is the purpose of this Chapter.

## 6.1 Introduction and mains results

This work is devoted to the study of the transport of particles in random media with a privileged direction of displacement. The random media is modeled here by a strong and random force field. For particles, we adopt a mesoscopic scale, so we will study the Liouville equation satisfied by the density  $f_\varepsilon$  of particles in phase space.

$$\partial_t f_\varepsilon + \frac{1}{\varepsilon} \partial_{x_1} f_\varepsilon + v \cdot \nabla_x f_\varepsilon + \mathcal{E}_\varepsilon(x, \omega) \cdot \nabla_v f_\varepsilon = 0 \quad (6.1)$$

This equation is naturally completed by the initial data

$$f_\varepsilon(0, x, v, \omega) = f_i(x, v).$$

Note that for any  $x \in \mathbb{R}^d$ ,  $\omega \in \Omega \mapsto \mathcal{E}_\varepsilon(x, \omega)$  is a random variable defined on a certain probability space  $(\Omega, \mathcal{A}, d\mu)$ , while the initial condition  $f_i$  is supposed to be deterministic. Considering that we want to study the asymptotic behavior of this equation when  $\varepsilon \rightarrow 0^+$ , and because  $\partial_{x_1} f_\varepsilon / \varepsilon$  blows up in this regime (this scaling allows us to ensure that particles have a privileged displacement along the direction  $\vec{e}_1$ ), we will make the following assumption on  $f_i$ .

**(H1)** The initial condition  $f_i$  is homogeneous along the space direction  $\vec{e}_1$  :  $f_i(x, v) = \tilde{f}_i(\tilde{x}, v)$ , where  $x = (x_1, \tilde{x})$ .

Note that such model arises naturally in physics. For example in medical imaging, tomography allows to reconstruct the internal structure of a solid object from external measurements by means of x-ray. In this case we are modeling the local heterogeneity of the solid object (the human body's tissues in fact) by the random force field  $\mathcal{E}_\varepsilon$  while the x-ray beam is modeled by a gas of photon for which we denote by  $f_\varepsilon$  its density in phase space  $\mathbb{R}_x^d \times \mathbb{R}_v^d$ . Since in tomography theory, by assumption, a x-ray beam travel along straight line and since in order to reconstruct a solid object one possible strategy is to use parallel x-ray (several time in several direction), the privileged direction of displacement arises naturally in this context (note that the assumption **(H1)** seems reasonable too). For an introduction to tomography theory we refer the reader to [32].

As regards the force field  $\mathcal{E}_\varepsilon$ , we suppose it comes from a re-scaled random force field  $E \in W^{2, \infty}$

$$\mathcal{E}_\varepsilon(x, \omega) = \frac{1}{\eta(\varepsilon)} E\left(\frac{x}{\lambda(\varepsilon)}, \omega\right). \quad (6.2)$$

We are going to consider a family of scaling parametrized by  $q \in (-1, 1)$ , by setting

$$\lambda(\varepsilon) = \varepsilon^q \quad \text{and} \quad \eta(\varepsilon) = \sqrt{\varepsilon^{q+1}}.$$

Note that the inverse of the scaling parameter  $\varepsilon$  characterize the speed of particles along the direction  $\vec{e}_1$ . Then the possible range of values for  $q$  comes from the following constraints. On one hand, in order to apply the (PV) strategy, we need a high force field  $\mathcal{E}_\varepsilon$  (which imposes  $(q+1)/2 > 0$ ) while on the other hand, in order to insure that particles have a privileged displacement along the direction  $\vec{e}_1$ , the size of the force field has to be smaller than  $\varepsilon^{-1}$  (and we get  $q < 1$ ). Applying the (PV) strategy consists in applying Duhamel's formula on a small time interval of size  $\tau(\varepsilon)$  with  $\tau(\varepsilon)/\eta(\varepsilon)^2 \sim 1$ , that means with  $\tau(\varepsilon) \sim \varepsilon^{q+1}$  (and

$\tau(\varepsilon)$  is small when  $q > -1$ ). Then on a time interval of typical size  $\tau(\varepsilon)$ , a particle has a displacement of size  $\tau(\varepsilon)/\varepsilon \sim \varepsilon^q$  along the direction  $\vec{e}_1$ . Thanks to the scaling parameter  $\lambda(\varepsilon)$ , this size of displacement becomes of size 1:  $\tau(\varepsilon)/(\varepsilon\lambda(\varepsilon)) \sim 1$ .

Throughout this document we will make the following assumptions about  $E$ .

**(H2)** For every  $x \in \mathbb{R}^d$ ,  $\mathbb{E}[E(x, \omega)] = 0$ .

**(H3)**  $\mathbb{E}[E(x, \cdot) \otimes E(y, \cdot)] = R(y-x)$  with  $\lim_{|x| \rightarrow +\infty} R(x) = 0$  and  $\partial_x^\alpha R \in L^1 \cap L^\infty(\mathbb{R}^d)$  for  $|\alpha| \leq 3$ .

**(H4)** For every  $x, y \in \mathbb{R}^d$  such that  $|x_1 - y_1| \geq 1$ ,  $\mathbb{E}[E(x, \cdot) \otimes E(y, \cdot)] = 0$ .

**(H5)** The random process  $E : \mathbb{R}^d \times \Omega \rightarrow \mathbb{R}^d$  is stationary along the direction  $\vec{e}_1$ : ie for every  $y \in \mathbb{R}$ , there exists a measure preserving transformation  $\varphi_y : \Omega \rightarrow \Omega$  such that for every  $(x, \omega) \in \mathbb{R}^d \times \Omega$ ,  $E(x + y\vec{e}_1, \omega) = E(x, \varphi_y(\omega))$ .

The assumption **(H5)** is classical and quite natural (see for example [17] for an other article with this hypothesis). It means that the model is (in expectation) invariant by translation along the direction  $\vec{e}_1$ . Assumptions **(H1)** and **(H5)** guarantee us, for the particles and for the force field, a certain homogeneity along the direction  $\vec{e}_1$ . This homogeneity will allow us to pass to the limit (in the sense of Lemma 6.1.3) in  $\partial_{x_1} f_\varepsilon/\varepsilon$ . The hypothesis **(H3)** is also classical and means that the correlation matrix  $\mathbb{E}[E(x, \cdot) \otimes E(y, \cdot)]$  is invariant by translation of the force field  $E$ . Assumption **(H4)**, which is a space decorrelation hypothesis on the force field, combined with the privileged direction of displacement of the particles, will allow us to implement the (PV) strategy. These remarks are summarized below in Lemmas 6.1.3 and 6.1.4.

We are now able to give the main result of this Chapter.

**Theorem 6.1.1** *Under the assumptions **(H1)**–**(H5)**, for all scaling parametrized by  $q \in (-1, 1)$  and up to a sub-sequence,  $(\mathbb{E}[f_\varepsilon])_\varepsilon$  converges in  $C^0([0, T]; L^p(\mathbb{R}^d \times \mathbb{R}^d) - w)$  to  $f \in L^\infty([0, T]; L^p(\mathbb{R}^d \times \mathbb{R}^d))$ , solution of*

$$\partial_t f + v \cdot \nabla_x f - \nabla_v \cdot (D \nabla_v f) = 0, \quad f(0, x, v) = f_i(x, v) \quad (6.3)$$

where

$$D = \int_0^1 R(\theta \vec{e}_1) d\theta.$$

**Remark 6.1.2** *The convergence of  $\mathbb{E}[f_\varepsilon]$  to  $f$  in  $C^0([0, T]; L^p(\mathbb{R}^d \times \mathbb{R}^d) - w)$  means that for all  $\varphi \in L^{p'}(\mathbb{R}^d \times \mathbb{R}^d)$ ,*

$$\sup_{t \in [0, T]} \left| \langle \mathbb{E}[f_\varepsilon] - f, \varphi \rangle_{L^p, L^{p'}} \right| \xrightarrow{\varepsilon \rightarrow 0} 0 \quad (6.4)$$

*uniformly in  $\varphi$ . Since  $L^{p'}(\mathbb{R}^d \times \mathbb{R}^d)$  has a dense countable family  $(\varphi_k)_{k \in \mathbb{N}} \subset C_c^\infty(\mathbb{R}^d \times \mathbb{R}^d)$  for  $1 \leq p' < +\infty$ , we can endowed this space with the metric*

$$d : (f, g) \mapsto \sum_{k \in \mathbb{N}} \frac{1}{2^k} \frac{|\langle f - g, \varphi_k \rangle_{L^p, L^{p'}}|}{1 + |\langle f - g, \varphi_k \rangle_{L^p, L^{p'}}|}$$

*and obtain equivalently that  $\mathbb{E}[f_\varepsilon]$  converges to  $f$  in  $C^0([0, T]; L^p(\mathbb{R}^d \times \mathbb{R}^d) - w)$  if and only if*

$$\sup_{t \in [0, T]} d(\mathbb{E}[f_\varepsilon], f) \xrightarrow{\varepsilon \rightarrow 0} 0.$$

*Then, thanks to a diagonal argument, to prove this convergence it is sufficient to prove (6.4) for all  $\varphi_k$ . We refer the reader to [75, Appendix C] for further details.*

The rest of this Chapter is organized as follow. Before to end this section we give and prove two lemmas which are the essential points to adapt the (PV) strategy in this context, that means without any time-decorrelation assumption on the force field  $\mathcal{E}_\varepsilon$ . Then, in Section 6.2 we give a sketch of the proof of Theorem 6.1.1. We only give the important steps in order to adapt the (PV) strategy, details regarding the method in itself can be found in [91] or [51]. We conclude this Chapter by giving in Section 6.3 an explicit example of force field  $E$  satisfying **(H2)**–**(H5)**.

**Lemma 6.1.3** *Under assumptions **(H1)** and **(H5)**,  $\mathbb{E}[f_\varepsilon]$  does not depend on the space variable  $x_1$ . In other words,  $\partial_{x_1}\mathbb{E}[f_\varepsilon] = 0$ .*

**Lemma 6.1.4** *Under assumption **(H4)**, for every time  $t > 0$  and  $(x, v) \in \mathbb{R}^d \times \mathbb{R}^d$  there exists a constant  $C = C(t, v_1, \|E\|_{L^\infty_{x,\omega}}) > 0$  such that for every  $0 < \varepsilon < C$  and  $h \in \mathbb{R}^d$  with  $h \cdot \vec{e}_1 > \lambda(\varepsilon)$ , the random variables  $f_\varepsilon(t, x, v, \cdot)$  and  $\mathcal{E}_\varepsilon(x + h, \cdot)$  are independent.*

**Proof of Lemma 6.1.3.** Let  $f_\varepsilon$  be the solution of (6.1) with initial value  $f_i(x, v) = \tilde{f}_i(\tilde{x}, v)$ . For all  $y \in \mathbb{R}$  we introduce the force field  $\mathcal{E}_\varepsilon^y(x, \omega) = \mathcal{E}_\varepsilon(x + y\vec{e}_1, \omega)$  and the solution  $f_\varepsilon^y$  of

$$\begin{cases} \partial_t f_\varepsilon^y + \frac{1}{\varepsilon} \partial_{x_1} f_\varepsilon^y + v \cdot \nabla_x f_\varepsilon^y + \mathcal{E}_\varepsilon^y(x, \omega) \cdot \nabla_v f_\varepsilon^y = 0 \\ f_\varepsilon^y(0, x, v, \omega) = f_i(x, v) \end{cases}$$

On one hand, since  $f_\varepsilon(0, x, v, \omega) = f_\varepsilon^y(0, x, v, \omega) = f_i(x, v)$  and because  $f_i$  does not depend on the space variable  $x_1$ , by uniqueness for (6.1), we get  $f_\varepsilon^y(t, x, v, \omega) = f_\varepsilon(t, x + y\vec{e}_1, v, \omega)$ . On the other hand, using assumption **(H5)**, since the solution of (6.1) is uniquely defined, we get  $f_\varepsilon^y(t, x, v, \omega) = f_\varepsilon(t, x, v, \varphi_y(\omega))$  and then

$$f_\varepsilon(t, x, v, \omega) = f_\varepsilon^y(t, x - y\vec{e}_1, v, \omega) = f_\varepsilon(t, x - y\vec{e}_1, v, \varphi_y(\omega)).$$

Passing to the expectation in this equality and using the fact that  $\varphi_y$  is measure preserving, we eventually get

$$\mathbb{E}[f_\varepsilon](t, x, v) = \mathbb{E}[f_\varepsilon](t, x - y\vec{e}_1, v).$$

■

**Proof of Lemma 6.1.4.** First, thanks to the regularity assumption on the force field  $\mathcal{E}_\varepsilon$ , we know that  $f_\varepsilon$  is globally defined and can be expressed in term of characteristics curves:

$$f_\varepsilon(t, x, v, \omega) = f_i(X_\varepsilon(0, t, x, v, \omega), V_\varepsilon(0, t, x, v, \omega)), \quad (6.5)$$

where  $(X_\varepsilon(s, t, x, v, \omega), V_\varepsilon(s, t, x, v, \omega))$  is the solution at time  $s$  of the system

$$\begin{cases} \dot{x}(s) = \frac{1}{\varepsilon} \vec{e}_1 + v(s) \\ \dot{v}(s) = \mathcal{E}_\varepsilon(x(s), \omega) \end{cases}$$

completed by the data  $(x, v)$  at time  $t$

$$x(t) = x \quad \text{and} \quad v(t) = v.$$

Then, on one hand we get

$$v = V_\varepsilon(0, t, x, v, \omega) + \int_0^t \mathcal{E}_\varepsilon(X_\varepsilon(\tau, t, x, v, \omega), \omega) \, d\tau, \quad (6.6a)$$

$$x = X_\varepsilon(0, t, x, v, \omega) + t \left( \frac{1}{\varepsilon} \vec{e}_1 + v \right) - \int_0^t \left( \int_s^t \mathcal{E}_\varepsilon(X_\varepsilon(\sigma, t, x, v, \omega), \omega) \, d\sigma \right) \, ds, \quad (6.6b)$$

and, on the other hand, for all  $s \in [0, t]$

$$\begin{aligned} \frac{d}{ds} X_\varepsilon(s, t, x, v, \omega) \cdot \vec{e}_1 &= \frac{1}{\varepsilon} + v_1 - \int_s^t \mathcal{E}_\varepsilon(X_\varepsilon(\sigma, t, x, v, \omega), \omega) \cdot \vec{e}_1 d\sigma \\ &\geq \frac{1}{\varepsilon} - |v_1| - \frac{|t-s|}{\eta(\varepsilon)} \|E\|_{L^\infty_{x,\omega}} = \frac{1}{\varepsilon} \left( 1 - |v_1|\varepsilon - |t-s| \|E\|_{L^\infty_{x,\omega}} \frac{\varepsilon}{\eta(\varepsilon)} \right). \end{aligned}$$

Since  $\varepsilon/\eta(\varepsilon) \rightarrow_{\varepsilon \rightarrow 0^+} 0$ , there exists a constant  $C = C(t, v_1, \|E\|_{L^\infty_{x,\omega}}) > 0$  such that for all  $0 < \varepsilon < C$  and for all  $s \in [0, t]$ ,

$$\frac{d}{ds} X_\varepsilon(s, t, x, v, \omega) \cdot \vec{e}_1 \geq 0.$$

It follows that the characteristic curves  $X_\varepsilon$  is increasing along the direction  $\vec{e}_1$  for  $s \in [0, t]$ . Then, this fact combined with (6.6a)–(6.6b) guarantees us that  $f_\varepsilon(t, x, v, \omega)$  only depends on the realization of  $\mathcal{E}_\varepsilon(y, \omega)$  for  $y_1 < x_1$ . Eventually we can use assumption **(H4)**, which implies that  $\mathcal{E}_\varepsilon(y, \omega)$  and  $\mathcal{E}_\varepsilon(z, \omega)$  are independent as soon as  $|y_1 - z_1| > \lambda(\varepsilon)$ , in order to conclude that  $f_\varepsilon(t, x, v, \omega)$  and  $\mathcal{E}_\varepsilon(z, \omega)$  are independent as soon as  $z_1 - x_1 > \lambda(\varepsilon)$ . ■

## 6.2 Sketch of the proof of Theorem 6.1.1

Here, in view to explain how the scaling that we are considering allows us to implement the (PV) strategy even if the force field has no time-decorrelation, we give a summarized proof of Theorem 6.1.1. For details we refer the reader to [91] or [51].

First we justify that the family  $(\mathbb{E}[f_\varepsilon])_\varepsilon$  admits a sub-family that converges in  $C^0([0, T]; L^p(\mathbb{R}^d \times \mathbb{R}^d) - w)$  to a certain  $f \in L^\infty([0, T]; L^p(\mathbb{R}^d \times \mathbb{R}^d))$  and then we will justify that  $f$  is the unique solution of (6.3) with initial data  $f_i$ .

Let us introduce the operators

$$\theta_\varepsilon(\varphi)(x, v, \omega) = -\mathcal{E}_\varepsilon(x, \omega) \cdot \nabla_v \varphi(x, v) \quad \text{and} \quad S_t(\varphi)(x, v) = \varphi\left(x - t\left(\frac{1}{\varepsilon}\vec{e}_1 + v\right), v\right)$$

and compute for  $\varphi \in C_c^\infty(\mathbb{R}^d \times \mathbb{R}^d)$

$$\begin{aligned} \frac{d}{dt} \iint_{\mathbb{R}^d \times \mathbb{R}^d} \mathbb{E}[f_\varepsilon](t, x, v) \varphi(x, v) dx dv &= \frac{1}{\varepsilon} \iint_{\mathbb{R}^d \times \mathbb{R}^d} \mathbb{E}[f_\varepsilon](t, x, v) \partial_{x_1} \varphi(x, v) dx dv \\ &+ \iint_{\mathbb{R}^d \times \mathbb{R}^d} \mathbb{E}[f_\varepsilon](t, x, v) v \cdot \nabla_x \varphi(x, v) dx dv - \iint_{\mathbb{R}^d \times \mathbb{R}^d} \mathbb{E}[f_\varepsilon(t, x, v, \cdot) \theta_\varepsilon(\varphi)(x, v, \cdot)] dx dv. \end{aligned} \tag{6.7}$$

Thanks to Lemma 6.1.3 the first term of the right hand side is equal to zero while the second one is controlled by

$$\left| \iint_{\mathbb{R}^d \times \mathbb{R}^d} \mathbb{E}[f_\varepsilon](t, x, v) v \cdot \nabla_x \varphi(x, v) dx dv \right| \leq \|f_i\|_{L^1_{x,v}} \|v \cdot \nabla_x \varphi\|_{L^\infty_{x,v}}$$

(where we have used the estimation  $\|f_\varepsilon(t)\|_{L^p_{x,v}} \leq \|f_i\|_{L^p_{x,v}}$  which is a direct consequence of (6.5) and the fact that the flow  $t \mapsto (X_\varepsilon(t), V_\varepsilon(t))$  is symplectic). For the last term we apply the Duhamel formula to  $f_\varepsilon$

$$f_\varepsilon(t) = S_{\tau(\varepsilon)}(f_\varepsilon(t - \tau(\varepsilon))) + \int_0^{\tau(\varepsilon)} S_\sigma \circ \theta_\varepsilon(f_\varepsilon(t - \sigma)) d\sigma$$



with  $\tau(\varepsilon) = 2\varepsilon^{2q}$  (from now on  $\tau(\varepsilon)$  will always refer to this quantity) to obtain

$$\begin{aligned} & \iint_{\mathbb{R}^d \times \mathbb{R}^d} \mathbb{E} [f_\varepsilon(t, x, v, \cdot) \theta_\varepsilon(\varphi)(x, v, \cdot)] dx dv \\ &= \mathbb{E} \left[ \iint_{\mathbb{R}^d \times \mathbb{R}^d} S_{\tau(\varepsilon)}(f_\varepsilon(t - \tau(\varepsilon)))(x, v, \cdot) \theta_\varepsilon(\varphi)(x, v, \cdot) dx dv \right] \\ & \quad - \mathbb{E} \left[ \int_0^{\tau(\varepsilon)} \left( \iint_{\mathbb{R}^d \times \mathbb{R}^d} f_\varepsilon(t - \sigma, x, v, \cdot) \theta_\varepsilon \circ S_{-\sigma} \circ \theta_\varepsilon(\varphi)(x, v, \cdot) dx dv \right) d\sigma \right]. \end{aligned}$$

Since the first integral term of the right hand side is of order (without considering the expectation  $\mathbb{E}$ )  $\eta(\varepsilon)^{-1} = \varepsilon^{-(q+1)/2}$ , we take advantage of Lemma 6.1.4 and the assumption **(H2)** to obtain

$$\begin{aligned} & \mathbb{E} \left[ \iint_{\mathbb{R}^d \times \mathbb{R}^d} S_{\tau(\varepsilon)}(f_\varepsilon(t - \tau(\varepsilon)))(x, v, \cdot) \theta_\varepsilon(\varphi)(x, v, \cdot) dx dv \right] \\ &= \iint_{\mathbb{R}^d \times \mathbb{R}^d} \mathbb{E} \left[ S_{\tau(\varepsilon)}(f_\varepsilon(t - \tau(\varepsilon))) \right] (x, v) \mathbb{E} [\theta_\varepsilon(\varphi)] (x, v) dx dv = 0. \end{aligned}$$

Note that to apply Lemma 6.1.4 we have to check that

$$h = \tau(\varepsilon) \left( \frac{1}{\varepsilon} \vec{e}_1 + v \right)$$

is such that for every  $v$  in the support of  $\varphi$ ,  $h \cdot \vec{e}_1 > \lambda(\varepsilon)$ . This is equivalent to

$$\frac{\tau(\varepsilon)}{\lambda(\varepsilon)} \left( \frac{1}{\varepsilon} + v_1 \right) = 2 + 2\varepsilon v_1 > 1.$$

Here, since  $\varphi$  has a compact support this inequality is always satisfied for  $\varepsilon$  sufficiently small. Then  $\varepsilon$  depends on  $\varphi$  but here it is not an issue since we only need this result for the countable family  $(\varphi_k)_{k \in \mathbb{N}}$ , see Remark 6.1.2. Eventually the last term is bounded by

$$\begin{aligned} & \left| \mathbb{E} \left[ \int_0^{\tau(\varepsilon)} \left( \iint_{\mathbb{R}^d \times \mathbb{R}^d} f_\varepsilon(t - \sigma, x, v, \cdot) \theta_\varepsilon \circ S_{-\sigma} \circ \theta_\varepsilon(\varphi)(x, v, \cdot) dx dv \right) d\sigma \right] \right| \\ & \leq \|f_i\|_{L^1_{x,v}} \int_0^{\tau(\varepsilon)} \mathbb{E} \left[ \|\theta_\varepsilon \circ S_{-\sigma} \circ \theta_\varepsilon(\varphi)\|_{L^\infty_{x,v}} \right] d\sigma \leq \|f_i\|_{L^1_{x,v}} \tau(\varepsilon) \|\theta_\varepsilon \circ S_{-\sigma} \circ \theta_\varepsilon(\varphi)\|_{L^\infty_{x,v,\omega}} \\ & \leq \|f_i\|_{L^1_{x,v}} \tau(\varepsilon) \left( \frac{1}{\eta(\varepsilon)^2} \|E\|_{L^\infty_{x,\omega}}^2 \left( \|\varphi\|_{W^{2,\infty}} + \tau(\varepsilon) \|\varphi\|_{W^{1,\infty}} \right) \right. \\ & \quad \left. + \frac{\tau(\varepsilon)}{\eta(\varepsilon)^2 \lambda(\varepsilon)} \|E\|_{L^\infty_{x,\omega}} \|\nabla_x E\|_{L^\infty_{x,\omega}} \|\varphi\|_{W^{1,\infty}} \right), \end{aligned}$$

where the last inequality is obtained thanks to the relation

$$\begin{aligned} & \theta_\varepsilon \circ S_{-\sigma} \circ \theta_\varepsilon(\varphi)(x, v, \omega) \\ &= \sum_{i,j=1}^d \mathcal{G}_\varepsilon^i(x, \omega) \mathcal{G}_\varepsilon^j \left( x - \sigma \left( \frac{1}{\varepsilon} \vec{e}_1 + v \right), \omega \right) (\partial_{v_i} \partial_{v_j} - \sigma \partial_{x_i} \partial_{v_j}) \varphi \left( x - \sigma \left( \frac{1}{\varepsilon} \vec{e}_1 + v \right), v \right) \\ & \quad - \sigma \sum_{i,j=1}^d \mathcal{G}_\varepsilon^i(x, \omega) \partial_{x_i} \mathcal{G}_\varepsilon^j \left( x - \sigma \left( \frac{1}{\varepsilon} \vec{e}_1 + v \right), \omega \right) \partial_{v_j} \varphi \left( x - \sigma \left( \frac{1}{\varepsilon} \vec{e}_1 + v \right), v \right). \end{aligned}$$

Since

$$\frac{\tau(\varepsilon)}{\eta(\varepsilon)^2} = 2 \quad \text{and} \quad \frac{\tau(\varepsilon)^2}{\eta(\varepsilon)^2 \lambda(\varepsilon)} = 4\varepsilon,$$

we have shown that the quantity

$$\frac{d}{dt} \iint_{\mathbb{R}^d \times \mathbb{R}^d} \mathbb{E}[f_\varepsilon](t, x, v) \varphi(x, v) \, dx \, dv$$

is uniformly bounded with respect to  $\varepsilon$  and we can apply the Arzela-Ascoli theorem to conclude (for details we refer the reader to [91] and [51]).

The next step is to determine the equation satisfied by  $f$ . For this purpose we consider a sub-family of  $(\mathbb{E}[f_\varepsilon])_\varepsilon$  that converges to  $f$  in  $C^0([0, T]; L^p(\mathbb{R}^d \times \mathbb{R}^d) - w)$  and we are going to determine the limit of  $\frac{d}{dt} \iint \mathbb{E}[f_\varepsilon(t)] \varphi \, dx \, dv$ . We have already seen that the first term of the right hand side of (6.7) is equal to zero for  $\varepsilon$  sufficiently small and it is clear that the second term converges to

$$\iint_{\mathbb{R}^d \times \mathbb{R}^d} f(t, x, v) v \cdot \nabla_v \varphi(x, v) \, dx \, dv.$$

Then the difficulty concentrates on the third term of the right hand side of (6.7). For this term we apply twice the Duhamel formula to  $f_\varepsilon$

$$\begin{aligned} f_\varepsilon(t) &= S_{\tau(\varepsilon)}(f_\varepsilon(t - \tau(\varepsilon))) + \int_0^{\tau(\varepsilon)} S_\sigma \circ \theta_\varepsilon \circ S_{2\tau(\varepsilon) - \sigma}(f_\varepsilon(t - 2\tau(\varepsilon))) \, d\sigma \\ &\quad + \int_0^{\tau(\varepsilon)} \int_0^{2\tau(\varepsilon) - \sigma} S_\sigma \circ \theta_\varepsilon \circ S_s \circ \theta_\varepsilon(f_\varepsilon(t - \sigma - s)) \, ds \, d\sigma, \end{aligned}$$

which yields to the following decomposition

$$\begin{aligned} &\iint_{\mathbb{R}^d \times \mathbb{R}^d} \mathbb{E}[f_\varepsilon(t, x, v, \cdot) \theta_\varepsilon(\varphi)(x, v, \cdot)] \, dx \, dv \\ &= \mathbb{E} \left[ \iint_{\mathbb{R}^d \times \mathbb{R}^d} S_{\tau(\varepsilon)}(f_\varepsilon(t - \tau(\varepsilon)))(x, v, \cdot) \theta_\varepsilon(\varphi)(x, v, \cdot) \, dx \, dv \right] \\ &\quad - \mathbb{E} \left[ \iint_{\mathbb{R}^d \times \mathbb{R}^d} S_{2\tau(\varepsilon)}(f_\varepsilon(t - 2\tau(\varepsilon)))(x, v, \cdot) \left( \int_0^{\tau(\varepsilon)} S_\sigma \circ \theta_\varepsilon \circ S_{-\sigma} \circ \theta_\varepsilon(\varphi)(x, v, \cdot) \, d\sigma \right) \, dx \, dv \right] \\ &\quad + \mathbb{E} \left[ \int_0^{\tau(\varepsilon)} \int_0^{2\tau(\varepsilon) - \sigma} \left( \iint_{\mathbb{R}^d \times \mathbb{R}^d} f_\varepsilon(t - \sigma - s, x, v, \cdot) \right. \right. \\ &\quad \left. \left. \theta_\varepsilon \circ S_{-s} \circ \theta_\varepsilon \circ S_{-\sigma} \circ \theta_\varepsilon(\varphi)(x, v, \cdot) \, dx \, dv \right) \, ds \, d\sigma \right] \\ &= I_1 + I_2 + I_3. \end{aligned}$$

We have already seen that  $I_1 = 0$  when  $\varepsilon$  is sufficiently small. We now treat  $I_2$  which is exactly the part of order 1 in our previous estimation of the third term of the right hand side of (6.7). Thanks to the relation

$$\begin{aligned} &S_\sigma \circ \theta_\varepsilon \circ S_{-\sigma} \circ \theta_\varepsilon(\varphi)(x, v, \omega) \\ &= (\operatorname{div}_v + \sigma \operatorname{div}_x) \left\{ (x, v) \mapsto \mathcal{E}_\varepsilon \left( x - \sigma \left( \frac{1}{\varepsilon} \vec{e}_1 + v \right), \omega \right) \otimes \mathcal{E}_\varepsilon(x, \omega) \cdot \nabla_v \varphi(x, v) \right\} \end{aligned}$$

we can, as previously, apply Lemma 6.1.4 to  $I_2$  and get

$$\begin{aligned} I_2 &= \iint_{\mathbb{R}^d \times \mathbb{R}^d} \mathbb{E}[S_{2\tau(\varepsilon)}(f_\varepsilon(t - 2\tau(\varepsilon)))](x, v) \left( \int_0^{\tau(\varepsilon)} (\operatorname{div}_v + \sigma \operatorname{div}_x) \right. \\ &\quad \left. \left\{ (x, v) \mapsto \mathbb{E} \left[ \mathcal{E}_\varepsilon \left( x - \sigma \left( \frac{1}{\varepsilon} \vec{e}_1 + v \right), \cdot \right) \otimes \mathcal{E}_\varepsilon(x, \cdot) \right] \cdot \nabla_v \varphi(x, v) \right\} \, d\sigma \right) \, dx \, dv. \end{aligned}$$

Then, thanks to **(H3)** we obtain

$$\begin{aligned}
& \int_0^{\tau(\varepsilon)} (\operatorname{div}_v + \sigma \operatorname{div}_x) \left\{ (x, v) \mapsto \mathbb{E} \left[ \mathcal{E}_\varepsilon \left( x - \sigma \left( \frac{1}{\varepsilon} \vec{e}_1 + v \right), \cdot \right) \otimes \mathcal{E}_\varepsilon(x, \cdot) \right] \cdot \nabla_v \varphi(x, v) \right\} d\sigma \\
&= \int_0^1 (\operatorname{div}_v + \tau(\varepsilon)s \operatorname{div}_x) \left[ (x, v) \mapsto \frac{1}{\eta(\varepsilon)^2} R \left( \frac{\tau(\varepsilon)s}{\lambda(\varepsilon)} \left( \frac{1}{\varepsilon} \vec{e}_1 + v \right) \right) \cdot \nabla_v \varphi(x, v) \right] \tau(\varepsilon) ds \\
&= 2 \int_0^1 (\operatorname{div}_v + \tau(\varepsilon)s \operatorname{div}_x) [(x, v) \mapsto R(2s\vec{e}_1 + 2s\varepsilon v) \cdot \nabla_v \varphi(x, v)] ds \\
&= \int_0^2 (\operatorname{div}_v + \tau(\varepsilon)\frac{\theta}{2} \operatorname{div}_x) [(x, v) \mapsto R(\theta\vec{e}_1 + \theta\varepsilon v) \cdot \nabla_v \varphi(x, v)] d\theta
\end{aligned}$$

and it is possible to show that this term converges in  $L^{p'}(\mathbb{R}_x^d \times \mathbb{R}_v^d)$  to

$$\operatorname{div}_v \left( \int_0^2 R(\theta\vec{e}_1) d\theta \right) \cdot \nabla_v \varphi(x, v).$$

This strong convergence can be combined with the weak convergence of  $(\mathbb{E}[f_\varepsilon])_\varepsilon$  to  $f$  in  $C^0([0, T]; L^p(\mathbb{R}^d \times \mathbb{R}^d) - w)$  in order to obtain

$$I_2 \xrightarrow{\varepsilon \rightarrow 0} \iint_{\mathbb{R}^d \times \mathbb{R}^d} f(t, x, v) \operatorname{div}_v \left( \int_0^2 R(\theta\vec{e}_1) d\theta \right) \cdot \nabla_v \varphi(x, v) dx dv.$$

We refer the reader to [91] and [51] for details about these convergences.

For the last integral term  $I_3$  it is not possible to apply Lemma 6.1.4 but, since this term is of order  $\tau(\varepsilon)^2/\eta(\varepsilon)^3 \sim \varepsilon^{(q+1)/2}$  (whereas  $I_1$  was of order  $\varepsilon^{-(q+1)/2}$  and  $I_2$  of order 1), a rough estimate is sufficient to show that it goes to 0 (again we refer the reader to [91] and [51] for details). This concludes the proof.

**Remark 6.2.1** *Our choice  $\tau(\varepsilon) = 2\varepsilon^{q+1}$  is arbitrary in the sense that for all real number  $z > 1$  the choice  $\tau(\varepsilon) = z\varepsilon^{q+1}$  is satisfying and allows us to obtain similar conclusions. In fact the only difference concerns the diffusion matrix that becomes*

$$\int_0^z R(\theta\vec{e}_1) d\theta.$$

*This expression depends a priori on the number  $z$  (that's problematic if it is so) but here it is not an issue because the assumptions **(H3)** and **(H4)** guarantee us that  $\operatorname{supp}(R) \subset [-1, 1] \times \mathbb{R}^{d-1}$ , so for all  $z > 1$*

$$\int_0^z R(\theta\vec{e}_1) d\theta = \int_0^1 R(\theta\vec{e}_1) d\theta = D.$$

### 6.3 An example of random force field satisfying **(H2)**–**(H5)**

We finish by giving an explicit example of a force field  $E \in W^{2,\infty}$  satisfying **(H2)**–**(H5)**. We construct this force field as an infinite sum of self-similar, compactly supported bubble of potential  $V = V(x)$ , randomly distributed in space and intensity. For this purpose we introduce

- $V \in C_c^\infty(\mathbb{R}^d)$  a potential such that  $\text{supp}(V) \subset [-1/4, 1/4]^d$
- $(w^k)_{k \in \mathbb{Z}^d}$  a sequence of uniform random variables on  $[-1, 1]$
- $(X^k)_{k \in \mathbb{Z}^d}$  a sequence of uniform random variables on  $[-1/2, 1/2]^d$
- $T$  a uniform random variable on  $[0, 1]$

and we consider the random potential

$$W(x) = \sum_{k \in \mathbb{Z}^d} w^k V(x - [k + X^k] - T\vec{e}_1).$$

More precisely we consider the set

$$\Omega = [-1, 1]^{\mathbb{Z}^d} \times \left([-1/2, 1/2]^d\right)^{\mathbb{Z}^d} \times [0, 1]$$

endowed with the measure

$$d\mu = \left(\prod_{k \in \mathbb{Z}^d} \frac{dx}{2}\right) \otimes \left(\prod_{k \in \mathbb{Z}^d} d\tilde{x}\right) \otimes dx$$

(where  $dx$  denotes the Lebesgue measure on  $\mathbb{R}$  and  $d\tilde{x}$  the Lebesgue measure on  $\mathbb{R}^d$ ) and the three random variables

$$\begin{aligned} w : \alpha = (\alpha^k)_k \in [-1, 1]^{\mathbb{Z}^d} &\longmapsto w(\alpha) = (w(\alpha)^k)_k = (\alpha^k)_k \\ X : \beta = (\beta^k)_k \in \left([-1/2, 1/2]^d\right)^{\mathbb{Z}^d} &\longmapsto X(\beta) = (X(\beta)^k)_k = (\beta^k)_k \\ T : \gamma \in [0, 1] &\longmapsto T(\gamma) = \gamma. \end{aligned}$$

So the random potential  $W$  is defined for all  $\omega = (\alpha, \beta, \gamma) \in \Omega$  by

$$W(x, \omega) = \sum_{k \in \mathbb{Z}^d} w(\alpha)^k V(x - [k + X(\beta)^k] - T(\gamma)\vec{e}_1). \quad (6.8)$$

Note that, since the measure  $d\mu$  is defined as a product, the random variables  $w^k$ ,  $X^k$  and  $T$  are supposed to be mutually independent.

**Proposition 6.3.1** *The force field  $E = \nabla_x W$  satisfies the assumptions **(H2)**–**(H5)**.*

As it will become clear in the proof, the random variable  $w^k$  represent the intensity of the force field created by a bubble of potential and since it is uniformly distributed on  $[-1, 1]$  it allows us to justify that **(H2)** is satisfied. The random variable  $k + X^k$  represents the center of a bubble of potential. Then, without the random variable  $T$ , the lattice where the bubbles can be located is fixed. The random variable  $T$  allows us to consider lattices translated along the direction  $\vec{e}_1$  and insures then that **(H5)** holds.

**Proof.** We start by checking that **(H2)** holds. A direct computation shows that

$$\begin{aligned} \mathbb{E}[E(x, \cdot)] &= \sum_{k \in \mathbb{Z}^d} \left( \int_{-1}^1 \alpha^k \frac{dx(\alpha^k)}{2} \right) \\ &\quad \times \left( \int_{[-1/2, 1/2]^d} \int_0^1 \nabla V((x - [k + \beta^k] - \gamma\vec{e}_1)) d\tilde{x}(\beta^k) dx(\gamma) \right) = 0. \end{aligned}$$

Next we turn to **(H3)**. As previously, a direct computation shows that

$$\begin{aligned}
& \mathbb{E}[E(x, \cdot) \otimes E(y, \cdot)] \\
&= \sum_{k, n \in \mathbb{Z}^d} \int_{\Omega} w(\alpha)^k w(\alpha)^n \nabla V(x - [k + X(\beta)^k] - T(\gamma)\vec{e}_1) \\
&\quad \otimes \nabla V(y - [n + X(\beta)^n] - T(\gamma)\vec{e}_1) d\mu(\omega) \\
&= \sum_{k \in \mathbb{Z}^d} \left( \int_{-1}^1 (\alpha^k)^2 \frac{dx(\alpha^k)}{2} \right) \left( \int_{[-1/2, 1/2]^d} \int_0^1 \nabla V(x - [k + \beta^k] - \gamma\vec{e}_1) \right. \\
&\quad \left. \otimes \nabla V(y - [k + \beta^k] - \gamma\vec{e}_1) d\tilde{x}(\beta^k) dx(\gamma) \right) \\
&= \frac{1}{3} \int_0^1 \left( \sum_{k \in \mathbb{Z}^d} \int_{k + [-1/2, 1/2]^d} \nabla V(x - \beta - \gamma\vec{e}_1) \otimes \nabla V(y - \beta - \gamma\vec{e}_1) d\beta \right) d\gamma \\
&= \frac{1}{3} \int_{\mathbb{R}^d} \nabla V(z) \otimes \nabla V(y - x + z) dz = R(y - x).
\end{aligned}$$

For **(H4)**, we note that, since  $\text{supp}(V) \subset [-1/2, 1/2]^d$ , for all  $x, y \in \mathbb{R}^d$  such that  $|x_1 - y_1| > 1$  there exists two subsets  $K_1$  and  $K_2$  of  $\mathbb{Z}^d$  with an empty intersection such that

$$E(x, \omega) = \sum_{k \in K_1} w(\alpha)^k \nabla V(x - [k + X(\beta)^k] - T(\gamma)\vec{e}_1)$$

and

$$E(y, \omega) = \sum_{n \in K_2} w(\alpha)^n \nabla V(y - [n + X(\beta)^n] - T(\gamma)\vec{e}_1).$$

Thus a direct computation shows that

$$\mathbb{E}[E(x, \cdot) \otimes E(y, \cdot)] = 0 = \mathbb{E}[E(x, \cdot)] \otimes \mathbb{E}[E(y, \cdot)],$$

which means that the random variables  $E(x, \cdot)$  and  $E(y, \cdot)$  are independent as soon as  $|x_1 - y_1| > 1$ .

Finally, for **(H5)** we will exhibit a  $C^1$ -piece-wise, measure preserving change of variable  $\varphi_y$ . For this purpose we first introduce for any vector  $k_0 \in \mathbb{Z}^d$  and for any sequence  $(u^k)_{k \in \mathbb{Z}^d}$  the operator

$$\mathcal{S}_{k_0} : (u^k)_{k \in \mathbb{Z}^d} \longmapsto (u^{k+k_0})_{k \in \mathbb{Z}^d}.$$

Then, for every  $y \in \mathbb{R}$ , let us denote  $k_y^1 := ([y] - 1)\vec{e}_1$ ,  $k_y^2 := [y]\vec{e}_1$  and define  $\varphi_y$  as follow : for every  $\omega = (\alpha, \beta, \gamma) \in \Omega$

$$\varphi_y(\omega) = \begin{cases} \left( \mathcal{S}_{k_y^1}(\alpha), \mathcal{S}_{k_y^1}(\beta), 1 + \gamma - (y - [y]) \right) & \text{if } \gamma \in [0, y - [y]] \\ \left( \mathcal{S}_{k_y^2}(\alpha), \mathcal{S}_{k_y^2}(\beta), \gamma - (y - [y]) \right) & \text{if } \gamma \in [y - [y], 1] \end{cases}$$

Note that it is clear that  $\varphi_y$  is measure preserving since it is only define in terms of trans-

lations. Eventually a direct computation allows us to obtain that

$$\begin{aligned}
E(x + y\vec{e}_1, \omega) &= \sum_{k \in \mathbb{Z}^d} \alpha^k \nabla V \left( x + y\vec{e}_1 - [k + \beta^k] - \gamma\vec{e}_1 \right) \\
&= \begin{cases} \sum_{k \in \mathbb{Z}^d} \alpha^k \nabla V \left( x - [k - k_y^1 + \beta^k] - [1 + \gamma - (y - \lfloor y \rfloor)]\vec{e}_1 \right) & \text{if } \gamma \in [0, y - \lfloor y \rfloor] \\ \sum_{k \in \mathbb{Z}^d} \alpha^k \nabla V \left( x - [k - k_y^2 + \beta^k] - [\gamma - (y - \lfloor y \rfloor)]\vec{e}_1 \right) & \text{if } \gamma \in [y - \lfloor y \rfloor, 1] \end{cases} \\
&= \begin{cases} \sum_{k \in \mathbb{Z}^d} \alpha^{k+k_y^1} \nabla V \left( x - [k + \beta^{k+k_y^1}] - [1 + \gamma - (y - \lfloor y \rfloor)]\vec{e}_1 \right) & \text{if } \gamma \in [0, y - \lfloor y \rfloor] \\ \sum_{k \in \mathbb{Z}^d} \alpha^{k+k_y^2} \nabla V \left( x - [k + \beta^{k+k_y^2}] - [\gamma - (y - \lfloor y \rfloor)]\vec{e}_1 \right) & \text{if } \gamma \in [y - \lfloor y \rfloor, 1] \end{cases} \\
&= E(x, \varphi_y(\omega)).
\end{aligned}$$

■



---

Additional details on non linear Landau damping in the free space case

---

In this appendix we first give some details on the continuity in time of a solution of (2.10a)–(2.10b) with respect to the norms of Proposition 2.3.9. This question is crucial in order to apply this proposition to prove the Landau damping result of Theorem 2.3.7. Then, in order to be self-consistent, we complete the proof of Proposition 2.3.9 that we had started in Section 2.3.3. We recall to the reader that this proof follows really closely [13] and that we have already explained in Section 2.3 how to adapt the strategy of this article to the Vlasov-Wave system.

### A.1 Remarks on the continuity of the solution with respect to the bootstrap norms

For the sake of simplicity we consider the Vlasov case

$$\begin{cases} \partial_t g(t, x, v) = (\nabla_x W \star \rho(t))(x + tv) \cdot (\nabla_v - t\nabla_x)g(t, x, v) \\ g(0, x, v) = f_0(x, v) \end{cases} \quad (\text{A.1})$$

Here the equation is written along the characteristic of the free transport operator as in (2.10a)–(2.10b) (but not in fluctuation around a spatially homogeneous background  $\mathcal{M}$ ).

#### A.1.1 Local existence in $C^0([0, T], H_P^\sigma)$

It is classical that this system admits a local solution in  $C^0([0, T], H_P^\sigma)$  when ( $\sigma \geq 0$  and  $P \in \mathbb{N}$  are sufficiently large and) the initial data  $f_0$  belongs to  $H_P^\sigma$ . The proof is based on the following energy type estimate which constrains the propagation by the equation of the  $H_P^\sigma$ -norm along time:

$$\frac{1}{2} \frac{d}{dt} \|g(t)\|_{H_P^\sigma}^2 \leq C \langle t \rangle \|g(t)\|_{H_P^\sigma}^3 \quad (\text{A.2})$$

This energy estimate implies that the  $H_P^\sigma$ -norm is at least propagated on a finite time interval  $[0, T^*)$  where  $T^*$  only depends on the initial data  $f_0$  and shrinks to 0 when its  $H_P^\sigma$ -norm blows up. This energy estimate comes from the following strategy which will be used in a finer way during the proof of the bootstrap statement. Having at hand a classical solution



$g(t)$  of (A.1) (obtained thanks to a fixed point on the characteristic curves for example) we get

$$\begin{aligned} \frac{1}{2} \frac{d}{dt} \|g(t)\|_{H^\sigma}^2 &= \langle \partial_t g(t), g(t) \rangle_{H^\sigma} \\ &= \iiint \langle k, \xi \rangle^\sigma \overline{\widehat{g}(t, k, \xi)} \langle k, \xi \rangle^\sigma n \widehat{W}(n) \widehat{\rho}(t, n) \cdot (\xi - tk) \widehat{g}(t, k - n, \xi - tn) \, dn \, dk \, d\xi. \end{aligned}$$

The most challenging part to obtain (A.2) is to control the extra factor  $\xi - tk$  (coming from the operator  $\nabla_v - t\nabla_x$ ) in order to obtain an estimation which does not depend on a  $H_P^s$ -norm of the solution with  $s > \sigma$ . Such an estimation is possible thanks to the structure of the Vlasov equation. Indeed, let us introduce the operator

$$\mathcal{L}_t[\rho] : f \in C_c^\infty(\mathbb{R}^d \times \mathbb{R}^d) \longmapsto [(x, v) \mapsto (\nabla_x W \star \rho(t))(x + tv) \cdot (\nabla_v - t\nabla_x) f(x, v)].$$

Then, a simple integration by part shows that

$$\langle f, \mathcal{L}_t[\rho] f \rangle_{L_{x,v}^2} = 0$$

holds for any  $f \in C_c^\infty(\mathbb{R}^d \times \mathbb{R}^d)$ . The operator  $\mathcal{L}_t[\rho]$ , as well as the previous relation, can be extended to  $f \in H^1(\mathbb{R}^d \times \mathbb{R}^d)$ . Using this specific structure of the Vlasov equation with

$$f = \mathcal{F}_{k,\xi}^{-1}(\langle k, \xi \rangle^\sigma \widehat{g}(t, k, \xi)),$$

we are lead to

$$\begin{aligned} \frac{1}{2} \frac{d}{dt} \|g(t)\|_{H^\sigma}^2 &= \iiint \langle k, \xi \rangle^\sigma \overline{\widehat{g}(t, k, \xi)} (\langle k, \xi \rangle^\sigma - \langle k - n, \xi - tn \rangle^\sigma) \\ &\quad \times n \widehat{W}(n) \widehat{\rho}(t, n) \cdot (\xi - tk) \widehat{g}(t, k - n, \xi - tn) \, dn \, dk \, d\xi. \end{aligned}$$

Then, depending on the leading frequency ( $|n, tn| \geq |k - n, \xi - tn|$  or  $|n, tn| \leq |k - n, \xi - tn|$ ), we adopt a different strategy. On one hand, in the case  $|n, tn| \geq |k - n, \xi - tn|$ , since

$$|\langle k, \xi \rangle^\sigma - \langle k - n, \xi - tn \rangle^\sigma| \lesssim \langle k - n, \xi - tn \rangle^\sigma + \langle n, tn \rangle^\sigma + \langle k - n, \xi - tn \rangle^\sigma \lesssim \langle n, tn \rangle^\sigma$$

there is no issue with the extra derivative term  $\xi - tk$ : for each of the three factors there is no weight with an exponent larger than  $\sigma$ . We can then apply Lemma 2.3.6 in order to obtain (where we used  $|\xi - tk| \leq \langle t \rangle \langle k - n, \xi - tn \rangle$ )

$$\begin{aligned} &\left| \iiint \langle k, \xi \rangle^\sigma \overline{\widehat{g}(t, k, \xi)} \langle n, tn \rangle^\sigma n \widehat{W}(n) \widehat{\rho}(t, n) \langle t \rangle \langle k - n, \xi - tn \rangle \widehat{g}(t, k - n, \xi - tn) \, dn \, dk \, d\xi \right| \\ &\lesssim \langle t \rangle \|g(t)\|_{H^\sigma} \left( \int_k \left( \int_\xi \langle k, \xi \rangle^2 |\widehat{g}(t, k, \xi)|^2 \, d\xi \right)^{1/2} \, dk \right) \left( \int_n \langle n, tn \rangle^{2\sigma} |\widehat{\rho}(t, n)|^2 \, dn \right)^{1/2} \end{aligned}$$

where for  $\sigma \geq 0$  sufficiently large

$$\int_k \left( \int_\xi \langle k, \xi \rangle^2 |\widehat{g}(t, k, \xi)|^2 \, d\xi \right)^{1/2} \, dk \lesssim \|g(t)\|_{H^\sigma}.$$

On the other hand the case  $|n, tn| \leq |k - n, \xi - tn|$  is more challenging since a rough estimate leads to a weight with an exponent  $\sigma + 1$  on the third factor. However, in this

regime, thanks to the following estimation (which is a straightforward consequence of the mean value theorem)

$$\left| \langle k, \xi \rangle^\sigma - \langle k - n, \xi - tn \rangle^\sigma \right| \leq 2\sigma |n, tn| \langle k - n, \xi - tn \rangle^{\sigma-2} |k - n, \xi - tn|, \quad (\text{A.3})$$

this issue is handled and Lemma 2.3.6 implies (by applying again  $|\xi - tk| \leq \langle t \rangle \langle k - n, \xi - tn \rangle$ )

$$\begin{aligned} & \left| \iiint \langle k, \xi \rangle^\sigma \overline{\widehat{g}(t, k, \xi)} \langle n, tn \rangle n \widehat{W}(n) \widehat{\rho}(t, n) \langle t \rangle \langle k - n, \xi - tn \rangle^\sigma \widehat{g}(t, k - n, \xi - tn) \, dn \, dk \, d\xi \right| \\ & \lesssim \langle t \rangle \|g(t)\|_{H^\sigma}^2 \left( \int_n \langle n, tn \rangle |\widehat{\rho}(t, n)| \, dn \right) \end{aligned}$$

where for  $\sigma \geq 0$  sufficiently large

$$\int_n \langle n, tn \rangle |\widehat{\rho}(t, n)| \, dn \lesssim \left( \int_n \langle n, tn \rangle^{2\sigma} |\widehat{\rho}(t, n)|^2 \, dn \right)^{1/2}.$$

Combining these estimations we eventually get

$$\frac{1}{2} \frac{d}{dt} \|g(t)\|_{H^\sigma}^2 \lesssim \langle t \rangle \|g(t)\|_{H^\sigma}^2 \left( \int_n \langle n, tn \rangle^{2\sigma} |\widehat{\rho}(t, n)|^2 \, dn \right)^{1/2}.$$

This estimate can also be performed with a weight  $v^\alpha$  and summing over  $\alpha$  implies

$$\frac{1}{2} \frac{d}{dt} \|g(t)\|_{H_P^\sigma}^2 \lesssim \langle t \rangle \|g(t)\|_{H_P^\sigma}^2 \left( \int_n \langle n, tn \rangle^{2\sigma} |\widehat{\rho}(t, n)|^2 \, dn \right)^{1/2}.$$

The introduction of the norm  $H_P^\sigma$  instead of the norm  $H^\sigma$  is required since it is only when  $P \in \mathbb{N}$  is sufficiently large that, thanks to the Trace Lemma 2.3.4, we have the embedding property

$$\left( \int_n \langle n, tn \rangle^{2\sigma} |\widehat{\rho}(t, n)|^2 \, dn \right)^{1/2} \lesssim \|g(t)\|_{H_P^\sigma}, \quad (\text{A.4})$$

which eventually provides the announced energy estimate.

### A.1.2 The Vlasov-Wave case

Since the Vlasov-Wave system has the same structure than the Vlasov equation we can obtain a rather similar energy like estimate. Indeed, if we redefine the operator  $\mathcal{L}_t[\rho]$  by

$$\mathcal{L}_t[\rho] : f \in C_c^\infty(\mathbb{R}^d \times \mathbb{R}^d) \mapsto \left[ (x, v) \mapsto \nabla \sigma_1 \star (\mathcal{F}_I(t) - \sigma_1 \star \mathcal{G}_\rho(t)) (x + tv) \cdot (\nabla_v - t \nabla_x) f(x, v) \right],$$

then a simple integration by part leads to

$$\langle f, \mathcal{L}_t[\rho] f \rangle_{L_{x,v}^2} = 0 \quad (\text{A.5})$$

and we can adapt the previous estimates in order to obtain from (2.10a)–(2.10b) (when  $\mathcal{M} \equiv 0$ , otherwise straightforward modifications lead to a similar result)

$$\frac{1}{2} \frac{d}{dt} \|g(t)\|_{H_P^\sigma}^2 \lesssim \langle t \rangle \|g(t)\|_{H_P^\sigma}^2 \left( \int_n \langle n, tn \rangle^{2\sigma} |n|^2 |\widehat{\sigma}_1(n)|^2 \left| \widehat{\mathcal{F}}_I(t, n) - \widehat{\sigma}_1(n) \widehat{\mathcal{G}}_\rho(t, n) \right|^2 \, dn \right)^{1/2}.$$

Then, thanks to a variant of Proposition 2.3.1 and the embedding property (A.4), we eventually obtain the energy estimate

$$\frac{1}{2} \frac{d}{dt} \|g(t)\|_{H_P^\sigma}^2 \lesssim \langle t \rangle \|g(t)\|_{H_P^\sigma}^2 \left( 1 + \int_0^t \|g(\tau)\|_{H_P^\sigma}^2 \, d\tau \right)^{1/2}.$$

By introducing the vector

$$X(t) = \left( \int_0^t \|g(\tau)\|_{H_P^\sigma}^2 d\tau, \|g(t)\|_{H_P^\sigma}^2 \right)^t,$$

the previous energy estimate implies

$$\|\dot{X}(t)\|^2 = \left( \|g(t)\|_{H_P^\sigma}^2 \right)^2 + \left( \frac{d}{dt} \|g(t)\|_{H_P^\sigma}^2 \right)^2 \leq (1 + C\langle t \rangle^2) \|X(t)\|^2 + C\langle t \rangle^2 \|X(t)\|^3.$$

We can rewrite this estimate as follow

$$\frac{1}{2} \frac{d}{dt} \|X(t)\|^2 \leq \|X(t)\| \|\dot{X}(t)\| \leq \left( 1 + C\langle t \rangle^2 + C\langle t \rangle^2 \|X(t)\| \right)^{1/2} \|X(t)\|^2,$$

which implies the local existence of the solution in  $C^0([0, T], H_P^\sigma)$  and this local existence is propagated as long as the  $H_P^\sigma$ -norm of the solution does not blow up.

### A.1.3 Continuity with the last bootstrap's norms

The continuity of  $g$  in  $H_P^\sigma$ -norm implies the continuity of  $g$  with respect to the norms involved in (2.46a)–(2.46c). We are left with the task of justifying the continuity of  $g$  with respect to the last two norms involved in (2.46d)–(2.46e) (where the supremum over the Fourier mode  $k$  is not controlled in terms of  $H_P^\sigma$ -norm). The same strategy than in the case of the  $H_P^\sigma$ -norm can be adapted in order to obtain an energy like estimate which guarantees that these norms are at least propagated by the equation on a finite time interval (which shrinks to  $\{0\}$  when the norm of the initial data blows up). For example, in the Vlasov case (A.1), we get

$$\begin{aligned} \langle k, \xi \rangle^{s_1} |\widehat{g}(T, k, \xi)| &\leq \langle k, \xi \rangle^{s_1} |\widehat{f}_0(k, \xi)| \\ &\quad + \int_0^T \int \langle k, \xi \rangle^{s_1} |n| |\widehat{W}(n)| |\widehat{\rho}(t, n)| |\xi - tk| |\widehat{g}(t, k - n, \xi - tn)| dn dt. \end{aligned}$$

Then, thanks to the rough estimate

$$\langle k, \xi \rangle^{s_1} |\xi - tk| \lesssim \langle t \rangle \langle n, tn \rangle^{s_1} \langle k - n, \xi - tn \rangle^{s_1+1},$$

we obtain

$$\begin{aligned} &\int_0^T \int \langle k, \xi \rangle^{s_1} |n| |\widehat{W}(n)| |\widehat{\rho}(t, n)| |\xi - tk| |\widehat{g}(t, k - n, \xi - tn)| dn dt \\ &\lesssim \langle T \rangle \left( \int_0^T \int |n|^2 |\widehat{W}(n)|^2 \langle n, tn \rangle^{2s_1} |\widehat{\rho}(t, n)|^2 dn dt \right)^{1/2} \\ &\quad \times \left( \int_0^T \int \langle k - n, \xi - tn \rangle^{2s_1+2} |\widehat{g}(t, k - n, \xi - tn)|^2 dn dt \right)^{1/2}. \end{aligned}$$

Eventually, the Trace Lemma 2.3.4 yields

$$\begin{aligned} &\left( \sup_{k, \xi} \langle k, \xi \rangle^{s_1} |\widehat{g}(T, k, \xi)| \right) \\ &\lesssim \left( \sup_{k, \xi} \langle k, \xi \rangle^{s_1} |\widehat{f}_0(k, \xi)| \right) + \langle T \rangle \left( \sup_{0 \leq s \leq T} \|g(s)\|_{H_P^{s_1}} \right) \left( \sup_{0 \leq s \leq T} \|g(s)\|_{H_P^{s_1+1}} \right) \end{aligned}$$

and this quantity remains bounded as long as the  $H_P^{s_1+1}$  norm of the solution  $g(t)$  is controlled. We do not perform these estimates in the Vlasov-Wave case here since the proof of the bootstrap statement consists exactly to perform them but in a finer way in order to obtain (2.47d)–(2.47e) from (2.46a)–(2.46e).

## A.2 Bootstrap analysis: end of the proof of Proposition 2.3.9

We come back to the proof of Proposition 2.3.9. We had started this proof in Section 2.3.3 where we perform the estimation of the  $L^2_{(k)}L^2_{(t)}$  norm of  $A_{s_4}\hat{\varrho}$ . We now give the other estimations.

### A.2.1 Estimate of the $L^\infty_{(k)}L^2_{(t)}$ norm of $A_{s_2}\hat{\varrho}$

We start from (2.48) which allows us to write

$$\|A_{s_2}\varrho(\cdot, k)\|_{L^2_{(t)}}^2 \lesssim \text{CT1} + \text{CT2} + \text{NLT}.$$

We split again the non linear term as  $\text{NLT} = \text{NLTR} + \text{NLTT}$  based on

$$\langle k, tk \rangle^{s_2} \lesssim \langle n, \tau n \rangle^{s_2} + \langle k - n, tk - \tau n \rangle^{s_2}.$$

**Estimate on CT1 and CT2.** Owing to the assumptions on  $f_0$  and Lemma 2.3.5, we have  $\text{CT1} \lesssim \varepsilon^2$  while Proposition 2.3.3 and the assumptions on  $\mathcal{F}_I$  implies  $\text{CT2} \lesssim \varepsilon^2$ .

**Estimate on NLTR.** The Cauchy-Schwarz inequality yields

$$\begin{aligned} \text{NLTR} &= \int_0^T \left( \int_0^t \int_{\mathbb{R}^d} |k|^{1/2} \langle n, \tau n \rangle^{s_2} |n| |\hat{\sigma}_1(n)| \left| \widehat{\mathcal{F}}_I(\tau, n) - \hat{\sigma}_1(n) \widehat{\mathcal{G}}_\varrho(\tau, n) \right| \right. \\ &\quad \left. \times |(t - \tau)k| |\widehat{g}(\tau, k - n, tk - \tau n)| \, d\tau \, dn \right)^2 dt \\ &\leq \int_0^T \left( \int_0^t \int_{\mathbb{R}^d} |n| \langle n, \tau n \rangle^{2s_4} \langle n \rangle^4 |\hat{\sigma}_1(n)|^2 \left| \widehat{\mathcal{F}}_I(\tau, n) - \hat{\sigma}_1(n) \widehat{\mathcal{G}}_\varrho(\tau, n) \right|^2 \, d\tau \, dn \right) \\ &\quad \times \left( \int_0^t \int_{\mathbb{R}^d} \frac{|k|^3 |t - \tau|^2 |n|}{\langle n \rangle^4 \langle n, \tau n \rangle^{2s_4 - 2s_2}} |\widehat{g}(\tau, k - n, tk - \tau n)|^2 \, d\tau \, dn \right) dt. \end{aligned}$$

We combine (2.34a) with (2.46b) and we obtain

$$\int_0^t \int_{\mathbb{R}^d} |n| \langle n, \tau n \rangle^{2s_4} \langle n \rangle^4 |\hat{\sigma}_1(n)|^2 \left| \widehat{\mathcal{F}}_I(\tau, n) - \hat{\sigma}_1(n) \widehat{\mathcal{G}}_\varrho(\tau, n) \right|^2 \, d\tau \, dn \lesssim (1 + K_2) \varepsilon^2$$

while (2.46e) implies  $\langle k - n, tk - \tau n \rangle^{s_1} |\widehat{g}(\tau, k - n, tk - \tau n)| \lesssim K_5 \varepsilon$ . Hence, we get

$$\text{NLTR} \lesssim (1 + K_2) K_5^2 \varepsilon^4 \int_0^T \int_0^t \int_{\mathbb{R}^d} \frac{|k|^3 |t - \tau|^2 |n|}{\langle n \rangle^4 \langle n, \tau n \rangle^{2s_4 - 2s_2} \langle k - n, tk - \tau n \rangle^{2s_1}} \, dt \, d\tau \, dn.$$

We are left with the task of proving

$$\sup_{T \geq 0} \sup_{k \in \mathbb{R}^d} \int_0^T \int_0^t \int_{\mathbb{R}^d} \frac{|k|^3 |t - \tau|^2 |n|}{\langle n \rangle^4 \langle n, \tau n \rangle^{2s_4 - 2s_2} \langle k - n, tk - \tau n \rangle^{2s_1}} \, dt \, d\tau \, dn \lesssim 1.$$

We postpone the proof of this estimate to Section A.2.7.

**Estimate on NLTT.** By virtue of (2.34c) and (2.46e), we obtain

$$|\widehat{\sigma}_1(n)| \left| \widehat{\mathcal{F}}_I(\tau, n) - \widehat{\sigma}_1(n) \widehat{\mathcal{G}}_\varrho(\tau, n) \right| \lesssim \frac{1}{\langle n \rangle^2 \langle n, \tau n \rangle^{s_1}} (1 + K_5) \varepsilon.$$

Since

$$\langle k - n, tk - \tau n \rangle^{s_2} |(t - \tau)k| \leq \frac{\langle \tau \rangle}{\langle k - n, tk - \tau n \rangle^{s_3 - s_2 - 1}} \langle k - n, tk - \tau n \rangle^{s_3},$$

the Cauchy-Schwarz inequality allow us to obtain

$$\begin{aligned} \text{NLTT} &= \int_0^T \left( \int_0^t \int_{\mathbb{R}^d} |k|^{1/2} \langle k - n, tk - \tau n \rangle^{s_2} |n| |\widehat{\sigma}_1(n)| \left| \widehat{\mathcal{F}}_I(\tau, n) - \widehat{\sigma}_1(n) \widehat{\mathcal{G}}_\varrho(\tau, n) \right| \right. \\ &\quad \left. \times |(t - \tau)k| |\widehat{g}(\tau, k - n, tk - \tau n)| \, d\tau \, dn \right)^2 dt \\ &\lesssim \int_0^T \left( \int_0^t \int_{\mathbb{R}^d} |k|^{1/2} \frac{|n|}{\langle n \rangle^2 \langle n, \tau n \rangle^{s_1}} \frac{\langle \tau \rangle}{\langle k - n, tk - \tau n \rangle^{s_3 - s_2 - 1}} \frac{1}{|k - n|^\delta} \right. \\ &\quad \left. \times |k - n|^\delta \langle k - n, tk - \tau n \rangle^{s_3} |\widehat{g}(\tau, k - n, tk - \tau n)| \, d\tau \, dn \right)^2 dt \\ &\lesssim (1 + K_5)^2 \varepsilon^2 \int_0^T \left( \int_0^t \int_{\mathbb{R}^d} \frac{|n|^2 \langle \tau \rangle^2}{\langle n \rangle^2 \langle n, \tau n \rangle^{2s_1}} \frac{|k|}{\langle k - n, tk - \tau n \rangle^{2s_3 - 2s_2 - 2}} \frac{1}{|k - n|^{2\delta}} \, d\tau \, dn \right) \\ &\quad \times \left( \int_0^t \int_{\mathbb{R}^d} |k - n|^{2\delta} \langle k - n, tk - \tau n \rangle^{2s_3} |\widehat{g}(\tau, k - n, tk - \tau n)|^2 \, d\tau \, dn \right) dt. \end{aligned}$$

Then, by the Trace Lemma (see the proof of Lemma 2.3.5 for more details) and (2.46c), we have (for  $k \neq 0$ )

$$\begin{aligned} &\int_0^t \int_{\mathbb{R}^d} |k - n|^{2\delta} \langle k - n, tk - \tau n \rangle^{2s_3} |\widehat{g}(\tau, k - n, tk - \tau n)|^2 \, d\tau \, dn \\ &= \int_0^t \int_{\mathbb{R}^d} |n|^{2\delta} \langle n, (t - \tau)k - \tau n \rangle^{2s_3} |\widehat{g}(\tau, n, (t - \tau)k - \tau n)|^2 \, d\tau \, dn \\ &\leq \sup_{s \in [0, T]} \sup_{\eta \in \mathbb{R}^d} \int_{\mathbb{R}^d} \int_{-\infty}^{+\infty} |n|^{2\delta} \langle n, \eta + \tau k \rangle |\widehat{g}(s, n, \eta + \tau k)|^2 \, dn \, d\tau \\ &\lesssim \sup_{s \in [0, T]} \left\| |\nabla_x|^\delta g(s) \right\|_{H^{s_3}}^2 \lesssim K_3 \varepsilon^2 \end{aligned}$$

Going back to NLTT we are finally led to

$$\begin{aligned} \text{NLTT} &\lesssim (1 + K_5)^2 K_3 \varepsilon^4 \\ &\quad \times \int_0^T \int_0^t \int_{\mathbb{R}^d} \frac{|n|^2 \langle \tau \rangle^{2\eta+2}}{\langle n \rangle^2 \langle n, \tau n \rangle^{2s_1}} \frac{|k|}{\langle k - n, tk - \tau n \rangle^{2s_3 - 2s_2 - 2}} \frac{1}{|k - n|^{2\delta}} \, dt \, d\tau \, dn \end{aligned}$$

and it remains to check that the integral is uniformly bounded with respect to both  $k$  and  $T$ . We postpone this integral estimate to Section A.2.7.

**Recap.** We have shown that, if  $g$  is a solution of (2.10a)–(2.10b) satisfying (2.46a)–(2.46e) on  $[0, T]$ , then

$$\|A_{s_2}\widehat{\varrho}\|_{L^\infty_{(k)}L^2_{(t)}}^2 \lesssim \left(1 + (1 + K_2)K_5^2\varepsilon^2 + (1 + K_5)^2K_3\varepsilon^2\right)\varepsilon^2$$

Let us denote  $C_2$  the constant hidden in the  $\lesssim$  symbol of this estimate. Choosing  $K_4 \geq C_2$  and  $\varepsilon \ll 1$  so that

$$(1 + K_2)K_5^2\varepsilon^2 + (1 + K_5)^2K_3\varepsilon^2 \leq 1$$

allows us to obtain (2.47d).

### A.2.2 Estimates on $g$ : general approach

We cannot apply directly the estimates coming from the linearized problem. Nevertheless, we are going to justify the estimates (2.47a), (2.47c) and (2.47e) from (2.46a)–(2.46e). To this end, we should play with the constants  $K_1$ ,  $K_3$  and  $K_5$  that depend themselves on  $K_2$  and  $K_4$ . What is crucial is to check the compatibility of the choices of these constants, and the consistency of the smallness assumption on  $\varepsilon$ .

We remark that

$$\| \langle t\nabla_x, \nabla_v \rangle g(t) \|_{H_P^{s_4}}^2 \leq \langle t \rangle^2 \| \langle \nabla_x \rangle g(t) \|_{H_P^{s_4}}^2 + \| \langle \nabla_v \rangle g(t) \|_{H_P^{s_4}}^2 \leq 2 \| \langle t\nabla_x, \nabla_v \rangle g(t) \|_{H_P^{s_4}}^2.$$

The first inequality tells us that it suffices to estimate independently  $\| \langle \nabla_v \rangle g(t) \|_{H_P^{s_4}}$  and  $\| \langle \nabla_x \rangle g(t) \|_{H_P^{s_4}}$  to get a control of  $\| \langle t\nabla_x, \nabla_v \rangle g(t) \|_{H_P^{s_4}}$ . We combine the second inequality with (2.46a), so that

$$\| \langle \nabla_v \rangle g(t) \|_{H_P^{s_4}}^2 \leq 8K_1\varepsilon^2 \langle t \rangle^5$$

and

$$\| \langle \nabla_x \rangle g(t) \|_{H_P^{s_4}}^2 \leq 8K_1\varepsilon^2 \langle t \rangle^3. \quad (\text{A.6})$$

Hence, we are going to handle separately the  $H_P^{s_4}$  norm of  $\langle \nabla_v \rangle g(t)$  and  $\langle \nabla_x \rangle g(t)$ .

Moreover, the following equality, obtained by derivating (2.43), will be usefull several times in the sequel

$$\begin{aligned} \partial_t \widehat{g}(t, k, \xi) &= \widehat{\nabla \sigma_1}(k) \left( \widehat{\mathcal{F}}_I(t, k) - \widehat{\sigma_1}(k) \widehat{\mathcal{G}}_\varrho(t, k) \right) \cdot \widehat{\nabla_v \mathcal{M}}(\xi - tk) \\ &+ \int_{\mathbb{R}^d} \widehat{\nabla \sigma_1}(n) \left( \widehat{\mathcal{F}}_I(t, n) - \widehat{\sigma_1}(n) \widehat{\mathcal{G}}_\varrho(t, n) \right) \cdot (\nabla_v - t\nabla_x) g(t)(k - n, \xi - tk) \, dn. \end{aligned} \quad (\text{A.7})$$

### A.2.3 Estimate of the $H_P^{s_4}$ norm of $\langle \nabla_v \rangle g(t)$

Let  $\alpha \in \mathbb{N}^d$ ,  $|\alpha| \leq P$  be given; we are going to estimate

$$\| (x, v) \mapsto \langle \nabla_v \rangle v^\alpha g(t, x, v) \|_{H^{s_4}}^2.$$

We postpone as far as possible the summation over  $\alpha$ . We work on the Fourier transform, and applying (A.7) leads to

$$\begin{aligned}
 & \frac{1}{2} \frac{d}{dt} \|(x, v) \mapsto \langle \nabla_v \rangle v^\alpha g(t, x, v)\|_{H^{s_4}}^2 \\
 &= \iint_{\mathbb{R}^d \times \mathbb{R}^d} \langle \xi \rangle \langle k, \xi \rangle^{s_4} D_\xi^\alpha \overline{\widehat{g}(t, k, \xi)} \langle \xi \rangle \langle k, \xi \rangle^{s_4} D_\xi^\alpha \partial_t \widehat{g}(t, k, \xi) \, dk \, d\xi \\
 &= \iint_{\mathbb{R}^d \times \mathbb{R}^d} \langle \xi \rangle \langle k, \xi \rangle^{s_4} D_\xi^\alpha \overline{\widehat{g}(t, k, \xi)} \langle \xi \rangle \langle k, \xi \rangle^{s_4} \widehat{\nabla \sigma_1}(k) \\
 &\quad \times \left( \widehat{\mathcal{F}}_I(t, k) - \widehat{\sigma}_1(k) \widehat{\mathcal{G}}_\rho(t, k) \right) D_\xi^\alpha \widehat{\nabla_v \mathcal{M}}(\xi - tk) \, dk \, d\xi \\
 &+ \iint_{\mathbb{R}^d \times \mathbb{R}^d} \langle \xi \rangle \langle k, \xi \rangle^{s_4} D_\xi^\alpha \overline{\widehat{g}(t, k, \xi)} \langle \xi \rangle \langle k, \xi \rangle^{s_4} D_\xi^\alpha \left\{ \xi \mapsto \int_{\mathbb{R}^d} \widehat{\nabla \sigma_1}(n) \left( \widehat{\mathcal{F}}_I(t, n) - \widehat{\sigma}_1(n) \widehat{\mathcal{G}}_\rho(t, n) \right) \right. \\
 &\quad \left. \cdot (\nabla_v - t \nabla_x) g(t)(k - n, \xi - tn) \, dn \right\} \, dk \, d\xi \\
 &= \text{LT} + \text{NLT}.
 \end{aligned}$$

We split the non linear term into two parts  $\text{NLT} = \text{NLT1} + \text{NLT2}$ : in NLT1 the operator  $D_\xi^\alpha$  acts on  $\widehat{g}$  only while in NLT2 it acts on both  $\widehat{g}$  and  $\xi - tk$ ,

$$\begin{aligned}
 & D_\xi^\alpha [\xi \mapsto (\xi - tk) \widehat{g}(t, k - n, \xi - tn)] \\
 &= (\xi - tk) D_\xi^\alpha \widehat{g}(t, k - n, \xi - tn) + \sum_{\substack{j \in \mathbb{N}^d \\ |j|=1, j \leq \alpha}} \binom{\alpha}{j} j D_\xi^{\alpha-j} \widehat{g}(t, k - n, \xi - tn).
 \end{aligned}$$

**The linear term LT.** By using

$$\langle \xi \rangle \langle k, \xi \rangle^{s_4} \lesssim \langle t \rangle \langle k \rangle \langle k, tk \rangle^{s_4} \langle \xi - tk \rangle^{s_4+1},$$

and Cauchy-Schwarz' inequality, we get

$$\begin{aligned}
 |\text{LT}| &\lesssim \langle t \rangle \int_{\mathbb{R}_{k, \xi}^{2d}} \langle \xi \rangle \langle k, \xi \rangle^{s_4} \left| D_\xi^\alpha \widehat{g}(t, k, \xi) \right| \langle k \rangle \langle k, tk \rangle^{s_4} |k| |\widehat{\sigma}_1(k)| \left| \widehat{\mathcal{F}}_I(t, k) - \widehat{\sigma}_1(k) \widehat{\mathcal{G}}_\rho(t, k) \right| \\
 &\quad \times \langle \xi - tk \rangle^{s_4+1} \left| D_\xi^\alpha \widehat{\nabla_v \mathcal{M}}(\xi - tk) \right| \, dk \, d\xi \\
 &\lesssim \langle t \rangle \left( \int_{\mathbb{R}_{k, \xi}^{2d}} \langle \xi \rangle^2 \langle k, \xi \rangle^{2s_4} \left| D_\xi^\alpha \widehat{g}(t, k, \xi) \right|^2 \, dk \, d\xi \right)^{1/2} \\
 &\quad \times \left( \int_{\mathbb{R}_{k, \xi}^{2d}} \langle k \rangle^2 \langle k, tk \rangle^{2s_4} |k|^2 |\widehat{\sigma}_1(k)|^2 \left| \widehat{\mathcal{F}}_I(t, k) - \widehat{\sigma}_1(k) \widehat{\mathcal{G}}_\rho(t, k) \right|^2 \right. \\
 &\quad \left. \times \langle \xi - tk \rangle^{2s_4+2} \left| D_\xi^\alpha \widehat{\nabla_v \mathcal{M}}(\xi - tk) \right|^2 \, dk \, d\xi \right)^{1/2} \\
 &\lesssim \langle t \rangle \| \langle \nabla_v \rangle g(t) \|_{H_P^{s_4}} \left( \int_{\mathbb{R}_k^d} \langle k \rangle^2 \langle k, tk \rangle^{2s_4} |k|^2 |\widehat{\sigma}_1(k)|^2 \left| \widehat{\mathcal{F}}_I(t, k) - \widehat{\sigma}_1(k) \widehat{\mathcal{G}}_\rho(t, k) \right|^2 \, dk \right)^{1/2} \\
 &\quad \times \left( \int_{\mathbb{R}_\xi^d} \langle \xi \rangle^{2s_4+2} \left| D_\xi^\alpha \widehat{\nabla_v \mathcal{M}}(\xi) \right|^2 \, d\xi \right)^{1/2}.
 \end{aligned}$$

Let us set

$$B(t) = \left( \int_{\mathbb{R}^d_k} \langle k \rangle^2 \langle k, tk \rangle^{2s_4} |k|^2 |\widehat{\sigma}_1(k)|^2 \left| \widehat{\mathcal{F}}_I(t, k) - \widehat{\sigma}_1(k) \widehat{\mathcal{G}}_\varrho(t, k) \right|^2 dk \right)^{1/2} \quad (\text{A.8})$$

We observe that (2.34a) and (2.46b) lead to

$$\int_0^T B(t)^2 dt \lesssim (1 + K_2) \varepsilon^2.$$

From now on, we adopt the convention that  $B$  denotes a function which satisfies such an estimate. Moreover  $\mathcal{M} \in H_P^{\tilde{s}}$  implies (for  $\tilde{s}$  large enough)

$$\int_{\mathbb{R}^d_\xi} \langle \xi \rangle^{2s_4+2} \left| D_\xi^\alpha \widehat{\nabla_v \mathcal{M}}(\xi) \right|^2 d\xi \lesssim 1,$$

and we are led to (owing to (2.46a))

$$|\text{LT}| \lesssim \sqrt{K_1} \varepsilon \langle t \rangle^{5/2+1} B(t).$$

**Remark A.2.1** *This estimate is quite rough and it involves a Sobolev regularity  $\tilde{s}$  higher than  $s_4$  on  $\nabla_v \mathcal{M}$ . For the non linear term a finer approach will be necessary since we cannot use a Sobolev regularity beyond  $s_4$  on  $\langle \nabla_v \rangle g(t)$ ; a gain of one derivative with respect to  $v$  will be necessary.*

We should pay attention not to have contradiction in the definition of the constant  $K_1$ . To this end, we introduce  $\delta' > 0$  that can be selected as small as necessary, and we use the following estimate

$$|\text{LT}| \lesssim \frac{\sqrt{\delta'}}{\sqrt{\langle t \rangle}} \sqrt{K_1} \varepsilon \langle t \rangle^{5/2} \times \frac{\sqrt{\langle t \rangle^3}}{\sqrt{\delta'}} B(t) \lesssim \delta' K_1 \varepsilon^2 \langle t \rangle^4 + \frac{B(t)^2}{\delta'} \langle t \rangle^3.$$

Using this way Young's inequality, we make the square of  $B(t)$  appear, which is the quantity that we are able to estimate.

**The non linear term NLT1.** Since we have to gain one derivative with respect to  $v$  we will use the specific structure of the equation that (A.5) provides. If

$$f = \mathcal{F}^{-1} \left( (k, \xi) \mapsto \langle \xi \rangle \langle k, \xi \rangle^{s_4} D_\xi^\alpha \widehat{g}(t, k, \xi) \right),$$

then, by Fourier-transforming and owing to Plancherel's theorem, (A.5) tells us

$$\begin{aligned} 0 &= \int_{\mathbb{R}^{2d}_{k, \xi}} \langle \xi \rangle \langle k, \xi \rangle^{s_4} D_\xi^\alpha \widehat{g}(t, k, \xi) \widehat{\mathcal{L}}_{(t)}[\varrho] f(t, k, \xi) dk d\xi \\ &= \int_{\mathbb{R}^{3d}_{k, \xi, n}} \langle \xi \rangle \langle k, \xi \rangle^{s_4} D_\xi^\alpha \widehat{g}(t, k, \xi) n \widehat{\sigma}_1(n) \left( \widehat{\mathcal{F}}_I(t, n) - \widehat{\sigma}_1(n) \widehat{\mathcal{G}}_\varrho(t, n) \right) \\ &\quad \times \langle \xi - tn \rangle \langle k - n, \xi - tn \rangle^{s_4} (\xi - tk) D_\xi^\alpha \widehat{g}(t, k - n, \xi - tn) dk d\xi dn. \end{aligned}$$



Therefore NLT1 can be cast as

$$\begin{aligned} \text{NLT1} &= - \int_{\mathbb{R}_{k,\xi,n}^{3d}} \langle \xi \rangle \langle k, \xi \rangle^{s_4} \overline{D_\xi^\alpha \widehat{g}(t, k, \xi)} \left[ \langle \xi \rangle \langle k, \xi \rangle^{s_4} - \langle \xi - tn \rangle \langle k - n, \xi - tn \rangle^{s_4} \right] \\ &\quad \times n \widehat{\sigma}_1(n) \left( \widehat{\mathcal{F}}_I(t, n) - \widehat{\sigma}_1(n) \widehat{\mathcal{G}}_\rho(t, n) \right) (\xi - tk) D_\xi^\alpha \widehat{g}(t, k - n, \xi - tn) dk d\xi dn. \end{aligned}$$

We split depending on the leading frequencies

$$\begin{aligned} \text{NLT1} &= - \int_{\mathbb{R}_{k,\xi,n}^{3d}} \left( \mathbf{1}_{|n,tn| \geq |k-n,\xi-tn|} + \mathbf{1}_{|n,tn| \leq |k-n,\xi-tn|} \right) \langle \xi \rangle \langle k, \xi \rangle^{s_4} \overline{D_\xi^\alpha \widehat{g}(t, k, \xi)} \\ &\quad \times \left[ \langle \xi \rangle \langle k, \xi \rangle^{s_4} - \langle \xi - tn \rangle \langle k - n, \xi - tn \rangle^{s_4} \right] n \widehat{\sigma}_1(n) \left( \widehat{\mathcal{F}}_I(t, n) - \widehat{\sigma}_1(n) \widehat{\mathcal{G}}_\rho(t, n) \right) \\ &\quad \times (\xi - tk) D_\xi^\alpha \widehat{g}(t, k - n, \xi - tn) dk d\xi dn \\ &= \text{NLT1R} + \text{NLT1T}. \end{aligned}$$

We are now going to study the two terms of this splitting.

**Estimate on NLT1R.** We remark that

$$|\xi - tk| \leq \langle t \rangle \langle k - n, \xi - tn \rangle.$$

and when  $|n, tn| \geq |k - n, \xi - tn|$ , we have

$$|\langle \xi \rangle \langle k, \xi \rangle^{s_4} - \langle \xi - tn \rangle \langle k - n, \xi - tn \rangle^{s_4}| \lesssim \langle \xi - tn \rangle \langle t \rangle \langle n \rangle \langle n, tn \rangle^{s_4}.$$

**Remark A.2.2** *This relation allows us to overcome the difficulty mentioned during the study of the linear term. In the regime  $|n, tn| \geq |k - n, \xi - tn|$  we have been able, at the price of an extra factor  $\langle t \rangle$ , to distribute the weights  $\langle n, tn \rangle$  and  $\langle k - n, \xi - tn \rangle$  on  $\rho(t)$  and  $\langle \nabla_v \rangle g(t)$  so that their estimate does not involve Sobolev exponent larger than  $s_4$ . This answers for NLT1R the regularity issue risen in Remark A.2.1.*

We apply these inequalities to NLT1R, and next we make use of Lemma 2.3.6; we obtain

$$\begin{aligned} |\text{NLT1R}| &\lesssim \langle t \rangle^2 \int_{\mathbb{R}_{k,\xi,n}^{3d}} \mathbf{1}_{|n,tn| \geq |k-n,\xi-tn|} \langle \xi \rangle \langle k, \xi \rangle^{s_4} \left| D_\xi^\alpha \widehat{g}(t, k, \xi) \right| \langle \xi - tn \rangle \langle n \rangle \langle n, tn \rangle^{s_4} \\ &\quad \times |n| |\widehat{\sigma}_1(n)| \left| \widehat{\mathcal{F}}_I(t, n) - \widehat{\sigma}_1(n) \widehat{\mathcal{G}}_\rho(t, n) \right| \langle k - n, \xi - tn \rangle \left| D_\xi^\alpha \widehat{g}(t, k - n, \xi - tn) \right| dk d\xi dn \\ &\lesssim \langle t \rangle^2 \left( \int_{\mathbb{R}_{k,\xi}^{2d}} \langle \xi \rangle^2 \langle k, \xi \rangle^{2s_4} \left| D_\xi^\alpha \widehat{g}(t, k, \xi) \right|^2 dk d\xi \right)^{1/2} \\ &\quad \times \left( \int_{\mathbb{R}_n^d} \langle n \rangle^2 \langle n, tn \rangle^{2s_4} |n|^2 |\widehat{\sigma}_1(n)|^2 \left| \widehat{\mathcal{F}}_I(t, n) - \widehat{\sigma}_1(n) \widehat{\mathcal{G}}_\rho(t, n) \right|^2 dn \right)^{1/2} \\ &\quad \times \int_{\mathbb{R}_k^d} \left( \int_{\mathbb{R}_\xi^d} \langle \xi \rangle^2 \langle k, \xi \rangle^2 \left| D_\xi^\alpha \widehat{g}(t, k, \xi) \right|^2 d\xi \right)^{1/2} dk \\ &\lesssim \langle t \rangle^2 \| \langle \nabla_v \rangle g(t) \|_{H_P^{s_4}} B(t) \int_{\mathbb{R}_k^d} \left( \int_{\mathbb{R}_\xi^d} \langle \xi \rangle^2 \langle k, \xi \rangle^2 \left| D_\xi^\alpha \widehat{g}(t, k, \xi) \right|^2 d\xi \right)^{1/2} dk. \end{aligned}$$

where we use again the generic notation  $B(t)$  as in (A.8). Let us consider in details the third term: as far as  $\delta < d/2$  (which holds since  $\delta < 1$ ) and  $s_3$  is large enough ( $s_3 > d/2 + 2$  is sufficient), the Cauchy-Schwartz inequality yields

$$\begin{aligned} & \int_{\mathbb{R}_k^d} \frac{|k|^\delta \langle k \rangle^{s_3-2}}{|k|^\delta \langle k \rangle^{s_3-2}} \left( \int_{\mathbb{R}_\xi^d} \langle \xi \rangle^2 \langle k, \xi \rangle^2 \left| D_\xi^\alpha \widehat{g}(t, k, \xi) \right|^2 d\xi \right)^{1/2} dk \\ & \leq \left( \int_{\mathbb{R}_k^d} \frac{1}{|k|^{2\delta} \langle k \rangle^{2s_3-4}} dk \right)^{1/2} \left( \int_{\mathbb{R}_{k,\xi}^{2d}} |k|^{2\delta} \langle k \rangle^{2s_3-4} \langle \xi \rangle^2 \langle k, \xi \rangle^2 \left| D_\xi^\alpha \widehat{g}(t, k, \xi) \right|^2 dk d\xi \right)^{1/2} \\ & \lesssim \| |\nabla_x|^\delta g(t) \|_{H_P^{s_3}}. \end{aligned}$$

Next, with (2.46a) and (2.46c) we get

$$|\text{NLT1R}| \lesssim \sqrt{K_1 K_3} \varepsilon^2 \langle t \rangle^{5/2+2} B(t).$$

In order to make the square of  $B(t)$  appear, we decompose the inequality as follows

$$|\text{NLT1R}| \lesssim \frac{1}{\sqrt{\langle t \rangle}} \sqrt{K_1 K_3} \varepsilon^{3/2} \langle t \rangle^{5/2} \times \sqrt{\langle t \rangle} \varepsilon^{1/2} \langle t \rangle^2 B(t) \lesssim K_1 K_3 \varepsilon^3 \langle t \rangle^4 + \varepsilon \langle t \rangle^5 B(t)^2.$$

**Estimate on NLT1T.** For  $|n, tn| \leq |k - n, \xi - tn|$  we have, see [13, Section 5.1.1]

$$\begin{aligned} & \langle \xi \rangle \langle k, \xi \rangle^{s_4} - \langle \xi - tn \rangle \langle k - n, \xi - tn \rangle^{s_4} \\ & \lesssim \langle n, tn \rangle^2 \left( \langle \xi - tn \rangle \langle k - n, \xi - tn \rangle^{s_4-1} + \langle k - n, \xi - tn \rangle^{s_4} \right). \end{aligned}$$

**Remark A.2.3** Note that we gain one order of Sobolev regularity on  $g$ , see Remark A.2.1 and A.2.2. Like when dealing with NLT1R, the idea is to distribute the weights  $\langle n, tn \rangle$  and  $\langle k - n, \xi - tn \rangle$  on  $\varrho(t)$  and  $\langle \nabla_v \rangle g(t)$  in order to make estimates with Sobolev exponents smaller or equal to  $s_4$  appear (see the regularity issue explained in Remark A.2.1). In the regime  $|k - n, \xi - tn| \geq |n, tn|$  we can not use an estimate as rough as for TNL1R since all the Sobolev exponents already apply to  $\langle k - n, \xi - tn \rangle$ . We should take advantage of cancellations between  $\langle \xi \rangle \langle k, \xi \rangle^{s_4}$  and  $\langle \xi - tn \rangle \langle k - n, \xi - tn \rangle^{s_4}$ . This motivates the introduction of the operator  $\mathcal{L}_t[\varrho]$ , see [12] and [36] where this operator already appeared for similar reasons.

We use this inequality for estimating NLT1T that we split according to the two terms above. We are led to

$$\begin{aligned} & |\text{NLT1T}| \\ & \lesssim \int_{\mathbb{R}_{k,\xi,n}^{3d}} \langle \xi \rangle \langle k, \xi \rangle^{s_4} \left| D_\xi^\alpha \widehat{g}(t, k, \xi) \right| \langle n, tn \rangle^2 \left( \langle \xi - tn \rangle \langle k - n, \xi - tn \rangle^{s_4-1} + \langle k - n, \xi - tn \rangle^{s_4} \right) \\ & \quad \times |n| |\widehat{\sigma}_1(n)| \left| \widehat{\mathcal{F}}_I(t, n) - \widehat{\sigma}_1(n) \widehat{\mathcal{G}}_\varrho(t, n) \right| |\xi - tk| \left| D_\xi^\alpha \widehat{g}(t, k - n, \xi - tn) \right| dk d\xi dn \\ & = \text{NLT1T1} + \text{NLT1T2}. \end{aligned}$$

We treat NLT1T1 by applying Lemma 2.3.6 (and  $|\xi - tk| \leq \langle t \rangle \langle k - n, \xi - tk \rangle$ ); we get

$$\begin{aligned} \text{NLT1T1} &\lesssim \langle t \rangle \int_{\mathbb{R}_{k,\xi,n}^{3d}} \langle \xi \rangle \langle k, \xi \rangle^{s_4} \left| D_\xi^\alpha \widehat{g}(t, k, \xi) \right| \langle n, tn \rangle^2 |n| |\widehat{\sigma}_1(n)| \left| \widehat{\mathcal{F}}_I(t, n) - \widehat{\sigma}_1(n) \widehat{\mathcal{G}}_\rho(t, n) \right| \\ &\quad \times \langle \xi - tn \rangle \langle k - n, \xi - tn \rangle^{s_4} \left| D_\xi^\alpha \widehat{g}(t, k - n, \xi - tn) \right| dk d\xi dn \\ &\lesssim \langle t \rangle \|\langle \nabla_v \rangle g(t)\|_{H_P^{s_4}} \left( \int_{\mathbb{R}_n^d} \langle n, tn \rangle^2 |n| |\widehat{\sigma}_1(n)| \left| \widehat{\mathcal{F}}_I(t, n) - \widehat{\sigma}_1(n) \widehat{\mathcal{G}}_\rho(t, n) \right| dn \right) \\ &\quad \times \left( \int_{\mathbb{R}_{k,\xi}^{2d}} \langle \xi \rangle^2 \langle k, \xi \rangle^{2s_4} \left| D_\xi^\alpha \widehat{g}(t, k, \xi) \right|^2 dk d\xi \right)^{1/2} \\ &\lesssim \langle t \rangle \|\langle \nabla_v \rangle g(t)\|_{H_P^{s_4}}^2 \left( \int_{\mathbb{R}_n^d} \langle n, tn \rangle^2 |n| |\widehat{\sigma}_1(n)| \left| \widehat{\mathcal{F}}_I(t, n) - \widehat{\sigma}_1(n) \widehat{\mathcal{G}}_\rho(t, n) \right| dn \right). \end{aligned}$$

However, (2.34c) and (2.46e) lead to

$$|\widehat{\sigma}_1(n)| \left| \widehat{\mathcal{F}}_I(t, n) - \widehat{\sigma}_1(n) \widehat{\mathcal{G}}_\rho(t, n) \right| \lesssim \frac{1}{\langle n, tn \rangle^{s_1}} (1 + K_5) \varepsilon,$$

so that (by using  $|n| \langle t \rangle \leq \langle n, tn \rangle$ )

$$\begin{aligned} &\int_{\mathbb{R}_n^d} \langle n, tn \rangle^2 |n| |\widehat{\sigma}_1(n)| \left| \widehat{\mathcal{F}}_I(t, n) - \widehat{\sigma}_1(n) \widehat{\mathcal{G}}_\rho(t, n) \right| dn \\ &\lesssim \langle t \rangle^{-1} \left( \int_{\mathbb{R}_n^d} \langle n, tn \rangle^{3-s_1} dn \right) (1 + K_5) \varepsilon \lesssim \varepsilon \langle t \rangle^{-d-1}. \end{aligned}$$

We gather these estimates with (2.46a), and we arrive at

$$\text{NLT1T1} \lesssim K_1^2 (1 + K_5) \varepsilon^3 \langle t \rangle^{5-d}.$$

For NLT1T2 we proceed similarly by using Lemma 2.3.6 (and remarking that  $|\xi - tk| \leq \langle t \rangle \langle k - n, \xi - tn \rangle$  holds); we are led to

$$\begin{aligned} \text{NLT1T2} &\lesssim \int_{\mathbb{R}_{k,\xi,n}^{3d}} \langle \xi \rangle \langle k, \xi \rangle^{s_4} \left| D_\xi^\alpha \widehat{g}(t, k, \xi) \right| \langle n, tn \rangle^2 |n| |\widehat{\sigma}_1(n)| \left| \widehat{\mathcal{F}}_I(t, n) - \widehat{\sigma}_1(n) \widehat{\mathcal{G}}_\rho(t, n) \right| \\ &\quad \times \langle t(k - n) \xi - tn \rangle \langle k - n, \xi - tn \rangle^{s_4} \left| D_\xi^\alpha \widehat{g}(t, k - n, \xi - tn) \right| dk d\xi dn \\ &\lesssim \|\langle \nabla_v \rangle g(t)\|_{H_P^{s_4}} \left( \int_{\mathbb{R}_{k,\xi}^{2d}} \langle tk, \xi \rangle^2 \langle k, \xi \rangle^{2s_4} \left| D_\xi^\alpha \widehat{g}(t, k, \xi) \right|^2 dk d\xi \right)^{1/2} \\ &\quad \times \int_{\mathbb{R}_n^d} \langle n, tn \rangle^2 |n| |\widehat{\sigma}_1(n)| \left| \widehat{\mathcal{F}}_I(t, n) - \widehat{\sigma}_1(n) \widehat{\mathcal{G}}_\rho(t, n) \right| dn \\ &\lesssim \|\langle \nabla_v \rangle g(t)\|_{H_P^{s_4}} \|\langle t \nabla_x \nabla_v \rangle g(t)\|_{H_P^{s_4}} \int_{\mathbb{R}_n^d} \langle t \rangle \langle n, tn \rangle^2 |n| |\widehat{\sigma}_1(n)| \left| \widehat{\mathcal{F}}_I(t, n) - \widehat{\sigma}_1(n) \widehat{\mathcal{G}}_\rho(t, n) \right| dn, \end{aligned}$$

and we deduce that

$$\text{NLT1T2} \lesssim K_1^2 (1 + K_5) \varepsilon^3 \langle t \rangle^{5-d-1}$$

holds.

**Estimate on NLT2.** Compared to what we just did, we are concerned with a term having less regularity (we do not have the factor  $\xi - tk$  which has been derivated). The regularity issue presented in Remark A.2.1 does not hold for NLT2 and there is no need to make use of (A.5). We turn to the second step, by decomposing between low and high frequencies

$$\begin{aligned} \text{NLT2} &= \sum_{\substack{j \in \mathbb{N}^d \\ |j|=1, j \leq \alpha}} \binom{\alpha}{j} j \int_{\mathbb{R}_{k,\xi,n}^{3d}} \langle \xi \rangle \langle k, \xi \rangle^{s_4} \overline{D_\xi^\alpha \widehat{g}(t, k, \xi)} \langle \xi \rangle \langle k, \xi \rangle^{s_4} n \widehat{\sigma}_1(n) \\ &\quad \times \left( \widehat{\mathcal{F}}_I(t, n) - \widehat{\sigma}_1(n) \widehat{\mathcal{G}}_\rho(t, n) \right) D_\xi^{\alpha-j} \widehat{g}(t, k - n, \xi - tn) \, dk \, d\xi \, dn \\ &= \sum_{\substack{j \in \mathbb{N}^d \\ |j|=1, j \leq \alpha}} \binom{\alpha}{j} j \int_{\mathbb{R}_{k,\xi,n}^{3d}} \left( \mathbf{1}_{|n,tn| \geq |k-n,\xi-tn|} + \mathbf{1}_{|n,tn| \leq |k-n,\xi-tn|} \right) \langle \xi \rangle \langle k, \xi \rangle^{s_4} \overline{D_\xi^\alpha \widehat{g}(t, k, \xi)} \\ &\quad \times \langle \xi \rangle \langle k, \xi \rangle^{s_4} n \widehat{\sigma}_1(n) \left( \widehat{\mathcal{F}}_I(t, n) - \widehat{\sigma}_1(n) \widehat{\mathcal{G}}_\rho(t, n) \right) D_\xi^{\alpha-j} \widehat{g}(t, k - n, \xi - tn) \, dk \, d\xi \, dn \\ &= \text{NLT2R} + \text{NLT2T}. \end{aligned}$$

On the integration domain of the reaction term, we have

$$\langle \xi \rangle \langle k, \xi \rangle^{s_4} \lesssim \langle \xi - tn \rangle \langle t \rangle \langle n \rangle \langle n, tn \rangle^{s_4}.$$

We apply Lemma 2.3.6 to obtain

$$\begin{aligned} |\text{NLT2R}| &\lesssim \langle t \rangle \sum_{\substack{j \in \mathbb{N}^d \\ |j|=1, j \leq \alpha}} \int_{\mathbb{R}_{k,\xi,n}^{3d}} \mathbf{1}_{|n,tn| \geq |k-n,\xi-tn|} \langle \xi \rangle \langle k, \xi \rangle^{s_4} \left| D_\xi^\alpha \widehat{g}(t, k, \xi) \right| \langle n \rangle \langle n, tn \rangle^{s_4} |n| |\widehat{\sigma}_1(n)| \\ &\quad \times \left| \widehat{\mathcal{F}}_I(t, n) - \widehat{\sigma}_1(n) \widehat{\mathcal{G}}_\rho(t, n) \right| \langle \xi - tn \rangle \left| D_\xi^{\alpha-j} \widehat{g}(t, k - n, \xi - tn) \right| \, dk \, d\xi \, dn \\ &\lesssim \langle t \rangle \sum_{\substack{j \in \mathbb{N}^d \\ |j|=1, j \leq \alpha}} \left( \int_{\mathbb{R}_{k,\xi}^{2d}} \langle \xi \rangle^2 \langle k, \xi \rangle^{2s_4} \left| D_\xi^\alpha \widehat{g}(t, k, \xi) \right|^2 \, dk \, d\xi \right)^{1/2} \\ &\quad \times \left( \int_{\mathbb{R}_n^d} \langle n \rangle^2 \langle n, tn \rangle^{2s_4} |n|^2 |\widehat{\sigma}_1(n)|^2 \left| \widehat{\mathcal{F}}_I(t, n) - \widehat{\sigma}_1(n) \widehat{\mathcal{G}}_\rho(t, n) \right|^2 \, dn \right)^{1/2} \\ &\quad \times \int_{\mathbb{R}_k^d} \left( \int_{\mathbb{R}_\xi^d} \langle \xi \rangle^2 \left| D_\xi^{\alpha-j} \widehat{g}(t, k, \xi) \right|^2 \, d\xi \right)^{1/2} \, dk. \end{aligned}$$

Hence it behaves like the reaction term NLT1R, up to a factor  $\langle t \rangle$ ; we can dominate the product and we get

$$|\text{NLT2R}| \lesssim \sqrt{K_1 K_3} \varepsilon^2 \langle t \rangle^{5/2+1} B(t) \lesssim K_1 K_3 \varepsilon^3 \langle t \rangle^4 + \varepsilon \langle t \rangle^3 B(t)^2.$$

For the transport term, on the integration domain

$$\langle \xi \rangle \langle k, \xi \rangle^{s_4} \lesssim \langle t \rangle \langle n \rangle \langle \xi - tn \rangle \langle k - n, \xi - tn \rangle^{s_4}$$

holds and applying Lemme 2.3.6 yields

$$\begin{aligned}
 |\text{NLT2T}| &\lesssim \langle t \rangle \sum_{\substack{j \in \mathbb{N}^d \\ |j|=1, j \leq \alpha}} \int_{\mathbb{R}_{k,\xi,n}^{3d}} \langle \xi \rangle \langle k, \xi \rangle^{s_4} \left| \text{D}_\xi^\alpha \widehat{g}(t, k, \xi) \right| \langle n \rangle |n| |\widehat{\sigma}_1(n)| \left| \widehat{\mathcal{F}}_I(t, n) - \widehat{\sigma}_1(n) \widehat{\mathcal{G}}_\rho(t, n) \right| \\
 &\quad \times \langle \xi - tn \rangle \langle k - n, \xi - tn \rangle^{s_4} \left| \text{D}_\xi^{\alpha-j} \widehat{g}(t, k - n, \xi - tn) \right| dk d\xi dn \\
 &\lesssim \langle t \rangle \sum_{\substack{j \in \mathbb{N}^d \\ |j|=1, j \leq \alpha}} \left( \int_{\mathbb{R}_{k,\xi}^{2d}} \langle \xi \rangle^2 \langle k, \xi \rangle^{2s_4} \left| \text{D}_\xi^\alpha \widehat{g}(t, k, \xi) \right|^2 dk d\xi \right)^{1/2} \\
 &\quad \times \left( \int_{\mathbb{R}_n^d} \langle n \rangle |n| |\widehat{\sigma}_1(n)| \left| \widehat{\mathcal{F}}_I(t, n) - \widehat{\sigma}_1(n) \widehat{\mathcal{G}}_\rho(t, n) \right| dn \right) \\
 &\quad \times \left( \int_{\mathbb{R}_{k,\xi}^{2d}} \langle \xi \rangle^2 \langle k, \xi \rangle^{2s_4} \left| \text{D}_\xi^{\alpha-j} \widehat{g}(t, k, \xi) \right|^2 dk d\xi \right)^{1/2},
 \end{aligned}$$

and we finally get

$$|\text{NLT2T}| \lesssim K_1^2 (1 + K_5) \varepsilon^3 \langle t \rangle^{5-d}.$$

**Remark A.2.4** *As said above, the regularity issue described in Remarks A.2.1 and A.2.2 does not hold with NLT2. Thus, there is no need to introduce the operator  $\mathcal{L}_t[\varrho]$  and we derive a better estimate for NLT2 than for NLT1. In fact, we will not use this improved estimate. We can also observe that it would be possible to use the obvious estimate  $1 \leq \langle \xi - tk \rangle$ , which yields*

$$\begin{aligned}
 &\left| \text{D}_\xi^\alpha [\xi \mapsto (\xi - tk) \widehat{g}(t, k - n, \xi - tn)] \right| \\
 &\leq \left| (\xi - tk) \text{D}_\xi^\alpha \widehat{g}(t, k - n, \xi - tn) \right| + \left| \sum_{\substack{j \in \mathbb{N}^d \\ |j|=1, j \leq \alpha}} \binom{\alpha}{j} j \text{D}_\xi^{\alpha-j} \widehat{g}(t, k - n, \xi - tn) \right| \\
 &\leq \left| (\xi - tk) \text{D}_\xi^\alpha \widehat{g}(t, k - n, \xi - tn) \right| + \sum_{\substack{j \in \mathbb{N}^d \\ |j|=1, j \leq \alpha}} \binom{\alpha}{j} \langle \xi - tk \rangle \left| \text{D}_\xi^{\alpha-j} \widehat{g}(t, k - n, \xi - tn) \right|.
 \end{aligned}$$

From this, NLT2 can be treated exactly like NLT1. In what follows, in similar situations we will only focus the discussion on the most regularity demanding terms.

**Recap.** We have shown that, if  $g$  is a solution of (2.10a)–(2.10b) satisfying moreover (2.46a)–(2.46e) on  $[0, T]$ , then, we have

$$\begin{aligned}
 &\frac{d}{dt} \left( t \mapsto \|(x, v) \mapsto \langle \nabla_v \rangle v^\alpha g(t, x, v)\|_{H^{s_4}}^2 \right) \\
 &\lesssim \delta' K_1 \varepsilon^2 \langle t \rangle^4 + \frac{\langle t \rangle^3}{\delta'} B(t)^2 + K_1 K_3 \varepsilon^3 \langle t \rangle^4 + \varepsilon \langle t \rangle^5 B(t)^2 + K_1^2 (1 + K_5) \varepsilon^3 \langle t \rangle^{5+\eta-d}.
 \end{aligned}$$

(note that we have used the rough estimates that consists in dominating NLT2R like NLT1R, NLT1T2 like NLT2T and NLT2T like NLT1T1). Let  $C_3$  be the constant hidden in the  $\lesssim$  symbol; integrating over  $[0, T]$  and summing over  $\alpha$ , we obtain (with the generic notation

(A.8) for  $B(t)$

$$\begin{aligned} \|\langle \nabla_v \rangle g(T)\|_{H_P^{s_4}}^2 &\leq \|\langle \nabla_v \rangle g(0)\|_{H_P^{s_4}}^2 + \left( C_3 \delta' K_1 \langle T \rangle^5 + C_3 \frac{\langle T \rangle^3}{\delta'} (1 + K_2) \right) \varepsilon^2 \\ &\quad + \left( C_3 K_1 K_3 \varepsilon \langle T \rangle^5 + C_3 (1 + K_2) \varepsilon \langle T \rangle^5 + C_3 K_1^2 (1 + K_5) \varepsilon \langle T \rangle^{6+\eta-d} \right) \varepsilon^2. \end{aligned}$$

Since  $g(0, x, v) = f_0(x, v)$  and  $f_0 \in H_P^s$  with  $s > s_4$ , we observe that

$$\|\langle \nabla_v \rangle g(0)\|_{H_P^{s_4}}^2 \leq \varepsilon^2.$$

Let  $\delta' \ll 1$  so that  $C_3 \delta' < 1/4$ . Once  $\delta'$  is fixed that way, we choose  $K_1 \gg 1$  so that

$$\|\langle \nabla_v \rangle g(0)\|_{H_P^{s_4}}^2 + C_3 \frac{\langle T \rangle^3}{\delta'} (1 + K_2) \varepsilon^2 \leq \frac{K_1}{4} \varepsilon^2 \langle T \rangle^5$$

holds. Therefore  $K_1$  depends on  $K_2$  and  $\delta'$ . We are left with the task of determining  $\varepsilon \ll 1$  in order to obtain

$$\left( C_3 K_1 K_3 \varepsilon \langle T \rangle^5 + C_3 (1 + K_2) \varepsilon \langle T \rangle^5 + C_3 K_1^2 (1 + K_5) \varepsilon \langle T \rangle^{6+\eta-d} \right) \varepsilon^2 \leq K_1 \varepsilon^2 \langle T \rangle^5,$$

which eventually leads to

$$\|\langle \nabla_v \rangle g(T)\|_{H_P^{s_4}}^2 \leq K_1 \varepsilon^2 \langle T \rangle^5.$$

#### A.2.4 Estimate of the $H_P^{s_4}$ norm of $\langle \nabla_x \rangle g(t)$

We proceed like in the previous section: we evaluate the time derivative of  $\|\langle \nabla_x \rangle \langle \nabla_x, \nabla_v \rangle^{s_4} v^\alpha g(t)\|_{L^2}^2$  by means of the Fourier variables, and we express  $\partial_t \widehat{g}$  with (A.7). We obtain

$$\begin{aligned} &\frac{1}{2} \frac{d}{dt} \|\langle \nabla_x \rangle \langle \nabla_x, \nabla_v \rangle^{s_4} v^\alpha g(t)\|_{L^2}^2 \\ &= - \int_{\mathbb{R}_{k,\xi}^{2d}} \langle k \rangle \langle k, \xi \rangle^{s_4} D_\xi^\alpha \overline{\widehat{g}(t, k, \xi)} \langle k \rangle \langle k, \xi \rangle^{s_4} k \widehat{\sigma}_1(k) \left( \widehat{\mathcal{F}}_I(t, k) - \widehat{\sigma}_1(k) \widehat{\mathcal{G}}_\rho(t, k) \right) \\ &\quad \times D_\xi^\alpha \left( (\xi - tk) \widehat{\mathcal{M}}(\xi - tk) \right) dk d\xi \\ &\quad - \int_{\mathbb{R}_{k,\xi,n}^{3d}} \langle k \rangle \langle k, \xi \rangle^{s_4} D_\xi^\alpha \overline{\widehat{g}(t, k, \xi)} \langle k \rangle \langle k, \xi \rangle^{s_4} n \widehat{\sigma}_1(n) \left( \widehat{\mathcal{F}}_I(t, n) - \widehat{\sigma}_1(n) \widehat{\mathcal{G}}_\rho(t, n) \right) (\xi - tk) \\ &\quad \times D_\xi^\alpha \widehat{g}(t, k - n, \xi - tn) dn dk d\xi \\ &\quad - \sum_{|j|=1; j \leq \alpha} \binom{\alpha}{j} \int_{\mathbb{R}_{k,\xi,n}^{3d}} \langle k \rangle \langle k, \xi \rangle^{s_4} D_\xi^\alpha \overline{\widehat{g}(t, k, \xi)} \langle k \rangle \langle k, \xi \rangle^{s_4} n \widehat{\sigma}_1(n) \left( \widehat{\mathcal{F}}_I(t, n) - \widehat{\sigma}_1(n) \widehat{\mathcal{G}}_\rho(t, n) \right) \\ &\quad \cdot j D_\xi^{\alpha-j} \widehat{g}(t, k - n, \xi - tn) dn dk d\xi \\ &= \text{LT} + \text{NLT1} + \text{NLT2}. \end{aligned}$$

The analysis of the the first non linear term also covers the second term, see Remark A.2.4. Thus we do not detail how to handle NLT2. Note however that similar manipulations as above can lead to a refined estimate on NLT2, but this is not necessary for our purpose.

**Estimate on the linear term** LT We apply the Cauchy-Schwarz inequality, up to the observation

$$\langle k \rangle \langle k, \xi \rangle^{s_4} \leq \langle k \rangle \langle k, tk \rangle^{s_4} \langle \xi - tk \rangle^{s_4};$$

we arrive at

$$\begin{aligned} |\text{LT}| &\lesssim \| \langle \nabla_x \rangle g(t) \|_{H_P^{s_4}} \left( \int_{\mathbb{R}_{k,\xi}^{2d}} \langle k \rangle^2 \langle k, tk \rangle^{2s_4} |k|^2 |\widehat{\sigma}_1(k)|^2 \left| \widehat{\mathcal{F}}_I(t, k) - \widehat{\sigma}_1(k) \widehat{\mathcal{G}}_\rho(t, k) \right|^2 \right. \\ &\quad \left. \times \langle \xi - tk \rangle^{2s_4} \left| D_\xi^\alpha \widehat{\nabla_v} \mathcal{M}(\xi - tk) \right|^2 dk d\xi \right)^{1/2} \\ &\lesssim \| \langle \nabla_x \rangle g(t) \|_{H_P^{s_4}} \left( \int_{\mathbb{R}_k^d} \langle k \rangle^2 \langle k, tk \rangle^{2s_4} |k|^2 |\widehat{\sigma}_1(k)|^2 \left| \widehat{\mathcal{F}}_I(t, k) - \widehat{\sigma}_1(k) \widehat{\mathcal{G}}_\rho(t, k) \right|^2 dk \right)^{1/2} \\ &\quad \times \left( \int_{\mathbb{R}_\xi^d} \langle \xi \rangle^{2s_4} \left| D_\xi^\alpha \widehat{\nabla_v} \mathcal{M}(\xi) \right|^2 d\xi \right)^{1/2} \\ &\lesssim \| \langle \nabla_x \rangle g(t) \|_{H_P^{s_4}} B(t). \end{aligned}$$

(where the assumption  $\mathcal{M} \in H_P^{\tilde{s}}$  with  $\tilde{s} > s_4 + 1$  has permitted us to obtain

$$\int_{\mathbb{R}_\xi^d} \langle \xi \rangle^{2s_4} \left| D_\xi^\alpha \widehat{\nabla_v} \mathcal{M}(\xi) \right|^2 d\xi \lesssim 1,$$

and we have used the notation (A.8) for  $B(t)$ ). Again, we introduce a positive number  $\delta''$ , as small as we wish, and we split the product into two parts so that the constant  $K_1$  is isolated and we make the square of  $B(t)$  appear. Namely, we have

$$|\text{LT}| \lesssim \frac{\delta''}{\langle t \rangle} \| \langle \nabla_x \rangle g(t) \|_{H_P^{s_4}}^2 + \langle t \rangle \frac{B^2(t)}{\delta''} \lesssim \delta'' K_1 \varepsilon^2 \langle t \rangle^2 + \langle t \rangle \frac{B^2(t)}{\delta''}.$$

where we have also made use of (A.6).

**Remark A.2.5** Here, in contrast to the previous estimate of  $\langle \nabla_v \rangle g(t)$  in norm  $H_P^{s_4}$ , we make the Sobolev estimate of  $\nabla_v \mathcal{M}$  appear with exactly the exponent  $s_4$ . Nevertheless we are facing a similar regularity difficulty since now we wish to estimate  $\langle \nabla_x \rangle g(t)$  in norm  $H_P^{s_4}$  (instead of  $\langle \nabla_v \rangle g(t)$ ). Hence, again, we need to gain one derivative. To this end we shall adapt the strategy designed for NLT1.

**Estimate on NLT1.** We use (A.5) with

$$f = \mathcal{F}^{-1} \left( (k, \xi) \mapsto \langle k \rangle \langle k, \xi \rangle^{s_4} D_\xi^\alpha \widehat{g}(t, k, \xi) \right).$$

We split between the contributions of low and high frequencies, so that

$$\begin{aligned} \text{NLT1} &= \int_{\mathbb{R}_{k,\xi,n}^{3d}} \left( \mathbf{1}_{|n,tn| \geq |k-n,\xi-tn|} + \mathbf{1}_{|n,tn| \leq |k-n,\xi-tn|} \right) \langle k \rangle \langle k, \xi \rangle^{s_4} \overline{D_\xi^\alpha \widehat{g}(t, k, \xi)} \\ &\quad \times (\langle k \rangle \langle k, \xi \rangle^{s_4} - \langle k-n \rangle \langle k-n, \xi-tn \rangle^{s_4}) n \widehat{\sigma}_1(n) \left( \widehat{\mathcal{F}}_I(t, n) - \widehat{\sigma}_1(n) \widehat{\mathcal{G}}_\rho(t, n) \right) \\ &\quad \cdot (\xi - tk) D_\xi^\alpha \widehat{g}(t, k-n, \xi-tn) dn dk d\xi \\ &= \text{NLT1R} + \text{NLT1T}. \end{aligned}$$

**Estimate on NLT1R.** On the integration domain, we have

$$|\langle k \rangle \langle k, \xi \rangle^{s_4} - \langle k-n \rangle \langle k-n, \xi - tn \rangle^{s_4}| \lesssim \langle k-n \rangle \langle n \rangle \langle n, tn \rangle^{s_4}.$$

Going back to Lemma 2.3.6 (and owing to  $|\xi - tk| \leq \langle t \rangle \langle k-n, \xi - tn \rangle$ ), we obtain

$$\begin{aligned} |\text{NLT1R}| &\lesssim \langle t \rangle \int_{\mathbb{R}_{k,\xi,n}^{3d}} \langle k \rangle \langle k, \xi \rangle^{s_4} \left| D_\xi^\alpha \widehat{g}(t, k, \xi) \right| |n| \langle n \rangle \langle n, tn \rangle^{s_4} |\widehat{\sigma}_1(n)| \left| \widehat{\mathcal{F}}_I(t, n) - \widehat{\sigma}_1(n) \widehat{\mathcal{G}}_\rho(t, n) \right| \\ &\quad \times \langle k-n \rangle \langle k-n, \xi - tn \rangle \left| D_\xi^\alpha \widehat{g}(t, k-n, \xi - tn) \right| dn dk d\xi \\ &\lesssim \langle t \rangle \| \langle \nabla_x \rangle g(t) \|_{H_P^{s_4}} B(t) \left( \int_{\mathbb{R}_k^d} \left( \int_{\mathbb{R}_\xi^d} \langle k \rangle^2 \langle k, \xi \rangle^2 \left| D_\xi^\alpha \widehat{g}(t, k, \xi) \right|^2 d\xi \right)^{1/2} dk \right) \end{aligned}$$

When estimating  $\langle \nabla_v \rangle g(t)$  in norm  $H_P^{s_4}$  we have seen that (cf. NLT1R)

$$\int_{\mathbb{R}_k^d} \left( \int_{\mathbb{R}_\xi^d} \langle k \rangle^2 \langle k, \xi \rangle^2 \left| D_\xi^\alpha \widehat{g}(t, k, \xi) \right|^2 d\xi \right)^{1/2} dk \lesssim \| |\nabla_x|^\delta g(t) \|_{H_P^{s_3}}.$$

Then, (A.6) and (2.46c) ensure that

$$|\text{NLT1R}| \lesssim \sqrt{K_1 K_3} \varepsilon^2 \langle t \rangle^{3/2+1} B(t).$$

With the Young inequality we make the square of  $B(t)$  appear; we conclude that

$$|\text{NLT1R}| \lesssim K_1 K_3 \varepsilon^3 \langle t \rangle^2 + \varepsilon \langle t \rangle^3 B(t)^2.$$

**Estimate on NLT1T.** Again we split  $\text{NLT1T} = \text{NLT1T1} + \text{NLT1T2}$  by using the fact that, on the integration domain, we have (see [13, Section 5.1.2])

$$\begin{aligned} |\langle k \rangle \langle k, \xi \rangle^{s_4} - \langle k-n \rangle \langle k-n, \xi - tn \rangle^{s_4}| \\ \lesssim \langle n, tn \rangle^2 \left( \langle k-n \rangle \langle k-n, \xi - tn \rangle^{s_4-1} + \langle k-n, \xi - tn \rangle^{s_4} \right). \end{aligned}$$

Thus, NLT1T1 stands for the term with the exponent  $s_4 - 1$ . We use Lemma 2.3.6 and  $|\xi - tk| \leq \langle t \rangle \langle k-n, \xi - tn \rangle$  and we obtain

$$\begin{aligned} |\text{NLT1T1}| &\lesssim \langle t \rangle \int_{\mathbb{R}_{k,\xi,n}^{3d}} \langle k \rangle \langle k, \xi \rangle^{s_4} \left| D_\xi^\alpha \widehat{g}(t, k, \xi) \right| |n| |\widehat{\sigma}_1(n)| \langle n, tn \rangle^2 \left| \widehat{\mathcal{F}}_I(t, n) - \widehat{\sigma}_1(n) \widehat{\mathcal{G}}_\rho(t, n) \right| \\ &\quad \times \langle k-n \rangle \langle k-n, \xi - tn \rangle^{s_4} \left| D_\xi^\alpha \widehat{g}(t, k-n, \xi - tn) \right| dn dk d\xi \\ &\lesssim \langle t \rangle \| \langle \nabla_x \rangle g(t) \|_{H_P^{s_4}}^2 \int_{\mathbb{R}_n^d} |n| |\widehat{\sigma}_1(n)| \langle n, tn \rangle^2 \left| \widehat{\mathcal{F}}_I(t, n) - \widehat{\sigma}_1(n) \widehat{\mathcal{G}}_\rho(t, n) \right| dn. \end{aligned}$$

Since (2.34c) and (2.46e) imply

$$|\widehat{\sigma}_1(n)| \left| \widehat{\mathcal{F}}_I(t, n) - \widehat{\sigma}_1(n) \widehat{\mathcal{G}}_\rho(t, n) \right| \lesssim \frac{1}{\langle n, tn \rangle^{s_1}} (1 + K_5) \varepsilon,$$

we get (by using additionally  $|n| \langle t \rangle \leq \langle n, tn \rangle$ )

$$\begin{aligned} \int_{\mathbb{R}_n^d} |n| \langle t \rangle |\widehat{\sigma}_1(n)| \langle n, tn \rangle^2 \left| \widehat{\mathcal{F}}_I(t, n) - \widehat{\sigma}_1(n) \widehat{\mathcal{G}}_\rho(t, n) \right| dn \\ \lesssim \langle t \rangle^{-1} \left( \int_{\mathbb{R}_n^d} \langle n, tn \rangle^{3-s_1} dn \right) (1 + K_5) \varepsilon \lesssim (1 + K_5) \varepsilon \langle t \rangle^{-d-1}. \end{aligned}$$



Using also (A.6), we thus show that

$$|\text{NLT1T1}| \lesssim K_1(1 + K_5)\varepsilon^3 \langle t \rangle^{3-d}.$$

For NLT1T2, we proceed similarly, by coming back to Lemma 2.3.6, but now we use  $|\xi - tk| \leq \langle t(k - n), \xi - tn \rangle$ ; we obtain

$$\begin{aligned} |\text{NLT1T2}| &\lesssim \int_{\mathbb{R}_{k,\xi,n}^{3d}} \langle k \rangle \langle \xi \rangle^{s_4} \left| D_\xi^\alpha \widehat{g}(t, k, \xi) \right| |n| |\widehat{\sigma}_1(n)| \langle n, tn \rangle^2 \left| \widehat{\mathcal{F}}_I(t, n) - \widehat{\sigma}_1(n) \widehat{\mathcal{G}}_\varrho(t, n) \right| \\ &\quad \times \langle t(k - n), \xi - tn \rangle \langle k - n, \xi - tn \rangle^{s_4} \left| D_\xi^\alpha \widehat{g}(t, k - n, \xi - tn) \right| dn dk d\xi \\ &\lesssim \|\langle \nabla_x \rangle g(t)\|_{H_P^{s_4}} \|\langle t \nabla_x, \nabla_v \rangle g(t)\|_{H_P^{s_4}} \left( \int_{\mathbb{R}_n^d} |n| |\widehat{\sigma}_1(n)| \langle n, tn \rangle^2 \left| \widehat{\mathcal{F}}_I(t, n) - \widehat{\sigma}_1(n) \widehat{\mathcal{G}}_\varrho(t, n) \right| dn \right). \end{aligned}$$

Gathering (2.34c), (2.46e), (2.46a) and (A.6), this leads to

$$|\text{NLT1T2}| \lesssim K_1(1 + K_5)\varepsilon^3 \langle t \rangle^{3-d}.$$

**Recap.** We have shown that, if  $g$  is a solution of (2.10a)–(2.10b) which satisfies (2.46a)–(2.46e) on  $[0, T]$ , then we get

$$\begin{aligned} \frac{d}{dt} \|\langle \nabla_x \rangle g(t)\|_{H_P^{s_4}}^2 &\lesssim \delta'' K_1 \varepsilon^2 \langle t \rangle^2 + \langle t \rangle \frac{B(t)^2}{\delta''} \\ &\quad + K_1 K_3 \varepsilon^3 \langle t \rangle^2 + \varepsilon \langle t \rangle^3 B(t)^2 + K_1(1 + K_5) \varepsilon^3 \langle t \rangle^{3-d}. \end{aligned}$$

Let us denote  $C_4$  the constant hidden in the  $\lesssim$  symbol. Integrating over  $[0, T]$  yields

$$\begin{aligned} \|\langle \nabla_x \rangle g(t)\|_{H_P^{s_4}}^2 &\leq \|\langle \nabla_x \rangle g(0)\|_{H_P^{s_4}}^2 + C_4 \delta'' K_1 \varepsilon^2 \langle T \rangle^3 + C_4 \frac{1 + K_2}{\delta''} \varepsilon^2 \langle T \rangle \\ &\quad + C_4 K_1 K_3 \varepsilon^3 \langle T \rangle^3 + C_4(1 + K_2) \varepsilon^3 \langle T \rangle^3 + C_4 K_1(1 + K_5) \varepsilon^3 \langle T \rangle^{4-d}. \end{aligned}$$

We remind the reader that  $K_1$  and  $\delta'$  have already been fixed at the previous step. Possibly at the price of making  $\delta'$  smaller, we can assume that  $\delta'' = \delta'$  and  $\delta' C_4 < 1/4$ . Next, choosing  $K_1$  larger if necessary, we can equally suppose that

$$\|\langle \nabla_x \rangle g(0)\|_{H_P^{s_4}}^2 + C_4 \frac{1 + K_2}{\delta''} \varepsilon^2 \langle T \rangle \leq \frac{K_1}{4} \langle T \rangle^3 \varepsilon^2$$

holds. Eventually, when  $\varepsilon \ll 1$ , we have

$$C_4 K_1 K_3 \varepsilon^3 \langle T \rangle^3 + C_4(1 + K_2) \varepsilon^3 \langle T \rangle^3 + C_4 K_1(1 + K_5) \varepsilon^3 \langle T \rangle^{4-d} \leq \frac{K_1}{2} \varepsilon^2 \langle T \rangle^3,$$

and we have shown that

$$\|\langle \nabla_x \rangle g(t)\|_{H_P^{s_4}}^2 \leq K_1 \varepsilon^2 \langle T \rangle^3$$

is satisfied.

### A.2.5 Estimates of the $H_P^{s_3}$ norm of $|\nabla_x|^\delta g(t)$ .

Since  $s_4 > s_3$ , we can naively think that this term can be dominated by using the estimates on  $g(t)$  and  $\varrho(t)$  with norms based on  $H_P^{s_4}$ . However, here we wish to establish estimates *uniform* with respect to  $t$ , while the  $H_P^{s_4}$  estimates were involving a polynomial weight  $\langle t \rangle^5$ .

Therefore, we shall need refined estimates in order to make use as less as possible of the  $H_P^{s_4}$  norm of  $\langle t \nabla_x, \nabla_v \rangle g(t)$ .

We compute the time derivative of  $\| |\nabla_x|^\delta \langle \nabla_x, \nabla_v \rangle^{s_3} v^\alpha g(t) \|_{L^2}^2$ , using the expression of  $\partial_t \widehat{g}$  in (A.7):

$$\begin{aligned} & \frac{1}{2} \frac{d}{dt} \left\| |\nabla_x|^\delta \langle \nabla_x, \nabla_v \rangle^{s_3} v^\alpha g(t) \right\|_{L^2}^2 \\ &= \int_{\mathbb{R}_{k,\xi}^{2d}} |k|^\delta \langle k, \xi \rangle^{s_3} D_\xi^\alpha \overline{\widehat{g}(t, k, \xi)} |k|^\delta \langle k, \xi \rangle^{s_3} \widehat{\nabla \sigma_1}(k) \left( \widehat{\mathcal{F}}_I(t, k) - \widehat{\sigma}(k) \widehat{\mathcal{G}}_\rho(t, k) \right) \\ & \quad \cdot D_\xi^\alpha \widehat{\nabla_v \mathcal{M}}(\xi - tk) dk d\xi \\ & - \int_{\mathbb{R}_{k,\xi,n}^{3d}} |k|^\delta \langle k, \xi \rangle^{s_3} D_\xi^\alpha \overline{\widehat{g}(t, k, \xi)} |k|^\delta \langle k, \xi \rangle^{s_3} n \widehat{\sigma_1}(n) \left( \widehat{\mathcal{F}}_I(t, n) - \widehat{\sigma}(n) \widehat{\mathcal{G}}_\rho(t, n) \right) \\ & \quad \cdot (\xi - tk) D_\xi^\alpha \widehat{g}(t, k - n, \xi - tk) dn dk d\xi \\ & - \sum_{|j|=1; j \leq \alpha} \int_{\mathbb{R}_{k,\xi,n}^{3d}} |k|^\delta \langle k, \xi \rangle^{s_3} D_\xi^\alpha \overline{\widehat{g}(t, k, \xi)} |k|^\delta \langle k, \xi \rangle^{s_3} n \widehat{\sigma_1}(n) \left( \widehat{\mathcal{F}}_I(t, n) - \widehat{\sigma}(n) \widehat{\mathcal{G}}_\rho(t, n) \right) \\ & \quad \cdot j D_\xi^{\alpha-j} \widehat{g}(t, k - n, \xi - tk) dn dk d\xi \\ &= \text{LT} + \text{NLT1} + \text{NLT2}. \end{aligned}$$

We shall only detail how to handle NLT1; similar estimates apply for NLT2, see Remark A.2.4.

**Estimate of LT.** Since

$$\langle k, \xi \rangle^{s_3} \lesssim \langle k, tk \rangle^{s_3} \langle \xi - tk \rangle^{s_3} \quad \text{and} \quad \langle t \rangle^{1/2+\delta} |k|^{1/2+\delta} \leq \langle k, tk \rangle^{1/2+\delta},$$

by using the Cauchy-Schwarz inequality and  $s_4 - s_3 - 1 - \delta/2 > 0$ , we get

$$\begin{aligned} |\text{LT}| &\lesssim \frac{1}{\langle t \rangle^{1/2+\delta}} \int_{k,\xi} |k|^\delta \langle k, \xi \rangle^{s_3} \left| D_\xi^\alpha \widehat{g}(t, k, \xi) \right| \frac{|k|^{1/2+\delta} \langle t \rangle^{1/2+\delta}}{\langle k, tk \rangle^{s_4-s_3}} \langle k, tk \rangle^{s_4} |k|^{1/2} |\widehat{\sigma_1}(k)| \\ & \quad \times \left| \widehat{\mathcal{F}}_I(t, k) - \widehat{\sigma}(k) \widehat{\mathcal{G}}_\rho(t, k) \right| \langle \xi - tk \rangle^{s_3} \left| D_\xi^\alpha \widehat{\nabla_v \mathcal{M}}(\xi - tk) \right| dk d\xi \\ &\lesssim \frac{1}{\langle t \rangle^{1/2+\delta}} \left( \int_{\mathbb{R}_{k,\xi}^{2d}} |k|^{2\delta} \langle k, \xi \rangle^{2s_3} \left| D_\xi^\alpha \widehat{g}(t, k, \xi) \right|^2 dk d\xi \right)^{1/2} \\ & \quad \times \left( \int_{\mathbb{R}_{k,\xi}^{2d}} \langle k, tk \rangle^{2s_4} |k| |\widehat{\sigma_1}(k)|^2 \left| \widehat{\mathcal{F}}_I(t, k) - \widehat{\sigma}(k) \widehat{\mathcal{G}}_\rho(t, k) \right|^2 \right. \\ & \quad \left. \times \langle \xi - tk \rangle^{2s_3} \left| D_\xi^\alpha \widehat{\nabla_v \mathcal{M}}(\xi - tk) \right|^2 dk d\xi \right)^{1/2} \\ &\lesssim \frac{1}{\langle t \rangle^{1/2+\delta}} \left\| |\nabla_x|^\delta g(t) \right\|_{H_P^{s_3}} \left( \int_{\mathbb{R}_k^d} \langle k, tk \rangle^{2s_4} |k| |\widehat{\sigma_1}(k)|^2 \left| \widehat{\mathcal{F}}_I(t, k) - \widehat{\sigma}(k) \widehat{\mathcal{G}}_\rho(t, k) \right|^2 dk \right)^{1/2} \\ & \quad \times \left( \int_{\mathbb{R}_\xi^d} \langle \xi \rangle^{2s_3} \left| D_\xi^\alpha \widehat{\nabla_v \mathcal{M}}(\xi) \right|^2 d\xi \right)^{1/2} \\ &\lesssim \frac{1}{\langle t \rangle^{1/2+\delta}} \left\| |\nabla_x|^\delta g(t) \right\|_{H_P^{s_3}} B(t) \|\nabla_v \mathcal{M}\|_{H_P^{s_3}} \lesssim \frac{1}{\langle t \rangle^{1/2+\delta}} \left\| |\nabla_x|^\delta g(t) \right\|_{H_P^{s_3}} B(t) \end{aligned}$$

The Young inequality then yields

$$|\text{LT}| \lesssim \frac{\tilde{\delta}}{\langle t \rangle^{1+2\delta}} \left\| |\nabla_x|^\delta g(t) \right\|_{H_P^{s_3}}^2 + \frac{B(t)^2}{\tilde{\delta}} \lesssim \tilde{\delta} K_3 \varepsilon^2 \langle t \rangle^{-1-2\delta} + \frac{B(t)^2}{\tilde{\delta}}$$

where we have used (2.46c) for the second inequality.

**Estimate of NLT1.** Again, we can use (A.5), where we set

$$f = \mathcal{F}^{-1} \left( (k, \xi) \mapsto |k|^\delta \langle k, \xi \rangle^{s_3} \text{D}_\xi^\alpha \widehat{g}(t, k, \xi) \right),$$

and we split the contributions of low and high frequencies

$$\begin{aligned} |\text{NLT1}| &\leq \int_{\mathbb{R}_{k,\xi,n}^{3d}} \left( \mathbf{1}_{|n,tn| \geq |k-n,\xi-tn|} + \mathbf{1}_{|n,tn| \leq |k-n,\xi-tn|} \right) |k|^\delta \langle k, \xi \rangle^{s_3} \left| \text{D}_\xi^\alpha \widehat{g}(t, k, \xi) \right| \\ &\quad \times \left| |k|^\delta \langle k, \xi \rangle^{s_3} - |k-n|^\delta \langle k-n, \xi-tn \rangle^{s_3} \right| |n| |\widehat{\sigma}_1(n)| \left| \widehat{\mathcal{F}}_I(t, n) - \widehat{\sigma}(n) \widehat{\mathcal{G}}_\rho(t, n) \right| \\ &\quad \times |\xi - tk| \left| \text{D}_\xi^\alpha \widehat{g}(t, k-n, \xi-tk) \right| \text{d}n \text{d}k \text{d}\xi \\ &= \text{NLT1R} + \text{NLT1T}. \end{aligned}$$

**Estimate of NLT1R.** We make 4 terms appear, remarking that  $|n, tn| \geq |k-n, \xi-tn|$  and  $\delta < 1$  allow us to write

$$\left| |k|^\delta \langle k, \xi \rangle^{s_3} - |k-n|^\delta \langle k-n, \xi-tn \rangle^{s_3} \right| \lesssim (|n|^\delta + |k-n|^\delta) \langle n, tn \rangle^{s_3}$$

while  $|\xi - tk| \leq |\xi - tn| + t|k-n|$ . We get

$$\begin{aligned} \text{NLT1R} &\lesssim \int_{\mathbb{R}_{k,\xi,n}^{3d}} |k|^\delta \langle k, \xi \rangle^{s_3} \left| \text{D}_\xi^\alpha \widehat{g}(t, k, \xi) \right| |n|^{1+\delta} |\widehat{\sigma}_1(n)| \langle n, tn \rangle^{s_3} \left| \widehat{\mathcal{F}}_I(t, n) - \widehat{\sigma}(n) \widehat{\mathcal{G}}_\rho(t, n) \right| \\ &\quad \times (|\xi - tn| + t|k-n|) \left| \text{D}_\xi^\alpha \widehat{g}(t, k-n, \xi-tk) \right| \text{d}n \text{d}k \text{d}\xi \\ &\quad + \int_{\mathbb{R}_{k,\xi,n}^{3d}} |k|^\delta \langle k, \xi \rangle^{s_3} \left| \text{D}_\xi^\alpha \widehat{g}(t, k, \xi) \right| |n| |\widehat{\sigma}_1(n)| \langle n, tn \rangle^{s_3} \left| \widehat{\mathcal{F}}_I(t, n) - \widehat{\sigma}(n) \widehat{\mathcal{G}}_\rho(t, n) \right| \\ &\quad \times |k-n|^\delta (|\xi - tn| + t|k-n|) \left| \text{D}_\xi^\alpha \widehat{g}(t, k-n, \xi-tk) \right| \text{d}n \text{d}k \text{d}\xi \\ &= R_{1,V} + R_{1,Z} + R_{2,V} + R_{2,Z} \end{aligned}$$

where  $R_{i,V}$  is the term with  $|\xi - tn|$  and  $R_{i,Z}$  the term with  $t|k-n|$ .

For  $R_{1,V}$  we apply Lemma 2.3.6

$$\begin{aligned} R_{1,V} &= \int_{\mathbb{R}_{k,\xi,n}^{3d}} |k|^\delta \langle k, \xi \rangle^{s_3} \left| \text{D}_\xi^\alpha \widehat{g}(t, k, \xi) \right| |n|^{1+\delta} |\widehat{\sigma}_1(n)| \langle n, tn \rangle^{s_3} \left| \widehat{\mathcal{F}}_I(t, n) - \widehat{\sigma}(n) \widehat{\mathcal{G}}_\rho(t, n) \right| \\ &\quad \times |\xi - tn| \left| \text{D}_\xi^\alpha \widehat{g}(t, k-n, \xi-tk) \right| \text{d}n \text{d}k \text{d}\xi \\ &\lesssim \left( \int_{\mathbb{R}_{k,\xi}^{2d}} |k|^{2\delta} \langle k, \xi \rangle^{2s_3} \left| \text{D}_\xi^\alpha \widehat{g}(t, k, \xi) \right|^2 \text{d}k \text{d}\xi \right)^{1/2} \\ &\quad \times \frac{1}{\langle t \rangle^{1/2+\delta}} \left( \int_{\mathbb{R}_n^d} \frac{|n|^{1+2\delta} \langle t \rangle^{1+2\delta}}{\langle n, tn \rangle^{2s_4-2s_3}} |\widehat{\sigma}_1(n)| \langle n, tn \rangle^{2s_4} \left| \widehat{\mathcal{F}}_I(t, n) - \widehat{\sigma}(n) \widehat{\mathcal{G}}_\rho(t, n) \right|^2 \text{d}n \right)^{1/2} \\ &\quad \times \int_{\mathbb{R}_k^d} \left( \int_{\mathbb{R}_\xi^d} |\xi|^2 \left| \text{D}_\xi^\alpha \widehat{g}(t, k, \xi) \right|^2 \text{d}\xi \right)^{1/2} \text{d}k \\ &\lesssim \frac{1}{\langle t \rangle^{1/2+\delta}} \left\| |\nabla_x|^\delta g(t) \right\|_{H_P^{s_3}} B(t) \left( \int_{\mathbb{R}_k^d} \left( \int_{\mathbb{R}_\xi^d} |\xi|^2 \left| \text{D}_\xi^\alpha \widehat{g}(t, k, \xi) \right|^2 \text{d}\xi \right)^{1/2} \text{d}k \right) \end{aligned}$$

where we have used the relations  $|n|\langle t \rangle \leq \langle n, tn \rangle$  and  $2s_4 - 2s_3 - 1 - 2\delta > 0$ . We have already seen (see the estimate of NLT1R when dealing with the norm  $H_P^{s_4}$  of  $\langle \nabla_v \rangle g(t)$ ) that

$$\int_{\mathbb{R}_k^d} \left( \int_{\mathbb{R}_\xi^d} |\xi|^2 \left| D_\xi^\alpha \widehat{g}(t, k, \xi) \right|^2 d\xi \right)^{1/2} dk \lesssim \left\| |\nabla_x|^\delta g(t) \right\|_{H_P^{s_3}}.$$

Using (2.46c) and the Young inequality, we obtain

$$R_{1,V} \lesssim K_3^2 \varepsilon^3 \langle t \rangle^{-1-2\delta} + \varepsilon B(t)^2.$$

For  $R_{1,Z}$  we apply the second inequality in Lemma 2.3.6 and we get

$$\begin{aligned} R_{1,Z} &= t \int_{\mathbb{R}_{k,\xi,n}^{3d}} |k|^\delta \langle k, \xi \rangle^{s_3} \left| D_\xi^\alpha \widehat{g}(t, k, \xi) \right| |n|^{1+\delta} |\widehat{\sigma}_1(n)| \langle n, tn \rangle^{s_3} \left| \widehat{\mathcal{F}}_I(t, n) - \widehat{\sigma}(n) \widehat{\mathcal{G}}_\rho(t, n) \right| \\ &\quad \times |k - n| \left| D_\xi^\alpha \widehat{g}(t, k - n, \xi - tk) \right| dn dk d\xi \\ &\lesssim \langle t \rangle \left\| |\nabla_x|^\delta g(t) \right\|_{H_P^{s_3}} \left( \int_{\mathbb{R}_n^d} |n|^{1+\delta} |\widehat{\sigma}_1(n)| \langle n, tn \rangle^{s_3} \left| \widehat{\mathcal{F}}_I(t, n) - \widehat{\sigma}(n) \widehat{\mathcal{G}}_\rho(t, n) \right| dn \right) \\ &\quad \times \left( \int_{\mathbb{R}_{k,\xi}^d} |k|^2 \left| D_\xi^\alpha \widehat{g}(t, k, \xi) \right|^2 dk d\xi \right)^{1/2}. \end{aligned}$$

Cauchy-Schwarz's inequality yields

$$\begin{aligned} &\int_{\mathbb{R}_n^d} |n|^{1+\delta} |\widehat{\sigma}_1(n)| \langle n, tn \rangle^{s_3} \left| \widehat{\mathcal{F}}_I(t, n) - \widehat{\sigma}(n) \widehat{\mathcal{G}}_\rho(t, n) \right| dn \\ &\lesssim \frac{1}{\langle t \rangle^{1/2+\delta}} \left( \int_{\mathbb{R}_n^d} \frac{|n|^{1+2\delta} \langle t \rangle^{1+2\delta}}{\langle n, tn \rangle^{2s_4-2s_3}} dn \right)^{1/2} \\ &\quad \times \left( \int_{\mathbb{R}_n^d} |n| \langle n, tn \rangle^{2s_4} |\widehat{\sigma}_1(n)|^2 \left| \widehat{\mathcal{F}}_I(t, n) - \widehat{\sigma}_1(n) \widehat{\mathcal{G}}_\rho(t, n) \right|^2 dn \right)^{1/2}. \end{aligned}$$

Since

$$\int_{\mathbb{R}_n^d} \frac{|n|^{1+2\delta} \langle t \rangle^{1+2\delta}}{\langle n, tn \rangle^{2s_4-2s_3}} dn \leq \int_{\mathbb{R}_n^d} \frac{1}{\langle n, tn \rangle^{2s_4-2s_3-1-2\delta}} dn \lesssim \frac{1}{\langle t \rangle^d},$$

we deduce that

$$\int_{\mathbb{R}_n^d} |n|^{1+\delta} |\widehat{\sigma}_1(n)| \langle n, tn \rangle^{s_3} \left| \widehat{\mathcal{F}}_I(t, n) - \widehat{\sigma}(n) \widehat{\mathcal{G}}_\rho(t, n) \right| dn \lesssim \frac{1}{\langle t \rangle^{(d+1)/2+\delta}} B(t).$$

Besides, we can dominate

$$\left( \int_{\mathbb{R}_{k,\xi}^d} |k|^2 \left| D_\xi^\alpha \widehat{g}(t, k, \xi) \right|^2 \right)^{1/2} \lesssim \left\| |\nabla_x|^\delta g(t) \right\|_{H_P^{s_3}},$$

since, assuming  $s_3$  large enough, with  $\delta < 1$ , we have

$$|k|^2 = |k|^{2\delta} |k|^{2-2\delta} \leq |k|^{2\delta} \langle k, \xi \rangle^{2-2\delta} \leq |k|^{2\delta} \langle k, \xi \rangle^{2s_3}.$$

By applying (2.46c) and the Young inequality, we end up with

$$R_{1,Z} \lesssim \frac{1}{\varepsilon \langle t \rangle^{d-1+2\delta}} \left\| |\nabla_x|^\delta g(t) \right\|_{H_P^{s_3}}^4 + \varepsilon B^2(t) \lesssim K_3^2 \varepsilon^3 \langle t \rangle^{1-d-2\delta} + \varepsilon B(t)^2.$$

The expressions of  $R_{2,V}$  and  $R_{2,Z}$  already involve  $|k - n|^\delta$  with  $D_\xi^\alpha \widehat{g}(t, k - n, \xi - tn)$ , and we can reproduce similar arguments as for  $R_{1,Z}$ ; we obtain

$$R_{2,V} \lesssim K_3^2 \varepsilon^3 \langle t \rangle^{-1-d} + \varepsilon B(t)^2 \quad \text{and} \quad R_{2,Z} \lesssim K_3^2 \varepsilon^3 \langle t \rangle^{1-d} + \varepsilon B(t)^2.$$

Observe that among  $R_{1,Z}$ ,  $R_{2,V}$  and  $R_{2,Z}$ , the worst domination is for  $R_{2,Z}$ . Thus it will guide the determination of the constants in the final estimate.

**Estimate of NLT1T.** We split as  $\text{NLT1T} = \text{NLT1T1} + \text{NLT1T2}$  noting that, on the integration domain, see [13, Section 5.2]

$$\begin{aligned} & \left| |k|^\delta \langle k, \xi \rangle^{s_3} - |k - n|^\delta \langle k - n, \xi - tn \rangle^{s_3} \right| \\ & \lesssim |k - n|^\delta |n, tn| \langle k - n, \xi - tn \rangle^{s_3 - 1} + \left| |k|^\delta - |k - n|^\delta \right| \langle k - n, \xi - tn \rangle^{s_3}. \end{aligned}$$

Here, NLT1T1 stands for the term that involves the exponent  $s_3 - 1$ . We use Lemma 2.3.6 and  $|\xi - tk| \leq \langle t \rangle \langle k - n, \xi - tn \rangle$  so that

$$\begin{aligned} |\text{NLT1T1}| & \lesssim \langle t \rangle \int_{\mathbb{R}_{k,\xi,n}^{3d}} |k|^\delta \langle k, \xi \rangle^{s_3} \left| D_\xi^\alpha \widehat{g}(t, k, \xi) \right| |n| |n, tn| |\widehat{\sigma}_1(n)| \left| \widehat{\mathcal{F}}_I(t, n) - \widehat{\sigma}_1(n) \widehat{\mathcal{G}}_\rho(t, n) \right| \\ & \quad \times |k - n|^\delta \langle k - n, \xi - tn \rangle^{s_3} \left| D_\xi^\alpha \widehat{g}(t, k - n, \xi - tn) \right| dn dk d\xi \\ & \lesssim \langle t \rangle \left\| |\nabla_x|^\delta g(t) \right\|_{H_P^{s_3}}^2 \left( \int_{\mathbb{R}_n^d} |n| |n, tn| |\widehat{\sigma}_1(n)| \left| \widehat{\mathcal{F}}_I(t, n) - \widehat{\sigma}_1(n) \widehat{\mathcal{G}}_\rho(t, n) \right| dn \right). \end{aligned}$$

By virtue of (2.34c) and (2.46e), we have

$$|\widehat{\sigma}_1(n)| \left| \widehat{\mathcal{F}}_I(t, n) - \widehat{\sigma}_1(n) \widehat{\mathcal{G}}_\rho(t, n) \right| \lesssim \frac{1}{\langle n, tn \rangle^{s_1}} (1 + K_5) \varepsilon,$$

and it follows that

$$\begin{aligned} & \int_{\mathbb{R}_n^d} |n| |n, tn| |\widehat{\sigma}_1(n)| \left| \widehat{\mathcal{F}}_I(t, n) - \widehat{\sigma}_1(n) \widehat{\mathcal{G}}_\rho(t, n) \right| dn \\ & \lesssim \frac{1}{\langle t \rangle} \left( \int_{\mathbb{R}_n^d} |n| \langle t \rangle |n, tn| \frac{\langle t \rangle^\eta}{\langle n, tn \rangle^{s_1}} dn \right) (1 + K_5) \varepsilon \\ & \lesssim (1 + K_5) \varepsilon \langle t \rangle^{-1} \int_{\mathbb{R}_n^d} \langle n, tn \rangle^{s_1 - 2} dn \lesssim (1 + K_5) \varepsilon \langle t \rangle^{-d-1}. \end{aligned}$$

We combine this to (2.46c) and we arrive at

$$|\text{NLT1T1}| \lesssim (1 + K_5) K_3 \varepsilon^3 \langle t \rangle^{-d}.$$

We proceed similarly for NLT1T2, applying Lemma 2.3.6, and remarking that  $||k|^\delta - |k - n|^\delta| \leq |n|^\delta$  and  $|\xi - tk| \leq \langle t(k - n), \xi - tn \rangle$ . We get

$$\begin{aligned} |\text{NLT1T2}| &\lesssim \int_{\mathbb{R}_{k,\xi,n}^{3d}} |k|^\delta \langle k, \xi \rangle^{s_3} \left| D_\xi^\alpha \widehat{g}(t, k, \xi) \right| |n|^{1+\delta} |\widehat{\sigma}_1(n)| \left| \widehat{\mathcal{F}}_I(t, n) - \widehat{\sigma}_1(n) \widehat{\mathcal{G}}_\rho(t, n) \right| \\ &\quad \times \langle t(k - n), \xi - tn \rangle^{s_3+1} \left| D_\xi^\alpha \widehat{g}(t, k, \xi) \right| dn dk d\xi \\ &\lesssim \left\| |\nabla_x|^\delta g(t) \right\|_{H_P^{s_3}} \left( \int_{\mathbb{R}_n^d} |n|^{1+\delta} |\widehat{\sigma}_1(n)| \left| \widehat{\mathcal{F}}_I(t, n) - \widehat{\sigma}_1(n) \widehat{\mathcal{G}}_\rho(t, n) \right| dn \right) \\ &\quad \times \left( \int_{\mathbb{R}_{k,\xi}^{2d}} \langle tk, \xi \rangle^2 \langle k, \xi \rangle^{2s_3} \left| D_\xi^\alpha g(t, k, \xi) \right|^2 \right)^{1/2} \\ &\lesssim \left\| |\nabla_x|^\delta g(t) \right\|_{H_P^{s_3}} \left\| \langle t \nabla_x, \nabla_v \rangle g(t) \right\|_{H_P^{s_4}} \left( \int_{\mathbb{R}_n^d} |n|^{1+\delta} |\widehat{\sigma}_1(n)| \left| \widehat{\mathcal{F}}_I(t, n) - \widehat{\sigma}_1(n) \widehat{\mathcal{G}}_\rho(t, n) \right| dn \right). \end{aligned}$$

With (2.34c) and (2.46e), we show that

$$\int_{\mathbb{R}_n^d} |n|^{1+\delta} |\widehat{\sigma}_1(n)| \left| \widehat{\mathcal{F}}_I(t, n) - \widehat{\sigma}_1(n) \widehat{\mathcal{G}}_\rho(t, n) \right| dn \lesssim (1 + K_5) \varepsilon \langle t \rangle^{-d-1-\delta},$$

which eventually leads to

$$|\text{NLT1T2}| \lesssim \sqrt{K_1 K_3} (1 + K_5) \varepsilon^3 \langle t \rangle^{5/2-d-1-\delta}.$$

**Recap.** We have shown that, if  $g$  is a solution of (2.10a)–(2.10b) which satisfies (2.46a)–(2.46e) on  $[0, T]$ , then we have

$$\begin{aligned} \frac{d}{dt} \left\| |\nabla_x|^\delta g(t) \right\|_{H_P^{s_3}}^2 &\lesssim \tilde{\delta} K_3 \varepsilon^2 \langle t \rangle^{-1-2\delta} + \frac{B(t)^2}{\tilde{\delta}} + K_3^2 \varepsilon^3 \langle t \rangle^{-1-2\delta} + \varepsilon B(t)^2 + K_3^2 \varepsilon^3 \langle t \rangle^{1-d} \\ &\quad + K_3 (1 + K_5) \varepsilon^3 \langle t \rangle^{-d} + \sqrt{K_1 K_3} (1 + K_5) \varepsilon^3 \langle t \rangle^{5/2-d-1-\delta}. \end{aligned}$$

Let  $C_5$  be the constant associated to the  $\lesssim$  symbol. We integrate over  $[0, T]$  and we bear in mind that all the exponents of  $\langle t \rangle$  are strictly less than 1. We get

$$\begin{aligned} \left\| |\nabla_x|^\delta g(T) \right\|_{H_P^{s_3}}^2 &\leq \left\| |\nabla_x|^\delta g(0) \right\|_{H_P^{s_3}}^2 + C_5 \tilde{\delta} K_3 \varepsilon^2 + C_5 \frac{1 + K_2}{\tilde{\delta}} \varepsilon^2 \\ &\quad + C_5 \left( K_3^2 \varepsilon^3 + (1 + K_2) \varepsilon^3 + K_3^2 \varepsilon^3 + K_3 (1 + K_5) \varepsilon^3 + \sqrt{K_1 K_3} (1 + K_5) \varepsilon^3 \right). \end{aligned}$$

First, let  $\tilde{\delta} \ll 1$  such that  $\tilde{\delta} C_5 < 1/2$ . Second, pick  $K_3 \gg 1$  so that

$$\left\| |\nabla_x|^\delta g(0) \right\|_{H_P^{s_3}}^2 + C_5 \frac{1 + K_2}{\tilde{\delta}} \varepsilon^2 \leq \frac{K_3}{2} \varepsilon^2.$$

Finally, choose  $\varepsilon \ll 1$  such that

$$C_5 \left( K_3^2 \varepsilon^3 + (1 + K_2) \varepsilon^3 + K_3^2 \varepsilon^3 + K_3 (1 + K_5) \varepsilon^3 + \sqrt{K_1 K_3} (1 + K_5) \varepsilon^3 \right) \leq K_3 \varepsilon^2.$$

We conclude that

$$\left\| |\nabla_x|^\delta g(T) \right\|_{H_P^{s_3}}^2 \leq 2K_3 \varepsilon^2$$

holds.

**A.2.6 Estimate of the  $L^\infty_{(k,\xi)}$  norm of  $\langle \nabla_{x,v} \widehat{g} \rangle^{s_1}(t)$**

We go back to (2.43) and we write

$$\begin{aligned} & \langle k, \xi \rangle^{s_1} |\widehat{g}(T, k, \xi)| \\ & \leq \langle k, \xi \rangle^{s_1} |\widehat{f}_0(k, \xi)| + \int_0^T \left| k \widehat{\sigma}_1(k) \left( \widehat{\mathcal{F}}_I(t, k) - \widehat{\sigma}_1(k) \widehat{\mathcal{G}}_\rho(t, k) \right) \cdot (\xi - tk) \widehat{\mathcal{M}}(\xi - tk) \right| dt \\ & \quad + \int_0^T \int_{\mathbb{R}^d} \left| n \widehat{\sigma}_1(n) \left( \widehat{\mathcal{F}}_I(t, n) - \widehat{\sigma}_1(n) \widehat{\mathcal{G}}_\rho(t, n) \right) (\xi - tk) \widehat{g}(\tau, k - n, \xi - tn) \right| dt dn \\ & = \text{CT} + \text{LT} + \text{NLT}. \end{aligned}$$

We also split the non linear term  $\text{NLT} = \text{NLT1} + \text{NLT2}$  according to

$$\langle k, \xi \rangle^{s_1} \lesssim \langle n, tn \rangle^{s_1} + \langle k - n, \xi - tn \rangle^{s_1}.$$

**Estimate of CT.** Since  $(x, v) \mapsto x^\alpha f_0(x, v)$  lies in  $H^s_P$ , with  $|\alpha| \leq P$ , it satisfies  $|\widehat{f}_0(k, \xi)| \lesssim \langle k, \xi \rangle^{-s}$ , see (2.38). Hence, assuming  $s \geq s_1$ , we get  $\text{CT} \lesssim \varepsilon$ .

**Estimate of LT.** We use the rough estimate

$$\langle k, \xi \rangle^{s_1} \lesssim \langle k, tk \rangle^{s_1} + \langle \xi - tk \rangle^{s_1} \leq \langle k, tk \rangle^{s_2} \langle \xi - tk \rangle^{s_1}.$$

The Cauchy-Schwarz inequality then leads to

$$\begin{aligned} \text{LT} & \lesssim \left( \int_0^T |k| \langle k, tk \rangle^{2s_2} \left| k \widehat{\sigma}_1(k) \right|^2 \left| \widehat{\mathcal{F}}_I(t, k) - \widehat{\sigma}_1(k) \widehat{\mathcal{G}}_\rho(t, k) \right|^2 dt \right)^{1/2} \\ & \quad \times \left( \int_0^T \langle \xi - tk \rangle^{2s_1} \left| \widehat{\nabla_{v \cdot} \mathcal{M}}(\xi - tk) \right|^2 dt \right)^{1/2}. \end{aligned}$$

For the first term, (2.34b) and (2.46d) allow us to get

$$\left( \int_0^T |k| \langle k, tk \rangle^{2s_2} \left| k \widehat{\sigma}_1(k) \right|^2 \left| \widehat{\mathcal{F}}_I(t, k) - \widehat{\sigma}_1(k) \widehat{\mathcal{G}}_\rho(t, k) \right|^2 dt \right)^{1/2} \lesssim \sqrt{1 + K_4} \varepsilon.$$

For the second term, since  $\nabla_{v \cdot} \mathcal{M} \in H^{\bar{s}}_P$ , we can write

$$(\xi \mapsto \langle \xi \rangle^{s_1} \widehat{\nabla_{v \cdot} \mathcal{M}}(\xi)) \in H^P_{(\xi)}.$$

Finally, the Trace Lemma 2.3.4 yields

$$\int_0^T \langle \xi - tk \rangle^{2s_1} \left| \widehat{\nabla_{v \cdot} \mathcal{M}}(\xi - tk) \right|^2 dt \lesssim \|\xi \mapsto \langle \xi \rangle^{s_1} \widehat{\nabla_{v \cdot} \mathcal{M}}(\xi)\|_{H^P_{(\xi)}}^2 \lesssim \|\nabla_{v \cdot} \mathcal{M}\|_{H^{s_1}}^2 \lesssim 1.$$

We have thus shown

$$\text{LT} \lesssim \sqrt{1 + K_4} \varepsilon.$$

**Estimate of NLT1.** The Cauchy-Schwarz inequality yields

NLT1

$$\begin{aligned}
&= \int_0^T \int_{\mathbb{R}_n^d} \langle n, tn \rangle^{s_1} |n| |\widehat{\sigma}_1(n)| \left| \widehat{\mathcal{F}}_I(t, n) - \widehat{\sigma}_1(n) \widehat{\mathcal{G}}_\rho(t, n) \right| |\xi - tk| |\widehat{g}(t, k - n, \xi - tk)| dt dn \\
&\leq \int_{\mathbb{R}_n^d} \left( \int_0^T \langle n \rangle^4 \langle n, tn \rangle^{2s_2} |n| |\widehat{\sigma}_1(n)|^2 \left| \widehat{\mathcal{F}}_I(t, n) - \widehat{\sigma}_1(n) \widehat{\mathcal{G}}_\rho(t, n) \right|^2 dt \right)^{1/2} \\
&\quad \times \left( \int_0^T \frac{|n| |\xi - tk|^2}{\langle n \rangle^4 \langle n, tn \rangle^{2s_2 - 2s_1}} \frac{\langle k - n, \xi - tn \rangle^{2s_1}}{\langle k - n, \xi - tn \rangle^{2s_1}} |\widehat{g}(t, k - n, \xi - tn)|^2 dt \right)^{1/2} dn.
\end{aligned}$$

Next (2.34b) and (2.46d) lead to

$$\left( \int_0^T \langle n \rangle^4 \langle n, tn \rangle^{2s_2} |n| |\widehat{\sigma}_1(n)|^2 \left| \widehat{\mathcal{F}}_I(t, n) - \widehat{\sigma}_1(n) \widehat{\mathcal{G}}_\rho(t, n) \right|^2 dt \right)^{1/2} \lesssim \sqrt{1 + K_4} \varepsilon,$$

and (2.46e) ensures that

$$\langle k - n, \xi - tn \rangle^{s_1} |\widehat{g}(t, k - n, \xi - tn)| \lesssim K_5 \varepsilon.$$

Therefore, we get

$$\text{NLT1} \lesssim \sqrt{1 + K_4} K_5 \varepsilon^2 \left[ \int_{\mathbb{R}_n^d} \left( \int_0^T \frac{|n| |\xi - tk|^2}{\langle n \rangle^4 \langle n, tn \rangle^{2s_2 - 2s_1}} \frac{1}{\langle k - n, \xi - tn \rangle^{2s_1}} \right)^{1/2} dn \right].$$

We are left with the task of justifying that the last integrals are bounded uniformly with respect to  $k$ ,  $\xi$  and  $T$ ; this will be detailed in Section A.2.7 below.

**Estimate of NLT2.** We combine (2.34c) and (2.46e) so that

$$|\widehat{\sigma}_1(n)| \left| \widehat{\mathcal{F}}_I(t, n) - \widehat{\sigma}_1(n) \widehat{\mathcal{G}}_\rho(t, n) \right| \lesssim \frac{1}{\langle n \rangle^2 \langle n, tn \rangle^{s_1}} (1 + K_5) \varepsilon.$$

Applying the Cauchy-Schwarz inequality (and  $|\xi - tk| = |\xi - tn + t(n - k)| \leq \langle t \rangle \langle k - n, \xi - tn \rangle$ ) we obtain

$$\begin{aligned}
\text{NLT2} &= \int_0^T \int_{\mathbb{R}_n^d} |n| |\widehat{\sigma}_1(n)| \left| \widehat{\mathcal{F}}_I(t, n) - \widehat{\sigma}_1(n) \widehat{\mathcal{G}}_\rho(t, n) \right| \\
&\quad \times \langle k - n, \xi - tn \rangle^{s_1} |\xi - tk| |\widehat{g}(t, k - n, \xi - tn)| dt dn \\
&\lesssim (1 + K_5) \varepsilon \int_0^T \int_{\mathbb{R}_n^d} \frac{|n| \langle t \rangle}{\langle n \rangle^2 \langle n, tn \rangle^{s_1}} \langle k - n, \xi - tn \rangle^{s_1 + 1} |\widehat{g}(t, k - n, \xi - tn)| dt dn \\
&\lesssim (1 + K_5) \varepsilon \left( \int_0^T \int_{\mathbb{R}_n^d} \frac{|n|^2 \langle t \rangle^2}{\langle n \rangle^4 \langle n, tn \rangle^{2s_1}} \frac{1}{|k - n|^{2\delta}} dt dn \right)^{1/2} \\
&\quad \times \left( \int_0^T \int_{\mathbb{R}_n^d} |k - n|^{2\delta} \langle k - n, \xi - tn \rangle^{2s_1 + 2} |\widehat{g}(t, k - n, \xi - tn)|^2 dt dn \right)^{1/2}.
\end{aligned}$$



Then, by Trace Lemma and (2.46c), we have (for  $k \neq 0$ )

$$\int_0^T \int_{\mathbb{R}^d} |k - n|^{2\delta} \langle k - n, tk - \tau n \rangle^{2s_3} |\widehat{g}(\tau, k - n, tk - \tau n)|^2 \, d\tau \, dn \lesssim \sup_{s \in [0, T]} \left\| |\nabla_x|^\delta g(s) \right\|_{H^{s_3}}^2 \lesssim K_3 \varepsilon^2.$$

Going back to NLT2 we are finally led to

$$\text{NLT2} \lesssim (1 + K_5) \sqrt{K_3} \varepsilon^2 \left( \int_0^T \int_{\mathbb{R}^d} \frac{|n|^2 \langle t \rangle^2}{\langle n \rangle^2 \langle n, tn \rangle^{2s_1}} \frac{1}{|k - n|^{2\delta}} \, dt \, dn \right)^{1/2}$$

and it remains to check that the integral is uniformly bounded with respect to both  $k$  and  $T$ . Again, we postpone this estimate to Section A.2.7 below.

**Recap.** We have shown that, if  $g$  is a solution of (2.10a)–(2.10b) satisfying (2.46a)–(2.46e) on  $[0, T]$ , then, we have

$$\| \langle \nabla_{x,v} \widehat{g}(T) \rangle \|_{L^\infty_{(k,\xi)}} \lesssim (1 + \sqrt{1 + K_4} + \sqrt{1 + K_4} K_5 \varepsilon + (1 + K_5) \sqrt{K_3} \varepsilon) \varepsilon$$

Let  $C_6$  be the constant involved in  $\lesssim$ . We set  $K_5 \gg 1$  such that

$$C_6(1 + \sqrt{1 + K_4}) \leq K_5$$

and, next, we pick  $\varepsilon \ll 1$  so that

$$C_6(\sqrt{1 + K_4} K_5 \varepsilon + (1 + K_5) \sqrt{K_3} \varepsilon) \leq K_5.$$

We are thus led to

$$\| \langle \nabla_{x,v} \widehat{g}(T) \rangle \|_{L^\infty_{(k,\xi)}} \leq 2K_5 \varepsilon.$$

We have checked at all steps of the proof that the choices of the constants  $K_i$  and of the parameter  $\varepsilon$  are compatible.

### A.2.7 Integral estimates

We collect here the estimates of the four integrals that we need to finish the proof of the bootstrap property. Namely, we wish to control, uniformly with respect to  $k$ ,  $\xi$  and  $T$  the following four quantities (in the same order as they appeared within the previous discussion)

$$\begin{aligned} \text{I1} &= \int_0^T \int_0^t \int_{\mathbb{R}^d} \frac{|k|^3 |t - \tau|^2 |n|}{\langle n \rangle^4 \langle n, \tau n \rangle^{2s_4 - 2s_2} \langle k - n, tk - \tau n \rangle^{2s_1}} \, dt \, d\tau \, dn, \\ \text{I2} &= \int_0^T \int_0^t \int_{\mathbb{R}^d} \frac{|n|^2 \langle \tau \rangle^2}{\langle n \rangle^2 \langle n, \tau n \rangle^{2s_1}} \frac{|k|}{\langle k - n, tk - \tau n \rangle} \frac{1}{|k - n|^{2\delta}} \, dt \, d\tau \, dn, \\ \text{I3} &= \int_{\mathbb{R}^d} \left( \int_0^T \frac{|n| |\xi - tk|^2}{\langle n \rangle^4 \langle n, tn \rangle^{2s_2 - 2s_1}} \frac{1}{\langle k - n, \xi - tn \rangle^{2s_1}} \, dt \right)^{1/2} \, dn, \\ \text{I4} &= \int_0^T \int_{\mathbb{R}^d} \frac{|n|^2 \langle t \rangle^2}{\langle n \rangle^2 \langle n, tn \rangle^{2s_1}} \frac{1}{|k - n|^{2\delta}} \, dt \, dn. \end{aligned}$$

Let us start with I4 which satisfies

$$\text{I4} \leq \int_0^T \left( \int_{\mathbb{R}^d} \frac{\langle n, tn \rangle^{-2s_1 + 2}}{|k - n|^{2\delta}} \, dn \right) \, dt.$$

Given  $t \geq 0$ , we have seen during the proof of Theorem 2.3.7 that

$$\int_{\mathbb{R}^d} \frac{\langle n, tn \rangle^{-2s_1+2}}{|k-n|^{2\delta}} dn \lesssim \langle t \rangle^{-d+2\delta}$$

holds. It follows that

$$I4 \lesssim \int_0^T \langle t \rangle^{-2+2\delta} dt \lesssim 1.$$

Next, for estimating I3, we observe that  $|\xi - tn| \leq \langle t \rangle \langle k - n, \xi - tn \rangle$ , so that

$$\begin{aligned} I3 &\leq \int_{\mathbb{R}^d} \frac{1}{\langle n \rangle^2} \left( \int_0^T \frac{|n| \langle t \rangle^2}{\langle n, tn \rangle^{2s_2-2s_1}} \frac{1}{\langle k-n, \xi - tn \rangle^{2s_1-2}} dt \right)^{1/2} dn \\ &\lesssim \int_{\mathbb{R}^d} \frac{1}{|n|^{1/2} \langle n \rangle^2} \left( \int_0^T \frac{\langle n, tn \rangle^{-2s_2+2s_1+2}}{\langle k-n \rangle^{2s_1-2}} dt \right)^{1/2} dn \\ &\leq \int_{\mathbb{R}^d} \frac{1}{|n|^{1/2} \langle n \rangle^2} \frac{1}{\langle k-n \rangle^{s_1-1}} \left( \int_0^T \langle tn \rangle^{-2s_2+2s_1+2} dt \right)^{1/2} dn. \end{aligned}$$

For any  $n \neq 0$  fixed, we get (with  $s_2$  sufficiently larger than  $s_1$ )

$$\int_0^T (1 + |n|^2 t^2)^{-s_2+s_1+1} dt \leq \frac{1}{|n|} \int_0^{|n|T} (1 + u^2)^{-s_2+s_1+1} dt \lesssim \frac{1}{|n|}.$$

Hence, we obtain

$$I3 \lesssim \int_{\mathbb{R}^d} \frac{1}{|n| \langle n \rangle^2} \frac{1}{\langle k-n \rangle^{s_1-1}} dn \lesssim \int_{\mathbb{R}^d} \frac{1}{|k-n|} \frac{1}{\langle n \rangle^{s_1-1}} dn \lesssim 1.$$

We estimate I2 by coming back to I4; indeed, I2 can be recast as

$$I2 = \int_0^T \int_{\mathbb{R}^d} \left( \int_{\tau}^T \frac{|k|}{\langle k-n, tk - \tau n \rangle^{2s_3-2s_2-2}} dt \right) \frac{|n|^2 \langle \tau \rangle^2}{\langle n \rangle^2 \langle n, \tau n \rangle^{2s_1}} \frac{1}{|k-n|^{2\delta}} d\tau dn.$$

It thus remains to show that

$$\int_{-\infty}^{+\infty} \frac{|k|}{\langle k-n, tk - \tau n \rangle^{2s_3-2s_2-2}} dt$$

is bounded uniformly with respect to  $k, n$  and  $\tau$ . To this end, let us set

$$n_{\parallel} = \frac{k \cdot n}{|k|^2} k, \quad n_{\perp} = n - n_{\parallel}.$$

For  $k \neq 0$ , we are led to

$$\begin{aligned} \langle k-n, tk - \tau n \rangle^2 &= 1 + |k - n_{\parallel}|^2 + |n_{\perp}|^2 + |tk - \tau n_{\parallel}|^2 + |\tau n_{\perp}|^2 \\ &\geq 1 + |tk - \tau n_{\parallel}|^2 = 1 + \left| t|k| - \tau \frac{k \cdot n}{|k|} \right|^2 = \left\langle t|k| - \tau \frac{k \cdot n}{|k|} \right\rangle^2. \end{aligned}$$

It yields

$$\begin{aligned} \int_{-\infty}^{+\infty} \frac{|k|}{\langle k-n, tk - \tau n \rangle^{2s_3-2s_2-2}} dt &\leq \int_{-\infty}^{+\infty} \frac{|k|}{\left\langle t|k| - \tau \frac{k \cdot n}{|k|} \right\rangle^{2s_2-2s_3-2}} dt \\ &\leq \int_{-\infty}^{+\infty} \frac{1}{\langle u \rangle^{2s_3-2s_2-2}} du \lesssim 1. \end{aligned}$$

We finally treat I1 like I2.



---

Analytic Cauchy theory for the Vlasov-Wave system

---

In this Appendix we go back to the Cauchy problem addressed in the functional framework of Chapter 2 Section 2.4. We are going to justify Theorem 2.4.6. The discussion is based on general arguments presented in [69, 89, 90]. Throughout this section we suppose **(K1)**–**(K4)**.

Before to perform this analysis we briefly explain why, in contrast with the proof of the Landau damping in the free space problem, further efforts are needed for the Cauchy theory on the torus. Then, we prove the local well-posedness of the equation in an analytic framework and we finish with the proof of the extension criteria of Proposition 2.4.6.

### B.1 Difference with the free space problem

In the case of the free space problem, as mentioned in Appendix A, the proof of the bootstrap statement furnishes in a quite indirect way the continuity of the solution with respect to the bootstrap’s norm. Hence, we could expect that the same occurs in the torus case. However, since in this case we work with Gevrey norms, we have to be more cautious. Indeed, with the Sobolev norm  $H_P^\sigma$  with  $\sigma \geq 0$  and  $P \in \mathbb{N}$  sufficiently large, we have seen that the structure of the Vlasov equation allows us to obtain the following energy like estimate

$$\frac{1}{2} \frac{d}{dt} \|g(t)\|_{H_P^\sigma}^2 \leq C \langle t \rangle \|g(t)\|_{H_P^\sigma}^3$$

which provides the local existence of the solution in  $C^0([0, T], H_P^\sigma)$  (see Appendix A Section A.1.1). In the case of Gevrey norms  $\mathcal{G}_P^{\lambda, \sigma; s}$  it is tempting to conjecture that the same energy estimate can be performed, up to replace the  $H_P^\sigma$ -norm by the  $\mathcal{G}_P^{\lambda, \sigma; s}$ -norm. However such a statement is wrong. Indeed, if in the case of polynomial weight the mean value theorem provides, in the regime  $|n, tn| \leq |k - n, \xi - tn|$ , the estimation (A.3), in the case of exponential weight it only implies

$$\begin{aligned} & \left| \langle k, \xi \rangle^\sigma e^{\lambda \langle k, \xi \rangle^s} - \langle k - n, \xi - tn \rangle^\sigma e^{\lambda \langle k - n, \xi - tn \rangle^s} \right| \\ & \leq 2 \langle n, tn \rangle \left( \sigma \langle k - n, \xi - tn \rangle^{\sigma-1} + \lambda s \langle k - n, \xi - tn \rangle^{\sigma+s-1} \right) e^{\lambda \langle n, tn \rangle^s} e^{\lambda \langle k - n, \xi - tn \rangle^s} \quad (\text{B.1}) \end{aligned}$$

which provides only a gain of  $(1 - s)$ -derivatives. The solution consists in using a time-decreasing analyticity radius  $\lambda = \lambda(t)$  in order to get

$$\frac{1}{2} \frac{d}{dt} \|g(t)\|_{\mathcal{G}_P^{\lambda(t), \sigma; s}}^2 = \frac{1}{2} \left( \frac{d}{dt} \lambda(t) \right) \|g(t)\|_{\mathcal{G}_P^{\lambda(t), \sigma + \frac{s}{2}; s}}^2 + \langle \partial_t g(t), g(t) \rangle_{\mathcal{G}_P^{\lambda(t), \sigma; s}}$$

where the first term of the right hand side is negative and provides two more  $s/2$ -derivative which will be used to absorb the highest regularity term coming from  $\langle g(t), \partial_t g(t) \rangle$ . Then, combining (B.1) with this strategy furnishes a gain of exactly one derivative. This approach is used in order to prove Proposition 2.4.12 (see [12, Section 5.3]). However, in this context the analyticity radius is prescribed in advance and the proof can be performed only thanks to the a priori estimates (2.57a)–(2.57c). Here, since we want to study how the  $\mathcal{G}_P^{\lambda(t), \sigma; s}$ -norm is propagated by the equation, we do not get at hand the a priori estimates (2.57a)–(2.57c) and then, we cannot work with a prescribed analyticity radius  $\lambda(t)$ . Thus, in full generality, we can only get an energy estimate which provides that the equation propagates the  $\mathcal{G}_P^{\nu(t), \sigma; s}$ -norm along time, where the analyticity radius  $\nu(t)$  depends itself of the solution  $g(t)$  and might be strictly smaller than  $\lambda(t)$  (where  $\lambda(t)$  is given by Proposition 2.4.12). Hence this strategy cannot be used in order to obtain the continuity of the solution with respect to the bootstrap norms.

In order to avoid this difficulty we consider the case of an initial data  $f_0$  in  $\mathcal{G}_P^{\nu, 0; 1}$  for which we are able to justify the local existence of the solution in  $C^0([0, T), \mathcal{G}_P^{\nu(t), 0; 1})$ , see Section B.2 below. Then, on the time interval  $[0, T)$  the solution is continuous with respect to the bootstrap norms and we can perform the proof of Proposition 2.4.12 on this time interval. In order to justify that the solution is globally defined and (2.58a)–(2.58d) holds at any time, we need a result of extension of the solution in analytic norms when another sub-analytic norm of the solution (controlled by the bootstrap norms) remains bounded. The extension result of Proposition 2.4.6 states that is the case when the Sobolev norm  $H_P^q$  of the solution remains bounded. The demonstration of this result is the purpose of Section B.3 below.

## B.2 Local analysis

We write the problem in the form

$$\begin{cases} \partial_t g(t, x, v) = \mathcal{N}(g)(t, x, v) \\ g(0, x, v) = f_0(x, v) \end{cases} \tag{B.2}$$

where

$$\begin{aligned} \mathcal{N}(g)(t, x, v) &= \nabla \sigma_1 \star (\mathcal{F}_I + \sigma_1 \star \mathcal{G}_0)(t, x + tv) \cdot (\nabla_v - t \nabla_x)(\mathcal{M} + g)(t, x, v), \\ \varrho(t, x) &= \int_{\mathbb{R}^d} g(t, x - tv, v) dv. \end{aligned}$$

We start with an abstract statement about the local existence of analytic solutions for (B.2).

**Theorem B.2.1** *Let  $P > d/2$  be an integer and let  $\sigma > d/2$ . For any  $\mathcal{M}, f_0 \in \mathcal{G}_P^{\lambda_0, \sigma; 1}$  with  $\lambda_0 < \min(\lambda_1 / \langle 2R_2/c \rangle, 2\lambda_1 / \langle S_0 \rangle)$ , there exists  $\varepsilon > 0$  such that, for any  $0 < T < \varepsilon$  the mapping*

$$\Phi : g \longmapsto \left( t \mapsto f_0 + \int_0^t \mathcal{N}(g)(\tau) d\tau \right)$$

admits a fixed point in the set  $B_T^{\lambda_0}$ , made of functions  $(t, x, v) \mapsto g(t, x, v)$  such that

$$\|g\|_{B_T^{\lambda_0}} := \sup_{0 < \lambda < \lambda_0} \left( \sup_{t \in [0, T(\lambda_0 - \lambda))} \left[ 1 - \frac{t}{T(\lambda_0 - \lambda)} \right] \|g(t)\|_{\mathcal{G}_P^{\lambda, \sigma; 1}} \right) < +\infty.$$

**Remark B.2.2** *The constraint on  $\lambda_0$  comes from the fact that the proof uses Proposition 2.4.2. When  $\lambda_0 \geq \min(\lambda_1/\langle 2R_2/c \rangle, 2\lambda_1/\langle S_0 \rangle)$ ,  $\mathcal{M}$  and  $f_0$  are also elements of  $\mathcal{G}_P^{\lambda_0, \sigma; 1}$  with  $\tilde{\lambda}_0 < \min(\lambda_1/\langle 2R_2/c \rangle, 2\lambda_1/\langle S_0 \rangle)$  and the same conclusion holds up to replace  $\lambda_0$  by  $\tilde{\lambda}_0$ . Note that the larger  $c$  is, the larger  $\lambda_0$  can be taken.*

**Remark B.2.3** *The proof of this statement provides further information: there exists  $R > 0$  such that for any  $0 < \lambda < \lambda_0$  and  $t \in [0, T(\lambda_0 - \lambda))$ , we have*

$$\|g(t) - f_0\|_{\mathcal{G}_P^{\lambda, \sigma; 1}} \leq R.$$

Before starting the proof, let us explain why it is somehow natural to deal with the spaces  $B_T^{\lambda_0}$ . First of all, remark that the operator  $\mathcal{N}$  involves first order derivatives with respect to space and velocity, and thus the mapping  $\Phi$  does not map  $\mathcal{G}_P^{\lambda_0, \sigma; 1}$  into itself, but has its range in  $\mathcal{G}_P^{\lambda, \sigma; 1}$  with  $0 < \lambda < \lambda_0$ , possibly arbitrarily close to  $\lambda_0$ . For this reason, we work instead with a space that involves all the norms  $\mathcal{G}_P^{\lambda, \sigma; 1}$  for  $\lambda \in (0, \lambda_0)$ . However, Lemma B.2.6 below suggests that  $\|\mathcal{N}(g)(t)\|_{\mathcal{G}_P^{\lambda, \sigma; 1}}$  blows up as  $\lambda \nearrow \lambda_0$ , and this viewpoint is not sufficient. We should also take advantage of the time integration in order to control this blow up. This leads to incorporate a suitable weight with respect to time

$$w(t) = 1 - \frac{t}{T(\lambda_0 - \lambda)}$$

and then to consider the supremum over  $t \in [0, T(\lambda_0 - \lambda))$ . These norms are a bit unusual, nevertheless the following claim shows that most of the analysis can be performed in more natural functional spaces.

**Corollary B.2.4** *Let  $P > d/2$  be an integer and let  $\sigma > d/2$ . For any  $\mathcal{M}, f_0 \in \mathcal{G}_P^{\lambda_0, 0; 1}$ , there exists  $T^* > 0$  and a function  $0 < \lambda(t) \leq \lambda_0$ , continuous and decreasing, such that (B.2) has a unique solution  $g$  in  $C^0([0, T^*]; \mathcal{G}_P^{\lambda(t), \sigma; 1})$ . Moreover, if for some  $0 < T \leq T^*$ , we have*

$$\begin{cases} \limsup_{t \nearrow T} \|g(t)\|_{\mathcal{G}_P^{\lambda(t), \sigma; 1}} < +\infty \\ \lim_{t \nearrow T} \lambda(t) > 0, \end{cases}$$

then  $T < T^*$ .

**Remark B.2.5** *The continuity in time of  $g$  with respect to the  $\mathcal{G}_P^{\lambda(t), \sigma; 1}$ -norm has to be understood in the following sense*

$$\lim_{h \rightarrow 0} \|g(t+h) - g(t)\|_{\mathcal{G}_P^{\lambda_h(t), \sigma; 1}} = 0 \quad \text{with} \quad \lambda_h(t) = \min(\lambda(t+h), \lambda(t)).$$

As a consequence, the function  $t \mapsto \|g(t)\|_{\mathcal{G}_P^{\lambda(t), \sigma; 1}}$  is continuous.

The proof of Theorem B.2.1 uses the estimates (2.49), (2.50) and Proposition 2.4.2 (see Chapter 2 Section 2.4) together with the following claim.

**Lemma B.2.6** *Let  $g = g(t, x, v) \in \mathcal{G}_P^{\lambda, \sigma; s}$ . Then, for any  $0 \leq \lambda' < \lambda$ , the function  $(\nabla_v - t \nabla_x)g(t)$  defines an element of  $\mathcal{G}_P^{\lambda', \sigma; s}$ ; we have*

$$\|(\nabla_v - t \nabla_x)g(t)\|_{\mathcal{G}_P^{\lambda', \sigma; s}} \lesssim_s \frac{\langle t \rangle}{(\lambda - \lambda')^{1/s}} \|g(t)\|_{\mathcal{G}_P^{\lambda, \sigma; s}}. \tag{B.3}$$

**Proof.** Since

$$\begin{aligned} \|(\nabla_v - t \nabla_x)g(t)\|_{\mathcal{G}_P^{\lambda', \sigma; s}}^2 &= \sum_{\substack{\alpha \in \mathbb{N}^d \\ |\alpha| \leq P}} \sum_{k \in \mathbb{Z}^d} \int_{\mathbb{R}_\xi^d} \langle k, \xi \rangle^{2\sigma} e^{2\lambda' \langle k, \xi \rangle^s} \left| \mathbb{D}_\xi^\alpha (\xi \mapsto (\xi - tk)\widehat{g}(t, k, \xi)) \right|^2 d\xi \\ &\lesssim \langle t \rangle^2 \sum_{\substack{\alpha \in \mathbb{N}^d \\ |\alpha| \leq P}} \sum_{\substack{j \in \mathbb{N}^d \\ |j| \leq 1}} \sum_{k \in \mathbb{Z}^d} \int_{\mathbb{R}_\xi^d} \langle k, \xi \rangle^{2\sigma} e^{2\lambda \langle k, \xi \rangle^s} \left| \mathbb{D}_\xi^{\alpha-j} \widehat{g}(t, k, \xi) \right|^2 \langle k, \xi \rangle^2 e^{-2(\lambda - \lambda') \langle k, \xi \rangle^s} d\xi, \end{aligned}$$

we are led to identify the supremum over  $[0, \infty)$  of the function  $x \mapsto x^2 \exp(-2(\lambda - \lambda')x^s)$ . It is reached at  $1/(s[\lambda - \lambda']^{1/s})$  and its value is  $\exp(-2/s)/(s[\lambda - \lambda']^{2/s})$ . This ends the proof. ■

**Proof of Theorem B.2.1.** We split the proof into three steps.

- *Step 1.* Fix  $R > 0$ . We introduce the subset  $E_{T,R}^{\lambda_0}$  of  $B_T^{\lambda_0}$  defined by

$$E_{T,R}^{\lambda_0} := \left\{ g \in B_T^{\lambda_0} \text{ s.t. } \forall \lambda \in (0, \lambda_0), \forall t \in [0, T(\lambda_0 - \lambda)), \|g(t) - f_0\|_{\mathcal{G}_P^{\lambda, \sigma; 1}} \leq R \right\}.$$

If  $g$  lies in  $E_{T,R}^{\lambda_0}$ , then  $\Phi(g)$  belongs to  $B_T^{\lambda_0}$ . To be more specific, we have

$$\|\Phi(g)\|_{B_T^{\lambda_0}} \leq \|f_0\|_{\mathcal{G}_P^{\lambda_0, \sigma; 1}} + C_1 T \langle T \lambda_0 \rangle \left( \mathcal{E}_I + R + \|f_0\|_{\mathcal{G}_P^{\lambda_0, \sigma; 1}} \right) \left( \|\mathcal{M}\|_{\mathcal{G}_P^{\lambda_0, \sigma; 1}} + \|g\|_{B_T^{\lambda_0}} \right).$$

- *Step 2.* If  $g$  and  $h$  belong to  $E_{T,R}^{\lambda_0}$ , then, we have

$$\begin{aligned} \|\Phi(g) - \Phi(h)\|_{B_T^{\lambda_0}} &\leq C_2 T \langle T \lambda_0 \rangle \sqrt{T \lambda_0} \left( \|\mathcal{M}\|_{\mathcal{G}_P^{\lambda_0, \sigma; 1}} + R + \|f_0\|_{\mathcal{G}_P^{\lambda_0, \sigma; 1}} \right) \|g - h\|_{B_T^{\lambda_0}} \\ &\quad + C_3 T \langle T \lambda_0 \rangle \left( \mathcal{E}_I + R + \|f_0\|_{\mathcal{G}_P^{\lambda_0, \sigma; 1}} \right) \|g - h\|_{B_T^{\lambda_0}}. \end{aligned}$$

With these estimates, we cannot apply directly the standard Banach-Picard fixed point theorem since the range of  $E_{T,R}^{\lambda_0}$  by  $\Phi$  is not necessarily included in  $E_{T,R}^{\lambda_0}$ . However, for any  $0 < T' < T$ , we have  $\Phi(E_{T',R}^{\lambda_0}) \subset E_{T',R}^{\lambda_0}$ . We are going to exploit this observation to construct a fixed point.

- *Step 3.* We introduce the following sequence of times

$$T_k = \delta \prod_{j=0}^k \left( 1 - \frac{1}{(j+2)^2} \right)$$

(where  $\delta > 0$  can be chosen arbitrarily small), and we define a sequence of functions by the recursion formula

$$\begin{cases} g_0 = f_0 \\ g_{k+1} = f_0 + \int_0^t \mathcal{N}(g_k)(\tau) d\tau = \Phi(g_k). \end{cases}$$

Provided  $\delta$  is small enough, we can show that, for any  $k \in \mathbb{N}$ , we have

- a)  $g_k \in E_{T_k, R}^{\lambda_0}$ .
- b)  $\mu_k := \|g_{k+1} - g_k\|_{B_{T_k}^{\lambda_0}} \leq C\delta \frac{1}{(k+3)^4}$  where  $C > 0$  is a certain constant that will be made precise later on.

Consequently,  $(g_k)_{k \in \mathbb{N}}$  is a Cauchy sequence in  $B_{\delta T^\infty}^{\lambda_0}$  (with  $T^\infty = \prod_{k=0}^{+\infty} (1 - (k+2)^{-2}) > 0$ ) and it converges to  $g$  in  $B_{\delta T^\infty}^{\lambda_0}$ , which is a fixed point of  $\Phi$ .

Let us now detail the justification of each of these steps.

*Step 1.* Remark that

$$\|\Phi(g)(t)\|_{\mathcal{G}_P^{\lambda, \sigma; 1}} \leq \|f_0\|_{\mathcal{G}_P^{\lambda, \sigma; 1}} + \int_0^t \|\mathcal{N}(g)(\tau)\|_{\mathcal{G}_P^{\lambda, \sigma; 1}} dt.$$

Then, we are going to estimate  $\|\mathcal{N}(g)(\tau)\|_{\mathcal{G}_P^{\lambda, \sigma; 1}}$ . We use the  $\sigma$ -ring property (2.49), the estimate (2.53b), the embedding (2.50) and Lemma B.2.6. We obtain, for any  $0 < \lambda < \lambda' < \lambda_0$  and  $0 \leq \tau \leq t < T(\lambda_0 - \lambda)$ :

$$\begin{aligned} \|\mathcal{N}(g)(\tau)\|_{\mathcal{G}_P^{\lambda, \sigma; 1}} &\lesssim \|\nabla \sigma_1 \star (\mathcal{F}_I(\tau) - \sigma_1 \star \mathcal{G}_\rho(\tau))\|_{\mathcal{F}^{\lambda, \sigma; 1}} \|(\nabla_v - \tau \nabla_x)(\mathcal{M} + g(\tau))\|_{\mathcal{G}_P^{\lambda, \sigma; 1}} \\ &\lesssim \left( \mathcal{E}_I + \sup_{\tau \in [0, T(\lambda_0 - \lambda)]} \|g(\tau)\|_{\mathcal{G}_P^{\lambda, \sigma; 1}} \right) \frac{\langle \tau \rangle}{\lambda' - \lambda} \|\mathcal{M} + g(\tau)\|_{\mathcal{G}_P^{\lambda', \sigma; 1}}. \end{aligned}$$

Moreover, since  $g$  lies in  $E_{T, R}^{\lambda_0}$  and possibly by adapting the choice of  $\lambda'$  as a function of  $\tau$ , we get

$$\|\mathcal{N}(g)(\tau)\|_{\mathcal{G}_P^{\lambda, \sigma; 1}} \lesssim \left( \mathcal{E}_I + R + \|f_0\|_{\mathcal{G}_P^{\lambda_0, \sigma; 1}} \right) \frac{\langle T\lambda_0 \rangle}{\lambda'(\tau) - \lambda} \|\mathcal{M} + g(\tau)\|_{\mathcal{G}_P^{\lambda'(\tau), \sigma; 1}}.$$

Consequently, for any  $0 < \lambda < \lambda_0$  and  $t \in [0, T(\lambda_0 - \lambda))$ , we are led to

$$\begin{aligned} \left[ 1 - \frac{t}{T(\lambda_0 - \lambda)} \right] \|\Phi(g)(t)\|_{\mathcal{G}_P^{\lambda, \sigma; 1}} &\lesssim \|f_0\|_{\mathcal{G}_P^{\lambda_0, \sigma; 1}} + \langle T\lambda_0 \rangle \left( \mathcal{E}_I + R + \|f_0\|_{\mathcal{G}_P^{\lambda_0, \sigma; 1}} \right) \left[ 1 - \frac{t}{T(\lambda_0 - \lambda)} \right] \\ &\quad \times \int_0^t \frac{\|\mathcal{M} + g(\tau)\|_{\mathcal{G}_P^{\lambda'(\tau), \sigma; 1}}}{\lambda'(\tau) - \lambda} d\tau. \end{aligned}$$

Let  $\lambda'(\tau) = (\lambda_0 - \tau/T + \lambda)/2$  so that both conditions  $\lambda < \lambda'(\tau) < \lambda_0$  and  $\tau \leq T(\lambda_0 - \lambda'(\tau))$  are satisfied for  $0 \leq \tau \leq t < T(\lambda_0 - \lambda)$ , we can make use of the assumption  $g \in B_T^{\lambda_0}$  and we obtain

$$\begin{aligned} &\int_0^t \frac{\|\mathcal{M} + g(\tau)\|_{\mathcal{G}_P^{\lambda'(\tau), \sigma; 1}}}{\lambda'(\tau) - \lambda} d\tau \\ &\leq \int_0^t \frac{\left[ 1 - \frac{\tau}{T(\lambda_0 - \lambda'(\tau))} \right] \|\mathcal{M} + g(\tau)\|_{\mathcal{G}_P^{\lambda'(\tau), \sigma; 1}}}{(\lambda'(\tau) - \lambda) \left[ 1 - \frac{\tau}{T(\lambda_0 - \lambda'(\tau))} \right]} d\tau \leq \int_0^t \frac{\|\mathcal{M}\|_{\mathcal{G}_P^{\lambda_0, \sigma; 1}} + \|g\|_{B_T^{\lambda_0}}}{(\lambda'(\tau) - \lambda) \left[ 1 - \frac{\tau}{T(\lambda_0 - \lambda'(\tau))} \right]} d\tau. \end{aligned}$$

Finally, since

$$\lambda'(\tau) - \lambda = \frac{1}{2T} [T(\lambda_0 - \lambda) - \tau]$$

and

$$T(\lambda_0 - \lambda'(\tau)) = \frac{1}{2} [T(\lambda_0 - \lambda) + \tau] \leq \frac{1}{2} [T(\lambda_0 - \lambda) + t] \leq T(\lambda_0 - \lambda),$$



we arrive at

$$\begin{aligned}
& \left[1 - \frac{t}{T(\lambda_0 - \lambda)}\right] \int_0^t \frac{1}{(\lambda'(\tau) - \lambda) \left[1 - \frac{\tau}{T(\lambda_0 - \lambda'(\tau))}\right]} d\tau \\
&= \left[1 - \frac{t}{T(\lambda_0 - \lambda)}\right] \int_0^t \frac{T(\lambda_0 - \lambda'(\tau))}{(\lambda'(\tau) - \lambda) [T(\lambda_0 - \lambda'(\tau)) - \tau]} d\tau \\
&\leq \left[1 - \frac{t}{T(\lambda_0 - \lambda)}\right] \int_0^t \frac{T(\lambda_0 - \lambda)}{\frac{1}{4T} [T(\lambda_0 - \lambda) - \tau]^2} d\tau \\
&= 4T [T(\lambda_0 - \lambda) - t] \int_0^t \frac{1}{[T(\lambda_0 - \lambda) - \tau]^2} d\tau = 4T \frac{t}{T(\lambda_0 - \lambda)} \leq 4T.
\end{aligned}$$

It allows us to conclude that

$$\|\Phi(g)\|_{B_T^{\lambda_0}} \lesssim \|f_0\|_{\mathcal{G}_P^{\lambda_0, \sigma; 1}} + 4T \langle T\lambda_0 \rangle \left( \mathcal{E}_I + R + \|f_0\|_{\mathcal{G}_P^{\lambda_0, \sigma; 1}} \right) \left( \|\mathcal{M}\|_{\mathcal{G}_P^{\lambda_0, \sigma; 1}} + \|g\|_{B_T^{\lambda_0}} \right).$$

*Step 2.* Like in Step 1, we introduce two real numbers  $0 < \lambda < \lambda' < \lambda_0$ , two times  $0 \leq \tau \leq t < T(\lambda_0 - \lambda)$  and we estimate

$$\begin{aligned}
& \|\mathcal{N}(g)(\tau) - \mathcal{N}(h)(\tau)\|_{\mathcal{G}_P^{\lambda, \sigma; 1}} \\
&\leq \|(x, v) \mapsto \nabla \Sigma \star \mathcal{G}_{\varrho_g - \varrho_h}(\tau, x + \tau v) \cdot (\nabla_v - \tau \nabla_x) (\mathcal{M}(v) + g(\tau, x, v))\|_{\mathcal{G}_P^{\lambda, \sigma; 1}} \\
&\quad + \|(x, v) \mapsto \nabla \sigma_1 \star (\mathcal{F}_I - \sigma_1 \star \mathcal{G}_{\varrho_h})(\tau, x + \tau v) \cdot (\nabla_v - \tau \nabla_x) (g(\tau, x, v) - h(\tau, x, v))\|_{\mathcal{G}_P^{\lambda, \sigma; 1}}.
\end{aligned}$$

The second term can be treated as in Step 1. For the first term, we apply (2.49) again, with (2.53b) and (2.50) combined to Lemma B.2.6, and we obtain

$$\begin{aligned}
I(\tau) &= \|(x, v) \mapsto \nabla \Sigma \star \mathcal{G}_{\varrho_g - \varrho_h}(\tau, x + \tau v) \cdot (\nabla_v - \tau \nabla_x) (\mathcal{M}(v) + g(\tau, x, v))\|_{\mathcal{G}_P^{\lambda, \sigma; 1}} \\
&\lesssim \left( \int_0^\tau \|g(s) - h(s)\|_{\mathcal{G}_P^{\lambda, \sigma; 1}}^2 ds \right)^{1/2} \frac{\langle T\lambda_0 \rangle}{\lambda'(\tau) - \lambda} \|\mathcal{M} + g(\tau)\|_{\mathcal{G}_P^{\lambda'(\tau), \sigma; 1}}.
\end{aligned}$$

Since  $0 \leq s < T(\lambda_0 - \lambda)$ , we can appeal to the assumption  $g, h \in B_T^{\lambda_0}$ , so that

$$\begin{aligned}
& \int_0^\tau \|g(s) - h(s)\|_{\mathcal{G}_P^{\lambda, \sigma; 1}}^2 ds \\
&= \int_0^\tau \frac{\left[1 - \frac{s}{T(\lambda_0 - \lambda)}\right]^2 \|g(s) - h(s)\|_{\mathcal{G}_P^{\lambda, \sigma; 1}}^2}{\left[1 - \frac{s}{T(\lambda_0 - \lambda)}\right]^2} ds \leq \|g - h\|_{B_T^{\lambda_0}}^2 \int_0^\tau \frac{1}{\left[1 - \frac{s}{T(\lambda_0 - \lambda)}\right]^2} ds \\
&= \|g - h\|_{B_T^{\lambda_0}}^2 \left[ \frac{T^2(\lambda_0 - \lambda)^2}{T(\lambda_0 - \lambda) - \tau} - \frac{T^2(\lambda_0 - \lambda)^2}{T(\lambda_0 - \lambda)} \right] \leq \|g - h\|_{B_T^{\lambda_0}}^2 \frac{T^2(\lambda_0 - \lambda)^2}{T(\lambda_0 - \lambda) - \tau}.
\end{aligned}$$

Moreover, still with  $\lambda'(\tau) = (\lambda_0 - \tau/T + \lambda)/2$  (the conditions  $\lambda < \lambda'(\tau) < \lambda_0$  and  $\tau \leq T(\lambda_0 - \lambda'(\tau))$  are thus fulfilled for  $0 \leq \tau \leq t < T(\lambda_0 - \lambda)$ ), we make use of the assumption  $g \in E_{T,R}^{\lambda_0}$  which yields

$$\|\mathcal{M} + g(\tau)\|_{\mathcal{G}_P^{\lambda'(\tau), \sigma; 1}} \leq \|\mathcal{M}\|_{\mathcal{G}_P^{\lambda_0, \sigma; 1}} + R + \|f_0\|_{\mathcal{G}_P^{\lambda_0, \sigma; 1}}.$$

Therefore, this discussion leads to

$$I(\tau) \lesssim \|g - h\|_{B_T^{\lambda_0}} \frac{T(\lambda_0 - \lambda)}{\sqrt{T(\lambda_0 - \lambda) - \tau}} \frac{\langle T\lambda_0 \rangle}{\lambda'(\tau) - \lambda} \left( \|\mathcal{M}\|_{\mathcal{G}_P^{\lambda_0, \sigma; 1}} + R + \|f_0\|_{\mathcal{G}_P^{\lambda_0, \sigma; 1}} \right).$$

Integrating over  $[0, t]$  and multiplying by  $(1 - t/[T(\lambda_0 - \lambda)])$ , we get

$$\left[1 - \frac{t}{T(\lambda_0 - \lambda)}\right] \int_0^t I(\tau) \, d\tau \lesssim \langle T\lambda_0 \rangle \left( \|\mathcal{M}\|_{\mathcal{G}_P^{\lambda_0, \sigma; 1}} + R + \|f_0\|_{\mathcal{G}_P^{\lambda_0, \sigma; 1}} \right) \|g - h\|_{B_T^{\lambda_0}} \times [T(\lambda_0 - \lambda) - t] \left( \int_0^t \frac{2T}{[T(\lambda_0 - \lambda) - \tau]^{3/2}} \, d\tau \right),$$

where

$$[T(\lambda_0 - \lambda) - t] \left( \int_0^t \frac{2T}{[T(\lambda_0 - \lambda) - \tau]^{3/2}} \, d\tau \right) \leq 2T\sqrt{T(\lambda_0 - \lambda) - t} \leq 2T\sqrt{T\lambda_0}$$

and we conclude with

$$\|\Phi(g) - \Phi(h)\|_{B_T^{\lambda_0}} \lesssim 2T\langle T\lambda_0 \rangle \sqrt{T\lambda_0} \left( \|\mathcal{M}\|_{\mathcal{G}_P^{\lambda_0, \sigma; 1}} + R + \|f_0\|_{\mathcal{G}_P^{\lambda_0, \sigma; 1}} \right) \|g - h\|_{B_T^{\lambda_0}} + 4T\langle T\lambda_0 \rangle \left( \mathcal{E}_I + R + \|f_0\|_{\mathcal{G}_P^{\lambda_0, \sigma; 1}} \right) \|g - h\|_{B_T^{\lambda_0}}.$$

*Step 3.* Let  $R > 0$ ,  $\delta_0 > 0$  and introduce  $C = C(R, \delta_0, \mathcal{E}_I, \mathcal{M}, f_0) > 0$  such that

$$\begin{cases} C_1 \langle \delta_0 \lambda_0 \rangle \left( \mathcal{E}_I + \|f_0\|_{\mathcal{G}_P^{\lambda_0, \sigma; 1}} \right) \left( \|\mathcal{M}\|_{\mathcal{G}_P^{\lambda_0, \sigma; 1}} + \|f_0\|_{\mathcal{G}_P^{\lambda_0, \sigma; 1}} \right) \leq C \frac{1}{3^4}, \\ \langle \delta_0 \lambda_0 \rangle \left( C_2 \sqrt{\delta_0 \lambda_0} + C_3 \right) \left( \mathcal{E}_I + \|\mathcal{M}\|_{\mathcal{G}_P^{\lambda_0, \sigma; 1}} + R + \|f_0\|_{\mathcal{G}_P^{\lambda_0, \sigma; 1}} \right) \leq C. \end{cases}$$

(The  $C_j$ 's are the constants that appear in the estimates established in the first two steps.) We introduce the sequences defined by

$$T_k = \delta \prod_{j=0}^k \left( 1 - \frac{1}{(j+2)^2} \right) \quad ; \quad \begin{cases} g_0 = f_0 \\ g_{k+1} = \Phi(g_k) \end{cases} \quad ; \quad \mu_k = \|g_{k+1} - g_k\|_{B_{T_k}}$$

where  $\delta > 0$  is such that

$$\begin{cases} \delta < \delta_0, \\ C\delta \sum_{k=0}^{+\infty} \frac{1}{(k+3)^2} \leq R, \\ C\delta \sup_{x \geq 0} \left( \frac{x+4}{x+3} \right)^4 \leq 1. \end{cases}$$

We are going to show that, with this definition of  $\delta$ , we have, for any  $k \in \mathbb{N}$ ,

$$g_k \in E_{T_k, R}^{\lambda_0} \quad \text{and} \quad \mu_k \leq C\delta \frac{1}{(k+3)^4} \tag{B.4}$$

We start by establishing that the sequence  $(T_k)_{k \in \mathbb{N}}$  is decreasing and that

$$0 < \delta T^\infty < T_k < T_0 < \delta_0.$$

*Initialisation.* Since  $g_0 = f_0 \in \mathcal{G}_P^{\lambda_0, \sigma; 1}$  does not depend on time, we obviously have  $g_0 \in E_{T_0, R}^{\lambda_0}$ . Step 1 tells us that  $g_1 = \Phi(g_0) \in B_{T_0}^{\lambda_0}$ . More precisely, we have

$$\|g_1 - g_0\|_{B_{T_0}^{\lambda_0}} = \|\Phi(g_0) - f_0\|_{B_{T_0}^{\lambda_0}} \leq C_1 \delta \langle \delta_0 \lambda_0 \rangle \left( \mathcal{E}_I + \|f_0\|_{\mathcal{G}_P^{\lambda_0, \sigma; 1}} \right) \left( \|\mathcal{M}\|_{\mathcal{G}_P^{\lambda_0, \sigma; 1}} + \|f_0\|_{\mathcal{G}_P^{\lambda_0, \sigma; 1}} \right).$$

The definition of  $C$  ensures that

$$\mu_0 \leq C\delta \frac{1}{(0+3)^4}.$$

*Recursion.* Suppose that (B.4) holds up to a certain step  $N$ . Then, for any  $0 < \lambda < \lambda_0$  and

$t \in [0, T_{N+1}(\lambda_0 - \lambda)]$ , we get

$$\begin{aligned} \|g_{N+1}(t) - f_0\|_{\mathcal{G}_P^{\lambda, \sigma; 1}} &\leq \frac{1 - \frac{t}{T_N(\lambda_0 - \lambda)}}{1 - \frac{t}{T_N(\lambda_0 - \lambda)}} \|g_{N+1}(t) - g_N(t)\|_{\mathcal{G}_P^{\lambda, \sigma; 1}} + \|g_N(t) - f_0\|_{\mathcal{G}_P^{\lambda, \sigma; 1}} \\ &\leq \frac{1}{1 - \frac{t}{T_N(\lambda_0 - \lambda)}} \mu_N + \|g_N(t) - f_0\|_{\mathcal{G}_P^{\lambda, \sigma; 1}} \leq \frac{1}{1 - \frac{T_{N+1}}{T_N}} \mu_N + \|g_N(t) - f_0\|_{\mathcal{G}_P^{\lambda, \sigma; 1}} \end{aligned}$$

and then

$$\begin{aligned} \|g_{N+1}(t) - f_0\|_{\mathcal{G}_P^{\lambda, \sigma; 1}} &\leq \sum_{k=0}^N \frac{\mu_k}{1 - \frac{T_{k+1}}{T_k}} + \|g_0 - f_0\|_{\mathcal{G}_P^{\lambda, \sigma; 1}} = \sum_{k=0}^N (k+3)^2 \mu_k \\ &\leq \sum_{k=0}^N (k+3)^2 C\delta \frac{1}{(k+3)^4} \leq C\delta \sum_{k=0}^{+\infty} \frac{1}{(k+3)^2}, \end{aligned}$$

where the definition of  $\delta$  implies

$$\|g_{N+1}(t) - f_0\|_{\mathcal{G}_P^{\lambda, \sigma; 1}} \leq R.$$

Since  $g_{N+1} = \Phi(g_N)$  and  $g_N \in E_{T_N, R}^{\lambda_0}$ , Step 1 and the previous computation show that  $g_{N+1} \in E_{T_{N+1}, R}^{\lambda_0}$ . Applying Step 2, we obtain (owing to the definition adopted for  $C$ )

$$\begin{aligned} \mu_{N+1} &= \|\Phi(g_{N+1}) - \Phi(g_N)\|_{B_{T_{N+1}}^{\lambda_0}} \\ &\leq C\delta \|g_{N+1} - g_N\|_{B_{T_{N+1}}^{\lambda_0}} \leq C\delta \mu_N \leq C\delta \left[ C\delta \left( \frac{N+4}{N+3} \right)^4 \right] \frac{1}{(N+4)^4}. \end{aligned}$$

Finally, the constraints imposed on  $\delta$  are such that

$$\mu_{N+1} \leq C\delta \frac{1}{(N+4)^4},$$

which ends the proof.

*Step 4: Conclusion.* Let  $g$  denote the limit of the sequence  $(g_k)_{k \in \mathbb{N}}$  in  $B_{\delta T^\infty}^{\lambda_0}$ . Let us show that  $g \in E_{\delta T^\infty, R}^{\lambda_0}$ . Let  $0 < \lambda < \lambda_0$  and  $t \in [0, \delta T^\infty(\lambda_0 - \lambda)]$ . Of course, we have, for any  $N \in \mathbb{N}$ ,

$$\|g(t) - f_0\|_{\mathcal{G}_P^{\lambda, \sigma; 1}} \leq \frac{1}{1 - \frac{t}{\delta T^\infty(\lambda_0 - \lambda)}} \|g - g_N\|_{B_{\delta T^\infty}^{\lambda_0}} + \|g_N(t) - f_0\|_{\mathcal{G}_P^{\lambda, \sigma; 1}}.$$

Let  $\varepsilon > 0$ . There exists  $N \in \mathbb{N}$  (that depends on  $t, \lambda$  and  $\varepsilon$ ) such that

$$\|g - g_N\|_{B_{\delta T^\infty}^{\lambda_0}} \leq \left[ 1 - \frac{t}{\delta T^\infty(\lambda_0 - \lambda)} \right] \varepsilon.$$

Using this in the previous estimate yields

$$\|g(t) - f_0\|_{\mathcal{G}_P^{\lambda, \sigma; 1}} \leq \varepsilon + R,$$

which thus holds for any  $\varepsilon > 0$ . We conclude that  $g \in E_{\delta T^\infty, R}^{\lambda_0}$ , by letting  $\varepsilon$  go to 0. Next, we can apply Step 2 and we conclude that  $g$  is a fixed point of  $\Phi$ :

$$\begin{aligned} \|g - \Phi(g)\|_{B_T} &\leq \|g - g_k\|_{B_T} + \|g_k - \Phi(g_k)\|_{B_T} + \|\Phi(g_k) - \Phi(g)\|_{B_T} \\ &\lesssim \|g - g_k\|_{B_T} + \|g_k - g_{k+1}\|_{B_T} + \|g_k - g\|_{B_T} \xrightarrow{k \rightarrow +\infty} 0. \end{aligned}$$

■

**Proof of Corollary B.2.4.** Since  $f_0, \mathcal{M} \in \mathcal{G}_P^{\lambda_0, 0; 1}$ , we can appeal to Theorem B.2.1: there exist  $T > 0$  and  $g \in B_T^{\lambda_0}$  solution of (B.2). We also know that there exists  $R > 0$  such that  $g \in E_{T, R}^{\lambda_0}$ .

We are going to show that  $g \in C^0([0, T(\lambda_0 - \lambda)]; \mathcal{G}_P^{\lambda, \sigma; 1})$  for any  $0 < \lambda < \lambda_0$ . By using an argument of composition of continuous functions, it follows that we can work with  $\lambda = \lambda(t)$  such that  $0 \leq t < T(\lambda_0 - \lambda(t))$  on a time interval  $[0, T_f]$ , and we have  $g \in C^0([0, T_f]; \mathcal{G}_P^{\lambda(t), \sigma; 1})$ .

Let us pick  $0 < \lambda < \lambda_0$  and a time  $t \in [0, T(\lambda_0 - \lambda))$ . Remark that we can find  $\lambda < \lambda' < \lambda_0$  verifying  $t < T(\lambda_0 - \lambda')$ . Then, for any  $h$  sufficiently small,  $t + h < T(\lambda_0 - \lambda')$ . Going back to the beginning of the proof of Theorem B.2.1, we get

$$\begin{aligned} \|g(t+h) - g(t)\|_{\mathcal{G}_P^{\lambda, \sigma; 1}} &= \|\Phi(g)(t+h) - \Phi(g)(t)\|_{\mathcal{G}_P^{\lambda, \sigma; 1}} \leq \int_t^{t+h} \|\mathcal{N}(g)(\tau)\|_{\mathcal{G}_P^{\lambda, \sigma; 1}} \, d\tau \\ &\lesssim \int_t^{t+h} \left( \mathcal{E}_I + R + \|f_0\|_{\mathcal{G}_P^{\lambda_0, \sigma; 1}} \right) \frac{\langle \tau \rangle}{\lambda' - \lambda} \|\mathcal{M} + g(\tau)\|_{\mathcal{G}_P^{\lambda', \sigma; 1}} \, d\tau. \end{aligned}$$

Since  $\tau \leq t + h < T(\lambda_0 - \lambda')$  and  $g \in E_{T, R}^{\lambda_0}$ , we are led to

$$\begin{aligned} \|g(t+h) - g(t)\|_{\mathcal{G}_P^{\lambda, \sigma; 1}} &\lesssim \left( \mathcal{E}_I + R + \|f_0\|_{\mathcal{G}_P^{\lambda_0, \sigma; 1}} \right) \frac{\langle T\lambda_0 \rangle}{\lambda' - \lambda} \left( \|\mathcal{M}\|_{\mathcal{G}_P^{\lambda_0, \sigma; 1}} + R + \|f_0\|_{\mathcal{G}_P^{\lambda_0, \sigma; 1}} \right) |h| \xrightarrow{h \rightarrow 0} 0. \end{aligned}$$

Let us end the discussion with a few hints on the extension criterion. We are going to show that, if  $g \in C^0([0, T]; \mathcal{G}_P^{\lambda(t), \sigma; 1})$  (with  $0 < \lambda(t) \leq \lambda_0$  continuous and decreasing) is a solution of (B.2) such that

$$\begin{cases} \limsup_{t \nearrow T} \|g(t)\|_{\mathcal{G}_P^{\lambda(t), \sigma; 1}} < +\infty \\ \lim_{t \nearrow T} \lambda(t) > 0 \end{cases}$$

then, possibly at the price of replacing  $\lambda(t)$  by another function  $\nu(t)$  such that  $0 < \nu(t) \leq \lambda(t)$  on  $[0, T)$ , we can extend  $g$  into a solution of (B.2) on  $[0, T')$ , with  $g \in C^0([0, T']; \mathcal{G}_P^{\nu(t), \sigma; 1})$ .

To this end, we apply Theorem B.2.1 with  $g(t)$  as initial data for any  $t \in [0, T)$ . For each of these data, there exists  $T'_t$  and a solution of (B.2) in  $B_{T'_t}^{\lambda(t)}$ . But the proof of Theorem B.2.1 shows that  $T'_t$  depends (among other things) on the norm  $\mathcal{G}_P^{\lambda, \sigma; 1}$  of the initial data and on the coefficient  $\lambda$  (see the role of the constants  $C$  and  $\delta$  in the third step of the proof of Theorem B.2.1). Here, we know that there exists  $A > 0$  such that, for any  $t \in [0, T)$ ,

$$\|g(t)\|_{\mathcal{G}_P^{\lambda(t), \sigma; 1}} \leq A$$

holds, and  $\lambda(t) \leq \lambda_0$ . Hence, the times  $T'_t$  can be chosen independently of the data  $g(t)$ :  $T'_t = T'$ . Furthermore, we also know that there exists a constant  $a > 0$  such that, for any  $t \in [0, T)$ ,  $\lambda(t) \geq a$ . Thus, there also exists  $t^* > 0$  such that  $t + T'\lambda(t) > T$  holds for any  $t \in [t^*, T)$ . This allows us to extend the solution; we refer the reader to Fig. B.1 for guiding the intuition. ■

### B.3 Extension of the strong analyticity property

In this section, for the sake of simplicity, we only consider the case  $\mathcal{M} \equiv 0$ . Since we work on the torus this is not a restriction and every estimate obtain here can also be obtained when  $\mathcal{M}$  is not equal to 0, up to replacing  $g(t)$  by  $g(t) + \mathcal{M}$ . We wish to prove Proposition 2.4.6.

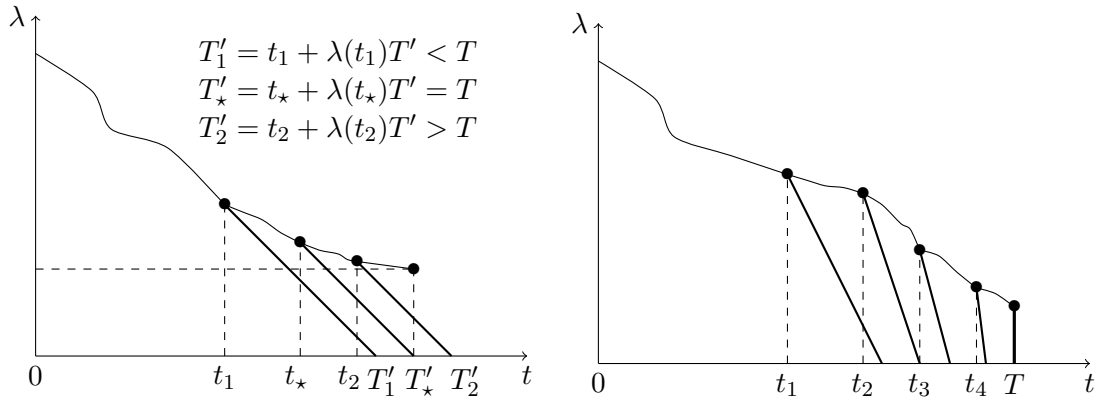

Figure B.1: Analyticity radius, as a function of the time variable: the case  $T'$  independents on  $t$  (left) and the critical case when  $T'$  depends on  $t$  (right)

To this end, we are going to combine Corollary B.2.4 to the following statement.

**Proposition B.3.1** *Let  $P > d/2$  be an integer and let  $\sigma > d/2$  be a real number. If  $g \in C^0([0, T]; \mathcal{G}_P^{\lambda(t), \sigma; 1})$  is a solution of (B.2) on  $[0, T)$  that satisfies*

$$\limsup_{t \nearrow T} \|g(t)\|_{H_P^\sigma} < +\infty,$$

*then, there exists a function  $\nu(t) > 0$  continuous and decreasing such that  $g \in C^0([0, T]; \mathcal{G}_P^{\nu(t), \sigma; 1})$ ,  $\inf_{t \in [0, T)} \nu(t) > 0$  and, for any  $t \in [0, T)$ , we have*

$$\|g(t)\|_{\mathcal{G}_P^{\nu(t), \sigma; 1}}^2 \leq \|g(0)\|_{\mathcal{G}_P^{\nu(0), \sigma; 1}}^2 + 1 + 2 \int_0^t \theta(\tau) \, d\tau$$

where  $\theta(t)$  depends on  $g$  only through the following Sobolev norms

$$\theta(t) = C \langle t \rangle \left( \mathcal{E}_I + \int_0^t \|g(\tau)\|_{H_P^\sigma}^2 \, d\tau \right)^{1/2} \|g(t)\|_{H_P^\sigma}^2. \tag{B.5}$$

and the constant  $C$  do not depend on  $g$ .

**Remark B.3.2** *The proof provides an explicit formula for  $\nu(t)$ . In particular, it justifies that  $\nu(T) > 0$ . The proof of Proposition 2.4.6 then follows readily from Corollary B.2.4 and this Proposition.*

Let us start by establishing the following *a priori* estimate.

**Lemma B.3.3** *Let  $P > d/2$  be an integer and let  $\sigma > d/2$  be a real number. If  $g \in C^0([0, T]; \mathcal{G}_P^{\lambda(t), \sigma+1/2; 1})$  is a solution of (B.2) on  $[0, T)$  with  $\lambda(t) > 0$  a derivable and decreasing function, then, for any  $t \in [0, T)$ , we have*

$$\begin{aligned} \frac{1}{2} \frac{d}{dt} \|g(t)\|_{\mathcal{G}_P^{\lambda(t), \sigma; 1}}^2 &\leq \left( \frac{d}{dt} \lambda(t) \right) \|g(t)\|_{\mathcal{G}_P^{\lambda(t), \sigma+1/2; 1}}^2 \\ &+ \lambda(t) C_1 \langle t \rangle^{3/2} \left( \mathcal{E}_I + \int_0^t \|g(\tau)\|_{\mathcal{G}_P^{\lambda(\tau), \sigma; 1}}^2 \, d\tau \right)^{1/2} \|g(t)\|_{\mathcal{G}_P^{\lambda(t), \sigma+1/2; 1}}^2 + \theta(t) \end{aligned}$$

where  $\theta(t)$  is defined by (B.5).

**Remark B.3.4** *In the Vlasov case a rather similar estimate can be obtained: if  $g$  is a solution of (A.1) on  $[0, T)$ , then*

$$\frac{1}{2} \frac{d}{dt} \|g(t)\|_{\mathcal{G}_P^{\lambda(t)}}^2 \leq \left( \frac{d}{dt} \lambda(t) \right) \|g(t)\|_{\mathcal{G}_P^{\lambda(t), \sigma + \frac{1}{2}; 1}}^2 + \lambda(t) C_1 \langle t \rangle \|g(t)\|_{\mathcal{G}_P^{\lambda(t), \sigma; 1}} \|g(t)\|_{\mathcal{G}_P^{\lambda(t), \sigma + \frac{1}{2}; 1}}^2 + \tilde{\theta}(t),$$

where  $\tilde{\theta}(t)$  is now defined by

$$\tilde{\theta}(t) = C \langle t \rangle \|g(t)\|_{H_P^\sigma}^3.$$

Applying this energy estimate with

$$\lambda(t) := \lambda(0) \exp \left( - C_1 \int_0^t \langle \tau \rangle \sqrt{Y(\tau)} d\tau \right),$$

where

$$Y(t) = \|g(0)\|_{\mathcal{G}_P^{\lambda(0), \sigma; 1}}^2 + 1 + 2 \int_0^t \theta(\tau) d\tau$$

implies

$$\frac{1}{2} \frac{d}{dt} \|g(t)\|_{\mathcal{G}_P^{\lambda(t)}}^2 \leq \lambda(t) C_1 \langle t \rangle \left( \|g(t)\|_{\mathcal{G}_P^{\lambda(t), \sigma; 1}} - \sqrt{Y(t)} \right) \|g(t)\|_{\mathcal{G}_P^{\lambda(t), \sigma + \frac{1}{2}; 1}}^2 + \tilde{\theta}(t).$$

Since  $\dot{Y}(t) = 2\theta(t)$ , we get

$$\frac{1}{2} \frac{d}{dt} \left( \|g(t)\|_{\mathcal{G}_P^{\lambda(t)}}^2 - Y(t) \right) \leq \frac{\lambda(t) C_1 \langle t \rangle}{\|g(t)\|_{\mathcal{G}_P^{\lambda(t), \sigma; 1}} + \sqrt{Y(t)}} \left( \|g(t)\|_{\mathcal{G}_P^{\lambda(t), \sigma; 1}}^2 - Y(t) \right) \|g(t)\|_{\mathcal{G}_P^{\lambda(t), \sigma + \frac{1}{2}; 1}}^2,$$

where  $\|g(t)\|_{\mathcal{G}_P^{\lambda(t), \sigma; 1}} + \sqrt{Y(t)} \geq \sqrt{Y(0)} > 0$ . Thanks to the initial condition

$$\|g(0)\|_{\mathcal{G}_P^{\lambda(0)}}^2 - Y(0) = -1 < 0 \quad \text{and} \quad \left. \frac{d}{dt} \left( \|g(t)\|_{\mathcal{G}_P^{\lambda(t), \sigma; 1}}^2 - Y(t) \right) \right|_{t=0} < 0,$$

classical ODE techniques allow us to eventually obtain for every  $t \in [0, T)$

$$\|g(t)\|_{\mathcal{G}_P^{\lambda(t)}}^2 \leq Y(t).$$

It only remains to make this argument rigorous since in that form it requires the a priori knowledge that  $g$  belongs to  $\mathcal{G}_P^{\lambda(t), \sigma + 1/2; 1}$  on  $[0, T)$ . We perform it in the sequel in the Vlasov-Wave case and the proof can be easily adapted to the Vlasov case.

**Remark B.3.5** i) *The attentive reader has noticed that in the energy like estimate in the pure Vlasov case there is only a factor  $\langle t \rangle$  in the right hand side whereas for the Vlasov-Wave case there is a factor  $\langle t \rangle^{3/2}$ . This difference comes from the half convolution with the kernel  $p_c$  and we will make clearly appear in the proof how it modifies the result.*

ii) *It might also be surprising that this difference does not impact the bootstrap statement of Proposition 2.4.12. Indeed, this proposition is exactly the same than in the pure Vlasov case: in both case the  $\mathcal{G}_P^{\lambda(t), \sigma + 1; s}$  norm of  $g(t)$  growth like  $\langle t \rangle^7$  whereas this estimate comes from an energy estimate which follows the same strategy (but in a finer way in order to exploit the a priori estimates (2.57a)–(2.57c) and (2.58d)) than the one used for proving Lemma B.3.3. We will explain this point in Remark B.3.7 after the proof of Lemma B.3.3.*

The proof of Lemma B.3.3 uses in several places the following claim. Its proof is performed in [12, Lemma 3.1] and consists in straightforward repeated applications of the Cauchy-Schwarz inequality.

**Lemma B.3.6** *For any  $\sigma > d/2$ , we have*

$$\left| \sum_{k,n \in \mathbb{Z}^d} \int_{\mathbb{R}^d} f(k, \xi) g(n) h(k - n, \xi - tn) \, d\xi \right| \lesssim_{\sigma,d} \|f\|_{L^2_{k,\xi}} \left( \sum_{n \in \mathbb{Z}^d} \langle n \rangle^{2\sigma} |g(n)|^2 \right)^{1/2} \|h\|_{L^2_{k,\xi}}$$

and

$$\left| \sum_{k,n \in \mathbb{Z}^d} \int_{\mathbb{R}^d} f(k, \xi) g(n) h(k - n, \xi - tn) \, d\xi \right| \lesssim_{\sigma,d} \|f\|_{L^2_{k,\xi}} \|g\|_{L^2_k} \left( \sum_{k \in \mathbb{Z}^d} \int_{\mathbb{R}^d} \langle n \rangle^{2\sigma} |h(k, \xi)|^2 \, d\xi \right)^{1/2}.$$

**Proof of Lemma B.3.3.** Since

$$\frac{1}{2} \frac{d}{dt} \|g(t)\|_{\mathcal{G}_P^{\lambda(t),\sigma;1}}^2 = \left( \frac{d}{dt} \lambda(t) \right) \|g(t)\|_{\mathcal{G}_P^{\lambda(t),\sigma+\frac{1}{2};1}}^2 + \langle g(t), \partial_t g(t) \rangle_{\mathcal{G}_P^{\lambda(t),\sigma;1}}$$

with

$$\langle g(t), \partial_t g(t) \rangle_{\mathcal{G}_P^{\lambda(t),\sigma;1}} = \sum_{\substack{\alpha \in \mathbb{N}^d \\ |\alpha| \leq P}} \sum_{k \in \mathbb{Z}^d} \underbrace{\int_{\mathbb{R}^d} \langle k, \xi \rangle^{2\sigma} e^{2\lambda(t)\langle k, \xi \rangle} D_\xi^\alpha \overline{\widehat{g}(t, k, \xi)} D_\xi^\alpha \partial_t \widehat{g}(t, k, \xi) \, d\xi}_{:=I(\alpha)},$$

we fix  $\alpha \in \mathbb{N}^d$ ,  $|\alpha| \leq P$  and estimate  $I(\alpha)$ . Let us write

$$\begin{aligned} D_\xi^\alpha \partial_t \widehat{g}(t, k, \xi) &= D_\xi^\alpha \widehat{\mathcal{N}}(g)(t, k, \xi) \\ &= - \sum_{n \in \mathbb{Z}^d} n \widehat{\sigma}_1(n) \left( \widehat{\mathcal{F}}_I(t, n) - \widehat{\sigma}_1(n) \widehat{\mathcal{G}}_\rho(t, n) \right) \cdot D_\xi^\alpha (\xi \mapsto (\xi - tk) \widehat{g}(t, k - n, \xi - tk)). \end{aligned}$$

Using the specific structure of the Vlasov-Wave system through (A.5) with

$$f = \mathcal{F}^{-1} \left( (k, \xi) \mapsto \langle k, \xi \rangle^\sigma e^{\lambda(t)\langle k, \xi \rangle} \widehat{g}(t, k, \xi) \right)$$

leads to

$$\begin{aligned} I(\alpha) &= \sum_{k,n \in \mathbb{Z}^d} \int_{\mathbb{R}^d} \langle k, \xi \rangle^\sigma e^{\lambda(t)\langle k, \xi \rangle} D_\xi^\alpha \overline{\widehat{g}(t, k, \xi)} \left( \langle k, \xi \rangle^\sigma e^{\lambda(t)\langle k, \xi \rangle} - \langle k - n, \xi - tn \rangle^\sigma e^{\lambda(t)\langle k - n, \xi - tn \rangle} \right) \\ &\quad \times n \widehat{\sigma}_1(n) \left( \widehat{\mathcal{F}}_I(t, n) - \widehat{\sigma}_1(n) \widehat{\mathcal{G}}_\rho(t, n) \right) \cdot D_\xi^\alpha (\xi \mapsto (\xi - tk) \widehat{g}(t, k - n, \xi - tn)) \, d\xi. \end{aligned}$$

Next, we apply the following statement

$$\begin{aligned} &\left| \langle k, \xi \rangle^\sigma e^{\lambda(t)\langle k, \xi \rangle} - \langle k - n, \xi - tn \rangle^\sigma e^{\lambda(t)\langle k - n, \xi - tn \rangle} \right| \\ &\leq c(\sigma) \langle n, tn \rangle \left( \langle n, tn \rangle^{\sigma-1} + \langle k - n, \xi - tn \rangle^{\sigma-1} \right) \\ &\quad + \lambda(t) [\langle n, tn \rangle^\sigma + \langle k - n, \xi - tn \rangle^\sigma] e^{\lambda(t)\langle n, tn \rangle} e^{\lambda(t)\langle k - n, \xi - tn \rangle}, \end{aligned}$$

which is nothing but (B.1) without any constrain on the leading frequency, combined with the basic inequality

$$e^{\lambda(t)\langle k, \xi \rangle} \leq 1 + \lambda(t) \langle k, \xi \rangle e^{\lambda(t)\langle k, \xi \rangle}. \tag{B.6}$$

We also apply (B.6) to the first exponential weight of  $I(\alpha)$  in order to get

$$\begin{aligned} & \langle k, \xi \rangle^\sigma e^{\lambda(t)\langle k, \xi \rangle} \left| \langle k, \xi \rangle^\sigma e^{\lambda(t)\langle k, \xi \rangle} - \langle k - n, \xi - tn \rangle^\sigma e^{\lambda(t)\langle k - n, \xi - tn \rangle} \right| \\ & \lesssim \left( \langle k, \xi \rangle^\sigma + \lambda(t)\langle k, \xi \rangle^{\sigma+1} e^{\lambda(t)\langle k, \xi \rangle} \right) \langle n, tn \rangle (\langle n, tn \rangle^{\sigma-1} + \langle k - n, \xi - tn \rangle^{\sigma-1}) \\ & \quad + \lambda(t)\langle k, \xi \rangle^\sigma e^{\lambda(t)\langle k, \xi \rangle} \langle n, tn \rangle (\langle n, tn \rangle^\sigma + \langle k - n, \xi - tn \rangle^\sigma) e^{\lambda(t)\langle n, tn \rangle} e^{\lambda(t)\langle k - n, \xi - tn \rangle}, \end{aligned}$$

which can be recast as follow:

$$\begin{aligned} & \langle k, \xi \rangle^\sigma e^{\lambda(t)\langle k, \xi \rangle} \left| \langle k, \xi \rangle^\sigma e^{\lambda(t)\langle k, \xi \rangle} - \langle k - n, \xi - tn \rangle^\sigma e^{\lambda(t)\langle k - n, \xi - tn \rangle} \right| \\ & \lesssim \langle k, \xi \rangle^\sigma \langle n, tn \rangle (\langle n, tn \rangle^{\sigma-1} + \langle k - n, \xi - tn \rangle^{\sigma-1}) \\ & \quad + \lambda(t)\langle k, \xi \rangle^{\sigma+\frac{1}{2}} e^{\lambda(t)\langle k, \xi \rangle} \langle n, tn \rangle \left( \langle n, tn \rangle^{\sigma-\frac{1}{2}} \langle k - n, \xi - tn \rangle^{\frac{1}{2}} \right. \\ & \quad \left. + \langle n, tn \rangle^{\frac{1}{2}} \langle k - n, \xi - tn \rangle^{\sigma-\frac{1}{2}} \right) e^{\lambda(t)\langle n, tn \rangle} e^{\lambda(t)\langle k - n, \xi - tn \rangle}. \quad (\text{B.7}) \end{aligned}$$

We can thus decompose  $I(\alpha)$  as follow, depending on the weight coming from (B.7)

$$I(\alpha) \lesssim I_1(\alpha) + I_2(\alpha) + \lambda(t)(I_3(\alpha) + I_4(\alpha)).$$

Since

$$\left| D_\xi^\alpha (\xi \mapsto (\xi - tk)\widehat{g}(t, k - n, \xi - tn)) \right| \lesssim \langle t \rangle \langle k - n, \xi - tn \rangle \sum_{\substack{\beta \in \mathbb{N}^d \\ |\beta| \leq P}} \left| D_\xi^\beta \widehat{g}(t, k - n, \xi - tn) \right|,$$

there is no polynomial weight with a power larger than  $\sigma$  in  $I_1(\alpha)$  and  $I_2(\alpha)$  and there is no polynomial weight with a power larger than  $\sigma + 1/2$  in  $I_3(\alpha)$  and  $I_4(\alpha)$ . Hence, applying Lemma B.3.6, Proposition 2.4.2, the injection property (2.50) (or a straightforward modifications when there is no exponential weight) and summing over  $\alpha$  leads to

$$\begin{aligned} \langle g(t), \partial_t g(t) \rangle_{\mathcal{G}_P^{\lambda(t), \sigma; 1}} & \lesssim \langle t \rangle \left( \mathcal{E}_I + \int_0^t \|g(\tau)\|_{H_P^\sigma}^2 d\tau \right)^{1/2} \|g(t)\|_{H_P^\sigma}^2 \\ & \quad + \lambda(t)\langle t \rangle \left( \mathcal{E}_I + \int_0^t \|g(\tau)\|_{\mathcal{G}_P^{\lambda(\tau), \sigma; 1}}^2 d\tau \right)^{1/2} \|g(t)\|_{\mathcal{G}_P^{\lambda(t), \sigma + \frac{1}{2}; 1}}^2 \\ & \quad + \lambda(t)\langle t \rangle \left( \mathcal{E}_I + \int_0^t \|g(\tau)\|_{\mathcal{G}_P^{\lambda(\tau), \sigma + \frac{1}{2}; 1}}^2 d\tau \right)^{1/2} \|g(t)\|_{\mathcal{G}_P^{\lambda(t), \sigma + \frac{1}{2}; 1}} \|g(t)\|_{\mathcal{G}_P^{\lambda(t), \sigma; 1}}. \end{aligned}$$

The last term does not get a good form since it is not possible to factorize it by

$$\|g(t)\|_{\mathcal{G}_P^{\lambda(t), \sigma + \frac{1}{2}; 1}}^2.$$

This difficulty is specific to the Vlasov-Wave case and comes from the half convolution in time with the kernel  $p_c$ . A simple idea to avoid this difficulty is to come back to (B.7) and treat in a different way the term with the weight  $\langle n, tn \rangle^{\sigma+1/2}$ . In order to gain a factor  $\langle n, tn \rangle^{1/2}$  in this term we just apply the rough estimate

$$\langle n, tn \rangle^{\frac{1}{2}} \leq \langle n \rangle^{\frac{1}{2}} \langle t \rangle^{\frac{1}{2}}.$$

Then, thanks to the natural smoothness of the form function  $\sigma_1$ , the extra factor  $\langle n \rangle^{1/2}$  can be easily controlled and the only price to pay is to get an estimation with a faster growth



in  $\langle t \rangle$ . At the end of the day, these minor modifications lead to the announced estimation

$$\begin{aligned} \langle g(t), \partial_t g(t) \rangle_{\mathcal{G}_P^{\lambda(t), \sigma; 1}} &\lesssim \langle t \rangle \left( \mathcal{E}_I + \int_0^t \|g(\tau)\|_{H_P^\sigma}^2 d\tau \right)^{1/2} \|g(t)\|_{H_P^\sigma}^2 \\ &\quad + \lambda(t) \langle t \rangle^{3/2} \left( \mathcal{E}_I + \int_0^t \|g(\tau)\|_{\mathcal{G}_P^{\lambda(\tau), \sigma; 1}}^2 d\tau \right)^{1/2} \|g(t)\|_{\mathcal{G}_P^{\lambda(t), \sigma + \frac{1}{2}; 1}}^2. \end{aligned}$$

■

**Remark B.3.7** We saw in the proof that the extra factor  $\langle t \rangle^{1/2}$  compared to the pure Vlasov case comes from the term

$$\lambda(t) \langle t \rangle \left( \mathcal{E}_I + \int_0^t \|g(\tau)\|_{\mathcal{G}_P^{\lambda(\tau), \sigma + \frac{1}{2}; 1}}^2 d\tau \right)^{1/2} \|g(t)\|_{\mathcal{G}_P^{\lambda(t), \sigma + \frac{1}{2}; 1}} \|g(t)\|_{\mathcal{G}_P^{\lambda(t), \sigma; 1}}$$

for which it is not possible to factorize by the square of the  $\mathcal{G}_P^{\lambda(t), \sigma + 1/2; 1}$ -norm of  $g$ . To be able to factorize by this term is important: the only terms for which such a factorization does not apply should not contain norms of  $g$  higher than  $H_P^\sigma$ . In the case of the proof of Proposition 2.4.12 this is no more mandatory since we can also use the a priori estimates (2.57a)–(2.57c). To be more specific, following [12], the term evolving the spatial density  $\rho$  is never estimated through the embedding property (2.50) but always with the estimate (2.58d) of Proposition 2.4.12. In the Vlasov-Wave case the force term can be estimated (pointwise in time) by (2.57c) since we have (2.53a) and the sequel of the proof is the same than in [12]. In particular the half convolution with the kernel  $p_c$  does not provide larger polynomial growth in time in the bootstrap statement.

**Proof of Proposition B.3.1.** We wish to apply Lemma B.3.3. However, the function  $g$  does not satisfy the required assumptions; we thus need to introduce a regularization

$$g_\varepsilon(t) = \chi_\varepsilon \star g(t) \quad \text{with} \quad \widehat{\chi}_\varepsilon(k, \xi) = e^{-\varepsilon|k, \xi|^2},$$

so that, for any  $\lambda > 0$ ,  $g_\varepsilon(t) \in \mathcal{G}_P^{\lambda, \sigma + 1/2; 1}$ . We still cannot apply Lemma B.3.3 to  $g_\varepsilon$  since  $g_\varepsilon$  is not a solution of (B.2). Nevertheless, we can write

$$\frac{1}{2} \frac{d}{dt} \|g_\varepsilon(t)\|_{\mathcal{G}_P^{\lambda(t), \sigma; 1}}^2 = \left( \frac{d}{dt} \lambda(t) \right) \|g_\varepsilon(t)\|_{\mathcal{G}_P^{\lambda(t), \sigma + 1/2; 1}}^2 + \langle g_\varepsilon(t), \partial_t g_\varepsilon \rangle.$$

Next,  $\partial_t g_\varepsilon$  can be cast as

$$\begin{aligned} \partial_t \widehat{g}_\varepsilon(t, k, \xi) &= \widehat{\chi}(k, \xi) \partial_t \widehat{g}(t, k, \xi) \\ &= - \sum_{n \in \mathbb{Z}^d} \frac{\widehat{\chi}(k, \xi)}{\widehat{\chi}(n, tn) \widehat{\chi}(k - n, \xi - tn)} n \widehat{\sigma}_1(n) \left( \widehat{\chi}(n, tn) \widehat{\mathcal{F}}_I(t, n) - \widehat{\chi}(n, tn) \widehat{\sigma}_1(n) \widehat{\mathcal{G}}_\rho(t, n) \right) \\ &\quad \cdot (\xi - tk) \widehat{\chi}(k - n, \xi - tn) \widehat{g}(t, k - n, \xi - tn) \\ &= - \sum_{n \in \mathbb{Z}^d} \frac{\widehat{\chi}(k, \xi)}{\widehat{\chi}(n, tn) \widehat{\chi}(k - n, \xi - tn)} n \widehat{\sigma}_1(n) \left( \widehat{\chi}(n, tn) \widehat{\mathcal{F}}_I(t, n) \right. \\ &\quad \left. - \widehat{\sigma}_1(n) \int_0^t \frac{\widehat{\chi}(n, tn)}{\widehat{\chi}(n, \tau n)} p_c(t - \tau) \widehat{\varrho}_\varepsilon(\tau, n) d\tau \right) \cdot (\xi - tk) \widehat{g}_\varepsilon(t, k - n, \xi - tn). \end{aligned}$$

Remarking that

$$\widehat{\chi}(k, \xi) \leq 1, \quad \frac{\widehat{\chi}(k, tk)}{\widehat{\chi}(k, \tau k)} \leq 1 \quad \text{and} \quad \frac{\widehat{\chi}(k + n, \xi + \zeta)}{\widehat{\chi}(k, \xi) \widehat{\chi}(n, \zeta)} \leq 1$$

holds, we go back to the proof of Lemma B.3.3 and we conclude that

$$\begin{aligned} \frac{1}{2} \frac{d}{dt} \|g_\varepsilon(t)\|_{\mathcal{G}_P^{\lambda(t),\sigma;1}}^2 &\leq \left(\frac{d}{dt} \lambda(t)\right) \|g_\varepsilon(t)\|_{\mathcal{G}_P^{\lambda(t),\sigma+\frac{1}{2};1}}^2 \\ &\quad + \lambda(t) C_1 \langle t \rangle^{3/2} \left( \mathcal{E}_I + \int_0^t \|g_\varepsilon(\tau)\|_{\mathcal{G}_P^{\lambda(\tau),\sigma;1}}^2 d\tau \right)^{1/2} \|g_\varepsilon(t)\|_{\mathcal{G}_P^{\lambda(t),\sigma+\frac{1}{2};1}}^2 + \theta_\varepsilon(t) \end{aligned}$$

holds with

$$\theta_\varepsilon(t) = C \langle t \rangle \left( \mathcal{E}_I + \int_0^t \|g_\varepsilon(\tau)\|_{H_P^\sigma}^2 d\tau \right)^{1/2} \|g_\varepsilon(t)\|_{H_P^\sigma}^2$$

where the constants  $C_1$  and  $C$  do not depend on  $\varepsilon$ . Let us introduce the function

$$Y_\varepsilon(t) = \|g_\varepsilon(0)\|_{\mathcal{G}_P^{\lambda_0,\sigma;1}}^2 + 1 + 2 \int_0^t \theta_\varepsilon(\tau) d\tau.$$

We apply Lemma B.3.3 to  $g_\varepsilon$  with  $\lambda(t) = \lambda_\varepsilon(t)$  defined by

$$\lambda_\varepsilon(t) = \lambda_0 \exp \left( - \int_0^t C_1 \langle \tau \rangle^{3/2} \left( \mathcal{E}_I + \int_0^\tau Y_\varepsilon(s) ds \right)^{1/2} d\tau \right).$$

We are led to

$$\begin{aligned} &\frac{1}{2} \frac{d}{dt} \left( \|g_\varepsilon(t)\|_{\mathcal{G}_P^{\lambda_\varepsilon(t),\sigma;1}}^2 - Y_\varepsilon(t) \right) \\ &\leq C_1 \langle t \rangle^{3/2} \lambda_\varepsilon(t) \left[ \left( \mathcal{E}_I + \int_0^t \|g(\tau)\|_{\mathcal{G}_P^{\lambda_\varepsilon(\tau),\sigma;1}}^2 d\tau \right)^{1/2} - \left( \mathcal{E}_I + \int_0^t Y_\varepsilon(\tau) d\tau \right)^{1/2} \right] \|g_\varepsilon(t)\|_{\mathcal{G}_P^{\lambda_\varepsilon(t),\sigma+\frac{1}{2};1}}^2 \\ &\leq \frac{C_1 \langle t \rangle^{3/2}}{2\sqrt{\mathcal{E}_I}} \lambda_\varepsilon(t) \left[ \int_0^t \left( \|g(\tau)\|_{\mathcal{G}_P^{\lambda_\varepsilon(\tau),\sigma;1}}^2 - Y_\varepsilon(\tau) \right) d\tau \right] \|g_\varepsilon(t)\|_{\mathcal{G}_P^{\lambda_\varepsilon(t),\sigma+\frac{1}{2};1}}^2. \end{aligned}$$

Since

$$\|g_\varepsilon(0)\|_{\mathcal{G}_P^{\lambda_\varepsilon(0),\sigma;1}}^2 - Y_\varepsilon(0) = -1 < 0 \quad \text{and} \quad \frac{d}{dt} \left( \|g_\varepsilon(t)\|_{\mathcal{G}_P^{\lambda_\varepsilon(t),\sigma;1}}^2 - Y_\varepsilon(t) \right) \Big|_{t=0} < 0,$$

it is now possible to check that for every  $t \in [0, T)$

$$\|g_\varepsilon(t)\|_{\mathcal{G}_P^{\lambda_\varepsilon(t),\sigma;1}}^2 \leq Y_\varepsilon(t).$$

We conclude by observing that

$$\theta_\varepsilon(t) \xrightarrow{\varepsilon \rightarrow 0^+} \theta(t) = C \langle t \rangle \left( \mathcal{E}_I + \int_0^t \|g(\tau)\|_{H_P^\sigma}^2 d\tau \right)^{1/2} \|g(t)\|_{H_P^\sigma}^2, \tag{B.8a}$$

$$Y_\varepsilon(t) \xrightarrow{\varepsilon \rightarrow 0^+} Y(t) = \|g(0)\|_{\mathcal{G}_P^{\lambda_0,\sigma;1}}^2 + 1 + 2 \int_0^t \theta(\tau) d\tau, \tag{B.8b}$$

$$\lambda_\varepsilon(t) \xrightarrow{\varepsilon \rightarrow 0^+} \lambda(t) = \lambda_0 \exp \left( - \int_0^t C_1 \langle \tau \rangle^{3/2} \left( \mathcal{E}_I + \int_0^\tau Y(s) ds \right)^{1/2} d\tau \right). \tag{B.8c}$$

By applying Fatou's lemma we finally obtain

$$\|g(t)\|_{\mathcal{G}_P^{\lambda(t),\sigma;1}}^2 \leq \liminf_{\varepsilon \rightarrow 0^+} \|g_\varepsilon(t)\|_{\mathcal{G}_P^{\lambda_\varepsilon(t),\sigma;1}}^2 \leq \liminf_{\varepsilon \rightarrow 0^+} Y_\varepsilon(t) = Y(t).$$

■



---

Cauchy theory for the Schrödinger-Wave system

---

In this Appendix we go back to the Cauchy theory of the Schrödinger-wave system (4.1a)–(4.1b). We introduced this system in Chapter 4 where we stated a theorem of uniqueness and global existence. From an energetic point of view, the natural functional spaces for the Cauchy theory are  $C^0([0, T], H^1(\mathbb{R}_x^d))$  for the wave function  $u$  and

$$\mathcal{E}_T = C^0\left([0, T]; L^2\left(\mathbb{R}_x^d; \dot{H}^1(\mathbb{R}_z^n)\right)\right) \cap C^1\left([0, T]; L^2\left(\mathbb{R}_x^d; L^2(\mathbb{R}_z^n)\right)\right)$$

for the vibrational environment  $\psi$ . We are going to prove the global existence with Cauchy data (4.2), in these spaces, see Theorem 4.1.1. Throughout this appendix, we work, without loss of generality, with  $c = 1$  and we assume **(H1)**–**(H2)** from Chapter 4.

The proof of this theorem is quite classical: the most important part consists in applying Strichartz’ estimates to the Schrödinger and the wave equation. In fact the main difficulty comes from the fact that Strichartz’ estimates for (4.1a) lead to estimates of  $u$  in  $L_t^q L_x^r$  norms whereas Strichartz’ estimates for (4.1b) lead to estimates of  $\psi$  in  $L_x^r L_t^q L_z^p$  norms. In order to combine these two estimates of different type, we need to permute Lebesgue-norms in time and space. For that purpose we will use Hölder and Young inequalities (and the fact that  $\sigma_1$  and  $\sigma_2$  are in any  $L^p$  space for  $1 \leq p \leq +\infty$ ) in order to work with  $L_t^q L_x^q$  norms.

Let us introduce some notation that we will use until the end of this section. First we denote by  $S$  the linear Schrödinger’s group and by  $(W, \dot{W})$  the free wave group: for any  $u_0 \in L^2(\mathbb{R}_x^d)$ ,  $S(t)u_0$  is the unique solution at time  $t$  of

$$\begin{cases} i\partial_t u + \Delta_x u = 0 \\ u(0, x) = u_0(x) \end{cases}$$

and for any  $(\psi_0, \psi_1) \in L^2(\mathbb{R}_x^d; \dot{H}^1(\mathbb{R}_z^n)) \times L^2(\mathbb{R}_x^d; L^2(\mathbb{R}_z^n))$ ,  $\dot{W}(t)\psi_0 + W(t)\psi_1$  is the unique solution at time  $t$  of

$$\begin{cases} \partial_{tt}^2 \psi - \Delta_z \psi = 0 \\ (\psi(0, x, z), \partial_t \psi(0, x, z)) = (\psi_0(x, z), \psi_1(x, z)) \end{cases}$$

With these notation we can now define (at least formally) the functions  $\mathcal{L}$ ,  $\mathcal{K}$  and  $\Phi$  by

$$\begin{cases} \mathcal{L}(u, \psi) : t \mapsto S(t)u_0 + \int_0^t S(t-s) \left[ \left( \sigma_1 \star_x \int \sigma_2 \psi(s) dz \right) u(s) \right] ds \\ \mathcal{K}(u, \psi) : t \mapsto \dot{W}(t)\psi_0 + W(t)\psi_1 + \int_0^t W(t-s) \left[ -\sigma_2 \sigma_1 \star_x |u(s)|^2 \right] ds \\ \Phi = (\mathcal{L}, \mathcal{K}) \end{cases}$$

where  $u_0 \in H^1(\mathbb{R}_x^d)$  and  $(\psi_0, \psi_1) \in L^2(\mathbb{R}_x^d; \dot{H}^1(\mathbb{R}_z^n)) \times L^2(\mathbb{R}_x^d; L^2(\mathbb{R}_z^n))$  are now fixed until the end of this section. From here it is obvious that any fixed point  $(u, \psi)$  of  $\Phi$  defines a solution of (4.1a)–(4.1b) and (4.2). In order to apply the Banach-Picard fixed point theorem we have to specify on which space we define the function  $\Phi$ . As already mentioned, since we wish to apply Strichartz estimates, we need that  $\Phi$  is defined on a well adapted space for this approach. We introduce the following notations and spaces for that purpose. First let us define the Lebesgue exponent  $p_0$  by

$$p_0 = \frac{2n}{n-2}. \tag{C.1}$$

Then, for any final time  $T > 0$  we introduce the following Banach spaces:  $X_T = L^\infty(0, T; H^1(\mathbb{R}_x^d))$ ,  $Y_T = L^2(\mathbb{R}_x^d; L^\infty(0, T; L^{p_0}(\mathbb{R}_z^n)))$  and  $Z_T = X_T \times Y_T$  endowed with the norm  $\|u, \psi\|_{Z_T} = \|u\|_{X_T} + \|\psi\|_{Y_T}$ .

We introduce these spaces because  $(\infty, 2)$  is a *Schrödinger-admissible* pair and  $(\infty, p_0)$  is a *wave-admissible* pair for  $n \geq 3$ . Let us briefly recall what are the definition of Schrödinger and wave-admissible pairs and what are Strichartz' estimates (we follow [60] and the interested reader can find further information about Strichartz' estimates in [46] and the references therein).

**Definition C.0.1** *i) We say that the exponent pair  $(q, r)$  is Schrödinger-admissible if  $d \geq 1$ ,  $q, r \geq 2$ ,  $(q, r, d) \neq (2, \infty, 2)$  and*

$$\frac{1}{q} + \frac{d}{2r} = \frac{d}{4}.$$

*ii) We say that the exponent pair  $(q, p)$  is wave-admissible if  $n \geq 2$ ,  $q, p \geq 2$ ,  $(q, p, n) \neq (2, \infty, 3)$  and*

$$\frac{1}{q} + \frac{n-1}{2p} \leq \frac{n-1}{4}.$$

From now on for any exponent  $a \geq 1$ ,  $a'$  will denote its conjugate exponent:  $1/a + 1/a' = 1$ .

**Proposition C.0.2 (Strichartz estimates)** *i) Let  $(q, r)$  and  $(\bar{q}, \bar{r})$  be Schrödinger - admissible pairs,  $u_0 \in L^2(\mathbb{R}_x^d)$ ,  $F \in L^{\bar{q}}(0, T; L^{\bar{r}'}(\mathbb{R}_x^d))$  and let us denoted by  $u$  the unique solution of  $i\partial_t u + \Delta_x u = F$  with initial data  $u_0$ . Then there exists a constant  $C > 0$  independent of  $T$  such that*

$$\|u\|_{L_t^q L_x^r} \leq C \left( \|u_0\|_{L_x^2} + \|F\|_{L_t^{\bar{q}'} L_x^{\bar{r}'}} \right) \tag{C.2}$$

*ii) Let  $(q, p)$  and  $(\bar{q}, \bar{p})$  be wave-admissible pairs with  $p, \bar{p} < +\infty$ ,  $(\psi_0, \psi_1) \in \dot{H}^s(\mathbb{R}_z^n) \times \dot{H}^{s-1}(\mathbb{R}_z^n)$ ,  $G \in L^{\bar{q}}(0, T; L^{\bar{p}'}(\mathbb{R}_z^n))$  and let us denoted by  $\psi$  the unique solution of  $\partial_{tt}^2 \psi - \Delta_z \psi = G$  with initial data  $(\psi_0, \psi_1)$ . Then, under the additional condition*

$$\frac{1}{q} + \frac{n}{p} = \frac{n}{2} - s = \frac{1}{\bar{q}'} + \frac{n}{\bar{p}'} - 2, \tag{C.3}$$

there exists a constant  $K > 0$  independent of  $T$  such that

$$\|\psi\|_{L_t^q L_z^p} + \|\psi\|_{L_t^\infty \dot{H}_z^s} + \|\partial_t \psi\|_{L_t^\infty \dot{H}_z^{s-1}} \leq K \left( \|\psi_0\|_{\dot{H}_z^s} + \|\psi_1\|_{\dot{H}_z^{s-1}} + \|G\|_{L_t^{q'} L_z^{p'}} \right) \quad (\text{C.4})$$

**Remark C.0.3** We will apply (C.4) with the Sobolev regularity  $s = 1$ . With this regularity the exponent pairs  $(q, p) = (\infty, p_0)$  and  $(\infty, 2)$  are wave-admissible and satisfies the additional condition (C.3).

The following two Lemma justify that the application  $\Phi$  is well defined on  $Z_T$ , sends  $Z_T$  into itself and admits a fixed point on it.

**Lemma C.0.4** There exists a constant  $C > 0$  independent of  $T$  such that

$$\|\mathcal{L}(u, \psi)\|_{L_t^\infty L_x^2} \leq C \left( \|u_0\|_{L_x^2} + |T| \|\psi\|_{Y_T} \|u\|_{L_t^\infty L_x^2} \right), \quad (\text{C.5a})$$

$$\|\nabla_x \mathcal{L}(u, \psi)\|_{L_t^\infty L_x^2} \leq C \left( \|\nabla_x u_0\|_{L_x^2} + |T| \|\psi\|_{Y_T} \left[ \|u\|_{L_t^\infty L_x^2} + \|\nabla_x u\|_{L_t^\infty L_x^2} \right] \right), \quad (\text{C.5b})$$

$$\begin{aligned} \|\mathcal{K}(u, \psi)\|_{Y_T} + \|\psi\|_{L_x^2 L_t^\infty \dot{H}_z^1} + \|\partial_t \psi\|_{L_x^2 L_t^\infty L_z^2} \\ \leq C \left( \|\psi_0\|_{L_x^2 \dot{H}_z^1} + \|\psi_1\|_{L_x^2 L_z^2} + |T| \|u\|_{L_t^\infty L_x^2}^2 \right), \end{aligned} \quad (\text{C.5c})$$

and

$$\|\mathcal{L}(u, \psi) - \mathcal{L}(v, \varphi)\|_{L_t^\infty L_x^2} \leq C |T| \left( \|\psi\|_{Y_T} \|u - v\|_{L_t^\infty L_x^2} + \|\psi - \varphi\|_{Y_T} \|v\|_{L_t^\infty L_x^2} \right), \quad (\text{C.6a})$$

$$\begin{aligned} \|\nabla_x (\mathcal{L}(u, \psi) - \mathcal{L}(v, \varphi))\|_{L_t^\infty L_x^2} \leq C |T| \left( \|\psi\|_{Y_T} \left[ \|u - v\|_{L_t^\infty L_x^2} + \|\nabla_x (u - v)\|_{L_t^\infty L_x^2} \right] \right. \\ \left. + \|\psi - \varphi\|_{Y_T} \left[ \|v\|_{L_t^\infty L_x^2} + \|\nabla_x v\|_{L_t^\infty L_x^2} \right] \right) \end{aligned} \quad (\text{C.6b})$$

$$\|\mathcal{K}(u, \psi) - \mathcal{K}(v, \varphi)\|_{Y_T} \leq C |T| \left( \|u\|_{L_t^\infty L_x^2} + \|v\|_{L_t^\infty L_x^2} \right) \|u - v\|_{L_t^\infty L_x^2}. \quad (\text{C.6c})$$

**Lemma C.0.5** There exists a universal constant  $C_1 > 0$  such that for any final time  $T > 0$  small enough,  $\Phi : B_T \rightarrow B_T$ , where

$$B_T = \left\{ (u, \psi) \in Z_T : \|u, \psi\|_{Z_T} \leq C_1 (\|u_0\|_{H_x^1} + \|\psi_0\|_{L_x^2 \dot{H}_z^1} + \|\psi_1\|_{L_x^2 L_z^2}) \right\}.$$

Moreover, considering smaller  $T$  if necessary,  $\Phi$  is indeed a contraction on  $B_T$ .

We postpone the proof of Lemma C.0.4 to the end of this Appendix and we start by proving Lemma C.0.5 and Theorem 4.1.1.

**Proof of Lemma C.0.5.** We can summarize the estimates (C.5a)–(C.5c) as follows:

$$\|\Phi(u, \psi)\|_{Z_T} \leq C \left[ \|u_0\|_{H_x^1} + \|\psi_0\|_{L_x^2 \dot{H}_z^1} + \|\psi_1\|_{L_x^2 L_z^2} + |T| \|u, \psi\|_{Z_T}^2 \right].$$

Next, let  $C_1 = 2C$ ; we thus obtain that for any  $(u, \psi) \in B_T$ ,

$$\begin{aligned} \|\Phi(u, \psi)\|_{Z_T} \leq C \left[ 1 + C_1^2 |T| \left( \|u_0\|_{H_x^1} + \|\psi_0\|_{L_x^2 \dot{H}_z^1} + \|\psi_1\|_{L_x^2 L_z^2} \right) \right] \\ \times \left( \|u_0\|_{H_x^1} + \|\psi_0\|_{L_x^2 \dot{H}_z^1} + \|\psi_1\|_{L_x^2 L_z^2} \right). \end{aligned}$$

Since for  $T$  small enough,

$$C_1^2 |T| \left( \|u_0\|_{H_x^1} + \|\psi_0\|_{L_x^2 \dot{H}_z^1} + \|\psi_1\|_{L_x^2 L_z^2} \right) < 1,$$

we obtain that  $\Phi$  sends  $B_T$  into  $B_T$  for  $T$  small enough. As previously, we can recast (C.6a)–(C.6c) as follows:

$$\|\Phi(u, \psi) - \Phi(v, \phi)\|_{Z_T} \leq C |T| (\|(u, \psi)\|_{Z_T} + \|(v, \phi)\|_{Z_T}) \|(u, \psi) - (v, \phi)\|_{Z_T}.$$

Therefore, for any  $(u, \psi), (v, \phi) \in B_T$ ,

$$\|\Phi(u, \psi) - \Phi(v, \phi)\|_{Z_T} \leq 2C C_1 \left( \|u_0\|_{H_x^1} + \|\psi_0\|_{L_x^2 \dot{H}_z^1} + \|\psi_1\|_{L_x^2 L_z^2} \right) |T| \|(u, \psi) - (v, \phi)\|_{Z_T},$$

holds and  $\Phi$  is a contraction as soon as  $T$  is small enough. ■

**Proof of Theorem 4.1.1. Step 1: Local existence.** For  $T$  small enough  $\Phi$  is a contraction on  $B_T$ , we thus know that (4.1a)–(4.1b) has a solution in  $Z_T$ . Then it is clear that for any solution  $(u, \psi) \in Z_T$  of (4.1a)–(4.1b),  $u \in L^\infty(0, T; H^1(\mathbb{R}^d_x))$ ,  $\psi \in L^2(\mathbb{R}^d_x; L^\infty(0, T; \dot{H}^1(\mathbb{R}^n_z)))$  and  $\partial_t \psi \in L^2(\mathbb{R}^d_x; L^\infty(0, T; L^2(\mathbb{R}^n_z)))$  (for  $\psi$  it comes from the Strichartz estimate (C.5c)). Moreover, using the fact that  $(u, \psi)$  is a fixed point of  $\Phi$  and the expressions of  $\mathcal{L}$  and  $\mathcal{K}$  in terms of  $S$  and  $(W, \dot{W})$ , one can prove that indeed  $u \in C^0([0, T]; H^1(\mathbb{R}^d_x))$ , for almost every  $x \in \mathbb{R}^d$ ,  $(t, z) \mapsto \psi(t, x, z) \in C^0([0, T]; \dot{H}^1(\mathbb{R}^n_z))$  and  $(t, z) \mapsto \partial_t \psi(t, x, z) \in C^0([0, T]; L^2(\mathbb{R}^n_z))$ . We finish the proof by applying the following lemma (proved at the end of this section) to  $\psi$  and  $\partial_t \psi$  in order to obtain that  $\psi \in \mathcal{E}_T$ .

**Lemma C.0.6** *If  $f \in L_x^2 L_t^\infty$  and for almost every  $x \in \mathbb{R}^d$ ,  $t \mapsto f(t, x) \in C^0([0, T])$ , then  $f \in C^0([0, T]; L^2(\mathbb{R}^d_x))$ .*

**Step 2: Uniqueness.** The uniqueness in  $B_T$  comes from the fixed point theorem and we can extend this uniqueness statement to the entire space  $Z_T$ . Then the uniqueness in  $C_t^0 H_x^1 \times \mathcal{E}_T$  comes from the fact that any fixed point  $(u, \psi) \in C_t^0 H_x^1 \times \mathcal{E}_T$  of  $\Phi$  is also an element of  $Z_T$  (thanks to the estimate (C.5c), we get that  $\psi$  is in  $Y_T$ ).

**Step 3: Global existence.** Since the time  $T$  in Lemma C.0.5 depends only on universal constants and on

$$\|u_0\|_{H_x^1} + \|\psi_0\|_{L_x^2 \dot{H}_z^1} + \|\psi_1\|_{L_x^2 L_z^2},$$

the first two steps of this proof allow us to obtain the following proposition.

**Proposition C.0.7** *Let  $n \geq 3$ . Then for any  $u_0 \in H^1(\mathbb{R}^d_x)$  and  $(\psi_0, \psi_1) \in L^2(\mathbb{R}^d_x; \dot{H}^1(\mathbb{R}^n_z)) \times L^2(\mathbb{R}^d_x; L^2(\mathbb{R}^n_z))$ , there exists  $T^* > 0$  such that for any  $0 < T < T^*$ , the problem (4.1a)–(4.1b) and (4.2) admits a unique solution  $(u, \psi) \in C^0([0, T]; H^1(\mathbb{R}^d_x)) \times \mathcal{E}_T$  on  $[0, T]$ . Moreover, if for some  $0 < T \leq T^*$ ,*

$$\limsup_{t \nearrow T} \|u(t)\|_{H_x^1} + \|\psi(t)\|_{L_x^2 \dot{H}_z^1} + \|\partial_t \psi(t)\|_{L_x^2 L_z^2} < +\infty,$$

then, actually,  $T < T^*$ .

Then in order to obtain the global existence we have to justify that the quantity

$$\|u(t)\|_{H_x^1} + \|\psi(t)\|_{L_x^2 \dot{H}_z^1} + \|\partial_t \psi(t)\|_{L_x^2 L_z^2}$$

does not blow up in finite time. Thanks to the mass conservation of the wave function  $u$  ( $M = \|u(t)\|_{L_x^2}$  is constant in time) and thanks to (C.5c) we get

$$\|u(t)\|_{H_x^1} + \|\psi(t)\|_{L_x^2 \dot{H}_z^1} + \|\partial_t \psi(t)\|_{L_x^2 L_z^2} \lesssim M + \|\nabla_x u(t)\|_{L_x^2} + \|\psi_0\|_{L_x^2 \dot{H}_z^1} + \|\psi_1\|_{L_x^2 L_z^2} + |t|M,$$

and it only remains to control  $\|\nabla_x u(t)\|_{L_x^2}$ . For that purpose we use the energy conservation (4.14) in order to obtain

$$\frac{1}{2} \|\nabla_x u(t)\|_{L_x^2}^2 + \int \left( \sigma_1 \star \int \sigma_2 \psi(t) dz \right) |u(t)|^2 dx \leq \mathcal{E}_{\text{Schr}}(t) = \mathcal{E}_{\text{Schr}}(0).$$

Then if  $\|\nabla_x u(t)\|_{L_x^2}$  blows up in finite time,  $|\int(\sigma_1 \star \int \sigma_2 \psi(t) dz)|u(t)|^2 dx|$  has to blows up in finite time too. But

$$\begin{aligned} \left\| \int (\sigma_1 \star \int \sigma_2 \psi dz) |u|^2 dx \right\|_{L_t^\infty} &\leq M^2 \left\| \sigma_1 \star \int \sigma_2 \psi dz \right\|_{L_t^\infty L_x^\infty} \\ &= M^2 \left\| \sigma_1 \star \int \sigma_2 \psi dz \right\|_{L_x^\infty L_t^\infty} \leq M^2 \|\sigma_2\|_{L_z^{p'_0}} \left\| \sigma_1 \star \|\psi\|_{L_z^{p_0}} \right\|_{L_x^\infty L_t^\infty} \\ &\leq M^2 \|\sigma_2\|_{L_z^{p'_0}} \left\| \sigma_1 \star \|\psi\|_{L_t^\infty L_z^{p_0}} \right\|_{L_x^\infty} \leq M^2 \|\sigma_2\|_{L_z^{p'_0}} \|\sigma_1\|_{L_x^2} \|\psi\|_{L_x^2 L_t^\infty L_z^{p_0}}, \quad (\text{C.7}) \end{aligned}$$

and eventually estimate (C.5c) tells us that  $|\int(\sigma_1 \star \int \sigma_2 \psi(t) dz)|u(t)|^2 dx|$  grows at most linearly in time.  $\blacksquare$

**Remark C.0.8** *In fact the proof of the global existence gives us the additional information that the quantities  $\|\nabla_x u(t)\|_{L_x^2}$ ,  $\|\psi(t)\|_{L_x^2 \dot{H}_z^1} + \|\partial_t \psi(t)\|_{L_x^2 L_z^2}$  and  $|\int(\sigma_1 \star \int \sigma_2 \psi(t) dz)|u(t)|^2 dx|$  grow at most linearly in time.*

We finish this Appendix with the proofs of Lemma C.0.4 and Lemma C.0.6.

**Proof of Lemma C.0.4.** *Estimate (C.5a).* We apply apply the Strichartz estimate (C.2) to  $\mathcal{L}(u, \psi)$  with the Schrödinger-admissible pair  $(\infty, 2)$  on both side to obtain

$$\|\mathcal{L}(u, \psi)\|_{L_t^\infty L_x^2} \lesssim \|u_0\|_{L_x^2} + \left\| \left( \sigma_1 \star_x \int \sigma_2 \psi dz \right) u \right\|_{L_t^1 L_x^2}.$$

Then, thanks to the following estimate

$$\begin{aligned} \left\| \left( \sigma_1 \star_x \int \sigma_2 \psi dz \right) u \right\|_{L_t^1 L_x^2} &\leq |T| \left\| \left( \sigma_1 \star_x \int \sigma_2 \psi dz \right) u \right\|_{L_t^\infty L_x^2} \\ &\leq \left\| \sigma_1 \star_x \int \sigma_2 \psi dz \right\|_{L_t^\infty L_x^\infty} \|u\|_{L_t^\infty L_x^2}, \end{aligned}$$

and thanks to (C.7), we eventually obtain

$$\|\mathcal{L}(u, \psi)\|_{L_t^\infty L_x^2} \lesssim \|u_0\|_{L_x^2} + |T| \|\psi\|_{Y_T} \|u\|_{L_t^\infty L_x^2}.$$

*Estimate (C.5b).* Since

$$\begin{aligned} \nabla_x \mathcal{L}(u, \psi)(t) &= S(t) \nabla_x u_0 \\ &+ \int_0^t S(t-s) \left[ \left( \nabla_x \sigma_1 \star \int \sigma_2 \psi(s) dz \right) u(s) + \left( \sigma_1 \star \int \sigma_2 \psi(s) dz \right) \nabla_x u(s) \right] ds, \end{aligned}$$

we just apply the same estimates as before.

*Estimate (C.5c).* We apply for almost every  $x \in \mathbb{R}^d$  the Strichartz estimate (C.4) to  $\mathcal{K}(u, \psi)(x)$  with the wave-admissible pair  $(\infty, p_0)$  on the left hand side and  $(\infty, 2)$  on the right hand side

$$\begin{aligned} \|\mathcal{K}(u, \psi)(x)\|_{L_t^\infty L_z^{p_0}} + \|\psi(x)\|_{L_t^\infty \dot{H}_z^1} + \|\partial_t \psi(x)\|_{L_t^\infty L_z^2} \\ \lesssim \|\psi_0(x)\|_{\dot{H}_z^1} + \|\psi_1(x)\|_{L_z^2} + \left\| \sigma_2 \sigma_1 \star |u|^2(x) \right\|_{L_t^1 L_z^2}. \end{aligned}$$

Then, since

$$\left\| \sigma_2 \sigma_1 \star |u|^2(x) \right\|_{L_t^1 L_z^2} = \|\sigma_2\|_{L_z^2} \|\sigma_1 \star |u|^2(x)\|_{L_t^1} \leq \|\sigma_2\|_{L_z^2} \|\sigma_1\|_{L_t^1} \|u\|_{L_t^2}^2(x)$$



we can pass in  $L_x^2$ -norm to obtain

$$\left\| \sigma_2 \sigma_1 \star |u|^2 \right\|_{L_x^2 L_t^1 L_z^2} \leq \|\sigma_2\|_{L_z^2} \left\| |\sigma_1| \star \|u\|_{L_t^2}^2 \right\|_{L_x^2}.$$

Here, thanks to the Young inequality we have

$$\left\| |\sigma_1| \star \|u\|_{L_t^2}^2 \right\|_{L_x^2} \leq \|\sigma_1\|_{L_x^2} \left\| \|u\|_{L_t^2}^2 \right\|_{L_x^1} = \|\sigma_1\|_{L_x^2} \|u\|_{L_t^2 L_x^2}^2 \leq \|\sigma_1\|_{L_x^2} |T| \|u\|_{L_t^\infty L_x^2}^2,$$

and we eventually obtain

$$\|\mathcal{K}(u, \psi)\|_{L_x^2 L_t^\infty L_z^{p_0}} + \|\psi\|_{L_x^2 L_t^\infty \dot{H}_z^1} + \|\partial_t \psi\|_{L_x^2 L_t^\infty L_z^2} \lesssim \|\psi_0\|_{L_x^2 \dot{H}_z^1} + \|\psi_1\|_{L_x^2 L_z^2} + |T| \|u\|_{L_t^\infty L_x^2}^2.$$

**Estimates (C.6a), (C.6b) and (C.6c).** Since

$$\begin{aligned} & \mathcal{L}(u, \psi)(t) - \mathcal{L}(v, \varphi)(t) = \\ & \int_0^t S(t-s) \left[ \left( \sigma_1 \star_x \int \sigma_2 \psi(s) dz \right) (u(s) - v(s)) + \left( \sigma_1 \star_x \int \sigma_2 (\psi(s) - \varphi(s)) dz \right) v(s) \right] ds \end{aligned}$$

and

$$\begin{aligned} & \mathcal{K}(u, \psi)(t) - \mathcal{K}(v, \varphi)(t) = \\ & \int_0^t W(t-s) [-\sigma_2 \sigma_1 \star_x ([u(s) - v(s)] \bar{u}(s) + v(s)[\bar{u}(s) - \bar{v}(s)])] ds, \end{aligned}$$

we just follow closely the proof of (C.5a), (C.5b) and (C.5c). ■

**Proof of Lemma C.0.6.** Let us fix  $\varepsilon > 0$  and  $t \in [0, T]$ . We know that for all  $x \in \mathbb{R}^d$  and for all  $\eta > 0$ , there exists  $\delta(\eta, t, x) \geq 0$  such that if  $|t - s| \leq \delta(\eta, t, x)$ , then  $|f(t, x) - f(s, x)| \leq \eta$ . Note that in fact  $\delta(\eta, t, x)$  is positive for almost every  $x \in \mathbb{R}^d$ . Moreover, since  $f \in L_x^2 L_t^\infty$  we now that

$$\int_{\mathbb{R}^d} \mathbf{1}_{|x| \geq R} \|f(x)\|_{L_t^\infty}^2 dx \xrightarrow{R \rightarrow \infty} 0.$$

Let  $\delta > 0$ . Let us also introduce the following subset of  $\mathbb{R}_x^d$

$$B_{t,\delta}^{R,\eta} = \left\{ x \in \mathbb{R}^d \text{ such that } |x| \leq R \text{ and } \delta(\eta, t, x) \leq \delta \right\}.$$

Note that  $\text{meas}(B_{t,\delta}^{R,\eta}) \rightarrow 0$  when  $\delta \rightarrow 0$ . Then for all  $R, \eta, \delta > 0$  and for all  $s$  such that  $|t - s| \leq \delta$ ,

$$\begin{aligned} \|f(t) - f(s)\|_{L_x^2} & \leq \|\mathbf{1}_{|x| \geq R} (f(t) - f(s))\|_{L_x^2} + \|\mathbf{1}_{|x| \leq R} (f(t) - f(s))\|_{L_x^2} \\ & \leq 2 \|\mathbf{1}_{|x| \geq R} f\|_{L_x^2 L_t^\infty} + \eta \text{meas}(B(0, R))^{1/2} + 2 \text{meas}(B_{t,\delta}^{R,\eta}) \|f\|_{L_x^2 L_t^\infty}. \end{aligned}$$

We can pick  $R$  large enough to obtain

$$2 \|\mathbf{1}_{|x| \geq R} f\|_{L_x^2 L_t^\infty} \leq \frac{\varepsilon}{3},$$

then we fix  $\eta$  small enough to get

$$\eta \text{meas}(B(0, R))^{1/2} \leq \frac{\varepsilon}{3},$$

and we eventually fix  $\delta$  small enough to get

$$2 \text{meas}(B_{t,\delta}^{R,\eta}) \|f\|_{L_x^2 L_t^\infty} \leq \frac{\varepsilon}{3}. \quad \blacksquare$$





---

Semi-Classical analysis: from Schrödinger-Wave to Vlasov-Wave

---

In this Appendix we rescale the Schrödinger-Wave system (4.1a)–(4.1b) introduced in Chapter 4 as follows

$$ih \partial_t u_h + \frac{h^2}{2} \Delta_x u_h = \left( \sigma_1 \star_x \int \sigma_2 \psi_h(t) dz \right) u_h, \quad t \in \mathbb{R}, x \in \mathbb{R}^d \quad (\text{D.1a})$$

$$\partial_t \psi_h = \chi_h, \quad t \in \mathbb{R}, x \in \mathbb{R}^d, z \in \mathbb{R}^n \quad (\text{D.1b})$$

$$\partial_t \chi_h = c^2 \Delta_z \psi_h - c^2 \sigma_2(z) \left( \sigma_1 \star_x |u_h(t)|^2 \right) (x), \quad t \in \mathbb{R}, x \in \mathbb{R}^d, z \in \mathbb{R}^n \quad (\text{D.1c})$$

where  $h > 0$  denotes (a dimensionless version of) the Planck constant. We wish to investigate the behavior of this rescaled system when  $h \rightarrow 0$ . This is expected to establish a connection between the classical and quantum models, see [76]. More precisely for every  $h > 0$  we consider the Wigner transform of  $u_h$

$$W_h(t, x, \xi) = \frac{1}{(2\pi)^d} \int_{\mathbb{R}^d} e^{-i\xi \cdot y} u_h(t, x + \frac{h}{2}y) \bar{u}_h(t, x - \frac{h}{2}y) dy$$

and we address the question of the asymptotic behavior of  $(W_h, \psi_h, \chi_h)$  when  $h$  goes to 0. Our goal is to prove that  $(W_h, \psi_h, \chi_h)$  admits a limit and this limit is a solution of the Vlasov-Wave system introduced in Chapter 2. For that purpose let us introduce some notations and assumptions.

We consider a sequence of initial data  $(u_0^h)_{h>0} \subset H_x^1$ ,  $(\psi_0^h)_{h>0} \subset L_x^2 \dot{H}_z^1$  and  $(\chi_0^h)_{h>0} \subset L_x^2 L_z^2$  such that

**(H)** the quantities  $\|u_h\|_{L_x^2}$  and

$$\begin{aligned} \mathcal{E}_{0,+}^h &= \frac{h^2}{2} \int_{\mathbb{R}^d} |\nabla_x u_0^h|^2 dx + \int_{\mathbb{R}^d} \left( \sigma_1 \star \int_{\mathbb{R}^n} \sigma_2 \psi_0^h dz \right)_+ |u_0^h|^2 dx \\ &\quad + \frac{1}{2c^2} \iint_{\mathbb{R}^d \times \mathbb{R}^n} |\chi_0^h|^2 dx dz + \frac{1}{2} \iint_{\mathbb{R}^d \times \mathbb{R}^n} |\nabla_z \psi_0^h|^2 dx dz \end{aligned}$$

are uniformly bounded with respect to  $h$ .

**Remark D.0.1** *i) Assumption (H) guarantees us that the sequences  $(\psi_0^h)$  and  $(\chi_0^h)$  are uniformly bounded with respect to  $h$  respectively in  $L_x^2 \dot{H}_z^1$  and  $L_x^2 L_z^2$ . Hence, there exists  $\psi_0 \in L_x^2 \dot{H}_z^1$  and  $\chi_0 \in L_x^2 L_z^2$  such that, sub-sequences still labelled  $(\psi_0^h)_{h>0}$  and  $(\chi_0^h)_{h>0}$  converge respectively to  $\psi_0$  in  $L_x^2 \dot{H}_z^1$ -weakly and  $\chi_0$  in  $L_x^2 L_z^2$ -weakly.*  
*ii) Moreover, since the rescaled Hamiltonian*

$$\begin{aligned} \mathcal{E}^h(t) &= \frac{h^2}{2} \int_{\mathbb{R}^d} |\nabla_x u_h(t)|^2 dx + \int_{\mathbb{R}^d} \left( \sigma_1 \star \int_{\mathbb{R}^n} \sigma_2 \psi_h(t) dz \right) |u_h(t)|^2 dx \\ &\quad + \frac{1}{2c^2} \iint_{\mathbb{R}^d \times \mathbb{R}^n} |\chi_h(t)|^2 dx dz + \frac{1}{2} \iint_{\mathbb{R}^d \times \mathbb{R}^n} |\nabla_z \psi_h(t)|^2 dx dz \end{aligned}$$

is conserved by the system (D.1a)–(D.1c), we have

$$\begin{aligned} 0 &\leq \frac{h^2}{2} \int_{\mathbb{R}^d} |\nabla_x u_h(t)|^2 dx + \frac{1}{2c^2} \iint_{\mathbb{R}^d \times \mathbb{R}^n} |\chi_h(t)|^2 dx dz + \frac{1}{2} \iint_{\mathbb{R}^d \times \mathbb{R}^n} |\nabla_z \psi_h(t)|^2 dx dz \\ &= \mathcal{E}^h(0) - \int_{\mathbb{R}^d} \left( \sigma_1 \star \int_{\mathbb{R}^n} \sigma_2 \psi_h(t) dz \right) |u_h(t)|^2 dx \\ &\leq \mathcal{E}_{0,+}^h - \int_{\mathbb{R}^d} \left( \sigma_1 \star \int_{\mathbb{R}^n} \sigma_2 \psi_h(t) dz \right) |u_h(t)|^2 dx. \end{aligned}$$

Then thanks to (C.7) coupled with the mass conservation of the wave function  $u_h$  and (C.5c) we have

$$\left\| \int_{\mathbb{R}^d} \left( \sigma_1 \star \int_{\mathbb{R}^n} \sigma_2 \psi_h(t) dz \right) |u_h(t)|^2 dx \right\|_{L_t^\infty} \lesssim \left( \|\psi_0^h\|_{L_x^2 \dot{H}_z^1} + \|\chi_0^h\|_{L_x^2 L_z^2} + |T| \|u_0^h\|_{L_x^2} \right) \|u_0^h\|_{L_x^2}^2,$$

that means  $h^2 \|\nabla_x u_h(t)\|_{L_x^2}^2$ ,  $\|\chi_h(t)\|_{L_x^2 L_z^2}$  and  $\|\psi_h(t)\|_{L_x^2 \dot{H}_z^1}$  are uniformly bounded with respect to  $h$  and  $t \in [0, T]$ .

One can check that the Wigner transform  $W_h$  associated to a solution  $u_h$  of (D.1a) satisfies the following equation

$$\partial_t W_h + \xi \cdot \nabla_x W_h + K_h \star_\xi W_h = 0, \tag{D.2}$$

where

$$K_h(t, x, \xi) = \frac{i}{(2\pi)^d} \int_{\mathbb{R}^d} e^{-i\xi \cdot y} \frac{1}{h} \left( \Phi_h(t, x + \frac{h}{2}y) - \Phi_h(t, x - \frac{h}{2}y) \right) dy. \tag{D.3}$$

This follows by direct inspection when  $u_h$  is a strong solution of (D.1a), which is the case if  $u_0^h$  is regular enough; dealing with weak solutions requires a step by regularization and approximation.

According to [76], we introduce the separable Banach space

$$\mathcal{A} = \left\{ \varphi \in C^0(\mathbb{R}_x^d \times \mathbb{R}_\xi^d) \text{ s.t. } \mathcal{F}_\xi \varphi(x, y) \in L^1 \left( \mathbb{R}_y^d; C^0(\mathbb{R}_x^d) \right) \right\}$$

equipped with the norm

$$\|\varphi\|_{\mathcal{A}} = \|\mathcal{F}_\xi \varphi\|_{L_y^1 C_x^0} = \int_{\mathbb{R}^d} \sup_x |\mathcal{F}_\xi \varphi(x, y)| dy,$$

and notice that the space

$$\mathcal{B} = \left\{ \varphi \in \mathcal{S} \text{ s.t. } \mathcal{F}_\xi \varphi \in C_c^\infty(\mathbb{R}_x^d \times \mathbb{R}_y^d) \right\}$$

is dense in  $\mathcal{A}$ . We also denote by  $\mathcal{M} = \mathcal{M}(\mathbb{R}_x^d \times \mathbb{R}_\xi^d)$  the space of bounded measures on  $\mathbb{R}_x^d \times \mathbb{R}_\xi^d$ , and  $\mathcal{M}_+$  its positive cone.

**Theorem D.0.2** *Let (H1)–(H2) from Chapter 4 and (H) be fulfilled. Up to a sub-sequence, the families  $(W_h)_{h>0}$ ,  $(\psi_h)_{h>0}$  and  $(\chi_h)_{h>0}$  converge respectively to  $\mu \in C^0([0, T]; \mathcal{M} - w\star)$ ,  $\psi \in C^0([0, T]; L_x^2 \dot{H}_z^1 - w)$  and  $\chi \in C^0([0, T]; L_x^2 L_z^2 - w)$  respectively in the spaces  $C^0([0, T]; \mathcal{A}' - w\star)$ ,  $C^0([0, T]; L_x^2 \dot{H}_z^1 - w)$  and  $C^0([0, T]; L_x^2 L_z^2 - w)$ . Moreover  $(\mu, \psi, \chi)$  is a solution of the Vlasov-Wave system*

$$\begin{aligned} \partial_t \mu + \operatorname{div}_x(\xi \mu) - \operatorname{div}_\xi \left( \nabla_x \left[ \sigma_1 \star_x \int \sigma_2 \psi(t) dz \right] \mu \right) &= 0, && \text{in } \mathcal{D}'((0, T); \mathcal{B}'), \\ \partial_t \psi &= \chi, && \text{in } \mathcal{D}'((0, T) \times \mathbb{R}^d \times \mathbb{R}^n), \\ \partial_t \chi &= c^2 \Delta_z \psi - \sigma_2(z) \left( \sigma_1 \star_x \int d\mu(\xi) \right) (x), && \text{in } \mathcal{D}'((0, T) \times \mathbb{R}^d \times \mathbb{R}^n). \end{aligned}$$

The proof follows closely the analysis of [76]; the main difference being that here we have to control also what happens as  $h \rightarrow 0$  for the wave part of the system (D.1a)–(D.1c). Note that if the sequence of initial data is supposed to converge, then, by uniqueness of the solution of the limit equation [25, Theorem 4], the entire sequence  $(W_h, \psi_h, \chi_h)_{h>0}$  converges.

**Proof. Step 1: Convergence of  $(\psi_h)_{h>0}$ .** Thanks to Remark D.0.1 we already know that the sequence  $(\psi_h)_{h>0}$  is bounded in  $L^\infty(0, T; L_x^2 \dot{H}_z^1)$ . Since any closed ball of  $L_x^2 \dot{H}_z^1$  is metrizable and compact for the weak topology, we are going to apply the Ascoli-Arzela theorem in order to justify that  $(\psi_h)_{h>0}$  admits a converging sub-sequence in  $C_t^0(L_x^2 \dot{H}_z^1 - w)$ . For that purpose it only remains to show that  $(\psi_h)_{h>0}$  is equi-continuous in  $C_t^0(L_x^2 \dot{H}_z^1 - w)$ . In fact, it is sufficient to prove that the family  $\{t \mapsto \langle \psi_h(t), g \rangle_{L_x^2 \dot{H}_z^1}\}$  is equi-continuous for every  $g$  in a dense countable subset of  $L_x^2 \dot{H}_z^1$ . Details on this argument can be found e. g. in [75, Appendix C]. For any  $g \in C_c^\infty(\mathbb{R}^d \times \mathbb{R}^n)$ ,

$$\left| \frac{d}{dt} \langle \psi_h(t), g \rangle_{L_x^2 \dot{H}_z^1} \right| = \left| \iint_{\mathbb{R}^d \times \mathbb{R}^n} \hat{\chi}_h(t, k, \zeta) |\zeta|^2 \overline{\hat{g}(k, \zeta)} dk d\zeta \right| \leq \|\chi_h(t)\|_{L_x^2 L_z^2} \|g\|_{L_x^2 H_z^2}$$

is uniformly bounded in  $h$  and  $t \in [0, T]$  (see Remark D.0.1) and the Ascoli-Arzela theorem insures us that, up to a sub-sequence,  $(\psi_h)_{h>0}$  converges in  $C^0([0, T]; L_x^2 \dot{H}_z^1 - w)$  to  $\psi \in C^0([0, T]; L_x^2 \dot{H}_z^1 - w)$ .

**Step 2: Convergence of  $(\chi_h)_{h>0}$ .** As in the previous step Remark D.0.1 insures us that the sequence  $(\chi_h)_{h>0}$  is bounded in  $L^\infty(0, T; L_x^2 L_z^2)$ . Moreover, for any  $g \in C_c^\infty(\mathbb{R}^d \times \mathbb{R}^n)$ ,

$$\begin{aligned} \left| \frac{d}{dt} \langle \chi_h(t), g \rangle_{L_x^2 L_z^2} \right| &\leq c^2 \left| \iint_{\mathbb{R}^d \times \mathbb{R}^n} \nabla_z \psi_h(t) \cdot \nabla_z g dx dz \right| + c^2 \left| \iint_{\mathbb{R}^d \times \mathbb{R}^n} \sigma_2(z) \sigma_1 \star |u_h(t)|^2(x) g(x, z) dx dz \right| \\ &\leq \|\psi_h\|_{L_x^2 \dot{H}_z^1} \|g\|_{L_x^2 H_z^1} + \|\sigma_1\|_{L_x^2} \|\sigma_2\|_{L_z^2} \|u_h(t)\|_{L_x^2}^2 \|g\|_{L_x^2 L_z^2} \end{aligned}$$

is uniformly bounded in  $h$  and  $t \in [0, T]$  (see Remark D.0.1). Eventually the Ascoli-Arzela theorem insures us that, up to a sub-sequence,  $(\chi_h)$  converges in  $C^0([0, T]; L_x^2 L_z^2 - w)$  to  $\chi \in C^0([0, T]; L_x^2 L_z^2 - w)$ .

**Step 3: Equation on  $\psi$ .** Since  $\chi_h$  converges to  $\chi$  in  $C^0([0, T]; L_x^2 L_z^2 - w)$  we obtain directly that for any  $g \in C_c^\infty(\mathbb{R}^d \times \mathbb{R}^n)$ ,

$$\frac{d}{dt} \langle \psi_h(t), g \rangle_{\mathcal{D}', \mathcal{D}} = \iint_{\mathbb{R}^d \times \mathbb{R}^n} \chi_h(t) g dx dz \xrightarrow{h \rightarrow 0} \langle \chi(t), g \rangle_{\mathcal{D}', \mathcal{D}}$$

the convergence being uniform on  $[0, T]$ . Note that here, since the duality product on  $L_x^2 \dot{H}_z^1$  is not compatible with the duality product in  $\mathcal{D}'$ , we have to say something in order to

justify the following convergence

$$\frac{d}{dt} \langle \psi_h(t), g \rangle_{\mathcal{D}', \mathcal{D}} \xrightarrow{h \rightarrow 0} \frac{d}{dt} \langle \psi(t), g \rangle_{\mathcal{D}', \mathcal{D}} \quad \text{in } \mathcal{D}'(0, T).$$

Since for any  $f \in C_c^\infty(0, T)$ ,

$$\left\langle \frac{d}{dt} \langle \psi_h, g \rangle_{\mathcal{D}', \mathcal{D}}, f \right\rangle_{\mathcal{D}'(0, T)} = - \int_0^T \langle \psi_h(t), g \rangle_{\mathcal{D}', \mathcal{D}} f'(t) dt$$

we have to justify the uniform convergence in time of  $\langle \psi_h(t), g \rangle_{\mathcal{D}'}$  to  $\langle \psi(t), g \rangle_{\mathcal{D}'}$ . For any  $g \in C_c^\infty(\mathbb{R}_x^d \times \mathbb{R}_z^n)$ , we have

$$\langle \psi_h(t), g \rangle_{\mathcal{D}'} = \iint_{\mathbb{R}^d \times \mathbb{R}^n} |\zeta| \hat{\psi}_h(t, k, \zeta) |\zeta| \frac{\overline{\hat{g}(k, \zeta)}}{|\zeta|^2} dk d\zeta.$$

The condition  $n \geq 3$  implies that  $\mathcal{F}^{-1}(\hat{g}(k, \zeta)/|\zeta|^2)$  lies in  $L_x^2 \dot{H}_z^1$ , and the convergence of  $\psi_h$  to  $\psi$  in  $C^0([0, T]; L_x^2 \dot{H}_z^1 - w)$  allows us to conclude. Eventually we have proved that  $\partial_t \psi = \chi$  in  $\mathcal{D}'$ .

**Step 4: Equation on  $\chi$ .** Let us temporarily assume that  $|u_h(t)|^2$  converges to a certain  $\rho \in C^0([0, T]; \mathcal{M} - w^*)$  (see **Step 7**). For any  $g \in C_c^\infty(\mathbb{R}_x^d \times \mathbb{R}_z^n)$ , we have

$$\frac{d}{dt} \langle \chi_h(t), g \rangle_{\mathcal{D}', \mathcal{D}} = -c^2 \iint_{\mathbb{R}^d \times \mathbb{R}^n} \nabla_z \psi_h(t) \cdot \nabla_z g dx dz - c^2 \iint_{\mathbb{R}^d \times \mathbb{R}^n} \sigma_2 \sigma_1 \star |u_h(t)|^2 g dx dz \tag{D.5}$$

The weak convergence of  $(\psi_h)_{h>0}$  insures us that

$$-c^2 \iint_{\mathbb{R}^d \times \mathbb{R}^n} \nabla_z \psi_h(t) \cdot \nabla_z g dx dz \xrightarrow{h \rightarrow 0} -c^2 \iint_{\mathbb{R}^d \times \mathbb{R}^n} \nabla_z \psi(t) \cdot \nabla_z g dx dz$$

and, if we rewrite the second term of the right hand side of (D.5) as follows

$$c^2 \iint_{\mathbb{R}^d \times \mathbb{R}^n} \sigma_2 \sigma_1 \star |u_h(t)|^2 g dx dz = c^2 \int_{\mathbb{R}^d} |u_h(t, y)|^2 \left( \int_{\mathbb{R}^n} \sigma_2 \sigma_1 \star g(y) dz \right) dy,$$

the weak convergence of  $|u_h|^2$  leads to

$$c^2 \iint_{\mathbb{R}^d \times \mathbb{R}^n} \sigma_2 \sigma_1 \star |u_h(t)|^2 g dx dz \xrightarrow{h \rightarrow 0} c^2 \iint_{\mathbb{R}^d \times \mathbb{R}^n} \sigma_2 \sigma_1 \star \rho(t) g dx dz.$$

These two convergences hold uniformly in time and we eventually obtain

$$\partial_t \chi = c^2 \Delta_z \psi - c^2 \sigma_2 \sigma_1 \star \rho(t) \quad \text{in } \mathcal{D}' \left( (0, T) \times \mathbb{R}_x^d \times \mathbb{R}_z^n \right).$$

**Step 5: Convergence of  $(W_h)_{h>0}$ .** We first prove that the sequence  $(W_h)_{h>0}$  is bounded in  $L^\infty(0, T; \mathcal{A}')$ . Since

$$\iint_{\mathbb{R}^d \times \mathbb{R}^d} W_h(t, x, \xi) \varphi(x, \xi) dx d\xi = \frac{1}{(2\pi)^d} \iint_{\mathbb{R}^d \times \mathbb{R}^d} u_h(t, x + \frac{h}{2}y) \bar{u}_h(t, x - \frac{h}{2}y) \mathcal{F}_\xi \varphi(x, y) dx dy,$$

we obtain directly

$$\begin{aligned} & \left| \iint_{\mathbb{R}^d \times \mathbb{R}^d} W_h(t, x, \xi) \varphi(x, \xi) dx d\xi \right| \\ & \leq \frac{1}{(2\pi)^d} \left( \sup_y \int_{\mathbb{R}^d} \left| u_h(t, x + \frac{h}{2}y) \bar{u}_h(t, x - \frac{h}{2}y) \right| dx \right) \left( \sup_x \int_{\mathbb{R}^d} |\mathcal{F}_\xi \varphi(x, y)| dy \right) \\ & \leq \frac{1}{(2\pi)^d} \|u_h(t)\|_{L_x^2}^2 \|\varphi\|_{\mathcal{A}}, \end{aligned}$$

which insures us

$$\|W_h(t)\|_{\mathcal{A}'} \leq \frac{1}{(2\pi)^d} \|u_h(t)\|_{L_x^2}^2$$

is bounded with respect to  $h$  and  $t$ . Since any closed ball of  $\mathcal{A}'$  is metrizable and compact for the weak- $\star$  topology, we will apply again the Ascoli-Arzelà theorem in order to justify that  $(W_h)_{h>0}$  admits a converging sub-sequence in  $C_t^0(\mathcal{A}' - w\star)$ . For that purpose we will prove that for any  $\varphi \in \mathcal{B}$ , the functions  $t \mapsto \langle W_h(t), \varphi \rangle_{\mathcal{A}', \mathcal{A}}$  are equi-continuous. Direct computations yield

$$\begin{aligned} \frac{d}{dt} \langle W_h(t), \varphi \rangle_{\mathcal{A}', \mathcal{A}} &= - \iint_{\mathbb{R}^d \times \mathbb{R}^d} W_h(t, x, \xi) \xi \cdot \nabla_x \varphi(x, \xi) dx d\xi \\ &\quad + \iint_{\mathbb{R}^d \times \mathbb{R}^d} W_h(t, x, \eta) \left( \int_{\mathbb{R}^d} K_h(t, x, \xi - \eta) \varphi(x, \xi) d\xi \right) dx d\eta, \end{aligned} \tag{D.6}$$

with

$$\begin{aligned} L_h(t, x, \eta) &:= \int_{\mathbb{R}^d} K_h(t, x, \xi - \eta) \varphi(x, \xi) d\xi \\ &= \frac{i}{(2\pi)^d} \int_{\mathbb{R}^d} e^{i\eta \cdot y} \frac{1}{h} \left( \Phi_h(t, x + \frac{h}{2}y) - \Phi_h(t, x - \frac{h}{2}y) \right) \mathcal{F}_\xi \varphi(x, y) dy \end{aligned}$$

and

$$\mathcal{F}_\eta L_h(t, x, y) = \frac{i}{h} \left( \Phi_h(t, x + \frac{h}{2}y) - \Phi_h(t, x - \frac{h}{2}y) \right) \mathcal{F}_\xi \varphi(x, y).$$

From (D.6) we get for any  $\varphi \in \mathcal{B}$ ,

$$\left| \frac{d}{dt} \langle W_h(t), \varphi \rangle_{\mathcal{A}', \mathcal{A}} \right| \leq \|W_h(t)\|_{\mathcal{A}'} (\|\xi \cdot \nabla_x \varphi\|_{\mathcal{A}} + \|L_h(t)\|_{\mathcal{A}})$$

and it only remains to prove that  $\mathcal{F}_\eta L_h(t)$  is bounded in  $L_y^1 C_x^0$ , uniformly with respect to  $t \in [0, T]$  and  $h$ . Since  $\Phi_h = \sigma_1 \star \int \sigma_2 \psi_h dz$ ,

$$\frac{1}{h} \left( \Phi_h(t, x + \frac{h}{2}y) - \Phi_h(t, x - \frac{h}{2}y) \right) = \frac{y}{h} \cdot \int_{-\frac{h}{2}}^{\frac{h}{2}} \nabla \sigma_1 \star \left( \int_{\mathbb{R}^n} \sigma_2 \psi_h(t) dz \right) (x + sy) ds$$

and we can estimate  $\mathcal{F}_\eta L_h(t)$  as follows

$$\begin{aligned} \|\mathcal{F}_\eta L_h(t)\|_{L_y^1 C_x^0} &\leq \|y \mathcal{F}_\xi \varphi\|_{L_y^1 C_x^0} \left\| \frac{1}{h} \int_{-\frac{h}{2}}^{\frac{h}{2}} \nabla \sigma_1 \star \left( \int_{\mathbb{R}^n} \sigma_2 \psi_h(t) dz \right) (x + sy) ds \right\|_{L_{x,y}^\infty} \\ &\leq \|y \mathcal{F}_\xi \varphi\|_{L_y^1 C_x^0} \left\| \nabla \sigma_1 \star \left( \int_{\mathbb{R}^n} \sigma_2 \psi_h(t) dz \right) \right\|_{L_x^\infty}. \end{aligned}$$

The following estimate coupled with (C.5c) and Remark D.0.1 allows us to conclude

$$\left\| \nabla \sigma_1 \star \left( \int_{\mathbb{R}^n} \sigma_2 \psi_h(t) dz \right) \right\|_{L_x^\infty} \leq \|\nabla \sigma_1\|_{L_x^2} \|\sigma_2\|_{L_z^{p_0}'} \|\psi_h\|_{L_x^2 L_t^\infty L_z^{p_0}}.$$

**Step 6: Equation on  $\mu$ .** For any  $\varphi \in \mathcal{B}$ , we have

$$\frac{d}{dt} \langle W_h(t), \varphi \rangle_{\mathcal{B}', \mathcal{B}} = - \langle W_h(t), \xi \cdot \nabla_x \varphi \rangle_{\mathcal{B}', \mathcal{B}} + \langle W_h(t), L_h(t) \rangle_{\mathcal{B}', \mathcal{B}}.$$

The weak convergence of  $(W_h)_{h>0}$  allows us to obtain

$$\frac{d}{dt} \langle W_h(t), \varphi \rangle_{\mathcal{B}', \mathcal{B}} \xrightarrow{h \rightarrow 0} \frac{d}{dt} \langle \mu(t), \varphi \rangle_{\mathcal{B}', \mathcal{B}} \quad \text{in } \mathcal{D}'(0, T),$$



and

$$\langle W_h(t), \xi \cdot \nabla_x \varphi \rangle_{\mathcal{B}'\mathcal{B}} \xrightarrow{h \rightarrow 0} \langle \mu(t), \xi \cdot \nabla_x \varphi \rangle_{\mathcal{B}'\mathcal{B}} \quad \text{uniformly in time } (t \in [0, T]),$$

and it only remains to prove that  $L_h(t)$  converges strongly in  $\mathcal{A}$  (uniformly with respect to  $t \in [0, T]$ ) to  $\nabla_x (\sigma_1 \star \int \sigma_2 \psi(t) dz) \cdot \nabla_\xi \varphi$ , which is equivalent to prove the strong convergence of  $\mathcal{F}_\xi L_h(t)$  to  $iy \cdot (\nabla \sigma_1 \star \int \sigma_2 \psi(t) dz) \mathcal{F}_\xi \varphi$  in  $L_y^1 C_x^0$ . For that purpose we decompose the difference of these two terms as follows

$$\begin{aligned} & \mathcal{F}_\xi L_h(t, x, y) - iy \cdot \left( \int_{\mathbb{R}^d} \nabla \sigma_1(x - \bar{x}) \left[ \int \sigma_2(z) \psi(t, \bar{x}, z) dz \right] d\bar{x} \right) \mathcal{F}_\xi \varphi(x, y) \\ &= iy \cdot \left( \int_{\mathbb{R}^d} \nabla \sigma_1(x - \bar{x}) \left[ \int \sigma_2(z) (\psi(t, \bar{x}, z) - \psi_h(t, \bar{x}, z)) dz \right] d\bar{x} \right) \mathcal{F}_\xi \varphi(x, y) \\ & \quad + iy \cdot \left( \int_{\mathbb{R}^d} \frac{1}{h} \left[ \int_{-\frac{h}{2}}^{\frac{h}{2}} \nabla \sigma_1(x - \bar{x}) - \nabla \sigma_1(x + sy - \bar{x}) ds \right] \right. \\ & \quad \quad \quad \left. \times \left[ \int \sigma_2(z) \psi_h(t, \bar{x}, z) dz \right] d\bar{x} \right) \mathcal{F}_\xi \varphi(x, y) \\ &= \text{I}(t, x, y) + \text{II}(t, x, y). \end{aligned}$$

We estimate the first term as follows (where the support of  $\mathcal{F}_\xi \varphi$  is supposed to be included in the compact  $K_1 \times K_2$ )

$$\|\text{I}(t)\|_{L_y^1 C_x^0} \leq \|y \mathcal{F}_\xi \varphi\|_{L_y^1 C_x^0} \sup_{x \in K_1} |\nabla \sigma_1 \star (\sigma_2(\psi(t) - \psi_h(t)))(x)|$$

and the weak convergence of  $(\psi_h)_{h>0}$  insures us that for every  $x \in K_1$

$$\begin{aligned} & \nabla \sigma_1 \star (\sigma_2(\psi(t) - \psi_h(t)))(x) \\ &= \iint_{\mathbb{R}^d \times \mathbb{R}^d} |\zeta| \nabla \sigma_1(x - \bar{x}) \frac{\hat{\sigma}_2(\zeta)}{|\zeta|^2} |\zeta| \overline{(\hat{\psi}(t, \bar{x}, \zeta) - \hat{\psi}_h(t, \bar{x}, \zeta))} d\bar{x} d\zeta \xrightarrow{h \rightarrow 0} 0. \end{aligned}$$

This convergence is not *a priori* uniform in  $x \in K_1$ . Nevertheless, we can combine the fact that  $\psi(t) - \psi_h(t)$  is uniformly bounded with respect to  $t$  and  $h$  in  $L_x^2 \dot{H}_z^1$ ,  $K_1$  is compact and the application

$$x \in \mathbb{R}^d \longmapsto \left( (\bar{x}, z) \mapsto \nabla \sigma_1(x - \bar{x}) \mathcal{F}_\zeta^{-1}(\hat{\sigma}_2(\zeta)/|\zeta|^2)(z) \right) \in L_x^2 \dot{H}_z^1$$

is continuous, to prove that the convergence is indeed uniform in  $x$ . For the second term, the estimate

$$\begin{aligned} \|\text{II}(t)\|_{L_y^1 C_x^0} &\leq \|y \mathcal{F}_\xi \varphi\|_{L_y^1 C_x^0} \|\sigma_2\|_{L_z^{p'_0}} \|\psi_h\|_{L_x^2 L_t^\infty L_z^{p_0}} \\ &\quad \times \sup_{\substack{x \in K_1 \\ y \in K_2}} \left( \int_{\mathbb{R}^d} \frac{1}{h^2} \left| \int_{-\frac{h}{2}}^{\frac{h}{2}} \nabla \sigma_1(x - \bar{x}) - \nabla \sigma_1(x + sy - \bar{x}) ds \right|^2 \right)^{1/2} \\ &= \|y \mathcal{F}_\xi \varphi\|_{L_y^1 C_x^0} \|\sigma_2\|_{L_z^{p'_0}} \|\psi_h\|_{L_x^2 L_t^\infty L_z^{p_0}} \sup_{y \in K_2} \left( \int_{\mathbb{R}^d} \frac{1}{h^2} \left| \int_{-\frac{h}{2}}^{\frac{h}{2}} \nabla \sigma_1(x) - \nabla \sigma_1(x + sy) ds \right|^2 dx \right)^{1/2} \end{aligned}$$

coupled with the regularity and the compactness of the support of  $\nabla \sigma_1$  and the uniform boundedness with respect to  $h$  of  $\|\psi_h\|_{L_x^2 L_t^\infty L_z^{p_0}}$ , allows us to conclude that  $\|\text{II}(t)\|_{L_y^1 C_x^0} \rightarrow 0$  when  $h \rightarrow 0$ .

**Step 7: Final details.** To conclude the proof it remains to justify that in fact the limit  $\mu$  of the sequence  $(W_h)_{h>0}$  defines an element of  $C^0([0, T], \mathcal{M}_+ - w\star)$  and that the sequence  $(|u_h|^2)_{h>0}$  converges in  $C^0([0, T], \mathcal{M}(\mathbb{R}^d) - w\star)$  to  $\rho = \int d\mu(\xi)$ . The first point comes from

the study of the Husimi transform of  $u_h$ :

$$\widetilde{W}_h(t) = W_h(t) \star \frac{e^{-(|x|^2+|\xi|^2)/h}}{(\pi h)^d}.$$

One can prove that, for every time  $t \in [0, T]$ ,  $\widetilde{W}_h(t)$  is non negative and the sequence  $(\widetilde{W}_h(t))_{h>0}$  is bounded in  $L_x^1 L_\xi^1$ . This allows us to conclude that, up to a sub-sequence,  $\widetilde{W}_h(t)$  converges weakly in the sense of measures to a certain  $\tilde{\mu}(t) \in \mathcal{M}_+$  and it is then possible to prove that indeed  $\mu(t) = \tilde{\mu}(t)$ . We refer the reader to [76, Section III] for details. However it is not possible yet to conclude that  $\mu$  is an element of  $C^0([0, T], \mathcal{M} - w\star)$ . In the previous argument each sub-sequence depends on  $t$  (then it is not possible to apply a diagonal argument) and we have no information about the time continuity. The missing step can be obtained by slightly modifying the compactness argument in **Step 5**, in order to obtain the compactness of the sequence  $(\widetilde{W}_h)_{h>0}$  in  $C^0([0, T], \mathcal{M} - w\star)$ , and conclude that, up to a sub-sequence,  $(\widetilde{W}_h)_{h>0}$  converges in  $C^0([0, T], \mathcal{M} - w\star)$  to  $\tilde{\mu} \in C^0([0, T], \mathcal{M} - w\star)$ . We eventually obtain that  $\mu = \tilde{\mu} \in C^0([0, T], \mathcal{M} - w\star)$ .

Finally, we make use of the results in the [76, Section III ] which tell us that if the sequence  $(h^{-d}|\hat{u}_h(t, h^{-1}\xi)|^2)_{h>0}$  is tightly relatively compact, then  $(|u_h(t)|^2)$  converges weakly in the sense of measures to  $\rho(t) = \int d\tilde{\mu}(t, \xi) = \int d\mu(t, \xi)$ . Moreover, we already know that  $(\widetilde{W}_h)_{h>0}$  converges in  $C^0([0, T], \mathcal{M} - w\star)$  to  $\tilde{\mu}$ , so that if  $(h^{-d}|\hat{u}_h(t, h^{-1}\xi)|^2)_{h>0}$  is tightly relatively compact, *uniformly in time*, then the proof [76, Theorem III.1 point 3] can be revisited in order to obtain that  $(|u_h|^2)_{h>0}$  converges in  $C^0([0, T], \mathcal{M}(\mathbb{R}^d) - w\star)$  to  $\rho = \int d\tilde{\mu}(\xi) = \int d\mu(\xi) \in C^0([0, T], \mathcal{M}(\mathbb{R}^d) - w\star)$ .

Let us conclude the proof by proving that the sequence  $(h^{-d}|\hat{u}_h(t, h^{-1}\xi)|^2)_{h>0}$  is tightly relatively compact uniformly in time, which can be cast as

$$\sup_{t \geq 0} \sup_{h > 0} \frac{1}{h^d} \int_{|\xi| \geq R} |\hat{u}_h(t, h^{-1}\xi)|^2 d\xi \xrightarrow{R \rightarrow \infty} 0.$$

Remark D.0.1, insures the existence of a constant  $C > 0$ , independent of  $h > 0$  and  $t \in [0, T]$ , such that  $h^2 \|\nabla_x u_h(t)\|_{L_x^2}^2 \leq C$ . Then a direct computation shows that

$$\begin{aligned} h^2 \int_{\mathbb{R}^d} |\nabla_x u_h(t, x)|^2 dx &= h^2 \int_{\mathbb{R}^d} |\xi|^2 |\hat{u}_h(t, \xi)|^2 d\xi \\ &= \frac{1}{h^d} \int_{\mathbb{R}^d} |\xi|^2 |\hat{u}_h(t, h^{-1}\xi)|^2 d\xi \geq \frac{1}{h^d} \int_{|\xi| \geq R} R^2 |\hat{u}_h(t, h^{-1}\xi)|^2 d\xi, \end{aligned}$$

and we eventually obtain

$$\sup_{t \geq 0} \sup_{h > 0} \frac{1}{h^d} \int_{|\xi| \geq R} |\hat{u}_h(t, h^{-1}\xi)|^2 d\xi \leq \frac{C}{R^2}.$$

■



- [1] B. Aguer. *Comportements asymptotiques dans des gaz de Lorentz inélastiques*. PhD thesis, Université Lille 1, 2010.
- [2] B. Aguer, S. De Bièvre, P. Lafitte, and P. E. Parris. Classical motion in force fields with short range correlations. *J. Stat. Phys.*, 138(4-5):780–814, 2010.
- [3] G. Allaire. *Analyse numérique et optimisation*. Editions de l'École Polytechnique, 2012.
- [4] R. Alonso, T. Goudon, and A. Vasseur. Damping of particles interacting with a vibrating medium. *Ann. IHP. Anal. Non-Linéaire*, 34(7):1727–1758, 2017.
- [5] X. Antoine, A. Arnold, C. Besse, M. Ehrhardt, and A. Schädle. A review of transparent and artificial boundary conditions techniques for linear and nonlinear schrödinger equations. *Commun. Comput. Phys.*, 4(4):729–796, 2008.
- [6] X. Antoine, A. Levitt, and Q. Tang. Efficient spectral computation of the stationary states of rotating Bose-Einstein condensates by the preconditioned nonlinear conjugate gradient method. *J. Comput. Phys.*, 343:92–109, August 2017.
- [7] G. Backus. Linearized plasma oscillations in arbitrary electron distributions. *J. Math. Phys.*, 1(559):178–191, 1960.
- [8] W. Bao and Q. Du. Computing the ground state solution of bose-einstein condensates by a normalized gradient flow. *SIAM J. Sci. Comput.*, 25(5):1674–1697, 2004.
- [9] P Bechouche, F. Poupaud, and J. Soler. Quantum transport and Boltzmann operators. *Journal of Statistical Physics*, 122(3):417–436, 02 2006.
- [10] J. Bedrossian. Nonlinear echoes and Landau damping with insufficient regularity. Technical report, Univ. of Maryland, 2016. [arXiv:1605.06841](https://arxiv.org/abs/1605.06841).
- [11] J. Bedrossian and N. Masmoudi. Inviscid damping and the asymptotic stability of planar shear flows in the 2D Euler equations. *Publications mathématiques de l'IHÉS*, 122(1):195–300, 2015.
- [12] J. Bedrossian, N. Masmoudi, and C. Mouhot. Landau damping: paraproducts and Gevrey regularity. *Annals of PDE*, 2016.

- [13] J. Bedrossian, N. Masmoudi, and C. Mouhot. Landau damping in finite regularity for unconfined systems with screened interactions. *Comm. Pure Applied Math.*, 71(3):537–576, 2018.
- [14] C. Boldrighini, L. A. Bunimovich, and Y. G. Sinai. On the boltzmann equation for the Lorentz gas. *Journal of Statistical Physics*, 32:477–501, 1983.
- [15] L. Bruneau. The ground state problem for a quantum Hamiltonian model describing friction. *Canadian J. Math.*, 59(5):897–916, 2007.
- [16] L. Bruneau and S. De Bièvre. A Hamiltonian model for linear friction in a homogeneous medium. *Comm. Math. Phys.*, 229(3):511–542, 2002.
- [17] L. Caffarelli, P. Souganidis, and L. Wang. Homogenization of fully nonlinear, uniformly elliptic and parabolic partial differential equations in stationary ergodic media. *Communications on Pure and Applied Mathematics*, 58:319 – 361, 03 2005.
- [18] E. Caglioti and F. Golse. On the Boltzmann-Grad limit for the two dimensional periodic Lorentz gas. *Journal of Statistical Physics*, 141:264–317, 2010.
- [19] A. O. Caldeira and A. J. Leggett. Quantum tunnelling in a dissipative system. *Ann. Phys.*, 149:374–456, 1983.
- [20] A.O. Caldeira and A.J. Leggett. Path integral approach to quantum brownian motion. *Physica A: Statistical Mechanics and its Applications*, 121(3):587 – 616, 1983.
- [21] T. Cazenave. *Semilinear Schrödinger Equations*, volume 10 of *Lecture Notes CIMS*. AMS, 2003.
- [22] T. Cazenave and P.-L. Lions. Orbital stability of standing waves for some nonlinear Schrödinger equations. *Comm. Math. Phys.*, 85(4):549–561, 1982.
- [23] P. D’Avenia and M. Squassina. Soliton dynamics for the Schrödinger-Newton system. *Math. Models Methods Appl. Sc.*, 24(03):553–572, 2014.
- [24] S. De Bièvre, J. Faupin, and B. Schubnel. Spectral analysis of a model for quantum friction. *Rev. Math. Phys.*, 29(6):1750019, 49, 2017.
- [25] S. De Bièvre, T. Goudon, and A. Vasseur. Particles interacting with a vibrating medium: existence of solutions and convergence to the Vlasov–Poisson system. *SIAM J. Math. Anal.*, 48(6):3984–4020, 2016.
- [26] S. De Bièvre, T. Goudon, and A. Vasseur. Stability analysis of a Vlasov–Wave system describing particles interacting with their environment. *J. Diff. Eq.*, 264(12):7069–7093, 2018.
- [27] S. De Bièvre, P. Lafitte, and P. E. Parris. Normal transport at positive temperatures in classical Hamiltonian open systems. In *Adventures in mathematical physics*, volume 447 of *Contemp. Math.*, pages 57–71. Amer. Math. Soc., Providence, RI, 2007.
- [28] S. De Bièvre and P. E. Parris. Equilibration, generalized equipartition, and diffusion in dynamical Lorentz gases. *J. Stat. Phys.*, 142(2):356–385, 2011.
- [29] S. De Bièvre, P. E. Parris, and A. Silvius. Chaotic dynamics of a free particle interacting linearly with a harmonic oscillator. *Phys. D*, 208(1-2):96–114, 2005.

- [30] P. De Smedt, D Dürr, J. L. Lebowitz, and C Liverani. Quantum system in contact with a thermal environment: Rigorous treatment of a simple model. *Communications in Mathematical Physics*, 120:195 – 231, 06 1988.
- [31] B. Engquist and A. Majda. Absorbing boundary conditions for the numerical simulation of waves. *Math. Comput.*, 31(139):629–651, 1977.
- [32] C. Epstein. *Introduction to the Mathematics of Medical Imaging*. Society for Industrial and Applied Mathematics, Philadelphia, PA, 2 edition, 2007.
- [33] G. Eskin. *Lectures on Linear Partial Differential Equations*, volume 123 of *Graduate Studies in Math*. Am. Math. Soc., 2011.
- [34] E. Faou, L. Gauckler, and C. Lubich. Sobolev stability of plane wave solutions to the cubic nonlinear schrodinger equation on a torus. *Communications in Partial Differential Equations*, 38, 09 2011.
- [35] E. Faou, R. Horsin, and F. Rousset. On numerical Landau damping for splitting methods applied to the Vlasov-HMF model. *Foundations Comput. Math.*, 18(1):97–134, 2018.
- [36] E. Faou and F. Rousset. Landau damping in Sobolev spaces for the Vlasov-HMF model. *Arch. Ration. Mech. Anal.*, 219(2):887–902, 2016.
- [37] F. Filbet and E. Sonnendrücker. Comparison of Eulerian Vlasov solvers. *Computer Physics Communications*, 150(3):247–266, 2003.
- [38] F. Filbet and E. Sonnendrücker. Numerical methods for the Vlasov equation. In F. Brezzi, A. Buffa, S. Corsaro, and A. Murli, editors, *Numerical Mathematics and Advanced Applications*, pages 459–468. Springer Milan, 2003.
- [39] F. Filbet, E. Sonnendrücker, and P. Bertrand. Conservative numerical schemes for the Vlasov equation. *J. Comput. Phys.*, 172:166–187, 2001.
- [40] G. Ford, M Kac, and P. Mazur. Statistical mechanics of assemblies of coupled oscillators. *Journal of Mathematical Physics*, 6:504 – 515, 1965.
- [41] G. W. Ford, J. T. Lewis, and R. F. O’Connell. Quantum Langevin equation. *Phys. Rev. A*, 37:4419–4428, Jun 1988.
- [42] J. Fröhlich, Z. Gang, and A. Soffer. Friction in a model of Hamiltonian dynamics. *Comm. Math. Phys.*, 315(2):401–444, 2012.
- [43] Gallavotti G. Rigorous theory of the Boltzmann equation in the Lorentz gas, 1972.
- [44] K. Gerdes. A review of infinite element methods for exterior Helmholtz problems. *J. Comput. Acoust.*, 8(1):43–62, 2000. Finite elements for wave problems (Trieste, 1999).
- [45] K. Gerdes and L. Demkowicz. Solution of 3D-Laplace and Helmholtz equations in exterior domains using *hp*-infinite elements. *Comput. Methods Appl. Mech. Engrg.*, 137(3-4):239–273, 1996.
- [46] J. Ginibre and G. Velo. Generalized strichartz inequalities for the wave equation. *Journal of Functional Analysis*, 133(1):50 – 68, 1995.

- [47] F. Golse. On the periodic Lorentz gas and the Lorentz kinetic equation. *Annales de la Faculté des sciences de Toulouse : Mathématiques*, Ser. 6, 17(4):735–749, 2008.
- [48] T. Goudon. *Mathematics for modeling and scientific computing*. Mathematics and Statistics Series. ISTE, London; John Wiley & Sons, Inc., Hoboken, NJ, 2016.
- [49] T. Goudon and F. Poupaud. On the modeling of the transport of particles in turbulent flows. *ESAIM: Mathematical Modelling and Numerical Analysis - Modélisation Mathématique et Analyse Numérique*, 38(4):673–690, 2004.
- [50] T. Goudon and F. Poupaud. Homogenization of transport equations: A simple PDE approach to the Kubo formula. *Bulletin des Sciences Mathématiques*, 131(1):72 – 88, 2007.
- [51] T. Goudon and A. Vasseur. Statistical Stability for Transport in Random Media. *Multi-scale Modeling and Simulation: A SIAM Interdisciplinary Journal*, 17(1):507–530, January 2019.
- [52] T. Goudon and A. Vasseur. Mean field limit for particles interacting with a vibrating medium. *Annali Univ. Ferrara*, 62(2):231–273, 2016.
- [53] E. Grenier, T. T. Nguyen, and I. Rodnianski. Landau damping for analytic and Gevrey data. *arXiv: Analysis of PDEs*, 2020.
- [54] E. Grenier, T. T. Nguyen, and I. Rodnianski. Plasma echoes near stable Penrose data. *arXiv: Analysis of PDEs*, 2020.
- [55] Wei Guo and Jing-Mei Qiu. Hybrid semi-Lagrangian finite element-finite difference methods for the Vlasov equation. *J. Comput. Phys.*, 234(0):108–132, 2013.
- [56] Y. Guo. Variational method for stable polytropic galaxies. *Archiv. Ration. Mech. Anal.*, 130:163–182, 1999.
- [57] Y. Guo and G. Rein. Stable steady states in stellar dynamics. *Archiv. Ration. Mech. Anal.*, 147:225–243, 1999.
- [58] E. Hairer, C. Lubich, and G. Wanner. *Geometric numerical integration*, volume 31 of *Springer Series in Computational Mathematics*. Springer, Heidelberg, 2010. Structure-preserving algorithms for ordinary differential equations, Reprint of the second (2006) edition.
- [59] D. Han-Kwan, T. Nguyen, and F. Rousset. Asymptotic stability of equilibria for screened Vlasov-Poisson systems via pointwise dispersive estimates. *arXiv:1906.05723*, 2019.
- [60] M. Keel and T. Tao. Endpoint Strichartz estimates. *American J. of Math.*, 120:955–980, 1998.
- [61] H. Kikuchi and M. Ohta. Stability of standing waves for the Klein-Gordon-Schrödinger system. *J. Math. Anal. Appl.*, 365:109–114, 2010.
- [62] A. Komech, M. Kunze, and H. Spohn. Effective dynamics for a mechanical particle coupled to a wave field. *Comm. Math. Phys.*, 203(1):1–19, 1999.

- [63] A. Komech and H. Spohn. Long—time asymptotics for the coupled Maxwell—Lorentz equations. *Communications in Partial Differential Equations*, 25(3-4):559–584, 2000.
- [64] A. Komech, H. Spohn, and M. Kunze. Long-time asymptotics for a classical particle interacting with a scalar wave field. *Comm. Partial Differential Equations*, 22(1-2):307–335, 1997.
- [65] J. Krieger, Y. Martel, and P. Raphael. Two-soliton solutions to the three-dimensional gravitational hartree equation. *Communications on Pure and Applied Mathematics*, 62, 11 2009.
- [66] P. Lafitte, P. E. Parris, and S. De Bièvre. Normal transport properties in a metastable stationary state for a classical particle coupled to a non-Ohmic bath. *J. Stat. Phys.*, 132(5):863–879, 2008.
- [67] L. Landau. On the vibration of the electronic plasma. *J. Phys. USSR*, 10:25, 1946. English translation in JETP 16, 574. Reproduced in Collected papers of L.D. Landau, edited and with an introduction by D. ter Haar, Pergamon Press, 1965, pp. 445–460; and in Men of Physics: L.D. Landau, Vol. 2, Pergamon Press, D. ter Haar, ed. (1965).
- [68] E. Lenzmann. Uniqueness of ground states for pseudo-relativistic Hartree equations. *Anal. PDE*, 2:1–27, 01 2009.
- [69] C. D. Levermore and M. Oliver. Analyticity of solutions for a generalized Euler equation. *J. Differential Equations*, 133(2):321–339, 1997.
- [70] E. H. Lieb. Existence and uniqueness of the minimizing solution of Choquard’s nonlinear equation. *Studies in Applied Mathematics*, 57(2):93–105, 1977.
- [71] L. Lieb and M. Loss. *Analysis*, volume 14 of *Graduate Studies in Mathematics*. AMS, 2001. (2nd. edition).
- [72] P.-L. Lions. Symétrie et compacité dans les espaces de Sobolev. *J. Funct. Anal.*, 49:315–334, 1982.
- [73] P.-L. Lions. The concentration-compactness principle in the calculus of variations. the locally compact case, part 1. *Annal. IHP., Non Lin. Anal.*, 1(2):109–145, 1984.
- [74] P.-L. Lions. The concentration-compactness principle in the calculus of variations. the locally compact case, part 2. *Annal. IHP., Non Lin. Anal.*, 1(2):223–283, 1984.
- [75] P. L. Lions. *Mathematical topics in fluid mechanics; Volume 1: Incompressible models*. Clarendon Press, Oxford, 1996.
- [76] P.-L. Lions and T. Paul. Sur les mesures de Wigner. *Revista Matemática iberoamericana*, 9(3):553–618, 1993.
- [77] P.L. Lions. The Choquard equation and related questions. *Nonlinear Analysis: Theory, Methods and Applications*, 4(6):1063–1072, 1980.
- [78] G Loeper and A. Vasseur. Electric turbulence in a plasma subject to a strong magnetic field. *Asymptotic Analysis*, 40:51–65, 05 2005.
- [79] H.A. Lorentz. The motion of electrons in metallic bodies i. *KNAWP Series B Physical Sciences*, 7:438–453, 1904.



- [80] D. Lynden-Bell. The stability and vibrations of a gas of stars. *Mon. Not. R. Astr. Soc.*, 124(4):279–296, 1962.
- [81] D. Lynden-Bell. Statistical mechanics of violent relaxation in stellar systems. *Mon. Not. R. Astr. Soc.*, 136:101–121, 1967.
- [82] L. Ma and L. Zhao. Classification of positive solitary solutions of the nonlinear Choquard equation. *Arch. Rational Mech. Anal.*, 195:455–467, 2010.
- [83] J. Marklof and A. Strömbergsson. The Boltzmann-Grad limit of the periodic Lorentz gas. *Annals of Mathematics*, 174:225–298, 02 2008.
- [84] Y. Martel. Notes on the interaction of solitary waves for NLS. [https://yvan\\_martel.wiki.math.cnrs.fr/uploads/Bonn2017.pdf](https://yvan_martel.wiki.math.cnrs.fr/uploads/Bonn2017.pdf), 2017. Lectures notes for a course given in the summer school Dispersive Equations, Solitons, and Blow-up in September 2017 at the Hausdorff Center for Mathematics in Bonn.
- [85] Y. Martel and F. Merle. Asymptotic stability of solitons for subcritical generalized KdV equations. *Arch. Rational Mech. Anal.*, 157:219–254, 2001.
- [86] Y. Martel and F. Merle. Multi solitary waves for nonlinear schrödinger equations. *Annales de l'Institut Henri Poincaré (C) Non Linear Analysis*, 23(6):849 – 864, 2006.
- [87] C. Mouhot and C. Villani. On Landau damping. *Acta Math.*, 207(1):29–201, 2011.
- [88] L. Nirenberg. On elliptic partial differential equations. *Ann. Scuola Norm. Sup. Pisa, Classe di Scienze*, 13(2):115–162, 1959.
- [89] L. Nirenberg. An abstract form of the nonlinear Cauchy-Kowalewski theorem. *J. Differential Geometry*, 6:561–576, 1972. Collection of articles dedicated to S. S. Chern and D. C. Spencer on their sixtieth birthdays.
- [90] T. Nishida. A note on a theorem of Nirenberg. *J. Differential Geom.*, 12(4):629–633 (1978), 1977.
- [91] F. Poupaud and A. Vasseur. Classical and quantum transport in random media. *J. Math. Pures et Appl.*, 82:711–748, 2003.
- [92] J.-M. Qiu and C.-W. Shu. Conservative semi-Lagrangian finite difference WENO formulations with applications to the Vlasov equation. *Comm. Comput. Phys.*, 10:979–1000, 2011.
- [93] J.-M. Qiu and C.-W. Shu. Positivity preserving semi-lagrangian discontinuous Galerkin formulation: Theoretical analysis and application to the Vlasov–Poisson system. *J. Comput. Phys.*, 230:8386–8409, 2011.
- [94] J. M. Sanz-Serna and M. P. Calvo. *Numerical Hamiltonian problems*, volume 7 of *Applied Mathematics and Mathematical Computation*. Chapman & Hall, London, 1994.
- [95] L. Schwartz. *Méthodes mathématiques pour les sciences physiques*. Enseignement des sciences. Herrmann, 1997.
- [96] E. Soret and S. De Bièvre. Stochastic acceleration in a random time-dependent potential. *Stochastic Process. Appl.*, 125(7):2752–2785, 2015.

- [97] E.M. Stein. *Singular Integrals and Differentiability Properties of Functions*. Princeton University Press, 1970.
- [98] W. Strauss. Existence of solitary waves in higher dimensions. *Commun. Math. Phys.*, 55:149–162, 1977.
- [99] T. Tao. Low regularity semi-linear wave equations. *Comm. PDE*, 24:599–629, 1999.
- [100] M. E. Taylor. *Measure theory and integration*, volume 76 of *Graduate Studies in Math.* AMS, 2006.
- [101] T. Umeda. A conservative and non-oscillatory scheme for Vlasov code simulations. *Earth Planets Space*, 60:773–779, 2008.
- [102] T. Umeda, M. Ashour-Abdalla, and D. Schriver. Comparison of numerical interpolation schemes for one-dimensional electrostatic Vlasov code. *J. Plasma Physics*, 72:1057–1060, 2006.
- [103] A. Vavasseur. *Some models of particles interacting with their environment*. PhD thesis, University Nice Sophia Antipolis, 2016.
- [104] A. Vavasseur. Long time behaviour of interacting particles through a vibrating medium: comparison between the N-particle system and the natural kinetic equation dynamics. Technical report, BCAM, Bilbao, Spain, 2019. Available at the URL <https://hal.archives-ouvertes.fr/hal-02012981>.
- [105] M. P. Velasco, D. Usero, S. Jiménez, and L. Vázquez. Transparent boundary condition for the wave equation in one dimension and for a Dirac like equation. *Electronic J. Diff. Equ.*, Conference 22:117–137, 2015. Madrid Conference on Applied Mathematics in honor of Alfonso Casal.
- [106] C. Villani. Landau damping, 2010. Lectures notes for a course given in Cotonou, Benin, and in CIRM, Luminy.
- [107] M. Weinstein. Modulational stability of ground states of nonlinear Schrödinger equations. *SIAM Journal on Mathematical Analysis*, 16(3):472–491, 1985.
- [108] M. Weinstein. Lyapunov stability of ground states of nonlinear dispersive evolution equations. *Communications on Pure and Applied Mathematics*, 39:51–67, 01 1986.
- [109] G. Wolansky. On nonlinear stability of polytropic galaxies. *Ann. Inst. H. Poincaré*, 16:15–48, 1999.
- [110] E. Zampieri and L. F. Pavarino. Implicit spectral element methods and Neumann-Neumann preconditioners for acoustic waves. *Comput. Methods Appl. Mech. Engrg.*, 195(19–22):2649–2673, 2006.
- [111] G. Zhang and N. Song. Travelling solitary waves for boson stars. *El. J. Diff. Eq.*, 2019:73: 1–12, 2019.



- [P1] T. Goudon and L. Vivion. Landau damping in dynamical Lorentz gases. Technical report, Univ. Côte d'Azur, Inria, CNRS, LJAD, 2019.
- [P2] T. Goudon and L. Vivion. Numerical investigation of Landau damping in dynamical Lorentz gases. *Phys. D.*, 403:132310, 2020.
- [P3] T. Goudon and L. Vivion. Numerical investigation of stability issues for quantum dissipative systems. Technical report, Université Côte d'Azur, Inria, CNRS, LJAD, 2020.
- [P4] T. Goudon and L. Vivion. On quantum dissipative systems: ground states and orbital stability. Technical report, Univ. Côte d'Azur, Inria, CNRS, LJAD, 2020.