

Acknowledgements

My thesis was done in the team of “Biologie des Semences” in UMR7622 “Biologie du développement” at Sorbonne Université. Before presenting the thesis, I would like to thank all those who contributed to its realization.

First of all, I would like to express my sincere gratitude to my supervisor Prof. Françoise CORBINEAU who offered me the Ph.D. position to study with her and led me to explore seed biology with curiosity, enthusiasm and concentration. In all the time of research and writing thesis, her guidance gave me a light. Without her critical comments and constructive suggestions, the thesis could not reach the present form. I would like to thank her for the tremendous patience and encouragement that gave me the motivation to continue on scientific research.

Secondly, I would like to acknowledge, Dr. Julia BUITINK and Dr. Karine GALLARDO, for accepting the invitation and spending much time in reviewing my thesis; and also the members of the jury, Prof. Pierre CAROL, Dr. Bertrand GAKIERE and Dr. Michel ZIVY for evaluating my work. I am also appreciated that the members of the thesis committee, Dr. Michel ZIVY, Dr. Isabelle PETROPOULOS and Dr. Mathilde GARCIA brought up the questions that inspired me to have a solid consideration of my project. Meanwhile, great thanks should be given to Dr. Michel ZIVY who gave me an opportunity to learn proteomic analysis in his platform PAPPSO and to attend the proteomic meeting. His brilliant ideas and insightful suggestions helped me a lot to write the thesis.

I would like to thank all the collaborations and supports in my project. Marlène DAVANTURE did the HPLC-MS and helped me with MassChroqR analysis; Michael HOLDSWORTH, Angelika MUSTROPH and Margret SAUTER generously provided us with the precious mutant seeds, overexpressed seeds and vectors; Eiji NAMBARA kindly measured the hormone contents for us.

Besides, I will express my special thanks to the “seed lab” family for keeping me company for the 3 years. Firstly, many thanks to the Prof. Christophe BAILLY, who gave me access to the laboratory and research facilities, provided a financial support for my French language learning and ISSS conference in Volendam. Secondly, I will say great thanks to Prof. Hayat BOUTEAU and Dr. Patrice MEIMOUN, who discussed with us about our project

many times and gave valuable suggestions. At the same time, I would like also to express my appreciation to Dr. Juliette PUYAUBERT and Dr. Emmanuel BAUDOUIN for their professional instructions. All the permanent researchers in the “seed lab” gave me many encouragements that I will never forget. At the same time, I will always keep my friends in mind, they are, Maharajah PONNAIAH, Marie BOURCY, Wei ZHANG, Huifang YAN, Qiong XIA, Anne-Sophie LACHABROUILLI, Queen Rana JURDAK, my favorite Nicole CHAUMONT, Baptiste VANCOSTENOBLE. We had many happy memories together. In addition, thanks to the intern student, Supangan THARMARETNAM who spent two months with us for the project concerning oxygen. Furthermore, my great acknowledgements go to Stéphanie AGYS, Carina RODRIGUES MENDES, Patrick DUMONT and Emilie DAVEAU who helped me to grow my Arabidopsis plants and harvest the seeds.

I would like to acknowledge the China Scholarship Council for the 38 months’ financial support, which is the essential prerequisite of the thesis. I will do my best to improve myself in all aspects and be a useful scientist in the future.

Last but not least, I am grateful to my parents and parents-in-law for their love, care and understanding. I am also deeply indebted to my beloved husband, Bing who came to France under intense pressure to take care of me. I could not imagine what a lonely and miserable life I will have without him. Thanks to my baby cat, Poyno, who woke me up every morning and stayed quietly with me when I was working at home. I am responsible for her life.

Abstract

Primary dormant *Arabidopsis thaliana* seeds did not germinate in darkness at temperatures higher than 10 °C. Ethylene, (10-100 $\mu\text{L L}^{-1}$) as well as chilling (2 to 4 days at 4 °C) and GA₃, was able to improve the germination of primary dormant wild-type (Col-0) seeds at 25 °C in darkness. Among all the ethylene insensitive mutants in triple response (*etr1*, *ein4*, and *ein2*), the dormancy of *etr1* and *ein2* could not be alleviated by ethylene on the contrary of *ein4*, which suggested a possible non-canonical ethylene signaling in seed dormancy release. The effect of stratification at 4 °C on dormancy alleviation was independent of ETR1, EIN4 and EIN2, while GA₃ required ethylene signaling component ETR1. The promoting effect of ethylene on seed germination was associated with a down-regulation of dormancy related genes in GA and ABA signalings, such as *RGA*, *GAI*, *RGL2* and *ABI5*.

The mutant affected in the proteolytic N-end rule pathway, *prt6*, was insensitive to ethylene in seed germination evidenced that PRT6 was involved in dormancy release by ethylene. It was confirmed that the insensitivity of *prt6* to ethylene was also related to the crosstalk with ABA/GAs. We also identified that substrates of the N-end rule pathway, the Ethylene Response Factors from group VII (ERFVIIs: HRE1, HRE2, RAP2.2, RAP2.3, and RAP2.12) might result in this insensitivity with the increased germination in *prt6 rap2.2 rap2.3 rap2.12* rather than in *prt6 hre1 hre2*, which also indicated that the 3 RAPs acted downstream of PRT6, while the 2 HREs acted at upstream of PRT6. Ethylene reduced the transcript expressions of the 3 RAPs in Col-0, but the 3 RAPs were maintained or induced by ethylene in *prt6*. Besides, the mutation in *PRT6* dramatically up-regulated *HRE2* in dry and imbibed seeds, but a mutation in the 3 RAPs in the background of *prt6* down-regulated *HRE2*, suggesting that the 3 RAPs might stimulate the expression of *HRE2* directly or indirectly. The proteome of *prt6* and Col-0 with (+) or (-) without ethylene treatment were compared. More significant proteins were selected in the group Col+/Col- (587 proteins) in comparison with that in *prt6*+/*prt6*- (30 proteins). The proteins in Col group were involved in signals perception and transduction, reserve mobilization and new material generation, which could contribute to seed germination. The functional class scoring analysis identified one Biological Process (BP) term, response to hypoxia, which was distinct in *prt6*, however it was then verified that the insensitivity of *prt6* to ethylene was independent of ROS production or respiration intensity.

Key words: ABA/GA; *Arabidopsis thaliana* L.; chilling; dormancy; ERFs; ethylene; germination; PRT6; N-end rule pathway

Résumé

Les graines dormantes d'*Arabidopsis thaliana* sont incapables de germer à l'obscurité et à des températures supérieures à 10 °C. L'éthylène (10-100 $\mu\text{L L}^{-1}$) comme la stratification au froid (2 à 4 jours à 4 °C) et le GA₃, stimule la germination des graines du genotype sauvage (Col-0) ayant une dormance primaire, à 25 °C et à l'obscurité. Parmi les mutants insensibles à l'éthylène n'ayant pas de triple réponse en présence de l'hormone (*etr1*, *ein4* et *ein2*), la dormance des graines de *etr1* and *ein2* n'est pas éliminée en présence de l'éthylène au contraire d'*ein4*, ce qui laisse penser que la lavée de dormance met en jeu une voie de signalisation non-canonique. L'élimination de la dormance au cours d'un traitement au froid n'exige pas la présence d'ETR1, d'EIN4 et d'EIN2, alors que l'effet stimulateur du GA₃ nécessite ETR1. L'amélioration de la germination des grains dormantes en présence d'éthylène est associée à une réduction de l'expression de gènes impliqués dans les voies de signalisation de l'ABA (*ABI5*) et des GAs (*RGA*, *GAI*, *RGL2*).

Les graines du mutant *prt6* affecté dans la voie "N-end rule" de la protéolyse, au niveau de la ligase E3 (PRT6) sont insensibles à l'éthylène, ce qui démontre que PRT6 intervient dans l'élimination de la dormance des graines par l'éthylène. Nos résultats montrent aussi que l'insensibilité des graines de *prt6* à l'éthylène résulte aussi d'une interrelation avec la balance ABA/GAs. Ils ont aussi permis de déterminer que les facteurs de transcription de la réponse à l'éthylène du groupe VII (ERFVII: HRE1, HRE2, RAP2.2, RAP2.3, and RAP2.12), substrats de la voie "N-end rule" de la protéolyse, interviennent vraisemblablement dans la réponse des graines à l'éthylène. L'acquisition d'une sensibilité à l'éthylène des graines après mutation des 3 RAPs et la meilleure germination des graines du quadruple mutant (*prt6 rap2.2 rap2.3 rap2.12*) que celle des graines du triple mutant (*prt6 hre1 hre2*), permet de suggérer que les 3 RAPs interviennent en aval de PRT6, alors que les 2 HREs sont actifs en amont de PRT6. L'éthylène induit une diminution de l'expression des transcrits des 3 *RAPs* dans Col-0, mais l'expression des 3 *RAPs* est maintenue ou induit par l'éthylène dans *prt6*. Par ailleurs, la mutation au niveau de *PRT6* entraîne une induction importante de *HRE2* dans les graines sèches et imbibées, alors qu'une mutation au niveau des 3 *RAPs* dans *prt6* résulte d'une réduction d'expression de *HRE2*, ce qui suggère que les 3 *RAPs* peuvent stimuler l'expression de *HRE2* de façon directe ou indirecte. Les protéomes des graines *prt6* et Col-0 en présence (+) ou en absence (-) d'éthylène ont été comparés grâce à une analyse de protéomique quantitative. Plus de protéines affectées significativement ont été sélectionnées et identifiées dans le groupe Col+/Col- (587 protéines) que dans le groupe *prt6*+/*prt6*- (30 protéines). Les protéines sélectionnées dans Col-0 interviennent dans la perception et la traduction des signaux, la mobilisation des réserves et la synthèse de nouveaux composés qui contribueraient à la germination. L'analyse des classes fonctionnelles a permis d'identifier « la réponse à hypoxie » comme processus biologique (BP) spécifique des graines de *prt6*, mais il a été montré que l'insensibilité à l'éthylène des graines de *prt6* est indépendante de la production des ROS et de l'intensité respiratoire.

Mots clés: ABA/GA; *Arabidopsis thaliana* L.; dormancy; ERFs; éthylène; froid; germination; PRT6; voie "N-end rule"

Résumé substantiel

La dormance des semences correspond à une inaptitude à la germination ou à une germination difficile lorsqu'elles sont placées dans des conditions apparemment favorables. Cette dormance s'installe pendant le développement sur la plante-mère, elle est alors qualifiée de dormance primaire, mais elle peut être induite après la récolte quand les semences sont placées dans des conditions environnementales défavorables à la germination, il s'agit alors d'une dormance secondaire. Dans le cas d'*Arabidopsis thaliana*, au moment de la récolte la dormance primaire des graines est caractérisée par une incapacité à germer à l'obscurité et à des températures supérieures à 10 °C. De nombreux travaux ont montré que le processus de dormance est régulé par des hormones, principalement, l'acide abscissique (ABA) impliqué dans l'induction des dormances primaire et secondaire et son maintien, et par les gibbérellines (GAs) qui favorisent l'élimination de la dormance et la germination. Le GA₃ (0,1 à 1 mM) ainsi que la stratification au froid (2 à 4 jours à 4 °C) permet aussi la germination des graines dormantes d'*Arabidopsis*. Par ailleurs, comme pour de nombreuses autres espèces, l'éthylène stimule la germination des graines dormantes du type sauvage (Col-0). Les objectifs de ce travail de thèse ont été (1) de préciser le rôle de la voie de signalisation de l'éthylène et du froid dans la régulation de la dormance des graines d'*Arabidopsis*, (2) de déterminer l'intervention de la voie "N-end rule" de la protéolyse et de ses substrats, les ERFVIIIs (facteurs de transcription de la réponse à l'éthylène du groupe VII) dans la réponse des graines à l'éthylène, et (3) d'analyser l'incidence d'un traitement en présence d'éthylène sur le protéome des graines dormantes du génotype sauvage (Col-0) et du mutant affecté dans la voie de protéolyse, *prt6*.

L'éthylène à 10-100 $\mu\text{L L}^{-1}$ permet la germination des graines dormantes placées à 25 °C et à l'obscurité; cet effet stimulateur nécessite l'application de l'hormone pendant au moins 16 h en présence d'au moins 5% d'oxygène et est associé à une diminution du rapport ABA/GA₄. La germination des graines dormantes en présence d'éthylène suggère une signalisation non-canonique de l'hormone car tous les mutants insensibles à l'éthylène caractérisés par l'absence d'une triple réponse des plantules (*etr1*, *ein4* et *ein2*) ne sont pas tous insensibles à l'éthylène au cours de la germination. Seules les graines dormantes des mutants *etr1* and *ein2* sont insensibles à l'éthylène, alors que la dormance des graines du

mutant *ein4* peut être éliminée en présence de l'hormone. La dormance des graines du génotype sauvage (Col-0) peut être éliminée par une stratification de 2 à 4 jours au froid (4 °C) ou une incubation en présence de GA₃ (0,1 à 1 mM). Les graines des 3 mutants (*etr1*, *ein4* et *ein2*) germent comme celles du type sauvage après une stratification au froid, ce qui suggère que la suppression de la dormance au froid n'exige pas la présence d'ETR1, EIN4 ou EIN2. Par contre, les graines dormantes du mutant *etr1* sont moins sensibles au GA₃, ce qui montre que l'action du GA₃ nécessite ETR1 dans la voie de signalisation de l'éthylène. Si l'action stimulatrice du froid est indépendante de la voie de signalisation de l'éthylène, une incubation de 24 h à 4 °C est capable d'induire une expression des transcrits *ETR1*, *EIN4* et *EIN2*. L'élimination de la dormance par de l'éthylène exogène est aussi associée à une réduction de l'expression des gènes intervenant dans la signalisation de l'ABA (*ABI5*) et des gibbérellines (*RGA*, *GAI* et *RGL2*) après 24-48 h d'incubation. L'éthylène exogène inhibe aussi l'expression d'*ETR1* et *EIN2*; ETR1 étant un régulateur négatif de la réponse à l'éthylène, cet effet peut sans doute conduire à une augmentation de la sensibilité des graines à l'hormone.

La voie "N-end rule" de la protéolyse est caractérisée par l'activité d'une ligase E3 (PRT6) pouvant dégrader les protéines en fonction de la nature de l'extrémité N-terminale. Les protéines caractérisées par les acides aminés His, Lys and Arg au niveau N-terminal sont reconnues par la ligase E3 et les ERFVII commençant par Met-Cys (HRE1, HRE2, RAP2.2, RAP2.3 et RAP2.12) ont été identifiées comme substrats de PRT6. Une fois, la Met éliminée, les Cys peuvent être oxydées. Nos résultats ont montré que les graines du mutant *prt6* sont insensibles à l'éthylène, mais que leur dormance peut être éliminée par un traitement au froid (4 °C) ce qui montre que PRT6 est impliquée dans la levée de la dormance par l'éthylène et non pas dans la levée de dormance au cours de la stratification au froid. Par ailleurs, les graines de *prt6* sont plus sensibles à l'ABA exogène et moins sensibles au GA₃ que celles de Col-0 et le rapport ABA/GA₄ est plus important dans les graines de *prt6* que dans celles de Col-0 incubées en présence d'éthylène. De plus, l'expression relative d'*ABI5*, *RGA* et *RGL2* pourrait être à l'origine d'un niveau plus élevé d'*ABI5* et *RGL2* dans *prt6* que dans Col-0. Par contre, si l'éthylène exogène inhibe l'expression de *ETR1* et *EIN2* dans Col-0, il n'a pas d'effet dans *prt6*.

Nous avons également montré que les substrats de la voie « N-end rule », ERFVII (HRE1, HRE2, RAP2.2, RAP2.3 et RAP2.12) peuvent intervenir dans l'insensibilité à l'éthylène des graines de *prt6*. Celle-ci est réversée par la mutation des 3 *RAPs*, et la germination des graines du quadruple mutant *prt6 rap2.2 rap2.2 rap2.3 rap2.12* est plus élevée que celle des graines du triple mutant *prt6 hre1 hre2*. Nos résultats indiquent également que les 3 *RAPs* fonctionnent en aval de PRT6, tandis que les 2 *HREs* agissent en amont de PRT6. L'éthylène entraîne une réduction de l'expression des transcrits des 3 *RAPs* dans Col-0, alors que l'expression des 3 *RAPs* est maintenue ou induite par l'éthylène dans *prt6*. En outre, *HRE2* est fortement régulée dans les graines *prt6* sèches et imbibées, mais une mutation des 3 *RAPs* dans le fond génétique de *HRE2* résulte d'une inhibition d'expression, ce qui suggère que les 3 *RAPs* pourraient stimuler l'expression de *HRE2* directement ou indirectement.

Les protéomes des graines du mutant *prt6* et de Col-0 imbibées pendant 16 et 30 h à 25 °C en présence (+) ou en absence (-) d'éthylène ont été comparés grâce à une analyse de protéomique quantitative (LC-MS/MS). Les protéines les plus significatives (avec des taux de variation <0.7 ou > 1.3 et un test de Tukey à P = 0.05) ont été identifiées dans le groupe de comparaison Col+/Col- (587 protéines) par rapport à *prt6*+/*prt6*- (30 protéines). Vingt-neuf protéines communes aux 2 groupes Col+/Col- et *prt6*+/*prt6*- ont aussi été identifiées, parmi celles-ci 5 présentent des variations dans des sens opposés avec une augmentation des protéines en présence d'éthylène dans Col-0 et une diminution de celles-ci dans *prt6*. Ces 5 protéines pouvaient constituer des candidats potentiels pour tester la sensibilité à l'éthylène, mais une seule mutation des 5 gènes correspondants ne s'est pas traduite par une différence de réponse des graines à l'éthylène par rapport à Col-0. Les protéines du groupe Col+/Col- sont impliquées dans la perception et la transduction de signaux, la mobilisation de réserves et la synthèse de nouveaux matériaux, susceptibles de contribuer à la germination des graines. L'analyse de la notation des classes fonctionnelles a mis en évidence un terme de « Processus Biologique » (BP), « réponse à l'hypoxie », qui est spécifique à *prt6*. Par ailleurs, en présence d'éthylène, la production de H₂O₂ est similaire dans les graines de *prt6* et de Col-0, et l'intensité de la respiration des graines est plus élevée dans *prt6* que pour le génotype sauvage, indiquant que l'insensibilité de *prt6* à l'éthylène était indépendante de la production de ROS ou de la respiration.

En conclusion, grâce à des approches physiologiques, génétiques, moléculaires et des analyses de protéomique quantitative, nos résultats ont permis de préciser l'intervention de la voie de signalisation de l'éthylène dans la levée de la dormance des graines d'Arabidopsis en relation avec l'activité de PRT6 de la voie « N-end rule » et une régulation mettant en jeu les ERFVIIIs en interrelation avec les voies de signalisation de l'ABA et des GAs.

List of Abbreviations

ABA	Abcisic Acid
ABI	ABA Insensitive
ACO	ACC Oxidase
ACS	ACC Synthetase
AHP	Arabidopsis Histidine-containing Phosphotransmitter
AO4	Aldehyde Oxidase 4
AP2	Apetala 2
ARR	Arabidopsis Response Regulators
ATE	Arginyl-tRNA Transferase
BP	Biological Process
BR	Brassinosteroids
CTR	Constitutive Triple Response
d	day
DEPs	Differentially Expressed Proteins
DW	Dry Weight
EBF	EIN3 Binding F-BOX
EIL	EIN Like
EIN	Ethylene Insensitive
ER	Endoplasmic Reticulum
ERF	Ethylene Response Factors
ERS	Ethylene Response Sensor
ETP	EIN2 Targeting Protein
ETR	Ethylene Response
GAI	GA Insensitive
GAs	Gibberellins
GO	Gene Ontology
GSEA	Gene Set Enrichment Analysis
HRE	Hypoxia Response
HRPEs	Hypoxia Responsive Promoter Elements
JAs	Jasmonates
LEA	Late Embryogenesis Abundant
MAPK	Mitogen-activated Protein Kinase
MAT3	Methionine Adenosyltransferase 3
MKK	Mitogen-Activated Protein Kinase Kinase

MTO	S-Adenosylmethionine Synthetase
NO	Nitrogen Oxide
PCA	Principle Components Analysis
PCO	Plant Cysteine Oxidases
PDS	Pathifier Deregulation Score
PRT	Proteolysis
PTM	Posttranslational Modification
PYR	Pyrabactin Resistance
QTL	Quantitative Trait Locus
RAN	Response to Antagonist 1
RAP	Related to AP
RGA	Repressor of <i>gal-3</i>
RGL2	RGA Like 2
RNS	Reactive Nitrogen Species
ROS	Reactive Oxygen Species
RTE1	Reversion to Ethylene Sensitivity 1
SAM1	S-Adenosylmethionine Synthetase 1
SD	Standard Deviation
SSP	Seed Storage Proteins
TAIL	Terminal Amine Isotope Labelling
UPS	Ubiquitin-Proteasome System
VRN2	Vernalization 2
XIC	eXtracted Ion Current

Contents

Introduction.....	13
Chapter I Review on the main processes studied: seed germination and dormancy, hormonal regulation of dormancy (ABA, GAs and ethylene) and the N-end rule pathway.....	17
I.1 Seed germination	18
I.2 Seed dormancy: definition, cause and classification	19
I.3 External factors regulating seed germination and dormancy.....	21
I.3.1 Water	21
I.3.2 Temperature.....	22
I.3.3 Oxygen	23
I.4 Regulation of seed dormancy by abscisic acid and gibberellins.....	25
I.4.1 Abscisic acid (ABA).....	25
I.4.2 Gibberellins (GAs)	27
I.4.3 Crosstalk between GAs and ABA	30
I.5 Effects of ethylene on seed germination.....	31
I.5.1 History of ethylene	31
I.5.2 Ethylene biosynthesis	32
I.5.3 Ethylene signaling	35
I.5.4 Non-canonical ethylene signaling.....	39
I.5.5 Ethylene signaling feedback	44
I.5.6 Ethylene responsive factors (ERFs).....	45
I.5.7 Ethylene crosstalk with ABA and GA in seed germination.....	50
I.6 Mechanisms involved in dormancy release	51
I.6.1 Stratification	51
I.6.2 After ripening	52
I.7 N-end rule pathway.....	54
I.7.1 Definition of N-end rule pathway.....	54
I.7.2 The Arg/N-end rule in plants.....	55
Chapter II Revisiting the role of ethylene and N-end rule pathway on chilling-induced dormancy release in Arabidopsis seeds	57
Chapter III Breaking <i>Arabidopsis thaliana</i> seed dormancy by ethylene is regulated by the N-end rule through the group VII ERF transcription factors	71
Abstract	72
III.1 Introduction	72
III.2 Materials and Methods	76

III.2.1 Seed material.....	76
III.2.2 Seed production	76
III.2.3 Germination assays	76
III.2.4 RNA extraction and real-time quantitative RT-PCR	77
III.2.5 Seed respiration.....	78
III.2.6 Hydrogen peroxide content.....	78
III.3 Results	78
III.3.1 Involvement of the N-end rule and ERFVII on dormancy release by ethylene	78
III.3.2 Effect of chilling on the relative expression of <i>ERFVII</i> s in Col-0	81
III.3.3 Effect of ethylene on the expression of <i>ERFVII</i> s in Col-0.....	85
III.3.4 Effect of ethylene on the expression of <i>ERFVII</i> s in <i>prt6</i>	88
III.3.5 The regulation of HRE2 in seed germination.....	90
III.3.6 Involvement of ABA and GA in the responsiveness of Col-0 and <i>prt6</i> to ethylene	92
III.3.7 Crosstalk of seed sensitivity to ethylene and hypoxia.....	95
III.4 Discussion	96
Supplementary results	100
Chapter IV Label-free quantitative proteomics reveals the involvement of the Arg/N-end rule pathway in <i>Arabidopsis thaliana</i> seed responsiveness to ethylene	105
Abstract	106
IV.1 Introduction.....	107
IV.2 Materials and Methods.....	107
IV.2.1 Seed material	110
IV.2.2 Germination assay	110
IV.2.3 Seed treatment	111
IV.2.4 Protein extraction and LC-MS analysis	111
IV.2.5 Protein identification and quantification.....	111
IV.2.6 Bioinformatic analysis	112
IV.2.7 Measurements of ABA and GA ₄	113
IV.3 Results and Discussion	113
IV.3.1 Effects of ethylene treatment on the germination of dormant seeds	113
IV.3.2 Proteome more affected after 30 h than after 16 h.....	115
IV.3.3 Effects of ethylene on the expression of DEPs	115
IV.3.4 Effect of <i>prt6</i> on the expression of DEPs after 30 h	122
IV.3.5 Functional class scoring analysis without filtering DEPs in 30 h proteome	124
IV.3.6 Abundant proteins in seed.....	126
IV.3.7 Hormone-related proteins in seed	127
IV.4 Discussion and conclusion.....	128
Supplementary results	133
General conclusion and perspectives	136
References (for Introduction, Chapter I, III, IV and Conclusion).....	141

Introduction

Spermatophytes are the most successful and advanced group of land plants, the seeds of which act as reproductive structures and have tremendous advantages to conservation, dispersion and propagation. The presence of surrounding integuments and nutrients improve the fitness of seeds to diverse environmental conditions, while the embryo within the seed contains the genetic information that allows seeds to develop into different organs (Kozłowski and Gunn, 1972). The importance of seeds is evident. Seeds comprise a large part of the human diet and livestock feed, and also contribute to the medical and industrial applications. Conversely, enhancing the seed production of food crop and economic crop, developing seed certification system have emerged as growing concerns for food safety economics.

In the plant life cycle, seed germination is an important event that represents the emergence of a new life. The germination efficiency depends on internal factors, development, maturation and dormancy state, and external factors, *i.e.* environmental conditions. In agriculture, the control of seed germination and dormancy plays a critical role in crop development synchronization and weed management strategies. Deep understanding of the transition between dormancy and germination, and of the effects of genetics and environment in the seed trait has then a long-lasting significance. Seed dormancy is an important component of plant fitness that results in a delay of germination (Bewley and Black, 1994; Finch-Savage and Leubner-Metzger, 2006). It corresponds to the inability to germinate in apparently favorable conditions, and its regulation by the hormonal balance between abscisic acid (ABA) and gibberellins (GAs) is well documented (Bewley, 1997; Graeber *et al.*, 2012). ABA dominates the induction and maintenance of dormancy, while GAs are involved in the release of dormancy and germination (Finkelstein, *et al.*, 2008; Shu *et al.*, 2016). In addition, other hormones such as ethylene, jasmonate or brassinosteroids, can improve the germination of dormant seeds in various species, by breaking of dormancy, and stimulate the germination of non-dormant seeds incubated in unfavourable conditions (Steber and McCourt, 2001; Linkies and Leubner-Metzger, 2012; Arc *et al.*, 2013b; Corbineau *et al.*, 2014).

The molecular mechanisms of seed germination and dormancy have been advanced by intensively genetic, epigenetic and omics studies. Some key regulators, such as hormones, proteins, QTLs and other small molecules work in a coordinated manner in this development fate switch (Finkelstein *et al.*, 2008; Nonogaki, 2014; Bassel, 2016; Shu *et al.*, 2016). However, the precise signal integration and information transduction about seed germination and dormancy remain to be further elucidated. The ubiquitin-proteasome system (UPS) degrades the proteins by targeting specific signals and contributes to numerous plant hormone signaling, in particular, that of ABA, GAs and ethylene (Santner and Estelle, 2010; Kelley and Estelle, 2012). As a part of the ubiquitin system, the N-end rule pathway regulates the *in vivo* half-life of the proteins depending on their N-terminal residue (Varshavsky, 1997; Graciet and Wellmer, 2010). Until now, some developmental and growth phenotypes have been reported in N-end rule mutants in plants. They were affected in the promotion of senescence (Yoshida *et al.*, 2002), in the regulation of germination in relation with ABA (Holman *et al.*, 2009), in tolerance to hypoxia (Bailey-Serres *et al.*, 2012; Gibbs *et al.*, 2011; Licausi *et al.*, 2011; Mendiondo *et al.*, 2016) and in pathogen responses in plants (De Marchi *et al.*, 2016). The group VII of Ethylene Response Factor (ERF) transcription factors and its regulation by the N-end rule pathway have emerged as pivotal regulators of low oxygen responses of crops (Bailey-Serres *et al.*, 2012; Hartman *et al.*, 2019) and pathogen resistance (De Marchi *et al.*, 2016).

The objectives of the present thesis were: (1) to study the effects of ethylene in germination of dormant seeds and the involvement of its signaling in the dormancy release by GA and chilling using various mutants; (2) to determine the role of the proteolytic N-end rule pathway on the responsiveness to ethylene, chilling, and GA/ABA; (3) to measure the gene expression of the important components in the GA, ABA and ethylene signaling, and particularly of Ethylene Response Factors from group VII (ERFVIIs) with the treatment of chilling and ethylene in the wild type (Col-0) and the N-end rule mutant, (*prt6*); (4) to search the mechanisms involved in the insensitivity of *prt6* mutant to C₂H₄ by doing a label-free quantitative proteomics with Col-0 and *prt6* seeds incubated with and without ethylene.

After a general review on seed germination and dormancy, and the main mechanisms involved in dormancy (part I), the results obtained were then presented in parts II, III and IV of the manuscript in a form of three articles. Results presented in Part II concerned the

involvement of the N-end rule pathway and ethylene signaling in the regulation of seed germination and dormancy in relation to chilling and GAs; these results were published in IJMS in 2018 (Wang *et al.*, 2018). Results obtained with N-end rule mutants, ERFVII mutants and the combination mutants used to test their responsiveness to ethylene, the transcript abundance of *ERFVII*s, *DELLA*s, *ABI5*, *ETR1*, *EIN2* determined in Col-0 seeds and *prt6* seeds were presented in Part III. In that Part, we have also investigated the crosstalk of seeds sensitivity to ethylene and hypoxia and mimicked the phenotype of *prt6*. In Part IV, proteomic analysis was employed to compare the sensitivity of Col-0 seeds and *prt6* seeds to ethylene, and to achieve significant proteins that result in their difference in ethylene response. Finally, the results were discussed in the general conclusion, and some research perspectives were suggested.

Chapter I Review on the main processes studied: seed germination and dormancy, hormonal regulation of dormancy (ABA, GAs and ethylene) and the N-end rule pathway

I.1 Seed germination

Germination occurs when seeds are incubated in favorable conditions. Germination *sensu stricto* is defined as the imbibed seeds completing radicle protrusion. Physically germination consists of testa and endosperm rupture, and then rupture of the micropylar endosperm by the emerging radicle. Following germination, root elongation and seedling development are referred to as post-germination events. However, in agriculture, seed germination is often considered as the emergence of seedlings from the soil and the transition from heterotrophy to autotrophy (Bewley, 1997; Nonogaki *et al.*, 2010). Germination is a triphasic process: imbibition (phase I), germination *stricto sensu* (phase II) and growth (phase III) (Figure 1). Upon imbibition, metabolic activities in the seeds are triggered. A rapid and short duration of water uptake initiated in phase I results from the matric force of the cell content. The occurrence of this phase is irrespective of the status of a seed (dormancy and viability). Following phase I, the solute or osmotic potential will gradually arrive at phase II plateau phase, where dormant or dead seeds can also maintain, but uptake of water increases exponentially again in germinating seeds, which is called phase III or growth where seeds complete radicle emergence and seedling growth (Bewley and Black, 1978).

Upon imbibition, the influx of water into cells results in structural perturbations of the membrane. Within a short period, the configuration of the membrane will become more stable and solutes leakage decrease. One of the initial changes upon imbibition is the resumption of respiratory activity, but the immediate and rapid water influx also damage organelles, for instance, mitochondria, which is critical for energy metabolism. At the same time, the damage to DNA is also inevitable and its repair also continues in phase II. It appears that cellular damage repair is a priority event in phase I rather than protein synthesis (Nonogaki *et al.*, 2010). Although some metabolic events start soon after imbibition, most of which occur in phase II. Stored mRNAs produce during seed development, they undertake their mission after water uptake, either being degraded because of oxidation or translation after modification (Kimura and Nambara, 2010a; Bazin *et al.*, 2011b; El-Maarouf-Bouteau *et al.*, 2013). Indeed, the *de novo* transcription is also present in phase II (Rajjou *et al.*, 2012). The initiation of reserves mobilization starts in phase II, but most take place in phase III, which begins with the radicle elongation. It is supported by the cell wall softening and the elongation of cells behind radicle, that is, hypocotyl and transition zone, rather the elongation

of radicle cells itself, that push out the radicle (Sliwinska *et al.*, 2009). Conversely, it is due to the cell expansion, not cell division, which otherwise mostly occurs in the post-germination stage, where also the presence of a series of DNA synthesis, transcription, translation and major reserve mobilization allow seedling development.

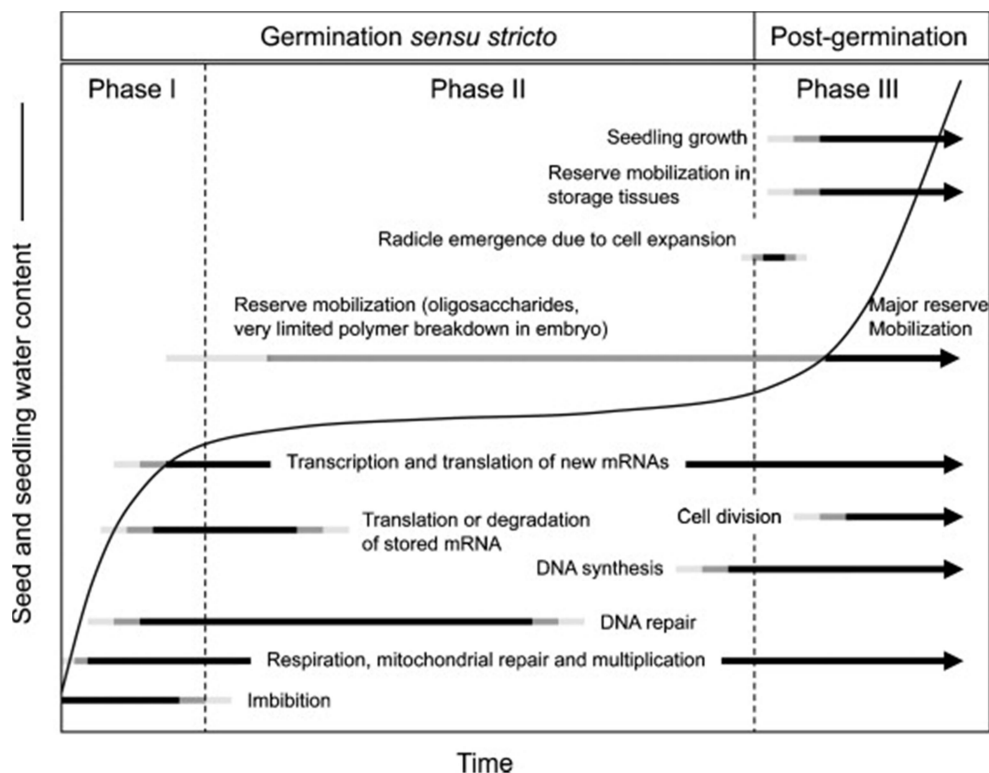

Figure 1 Time course of major events in the process of seed germination (phases I and II) and post-germination (phase III). The exact duration of each phase depends on species and imbibition conditions. The curve shows the time course of water content (Nonogaki *et al.*, 2010).

I.2 Seed dormancy: definition, cause and classification

Seed dormancy corresponds to the inability of viable seeds to germinate under apparently favorable environmental conditions that otherwise is suitable for the germination of non-dormant seeds (Bewley, 1997; Baskin and Baskin, 2004). Depending on its cause, seed dormancy is classified into several classes: (1) Physical dormancy (PY), which is caused by the restriction of water-impermeable seed coat or embryo covering layer. The treatment of disruption or scarification on seeds will weaken the surrounding structures, allowing water uptake; (2) Morphological dormancy (MD), that corresponds to underdeveloped or

undifferentiated embryos, which only need time to grow into full size or differentiate into different tissues; (3) Physiological dormancy (PD), which is the most common kind of dormancy and has been extensively studied in *Arabidopsis thaliana*. The embryo of physiologically dormant seeds isolated from surrounding structures grows normally and its surrounding structure is water-permeable. The cause of PD can be from the inhibited growth potential of the embryo or the mechanical resistance from embryo covering structure (testa or endosperm). PD can be alleviated during dry storage (after-ripening), moist-chilling, gibberellins (GAs) or ethylene treatment; (4) Combinational dormancy, such as PY+PD, PD+MD, which makes the scheme of dormancy more complex (Baskin and Baskin, 2004; Finch-Savage and Leubner-Metzger, 2006). PD or combinational dormancy is not an all or nothing stage, the dormant level of which changes with the environmental factors and internal physiological response. The transitional status has been named as “dormancy continuum”, conditional dormancy or relative dormancy (Baskin and Baskin, 1985; Baskin *et al.*, 1998; Probert, 2000; Baskin and Baskin, 2004).

Seed dormancy is also classified into primary dormancy and secondary dormancy according to their establishment. Primary dormancy develops during seed development and is acquired after seed maturation on the mother plant. The primary dormancy is determined by the maternal environment during seed maturation except for the genetic origin. The secondary dormancy develops when primary dormant seeds or non-dormant seeds are incubated under unfavorable conditions, for example, anoxia or hypoxia, unsuitable temperature or illumination (Figure 2) (Bewley, 1997; Finch-Savage and Leubner-Metzger, 2006). The adaptive trait of seed dormancy is beneficial for seed preservation, by preventing germination out of season and ensuring plant survive under stressful conditions (Bewley, 1997). In agricultural production, most of the domesticated crops show decreased level of seed dormancy in comparison with wild species. The inappropriate loss of dormancy and rapid germination before sowing, or even on the mother plant such as pre-harvest sprouting, will result in huge loss to the yield and quality of crops production (Simsek *et al.*, 2014). For this reason, QTLs analysis and molecular breeding has facilitated strategies of marker-assisted selection for the improvement of pre-harvest sprouting tolerance (Kulwal *et al.*, 2010; Kulwal *et al.*, 2012).

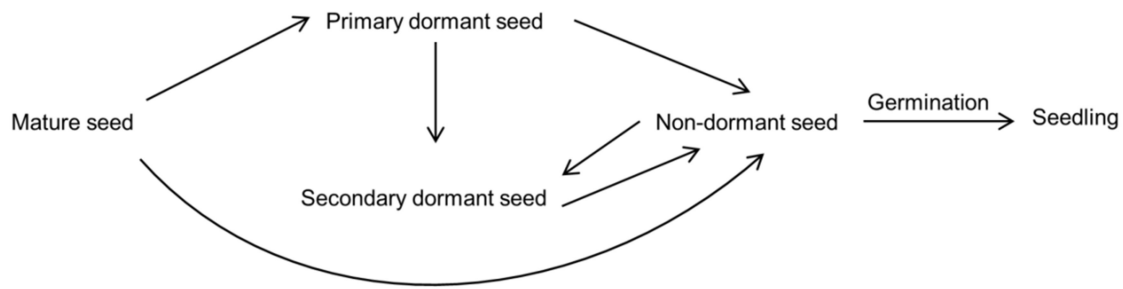

Figure 2. Development of primary and secondary dormancy in seeds (adapted from Kermode, 2005).

I.3 External factors regulating seed germination and dormancy

Water, oxygen and temperature, the three essential factors to trigger metabolic activity in seed germination and dormancy are practically inseparable (Corbineau and Côme, 1995; Baskin and Baskin, 1998). In addition, the effect of light should not be ignored.

I.3.1 Water

Water status of the seed is critical to its survival and germination. Based on the water content and desiccation tolerance, seeds are divided into orthodox seeds and recalcitrant seeds. The moisture of orthodox seeds is about 5-15% dry weight and they can withstand more intense desiccation. Moreover, the low water content also improves their tolerance to low temperatures. In contrast, at dispersal or harvest, recalcitrant seeds contain much water, the water content being from 20-180% dry weight basis (Robert and Ellis, 1989). They usually have no dormancy after seed dispersal, but they cannot survive dehydration below such as 15-20% in *Hevea brasiliensis* or 30-40% in *Mangifera indica*, *Araucaria angustifolia* and *Quercus sessiliflora*. (Berjak *et al.*, 1984; Chin *et al.*, 1981; Robert and Ellis, 1989; Hendry *et al.*, 1992; Espindola *et al.*, 1994). It is then proposed that a gradient of the intermediate state exists between orthodox and recalcitrant categories after more and more species are studied (Barbedo *et al.*, 2013).

Otherwise, excess of water in orthodox seeds, for instance, immersing seeds into water, inhibits germination or induces a secondary dormancy because of hypoxia (Benvenuti and Macchia, 1997). However, seeds from aquatic plants or some seed species like rice can germinate well with excessive water (Corbineau, 1995; Corbineau and Côme 1995). For

ultra-dried seeds, in order to decrease the cell injury that comes from membrane damage or fast water uptake, it is recommended firstly rehydrate them in an atmosphere with high humidity before imbibition (Black *et al.*, 2006a).

I.3.2 Temperature

Temperature affects the germination directly, through action on germination itself, or indirectly, by affecting dormancy and viability. The effect of temperature on dormant seeds is quite complicated and it is well explained in section I.6 in the case of dormancy alleviation, such as after-ripening and stratification. In *Arabidopsis*, primary dormancy cannot be removed at higher temperatures above 20 °C in darkness (Figure 3A) (Leymarie *et al.*, 2012). It has been suggested that seed dormancy at high temperatures after imbibition is due to a barrier for transport of O₂ to the embryo (Junttila, 1974).

Each species is characterized by a temperature range over which germination is possible. For each seed population there exist 3 cardinal temperatures for germination: the maximum (the temperature above which no seed can complete germination), minimum (the temperature below which no seed can germinate) and optimum (the temperature at which the germination rate is the highest). The use of cardinal temperature is possible to predict the time of crop sowing and weed management. For most plants, the optimum and base temperature is 15-20 °C, 20-30 °C, respectively (Roberts, 1988; Heidari *et al.*, 2014). Non-dormant seeds can be classified in 3 categories according to the temperature range that allows their germination: seeds from temperate climates germinate at relatively low temperatures (optimum around 10-20 °C or less), seeds from tropical or subtropical climates which only germinate at relatively high temperatures (30-40 °C) and some seeds are able to germinate in wide range of temperature (Black *et al.*, 2006b).

Once a seed has lost dormancy, they germinate at a wide temperature range after imbibition (Figure 3B). The temperature higher than the maximum temperature often results in induction in thermo-inhibition of germination or thermo-dormancy. The seeds in the former case are able to germinate once moved to an optimal temperature, whereas the seeds in the latter case need dormancy release before germination.

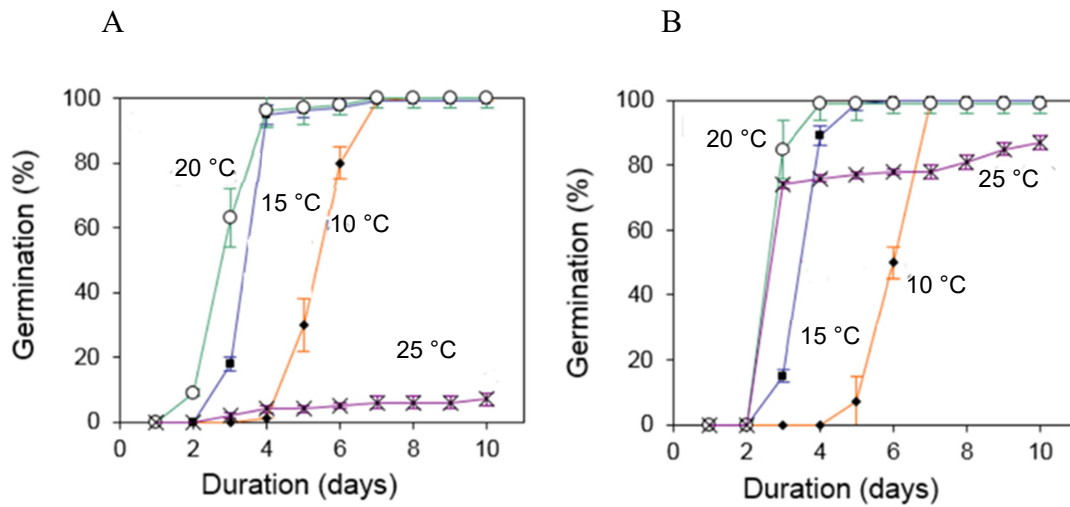

Figure 3. Germination of dormant and non-dormant Col-0 seeds. (A) Freshly harvested seeds. (B) Seeds after-ripened for 5 weeks at 20 °C. Germination assay was carried out at 10 °C (orange), 15 °C (blue), 20 °C (green) and 25 °C (purple) in the dark (from Leymarie *et al.*, 2011).

I.3.3 Oxygen

The capability of seed germination firstly relies on the imbibition at suitable temperatures, but the essential necessity of oxygen should also be taken into consideration (Shull, 1914; Junttila, 1974; Corbineau and Côme, 1995). Promoted respiration is one of the most important events after seed imbibition, which increases the requirement of oxygen (Nonogaki *et al.*, 2010). Measurement of oxygen concentration in seeds by oxygen micro-sensors shows that the imbibing hydro-absorber coating resulted in strongly hypoxic conditions in the embryo. It has been proposed that the cause of seed coat or endosperm imposed dormancy is possibly a low oxygen supply to the embryo apart from the mechanical restrictions (Simon and Keith, 2008; Borisjuk and Rolletschek, 2009; Rolletschek *et al.*, 2009; Gorim and Asch, 2015, 2017; McGill *et al.*, 2018). The restriction of oxygen availability in the embryo can be alleviated by removing the covering structure. In addition, increasing partial oxygen pressure also takes effect, which has been developed into elevated partial pressure of oxygen system to mimic accelerated dry after-ripening in research and industry (Buijs *et al.*, 2018).

The sensitivity to oxygen during the germination process is species-specific. It is indicated that oilseeds are more sensitive to oxygen than starchy seeds (Al-Ani *et al.*, 1985). Several aquatic plants are less sensitive to hypoxia (Corbineau and Côme, 1995). Enough oxygen within the lotus seed allows its germination at 100% nitrogen (Ohga, 1926). Otherwise, oxygen deficiency at optimal temperature often leads to dormancy induction (secondary dormancy) in seeds *Brassica napus* and *Lactuca sativa* (Vidaver and Hsiao, 1975; Pekrun *et al.*, 1997). As discussed previously, covering structure inhibits oxygen availability in embryo, and it will be much worse after water penetrates and drives off the air. In this case, oxygen availability mainly depends on temperature. For example, the effect of hypoxia on the induction of seed dormancy will be terminated or even be promoted germination at low temperature, which is owing to the low-temperature increase oxygen solubility that in turn, decreasing its sensitivity to anoxia (Honěk and Martinková, 1992). Interestingly, complete deprivation of oxygen may also break dormancy and promote germination, such as in apple embryo or lettuce seeds, which is suggested that the opposite effect results from the production of ethanol, since it is able to stimulate germination at a certain concentration (Corbineau and Côme, 1995; Miyoshi and Sato, 1997). On the other hand, the regulation of anoxia or intense hypoxia on seed germination or dormancy is also involved in the effect of ethylene (Corbineau and Côme, 1995). Last but not least, the oxygen level is essential for the production of ROS and NO, both of which play a role in the promotion of seed germination (Arc *et al.*, 2013a; Soundararajan *et al.*, 2017).

I.3.4 Light

Light can enhance or inhibits seed germination according to the plant species and light quality. The photoreceptor responsible for most types of light-responsiveness is the phytochrome that exists in 2 reversible forms, the red-absorbing Pr (inactive form) and the far-red absorbing Pfr (active form). In Arabidopsis, the role of the red/far-red absorbing phytochromes is well known. The light signals are transmitted to GA and ABA-related genes via PIL5/PIF1 and SOM that are negative regulators of germination (Oh *et al.*, 2007; Seo *et al.*, 2009). The plant blue-light photoreceptors are cryptochromes, phototropins and ZTL/FKF1/LKP2 family (Banerjee and Batschauer, 2005). In seed germination, the blue light

perception by cryptochrome is the most important category (Gogin and Steadman, 2011; Barrero *et al.*, 2012).

I.4 Regulation of seed dormancy by abscisic acid and gibberellins

I.4.1 Abscisic acid (ABA)

During seed development and maturation, ABA plays an essential role in the regulation of *LEA* gene expression, levels of seed storage proteins and desiccation tolerance (Finkelstein *et al.*, 1985; Vicente-Carbajosa and Carbonero, 2005; Gutierrez *et al.*, 2007). It was also shown that the establishment of dormancy during seed development involves ABA produced by fertilization-derived seed tissues rather than that produced by maternal tissues (Karszen *et al.*, 1983; Kanno *et al.*, 2010). Exogenous ABA blocks the germination of non-dormant seeds, and the sensitivity to ABA is higher in dormant seeds than after-ripened (non-dormant) seeds (Nambara *et al.*, 2010).

The endogenous ABA level depends on the biosynthesis and catabolism of the hormone (Figure 4). Its biosynthesis starts with epoxidation of zeaxanthin by zeaxanthin epoxidase (ZEP/ABA1) in plastids, and then the products are cleaved by 9-cis-epoxycarotenoid dioxygenase (NCED/ABA4) to yield xanthoxin with NCED acting as the critical rate-limiting enzyme in the ABA synthesis. In the cytosol, xanthoxin is then converted to ABA precursor, abscisic aldehyde by a short-chain dehydrogenase reductase (SDR/ABA2). Finally, the precursor is catalyzed into ABA by abscisic aldehyde oxidase (AAO) (Thompson *et al.*, 2000). It is also reported that the enzyme AAO can be activated by the sulfated form of molybdenum cofactor (MoCo) with the involvement of molybdenum cofactor sulfurase (ABA3) (Watanabe *et al.*, 2018) (Figure 4). At the same time, ABA can be inactivated through oxidation mainly at C-8' position by cytochrome P450-dependent monooxygenase, CYP707A (Figure 4). ABA catabolism mutant *cyp707a1* shows enhanced dormancy while ABA biosynthesis mutant such as *nced6* and *nced9*, exhibit less dormancy (Kushiro *et al.*, 2004) (Lefebvre *et al.*, 2006). However, it is indicated that ABA content in mature dry seeds is not related to the dormancy level, which suggests that ABA signaling also plays a role in the promotion of seed dormancy apart from ABA abundance (Ali-Rachedi *et al.*, 2004; Lee *et al.*, 2010).

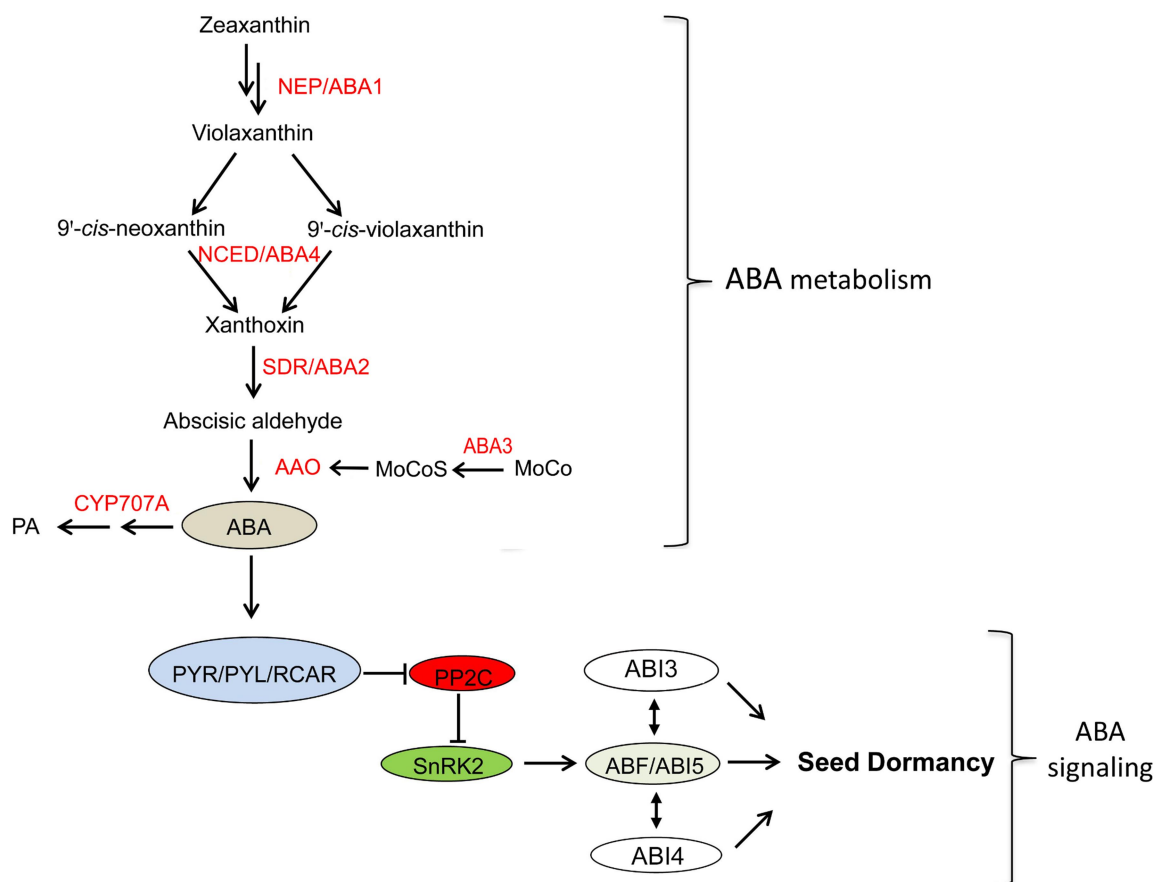

Figure 4. ABA metabolism and ABA signaling in seed dormancy. ABA metabolism and ABA signaling in seed dormancy. NEP (ABA1): zeaxanthin epoxidase; NCED (ABA4): 9-cis-epoxycarotenoid dioxygenase; SDR/ABA2: a cytosolic short-chain dehydrogenase/reductase; AAO: abscisic aldehyde oxidase; ABA3: molybdenum cofactor sulfurase; CYP707A: cytochrome P450-dependent mono-oxygenase; PYR: pyrabactin resistance1; PYL: PYR1-like; RCAR: regulatory components of ABA receptor; PP2C: phosphatase 2C proteins; SnRK2: subfamily 2 SNF1-related kinase; ABF: ABA-responsive element-(ABRE) binding factors; ABI5: ABA INSENSITIVE 5 (adapted from Tuan *et al.*, 2018).

ABA receptor pyrabactin resistance1/PYR1-like/regulatory components of ABA receptor (PYR1/PYL/RCAR) (named PYLs for simplicity) are core regulators of ABA signaling. The phosphatase 2C proteins (PP2C) locate at the center of the ABA signaling, which interacts with ABA receptors or subfamily 2 SNF1-related kinase (SnRK2) in a similar manner, negatively regulating ABA responses (Ma *et al.*, 2009; Soon *et al.*, 2012). The formation of the complex ABA-PYR1/PYL/RCAR inhibits the phosphatase activity of PP2C and thereby activates SnRK2 (Ng *et al.*, 2014). SnRK2 then turns on ABA-responsive element-(ABRE) binding factors (ABFs). Subsequently, ABFs bind with ABA-responsive

genes that contain ABRE motif (Hobo *et al.*, 1999; Nambara *et al.*, 2010). ABI5 is one of the important ABFs and it is positively regulated by ABI3 and ABI4 (Reeves *et al.*, 2011; Skubacz *et al.*, 2016). Many target genes of ABI5 are involved in the regulation of the seed dormancy process, such as *PGIP1* (*POLYGALACTURONASE INHIBITING PROTEIN 1*), *LEAs* and *EMI* (*EARLY METHIONINE-LABELED 1*) (Finkelstein and Lynch, 2000; Kanai *et al.*, 2010; Chauffour *et al.*, 2019).

In ABA signaling, some of the receptors are regulated by ubiquitination-mediated degradation via the 26S proteasome. RSL1 (Ring finger of Seed Longevity1) from RING-type E3 ligase and DDA1 (Damaged DNA Binding protein1 (DDB1)-Associated1) from CUL4-DDB type E3 ligase are involved in the process (Yu *et al.*, 2016). Plant U-box type E3 ligase PUB12 and PUB13 interact with PP2C protein, ABI1 (Kong *et al.*, 2015). In the nucleus, ABI5 interacts with KEG (KEEP ON GOING), a RING finger-type ligase. It is then suggested that KEG is also possible to regulate ABF1 and ABF3 (Stone *et al.*, 2006; Chen *et al.*, 2013).

I.4.2 Gibberellins (GAs)

GAs is the major hormone that breaks seed dormancy and promotes seed germination by repressing the ABA-imposed seed dormancy. There is more than 160 GAs and they are named according to the order of discovery. The major bioactive GAs includes GA₁, GA₃, GA₄ and GA₇ with GA₁ and GA₄ being more widespread (Yamaguchi, 2008). In Arabidopsis, GA₄ is thought to be the major bioactive GAs (Hu *et al.*, 2008). The level of bioactive GAs is determined by the balance between GAs synthesis and GAs catabolism.

GA synthesis is initiated by geranylgeranyl diphosphate (GGDP). After two steps of catalyzations in the plastid, it is converted to *ent*-kaurene. Sequentially, in the endoplasmic reticulum, *ent*-kaurene is oxidized into GA₁₂ aldehyde by cytochrome P450 monooxygenases, KO and KAO. Finally, the formation of bioactive GA is mainly controlled by GA 20-oxidase (GA20ox) and GA3-oxidase (GA3ox), while its inactivation is regulated by GA2-oxidase (GA2ox) (Yamauchi *et al.*, 2004) (Figure 5). GAs signaling is triggered by the perception of GAs by the receptor GID1 (GIBBERELLIN INSENSITIVE DWARF1). The binding of GAs-GIDs promotes the interaction between GIDs and DELLAs and then enhances the recognition of DELLAs by ubiquitin E3 ligase SCF complex (Skp, Cullin, F-box containing

complex), resulting in the degradation of DELLAs through 26S ubiquitin-proteasome (Murase *et al.*, 2008; Sponsel, 2018) (Figure 5). The repression of DELLAs will then alleviate the expression of GA-responsive genes directly or indirectly (Eckardt, 2007; Yoshida *et al.*, 2014). In Arabidopsis, there are five DELLAs, RGA (REPRESSOR OF *gal-3*), GAI (GA INSENSITIVE), RGL1 (RGA LIKE 1), RGL2, RGL3 that have distinct or overlapping functions. RGL2 plays the main role in the regulation of seed germination, although RGA, GAI, and RGL3 also contribute (Lee *et al.*, 2002; Stamm *et al.*, 2012). In the developing seeds, there is an accumulation of GA precursors or bioactive GA that takes effects in fertilization, embryo growth and assimilate uptake (Kucera *et al.*, 2005). The mechanism of GAs in the release of seed dormancy and promotion of seed germination has been proposed as (1) GAs increase the growth potential of the embryo; (2) GAs improve the expression of hydrolytic enzymes to weaken the surrounding structure (Finch-Savage and Leubner-Metzger, 2006; Holdsworth *et al.*, 2008).

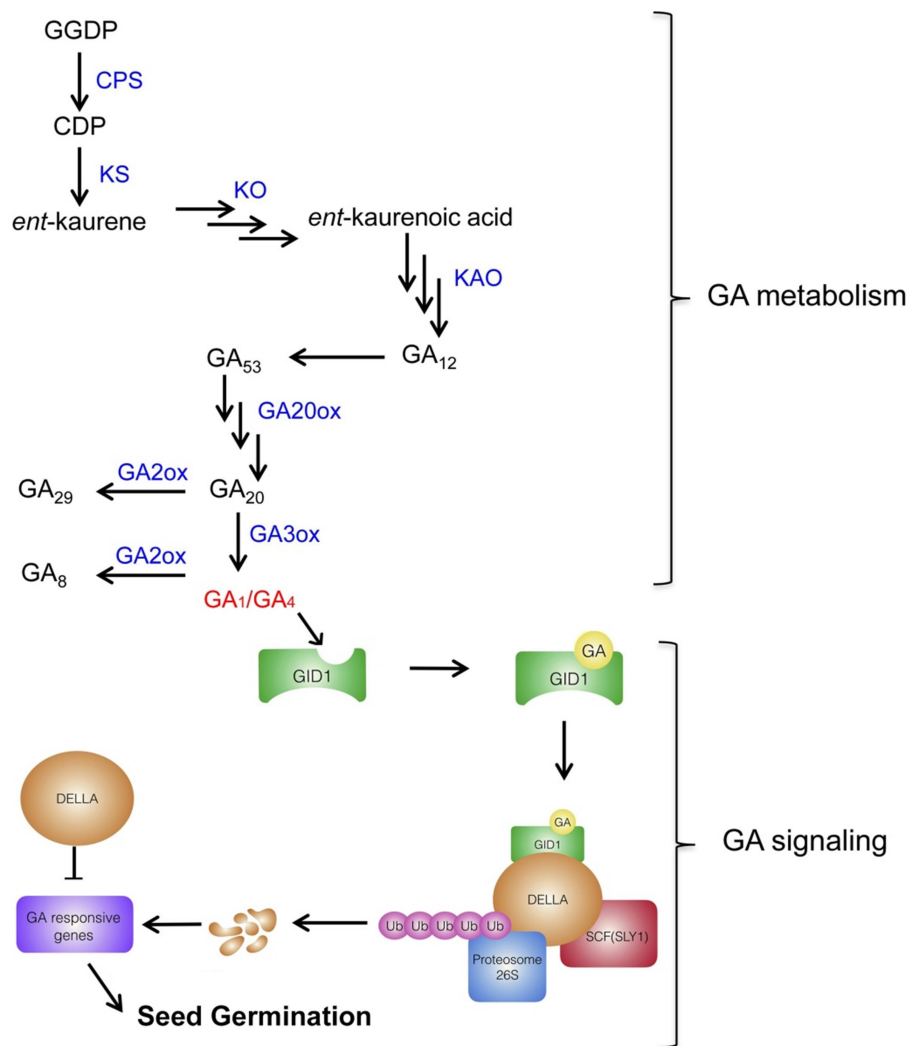

Figure 5. GA metabolism and GA signaling during seed germination. GGDP: geranylgeranyl diphosphate; CPS: ent-copalyl diphosphate synthase; KS: ent-kaurene synthase; KO: ent-kaurene oxidase; KAO: ent-kaurenoic acid oxidase; GA20ox: GA 20-oxidase; GA3ox: GA3-oxidase; GA2ox: GA2-oxidase; SCF: Skp, Cullin, F-box containing complex; SLY1: F box protein, SLEEPY1 (adapted from Hauvermale *et al.*, 2012; Tuan *et al.*, 2018).

In the GA signaling, DELLAs are targeted by F box protein SLEEPY1 (SLY1) to the SCF ligase complex for ubiquitin-mediated proteasome degradation (Dill *et al.*, 2004; Fu *et al.*, 2004). In the presence of GA, GA-GID binding facilitates the interaction with DELLAs. Subsequently, the generation of DELLAs-GA-GID will be targeted by F box protein SLY. The degradation of DELLAs alleviates the repression of GA-responsive genes that results in seed germination (Wang and Deng, 2011).

I.4.3 Crosstalk between GAs and ABA

In agreement among plant physiologists/molecular biologists, the ratio between ABA and GA levels and the change in ABA and GAs sensitivities are strongly involved in the regulation of seed dormancy (Finkelstein *et al.*, 2008; Graeber *et al.*, 2012). In the hormone balance model, ABA plays a stimulatory effect on the onset or maintenance of seed dormancy, while GA acts antagonistically to regulate the alleviation or termination of seed dormancy, in another word, the promotion or maintenance of seed germination (Figure 6) (Hilhorst *et al.*, 2010).

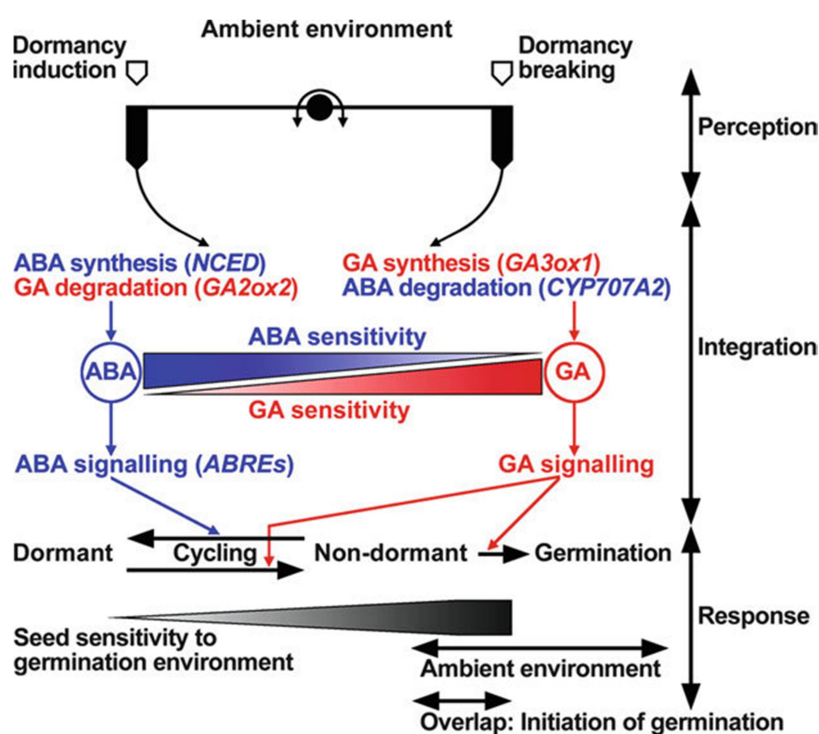

Figure 6. Hormone balance of ABA/GA in the regulation of seed germination and dormancy in response to environmental conditions. In the hormone balance model, synthesis and signaling of ABA dominate the dormant status of seeds whereas synthesis and signaling of GA control the transition from dormant status to non-dormant status and induce seed germination. The changes in hormone levels or sensitivity result in dormancy cycling. When the seed becomes less-dormant due to GA prevails against ABA, and the environment is ambient at the same time, seed germination will be initiated (from Hilhorst *et al.*, 2010).

Firstly, the antagonistic effects of GAs and ABA on seed germination and dormancy result in the metabolism of both hormones in response to endogenous or exogenous signals,

leading to an opposite accumulation of both hormones. For example, the light-regulated seed germination process is associated with opposing mechanisms of GAs and ABA metabolism, such as a down-regulation of ABA biosynthesis genes such as *NECD6*, and an up-regulation of ABA deactivation gene *CYP707A2*, and at the same time with an up-regulation of GA biosynthesis genes (*GA3ox1* and *GA3ox2*) and a down-regulation of GA deactivation gene (*GA2ox2*) (Seo *et al.*, 2006; Oh *et al.*, 2007). The soil temperature that regulates seed dormancy process is correlated with an increased expression of ABA synthesis gene (*NCED6*) and GA catabolism gene (*GA2ox2*) when the temperature declines (Footitt *et al.*, 2011). During seed development, the important transcription factors, *LEC2*, *FUS3*, are also able to modulate ABA and GAs metabolism in an opposite manner (Curaba *et al.*, 2004; Gazzarrini *et al.*, 2004).

Secondly, these antagonistic effects could also result in the differential role at the level of GAs and ABA signaling pathways. One of the small ubiquitin-related modifier (SUMO) ligases, *SIZ1*, negatively regulates ABA signaling through sumoylation of *ABI5*, but positively regulates GAs signaling through sumoylation of F box protein, *SLY1* (Miura *et al.*, 2009; Kim *et al.*, 2015). Arabidopsis transcription factor NUCLEAR FACTOR-Y C homologs (*NF-YC3*, 4 and 9) interact with *RGL2* to form a complex *NF-YC-RGL2* that regulates the expression of *ABI5* during seed germination (Liu *et al.*, 2016). *COP9* signalosome (*CSN*) acts as one regulator of Cullin-RING family of ubiquitin E3 ligases (*CRLs*) is also able to coordinate GAs and ABA signaling. Mutants *csn1-10* and *csn5b-1* exhibit stronger seed dormancy or retarded seed germination which is related to the accumulation of *RGL2* and *ABI5* (Jin *et al.*, 2018).

I.5 Effects of ethylene on seed germination

I.5.1 History of ethylene

Ethylene was the firstly identified plant hormone, and it is a gaseous hormone with the simplest structure unlike the others, such as auxin, gibberellin, cytokinin and abscisic acid. In 1864, the gas leaks from street light affects the growth of the trees with abnormal phenotype, such as twisted or thicken stems. This response is known as etiolated triple response (a short root, short and thick hypocotyl, and exaggerated apical hook) in pea

seedlings that being used as an active bioassay of ethylene. In 1901, it is shown that the active component in the illuminating gas is ethylene. It is then reported in 1934 that plants synthesize ethylene by a quantitative chemical method to show that apples release ethylene. In the 1950s, the application of gas chromatography confirms that ethylene acting as a plant hormone. Subsequently, ethylene biosynthesis and ethylene-binding sites are identified from the 1960s to 1970s. Model plant, *Arabidopsis thaliana* is then used in ethylene research to screen ethylene signaling components through the triple response of the mutants in the 1990s (Guzmán and Ecker, 1990). Although ethylene is popularly associated with ripening, it affects the entire life of the plant, for instance, leaf senescence and abscission, adventitious root formation, response to stress, and also seed germination (Dubois *et al.*, 2018).

The effect of ethylene in dormancy release can be traced to the 1920s (Vacha and Harvey, 1927). It has been evidenced that exogenous ethylene break primary seed dormancy in numerous species, *Amaranthus caudatus*, *Amaranthus retroflexus*, *Arabidopsis thaliana*, *Arachis hypogaea*, *Chenopodium album*, *Fagus sylvatica*, *Helianthus annuus*, *Pyrus malus*, *Rhus coriaria*, *Rumex crispus*, *Stylosanthes humilis*, *Trifolium subterraneum*, *Xanthium pennsylvanicum* (reviewed by Corbineau *et al.*, 2014). Germination rate is also accelerated by ethylene (Takayanagi and Harrington, 1971; Gianinetti *et al.*, 2007). It can also stimulate seed germination when non-dormant seeds are placed under unfavorable conditions, such as hypoxia, high temperature or salinity (Corbineau *et al.*, 2014). However, depending on the species, ethylene does not increase seed germination to some extent, for example, there is no physiological significance in *Echinacea* species or red rice dormancy release (Wood, 2007; Gianinetti *et al.*, 2007).

I.5.2 Ethylene biosynthesis

Ethylene is produced from all parts of plants at its particular stage that is regulated by developmental and environmental factors. Endogenous ethylene production in the seed germination process is initiated after seed imbibition and a burst of ethylene is detected when the radicle emerges and it has been reported as early as the 1970s that is facilitated by gas chromatography technology (Abeles and Lonski, 1969; Ketring and Morgan, 1969). Last decade, laser photoacoustic spectroscopy that is capable of measuring trace gas concentrations, has been applied to ethylene detection in seeds with higher sensitivity (El-

Maarouf-Bouteau *et al.*, 2015). It is reported that the ability to produce ethylene is associated with seed vigor, so ACC-dependent ethylene production has been selected as one of the markers of seed quality (Samimy and Taylor, 1983; Gorecki *et al.*, 1991; Corbineau, 2012). Some other dormancy-breaking agents are also associated with ethylene production like cold stratification, other phytohormones (GAs, JA (Jasmonates) and BR (Brassinosteroids)) other signalling molecules such as ROS or reactive nitrogen species (*e.g.* NO) and HCN (Steber and McCourt, 2001; Watanabe *et al.*, 2001; Calvo *et al.*, 2004b; Gniazdowska *et al.*, 2007; Garnica *et al.*, 2009; Ishibashi *et al.*, 2013; Zheng *et al.*, 2013; El-Maarouf-Bouteau *et al.*, 2015; Khan *et al.*, 2015; Huang *et al.*, 2017) (Figure 7).

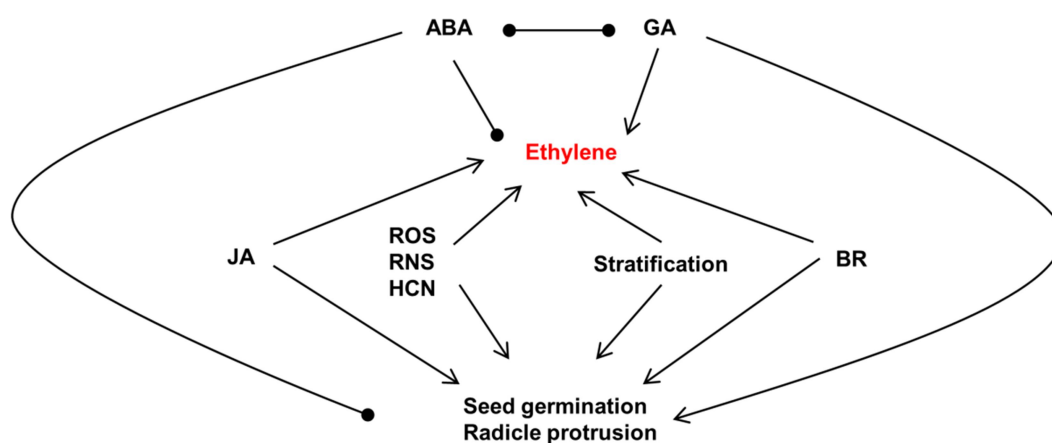

Figure 7. Interaction of ethylene production with other phytohormones, molecules or treatments in the alleviation of seed dormancy and germination. Arrow indicates a stimulatory effect in ethylene production or seed germination, while a solid circle represents an inhibitory effect in ethylene production or seed germination. ABA: abscisic acid; BR: brassinosteroids; GA: gibberellins; JA: jasmonate acid; ROS: reactive oxygen species; RNS: reactive nitrogen species; HCN: Hydrogen cyanide (adapted from Bogatek and Gniazdowska, 2012).

The ethylene biosynthesis cycle was found by Yang *et al.* in the 1960s in fruit (Yang, 1967; Yang and Baur, 1969) (Figure 8). The first portion of the pathway that produces the main intermediates, S-adenosylmethionine (S-AdoMet) has been named as Yang cycle in honor of Yang Shangfang's contribution. S-AdoMet is synthesized from methionine by S-Adenosylmethionine synthetase (SAMS) (Figure 8). S-AdoMet is a versatile co-factor, whose metabolites include methylated molecules, polyamines, ethylene and so on (Sufirin *et al.*, 2009). In the case of ethylene production, S-AdoMet is converted to 1-aminocyclopropane-1-carboxylic acid (ACC) and methylthioadenosine (MTA) by ACC synthetase (ACS) (Figure

8). MTA is recycled back to methionine through Yang cycle, while ACC is synthesized to ethylene by ACC oxidase (ACO), with carbon dioxide (CO₂) and hydrogen cyanide (HCN) as by-products (Bleecker and Kende, 2000; Wang *et al.*, 2002) (Figure 8). ACS is a rate-limiting enzyme in ethylene biosynthesis and its activity is closely parallel to ethylene production (Acaster and Kende, 1983) (Yang and Hoffman, 1984).

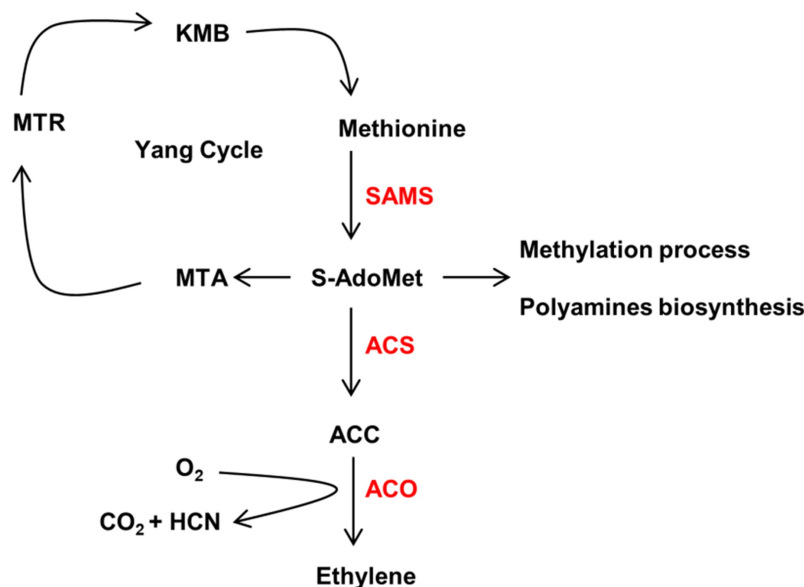

Figure 8. Ethylene biosynthesis pathway in plants. KMB: 2-keto-4-methylthiobutyrate; MTR: 5-methylthioribose; MTA: methylthioadenosine; SAMS: S-Adenosylmethionine synthetase; S-AdoMet: S-adenosylmethionine; ACC: 1-aminocyclopropane-1-carboxylic acid; ACS: ACC synthetase; ACO: ACC oxidase (Corbineau *et al.*, 2014).

ACS is encoded by a multi-gene family; there are 10 genes present in the genome of *Arabidopsis*, but *AtACS3* is a pseudogene and *AtACS1* is catalytically inactive (Yamagami *et al.*, 2003). The homology analysis generates five *AtACO* genes showing a strict distinction with other putative sequences, while *ACO1* and *ACO2* seem to be the major ACOs in seeds of Brassicaceae species (Linkies *et al.*, 2009a; Ruduś *et al.*, 2013). Ethylene production during the seed germination process is associated with a progressive change in the transcripts of *ACS*s and *ACO*s. It is reported that GA up-regulates *AtACO1*, but down-regulates *AtACO2*, while ABA slightly decreases the expression of *AtACO1*, does not affect the transcript level of *AtACO2*. In addition, the transcript abundance of *ACS*s is not apparently affected by GA or ABA (Linkies and Leubner-Metzger, 2012). It should be noted that the effect of cold

stratification on the promoted ethylene production occurs after transferring seed at favorable temperature, which results from the accumulation of ACC due to inhibited expression of all *ACOs* and a transit increased expression of some *ACSs* (Narsai *et al.*, 2011; Linkies and Leubner-Metzger, 2012). Results obtained using ACS inhibitors, such as aminoethoxyvinylglycine (AVG) and aminoxyacetic acid (AOA), and ACO inhibitors, such as CoCl₂ and α -aminoisobutyric acid (α -AIB) show suppressed seed germination that confirm the effect of ethylene in seed germination (Sato and Esashi, 2006; Schaller and Binder, 2017). In addition, incubation with ACC, the precursor of ethylene promotes seed germination in many species that results from ethylene production (reviewed by Corbineau *et al.*, 2014). HCN, as the by-product of ethylene synthesis, is also able to release seed dormancy which is related to the role of ROS in cell signaling (Oracz *et al.*, 2009).

In the ethylene synthesis, the turn-over of type-2 ACS proteins (ACS4, ACS5, ACS9) are mediated by ubiquitin/26 S proteasome system with the involvement of E3 ligase, bric a brac, tramtrack and broad complex (BTB) (Christians *et al.*, 2009).

I.5.3 Ethylene signaling

Ethylene signaling components are determined by the successive identification of ethylene-insensitive and constitutive-response mutants by “triple response” in Arabidopsis, especially after the landmark article in *The Plant Cell* (Guzmán and Ecker, 1990). Insensitive mutants *ein* (*ethylene insensitive*), *etr* (*ethylene response*), *ers* (*ethylene response sensor*), *ain* (*ACC insensitive*) are insensitive to ethylene or ACC, or possess partial or weak insensitivity. Some of them show a higher level of ethylene biosynthesis rate, indicating that ethylene signaling feedback inhibits ethylene production (Guzman and Ecker, 1990; Hua *et al.*, 1995; Hua *et al.*, 1998; Sakai *et al.*, 1998). The constitutive mutants are selected with the induction of these responses in the absence of ethylene. Mutants *eto* (*ethylene overproducing*)-type, such as *eto1*, *eto2*, *eto3*, are characterized by an overproduction of ethylene in the seedling stage. Recent studies indicate that ETO1 affects the stability of ACS5 by targeting for polyubiquitination degradation. Mutant *eto2* is identified as 1-bp insertion in the C-terminal of *ACS5*, which results in its increased stability. Mutant *eto3* possesses a T-to-A transversion within the *ACS9* that also increases its half-life (Vogel *et al.*, 1998; Chae *et al.*, 2003; Wang *et al.*, 2004). Mutants *ctr* (*constitutive triple response*)-type, for example, *ctrl* exhibits the

same phenotypes as ethylene-treated wild-type plants but its phenotype is not able to be reversed by ethylene biosynthesis inhibitors (Guzman and Ecker, 1990; Fluhr and Mattoo, 1996).

Epistatic analysis among these mutants determines the order of the linear pathway. For example, the double mutant of *etr1* and *ctr1* showing the phenotype of *ctr1* indicates that *CTR1* acts downstream of *ETR1* (Roman *et al.*, 1995; Clark *et al.*, 1998). Firstly, the order of ethylene-insensitive mutants relative to *ctr1* is gradually unveiled that the *ETR1*, *ETR2*, *ERS*, *EIN4* are predicted to act upstream of *CTR1*, while the *EIN2*, *EIN3*, *EIN5*, *EIN6*, and *EIN7* gene products are predicted to act downstream (Roman *et al.*, 1995). In addition, the order of ethylene-insensitive components after *CTR1* is determined that *EIN2* acts at upstream of the others with the proofs that the inhibiting protein expression of *EIN3* in *ein2* mutant and overexpression of *EIN3* or *EIL1* (*EIN LIKE 1*) in *ein2* plants conferring constitutive ethylene phenotypes. At the same time, detailed interaction and expression analysis decipher the mainline of ethylene signaling, and *EIN3* regulation is pinpointed as a key step in ethylene response (Chao *et al.*, 1997; Guo and Ecker, 2003; Ju *et al.*, 2012). Thirdly, other regulatory modules along the mainline of ethylene signaling are also elucidated subsequently. The binding activity of *ETR1* is facilitated by copper cofactor *RAN1* (*RESPONSE-TO-ANTAGONIST 1*) (Hirayama *et al.*, 1999). The turnover of *EIN2* is regulated by *ETP* (*EIN2 TARGETING PROTEIN*) (Qiao *et al.*, 2009). The degradation of *EIN3* is controlled by *EBF* (*EIN3 BINDING F-BOX*), while *EBF* 3'UTR mediates *EIN2*-directed translational repression through *XRN4* (*EXORIBONUCLEASE4*, *EIN5*, *AIN1*) (Gagne *et al.*, 2004; Olmedo *et al.*, 2006; Potuschak *et al.*, 2006; Li *et al.*, 2015).

Ethylene insensitive mutation in any of the genes *ETR1*, *ETR2*, *ERS1*, *ERS2*, *EIN4* are indicated as the dominant gain-of-function mutation that disrupts ethylene binding (Chang *et al.*, 1993; Hua *et al.*, 1995; Hua *et al.*, 1998; Sakai *et al.*, 1998). Thus, it is crucial to use loss-of-function mutants to verify whether these genes are involved in ethylene signaling, whether they act positively or negatively. It is shown that a single loss-of-function mutant exhibits ethylene sensitivity similar to wild-type, though there also exists a small growth defect in cell elongation especially in loss-of-function mutant *etr1*, it is then confirmed that the defect results from enhanced ethylene sensitivity. Only double, triple quadruple or quintuple loss-of-function mutants present different extents of sensitive or constitutive phenotype, all of which

suggest they negatively and redundantly regulate ethylene signaling. (Hua and Meyerowitz, 1998; Cancel and Larsen, 2002; Qu *et al.*, 2007).

Figure 9 illustrates the ethylene signaling pathway. Ethylene signaling is triggered by its binding to receptors, which are localized at endoplasmic reticulum (ER) or possibly at Golgi apparatus (Dong *et al.*, 2008; Gallie, 2015). The five receptors are divided into 2 subfamilies based on the feature of the histidine kinase motif. ETR1 and ERS1 fall into the subfamily I, with 3 transmembrane domains, GAF domain and also the motif for histidine kinase activity. Subfamily II includes ETR2, ERS2 and EIN4, which possess 4 transmembrane regions, GAF domain and degenerate histidine kinase domains that instead exhibit serine/threonine kinase activity. Besides, a receiver domain is present in ETR1, ETR2 and EIN4 (Chang *et al.*, 1993; Hua *et al.*, 1995; Hua *et al.*, 1998; Sakai *et al.*, 1998; Shakeel *et al.*, 2013). It is shown that ETR1, ERS1 are suggested to be more important than the other 3 receptors with loss of subfamily I show a severe constitutive response than the loss of subfamily II (Qu *et al.*, 2007). Ethylene receptors often form homodimers through disulfide to bind with ethylene (Schaller *et al.*, 1995; Hall *et al.*, 2000; Gao *et al.*, 2008). Heterodimers through GAF domain which mediates non-covalent receptor associations also occur suggesting the presence of receptor cluster or receptor complex for ethylene signaling. It is proposed that the active receptors occupied by ethylene also recruit physically interacted neighboring receptors, thus enable the perception of the subtle change and amplification of the signal. The inter-receptor signaling may also explain the gain-of-function mutant in any of the receptors result in its insensitivity to ethylene (Gao *et al.*, 2008; Grefen *et al.*, 2008; Gao and Schaller, 2009; Chen *et al.*, 2010; Liu and Wen, 2012).

Binding of ethylene with the receptor ETR1 is facilitated by RAN1, which is a copper cofactor, that it is also related to the biogenesis of ETR1 (Woeste and Kieber, 2000; Binder *et al.*, 2010). In addition, a recent study shows that a novel protein CPR5 (CONSTITUTIVE EXPRESSOR OF PATHOGENESIS-RELATED GENES 5) also possesses a direct association with ETR1 possibly at its upstream (Wang *et al.*, 2017) (not shown in Figure 9). The downstream component of receptors is CTR1. Though without the transmembrane domain, it is able to anchor at the membrane by being associated with receptors (not shown the physical interaction in Figure 9A). Upon ethylene perception, the receptors-CTR1 complex results in a conformational change rather than the phosphorylation

of CTR1 by kinase activity of receptors, which is possible for the inactivation of CTR1 (Wang *et al.*, 2003; Binder *et al.*, 2012; Hall *et al.*, 2012). EIN2 ceases to be phosphorylated by CTR1, acting as Raf-like kinase. Subsequently, C-terminal in the cytoplasmic portion of EIN2 proteolytically is released by unknown protease and then targets into the nucleus, which increases the proteasomal degradation of EBF1/2 which in turn enhances the stabilization of EIN3/EIL1 (An *et al.*, 2010). EIN3/EIL1 as a transcription factor is responsible for the transcriptional regulation of ethylene-responsive factors (ERFs). EIN3/EIL1 and ERFs will then regulate the expression of ethylene-responsive genes (Ju and Chang, 2015). Moreover, not all C-terminal of EIN2 move into the nucleus, some stay in the cytoplasm that direct the translational repression of *EBF1/2* with the involvement of cytoplasmic processing-body (P-body) and EIN5 (Li *et al.*, 2015) (Figure 9A).

In the absence of ethylene, the receptors-CTR1 complex maintains an active state that allows CTR1 to phosphorylates EIN2, thus preventing ethylene response through EIN2. At the same time, the stability of EIN2 is also regulated by ETP1/2 through interaction with its C-terminal. Meanwhile, in the nucleus, EIN3 also suffers its degradation by EBF1/2 (Qiao *et al.*, 2009; Ju and Chang, 2015) (Figure 9B).

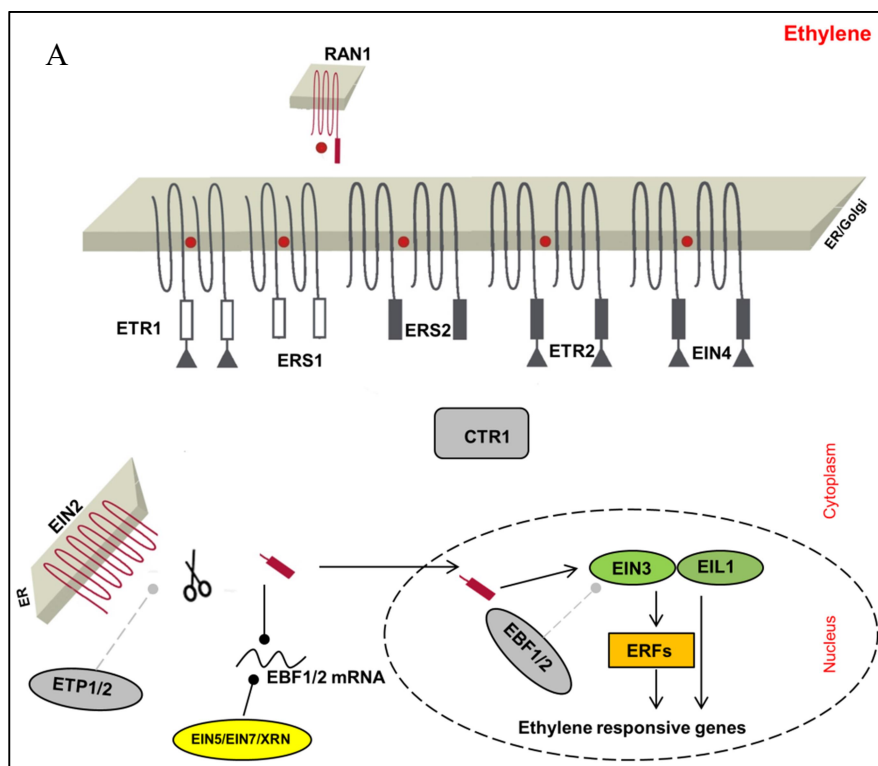

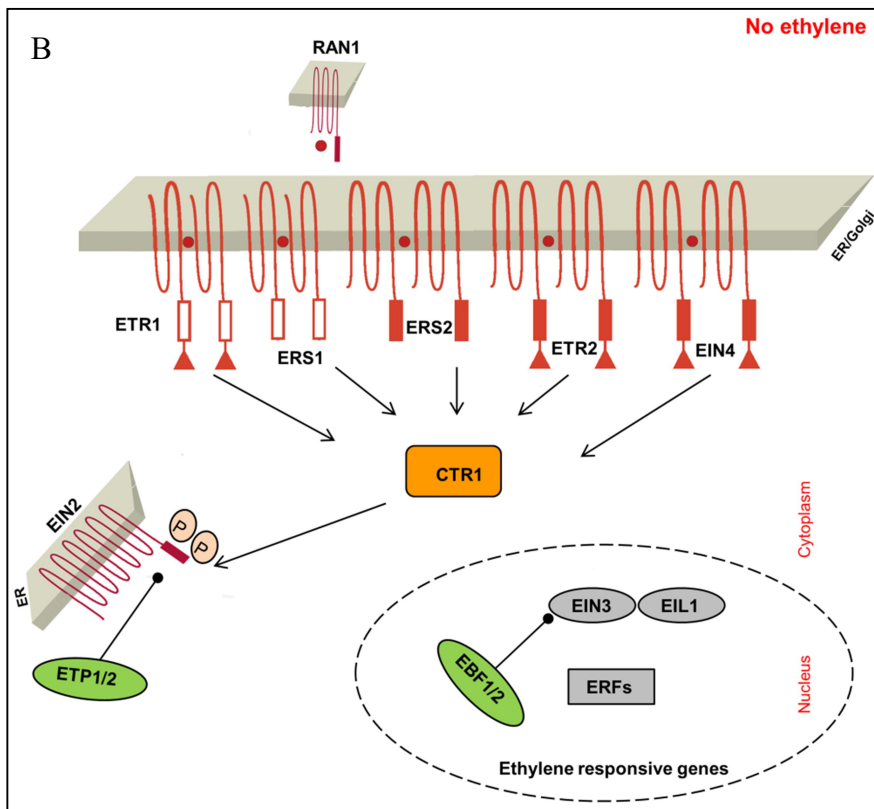

Figure 9. Schematic model of the ethylene signaling pathway shown in a separated state, in the presence of ethylene (Figure 9A) and in the absence of ethylene (Figure 9B). Membrane proteins such as RAN1, ETR1, ERS1, ERS2, ETR2, EIN4 and EIN2 in the signaling pathway are shown with the membrane (ER or Golgi) and the transmembrane domain. Red solid circles in the membrane represent copper. CTR1 physically interacts with the five receptors, but they are presented in a separated manner in order to better illustrate its state (active or inactive). An activated or stimulated component is shown by colors, while an inactivated or repressed component is shown by grey. Line with a solid circle means its effects on degradation or inhibition, while a line with an arrow indicates its effects on stabilization or activation (adapted from Ju and Chang, 2015).

I.5.4 Non-canonical ethylene signaling

Except for the classical pathway (Figure 10 Line A) together with the specific regulated modules along the mainline, there appears to be the mitogen-activated protein kinase (MAPK) kinases cascade in the ethylene signaling that bypass EIN2, and acts at downstream of CTR1 (Figure 10 Line B). MKK9 is reported to activate MAP3/6, which then subsequently phosphorylate EIN3 and increase its stability (Yoo *et al.*, 2008). However, the presence of this MAPK cascade in ethylene signaling is under debate for other controversial results. The disfavored result suggests that, between Col and *mkk9*, between *ctr1 mkk9* and

ctr1, they present comparable phenotype, as well as the protein accumulation of EIN3 and ERF1. It indicates that MKK9 is not involved in the ethylene signaling (An *et al.*, 2010). Rather, it is evidenced that MKK9 or MKK4/5 activates MPK3/6 that increases ethylene biosynthesis by the phosphorylation of ACS2/6 (Liu and Zhang, 2004; Joo *et al.*, 2008; Xu *et al.*, 2008; Bethke *et al.*, 2009). The possible reason for the contradictory proof of MAPK cascade in the ethylene signaling may lie in the feature of MAPK cascade that is sensitively affected by environmental stress, such as wounding and touch (Colcombet and Hirt, 2008; Zhao and Guo, 2011). Therefore, the presence of MAPK cascade in the ethylene signaling independent of EIN2 awaits clarification.

It often believed that the carboxyl terminus of receptors directly interacts with CTR1 that mediates ethylene signal output. However, it is proposed the ethylene receptor N-terminal portion is able to initiate an alternative signaling pathway without involving CTR1 that represses the ethylene signaling (Xie *et al.*, 2006; Xie *et al.*, 2012) (Figure 10 Line C). It is then proved that RTE1 (REVERSION-TO-ETHYLENE SENSITIVITY1) is essential to ETR1 N-terminal signaling, that acts upstream of ETR1 with the cooperation of cytochrome b5 (Cb5) and RTH (RTE1-Homolog) (Resnick *et al.*, 2006; Qiu *et al.*, 2012; Chang *et al.*, 2014; Zheng *et al.*, 2017). The downstream of the N-terminal signaling in the absence of CTR1 is still elusive. It is speculated that EIN2 is the potential candidate considering that the increased affinity between receptors and EIN2 after ethylene binding (Bisson and Groth, 2010, 2011).

Unlike ETR1 N-terminal signaling, another non-canonical ethylene signaling is mediated by receptor C-terminal histidine kinase domain in subfamily I members, ETR1 and ERS1. It is named as two-component signaling (TCS) because its simplest form involves histidine kinases and response regulator, which serves as a basic stimulus-response coupling mechanism that presents in all life (Koretke *et al.*, 2000). In plants, there often exists a histidine-containing phosphotransfer protein between the two critical components, so it is also called as multistep phosphorelay (MSP) pathway. The presence of TCS-related pathway in ethylene signaling is able to explain in part why subfamily I receptors exhibit stronger effects than subfamily II receptors (O'Malley and Bleecker, 2002; Qu *et al.*, 2007). In Arabidopsis, the mediated proteins are referred to as Arabidopsis histidine-containing phosphotransmitters (AHPs) which target at the Arabidopsis response regulators (ARRs)

(Lohrmann and Harter, 2002) (Figure 10 Line D). It is evidenced that ETR1 and AHP1 are able to form a tight complex through the receiver domain of ETR1 (Scharein and Groth, 2011). In the absence of ethylene, ETR1 histidine autophosphorylates followed by phosphotransfer to AHP1 through the receiver domain, and AHP1 subsequent phosphotransfer to ARRs, thereby possibly affecting the ethylene signaling (Zhang *et al.*, 2014). It is then proved on the other side that following cessation of ethylene treatment, TCS-related pathway is responsible for the Arabidopsis growth recovery from the inhibition of triple response (Binder *et al.*, 2004; Binder *et al.*, 2018). However, the TCS pathway is not always as an inhibition for ethylene signaling, it is also reported that B-type response regulator ARR2 stimulates ethylene response in seedlings (Hass *et al.*, 2004), even Binder *et al.* (2018) suggested further that its sensitivity to ethylene is in ARR2-independent manner. The effect of TCS-related pathway in the regulation of hypocotyl growth response seems to be under debate, but it appears to be critical that ARR2-dependent TCS pathway is related the ethylene-induced stomatal closure (Desikan *et al.*, 2006). In addition, ethylene-induced shortening root meristem is also required TCS pathway with the involvement of ARR10 (Street *et al.*, 2015; Zdarska *et al.*, 2019). In plant defense, there is the involvement of ETR1 induced cytokine signaling through the activation of different types of ARRs (Piya *et al.*, 2019).

Ethylene signaling components are initially determined by Arabidopsis seedling triple response with inhibited root hypocotyl growth and exaggerated apical hook. However, it seems that in other developmental processes, such as normal growth recovery, stomatal closure and plant defense, ethylene signaling exhibits its non-canonical pathway as detailed above.

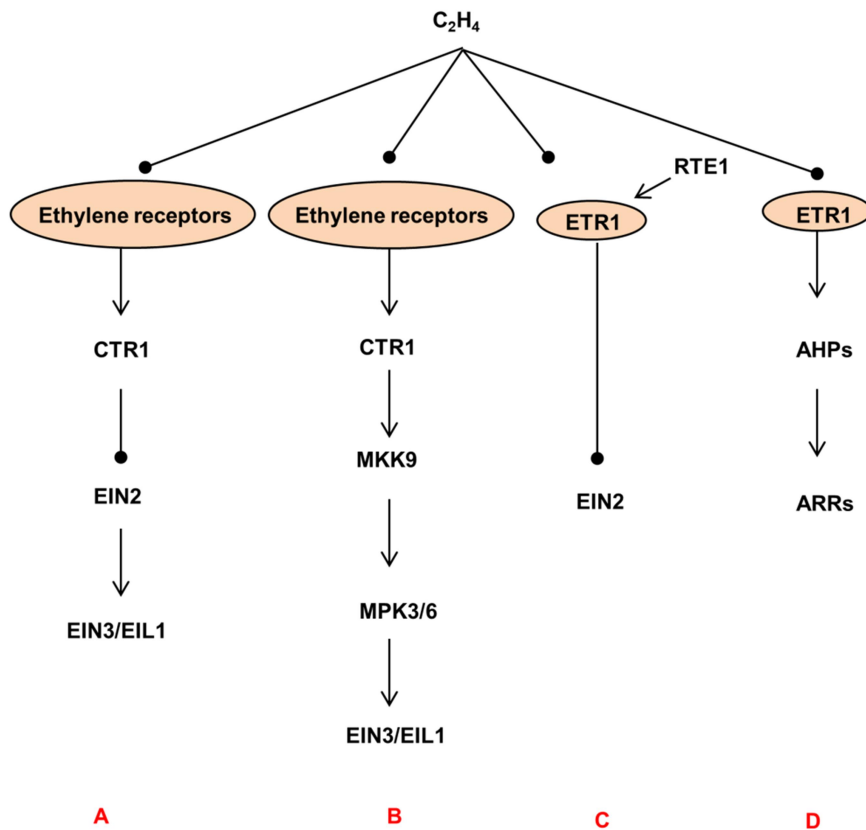

Figure 10. Collectives of ethylene signaling transduction. Line A represents the canonical ethylene signaling. Line B represents the EIN2-independent ethylene signaling involves MAPK cascade. Line C represents the CTR1-independent ethylene signaling involves RTE1. Line D represents two-component signaling that relies on the histidine kinase activity of receptors (Cho and Yoo, 2009; Qiu *et al.*, 2012; Zhang *et al.*, 2014)

Ethylene signaling components are initially determined by Arabidopsis seedling triple response with inhibited root hypocotyl growth and exaggerated apical hook. However, it seems that in other developmental processes, such as normal growth recovery, stomatal closure and plant defense, ethylene signaling exhibits its non-canonical pathway as detailed above. Ethylene receptor perception and signaling in seed germination is one of our topics, but published genetic results about seed germination in the mutation of receptors is confusing. Previous reports from gain of function mutation and loss of function mutation in *ETR1*, such as (*etr1-1*, *etr1-2*, *etr1-3*) and loss of function mutant (*etr1-6*, *etr1-8*) all show enhanced seed dormancy or induced sensitivity to ABA (Beaudoin *et al.*, 2000b; Siriwitayawan *et al.*, 2003; Chiwocha *et al.*, 2005). It was then proposed that increased seed dormancy only present in the gain of function mutant, like *etr1-2* in Col background. For loss of function mutant, such

as *etr1-6*, *etr1-7* or *rdo3*, a loss-of-function mutant of *ETR1* in Ler background, they exhibit reduced seed dormancy (Li *et al.*, 2019). Moreover, the reduced seed dormancy of *etr1-6* and *etr1-7* is easier to detect in salt stress than in water, where they exhibit the same germination rate as Col, based on the dynamic dormant level in seeds (Wilson *et al.*, 2014b). The effects of other receptors in seed germination are also examined in salt stress, which drives non-dormant seeds into a secondary dormant state (Kranter and Seal, 2013). Double mutant loss of *ETR1* and loss of *EIN4* show early seed germination, but the loss of *ETR2* delays germination, loss of *ERS1* and *ERS2* do not exhibit difference (Wilson *et al.*, 2014a). Subsequently, it is proposed that *ETR1* and *ETR2* possess contrasting roles in seed germination under various inhibitory conditions and their effects are independent of one of the important roles in canonical signaling, *CTR1*. It is also suggested the receiver domain of *ETR1* is required for this process, which domain is also critical in TCS-related pathway as discussed above. More surprisingly, the contrasting effects of ethylene receptors *ETR1* and *ETR2* in the regulation of seed germination under salt stress are not related to endogenous ethylene production difference nor the sensitivity to exogenous ethylene treatment, rather ABA plays a major role (Wilson *et al.*, 2014a; Wilson *et al.*, 2014b; Bakshi *et al.*, 2018). The mechanism for the regulation of ABA response in seed germination by ethylene receptors (*ETR1* and *ETR2*) independent of *CTR1* is speculated as the interaction between receptors and ABA signaling components, the candidate such as *ABF2* that potentially physically interacts with *ETR2* (Bakshi *et al.*, 2018). In the case of *ETR1*, it is suggested that it connects with ABA signaling through its histidine kinase activity and receiver domain, neither of which is required in the canonical ethylene signaling, considering that ABA signaling involves the phosphorylation of many proteins (Yang *et al.*, 2017; Bakshi *et al.*, 2018).

Additionally, the existing ethylene signaling model (Figure 7) is not able to explain the dual functions of *ERS1*. It promotes ethylene response in an *ETR1*-dependent manner except that it represses ethylene signaling (Liu *et al.*, 2010). Last but not least, it is reported that only *ETR1* is responsible for the nutation angles of hypocotyls (Binder *et al.*, 2006).

During the process of the identification of ethylene signaling, researchers found several chemicals that are able to inhibit ethylene action, mostly on the ethylene receptors. Silver blocking ethylene perception is predominantly mediated by *ETR1* with a reduced affinity of ethylene to the receptor in the presence of silver than the cofactor copper. It is also

shown that the effect of silver on the ETR1 does not require phospho-transfer (Figure 10, Line D) nor the RTE1 (Figure 10, Line C) (McDaniel and Binder, 2012). It is not surprising that silver stimulates auxin efflux which signaling is mediated through AHPs and ARRs (Figure 10, line D) (Strader *et al.*, 2009). Ethylene binding to receptors can also be suppressed by 1-methylcyclopropene (1-MCP) which has a similar structure with ethylene. It binds competitively with receptors with great affinity that has been applied into horticultural crops storage (Watkins, 2008). Except for the suppression of MCP on ethylene signaling, it is reported that it also reduces endogenous ethylene production (Khan and Singh, 2009).

1.5.5 Ethylene signaling feedback

Several adaptive mechanisms for fine-tuning ethylene response or feedback regulation have evolved in plants. As detailed above, ethylene receptors act as negative regulators of ethylene signaling. It is shown that ethylene-receptor binding induces the degradation of receptor ETR2 through ER-associated protein degradation, while in transcript level, expression of genes *ETR2*, *ERS1* and *ERS2* are induced by ethylene (Hua *et al.*, 1998; Chen *et al.*, 2007). It is suggested that newly synthesized ETR2 that is not able to be degraded by proteasome will inhibit the downstream ethylene signaling pathway. Attenuation at the receptor level helps the conservation of the responsiveness of subsequent ethylene signaling. In the same results, the protein level of ETR1 or transcript level of *ETR1* is not much affected indicating that the proteasome-dependent degradation is specific within receptors and it is possible that ETR1 has its own system to feedback the ethylene signaling, such as the non-canonical signaling pathway (Hua *et al.*, 1998; Chen *et al.*, 2007) (Figure 8 Line C and D).

In the current ethylene signaling, EIN3 is critical to activate the downstream ethylene response. As discussed above, EBF1/2 mediates the degradation of EIN3 under ethylene treatment and ethylene induce the degradation of EBF1/2 through the EIN2-dependent manner (Guo and Ecker, 2003; An *et al.*, 2010). Meanwhile, EIN3 as a transcription factor targets the promoter of *EBF2* and also activates its expression in the ethylene environment (Konishi and Yanagisawa, 2008; Chang *et al.*, 2013). The regulatory loop by a dynamic mechanism maintains the balance of the EIN3 protein level for appropriate ethylene responsiveness. Chang *et al* (2013) propose that EIN3 is able to bind and activate the

expression of ethylene signaling components, some of which are negative regulators of ethylene signaling, such as ETR2, ERS1/2, RTE1 and CTR1.

I.5.6 Ethylene responsive factors (ERFs)

I.5.6.1 Generalities

In the downstream of ethylene signaling, the transcription factors EIN3/EIL1 dimerize and activate the expression of ethylene target genes, including ethylene response factors (ERF), also known as ethylene response element binding protein (EREBP). It is a large family of transcription factors and it is included in the AP2/ERF superfamily (Riechmann *et al.*, 2000). ERF family is characterized by a single AP2/ERF domain. The conserved motif in AP2 domain is named after the gene *APETALA2* that is involved in the flower development, while ERF domain is named after the conserved motif within ethylene-inducible pathogenesis-related genes *ERFs* from tobacco (Ohme-Takagi and Shinshi, 1995; Riechmann and Meyerowitz, 1998). At present, ERF domain is homologous with AP2 domain (Weigel, 1995). Although we maintain the original acronym ERF, it is not a universal feature for all the members in ERF family to possess the responsiveness to ethylene (Chang *et al.*, 2013). In addition, the activation of members in ERF family is not always ethylene dependent, for example, MAPK cascade is sufficient to activate the expression of *ERF6* (Fujimoto *et al.*, 2000; Meng *et al.*, 2013). It is reviewed that ERF family is involved in diverse functions, such as hormone response, biotic or abiotic stress or plant development processes (Nakano *et al.*, 2006; Licausi *et al.*, 2013; Huang *et al.*, 2015).

ERF family possesses one single AP2/ERF domain, which is composed of 60-70 amino acids involved in DNA binding. Previously, the specificity of binding is classified into DNA sequences containing GCC (AGCCGCC) box and/or DRE/CRT (dehydration-responsive element/C-repeat; A/GCCGAC) box (Ohme-Takagi and Shinshi, 1995; Hao *et al.*, 1998). The GCC box often presents in the promoter regions of jasmonic acid or ethylene-induced pathogenesis-related (PR) genes; while DRE box is identified in the salt, cold, drought-inducible genes (Ohme-Takagi and Shinshi, 1995; Hao *et al.*, 2002). However, DNA binding is complex than ever suspected. Some ERFs are able to bind flexible regions that are variants of the core box. In addition, DNA binding also depends on its flanking sequence and on the different environmental conditions (Cheng *et al.*, 2013; Franco-Zorrilla *et al.*, 2014).

ERF1 is the first gene identified from ERF family. It acts downstream of all the components of current ethylene signaling (Figure 10, Line A) and it is directly regulated by EIN3 (Solano *et al.*, 1998). *ERF1* acts as the intermediate between EIN3 and ethylene-inducible target genes. Overexpression of *ERF1* exhibits partial constitutive response and activates the expression of two ethylene-inducible messages, *CHI* (*BASIC-CHITINASE*) and *PDF1.2* (*PLANT DEFENSE*) (Solano *et al.*, 1998). Subsequently, functional analysis of other proteins from ERF family has advanced by using the method of knockout mutant, overexpression and activation tag (reviewed by Nakano *et al.*, 2006; Gu *et al.*, 2017). Recently, chromatin immunoprecipitation and RNA sequencing have identified several proteins in ERF family that are targets of EIN3 and are also induced by ethylene, such as *ERF2*, *ERF5* and *ERF11* (Chang *et al.*, 2013). *ERF1* promotes seed germination at high temperatures by increasing GA synthesis (Yoong *et al.*, 2016). It is shown that *ERF7*-deficient RNA interference transgenic Arabidopsis exhibits increased sensitivity to ABA (Song *et al.*, 2005). Overexpression of *ERF2* in tomato contributes to reduced seed dormancy (Pirrello *et al.*, 2006). *ERF12* recruits TPL to promotes seed germination by the repression of *DOG1* (*DELAY OF GERMINATION*) (Li *et al.*, 2019).

On the basis of the available Arabidopsis genome data, 125 members in EREBP family were firstly identified in 1998 depending on the presence of the conserved AP/ERF domain (Riechmann and Meyerowitz, 1998). Subsequently, the family of ERF transcription factors undergoes subdivision and complement (Sakuma *et al.*, 2002). Nakano *et al.* (2006) refine that 122 members in ERF family belong to the AP2/ERF superfamily (147 members). The remaining ones are AP2 family (18 members), RAV family (6 members) and At4g13040, respectively. Depending on the structure of intron, exon in the nucleotide sequence and AP2/ERF motif in the amino acid sequence, ERF family is subdivided into 12 groups, groups I to X (Figure 11), VI-L, and Xb-L (Nakano *et al.*, 2006). The phylogenetic analysis provides us a guide for the gene function prediction in ERF family.

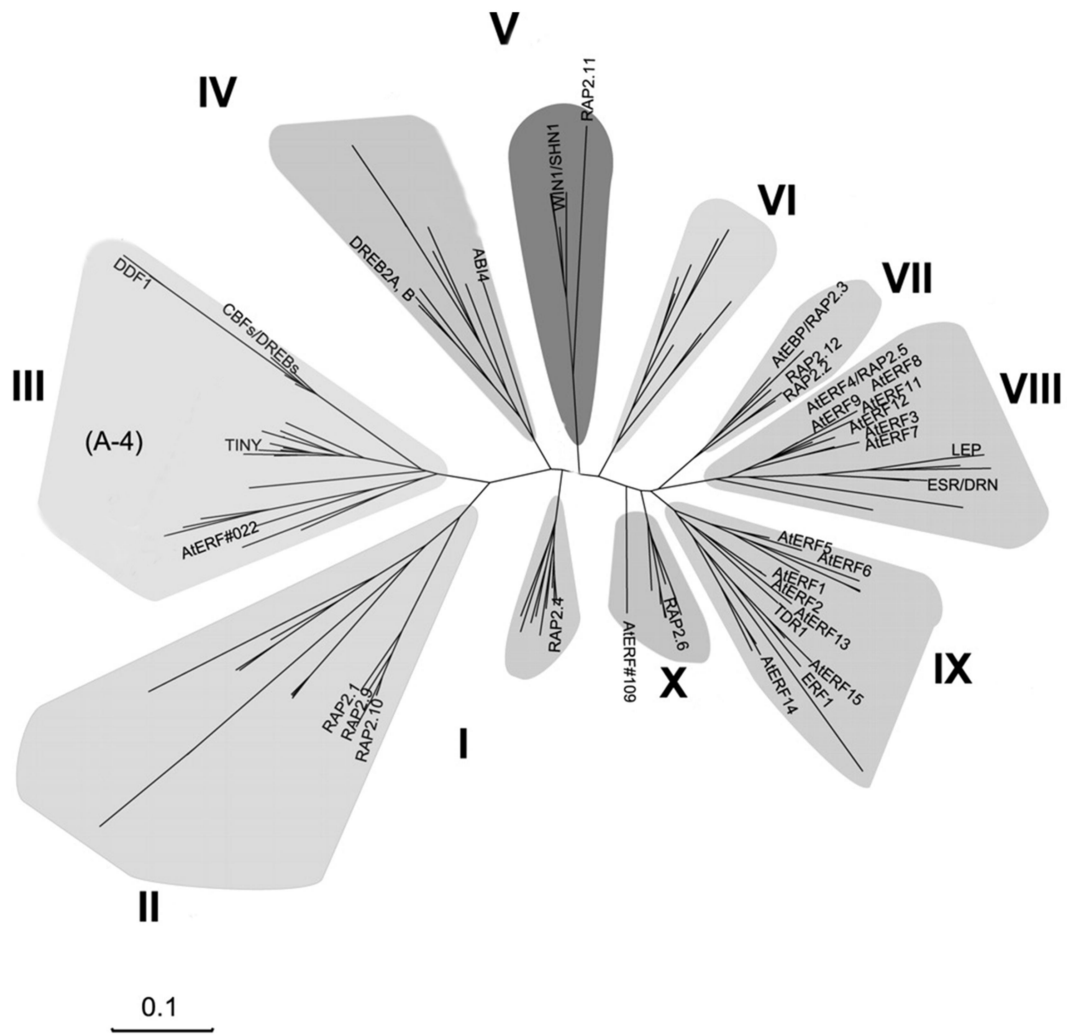

Figure 11. Phylogenetic tree of proteins from the Arabidopsis ERF family. Except for 7 proteins from VI-L, and Xb-L, the other 115 proteins from ERF family are shown in the tree (Nakano *et al.*, 2006).

I.5.6.2 ERFVIIIs

In the group VII of ERF family, there are five proteins, RAP2.2 (RELATED TO AP), RAP2.3, RAP2.12, HRE1 (HYPOXIA RESPONSE) and HRE2, which are nominated as ERF75, 72, 74, 73 and 71, respectively (Nakano *et al.*, 2006). Syntenic analysis of ERFVIIIs from several species indicates that they derived from two ancestral genes (Figure 12 A). RAP2.12, RAP2.2 and HRE1 evolve from one ancestral gene (synteny block I, SBI), while RAP2.3 and HRE2 originate the other ancestral gene (SBII) (van Veen *et al.*, 2014; Gibbs *et al.*, 2015). Except for the AP2 domain that should be present in all the ERF family members,

one of the universal conserved motifs within ERFVII is the Nt-domain (CMVII-1), which is Nt-MCGGAI/L (Figure 12A and B) (Nakano *et al.*, 2006). The amino acid sequence of HRE2 is shorter than the other 4 members (Figure 12A). The lacking sequence is part of the binding domain, suggesting that the transcription activity of HRE2 may rely on cooperated partners (Licausi *et al.*, 2010).

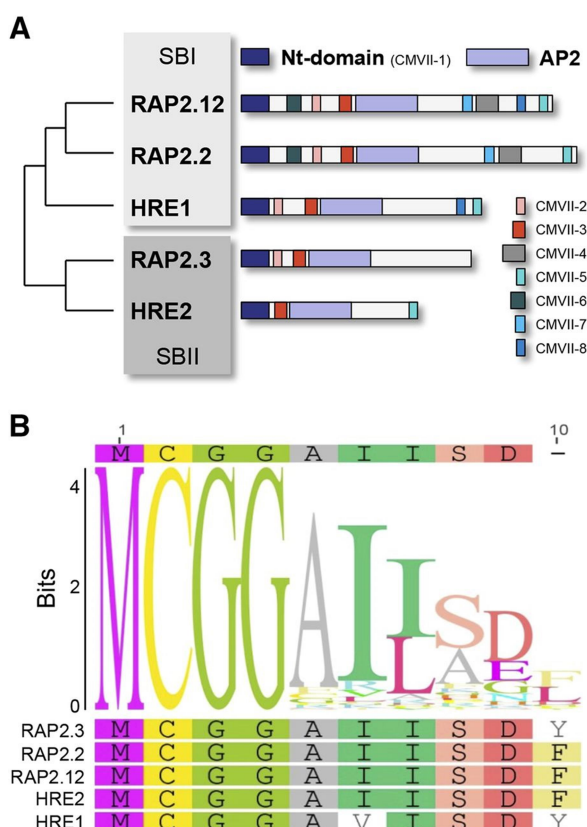

Figure 12. Phylogenetic analysis of ERFVII proteins (A) and N-terminal conserved amino acid sequence of ERFVII proteins (B). SB, synteny block; CM, conserved motif (Gibbs *et al.*, 2015).

ERFVII proteins are initially studied in rice under hypoxic conditions. It is proposed that SUB1a is able to increase the submergence tolerance (Xu *et al.*, 2006; Perata and Voosenek, 2007). Corresponding genes in the model plant, Arabidopsis, are further identified to elucidate its molecular mechanism. Among the five ERFVII members, *HRE1* and *HRE2* are primarily induced in roots during the early hours of submergence. It is shown that *hre1 hre2* mutant is more sensitive to hypoxia. Overexpression of *HRE1* rather than *HRE2* induces anoxia tolerance. Experiments with the aids of protein synthesis inhibitor, proteasome inhibitors and RNA process mutants show that even *HRE2* is dramatically transcribed by

unknown activation, it is regulated at the post-transcriptional level of mRNA stability (Licausi *et al.*, 2010). Very shortly, great breakthroughs are made in 2011, when ERFVIIIs were identified as the substrates of N-end rule proteolytic pathway (see below) by targeting at the N-terminal MC. Under anaerobic conditions, the stabilization of one of the proteins, HRE2 enhances hypoxia survival of the seedlings. One of ERFVII protein, RAP2.12 is constitutively expressed and the protein is anchored at membrane with the association of membrane-localized protein, acyl-CoA-binding proteins ACBP1 and ACBP2, In hypoxia, RAP2.12 is recruited and translocates into nucleus to activate hypoxia response, while in normoxia, RAP1.12 undergoes degradation through N-end rule pathway (see below) (Gibbs *et al.*, 2011; Licausi *et al.*, 2011). Subsequently, emerging evidence shows that ERFVIIIs are involved in transcriptional regulation that far from the activation of hypoxia response. ERFVIIIs act as hubs for NO sensing during the processes of seed germination, hypocotyl elongation and stomatal closure (Gibbs *et al.*, 2014a). In oxidative stress, ERFVIIIs is devoted to the ROS scavenging reactions and trigger protective response (Park *et al.*, 2011; Yao *et al.*, 2017).

Conventional study indicates that ERF family associates with genes that are present GCC box or DRE box in their promoter region. The interaction between ERFVIIIs and GCC box is not always in agreement. It is shown that RAP2.2 fails to interact with the promoter that contains the tandem GCC box from *PDF1.2* through the method of yeast one-hybrid (Ou *et al.*, 2011). Gibbs *et al.* (2014) show that RAP2.3 directly interacts with ABI5 which contains GCC-box (Gibbs *et al.*, 2014a). RAP2.3 is also able to trans-activate a synthetic promoter that is composed of 5 copies of the tandem of GCC box from gene *HOOKLESS1* (Marin-de la Rosa *et al.*, 2014). HRE2 exhibits binding ability in vitro and trans-activation in protoplast with synthetic GCC probe and DRE probe (Lee *et al.*, 2015). The difference of ERFVIIIs protein structure and diversity of cis-acting elements in the promoter region suggest that they may have evolved the adaptability of the environment-dependent binding activity. Bui *et al.* (2015) indicate that RAP2.2, RAP2.3 and RAP2.12 are proved to activate the promoters of hypoxia-responsive genes, *STEAROYL-ACYLCARRIER PROTEIN 9-DESATURASE6 (SAD6)*, *Hemoglobin (Hb1)*, and *Hypoxia Responsive Attenuator 1(HRA1)*, while HRE1 and HRE2 not (Bui *et al.*, 2015). Gasch *et al.* (2016) propose a DNA motif pattern from core anaerobic genes, which is named as hypoxia-responsive promoter elements

(HRPE). It is then verified that RAP-type, rather than HRE-type is able to bind with HRPE (Gasch *et al.*, 2016).

I.5.7 Ethylene crosstalk with ABA and GA in seed germination

Apart from the hormone balance between ABA and GA in the control of seed germination, ethylene is also a particular hormone in this regulation network by affecting the hormone synthesis or signaling of ABA and GA, meanwhile, ethylene itself also undergoes the regulation by the other two hormones.

There is a negative interaction between ABA and ethylene. During the transition from the dormant state to the nondormant state and then germinating state, ethylene competes with the ABA and counteracts with its inhibitory effects on seed germination (Linkies *et al.*, 2009b). Though ABA content is not always negative correlation with the seed germination potential, seed sensitivity is decreasing along this process, and endogenous ethylene generally initiates after seed imbibition and radicle protrusion is accompanied by a burst ethylene production (Miransari and Smith, 2014; El-Maarouf-Bouteau *et al.*, 2015). As described above, the mutation in the ethylene signaling components results in changes in responsiveness to ABA. Mutation in ethylene synthesis often increases sensitivity to ABA (Dong *et al.*, 2011). In parallel, the mutation in ABA signaling or synthesis also affects seed sensitivity to ethylene (Beaudoin *et al.*, 2000; Cheng *et al.*, 2009; Linkies and Leubner-Metzger, 2012; Arc *et al.*, 2013b).

There is a positive interaction between ethylene and GA. Both hormones contribute to seed dormancy release and germination acceleration. The stimulatory effect of ethylene is related to the activation of GA synthesis and signaling while the promoting effect of GA often involves in the stimulation of ethylene synthesis and signaling (Linkies and Leubner-Metzger, 2012; Corbineau *et al.*, 2014).

Recently, what drives us more attention is the common hubs for the interaction among the 3 hormones. ERFs in ethylene signaling, DELLAs in GA signaling and ABFs in ABA signaling are critical for respective signaling response, and they often act as the crosslinking that mediates crosstalk between other processes with hormone signaling. ERFVIIIs mediate NO sensing with ABA signaling by positively regulate the expression of ABI5 (Gibbs *et al.*, 2014a). One of DELLAs proteins, GAI interacts with RAP2.3 and inhibits its downstream

activation in the apical hook development (Marin-de la Rosa *et al.*, 2014). Thermoinhibition in seeds is induced by the interaction between ABI3, ABI5 and DELLAs. The generated complex activates the expression of SOMNUS (SOM) (Lim *et al.*, 2013).

I.6 Mechanisms involved in dormancy release

After seed dispersal, the dormancy can be release (1) in the imbibed state in autumn or winter, called warm or cold stratification or (2) in a relatively dry state, which has been considered as after-ripening. During the two processes, the light climate under natural conditions also plays a role in the regulation of seed dormancy and germination (Derkx and Karssen, 1993; Pons, 2000; Plummer *et al.*, 2001). Most of the processes of dormancy release in the wild are related to the effect of endogenous ABA/GA. Thus, exogenous GAs or other treatments which affect the hormone balance or signaling are employed as dormancy release methods, such as norflurazon, fluridon, nitrate, NO, cyanide, karrikin, strigolactone *et al.* (Derkx and Karssen, 1993; Ali-Rachedi *et al.*, 2004; Bethke *et al.*, 2006; Liu *et al.*, 2009; Nelson *et al.*, 2009; Lee *et al.*, 2010; Nelson *et al.*, 2011).

I.6.1 Stratification

In the wild, seed dormancy is usually overcome by the seed spending time out in the open and subjected to low and high temperatures. As nature can be seen to be unpredictable and it takes longer than the case if humans intervened. Stratification is a process of treating seeds to mimic the natural conditions that they require when breaking dormancy in nature. This term can be traced back to 1664 (Evelyn, 1664), where seeds are layered (stratified) by several layers of moist soil and are placed outdoors in winter. However, depending on the species, cold stratification (0-10 °C) is not very effective in breaking dormancy unless the seeds first receive a period of warm stratification (≥ 15 °C) (Baskin *et al.*, 1993; Baskin and Baskin, 1995, 1998). In general, imbibition at low temperatures releases dormancy in seeds of summer annuals, while high temperatures release dormancy in seeds of winter annuals (Probert, 2000).

It is still unknown how the temperature sensing mechanism works during the process of stratification. Only a few reports set a correlation with simple physiological or molecular responses. The treatment of stratification significantly reduces the expression of genes related

to ABA synthesis, or even the level of endogenous ABA in seeds of *Taxus mairei* *Fagus sylvatica* and *Prunus persica* (Chien *et al.*, 1998; Eliášová *et al.*, 2015; Wang *et al.*, 2016). It is reported that the effect of stratification in seed germination is related to the up-regulation of GAs biosynthesis gene *GA20ox1*, *GA20ox2*, *GA3ox1* and GAs inactivation gene, *GA2ox1*, resulting in the increased accumulation of GAs (Yamauchi *et al.*, 2004). It is then proposed that removal of dormancy by cold stratification is associated with the increased production of ROS (reactive oxygen species) and NO (nitric oxide) and the fluctuation of protein carbonylation level in apple seeds (Dębska *et al.*, 2013). Our previous work shows a decreased expression of *ABI5* and *DELLAs* which are involved in ABA and GAs signaling, respectively, after stratification treatment (Wang *et al.*, 2018). Moreover, it is suggested that breaking of *Fagus sylvatica* L. seeds dormancy is related to the production of another hormone, ethylene, which also positively regulates seed germination like GAs (Calvo *et al.*, 2004a).

I.6.2 After ripening

After-ripening corresponds to a period of dry storage of freshly harvest mature seeds generally at room temperature. The duration for dormancy release through after-ripening is inter or intra-species specific (Stanisavljević *et al.*, 2010; Veatch-Blohm and Koutavas, 2011). Dormancy release in dry seeds is mainly temperature-dependent and depends on seed moisture content equilibrated with the relative humidity of the atmosphere. In most species, there is a positive correlation between temperature and dormancy release, and this has developed into an after-ripening thermal-time model to predict its required duration (Chantre *et al.*, 2009). It is evidenced that in *Arabidopsis* and sunflower, above 0.06 and 0.10 g H₂O/g dry weight, respectively, dormancy is gradually alleviated with increasing temperature (Basbouss-Serhal *et al.*, 2016; Bazin *et al.* 2011a). Besides, at extreme conditions, after-ripening is prevented and sometimes leads to decreased viability (Baskin and Baskin, 1979; Probert, 2000; Sharif-Zadeh and Murdoch, 2001; Bair *et al.*, 2006; Mohamed *et al.*, 2010).

The detailed molecular mechanism of after-ripening remains elusive, but several reports indicate that after-ripened seeds become more sensitive to GA and less sensitive to ABA and that the after-ripening process affects the hormone metabolism (Millar *et al.*, 2006; Gubler *et al.*, 2008; Liu *et al.*, 2013; Chitnis *et al.*, 2014). Considering the low water content

in dry seeds, it is unlikely that active gene expression occurs. However, transcript-level expression in tobacco shows specific changes in comparison with freshly harvested dormant dry seeds, which might be due to the existence of “water pocket” in non-oil body regions (Bove *et al.*, 2005; Leubner-Metzger, 2005). Apart from that, transcript changes in after-ripened dry seeds also occurred in barley (Leymarie *et al.*, 2006). Whereas, in sunflower dry seeds, it is concluded that there were no significant changes in mRNA abundance during after-ripening (Meimoun *et al.*, 2014). Microarray analysis performed in *Arabidopsis* also demonstrate that stored mRNA in non-dormant Columbia (Col) and dormant Cape Verde Islands (Cvi) resemble each other and do not reflect either the degree of dormancy or germination potential (Kimura and Nambara, 2010). The other informative results with transcript changes from after-ripened Cvi seed following several hours of imbibition, which allow the occurrence of active transcription during this short period (Cadman *et al.*, 2006; Finch-Savage *et al.*, 2007). The presence of active transcription in dry seeds during after-ripening need more proof.

It is proposed that the stored mRNA in dry seeds might have changed by mechanisms that do not need active metabolism, such as selective oxidation by ROS during after-ripening (Bazin *et al.*, 2011b; El-Maarouf-Bouteau *et al.*, 2013). It is reported that certain content of ROS production enclosed in the “oxidative window” during dry storage is able to stimulate the oxidative signaling that includes gene expression, protein oxidation, redox regulation and hormone signaling (Bailly *et al.*, 2008). An irreversible posttranslational modification (PTM), protein carbonylation respond to reactive oxygen species (ROS) and leads to enzymatic and binding properties changes, which increase its vulnerability to proteolysis degradation (Job *et al.*, 2005; Oracz *et al.*, 2007). Besides that, accumulation of lipid oxidation during after-ripening is also reported (Mène-Saffrané *et al.*, 2010). The genetic study of important mutants that affect ROS homeostasis has shown the changes in dormancy level. Therefore, researchers proposed that oxidation is responsible for the loss of dormancy during after-ripening (Oracz *et al.*, 2007; Carrera *et al.*, 2008; Bazin *et al.*, 2011b; El-Maarouf-Bouteau *et al.*, 2013). Unsurprisingly, oxidation also accelerates seed aging, affecting seed viability at the same time (Rajjou *et al.*, 2008). Then it is proposed that seed longevity and seed dormancy are negatively correlated (Nguyen *et al.*, 2012). Another report suggests that after-ripening breaks dormancy is related to changes of amphipathic molecules that facilitate the

activation of a peripheral membrane protein in signaling transductions (Hallett and Bewley, 2002).

I.7 N-end rule pathway

I.7.1 Definition of N-end rule pathway

The ubiquitin-proteasome system (UPS) degrades the proteins by targeting specific signals, such as classical degradation motif (PEST region, destruction-box, KEN-box, or the N-terminal residue), and other physicochemical characteristics, like structural disorders (Tompa and Fuxreiter, 2008; Radivojac *et al.*, 2010). Among all the identification of degradation signals (known as degrons) up to now, N-terminus is the one targeted at the N-terminal residues rather than the sequence elements of the protein. This rule is discovered by Alexander Varshavsky and his co-workers in 1986 (Bachmair *et al.*, 1986). A specialized case of the RING domain ligase which recognizes substrates by identifying its N-terminal residues has been reported in plants, *e.g.* PRT1 (PROTEOLYSIS 1) and PRT6 (PROTEOLYSIS 6) (Stary *et al.*, 2003; Garzón *et al.*, 2007).

This N-end rule pathway of the proteolysis has 3 branches, the Arg/N-end rule pathway, the Ac/N-end rule pathway, and the Pro/N-end rule pathway (Lee *et al.*, 2016; Dong *et al.*, 2018; Dougan and Varshavsky, 2018; Nguyen *et al.*, 2018; Nguyen *et al.*, 2019). Firstly, the Arg/N-end rule pathway identifies specific N-degrons such as aromatic residues (Phe, Trp, Tyr) by PROTEOLYSIS 1 (PRT1) and basic residues (Arg, His, Lys) by PRT6 in plants. Secondly, the Ac/N-end rule pathway targets the peptides starting with acetylation. Nt-acetylation is one of the most common protein modifications in plant cells, occurs around 70% in Arabidopsis proteins (Bienvenut *et al.*, 2012). It seems that Ac/N-end rule pathway might be more universal than first expected, but the related N-recognins and the selectivity to N-degrons are still intriguing in plants (Linster *et al.*, 2015; Xu *et al.*, 2015). The Pro/N-end rule pathway recognizes the Nt-Pro residue or a Pro at position 2 through the activity of the N-recognin Gid4, a subunit of the GID ubiquitin ligase in yeast, and it is not yet known whether the Pro/N end rule is present in plants. In brief, Arg/N-end rule pathway is the classical one and has been well studied. The N-degrons as listed above of Arg/N-end rule pathway can be generated by proteolytic cleavages such as N-terminal Met excision by

methionine aminopeptidase (MAP) or endoproteolytic cleavage by endopeptidase (EP). It can also be produced by post-translational modification of tertiary residues (Asn, Gln, Cys) by deamidation of Asn or Gln, and oxidation of Cys to secondary residues Asp, Glu, Cys-sulfinic acid, respectively, and then arginylated by arginyl-tRNA transferase (ATE) (Graciet and Wellmer, 2010; Sriram *et al.*, 2011) (Figure 13).

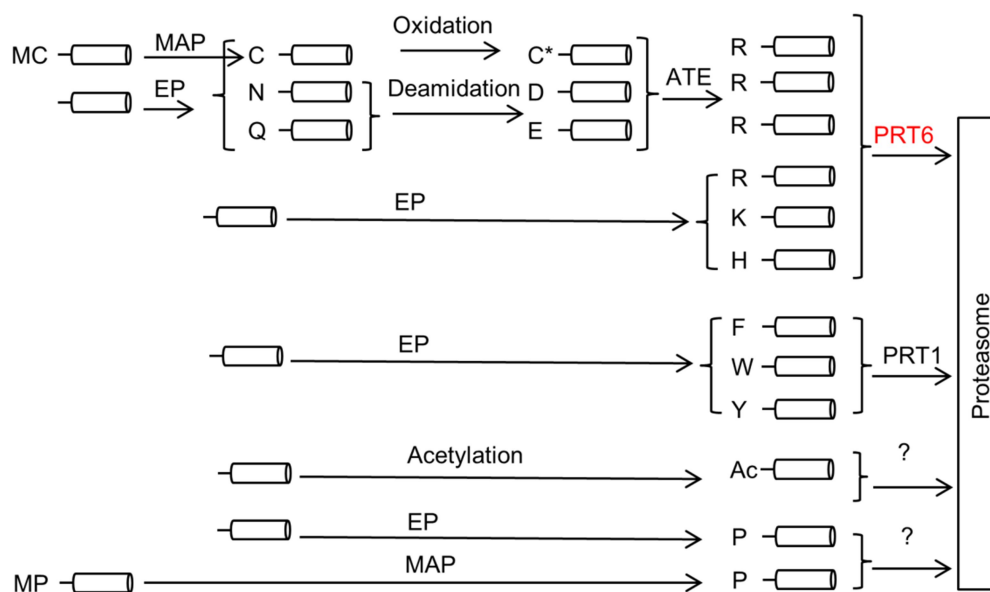

Figure 13. The Arg/N-end rule pathway, the Ac/N-end rule pathway and the Pro/N-end rule pathway. Ac: acetylated amino acid; ATE: arginyl-tRNA transferase; EP: endopeptidase; MAP: methionine aminopeptidase; PRT1/6: PROTEOLYSIS 1/6. Abbreviations of amino acid: C: cysteine; D: aspartic acid; E: glutamic acid; F: phenylalanine; H: histidine; K: lysine; M: methionine; N: asparagine; P: Proline; Q: glutamine; R: arginine; W: tryptophan; Y: tyrosine (adapted from Zhang *et al.*, 2018).

1.7.2 The Arg/N-end rule in plants

PRT6 and ATE1/2 mediated the N-end rule pathway regulate diverse processes in plant life, such as seed germination, seedling establishment, shoot/root development, leaf senescence, stomatal closure, pathogen response and submergence response (Yoshida *et al.*, 2002; Graciet *et al.*, 2009; Holman *et al.*, 2009; Gibbs *et al.*, 2014b; Abbas *et al.*, 2015; de Marchi *et al.*, 2016; Vicente *et al.*, 2017; Vicente *et al.*, 2019). The involvement of the N-end rule in the regulation of submergence response is particularly important because it accelerates the identification of the N-end rule targets. The ERFVIIIs, HRE1, HRE2, RAP2.2, RAP2.3 and RAP2.12, are all initiated from Met-Cys at the N-terminal. The hypoxia condition

increases the stability of some ERF that contributes to enhanced survival (Gibbs *et al.*, 2011; Licausi *et al.*, 2011). Subsequently, ERFVII is suggested as the central hubs that mediate NO sensing in the regulation of seed germination and stomatal closure and hypocotyl elongation (Gibbs *et al.*, 2014b). The mechanism of the N-end rule pathway in plant biological processes is not just directly ERFVII-dependent. It is reported that PRT6 branch of Arg/N-end rule pathway is involved in biotic and abiotic stress response by the regulation of plant-defense metabolites, defense-response gene expression (de Marchi *et al.*, 2016; Vicente *et al.*, 2017; Vicente *et al.*, 2019). In addition, N-end rule mutant analysis has revealed other growth phenotypes (Figure 14). *ATE1* gene insertion line mutant, *delayed-leaf-senescence1* (*dls1*) showed slow senescence (Yoshida *et al.*, 2002). *ate1 ate2* mutant plants exhibit abnormal shoot and leaf development (Graciet *et al.*, 2009). *PRT6* gene mutant *greening after extended darkness 1* (*ged1*) is more tolerant to starvation conditions, such as prolonged darkness (Riber *et al.*, 2015). Until now, the reported correlation between N-end rule and seed germination is the affected sensitivity to ABA, nitric oxide and sugar, or oil body retention (Holman *et al.*, 2009; Gibbs *et al.*, 2014b) (Figure 14).

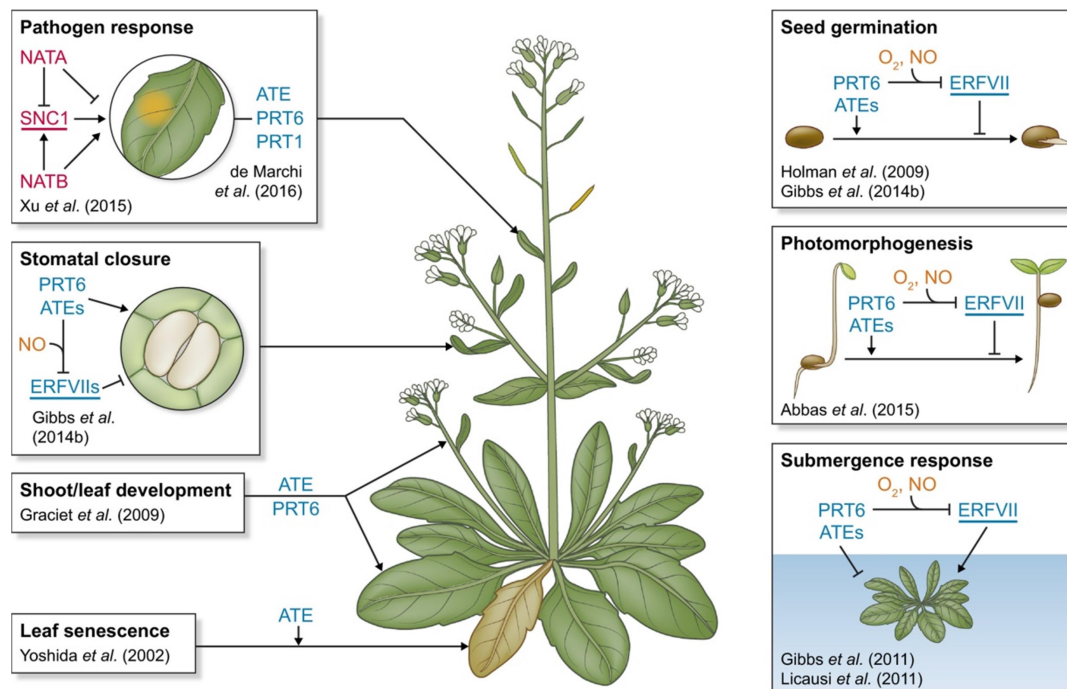

Figure 14. The effects on The Arg/N-end rule in plant development from published reports (Gibbs *et al.*, 2016).

Chapter II Revisiting the role of ethylene and N-end rule pathway on chilling-induced dormancy release in *Arabidopsis* seeds



Article

Revisiting the Role of Ethylene and N-End Rule Pathway on Chilling-Induced Dormancy Release in *Arabidopsis* Seeds

Xu Wang, Zhazira Yesbergenova-Cuny, Catherine Biniek, Christophe Bailly , Hayat El-Maarouf-Bouteau and Françoise Corbineau *

CNRS, Laboratoire de Biologie du Développement, Sorbonne Université, Boîte 24, 4 Place Jussieu, 75005 Paris, France; xu.wang@upmc.fr (X.W.); cuny@mail.ru (Z.Y.-C.); biniekcatherine@gmail.com (C.B.); christophe.bailly@upmc.fr (C.B.); hayat.bouteau@upmc.fr (H.E.-M.-B.)

* Correspondence: francoise.corbineau@upmc.fr; Tel.: +33-687275341 or +33-144275987

Received: 24 September 2018; Accepted: 9 November 2018; Published: 13 November 2018



Abstract: Dormant *Arabidopsis thaliana* seeds do not germinate easily at temperatures higher than 10–15 °C. Using mutants affected in ethylene signaling (*etr1*, *ein2* and *ein4*) and in the N-end-rule pathway of the proteolysis (*prt6* and *ate1-ate2*) we have investigated the effects of cold and ethylene on dormancy alleviation. Ethylene (10–100 ppm) and 2–4 days chilling (4 °C) strongly stimulate the germination of wild type (Col-0) seeds at 25 °C. Two to four days of chilling promote the germination at 25 °C of all the mutants suggesting that release of dormancy by cold did not require ethylene and did not require the N-end-rule pathway. One mutant (*etr1*) that did not respond to ethylene did not respond to GA₃ either. Mutants affected in the N-end rule (*prt6* and *ate1-ate2*) did not respond to ethylene indicating that also this pathway is required for dormancy alleviation by ethylene; they germinated after chilling and in the presence of GA₃. Cold can activate the ethylene signaling pathway since it induced an accumulation of *ETR1*, *EINI4*, and *EIN2* transcripts, the expression of which was not affected by ethylene and GA₃. Both cold followed by 10 h at 25 °C and ethylene downregulated the expression of *PRT6*, *ATE1*, *ATE2*, and of *ABI5* involved in ABA signaling as compared to dormant seeds incubated at 25 °C. In opposite, the expression of *RGA*, *GAI*, and *RGL2* encoding three DELLAs was induced at 4 °C but downregulated in the presence of ethylene.

Keywords: *Arabidopsis thaliana*; seed dormancy; cold; ethylene; gibberellins; N-end rule pathway

1. Introduction

Seed dormancy is an important component of plant fitness that results in a delay of germination [1]. It corresponds to the inability to germinate of seeds even placed under apparently favorable conditions [1,2]. Dormancy and germination are characterized by a different balance between abscisic acid (ABA) and gibberellins (GAs) levels and metabolism [3–5]. ABA mainly plays a key role in the induction or maintenance of dormancy, while GAs are involved in germination and release of dormancy [6,7]. DELLAs negatively regulate the effects of GAs [8] and among them RGL2 (RGA-like 2) has been demonstrated as a regulator of dormancy in *Arabidopsis* by controlling ABA synthesis and activation of ABI5 (ABA insensitive 5) [9]. In addition, other hormones, ethylene (C₂H₄) in particular, participates in the control of seed germination [10–12]. Exogenous ethylene can break primary and secondary dormancies or stimulate germination of non-dormant seeds incubated in unfavorable conditions [10–12].

Treatment of seeds by chilling (2 to 5 °C) also promotes seed germination in many species [1,13] including *Arabidopsis* [14,15]. The stimulatory effect of cold is associated with an enhancement in

seed sensitivity to GAs and an induction of GAs biosynthesis through changes in transcript abundance involved in GAs biosynthesis (*gibberellin 3-oxidase 1 = GA3OX1*, *gibberellin 20 oxidase 1 = GA20OX1*, *GA20OX2*) and GA degradation (*gibberellin 2 oxidase 2 = GA2OX2*), and a decrease in ABA through induction of *abscisic acid 8'-hydroxylase 2 (CYP707A2)* [7,9,13,16,17]. Cold treatment also affects ABA and GAs signaling pathway associated proteins; for example, ABI5 and RGL2 decrease with loss of dormancy in Norway maple seeds [18]. Breaking of dormancy in Arabidopsis seeds by chilling is also associated with a decrease in expression of the *ACO (1-aminocyclopropane-1-carboxylic acid oxidase)* gene and a transient increase in *ACS (1-aminocyclopropane-1-carboxylic acid synthase)* expression [19]. In addition, low temperatures inhibit the ethylene production, but have a differential inhibitory effect on the activity of ACO and ACS, ACO being more inhibited than ACS, resulting in an accumulation of ACC in the tissues, and then a burst of ethylene production after transfer to 20–25 °C [20].

Identification of ethylene-insensitive and constitutive-response mutants by “triple response” in Arabidopsis, and the subsequent genetic study of these mutants have identified the key components of the ethylene biosynthesis and signaling pathways [21,22]. The ethylene-signaling cascade starts with ethylene binding to its receptors, which include ETR1 (ethylene receptor 1), ETR2, ERS1 (ethylene response sensor 1), ERS2, and EIN4 (ethylene insensitive 4). In the absence of C₂H₄, the receptors activate CTR1 (constitutive response 1), and CTR1 inactivates EIN2, by directly phosphorylating its C-terminal end. The level of EIN2 is negatively regulated by the F-box proteins ETP1/2 (EIN2 targeting protein 1/2) through proteasome. In the nucleus, the transcription factors EIN3/EIL1 (EIN3 like 1) are degraded by the other 2 F-box proteins, EBF1/2 (EIN3 binding F-box 1/2) through the proteasome. In the absence of EIN3/EIL1, transcription of the ethylene response genes is shut off. In the presence of ethylene, the receptors bind the hormone and become inactivated, which in turn, switches off CTR1. This inactivation prevents the phosphorylation of EIN2. The C-terminal end of EIN2 is cleaved off by an unknown mechanism and moves to the nucleus where it stabilizes EIN3/EIL1 and induces degradation of EBF1/2. The transcription factors EIN3/EIL1 dimerize and activate the expression of ethylene target genes, including ethylene response factors (ERFs), which are one of the largest subfamilies of the *apetala2 (AP2)/ERF* transcription factor family. Many proteins in the ERF family were identified and implicated in various functions in cellular processes, such as hormonal signal transduction, response to biotic, and abiotic stresses and in developmental processes in various plant species [23]. Ethylene breaks seed dormancy by decreasing seed sensitivity to ABA, and by inhibiting ABA signaling [10–12,24,25]. Numerous data demonstrates that exogenous ethylene promotes seed germination by stimulating GAs biosynthesis [12,26,27]. In Arabidopsis, it was also reported that repression of growth by ethylene is regulated by its effects on the DELLA proteins [28].

The ubiquitin-proteasome system (UPS) degrades the proteins by targeting specific signals, and contributes to numerous plant hormone signaling, in particular that of ABA, GAs, and ethylene [29–31]. As a part of the ubiquitin system, the N-end rule pathway regulates the *in vivo* half-life of the proteins depending on their N-terminal residue [32,33]. The essential components of N-end rule, which recognize the destabilized N-terminal residues (N-degrons), called N-recognins, belong to specific E3 ligase of UPS [33]. In general, tertiary destabilizing residues (Asn, Gln and Cys) are first modified, either enzymatically (by deamidation of Asn or Gln) or chemically (by oxidation of Cys), to generate a secondary destabilizing residue (Asp, Glu and oxidized Cys (C^{*})), respectively. Secondary destabilizing residues arginylated by Arg-tRNA protein transferase (ATE) generate destabilizing residue (Arg) [33,34]. Primary destabilizing residues fall into two categories, type 1 (Arg, Lys and His) and type 2 (Phe, Tyr and Trp) which are recognized by E3 specific ligases (N-recognins), PROTEOLYSIS 6 (PRT6) and PROTEOLYSIS 1 (PRT1), respectively [33,34]. In response to GAs, DELLA proteins are targeted for degradation via the ubiquitin-26S proteasome pathway [30,31,35–38]. The physiological effect of ABA, including seed germination is controlled by protein degradation [31]. ABA biosynthesis and signaling including the level of ABI5 are regulated by the UPS activity [31,39,40], and the N-end rule plays a role in seed sensitivity to ABA [41]. At least, stability of the aminocyclopropane-1-carboxylic acid synthase (ACS4, ACS5 and ACS9) enzyme

involved in ethylene biosynthesis is regulated by the ubiquitin-dependent degradation [42,43], and proteasomal degradation of EIN3 and EIL1 transcription factors depends on ethylene concentration [44]. In addition, recently, ERFs from group VII which are characterized by Met-Cys at N-terminal have been identified as substrates of the N-end rule [45].

The purpose of the present work was (1) to determine the effects of cold, ethylene, and exogenous GA₃ on the germination of dormant Arabidopsis seeds; (2) to investigate whether the responsiveness to chilling and GA₃ involved C₂H₄ signaling using various mutants of this pathway; (3) to determine the role of the N-end rule on the responsiveness to ethylene, chilling, and GA₃; and (4) to investigate the effects of chilling and ethylene that both alleviate seed dormancy on the expression of genes involved in the ethylene signaling pathway (*ETR1*, *EIN4*, and *EIN2*), N-end rule pathway (*PRT6*, *ATE1*, *ATE2*), and of *ABI5*, gene encoding ABI5, regulator of ABA action, and three genes encoding DELLAs (*gibberellin insensitive* = *GAI*, *repressor of ga1-3* = *RGA* and *RGA-like 2* = *RGL2*) which regulate the GAs signaling.

2. Results

2.1. Effects of Cold, Ethylene and GA₃ on Germination of Dormant Seeds

Dormant Arabidopsis (Col-0) seeds were able to easily germinate at 15 °C but no germination occurred at 25 °C (Figure 1a). This dormancy was progressively broken by an incubation at 4 °C (Figure 1a). After one, two, three, and four days at 4 °C, 6.3, 49.5, and 99.5% of the seed population became able to germinate at 25 °C within two days (Figure 1a). Moreover, 0.125 ppm exogenous ethylene improved the germination at 25 °C. This stimulatory effect increased with increasing ethylene concentration, around 50% and 100% of the seed population being able to germinate at 25 °C within seven days in the presence of ethylene at 1.25 ppm and 50–100 ppm, respectively (Figure 1b). Incubation of dormant seeds for one day at 4 °C did not strongly improve the germination in air, but had an additive effect with ethylene; around 75% of the seed population became able to germinate in the presence of 1.25 ppm ethylene against 50% for the control non-chilled seeds (Figure 1b). In contrast, 1-methylcyclopropene (1-MCP) 1000 ppb, an inhibitor of ethylene action, resulted in an inhibition of germination at 15 °C and a suppression of the improving effect of ethylene at 25 °C (Table S1).

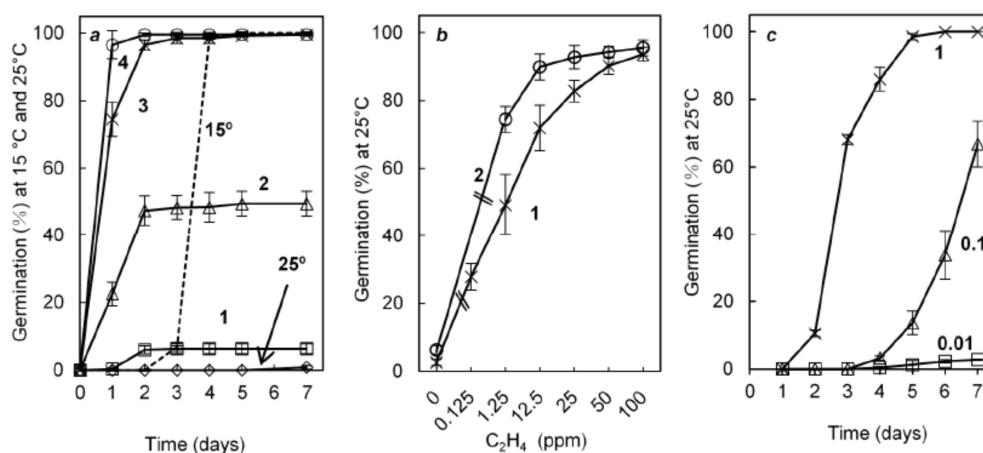

Figure 1. Effects of temperature (a), ethylene (b) and GA₃ (c) on the germination of dormant Col-0 seeds. (a) germination at 15 °C (—) and 25 °C (indicated by arrow, open diamonds), and at 25 °C after one (1), two (2), three (3), and four (4) days of incubation at 4 °C; (b) effects of ethylene concentration on the germination percentages obtained after seven days at 25 °C with seeds placed directly at 25 °C in the presence of C₂H₄ (1) or after one day of incubation at 4 °C (2); (c) effects of GA₃ concentration (mM) on the germination percentage obtained at 25 °C. Seeds harvested in 2014. Means of 3 replicates ± SD.

GA₃ at high concentration (0.1 and 1 mM) improved the germination of dormant seeds placed at 25 °C (Figure 1c). All the seed population germinated within five days at 25 °C in the presence of GA₃ 1 mM, when only 2.8% and 66.8% of the seed population germinated within seven days in the presence of GA₃ 0.01 and 0.1 mM, respectively (Figure 1c). In addition, the stimulatory effect of ethylene (12.5 and 50 ppm) was reduced in the presence of ABA, and suppressed in the presence of ABA 10 μM (Figure S1).

2.2. Involvement of Ethylene Signaling Pathway and of the N-End Rule Pathway on the Responsiveness of Dormant Seeds to Cold, Ethylene and GA₃

In order to determine the involvement of ethylene in the regulation of dormancy, we have used various mutants (*etr1*, *ein2*, and *ein4*) affected in the ethylene signaling pathway at the level of the receptor (ETR1 and EIN4), and of EIN2 which play a central role in the responsiveness to this hormone [12,46,47]. Seeds of Col-0 and all the mutants studied did not germinate at 25 °C, but easily germinate at 15 °C except *etr1* and *ein2* mutants (Table 1). The same behavior was observed with seeds harvested in 2016; the germination of *etr1* and *ein2* seeds was lower at 15 °C than that of Col-0, and neither of the mutants replied to exogenous ethylene (Table S2).

Table 1. Germination percentages obtained after seven days at 15 and 25 °C, at 15 °C in the presence of the paclobutrazol (1 μM) and at 25 °C in the presence of ethylene 50 ppm, GA₃ 1 mM and after four days of incubation at 4 °C. Means of 3 replicates ± SD. Seeds harvested in 2014.

Lines	Germination (%) after 7 Days at					
	15 °C	15 °C with 1 μM Paclobutrazol	25 °C	25 °C with 50 ppm C ₂ H ₄	25 °C after 4 Days at 4 °C	25 °C with 1 mM GA ₃
Col-0	100	91.5 ± 5.4	0.9 ± 0.1	96.3 ± 2.2	99.5 ± 0.3	100
<i>etr1</i>	42.4 ± 3.4	2.5 ± 0.9	2.3 ± 2.1	7.5 ± 0.3	81.6 ± 2.5	23.8 ± 13.0
<i>ein4</i>	100	76.9 ± 0.8	19.6 ± 10.4	75.6 ± 3.8	99.5 ± 0.2	88.0 ± 2.3
<i>ein2</i>	86.4 ± 2.5	95.1 ± 0.8	0.3 ± 0.3	2.8 ± 2.8	98.6 ± 0.3	81.1 ± 9.1

Etr1 and *ein2* were almost totally insensitive to C₂H₄ (Table 1 and Table S2), but three to four days of chilling at 4 °C promoted germination at 25 °C of all mutants including the ethylene insensitive ones (*etr1*, *ein2*) (Table 1, Figure 2) suggesting that cold could act directly on dormancy by bypassing the ethylene pathway even though *etr1* remained the less sensitive to stratification (Figure 2).

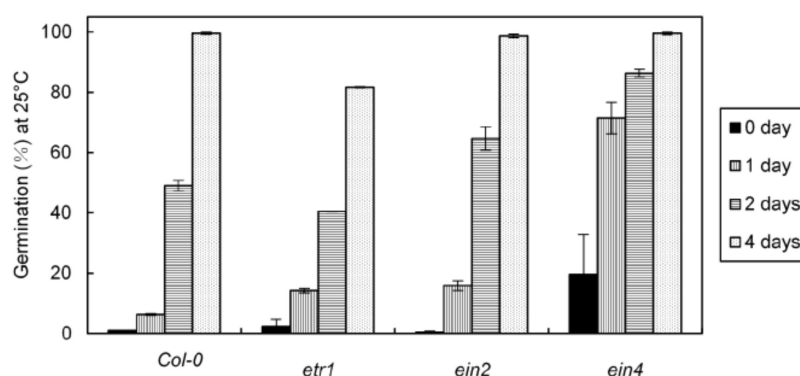

Figure 2. Effects of seed stratification at 4 °C for one, two, three, and four days on the germination percentages obtained after seven days at 25 °C with various genotypes affected in the ethylene signaling pathway (*etr1*, *ein2* and *ein4*). Means of three replicates ± SD.

GA₃ at high concentration (1 mM) promoted the germination of dormant seeds in Col-0 (Figure 1c). Among the mutants studied, *ein2* seeds were responsive to GA₃ to a high extent as germination reached

around 40% and 80% in the presence of GA₃ 0.1 mM (data not shown) and 1 mM (Table 1), respectively. In contrast, *etr1* did not respond to GA₃ (Table 1), and it was also more sensitive to paclobutrazol (1 μM) at 15 °C (Table 1).

Ethylene did not break the dormancy of seeds from *prt6* mutant and *ate1-ate2* double mutant suggesting that the N-end rule is involved in seed responsiveness to ethylene (Figure 3). Like the mutants affected in the ethylene signaling pathway (*etr1* and *ein2*) (Table 1), 2–4 days of incubation at 4 °C promoted the germination of almost all the seed population from the mutants affected in the N-end rule pathway (Figure 3). Unlike *etr1* (Table 1), the germination of *prt6* and *ate1-ate2* mutants was promoted by GA₃ (1 mM) (Figure 3).

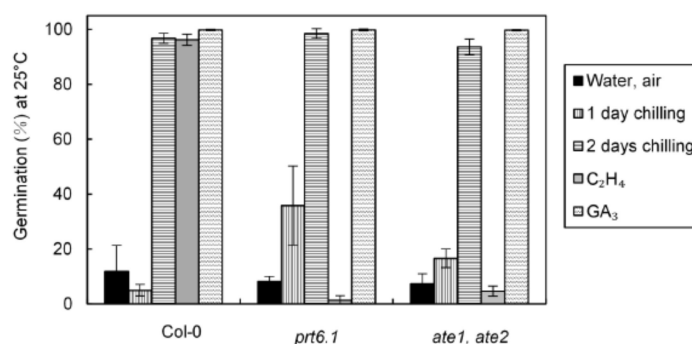

Figure 3. Germination percentages obtained after seven days at 25 °C with Col-0 and the N-end rule mutants (*prt6-1* and *ate1-ate2*) seeds placed directly at 25 °C on water without ethylene (control) or in the presence of ethylene 100 ppm, at 25 °C in the presence of GA₃ 1 mM and at 25 °C after 1 and 2 days of incubation at 4 °C. Means of three replicates ± SD. Seeds harvested in 2016.

2.3. Effect of Cold, Ethylene and GA₃ Treatments on the Relative Expression of *ETR1*, *EIN4*, and *EIN2* Involved in Ethylene Signaling Pathway

Figure 4 shows the effects of incubation of wild type seeds (Col-0) for 24 h at 4 °C, at 25 °C in the presence of ethylene or GA₃ on the relative expression of *ETR1*, *EIN4*, and *EIN2* calculated as compared to control seeds imbibed for 24 h on water without either ethylene or cold. One day at 4 °C strongly induced the relative expression of the gene involved in ethylene perception (*ETR1*, *EIN4*) and the major signaling elements gene (*EIN2*) (Figure 4) indicating the involvement of ethylene in the cold response. After 24 h treatment at 4 °C, the transcript abundance was 2.21, 5.40, and 7.50 times of the transcript abundance measured in the control seeds incubated at 25 °C, for *ETR1*, *EIN2*, and *EIN4*, respectively. In contrast, 24 h-incubation in the presence of either ethylene or GA₃ (Figure 4) did not significantly induced changes in the relative expression of the three genes.

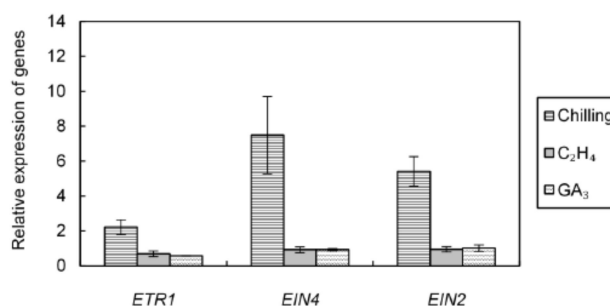

Figure 4. Relative expression of *ETR1*, *EIN4*, and *EIN2* in seeds (Col-0) incubated for 24 h at 4 °C, at 25 °C in the presence of ethylene or GA₃ 1 mM. Control seeds were incubated for 24 h at 25 °C on water, an arbitrary value of 1 was assigned to control seeds incubated for 24 h at 25 °C on water. Means of three replicates ± SD. Seeds harvested in 2014.

Seed incubation for 16 h increased both gene expressions as compared to the dry seeds (Table 2). Longer incubation (30 and 48 h) at 25 °C in the presence of ethylene results then in a decrease in *ERT1* and *EIN2* expression as compared to seeds incubated without ethylene (Table 2).

Table 2. Relative expression of *ERT1* and *EIN2* in seeds (Col-0) incubated for 16, 30, and 48 h at 25 °C in the absence or the presence of ethylene 100 ppm. Calculation was done as compared to dry seeds. Means of three replicates \pm SD. Seeds harvested in 2016.

Conditions of Seed Incubation at 25 °C		Relative Expression (Dry Seeds) of	
Treatment	Duration (h)	<i>ERT1</i>	<i>EIN2</i>
Air	16	3.09 \pm 0.55	5.66 \pm 0.27
	30	1.97 \pm 0.27	3.16 \pm 0.46
	48	5.20 \pm 1.72	9.41 \pm 0.67
Ethylene (100 ppm)	16	2.64 \pm 0.38	4.98 \pm 1.05
	30	1.20 \pm 0.19	1.55 \pm 0.18
	48	0.63 \pm 0.16	1.72 \pm 0.18

2.4. Effect of Cold and Ethylene Treatments on the Relative Expression of *PRT6*, *ATE1*, and *ATE2* Involved in the N-End Rule

Incubation at 25 °C, a temperature at which wild type seeds (Col-0) did not germinate, resulted in an increase in *PRT6* and *ATE2* relative expression which was 2.62 and 1.66 times higher than that in the dry seeds after 48 h of incubation (Figure 5a,c), but did not result in significant changes in *ate1* transcript relative abundance (Figure 5b). Seed incubation at 4 °C, a temperature which progressively alleviated dormancy was also associated with an increase in *PRT6* similar to that observed at 25 °C (Figure 5a) and a decrease in *ATE1* and *ATE2* expression (Figure 5b,c). However, transfer of seeds from 4 °C to 25 °C for 10 h resulted in a strong decrease in *PRT6* relative expression (Figure 5a). This down-regulation of *PRT6* and *ATE1* from 24 h (Figure 5a,b) was associated with breaking of dormancy or the start of the germination process.

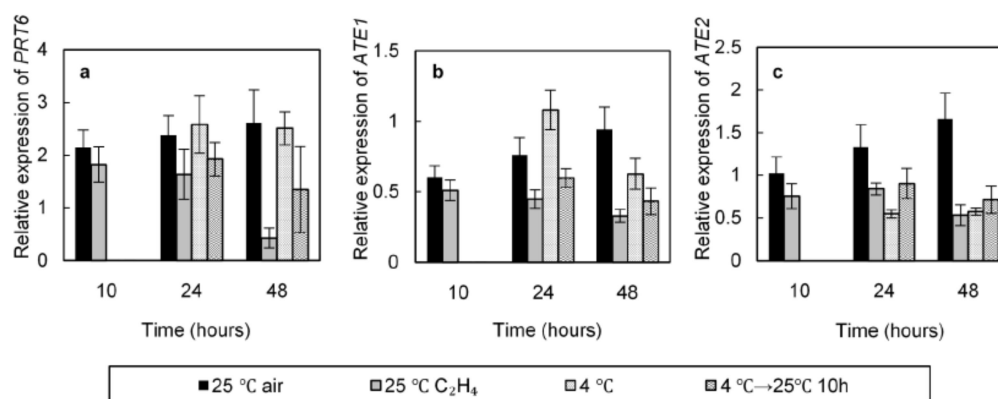

Figure 5. Relative expression of *PRT6* (a), *ATE1* (b), and *ATE2* (c) in seeds (Col-0) incubated at 25 °C or at 4 °C on water, at 25 °C for 10 h after stratification at 4 °C, and at 25 °C in the presence of ethylene 100 ppm. An arbitrary value of 1 was assigned to dry seeds. Means of three replicates \pm SD. Seeds harvested in 2016.

Seed incubation at 25 °C in the presence of ethylene (100 ppm) resulted in a significant decrease in *PRT6*, *ATE1*, and *ATE2* transcript levels for 24 h of imbibition as compared with seeds placed at 25 °C without ethylene (Figure 5). After 48 h in the presence of ethylene the transcript abundance of *PRT6*, *ATE1*, and *ATE2* corresponded to around 0.43, 0.33, and 0.53 of the initial value, respectively,

when *PRT6* relative expression reached 2.60 and *ATE1* and *ATE2* remained unchanged or less than double (0.94 and 1.66, respectively) for seeds incubated at 25 °C without ethylene (Figure 5).

2.5. Effect of Cold and Ethylene Treatments on the Relative Expression of *ABI5*, *RGA*, *GAI*, and *RGL2*

ABA and GAs being involved in the germination of dormant seeds, we have compared the effects of cold and ethylene on the expression of *ABI5*, involved in ABA signaling, in particular ABA inactivation, and *RGA*, *GAI*, and *RGL2* encoding three DELLAs involved in the regulation of GAs efficiency.

Seed imbibed at either 25 or 4 °C resulted in a decrease in *ABI5* relative expression, this phenomenon being more important at 4 °C than that at 25 °C (Figure 6a). For example, after 48 h incubation the *ABI5* transcript relative abundance was 0.12 and 0.41 of its initial value, at 4 and 25 °C, respectively. Seed transferred from 4 °C to 25 °C resulted in an additional reduction of the transcript level. Ethylene applied at 25 °C almost completely suppressed the expression of *ABI5* after 24 h of incubation (Figure 6a).

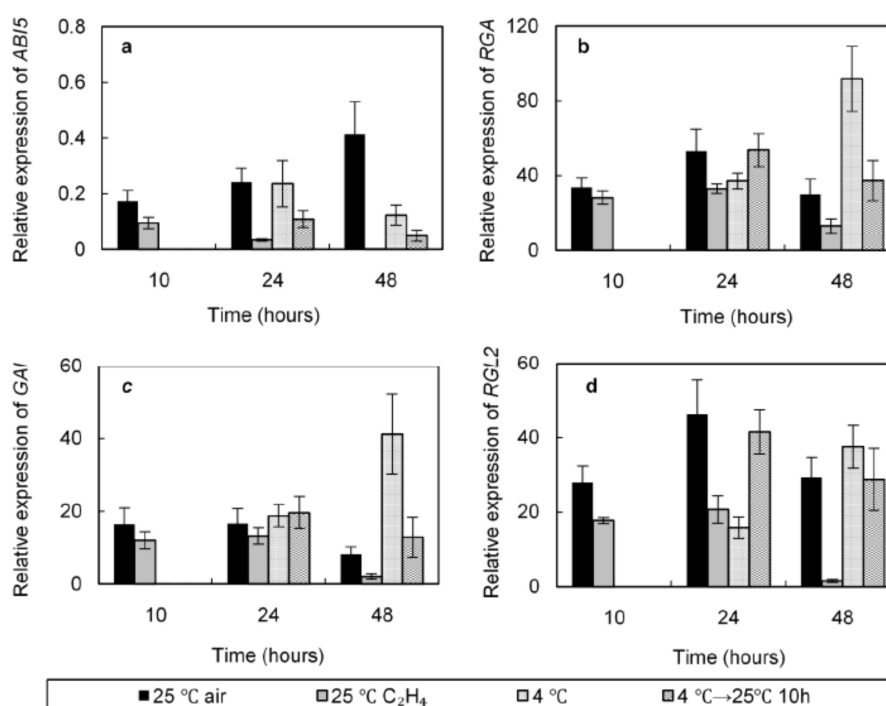

Figure 6. Relative expression of *ABI5* (a), *RGA* (b), *GAI* (c), and *RGL2* (d) in seeds (Col-0) incubated at 25 °C or at 4 °C on water, at 25 °C for 10 h after stratification at 4 °C and at 25 °C in the presence of ethylene 100 ppm. An arbitrary value of 1 was assigned to dry seeds. Means of three replicates \pm SD. Seeds harvested in 2016.

Expression of the genes encoding the three DELLAs was induced during seed incubation at 4 and 25 °C, but this increase depended on the temperature (Figure 6b–d). Except for that of *RGL2* (Figure 6d), the relative expression of *RGA* (Figure 6b) and *GAI* (Figure 6c) was higher at 4 °C than that at 25 °C at 48 h, and transfer of seeds from 4 to 25 °C resulted in a decrease in the transcript relative abundance for the three *DELLA* genes. Application of ethylene at 25 °C for at least 24 h resulted in a decrease in the gene relative expression for the three *DELLAs* (Figure 6b–d). After 48 h of seed incubation in the presence of ethylene, the relative expression of *RGA*, *GAI*, and *RGL2* respectively represented 0.43, 0.26, and 0.05 of that calculated in the control seeds placed at 25 °C without ethylene.

3. Discussion and Conclusions

At harvest, *Arabidopsis* seeds easily germinate at low temperatures (10–15 °C), but their germination become progressively impossible with increasing temperature and does not occur at 25 °C (Figure 1a). Two days of incubation at 4 °C was enough to alleviate dormancy (Figure 1a) whereas removal of dormancy requires more than 2–8 weeks of seed stratification in other species [48]. The involvement of ABA and GAs, and the hormonal balance between both hormones in the regulation of dormancy in response to chilling is well documented [3,4,6,49]. Breaking of dormancy by cold treatment is associated with a decrease in ABA resulting in induction of *CYP707A2* and in ABA sensitivity, and an increase in GAs biosynthesis through changes in *GA3OX1* and *GA20OX* expression [13,16,17,50,51]. Our results demonstrate that cold treatment breaks dormancy of all mutants affected in ethylene signaling, however *etr1* seeds have the lowest responsiveness to chilling suggesting that ethylene might be indirectly involved in dormancy (Figure 2, Table 1). Figure 4 also indicates that 24 h of cold stratification results in an up-regulation of *ETR1*, *EIN4*, and *EIN2* which can explain the increase in ethylene sensitivity after stratification of *Arabidopsis* (Figure 1b) and apple embryos [52]. Opposingly, incubation of seeds in the presence of GA₃ and ethylene does not affect the expression of these three genes (Figure 4).

Exogenous ethylene also stimulates the germination of dormant *Arabidopsis* seeds (Figure 1b) as in other numerous species [10–12]. This stimulatory effect is dose dependent, and Figure 1b shows that 50–100 ppm ($\mu\text{L L}^{-1}$) is optimal to alleviate seed dormancy. However seed responsiveness to ethylene depends on the species and the depth of dormancy [12]. Our results demonstrate that one day chilling is associated with an increasing sensitivity to ethylene (Figure 1b) in agreement with the results obtained during breaking of dormancy by chilling in apple [52] and during dry storage in sunflower [53]. In agreement with the results published by Beaudoin et al. [24] and Siriwitayawan et al. [54] *etr1* as well as *ein2* are more dormant than wild type ones (Table 1 and Table S2) demonstrating that lower responsiveness to ethylene is associated with dormancy. Our results also demonstrate that an inhibitor of ethylene action (MCP) inhibits seed germination at 15 °C (Table S1). The regulation of germination by ethylene in relation with ABA and GAs is well documented [11,12]. Among the mutant studied, Table 1 shows that at 25 °C *etr1* does not response to GA₃, even applied at high concentrations (1 mM) and that the germination at 15 °C is strongly inhibited in the presence of paclobutrazol (1 μM); these results are in agreement with a crosstalk between ethylene and GAs signaling pathway, *ETR1* being a possible sharing component. Chiwocha et al. [55] also indicates that lack of *ETR1* leads to changes in GAs biosynthesis and a lower sensitivity to GAs. Our results also indicate that the improving effect of chilling and exogenous ethylene on seed germination do not result in similar changes in expression of *RGA*, *GAI*, and *RGL2*, genes encoding three DELLAs. After 48 h, the transcript abundance remains higher at 4 °C than that at 25 °C, temperature at which germination does not occur when application of ethylene results in a fast decrease in *RGA*, *GAI*, and *RGL2* relative expression (Figure 6b–d). Alleviation of dormancy after two days at 4 °C is not associated with a strong decrease of the three gene expression; after transfer of seeds from 4 °C to 25 °C (i.e., in non-dormant seeds), *RGA* (Figure 6b), *GAI* (Figure 6c), and *RGL2* (Figure 6d) relative expressions are similar to those measured in dormant seeds maintained at 25 °C. Achard et al. [28,56] reported that ethylene action is mediated via its effects on DELLAs proteins. The decrease in *DELLAs* transcripts in the presence of ethylene observed in Figure 6 could result from a crosstalk between GAs and ethylene signaling pathway. ABA counteracts the effect of C₂H₄ (Figure S1) and Beaudoin et al. [24] reported a high sensitivity to ABA of seeds from the mutant affected in the ethylene signaling pathway. Among the mutants studied, *etr1* is the more sensitive to ABA (Table S2). In addition we demonstrate that exogenous ethylene strongly down-regulates the expression of *ABI5* and that this decrease in *ABI5* expression is more important in the presence of ethylene than that at 4 °C (Figure 6a). Beside the effects of chilling on ethylene signaling pathway (Figure 4) and ethylene sensitivity (Figure 1b), stratification at low temperatures can improve germination after seed transfer at 25 °C through an effect on ABA and GAs signaling pathways, transcript abundance of *ABI5*, and *DELLA5* being modified (Figure 6).

It is well accepted that E3 ligase activity plays an essential role in hormone signal transduction pathway [29–31,36,57]. For the first time, we demonstrate that the seed responsiveness to ethylene requires the N-end rule pathway, dormancy of seeds from *prt6* and *ate1-ate2* mutants being insensitive to ethylene (Figure 3). As an *ein2* mutant (Table 1), dormancy of *prt6* and *ate1-ate2* mutants can be alleviated by 2–4 days of cold stratification or application of GA₃ (Figure 3). As previously published by Holman et al. [41] and Gibbs et al. [45], *prt6* and *ate1-ate2* seeds are more sensitive to ABA and more tolerant to hypoxia than the wild type. In addition, the ethylene response factors from group VII (RAP2.2, RAP2.3, RAP2.12, HRE1, and HRE2) have been identified as substrates of the N-end rule pathway [45,58,59]. Gibbs et al. [59] demonstrate that the effect of NO which alleviates Arabidopsis dormancy [11] requires a regulation through the expression of *ABI5* [60]. Figure 5 indicates that exogenous ethylene and 2 day-chilling followed by 10 h at 25 °C, conditions which allow germination, result in a decrease of the relative expression of *PRT6* (Figure 5a), *ATE1* (Figure 5b), and *ATE2* (Figure 5c), whereas seed incubation at 25 °C which does not allow germination, does not significantly affect the relative expression of *PRT6*, *ATE1*, and *ATE2*. These data suggest that down-regulation of the genes involved in the N-end rule is associated with the germination of Col-0. Using mutants and as demonstrated by Gibbs et al. [59,60] concerning the seed responsiveness to NO, we suggest that the insensitivity to ethylene probably results from a regulation of group VII ERF levels via the N-end rule activity and a crosstalk with ABA and GAs signaling.

In conclusion, the present work demonstrates that cold treatment and exogenous ethylene, which both alleviate seed dormancy, do not result in comparable changes in expression of genes involved in the ethylene signaling pathway, in ABA signaling (*ABI5*) and in genes encoding DELLAs (Figures 4–6). We report for the first time the involvement of the N-end rule pathway in the responsiveness of seeds to ethylene. The aims of our further researches are to determine whether the ERF transcription factors have a role in the interaction between the N-end rule pathway, ABA, and GAs signaling pathways in the regulation of dormancy.

4. Materials and Methods

4.1. Seed Material

Arabidopsis thaliana seeds from Columbia-0 (Col-0) were used as the wild type of this study. The mutants affected in the ethylene signaling pathway and the N-end rule pathway were obtained from the Nottingham Arabidopsis Stock Center (NASC) or from individual researchers: *etr1* (NASC ID number N237); *ein4* (NASC ID number N8053) [61]; *ein2* (NASC ID number N3071) [62]; *prt6-1* (Sail-1278-H11); *ate1-ate2* (gifts from Dr. M. J. Holdsworth, Nottingham University) [41,45,59,63]. All mutants were in the Arabidopsis genetic background Columbia-0. Seeds were sown in a mixture of soil and vermiculite (9:1) and placed in a growth chamber at 21 °C under a photoperiod of 16 h light/8 h dark with a light intensity between 150 and 200 $\mu\text{mol}\cdot\text{m}^{-2}\cdot\text{s}^{-1}$. After 12–15 days, germinated seeds were transferred on soil/perlite/vermiculite (2:1:1) and plants were grown in the same conditions. Siliques were harvested at maturity and seeds were collected. Seeds freshly harvested in 2014, 2015, and 2016 with a moisture content at around 5–6% dry weight were stored at –30 °C in order to preserve their initial dormancy.

4.2. Germination Assays

Germination assays were performed in darkness in 9 cm Petri dishes (100 to 200 seeds per assay in 3 replicates) by placing seeds on a filter paper on the top of a layer of cotton wool moistened with deionized water, abscisic acid (ABA: 0.1, 1 or 10 μM), gibberellic acid (GA₃: 0.01, 0.1 or 1 mM), paclobutrazol, and 1-methylcyclopropene (1-MCP: 1000 ppb). Seed stratification was carried out at 4 °C as the germination assays on water for 1 to 4 days.

Germination assays in the presence of gaseous ethylene were carried out in tightly closed 360 mL-containers in which was injected gaseous ethylene (5%) (Air Liquide, Paris, France) in order to obtain concentration from 0 to 100 $\mu\text{L L}^{-1}$.

A seed was considered to have germinated as soon as the radicle protruded through the seed coat. Germination counts were made every 24 h for 7 days, and the results presented are the means of the germination percentages obtained with 3 replicates \pm SD.

4.3. RNA Extraction and Real-Time Quantitative RT-PCR

A 50 mg aliquot of seeds was ground in liquid nitrogen, and total RNA was extracted by a modified CTAB method as described by Chang et al. [64]. Total RNA (1 μg) was treated with DNase I (ThermoFisher, Waltham, MA, USA), reverse transcribed with Revertaid Reverse Transcriptase (ThermoFisher) in a 25 μL reaction volume and amplified with Mastercycler ep Realplex (Eppendorf, Hamburg, Germany) using 5 μL of 30-fold diluted cDNA solution. Primers were designed with primer3 software. They were obtained from Eurogentec (Angers, France) and the primer sequences are shown in Table S1. Real-time PCRs were performed with the Maxima™ SYBR Green qPCR Master Mix (ThermoFisher) and 0.23 μM of each primer in a 15 μL reaction. Cycle thresholds (Cts) were calculated using the Realplex 2.0 software (Eppendorf). For each plate and each gene, a standard curve made with dilutions of cDNA pools was used to calculate the reaction efficiencies, and the relative expression was calculated according to Hellemans et al. [65] with *UBQ5* (*Ubiquitin5*, AT3G62250) and *EMB1345* (*Embryo defective 1345*, AT2G26060), or with *CB5-E* (*Cytochrome B5 isoform E*, AT5G53560), *RHIP1* (*Chromosome associated kinesin*, AT4G26410) and *TIP41* (*Tip-like family Protein*, AT4G34270) as reference genes used by [66] and by [67,68], respectively. An arbitrary value of 1 was assigned to the Col-0 seeds imbibed during 24 h at 25 °C on water (Figure 4) or to the dry seeds (Figures 5 and 6), which were used as control for normalization [69]. Results presented are the means \pm SD of 3 or 4 biological replicates.

Supplementary Materials: The following are available online at <http://www.mdpi.com/1422-0067/19/11/3577/s1>.

Author Contributions: Data analysis, X.W., Z.Y.-C., C.B. (Catherine Biniek) and F.C.; Supervision, F.C.; Writing—Original draft, H.E.-M.-B., F.C.; Review and editing, C.B. (Christophe Bailly), H.E.-M.-B. and F.C.

Funding: The Xu Wang was funded by China Scholarship Council.

Acknowledgments: Authors thank M.J. Holdsworth (School of Biosciences, University of Nottingham, UK) for providing the mutants affected in the N-end rule pathway.

Conflicts of Interest: The authors declare no conflict of interest.

References

1. Finch-Savage, W.E.; Leubner-Metzger, G. Seed dormancy and the control of germination. *New Phytol.* **2006**, *171*, 501–523. [[CrossRef](#)] [[PubMed](#)]
2. Finch-Savage, W.E.; Footitt, S. Seed dormancy cycling and the regulation of dormancy mechanisms to time germination in variable field environments. *J. Exp. Bot.* **2017**, *68*, 843–856. [[CrossRef](#)] [[PubMed](#)]
3. Graeber, K.; Nakabayashi, K.; Miatton, E.; Leubner-Metzger, G.; Soppe, W.J. Molecular mechanisms of seed dormancy. *Plant Cell Environ.* **2012**, *35*, 1769–1786. [[CrossRef](#)] [[PubMed](#)]
4. Miransari, M.; Smith, D.L. Plant hormones and seed germination. *Environ. Exp. Bot.* **2014**, *99*, 110–121. [[CrossRef](#)]
5. Nonogaki, H. Seed biology updates—Highlights and new discoveries in seed dormancy and germination research. *Front. Plant Sci.* **2017**, *8*, 524:1–524:16. [[CrossRef](#)] [[PubMed](#)]
6. Finkelstein, R.; Reeves, W.; Ariizumi, T.; Steber, C. Molecular aspects of seed dormancy. *Annu. Rev. Plant Biol.* **2008**, *59*, 387–415. [[CrossRef](#)] [[PubMed](#)]
7. Shu, K.; Liu, X.; Xie, Q.; He, Z. Two faces of one seed: Hormonal regulation of dormancy and germination. *Mol. Plant* **2016**, *9*, 34–45. [[CrossRef](#)] [[PubMed](#)]
8. Dill, A.; Sun, T. Synergistic derepression of gibberellin signaling by removing RGA and GAI function in *Arabidopsis thaliana*. *Genetics* **2001**, *159*, 777–785. [[PubMed](#)]

9. Piskurewicz, U.; Jikumaru, Y.; Kinoshita, N.; Nambara, E.; Kamiya, Y.; Lopez-Molina, L. The gibberellic acid signaling repressor RGL2 inhibits Arabidopsis seed germination by stimulating abscisic acid synthesis and ABI5 activity. *Plant Cell* 2008, 20, 2729–2745. [[CrossRef](#)] [[PubMed](#)]
10. Matilla, A.J.; Matilla-Vazquez, M.A. Involvement of ethylene in seed physiology. *Plant Sci.* 2008, 175, 87–97. [[CrossRef](#)]
11. Arc, E.; Sechet, J.; Corbineau, F.; Rajjou, L.; Marion-Poll, A. ABA crosstalk with ethylene and nitric oxide in seed dormancy and germination. *Front. Plant Sci.* 2013, 4, 63:1–63:19. [[CrossRef](#)] [[PubMed](#)]
12. Corbineau, F.; Xia, Q.; Bailly, C.; El-Maarouf-Bouteau, H. Ethylene, a key factor in the regulation of seed dormancy. *Front. Plant Sci.* 2014, 5, 539:1–539:13. [[CrossRef](#)] [[PubMed](#)]
13. Holdsworth, M.J.; Bentsink, L.; Soppe, W.J.J. Molecular networks regulating Arabidopsis seed maturation, after-ripening, dormancy and germination. *New Phytol.* 2008, 179, 33–54. [[CrossRef](#)] [[PubMed](#)]
14. Derkx, M.P.M.; Karssen, C.M. Variability in light gibberellin and nitrate requirement of *Arabidopsis thaliana* seeds due to harvest time and conditions of dry storage. *J. Plant Physiol.* 1993, 141, 574–582. [[CrossRef](#)]
15. Koornneef, M.; Karssen, C.M. Seed dormancy and germination. In *Arabidopsis*, 1st ed.; Meyerowitz, E.M., Somerville, C.R., Eds.; Cold Spring Harbor Laboratory Press: Cold Spring Harbor, NY, USA, 1994; Volume 27, pp. 313–334. ISBN 9780879694289.
16. Yamauchi, Y.; Ogawa, M.; Kuwahara, A.; Hanada, A.; Kamiya, Y.; Yamaguchi, S. Activation of gibberellin biosynthesis and response pathways by low temperature during imbibition of *Arabidopsis thaliana* seeds. *Plant Cell* 2004, 16, 367–378. [[CrossRef](#)] [[PubMed](#)]
17. Topham, A.T.; Taylor, R.E.; Yan, D.; Nambara, E.; Johnston, I.G.; Bassel, G.W. Temperature variability is integrated by a spatially embedded decision-making center to break dormancy in Arabidopsis seeds. *Proc. Natl. Acad. Sci. USA* 2017, 114, 6629–6634. [[CrossRef](#)] [[PubMed](#)]
18. Staszak, A.M.; Guzicka, M.; Pawlowski, T.A. Signalling regulators of abscisic and gibberellic acid pathways are involved in dormancy breaking of norway maple (*Acer platanoides* L.) seeds. *Acta Physiol. Plant.* 2017, 39, 251:1–251:10. [[CrossRef](#)]
19. Linkies, A.; Leubner-Metzger, G. Beyond gibberellins and abscisic acid: How ethylene and jasmonates control seed germination. *Plant Cell Rep.* 2012, 31, 253–270. [[CrossRef](#)] [[PubMed](#)]
20. Wang, C.Y. Relation of chilling stress to ethylene production. In *Low Temperature Stress Physiology in Crops*, 1st ed.; CRC Press: Boca Raton, FL, USA, 1989; pp. 177–190, ISBN 9780849365676.
21. Wang, K.L.; Li, H.; Ecker, J.R. Ethylene biosynthesis and signaling networks. *Plant Cell* 2002, 14, S131–S151. [[CrossRef](#)] [[PubMed](#)]
22. Merchante, C.; Alonso, J.M.; Stepanova, A.N. Ethylene signaling: Simple ligand, complex regulation. *Curr. Opin. Plant Biol.* 2013, 16, 554–560. [[CrossRef](#)] [[PubMed](#)]
23. Ohme-Takagi, M.; Shinshi, H. Ethylene-inducible DNA binding proteins that interact with an ethylene-responsive element. *Plant Cell* 1995, 7, 173–182. [[CrossRef](#)] [[PubMed](#)]
24. Beaudoin, N.; Serizet, C.; Gosti, F.; Giraudat, J. Interactions between abscisic acid and ethylene signaling cascades. *Plant Cell* 2000, 12, 1103–1115. [[CrossRef](#)] [[PubMed](#)]
25. Ghassemian, M.; Nambara, E.; Cutler, S.; Kawaide, H.; Kamiya, Y.; McCourt, P. Regulation of abscisic acid signaling by the ethylene response pathway in Arabidopsis. *Plant Cell* 2000, 12, 1117–1126. [[CrossRef](#)] [[PubMed](#)]
26. Calvo, A.P.; Nicolas, C.; Lorenzo, O.; Nicolas, G.; Rodriguez, D. Evidence for positive regulation by gibberellins and ethylene of ACC oxidase expression and activity during transition from dormancy to germination in *Fagus Sylvatica* L. Seeds. *J. Plant Growth Regul.* 2004, 23, 44–53. [[CrossRef](#)]
27. Iglesias-Fernandez, R.; Matilla, A.J. Genes involved in ethylene and gibberellins metabolism are required for endosperm-limited germination of *Sisymbrium officinale* L. Seeds: Germination in *Sisymbrium officinale* L. Seeds. *Planta* 2010, 231, 653–664. [[CrossRef](#)] [[PubMed](#)]
28. Achard, P.; Vriezen, W.H.; Van Der Straeten, D.; Harberd, N.P. Ethylene regulates Arabidopsis development via the modulation of DELLA protein growth repressor function. *Plant Cell* 2003, 15, 2816–2825. [[CrossRef](#)] [[PubMed](#)]
29. Penfield, S.; King, J. Towards a systems biology approach to understanding seed dormancy and germination. *Proc. Biol. Sci.* 2009, 276, 3561–35699. [[CrossRef](#)] [[PubMed](#)]
30. Santner, A.; Estelle, M. The ubiquitin-proteasome system regulates plant hormone signaling. *Plant J.* 2010, 61, 1029–1040. [[CrossRef](#)] [[PubMed](#)]

31. Kelley, D.R.; Estelle, M. Ubiquitin-mediated control of plant hormone signaling. *Plant Physiol.* **2012**, *160*, 47–55. [[CrossRef](#)] [[PubMed](#)]
32. Varshavsky, A. The N-end rule pathway of protein degradation. *Genes Cells* **1997**, *2*, 13–28. [[CrossRef](#)] [[PubMed](#)]
33. Graciet, E.; Mesiti, F.; Wellmer, F. Structure and evolutionary conservation of the plant N-end rule pathway. *Plant J.* **2010**, *61*, 741–751. [[CrossRef](#)] [[PubMed](#)]
34. Sriram, S.M.; Kim, B.Y.; Kwon, Y.T. The n-end rule pathway: Emerging functions and molecular principles of substrate recognition. *Nat. Rev. Mol. Cell Biol.* **2011**, *12*, 735–747. [[CrossRef](#)] [[PubMed](#)]
35. Wang, F.; Deng, X.W. Plant ubiquitin-proteasome pathway and its role in gibberellin signaling. *Cell Res.* **2011**, *21*, 1286–1294. [[CrossRef](#)] [[PubMed](#)]
36. Tyler, L.; Thomas, S.G.; Hu, J.; Dill, A.; Alonso, J.M.; Ecker, J.R.; Sun, T.P. DELLA proteins and gibberellin-regulated seed germination and floral development in Arabidopsis. *Plant Physiol.* **2004**, *135*, 1008–1019. [[CrossRef](#)] [[PubMed](#)]
37. Schwechheimer, C. Understanding gibberellic acid signaling—Are we there yet? *Curr. Opin. Plant Biol.* **2008**, *11*, 9–15. [[CrossRef](#)] [[PubMed](#)]
38. Sun, T.P. The molecular mechanism and evolution of the GA-GID1-DELLA signaling module in plants. *Curr. Biol.* **2011**, *21*, R338–R345. [[CrossRef](#)] [[PubMed](#)]
39. Miura, K.; Lee, J.; Jin, J.B.; Yoo, C.Y.; Miura, T.; Hasegawa, P.M. Sumoylation of ABI5 by the Arabidopsis SUMO E3 ligase SIZ1 negatively regulates abscisic acid signaling. *Proc. Natl. Acad. Sci. USA* **2009**, *106*, 5418–5423. [[CrossRef](#)] [[PubMed](#)]
40. Lee, J.H.; Yoon, H.J.; Terzaghi, W.; Martinez, C.; Dai, M.Q.; Li, J.G.; Byun, M.O.; Deng, X.W. DWA1 and DWA2, two Arabidopsis DWD protein components of CUL4-based E3 ligases, act together as negative regulators in ABA signal transduction. *Plant Cell* **2010**, *22*, 1716–1732. [[CrossRef](#)] [[PubMed](#)]
41. Holman, T.J.; Jones, P.D.; Russell, L.; Medhurst, A.; Tomas, S.U.; Talloji, P.; Marquez, J.; Schmutz, H.; Tung, S.A.; Taylor, I.; et al. The N-end rule pathway promotes seed germination and establishment through removal of ABA sensitivity in Arabidopsis. *Proc. Natl. Acad. Sci. USA* **2009**, *106*, 4549–4554. [[CrossRef](#)] [[PubMed](#)]
42. Christians, M.J.; Gingerich, D.J.; Hansen, M.; Binder, B.M.; Kieber, J.J.; Vierstra, R.D. The BTB ubiquitin ligases ETO1, EOL1 and EOL2 act collectively to regulate ethylene biosynthesis in Arabidopsis by controlling type-2 ACC synthase levels. *Plant J.* **2009**, *57*, 332–345. [[CrossRef](#)] [[PubMed](#)]
43. Lyzenga, W.J.; Stone, S.L. Regulation of ethylene biosynthesis through protein degradation. *Plant Signal Behav.* **2012**, *7*, 1438–1442. [[CrossRef](#)] [[PubMed](#)]
44. An, F.; Zhao, Q.; Ji, Y.; Li, W.; Jiang, Z.; Yu, X.; Zhang, C.; Han, Y.; He, W.; Liu, Y.; et al. Ethylene-induced stabilization of ETHYLENE INSENSITIVE3 and EIN3-LIKE1 is mediated by proteasomal degradation of EIN3 binding F-box 1 and 2 that requires EIN2 in Arabidopsis. *Plant Cell* **2010**, *22*, 2384–2401. [[CrossRef](#)] [[PubMed](#)]
45. Gibbs, D.J.; Lee, S.C.; Isa, N.M.; Gramuglia, S.; Fukao, T.; Bassel, G.W.; Correia, C.S.; Corbineau, F.; Theodoulou, F.L.; Bailey-Serres, J.; et al. Homeostatic response to hypoxia is regulated by the N-end rule pathway in plants. *Nature* **2011**, *479*, 415–423. [[CrossRef](#)] [[PubMed](#)]
46. Qiao, H.; Chang, K.N.; Yazaki, J.; Ecker, J.R. Interplay between ethylene, ETP1/ETP2 F-box proteins, and degradation of EIN2 triggers ethylene responses in Arabidopsis. *Genes Dev.* **2009**, *23*, 512–521. [[CrossRef](#)] [[PubMed](#)]
47. Ju, C.; Yoon, G.M.; Shemansky, J.M.; Lin, D.Y.; Ying, Z.I.; Chang, J.; Garrett, W.M.; Kessenbrock, M.; Groth, G.; Tucker, M.L.; et al. CTR1 phosphorylates the central regulator EIN2 to control ethylene hormone signaling from the ER membrane to the nucleus in Arabidopsis. *Proc. Natl. Acad. Sci. USA* **2012**, *109*, 19486–19491. [[CrossRef](#)] [[PubMed](#)]
48. Baskin, C.C.; Baskin, J.M. *Seeds: Ecology, Biogeography, and Evolution of Dormancy and Germination*, 2nd ed.; Academic Press: Cambridge, MA, USA, 2014; ISBN 9780124166776.
49. Nonogaki, H.; Bassel, G.W.; Bewley, J.D. Germination—still a mystery. *Plant Sci.* **2010**, *179*, 574–581. [[CrossRef](#)]
50. Hauvermale, A.L.; Ariizumi, T.; Steber, C.M. Gibberellin signaling: A theme and variations on DELLA repression. *Plant Physiol.* **2012**, *160*, 83–92. [[CrossRef](#)] [[PubMed](#)]
51. Chen, W.H.; Li, P.F.; Chen, M.K.; Lee, Y.I.; Yang, C.H. Forever young flower negatively regulates ethylene response DNA-binding factors by activating an ethylene-responsive factor to control Arabidopsis floral organ senescence and abscission. *Plant Physiol.* **2015**, *168*, 1666–1683. [[CrossRef](#)] [[PubMed](#)]

52. Sinska, I. Interaction of ethephon with cytokinin and gibberellin during the removal of apple seed dormancy and germination of embryos. *Plant Sci.* **1989**, *64*, 39–44. [[CrossRef](#)]
53. Corbineau, F.; Côme, D. Germination of sunflower seeds as related to ethylene synthesis and sensitivity. In *Biology and Biotechnology of the Plant Hormone Ethylene*, 3rd ed.; Vendrell, M., Ed.; IOS Press: Amsterdam, The Netherlands, 2003; pp. 216–221. ISBN 9781586033460.
54. Siritwitayawan, G.; Geneve, R.L.; Downie, A.B. Seed germination of ethylene perception mutants of tomato and Arabidopsis. *Seed Sci. Res.* **2003**, *13*, 303–314. [[CrossRef](#)]
55. Chiwocha, S.D.; Cutler, A.J.; Abrams, S.R.; Ambrose, S.J.; Yang, J.; Ross, A.R.; Kermode, A.R. The *etr1-2* mutation in *Arabidopsis thaliana* affects the abscisic acid, auxin, cytokinin and gibberellin metabolic pathways during maintenance of seed dormancy, moist-chilling and germination. *Plant J.* **2005**, *42*, 35–48. [[CrossRef](#)] [[PubMed](#)]
56. Achard, P.; Baghour, M.; Chapple, A.; Hedden, P.; Van Der Straeten, D.; Genschik, P.; Moritz, T.; Harberd, N.P. The plant stress hormone ethylene controls floral transition via DELLA dependent regulation of floral meristem-identity genes. *Proc. Natl. Acad. Sci. USA* **2007**, *104*, 6484–6489. [[CrossRef](#)] [[PubMed](#)]
57. Liu, H.; Stone, S.L. Abscisic acid increases Arabidopsis ABI5 transcription factor levels by promoting KEG E3 ligase self-ubiquitination and proteasomal degradation. *Plant Cell* **2010**, *22*, 2630–2641. [[CrossRef](#)] [[PubMed](#)]
58. Licausi, F.; Kosmacz, M.; Weits, D.A.; Giuntoli, B.; Giorgi, F.M.; Voeselek, L.A.C., Jr.; Perata, P.; van Dongen, J.T. Oxygen sensing in plants is mediated by an N-end rule pathway for protein destabilization. *Nature* **2011**, *479*, 419–441. [[CrossRef](#)] [[PubMed](#)]
59. Gibbs, D.J.; Md Isa, N.; Movahedi, M.; Lozano-Juste, J.; Mendiondo, G.M.; Berckhan, S.; Marín-de la Rosa, N.; Vicente Conde, J.; Sousa Correia, C.; Pearce, S.P.; et al. Nitric oxide sensing in plants is mediated by proteolytic control of group VII ERF transcription factors. *Mol. Cell* **2014**, *53*, 369–379. [[CrossRef](#)] [[PubMed](#)]
60. Gibbs, D.J.; Conde, J.V.; Berckhan, S.; Prasad, G.; Mendiondo, G.M.; Holdsworth, M.J. Group VII ethylene response factors coordinate oxygen and nitric oxide signal transduction and stress responses in plants. *Plant Physiol.* **2015**, *169*, 23–31. [[CrossRef](#)] [[PubMed](#)]
61. Roman, G.; Lubarsky, B.; Kieber, J.J.; Rothenberg, M.; Ecker, J.R. Genetic analysis of ethylene signal transduction in *Arabidopsis thaliana*: Five novel mutant loci integrated into a stress response pathway. *Genetics* **1995**, *139*, 1393–1409. [[PubMed](#)]
62. Guzman, P.; Ecker, J.R. Exploiting the triple response of *Arabidopsis* to identify ethylene-related mutants. *Plant Cell* **1990**, *2*, 513–523. [[CrossRef](#)] [[PubMed](#)]
63. Licausi, F.; van Dongen, J.T.; Giuntoli, B.; Novi, G.; Santaniello, A.; Geigenberger, P.; Perata, P. *HRE1* and *HRE2*, two hypoxia-inducible ethylene response factors, affect anaerobic responses in *Arabidopsis thaliana*. *Plant J.* **2010**, *62*, 302–315. [[CrossRef](#)] [[PubMed](#)]
64. Chang, E.; Zhao, Y.; Wei, Q.; Shi, S.; Jiang, Z. Isolation of high-quality RNA from *Platycladus orientalis* and other cupressaceae plants. *Electron. J. Biotechnol.* **2016**, *23*, 21–27. [[CrossRef](#)]
65. Hellemans, J.; Mortier, G.; De Paepe, A.; Speleman, F.; Vandesompele, J. qBase relative quantification framework and software for management and automated analysis of real-time quantitative PCR data. *Genome Biol.* **2007**, *8*, R19. [[CrossRef](#)] [[PubMed](#)]
66. Leymarie, J.; Vitkauskaitė, G.; Hoang, H.H.; Gendreau, E.; Chazoule, V.; Meimoun, P.; Corbineau, F.; El-Maarouf-Bouteau, H.; Bailly, C. Role of reactive oxygen species in the regulation of Arabidopsis seed dormancy. *Plant Cell Physiol.* **2012**, *53*, 96–106. [[CrossRef](#)] [[PubMed](#)]
67. Czechowski, T.; Stitt, M.; Altmann, T.; Udvardi, M.K.; Scheible, W.R. Genome-wide identification and testing of superior reference genes for transcript normalization in Arabidopsis. *Plant Physiol.* **2005**, *139*, 5–17. [[CrossRef](#)] [[PubMed](#)]
68. Djafi, N.; Vergnolle, C.; Cantrel, C.; Wietrzynski, W.; Delage, E.; Cochet, F.; Puyaubert, J.; Soubigou-Taconnat, L.; Gey, D.; Collin, S.; et al. The Arabidopsis DREB2 genetic pathway is constitutively repressed by basal phosphoinositide-dependent phospholipase C coupled to diacylglycerol kinase. *Front. Plant Sci.* **2013**, *4*. [[CrossRef](#)] [[PubMed](#)]
69. Pfaffl, M.W. A new mathematical model for relative quantification in real-time RT-PCR. *Nucleic Acids Res.* **2001**, *29*, e45. [[CrossRef](#)] [[PubMed](#)]



Chapter III Breaking *Arabidopsis thaliana* seed dormancy by ethylene is regulated by the N-end rule through the group VII ERF transcription factors

(Article in preparation)

Abstract

Ethylene participates in the alleviation of seed dormancy in *Arabidopsis thaliana*. The mutant affected in the proteolytic N-end rule pathway, *prt6*, was insensitive to ethylene, but the mutation of *RAP2.2*, *RAP2.3* and *RAP2.12*, which encode proteins that were substrates of N-end rule pathway, improved seed sensitivity to ethylene in *prt6* background. Dormancy alleviation by ethylene and stratification (4 °C) was associated with the down-regulation of the 3 *RAPs* and up-regulation of *HRE2*. It was then proposed that the transcript expression of *HRE2* was possibly regulated by the transcription regulators, *RAPs*, but the actual effect of *HRE2* in seed germination was still elusive. The insensitivity of *prt6* to ethylene is related to an induced sensitivity to exogenous ABA and reduced sensitivity to exogenous GA, and also the improving expression in *ETR1* and *RGA*, the corresponding proteins of which acted as negative regulators in ethylene signaling and GA signaling, respectively. Besides, there also existed interaction effects between ethylene and oxygen. The improving effect of ethylene on seed germination required the presence of more than 5% oxygen, and the ethylene signaling was also involved in the seed responsiveness to hypoxia, but the insensitivity of *prt6* to ethylene was independent of ROS production and respiration intensity.

Key words: *Arabidopsis thaliana*, seed dormancy, N-end rule pathway, ethylene, *RAPs*, *HRE2*, oxygen

III.1 Introduction

Dormancy corresponds to the inability of viable seeds to germinate in apparently favorable conditions (Bewley, 1997). For example, freshly harvested *Arabidopsis thaliana* seeds have a difficulty to germinate at a temperature higher than 15 °C and in darkness. It is well studied that seed dormancy could be released by exogenous ethylene (C₂H₄) in many species (Arc *et al.*, 2013; Corbineau *et al.*, 2014). In *Arabidopsis*, ethylene at the concentration of 50-100 μL L⁻¹ is able to completely alleviate the seed dormancy (Wang *et al.*, 2018). Ethylene plays its improving role in seed germination by affecting the antagonistic hormone balance between abscisic acid (ABA) and gibberellins (GAs). In detail, ABA synthesis or signaling could be negatively regulated by ethylene and

GAs synthesis and signaling could be positively regulated by ethylene (Beaudoin *et al.*, 2000; Gazzarrini and McCourt, 2001; Calvo *et al.*, 2004b; Cheng *et al.*, 2009; Iglesias-Fernandez and Matilla, 2010; Subbiah and Reddy, 2010; Wang *et al.*, 2018). It is reported that radicle protrusion is associated with endogenous ethylene production (Siriwitayawan *et al.*, 2003; El-Maarouf-Bouteau *et al.*, 2015). Besides, treatments that break seed dormancy, such as cold stratification, GAs, nitrite are also correlated with ethylene production, increase in sensitivity to ethylene or up-regulation of ethylene signaling components (Calvo *et al.*, 2004b; Garnica *et al.*, 2009; Zheng *et al.*, 2013; Khan *et al.*, 2015; Wang *et al.*, 2018).

Gaseous ethylene is firstly perceived by receptors, localized in the endoplasmic reticulum membrane. The receptors should act in the cooperation with the cofactor, copper, supplied by the intracellular copper transporter RAN1 (RESPONSIVE TO ANTAGONIST1) (Hirayama *et al.*, 1999; Binder *et al.*, 2010). Upon ethylene binding, the receptors become inactivated and will inhibit the function of CTR1 (CONSTITUTIVE TRIPLE RESPONSE 1), and thus allow EIN2 (ETHYLENE INSENSITIVE 2) to act as a positive regulator of ethylene signaling with the C-terminal end of EIN2 moving to the nucleus, which facilitates the accumulation of EIN3. EIN3 acts as a transcription factor binds to the promoters of *ERF* (*ETHYLENE RESPONSIVE FACTORS*) genes (Wang *et al.*, 2002; Merchante *et al.*, 2013). Except for the classical ethylene signaling transduction, it is reported that ethylene signaling is also able to mediate through a CTR-independent or EIN3-independent pathway (Binder *et al.*, 2004; Qiu *et al.*, 2012). Proteasome degradation is involved in the regulation of the ethylene signaling cascade in the protein level. EIN2 and EIN3 can be targeted by F-box proteins and other partners to form an SCF ubiquitin ligase complex, which triggers proteasome-mediated degradation in the absence of ethylene (Gagne *et al.*, 2004; Qiao *et al.*, 2009). Ethylene receptor ETR2 can also be degraded by the proteasome, but it is not yet known which ubiquitin ligase can identify ETR2 (Chen *et al.*, 2007).

Ubiquitin ligase is the most diverse proteins in the ubiquitin-proteasome degradation cascade which confers the selectivity to a particular substrate. In Arabidopsis, over 1400 genes encode the ubiquitin ligase and 7 types are divided based on the protein domain and functional difference in working as an independent unit or as part of a multi-subunit complex (Mazzucotelli *et al.*, 2006; Vierstra, 2009; Sadanandom *et al.*, 2012). The first and second largest gene family encodes SCF ubiquitin ligase (> 700 members), and RING (REALLY

INTERESTING NEW GENE) domain ubiquitin ligase (> 400 members), respectively (Mazzucotelli *et al.*, 2006). A specialized case of the RING domain ligase which recognizes substrates by identifying its N-terminal residues has been reported in plants and is encoded by *PRT1* (*PROTEOLYSIS 1*) and *PRT6* (*PROTEOLYSIS 6*) (Stary *et al.*, 2003; Garzón *et al.*, 2007). The rule that the half-life of the protein is determined by the amino acid in the N-terminal is termed as the N-end rule (Varshavsky, 1997). *PRT1* and *PRT6* identify the peptides initialing with aromatic amino acids (Phe, Try and Trp) and positively charged amino acids (Arg, Lys, His), respectively (Graciet and Wellmer, 2010; Sriram *et al.*, 2011). The destabilizing residues can be generated by proteolytic cleavage such as N-terminal Met excision or endoproteolytic cleavages, which expose the internal embedded destabilized residues. Considering that N-terminal Met excision is achievable only when following the amino acids with small side chain (Gly, Ala, Ser, Cys, Pro, Thr, and Val) (Tsunasawa *et al.*, 1985; Huang *et al.*, 1987), it seems that endo-aminopeptidases together with further modification play a major role in producing substrates of N-end rule. However, since the generation of destabilized residues beginning with N-terminal Met excision is relatively easy to follow, the first substrate of the N-end rule pathway was identified by Gibbs *et al.* (2011) with Met-Cys at the N-terminal. They are HYPOXIA RESPONSIVE ERF 1 (HRE1), HRE2, RAP2.12 (RELATED TO AP 2.12), RAP2.2, and RAP2.3, belonging to the group VII ERF transcription factor family. After removing its Met, the exposed Cys can be oxidized by PCOs (PLANT CYSTEINE OXIDASES), using oxygen (O₂) or nitric oxide (NO) as a cofactor (Weits *et al.*, 2014). Then Arg is transferred to oxidized N-terminal by ATE1/2 (Arg tRNA-transferase 1/2), the produced peptide giving a chance to be identified by *PRT6*. It is interesting that there exists a specific preference for the second amino acid following Met (Shemesh *et al.*, 2010). In Arabidopsis, for example, Cys at the second position is highly restricted, occurring around 200 proteins, taking up 0.2% of the total proteins, which is the lowest distribution rate (Shemesh *et al.*, 2010; Gibbs *et al.*, 2016). The stabilization of ERFVIIs coordinates plant homeostatic responses to oxygen availability, that is important for the regulation of flooding survival, photomorphogenesis, biotic or abiotic stress (Licausi *et al.*, 2010; Gibbs *et al.*, 2011; Licausi *et al.*, 2011; Sasidharan and Mustroph, 2011; Gibbs *et al.*, 2014; Bui *et al.*, 2015; Gibbs *et al.*, 2015; Gasch *et al.*, 2016). It is also coupled to NO availability that regulates seed germination, stomatal closure, and hypocotyl elongation

(Gibbs *et al.*, 2014; Gibbs *et al.*, 2015). To date, except for ERFVIIIs, another Met-Cys starting protein, VERNALIZATION 2 (VRN2) has also been verified as a substrate of N-end rule, it accumulates in hypoxia that improves stress-survival and also stabilizes after long-time cold that is related to reduced PCO enzyme activity and NO levels (Gibbs *et al.*, 2018).

There are several reports discussing the involvement of the N-end rule pathway in seed germination. Holman *et al.* (2009) reported that *prt6* exhibits a greatly increased after-ripening time. Hypersensitivity to ABA is present in *prt6*, *ate1ate2* non-dormant seeds (2 days moist chilling before assay) at 22 °C and lipid degradation are inhibited in 5 days *prt6*, *ate1ate2* seedlings (Holman *et al.*, 2009). Gibbs *et al.* (2011) also reports that *prt6* and *ate1ate2* mutants germinate better compared to wild type, and stable C2A versions of HRE1 and HRE2 seeds also show more increased germination than wild type, when pre-chilled seeds imbibed in 22 °C under low oxygen (3%) with constant light (Gibbs *et al.*, 2011). The effect of N-end rule in seed germination is thoroughly deciphered again by Gibbs *et al.* (2014) that NO controls the seed germination through the stabilization of ERFVIIIs and the crosstalk of NO/ABA in seed germination is regulated by ERFVIIIs controlling the expression of ABI5 (ABA INSENSITIVE 5) (Gibbs *et al.*, 2014). Mendiondo *et al.* (2016) demonstrate that in barley, *HvPRT6* RNAi lines show a severe reduction in germination compared with null control in white light; the germination level and speed are reduced in pre-chilled *HvPRT6* RNAi lines in comparison with wild-type at low oxygen level (Mendiondo *et al.*, 2016). Previously, we propose that the N-end rule might be involved in seed responsiveness to ethylene with the result showing that primary dormant seeds *prt6* and *ate1ate2* are less sensitive to exogenous ethylene treatment than Col seeds (Wang *et al.*, 2018). The aims of the present work are (1) to study the involvement of ERFVIIIs in the responsiveness to ethylene in *prt6* background; (2) to determine the effects of chilling and ethylene on the transcript expression of *ERFVIIIs* in Col and (or) in *prt6*; (3) to identify the regulation of *HRE2* by ERFVIIIs; (4) to study the involvement of ABA and GA signaling in the insensitivity of *prt6* to ethylene, and (5) to investigate the crosstalk of seed sensitivity to ethylene and hypoxia.

III.2 Materials and Methods

III.2.1 Seed material

Arabidopsis thaliana seeds from Columbia-0 (Col-0) were used as the wild type of this study. The mutants affected in the ethylene signaling pathway and the N-end rule pathway were obtained from the Nottingham Arabidopsis Stock Center (NASC) or from the individual researcher, Dr. M.J. Holdsworth. Mutant *prt6* (SAIL-1278-H11), *atel* (SALK_023492), *ate2* (SALK_040788), *hre1* (SALK_023445), *hre2* (SALK_052858), *rap2.2* (SAIL_184_G12), *rap2.3* (SAIL_808_F04), *rap2.12* (GK_503A11), *hre1 hre2*, *prt6 hre1 hre2*, *prt6 rap2.2 rap2.3 rap2.12*, *prt6 hre1 hre2 rap2.2 rap2.3 rap2.12*, were in the genetic background of Columbia-0. The T-DNA insertion of each mutant was confirmed by a quick genotyping PCR method and the flanking primer sequences are shown in Table S1. Transgenic seeds *prom35S:(MC)-HRE2-HA*, *prom35S:(MA)-HRE2-HA* and *promHRE2:(MA)HRE2-GUS* lines were kindly received from Dr. M. J. Holdsworth (Gibbs *et al.*, 2011).

III.2.2 Seed production

Seeds were firstly imbibed in the water at 4 °C for 3 days to break dormancy then transferred into the potting mixture (Jiffy® substrates, Tref, France) placed in a growth chamber at 21 °C under a photoperiod of 16 h light/8 h dark. Siliques were harvested at maturity and seeds were collected in 2016, 2017, 2018, 2019, and then were stored at -20 °C before the experiment.

III.2.3 Germination assays

Germination assays were performed in darkness in 9-cm Petri dishes (100 to 200 seeds per assay in 3 replicates) by placing seeds on a filter paper on the top of a layer of cotton wool moistened with deionized water, ABA at 0.1, 0.5, 1 or 5 µM, or GA₃ at 0.01, 0.1, 1 mM. Seed stratification was carried out on the water at 4 °C as the germination assays for 1 to 4 days. Germination assays in the presence of gaseous ethylene were carried out in tightly closed 360 ml-containers in which was injected gaseous ethylene (5%) (Air Liquide, Paris, France) in order to obtain a final concentration at 20 or 100 µL L⁻¹. Germinating seedlings

were counted every 24 h for 7 days. Germination assays in low oxygen conditions (mixtures of air and nitrogen) were carried out as described by Gay *et al.*, 1991) to obtain oxygen concentration at 1%, 3%, 5%, 10% and 15%. Ethylene was injected into the well-closed bottles with controlled oxygen tensions if needed and germination counts were made after 7 days. A seed was considered to be germinated as soon as the radicle protruded through the seed coat. The results presented are the means of the germination percentages obtained with 3 replicates \pm SD.

III.2.4 RNA extraction and real-time quantitative RT-PCR

A 50 mg aliquot of seeds was ground in liquid nitrogen, and total RNA was extracted by a modified CTAB method. Total RNA (2 μ g) was treated with DNase I (ThermoFisher, Waltham, MA, USA), reverse transcribed with RevertAid Reverse Transcriptase (ThermoFisher, Waltham, MA, USA) in a 25 μ L reaction volume and amplified with Mastercycler ep Realplex (Eppendorf, Hamburg, Germany) using 5 μ L of 30-fold diluted cDNA solution. Primers were designed with Oligo7 software. They were obtained from Eurogentec (Angers, France) and the primer sequences are shown in Table S1. Real-time PCRs were performed with the Maxima™ SYBR Green qPCR Master Mix (Thermo Fisher, Waltham, MA, USA) and 0.23 μ M of each primer in a 15 μ L reaction. Cycle thresholds (Cts) were calculated using the Realplex 2.0 software (Eppendorf, Hamburg, Germany). For each gene, a standard curve made with dilutions of cDNA pools were used to calculate the reaction efficiencies. And the relative expression was calculated with *CB5-E* (*Cytochrome B5 isoform E*, AT5G53560), *RHIP1* (*Chromosome associated kinesin*, AT4G26410) and *TIP41* (*Tip-like family Protein*, AT4G34270) as internal reference genes used by Czechowski *et al.* (2005), Leymarie *et al.* (2012) and Djafi *et al.* (2013) and dry Col-0 seeds as control condition. Relative expressions were shown by $-\Delta\Delta Ct$ ($\log_2 FC$) of 3 or 4 biological replicates and visualized by boxplot diagrams depicting the smallest observation, lower quartile, median, upper quartile, and largest observation. Statistical analysis was carried out by a t-test and a significant difference was determined by P value < 0.05 .

III.2.5 Seed respiration

An aliquot of 15 mg seeds was firstly imbibed at 25 °C for 1 h, then the imbibed seeds were transferred into a 2 mL glass vial. Gaseous ethylene (5%) (Air Liquide, Paris, France) was injected into the glass vial if needed, in order to obtain concentration at 100 $\mu\text{L L}^{-1}$. Oxygen concentration was measured every 10 minutes by meter FireSting GO2 (PyroScience, Aachen, Germany). Then the intensity of respiration was calculated as the change of oxygen divided by 15 mg seeds in 6 h. The results were shown by means of respiration intensity from 3 biological replicates \pm SD.

III.2.6 Hydrogen peroxide content

H₂O₂ contents were determined spectrophotometrically as described by (Lehner *et al.*, 2008). Thirty mg seeds were ground in ice with perchloric acid. The supernatant was used for spectrophotometric determination of H₂O₂ at 590 nm using a peroxidase-based assay with a mixture containing 3-methyl-2-benzothiazolinone hydrazone (MBTH), 3-(dimethylamino) benzoic acid (DMAB) and horseradish peroxidase (Sigma, St. Louis, USA). A standard curve was made with known amounts of H₂O₂ and the corresponding absorbance value after peroxidase-based assay. H₂O₂ contents of each sample were generated from the curve and the result was expressed as means of nmol H₂O₂ g⁻¹ DW from 3 biological replicates \pm SD; measurements were carried out with seeds incubated at 25 °C for 24 h with or without ethylene at 100 $\mu\text{L L}^{-1}$.

III.3 Results

III.3.1 Involvement of the N-end rule and ERFVII on dormancy release by ethylene

Freshly harvested Arabidopsis seeds (mutants or Col-0) did not germinate at 25 °C in darkness. This dormancy was broken by 100 $\mu\text{L L}^{-1}$ ethylene in Col-0 seeds (Figure 1 A,B,C), 85.7% of the seed population being able to germinate at 25 °C after 5 days. In contrast, ethylene did not break the dormancy of seeds from *prt6* mutant and *ate1 ate2* double mutant suggesting that the N-end rule was involved in seed responsiveness to ethylene (Wang *et al.*, 2018) (Figure 1A). The *ERFVII* single mutant (*hre1* or *hre2*), double mutant (*hre1 hre2*) and

triple mutant (*rap2.2 rap2.3 rap2.12*) could respond to ethylene, with all the seed population germinating within 5 d at 25 °C in the presence of ethylene, suggesting that mutation of *ERFVII* in wild-type background did not much affect the sensitivity of seeds to ethylene (Figure 1B). Analysis of the mutant *prt6* in combination with *ERFVII*s, such as *prt6 rap2.2 rap2.3 rap2.12*, showed that the quadruple mutant could germinate in the presence of ethylene. It was opposite with the result of single mutant *prt6*, indicating that RAPs located downstream of PRT6 in the signaling of ethylene in seed germination (Figure 1C). Remarkably, the triple mutant *prt6 hre1 hre2* behaved similarly to *prt6*, while the phenotype of sextuple mutant *prt6 hre1 hre2 rap2.2 rap2.3 rap2.12* was in accordance with that of *prt6 rap2.2 rap2.3 rap2.12* indicating that these HREs might locate upstream of PRT6 and RAPs (Figure 1C).

ETR1 is one of the receptors that acts as a negative regulator in ethylene signaling, while *EIN2* is a central regulator that linking ethylene perception on ER to transcriptional regulation in the nucleus. As shown in Figure 2, dormancy breaking by ethylene in Col was associated with the down-regulation of *EIN2* and *ETR1* at 30 and 48 h at the transcript level. However, the insensitivity of *prt6* to ethylene in seed germination is coupled with the unaffected expression of the two genes. At 30 h, *prt6* mutation improved the transcript expression of *ETR1* (Figure 2).

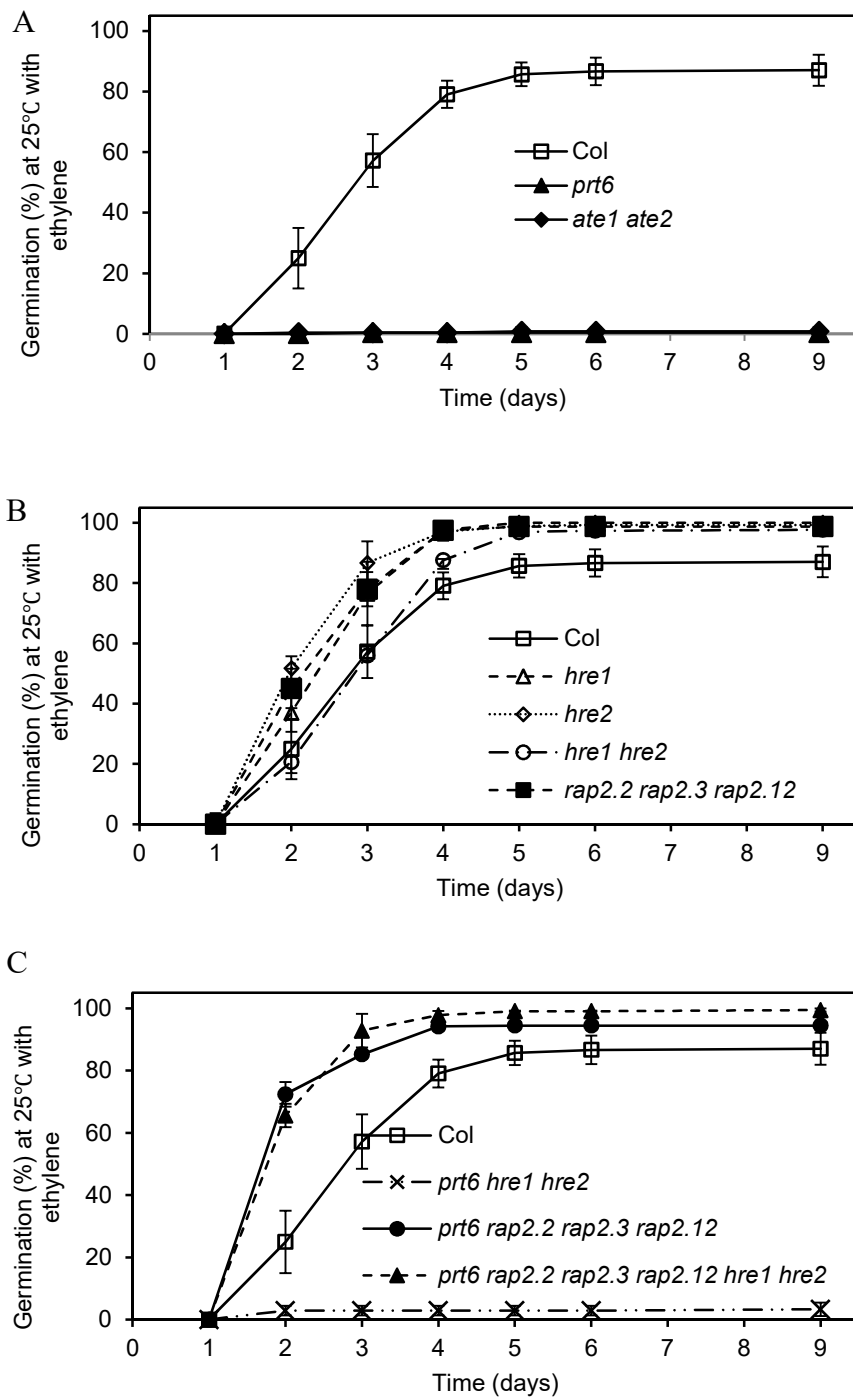

Figure 1. Effects of the N-end rule in the responsiveness of seeds to ethylene. Germination percentages obtained after 9 d at 25 °C with Col and the N-end rule mutants (*prt6* and *ate1 ate2*) seeds (A), ERFVII mutant seeds (*hre1*, *hre2*, *hre1 hre2*, *rap2.2 rap2.3 rap2.12*) (B) and cross mutant seeds (*prt6 hre1 hre2*, *prt6 rap2.2 rap2.3 rap2.12*, *prt6 rap2.2 rap2.3 rap2.12 hre1 hre2*) (C) placed directly at 25 °C on water in the presence of ethylene 100 $\mu\text{L L}^{-1}$ in darkness. Means of 3 replicates \pm SD.

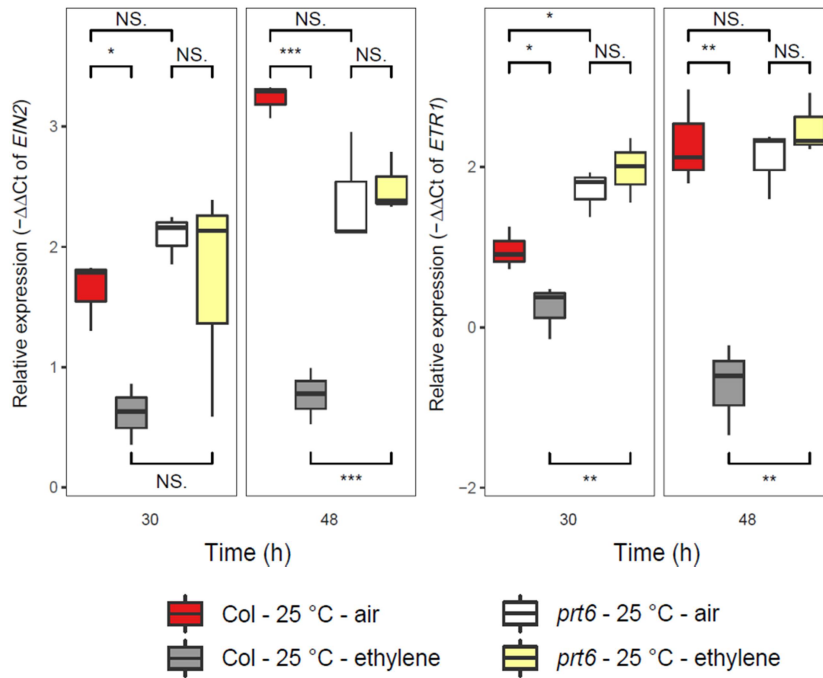

Figure 2. Relative delta delta Ct expression values of *EIN2* and *ETR1* in seeds Col-0 incubated at 25 °C in air (red) or in the presence of 100 $\mu\text{L L}^{-1}$ ethylene (grey), in *prt6* seeds incubated at 25 °C in air (white) or in the presence of 100 $\mu\text{L L}^{-1}$ ethylene (yellow) for 30 and 48 h. Significant levels between conditions were shown by NS, $P > 0.05$, * $0.01 < P < 0.05$, ** $0.001 < P < 0.01$, *** $P < 0.001$.

III.3.2 Effect of chilling on the relative expression of *ERFVII*s in Col-0

Arabidopsis Col-0 seeds used in this study were primary dormant and could not germinate at 25 °C in darkness, while 3-4 days of stratification at 4 °C allow germination to occur after transferring the imbibed seeds to 25 °C (Wang *et al.*, 2018). As shown in Figure 3, imbibition at 4 °C for 24, 48 and 96 h resulted in a significant increase in the transcript levels of *HRE2* (Figure 3A) and a significant decrease in the transcript levels of *RAP2.3* (Figure 3 D) in comparison with the results obtained at 25 °C. The relative expression of *HRE1* was significantly enhanced when seeds are imbibed at 4 °C in comparison with 25 °C for 24 or 48 h, but after 96 h, there was no significant difference (Figure 3A), whereas, imbibition at 4 °C did not affect the expression of *RAP2.2* and *RAP2.12* (Figure 3C, E). Significantly decreased expression was observed in *RAP2.2* and *RAP2.12* after 48 and 96 h pre-chilling following by 10 h at 25 °C, in *RAP2.3* after 96 h pre-chilling then transferring, in *HRE1* after 24 and 48 h pre-chilling then transferring when compared with the condition only

chilling without transferring. However, it was interesting for *HRE2*, which expression dramatically decreased after 24 h chilling then transfer for 10 h at 25 °C, but increased again after 96 h chilling followed by 10 h at 25 °C (Figure 3B).

When we compared the seeds imbibed at 25 °C with those imbibed at 4 °C and then transferred to 25 °C, *i.e.*, primary dormant seeds with non-dormant ones (which were starting to germinate), the relative expressions of *HRE1* (Figure 3A) and *RAP2.12* (Figure 3E) were lower in pre-chilled seeds after 24 h and 96 h, respectively, and the relative expression of *RAP2.3* (Figure 3D) was strongly inhibited after 24, 48 and 96 h. However, the treatment of pre-chilling followed by transferring significantly improved the expression of *HRE2* after 48 or 96 h (Figure 3B). In addition, it seems that no statistical difference occurred in the expression of *RAP2.2* (Figure 3C).

Furthermore, it was noticed that after 24, 48 and 96 h of pre-chilling then transferring to 25 °C the relative expressions of *RAP2.2*, *RAP2.3* and *RAP2.12* gradually decreased while a gradual increase occurred distinctly in the expression of *HRE2*.

A

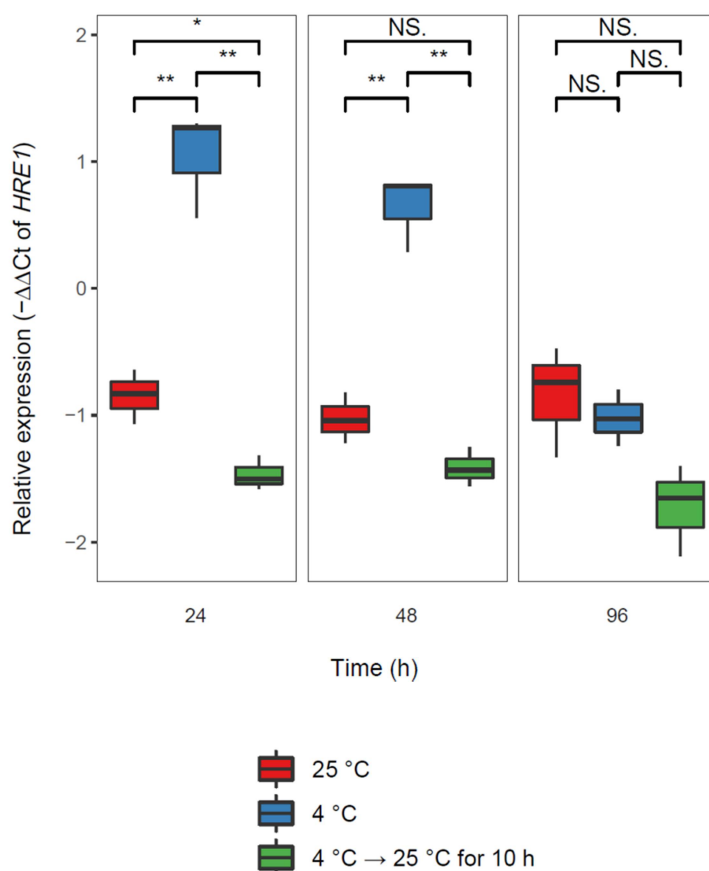

B

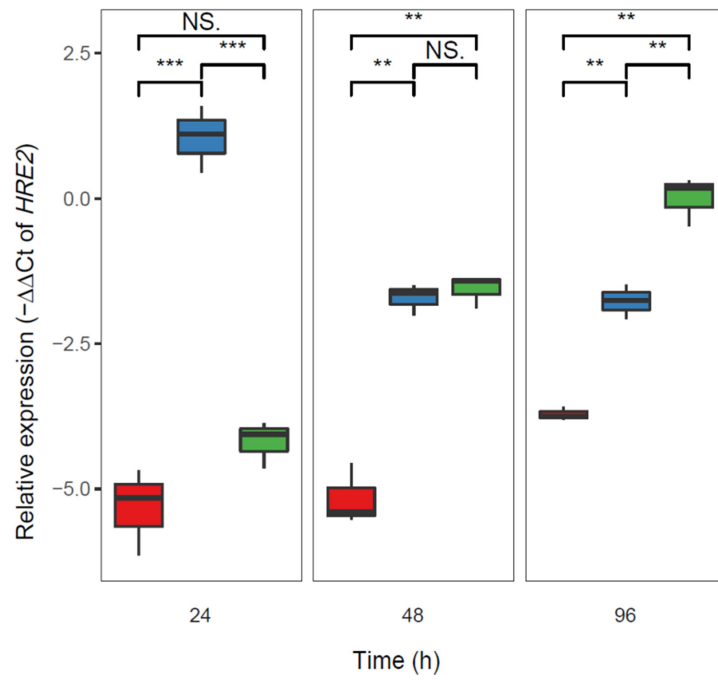

C

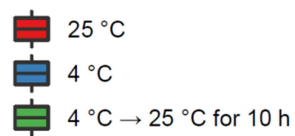
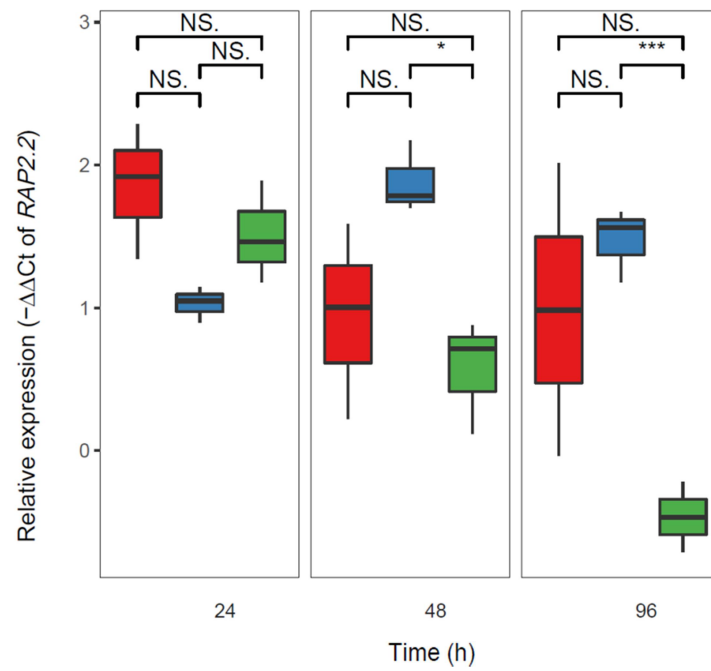

D

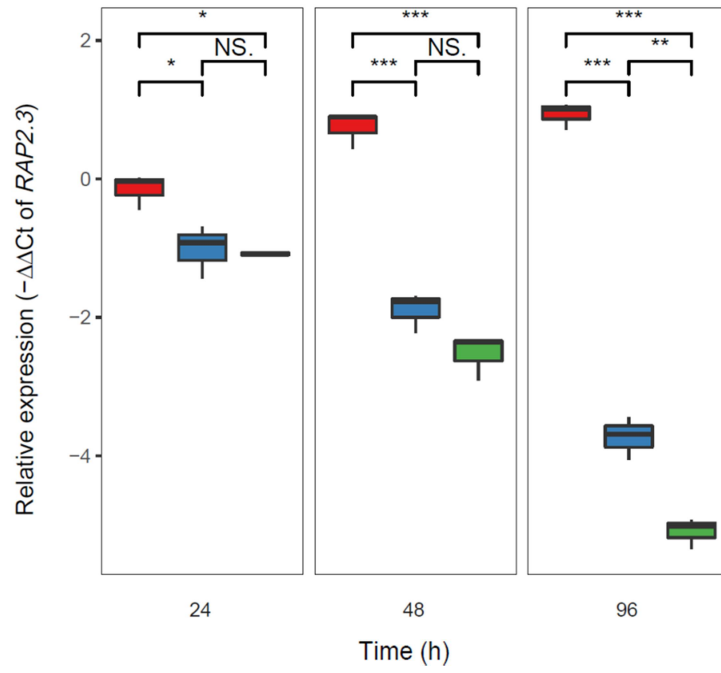

E

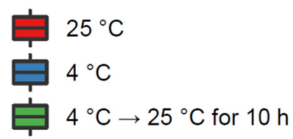
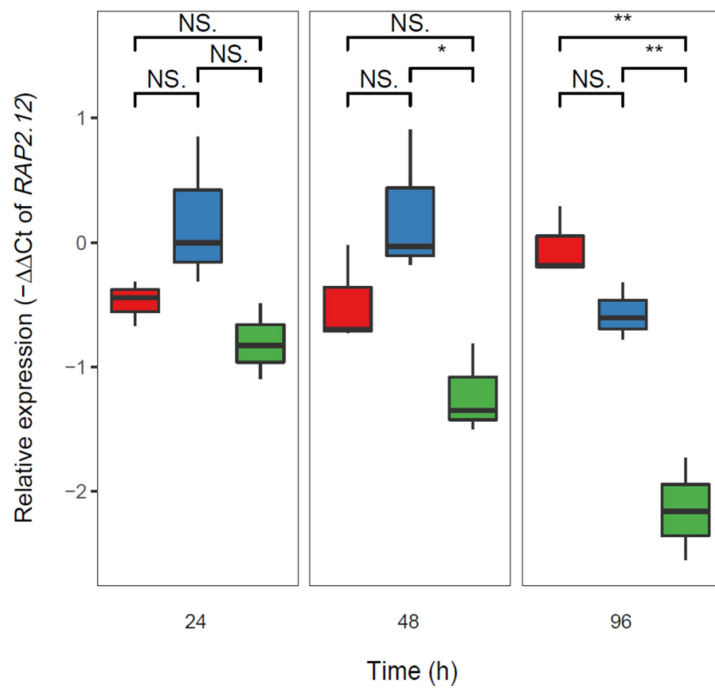
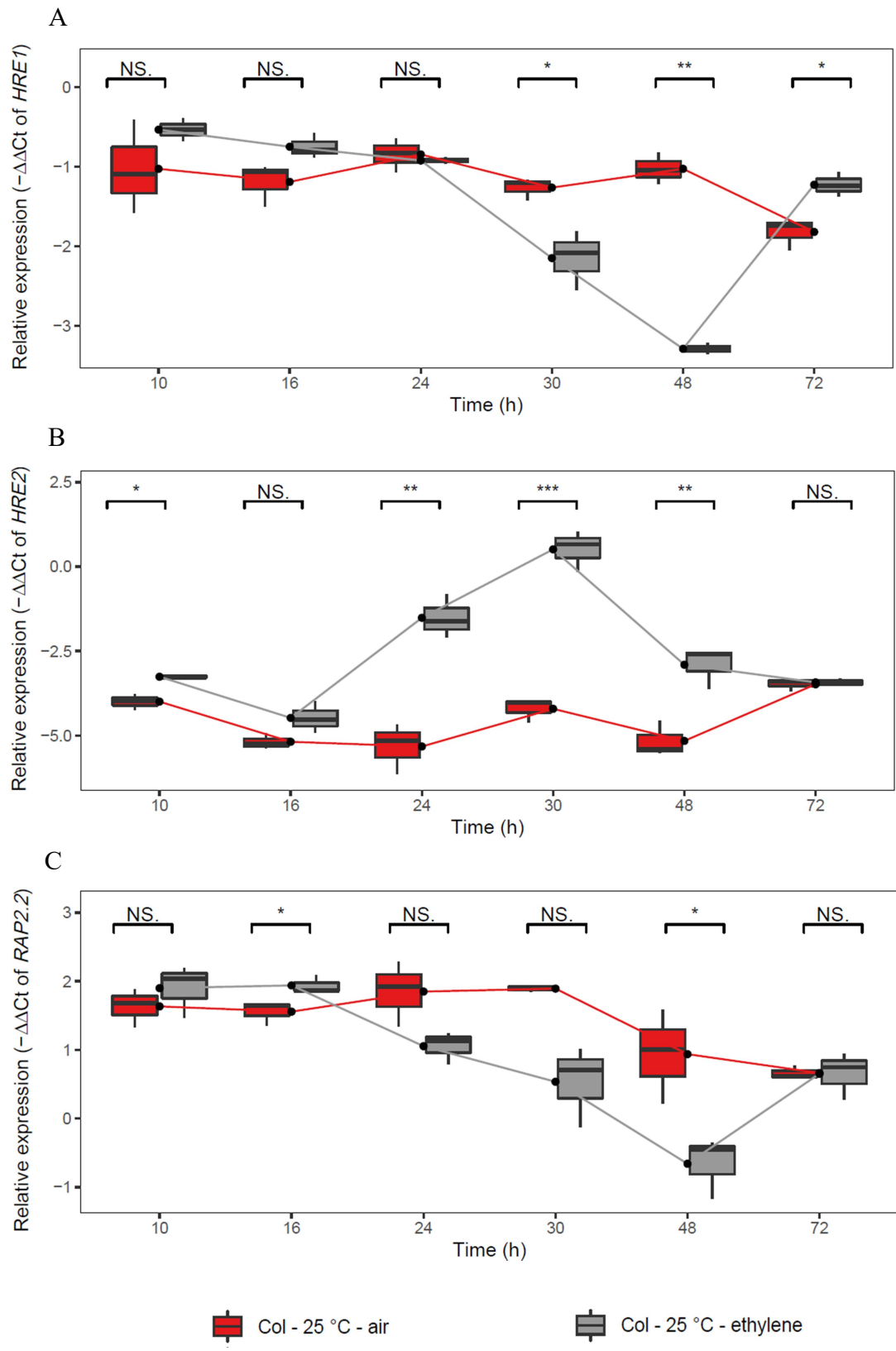

Figure 3. Relative delta delta Ct expression values for *ERFVII*s gene transcript expression in 24, 48 and 96 h of imbibition at 25 °C (red), 4 °C (blue) or firstly at 4 °C then transfer to 25 °C for 10 h (green). A, *HRE1*; B, *HRE2*; C, *RAP2.2*; D, *RAP2.3*; E, *RAP2.12*. Significant level between conditions were shown by NS, $P > 0.05$, * $0.01 < P < 0.05$, ** $0.001 < P < 0.01$, *** $P < 0.001$.

III.3.3 Effect of ethylene on the expression of *ERFVII*s in Col-0

In the presence of ethylene at 25 °C in darkness, Col-0 seeds germinated perfectly. In the batch used that was harvested in 2016, radical protrusion started after 30 h and all the seed population was germinated at 3 days (Figure S1). Figure 4 and Table 1 show the relative expression of the *ERFVII* during incubation of wild type seeds (Col-0) at 25 °C in darkness without ethylene (dormant seeds) and in the presence of ethylene (100 $\mu\text{L L}^{-1}$). A significant decrease could be noticed in *RAP2.3* as early as 16 h until 72 h, while this decrease occurred in *RAP2.12* at 30 h until 72 h. The inhibition of relative expression of *RAP2.2* was only present after 48 h. Ethylene notably suppressed the expression of *HRE1* after 30 h and 48 h, but the expression of *HRE1* was induced again after 72 h when all the seed population was germinated (Figure S1). However, *HRE2* was the only one which expression was improved by ethylene before or after radicle protrusion (24, 30 and 48 h) (Figure 4B).

We have also analyzed the effect of ethylene by calculation of the ratio of average fold change between the results obtained at 25 °C with ethylene and those obtained at 25 °C without ethylene. As shown in Table 1, the presence of ethylene inhibited the expression of *HRE1*, *RAP2.2*, *RAP2.3* and *RAP2.12* after 30 h, the lowest point of each appearing at 48 h, at a value of 0.21, 0.32, 0.01 and 0.26, respectively. However, the expression of *HRE2* was stimulated by ethylene with almost 30 times induction when compared with the control seeds without ethylene. All the seeds have been germinated after 72 h in the presence of ethylene, at which time the effect of ethylene disappeared in *HRE1*, *HRE2*, *RAP2.2*, *RAP2.12*, while the inhibitory effect of ethylene still existed in *RAP2.3* with the ratio, 0.09.



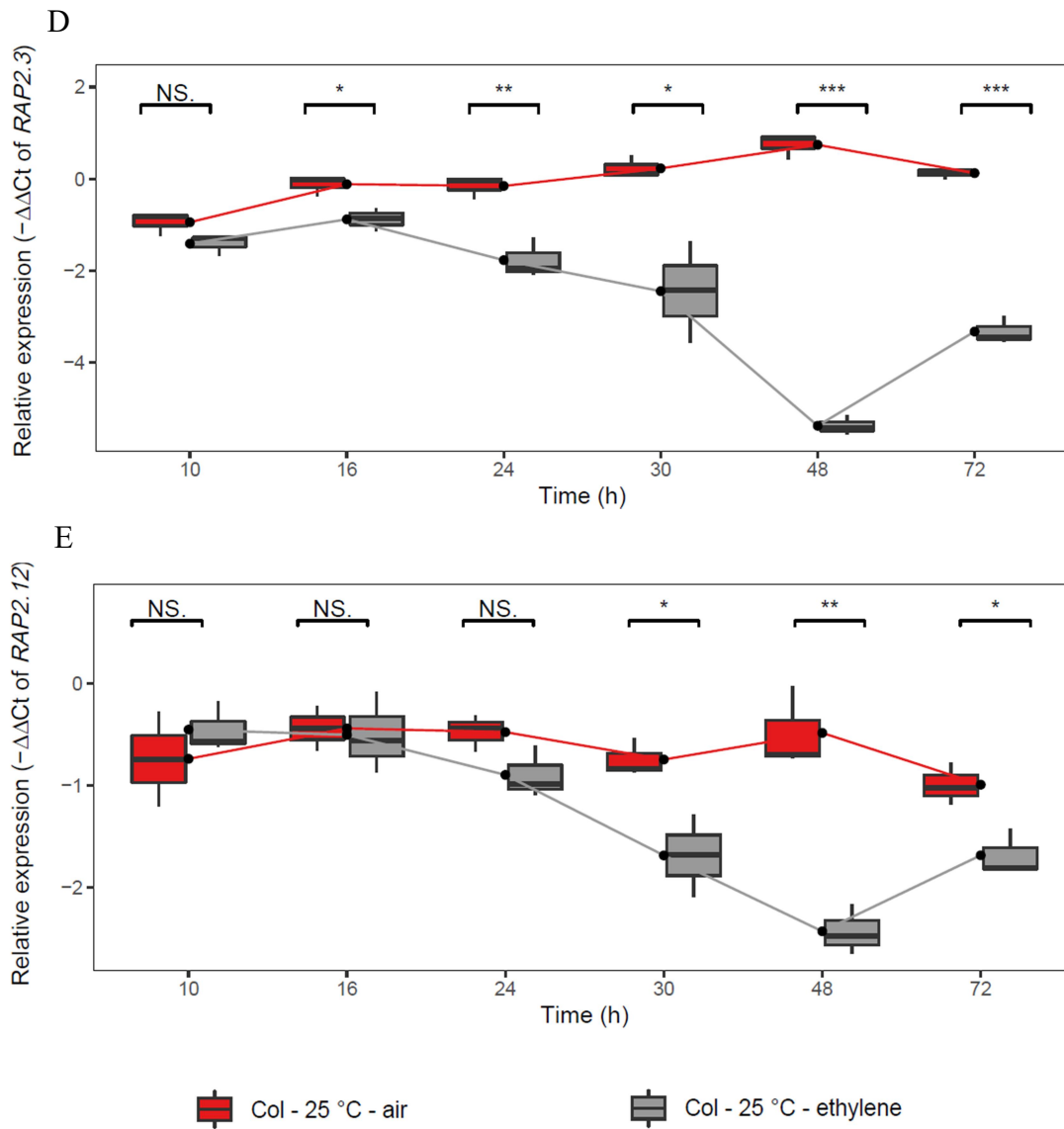

Figure 4. Relative delta delta Ct expression values of *HRE1* (A), *HRE2* (B), *RAP2.2* (C), *RAP2.3* (D) and *RAP2.12* (E) in seeds (Col-0) incubated at 25 °C in air (red) without ethylene or in the presence of 100 $\mu\text{L L}^{-1}$ ethylene (grey). Significant level between conditions were shown by NS, $P > 0.05$, * $0.01 < P < 0.05$, ** $0.001 < P < 0.01$, *** $P < 0,001$.

Table 1. Relative expression of *HRE1*, *HRE2*, *RAP2.2*, *RAP2.3* and *RAP2.12* in seeds (Col-0) incubated for 10, 24, 30, 48 and 72 h at 25 °C in the presence of ethylene 100 $\mu\text{L L}^{-1}$. The calculation was done as compared to the relative expression in the absence of ethylene. Means of three replicates \pm SD. Seeds harvested in 2016.

Imbibition at 25 °C	Relative expression in the condition of with/without ethylene in Col-0				
Duration (hours)	<i>HRE1</i>	<i>HRE2</i>	<i>RAP2.2</i>	<i>RAP2.3</i>	<i>RAP2.12</i>
10	1.34	1.65	1.21	0.72	1.19
24	0.94	13.80	0.56	0.33	0.75
30	0.55	27.29	0.41	0.19	0.53
48	0.21	4.82	0.32	0.01	0.26
72	1.51	1.04	1.01	0.09	0.62

III.3.4 Effect of ethylene on the expression of *ERFVII*s in *prt6*

The relative expression of *HRE1* and *RAP2.3* were not shown in Figure 5 since the effect of *prt6* mutation and ethylene did not result in a significant difference in the 3 conditions (Col and *prt6* in air, and *prt6* in the presence of ethylene).

Without ethylene, *HRE2* showed a dramatic increase in *prt6* seeds than that in Col seeds at 16, 30 and 48 h (Figure 5A), whereas only *RAP2.12* relative expression decreased in *prt6* at 30 h (Figure 5C). Ethylene notably changed the expressions of *ERFVII*s in Col-0 seeds especially at 30 or 48 h (Figure 4). However, the effect of ethylene was not the same in *prt6* as shown in Figure 5. Ethylene did not statistically affect the relative expression of *HRE1* and *RAP2.3* (data not shown) but the expression of *RAP2.2* was improved by ethylene at 16 h and 48 h, while *RAP2.12* was transcriptionally accumulated only at 30 h. It was shown that ethylene significantly increased the expressions of *HRE2* at all the imbibition stages (Figure 5A).

Incubation at 25 °C in the presence of ethylene (100 $\mu\text{L L}^{-1}$) resulted in germination in Col-0, but not in *prt6* mutant (Figure 1). Ethylene reduced the expression of *HRE1*, *RAP2.2*, *RAP2.3* and *RAP2.12* in Col-0 after 30 h (Figure 3), while the expressions of the 4 genes were maintained with no significant difference or increased to some degree in *prt6* (Figure 5). Though *HRE2* was the unique gene the expression of which was stimulated by ethylene in Col-0, it could not compete with the much higher increase by ethylene in *prt6*, which was on the basis of dramatic accumulation by genotype (Figure 4, 5 and Table1). Altogether, it

indicated that all the five *ERFVII*s were more expressed or stabilized in *prt6* than in Col with exogenous ethylene treatment.

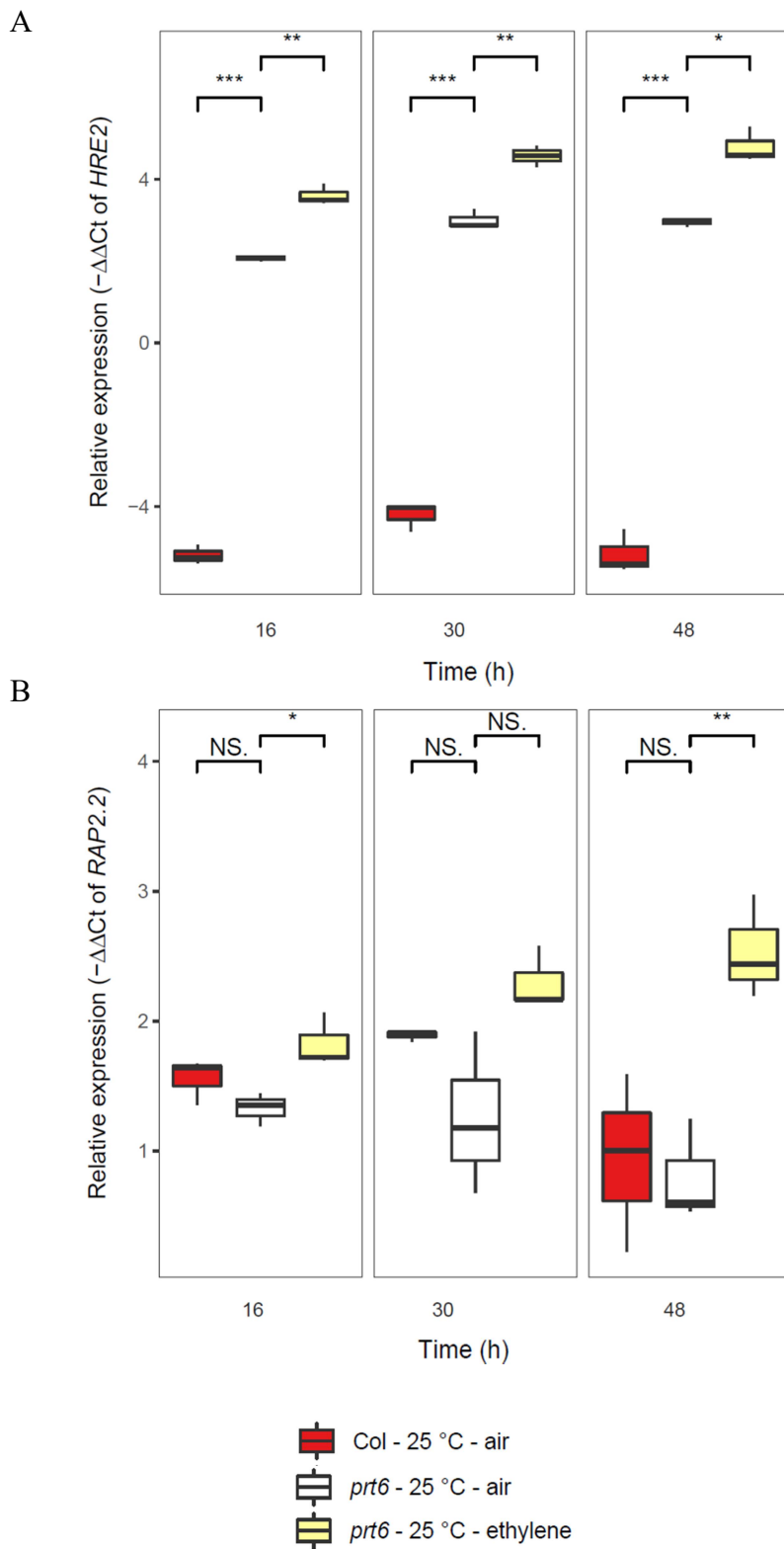

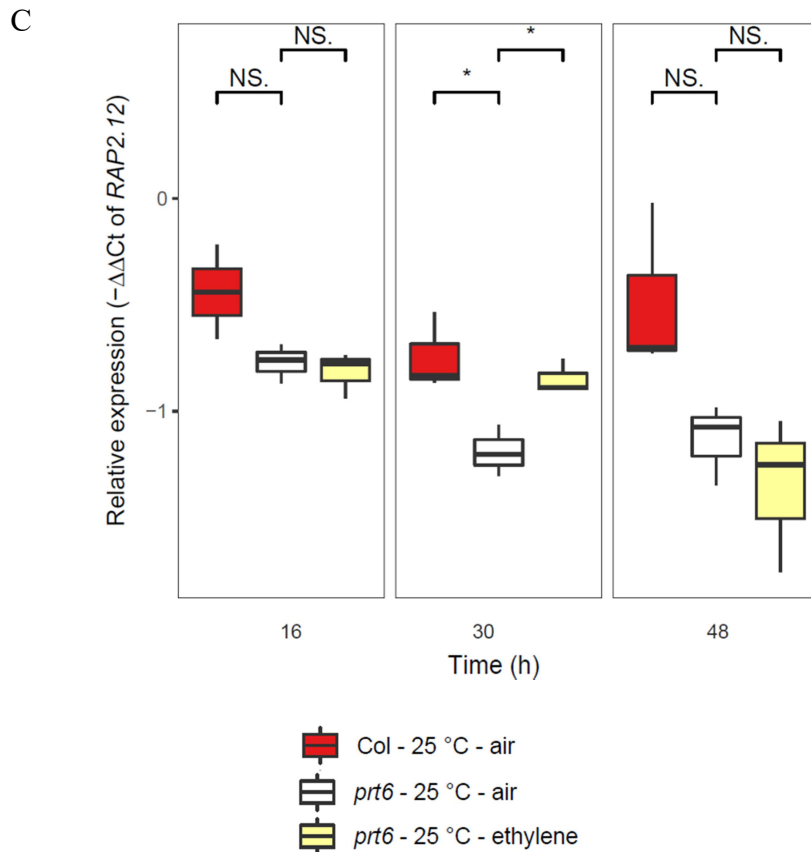

Figure 5. Relative delta delta Ct expression values of *HRE2* (A) *RAP2.2* (B) and *RAP2.12* (C) in seeds (Col-0) incubated at 25 °C in air without ethylene (red), and in *prt6* seeds incubated at 25 °C in air without ethylene (white) or in the presence of 100 $\mu\text{L L}^{-1}$ ethylene (yellow) for 16, 30 and 48 h. Significant levels between conditions were shown by NS, $P > 0.05$, * $0.01 < P < 0.05$, ** $0.001 < P < 0.01$, *** $P < 0.001$.

III.3.5 The regulation of *HRE2* in seed germination

The higher accumulation of *HRE2* was not only present in the imbibed *prt6* seeds, but also in dry seeds ($0.01 < P < 0.05$) (Figure S2). Newly harvested seeds (2018) showed again that the relative expression of *HRE2* was stimulated by ethylene either in Col seeds or in *prt6* seeds, as well as in *prt6 rap2.2 rap2.3 rap2.12* and *rap2.2 rap2.3 rap2.12* (Figure 6). Without ethylene treatment, *HRE2* was dramatically induced in *prt6* seeds (Figure 5 and Figure 6), but the mutation of *RAPs* in the *prt6* background significantly reduced the expression of *HRE2* when compared with *prt6*, which suggested that the relative expression of *HRE2* is regulated by *RAPs*. However, it was curious that there was no significant reduction of *HRE2* in *rap2.2 rap2.3 rap2.12* when compared with Col (Figure 6).

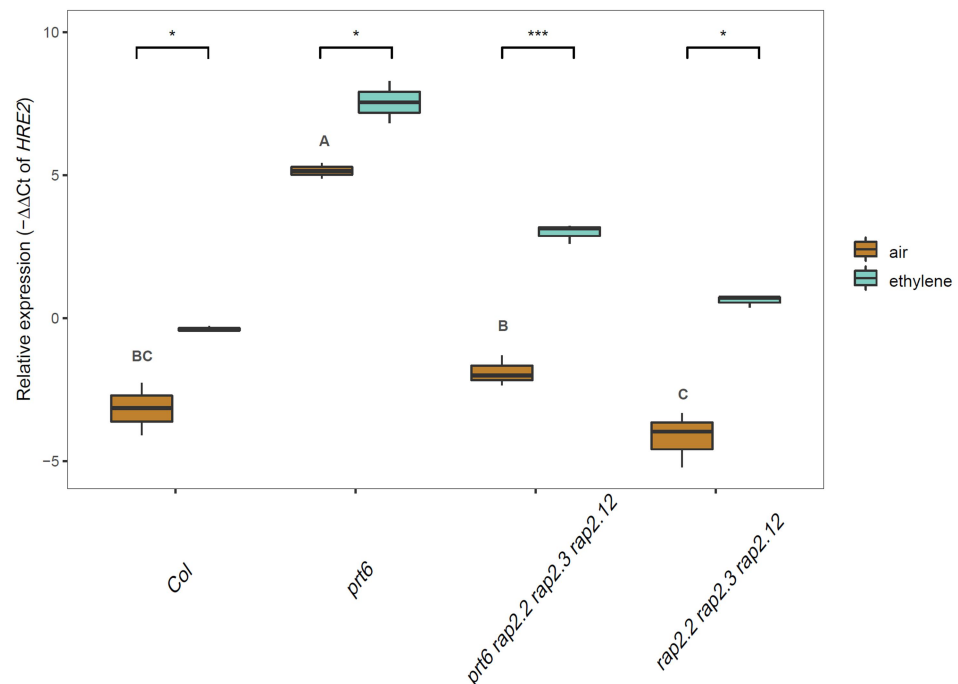

Figure 6. Relative delta delta Ct expression values of *HRE2* in seeds Col-0, *prt6*, *prt6 rap2.2 rap2.3 rap2.12* and *rap2.2 rap2.3 rap 2.12* incubated at 25 °C in the air without ethylene (golden) or in the presence of 100 $\mu\text{L L}^{-1}$ ethylene (light blue) for 30 h. Significant levels between conditions were shown by NS, $P > 0.05$, * $0.01 < P < 0.05$, ** $0.001 < P < 0.01$, *** $P < 0,001$ and multiple comparison results among the 4 material in air were shown by up case letters. Seeds used in this study were harvested in 2018.

In order to verify the effect of *HRE2* in seed responsiveness to ethylene, ectopically expressed *HRE2* was used to test seed sensitivity to ethylene in seed germination. As shown in the Figure 7A, with the presence of 100 $\mu\text{L L}^{-1}$ ethylene, N-terminal muted version of overexpressed seeds, *35S:(MA)HRE2-HA* germinated as well as Col or mutant *hre2*, whereas normal version of overexpressed seeds, *35S:(MC)HRE2-HA* presented a retarded germination especially at the 2nd day, but they almost caught up with the other seeds at the 3rd day. When the germination assay was repeated at 50 $\mu\text{L L}^{-1}$ of ethylene was applied, it seems that *35S:(MA)HRE2-HA* became more sensitive to ethylene at 1st day. After 7 days, the germination percentage of *35S:(MA)HRE2-HA*, *hre2* and Col reached 75.8-90.5%, whereas only 65.3% of seeds *35S:(MC)HRE2-HA* germinated.

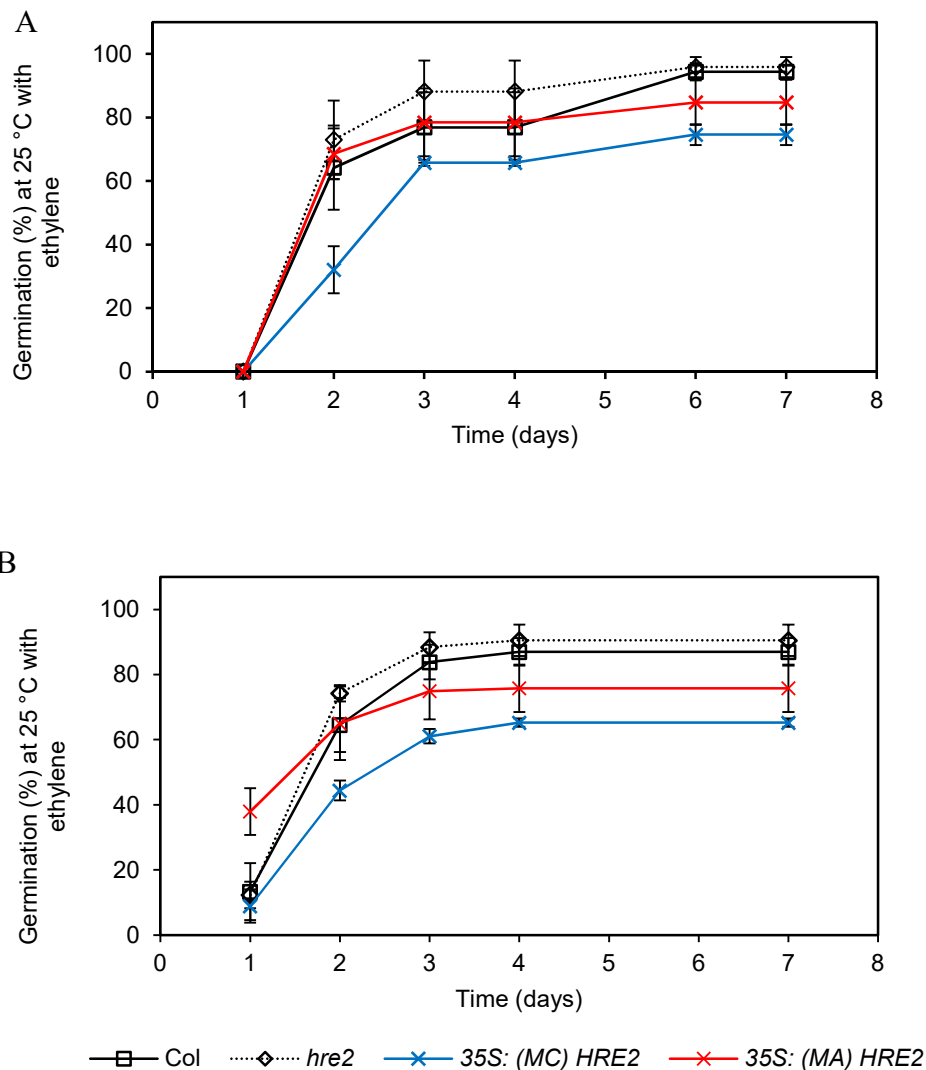

Figure 7. Germination percentages obtained after 7 d at 25 °C in Col, mutant *hre2* and ectopically expressing *HRE2* seeds with normal N-terminal version (MC) and stabilized N-terminal version (MA), that placed directly at 25 °C on water in the presence of ethylene at 100 µL L⁻¹ in darkness (A) or at 50 µL L⁻¹ (B). Means of 3 replicates ± SD.

III.3.6 Involvement of ABA and GA in the responsiveness of Col-0 and *prt6* to ethylene

The N-end rule mutants *prt6* and *ate1 ate2* germinated less than Col-0 in the presence of 10 or 100 µM GA₃, however, both mutants could germinate as well as Col-0 at higher GA₃ concentration (1000 µM). The germination percentage of both mutants was lower than wild-type that obtained in the presence of ABA higher than 0.5 µM, whereas no germination occurred when its concentration reached to 5 µM. Altogether, it seems that at certain

concentration, N-end rule mutants were less sensitive to GA₃ and more sensitive to ABA in seed germination (Figure 8).

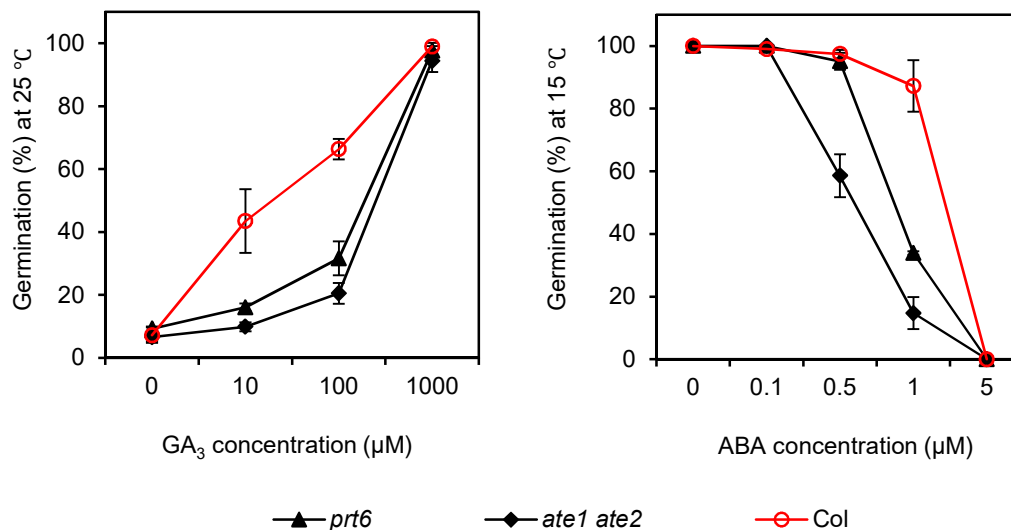

Figure 8 Effects exogenous hormone on the germination of dormant seeds Col-0, *prt6* and *ate1 ate2* obtained after seven days at 25 °C in the presence of 10, 100 and 1000 µM GA₃ (A); at 15 °C in the presence of 0.1, 0.5, 1 and 5 µM ABA (B). Means of 3 replicates ± SD.

ABI5 (ABA INSENSITIVE 5) is a core component in the ABA signaling pathway and is strongly responsive to ABA treatment (Skubacz *et al.*, 2016). RGA (repressor of *gal-3*) and RGL2 (RGA-like2) are negative regulators of GA signaling and they act immediately downstream of the GA receptors (Tyler *et al.*, 2004). Figure 9 shows that ethylene significantly reduced the relative expression of *ABI5*, *RGL2* and *RGA* in Col seeds at 30 and (or) 48 h while ethylene resulted in a less reduction of *ABI5* in *prt6* than in Col, or even did not make a difference in the expression of *RGL2* in *prt6* seeds. It was obvious that the genotype effect also existed in *RGA* (Figure 9B). As shown in Figure 9B, *RGA* was up-regulated in *prt6* at 30 and 48 h. The *RGA* transcript responsiveness to ethylene was similar in Col and *prt6* with both being inhibited by ethylene at 30 h or both showing no statistical change by ethylene at 48 h. However, the presence of genotype effect contributed to the basis of differential expression between Col and *prt6* without ethylene treatment, which also leads to the difference between them with ethylene treatment (Figure 9).

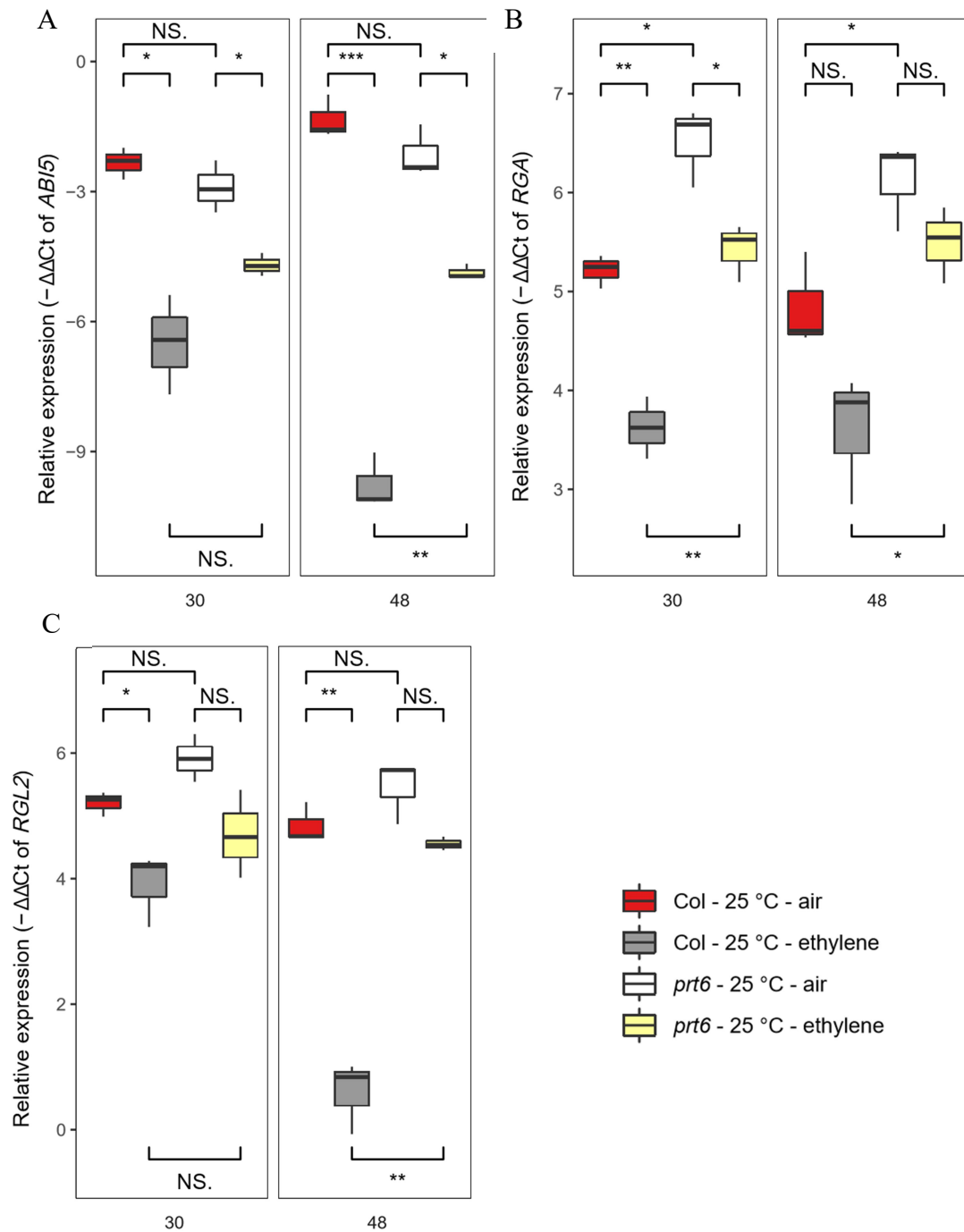

Figure 9. Relative delta delta Ct expression values of *ABI5* (A), *RGA* (B), *RGL2* (C) in seeds (Col-0) incubated at 25 °C in air without ethylene (red) or in the presence of 100 $\mu\text{L L}^{-1}$ ethylene (grey), in *prt6* seeds incubated at 25 °C in air without ethylene (white) or in the presence of 100 $\mu\text{L L}^{-1}$ ethylene (yellow) for 30 and 48 h. Significant levels between conditions were shown by NS, $P > 0.05$, $* 0.01 < P < 0.05$, $** 0.001 < P < 0.01$, $*** P < 0.001$.

III.3.7 Crosstalk of seed sensitivity to ethylene and hypoxia

As shown in Figure 10A, the improving effect of ethylene in wild-type seeds only occurred when the oxygen concentration was more than 5%. At 25 °C, the non-dormant seeds (4 days pre-chilled) *prt6* germinated as well as wild-type at low oxygen conditions in darkness (Figure 10B). However, mutants affected in the ethylene signaling, *etr1* and *ein2* were more sensitive to hypoxia, suggesting that ethylene signaling was involved in the responsiveness of seed to hypoxia (Figure 10B).

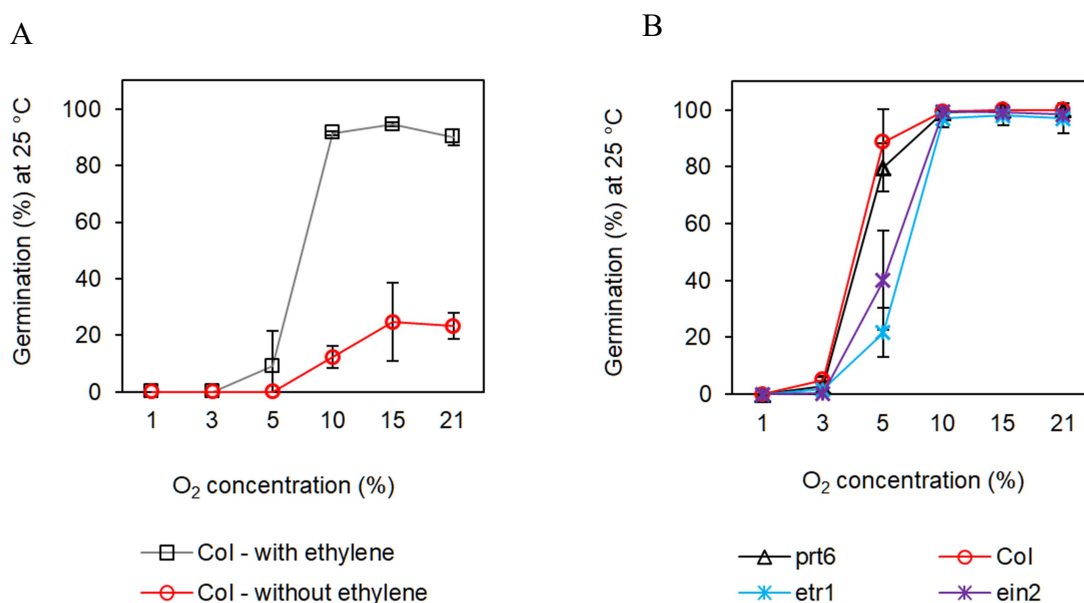

Figure 10. Crosstalk of seed sensitivity to ethylene and oxygen. A: Germination percentage of Col-0 seeds obtained after 6 days at 25 °C in different concentrations of oxygen with (grey) or without (red) the presence of 100 $\mu\text{L L}^{-1}$ ethylene; B: Germination percentage obtained with seeds of Col-0, *prt6*, *etr1*, *ein2* chilled for 4 days and then transferred at 25 °C within the presence of various oxygen concentrations. Means of 3 replicates \pm SD.

In order to verify whether the insensitivity of *prt6* to ethylene was related to seed respiration or ROS production, respiration intensity and H₂O₂ production were measured in *prt6* and Col. In atmosphere containing 3 and 21% oxygen, and in the presence of ethylene there was no significant difference in H₂O₂ production in both *prt6* and Col (Figure 11C), but

prt6 produced more H₂O₂ than in Col in 1% oxygen (Figure 11C). In addition, ethylene treatment did not statistically affect the respiration intensity in Col, neither in *prt6*, but t-test between Col and *prt6* in the presence of ethylene confirmed that the respiration was enhanced in *prt6* mutant (Figure 11D). Taken together, it seems that the insensitivity of *prt6* to ethylene is independent of respiration and H₂O₂ production.

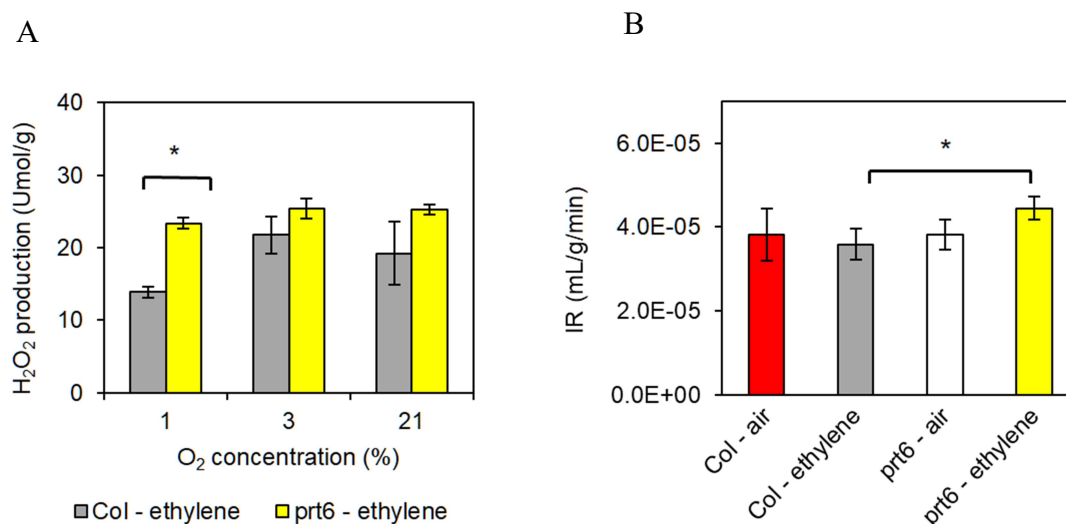

Figure 11. Effect of ethylene on the H₂O₂ production and respiration intensity in Col-0 and *prt6*. A: H₂O₂ in Col-0 and *prt6* seeds incubated for 24 h in different concentrations of oxygen and in the presence of 100 $\mu\text{L L}^{-1}$ ethylene; B: Respiration intensity of Col-0 and *prt6* seeds imbibed for 6 h at 25 °C with or without 100 $\mu\text{L L}^{-1}$ ethylene. Means of 3 replicates \pm SD.

III.4 Discussion

Freshly harvested *Arabidopsis* seeds are dormant, and their germination is impossible in darkness at 25 °C. Ethylene, acting as an important hormonal regulator, could release wide-type (Col-0) seed dormancy, but it did not break the dormancy of mutant *prt6* seeds indicating that the N-end rule is involved in seed responsiveness to ethylene (Figure 1). ERFVIIIs acted as substrates of the N-end rule and they were suffered proteasome degradation by E3 ligase PRT6 (Gibbs *et al.*, 2011). In order to precise the role of ERFVIIIs in the response to ethylene, mutation of *ERFVIIIs* in *prt6* background was carried out, and it was shown that the quadruple mutant *prt6 rap2.2 rap2.3 rap2.12* was able to germinate in contrast to the phenotype in *prt6* (Figure 1C). The epistasis test showed that RAPs located

downstream of PRT6 in the seed responsiveness to ethylene. The knock off the *RAPs* contributed to seed germination in *prt6*, that is to say, *RAPs* played an inhibitory role in seed germination. This fitted nicely with the observation that dormancy alleviation by ethylene in *Col* was associated with the down-regulation of 3 *RAPs* (Figure 4). Breaking seed dormancy by stratification at 4 °C also resulted in a decrease in *RAPs* expression, especially in *RAP2.3* and *RAP2.12* (Figure 3). Meanwhile, *prt6* seeds treated with ethylene that did not alleviate dormancy but showed constant maintenance or induction of *RAPs* (Figure 5). The inhibitory effects of *RAPs* in seed germination was consistent with the perfect germination of triple mutant *rap2.2 rap2.3 rap2.12* (Figure 1B). Nevertheless, the ectopically single *RAPs* seeds did not present a reduced sensitivity to ethylene (data not shown). As demonstrated by Gibbs *et al.* (2014), *prt6* mutant was more sensitive to ABA than *Col* (Figure 8B), which was suggested to be due to the accumulation of *RAPs* in *prt6*, that was also verified by the fact that quadruple mutant *prt6 rap2.2 rap2.3 rap2.12* was less sensitive to ABA than single mutant *prt6*.

The receptor *ETR1* negatively regulated ethylene signaling (Cancel and Larsen, 2002). It was reported that the transcript expression of *ETR1* and the protein level of *ETR1* are not much affected by ethylene in seedlings (Hua *et al.*, 1998; Chen *et al.*, 2007). In addition, *ETR1* was degraded with the presence of a higher concentration of ethylene in a *CTR1*-dependent manner (Shakeel *et al.*, 2015). *EIN2* transduced the signal from the cytoplasm to the nucleus and positively regulated ethylene signaling (Bisson and Groth, 2011). It was evidenced that mRNA of *EIN2* was unaffected by exogenous ethylene in seedlings, but *EIN2* protein level was improved in the early stage of treatment (Alonso *et al.*, 1999; Qiao *et al.*, 2009). The significantly reduced expression of *EIN2* by ethylene in *Col* in our study might result from the attenuation of ethylene signal after 30 and 48 h, which was also a kind of responsiveness, whereas, with ethylene treatment, expression of *ETR1* and *EIN2* in *prt6* was reluctant to move. Besides, the genotype effect resulted in a higher accumulated expression of *ETR1* in *prt6* mutant than in *Col* (Figure 1D). Interestingly, the report from Gibbs *et al.* (2014) and Holman *et al.* (2009) hinted that the insensitiveness of *prt6* to ethylene might also be related to the crosstalk of GA and ABA signaling. It was shown that except for improved sensitivity of the N-end rule mutants to ABA, they also presented reduced sensitivity to GA (Figure 8B). On one hand, it is noticed that without

ethylene, genotype effect did not affect the relative expression of *ABI5*, but *ABI5* seems to be less induced by ethylene in *prt6* than in Col, that resulted in a higher level of *ABI5* with ethylene treatment in *prt6* than in Col (Figure 9). On the other hand, *PRT6* mutation stimulated the relative expression of *RGA*, which also occurred even with the presence of ethylene (Figure 9). The accumulation of *RGA* played a negative effect in GA signaling in seed germination, which might also influence the sensitivity of *prt6* to ethylene. In addition, our previous results showed that the endogenous ABA/GA balance was affected in *prt6* after ethylene treatment (data not shown). Taken together, it was proposed that the insensitivity of *prt6* to ethylene was associated with the affected ethylene, ABA and GA signalings.

The germination curve also showed that the triple mutant *prt6 hre1 hre2* behaved similarly to *prt6* (Figure 1C), suggesting that these two HREs might locate at upstream of *PRT6* in seed responsiveness to ethylene. It is also curious that among the five *ERFVII* genes, only *HRE2* showed an induction after dormancy alleviation treatment, pre-chilling or ethylene (Figures 3 and 4). It was preliminarily speculated that *HRE2* might play a promoting effect in seed germination, but genetic results failed to support this conclusion. As shown in Figure 1B and Figure 7, *hre2* mutant, overexpressed *HRE2* seeds with either normal version or N-terminal muted version, germinated similarly with wild-type, suggesting that there might be redundant regulators as the same with *HRE2* in seed germination, and *HRE2* was possible to be regulated in a post-transcription manner, which has been proposed by Licausi *et al.* (2010). Except for the stimulated expression of *HRE2* by ethylene in Col, it was also induced by ethylene in *prt6* (Figures 5 and 6). Moreover, without ethylene treatment, *HRE2* was more strikingly enhanced in *prt6* than in Col, but the mutation of 3 *RAPs* in *prt6* background dramatically reduced the expression of *HRE2* (Figures 5 and 6). The transcription results and the presence of one GCC box, a conserved motif for the binding of ERFs, in the promoter region of *HRE2* led us to achieve a speculation that 3 *RAPs* acting as transcription factors might regulate the transcription expression of *HRE2*, but it was curious that expression of *HRE2* was not inhibited in *rap2.2 rap2.3 rap2.12* when compared with Col (Figure 6). Because the N-end rule pathway was well studied its involvement in the homeostatic response to hypoxia, the relative expression of *HRE2* was also carried out in Col treated with hypoxic stress to mimic the regulation of *HRE2* in *prt6* seeds. As shown in Figure S3, the expression of *HRE2* was significantly induced at low oxygen conditions in the

imbibed seeds. The improving expression of *HRE2* in the transcript level by hypoxia also shown by Gibbs *et al.* (2011) and Licausi *et al.* (2010) in seedlings. The insensitivity of *prt6* to ethylene was associated with a dramatic increase of *HRE2*, but the effect of *HRE2* in seed germination, especially in *prt6* background was still elusive. Hence, after the construction of crossbreeding seed such as *prt6 hre2* and *prt6 prom (HRE2):TAG*, the genetic and molecular analysis needs to be clarified.

Finally, we also discussed the crosstalk of ethylene and oxygen in seed germination. The improving effect of ethylene on seed germination required at least 5% of oxygen (Figure 10 A). Besides, seed responsiveness to hypoxia also required ethylene signaling (Figure 10 B). Meanwhile, we found that *prt6* mutant seeds did not present an enhanced tolerance to hypoxia stress (Figure 10 B), which was against with the previous reports (Gibbs *et al.*, 2011; Mendiondo *et al.*, 2016). It was possibly due to the different imbibition conditions, like temperature (22 °C instead of 25 °C) or light (darkness in this work). In addition, our proteomic analysis revealed a distinct GO term, response to hypoxia, which was strikingly different in *prt6* (data not shown). At the same time, *prt6* mutant exhibited unaffected H₂O₂ production in normoxia or even stimulated H₂O₂ production in hypoxia, and *prt6* mutant presented improved respiration speed when compared with Col in the ethylene treatment (Figure 10 C,D). It seems that the insensitivity of *prt6* to ethylene in seed germination was independent of ROS production and respiration.

Supplementary results

Table S1. Primers used in the study

Genotyping primers			
<i>Lbb1.3-(SALK)</i>	ATTTTGCCGATTCGGAAC		
<i>LBI-(SAIL)</i>	GCCTTTTCAGAAATGGATAAATAGCCTTGCTTCC		
<i>o8474-(GABI)</i>	ATAATAACGCTGCGGACATCTACATTTT		
<i>LT6-(wiscDslox)</i>	AATAGCCTTTACTTGAGTTGGCGTAAAAAG		
<i>T-DNA mutant</i>	Forward primer		Reverse primer
<i>ate1-(SALK)</i>	CTGGAACACAACCTCCGAGTG	AAGAGGTGCTTCTCCTCTGG	
<i>ate2-(SALK)</i>	GTACCGGAGAGGGCATAGAAG	CTCCCGTGAAGTTTCAGTGTC	
<i>hre1-(SALK)</i>	AACTAATCACCGTGACGACT	CTCCACGGATTCTCTTAGCTT	
<i>hre2-(SALK)</i>	ATTTCTGATTTTCATCTGGTCGAA	GATGAAACCATGAGCGTCTT	
<i>prt6.1-(SAIL)</i>	TTGACCTTTTGTCAAGGAATG	CAAGCTCAAGTCCCTGTTCTG	
<i>rap2.2-(SAIL)</i>	ATGACAACATTGGGATGCAAC	TTTCTTGGCATATGCTGAACC	
<i>rap2.3-(SAIL)</i>	ATGTGTGGCGGTGCTATTATT	TTACTCATACGACGCAATGAC	
<i>rap2.12-(GABI)</i>	CTCAGCTGTCTTGAACGTTCC	TGGCTACTCCTGAATGCAAAAC	
<i>gl22-1 (SALK)</i>	GTCACATGCTTTTCTGTGAAG	TTGCCAAATTGTAGTACTTGC	
<i>pbp1 (SALK)</i>	ATCCGGTCTTGTATCTAGATTTTT	GAAAGAAGAAGATTAATGGGCAAGGA	
<i>pyk10-1(wiscDslox)</i>	AGGAAATATTCTTGGCCATGC	TTGATTAATATGGCCTGGCTG	
<i>ldap1(SALK)</i>	AGATGTCTTTGCGATCCAATG	ATCGAAGAACACATCGTCCAC	
<i>expasin2 (SALK)</i>	TTTCTGGTGTGGTTTCTTTG	GCAGAAGTTGAGGGTGCATAG	
q-RT-PCR primers			
Gene	Locus ref.	Forward primer	Reverse primer
<i>ETR1</i>	AT1G66340	CAAGAGGTTTGTGAATCTGATGGA	TTAACATCAAAGATAGCCGTGCAT
<i>EIN2</i>	AT5G03280	TTTTGCTGGGGAAAGTACATCTTC	GACACCAAAGATGGCGAACAAA
<i>GAI</i>	AT1G14920	ATCTTAAAGCTATTCCTGGTGAC	GTATCTCCTCCGCCGCTTG
<i>RGA</i>	AT2G01570	CCAATTCCAAGGTCGATTGTCC	CTCGTCGTCCATGTTACCTCC
<i>RGL2</i>	AT3G03450	AAAACCACTACCAGTTCTCGTT	CAGCCATCTCAGAAGATCGAAC
<i>ABI5</i>	AT2G36270	GAGAATGCGCAGCTAAAACA	GTGGACAACCTCGGGTTCCTC
<i>HRE1</i>	At1G72360	CTGATTGATACACAATGGCTCGA	AGTTTCCCTCCGTAAGGCATC
<i>HRE2</i>	AT2G47520	GCGTAAACCCGTCTCAGTGAGTG	GGCCTCTGCCTTATCCCTCTGT
<i>RAP2.2</i>	AT3G14230	GGTATATATTTGGTAGGTTTCAGCA	TCCAAGCCATTCTCGGGAGC
<i>RAP2.3</i>	AT3G16770	GCCGGATTATGATCTGAAACA	CAAGCATCCACATATCCACCT
<i>RAP2.12</i>	AT1G53910	AAGCCAATCCAGCTAAGAAGC	GTTTGCACCATTGTCTGAGT
<i>CB5-E</i>	AT5G53560	TGAAGAAGTTTCAAAGCACAACA	TGAAGAAGTTTCAAAGCACAACA
<i>RHIP1</i>	AT4G26410	GAGCTGAAGTGGCTTCCATGAC	GGTCCGACATACCCATGATCC
<i>TIP41</i>	AT4G34270	GTGAAAACCTGTTGGAGAGAAGCAA	TCAACTGGATACCCTTTCGCA

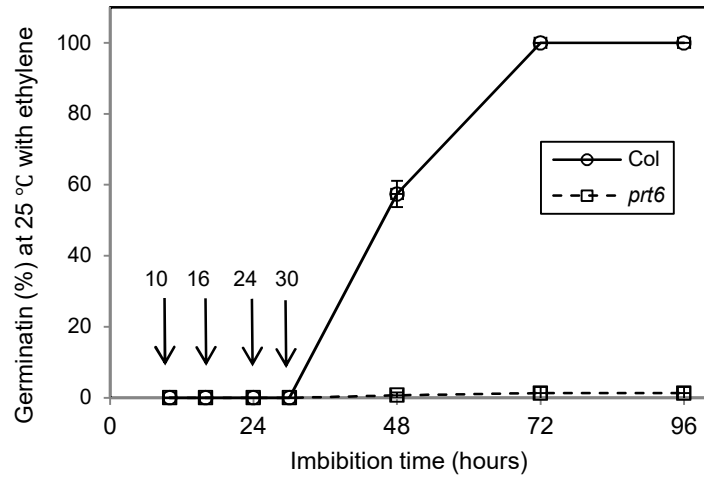

Figure S1. Germination percentages obtained at 25 °C with Col-0 and *prt6* seeds placed directly at 25 °C on water in the presence of ethylene at 100 $\mu\text{L L}^{-1}$. Means of 3 replicates \pm SD. Seeds harvested in 2016. The sampling time used for the analysis were shown in axis scale and the arrows.

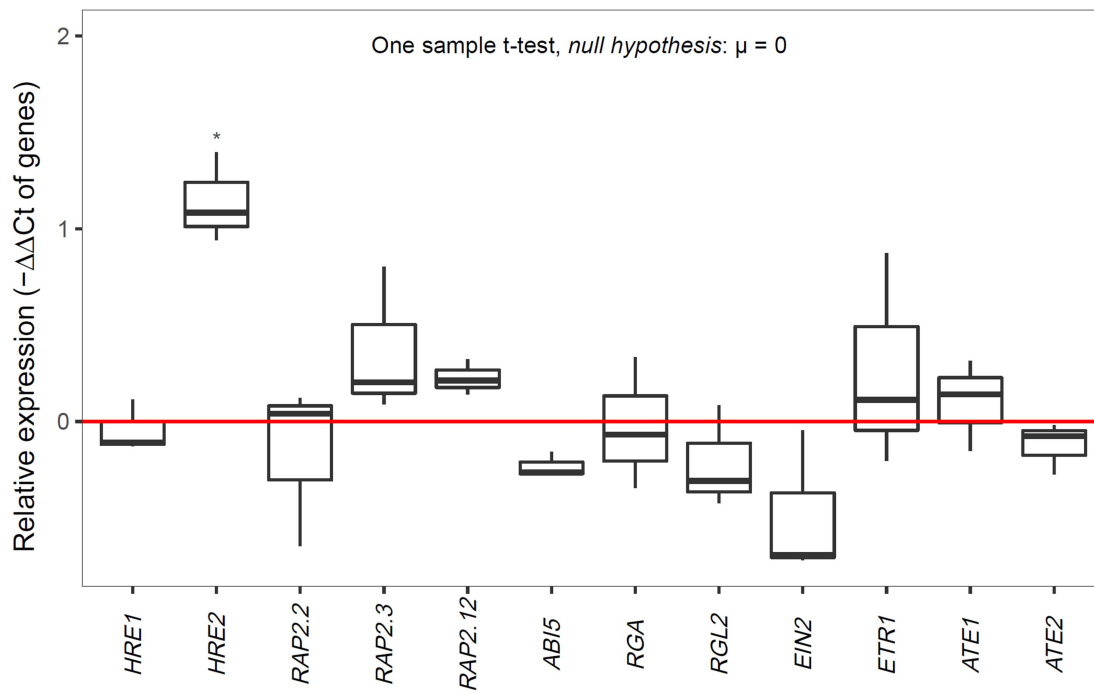

Figure S2. Relative delta delta Ct expression values of all the genes in dry *prt6* seeds. Difference of each gene expression in dry *prt6* seeds and Col-0 seeds were carried out by one sample t-test with null hypothesis $\mu = 0$. Significant level was shown by * $0.01 < P < 0.05$.

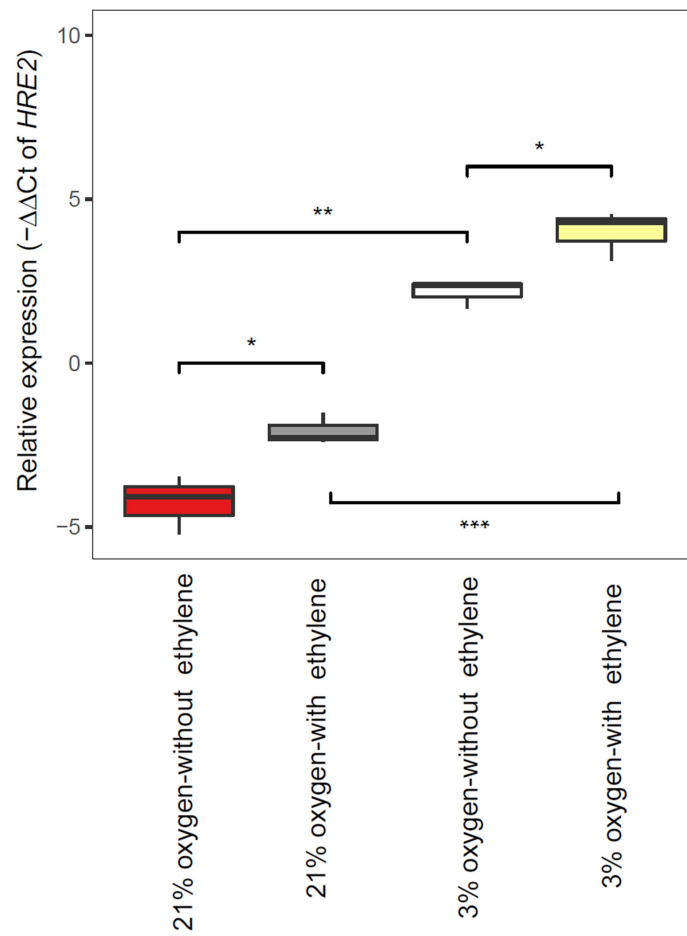

Figure S3. Relative delta delta Ct expression values of *HRE2* in Col seeds imbibed at 25 °C for 30 h at 21% oxygen with (red) or without (grey) the presence of ethylene or at 3% oxygen with (white) or without (yellow) the presence of ethylene. Significant levels between conditions were shown by NS, $P > 0.05$, * $0.01 < P < 0.05$, ** $0.001 < P < 0.01$, *** $P < 0.001$.

Chapter IV Label-free quantitative proteomics reveals the involvement of the Arg/N-end rule pathway in *Arabidopsis thaliana* seed responsiveness to ethylene

(Article in preparation)

Xu WANG¹, Michel ZIVY², Marlène DAVANTURE², Eiji NAMBARA³, Françoise CORBINEAU¹

¹Biologie des semences, UMR 7622, IBPS, Sorbonne Université, 4place Jussieu, 75005 Paris, France;

²PAPPSO, GQE-Le Moulon, INRA, Univ. Paris-Sud, CNRS, AgroParisTech, Université Paris-Saclay, 91190, Gif-sur-Yvette, France;

³Department of Cell & Systems Biology, University of Toronto, 25 Willcocks St, Toronto ON M5S 3B2, Canada

Abstract

Ethylene, an important gaseous hormone, participates in the alleviation of seed dormancy in numerous species including *Arabidopsis thaliana*. Using mutant of the N-end rule pathway, lacking the E3 ligase *PROTEOLYSIS 6 (PRT6)*, it has been demonstrated that this proteolysis pathway that targeted the protein by its N-terminal residues, was involved in seed responsiveness to ethylene. In the present work, we carried out shotgun label-free quantitative proteomics (LC-MS/MS) of dormant wild type Col-0 and *prt6* seeds treated with (+) or without (–) ethylene. After 16 h, 1737 proteins were identified, but none was significant after two factors ANOVA analysis (adjusted P = 0.05). After extending ethylene treatment up to 30 h, 2552 proteins were identified, and 619 proteins had significant interaction effects. Tukey test (P = 0.05) and fold change ratio (< 0.7 or > 1.3) allowed to select 587 and 30 proteins in the group Col+/Col– and *prt6*+/*prt6*–, respectively. These results indicated that ethylene did not have a marked effect on the global proteome of *prt6* seeds, suggesting that the N-end rule pathway might be important in ethylene response. Over representation analysis of the significant proteins in Col+/Col– showed that biological process were enriched in signals perception and transduction, reserve mobilization and new material generation, which could contribute to seed germination. Twenty-nine common proteins were overlapped in the two groups, 5 of which presented opposite changes. However, single mutation of these 5 genes did not result in change in ethylene responsiveness. Taken all together, our data suggested that the insensitivity of *prt6* to ethylene might be related to a delay in the mobilization of seed storage proteins and most oleosins. Particularly, the different responsiveness of Col and *prt6* to exogenous ethylene was associated with the higher hormone balance ABA/GA₄ in *prt6* than in Col.

Key words: *Arabidopsis thaliana*, seed dormancy, N-end rule pathway, ethylene, quantitative proteomics, label-free

IV.1 Introduction

Seeds are essential to reproduce progenies in many plants. Seed germination and seedling establishment are crucial stages for plant production. At harvest, seeds of numerous species cannot germinate. They are considered as quiescent when the environmental conditions are unfavorable for the germination (not enough water, too low or too high temperatures, hypoxia, darkness or light) or dormant when seeds fail to germinate despite apparently favorable germination conditions (Finch-Savage and Leubner-Metzger, 2006; Finch-Savage and Footitt, 2017). In *Arabidopsis* (*Arabidopsis thaliana*), dormant seeds have marked difficulty to germinate at temperature higher than 15 °C in darkness. It is reported that the plant hormone, ethylene, could release seed dormancy of numerous species through a crosstalk with the hormonal balance between abscisic acid (ABA) which inhibits germination and gibberellins (GAs) which promotes germination (Matilla and Matilla-Vázquez, 2008; Arc *et al.*, 2013; Corbineau *et al.*, 2014). In *Arabidopsis*, dormant Col-0 seed population is able to germinate at 25 °C within seven days in the presence of ethylene at 50-100 $\mu\text{L L}^{-1}$ (Wang *et al.*, 2018). In addition, the application of dormancy-breaking agents, stratification, GAs, jasmonates, brassinosteroids and some signalling molecules, such as reactive oxygen species (ROS) or reactive nitrogen species (RNS) promote seed germination in correlation with ethylene production (Bogatek and Gniazdowska, 2012). It is also shown that endogenous ethylene production begins with the onset of seed imbibition, following an emission peak with the radical emergence (Siriwitayawan *et al.*, 2003; El-Maarouf-Bouteau *et al.*, 2015). Ethylene plays its role in seed germination by the regulation of hormonal balance (ABA/GAs), as well as by the activation of its responsive genes, such as ethylene responsive factors (ERFs) or even the downstream specific functional genes through its own signaling transduction (Linkies *et al.*, 2009; Corbineau *et al.*, 2014; Liu *et al.*, 2016; Wang *et al.*, 2018).

The N-end rule pathway corresponds to the ubiquitin-proteasome system (UPS) degradation by targeting specific N-terminal residue of a protein (Bachmair *et al.*, 1986). This proteolytic N-end rule pathway has 3 branches, the Arg/N-end rule pathway, the Ac/N-end rule pathway, and the Pro/N-end rule pathway (Lee *et al.*, 2016; Dong *et al.*, 2018; Dougan and Varshavsky, 2018; Nguyen *et al.*, 2018; Nguyen *et al.*, 2019). In *Arabidopsis*, there are two N-recognins that act as specific E3 ligase identifying specific N-degrons in the Arg/N-end rule pathway, namely, PROTEOLYSIS 1 (PRT1) and PRT6, which recognize the

aromatic residues (Phe, Trp, Tyr) and the basic residues (Arg, His, Lys) respectively. The N-degrons as listed above can be generated by proteolytic cleavage such as N-terminal Met excision by methionine aminopeptidase (MAP) or endoproteolytic cleavage by endopeptidase (EP). It can also be produced by post-translational modification of tertiary residues (Asn, Gln, Cys). Firstly, it is the deamidation of Asn or Gln, and oxidation of Cys to secondary residues Asp, Glu, Cys-sulfinic acid, respectively. Subsequently, they are arginylated by arginyl-tRNA transferase (ATE) to generate a peptide initiating with Arg (Graciet and Wellmer, 2010; Sriram *et al.*, 2011) (Figure 1). Using the Arg/N-end rule mutant, especially, *prt6*, it has been identified that it is involved in many aspects of plant development. Firstly, *prt6* exhibits wavy and lobed leaves with deeper serrations and a loss of apical dominance, the phenotypes of which are more severe in *ate1 ate2* (Graciet *et al.*, 2009). Then, one *prt6* mutant allele, *greening after extended darkness 1 (ged1)* is more tolerant to starvation conditions, such as prolonged darkness, than the wild type (Choy *et al.*, 2008; Riber *et al.*, 2015). More importantly, the particular attentions are paid on the less sensitivity of *prt6* seedlings to hypoxia, which allow the researchers to identify the innovative substrates of N-end rule, MC-initiating ERFVIIIs in Arabidopsis (Gibbs *et al.*, 2011; Licausi *et al.*, 2011). Besides, mutant *prt6* exhibits an increase in susceptibility to infection with pathogen and down-regulation of JA-response genes (de Marchi *et al.*, 2016). Curiously, it was then proposed that *prt6* mutant in Arabidopsis and reduced expression of *HvPRT6* in barley showed enhanced resistance to biotic and abiotic stress (Vicente *et al.*, 2017; Vicente *et al.*, 2019). In addition, *prt6* was insensitive to NO donors SNAP in the stomatal closure and seed germination (Gibbs *et al.*, 2014). Until now, the reports concerning *prt6* in seed germination are the stronger sensitivity to ABA and NO; impaired seed reserve mobilization; the higher tolerance to hypoxia (Holman *et al.*, 2009; Gibbs *et al.*, 2011; Gibbs *et al.*, 2014).

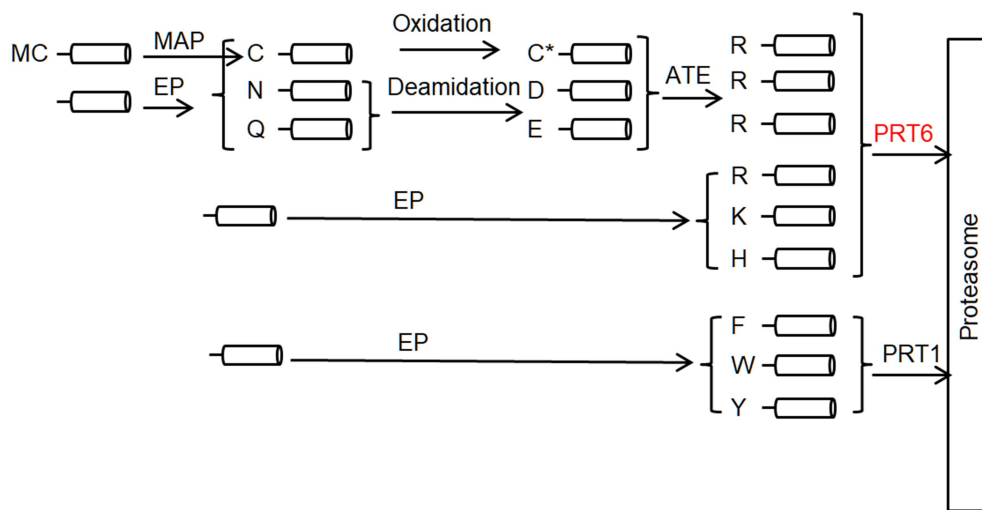

Figure 1. The Arg/N-end rule pathway. ATE: arginyl-tRNA transferase; EP: endopeptidase; MAP: methionine aminopeptidase; PRT1/6: PROTEOLYSIS 1/6. C: cysteine; D: aspartic acid; E: glutamic acid; F: phenylalanine; H: histidine; K: lysine; M: methionine; N: asparagine; Q: glutamine; R: arginine; W: tryptophan; Y: tyrosine (Zhang *et al.*, 2018a).

With the urge to enrich the mechanism of N-end rule in plant development, the availability of genome information and the development of technology has facilitated the omics study to quantify the moving molecules, to detect the half-life of the N-termini (Choy *et al.*, 2008; Gibbs *et al.*, 2011; Majovsky *et al.*, 2014; Zhang *et al.*, 2015; Zhang *et al.*, 2018a). Microarray analysis of Choy *et al.* (2008) shows lower amounts of genes encoding seed storage proteins, oleosins, and late embryogenesis abundant (LEA) proteins in 7-day-old seedlings of *ged1* compared with the wild type. Gibbs *et al.* (2010) finds the up-regulated genes in *prt6* mutant and *ate1 ate2* mutant overlapping more than half of the 49 core genes from hypoxia response (Mustroph *et al.*, 2009). Zhang *et al.* (2015) undertakes a quantitative proteomic analysis of *prt6* in Arabidopsis root using terminal amine isotope labelling (TAILS). It indicates that, surprisingly, the mutation of *prt6* does not markedly enrich the accumulation of destabilising residues. Furthermore, consistent results are found that Arg/N-end rule pathway does not make dramatic changes in the targeted proteome of Arabidopsis seedlings (Majovsky *et al.*, 2014). Recently, N-termiomics has been used again by Zhang *et al.* (2018) to analyze etiolated seedlings *prt6*, which identify few up-regulated seed storage proteins and several down-regulated proteases, some of which are regulated by ERFVII (Zhang *et al.*, 2018a). To date, Arabidopsis seeds have not yet been selected to launch omic

analysis of N-end rule pathway, though Gibbs *et al.* (2011) include seed materials of *prt6* along with the microarray analysis of seedlings. As the N-end rule modifies or degrades targets in protein level, proteomic analysis is preferred considering it reflects more accurately on the dynamic state of a cell. In the present study, we would like to determine the impact of PRT6 E3 ligase and ethylene treatment on the Arabidopsis seed proteome. Using *prt6* mutant, we previously demonstrated that dormant seeds of *prt6* mutant cannot germinate in the presence of ethylene, and in other words, that ethylene could not break seed dormancy of *prt6* (Wang *et al.*, 2018). Therefore, proteomic method was used to compare the different sensitivity of *prt6* and wild type seeds to ethylene and we have analyzed the proteomic changes in both genotypes incubated at 25 °C in air and in the presence of ethylene.

IV.2 Materials and Methods

IV.2.1 Seed material

Arabidopsis thaliana seeds from Columbia-0 (Col-0) were used as the wild type of this study. Mutant *prt6* (Sail-1278-H11) was in the genetic background of Columbia-0, and obtained as a gift from Dr. M. J. Holdsworth. For seed multiplication, seeds were firstly imbibed in the water at 4 °C for 3 days then transferred into the potting mixture (Jiffy® substrates, Tref, France) placed in a growth chamber at 21 °C under a photoperiod of 16 h light/8 h dark. Siliques were harvested at maturity and seeds were collected in 2016 and 2018 were stored at -20 °C before the experiment.

IV.2.2 Germination assay

Germination assays were performed in darkness in 9-cm Petri dishes (100 to 200 seeds per assay in 3 replicates) by placing seeds on a filter paper on the top of a layer of cotton wool moistened with deionized water at 25 °C. Germination assays in the presence of gaseous ethylene were carried out in tightly closed 360 ml-containers in which was injected gaseous ethylene (5%) (Air Liquide, Paris, France) in order to obtain ethylene at 100 $\mu\text{L L}^{-1}$. A seed was considered to have germinated as soon as the radicle protruded through the seed coat. Germination counts were made every 24 h for 7 days, and the results presented are the means of the germination percentages obtained with 3 replicates \pm SD.

IV.2.3 Seed treatment

Col and *prt6* seeds were imbibed on a filter paper on the top of a layer of cotton wool moistened with deionized water in a tightly closed 360 ml-containers (50 mg per assay in 3 replicates) in darkness. Seeds were incubated with (+) or without ethylene (-) $100 \mu\text{L L}^{-1}$ for 16h and 30 h. They were then fixed in liquid nitrogen and stored at $-80 \text{ }^{\circ}\text{C}$. Dry seeds from both genotypes were also analyzed.

IV.2.4 Protein extraction and LC-MS analysis

The total protein was extracted by a modified phenol extraction method as described by Desjardin *et al.* (2012). The protein concentration was determined using 2D-QUANT kit (Amersham Biosciences, Little Chalfont, UK), then it was digested by trypsin (Promega, Madison, Wisconsin, United States). Desalting and concentration of the peptides were implemented before the operation of HPLC by NanoLC-Ultra (Eksigent, Dublin, USA) coupled to an MS analysis by Qexactive (Thermo Fisher, Waltham, MA, USA). LC-MS analyses were performed in two independent batches: one batch included dry and 16 h-imbibed seeds and the other included 30 h-imbibed seeds.

IV.2.5 Protein identification and quantification

Arabidopsis FASTA format database was downloaded from TAIR (<https://www.Arabidopsis.org/>) and database searches were performed using the X!Tandem search engine (Craig and Beavis 2004) and protein inference and post-treatment filtering was performed by using X!TandemPipeline (Langella *et al.*, 2017). Data filtering was achieved according to a peptide E-value < 0.01 , protein $\log(\text{E-value}) < -4$ and to a minimum of two identified peptides per protein. Peptides were quantified based on eXtracted Ion Current (XIC) of their peptides using MassChroQ (Valot *et al.*, 2011). Relative quantification of the proteins was analyzed using R scripts by analyzing peptide intensities obtained from XIC. Firstly, reliable peptides were selected according to the criteria described in Belouah *et al* (2019), *i.e.* shared peptides, uncorrelated peptides, peptides showing retention time instability, and peptides showing more than $3/(\text{the number of total samples})$ missing data were filtered out. Only proteins represented by at least two reliable peptides were kept for analysis. Then

protein relative abundances were computed as the sum of the peptide intensities. Protein abundance changes were detected separately for 16 and 30 h-imbibed seeds by a 2-way ANOVA (ethylene treatment and genotype) with interaction. Dry seeds were only analyzed with 16 h-imbibed seeds in the absence of ethylene treatment by 2-way ANOVA (imbibition and genotype) with interaction. The proteins having interaction effects were selected under adjusted P values corrected for multiple comparisons < 0.05 . The down and up-regulated proteins were then defined as those with significantly changed after Tukey test with P value < 0.05 and fold-change < 0.7 or > 1.3 .

IV.2.6 Bioinformatic analysis

Principle component analysis was conducted by the R package *factoextra* (Kassambara and Mundt, 2017). Heatmap clustering was drawn by R package *pheatmap* (Kolde, 2019) with values being centered in row direction and clustering distance method being chosen as “Euclidean”. Volcano plot was finished by *EnhancedVolcano* (Blighe, 2019) with cutoff of \log_2 (fold change) at 0.4. Down-regulated and up-regulated proteins in comparison group were input into the SeedNet (Bassel *et al.*, 2011), in the platform of Cytoscape to capture the overlapping proteins. Gene ontology analysis was launched by the R package *clusterProfiler* (Yu *et al.*, 2012). Biological Process (BP) terms of Arabidopsis were downloaded from the new release (TAIR Data 20180331) of GO annotation (<https://www.Arabidopsis.org/index.jsp>) and automatically generated annotations, that is, Inferred from Electronic Annotation (IEA) were removed to improve the credibility of overrepresentation analysis. The redundant BP terms were discarded and by using the function “simplify” in R package *clusterProfiler* (Yu *et al.*, 2012) to keep the term with lower P value among all the similar terms. The connected BP terms were then input into the *networkD3* (Allaire *et al.*, 2017) to present the functional module. Gene Set Enrichment Analysis (GSEA) of the comparison group was carried out by analyzing the rank ordered protein list from comparison group (Col+/Col-, *prt6*+/*prt6*-, *prt6*-/Col-), significant BP terms were kept after P value (< 0.05) selection and discarding the redundant BP terms (Yu *et al.*, 2012). Pathifier pipeline was applied to determine the extent to which individual BP terms are deregulated in every individual condition (Drier *et al.*, 2013). Before Pathifier analysis, the selected BP terms extracted from GO annotation data were mapped to ancestor

BP terms by using the function “buildGOMap” to get all the genes included in a specific BP category (Yu *et al.*, 2012). Each BP category included a list of proteins which expression data were available in all samples thus allowing the calculation of a deregulation score (PDS) measuring the deviation of a biological process from a reference condition (Col-).

IV.2.7 Measurements of ABA and GA₄

GA₄ and ABA were extracted from 100 mg dry weight (DW) of dry seeds and seeds incubated for 30 h at 25 °C in the presence or without ethylene at 100 μL L⁻¹. The purification and measurement were performed by LC-ESI-MS based analysis as described in Yano *et al.* (2009). Seeds were frozen in liquid nitrogen, homogenized, freeze-dried and stored at -80 °C until used. Stable isotope-labeled standards (D6-ABA, D2-GA1, D2-GA4) (Olchemim, Olomouc, Czech Republic) were added and hormones were extracted 3 times with 1 ml of 80% (v/v) methanol containing 1% (v/v) acetic acid and dried up in a vacuum. Solid phase extraction with 3 different disposable cartridge column (Waters, Massachusetts, USA), Oasis HLB, WCW and WAX, were used to purify hormone. The resultant samples were then fractionated by HPLC with a C18 column and then subjected to an LC-ESI-MS/MS (Agilent, Santa Clara, California) equipped with a phenyl column. Results are expressed as ng g DW⁻¹ and represent the mean of 3 replicates ± SD.

IV.3 Results and Discussion

IV.3.1 Effects of ethylene treatment on the germination of dormant seeds

At harvest, seeds from both genotypes (Col and *prt6*) were dormant and did not germinate at 25 °C and in darkness (data not shown). Seeds incubation in the presence of ethylene at 100 μL L⁻¹ promoted the germination of Col seeds, while the *prt6* seeds were insensitive to ethylene (Figure 2). Germination of dormant Col seeds occurred after 30 h in the presence of ethylene, and about 55% and 96% of the seed population became able to germinate after 48 and 72 h, respectively. Table 1 showed that breaking of dormancy required at least 24-30 h application of ethylene. When the batch is deeply dormant like that harvested in 2018, only 7% of the seed population can germinate after 16 h of incubation in the presence of ethylene, while a pretreatment of 30 h resulted in 54.6% germination. Seeds

harvested in 2016 which were less dormant, were more sensitive to ethylene, half of the population being able to germinate after 24 h (Table 1). In addition, 30 h incubation in the presence of ethylene contributed to a decrease in ABA in seeds of both Col and *prt6* and an increase in GA₄, being higher in Col than in *prt6* (Table 2). It resulted in a decrease in ABA/GA₄ ratio from 89.69 in air to 5.73 in the presence of ethylene for Col, and from 66.77 in air down to 17.47 with ethylene for *prt6* seeds (Table 2).

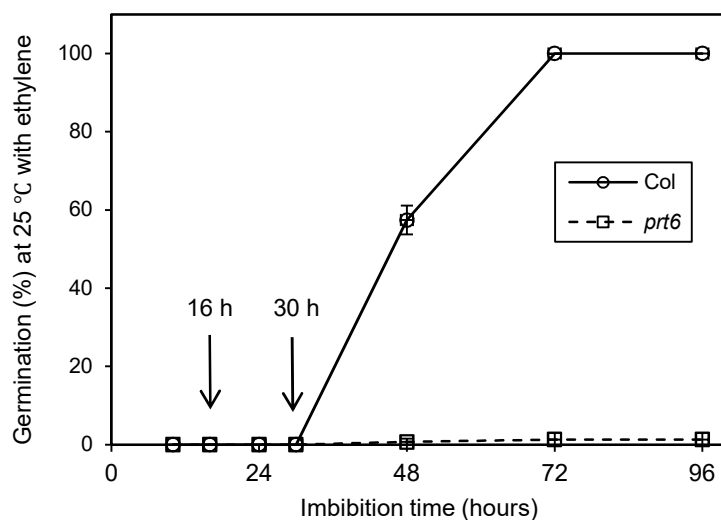

Figure 2. Germination percentages obtained at 25 °C with Col-0 and *prt6* seeds placed directly at 25 °C on the water in the presence of ethylene at 100 $\mu\text{L L}^{-1}$. Means of 3 replicates \pm SD. Seeds harvested in 2016. The arrows indicate the sampling time used for label-free quantitative analysis.

Table 1. Effects of the duration of incubation at 25 °C in the presence of ethylene at 100 $\mu\text{L L}^{-1}$ on subsequent germination of dormant Col seeds after transfer in the air at 25 °C. Means of 3 replicates \pm SD. Seeds harvested in 2016 and 2018.

Duration of seed incubation in the presence of ethylene (h)	Germination (%) after 7 days at 25 °C in the air after ethylene treatment	
	2016 harvest	2018 harvest
0	11.9 \pm 4.0	0
10	39.9 \pm 3.0	-
16	48.3 \pm 4.0	7.7 \pm 7.5
24	54.5 \pm 6.2	21.0 \pm 1.0
30	-	54.6 \pm 4.6
48	61.9 \pm 3.7	81.3 \pm 4.0

Table 2. Effects of 30 h incubation of seeds of Col and *prt6* at 25 °C in the air or in the presence of ethylene at 100 $\mu\text{L L}^{-1}$ on ABA and GA₄ levels and ABA/ GA₄ ratio. Means of 3 replicates \pm SD.

Genotype	Incubation	ABA (ng g ⁻¹ DW)	GA ₄ (ng g ⁻¹ DW)	ABA/GA ₄
Col	Air	43.95 \pm 6.02	0.49 \pm 0.37	89.69
	C ₂ H ₄	6.19 \pm 0.31	1.08 \pm 0.16	5.73
<i>prt6</i>	Air	20.70 \pm 1.87	0.31 \pm 0.19	66.77
	C ₂ H ₄	7.51 \pm 1.79	0.43 \pm 0.14	17.47

IV.3.2 Proteome more affected after 30 h than after 16 h

To identify the global proteomic changes in *prt6* and Col seeds that occurred in response to ethylene, proteome data were collected from dry seeds, and from seeds imbibed for 16 h and 30 h in the presence of ethylene. A total of 1737 proteins were detected across samples from dry and 16h-imbibed seeds and 1002 of them were selected for further quantification analysis by XIC method (Supplementary dataset S1, sheets 1,2). Two factors ANOVA analysis showed that no differentially expressed proteins (DEPs) existed (adjusted P value < 0.05) (Figure 3A). 2552 proteins were identified in 30 h-imbibed seeds and 2202 proteins were remained for further quantification, and 619 proteins showed a significant interaction between genotype and ethylene, indicating that for these proteins the two genotypes responded differently to the presence of ethylene (adjusted P value < 0.05) (Figure 3B) (Supplementary dataset S1, sheets 3,4,5). These results suggested that longer imbibition duration allows to highlight effects of ethylene and genotype. Except that 38 out of 1002 quantified proteins were only present in the 16 h-proteome, all the remaining proteins were also present in the 30 h-proteome (Supplementary dataset S1, sheet 6).

Scatter plots (Figure 3C,D) illustrated that ethylene did not affect the majority of proteins 16 h-imbibed seeds, all the points being located around the center from -1 to 1 (Figure 3C). However, in the 30 h-proteome, it seems obvious that 30 h of imbibition extended the range of log 2 (Col+/Col-) while the range of log 2 (*prt6*+/*prt6*-) were still located from -1 to +1, which suggested that ethylene much more affected the protein profile in Col than that in *prt6* after 30 h of imbibition (Figure 3D). Protein expression level for each replicate were assessed using PCA analysis (Figure 3E,F). In the “dry” and “16 h” proteome, even the first (PC1) and the second primary component (PC2) were lower than 20%, we noticed that *prt6* was more localized in the positive side of PC1 while Col was in the negative

side of PC1. Besides, PC2 was able to separate dry seeds from 16 h-imbibed seeds, but the 4 conditions of imbibed seeds could not be separated as shown by the ellipses were clustered close to each other, indicating that ethylene had weak effect on the proteome up to 16h imbibition (Figure 3E). However, after 30 h of imbibition, the position of each condition presented in different corner of the plot (Figure 3F). It was also shown that the PC1 from 30 h-proteome was 46.8% which was higher than 13.3% from “dry and 16 h” proteome. This presentation indicated again that much more changes were captured after 30 h of seed imbibition. PC1 also shows that ethylene has clearly a larger effect on the proteome in Col than in the one of *prt6* (Figure 3F).

IV.3.3 Effects of ethylene on the expression of DEPs

As shown in Figure 3B, 619 proteins showed genotype/ethylene interaction. Quantification of 619 DEPs on the basis of log XIC values in the four genotype/treatment combinations (Col+, Col-, *prt6*+, *prt6*-) were used to present expression patterns by hierarchical clustering heatmap (Figure 4A). On the one hand, it was revealed that Col+ clustered separately from the remaining ones. The sample clustering fit nicely with the observation that only Col seeds could germinate in the presence of ethylene. On the other hand, the color of each column indicated that ethylene played a stronger effect in Col than that in *prt6*. Tukey analysis (P value < 0.05) and fold change filtering (fold change >1.3 or < 0.7) was then employed to select DEPs that showed significant effect of ethylene in Col and in *prt6* (Supplementary dataset S2). Three hundred and eleven down-regulated and 276 up-regulated DEPs in Col+/Col- were detected compared with 15 down-regulated and 15 up-regulated DEPs in *prt6*+/*prt6*-, respectively (Figures 4B and 4D). In addition, we also observed that there existed genotype difference without ethylene treatment with 23 down-regulated DEPs and 77 up-regulated DEPs (Figure 4C) (Table S1).

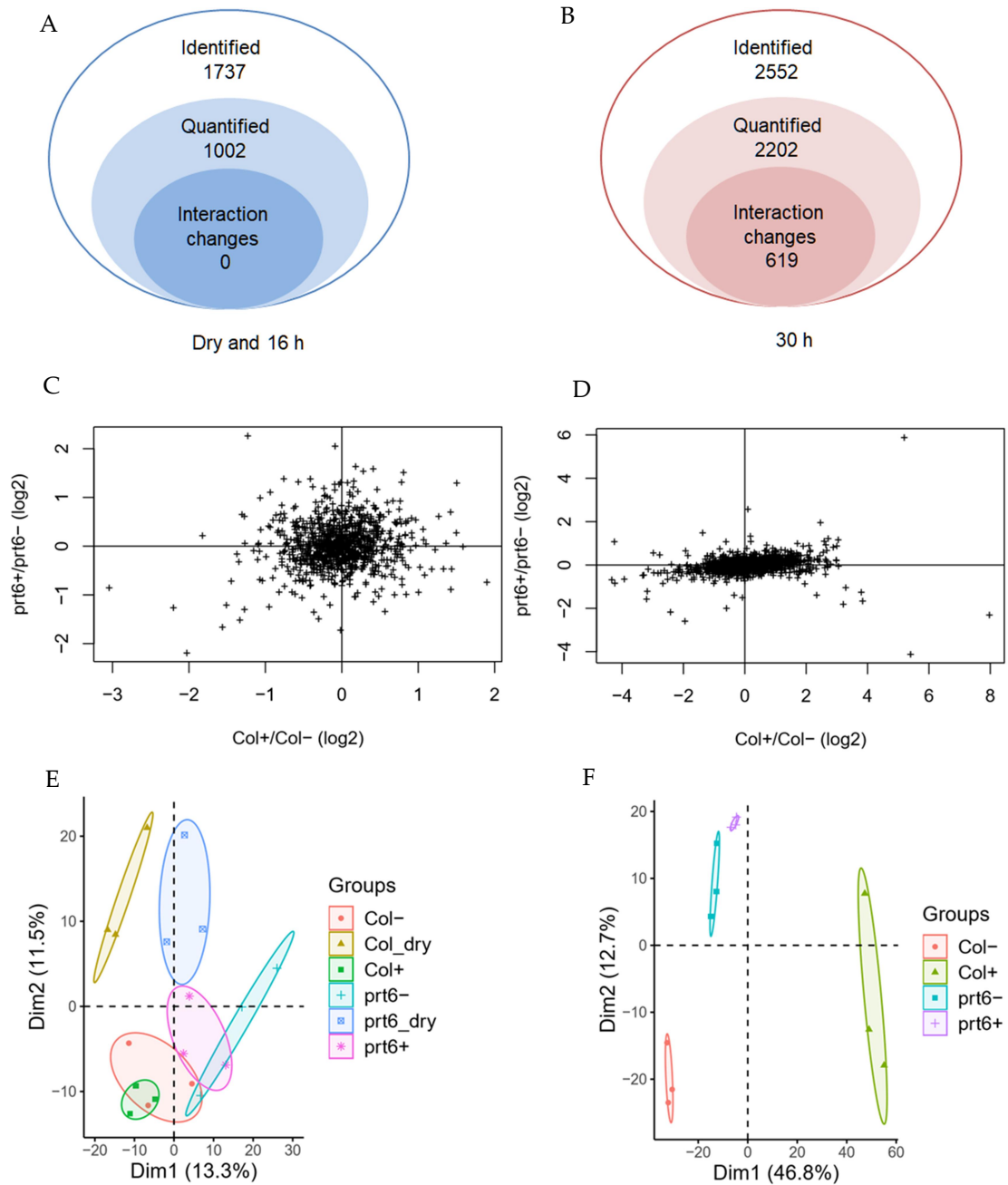

Figure 3. Effects of ethylene on the 16 and 30 h-proteome of Arabidopsis seeds (Col and *prt6*). A, B: The number of identified, quantified and significantly changed proteins in label free quantification by XIC method from seed proteome of dry seeds and 16 h-imbibed seeds (A) and 30 h-imbibed seeds (B). C, D: Scatter plot of the log₂ transformed ratio (Col+/Col- versus *prt6*+/*prt6*-) for 1002 proteins from “dry and 16 h” proteome (C) and 2202 proteins from 30 h-proteome (D), + represents the presence of ethylene treatment, - represents the absence of ethylene treatment. E, F: Principle components analysis (PCA) of the protein quantification for 1002 proteins from “dry and 16 h” proteome (E) and 2202 proteins from 30 h-proteome (F), each dot corresponds to one of the replicates, each circle indicates 95% confidence interval of each condition.

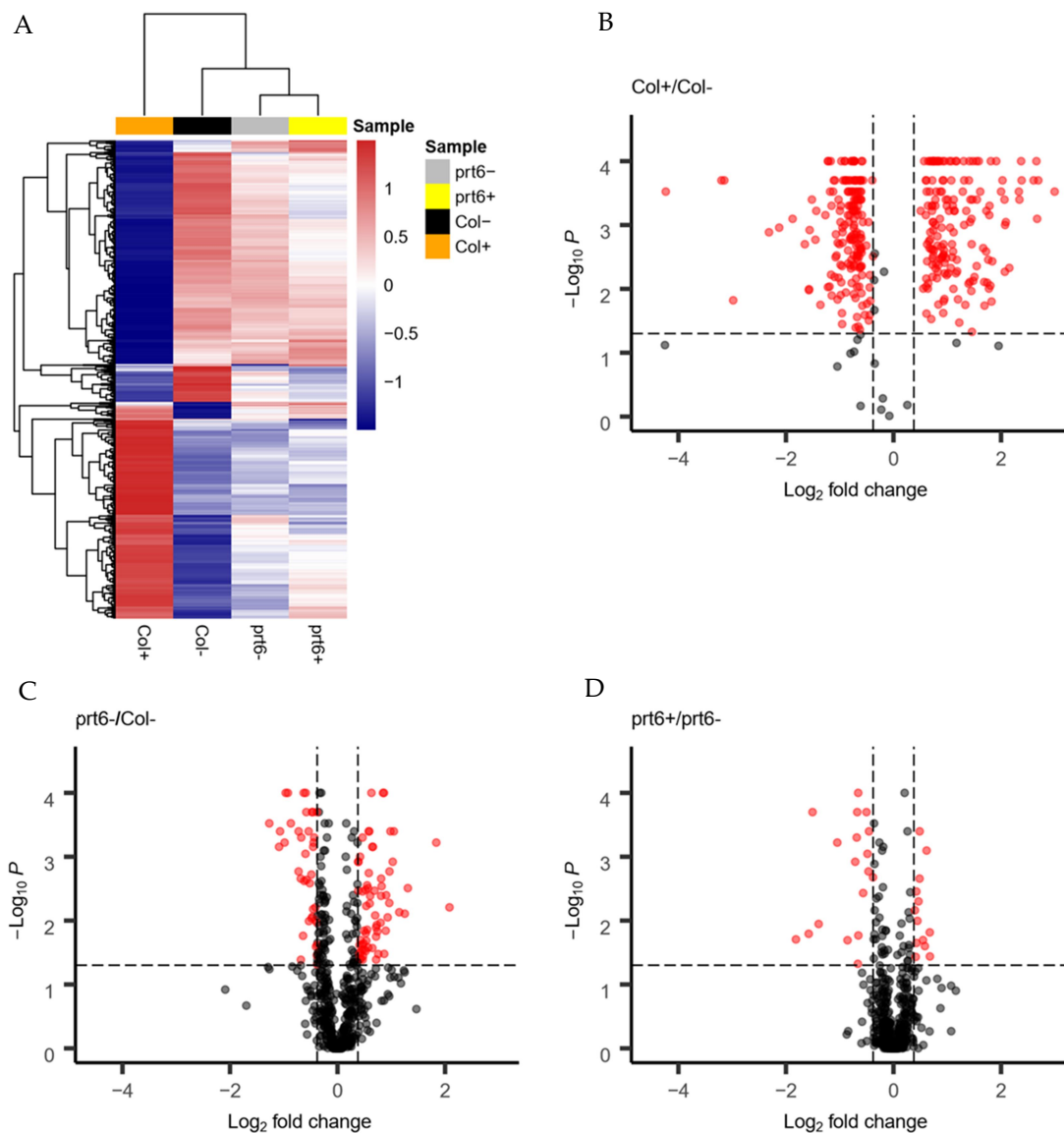

Figure 4. Expression patterns of the 619 DEPs estimated by XIC abundance. A: The hierarchical clustering analysis of the 619 DEPs in Col+, Col-, *prt6+*, *prt6-*. In the heatmap, blue represents down-regulated expression, red represents up-regulated expression and white represents no change in expression. B, C, D: The volcano plots representing the quantitative analysis of 619 proteins in Col+ versus Col- (B), *prt6-* versus Col- (C), *prt6+* versus *prt6-* (D). X-axis and Y-axis presents the log₂ (fold ratio) and -log₁₀ (P) respectively. Red dots mean that the proteins have significant difference ($P < 0.05$, and fold change < 0.7 or fold change > 1.3 , but the threshold of fold change was shown as $|\log_2(\text{fold ratio})| > 0.4$ in the plot), while the black dots correspond to proteins with no significant differences. The horizontal dashed line represents $P = 0.05$, namely, $-\log_{10}(P) = 1.3$. The two vertical dashed lines correspond to $\log_2(\text{fold change}) = 0.4$.

Significant proteins from comparison group Col+/Col- and *prt6+*/*prt6-* were localized in the SeedNet, a transcriptional topological model (Bassel *et al.*, 2011) (Figure 5

A,B). It was revealed that 234 out of 311 down-regulated proteins and 234 out of 276 up-regulated proteins in Col⁺/Col⁻ were included in the SeedNet model (Supplementary dataset S2, sheet 1). As shown in Figure 5A, the down-regulated DEPs were predominantly located within region 1 where genes were associated with dormancy. Conversely, up-regulated DEPs were primarily presented within region 3 where genes were associated with germination. These results indicated that the regulation of the proteins by ethylene in wild-type (Col) seeds was consistent with the general transcriptional regulation related to seed germination. In parallel, 10 out of 15 down-regulated DEPs and 13 out of 15 up-regulated DEPs in *prt6*⁺/*prt6*⁻ were overlapped in the SeedNet (Figure 5B) (Supplementary dataset S2, sheet 2). As shown in the Figure 5B, the up-regulated proteins were located within regions 2 and 3, while the down-regulated proteins were in regions 1 and 3. The Venn graph showed there were 29 common proteins in both groups Col⁺/Col⁻ and *prt6*⁺/*prt6*⁻, which left only one specific protein PHYTOCHROME A (AT1G09570) in *prt6*⁺/*prt6*⁻ decreased with ethylene treatment (Figure 5C). The relative abundance of the 29 common proteins were used to present expression patterns by hierarchical clustering heatmap (Figure 5D). As shown in the gene tree, four clusters were divided depend on the expression profiles. The cluster I illustrated the reduction of protein expressions in Col and *prt6* in the presence of ethylene, while the cluster IV showed that ethylene induced the protein expressions in both samples even the reduction and induction were much more pronounced in Col than that in *prt6*. The cluster II indicated that ethylene stimulated protein expressions of SAD6 (stearoyl-acyl carrier protein 9-desaturase 6, AT1G43800) and an adenine nucleotide alpha hydrolases-like superfamily protein (AT3G03270), but it should be noted that already existed obvious difference between Col⁻ and *prt6*⁻, that is, two proteins were more abundant in *prt6*⁻ than that in Col⁻. The cluster III presented opposite changes with ethylene increasing the expressions of the 5 proteins LDAP2 (lipid droplet associated protein 2, AT2G47780), EXP2 (expasin 2, AT5G05290), GLL22 (GDSL lipase-like protein 22), JLL30 (jacalin-related lectin, AT3G16420) and PYK10 (beta-glucosidase, AT3G09260) in Col, while the five proteins were down-regulated in *prt6* with ethylene treatment. We noticed that the five proteins were also promoted in *prt6* mutant in the absence of ethylene. However, the five mutants germinated as well as Col in the presence of ethylene (data not shown), suggesting that one single gene was not sufficient to affect seed responsiveness to ethylene.

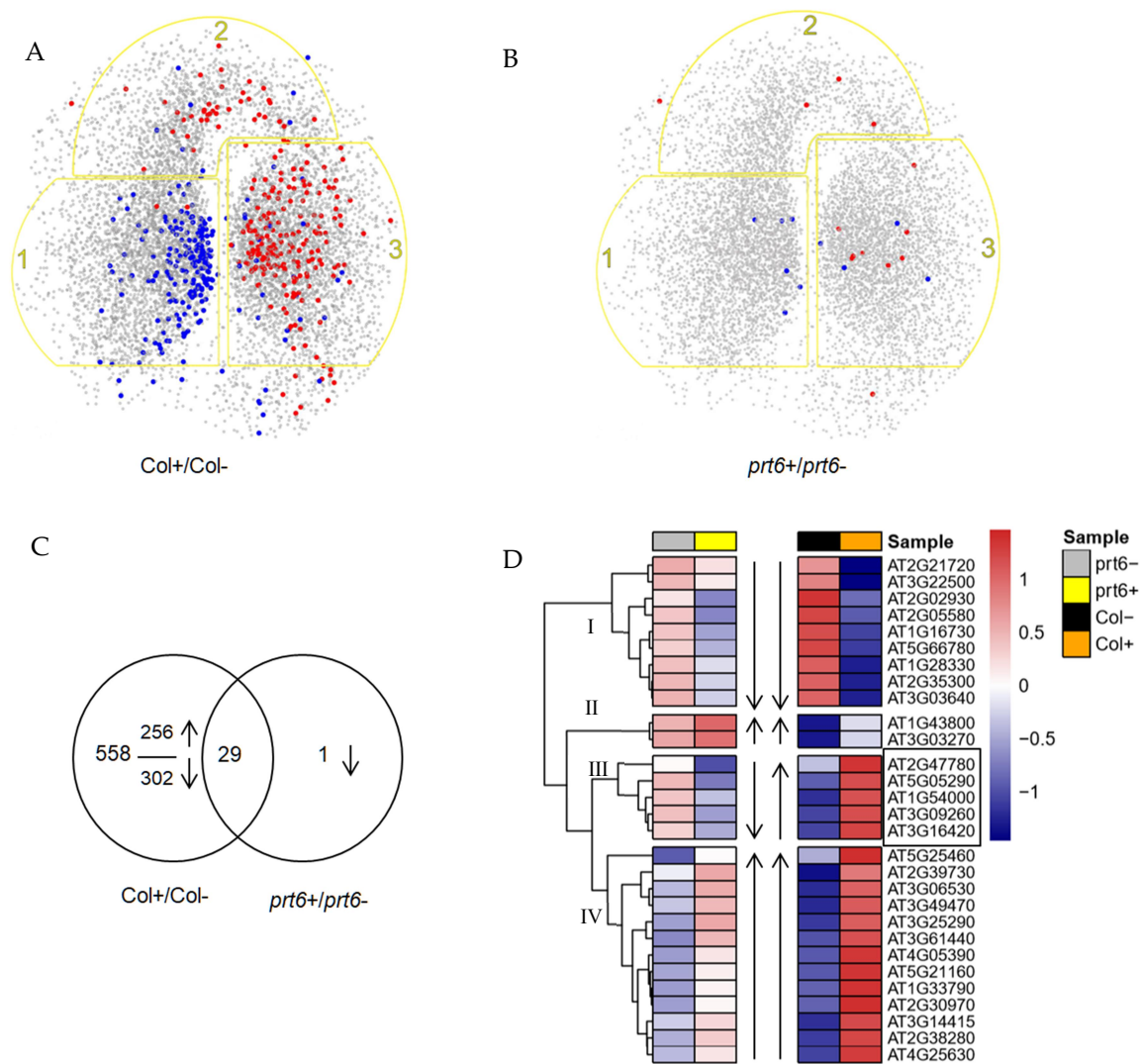

Figure 5. Classification of DEGs from comparison group Col+/Col- and *prt6+*/*prt6-*. A,B: Localization of the DEPs from group Col+/Col- (A) and *prt6+*/*prt6-* (B) in the SeedNet gene co-expression network, region 1,3 and 2 outlined in yellow represented genes associated with seed dormancy, seed germination and dormancy-germination transition, respectively. Red dots and blue dots represent the down and up-regulated proteins in corresponding group. C: Venn diagram analysis showing the common and specific proteins in group Col+/Col- and *prt6+*/*prt6-*, the up and down-arrow indicate up and down-regulated proteins, respectively. D: The hierarchical clustering analysis of the 29 common DEPs in Col+, Col-, *prt6+*, *prt6-*. The top bars show the clustering of the different samples grey, yellow, black and orange represent *prt6-*, *prt6+*, Col- and Col+, respectively. In the heatmap, blue represents down-regulated expression, red represents up-regulated expression and white represents no change in expression. The inner arrows represent the effect of ethylene on *prt6* and Col with showing up-arrow if fold change ratio (Col+/Col- or *prt6+*/*prt6-*) < 1, down-arrow if fold change ratio (Col+/Col- or *prt6+*/*prt6-*) > 1. Gene trees were divided into 4 clusters indicated by I, II, III, IV.

GO enrichment analysis, especially biological process was performed to interpret the functional module of DEPs. Down and up-regulated DEPs in Col+/Col- group were separated to launch the analysis. As shown in Figure 6, the network of biological process enrichment analysis indicated that down-regulated proteins were enriched in the seed development and dormancy, secondary metabolic process, glutathione metabolism, various responsive processes, such as the response to ABA, lipid, water, light, heat and H₂O₂. While the up-regulated proteins were enriched in amino acids biosynthetic process, gene expression and protein metabolism, RNA modification, lipid catabolic process and also some responsive processes, such as response to ABA, alcohol and so on. To sum up, the signal perception and transduction from down and up-regulated proteins, the energy mobilization from up-regulated proteins, new material generation from up-regulated proteins and some other assisting process work together to contribute to seed germination of Col seeds.

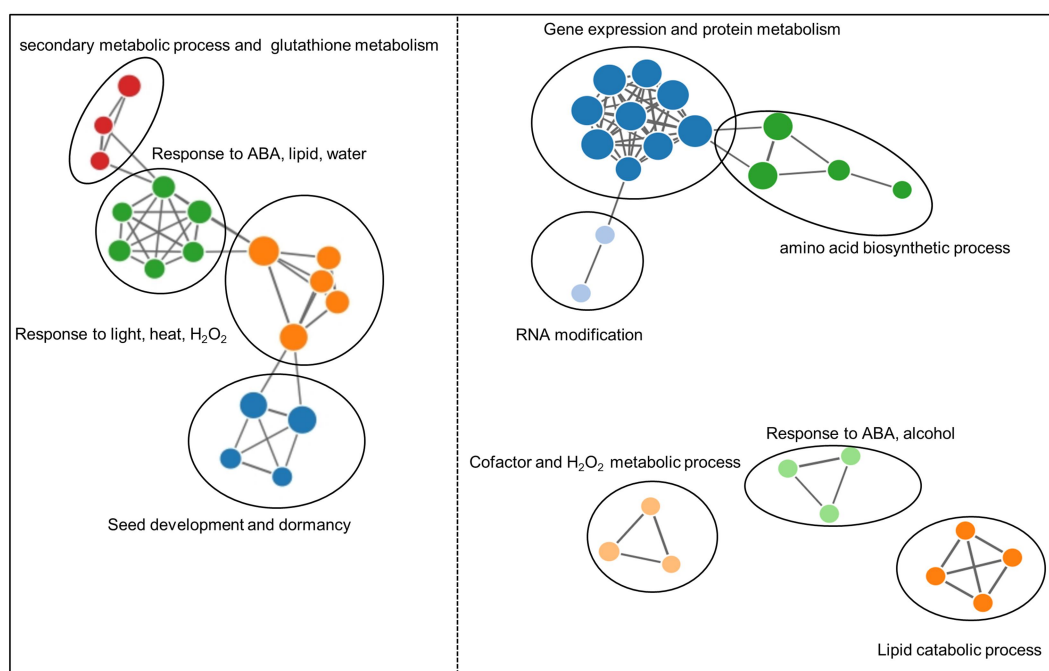

Figure 6. Enrichment map organizing enriched terms of biological process from DEPs in Col+/Col- into a network with edges connecting overlapping gene sets. The left part represent enrichment map from down-regulated proteins in Col+/Col-, while the right part represent enrichment map from up-regulated proteins in Col+/Col-. Each node corresponds to significant biological process, and the size of the node indicates gene numbers in each set, while the edge connects the overlapping gene set. Distinct color are given to different clusters calculated by walktrap community finding algorithm (Csardi and Nepusz, 2006; Allaire *et al.*, 2017).

IV.3.4 Effect of *prt6* on the expression of DEPs after 30 h

As shown in Table S1, 100 DEPs were selected in group *prt6*⁻/Col⁻. These proteins were classified manually since gene ontology terms were uninformative. Three proteins encoded by “core hypoxia” genes characterized by transcriptionally up-regulation in hypoxia condition (Mustroph *et al.*, 2009), were also increased in *prt6*⁻ mutant, among which, the protein expression of HB1 (hemoglobin 1) and SAD6 (stearoyl-acyl-carrier-protein desaturase family) were 20 times higher in *prt6*⁻ than that in Col⁻. In addition, we noticed that several proteins involved in nucleobases synthesis, transcription, translation, protein modification and transport were moderately improved in *prt6*⁻, most of which showing less than 2 times increase. Three seed storage proteins LEAs were found with less abundance in *prt6*⁻ compared to Col⁻. Other proteins involved in ABA synthesis, such as AO4 (aldehyde oxidase 4) with reduced abundance in *prt6*⁻; involved in ethylene synthesis, such as MTO3 (S-adenosylmethionine synthetase), MAT3 (methionine adenosyltransferase 3) with induced abundance.

Table 3. Classified DEPs from comparison group *prt6*⁻/Col⁻. Except for 19 proteins which were miscellaneous, 81 out of 100 significant proteins in group *prt6*⁻/Col⁻ were shown below.

ID	Description	<i>prt6</i> ⁻ /Col ⁻
Hypoxia-responsive		
AT1G19530	DNA polymerase epsilon catalytic subunit A	1.64
AT2G16060	Hemoglobin 1	18.74
AT1G43800	Plant stearoyl-acyl-carrier-protein desaturase family protein	21.64
Carbohydrate metabolism		
AT4G33820	Glycosyl hydrolase superfamily protein	0.39
AT5G63800	Glycosyl hydrolase family 35 protein	0.48
AT3G09260	Glycosyl hydrolase superfamily protein	5.78
AT1G53580	Glyoxalase II 3	1.52
AT4G34260	1,2-alpha-L-fucosidase	0.70
AT5G26120	Alpha-L-arabinofuranosidase 2	0.65
AT4G15210	Beta-amylase 5	1.98
AT4G36360	Beta-galactosidase 3	0.60
AT5G49360	Beta-xylosidase 1	1.51
AT1G02640	Beta-xylosidase 2	1.47
AT5G57550	Xyloglucan endotransglucosylase/hydrolase 25	0.47
AT2G47510	Fumarase 1	1.30
AT1G12780	UDP-D-glucose/UDP-D-galactose 4-epimerase 1	1.57
AT2G39730	Rubisco activase	1.80
Cell wall		
AT1G19900	Glyoxal oxidase-related protein (involved in cell wall modification)	0.51
AT5G15490	UDP-glucose 6-dehydrogenase protein (required for the formation of cell wall ingrowths)	1.47
AT5G05290	Expansin A2	4.24
AT3G14310	Pectin methylesterase 3	1.32
Oxidation and reduction		
AT3G61070	Peroxin 11E (integral to peroxisome membrane, controls peroxisome proliferation)	1.34

AT2G46750	D-arabinono-1,4-lactone oxidase activity	0.51
AT3G14415	Aldolase-type TIM barrel family protein (modulates ROS-mediated signal transduction)	1.95
AT4G35000	Ascorbate peroxidase 3	1.67
AT4G20860	FAD-binding Berberine family protein (involved in the generation of H ₂ O ₂)	0.53
AT2G02930	Glutathione S-transferase F3	0.52
AT2G30870	Glutathione S-transferase PHI 10	1.95
AT2G47730	Glutathione S-transferase phi 8	2.14
AT5G66920	SKU5 similar 17 (oxidation-reduction process)	1.63
AT3G27820	Monodehydroascorbate reductase 4	1.83
AT1G60680	NAD(P)-linked oxidoreductase superfamily protein	0.66
AT3G44880	Pheophorbide a oxygenase family protein with Rieske 2Fe-2S domain-containing protein	1.38
AT5G63030	Thioredoxin superfamily protein	0.67
Transcription		
AT5G02490	Heat shock protein 70 (HSP 70) (mediator of RNA polymerase II transcription subunit	1.38
AT4G25630	Ibbrillarin 2 (Mediator of RNA polymerase II transcription subunit 36a)	1.45
AT3G08030	DNA-directed RNA polymerase subunit beta	1.77
AT3G03270	Adenine nucleotide alpha hydrolases-like superfamily protein	7.91
AT1G74260	Purine biosynthesis 4	1.61
AT3G57610	Adenylosuccinate synthase (purine synthesis)	1.50
AT2G45300	RNA 3'-terminal phosphate cyclase/enolpyruvate transferase%2C alpha/beta	1.80
AT3G52150	RNA-binding (RRM/RBD/RNP motifs) family protein	1.37
AT3G19130	RNA-binding protein 47B	1.86
AT5G63420	RNA-metabolising metallo-beta-lactamase family protein	1.34
AT3G58510	DEA(D/H)-box RNA helicase family protein	1.31
Translation		
AT4G01310	Ribosomal L5P family protein	1.35
AT5G23900	Ribosomal protein L13e family protein	1.38
AT3G63490	Ribosomal protein L1p/L10e family	1.44
AT1G50920	Nucleolar GTP-binding protein (Involved in the biogenesis of the 60S ribosomal subunit)	1.57
ATCG00830	Ribosomal protein L2	1.67
AT2G33800	Ribosomal protein S5 family protein	1.67
AT1G32990	Plastid ribosomal protein I11	1.91
AT2G40290	Eukaryotic translation initiation factor 2 subunit 1	1.39
AT3G56150	Eukaryotic translation initiation factor 3C	1.74
AT4G20360	RAB GTPase homolog E1B (Elongation factor Tu)	1.55
Protein folding		
AT3G13470	TCP-1/cpn60 chaperonin family protein (protein folding)	1.49
AT1G56340	Calreticulin 1a (Molecular calcium-binding chaperone promoting folding)	2.38
AT1G09210	Calreticulin 1b (Molecular calcium-binding chaperone promoting folding)	2.07
AT3G09440	Heat shock protein 70 (HSP70) (mediate the folding of newly translated peptides)	1.48
AT1G55490	Chaperonin 60 beta (suppressing protein aggregation in vitro)	1.34
AT3G16420	PYK10-binding protein 1 (chaperone that facilitates the correct polymerization of PYK10)	4.71
Protein transport		
AT4G10480	Nascent polypeptide-associated complex (NAC) 2C alpha	1.50
AT3G49470	Nascent polypeptide-associated complex subunit alpha-like protein 2	1.40
AT3G15980	Coatomer subunit beta -3	1.44
AT3G46830	RAB GTPase homolog A2C	1.44
Protein modification		
AT4G17040	CLP protease R subunit 4	1.38
AT2G47390	Prolyl oligopeptidase family protein	1.46
AT2G38280	AMP deaminase%2C putative / myoadenylate deaminase	1.34
AT3G45010	Serine carboxypeptidase-like 48	3.57
AT5G10240	Asparagine synthetase 3	1.45
AT5G11880	Pyridoxal-dependent decarboxylase family protein	1.33
AT1G61790	Oligosaccharyltransferase complex/protein N-linked glycosylation	1.41
AT1G48630	Receptor for activated C kinase 1B (shuttle activated protein kinase C)	2.04
AT3G18130	Receptor for activated C kinase 1C (shuttle activated protein kinase C)	1.66
AT1G25490	ARM repeat superfamily protein (encoding phosphoprotein phosphatase)	1.69
LEAs		
AT3G22500	Seed maturation protein (LEA protein)	0.63
AT3G51810	Stress induced protein (LEA protein)	0.69
AT5G66780	Late embryogenesis abundant protein	0.55

Hormone		
AT1G04580	Aldehyde oxidase 4 (ABA synthesis)	0.61
AT3G17390	S-adenosylmethionine synthetase family protein (ethylene synthesis)	2.45
AT2G36880	Methionine adenosyltransferase 3 (ethylene synthesis)	1.50

IV.3.5 Functional class scoring analysis without filtering DEPs in 30 h proteome

Because of the low variance in comparison group, especially in *prt6+prt6-*, less DEPs were achieved after cut-off selection, so over representation analysis failed to give us informative result. GSEA (gene set enrichment analysis) (Subramanian *et al.*, 2005) and Pathifier (Drier *et al.*, 2013) were then used to address this limitation and give us the affected expression profile. The subtle but coordinated changes in the group *prt6+prt6-* were captured by GSEA analysis (Figure 7). Most of the up-regulated BP terms were enriched in protein synthesis, transport, localization and modification. Curiously, some BP terms related to tissue development or morphogenesis (class 2, Figure 7) were stimulated in the presence of ethylene, but at the same time, BP terms involved in development growth (class 5, Figure 7) were inhibited in the presence of ethylene. It suggested that BP terms in class 5 might partially led to the dormancy of *prt6* when treated with ethylene. In parallel, GSEA analysis was also carried out in *Col+Col-* group to compare the different effect of ethylene on *prt6* and *Col* (Figure S1A). It seems that lipid transport and localization, response to hydrogen peroxide were down-regulated in both groups. However, some BP terms such as, fatty acid oxidation, lipid biosynthetic process, mitochondrial transport, hormone biosynthetic process coenzyme biosynthetic process and so on, were specific in the *Col+Col-*, which contributed to diversity and complexity of the affected BP categories. It was shown that even without ethylene treatment, the genotype effect had revealed some distinct BP terms (Figure S1B). It was surprising that the suppressed lipid localization was universal in the 3 comparison groups.

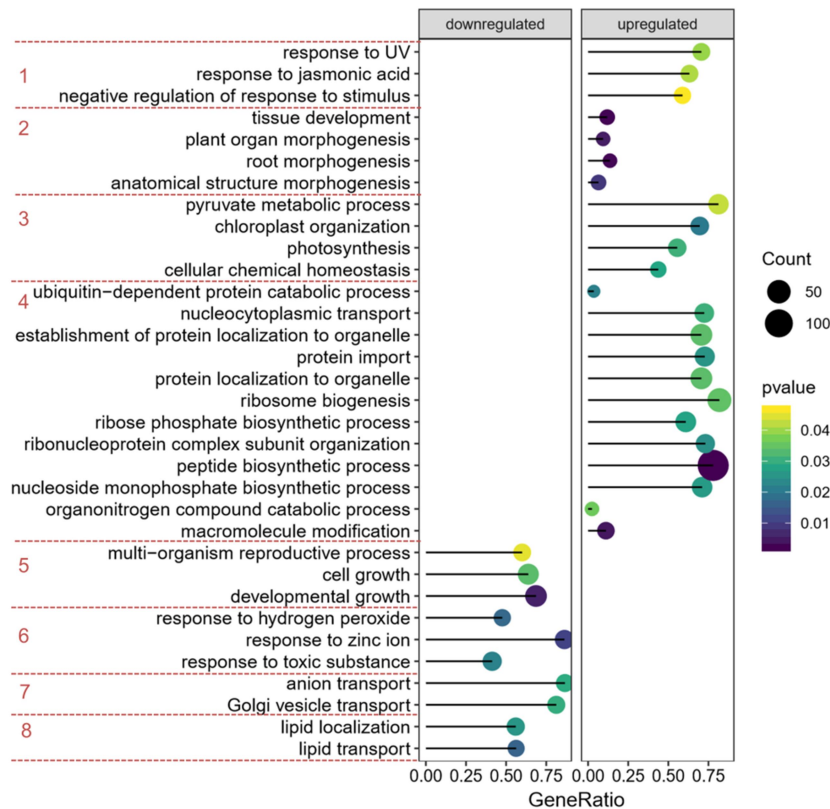

Figure 7. Dot plot of enriched BP terms in *prt6*⁺/*prt6*⁻ determined from GSEA results. The size of the dot represents count of the core proteins in each set, the color represents P value, and generatio represents the number of core genes in gene set/the total number of genes in this genes set. The enriched BP terms were classified into several groups depending on functional connection and similarity, that is, class 1, response to stimuli; class 2, plant morphogenesis; class 3, energy metabolism; class 4, protein synthesis, localization and modification; class 5, development growth; class 6, response to stimuli; class 7, anion and Golgi transport; class 8, lipid transport and localization.

Considering that GSEA evaluated the involvement of biological process without judging the significance of the included proteins before analysis because all the proteins in the comparison group were taken into consideration, but the inclusion of important BP terms was still determined by P value cutoff. As occurred in Figure 7 and Figure S1A, the presence of lipid localization in both graphs could not be concluded which one (*Col* or *prt6*) was more affected by ethylene concerning this BP term. Therefore, Pathifier analysis was chosen to give us a quantified deregulation level of a specific biological process pathway. Hormone regulation, protein metabolism (folding, localization), molecule transport, development growth and response to hypoxia were selected to perform Pathifier analysis with *Col*⁻ acting as reference. As shown in Figure 8A, Pathifier successfully discriminate dormant and non-

dormant seeds. Among the 4 samples, only Col+ possessed germination potential, which PDS values of each BP category were particularly higher than that in the other 3 samples. Secondly, indeed, some biological processes were deregulated between Col- and *prt6*-, and especially the BP term, response to hypoxia, which was much more affected than the other ones. As shown in Figure 8B, the PDS value of response to hypoxia in Col- and *prt6*- were 0.011 and 0.74, respectively. In addition, with the treatment of ethylene, response to H₂O₂, response to stress were also deregulated in *prt6* to some degree, but the inductive effect could not be compared with the changes observed in Col in the presence of ethylene (Figure 8B).

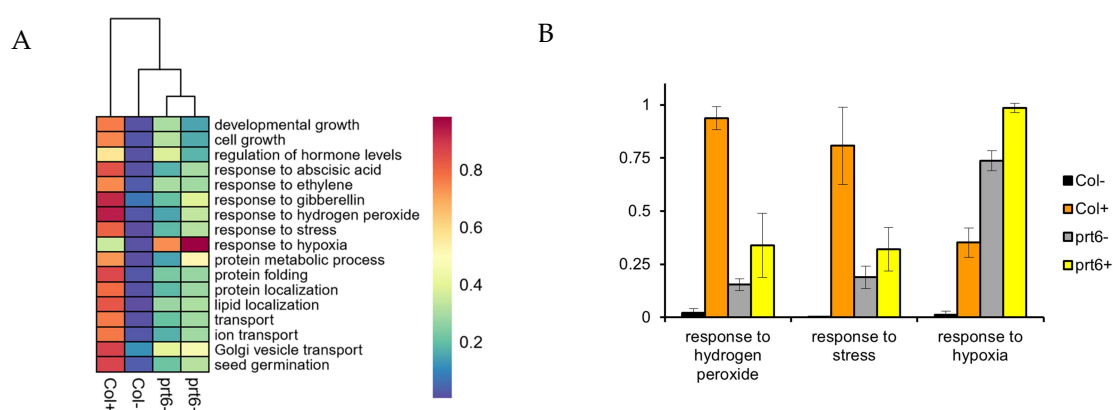

Figure 8. Individual pathway deregulation scores (PDS) of the selected biological process in 4 conditions showing by heatmap clustering (A) and bar plot (B). In the heatmap, blue to red represents the PDS score from low to high.

IV.3.6 Abundant proteins in seed

Abundantly expressed proteins in seeds such as, seed storage proteins (SSPs), late embryogenesis abundant proteins (LEAs) and oleosins were selected to compare their changes in expression as related to ethylene treatment or the genotype. In 30 h-proteome, 47 abundant proteins were identified while in 0 and 16 h-proteome, the quantity was only 36, all of which being present after 30 h-proteome (Supplementary dataset S3). The common 11 SSPs in dry seeds, 16 and 30 h-imbibed seeds, and their expression ratios (*prt6*-/Col-) (Table 4) showed that cruciferin A (AT5G44120.3) and 2S albumins (AT4G30880) were mostly at a higher level in *prt6* in dry seeds, suggesting that N-end rule pathway was involved in the stabilization of some seed storage proteins during seed development. After 16 h of imbibition,

all the SSPs were slightly higher in *prt6*, but after 30 h, most of which ratio were lower than 1, indicating that during seed imbibition, the N-end rule affected the mobilization of SSPs.

Table 4. The protein expression ratios (*prt6*⁻/*Col*⁻) of SSPs in dry seeds, and in seeds imbibed for 16, 30 h.

Locus	Description	0	16	30
AT5G44120.3	Cruciferin A	1.44	2.73	0.56
AT5G44120.1	Cruciferin A	1.13	1.74	0.88
AT1G03880	Cruciferin B	1.12	1.43	0.81
AT4G28520	Cruciferin C	1.00	1.04	0.73
AT4G30880	2S albumin	1.59	1.42	0.90
AT3G22640	Cupin	0.97	1.14	0.73
AT1G07750	RmlC-like cupins	0.73	1.65	1.05
AT4G36700	RmlC-like cupins	0.77	1.19	0.81
AT1G03890	RmlC-like cupins	0.85	1.01	0.75
AT2G28490	RmlC-like cupins	0.94	1.09	0.83
AT2G18540	RmlC-like cupins	1.07	1.17	0.85

In 30 h-proteome, the effect of ethylene was also compared between wild type and *prt6* mutant. It was shown that general ratios of *Col*⁺/*Col*⁻ was much lower than that of *prt6*⁺/*prt6*⁻ (Supplementary dataset S3, sheet 2), indicating that mutation of N-end rule inhibited the degradation of SSPs, LEA and oleosins in the presence of ethylene.

IV.3.7 Hormone-related proteins in seed

Proteins participating in hormone synthesis or hormone signaling were obtained from proteomic data. It was known that the sequence of ethylene biosynthesis pathway was: methionine → S-adenosylmethionine → ACC → ethylene (Wang *et al.*, 2002). Four proteins involved in the ethylene synthesis were presented: MTO3 (S-Adenosylmethionine Synthase 4), MAT3 (Methionine Adenosyltransferase 3) and SAM (S-Adenosylmethionine Synthetase 1) which catalyzed the formation of S-adenosylmethionine, and ACO (ACC oxidase) which oxydized ACC in ethylene. As shown in Figure 9, ethylene significantly induced the protein expression of MTO3 and MAT3 in *Col*. The quantification of ACO and SAM were also improved to some degree in *Col* even they failed the ANOVA analysis. However, ethylene did not make a marked induction of the 4 proteins in *prt6*. AO4 (Aldehyde Oxidase 4) catalyzed the final steps of carotenoid catabolism and it is a key enzyme in the ABA biosynthesis, while PYR (Pyrabactin Resistance) acted as one of the receptors of the hormone (Melcher *et al.*, 2010; Colasuonno *et al.*, 2017). Similarly, as the changes of ethylene

components observed in *prt6*, we noticed that no statistically difference of AO4, PYR between *prt6*⁻ and *prt6*⁺. However, ethylene dramatically increased the protein abundance of PYR, and decreased the protein abundance of AO4 in Col. Decrease in AO4 could explain the decrease in endogenous ABA in Col seeds when treated with ethylene (Table 2). It was curious that in Col, ethylene induced protein abundance of PYR, which was involved in seed dormancy (Ng *et al.*, 2014).

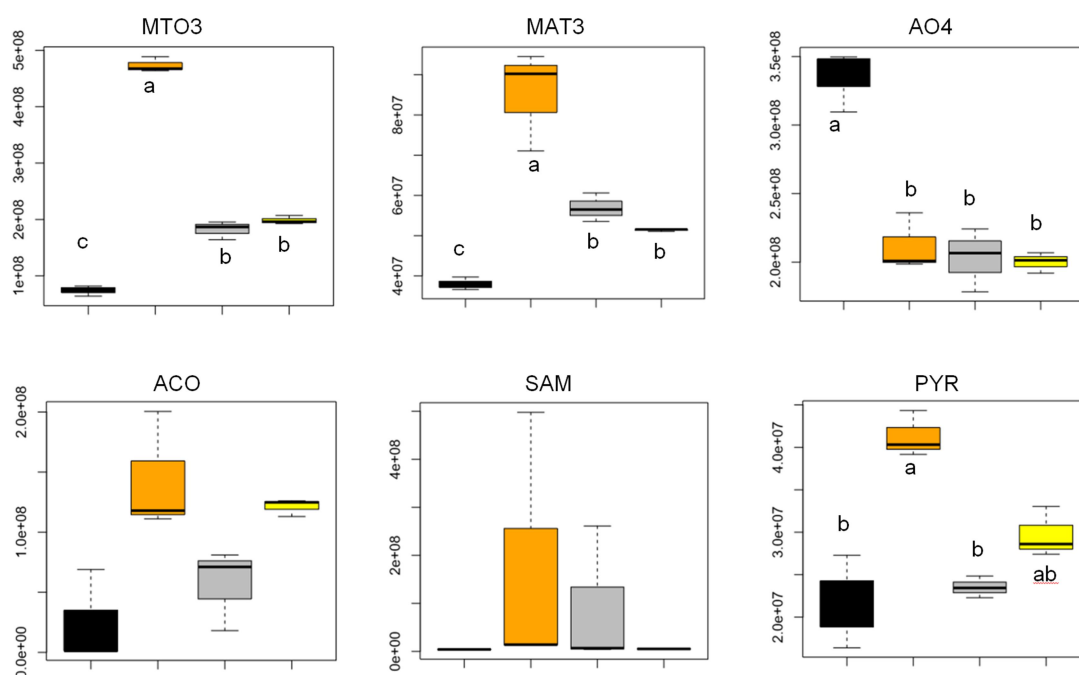

Figure 9. Quantification of the proteins involved in the hormone synthesis and signaling in 4 samples, Col⁻ (black), Col⁺ (orange), *prt6*⁻ (grey), *prt6*⁺ (yellow). Significant levels were only shown on the proteins which passed the 2 factors ANOVA analysis and have interaction effects.

IV.4 Discussion and conclusion

In the present work, protein functional analysis was performed using 2 classes of tools. Firstly, over-representation analysis was carried out using the defining DEPs produced with a cutoff. However, over-representation could not be powerful if we meet gene-sets containing low frequencies of DEPs, like our comparison group *prt6*⁺/*prt6*⁻. The second class of tool such as GSEA, acted as a complementary method which could catch small but consistent changes in a set of and, then yielded the affected categories. Because of the slightly different input and analysis algorithms, it is normal that there will be some differences of the enriched

categories with the 2 enrichment analyses (Yang *et al.*, 2008; Hong *et al.*, 2014). Furthermore, Pathifier belonging to the second class was also employed to improve the depth and breadth of our study.

It was reported that compared to leaf proteome or entire plant proteome, the general categories like seed storage proteins, cell rescue, cell defense, protein fate, were over-represented in seed proteome (Galland *et al.*, 2012). For this reason, several selected GO terms like response to stress, protein folding, protein transport, protein metabolism were included in the Pathifier analysis (Figure 8). At the same time, seed storage protein analysis were launched by filtering all these proteins and compare their exact value (Table 4 and Supplementary dataset S3). One BP term, response to hypoxia, was also taken into the Pathifier analysis, given that the effect of the N-end rule coordinated with oxygen sensing in the regulation of seedling survival or roots growth under hypoxia (Licausi *et al.*, 2010; Gibbs *et al.*, 2011; Licausi *et al.*, 2011; Sasidharan and Mustroph, 2011; Bui *et al.*, 2015; Gibbs *et al.*, 2015; Gasch *et al.*, 2016). This would fit nicely with our result that, there existed significant difference in PDS score of response to hypoxia, between *prt6*⁻ and Col⁻, meaning that many proteins involved in this process were changed in *prt6* mutant seeds (Figure 8B). Pathifier analysis quantified the deregulation level of a specific pathway in the tested condition compared with the control condition, but it failed to tell us the direction of this variation in comparison with control, that is, up-regulation or down-regulation. However, GSEA analysis was specialized to tell the positions of core genes in a significant functional category from a ranked list, which could meet the requirement to a certain degree (Figure 7 and Figure S1). For example, GSEA visualization plot of the BP category, lipid localization in the group *prt6*⁻/Col⁻ showed that the leading edge gene set presented in the bottom of the ranked list, which suggested that this category was mostly suppressed in *prt6*⁻ mutant (Figure S2). As shown in Table S2, all the members involved in lipid localization in 30 h-proteome were collected, which consisted of different classes of proteins, such as oleosins, lipid transfer proteins or some other binding proteins. It was shown that the reduced protein levels predominated through the list (Table S2). Considering that more than half of the proteins here were storage proteins or oleosins, it was logical that they were degraded and worked as energy support. In this case, it seems that we need much more carrier proteins or transfer proteins to transport the “cargo”, but in the Table S2, only 3, 4 aiding proteins increased. The

predominance of the down-regulated proteins in this category might result from the lower abundance of the transferring proteins. In the over representation analysis of DEPs in Col⁺/Col⁻, we also find some BP terms concerning lipid metabolism, but which was more related to lipid catabolic process and fatty acid beta-oxidation (Figure 5). It was also interesting for oleosins and oil body associated proteins, most of which ratios in Col⁺/Col⁻ were generally lower than the ratio in *prt6*⁺/*prt6*⁻ (Table S2 and Supplementary dataset S3, sheet 2), indicating that in the presence of ethylene, the N-end rule mutation impaired the oil body metabolism, as the same phenotype occurred in mutant seedlings (Holman *et al.*, 2009; Zhang *et al.*, 2018b).

Seed storage proteins (SSPs) accumulated during seed development and could work as substrates for early stage of seed germination. SSPs are the most abundant part in total seed proteome and the presence of SSPs reduces the sensitivity to detect other low abundant proteins in seeds. In our study, we demonstrated that the N-end rule pathway could slightly regulate the accumulation or stabilization of SSPs during seed development or seed imbibition (Table 4). In addition, a preliminary conclusion could be drawn that the insensitivity of *prt6* seeds to ethylene might be related to the inhibited SSPs mobilization after 30 h (Supplementary dataset S3, sheet 2). It was reported that there were increased abundance of seed storage proteins, especially cruciferins in *prt6* etiolated seedlings (4 d under green light) (Zhang *et al.*, 2018a). Whereas, Choy *et al.* (2008) reported that transcript abundance of genes encoding seed storage proteins, oleosins, and late embryogenesis abundant and (LEA) proteins, were much lower in *ged1* (*prt6* mutant allele) seedlings (5 d in the dark followed by 2 d in the light). The opposite changes of seed storage proteins in transcript level and protein level might be due to the sufficient proteins in *prt6* mutant that did not require large quantities of de-novo transcripts. It might also result from the different condition of light in the 2 studies, as reported that N-end rule coordinated with light perception regulate seedling establishment after germination (Abbas *et al.*, 2015).

It was well documented that seed germination and dormancy was regulated via a crosstalk of ABA, GAs and ethylene, which hormone synthesis and signaling pathway could interact with each other to control seed dormancy (Finch-Savage and Leubner-Metzger, 2006; Matilla and Matilla-Vázquez, 2008; Arc *et al.*, 2013; Corbineau *et al.*, 2014; Finch-Savage and Footitt, 2017). Breaking of seed dormancy by exogenous ethylene was associated with an

activation of its own responsive genes as well as the regulation of hormonal balance ABA and GA (Linkies *et al.*, 2009; Corbineau *et al.*, 2014; Liu *et al.*, 2016) (Table 2). Here, the Pathifier analysis was carried out and gave us the deregulation score of seed sensitivity to hormones (Figure 8A and Figure S3). The PDS scores of Col⁺ were significantly higher than that of Col⁻ (Figure S3). In contrast, with the treatment of ethylene, the PDS scores of response to the three hormones did not show a dramatic increase (Figure S3). Particularly, almost no difference in PDS score of response to ethylene between *prt6*⁻ and *prt6*⁺, indicating that the related proteins in this category were reluctant to move in the presence of ethylene. Proteins related to ethylene synthesis such as, MTO3, MAT3, ACO and SAM, were enhanced in Col in the presence of exogenous ethylene, which was in agreement with Liu *et al.* (1999) that exogenous ethylene induce the endogenous ethylene biosynthesis (Figure 9). Besides, there is a negative interaction between ethylene and ABA in seed germination (Arc *et al.*, 2013; Corbineau *et al.*, 2014). In Col, exogenous ethylene decreased ABA level and the protein abundance of AO4, which was involved in ABA synthesis (Table 3 and Figure 9). Surprisingly, the protein level of PYR were stimulated by ethylene in Col, but considering that ethylene could suppress ABA signaling (Beaudoin *et al.*, 2000), we speculated that the higher abundance of PYR might be inactivated (Castillo *et al.*, 2015), or the less production of ABA in the presence of ethylene could also limit its binding with receptors. At the same time, we also measured the endogenous ABA/GA₄ ratio which was higher in *prt6* than in Col in the presence of ethylene (Table 2).

The N-end rule identified peptides to be degraded through proteasome by the N-terminal residues (Bachmair *et al.*, 1986). Considering that the diversity of generation methods of neo-N-termini, the targets of the N-end rule pathway was only achieved in the pre-pro-protein, while in plants, they are ERFVII proteins, all of which were starting with Met-Cys (Gibbs *et al.*, 2011). In our study, 100 proteins were significantly accumulated in *prt6* mutant at 30 h (Table 3, Supplementary S2). All amino acids sequence of the 100 proteins were retrieved from database to identify new putative substrates among Nt Met-Cys proteins. It showed that only one protein ASN3 (Asparagine Synthetase 3, AT5G10240) was the potential one, which was also suggested by Majovsky *et al.* (2014) with increased abundance in both *ate1 ate2* seedlings and *prt6* seedling. To date, several transcriptomic or proteomic analysis of the effect of the N-end rule by using the related mutant *prt6* or *ate1 ate2*

samples have been published (Choy *et al.*, 2008; Gibbs *et al.*, 2011; Majovsky *et al.*, 2014; Zhang *et al.*, 2015; Zhang *et al.*, 2018a). As shown in the Supplementary Dataset S4, there were few proteins being overlapped, suggesting the difference of protein abundance between seedlings and seeds. Though Gibbs *et al.* (2011) included imbibed *prt6* seeds, the different imbibition duration and different statistical method might also contributed to less DEPs in common. It was shown AT2G16060 (Hemoglobin 1) presented across all the published data.

Here, *prt6* mutation was connected with ethylene signaling, which was a novel cut to deeply study the effect of the N-end rule pathway in seed dormancy. In the future study, much more attention should be paid to the transcriptomic changes of *prt6* imbibed seeds and the involvement of ERFVIIIs in the insensitivity of *prt6* to ethylene.

Supplementary results

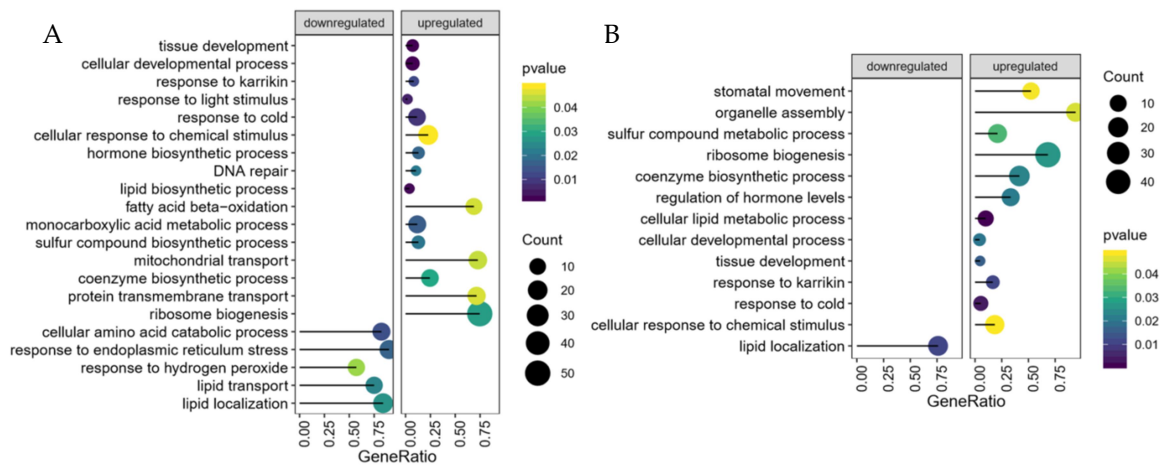

Figure S1. Dot plot of enriched BP terms in Col⁺/Col⁻ (A) and *prt6*⁻/Col⁻ (B) determined from GSEA results. The size of the dot represents count of the core proteins in each set, the color represents p-value, and generatio represents the number of core genes in gene set/the total number of genes in a gene set.

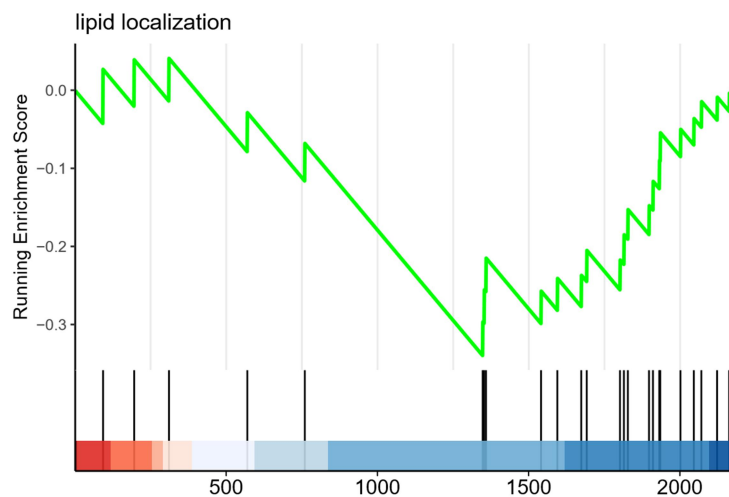

Figure S2. GSEA plot showing enrichment of lipid localization category among protein expressions in *prt6*⁻ versus Col⁻. The green line represents the running enrichment score; the color bar from red to blue represents the descending order of the ratio (*prt6*⁻/Col⁻); the short black lines corresponds to the presence of members in this BP category; the leading gene set contains the proteins appear subsequent to the peak score.

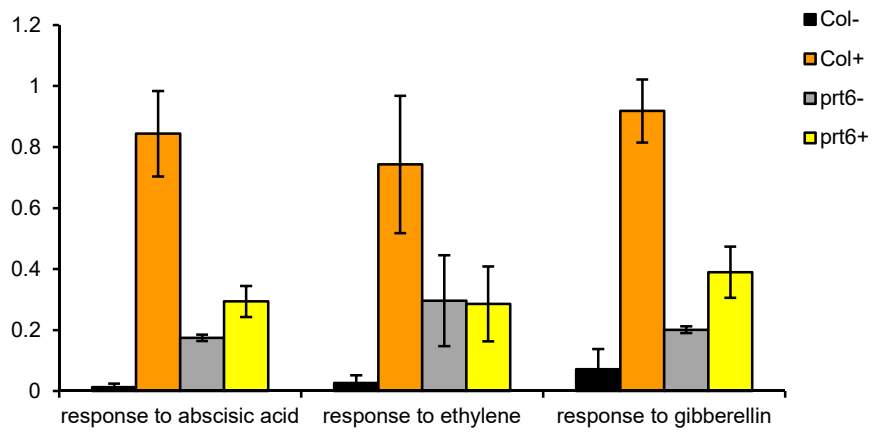

Figure S3. Individual pathway deregulation scores (PDS) of the selected biological process related to hormone response.

Table S1. Differentially expressed proteins in comparison groups after Tukey analysis of 619 proteins in conditions, Col+, Col-, *prt6+*, *prt6-*. Down and up-regulated proteins were determined by P value (< 0.05) and fold change (< 0.7 or > 1.3).

Tukey analysis	down	up	total
Col+/Col-	311	276	587
<i>prt6+</i> / <i>prt6-</i>	15	15	30
<i>prt6-</i> /Col-	23	77	100

Table S2. Proteins present in the “30 h” proteome belonging to the category of lipid localization.

ID	Category	Col+/Col-	<i>prt6+</i>/<i>prt6-</i>	<i>prt6-</i>/Col-
AT1G31812	acyl-CoA binding protein	0.76	0.74	1.09
AT5G53470	acyl-CoA binding protein	0.57	1.68	0.53
AT3G05420	acyl-CoA binding protein	1.16	1.12	1.13
AT5G59310	lipid-transfer protein	0.50	0.95	0.98
AT2G38530	lipid-transfer protein	0.49	0.75	0.83
AT1G27950	lipid-transfer protein	0.87	0.93	0.86
AT4G30880	lipid-transfer protein	0.64	0.76	0.90
AT5G38160	lipid-transfer protein	0.53	0.88	0.79
AT5G38170	lipid-transfer protein	0.63	1.04	1.24
AT5G55410	lipid-transfer protein	0.51	0.60	0.98
AT5G42890	sterol carrier protein	2.24	0.91	0.97
AT4G27140	albumin	0.79	0.76	0.82
AT4G27150	albumin	0.70	0.66	1.57
AT4G27160	albumin	0.72	1.54	0.33
AT4G27170	albumin	0.78	0.89	0.87
AT5G54740	albumin	0.45	0.66	0.77
AT1G48990	Oleosin	0.55	0.76	0.91
AT2G25890	Oleosin	0.74	0.72	0.86
AT3G01570	Oleosin	0.51	1.01	0.66
AT3G18570	Oleosin	0.64	0.93	0.94
AT4G25140	Oleosin	0.86	1.40	0.93
AT5G40420	Oleosin	0.60	0.88	0.84
AT3G27660	Oleosin	0.58	1.03	0.74
AT1G05510	Oli body associated protein	0.58	0.95	0.82
AT1G01050	Pyrophosphorylase	2.02	1.31	1.35

General conclusion and perspectives

Dormant *Arabidopsis thaliana* seeds did not germinate easily at temperatures higher than 10-15 °C in darkness. Ethylene at 10-100 $\mu\text{L L}^{-1}$, 2-4 days of stratification at 4 °C and GA₃ at 0.1-1 mM strongly stimulated the germination of wild-type (Col-0) at 25 °C in darkness. The stimulatory effect of ethylene on seed germination required an application of the hormone for more than 16 h and at least with 5% of oxygen. Ethylene insensitive mutants (*etr1*, *ein4* and *ein2*) in seedling triple response, were used to identify the involvement of ethylene signaling in seed dormancy release by ethylene, stratification and GA₃. Firstly, *etr1* and *ein2* dormant seeds were insensitive to ethylene, while *ein4* dormant seeds were sensitive to ethylene in seed germination. It indicated that the ethylene signaling related to seed germination involved ETR1 and EIN2, but not EIN4. The three mutants germinated as well as Col-0 after 4 days of stratification, suggesting that dormancy alleviation by chilling did not require ethylene signaling components ETR1, EIN4 or EIN2. In addition, *etr1* dormant seeds were less sensitive to GA₃, while *ein4* and *ein2* seeds exhibited a similar sensitivity to GA₃ with that of Col-0. These results evidenced that GA₃ required ethylene signaling component ETR1. The effect of chilling in breaking of dormancy was independent of ethylene signaling, but 24 h chilling resulted in an increase in the transcript expression of *ETR1*, *EIN4* and *EIN2*.

In our study dormancy alleviation by ethylene was associated with the down-regulation of genes encoding ABA signaling component (*ABI5*) and GA signaling components (*RGA*, *GAI*, *RGL2*) after 24-48 h of imbibition. The corresponding proteins negatively regulated seed germination (Tyler *et al.*, 2004; Skubacz *et al.*, 2016). Furthermore, ethylene signaling itself was also affected by exogenous ethylene which reduced the relative expression of *ETR1* and *EIN2* at 30-48 h. The receptor ETR1 was a negative regulator in ethylene response (Cancel and Larsen, 2002), the down-regulation of which in transcript level was possible to enhance the sensitivity to ethylene. EIN2 transduced the signal from cytoplasm to nucleus and positively regulated ethylene signaling (Bisson and Groth, 2011), the decreased expression of which might be the attenuation of ethylene signal after long duration (30-48 h) treatment at high concentration (100 $\mu\text{L L}^{-1}$) (Shakeel *et al.*, 2015). However Qiao *et al.* (2009) reported that transcript expression of genes involved in ethylene signaling, especially *EIN2*, was not in accordance with its protein level in seedlings; the

turnover of the protein ETR1 and EIN2 in seeds after ethylene treatment remain then still elusive and must be investigated.

The mutant affected in the proteolytic N-end rule pathway, *prt6*, was sensitive to stratification at 4 °C, but insensitive to ethylene in seed germination, suggesting that dormancy alleviation by chilling did not require the N-end rule pathway, while dormancy alleviation by ethylene did require it. Mutants in *ERFVII*s (*HRE1*, *HRE2*, *RAP2.2*, *RAP2.3*, *RAP2.12*), the encoding proteins of which acted as substrates of the N-end rule, were crossbred with *prt6* to generate combinational mutants. It was shown that the insensitivity of *prt6* to ethylene could be reversed by the mutation of *RAP2.2*, *RAP2.3* and *RAP2.12*, rather the mutation of *HRE1* and *HRE2* in *prt6* background, indicating that 3 RAPs acted as downstream of PRT6 in seed responsiveness to ethylene (Figure 15), while 2 HREs were located at its upstream. The knock off the *RAP*s contributed to seed germination in *prt6*, that is to say, *RAP*s played an inhibitory role in germination. It was verified by the down-regulation of the 3 *RAP*s transcripts after dormancy alleviation by ethylene or stratification in Col-0. Whereas, the relative expression of the 3 *RAP*s was maintained or induced by ethylene in *prt6*. Meanwhile, single or triple mutation in *RAP*s resulted in perfect sensitivity to ethylene, but the ectopically expressed single *RAP* seeds did not exhibit reduced sensitivity, which might result from the missing of their cooperative interactions. It was interesting that only the expression of *HRE2* was stimulated by dormancy release, either by ethylene or chilling in Col-0. In addition, the improving expression of *HRE2* after ethylene treatment was also shown in *prt6* seeds, the germination of which were insensitive to ethylene. Therefore, it seems that the transcript expression of *HRE2* was independent of the seed germination potential. Except for the stimulatory effect of ethylene treatment in *HRE2* transcripts in both Col-0 and *prt6*, the effect of *PRT6* mutation also induced its expression. However, the mutation of the 3 *RAP*s in *prt6* background significantly reduced the expression of *HRE2*, suggesting that the 3 *RAP*s might directly or indirectly regulate the expression of *HRE2* (Figure 15). If so, it was curious that the mutation of the 3 *RAP*s in Col-0 background did not affect *HRE2* transcripts. At the same time, *HRE2* was also stimulated by ethylene in *prt6 rap2.2 rap2.3 rap2.12* and *rap2.2 rap2.3 rap2.12*. It was then speculated other ERFs or down-stream responsive proteins might target at the promoter of *HRE2* and stimulate its expression and the presence of GCC box, which was a common motif identified as the

specific binding site for members of the ERF subfamily (Hao *et al.*, 1998), also offered a possibility. The future work will focus on the verification of the interactions between RAPs and *HRE2* by transactivation assay and ChIP-qPCR. Though *HRE2* transcripts were dramatically enhanced, it was proposed that *HRE2* seems to be regulated in a post-transcription manner (Licausi *et al.* 2010). Hence, the effect of *HRE2* in seed germination was under debate. In Col-0 background, *hre2* mutant or overexpressed *HRE2* presented a similar phenotype with that in Col-0. In *prt6* background, the germination of the triple mutant *prt6 hre1 hre2* was insensitive to ethylene like *prt6*. It was necessary to construct double mutant *prt6 hre2* or transgenic seeds *prt6 prom (HRE2):TAG* to confirm their phenotypes.

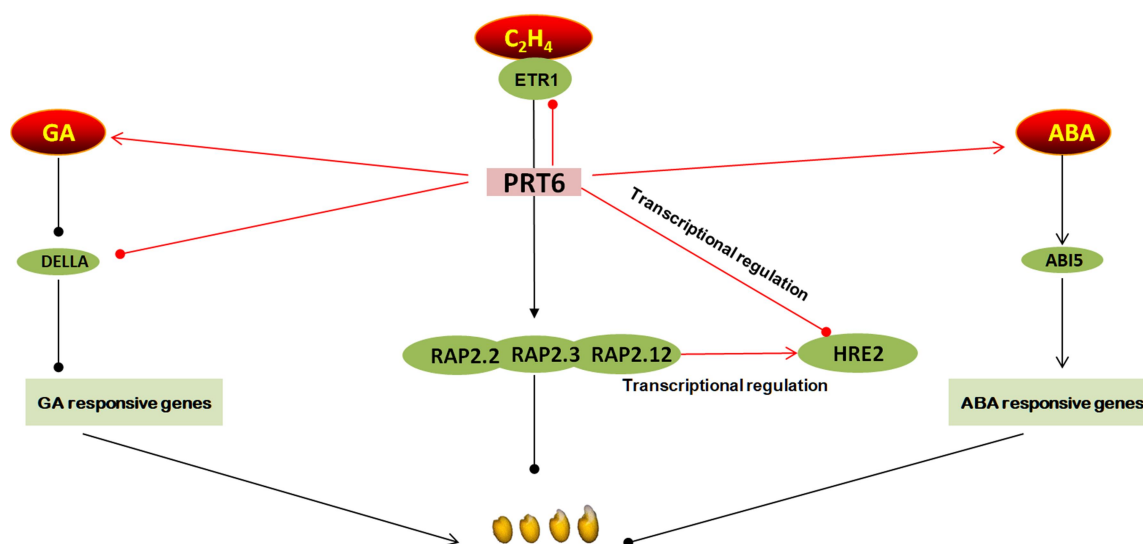

Figure 15. Proposed scheme showing the main pathways involved in the seed responsiveness to ethylene.

It was tested that *prt6* seeds were more sensitive to exogenous ABA and less sensitive to exogenous GA₃. In addition, the endogenous ABA/GA₄ ratio was higher in *prt6* than in Col when treated with ethylene. Besides, the relative expression of *ABI5*, *RGA* and *RGL2* exhibited a distinct profile in *prt6* when compared with Col-0 in the presence of ethylene. Genotype effect did not significantly affect the expression of *ABI5* and *RGL2*, but they were less reduced by ethylene or even did not change in the presence of ethylene in *prt6* than in Col, which resulted in a higher level of *ABI5* and *RGL2* in *prt6* than in Col-0 in the presence of ethylene. In parallel, ethylene down-regulated the expression of *RGA* in *prt6* and in Col-0, but the genotype effect up-regulated the expression of *RGA* (Figure 15), the interaction

effects of which resulted in a higher level of *RGA* in *prt6* than in Col-0 in the presence of ethylene. As discussed before, ethylene decreased the expression of *ETR1* and *EIN2* in Col, but neither of which was affected by ethylene in *prt6*. Meanwhile, the genotype effect increased the expression of *ETR1* (Figure 15). Taken together, the insensitivity of *prt6* to ethylene was related to the induced ABA/GA₄ content and the affected ethylene, ABA and GA signaling.

Finally, quantitative proteomics (LC-MS/MS) was also performed to screen significant proteins in Col-0 and *prt6* with (+) or without (-) ethylene treatment. After 16 h and 30 h of imbibition, 1737 and 2552 proteins were respectively identified. However, at 16 h, none was significant after two factors (genotype and treatment) ANOVA analysis with adjusted P value 0.05, while 619 proteins were achieved at 30 h at this cutoff. It was suggested that longer duration of imbibition was able to exhibit the affected protein expressions. The following Tukey test (P = 0.05) and fold change ratio (<0.7 or >1.3) allowed to select 587 and 30 proteins in the group Col+/Col- and *prt6*+/*prt6*-, respectively. It indicated that ethylene did not have a marked effect on the global proteome of *prt6* seeds, which in turn confirmed that the involvement of N-end rule pathway in seed responsiveness to ethylene. Subsequently, over representation analysis of the significant proteins in Col+/Col- showed that the significant biological process involved signals reception and transduction, reserve mobilization and new material generation, which could contribute to seed germination. Twenty-nine common proteins were overlapped in the two groups, 5 of which presented opposite changes with increasing protein expression by ethylene in Col-0 and decreasing protein expression by ethylene in *prt6*. It seems that the 5 proteins might act as potential candidates to test the sensitivity to ethylene. However, single mutation of these 5 genes did not result in difference in seed responsiveness to ethylene when compared with Col-0. It was then proposed that single mutation was not sufficient to inhibit seed sensitivity to ethylene. Since classical over representation analysis of the group *prt6*+/*prt6*- was uninformative because of less proteins. Functional class scoring such as GSEA and Pathifier analysis were carried out to identify the slight but coordinated changes in each condition. One biological process, response to hypoxia was specific with higher PDS score in *prt6* than in Col. With the presence of ethylene, H₂O₂ production in *prt6* was similar with that in Col-0 and respiration intensity was higher in *prt6* than in Col-0, indicating that insensitivity of *prt6*

to ethylene was independent of ROS production and respiration. More importantly, the protein expression in SSPs, LEA and oleosins showed that the ratios of Col⁺/Col⁻ was much lower than that of *prt6*⁺/*prt6*⁻. It was then speculated that the insensitivity of *prt6* seeds to ethylene might be related to the delayed mobilization of seed storage proteins, oil bodies and LEA.

References (for Introduction, Chapter I, III, IV and Conclusion)

- Abbas M, Berckhan S, Rooney DJ, Gibbs DJ, Vicente Conde J, Sousa Correia C, Bassel GW, Marin-de la Rosa N, Leon J, Alabadi D, Blazquez MA, Holdsworth MJ (2015) - Oxygen sensing coordinates photomorphogenesis to facilitate seedling survival. *Current Biology* **25** (11):1483-1488.
- Abeles FB, Lonski J (1969) - Stimulation of lettuce seed germination by ethylene. *Plant Physiology* **44** (2):277-280.
- Acaster MA, Kende H (1983) - Properties and partial purification of 1-aminocyclopropane-1-carboxylate synthase. *Plant Physiology* **72** (1):139-145.
- Al-Ani A, Bruzau F, Raymond P, Saint-Ges V, Leblanc JM, Pradet A (1985) - Germination, respiration, and adenylate energy charge of seeds at various oxygen partial pressures. *Plant Physiology* **79** (3):885-890.
- Ali-Rachedi S, Bouinot D, Wagner MH, Bonnet M, Sotta B, Grappin P, Jullien M (2004) - Changes in endogenous abscisic acid levels during dormancy release and maintenance of mature seeds: studies with the Cape Verde Islands ecotype, the dormant model of *Arabidopsis thaliana*. *Planta* **219** (3):479-488.
- Allaire J.J., Gandrud C, Russell K and Yetman CJ (2017) - NetworkD3: D3 JavaScript Network Graphs from R. R package version 0.4.
- Alonso JM, Hirayama T, Roman G, Nourizadeh S, Ecker JR (1999) - EIN2, a bifunctional transducer of ethylene and stress responses in *Arabidopsis*. *Science* **284** (5423):2148-2152.
- An F, Zhao Q, Ji Y, Li W, Jiang Z, Yu X, Zhang C, Han Y, He W, Liu Y, Zhang S, Ecker JR, Guo H (2010) - Ethylene-induced stabilization of ETHYLENE INSENSITIVE3 and EIN3-LIKE1 is mediated by proteasomal degradation of EIN3 binding F-box 1 and 2 that requires EIN2 in *Arabidopsis*. *The Plant Cell* **22** (7):2384-2401.
- Arc E, Galland M, Godin B, Cueff G, Rajjou L (2013a) - Nitric oxide implication in the control of seed dormancy and germination. *Frontiers in Plant Science* **4**:346
- Arc E, Sechet J, Corbineau F, Rajjou L, Marion-Poll A (2013b) - ABA crosstalk with ethylene and nitric oxide in seed dormancy and germination. *Frontiers in Plant Science* **4**:63.
- Bachmair A, Finley D, Varshavsky A (1986) - In vivo half-life of a protein is a function of its amino-terminal residue. *Science* **234** (4773):179-186.
- Bailly C, El-Maarouf-Bouteau H, Corbineau F (2008) - From intracellular signaling networks to cell death: the dual role of reactive oxygen species in seed physiology. *Comptes Rendus Biologies*. **331**(10):806-14.

- Bair NB, Meyer SE, Allen PS (2006) - A hydrothermal after-ripening time model for seed dormancy loss in *Bromus tectorum* L. *Seed Science Research* **16** (1):17-28.
- Bakshi A, Piya S, Fernandez JC, Chervin C, Hewezi T, Binder BM (2018) - Ethylene receptors signal via a noncanonical pathway to regulate abscisic acid responses. *Plant Physiology* **176** (1):910-929.
- Banerjee R, Batschauer A (2005) - Plant blue-light receptors. *Planta*. 220(3):498-502.
- Barrero JM, Jacobsen JV, Talbot MJ, White RG, Swain SM, Garvin DF (2012) - Grain dormancy and light quality effects on germination in the model grass *Brachypodium distachyon*. *New Phytologist*. **193**(2):376-86.
- Basbous-Serhal I, Leymarie J, Bailly C (2016) - Fluctuation of Arabidopsis seed dormancy with relative humidity and temperature during dry storage. *Journal of Experimental Botany*. **67** (1):119-130.
- Baskin CC, Baskin JM (1995) - Warm plus cold stratification requirement for dormancy break in seeds of the woodland herb *Cardamin concatenata* (Brassicaceae), and evolutionary implications. *Canadian Journal of Botany* **73** (4):608-612.
- Baskin CC, Baskin JM (1998) - Seeds: Ecology, biogeography, and, evolution of dormancy and germination. Academic Press, San Diego, CA, USA.
- Baskin CC, Baskin JM, Leck MA (1993) – After-ripening pattern during cold stratification of achenes of ten perennial Asteraceae from eastern North America, and evolutionary implication. *Plant Species Biology* **8** (1):61-65.
- Baskin JM, Baskin CC (1979) - Effect of relative humidity on afterripening and viability in seeds of the winter annual *Draba verna*. *Botanical Gazette* **140** (3):284-287.
- Baskin JM, Baskin CC (1985) - The annual dormancy cycle in buried weed seeds: A continuum. *BioScience* **35** (8):492-498.
- Baskin JM, Baskin CC (2004) - A classification system of seed dormancy, *Seed Science Research* **14**(1):1-16.
- Baskin JM, Nan X, Baskin C (1998) - A comparative study of seed dormancy and germination in an annual and perennial species of Senna (Fabaceae). *Seed Science Research* **8**:501-512.
- Bassel GW (2016) - To grow or not to grow? *Trends in Plant Science* **21** (6):498-505.
- Bassel GW, Lan H, Glaab E, Gibbs DJ, Gerjets T, Krasnogor N, Bonner AJ, Holdsworth MJ, Provart NJ (2011) - Genome-wide network model capturing seed germination reveals coordinated regulation of plant cellular phase transitions. *Proceedings of the National Academy of Sciences of the United States of America* **108** (23):9709-9714.

- Bazin J, Batlla D, Dussert S, El-Maarouf-Bouteau H, Bailly C (2011a) - Role of relative humidity, temperature, and water status in dormancy alleviation of sunflower seeds during dry after-ripening. *Journal of Experimental Botany* **62** (2):627-640.
- Bazin J, Langlade N, Vincourt P, Arribat S, Balzergue S, El-Maarouf-Bouteau H, Bailly C (2011b) - Targeted mRNA oxidation regulates sunflower seed dormancy alleviation during dry after-ripening. *The Plant Cell* **23** (6):2196-2208.
- Beaudoin N, Serizet C, Gosti F, Giraudat J (2000) - Interactions between abscisic acid and ethylene signaling cascades. *The Plant Cell* **12** (7):1103-1115.
- Belouah I, Blein-Nicolas M, Balliau T, Gibon Y, Zivy M, Colombié S (2019) Peptide filtering differently affects the performances of XIC-based quantification methods. *Journal of Proteomics* **193**:131-141.
- Benvenuti S, Macchia M (1997) - Germination ecophysiology of bur beggarticks (*Bidens tripartita*) as affected by light and oxygen. *Weed Science* **45** (5):696-700.
- Bethke G, Unthan T, Uhrig JF, Pöschl Y, Gust AA, Scheel D, Lee J (2009) - FLG22 regulates the release of an ethylene response factor substrate from MAP kinase 6 in *Arabidopsis thaliana* via ethylene signaling. *Proceedings of the National Academy of Sciences* **106** (19):8067-8072.
- Bethke PC, Libourel IG, Reinohl V, Jones RL (2006) - Sodium nitroprusside, cyanide, nitrite, and nitrate break *Arabidopsis* seed dormancy in a nitric oxide-dependent manner. *Planta* **223** (4):805-812.
- Bewley JD (1997) - Seed germination and dormancy. *The Plant Cell* **9** (7):1055-1066.
- Bewley JD, Black M (1978) - Imbibition, germination, and growth. In: Bewley JD, Black M (eds) *Physiology and biochemistry of seeds in relation to germination: I development, germination, and growth*. Springer Verlag, Berlin, Heidelberg, pp 106-131.
- Bewley JD, Black M (1994a) - Dormancy and the control of germination. In: Bewley JD, Black M (eds) *Seeds: Physiology of development and germination*. Springer US, Boston, MA, pp 199-271.
- Bienvenut WV, Sumpton D, Martinez A, Lilla S, Espagne C, Meinel T, Giglione C (2012) - Comparative large scale characterization of plant versus mammal proteins reveals similar and idiosyncratic N-alpha-acetylation features. *Molecular Cellular Proteomics* **11** (6): M111.015131.
- Binder BM, Chang C, Schaller GE (2012) - Perception of ethylene by plants – ethylene receptors. *Annual Plant Reviews* (**44**):117-145.

- Binder BM, Kim HJ, Mathews DE, Hutchison CE, Kieber JJ, Schaller GE (2018) - A role for two-component signaling elements in the Arabidopsis growth recovery response to ethylene. *Plant Direct* **2** (5):e00058.
- Binder BM, Malley RC, Wang W, Zutz TC, Bleecker AB (2006) - Ethylene stimulates nutations that are dependent on the ETR1 receptor. *Plant Physiology* **142** (4):1690-1700.
- Binder BM, Mortimore LA, Stepanova AN, Ecker JR, Bleecker AB (2004) - Short-term growth responses to ethylene in Arabidopsis seedlings are EIN3/EIL1 independent. *Plant Physiology* **136** (2):2921-2927.
- Binder BM, O'Malley R C, Wang W, Moore JM, Parks BM, Spalding EP, Bleecker AB (2004) - Arabidopsis seedling growth response and recovery to ethylene. A kinetic analysis. *Plant Physiology* **136** (2):2913-2920.
- Binder BM, Rodriguez FI, Bleecker AB (2010) - The copper transporter RAN1 is essential for biogenesis of ethylene receptors in Arabidopsis. *Journal of Biological Chemistry* **285** (48):37263-37270.
- Bisson MM, Groth G (2010) - New insight in ethylene signaling: Autokinase activity of ETR1 modulates the interaction of receptors and EIN2. *Molecular Plant* **3** (5):882-889.
- Bisson MM, Groth G (2011) - New paradigm in ethylene signaling: EIN2, the central regulator of the signaling pathway, interacts directly with the upstream receptors. *Plant Signaling and Behavior* **6** (1):164-166.
- Black M, Bewley JD and Halmer P (2006a) - *The Encyclopedia Of Seeds Science, Technology And Uses*. Wallingford, U.K, Cambridge, pp 275-277.
- Black M, Bewley JD and Halmer P (2006b) - *The Encyclopedia Of Seeds Science, Technology And Uses*. Wallingford, U.K, Cambridge, pp 271-274.
- Bleckmann A, Alter S, Dresselhaus T (2014) - The beginning of a seed: Regulatory mechanisms of double fertilization. *Frontiers in Plant Science* **5**:452
- Bleecker AB, Kende H (2000) - Ethylene: A gaseous signal molecule in plants. *Annual Review of Cell and Developmental Biology* **16** (1):1-18.
- Blighe K (2019) - EnhancedVolcano: Publication-ready volcano plots with enhanced colouring and labeling. R package version 1.1.3.
- Bogatek R, Gniazdowska A (2012) - Ethylene in seed development, dormancy and germination. In: McManus MT (eds) *Annual Plant Reviews Volume 44: The Plant Hormone Ethylene*. Wiley-Blackwell, Wiley-Blackwell, Oxford, UK, pp 189-218.
- Borisjuk L, Rolletschek H (2009) - The oxygen status of the developing seed. *New Phytologist* **182** (1):17-30.

- Bove J, Lucas P, Godin B, Ogé L, Jullien M, Grappin P (2005) - Gene expression analysis by cDNA-AFLP highlights a set of new signaling networks and translational control during seed dormancy breaking in *Nicotiana plumbaginifolia*. *Plant Molecular Biology* **57** (4):593-612.
- Bui LT, Giuntoli B, Kosmacz M, Parlanti S, Licausi F (2015) - Constitutively expressed ERF-VII transcription factors redundantly activate the core anaerobic response in *Arabidopsis thaliana*. *Plant Science* **236**:37-43.
- Buijs G, Kodde J, Groot SPC, Bentsink L (2018) - Seed dormancy release accelerated by elevated partial pressure of oxygen is associated with *DOG* loci. *Journal of Experimental Botany* **69** (15):3601-3608.
- Cadman CS, Toorop PE, Hilhorst HW, Finch-Savage WE (2006) - Gene expression profiles of *Arabidopsis* cvi seeds during dormancy cycling indicate a common underlying dormancy control mechanism. *Plant Journal* **46** (5):805-822.
- Calvo AP, Nicolás C, Lorenzo O, Nicolás G, Rodríguez D (2004a) - Evidence for positive regulation by gibberellins and ethylene of ACC oxidase expression and activity during transition from dormancy to germination in *Fagus sylvatica* L. Seeds. *Journal of Plant Growth Regulation* **23** (1):44-53.
- Calvo AP, Nicolas C, Nicolas G, Rodriguez D (2004b) - Evidence of a cross-talk regulation of a GA 20-oxidase (*FsGA20ox1*) by gibberellins and ethylene during the breaking of dormancy in *Fagus sylvatica* seeds. *Physiologia Plantarum* **120** (4):623-630.
- Cancel JD, Larsen PB (2002) - Loss-of-function mutations in the ethylene receptor *ETRI* cause enhanced sensitivity and exaggerated response to ethylene in *Arabidopsis*. *Plant Physiology* **129** (4):1557-1567.
- Carrera E, Holman T, Medhurst A, Dietrich D, Footitt S, Theodoulou FL, Holdsworth MJ (2008) - Seed after-ripening is a discrete developmental pathway associated with specific gene networks in *Arabidopsis*. *The Plant Journal* **53** (2):214-224.
- Castillo MC, Lozano-Juste J, Gonzalez-Guzman M, Rodriguez L, Rodriguez PL, Leon J (2015) - Inactivation of PYR/PYL/RCAR ABA receptors by tyrosine nitration may enable rapid inhibition of ABA signaling by nitric oxide in plants. *Science Signaling* **8** (392):ra89.
- Chae HS, Faure F, Kieber JJ (2003) - The *eto1*, *eto2*, and *eto3* mutations and cytokinin treatment increase ethylene biosynthesis in *Arabidopsis* by increasing the stability of ACS protein. *The Plant Cell* **15** (2):545-559.
- Chahtane H, Kim W, Lopez-Molina L (2016) - Primary seed dormancy: A temporally multilayered riddle waiting to be unlocked. *Journal of Experimental Botany* **68** (4): 857-869.

- Chang C, Kwok SF, Bleecker AB, Meyerowitz EM (1993) - Arabidopsis ethylene-response gene ETR1: Similarity of product to two-component regulators. *Science* **262** (5133):539-544.
- Chang J, Clay JM, Chang C (2014) - Association of cytochrome b5 with ETR1 ethylene receptor signaling through RTE1 in Arabidopsis. *The Plant Journal* **77** (4):558-567.
- Chang KN, Zhong S, Weirauch MT, Hon G, Pelizzola M, Li H, Huang S-SC, Schmitz RJ, Urich MA, Kuo D, Nery JR, Qiao H, Yang A, Jamali A, Chen H, Ideker T, Ren B, Bar-Joseph Z, Hughes TR, Ecker JR (2013) - Temporal transcriptional response to ethylene gas drives growth hormone cross-regulation in Arabidopsis. *Elife* **2**:e00675.
- Chantre GR, Batlla D, Sabbatini MR, Orioli G (2009) - Germination parameterization and development of an after-ripening thermal-time model for primary dormancy release of *Lithospermum arvense* seeds. *Annals of Botany* **103** (8):1291-1301.
- Chao Q, Rothenberg M, Solano R, Roman G, Terzaghi W, Ecker† JR (1997) - Activation of the ethylene gas response pathway in Arabidopsis by the nuclear protein ETHYLENE-INSENSITIVE3 and related proteins. *Cell* **89** (7):1133-1144.
- Chauffour F, Bailly M, Perreau F, Cueff G, Suzuki H, Collet B, Frey A, Clément G, Soubigou-Taconnat L, Balliau T, Krieger-Liszakay A, Rajjou L, Marion-Poll A (2019) - Multi-omics analysis reveals sequential roles for ABA during seed maturation. *Plant Physiology* **180** (2):1198-1218.
- Chen Y-F, Gao Z, Kerris RJ, 3rd, Wang W, Binder BM, Schaller GE (2010) - Ethylene receptors function as components of high-molecular-mass protein complexes in Arabidopsis. *Plos One* **5** (1):e8640.
- Chen Y-F, Shakeel SN, Bowers J, Zhao X-C, Etheridge N, Schaller GE (2007) - Ligand-induced degradation of the ethylene receptor ETR2 through a proteasome-dependent pathway in Arabidopsis. *Journal of Biological Chemistry* **282** (34):24752-24758.
- Chen YT, Liu H, Stone S, Callis J (2013) - ABA and the ubiquitin E3 ligase keep on going affect proteolysis of the *Arabidopsis thaliana* transcription factors ABF1 and ABF3. *The Plant Journal* **75** (6):965-976.
- Cheng MC, Liao PM, Kuo WW, Lin TP (2013) - The Arabidopsis ethylene response factor1 regulates abiotic stress-responsive gene expression by binding to different cis-acting elements in response to different stress signals. *Plant Physiology* **162** (3):1566-1582.
- Cheng W-H, Chiang M-H, Hwang S-G, Lin P-C (2009) - Antagonism between abscisic acid and ethylene in Arabidopsis acts in parallel with the reciprocal regulation of their metabolism and signaling pathways. *Plant Molecular Biology* **71** (1):61-80.

- Chien C-T, Kuo-Huang L-L, Lin T-P (1998) - Changes in ultrastructure and abscisic acid level, and response to applied gibberellins in *Taxus mairei* seeds treated with warm and cold stratification. *Annals of Botany* **81** (1):41-47.
- Chitnis VR, Gao F, Yao Z, Jordan MC, Park S, Ayele BT (2014) - After-ripening induced transcriptional changes of hormonal genes in wheat seeds: The cases of brassinosteroids, ethylene, cytokinin and salicylic acid. *Plos One* **9** (1):e87543.
- Chiwocha SD, Cutler AJ, Abrams SR, Ambrose SJ, Yang J, Ross AR, Kermode AR (2005) - The *etr1-2* mutation in *Arabidopsis thaliana* affects the abscisic acid, auxin, cytokinin and gibberellin metabolic pathways during maintenance of seed dormancy, moist-chilling and germination. *Plant Journal* **42** (1):35-48.
- Cho Y-H, Yoo S-D (2009) - Emerging complexity of ethylene signal transduction. *Journal of Plant Biology* **52** (4):283-288.
- Choy MK, Sullivan JA, Theobald JC, Davies WJ, Gray JC (2008) - An Arabidopsis mutant able to green after extended dark periods shows decreased transcripts of seed protein genes and altered sensitivity to abscisic acid. *Journal of Experimental Botany* **59** (14):3869-3884.
- Christians MJ, Gingerich DJ, Hansen M, Binder BM, Kieber JJ, Vierstra RD (2009) - The BTB ubiquitin ligases ETO1, EOL1 and EOL2 act collectively to regulate ethylene biosynthesis in Arabidopsis by controlling type-2 ACC synthase levels. *Plant Journal* **57** (2):332-345.
- Clark KL, Larsen PB, Wang X, Chang C (1998) - Association of the Arabidopsis CTR1 raf-like kinase with the ETR1 and ERS ethylene receptors. *Proceedings of the National Academy of Sciences* **95** (9):5401-5406.
- Colasuonno P, Marcotuli I, Lozito ML, Simeone R, Blanco A, Gadaleta A (2017) - Characterization of aldehyde oxidase (AO) genes involved in the accumulation of carotenoid pigments in wheat grain. *Frontiers in plant science* **8**:863.
- Colcombet J, Hirt H (2008) - Arabidopsis MAPKs: A complex signalling network involved in multiple biological processes. *Biochemical Journal* **413** (2):217-226.
- Corbineau F (2012) - Markers of seed quality: From present to future. *Seed Science Research* **22** (S1):S61-S68.
- Corbineau F, Côme D (1995) - Control of seed germination and dormancy by the gaseous environment. In: Kigel J and Galili G (eds) *Seed development and germination*. Marcel Dekker. New York, Basel, pp 397-424.
- Corbineau F, Xia Q, Bailly C, El-Maarouf-Bouteau H (2014) - Ethylene, a key factor in the regulation of seed dormancy. *Frontiers in Plant Science* **5**:539.

- Craig R, Beavis RC (2004) - TANDEM: matching proteins with tandem mass spectra. *Bioinformatics* **20**(9): 1466–1467.
- Csardi G, Nepusz T (2006) - The igraph software package for complex network research. *InterJournal* 1695(5):1-9.
- Curaba J, Moritz T, Blervaque R, Parcy F, Raz V, Herzog M, Vachon G (2004) - *AtGA3ox2*, a key gene responsible for bioactive gibberellin biosynthesis, is regulated during embryogenesis by LEAFY COTYLEDON2 and FUSCA3 in Arabidopsis. *Plant Physiology* **136** (3):3660-3369.
- Czechowski T, Stitt M, Altmann T, Udvardi MK, Scheible W-R (2005) - Genome-wide identification and testing of superior reference genes for transcript normalization in Arabidopsis. *Plant Physiology* **139** (1):5-17.
- de Marchi R, Sorel M, Mooney B, Fudal I, Goslin K, Kwasniewska K, Ryan PT, Pfalz M, Kroymann J, Pollmann S, Feechan A, Wellmer F, Rivas S, Graciet E (2016) - The N-end rule pathway regulates pathogen responses in plants. *Scientific Reports* **6**:26020.
- Debeaujon I, Koornneef M (2000) - Gibberellin requirement for Arabidopsis seed germination is determined both by testa characteristics and embryonic abscisic acid. *Plant Physiology* **122** (2):415-424.
- Dębska K, Krasuska U, Budnicka K, Bogatek R, Gniazdowska A (2013) - Dormancy removal of apple seeds by cold stratification is associated with fluctuation in h2o2, no production and protein carbonylation level. *Journal of Plant Physiology* **170** (5):480-488.
- Derkx MPM, Karssen CM (1993) - Effects of light and temperature on seed dormancy and gibberellin-stimulated germination in *Arabidopsis thaliana*: Studies with gibberellin-deficient and -insensitive mutants. *Physiologia Plantarum* **89** (2):360-368.
- Desikan R, Last K, Harrett-Williams R, Tagliavia C, Harter K, Hooley R, Hancock JT, Neill SJ (2006) - Ethylene-induced stomatal closure in Arabidopsis occurs via atrbohF-mediated hydrogen peroxide synthesis. *The Plant Journal* **47** (6):907-916.
- Desjardin C, Balliau T, Valot B, Zivy M, Wimel L, Guerin G, Cribiu E, Schibler L (2012) - A method for proteomic analysis of equine subchondral bone and epiphyseal cartilage. *Proteomics* **12** (11):1870-1874.
- Devic M, Roscoe T (2016) - Seed maturation: Simplification of control networks in plants. *Plant Science* **252**:335-346.
- Dill A, Thomas SG, Hu J, Steber CM, Sun T-p (2004) - The Arabidopsis F-box protein SLEEPY1 targets gibberellin signaling repressors for gibberellin-induced degradation. *The Plant Cell* **16** (6):1392-1405.

- Djafi N, Vergnolle C, Cantrel C, Wietrzynski W, Delage E, Cochet F, Puyaubert J, Soubigou-Taconnat L, Gey D, Collin S, Balzergue S, Zachowski A, Ruelland E (2013) - The Arabidopsis DREB2 genetic pathway is constitutively repressed by basal phosphoinositide-dependent phospholipase C coupled to diacylglycerol kinase. *Frontiers in Plant Science* **4**:307.
- Dong C-H, Rivarola M, Resnick JS, Maggin BD, Chang C (2008) - Subcellular co-localization of Arabidopsis RTE1 and ETR1 supports a regulatory role for RTE1 in ETR1 ethylene signaling. *The Plant Journal* **53** (2):275-286.
- Dong C, Zhang H, Li L, Tempel W, Loppnau P, Min JR (2018) - Molecular basis of gid4-mediated recognition of degrons for the Pro/N-end rule pathway. *Nature Chemical Biology* **14** (5):466-473.
- Dong H, Zhen Z, Peng J, Chang L, Gong Q, Wang NN (2011) - Loss of *acs7* confers abiotic stress tolerance by modulating ABA sensitivity and accumulation in Arabidopsis. *Journal of Experimental Botany* **62** (14):4875-4887.
- Dougan DA, Varshavsky A (2018) - Understanding the Pro/N-end rule pathway. *Nature Chemical Biology* **14** (5):415-416.
- Drier Y, Sheffer M, Domany E (2013) - Pathway-based personalized analysis of cancer. *Proceedings of the National Academy of Sciences of the United States of America* **110** (16):6388-6393.
- Dubois M, Van den Broeck L, Inzé D (2018) - The pivotal role of ethylene in plant growth. *Trends in Plant Science* **23** (4):311-323.
- Eckardt NA (2007) - GA signaling: Direct targets of DELLA proteins. *The Plant Cell* **19** (10):2970.
- El-Maarouf-Bouteau H, Meimoun P, Job C, Job D, Bailly C (2013) - Role of protein and mRNA oxidation in seed dormancy and germination. *Frontiers in Plant Science* **4**:77.
- El-Maarouf-Bouteau H, Sajjad Y, Bazin J, Langlade N, Cristescu SM, Balzergue S, Baudouin E, Bailly C (2015) - Reactive oxygen species, abscisic acid and ethylene interact to regulate sunflower seed germination. *Plant Cell Environment* **38** (2):364-374.
- Eliášová K, Pešek B, Vondráková Z (2015) - Storage compounds, ABA and fumarase in *Fagus sylvatica* embryos during stratification. *Dendrobiology* **74**:25-33.
- Evelyn J (1664) - Sylva, or a discourse of forest-trees, and the propagation of timber in his majesty's dominions. London, Printed by Martyn J and Allestry J.
- Finch-Savage WE, Cadman CSC, Toorop PE, Lynn JR, Hilhorst HWM (2007) - Seed dormancy release in Arabidopsis Cvi by dry after-ripening, low temperature, nitrate and light shows common quantitative patterns of gene expression directed by environmentally specific sensing. *The Plant Journal* **51** (1):60-78.

- Finch-Savage WE, Footitt S (2017) - Seed dormancy cycling and the regulation of dormancy mechanisms to time germination in variable field environments *Journal of Experimental Botany* **68** (4):843-856.
- Finch-Savage WE, Leubner-Metzger G (2006) - Seed dormancy and the control of germination. *New Phytologist* **171** (3):501-523.
- Finkelstein R, Reeves W, Ariizumi T, Steber C (2008) - Molecular aspects of seed dormancy. *Annual Review of Plant Biology* **59**:387-415.
- Finkelstein RR, Lynch TJ (2000) - The Arabidopsis abscisic acid response gene *ABI5* encodes a basic leucine zipper transcription factor. *The Plant Cell* **12** (4):599-609.
- Finkelstein RR, Tenbarger KM, Shumway JE, Crouch ML (1985) - Role of ABA in maturation of rapeseed embryos. *Plant Physiology* **78** (3):630-636.
- Fluhr R, Mattoo A (1996) - Ethylene - biosynthesis and perception. *Critical Reviews in Plant Sciences* **15**:479-524.
- Footitt S, Douterelo-Soler I, Clay H, Finch-Savage WE (2011) - Dormancy cycling in Arabidopsis seeds is controlled by seasonally distinct hormone-signaling pathways. *Proceedings of the National Academy of Sciences* **108** (50):20236-20277.
- Franco-Zorrilla JM, López-Vidriero I, Carrasco JL, Godoy M, Vera P, Solano R (2014) - DNA-binding specificities of plant transcription factors and their potential to define target genes. *Proceedings of the National Academy of Sciences* **111** (6):2367-2372.
- Fu X, Richards DE, Fleck B, Xie D, Burton N, Harberd NP (2004) - The Arabidopsis mutant *sleepy1^{gar2-1}* protein promotes plant growth by increasing the affinity of the SCF^{sly1} E3 ubiquitin ligase for DELLA protein substrates. *Plant Cell* **16** (6):1406-1418.
- Fujimoto SY, Ohta M, Usui A, Shinshi H, Ohme-Takagi M (2000) - Arabidopsis ethylene-responsive element binding factors act as transcriptional activators or repressors of gcc box-mediated gene expression. *Plant Cell* **12** (3):393-404.
- Gagne JM, Smalle J, Gingerich DJ, Walker JM, Yoo S-D, Yanagisawa S, Vierstra RD (2004) - Arabidopsis EIN3-binding F-box 1 and 2 form ubiquitin-protein ligases that repress ethylene action and promote growth by directing EIN3 degradation. *Proceedings of the National Academy of Sciences* **101** (17):6803-6808.
- Galland M, Job D, Rajjou L (2012) - The seed proteome web portal. *Frontiers in Plant Science* **3**:98.
- Gallie DR (2015) - Ethylene receptors in plants - why so much complexity? *F1000 Prime Reports* **7**:39-39.
- Gao Z, Schaller GE (2009) - The role of receptor interactions in regulating ethylene signal transduction. *Plant Signal Behaviour* **4** (12):1152-1153.

- Gao Z, Wen C-K, Binder BM, Chen Y-F, Chang J, Chiang Y-H, Kerris RJ, Chang C, Schaller GE (2008) - Heteromeric interactions among ethylene receptors mediate signaling in Arabidopsis. *The Journal of Biological Chemistry* **283** (35):23801-23810.
- Garnica M, Houdusse F, Claude Yvin J, Garcia-Mina JM (2009) - Nitrate supply induces changes in polyamine content and ethylene production in wheat plants grown with ammonium. *Plant Physiology* **166** (4):363-374.
- Garzón M, Eifler K, Faust A, Scheel H, Hofmann K, Koncz C, Yephremov A, Bachmair A (2007) - *PRT6/AT5g02310* encodes an Arabidopsis ubiquitin ligase of the N-end rule pathway with arginine specificity and is not the *CER3* locus. *FEBS Letters* **581** (17):3189-3196.
- Gasch P, Fundinger M, Muller JT, Lee T, Bailey-Serres J, Mustroph A (2016) - Redundant ERF-VII transcription factors bind to an evolutionarily conserved cis-motif to regulate hypoxia-responsive gene expression in Arabidopsis. *Plant Cell* **28** (1):160-180.
- Gay C, Corbineau F, Côme D (1991) - Effects of temperature and oxygen on seed germination and seedling growth in sunflower (*Helianthus annuus* L.). *Environmental and Experimental Botany* **31** (2):193-200.
- Gazzarrini S, McCourt P (2001) - Genetic interactions between ABA, ethylene and sugar signaling pathways. *Current Opinion in Plant Biology* **4** (5):387-391.
- Gazzarrini S, Tsuchiya Y, Lumba S, Okamoto M, McCourt P (2004) - The transcription factor *fusca3* controls developmental timing in Arabidopsis through the hormones gibberellin and abscisic acid. *Developmental Cell* **7** (3):373-385.
- Geneve RL, Wood L (2008) - The relationship between ethylene and dormancy release in Echinacea seeds. *Acta Horticulturae* **771**:33-35.
- Gianinetti A, Laarhoven LJJ, Persijn ST, Harren FJM, Petruzzelli L (2007) - Ethylene production is associated with germination but not seed dormancy in red rice. *Annals of Botany* **99** (4):735-745.
- Gibbs DJ, Bailey M, Tedds HM, Holdsworth MJ (2016) - From start to finish: Amino-terminal protein modifications as degradation signals in plants. *New Phytologist* **211** (4):1188-1194.
- Gibbs DJ, Conde JV, Berckhan S, Prasad G, Mendiondo GM, Holdsworth MJ (2015) - Group VII ethylene response factors coordinate oxygen and nitric oxide signal transduction and stress responses in plants. *Plant Physiology* **169** (1):23-31.
- Gibbs DJ, Isa NM, Movahedi M, Lozano-Juste J, Mendiondo GM, Berckhan S, Marin-de la Rosa N, Conde JV, Correia CS, Pearce SP, Bassel GW, Hamali B, Talloji P, Tome

- DFA, Coego A, Beynon J, Alabadi D, Bachmair A, Leon J, Gray JE, Theodoulou FL, Holdsworth MJ (2014) - Nitric oxide sensing in plants is mediated by proteolytic control of group VII ERF transcription factors. *Molecular Cell* **53** (3):369-379.
- Gibbs DJ, Lee SC, Isa NM, Gramuglia S, Fukao T, Bassel GW, Correia CS, Corbineau F, Theodoulou FL, Bailey-Serres J, Holdsworth MJ (2011) - Homeostatic response to hypoxia is regulated by the N-end rule pathway in plants. *Nature* **479** (7373):415-418.
- Gibbs DJ, Tedds HM, Labandera A-M, Bailey M, White MD, Hartman S, Sprigg C, Mogg SL, Osborne R, Dambire C, Boeckx T, Paling Z, Voesenek LACJ, Flashman E, Holdsworth MJ (2018) - Oxygen-dependent proteolysis regulates the stability of angiosperm polycomb repressive complex 2 subunit VERNALIZATION 2. *Nature Communications* **9** (1):5438.
- Gniazdowska A, Dobrzyńska U, Babańczyk T, Bogatek R (2007) - Breaking the apple embryo dormancy by nitric oxide involves the stimulation of ethylene production. *Planta* **225** (4):1051-1057.
- Goggin DE, Steadman KJ. Blue and green are frequently seen: responses of seeds to short- and mid-wavelength light. *Seed Science Research*. 2011;22(1):27-35.
- Gorecki RJ, Ashino H, Satoh S, Esashi Y (1991) - Ethylene production in pea and cocklebur seeds of differing vigour. *Journal of Experimental Botany* **42** (236):407-414.
- Gorim L, Asch F (2015) - Seed coating reduces respiration losses and affects sugar metabolism during germination and early seedling growth in cereals. *Functional Plant Biology* **42** (2):209-218.
- Gorim L, Asch F (2017) - Seed coating increases seed moisture uptake and restricts embryonic oxygen availability in germinating cereal seeds. *Biology* **6** (2):31.
- Graciet E, Walter F, O'Maoileidigh DS, Pollmann S, Meyerowitz EM, Varshavsky A, Wellmer F (2009) - The N-end rule pathway controls multiple functions during Arabidopsis shoot and leaf development. *Proceedings of the National Academy of Sciences* **106** (32):13618-13623.
- Graciet E, Wellmer F (2010) - The plant N-end rule pathway: Structure and functions. *Trends in Plant Science* **15** (8):447-453.
- Graeber K, Nakabayashi K, Miatton E, Leubner-Metzger G, Soppe WJ (2012) - Molecular mechanisms of seed dormancy. *Plant Cell Environment* **35** (10):1769-1786.
- Grefen C, Städele K, Růžička K, Obrdlík P, Harter K, Horák J (2008) - Subcellular localization and in vivo interactions of the *Arabidopsis thaliana* ethylene receptor family members. *Molecular Plant* **1** (2):308-320.

- Gu C, Guo Z-H, Hao P-P, Wang G-M, Jin Z-M, Zhang S-L (2017) - Multiple regulatory roles of AP2/ERF transcription factor in angiosperm. *Botanical studies* **58**:6.
- Gubler F, Hughes T, Waterhouse P, Jacobsen J (2008) - Regulation of dormancy in barley by blue light and after-ripening: Effects on abscisic acid and gibberellin metabolism. *Plant Physiology* **147** (2):886-896.
- Guo H, Ecker JR (2003) - Plant responses to ethylene gas are mediated by SCF(EBF1/EBF2)-dependent proteolysis of EIN3 transcription factor. *Cell* **115** (6):667-677.
- Gutierrez L, Van Wuytswinkel O, Castelain M, Bellini C (2007) - Combined networks regulating seed maturation. *Trends in Plant Science* **12** (7):294-300.
- Guzman P, Ecker JR (1990) - Exploiting the triple response of Arabidopsis to identify ethylene-related mutants. *The Plant Cell* **2** (6):513-523.
- Hall AE, Findell JL, Schaller GE, Sisler EC, Bleecker AB (2000) - Ethylene perception by the ERS1 protein in Arabidopsis. *Plant Physiology* **123** (4):1449-1457
- Hall BP, Shakeel SN, Amir M, Haq NU, Qu X, Schaller GE (2012) - Histidine kinase activity of the ethylene receptor ETR1 facilitates the ethylene response in Arabidopsis. *Plant Physiology* **159** (2):682-695
- Hallett B, Bewley JD (2002) - Membranes and seed dormancy: Beyond the anaesthetic hypothesis. *Seed Science Research* **12**:69-82.
- Hao D, Ohme-Takagi M, Sarai A (1998) - Unique mode of gcc box recognition by the DNA-binding domain of ethylene-responsive element-binding factor (ERF domain) in plant. *Journal of Biological Chemistry* **273** (41):26857-26861.
- Hao D, Yamasaki K, Sarai A, Ohme-Takagi M (2002) - Determinants in the sequence specific binding of two plant transcription factors, CBF1 and NtERF2, to the DRE and GCC motifs. *Biochemistry* **41** (13):4202-4208.
- Hass C, Lohrmann J, Albrecht V, Sweere U, Hummel F, Yoo SD, Hwang I, Zhu T, Schäfer E, Kudla J, Harter K (2004) - The response regulator 2 mediates ethylene signalling and hormone signal integration in Arabidopsis. *The EMBO Journal* **23** (16):3290-3302.
- Hauvermale AL, Ariizumi T, Steber CM (2012) - Gibberellin signaling: A theme and variations on DELLA repression. *Plant Physiology* **160** (1):83-92.
- Heidari Z, Kamkar B, Masoud Sinaky J (2014) - Influence of temperature on seed germination response of fennel. *Advances in Plants and Agriculture Research* **1** (5):00032.

- Hilhorst H, E. Finch-Savage W, Buitink J, Bolingue W, Leubner-Metzger G (2010) - Dormancy in plant seeds. In: Lubzens E, Cerda J, Clark M (eds) *Dormancy and Resistance in Harsh Environments*, Springer Verlag, Berlin, Heidelberg, pp 43-67.
- Hilhorst HWM (1998) - The regulation of secondary dormancy. The membrane hypothesis revisite. *Seed Science Research* **8** (2):77-90.
- Hirayama T, Kieber JJ, Hirayama N, Kogan M, Guzman P, Nourizadeh S, Alonso JM, Dailey WP, Dancis A, Ecker JR (1999) - RESPONSIVE-TO-ANTAGONIST1, a Menkes/Wilson disease-related copper transporter, is required for ethylene signaling in Arabidopsis. *Cell* **97** (3):383-393.
- Hobo T, Asada M, Kowyama Y, Hattori T (1999) - ACGT-containing abscisic acid response element (ABRE) and coupling element 3 (CE3) are functionally equivalent. *Plant Journal* **19** (6):679-689.
- Holdsworth MJ, Bentsink L, Soppe WJ (2008) - Molecular networks regulating Arabidopsis seed maturation, after-ripening, dormancy and germination. *New Phytologist* **179** (1):33-54.
- Holman TJ, Jones PD, Russell L, Medhurst A, Ubeda Tomas S, Talloji P, Marquez J, Schmuths H, Tung SA, Taylor I, Footitt S, Bachmair A, Theodoulou FL, Holdsworth MJ (2009) - The N-end rule pathway promotes seed germination and establishment through removal of ABA sensitivity in Arabidopsis. *Proceedings of the National Academy of Sciences* **106** (11):4549-4554.
- Hong G, Zhang W, Li H, Shen X, Guo Z (2014) - Separate enrichment analysis of pathways for up- and downregulated genes. *Journal of The Royal Society Interface* **11** (92):20130950.
- Honěk A, Martinková Z (1992) - The induction of secondary seed dormancy by oxygen deficiency in a barnyard grass *Chinocloa crus-galli*. *Experientia* **48** (9):904-906.
- Hu J, Mitchum MG, Barnaby N, Ayele BT, Ogawa M, Nam E, Lai W-C, Hanada A, Alonso JM, Ecker JR, Swain SM, Yamaguchi S, Kamiya Y, Sun T-P (2008) - Potential sites of bioactive gibberellin production during reproductive growth in Arabidopsis. *The Plant Cell* **20** (2):320-336.
- Hua J, Chang C, Sun Q, Meyerowitz EM (1995) - Ethylene insensitivity conferred by Arabidopsis ers gene. *Science* **269** (5231):1712-1714.
- Hua J, Meyerowitz EM (1998) - Ethylene responses are negatively regulated by a receptor gene family in Arabidopsis thaliana. *Cell* **94** (2):261-271.
- Hua J, Sakai H, Nourizadeh S, Chen QG, Bleecker AB, Ecker JR, Meyerowitz EM (1998) - EIN4 and ERS2 are members of the putative ethylene receptor gene family in Arabidopsis. *The Plant Cell* **10** (8):1321-1332.

- Huang S, Elliott RC, Liu PS, Koduri RK, Blair LC, Bryan KM, Ghosh-Dastidar P, Einarson B, Kendall RL (1987) - Specificity of cotranslational amino-terminal processing of proteins in yeast. *Biochemistry* **26** (25):8242-8246.
- Huang H, Liu B, Liu L, Song S (2017) - Jasmonate action in plant growth and development. *Journal of Experimental Botany* **68** (6):1349-1359.
- Huang P-Y, Catinot J, Zimmerli L (2015) - Ethylene response factors in Arabidopsis immunity. *Journal of Experimental Botany* **67** (5):1231-1241.
- Iglesias-Fernandez R, Matilla AJ (2010) - Genes involved in ethylene and gibberellins metabolism are required for endosperm-limited germination of *Sisymbrium officinale* L. Seeds: Germination in *Sisymbrium officinale* L. Seeds. *Planta* **231** (3):653-664.
- Ishibashi Y, Koda Y, Zheng SH, Yuasa T, Iwaya-Inoue M (2013) - Regulation of soybean seed germination through ethylene production in response to reactive oxygen species. *Annals of Botany* **111** (1):95-102.
- Jin D, Wu M, Li B, Bucker B, Keil P, Zhang S, Li J, Kang D, Liu J, Dong J, Deng XW, Irish V, Wei N (2018) - The COP9 signalosome regulates seed germination by facilitating protein degradation of RGL2 and ABI5. *PLOS Genetics* **14** (2):e1007237.
- Job C, Rajjou L, Lovigny Y, Belghazi M, Job D (2005) - Patterns of protein oxidation in Arabidopsis seeds and during germination. *Plant Physiology* **138** (2):790-802
- Joo S, Liu Y, Lueth A, Zhang S (2008) - MAPK phosphorylation-induced stabilization of ACS6 protein is mediated by the non-catalytic c-terminal domain, which also contains the cis-determinant for rapid degradation by the 26S proteasome pathway. *Plant Journal* **54** (1):129-140.
- Ju C, Chang C (2015) - Mechanistic insights in ethylene perception and signal transduction. *Plant Physiology* **169** (1):85-95.
- Ju C, Yoon GM, Shemansky JM, Lin DY, Ying ZI, Chang J, Garrett WM, Kessenbrock M, Groth G, Tucker ML, Cooper B, Kieber JJ, Chang C (2012) - CTR1 phosphorylates the central regulator EIN2 to control ethylene hormone signaling from the cell membrane to the nucleus in Arabidopsis. *Proceedings of the National Academy of Sciences* **109** (47):19486-19491.
- Junttila O (1974) - Effects of low oxygen concentrations on the germination of *Syringa* seeds. *Zeitschrift für Pflanzenphysiologie* **74** (2):168-171.
- Kanai M, Nishimura M, Hayashi M (2010) - A peroxisomal ABC transporter promotes seed germination by inducing pectin degradation under the control of ABI5. *Plant Journal* **62** (6):936-947.
- Kanno Y, Jikumaru Y, Hanada A, Nambara E, Abrams SR, Kamiya Y, Seo M (2010) - Comprehensive hormone profiling in developing Arabidopsis seeds: Examination of

- the site of ABA biosynthesis, ABA transport and hormone interactions. *Plant and Cell Physiology* **51** (12):1988-2001.
- Karssen CM, Brinkhorst-van der Swan DL, Breeklund AE, Koornneef M (1983) - Induction of dormancy during seed development by endogenous abscisic acid: Studies on abscisic acid deficient genotypes of *Arabidopsis thaliana* (L.) Heynh. *Planta* **157** (2):158-165.
- Kassambara A and Mundt F (2017) - Factoextra: extract and visualize the results of multivariate data analyses. R package version 1.0.5.
- Kermode AR (2005) - Role of abscisic acid in seed dormancy. *Journal of Plant Growth Regulation* **24** (4):319-344.
- Ketring DL, Morgan PW (1969) - Ethylene as a component of the emanations from germinating peanut seeds and its effect on dormant virginia-type seeds. *Plant Physiology* **44** (3):326-330.
- Khan AS, Singh Z (2009) - 1-MCP application suppresses ethylene biosynthesis and retards fruit softening during cold storage of 'tegan blue' japanese plum. *Plant Science* **176** (4):539-544.
- Khan MIR, Trivellini A, Fatma M, Masood A, Francini A, Iqbal N, Ferrante A, Khan NA (2015) - Role of ethylene in responses of plants to nitrogen availability. *Frontiers in Plant Science* **6**:927.
- Kim S-I, Park BS, Yeu SY, Song SI, Song JT, Seo HS (2015) - E3 sumo ligase AtSIZ1 positively regulates SLY1-mediated GA signalling and plant development. *Biochemical Journal* **469** (2):299-314.
- Kimura M, Nambara E (2010) - Stored and neosynthesized mRNA in Arabidopsis seeds: Effects of cycloheximide and controlled deterioration treatment on the resumption of transcription during imbibition. *Plant Molecular Biology* **73** (1):119-129.
- Kolde R (2019) - pheatmap: Pretty Heatmaps. R package version 1.0.12. <https://CRAN.R-project.org/package=pheatmap>.
- Kong L, Cheng J, Zhu Y, Ding Y, Meng J, Chen Z, Xie Q, Guo Y, Li J, Yang S (2015) - Degradation of the ABA co-receptor ABI1 by PUB12/13 U-box E3 ligases. *Nature Communications* **6**:8630.
- Konishi M, Yanagisawa S (2008) - Ethylene signaling in Arabidopsis involves feedback regulation via the elaborate control of *EBF2* expression by EIN3. *Plant Journal* **55** (5):821-831.
- Koretke KK, Lupas AN, Warren PV, Rosenberg M, Brown JR (2000) - Evolution of two-component signal transduction. *Molecular Biology and Evolution* **17** (12):1956-1970.

- Kozłowski T, Gunn C (1972) - Importance and characteristics of seeds. In: Kozłowski T (eds). *Seed Biology-Importance, Development and Germination*. Academic Press, New York, NY and London, 1-20.
- Kucera B, Cohn MA, Leubner-Metzger G (2005) - Plant hormone interactions during seed dormancy release and germination. *Seed Science Research* **15** (4):281-307.
- Kulwal P, Ishikawa G, Benscher D, Feng Z, Yu L-X, Jadhav A, Mehetre S, Sorrells ME (2012) - Association mapping for pre-harvest sprouting resistance in white winter wheat. *Theoretical and Applied Genetics* **125** (4):793-805.
- Kulwal PL, Mir RR, Kumar S, Gupta PK (2010) - QTL analysis and molecular breeding for seed dormancy and pre-harvest sprouting tolerance in bread wheat. *Journal of Plant Biology* **37**:59-74.
- Kushiro T, Okamoto M, Nakabayashi K, Yamagishi K, Kitamura S, Asami T, Hirai N, Koshiba T, Kamiya Y, Nambara E (2004) - The Arabidopsis cytochrome P450 CYP707a encodes ABA 8'-hydroxylases: Key enzymes in ABA catabolism. *EMBO Journal* **23** (7):1647-1656.
- Langella O, Valot B, Balliau T, Blein-Nicolas M, Bonhomme L, Zivy M (2017) - X!Tandempipeline: A tool to manage sequence redundancy for protein inference and phosphosite identification. *Journal of Proteome Research* **16** (2):494-503.
- Lee KE, Heo JE, Kim JM, Hwang CS (2016) - N-terminal acetylation-targeted N-end rule proteolytic system: The Ac/N-end rule pathway. *Molecules and Cells* **39** (3):169-178.
- Lee KP, Piskurewicz U, Tureckova V, Strnad M, Lopez-Molina L (2010) - A seed coat bedding assay shows that RGL2-dependent release of abscisic acid by the endosperm controls embryo growth in Arabidopsis dormant seeds. *Proceedings of the National Academy of Sciences* **107** (44):19108-19113.
- Lee S, Cheng H, King KE, Wang W, He Y, Hussain A, Lo J, Harberd NP, Peng J (2002) - Gibberellin regulates Arabidopsis seed germination via RGL2, a GAI/RGA-like gene whose expression is up-regulated following imbibition. *Genes Development* **16** (5):646-658.
- Lee SY, Hwang EY, Seok HY, Tarte VN, Jeong MS, Jang SB, Moon YH (2015) - Arabidopsis AtERF71/HRE2 functions as transcriptional activator via cis-acting GCC box or DRE/CRT element and is involved in root development through regulation of root cell expansion. *Plant Cell Reports* **34** (2):223-231.
- Lefebvre V, North H, Frey A, Sotta B, Seo M, Okamoto M, Nambara E, Marion-Poll A (2006) - Functional analysis of Arabidopsis NCED6 and NCED9 genes indicates that ABA synthesized in the endosperm is involved in the induction of seed dormancy. *Plant Journal* **45** (3):309-319.

- Lehner A, Mamadou N, Poels P, Côme D, Bailly C, Corbineau F (2008) - Changes in soluble carbohydrates, lipid peroxidation and antioxidant enzyme activities in the embryo during ageing in wheat grains. *Journal of Cereal Science* **47** (3):555-565.
- Leprince O, Pellizzaro A, Berriri S, Buitink J (2016) - Late seed maturation: Drying without dying. *Journal of Experimental Botany* **68** (4):827-841.
- Leubner-Metzger G (2005) - Beta-1,3-glucanase gene expression in low-hydrated seeds as a mechanism for dormancy release during tobacco after-ripening. *Plant Journal* **41** (1):133-145.
- Leymarie J, Bruneaux E, Gibot-Leclerc S, Corbineau F (2006) - Identification of transcripts potentially involved in barley seed germination and dormancy using cDNA-AFLP. *Journal of Experimental Botany* **58** (3):425-437.
- Leymarie J, Vitkauskaite G, Hoang HH, Gendreau E, Chazoule V, Meimoun P, Corbineau F, El-Maarouf-Bouteau H, Bailly C (2012) - Role of reactive oxygen species in the regulation of Arabidopsis seed dormancy. *Plant and Cell Physiology* **53** (1):96-106.
- Li W, Ma M, Feng Y, Li H, Wang Y, Ma Y, Li M, An F, Guo H (2015) - EIN2-directed translational regulation of ethylene signaling in Arabidopsis. *Cell* **163** (3):670-683.
- Li X, Chen T, Li Y, Wang Z, Cao H, Chen F, Li Y, Soppe WJJ, Li W, Liu Y (2019) - ETR1/RDO3 regulates seed dormancy by relieving the inhibitory effect of the ERF12-TPL complex on *DELAY OF GERMINATION1* Expression. *The Plant Cell* **31** (4):832-847.
- Licausi F, Kosmacz M, Weits DA, Giuntoli B, Giorgi FM, Voeselek LA, Perata P, van Dongen JT (2011) - Oxygen sensing in plants is mediated by an N-end rule pathway for protein destabilization. *Nature* **479** (7373):419-422.
- Licausi F, Ohme-Takagi M, Perata P (2013) - APETALA2/ethylene responsive factor (AP2/ERF) transcription factors: Mediators of stress responses and developmental programs. *New Phytologist* **199** (3):639-649.
- Licausi F, van Dongen JT, Giuntoli B, Novi G, Santaniello A, Geigenberger P, Perata P (2010) - HRE1 and HRE2, two hypoxia-inducible ethylene response factors, affect anaerobic responses in *Arabidopsis thaliana*. *Plant Journal* **62** (2):302-315.
- Lim S, Park J, Lee N, Jeong J, Toh S, Watanabe A, Kim J, Kang H, Kim DH, Kawakami N, Choi G (2013) - ABA-INSENSITIVE3, ABA-INSENSITIVE5, and DELLAs interact to activate the expression of *SOMNUS* and other high-temperature-inducible genes in imbibed seeds in Arabidopsis. *Plant Cell* **25** (12):4863-4878.
- Linkies A, Leubner-Metzger G (2012) - Beyond gibberellins and abscisic acid: How ethylene and jasmonates control seed germination. *The Plant Cell Reports* **31** (2):253-270.

- Linkies A, Müller K, Morris K, Turečková V, Wenk M, Cadman CSC, Corbineau F, Strnad M, Lynn JR, Finch-Savage WE (2009a) - Ethylene interacts with abscisic acid to regulate endosperm rupture during germination: A comparative approach using *Lepidium sativum* and *Arabidopsis thaliana*. *The Plant Cell* **21** (12):3803-3822.
- Linster E, Stephan I, Bienvenut WV, Maple-Grodem J, Myklebust LM, Huber M, Reichelt M, Sticht C, Moller SG, Meinnel T, Arnesen T, Giglione C, Hell R, Wirtz M (2015) - Downregulation of N-terminal acetylation triggers ABA-mediated drought responses in *Arabidopsis*. *Nature Communications* **6**:7640.
- Liu A, Gao F, Kanno Y, Jordan MC, Kamiya Y, Seo M, Ayele BT (2013) - Regulation of wheat seed dormancy by after-ripening is mediated by specific transcriptional switches that induce changes in seed hormone metabolism and signaling. *Plos One* **8** (2):e56570.
- Liu M, Gomes BL, Mila I, Purgatto E, Peres LEP, Frasse P, Maza E, Zouine M, Roustan J-P, Bouzayen M, Pirrello J (2016) - Comprehensive profiling of ethylene response factor expression identifies ripening-associated ERF genes and their link to key regulators of fruit ripening in tomato. *Plant Physiology* **170** (3):1732-1744.
- Liu Q, Wen C-K (2012) - *Arabidopsis* ETR1 and ERS1 differentially repress the ethylene response in combination with other ethylene receptor genes. *Plant Physiology* **158** (3):1193-1207.
- Liu Q, Xu C, Wen C-K (2010) - Genetic and transformation studies reveal negative regulation of ERS1 ethylene receptor signaling in *Arabidopsis*. *BMC Plant Biology* **10**:60.
- Liu X, Hu P, Huang M, Tang Y, Li Y, Li L, Hou X (2016) - The NF-YC–RGL2 module integrates GA and ABA signalling to regulate seed germination in *Arabidopsis*. *Nature Communications* **7**:12768.
- Liu X, Shiomi S, Nakatsuka A, Kubo Y, Nakamura R, Inaba A (1999) - Characterization of ethylene biosynthesis associated with ripening in banana fruit. *Plant Physiology* **121** (4):1257-1266.
- Liu Y, Shi L, Ye N, Liu R, Jia W, Zhang J (2009) - Nitric oxide-induced rapid decrease of abscisic acid concentration is required in breaking seed dormancy in *Arabidopsis*. *New Phytologist* **183** (4):1030-1042.
- Liu Y, Zhang S (2004) - Phosphorylation of 1-aminocyclopropane-1-carboxylic acid synthase by MPK6, a stress-responsive mitogen-activated protein kinase, induces ethylene biosynthesis in *Arabidopsis*. *The Plant cell* **16** (12):3386-3399.
- Lohrmann J, Harter K (2002) - Plant two-component signaling systems and the role of response regulators. *Plant Physiology* **128** (2):363-369.

- Ma B, Yin CC, He SJ, Lu X, Zhang WK, Lu TG, Chen SY, Zhang JS (2014) - Ethylene-induced inhibition of root growth requires abscisic acid function in rice (*oryza sativa* L.) seedlings. *PLOS Genetics* **10** (10):e1004701.
- Ma Y, Szostkiewicz I, Korte A, Moes D, Yang Y, Christmann A, Grill E (2009) - Regulators of PP2C phosphatase activity function as abscisic acid sensors. *Science* **324** (5930):1064-1068.
- Majovsky P, Naumann C, Lee CW, Lassowskat I, Trujillo M, Dissmeyer N, Hoehenwarter W (2014) - Targeted proteomics analysis of protein degradation in plant signaling on an LTQ-Orbitrap mass spectrometer. *Journal of Proteome Research* **13** (10):4246-4258.
- Manz B, Müller K, Kucera B, Volke F, Leubner-Metzger G (2005) - Water uptake and distribution in germinating tobacco seeds investigated in vivo by nuclear magnetic resonance imaging. *Plant Physiology* **138** (3):1538-1551.
- Marin-de la Rosa N, Sotillo B, Miskolczi P (2014) - Large-scale identification of gibberellin-related transcription factors defines group VII ethylene response factors as functional DELLA partners. *Plant Physiology* **166** (2):1022-1032.
- Matilla AJ, Matilla-Vázquez MA (2008) - Involvement of ethylene in seed physiology. *Plant Science* **175** (1):87-97.
- Mazzucotelli E, Belloni S, Marone D, De Leonardis AM, Guerra D, Fonzo N, Cattivelli L, Mastrangelo AM (2006) - The E3 ubiquitin ligase gene family in plants: Regulation by degradation. *Current Genomics* **7** (8):509-522.
- McDaniel BK, Binder BM (2012) - ETHYLENE RECEPTOR 1 (ETR1) is sufficient and has the predominant role in mediating inhibition of ethylene responses by silver in *Arabidopsis thaliana*. *Journal of Biological Chemistry* **287** (31):26094-26103.
- McGill CR, Park MJ, Williams WM, Outred HA, Nadarajan J (2018) - The mechanism of seed coat-imposed dormancy revealed by oxygen uptake in Chatham Island forget-me-not *Myosotidium hortensia* (Decne.) Baill. *New Zealand Journal of Botany* **56** (1):38-50.
- Meimoun P, Mordret E, Langlade NB, Balzergue S, Arribat S, Bailly C, El-Maarouf-Bouteau H (2014) - Is gene transcription involved in seed dry after-ripening? *Plos One* **9** (1):e86442.
- Melcher K, Xu Y, Ng L-M, Zhou XE, Soon F-F, Chinnusamy V, Suino-Powell KM, Kovach A, Tham FS, Cutler SR, Li J, Yong E-L, Zhu J-K, Xu HE (2010) - Identification and mechanism of ABA receptor antagonism. *Nature Structural & Molecular Biology* **17** (9):1102-1108.
- Mendonzo GM, Gibbs DJ, Szurman-Zubrzycka M, Korn A, Marquez J, Szarejko I, Maluszynski M, King J, Axcell B, Smart K, Corbineau F, Holdsworth MJ (2016) -

- Enhanced waterlogging tolerance in barley by manipulation of expression of the N-end rule pathway E3 ligase PROTEOLYSIS6. *Plant Biotechnology Journal* **14** (1):40-50.
- Mène-Saffrané L, Jones AD, DellaPenna D (2010) - Plastochromanol-8 and tocopherols are essential lipid-soluble antioxidants during seed desiccation and quiescence in *Arabidopsis*. *Proceedings of the National Academy of Sciences of the United States of America* **107** (41):17815-17820.
- Meng X, Xu J, He Y, Yang K-Y, Mordorski B, Liu Y, Zhang S (2013) - Phosphorylation of an ERF transcription factor by *Arabidopsis* MPK3/MPK6 regulates plant defense gene induction and fungal resistance. *The Plant Cell* **25** (3):1126-1142.
- Merchante C, Alonso JM, Stepanova AN (2013) - Ethylene signaling: Simple ligand, complex regulation. *Current Opinion in Plant Biology* **16** (5):554-560.
- Millar AA, Jacobsen JV, Ross JJ, Helliwell CA, Poole AT, Scofield G, Reid JB, Gubler F (2006) - Seed dormancy and ABA metabolism in *Arabidopsis* and barley: The role of ABA 8'-hydroxylase. *Plant Journal* **45** (6):942-954.
- Miransari M, Smith DL (2014) - Plant hormones and seed germination. *Environmental and Experimental Botany* **99**:110-121.
- Miura K, Lee J, Jin JB, Yoo CY, Miura T, Hasegawa PM (2009) - Sumoylation of ABI5 by the *Arabidopsis* sumo E3 ligase SIZ1 negatively regulates abscisic acid signaling. *Proceedings of the National Academy of Sciences* **106** (13):5418-5423.
- Miyoshi K, Sato T (1997) - The effects of ethanol on the germination of seeds of Japonica and Indica rice (*Oryza sativa* L.) under anaerobic and aerobic conditions. *Annals of Botany* **79** (4):391-395.
- Mohamed, Ejeta, Butler, Housley (2010) - Moisture content and dormancy in *Striga asiatica* seeds. *Weed Research* **38**:257-265.
- Muller K, Tintelnot S, Leubner-Metzger G (2006) - Endosperm-limited brassicaceae seed germination: Abscisic acid inhibits embryo-induced endosperm weakening of *Lepidium sativum* (cress) and endosperm rupture of cress and *Arabidopsis thaliana*. *Plant and Cell Physiology* **47** (7):864-877.
- Murase K, Hirano Y, Sun T-p, Hakoshima T (2008) - Gibberellin-induced DELLA recognition by the gibberellin receptor GID1. *Nature* **456** (7221):459-463.
- Mustroph A, Zanetti ME, Jang CJH, Holtan HE, Repetti PP, Galbraith DW, Girke T, Bailey-Serres J (2009) - Profiling transcriptomes of discrete cell populations resolves altered cellular priorities during hypoxia in *Arabidopsis*. *Proceedings of the National Academy of Sciences of the United States of America* **106** (44):18843-18848.

- Nakano T, Suzuki K, Fujimura T, Shinshi H (2006) - Genome-wide analysis of the ERF gene family in Arabidopsis and rice. *Plant Physiology* **140** (2):411-432.
- Nambara E, Okamoto M, Tatematsu K, Yano R, Seo M, Kamiya Y (2010) - Abscisic acid and the control of seed dormancy and germination. *Seed Science Research* **20** (2):55-67
- Narsai R, Law SR, Carrie C, Xu L, Whelan J (2011) - In-depth temporal transcriptome profiling reveals a crucial developmental switch with roles for RNA processing and organelle metabolism that are essential for germination in Arabidopsis. *Plant Physiology* **157** (3):1342-1362.
- Nelson DC, Riseborough J-A, Flematti GR, Stevens J, Ghisalberti EL, Dixon KW, Smith SM (2009) - Karrikins discovered in smoke trigger Arabidopsis seed germination by a mechanism requiring gibberellic acid synthesis and light. *Plant Physiology* **149** (2):863-873.
- Nelson DC, Scaffidi A, Dun EA, Waters MT, Flematti GR, Dixon KW, Beveridge CA, Ghisalberti EL, Smith SM (2011) - F-box protein MAX2 has dual roles in karrikin and strigolactone signaling in *Arabidopsis thaliana*. *Proceedings of the National Academy of Sciences* **108** (21):8897-8902.
- Ng LM, Melcher K, Teh BT, Xu HE (2014) - Abscisic acid perception and signaling: Structural mechanisms and applications. *Acta Pharmacologica Sinica* **35** (5):567-584.
- Nguyen KT, Lee CS, Mun SH, Truong NT, Park SK, Hwang CS (2019) - N-terminal acetylation and the N-end rule pathway control degradation of the lipid droplet protein PLIN2. *Journal of Biological Chemistry* **294** (1):379-388.
- Nguyen KT, Mun SH, Lee CS, Hwang CS (2018) - Control of protein degradation by N-terminal acetylation and the N-end rule pathway. *Experimental and Molecular Medicine* **50** (7):91.
- Nguyen T-P, Keizer P, van Eeuwijk F, Smeekens S, Bentsink L (2012) - Natural variation for seed longevity and seed dormancy are negatively correlated in Arabidopsis. *Plant Physiology* **160** (4):2083-2092.
- Nonogaki H (2014) - Seed dormancy and germination-emerging mechanisms and new hypotheses. *Frontiers in Plant Science* **5**:233.
- Nonogaki H, Bassel GW, Bewley JD (2010) - Germination—still a mystery. *Plant Science* **179** (6):574-581.
- O'Malley RC, Bleecker AB (2003) - Ethylene perception in Arabidopsis by the ETR1 receptor family: Evaluating a possible role for two-component signaling in plant

- ethylene responses. In: Inouye M and Dutta R (eds) Histidine kinases in signal transduction. Academic Press, San Diego, CA, USA, pp 439-457.
- Oh E, Yamaguchi S, Hu J, Yusuke J, Jung B, Paik I, Lee HS, Sun TP, Kamiya Y, Choi G (2007) - PIL5, a phytochrome-interacting bHLH protein, regulates gibberellin responsiveness by binding directly to the GAI and RGA promoters in Arabidopsis seeds. *The Plant Cell* **19** (4):1192-1208.
- Ohga I (1926) - The germination of century-old and recently harvested indian lotus fruits, with special reference to the effect of oxygen supply. *American Journal of Botany* **13** (10):754-759.
- Ohme-Takagi M, Shinshi H (1995) - Ethylene-inducible DNA binding proteins that interact with an ethylene-responsive element. *The Plant Cell* **7** (2):173-182.
- Olmedo G, Guo H, Gregory BD, Nourizadeh SD, Aguilar-Henonin L, Li H, An F, Guzman P, Ecker JR (2006) - ETHYLENE-INSENSITIVE5 encodes a 5'→3' exoribonuclease required for regulation of the EIN3-targeting F-box proteins EBF1/2. *Proceedings of the National Academy of Sciences of the United States of America* **103** (36):13286-13293.
- Oracz K, El-Maarouf-Bouteau H, Kranner I, Bogatek R, Corbineau F, Bailly C (2009) - The mechanisms involved in seed dormancy alleviation by hydrogen cyanide unravel the role of reactive oxygen species as key factors of cellular signaling during germination. *Plant Physiology* **150** (1):494-505.
- Oracz K, El-Maarouf Bouteau H, Farrant JM, Cooper K, Belghazi M, Job C, Job D, Corbineau F, Bailly C (2007) - ROS production and protein oxidation as a novel mechanism for seed dormancy alleviation. *Plant Journal* **50** (3):452-465.
- Ou B, Yin K-Q, Liu S-N, Yang Y, Gu T, Wing Hui JM, Zhang L, Miao J, Kondou Y, Matsui M, Gu H-Y, Qu L-J (2011) - A high-throughput screening system for Arabidopsis transcription factors and its application to Med25-dependent transcriptional regulation. *Molecular Plant* **4** (3):546-555.
- Park HY, Seok HY, Woo DH, Lee SY, Tarte VN, Lee EH, Lee CH, Moon YH (2011) - AtERF71/HRE2 transcription factor mediates osmotic stress response as well as hypoxia response in Arabidopsis. *Biochemical and Biophysical Research Communications* **414** (1):135-141.
- Pekrun C, Lutman PJW, Baeumer K (1997) - Induction of secondary dormancy in rape seeds (*Brassica napus* L.) by prolonged imbibition under conditions of water stress or oxygen deficiency in darkness. *European Journal of Agronomy* **6** (3):245-255.
- Perata P, Voesenek LA (2007) - Submergence tolerance in rice requires SUB1a, an ethylene-response-factor-like gene. *Trends in Plant Science* **12** (2):43-46.

- Pirrello J, Jaimes-Miranda F, Sanchez-Ballesta MT, Tournier B, Khalil-Ahmad Q, Regad F, Latche A, Pech JC, Bouzayen M (2006) - Sl-ERF2, a tomato ethylene response factor involved in ethylene response and seed germination. *Plant and Cell Physiology* **47** (9):1195-1205.
- Piya S, Binder BM, Hewezi T (2019) - Canonical and noncanonical ethylene signaling pathways that regulate Arabidopsis susceptibility to the cyst nematode *Heterodera schachtii*. *New Phytologist* **221** (2):946-959.
- Plummer JA, Roger AD, Turner DW, Bell DT (2001) - Light, nitrogenous compounds, smoke and GA₃ break dormancy and enhance germination in the australian everlasting daisy, *Shoena filifolia* subsp. *Subulifolia*. *Seed Science and Technology* **29**:321-330.
- Pons TL (2000) - Seed responses to light. In: Fenner M (eds) *Seeds: The Ecology of Regeneration in Plant Communities*, CABI Publishing, Wallingford, UK, pp 237-260.
- Potuschak T, Vansiri A, Binder BM, Lechner E, Vierstra RD, Genschik P (2006) - The exoribonuclease XRN4 is a component of the ethylene response pathway in Arabidopsis. *The Plant Cell* **18** (11):3047-3057.
- Probert, R.J. (2000) The Role of Temperature in the Regulation of Seed Dormancy and Germination. In: Fenner, M (eds) *Seeds: The Ecology of Regeneration in Plant Communities*, CABI Publishing, Wallingford, UK, pp 261-292.
- Qiao H, Chang KN, Yazaki J, Ecker JR (2009) - Interplay between ethylene, ETP1/ETP2 F-box proteins, and degradation of EIN2 triggers ethylene responses in Arabidopsis. *Genes Development* **23** (4):512-521.
- Qiu LP, Xie F, Yu J, Wen CK (2012) - Arabidopsis RTE1 is essential to ethylene receptor ETR1 amino-terminal signaling independent of CTR1. *Plant Physiology* **159** (3):1263-1276.
- Qu X, Hall BP, Gao Z, Schaller GE (2007) - A strong constitutive ethylene-response phenotype conferred on Arabidopsis plants containing null mutations in the ethylene receptors ETR1 and ERS1. *BMC Plant Biology* **7** (1):3.
- Radivojac P, Vacic V, Haynes C, Cocklin RR, Mohan A, Heyen JW, Goebel MG, Iakoucheva LM (2010) - Identification, analysis, and prediction of protein ubiquitination sites. *Proteins* **78** (2):365-380.
- Rajjou L, Duval M, Gallardo K, Catusse J, Bally J, Job C, Job D (2012) - Seed germination and vigor. *Annual Review of Plant Biology* **63** (1):507-533.

- Rajjou L, Lovigny Y, Groot SPC, Belghazi M, Job C, Job D (2008) - Proteome-wide characterization of seed aging in Arabidopsis: A comparison between artificial and natural aging protocols. *Plant Physiology* **148** (1):620-641.
- Raz V, Bergervoet JH, Koornneef M (2001) - Sequential steps for developmental arrest in Arabidopsis seeds. *Development* **128** (2):243-252.
- Reeves WM, Lynch TJ, Mobin R, Finkelstein RR (2011) - Direct targets of the transcription factors ABA-INSENSITIVE(ABI)4 and ABI5 reveal synergistic action by ABI4 and several bZIP ABA response factors. *Plant Molecular Biology* **75** (4-5):347-363.
- Resnick JS, Wen C-K, Shockey JA, Chang C (2006) - REVERSION-TO-ETHYLENE SENSITIVITY1, a conserved gene that regulates ethylene receptor function in Arabidopsis. *Proceedings of the National Academy of Sciences* **103** (20):7917-7922.
- Riber W, Müller J, Visser E, Sasidharan R, A.C.J. Voesenek L, Mustroph A (2015) - The *greening after extended darkness1* is an N-end rule pathway mutant with high tolerance to submergence and starvation. *Plant Physiology* **167**(4):1616-1629.
- Riechmann JL, Heard J, Martin G, Reuber L, Jiang C, Keddie J, Adam L, Pineda O, Ratcliffe OJ, Samaha RR, Creelman R, Pilgrim M, Broun P, Zhang JZ, Ghandehari D, Sherman BK, Yu G (2000) - Arabidopsis transcription factors: Genome-wide comparative analysis among eukaryotes. *Science* **290** (5499):2105-2110.
- Riechmann JL, Meyerowitz EM (1998) - The AP2/EREBP family of plant transcription factors. *Biological Chemistry* **379**:633-646.
- Roberts EH (1988) - Temperature and seed germination. *Symposia of the Society for Experimental Biology* **42**:109-132.
- Rolletschek H, Stangelmayer A, Borisjuk L (2009) - Methodology and significance of microsensor-based oxygen mapping in plant seeds – an overview. *Sensors (Basel, Switzerland)* **9**:3218-3227.
- Roman G, Lubarsky B, Kieber JJ, Rothenberg M, Ecker JR (1995) - Genetic analysis of ethylene signal transduction in *Arabidopsis thaliana*: Five novel mutant loci integrated into a stress response pathway. *Genetics* **139** (3):1393-1409.
- Ruduś I, Sasiak M, Kępczyński J (2013) - Regulation of ethylene biosynthesis at the level of 1-aminocyclopropane-1-carboxylate oxidase (ACO) gene. *Acta Physiologiae Plantarum* **35** (2):295-307.
- Sadanandom A, Bailey M, Ewan R, Lee J, Nelis S (2012) - The ubiquitin–proteasome system: Central modifier of plant signalling. *New Phytologist* **196** (1):13-28.
- Sakai H, Hua J, Chen QG, Chang C, Medrano LJ, Bleecker AB, Meyerowitz EM (1998) - ETR2 is an ETR1-like gene involved in ethylene signaling in Arabidopsis. *Proceedings of the National Academy of Sciences* **95** (10):5812-5817.

- Sakuma Y, Liu Q, Dubouzet JG, Abe H, Shinozaki K, Yamaguchi-Shinozaki K (2002) - DNA-binding specificity of the ERF/AP2 domain of Arabidopsis drebs, transcription factors involved in dehydration- and cold-inducible gene expression. *Biochemical and Biophysical Research Communications* **290** (3):998-1009.
- Samimy C, Taylor AG (1983) - Influence of seed quality on ethylene production of germinating snap beans. *Journal of the American Society for Horticultural Science* **108**:767-769.
- Santner A, Estelle M (2010) - The ubiquitin-proteasome system regulates plant hormone signaling. *The Plant Journal* **61** (6):1029-1040.
- Sasidharan R, Mustrup A (2011) - Plant oxygen sensing is mediated by the N-end rule pathway: A milestone in plant anaerobiosis. *The Plant Cell* **23** (12):4173-4183.
- Sato S, Esashi Y (2006) - α -aminoisobutyric acid, propyl gallate and cobalt ion and the mode of inhibition of ethylene production by cotyledonary segments of cocklebur seeds. *Physiologia Plantarum* **57**:521-526.
- Schaller G, Binder B (2017) - Inhibitors of ethylene biosynthesis and signaling. In: Binder BM, Eric Schaller G (eds) *Ethylene Signaling: Methods and Protocols*. Springer New York, New York, USA, pp 223–235.
- Schaller GE, Ladd AN, Lanahan MB, Spanbauer JM, Bleecker AB (1995) - The ethylene response mediator ETR1 from Arabidopsis forms a disulfide-linked dimer. *Journal of Biological Chemistry* **270** (21):12526-12530.
- Scharein B, Groth G (2011) - Phosphorylation alters the interaction of the Arabidopsis phosphotransfer protein AHP1 with its sensor kinase ETR1. *Plos One* **6** (9):e24173.
- Seo M, Hanada A, Kuwahara A, Endo A, Okamoto M, Yamauchi Y, North H, Marion-Poll A, Sun TP, Koshiba T, Kamiya Y, Yamaguchi S, Nambara E (2006) - Regulation of hormone metabolism in Arabidopsis seeds: Phytochrome regulation of abscisic acid metabolism and abscisic acid regulation of gibberellin metabolism. *Plant Journal* **48** (3):354-366.
- Shakeel SN, Gao Z, Amir M, Chen Y-F, Rai MI, Haq NU, Schaller GE (2015) - Ethylene regulates levels of ethylene receptor/CTR1 signaling complexes in *Arabidopsis thaliana*. *The Journal of Biological Chemistry* **290** (19):12415-12424.
- Shakeel SN, Wang X, Binder BM, Schaller GE (2013) - Mechanisms of signal transduction by ethylene: Overlapping and non-overlapping signalling roles in a receptor family. *AoB Plants* **5**:plt010.
- Sharif-Zadeh F, Murdoch AJ (2001) - The effects of temperature and moisture on after-ripening of *Cenchrus ciliaris* seeds. *Journal of Arid Environments* **49** (4):823-831.

- Shemesh R, Novik A, Cohen Y (2010) - Follow the leader: Preference for specific amino acids directly following the initial methionine in proteins of different organisms. *Genomics Proteomics Bioinformatics* **8** (3):180-189.
- Shu K, Liu XD, Xie Q, He ZH (2016) - Two faces of one seed: Hormonal regulation of dormancy and germination. *Molecular Plant* **9** (1):34-45.
- Shull CA (1914) - The role of oxygen in germination. *Botanical Gazette* **57** (1):64-69.
- Simon MC, Keith B (2008) - The role of oxygen availability in embryonic development and stem cell function. *Nature Reviews Molecular Cell Biology* **9** (4):285-296.
- Simsek S, Ohm JB, Lu H, Rugg M, Berzonsky W, Alamri MS, Mergoum M (2014) - Effect of pre-harvest sprouting on physicochemical changes of proteins in wheat. *Journal of the Science of Food and Agriculture* **94** (2):205-212.
- Siriwitayawan G, Geneve RL, Downie AB (2003) - Seed germination of ethylene perception mutants of tomato and Arabidopsis. *Seed Science Research* **13** (4):303-314.
- Skubacz A, Daszkowska-Golec A, Szarejko I (2016) - The role and regulation of ABI5 (ABA-INSENSITIVE 5) in plant development, abiotic stress responses and phytohormone crosstalk. *Frontiers in Plant Science* **7**:1884.
- Sliwinska E, Bassel GW, Bewley JD (2009) - Germination of *Arabidopsis thaliana* seeds is not completed as a result of elongation of the radicle but of the adjacent transition zone and lower hypocotyl. *Journal of Experimental Botany* **60** (12):3587-3594.
- Solano R, Stepanova A, Chao Q, Ecker JR (1998) - Nuclear events in ethylene signaling: A transcriptional cascade mediated by ETHYLENE-INSENSITIVE3 and ETHYLENE-RESPONSE-FACTOR1. *Genes & Development* **12** (23):3703-3714.
- Song C-P, Agarwal M, Ohta M, Guo Y, Halfter U, Wang P, Zhu J-K (2005) - Role of an Arabidopsis AP2/EREBP-type transcriptional repressor in abscisic acid and drought stress responses. *The Plant Cell* **17** (8):2384-2396.
- Soon FF, Ng LM, Zhou XE, West GM, Kovach A, Tan MH, Suino-Powell KM, He Y, Xu Y, Chalmers MJ, Brunzelle JS, Zhang H, Yang H, Jiang H, Li J, Yong EL, Cutler S, Zhu JK, Griffin PR, Melcher K, Xu HE (2012) - Molecular mimicry regulates ABA signaling by SnRK2 kinases and PP2C phosphatases. *Science* **335** (6064):85-88.
- Soundararajan P, Manivannan A, Jeong BR (2017) - Reactive oxygen species signaling and seed germination. In: Singh VP, Singh S, Tripathi DK, Prasad SM and Chauhan DK (eds) *Reactive Oxygen Species in Plants*, Wiley, Hoboken, New Jersey, US, 291-306.
- Sponsel VM (2018) - Signal achievements in gibberellin research: The second half-century. *Annual Plant Reviews*:1-36.

- Sriram SM, Kim BY, Kwon YT (2011) - The N-end rule pathway: Emerging functions and molecular principles of substrate recognition. *Nature Reviews Molecular Cell Biology* **12** (11):735-747.
- Stamm P, Ravindran P, Mohanty B, Tan EL, Yu H, Kumar PP (2012) - Insights into the molecular mechanism of RGL2-mediated inhibition of seed germination in *Arabidopsis thaliana*. *BMC Plant Biology* **2** (1):179.
- Stanisavljević R, Dragicevic V, Milenkovic J, Đukanović L, Đokić D, Terzic D, Dodig D (2010) - Effects of the duration of after-ripening period on seed germinations and seedling size in three fescue species. *Spanish Journal of Agricultural Research* **8**:454-459.
- Sтары S, Yin X-j, Potuschak T, Schlögelhofer P, Nizhynska V, Bachmair A (2003) - PRT1 of *Arabidopsis* is a ubiquitin protein ligase of the plant N-end rule pathway with specificity for aromatic amino-terminal residues. *Plant Physiology* **133** (3):1360-1366.
- Steber CM, McCourt P (2001) - A role for brassinosteroids in germination in *Arabidopsis*. *Plant Physiology* **125** (2):763-769.
- Stone SL, Williams LA, Farmer LM, Vierstra RD, Callis J (2006) - Keep on going, a ring E3 ligase essential for *Arabidopsis* growth and development, is involved in abscisic acid signaling. *The Plant Cell* **18** (12):3415-3428.
- Strader LC, Beisner ER, Bartel B (2009) - Silver ions increase auxin efflux independently of effects on ethylene response. *The Plant Cell* **21** (11):3585-3590.
- Street IH, Aman S, Zubo Y, Ramzan A, Wang X, Shakeel SN, Kieber JJ, Schaller GE (2015) - Ethylene inhibits cell proliferation of the *Arabidopsis* root meristem. *Plant Physiology* **169** (1):338-350.
- Subbiah V, Reddy KJ (2010) - Interactions between ethylene, abscisic acid and cytokinin during germination and seedling establishment in *Arabidopsis*. *Journal of Biosciences* **35** (3):451-458.
- Subramanian A, Tamayo P, Mootha VK, Mukherjee S, Ebert BL, Gillette MA, Paulovich A, Pomeroy SL, Golub TR, Lander ES, Mesirov JP (2005) - Gene set enrichment analysis: A knowledge-based approach for interpreting genome-wide expression profiles. *Proceedings of the National Academy of Sciences of the United States of America* **102** (43):15545-15550.
- Sufrin JR, Finckbeiner S, Oliver CM (2009) - Marine-derived metabolites of s-adenosylmethionine as templates for new anti-infectives. *Marine Drugs* **7** (3):401-434.

- Takayanagi K, Harrington JF (1971) - Enhancement of germination rate of aged seeds by ethylene. *Plant Physiology* **47** (4):521-524.
- Thompson AJ, Jackson AC, Symonds RC, Mulholland BJ, Dadswell AR, Blake PS, Burbidge A, Taylor IB (2000) - Ectopic expression of a tomato 9-cis-epoxycarotenoid dioxygenase gene causes over-production of abscisic acid. *Plant Journal* **23** (3):363-374.
- Tompa P, Fuxreiter M (2008) - Fuzzy complexes: Polymorphism and structural disorder in protein-protein interactions. *Trends in Biochemical Sciences* **33** (1):2-8.
- Tsiatsiani L, Timmerman E, De Bock PJ, Vercammen D, Stael S, van de Cotte B, Staes A, Goethals M, Beunens T, Van Damme P, Gevaert K, Van Breusegem F (2013) - The Arabidopsis metacaspase9 degradome. *The Plant Cell* **25** (8):2831-2847.
- Tsunasawa S, Stewart JW, Sherman F (1985) - Amino-terminal processing of mutant forms of yeast iso-1-cytochrome c. The specificities of methionine aminopeptidase and acetyltransferase. *Journal of Biological Chemistry* **260** (9):5382-5391.
- Tuan PA, Kumar R, Rehal PK, Toora PK, Ayele BT (2018) - Molecular mechanisms underlying abscisic acid/gibberellin balance in the control of seed dormancy and germination in cereals. *Frontiers in Plant Science* **9**:668.
- Tyler L, Thomas SG, Hu J, Dill A, Alonso JM, Ecker JR, Sun T-P (2004) - DELLA proteins and gibberellin-regulated seed germination and floral development in Arabidopsis. *Plant Physiology* **135** (2):1008-1019.
- Vacha GA, Harvey RB (1927) - The use of ethylene, propylene, and similar compounds in breaking the rest period of tubers, bulbs, cuttings, and seeds. *Plant Physiology* **2** (2):187-193.
- Valot B, Langella O, Nano E, Zivy M (2011) - Masschroq: A versatile tool for mass spectrometry quantification. *Proteomics* **11** (17):3572-3577.
- van Veen H, Akman M, Jamar DCL, Vreugdenhil D, Kooiker M, van Tienderen P, Voesenek LACJ, Schranz ME, Sasidharan R (2014) - Group VII ethylene response factor diversification and regulation in four species from flood-prone environments. *Plant Cell Environment* **37** (10):2421-2432.
- Varshavsky A (1997) - The N-end rule pathway of protein degradation. *Genes to Cells* **2** (1):13-28.
- Veatch-Blohm ME, Koutavas E (2011) - The Effect of Stratification and After-ripening Time on Seed Germination of Three Populations of *Arabidopsis lyrata* ssp. *lyrata* (Brassicaceae). *Castanea* **76** (2):199-209.

- Vicente-Carbajosa J, Carbonero P (2005) - Seed maturation: Developing an intrusive phase to accomplish a quiescent state. *The International Journal of Developmental Biology* **49** (5-6):645-651.
- Vicente J, Mendiondo GM, Movahedi M, Peirats-Llobet M, Juan YT, Shen YY, Dambire C, Smart K, Rodriguez PL, Charng YY, Gray JE, Holdsworth MJ (2017) - The Cys-Arg/N-end rule pathway is a general sensor of abiotic stress in flowering plants. *Current Biology* **27** (20):3183-3190.
- Vicente J, Mendiondo GM, Pauwels J, Pastor V, Izquierdo Y, Naumann C, Movahedi M, Rooney D, Gibbs DJ, Smart K, Bachmair A, Gray JE, Dissmeyer N, Castresana C, Ray RV, Gevaert K, Holdsworth MJ (2019) - Distinct branches of the N-end rule pathway modulate the plant immune response. *New Phytologist* **221** (2):988-1000.
- Vidaver W, Hsiao AI (1975) - Secondary dormancy in light-sensitive lettuce seeds incubated anaerobically or at elevated temperature. *Canadian Journal of Botany* **53** (22):2557-2560.
- Vierstra RD (2009) - The ubiquitin-26S proteasome system at the nexus of plant biology. *Nature Reviews Molecular Cell Biology* **10** (6):385-397.
- Vogel JP, Woeste KE, Theologis A, Kieber JJ (1998) - Recessive and dominant mutations in the ethylene biosynthetic gene *ACS5* of *Arabidopsis* confer cytokinin insensitivity and ethylene overproduction, respectively. *Proceedings of the National Academy of Sciences* **95** (8):4766-4771.
- Wang D, Gao Z, Du P, Xiao W, Tan Q, Chen X, Li L, Gao D (2016) - Expression of ABA metabolism-related genes suggests similarities and differences between seed dormancy and bud dormancy of peach (*Prunus persica*). *Frontiers in Plant Science* **6**:1248.
- Wang F, Deng XW (2011) - Plant ubiquitin-proteasome pathway and its role in gibberellin signaling. *Cell Research* **21** (9):1286-1294.
- Wang F, Wang L, Qiao L, Chen J, Pappa MB, Pei H, Zhang T, Chang C, Dong C-H (2017) - *Arabidopsis* CPR5 regulates ethylene signaling via molecular association with the ETR1 receptor. *Journal of Integrative Plant Biology* **59** (11):810-824.
- Wang KLC, Li H, Ecker JR (2002) - Ethylene biosynthesis and signaling networks. *The Plant Cell* **14** (suppl 1):S131.
- Wang KLC, Yoshida H, Lurin C, Ecker JR (2004) - Regulation of ethylene gas biosynthesis by the *Arabidopsis* ETO1 protein. *Nature* **428** (6986):945-950.
- Wang W, Hall AE, Malley R, Bleecker AB (2003) - Canonical histidine kinase activity of the transmitter domain of the ETR1 ethylene receptor from *Arabidopsis* is not required

- for signal transmission. *Proceedings of the National Academy of Sciences* **100** (1):352-359.
- Wang X, Yesbergenova-Cuny Z, Biniek C, Bailly C, El-Maarouf-Bouteau H, Corbineau F (2018) - Revisiting the role of ethylene and N-end rule pathway on chilling-induced dormancy release in *Arabidopsis* seeds. *International Journal of Molecular Sciences* **19** (11):3577.
- Watanabe S, Sato M, Sawada Y, Tanaka M, Matsui A, Kanno Y, Hirai M, Seki M, Sakamoto A, Seo M (2018) - *Arabidopsis* molybdenum cofactor sulfurase ABA3 contributes to anthocyanin accumulation and oxidative stress tolerance in ABA-dependent and independent ways. *Scientific Reports* **8** (1):16592.
- Watanabe T, Seo S, Sakai S (2001) - Wound-induced expression of a gene for 1-aminocyclopropane-1-carboxylate synthase and ethylene production are regulated by both reactive oxygen species and jasmonic acid in *Cucurbita maxima*. *Plant Physiology and Biochemistry* **39** (2):121-127.
- Watkins CB. (2008) Overview of 1-methylcyclopropene trials and uses for edible horticultural crops. *HortScience* **43**(1):86-94.
- Weigel D (1995) - The APETALA2 domain is related to a novel type of DNA binding domain. *The Plant Cell* **7** (4):388-397.
- Weits DA, Giuntoli B, Kosmacz M, Parlanti S, Hubberten HM, Riegler H, Hoefgen R, Perata P, van Dongen JT, Licausi F (2014) - Plant cysteine oxidases control the oxygen-dependent branch of the N-end rule pathway. *Nature Communications* **5**:3425.
- Willis CG, Baskin CC, Baskin JM, Auld JR, Venable DL, Cavender-Bares J, Donohue K, Rubio de Casas R, The NGWG (2014) - The evolution of seed dormancy: environmental cues, evolutionary hubs, and diversification of the seed plants. *New Phytologist* **203** (1):300-309.
- Wilson RL, Bakshi A, Binder BM (2014a) - Loss of the ETR1 ethylene receptor reduces the inhibitory effect of far-red light and darkness on seed germination of *Arabidopsis thaliana*. *Frontiers in Plant Science* **5**:433.
- Wilson RL, Kim H, Bakshi A, Binder BM (2014b) - The ETHYLENE RECEPTORS ETHYLENE RESPONSE1 and ETHYLENE RESPONSE2 have contrasting roles in seed germination of *Arabidopsis* during salt stress. *Plant Physiology* **165** (3):1353-1366.
- Woeste KE, Kieber JJ (2000) - A strong loss-of-function mutation in RAN1 results in constitutive activation of the ethylene response pathway as well as a rosette-lethal phenotype. *The Plant Cell* **12** (3):443-455.

- Xie F, Liu Q, Wen C-K (2006) - Receptor signal output mediated by the ETR1 N terminus is primarily subfamily I receptor dependent. *Plant Physiology* **142**:492-508.
- Xie F, Qiu L, Wen C-K (2012) - Possible modulation of Arabidopsis ETR1 N-terminal signaling by CTR1. *Plant Signal Behaviour* **7** (10):1243-1245.
- Xu F, Huang Y, Li L, Gannon P, Linster E, Huber M, Kapos P, Bienvenut W, Polevoda B, Meinel T, Hell R, Giglione C, Zhang Y, Wirtz M, Chen S, Li X (2015) - Two N-terminal acetyltransferases antagonistically regulate the stability of a nod-like receptor in Arabidopsis. *The Plant Cell* **27** (5):1547-1562.
- Xu J, Li Y, Wang Y, Liu H, Lei L, Yang H, Liu G, Ren D (2008) - Activation of MAPK kinase 9 induces ethylene and camalexin biosynthesis and enhances sensitivity to salt stress in Arabidopsis. *Journal of Biological Chemistry* **283** (40):26996-27006.
- Xu K, Xu X, Fukao T, Canlas P, Maghirang-Rodriguez R, Heuer S, Ismail AM, Bailey-Serres J, Ronald PC, Mackill DJ (2006) - SUB1A is an ethylene-response-factor-like gene that confers submergence tolerance to rice. *Nature* **442** (7103):705-708.
- Yamagami T, Tsuchisaka A, Yamada K, Haddon WF, Harden LA, Theologis A (2003) - Biochemical diversity among the 1-amino-cyclopropane-1-carboxylate synthase isozymes encoded by the Arabidopsis gene family. *Journal of Biological Chemistry* **278** (49):49102-49112.
- Yamaguchi S (2008) - Gibberellin metabolism and its regulation. *Annual Review of Plant Biology* **59**:225-251.
- Yamauchi Y, Ogawa M, Kuwahara A, Hanada A, Kamiya Y, Yamaguchi S (2004) - Activation of gibberellin biosynthesis and response pathways by low temperature during imbibition of *Arabidopsis thaliana* seeds. *The Plant Cell* **16** (2):367-378.
- Yang SF (1967) - Biosynthesis of ethylene: Ethylene formation from methional by horseradish peroxidase. *Archives of Biochemistry and Biophysics* **122** (2):481-487.
- Yang SF, Baur AH (1969) - Pathways of ethylene biosynthesis. *Qualitas Plantarum et Materiae Vegetabiles* **19** (1-3):201-220.
- Yang SF, Hoffman NE (1984) - Ethylene biosynthesis and its regulation in higher plants. *Annual Review of Plant Physiology* **35** (1):155-189.
- Yang W, Zhang W, Wang X (2017) - Post-translational control of ABA signalling: The roles of protein phosphorylation and ubiquitination. *Plant Biotechnology Journal* **15** (1):4-14.
- Yano R, Kanno Y, Jikumaru Y, Nakabayashi K, Kamiya Y, Nambara E (2009) - CHOTTO1, a putative double APETALA2 repeat transcription factor, is involved in abscisic acid-mediated repression of gibberellin biosynthesis during seed germination in Arabidopsis. *Plant Physiology* **151** (2): 641-654.

- Yao Y, Chen X, Wu A-M (2017) - ERFVII members exhibit synergistic and separate roles in Arabidopsis. *Plant Signal Behaviour* **12** (6):e1329073.
- Yoo SD, Cho YH, Tena G, Xiong Y, Sheen J (2008) - Dual control of nuclear EIN3 by bifurcate MAPK cascades in C₂H₄ signalling. *Nature* **451** (7180):789-795.
- Yoong F-Y, O'Brien LK, Truco MJ, Huo H, Sideman R, Hayes R, Michelmore RW, Bradford KJ (2016) - Genetic variation for thermotolerance in lettuce seed germination is associated with temperature-sensitive regulation of ETHYLENE RESPONSE FACTOR1 (ERF1). *Plant Physiology* **170** (1):472-488.
- Yoshida H, Hirano K, Sato T, Mitsuda N, Nomoto M, Maeo K, Koketsu E, Mitani R, Kawamura M, Ishiguro S, Tada Y, Ohme-Takagi M, Matsuoka M, Ueguchi-Tanaka M (2014) - DELLA protein functions as a transcriptional activator through the DNA binding of the indeterminate domain family proteins. *Proceedings of the National Academy of Sciences* **111** (21):7861-7867.
- Yoshida S, Ito M, Callis J, Nishida I, Watanabe A (2002) - A delayed leaf senescence mutant is defective in arginyl-tRNA: protein arginyltransferase, a component of the N-end rule pathway in Arabidopsis. *Plant Journal* **32** (1):129-137.
- Yu F, Wu Y, Xie Q (2016) - Ubiquitin-Proteasome System in ABA Signaling: From Perception to Action. *Molecular Plant* **9** (1):21-33.
- Yu G, Wang L, Han Y and He Q. clusterProfiler: an R package for comparing biological themes among gene clusters. *OMICS: A Journal of Integrative Biology* 2012, 16(5):284-287.
- Zdarska M, Cuyacot AR, Tarr PT, Yamoune A, Szmitkowska A, Hrdinová V, Gelová Z, Meyerowitz EM, Hejácíko J (2019) - ETR1 integrates response to ethylene and cytokinins into a single multistep phosphorelay pathway to control root growth. *Molecular Plant*. **12** (10):1338-1352.
- Zhang HT, Deery MJ, Gannon L, Powers SJ, Lilley KS, Theodoulou FL (2015) - Quantitative proteomics analysis of the Arg/N-end rule pathway of targeted degradation in Arabidopsis roots. *Proteomics* **15** (14):2447-2457.
- Zhang HT, Gannon L, Hassall KL, Deery MJ, Gibbs DJ, Holdsworth MJ, van der Hoorn RAL, Lilley KS, Theodoulou FL (2018a) - N-terminomics reveals control of Arabidopsis seed storage proteins and proteases by the Arg/N-end rule pathway. *The New Phytologist* **218** (3):1106-1126.
- Zhang HT, Gannon L, Jones PD, Rundle CA, Hassall KL, Gibbs DJ, Holdsworth MJ, Theodoulou FL (2018b) - Genetic interactions between ABA signalling and the Arg/N-end rule pathway during Arabidopsis seedling establishment. *Scientific Reports* **8**:15192.

- Zhang J, Yu J, Wen C-K (2014) - An alternate route of ethylene receptor signaling. *Frontiers in Plant Science* **5**:648.
- Zhao Q, Guo H-W (2011) - Paradigms and paradox in the ethylene signaling pathway and interaction network. *Molecular Plant* **4** (4):626-634.
- Zheng F, Cui X, Rivarola M, Gao T, Chang C, Dong C-H (2017) - Molecular association of Arabidopsis RTH with its homolog RTE1 in regulating ethylene signaling. *Journal of Experimental Botany* **68** (11):2821-2832.
- Zheng D, Han X, An YI, Guo H, Xia X, Yin W (2013) - The nitrate transporter NRT2.1 functions in the ethylene response to nitrate deficiency in Arabidopsis. *Plant Cell Environment* **36** (7):1328-1337.