



HAL
open science

Universal permuton limits of random pattern-avoiding permutations

Mickaël Maazoun

► **To cite this version:**

Mickaël Maazoun. Universal permuton limits of random pattern-avoiding permutations. Probability [math.PR]. Université de Lyon, 2020. English. NNT : 2020LYSEN064 . tel-03151254

HAL Id: tel-03151254

<https://theses.hal.science/tel-03151254>

Submitted on 24 Feb 2021

HAL is a multi-disciplinary open access archive for the deposit and dissemination of scientific research documents, whether they are published or not. The documents may come from teaching and research institutions in France or abroad, or from public or private research centers.

L'archive ouverte pluridisciplinaire **HAL**, est destinée au dépôt et à la diffusion de documents scientifiques de niveau recherche, publiés ou non, émanant des établissements d'enseignement et de recherche français ou étrangers, des laboratoires publics ou privés.



Numéro national de thèse : 2020LYSEN064

THÈSE DE DOCTORAT DE L'UNIVERSITÉ DE LYON

opérée par

L'ÉCOLE NORMALE SUPÉRIEURE DE LYON

École doctorale N° 512

École doctorale en informatique et mathématiques de Lyon

Discipline : mathématiques

Soutenue publiquement le 23/11/2020, par

Mickaël MAAZOUN

Permutons limites universels de permutations aléatoires à motifs exclus.

Après l'avis de :

Éric FUSY directeur de recherche, CNRS, Université Paris-Est Marne-la-Vallée

Svante JANSON professeur, Université d'Uppsala

Devant le jury composé de :

Éric FUSY	directeur de recherche	CNRS, UPEM	rapporteur
Mireille BOUSQUET-MÉLOU	directrice de recherche	CNRS, Univ. Bordeaux	examinatrice
Thomas DUQUESNE	professeur	Sorbonne Université	examinateur
Alice GUIONNET	directrice de recherche	CNRS, ÉNS de Lyon	examinatrice
Igor KORTCHEMSKI	chargé de recherche	CNRS, É. Polytechnique	examinateur
Bruno SALVY	directeur de recherche	Inria, ÉNS de Lyon	examinateur
Grégory MIERMONT	professeur	ÉNS de Lyon	directeur de thèse

Permutons limites universels de permutations
aléatoires à motifs exclus.

RÉSUMÉ. Les permutations à motifs exclus sont un thème important de la combinatoire énumérative et leur étude probabiliste un sujet récent en pleine expansion, notamment l'étude de la limite d'échelle, au sens des permutons, du diagramme d'une permutation aléatoire uniforme dont la taille tend vers l'infini dans une classe définie par exclusion de motifs. Le cas des permutations séparables a été étudié par Bassino, Bouvel, Féray, Gerin et Pierrot, qui ont démontré la convergence vers un objet aléatoire, permuton séparable Brownien. Nous fournissons une construction explicite à partir de processus stochastiques permettant d'étudier les propriétés fractales et de calculer certaines statistiques de cet objet.

Nous étudions la classe d'universalité de ce permuton dans le cadre des classes admettant une spécification finie au sens de la décomposition par substitution. Pour nombre d'entre elles, sous une condition combinatoire simple, leur limite est une déformation à un paramètre du permuton séparable Brownien. Dans le cas des classes closes par substitution, nous considérons également des conditions suffisantes pour sortir de cette classe d'universalité, et introduisons la famille des permutons stables.

Les cographe sont les graphes d'inversion des permutations séparables. Nous étudions par des méthodes similaires la convergence au sens des graphons du cographe étiqueté ou non-étiqueté uniforme, et montrons que le degré normalisé d'un sommet uniforme dans un cographe uniforme est asymptotiquement uniforme.

Finalement, nous étudions les limites d'échelle et locale de la famille à motifs vinciulaires exclus des permutations de Baxter. Cette classe est en bijection avec de nombreux objets combinatoires remarquables, notamment les cartes bipolaires orientées. Notre résultat s'interprète en terme de la convergence de telles cartes au sens de la Peanosphere, complétant un résultat de Gwynne, Holden et Sun.

Table des matières

Chapitre 1. Présentation du domaine	7
1.1. Classes de permutation et permutations aléatoires	8
1.2. Limite des permutations séparables	11
Chapitre 2. Description des résultats	21
2.1. Construction du permuton brownien	21
2.2. Limites d'échelle de classes closes par substitution	24
2.3. Limites d'échelle de classes à spécification finie.	29
2.4. Limites d'échelle des cographes	33
2.5. Limites d'échelle et locale des permutations de Baxter	35
2.6. Perspectives	39
Chapter 3. Convergence of random permutons	41
3.1. Deterministic permutons	41
3.2. Random permutons and extracted permutations	41
3.3. Convergence in distribution of random permutations	42
Chapter 4. On the Brownian separable permuton	47
4.1. Introduction	47
4.2. Definitions	53
4.3. The function φ	56
4.4. The support of the permuton	58
4.5. Self-similarity	61
4.6. Expectation of the permuton	63
4.7. Shuffling of excursions and trees.	66
Chapter 5. A toolbox of substitution trees and tree-specifications	69
5.1. Substitution trees and pattern extraction	69
5.2. Tree-specifications	72
5.3. Decomposition of trees inducing a given tree	73
5.4. Analysis of systems of functional equations	77
Chapter 6. Universal limits of substitution-closed permutation classes	85
6.1. Introduction	85
6.2. Generalities	88
6.3. The standard case $S'(R_S) > 2/(1 + R_S)^2 - 1$	88
6.4. Generalities for the analysis of the non-standard cases	92
6.5. The degenerate case $S'(R_S) < 2/(1 + R_S)^2 - 1$	95
6.6. The critical case $S'(R_S) = 2/(1 + R_S)^2 - 1$	97
6.7. Singularity analysis of leaf-counted monotype trees	100
Chapter 7. Scaling limits of permutation classes with a finite specification	105
7.1. Classification of specifications	105
7.2. The essentially branching case	107
7.3. The essentially linear case	110
7.4. Beyond the strongly connected case	120
7.5. Details on the examples	128

Chapter 8. Random cographs: Brownian graphon limit and asymptotic degree distribution	137
8.1. Introduction	137
8.2. Cographs, cotrees and induced subgraphs	140
8.3. Graphons	144
8.4. The Brownian cographon	149
8.5. Convergence of labeled cographs to the Brownian cographon	152
8.6. Convergence of unlabeled cographs to the Brownian cographon	157
8.7. Vertex connectivity	163
Chapter 9. Scaling and local limit of Baxter permutations	167
9.1. Introduction and main results	167
9.2. Bipolar orientations, walks in cones, Baxter permutations and coalescent-walk processes	178
9.3. Local limit results	189
9.4. Scaling limits of coalescent-walk processes	196
9.5. Scaling limits of Baxter permutations and bipolar orientations	202
9.A. Walks in the two-dimensional non-negative quadrant	210
9.B. Generalizations	213
9.C. Simulations of large Baxter permutations	216
Appendix A. Analytic combinatorics toolbox	219
A.1. Aperiodicity and Daffodil Lemma	219
A.2. Transfer theorem	219
A.3. Singular differentiation	219
A.4. Exponents of dominant singularity	220
A.5. An analytic implicit function theorem	223
Appendix. Bibliography	225

Présentation du domaine

Cette thèse est consacrée à l'étude probabiliste de structures combinatoires, en l'occurrence de certaines familles de permutations, par l'établissement de résultats de limites d'échelle. De tels résultats décrivent comment, dans certaines familles d'objets discrets, la forme macroscopique d'un élément typique de grande taille se conforme asymptotiquement à celle d'un objet aléatoire continu. Un tel résultat nous satisfait d'autant plus quand il est universel, c'est-à-dire que de nombreuses familles convergent vers le même objet limite sous des conditions faciles à vérifier ; il a lieu pour une topologie suffisamment forte, qui emporte la convergence de nombreuses statistiques intéressantes ; et surtout si l'objet limite est maniable, possède une construction explicite et canonique à partir de processus stochastiques connus comme le mouvement Brownien ou les processus de Poisson, et possède certaines symétries. Nous pouvons citer, comme résultats importants et récents de cette nature, les limites d'échelle de graphes aléatoires critiques [Ald97 ; ABG12 ; ABGM17], et, un peu plus éloigné de nos méthodes, de serpents et de cartes aléatoires [Le 13 ; Mie13].

Ce programme remonte à la *big picture* d'Aldous dans le cas des arbres [Ald91], qui montre dans [Ald93] que de nombreuses familles d'arbres finis admettent comme limite le CRT, l'arbre continu brownien. Dans la filiation de ces travaux se trouvent de nombreuses généralisations et extensions à d'autres familles d'arbres, mais aussi des applications à des objets discrets admettant une structure récursive comme les triangulations planes et autres partitions non-croisées [Ald94a ; Ald94b ; Kor14 ; FK18 ; Thé20b ; Thé20a]. Une partie des résultats présentés ici appartiennent à cette filiation, puisque nous étudions des familles d'objets encodés par des arbres.

Dans cette thèse, nous nous intéresserons notamment à la convergence de certaines familles de permutations au sens des *permutons*. Cette notion de convergence introduite dans [Hop+13], analogue à celle des graphons pour les graphes denses, provient de la combinatoire extrémale et peut se définir de manière purement combinatoire et abstraite par la convergence de sous-structure finies. Néanmoins, elle s'interprète également comme un résultat de limite d'échelle pour le diagramme de la permutation, à condition de représenter l'objet limite de manière concrète, en l'occurrence par une mesure dans le carré unité. Cette notion de représentation, au coeur des *combinatorial stochastic processes* de Pitman [Pit06], se retrouve régulièrement dans la théorie des probabilités, pour les *partitions échangeables* de Kingman et les processus de fragmentation et de coagulation, dans la théorie des arbres continus d'Aldous, et plus récemment donc, dans les graphons et les permutons.

L'étude probabiliste de structures combinatoires est une des piliers de l'*analyse d'algorithmes*, au sens de Knuth. Nous ferons régulièrement appel aux méthodes de la *combinatoire analytique* [FS09], qui sont centrales dans ce domaine.

To me, the beauty of this topic is the interaction between the discrete and continuous worlds. It is possible to be tidy-minded and treat asymptotics of discrete random objects via discrete methods which pay no attention to the existence of continuous limit objects, and to treat continuous random objects by continuous methods without reference to discrete approximations, but why?
— D. Aldous.¹

1. La citation complète est plus amusante, et le lecteur la trouvera dans l'introduction de [Ald94a]

1.1. Classes de permutation et permutations aléatoires

1.1.1. Permutations, motifs, et classes de permutations. Pour tout entier $n \geq 1$, une *permutation de taille n* est une suite $(\sigma(1), \dots, \sigma(n))$ qui énumère chaque entier de $[n] := \{1, 2, \dots, n\}$ exactement une fois. L'ensemble des permutations de taille n est noté \mathfrak{S}_n . On notera $\mathfrak{S} = \cup_{n \geq 1} \mathfrak{S}_n$ l'ensemble des permutations de toute taille, et la taille d'un élément arbitraire $\sigma \in \mathfrak{S}$ sera notée $|\sigma|^2$. Il est bien connu que le cardinal de \mathfrak{S}_n est $n!$.

Il est également bien connu que \mathfrak{S}_n est l'ensemble des bijections de l'ensemble $[n]$ sur lui-même, et forme un groupe pour l'opération de composition. Nous ne ferons pas appel dans cette thèse à ce point de vue, et ne composerons pratiquement jamais deux permutations³. Insistons en particulier sur le fait que nous employons la notation dite « en une ligne » des permutations, et non pas celle de la décomposition en cycles. Ainsi (321) est telle que $\sigma(1) = 3, \sigma(2) = 2, \sigma(3) = 1$.

On peut également représenter une permutation $\sigma \in \mathfrak{S}_n$ par son diagramme, c'est-à-dire l'ensemble des points $(i, \sigma(i))$. Une permutation est alors un ensemble de points dans un tableau $n \times n$ tel qu'exactly un point est contenu dans chaque ligne et colonne.

Soit x_1, \dots, x_n une suite de points distincts de la droite réelle. On notera $\text{rank}(x_1, \dots, x_n)$ l'unique permutation $\pi \in \mathfrak{S}_n$ telle que $x_{\pi(1)} < \dots < x_{\pi(n)}$. Si $E = \{(x_1, y_1), \dots, (x_n, y_n)\}$ est un ensemble de points du plan tel que deux points ne sont jamais alignés verticalement ou horizontalement, on notera $\text{std}(E)$ l'unique permutation de \mathfrak{S}_n *isomorphe pour l'ordre* à E , définie comme $\text{std}(\{(x_1, y_1), \dots, (x_n, y_n)\}) = \text{rank}(y_1, \dots, y_n)^{-1} \circ \text{rank}(x_1, \dots, x_n)$.

Soit $\sigma \in \mathfrak{S}_n$, et \mathcal{I} un sous-ensemble de $[n]$. On notera $\text{pat}_{\mathcal{I}}(\sigma)$ la permutation $\text{std}\{(i, \sigma(i)), i \in \mathcal{I}\}$, dénommé *motif induit par \mathcal{I} dans σ* . On dit que $\pi = \text{pat}_{\mathcal{I}}(\sigma)$ est un *motif* de σ , ou motif contenu dans σ , et la sous-suite $(\sigma(i))_{i \in \mathcal{I}}$ est une *occurrence* de π dans σ . Quand un motif π n'est pas contenu dans σ , on dit que σ *évite* π . Des exemples sont donnés dans la fig. 1.1. On note $\pi \preceq \sigma$ si π est un motif de σ . La relation \preceq est un ordre partiel sur l'ensemble \mathfrak{S}_n .

Introduisons pour un usage futur le nombre d'occurrences $\text{occ}(\pi, \sigma)$ du motif $\pi \in \mathfrak{S}_k$ dans $\sigma \in \mathfrak{S}_n$, c'est-à-dire $\text{occ}(\pi, \sigma) = \text{card}\{I \subset [n] : \text{pat}_I(\sigma) = \pi\}$, et notons $\widetilde{\text{occ}}(\pi, \sigma) = \binom{n}{k}^{-1} \text{occ}(\pi, \sigma)$ la *densité* de π dans σ , c'est-à-dire la probabilité qu'un motif de taille k de σ choisi uniformément au hasard soit π .

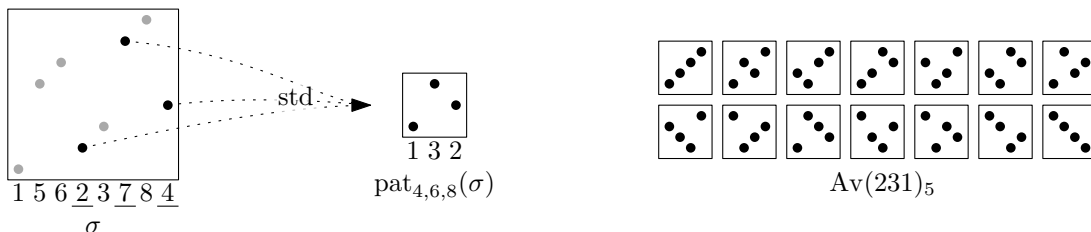

FIGURE 1.1. Un exemple d'extraction de motif, et les quatorze permutations de taille 5 évitant (231) .

Une classe de permutations \mathcal{C} est un sous-ensemble de \mathfrak{S} clos par extraction de motifs, c'est à dire tel que pour tout $\sigma \in \mathcal{C}$ et $\pi \preceq \sigma$, l'on ait $\pi \in \mathcal{C}$. L'ensemble $\text{Av}(B)$ des permutations qui évitent une famille finie ou infinie $B \subset \mathfrak{S}$ de motifs est évidemment une classe, et pour toute classe \mathcal{C} , il existe un unique ensemble constitué d'éléments deux à deux incomparables pour \preceq tel que $\mathcal{C} = \text{Av}(B)$ [Bón12a, §5.1.2]. L'ensemble B est alors appelé la *base* de \mathcal{C} .

Les classes de permutations sont un objet central de la combinatoire énumérative. On fait traditionnellement remonter leur histoire aux exercices 4 et 5 de [Knu69, Section 2.2.1].

2. Cette convention sera adoptée dans l'ensemble de cette thèse, pour toute famille d'objets indexée par une notion de taille, dite classe combinatoire

3. Dans le langage de [ABF20], nous voyons les permutations comme des ordres totaux, et non pas comme des bijections, points de vues qui sont orthogonaux au sens de la logique du premier ordre.

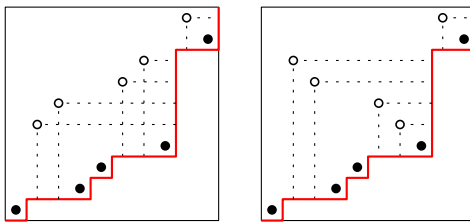

FIGURE 1.2. Un chemin de Dyck et l'unique permutation de $Av(321)$ (resp. $Av(231)$) qui admet ce chemin de Dyck comme support inférieur.

Knuth demande à ses lecteurs de démontrer que l'ensemble des permutations qui peuvent être triées en utilisant une pile est $Av(231)$, et que cette famille combinatoire est comptée par les nombres de Catalan. Néanmoins, Percy MacMahon, à qui l'on doit également la première étude combinatoire de la statistique $occ(12, \cdot)$, avait déjà étudié dès 1915 la classe $Av(321)$ des permutations isomorphes à des ensembles de points sur deux lignes parallèles de pente strictement positive, elle aussi comptée par les nombres de Catalan. Nous présentons sur un exemple des bijections naturelles entre ces deux classes et l'ensemble des chemins de Dyck, dues respectivement à Billey-Jockusch-Stanley et à Knuth-Krattenthaler, dans la fig. 1.2.

Les classes de permutations ont été énormément étudiées d'un point de vue combinatoire (énumération, bijections), mais aussi algorithmiques. Nous renvoyons le lecteur aux chapitres 4 et 5 de [Bón12a] pour une riche introduction aux motifs de permutation, à [Kit11] pour une référence exhaustive, et à [Vat15] ainsi qu'aux références qu'il contient pour un historique et un survol de travaux récents. On trouvera également dans le livre de Kitaev des généralisations de la notion de motif, en particulier les motifs *vinculaires*, que l'on retrouvera plus tard dans cette thèse.

Présentons maintenant quelques résultats marquants du domaine, sans aucune prétention d'exhaustivité. Marcus et Tardos [MT04] ont démonté un résultat longtemps connu sous le nom de conjecture de Stanley-Wilf : toute classe de permutation évitant un seul motif (dite principale) admet un taux de croissance exponentiel, et ainsi toute classe sauf \mathfrak{S} croît au plus exponentiellement. L'étude de l'ensemble des réels réalisés comme taux de croissance d'une classe de permutations a fait l'objet de nombreux travaux, voir [PV20] et les références qu'il contient. La question de la classe $Av(\tau)$ croissant le plus vite à $|\tau|$ fixé est encore ouverte.

De nombreuses classes de permutations ont été énumérées par des méthodes analytiques ou bijectives. La plus célèbre des classes pour lesquelles ce problème est toujours ouvert est $Av(1324)$. Les bornes les plus récentes sur son taux de croissance exponentiel sont $[10.271, 13.5]$ [BBEP20].

Ont été également traitées des questions algorithmiques, comme la caractérisation de nombreuses classes selon leur capacité à être triée par tel ou tel algorithme, et l'étude de la complexité de certains problèmes restreints à des classes. On peut citer également l'étude des densités maximales de motifs (*packing densities*) [PS10].

1.1.2. Permutations aléatoires. L'étude probabiliste de l'ensemble des permutations est une vieille histoire. La convergence du nombre de points fixes d'une permutation aléatoire uniforme vers une loi de Poisson est un des plus vieux théorèmes des probabilités, dû à De Montmort [Mon14] et Bernoulli (voir [Tak80]). On mentionnera le célèbre problème de la plus longue sous-suite croissante d'Ulam et Hammersley, résolu par Vershik-Kerov [VK77] et Logan-Shepp. Gontcharoff [Gon42] a démontré en 1942 la normalité asymptotique du nombre de cycles et la loi limite pour la taille du plus grand cycle dans les permutations uniformes (voir [ABT03] pour un traitement moderne, et [Pit06, §3.1] pour un point de vue différent), problèmes qui ont trouvé des applications en analyse d'algorithmes à l'aube de l'informatique [GWG59]. Les densités de motifs $\widetilde{occ}(\pi, \cdot)$ introduites plus haut ont également été étudiées. La normalité asymptotique de la densité d'inversions

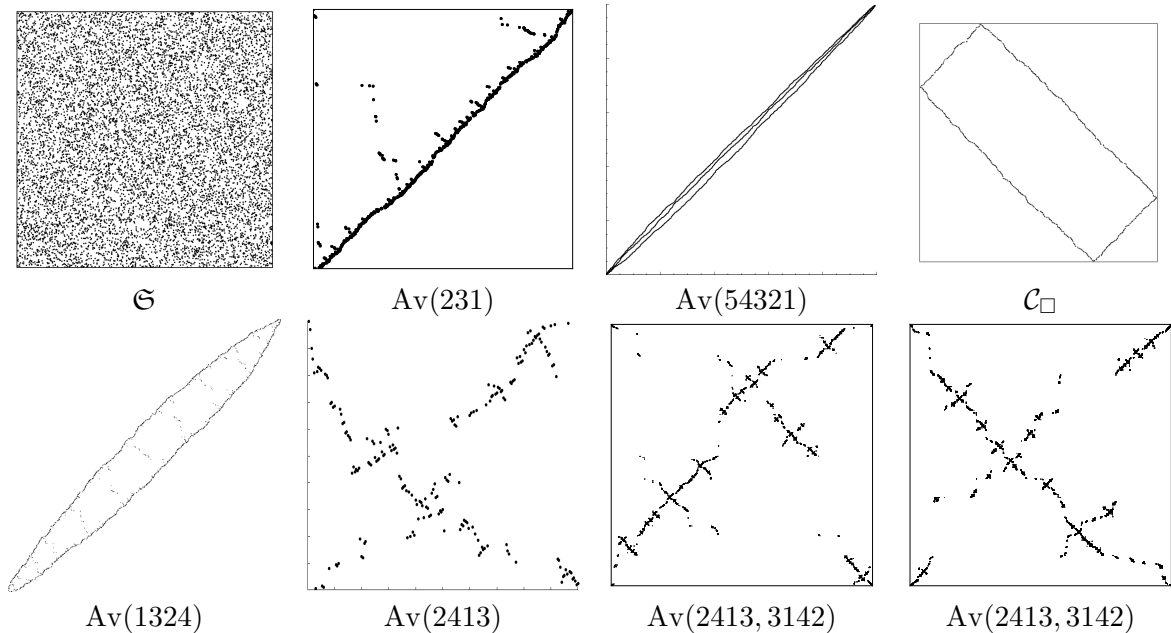

FIGURE 1.3. Permutations aléatoires uniformes de grande taille dans diverses classes. $Av(231)$ est étudiée dans [HRS17a], $Av(54321)$ dans [HRS19] (d'où sont issues la seconde simulation). La classe des permutations carrées \mathcal{C}_{\square} admet une limite aléatoire [BS19] (d'où est issue la simulation). Le comportement de $Av(1324)$ et de $Av(2413)$ est inconnu (simulations de [Cib; MY17]). La classe $Av(2413, 3142)$ des permutations séparables est centrale dans cette thèse, nous en discutons plus bas.

$\widetilde{occ}(21, \cdot)$ remonte à [Ken38], en vue d'applications à la statistique non-paramétrique. Les densités de motifs en général ont été considérées dans [JNZ15; Eve18].

L'étude probabiliste des classes de permutations est un sujet plus récent mais en grande expansion. Fixons une classe \mathcal{C} et pour tout n dénotons σ_n un élément uniforme de $\mathcal{C} \cap \mathfrak{S}_n$. Les statistiques $\widetilde{occ}(\pi, \sigma_n)$ ont été particulièrement étudiées [Bón10; Bón12b; Hom12; CEF07; Rud13; JNZ15; Jan17; Jan20] pour des classes évitant certains motifs de petite taille. La plus longue sous-suite croissante a également été considérée, voir [MY17; MY20] et les travaux des mêmes auteurs.

Un intérêt croissant a été donné à l'étude du diagramme de la permutation σ_n . Citons notamment [ML10; AM14; MP16b; MP14; MP16a; MY17], principalement dans des classes pour lesquelles la plupart des points se concentrent autour de la diagonale ou l'antidiagonale. Le cas des permutations évitant 231, 321 ou plus généralement les motifs monotones a été étudié plus précisément dans [HRS17a; HRS17b; HRS19], avec notamment des remarquables résultats de convergence fonctionnelle pour l'écart des points à la diagonale, mais aussi pour le nombre de points fixes et leur emplacement.

Nous présentons dans la fig. 1.3 des diagrammes de permutations aléatoires uniformes de grande taille dans diverses classes, pour illustrer la diversité des comportements asymptotiques possibles. D'autres simulations de classes étudiées dans cette thèse sont disponibles plus bas figs. 2.6 et 2.8.

1.1.3. Permutons. Une approche récente, employée dans cette thèse, consiste à étudier le diagramme d'une permutations comme un objet analytique par le formalisme des *permutons*. Nous introduisons maintenant cette notion centrale.

Définition 1.1.1. Un permuton est une mesure de probabilité sur le carré unité $[0, 1]^2$ dont les deux marginales sont uniformes.

Le permuton associé à une permutation $\sigma \in \mathfrak{S}_n$ est la mesure μ_σ à densité $\mu_\sigma(dx dy) = n \mathbb{1}_{\sigma([xn])=[yn]} dx dy$, qui n'est rien d'autre qu'un choix de représentation graphique du diagramme de σ . L'ensemble des permutons est noté \mathcal{M} , et est équipé de la topologie de la convergence faible des mesures (voir [Bil99]), pour laquelle il est compact, et $(\mu_\sigma)_{\sigma \in \mathfrak{S}}$ forme une partie dense. Une suite de permutations $(\sigma_n)_n$ est dite convergente, et converge vers le permuton μ , si et seulement si $\mu_{\sigma_n} \rightarrow \mu$ quand $n \rightarrow \infty$.

Soit μ un permuton et $\sigma \in \mathfrak{S}_k$. On définit la *densité de σ dans μ* comme la probabilité que k points tirés indépendamment selon μ soient isomorphes pour l'ordre à σ :

$$\widetilde{\text{occ}}(\pi, \mu) = \int_{([0,1]^2)^k} \mathbb{1}_{\text{std}(u_1, \dots, u_k) = \sigma} \mu(du_1) \cdots \mu(du_k).$$

La fonctionnelle $\widetilde{\text{occ}}(\pi, \cdot)$ est continue sur l'espace \mathcal{M} , et $\widetilde{\text{occ}}(\pi, \mu_\sigma) = \widetilde{\text{occ}}(\pi, \sigma) + O(|\pi|/|\sigma|)$ (voir lemme 3.2.1). Ainsi la convergence d'une suite de permutations vers un permuton implique la convergence de toutes les statistiques $\widetilde{\text{occ}}(\pi, \cdot)$. Cette implication est en réalité une équivalence ; nous reviendrons sur ce point plus tard (théorème 1.2.1), mais remarquons immédiatement que la théorie des permutons unifie deux points de vue très différents sur les permutations. Elle est néanmoins limitée par le fait qu'elle ne considère que le « premier ordre ». Par exemple la convergence au sens des permutons d'Av(321) et Av(231) ne témoignerait que de la concentration du diagramme autour de la diagonale, et du fait que les motifs croissants dominent les autres, les résultats de [HRS17a ; Jan19] étant strictement plus forts.

La convergence d'une grande permutation aléatoire uniforme vers un permuton a été établie pour plusieurs classes. La classe \mathfrak{S} converge vers la mesure uniforme sur le carré, ce qui viendra en corollaire immédiat du théorème 1.2.1. Certains travaux déjà cités contiennent implicitement la convergence vers la mesure de Lebesgue sur la diagonale ou l'antidiagonale. La convergence vers des diagrammes décomposables en blocs diagonaux ou antidiagonaux a été établie pour les *connected monotone grid classes* dans [Bev15, Chapter 6], et les permutations carrées et presque carrées dans [BS19 ; BDS19]).

Le lecteur remarquera que pour la classe Av(2413, 3142), dite des permutations séparables, nous présentons deux simulations, macroscopiquement différentes mais d'aspect similaire. En effet, dans ce cas, la forme limite est aléatoire. Nous énonçons ce résultat, du à Frédérique Bassino, Mathilde Bouvel, Valentin Féray, Lucas Gerin et Adeline Pierrot.

Théorème 1.1.2 (Théorème 1.6 dans [Bas+18]). *Soit σ_n une permutation séparable de taille n uniforme. Alors la suite μ_{σ_n} converge en loi dans l'espace \mathcal{M} . Sa limite $\mu^{1/2}$ est un élément aléatoire de \mathcal{M} dénommé permuton séparable brownien.*

Les travaux présentés dans cette thèse témoignent des efforts, en partie communs avec les auteurs de [Bas+18], pour préciser ce résultat, le généraliser, et obtenir des résultats de même nature pour des familles différentes. Il seront présentés dans le chapitre suivant.

Mais avant, nous terminons ce chapitre en esquissant une démonstration, différente car plus combinatoire de celle de [Bas+18], du théorème 1.1.2. La structure de la preuve est très proche de celle employée pour les généralisations présentées dans cette thèse, et nous permet de détailler au passage certains ingrédients-clés que nous réutilisons plus tard.

1.2. Limite des permutations séparables

1.2.1. Retour sur les permutons. Notre but dans cette section est de décrire une caractérisation combinatoire de la convergence en loi au sens des permutons. Commençons d'abord par quelques considérations historiques.

Les permutons ont été d'abord considérés par Presutti and Stromquist [PS10] sous le nom de *normalized measures*. Ils ont réalisé que la convergence dans l'espace des permutons implique la convergence des densités de motifs, et que les permutations induites par un permuton fournissent un modèle intéressant de permutations aléatoires. La théorie a été développée indépendamment par Hoppen, Kohayakawa, Moreira, Rath and Sampaio dans [Hop+13], inspirés par la théorie des limites de graphes denses, ou *graphons*. Leur résultat

principal est l'équivalence entre la convergence vers un permuton et la convergence de toutes les densités de motifs. La terminologie *permuton* a été proposée ensuite par Glebov, Grzesik, Klímošová and Král [GGKK15]. Mentionnons que les permutons sont connus dans la littérature statistique sous le nom de *copules de dimension 2*, et dans de nombreux autres domaines sous le nom de *mesures doublement stochastiques*.

Des convergences vers un permuton ont également été établies pour le modèle non uniforme des permutations de Mallows [Muk16a] et pour des permutations à densités de motifs fixées [KKRW20]. La théorie des permutons a été utilisée pour construire des exemples réalisant des bornes inférieures de densité de remplissage [PS10], pour montrer la convergence des statistiques de petits cycles dans des modèles non-uniformes de permutations [Muk16b], pour obtenir des résultats de combinatoire extrémale sur les motifs dans les permutations [GGKK15; Gle+17; KKRW20; KP13; Cha+19], et pour étudier les formes limites des *random sorting networks* [RVV19].

Soit $M_1(X)$ l'espace des mesures de probabilité sur un espace polonais X , muni de la convergence faible des mesures. Soit μ un élément aléatoire de $M_1(X)$ (une *mesure aléatoire*). Une suite $\mathbf{x}_1, \dots, \mathbf{x}_k$ est dite *i.i.d. de loi μ conditionnellement à μ* si pour toute fonction $f : M_1(X) \times X^k \rightarrow \mathbb{R}_+$ mesurable,

$$\mathbb{E}[f(\mu, \mathbf{x}_1, \dots, \mathbf{x}_k)] = \int_{M_1(X)} \left(\int_{X^k} f(\mu, x_1, \dots, x_k) \mu(dx_1) \cdots \mu(dx_k) \right) \mathbb{P}_\mu(d\mu).$$

Soit maintenant μ un permuton aléatoire, $k \geq 1$ et $(\mathbf{x}_1, \mathbf{y}_1), \dots, (\mathbf{x}_k, \mathbf{y}_k)$ une suite i.i.d. de loi μ conditionnellement à μ . Par la définition de permuton, presque sûrement, aucune paire de points n'est alignée verticalement ou horizontalement. Ainsi on peut définir la permutation de taille k induite par μ comme suit⁴ :

$$\mathbf{Perm}_k(\mu) = \text{std}((\mathbf{x}_1, \mathbf{y}_1), \dots, (\mathbf{x}_k, \mathbf{y}_k)) \text{ p.s.}$$

De même si σ est une permutation aléatoire de taille $n \geq k \geq 1$, on note $\mathbf{Perm}_k(\sigma) = \text{pat}_{\mathbf{I}_{n,k}}(\sigma)$, où $\mathbf{I}_{n,k}$ est un sous-ensemble de taille k de $[n]$ choisi uniformément au hasard, indépendamment de σ . Le lecteur pourra vérifier immédiatement que pour $\pi \in \mathfrak{S}_k$,

$$(1.1) \quad \mathbb{P}(\mathbf{Perm}_k(\mu) = \pi \mid \mu) = \widetilde{\text{occ}}(\pi, \mu) \quad \mathbb{P}(\mathbf{Perm}_k(\mu) = \pi) = \mathbb{E}[\widetilde{\text{occ}}(\pi, \mu)]$$

$$(1.2) \quad \mathbb{P}(\mathbf{Perm}_k(\sigma) = \pi \mid \sigma) = \widetilde{\text{occ}}(\pi, \sigma) \quad \mathbb{P}(\mathbf{Perm}_k(\sigma) = \pi) = \mathbb{E}[\widetilde{\text{occ}}(\pi, \sigma)]$$

Nous énonçons maintenant notre premier résultat. Il s'agit d'une extension du théorème principal de [Hop+13] au cas des permutations aléatoires, et la preuve diffère peu. Il apparaît que le cadre naturel de la convergence en permuton est celui des permutons aléatoires, et non déterministes, ce qui ne surprendra pas les lecteurs familiers avec la théorie des graphons aléatoires développée dans [DJ08], en lien avec la représentation de tableaux doublement échangeables. De fait, notre théorème est un analogue exact du théorème 3.1 de [DJ08]. Ce résultat, implicite dans [Bas+18] et donné sous cette forme dans [Bas+20], sera démontré dans cette thèse dans le chapitre 3.

Théorème 1.2.1 (avec F. Bassino, M. Bouvel, V. Féray, L. Gerin et A. Pierrot, théorème 3.3.2). *Pour tout $n \geq 1$ soit σ_n une permutation aléatoire de taille n . Soit $k_0 \geq 1$. Les propriétés suivantes sont équivalentes :*

- i) *Le permuton $(\mu_{\sigma_n})_n$ converge en loi vers un permuton aléatoire μ .*
- ii) *Le vecteur $(\widetilde{\text{occ}}(\pi, \sigma_n))_{\pi \in \mathfrak{S}_k}$ converge en loi vers $(\widetilde{\text{occ}}(\pi, \mu))_{\pi \in \mathfrak{S}_k}$.*
- iii) *Pour tout $k \geq k_0$, $\mathbf{Perm}_k(\sigma_n)$ converge en loi vers une permutation aléatoire ρ_k .*

4. Notons que puisque $\mathbf{Perm}_k(\mu)$ est construit sur un espace probabilisé plus riche que celui où μ est construit, il ne s'agit pas d'une fonction de μ comme suggéré par la notation quelque peu abusive. Puisque la plupart du temps nous ne serons intéressés que par la loi de $\mathbf{Perm}_k(\mu)$ (qui est fonction de celle de μ), ou par sa loi conditionnelle à μ (qui elle est bien fonction de la variable μ , donnée par $\mu \mapsto (\widetilde{\text{occ}}(\pi, \mu))_{\pi \in \mathfrak{S}_k}$, voir eq. (1.2)), ceci ne porte pas à conséquence. Dans les rares cas où la construction explicite de $\mathbf{Perm}_k(\mu)$ importe, les précisions nécessaires seront apportées par le contexte. Cette remarque s'applique aussi à $\mathbf{Perm}_k(\sigma)$.

Dans ce cas on a alors $\rho_k \stackrel{(d)}{=} \mathbf{Perm}_k(\boldsymbol{\mu})$ pour tout $k \geq k_0$, et l'ensemble de ces relations caractérisent la loi de $\boldsymbol{\mu}$ comme permuton aléatoire.

Remarquons que l'équivalence (i) \iff (ii) est une simple randomisation du théorème principal de [Hop+13]. Vu l'éq. (1.2), l'équivalence avec (iii) peut se voir de la manière suivante: la convergence des $(\widetilde{\text{occ}}(\pi, \boldsymbol{\sigma}_n))_{\pi \in \mathfrak{S}}$ est caractérisée par la convergence des espérances. Bien entendu, c'est le critère (iii), plus faible et combinatoire, qui sera désormais utilisé pour démontrer une convergence au sens des permuton.

Revenons plus en avant sur le lien entre un permuton aléatoire et ses permutations induites $(\mathbf{Perm}_k(\boldsymbol{\mu}))_{k \geq 1}$. Le résultat suivant, qui dit qu'un permuton aléatoire est équivalent à une suite *cohérente* de permutations aléatoires est un analogue du théorème 5.3 de Diaconis et Janson.

Proposition 1.2.2 (issue des propositions 3.3.1 et 3.3.6). *Soit $(\rho_k)_{k \geq 1}$ une suite de permutations aléatoires, et $k_0 \geq 1$. Alors il y a unicité en loi des permutons aléatoires $\boldsymbol{\mu}$ vérifiant*

$$(1.3) \quad \rho_k \stackrel{(d)}{=} \mathbf{Perm}_k(\boldsymbol{\mu}), \text{ pour tout } k \geq k_0.$$

De plus si la suite $(\rho_k)_{k \geq 1}$ est consistante, c'est-à-dire si pour tout $k \leq \ell \leq 1$, $\mathbf{Perm}_\ell(\rho_k) = \rho_\ell$, alors un tel permuton aléatoire $\boldsymbol{\mu}$ existe.

1.2.2. Structure des permutations séparables. La classe des permutations séparables $\text{Av}(2413, 3142)$ a été introduite dans [BBL93], mais est apparue auparavant dans la littérature [AN81 ; SS91]. On peut trouver diverses caractérisations de cette classe dans [BBL93 ; AN81 ; SS91 ; Ghy17].

La caractérisation la plus simple est la suivante. Soit une suite de permutations $\sigma_1, \dots, \sigma_n$. La somme directe $\oplus[\sigma_1, \dots, \sigma_n]$ (resp. la somme gauche $\ominus[\sigma_1, \dots, \sigma_n]$) est la permutation dont le diagramme est diagonal par blocs (resp. antidiagonal par blocs), les blocs successifs étant composés du diagramme de $\sigma_1, \dots, \sigma_n$ respectivement. Un exemple est présenté dans la fig. 1.4. Il se trouve [BBL93, lemme 3.1] que les permutations séparables sont exactement

$$\oplus[132, 21] = \begin{array}{|c|c|} \hline & 21 \\ \hline 132 & \\ \hline \end{array} = \begin{array}{|c|c|c|} \hline & & \bullet \\ \hline & \bullet & \\ \hline \bullet & & \bullet \\ \hline \end{array} = 13254 \quad \ominus[132, 21] = \begin{array}{|c|c|} \hline 132 & \\ \hline & 21 \\ \hline \end{array} = \begin{array}{|c|c|c|} \hline \bullet & & \\ \hline & \bullet & \\ \hline \bullet & & \bullet \\ \hline & & \bullet \\ \hline \end{array} = 35421$$

FIGURE 1.4. Somme directe et somme gauche de permutations

celles que l'on peut obtenir en itérant ces opérations à partir de la permutation unité. Plus précisément, appelons arbre signé t un arbre plan enraciné dont les noeuds internes sont décorés par $\{\oplus, \ominus\}$ et définissons $\text{perm}(t)$ ainsi:

- i) Si $t = \bullet$, alors $\text{perm}(t) = 1$.
- ii) Si le signe de la racine est ε et les sous arbres de la racines sont t_1, \dots, t_k , alors $\text{perm}(t) = \varepsilon[\text{perm}(t_1, \dots, t_k)]$.

La taille d'un arbre signé est son nombre de feuilles, feuilles qui seront toujours étiquetées $1, \dots, |t|$ dans l'ordre du parcours en profondeur. On a le résultat suivant.

Proposition 1.2.3. *L'application perm envoie un arbre à k feuilles sur une permutation de taille k . La classe $\text{Av}(2413, 3142)$ est l'image par perm de l'ensemble des arbres signés. De plus, perm est une bijection entre $\text{Av}(2413, 3142)$ et l'ensemble des arbres signés n'ayant aucun sommet de degré 1, et dont les signes alternent entre deux générations successives, dits arbres de Schröder signés.*

La seconde affirmation est due à l'associativité des opérations \oplus et \ominus , qui fait que perm n'est pas une bijection. On fait alors le choix d'utiliser l'associativité au maximum pour obtenir une représentation canonique.

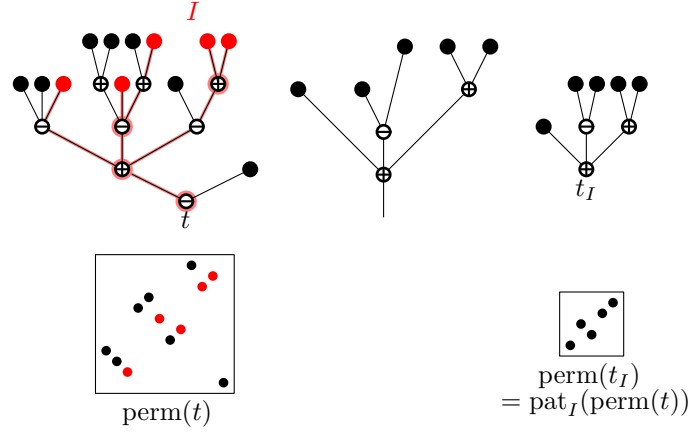

FIGURE 1.5. Extraction de motifs et d'arbres induits

Finalement, cette représentation par les arbres est fondamentale pour l'extraction de motifs. En effet, soit t un arbre signé ou non et $I \subset [n]$ vu comme un sous-ensemble de ses feuilles. L'arbre induit t_I est défini informellement comme suit: son ensemble de sommets est l'ensemble des feuilles de I , additionné de l'ensemble des plus récents ancêtres communs de deux feuilles distinctes de I . Ces derniers conservent le cas échéant dans t_I leur décoration par un signe \oplus ou \ominus . La structure de l'arbre t_I est la seule telle que l'ordre de contour sur t_I respecte celui de t .

Alors on a la relation de commutativité suivante, illustrée par la fig. 1.5 :

$$(1.4) \quad \text{pat}_I(\text{perm}(t)) = \text{perm}(t_I).$$

Ainsi, au vu du théorème 1.2.1, il suffit de montrer la convergence en loi d'un arbre induit uniforme $\mathbf{t}_{n|I_{n,k}}$ dans un grand arbre de Schröder signé uniforme \mathbf{t}_n pour démontrer le théorème 1.1.2, ce a quoi est consacré le reste de cette section.

1.2.3. Combinatoire analytique d'arbres comptés par les feuilles. Soit $(f_i)_{i \geq 2} \in \{0, 1\}^{\mathbb{Z}_{\geq 2}}$ une suite non nulle, et $F(t) = \sum f_i t^i$. Soit \mathcal{T} l'ensemble des arbres plans enracinés dont tout les noeuds internes ont un degré dans $\{i \geq 2 : f_i = 1\}$, comptés par leur nombre de feuilles. Alors la série génératrice T de la famille \mathcal{T} vérifie

$$(1.5) \quad T = z + F(T).$$

Remarquons que les arbres de Schröder correspondent à $f_i \equiv 1$ et $F(t) = \sum_{i \geq 2} t^i = \frac{t^2}{1-t}$.⁵

Pour tout $z \geq 0$ tel que $T(z) < \infty$, considérons l'arbre de Galton-Watson de loi de reproduction

$$\nu_z = \frac{1}{T(z)} \left(z \delta_0 + \sum_{i \geq 2} f_i T(z)^i \delta_i \right).$$

Le lecteur pourra vérifier (c'est un avatar très simple du principe général d'échantillonnage de Boltzmann [DFLS04]), que la loi de ce processus attribue la masse $\frac{z^{|t|}}{T(z)}$ à chaque arbre fini t , et qu'un tel arbre de Galton-Watson, conditionné à avoir taille k , est un élément uniforme de \mathcal{T} de taille k . On remarquera immédiatement que l'espérance de ν_z est alors $F'(T(z))$.

Lemme 1.2.4. Soit $F(t) = \sum_{i \geq 2} f_i t^i$ une série génératrice à coefficients positifs et notons R_F son rayon de convergence. Supposons que

$$F'(R_F) > 1.$$

5. La série génératrice des arbres de Schröder est bien entendu explicite, mais nous n'en ferons pas usage, pour montrer la généralité de l'approche. Le niveau de généralité adopté ici est celui des arbres à degré restreints mais en réalité en prenant $f_i \in \mathbb{R}_+$ l'équation (1.5) définit une classe pondérée d'arbres, dite simplement générée (voir [Jan12]), qui s'étudient de la même manière

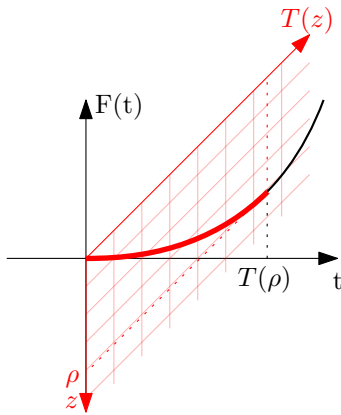

FIGURE 1.6. Inversion de l'équation $T = z + F(T)$ sous hypothèse d'analyticité.

Soit ρ le rayon de convergence de la solution $T = T(z)$ de $T = z + F(T)$. Alors F est analytique au point $T(\rho)$, $F'(T(\rho)) = 1$, et il existe $c > 0$ tel que quand $z \uparrow \rho$,

$$(1.6) \quad T(z) = T(\rho) - (c + o(1))\sqrt{\rho - z}.$$

En particulier, ν_ρ est d'espérance 1 et admet des moments exponentiels.

En guise de preuve, nous fournissons la fig. 1.6. Ce lemme s'applique en particulier à la série génératrice des arbres de Schröder, pour laquelle on trouve $T(\rho) = 1 - \frac{\sqrt{2}}{2}$ et $\rho = 3 - \sqrt{8}$.

1.2.4. Arbre continu brownien et limites d'échelle d'arbres de Galton-Watson.

La relation de commutativité (1.4) nous incite à chercher une notion de convergence au sens des sous-structures uniformes pour les arbres signés, et d'examiner la convergence des arbres de Schröder signés en ce sens. Quitte à oublier les signes, on retrouve la théorie des *Continuum Random Trees* d'Aldous, développée dans [Ald93], que nous exposons dans cette sous-section.

Les arbres sont apparus il y a longtemps dans la théorie probabiliste avec les processus de branchement, dits de Galton-Watson, qui correspondent à un modèle d'arbre aléatoire. Les arbres, en tant que famille combinatoire, ont été étudiés dès les années 60 du point de vue asymptotique et probabiliste (voir par exemple [Kol86]). Il s'agit d'un grand classique, avec les permutations, du domaine de l'*analyse d'algorithmes*. Le livre de Drmota [Drm09] et les références qu'il contient fournit un panorama moderne de tels résultats.

L'introduction par Aldous dans [Ald91 ; Ald93] d'une notion de limite d'échelle pour les arbres a permis d'unifier de nombreux résultats existants [RS67 ; MM78].

Nous voyons un arbre plan enraciné comme un assemblage métrique d'arêtes toutes de longueur 1. Informellement, la fonction de contour $C_t : [0, 1] \rightarrow \mathbb{R}$ d'un arbre t à n arêtes enregistre la distance à la racine au cours d'un parcours autour de l'arbre à vitesse $2n$. Aldous a démontré que pour de nombreux modèles d'arbres aléatoires, la fonction de contour converge vers l'excursion brownienne. Nous ne citons pas ici le théorème d'Aldous, mais un cas particulier d'un théorème dû à Kortchemski [Kor12], qui couvre le cas qui nous intéresse ici.

Théorème 1.2.5. *Soit \mathbf{t}_n un arbre de Galton-Watson dont la loi de reproduction est critique à variance finie, conditionné à avoir n feuilles. Alors il existe une constante $c > 0$ telle que*

$$\frac{1}{c\sqrt{n}}C_{\mathbf{t}_n} \xrightarrow[n \rightarrow \infty]{d} e$$

où e est l'excursion brownienne. De plus la mesure empirique sur $[0, 1]$ des instants de parcours des feuilles de \mathbf{t}_n lors du parcours de contour converge vers la mesure uniforme sur $[0, 1]$.

Au vu des résultats de la section précédente, ceci s'applique notamment aux arbres de Schröder. Notre but initial est de comprendre la forme d'un arbre induit uniforme dans un grand arbre de Schröder. Ce genre de considérations est en réalité au coeur de la théorie d'Aldous. Rappelons la définition donnée plus haut de l'arbre $t_{|I}$ induit dans t par un sous-ensemble des feuilles I . Une arête e de $t_{|I}$ correspond à un chemin dans t , et l'on pourra retenir le nombre d'arêtes dans ce chemin comme étant la longueur de e . Le chemin de la racine de t à celle de $t_{|I}$ peut aussi s'interpréter comme la longueur d'une arête supplémentaire sous la racine de $t_{|I}$. Ceci fait de $t_{|I}$ un arbre planté muni de longueurs (voir une illustration au milieu de la fig. 1.5). On notera $c \cdot \tau$ l'arbre obtenu d'un arbre muni de longueurs τ en multipliant toutes les longueurs par c . Alors une adaptation du théorème 15 de [Ald93] donne l'équivalence suivante

Théorème 1.2.6. *Pour tout $n \geq 1$ soit \mathbf{t}_n un arbre aléatoire à n feuilles. Pour $n \geq k \geq 1$ Soit $\mathbf{I}_{n,k}$ un sous-ensemble uniforme de $[n]$ à k éléments, indépendant de \mathbf{t}_n . Les propriétés suivantes sont équivalentes :*

- i) $\frac{1}{c\sqrt{n}}C_{\mathbf{t}_n} \xrightarrow[n \rightarrow \infty]{d} e$ et la mesure empirique de l'emplacement des feuilles de \mathbf{t}_n le long du chemin $C_{\mathbf{t}_n}$ converge vers la mesure uniforme sur $[0, 1]$.
- ii) Pour tout $k \geq 1$, l'arbre $\frac{1}{c\sqrt{n}}\mathbf{t}_{n|\mathbf{I}_{n,k}}$ converge en loi vers l'arbre planté à k feuilles muni de longueurs défini ainsi :
 - (a) sa structure est celle d'un arbre binaire planté à k feuilles uniforme.
 - (b) le vecteur $(\mathbf{x}_1, \dots, \mathbf{x}_{2k-1})$ des longueurs d'arêtes est échangeable. Sa loi est à densité $(x_1 + \dots + x_{2k-1})e^{-(x_1 + \dots + x_{2k-1})^2/2} dx_1, \dots, dx_{2k-1}$.

Ce résultat s'applique donc aux cas des arbres de Schröder. Néanmoins ce qui nous intéresse, au vu de (1.4), est un sous-arbre induit *signé*, où l'information correspondant aux signes aux points de branchement sont conservés. Les arbres de Schröder signés ont leurs signes qui alternent en partant d'un signe choisi uniformément à la racine. Le signe d'un sommet donné est donc par symétrie, uniforme dans $\{\oplus, \ominus\}$. De plus les autres signes dépendent de la parité de la distance à la racine. Il est raisonnable de supposer que cette information microscopique se mélange à la limite, puisque les distances dans l'arbre sont d'ordre \sqrt{n} , ce qui impliquerait la proposition suivante :

Proposition 1.2.7. $\mathbf{t}_{n|\mathbf{I}_{n,k}}$ converge en loi vers $\mathbf{b}_k^{1/2}$, un arbre binaire aléatoire uniforme, décoré par des signes indépendants et uniformément choisis dans $\{\oplus, \ominus\}$.

Alors, au vu du théorème 1.2.1 et de (1.4), $\sigma_n = \text{perm}(\mathbf{t}_n)$ est une permutation séparable uniforme, et $(\mu_{\sigma_n})_n$ est une suite convergente au sens des permutons, ce qui implique le théorème 1.1.2

1.2.5. Démonstration combinatoire de la proposition 1.2.7.

1.2.5.1. *Combinatoire Analytique.* La démonstration à suivre fait appel aux techniques de l'analyse de singularité décrites dans le chapitre VI de [FS09]. Concrètement, cette méthode relie le comportement asymptotique des coefficients $([z^n]A(z))_{n \geq 0}$ d'une série entière A au comportement de A au voisinage de ses singularités. Une version générale d'un tel résultat (théorème A.2.2) nécessite des hypothèses de régularité supplémentaires, en premier lieu la positivité des coefficients, mais aussi certaines conditions d'analyticité au voisinage des singularités. Dans le cas des séries A algébriques, c'est à dire telles qu'il existe un polynôme $P \in \mathbb{C}[a, z]$ tel que $P(A(z), z) = 0$, ces conditions sont presque automatiquement vérifiées, et nous avons le résultat suivant, résumant les résultats obtenus dans [FS09, § VII.7]

Proposition 1.2.8. *Soit $A(z)$ une série entière algébrique, dont les coefficients $([z^k]A(z))_k$ sont positifs. Soit ρ son rayon de convergence. Supposons que A n'admette qu'une seule singularité sur le cercle $\{|z| = \rho\}$. Alors cette singularité est en ρ , et A s'étend analytiquement à un ensemble fendu $D(0, \rho + \varepsilon) \setminus [\rho, +\infty)$ pour un certain $\varepsilon > 0$. De plus, il*

existe $c \neq 0$, $\alpha \in \mathbb{Q} \setminus \mathbb{Z}_{\geq 0}$ et un polynôme P tel que l'asymptotique suivante soit valable sur $D(0, \rho + \varepsilon) \setminus [\rho, +\infty)$:

$$A(z) = P(z - \rho) + (c + o(1))(\rho - z)^\alpha, \quad z \rightarrow \rho.$$

On a alors

$$[z^n]A(z) = \frac{c + o(1)}{\Gamma(-\alpha)} \rho^{-n} n^{-1-\alpha}.$$

Les séries génératrices que nous utiliserons à partir de maintenant dans l'analyse des arbres de Schröder sont toutes algébriques avec une seule singularité sur leur cercle de convergence. Afin de rester le plus accessible possible, nous ne démontrons pas ce fait, qui peut être vérifié en cherchant des expressions explicites de chacune. Dans les généralisations présentés dans cette thèse, des raisonnements généraux garantiront que les conditions du théorème A.2.2 sont bien vérifiées pour toutes les séries analysées.

Au vu de la proposition précédente, (1.6) implique l'asymptotique suivante, classique pour les séries comptant des arbres :

$$(1.7) \quad [z^n]T(z) \sim C \rho^{-n} n^{-3/2}.$$

1.2.5.2. *Réécriture combinatoire.* Soit t_0 un arbre signé à k feuilles. Notre but est de calculer $\lim_{n \rightarrow \infty} \mathbb{P}(\mathbf{t}_{n|I_{n,k}} = t_0)$. Définissons pour cela la classe combinatoire \mathcal{T}_{t_0} des paires (t, I) , où t est un arbre de Schröder signé, $I \subset [|t|]$, et $t|_I = t_0$, où la taille de l'objet (t, I) est le nombre de feuilles de t . Soit T_{t_0} la série génératrice associée. Il vient

$$(1.8) \quad \mathbb{P}(\mathbf{t}_{n|I_{n,k}} = t_0) = \frac{[z^n]T_{t_0}(z)}{\binom{n}{k}[z^n]T(z)}.$$

D'après l'éq. (1.7), le dénominateur est d'ordre $\rho^n n^{k-3/2}$. Nous cherchons maintenant à analyser le numérateur, en donnant une décomposition de la classe \mathcal{T}_{t_0} .

1.2.5.3. *Décomposition combinatoire d'arbres induisant un arbre donné.* Soit maintenant \mathcal{T}' la classe combinatoire des arbres de Schröder avec une feuille marquée, comptée par le nombre de feuilles non marquées. La notation est immédiatement justifiée par le fait que T' est la série génératrice de \mathcal{T}' . Écrivons $\mathcal{T}' = \mathcal{T}'_0 \uplus \mathcal{T}'_1$, où \mathcal{T}'_0 (respectivement \mathcal{T}'_1) est l'ensemble des éléments de \mathcal{T}' tels que la distance de la racine à la feuille marquée soit paire (resp. impaire).

Soit un élément t de \mathcal{T}_{t_0} . L'arbre induit par les feuilles marquées dans t est t_0 . Rappelons que dans la définition d'induction, chaque sommet v de t_0 est associé à un sommet de t , que l'on notera $\phi(v)$. En particulier si v est la i -ème feuille de t_0 , alors $\phi(v)$ est la i -ème feuille marquée de t , et l'ensemble des noeuds internes de t_0 est envoyé sur l'ensemble des plus récents ancêtres communs de deux feuilles marquées distinctes de t . Découpons l'arbre t en chacun de ces sommets, comme indiqué sur la fig. 1.7.

Cette procédure découpe t en un certain nombre d'arbres de Schröder, plus précisément:

- i) En dessous de chaque feuille marquée $\phi(v)$ de t , qui correspond à une feuille v de t_0 , il y a un arbre de Schröder (en rouge sur la figure), dans laquelle la feuille marquée est présente et contribue à la taille totale de t . Une telle composante est comptée par zT'
- ii) En dessous du sommet $\phi(\emptyset) \in t$ correspondant à la racine de t_0 , il y a un arbre de Schröder (en noir sur la figure), et le sommet $\phi(\emptyset)$ y identifie une feuille marquée, qui ne contribue pas à la taille de t . Une telle composante est comptée par T' .
- iii) Entre deux sommets $\phi(v), \phi(w) \in t$ correspondants à deux noeuds internes v, w adjacents de t_0 , il y a un arbre de Schröder (en vert sur la figure), et le sommet $\phi(w)$ y identifie une feuille marquée, qui ne contribue pas à la taille. De plus la distance entre la feuille marquée et la racine est nécessairement paire si les signes de v et w sont différents, et impaire sinon. Alors une telle composante est respectivement comptée par T'_0 et T'_1 .

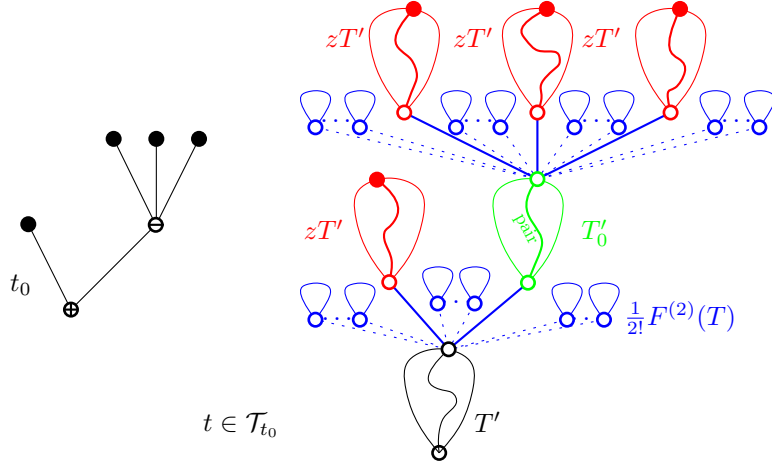

FIGURE 1.7. Un arbre signé t_0 et le découpage d'un élément arbitraire $t \in \mathcal{T}_{t_0}$.

- iv) Chaque sommet $\phi(v) \in t$ correspondant à un noeud interne v de t_0 a un nombre d'enfants k tel que $f_k \neq 0$, au moins égal à $\deg(v)$. Parmi ces enfants, $\deg(v)$ d'entre eux mènent à d'autres sommets marqués. En les $k - \deg(v)$ autres sont enracinés un arbre de Schröder non marqué (en bleu sur la figure). Cette composante est comptée par

$$\sum_{k \geq 0} f_k \binom{k}{\deg(v)} T^{k-\deg(v)} = \frac{F^{(\deg(v))}(T)}{\deg(v)!}.$$

Nous résumons cette décomposition dans le résultat suivant :

Proposition 1.2.9. *Soit t_0 un arbre signé à k feuilles. Notons $\text{Int}(t_0)$ son ensemble de noeuds internes, a (resp. b) le nombre de paires de noeuds internes adjacents de même signe (resp. de signe distinct). Alors*

$$(1.9) \quad T_{t_0} = T'(zT')^k (T'_1)^a (T'_0)^b \prod_{v \in \text{Int}(t_0)} \frac{F^{(\deg(v))}(T)}{\deg(v)!}.$$

1.2.5.4. *Analyse asymptotique.* Nous passons maintenant à l'étude asymptotique des facteurs de cette équation. Tout d'abord, T' est également algébrique, et en utilisant la proposition 1.2.8 de manière inversée, on obtient ainsi qu'il existe $c' > 0$ tel que

$$(1.10) \quad T'(z) \sim c'(\rho - z)^{-1/2}, z \rightarrow \rho.$$

Par ailleurs, en décomposant un élément de \mathcal{T}'_1 à sa racine, on obtient (par un raisonnement similaire au point iv) ci-dessus) $T'_1 = F'(T)T'_0$. Comme T est continue au voisinage de ρ (1.6) et comme F est analytique en $T(\rho)$ avec $F'(T(\rho)) = 1$, on a alors $T'_1 \sim T'_0$ quand $z \rightarrow \rho$. Mais alors, puisque $T'_0 + T'_1 = T'$, on a nécessairement

$$(1.11) \quad T'_0 \sim T'_1 \sim \frac{1}{2}T' \sim \frac{c'}{2}(\rho - z)^{-1/2}, z \rightarrow \rho.$$

Tous les ingrédients sont maintenant réunis pour conclure. En effet en remplaçant les facteurs divergents quand $z \rightarrow \rho$ par leurs équivalents (1.11) et (1.10), et les facteurs convergents par leur valeur en $z = \rho$ dans (1.9), on obtient

$$(1.12) \quad T_{t_0} \sim \rho^k c^{\#V(t_0)} 2^{-a-b} \prod_{v \in \text{Int}(t_0)} \frac{F^{(\deg(v))}(T(\rho))}{\deg(v)!} (\rho - z)^{-(\#V(t_0)+1)/2}.$$

Cet équivalent asymptotique domine quand $\#V(t_0)$ est maximal. À nombre de feuilles k fixés, ce maximum est atteint quand l'arbre t_0 est binaire et possède $k - 1$ noeuds internes.

Dans ce cas, (1.13) se spécialise ainsi :

$$(1.13) \quad T_{t_0} \sim \rho^k c^{2k-1} 2^{-k+2} \left(\frac{F^{(2)}(T(\rho))}{2} \right)^{k-1} (\rho - z)^{1/2-k}.$$

Nous constatons que cet équivalent asymptotique ne dépend que de k . Alors, en combinant les eqs. (1.8), (1.12) et (1.13) et la proposition 1.2.8, on obtient que $\mathbf{t}_{\mathbf{n}|\mathbf{I}_{n,k}}$ converge en loi vers un arbre signé à k feuilles uniforme. Ceci conclut la preuve de la proposition 1.2.7 et du théorème 1.1.2.

Description des résultats

Nous présentons maintenant les résultats obtenus pendant cette thèse, issus de cinq publications et prépublications.

- Dans [Maa20], nous présentons une construction explicite du permuton brownien $\mu^{1/2}$. Cet article est devenu le chapitre 4 de cette thèse.
- Dans [Bas+20 ; Bas+19b], en commun avec Frédérique Bassino, Mathilde Bouvel, Valentin Féray, Lucas Gerin et Adeline Pierrot, nous généralisons le théorème 1.1.2 à d'autres classes de permutations, mettant à jour un phénomène d'universalité pour le permuton brownien ainsi que des moyens de sortir de cette classe d'universalité. Ces articles sont devenus les chapitres 3 et 5 à 7 de cette thèse.
- Dans [Bas+19a] toujours avec les mêmes auteurs, nous étudions la convergence au sens des graphons des cographes, qui sont les graphes d'inversion des permutations séparables. Cet article est devenu le chapitre 8 de cette thèse.
- Dans [BM20a], en commun avec Jacopo Borga, nous étudions la forme limite de la famille des permutations de Baxter, définies par évitement de motifs généralisés. Cet article, différent conceptuellement des autres, est devenu le chapitre 9 de cette thèse.

2.1. Construction du permuton brownien

Cette section décrit les travaux effectués dans [Maa20], chapitre 4 de cette thèse, pour construire le permuton brownien directement comme objet continu, en partant d'une *excursion brownienne signée*. Nous tirons ensuite plusieurs propriétés de $\mu^{1/2}$ comme conséquence de cette construction. Tout d'abord, introduisons pour le besoin de futures généralisations le permuton brownien biaisé de paramètre p .

Définition 2.1.1. Soit $p \in [0, 1]$. Le permuton brownien biaisé de paramètre p est un permuton aléatoire μ^p dont la loi est caractérisée par

$$\text{Perm}_k(\mu^p) = \text{perm}(\mathbf{b}_{k,p}), \text{ for every } k \geq 1,$$

où $\mathbf{b}_{k,p}$ est un arbre binaire aléatoire uniforme à k feuilles, dont les noeuds internes sont décorés indépendamment par des signes i.i.d. de biais p (c'est-à-dire $\mathbb{P}(\oplus) = p$ et $\mathbb{P}(\ominus) = 1 - p$).

L'unicité en loi d'un tel permuton est une conséquence du théorème 1.2.1, l'existence suit de la proposition 1.2.2.

2.1.1. L'excursion brownienne signée. Soit e l'excursion brownienne. Le lemme suivant dit qu'il est possible d'énumérer ses minima locaux d'une manière mesurable. Notons que de tels ensembles denses aléatoires ont été étudiés dans [Tsi06].

Lemme 2.1.2 (lemme 4.2.2). *Il existe une suite $(b_i)_{i \in \mathbb{N}}$ d'applications mesurables $b_i : \mathcal{C}([0, 1]) \rightarrow \mathbb{R}$, telle que presque sûrement, $i \mapsto b_i(e)$ est une bijection entre \mathbb{N} et les minima locaux stricts de e autres que 0 et 1.*

Nous appellerons alors *excursion brownienne signée de biais p* la paire (e, s) où e est une excursion brownienne, et $s = (s_i)_{i \in \mathbb{N}}$ est une suite i.i.d. de signes aléatoires telle que $\mathbb{P}(s_i = \oplus) = p$. Il sera entendu que le signe s_i est attaché au minimum local $b_i(e)$.

Si $x < y \in [0, 1]$, nous disons que x et y sont e -comparables si le minimum de e sur $[x, y]$ est réalisé en un unique point qui est un $b_i(e) \in (x, y)$. Pour l'excursion brownienne, ceci se produit avec probabilité 1 à x et y fixés.

Dans ce cas si $s_i = \oplus$ nous disons que $x \prec_e^s y$, sinon $y \prec_e^s x$. La relation \prec_e^s est un ordre strict sur $[0, 1]$, mais n'est total que sur un ensemble de mesure 1 avec probabilité 1. En réalité l'on peut étendre \prec_e^s à un préordre total sur $[0, 1]$ avec probabilité 1, comme discuté en section 4.1.6.

2.1.2. Construction du permuton. Nous définissons le processus stochastique suivant

$$(2.1) \quad \varphi_{e,s}(t) = \text{Leb}\{u \in [0, 1], u \prec_e^s t\}, \quad t \in [0, 1]$$

et

$$\mu_{e,s} = (\text{Id}, \varphi_{e,s})_* \text{Leb},$$

où $H_*\nu$ désigne la mesure image $\nu(H^{-1}(\cdot))$, dès que H et ν sont respectivement une fonction et une mesure définies sur le même espace mesurable. Le lecteur pourra considérer la fig. 2.4, laissant de côté pour le moment l'excursion verticale \tilde{e} , pour voir un exemple d'excursion signée (e, S) avec $\varphi_{e,S}$. Notre principal résultat est le suivant.

Théorème 2.1.3 (théorème 4.1.3). *Les applications $(e, s, t) \mapsto \varphi_{e,s}(t)$ et $(e, s) \mapsto \mu_{e,s}$ sont mesurables, et la mesure aléatoire $\mu_{e,S}$ a la loi de μ^p , le permuton brownien biaisé de paramètre p .*

Nous démontrons également une réécriture du théorème 1.1.2 sans permutons, mais en termes de convergence de fonctions aléatoires. Pour $\sigma \in \mathfrak{S}_n$, nous définissons la fonction affine par morceaux et préservant la mesure $f_\sigma : [0, 1] \rightarrow [0, 1]$ avec $f_\sigma(x) = \frac{1}{n}(\sigma(\lfloor nt \rfloor + 1) - 1) + \frac{1}{n}\{\sigma\}$.

Corollaire 2.1.4 (corollaire 4.1.4). *Soit σ_n un élément aléatoire de \mathfrak{S}_n pour tout $n \in \mathbb{N}$. Si μ_{σ_n} converge en loi vers μ^p , alors pour tout $q \in [1, \infty)$, nous avons la convergence en loi suivante dans l'espace $L^q([0, 1])$:*

$$f_{\sigma_n} \xrightarrow[n \rightarrow \infty]{d} \varphi_{e,S}.$$

2.1.3. Propriétés du permuton. Cette construction continue nous permet d'obtenir plusieurs propriétés de μ^p . Tout d'abord, la structure autosimilaire apparente du permuton brownien pourrait laisser entrevoir une dimension fractale non-triviale. Nous montrons qu'il n'en est rien.

Théorème 2.1.5 (théorème 4.1.5). *Presque sûrement, le support de μ^p est totalement déconnecté, et sa dimension de Hausdorff est 1 (la mesure de Hausdorff 1-dimensionnelle étant majorée par $\sqrt{2}$)*

L'affirmation que la dimension de Hausdorff est 1 intervient aussi comme cas particulier d'un résultat de Riera [Rie]: toute limite d'une suite de permutations dans une classe non-triviale, a un support de dimension de Hausdorff 1.

En revanche, μ^p hérite des propriétés d'auto-similarité de e , de sorte que μ^p contient beaucoup de copies en loi de lui-même. En particulier, nous obtenons le théorème suivant, illustré dans la fig. 2.1, selon lequel μ^p peut être obtenu par copier-coller, après remise à l'échelle, de trois permutons séparables browniens indépendants.

Théorème 2.1.6 (théorème 4.1.6). *Soit $(\Delta_0, \Delta_1, \Delta_2)$ un triplet aléatoire de loi Dirichlet $(\frac{1}{2}, \frac{1}{2}, \frac{1}{2})$. Soit μ_0, μ_1, μ_2 indépendants et distribués comme μ^p , et conditionnellement à μ_0 , soit (X_0, Y_0) un point aléatoire de loi μ_0 . Soit β une variable de Bernoulli indépendante de paramètre p . Nous définissons trois applications affines par morceaux du carré dans lui-même*

$$(2.2) \quad \begin{aligned} \theta_0(x, y) &= (\eta_0(x), \zeta_0(y)) = \Delta_0(x, y) + (1 - \Delta_0)(\mathbb{1}_{[x > X_0]}, \mathbb{1}_{[y > Y_0]}) \\ \theta_1(x, y) &= (\eta_1(x), \zeta_1(y)) = \Delta_1(x, y) + \Delta_0(X_0, Y_0) + \Delta_2(0, \beta) \\ \theta_2(x, y) &= (\eta_2(x), \zeta_2(y)) = \Delta_2(x, y) + \Delta_0(X_0, Y_0) + \Delta_1(1, 1 - \beta) \end{aligned}$$

Alors

$$(2.3) \quad \Delta_0 \theta_0 * \mu_0 + \Delta_1 \theta_1 * \mu_1 + \Delta_2 \theta_2 * \mu_2 \stackrel{d}{=} \mu^p,$$

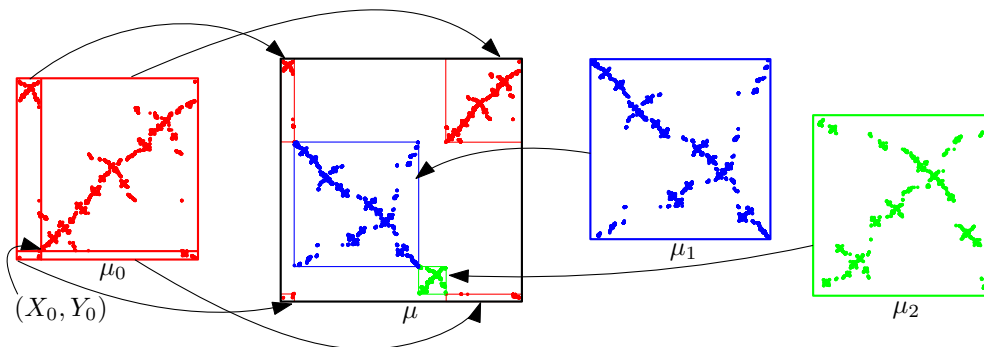

FIGURE 2.1. La construction de μ à partir de trois permutons indépendants distribués comme μ . Ici $\beta = 0$ et $(\Delta_0, \Delta_1, \Delta_2) \approx (0.4, 0.5, 0.1)$.

Nous pensons qu'un résultat d'Albenque and Goldschmidt [AG15] sur l'arbre brownien peut être adapté pour montrer que l'identité en loi (2.3) caractérise μ^p (voir remarque 4.5.5.)

Finalement, notre construction permet de calculer le permuton moyenné (ou *intensité* $\mathbb{E} \mu^p$, obtenu en définissant $\mathbb{E} \mu^p(A) = \mathbb{E}[\mu^p(A)]$ pour tout Borélien A . Nous obtenons le résultat suivant.

Théorème 2.1.7 (théorème 4.1.7). *Le permuton $\mathbb{E} \mu^p$ est la mesure $\alpha_p(x, y) dx dy$, où $\alpha_p(x, y)$ vaut*

$$\int_{\max(0, x+y-1)}^{\min(x, y)} \frac{3p^2(1-p)^2 da}{2\pi(a(x-a)(1-x-y+a)(y-a))^{3/2} \left(\frac{p^2}{a} + \frac{(1-p)^2}{(x-a)} + \frac{p^2}{(1-x-y+a)} + \frac{(1-p)^2}{(y-a)} \right)^{5/2}}.$$

Dans le cas $p = 1/2$, $\alpha_{1/2}$ a toutes les symétries du carré, et

$$(2.4) \quad \alpha_{1/2}(x, y) = \frac{1}{\pi}(\beta(x, y) + \beta(x, 1-y)), \quad 0 \leq x \leq \min(y, 1-y),$$

$$\text{où } \beta(x, y) = \frac{3xy - 2x - 2y + 1}{(1-x)(1-y)} \sqrt{\frac{1-x-y}{xy}} + 3 \arctan \sqrt{\frac{xy}{1-x-y}}.$$

Des graphes de la fonction α pour diverses valeurs de p sont fournis en fig. 2.2. La fonction $\alpha_{1/2}$ est déjà apparue sous une forme différente dans le travail de Dokos and Pak [DP14] sur la forme limite des permutations séparables doublement alternantes, qui sont aussi les permutations de Baxter doublement alternantes, qui semblent également converger vers le permuton brownien. Nous discutons ceci plus en avant à la fin de la section 4.6.

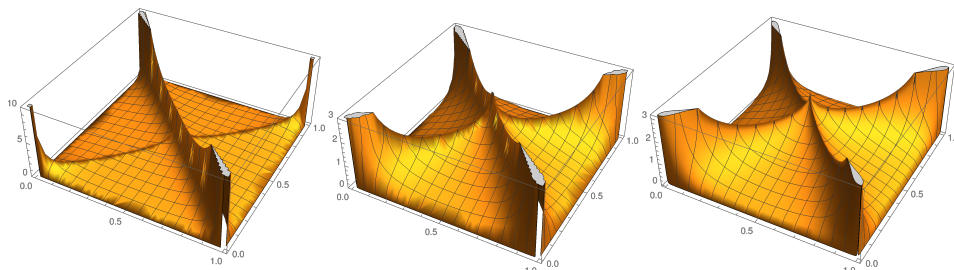

FIGURE 2.2. La fonction α_p pour $p \in \{0.3, 0.45, 0.5\}$. L'axe vertical est tronqué.

2.1.4. Réordonnement d'arbres continus. Soit t un arbre signé de taille n et σ la permutation séparable associée. Remarquons que le parcours des feuilles de t dans l'ordre $\sigma^{-1}(1), \dots, \sigma^{-1}(n)$, c'est à dire dans l'ordre croissant des $\sigma(i)$, forme un parcours en profondeur de l'arbre t , seulement un qui visite les enfants d'un sommet de signe \ominus de droite à gauche plutôt que de gauche à droite. Ainsi il est possible de construire un arbre \tilde{t} isomorphe à t en tant qu'arbre enraciné étiqueté, mais dont les étiquettes des feuilles, lues de gauche à droite, sont $\sigma^{-1}(1), \dots, \sigma^{-1}(n)$, comme présenté sur la figure suivante. De plus $t \mapsto \tilde{t}$ est une involution de l'ensemble des arbres signés.

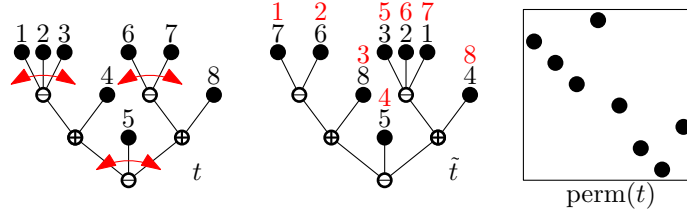

FIGURE 2.3. Un arbre signé t , avec \tilde{t} et $\sigma = \text{perm}(t)$.

Le théorème suivant est l'analogie continue de ce phénomène. Pour e une excursion brownienne, notons $(L_t^y(e))_{0 \leq t \leq 1, y \geq 0}$ le processus des temps locaux associé. Définissons également la pseudo-distance $d_e(s, t) = e(s) + e(t) - 2 \min_{[s, t]} e$ sur $[0, 1]$, qui munit (après quotient) le segment $[0, 1]$ d'une structure d'arbre réel, et réalise l'arbre continu brownien d'Aldous comme espace métrique compact aléatoire (voir [Le 05] et la section 4.7).

Rappelons la définition du temps local du processus stochastique e :

$$L_t^y(e) = \lim_{\varepsilon \rightarrow 0} \frac{1}{2\varepsilon} \text{Leb}\{s \in [0, t] : |e(s) - y| \leq \varepsilon\} \text{ en probabilité, } t \geq 0, y \geq 0,$$

ce processus admettant presque sûrement une modification continue en temps et espace.

Théorème 2.1.8 (théorème 4.1.8). *Il existe une fonction continue aléatoire \tilde{e} , définie de manière mesurable à partir de (e, S) , avec les propriétés suivantes:*

- i) *La fonction \tilde{e} a la loi d'une excursion brownienne, et presque sûrement, $L_1^y(\tilde{e}) = L_1^y(e)$ pour tout $y \geq 0$.*
- ii) *Presque sûrement, la fonction $\varphi_{e, S}$ est une isométrie entre les pseudo-distances d_e et $d_{\tilde{e}}$. En particulier, $\tilde{e} \circ \varphi_{e, S} = e$.*

Sa preuve est l'objet de la section 4.7. On discute également d'une interprétation de ce résultat en termes d'encodage d'arbres continus par des excursions, au sens de [Le 05; Duq06], à la fin de l'introduction du chapitre 4. Notons que nous revenons sur la présente construction à nouveau dans le dernier chapitre de cette thèse, section 9.B.1.

2.2. Limites d'échelle de classes closes par substitution

Cette section et la suivante décrivent les résultats obtenus en collaboration avec F. Bassino, M. Bouvel, V. Féray, L. Gerin et A. Pierrot dans les articles [Bas+20; Bas+19b], et démontrés dans les chapitres 5 à 7, qui consistent en des généralisations du théorème 1.1.2 à d'autres classes de permutations.

Nous obtiendrons deux types de résultats. Les résultats d'universalité, comme le théorème principal 2.2.4 de cette section, montrent que de nombreuses autres classes de permutation convergent également vers le permuton brownien (biaisé). Nous montrons également comment sortir en théorie de cette classe d'universalité.

L'approche suivie est très proche de la démonstration du théorème 1.1.2 présentée en section 1.2. Nous utiliserons la *décomposition par substitution* des permutations, qui généralise l'encodage des permutations séparables par les arbres de Schröder à l'ensemble des permutations. Pour la plupart (au sens des probabilités) des permutations, elle est

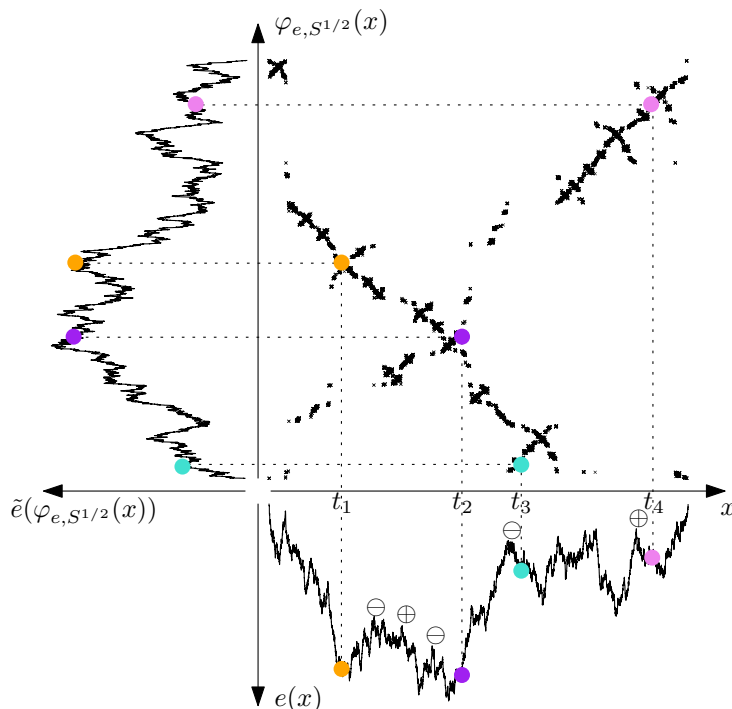

FIGURE 2.4. Une réalisation de (e, S) (ici $p = 1/2$), et les fonctions associées $\varphi_{e,S}$ et \tilde{e} , mettant en exergue la propriété $\tilde{e} \circ \varphi_{e,S} = e$. Les images de quatre points $t_1 < \dots < t_4$ sont spécifiées.

presque triviale. Nous considérerons des classes de permutations avec une structure riche par rapport à cette décomposition, celles qui admettent une *spécification finie*.

Le cas le plus simple de telles classes est celui des *classes closes par substitution*, qui sont l'objet de la présente section. La section suivante sera consacrée au cas général.

2.2.1. Décomposition par substitution. La substitution $\pi[\sigma_1, \dots, \sigma_k]$ d'une suite de k permutations dans $\pi \in \mathfrak{S}_k$ s'obtient en remplaçant le i -ème point du diagramme de π par le diagramme de la permutation σ_i pour $1 \leq i \leq k$. Remarquons que les opérations \oplus et \ominus définies plus haut sont simplement les substitutions dans la permutation croissante ou décroissante de la taille appropriée. (voir fig. 2.5 ci-dessous et fig. 1.4 plus haut.).

$$2413[132, 21, 1, 12] = \begin{array}{|c|c|c|c|} \hline & 21 & & \\ \hline & & & 12 \\ \hline 132 & & & \\ \hline & & 1 & \\ \hline \end{array} = \begin{array}{|c|c|c|c|} \hline & \bullet & & \\ \hline & \bullet & \bullet & \\ \hline & \bullet & \bullet & \bullet \\ \hline \bullet & \bullet & \bullet & \bullet \\ \hline \end{array} = 24387156$$

FIGURE 2.5. Substitution de permutations.

La *décomposition par substitution* consiste en l'écriture d'une permutation donnée comme substitution de plus petites. Certaines permutations ne peuvent être décomposées davantage, nous les appelons *permutations simples*.

Définition 2.2.1. Une *permutation simple* est une permutation σ de taille $n > 2$ qui n'envoie pas d'intervalle non trivial. (i.e. un intervalle de $[n]$ contenant au moins deux et au plus $n - 1$ éléments) sur un intervalle.

Par exemple, 451326 n'est pas simple car elle envoie $[3; 5]$ sur $[1; 3]$. Les plus petites permutations simples sont 2413 et 3142 (il n'y a pas de permutation simple de taille 3). Notons que nous employons une convention différente de celle habituelle dans la littérature, où (12) et (21) sont également des permutations simples. Nous les considérons à part car elles jouent un rôle spécial dans la décomposition de la proposition 2.2.2.

La proposition 2 de [AA05] garantit que la décomposition par substitution permet d'obtenir toutes les permutations, à partir de la permutation unité (1) dénotée \bullet , des permutations (12) notée \oplus , (21) notée \ominus , et des permutations simples. De plus on peut rendre cette décomposition unique quitte à adopter une convention levant l'ambiguïté. Ceci se résume en une spécification combinatoire, au sens de la définition I.2 de [FS09], pour l'ensemble des permutations.

Proposition 2.2.2. *Soit $\mathfrak{S}^{\text{not}\oplus}$ (resp. $\mathfrak{S}^{\text{not}\ominus}$) l'ensemble des permutations qui ne peuvent pas s'écrire comme une substitution non triviale dans (12) (resp. (21)). Alors on a la spécification combinatoire suivante:*

$$(2.5) \quad \begin{cases} \mathfrak{S} &= \{\bullet\} \uplus \oplus[\mathfrak{S}^{\text{not}\oplus}, \mathfrak{S}] \uplus \ominus[\mathfrak{S}^{\text{not}\ominus}, \mathfrak{S}] \uplus (\uplus_{\pi \text{ simple}} \pi[\mathfrak{S}, \dots, \mathfrak{S}]) \\ \mathfrak{S}^{\text{not}\oplus} &= \{\bullet\} \uplus \ominus[\mathfrak{S}^{\text{not}\ominus}, \mathfrak{S}] \uplus (\uplus_{\pi \text{ simple}} \pi[\mathfrak{S}, \dots, \mathfrak{S}]) \\ \mathfrak{S}^{\text{not}\ominus} &= \{\bullet\} \uplus \oplus[\mathfrak{S}^{\text{not}\oplus}, \mathfrak{S}] \uplus (\uplus_{\pi \text{ simple}} \pi[\mathfrak{S}, \dots, \mathfrak{S}]). \end{cases}$$

Cette décomposition témoigne d'une bijection entre les permutations et une famille d'arbres plans enracinés aux noeuds internes décorés par une permutation simple ou les symboles \oplus et \ominus , que l'on appelle *arbres standard*. Remarquons que l'application de cette bijection à une permutation séparable donne un arbre signé binaire et non pas un arbre de Schröder, qui correspond à une convention différente de celle ci-dessus. On identifiera désormais à travers cette bijection, les permutations à leurs arbres standard.

La décomposition par substitution a été introduite par [AA05] et utilisée pour étudier de nombreuses classes de permutations, notamment dans [BHV08b] pour montrer que toute classe de permutations contenant un nombre fini de permutations simples est algébrique.

2.2.2. Classes closes par substitution. Soit \mathcal{S} un ensemble fini ou infini de permutation simples. Nous dénotons par $[\mathcal{S}]$ l'ensemble des permutations obtenues en se restreignant aux substitutions dans \oplus , \ominus et $\alpha \in \mathcal{S}$, dénommé *clôture par substitution* de \mathcal{S} . L'ensemble \mathcal{T} des arbres standard de $[\mathcal{S}]$ obéit à la spécification suivante:

$$(2.6) \quad \begin{cases} \mathcal{T} &= \{\bullet\} \uplus \oplus[\mathcal{T}^{\text{not}\oplus}, \mathcal{T}] \uplus \ominus[\mathcal{T}^{\text{not}\ominus}, \mathcal{T}] \uplus (\uplus_{\pi \in \mathcal{S}} \pi[\mathcal{T}, \dots, \mathcal{T}]) \\ \mathcal{T}^{\text{not}\oplus} &= \{\bullet\} \uplus \ominus[\mathcal{T}^{\text{not}\ominus}, \mathcal{T}] \uplus (\uplus_{\pi \in \mathcal{S}} \pi[\mathcal{T}, \dots, \mathcal{T}]) \\ \mathcal{T}^{\text{not}\ominus} &= \{\bullet\} \uplus \oplus[\mathcal{T}^{\text{not}\oplus}, \mathcal{T}] \uplus (\uplus_{\pi \in \mathcal{S}} \pi[\mathcal{T}, \dots, \mathcal{T}]). \end{cases}$$

Remarquons qu'une famille de type $[\mathcal{S}]$ n'est pas forcément une classe de permutations. Néanmoins nous avons le résultat suivant :

Proposition 2.2.3. *Soit \mathcal{C} une famille de permutations. Les propriétés suivantes sont équivalentes.*

- i) \mathcal{C} est une classe de permutations close sous l'opération de substitution, qui n'est ni Av(21) ni Av(12).
- ii) $\mathcal{C} = [\mathcal{S}]$ avec \mathcal{S} un ensemble de permutations simples tel que pour tout $\alpha \in \mathcal{S}$, si α' est une simple tel que $\alpha' \preceq \alpha$, alors $\alpha' \in \mathcal{S}$.
- iii) $\mathcal{C} = \text{Av}(B)$ avec B un ensemble de permutations simples.

Par exemple, les permutations séparables sont $\text{Av}(2413, 3142) = [\emptyset]$. Un autre exemple est $\text{Av}(24153, 25314, 3142) = [2413]$.

2.2.3. Un premier résultat: universalité dans les classes closes par substitution. Nous nous intéressons au comportement asymptotique de σ_n , un élément uniforme de $[\mathcal{S}]_n$. Soit $S(z) = \sum_{\alpha \in \mathcal{S}} z^{|\alpha|}$ la série génératrice de \mathcal{S} et $R_S \in [0, +\infty]$ le rayon de convergence de S .

Théorème 2.2.4 (théorème 6.1.3, avec F. Bassino, M. Bouvel, V. Féray, L. Gerin et A. Pierrot). *Soit \mathcal{S} une famille de permutations simples telles que*

$$(H1) \quad R_S > 0 \quad \text{et} \quad \lim_{\substack{r \rightarrow R_S \\ r < R_S}} S'(r) > \frac{2}{(1 + R_S)^2} - 1.$$

Alors la suite $(\mu_{\sigma_n})_n$ converge en loi dans l'espace \mathcal{M} vers le permuton biaisé $\mu^{(p)}$ dont le paramètre p est donné par l'équation (6.3) p. 86.

Le cas correspondant à l'hypothèse (H1) est appelé *standard* car il existe des conditions simples et naturelles qui le garantissent, par exemple lorsque \mathcal{S} a un nombre fini de permutations simples, quand S est une fonction rationnelle ou a une singularité en racine. De plus, la plupart des ensembles de permutations simples dans une classe donnée qui ont été énumérés à ce jour la vérifient, et une liste est donnée dans la section 6.3.

Ici l'objet limite ne dépend de \mathcal{S} que par un paramètre réel p qui dépend en réalité du nombre de motifs (12) et (21) dans les éléments de \mathcal{S} . Dans la fig. 2.6, nous produisons des simulations de grandes permutations uniformes dans une classe close par substitution. La première contient l'ensemble fini de simples $\mathcal{S} = \{2413, 3142, 24153, 42513\}$, la seconde est la clôture par substitution d'Av(321), qui contient une infinité de permutations simples mais vérifie toutefois (H1). La valeur du paramètre p diffère: .5 et $\approx .6$ respectivement. (voir section 6.3, exemples 6.1.4 et 6.1.6).

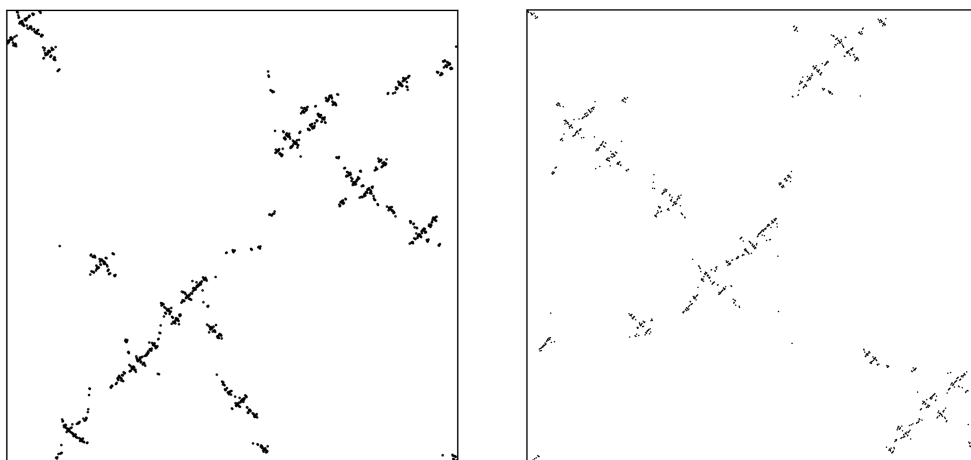

FIGURE 2.6. Gauche: une permutation uniforme de taille 981 dans la classe $[S]$ où $\mathcal{S} = \{2413, 3142, 24153, 42513\}$. Droite: Une permutation uniforme de taille 840 dans la classe $[S]$ où \mathcal{S} est l'ensemble des permutations simples évitant 321.

Finalement, rappelons nous que d'après le théorème 1.2.1, le résultat du théorème 2.2.4 implique immédiatement la convergence jointe

$$(2.7) \quad (\widetilde{\text{occ}}(\pi, \sigma_n))_\pi \xrightarrow[n \rightarrow \infty]{d} (\widetilde{\text{occ}}(\pi, \mu_p))_\pi.$$

Au vu de la définition de μ_p , il est clair que $\widetilde{\text{occ}}(\pi, \mu_p) = 0$ quand π n'est pas séparable. Ainsi les motifs non-séparables disparaissent à la limite. Il serait intéressant de trouver, comme dans [Jan17], la bonne échelle à laquelle regarder $\widetilde{\text{occ}}(\pi, \sigma_n)$ pour obtenir une limite non-triviale. Nous montrons dans la section 6.3.3 qu'une approche naïve par la méthode des moments ne permet pas de conclure: tous les moments $\mathbb{E}[\widetilde{\text{occ}}(\pi, \sigma_n)^m]$ décroissent à la même vitesse, étant "pollués" par un évènement de petite probabilité où $\widetilde{\text{occ}}(\pi, \sigma_n)$ est d'ordre 1.

2.2.4. Classes closes par substitution hors de la classe d'universalité brownienne. Quand $R_S > 0$, pour les deux autres cas $S'(R_S) < 2/(1 + R_S)^2 - 1$ et $S'(R_S) = 2/(1 + R_S)^2 - 1$, le comportement asymptotique de μ_{σ_n} diffère. Les résultats que nous obtenons supposent des hypothèses fortes de régularité sur la série S et d'autres séries qui en dérivent. Ainsi nous les décrivons rapidement et remettons un énoncé complet à plus tard.

- Dans le cas *dégénéré* $S'(R_S) < 2/(1 + R_S)^2 - 1$, nous montrons sous les hypothèses supplémentaires, que si la permutation simple uniforme dans \mathcal{S} a une limite au

sens des permutons, alors σ_n converge vers la même limite (théorème 6.6.6). Ce cas traduit un phénomène de *condensation*, au sens de [JS11], dans l'arbre codant σ_n .

- Dans le cas *critique* $S'(R_S) = 2/(1 + R_S)^2 - 1$ deux sous-cas apparaissent. Si $S''(R_S) < \infty$, alors nous avons à nouveau convergence vers le permuton brownien biaisé (théorème 6.6.4). Sinon, toujours sous les mêmes hypothèses fortes, le permuton limite appartient à une nouvelle famille, les *permutons stables* (théorème 6.6.6), dont la définition est liée à l'arbre stable, et dont des approximations sont présentées dans la fig. 2.7. Ce dernier cas traduit la convergence de l'arbre codant σ_n vers un arbre stable, comme dans [Duq03] et [Kor12].

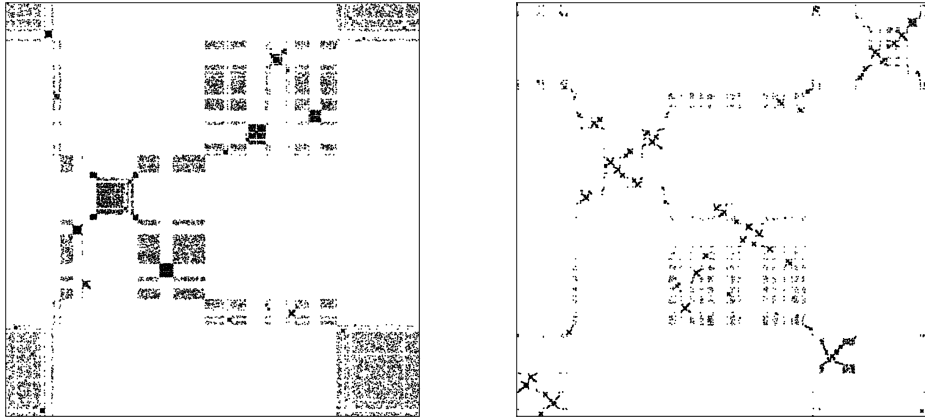

FIGURE 2.7. Simulations d'un permuton 1.1-stable et 1.5-stable, associés à la mesure uniforme.

Nous faisons remarquer que nous n'avons pas d'exemple de classes de permutation pour laquelle nous pouvons vérifier l'ensemble des hypothèses de l'un de ces théorèmes. Nous pensons que le phénomène de dégénérescence se produit dans de nombreux cas, comme par exemple la classe close par substitution $\text{Av}(2413)$, mais n'avons pas été capables d'étudier nos hypothèses supplémentaires dans ce cas. Nous en discutons plus en avant dans la remarque 6.5.3.

Quand au cas critique, nous ne savons pas s'il existe une classe de permutations qui obéit aux conclusions du théorème 6.6.6, encore moins à ses hypothèses. Les simulations de fig. 2.7 présentent de grandes permutations induites par le permuton stable, et non pas des permutations uniformes dans une quelconque classe.

2.2.5. Intuition probabiliste. Considérons une classe close par substitution $\mathcal{C} = [\mathcal{S}]$, que l'on identifie à son ensemble d'arbres standards \mathcal{T} , qui admet la spécification (2.6). Par la méthode symbolique, on transforme cette spécification en système sur les séries génératrices associées, qui peut être réécrit par de simples manipulations algébriques.

$$\begin{cases} T &= z + T^{\text{not}\oplus}T + T^{\text{not}\ominus}T + S(T) \\ T^{\text{not}\oplus} &= z + T^{\text{not}\ominus}T + S(T) \\ T^{\text{not}\ominus} &= z + T^{\text{not}\oplus}T + S(T). \end{cases} \iff \begin{cases} T &= \frac{T^{\text{not}\oplus}}{1 - T^{\text{not}\oplus}} \\ T^{\text{not}\ominus} &= T^{\text{not}\oplus} \\ T^{\text{not}\oplus} &= z + \Lambda(T^{\text{not}\oplus}), \text{ où} \\ \Lambda(t) &= \frac{t^2}{1-t} + S\left(\frac{t}{1-t}\right) \end{cases}$$

Commençons par décrire l'intuition probabiliste derrière ce résultat. La théorie de l'échantillonnage de Boltzmann [DFLS04] appliquée au système à gauche permet de voir un élément de \mathcal{T} uniforme comme un arbre de Galton-Watson multitype conditionné à avoir n feuilles. Les travaux probabilistes [Mie08; Ber18] sur les arbres multitypes, qui ne sont pas directement applicables ici car ils supposent un conditionnement au nombre total de sommets, peuvent guider notre intuition. En particulier, sous une hypothèse de variance

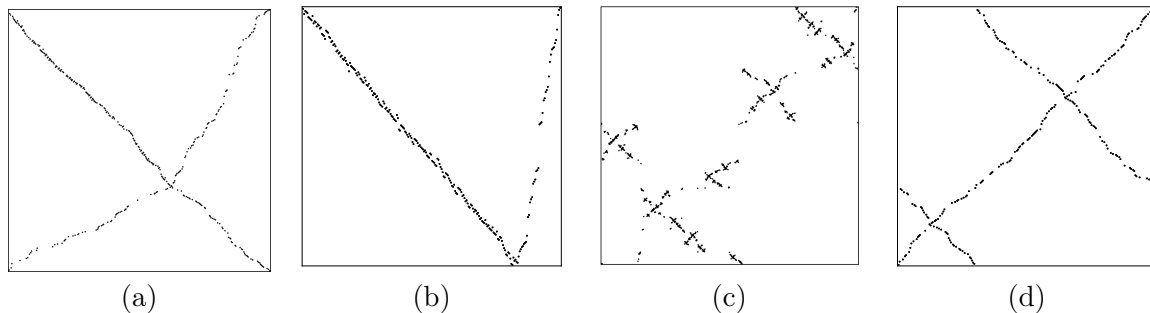

FIGURE 2.8. Grandes permutations tirées au hasard dans quatre classes à spécification finies

finie, qui est vérifiée sous $(H1)$, et de forte connexité du graphe de dépendance des types, clairement vérifiée ici, le théorème principal de [Mie08] donne la convergence des arbres de Galton-Watson conditionnés à avoir n sommets, vers l'arbre brownien.

Comme le montre l'analyse des permutations séparables dans la section 1.2, la forme asymptotique de l'arbre codant n'est pas suffisante pour conclure. On a également besoin de connaître les permutations simples apparaissant sur les points de branchement d'un arbre induit uniforme. La structure multitype de \mathcal{T} est ici un obstacle: un noeud de type \oplus a plus de chance de porter une permutation simple qu'un noeud de type \emptyset . Mais heureusement, la littérature des arbres multitypes met en évidence un phénomène d'ergodicité (et donc d'indépendance à longue portée) des types le long des lignées ancestrales.

Nous n'avons pas recours à ce raisonnement, qui a été développé à posteriori dans [BBFS19] pour retrouver le théorème 2.2.4 de manière plus probabiliste. Notre preuve est combinatoire et se rapproche de celle donnée dans la section 1.2.

Les résultats énoncés dans cette section, provenant de [Bas+20], sont démontrés dans le chapitre 6. Les démonstrations ont été réécrites afin de réutiliser des constructions combinatoires et des résultats généraux de notre article suivant [Bas+19b]. Ces résultats nécessaires à la fois au chapitre 6 et au chapitre 7, sont regroupés dans le chapitre 5.

2.3. Limites d'échelle de classes à spécification finie.

Cette section est consacrée aux résultats obtenus dans l'article [Bas+19b] en collaboration avec F. Bassino, M. Bouvel, V. Féray, L. Gerin et A. Pierrot. Cet article est devenu le chapitre 7 de cette thèse, certains outils combinatoires et analytiques ayant été transférés dans le chapitre 5.

La section précédente était consacrée aux classes de permutations closes par substitution, où nous avons vu qu'une telle classe disposait d'une spécification finie (2.6). Les résultats de cette section s'appliquent à des classes quelconques admettant une spécification finie.

Une condition suffisante pour avoir une spécification finie est de contenir un nombre fini de permutations simples. Dans ce cas, la série génératrice est nécessairement algébrique [AA05], et [Bas+17] fournit une méthode algorithmique pour calculer une spécification de la classe. Cet algorithme a été implémenté par l'auteur de cette thèse [Maa19], et a fourni les divers exemples étudiés.

Nous ne définirons pas formellement la notion de spécification finie dans cette introduction, laissant au lecteur le soin de se faire une idée sur deux exemples choisis pour leur simplicité (et peu intéressants du point de vue de la forme limite, voir plus bas), obtenus par l'algorithme de [Bas+17]¹. Rappelons ici que l'on identifie les permutations avec leurs

1. Voir les notebooks Jupyter `examples/Av132.ipynb` et `examples/Layered.ipynb`

arbres standards.

$$(2.8) \quad \mathcal{T} = \text{Av}(132) : \begin{cases} \mathcal{T} &= \{\bullet\} \uplus \oplus[\mathcal{T}^{\text{not}\oplus}, \mathcal{T}_{\langle 21 \rangle}] \uplus \ominus[\mathcal{T}^{\text{not}\ominus}, \mathcal{T}] \\ \mathcal{T}^{\text{not}\oplus} &= \{\bullet\} \uplus \ominus[\mathcal{T}^{\text{not}\ominus}, \mathcal{T}] \\ \mathcal{T}^{\text{not}\ominus} &= \{\bullet\} \uplus \oplus[\mathcal{T}^{\text{not}\oplus}, \mathcal{T}_{\langle 21 \rangle}] \\ \mathcal{T}_{\langle 21 \rangle} &= \{\bullet\} \uplus \oplus[\mathcal{T}_{\langle 21 \rangle}^{\text{not}\oplus}, \mathcal{T}_{\langle 21 \rangle}] \\ \mathcal{T}_{\langle 21 \rangle}^{\text{not}\oplus} &= \{\bullet\}. \end{cases}$$

$$(2.9) \quad \text{Av}(231, 312) = \mathcal{T}_0 = \{\bullet\} \uplus \oplus[\mathcal{T}_1, \mathcal{T}_0] \uplus \ominus[\mathcal{T}_2, \mathcal{T}_1], \quad \mathcal{T}_1 = \{\bullet\} \uplus \ominus[\mathcal{T}_2, \mathcal{T}_1], \quad \mathcal{T}_2 = \{\bullet\}.$$

Une telle spécification permet ensuite d'obtenir un système d'équations sur les séries correspondantes (voir par exemple eq. (2.10)) ainsi qu'un générateur de Boltzmann de la classe. Nous montrons dans la fig. 2.8 de grandes permutations uniformes dans certaines telles classes. Nous constatons plusieurs comportements différents, et dans chacun de ces cas un théorème du chapitre 7 donne un résultat explicite de limite d'échelle.

2.3.1. Types de spécifications. Considérons une spécification finie d'une classe \mathcal{T} . Cette spécification relie \mathcal{T} à plusieurs familles de permutations $\mathcal{T}_0 = \mathcal{T}, \mathcal{T}_1, \dots, \mathcal{T}_d$. Nous notons T_0, \dots, T_d les séries génératrices correspondantes.

Il est classique d'associer à la spécification de \mathcal{T} un graphe orienté sur l'ensemble $\{\mathcal{T}_0, \dots, \mathcal{T}_d\}$, où $\mathcal{T}_i \rightarrow \mathcal{T}_j$ si \mathcal{T}_i apparaît dans l'équation de \mathcal{T}_j . Ce graphe est dénommé *graphe de dépendance* de la spécification. On suppose généralement que ce graphe est fortement connexe (voir [FS09, th. VII.6, p. 489], [Drm09, th. 2.33] ou [BD15, lemme 2]), ce qui implique en particulier que les séries T_0, \dots, T_d ont toutes le même rayon de convergence. Ceci n'est quasiment jamais vérifiée dans notre contexte et nous devons introduire une hypothèse plus faible.

Les séries T_i dont le rayon de convergence est minimal sont dites *critiques*, vocable que nous associons également à la famille \mathcal{T}_i et au type i . Dans notre cas \mathcal{T} est toujours critique. Nous supposons alors que le graphe de dépendance *restreint aux familles critiques* est fortement connexe, et faisons ensuite une distinction entre deux cas.

- soit les équations définissant les familles critiques sont linéaires en les familles critiques (c'est-à-dire ne contiennent pas de termes $\pi[\dots, \mathcal{T}_i, \dots, \mathcal{T}_j, \dots]$ avec $\mathcal{T}_i, \mathcal{T}_j$ deux familles critiques). On dit alors que la spécification est *essentiellement linéaire*
- dans le cas contraire, on dit que la spécification est *essentiellement branchante*

Exemple 2.3.1. Considérons la classe $\text{Av}(132)$ dont la spécification est donnée en (2.8). Le système d'équations associé se résout et l'on obtient

$$(2.10) \quad \begin{cases} T &= z + T^{\text{not}\oplus} T_{\langle 21 \rangle} + T^{\text{not}\ominus} T \\ T^{\text{not}\oplus} &= z + T^{\text{not}\ominus} T \\ T^{\text{not}\ominus} &= z + T^{\text{not}\oplus} T_{\langle 21 \rangle} \\ T_{\langle 21 \rangle} &= z + T_{\langle 21 \rangle}^{\text{not}\oplus} T_{\langle 21 \rangle} \\ T_{\langle 21 \rangle}^{\text{not}\oplus} &= z. \end{cases} \quad \begin{cases} T &= \frac{1 - \sqrt{1 - 4z}}{2z} - 1 \\ T^{\text{not}\oplus} &= \frac{1 - \sqrt{1 - 4z}}{2} + z \\ T^{\text{not}\ominus} &= (1 - z) \frac{1 - \sqrt{1 - 4z}}{2z} \\ T_{\langle 21 \rangle} &= \frac{z}{1 - z} \\ T_{\langle 21 \rangle}^{\text{not}\oplus} &= z. \end{cases}$$

Le lecteur pourra vérifier aisément que les famille $\mathcal{T}, \mathcal{T}^{\text{not}\oplus}$, et $\mathcal{T}^{\text{not}\ominus}$ sont critiques de rayon de convergence $1/4$, et que le graphe restreint au séries critiques est fortement connexe. La présence d'un terme $\ominus[\mathcal{T}^{\text{not}\ominus}, \mathcal{T}]$ indique que la spécification est essentiellement branchante.

Exemple 2.3.2. Considérons la classe $\text{Av}(231, 312)$ dont la spécification est donnée en (2.9). Le système d'équations associé se résout et l'on obtient

$$T_0 = \frac{z}{1 - 2z} \quad T_1 = \frac{z}{1 - z} \quad T_2 = z$$

Le lecteur pourra vérifier que \mathcal{T}_0 est la seule famille critique, de rayon de convergence $1/2$, et que la spécification (2.9) est essentiellement linéaire.

2.3.2. Énoncé des résultats. Ces deux cas mènent chacun à un comportement asymptotique différent. Nous énonçons ici nos théorèmes dans le cas spécifique de la spécification d'une classe avec un nombre fini de simples obtenue par l'algorithme de [Bas+17], afin d'en simplifier les hypothèses à ce stade. Pour des spécifications finies générales, qui peuvent contenir une infinité de permutations simples, il y a des conditions supplémentaires d'analyticité et d'apériodicité qui sont énoncées dans les versions complètes des théorèmes.

Théorème 2.3.3 (Version simplifiée du théorème 7.2.1, avec F. Bassino, M. Bouvel, V. Féray, L. Gerin et A. Pierrot). *Soit une classe de permutations \mathcal{C} ayant un nombre fini de permutations simples, et dont la spécification obtenue par [Bas+17] est essentiellement branchante. Soit σ_n un élément uniforme de \mathcal{C} de taille n . Alors σ_n converge en loi vers un permuton brownien biaisé μ_p , de paramètre p explicite.*

La simulation (c) de la fig. 2.8 rentre dans ce cas, et la classe en question est étudiée dans la section 7.2.1.1, la limite est un permuton brownien biaisé. Pour $\text{Av}(132)$, le calcul du paramètre (section 7.2.1.2) donne $p = 0$: il s'agit d'un cas dégénéré du permuton brownien, l'antidiagonale.

Finalement remarquons que cet énoncé implique le théorème 2.2.4 dans le cas des classes closes par substitution ayant un nombre fini de simples, leur spécification (2.6) étant essentiellement branchante. En réalité la version complète du théorème (théorème 7.2.1) implique le théorème 2.2.4 en toute généralité.

Théorème 2.3.4 (Version simplifiée du théorème 7.3.2, avec F. Bassino, M. Bouvel, V. Féray, L. Gerin et A. Pierrot). *Soit une classe de permutations \mathcal{C} ayant un nombre fini de permutations simples, et dont la spécification obtenue par [Bas+17] est essentiellement linéaire et contient une famille sous-critique infinie. Soit σ_n un élément uniforme de \mathcal{C} de taille n . Alors σ_n converge en loi vers un permuton déterministe à forme en X , de paramètre explicite dans une famille à trois paramètres.*

Les simulations (a) et (b) de la fig. 2.8 rentrent dans ce cadre, le second cas étant un permuton X dégénéré en V . L'étude de ces classes est réalisée dans les sections 7.3.1.2, 7.3.1.3. Pour $\text{Av}(231, 4321)$, le calcul des paramètres (section 7.3.1.4) indique que sa limite est en réalité la diagonale, qui est également un cas dégénéré du permuton X .

Remarquons que la simulation (d) de la fig. 2.8 ne correspond pas à l'un de ces deux cas. En effet pour cette classe, le graphe de dépendance des familles critiques n'est pas simplement connexe. Dans la section 7.4, nous décrivons comment réduire de tels cas à la situation simplement connexe. Cette stratégie s'applique en particulier à cet exemple, et nous montrons dans la section 7.4.3.3 la convergence vers une juxtaposition diagonale de deux permutons X de taille aléatoire.

2.3.3. Combinatoire analytique de systèmes d'équations. La méthode de preuve des théorèmes 7.2.1 et 7.3.2 est exactement la même que celle présentée dans la section 1.2, et nécessite également de connaître le comportement asymptotique des séries génératrices des familles de la spécification. Une spécification se traduit en un système d'équations sur les séries génératrices correspondantes. Sous une hypothèse raisonnable d'analyticité, et en supposant que le graphe de dépendance du système est fortement connexe, nous avons la dichotomie suivante.

- soit le système est linéaire, et les séries ont toutes une singularité polaire [BD15];
- soit le système est non-linéaire, dit encore branchant, auquel cas le théorème de Drmota-Lalley-Woods garantit que chaque série a une singularité en racine [FS09; Drm09].

Nous présentons nos versions de ces théorèmes dans la section 5.4. Pour prouver nos résultats, nous considérons le système d'équations restreint aux séries critiques, remplaçant

les séries non-critiques par leur valeur. Il apparaît ensuite que le comportement des séries critiques suffit à conclure.

2.3.4. Intuition probabiliste. De la même manière qu'à la section précédente, il est facile de voir qu'un élément uniforme de \mathcal{T} s'écrit comme un arbre de Galton-Watson multitype conditionné. Contrairement à la section précédente, nos hypothèses d'analyticité nous garantissent toujours une loi de reproduction critique avec des moments exponentiels.

Pour de tels arbres, la littérature [Mie08 ; Ste18] s'est intéressée au cas où la matrice des types est irréductible, c'est-à-dire pour nous quand le graphe est fortement connexe. Sous cette hypothèse le cas linéaire est trivial: l'arbre est une ligne et la théorie se ramène à l'étude des chaînes de Markov irréductibles. Dans le cas branchant, il est attendu une convergence vers l'arbre brownien, comme nous l'avons vu dans la section précédente en application des résultats de [Mie08].

Le cas réductible n'est pas traité en toute généralité dans la littérature. On peut citer les *urnes de Pólya triangulaires* [Jan06], qui modélisent des processus de branchements réductibles à deux types, et montrent déjà une grande variété de cas possibles.

Sous notre hypothèse intermédiaire de forte connexité pour les types critiques, nous nous attendons à ce que la partie de l'arbre composée des noeuds de type critique forme une composante géante, dont l'analyse se ramène au cas précédent. De plus cette composante dicte la forme de l'arbre, le reste étant une collection de petits arbres de taille typique $O(1)$ qui s'y rattache. Ceci est confirmé par les simulations, dans les deux cas branchant et linéaire, voir fig. 2.9.

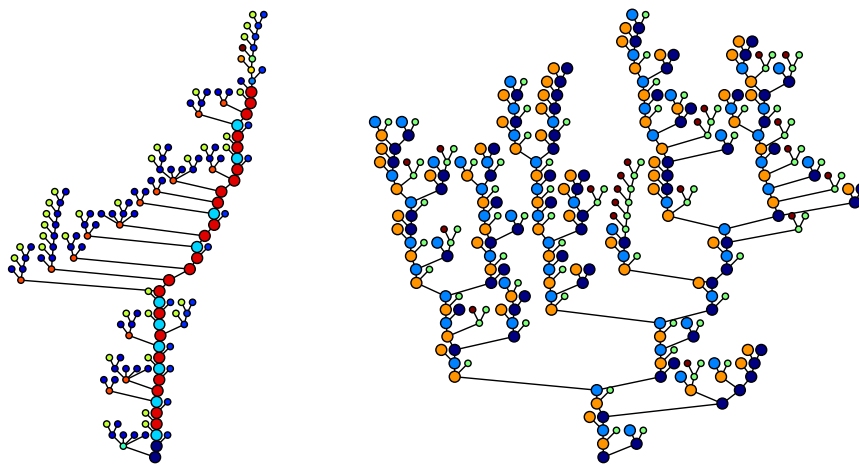

FIGURE 2.9. Arbres standards de permutations uniformes dans des classes à spécification finie. Les sommets sont coloriés selon leur type, ceux de type critiques sont plus gros. Gauche: le cas essentiellement linéaire (pour la classe $\text{Av}(2413, 1243, 2341, 41352, 531642)$, voir section 7.3.1.3). Droite: le cas essentiellement branchant (pour la classe $\text{Av}(132)$, voir section 7.2.1.2).

2.3.5. Simulations et exemples. Nous avons appliqué nos résultats à un certain nombre d'exemples, pour la plupart issus de l'implémentation [Maa19] de l'algorithme de [Bas+17], et utilisant le logiciel de calcul formel sage pour calculer les paramètres du permuton limite à partir de la spécification et des expressions exactes des séries T_0, \dots, T_d . Une intervention humaine est toutefois nécessaire pour notamment identifier les séries critiques. Ces exemples sont énoncés, avec des simulations, à la suite des théorèmes qu'ils

illustrent dans le chapitre 7. Des détails sont donnés dans la section 7.5. Nous fournissons également les feuilles de calcul Jupyter/sage que nous avons employé².

2.4. Limites d'échelle des cographe

Une construction classique consiste à associer à une permutation $\sigma \in \mathfrak{S}_n$ son *graphe de permutation*, ou *graphe d'inversion*, c'est à dire l'ensemble des arêtes $\{\{i, j\}, i < j, \sigma(j) > \sigma(i)\}$ sur l'ensemble des sommets $[n]$. Un graphe non étiqueté que l'on peut obtenir comme graphe de permutation d'une permutation séparable est un *cographe*. Nous considérerons également dans la suite des cographe étiquetés, mais leur étiquetage ne provient pas nécessairement de la construction comme graphe de permutation.

De nombreuses familles de graphes ont été étudiées de manière probabiliste, mais nous n'avons pas trouvé de tels résultats à propos des cographe, qui ont été considérés dans la littérature de la théorie des graphes principalement de manière algorithmique.

Nous avons déjà mentionné que la théorie des permutons est un analogue de la théorie des limites de graphes denses et de leur représentation par des *graphons*, introduite dans [Bor+08], voir [Lov12], et que notre théorème 1.2.1 est l'analogue du théorème principal de [DJ08]. En combinant ces deux théorèmes, il est très facile de voir que la convergence en loi d'une suite de permutations vers un permuton implique la convergence en loi des graphes de permutation associés, et que la limite est le cographe brownien $W_{1/2}$ défini ci-dessous. Ainsi, le théorème 1.1.2 peut se comprendre comme un résultat de convergence de cographe aléatoires. Néanmoins, la transformation d'une permutation séparable en un cographe n'étant pas bijective, ce résultat ne correspond à aucun des deux modèles naturels de cographe aléatoires, le cographe étiqueté uniforme, et le cographe non-étiqueté uniforme.

Ces modèles font l'objet de l'article [Bas+19a] en collaboration avec F. Bassino, M. Bouvel, V. Féray, L. Gerin et A. Pierrot, chapitre 8 de cette thèse. Notons qu'une partie de ces résultats (théorème 2.4.1) a été indépendamment obtenue dans [Stu19] pendant la préparation de [Bas+19a].

2.4.1. Énoncé des résultats. Pour $n \geq 1$, soit \mathbf{G}_n un cographe aléatoire uniforme étiqueté de taille n et \mathbf{G}_n^u un cographe aléatoire uniforme non-étiqueté de taille n .

Le point de départ de la théorie des graphons est que tout graphe non-étiqueté G peut se voir comme un élément de l'espace des graphons (voir définition 8.3.2 pour une définition précise), considérons alors $W_{\mathbf{G}_n}$ et $W_{\mathbf{G}_n^u}$ les graphons aléatoires associés à \mathbf{G}_n et \mathbf{G}_n^u . Cette définition nous amène à oublier l'étiquetage de \mathbf{G}_n . Il n'empêche que $W_{\mathbf{G}_n}$ et $W_{\mathbf{G}_n^u}$ n'ont pas la même loi, puisque le nombre d'étiquetages distincts d'un cographe n'est pas constant (ceci est illustré fig. 8.3 p.143). Notre théorème principal est le suivant.

Théorème 2.4.1 (théorème 8.1.1, avec F. Bassino, M. Bouvel, V. Féray, L. Gerin et A. Pierrot). *Nous avons les convergences en loi suivantes quand n tend vers $+\infty$:*

$$W_{\mathbf{G}_n} \rightarrow W^{1/2}, \quad W_{\mathbf{G}_n^u} \rightarrow W^{1/2},$$

où $W^{1/2}$ est le cographe brownien construit dans la définition 8.4.2.

La convergence au sens des graphons correspond à une convergence de la matrice d'adjacence vue à réétiquetage près et mise à l'échelle, pour une métrique dénommée *cut metric*, comme expliqué dans la section 8.3.1. Nous illustrons donc le théorème 2.4.1 en tracant dans la fig. 2.10 la matrice d'adjacence d'un grand cographe étiqueté choisi uniformément au hasard, obtenue par échantillonnage de Boltzmann [DFLS04]. L'ordre des sommets n'est pas arbitraire, mais provient de l'écriture du cographe comme graphe d'inversion d'une permutation séparable.

Passons à une conséquence intéressante de ce résultat. La convergence au sens des graphons implique la convergence de nombreuses statistiques du graphe associé: les densités

2. Disponibles à cette adresse: <http://mmaazoun.perso.math.cnrs.fr/pcf/s/>

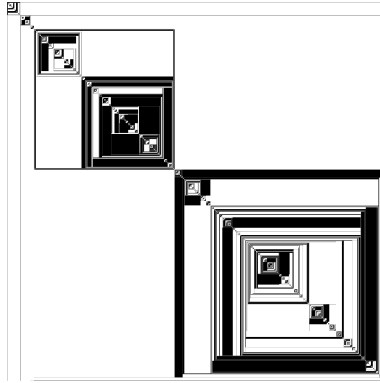

FIGURE 2.10. La matrice d'adjacence d'un cographe étiqueté uniforme de taille 4482.

de sous-graphes, le spectre de la matrice d'adjacence, et la distribution des degrés normalisés (voir [Lov12; DHJ08] et section 8.3 ci-dessous). Ainsi, le théorème 2.4.1 implique une convergence vers la statistique correspondante du cographe brownien. Bien que la distribution des degrés du cographe brownien est un objet complexe, il se trouve le degré d'un point choisi uniformément au hasard est une variable aléatoire uniforme. Ainsi nous avons le résultat suivant, $\deg_G(v)$ étant le degré du sommet v dans le graphe G .

Théorème 2.4.2 (théorème 8.1.2, avec F. Bassino, M. Bouvel, V. Féray, L. Gerin et A. Pierrot). *Pour tout $n \geq 1$, soit \mathbf{v} et \mathbf{v}^u des sommets choisis uniformément au hasard dans \mathbf{G}_n et \mathbf{G}_n^u , respectivement. Nous avons la convergence en loi suivante, quand n tend vers $+\infty$:*

$$\frac{1}{n} \deg_{\mathbf{G}_n}(\mathbf{v}) \rightarrow U, \quad \frac{1}{n} \deg_{\mathbf{G}_n^u}(\mathbf{v}^u) \rightarrow U,$$

où U est une variable aléatoire uniforme de $[0, 1]$.

D'autre part, certaines statistiques ne sont pas continues pour la convergence au sens des graphons. Nous illustrons ce phénomène dans le cas du degré de connectivité κ , le nombre minimum de sommets à supprimer pour déconnecter un graphe.

Théorème 2.4.3 (théorème 8.7.2, avec F. Bassino, M. Bouvel, V. Féray, L. Gerin et A. Pierrot). *Il existe deux lois de probabilité sur \mathbb{N} différentes $(\pi_j)_{j \geq 1}$ et $(\pi_j^u)_{j \geq 1}$ telles que pour tout $j \geq 1$, quand $n \rightarrow \infty$,*

$$(2.11) \quad \mathbb{P}(\kappa(\mathbf{G}_n) = j) \rightarrow \pi_j, \quad \mathbb{P}(\kappa(\mathbf{G}_n^u) = j) \rightarrow \pi_j^u.$$

Les valeurs de π_j et π_j^u sont données dans le théorème 8.7.2.

2.4.2. Stratégie de preuve. La preuve du théorème 2.4.1 est basée sur un résultat de Diaconis and Janson [DJ08, Théorème 3.1], qui est l'exact analogue du théorème 1.2.1 pour les graphons. La preuve est donc particulièrement similaire à celle du théorème 1.1.2 présentée dans cette introduction. Un cographe est associé à un co-arbre, c'est à dire un arbre de Schröder signé *non plan*. La combinatoire de tels arbres est différente de celle des arbres de Schröder. Si le cas étiqueté ne pose pas de grande difficulté, les arbres non plans non étiquetés n'ont pas de description récursive simple (ceci est discuté en section 8.6.1). Pour traiter cette difficulté, nous remarquons que l'application qui associe (G, a) (où G est un cographe étiqueté et a un automorphisme de G) à G en oubliant l'étiquetage, est $n!$ -vers-1. Puis nous utilisons une décomposition récursive de (G, a) qui nous permet de poursuivre notre analyse. Ceci donne d'ailleurs une interprétation bijective de l'opérateur de Pólya classiquement utilisé pour analyser la combinatoire des structures non étiquetées.

Le point important qui fait que cette approche fonctionne est le suivant: pour un élément uniforme (G, a) de cette classe combinatoire, l'ensemble des sommets de G fixés par l'automorphisme a forme une composante géante qui dicte la forme macroscopique de

l'arbre. Ceci rappelle le phénomène observé avec les types critiques dans la section 2.3.4. Ce point de vue probabiliste est utilisé dans [PS18 ; GJW18], pour montrer que les arbres non plans convergent vers l'arbre brownien. Le notre est plus combinatoire.

Pour la démonstration du théorème 8.1.2, nous utilisons un résultat de [DHJ08] établissant la continuité de la distribution des degrés normalisés dans l'espace des graphons. Nous poursuivons ensuite par des moyens purement discrets : nous fournissons un autre modèle de graphe aléatoire \mathbf{G}_n^b convergeant vers le cographe brownien, ayant la propriété remarquable suivante: le degré d'un sommet uniformément choisi de \mathbf{G}_n^b est une variable aléatoire uniforme dans $\{0, 1, \dots, n-1\}$ (voir proposition 8.4.5).

La preuve du théorème 8.7.2 est purement combinatoire et revient à analyser le degré de la racine d'un co-arbre uniforme.

2.5. Limites d'échelle et locale des permutations de Baxter

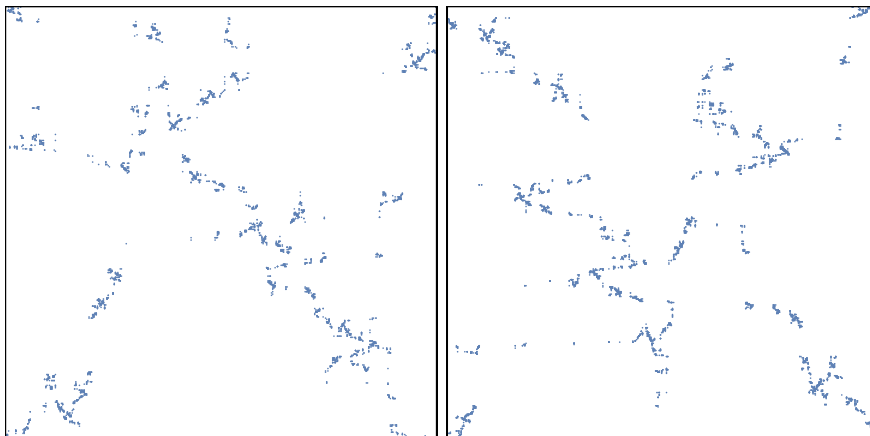

FIGURE 2.11. Le diagramme de deux grandes permutations de Baxter.

Cette section décrit les travaux en commun avec Jacopo Borga dans [BM20a], visant à démontrer un résultat de limite d'échelle au sens des permutons, pour la famille des permutations de Baxter. Une version courte de cet article a été présentée à la conférence AofA [BM20b].

Les permutations de Baxter furent introduites par Glen Baxter en 1964 [Bax64] afin d'étudier les points fixes des fonctions qui commutent. Une permutation σ est de Baxter s'il n'est pas possible de trouver $i < j < k$ tels que $\sigma(j+1) < \sigma(i) < \sigma(k) < \sigma(j)$ ou $\sigma(j) < \sigma(k) < \sigma(i) < \sigma(j+1)$. Les permutations de Baxter ont été étudiées d'un point de vue combinatoire par la communauté *permutation patterns* (voir par exemple [Boy67 ; CGHK78 ; Mal79 ; BGRR18]), et sont en bijection avec de nombreuses autres familles combinatoires [FFNO11]. Elles sont un exemple particulier de famille de permutations qui évitent des *motifs vinculaires* (voir [BP12] pour plus de détails). On note \mathcal{P} l'ensemble des permutations de Baxter. Nous avons déjà mentionné que les permutations de Baxter doublement alternantes ont été étudiées par Dokos et Pak [DP14], et que cette sous-famille semble converger vers le permuton brownien. Dokos et Pak soulèvent la question de la forme asymptotique des permutations de Baxter, à laquelle notre résultat principal (théorème 2.5.3) répond. Nous n'avons pas trouvé d'autre mention de permutations de Baxter aléatoires dans la littérature.

Nous présentons maintenant une paire de bijections, remarquables à plus d'un titre, permettant de relier les permutations de Baxter à une famille de marches dans le quart de plan.

2.5.1. Orientations bipolaires, marches dans le quart de plan, et permutations de Baxter. Les orientations bipolaires planaires, abrégées en orientations bipolaires, sont des cartes planaires équipées d'une orientation acyclique des arêtes avec exactement une source (i.e. un sommet avec des arêtes sortantes seulement) et un puits (i.e. un sommet avec seulement des arêtes entrantes), tous deux sur la face externe. Soit \mathcal{O} l'ensemble des orientations bipolaires. La taille d'une orientation bipolaire m est son nombre d'arêtes et sera notée $|m|$.

Toute orientation bipolaire peut être dessinée dans le plan avec les arêtes orientées du bas vers le haut. Il existe une notion naturelle de dualité pour les orientations bipolaires. Il s'agit de la dualité usuelle des cartes planaires, sauf que la face externe est comprise comme coupée en deux : la *face externe gauche*, qui devient le puits dual, et la *face externe droite*, qui devient la source duale. Les arêtes sont maintenant orientées de droite à gauche. La carte m^{**} est juste m avec l'orientation inversée, et $m^{****} = m$. Un exemple est donné à gauche de la fig. 2.13.

Soit m une orientation bipolaire. Déconnecter chaque arête entrante sauf la plus à droite à chaque sommet transforme la carte m en arbre plan $T(m)$ enraciné à la source (voir sur la gauche de fig. 2.12 un exemple). L'arbre $T(m)$ contient toutes les arêtes de m , et le parcours en profondeur de $T(m)$ identifie un ordre sur les arêtes de m . Nous notons $e_1, \dots, e_{|m|}$ les arêtes de m dans cet ordre. L'arbre $T(m^{**})$ peut être obtenu de la même manière à partir de m en déconnectant toutes les arêtes sortantes sauf la plus à gauche, et est enraciné au puits. La fait remarquable suivant ressort : *Le parcours en profondeur de $T(m^{**})$ passe par les arêtes de m dans l'ordre $e_{|m|}, \dots, e_1$. De plus, on peut dessiner $T(m)$ et $T(m^{**})$ dans le plan, l'un à côté de l'autre, de manière à ce que l'interface entre les deux arbres trace un chemin, nommé chemin d'interface, de la source au puits en passant par les arêtes $e_1, \dots, e_{|m|}$ dans cet ordre (voir l'image centrale de la fig. 2.12 pour un exemple).*

Kenyon, Miller, Sheffield et Wilson [KMSW19] ont démontré que la fonction OW définie ci-après et illustrée par la fig. 2.12, est une bijection entre les orientations bipolaires et une famille de marches dans le quart de plan, dénommées *marches tandem*.

Définition 2.5.1. Soit $n \geq 1$, $m \in \mathcal{O}_n$. On définit $\text{OW}(m) = (X_t, Y_t)_{1 \leq t \leq n} \in (\mathbb{Z}_{\geq 0}^2)^n$ ainsi: pour $1 \leq t \leq n$, X_t est la hauteur dans l'arbre $T(m)$ du sommet inférieur de e_t (i.e. sa distance à la source s dans $T(m)$), et Y_t est la hauteur dans l'arbre $T(m^{**})$ du sommet supérieur de e_t (i.e. sa distance au puits s' dans $T(m^{**})$).

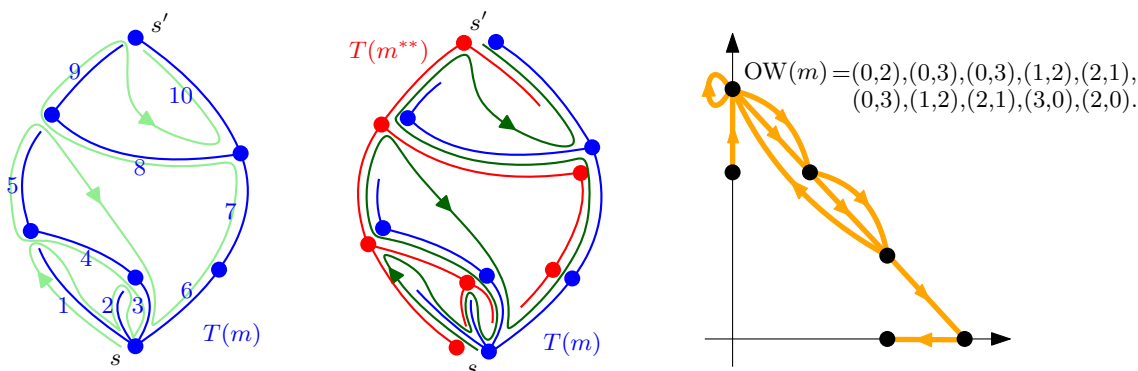

FIGURE 2.12. Sur la gauche, l'arbre $T(m)$, construit en déconnectant l'orientation bipolaire m de fig. 2.13 avec les arêtes numérotées dans l'ordre du parcours en profondeur (en vert clair). Au centre, les deux arbres $T(m)$ et $T(m^{**})$ avec le chemin suivant l'interface entre les deux arbres (en vert foncé). À droite, la marche dans le quart de plan $\text{OW}(m)$, voir définition 2.5.1.

Bonichon, Bousquet-Mélou et Fusy [BBF11] ont quant à eux démontré que la fonction OP définie comme suit et illustrée dans la fig. 2.13, est une bijection entre orientations bipolaires et permutations de Baxter.

Définition 2.5.2. Soit $n \geq 1, m \in \mathcal{O}_n$. Rappelons que chaque arête de la carte m correspond à son arête duale dans la carte duale m^* . Soit $\text{OP}(m)$ la seule permutation π telle que pour tout $1 \leq i \leq n$, la i -ème arête à être visitée dans le parcours de $T(m)$ corresponde à la $\pi(i)$ -ème arête à être visitée dans le parcours de $T(m^*)$.

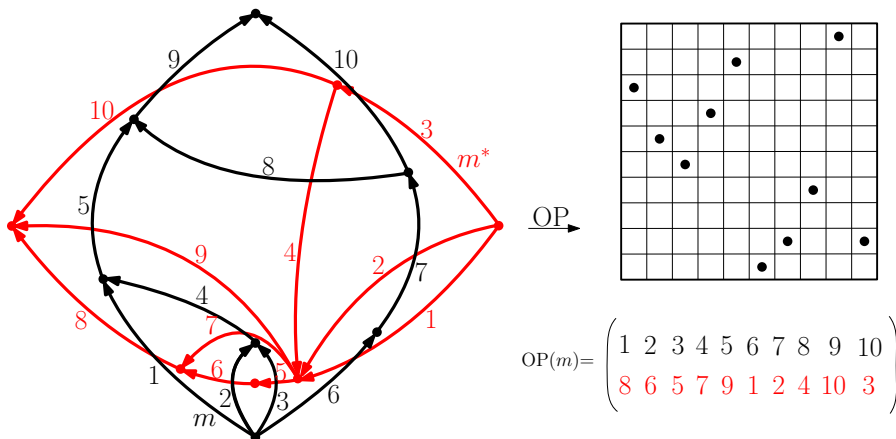

FIGURE 2.13. Schéma explicatif de l'application OP. À gauche, l'orientation bipolaire m et son orientation duale m^* . Les arêtes de chacune sont étiquetées dans l'ordre du parcours en profondeur de l'arbre $T(\cdot)$. À droite, la permutation $\text{OP}(m)$.

2.5.2. Résultats principaux. Pour $n \geq 1$, σ_n est une permutation de Baxter uniforme de taille n et $\mathbf{m}_n = \text{OP}^{-1}(\sigma_n)$ est l'orientation bipolaire uniforme correspondante avec n arêtes. $\mathbf{W}_n = \text{OW}(\mathbf{m}_n)$ et $\mathbf{W}_n^* = \text{OW}(\mathbf{m}_n^*)$ sont les deux marches tandem dans le quart de plan associées à \mathbf{m}_n et à son orientation duale. Soit \mathcal{W}_n et \mathcal{W}_n^* les deux fonctions continues de $[0, 1]$ vers $\mathbb{R}_{\geq 0}^2$ qui interpolent linéairement entre les points $\mathcal{W}_n^\theta(\frac{k}{n}) = \frac{1}{\sqrt{2n}} \mathbf{W}_n^\theta(k)$ pour $1 \leq k \leq n$ et $\theta \in \{\emptyset, *\}$.

Soit $\mathcal{W} = (\mathcal{X}(t), \mathcal{Y}(t))_{t \geq 0}$ un mouvement brownien standard dans le plan de corrélation $-1/2$, c'est-à-dire un processus gaussien tel que \mathcal{X} et \mathcal{Y} sont des mouvements browniens standards et $\text{Cov}(\mathcal{X}(t), \mathcal{Y}(s)) = -1/2 \cdot t \wedge s$. Soit \mathcal{W}_e l'excursion brownienne de corrélation $-1/2$ dans le quart de plan, c'est-à-dire le processus $(\mathcal{W}(t))_{0 \leq t \leq 1}$ conditionné à ce que $\mathcal{W}(1) = 0$ et à rester dans le quart de plan $\mathbb{R}_{\geq 0}^2$. Une définition rigoureuse est donnée dans la section 9.A.

Considérons la fonction $s : \mathcal{C}([0, 1], \mathbb{R}^2) \rightarrow \mathcal{C}([0, 1], \mathbb{R}^2)$ définie par $s(f, g) = (g(1 - \cdot), f(1 - \cdot))$. Considérons la fonction $R : \mathcal{M} \rightarrow \mathcal{M}$ qui tourne un permuton d'un angle $-\pi/2$, c'est-à-dire $R(\mu)(A) = \mu\left(\begin{pmatrix} 0 & -1 \\ 1 & 0 \end{pmatrix} \cdot A\right)$ pour tout borélien A .

Théorème 2.5.3 (théorème 9.1.9, avec J. Borga). *Il existe deux applications mesurables $r : \mathcal{C}([0, 1], \mathbb{R}_{\geq 0}^2) \rightarrow \mathcal{C}([0, 1], \mathbb{R}_{\geq 0}^2)$ et $\phi : \mathcal{C}([0, 1], \mathbb{R}_{\geq 0}^2) \rightarrow \mathcal{M}$ telles que nous avons une convergence en loi*

$$(2.12) \quad (\mathcal{W}_n, \mathcal{W}_n^*, \mu_{\sigma_n}) \rightarrow (\mathcal{W}_e, \mathcal{W}_e^*, \mu_B),$$

où $\mathcal{W}_e^* = r(\mathcal{W}_e)$, et $\mu_B = \phi(\mathcal{W}_e)$. En particulier, nous avons $r(\mathcal{W}_e) \stackrel{d}{=} \mathcal{W}_e$. De plus les égalités suivantes sont vérifiées en $\mathbb{P}_{\mathcal{W}_e}$ -presque tout point de $\mathcal{C}([0, 1], \mathbb{R}_{\geq 0}^2)$.

$$r^2 = s, \quad r^4 = \text{Id}, \quad \phi \circ r = R \circ \phi$$

La construction explicite des applications ϕ et r n'est pas énoncée ici mais pourra être trouvée dans la section 9.5, en particulier les théorèmes 9.5.6 et 9.5.8.

À l'opposé de ce résultat de limite d'échelle, il est possible d'étudier des *limites locales* de cartes, marches, et permutations aléatoires. La convergence locale, au sens Benjamini-Schramm, de la carte bipolaire aléatoire uniforme \mathbf{m}_n vers la *carte bipolaire infinie du plan* a été obtenue dans [GHS17, Prop. 3.10]. Notre second résultat (théorème 9.1.6) donne un résultat plus fort de convergence jointe, et *quenched*, pour les objets reliés par les bijections OW et OP. Nous ne le reprenons pas dans cette introduction afin d'éviter d'introduire trop de notations, mais en énonçons ici une conséquence nouvelle.

Théorème 2.5.4 (théorème 9.1.6, avec J. Borga). *La suite σ_n est convergente au sens Benjamini-Schramm quenched, tel que défini dans [Bor20b]. En particulier, $(\widehat{c\text{-occ}}(\pi, \sigma_n))_{\pi \in \mathfrak{S}}$ a une limite en loi dans $[0, 1]^{\mathfrak{S}}$, où pour $\pi \in \mathfrak{S}_k$ et $\sigma \in \mathfrak{S}_n$ $\widehat{c\text{-occ}}(\pi, \sigma)$ désigne la proportion des $n - k + 1$ ensembles de k indices consécutifs de $[n]$ qui induisent le motif π dans σ .*

2.5.3. Outils de démonstration. La bijection $\text{OP} \circ \text{OW}^{-1}$ permet de relier les permutations de Baxter à une famille de marches dans le quart de plan, pour lesquelles des résultats de limite locale et d'échelle sont déjà disponibles dans la littérature. Il est alors nécessaire de comprendre cette bijection d'une manière qui « passe à la limite ».

Considérons une marche tandem $W = (X, Y) \in \mathcal{W}_n$, l'orientation bipolaire associée $m = \text{OW}^{-1}(W)$, et la permutation de Baxter $\sigma = \text{OP}(m)$. Nous introduisons le *processus de marches coalescentes* conduit par W . Il s'agit d'une famille $Z = \{Z^{(i)}\}_{1 \leq i \leq n}$ où $Z^{(i)}$ est une marche dans \mathbb{Z} indexée par les entiers $\{i, \dots, n\}$. Elle est définie informellement comme suit: $Z^{(i)}$ vaut 0 au temps i , suit parallèlement Y tant qu'elle est positive, et suit parallèlement $-X$ tant qu'elle est négative, sauf si un tel pas la mène de $Z^{(i)}(j) < 0$ à $Z^{(i)}(j+1) > 0$. Dans ce cas particulier, $Z^{(i)}$ est forcée à rejoindre la marche $Z^{(j)}$ au temps $j+1$. Une illustration est donnée à gauche de la fig. 2.14.

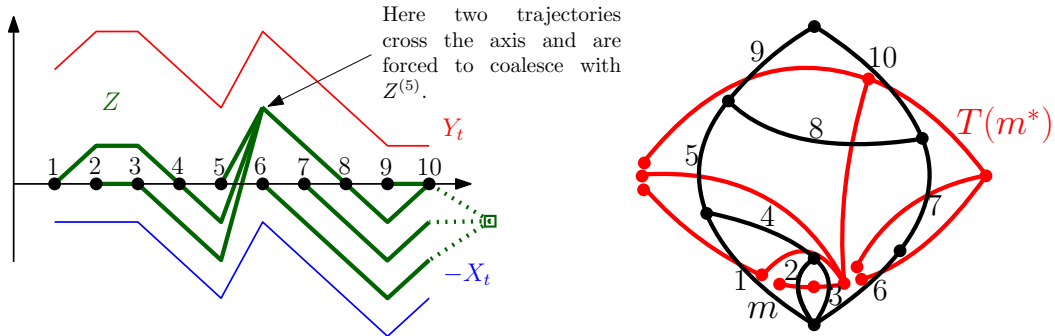

FIGURE 2.14. Le processus coalescent Z associé à $W = (X, Y) = \text{OW}(m)$, où m est la carte de la fig. 2.12. Sur le même graphique, la marche $Y + 1$ en rouge, et $-X - 1$ en bleu. À droite, la carte m dessinée avec l'arbre $T(m^*)$ en rouge.

Nous laissons le lecteur vérifier sur la fig. 9.5 les faits suivants, démontré dans la section 9.2: *L'union des graphes des trajectoires $Z^{(i)}$ donne une structure de forêt plane étiquetée à l'ensemble des points d'abscisse 1 à n . L'arbre obtenu en ajoutant une racine à cette forêt est le même que l'arbre $T(m^*)$ où chaque arête est étiquetée par la position de l'arête primale dans le parcours en profondeur de $T(m)$.* Au vu de la définition de σ à partir de $T(m)$ et $T(m^*)$, il devient alors aisé de lire la permutation σ dans le processus coalescent Z : si les trajectoires $(Z^{(i)})_{1 \leq i \leq n}$ sont ordonnées de bas en haut puis de droite à gauche, pour $1 \leq i \leq n$, $\sigma(i)$ est le rang de la trajectoire $Z^{(i)}$.

L'étape suivante dans la preuve du théorème 2.5.3 consiste à montrer que ce processus coalescent admet une limite d'échelle, qui est la famille $(\mathfrak{Z}^{(u)})_{u \in [0,1]}$ de solutions aux

équations différentielles stochastiques suivantes:

$$(2.13) \quad \begin{cases} d\mathbf{z}^{(u)}(t) = \mathbb{1}_{\{\mathbf{z}^{(u)}(t) > 0\}} d\mathbf{y}(t) - \mathbb{1}_{\{\mathbf{z}^{(u)}(t) \leq 0\}} d\mathbf{x}(t), & t \geq u, \\ \mathbf{z}^{(u)}(t) = 0, & t \leq u, \end{cases}$$

où $\mathbf{W} = (\mathbf{X}, \mathbf{Y})$ est une excursion brownienne dans le quart de plan de corrélation $1/2$.

Dans le cas où \mathbf{W} est un mouvement brownien (et non une excursion) de corrélation $\rho \in (-1, 1)$, cette équation est connue dans le littérature sous le nom d'équation de Tanaka perturbée [Pro13], et étudiée dans [CHK18] dans le cadre de la théorie des flots coalescents de Le Jan et Raimond [LR04]. Les limites d'échelle de processus de marches coalescentes discrètes fait l'objet de la section 9.4.

2.5.4. Limites d'échelle d'orientations bipolaires. Considérons la convergence des deux premières marginales dans le théorème 2.5.3. Elle traduit la convergence des fonctions de hauteur des quatres arbres $T(m), T(m^*), T(m^{**}), T(m^{***})$ vers un couplage de quatre arbres browniens. Nous observons qu'un résultat similaire a été obtenu par Gwynne, Holden et Sun [GHS16] dans le cas de triangulations bipolaires infinies, répondant à une conjecture de Kenyon, Miller, Sheffield et Wilson [KMSW19]. Notre résultat complète la réponse à cette conjecture dans le cas de orientation bipolaires générales en volume fini. Plus de détails sur le contexte de la gravité quantique de Liouville et sur les similitudes et différences entre nos travaux et ceux de [GHS16] sont donnés dans les sections 9.B.2 et section 9.1.6.

2.6. Perspectives

Les résultats du chapitre 4 amènent naturellement à quelques questions ouvertes. Le permuton brownien est construit à partir d'une excursion brownienne signée. Les permutations séparables sont construites à partir d'arbres de Schröder signés, auxquels on peut associer une excursion signée. Il serait intéressant de pouvoir démontrer la convergence de la seconde vers la première, dans une certaine topologie qui reste à définir. Pour cela on pourrait par exemple enrichir la proposition 1.2.7 d'informations de longueur, et définir un analogue du théorème 1.2.6 pour les excursions signées. Enfin, comme discuté en section 4.1.7, il serait intéressant de construire le permuton stable de manière explicite, et surtout de montrer que sa dimension de Hausdorff est également 1.

Il serait intéressant d'étudier la continuité de certaines statistiques par rapport à la topologie de la convergence au sens des permutons, et l'application aux permutations convergeant vers le permuton brownien. En particulier, la question de la plus grande sous-suite croissante dans les permutations séparables semble prometteuse.

Les résultats de limite d'échelle présentés ici ne couvrent que certaines rares classes "bien élevées" parmi l'ensemble des classes de permutations. Ceci fournit une infinité indénombrable de problèmes ouverts. Il serait raisonnable de commencer par certaines classes admettant des bijections que l'on peut essayer d'exploiter, comme $\text{Av}(2413)$ et certaines autres classes évitant un motif de taille 4 qui sont en bijection avec elle.

Finalement, mentionnons que le chapitre 9 ouvre la porte a de nombreuses généralisations, et des perspectives de recherche sont détaillées en section 9.1.7.

Convergence of random permutons

This chapter was extracted from [Bas+20], which became Chapter 6 of this thesis.

ABSTRACT. We recall the theory of permutons as defined in [Hop+13], and show a criterion for convergence in distribution of random permutons. The theory of random permuton comes off as a perfect mirror of the theory of random graphons developed in [DJ08].

3.1. Deterministic permutons

A permuton is a probability measure on the unit square with uniform marginals. To a permutation σ of size n , we can associate the permuton μ_σ which is essentially the (normalized) diagram of σ , where each dot has been replaced with a small square of dimension $1/n \times 1/n$ carrying a mass $1/n$.

Let \mathcal{M} be the set of permutons. We need to equip \mathcal{M} with a topology. We say that a sequence of (deterministic) permutons $(\mu_n)_n$ converges *weakly* to μ (simply denoted $\mu_n \rightarrow \mu$) if

$$\int_{[0,1]^2} f d\mu_n \xrightarrow{n \rightarrow +\infty} \int_{[0,1]^2} f d\mu,$$

for every bounded and continuous function $f : [0,1]^2 \rightarrow \mathbb{R}$. With this topology, \mathcal{M} is compact and metrizable by a metric d_\square which has been introduced in [Hop+13] (see Lemmas 2.5 and 5.3 in [Hop+13]):

$$\mu_n \xrightarrow{n \rightarrow +\infty} \mu \quad \Leftrightarrow \quad d_\square(\mu_n, \mu) \xrightarrow{n \rightarrow +\infty} 0.$$

The following statistics were introduced in [Hop+13] and shown to be continuous on the space \mathcal{M} .

$$(3.1) \quad \widetilde{\text{occ}}(\pi, \mu) = \int_{([0,1]^2)^k} \mathbb{1}_{\text{std}(\{(x_i, y_i) : 1 \leq i \leq k\}) = \pi} \mu(dx_1 dy_1) \cdots \mu(dx_k dy_k)$$

The main result of [Hop+13] is that convergence in the space \mathcal{M} is equivalent to convergence of all statistics $\widetilde{\text{occ}}(\pi, \cdot)$. The goal of this chapter is to provide a similar characterization for convergence of *random* objects in the space \mathcal{M} .

3.2. Random permutons and extracted permutations

Denote by $M_1(X)$ the space of probability measures over a given Polish space X , equipped with weak convergence of measures, making it itself a Polish space. Let $\boldsymbol{\mu}$ be a random element of $M_1(X)$ (a *random measure*). A sequence $\mathbf{x}_1, \dots, \mathbf{x}_k$ is *i.i.d. with distribution $\boldsymbol{\mu}$ conditional on $\boldsymbol{\mu}$* if for every measurable function $f : M_1(X) \times X^k \rightarrow \mathbb{R}_+$,

$$(3.2) \quad \mathbb{E}[f(\boldsymbol{\mu}, \mathbf{x}_1, \dots, \mathbf{x}_k)] = \int_{M_1(X)} \left(\int_{X^k} f(\mu, x_1, \dots, x_k) \mu(dx_1) \cdots \mu(dx_k) \right) \mathbb{P}_\boldsymbol{\mu}(d\mu).$$

Let now $\boldsymbol{\mu}$ be a random permuton, $k \geq 1$ and $(\mathbf{x}_1, \mathbf{y}_1), \dots, (\mathbf{x}_k, \mathbf{y}_k)$ an i.i.d. sequence of distribution $\boldsymbol{\mu}$ conditional on $\boldsymbol{\mu}$. By the definition of a permuton, almost surely, no two

pair of points is vertically or horizontally aligned. Hence almost surely, the permutation of size k induced by $\boldsymbol{\mu}$ is almost surely well-defined¹:

$$(3.3) \quad \mathbf{Perm}_k(\boldsymbol{\mu}) = \text{std}((\mathbf{x}_1, \mathbf{y}_1), \dots, (\mathbf{x}_k, \mathbf{y}_k)).$$

Similarly, if $\boldsymbol{\sigma}$ is a random permutation of size $n \geq k \geq 1$, we denote $\mathbf{Perm}_k(\boldsymbol{\sigma}) = \text{pat}_{\mathbf{I}_{n,k}}(\boldsymbol{\sigma})$, where $\mathbf{I}_{n,k}$ is a uniformly random subset of $[n]$ of size k , independent of $\boldsymbol{\sigma}$. From this definition, it immediately results that $\pi \in \mathfrak{S}_k$,

$$(3.4) \quad \mathbb{P}(\mathbf{Perm}_k(\boldsymbol{\sigma}) = \pi \mid \boldsymbol{\sigma}) = \widetilde{\text{occ}}(\pi, \boldsymbol{\sigma}) \quad \mathbb{P}(\mathbf{Perm}_k(\boldsymbol{\mu}) = \pi) = \mathbb{E}[\widetilde{\text{occ}}(\pi, \boldsymbol{\sigma})]$$

while a direct consequence of (3.2) is the following:

$$(3.5) \quad \mathbb{P}(\mathbf{Perm}_k(\boldsymbol{\mu}) = \pi \mid \boldsymbol{\mu}) = \widetilde{\text{occ}}(\pi, \boldsymbol{\mu}) \quad \mathbb{P}(\mathbf{Perm}_k(\boldsymbol{\mu}) = \pi) = \mathbb{E}[\widetilde{\text{occ}}(\pi, \boldsymbol{\mu})]$$

We end this section by the following two estimates, proved in [Hop+13].

Lemma 3.2.1 (Occurrences in a permutation and its associated permuton [Hop+13, Lemma 3.5]). *If $\pi \in \mathfrak{S}_k$ and $\sigma \in \mathfrak{S}_n$, then*

$$|\widetilde{\text{occ}}(\pi, \sigma) - \widetilde{\text{occ}}(\pi, \mu_\sigma)| \leq \frac{1}{n} \binom{k}{2}.$$

The second one is [Hop+13, Lemma 4.2], stated there for deterministic permutons, but a version for random permutons follows by averaging.

Lemma 3.2.2 (Approximation of a (random) permuton by a permutation). *There is a k_0 such that if $k > k_0$, for any permuton ν ,*

$$\mathbb{P} \left[d_{\square}(\mu_{\mathbf{Perm}_k(\nu)}, \nu) \geq 16k^{-1/4} \right] \leq \frac{1}{2} e^{-\sqrt{k}}.$$

3.3. Convergence in distribution of random permutations

We now consider a sequence of random permutations $(\boldsymbol{\sigma}_n)$ (with $\boldsymbol{\sigma}_n$ of size n). An example of interest for the present thesis is when, for each $n \geq 1$, $\boldsymbol{\sigma}_n$ is a uniform random permutation of size n in a given class \mathcal{C} . Another example are the random permutations $(\boldsymbol{\sigma}_n)_{n \geq 1} = (\mathbf{Perm}_n(\boldsymbol{\mu}))_n$ constructed above from a given random permuton $\boldsymbol{\mu}$. In the case where $\boldsymbol{\mu}$ is deterministic, these are called Z -random in [Hop+13] and used to prove that each permuton is the limit of some permutation sequence.

Proposition 3.3.1 (Subpermutations characterize the distribution of $\boldsymbol{\mu}$). *Let $\boldsymbol{\mu}, \boldsymbol{\mu}'$ be two random permutons. If there exists k_1 such that for $k \geq k_1$ and every π of size k we have*

$$\mathbb{P}(\mathbf{Perm}_k(\boldsymbol{\mu}) = \pi) = \mathbb{P}(\mathbf{Perm}_k(\boldsymbol{\mu}') = \pi),$$

then $\boldsymbol{\mu} \stackrel{d}{=} \boldsymbol{\mu}'$.

PROOF. We need to prove that $\mathbb{E}[\phi(\boldsymbol{\mu})] = \mathbb{E}[\phi(\boldsymbol{\mu}')]$ for every bounded and continuous function $\phi : \mathcal{M} \rightarrow \mathbb{R}$. Fix $k \geq k_1$. It holds that

$$\begin{aligned} \mathbb{E}[\phi(\boldsymbol{\mu})] - \mathbb{E}[\phi(\boldsymbol{\mu}')] &= \mathbb{E}[\phi(\boldsymbol{\mu}) - \phi(\mu_{\mathbf{Perm}_k(\boldsymbol{\mu})})] \\ &\quad + (\mathbb{E}[\phi(\mu_{\mathbf{Perm}_k(\boldsymbol{\mu})})] - \mathbb{E}[\phi(\mu_{\mathbf{Perm}_k(\boldsymbol{\mu}')})]) \\ &\quad + \mathbb{E}[\phi(\mu_{\mathbf{Perm}_k(\boldsymbol{\mu}')}) - \phi(\boldsymbol{\mu}')], \end{aligned}$$

The second term in the above display is zero by assumption. Moreover, from Lemma 3.2.2 the first and third terms go to zero when $k \rightarrow +\infty$. \square

1. Note that as $\mathbf{Perm}_k(\boldsymbol{\mu})$ is built on a larger probability space than the one where $\boldsymbol{\mu}$ is constructed, it is not a function of $\boldsymbol{\mu}$ and this notation is somewhat abusive. Since at most times we are only interested in the distribution of $\mathbf{Perm}_k(\boldsymbol{\mu})$ (which is a function of that of $\boldsymbol{\mu}$), or in its distribution conditional on $\boldsymbol{\mu}$ (which is a measurable function of $\boldsymbol{\mu}$, namely $(\widetilde{\text{occ}}(\pi, \boldsymbol{\mu}))_{\pi \in \mathfrak{S}_k}$, see Equation (3.5)), this bears no consequence. In the rare case where knowledge of the actual value of $\mathbf{Perm}_k(\boldsymbol{\mu})$ is important, necessary precisions will be made. This remark also applies to $\mathbf{Perm}_k(\boldsymbol{\sigma})$.

Our main theorem in this section deals with the convergence of sequences of random permutations to a random permuton. It generalizes the result of [Hop+13] which states that *deterministic* permuton convergence is characterized by convergence of pattern densities. We extend their proof to the case of *random* sequences, where permuton convergence *in distribution* is characterized by convergence of *average* pattern densities, or equivalently of the induced subpermutations of any (fixed) size.

Theorem 3.3.2. *For any n , let σ_n be a random permutation of size n . Let $k_0 \geq 1$. The following assertions are equivalent.*

- (a) $(\mu_{\sigma_n})_n$ converges in distribution for the weak topology to some random permuton μ .
- (b) The random infinite vector $(\widetilde{\text{occ}}(\pi, \sigma_n))_{\pi \in \mathfrak{S}}$ converges in distribution in the product topology to some random infinite vector $(\Lambda_\pi)_{\pi \in \mathfrak{S}}$.
- (c) For every π in \mathfrak{S} such that $k \geq k_0$, there is a $\Delta_\pi \geq 0$ such that

$$\mathbb{E}[\widetilde{\text{occ}}(\pi, \sigma_n)] \xrightarrow{n \rightarrow \infty} \Delta_\pi.$$

- (d) For every $k \geq k_0$, the sequence $(\mathbf{Perm}_k(\sigma_n))_n$ of random permutations converges in distribution to some random permutation ρ_k .

Whenever these assertions are verified, we have $(\Lambda_\pi)_\pi \stackrel{d}{=} (\widetilde{\text{occ}}(\pi, \mu))_\pi$ and for every $\pi \in \mathfrak{S}_k$,

$$\mathbb{P}(\rho_k = \pi) = \Delta_\pi = \mathbb{E}[\Lambda_\pi] = \mathbb{E}[\widetilde{\text{occ}}(\pi, \mu)] = \mathbb{P}(\mathbf{Perm}_k(\mu) = \pi).$$

Observation 3.3.3. In item (c) above, it is enough to consider all π of size at least 2. Indeed, for $\pi = 1$, the statement is trivial, since $\widetilde{\text{occ}}(\pi, \cdot)$ is identically 1.

Before moving on to the proof of the theorem, we point out that an alternative derivation is possible using the method of moments, as in [DJ08] and [Bas+18]. **Proof of (a) \Rightarrow (b).** Let π_1, \dots, π_r be a finite sequence of patterns. By [Hop+13, Lemma 5.3], the map $\mu \mapsto (\widetilde{\text{occ}}(\pi_i, \mu))_{1 \leq i \leq r}$ is continuous. Therefore, $\mu_{\sigma_n} \xrightarrow{d} \mu$ implies

$$(\widetilde{\text{occ}}(\pi_i, \mu_{\sigma_n}))_{1 \leq i \leq r} \xrightarrow{d} (\widetilde{\text{occ}}(\pi_i, \mu))_{1 \leq i \leq r}.$$

Using Lemma 3.2.1, one can replace each $\widetilde{\text{occ}}(\pi_i, \mu_{\sigma_n})$ by $\widetilde{\text{occ}}(\pi_i, \sigma_n)$ in the above convergence. This proves the convergence in distribution of the vector of pattern densities $(\widetilde{\text{occ}}(\pi_i, \sigma_n))_{1 \leq i \leq r}$, and hence of $(\widetilde{\text{occ}}(\pi, \sigma_n))_{\pi \in \mathfrak{S}}$ in the product topology (see for instance [Bil99, ex. 2.4 p. 19]).

Proof of (b) \Rightarrow (c). If $\widetilde{\text{occ}}(\pi, \sigma_n) \xrightarrow{d} \Lambda_\pi$, as $\widetilde{\text{occ}}$ takes values in $[0, 1]$, we have

$$\mathbb{E}[\widetilde{\text{occ}}(\pi, \sigma_n)] \xrightarrow{n \rightarrow \infty} \mathbb{E}[\Lambda_\pi].$$

Proof of (c) \Rightarrow (d). Fix $\pi \in \mathfrak{S}_k$ and consider the sequence

$$\mathbb{P}(\mathbf{Perm}_k(\sigma_n) = \pi) = \mathbb{E}[\widetilde{\text{occ}}(\pi, \sigma_n)],$$

which converges if (c) holds (the equality comes from Equation (3.4)). Since $\mathbf{Perm}_k(\sigma_n)$ is a random variable taking its values in the finite set \mathfrak{S}_k , this says exactly that the sequence $(\mathbf{Perm}_k(\sigma_n) = \pi)_n$ converges in distribution.

Proof of (d) \Rightarrow (a). Consider a sequence of random permutations (σ_n) satisfying (d), *i.e.* for every $k \geq k_0$, there is a random permutation ρ_k such that $\mathbf{Perm}_k(\sigma_n) \xrightarrow{d} \rho_k$. Set now $\theta_{k,n} = \mathbf{Perm}_k(\mu_{\sigma_n})$. From Lemma 3.2.1, Equation (3.5) and Equation (3.4), we get

$$\begin{aligned} \mathbb{P}(\theta_{k,n} = \pi) &= \mathbb{E}[\widetilde{\text{occ}}(\pi, \mu_{\sigma_n})] = \mathbb{E}[\widetilde{\text{occ}}(\pi, \sigma_n)] + \mathcal{O}(1/n) = \mathbb{P}(\mathbf{Perm}_k(\sigma_n) = \pi) + \mathcal{O}(1/n) \\ &\rightarrow \mathbb{P}(\rho_k = \pi). \end{aligned}$$

In other words, $\theta_{k,n} \xrightarrow{d} \rho_k$ for every fixed $k \geq k_0$. Since μ_{ρ_k} takes its values in a finite set of permutons, this also implies

$$(3.6) \quad \mu_{\theta_{k,n}} \xrightarrow{d} \mu_{\rho_k}.$$

Let $H : (\mathcal{M}, d_{\square}) \rightarrow \mathbb{R}$ be a bounded continuous functional. It holds that

$$\begin{aligned} |\mathbb{E}[H(\mu_{\sigma_n})] - \mathbb{E}[H(\mu_{\theta_{k,n}})]| &\leq \mathbb{E}[|H(\mu_{\sigma_n}) - H(\mu_{\theta_{k,n}})|] \\ &\leq \mathbb{E}\left[|H(\mu_{\sigma_n}) - H(\mu_{\theta_{k,n}})| \mathbf{1}_{d_{\square}(\mu_{\sigma_n}, \mu_{\theta_{k,n}}) \leq 16k^{-1/4}}\right] \\ &\quad + \mathbb{E}\left[|H(\mu_{\sigma_n}) - H(\mu_{\theta_{k,n}})| \mathbf{1}_{d_{\square}(\mu_{\sigma_n}, \mu_{\theta_{k,n}}) > 16k^{-1/4}}\right]. \end{aligned}$$

The first term can be bounded by introducing the modulus of continuity of H , which is defined as $\omega(\varepsilon) = \sup_{d_{\square}(\xi, \zeta) \leq \varepsilon} |H(\xi) - H(\zeta)|$. Since \mathcal{M} is compact, it goes to 0 when ε goes to 0. Hence,

$$\begin{aligned} &\mathbb{E}\left[|H(\mu_{\sigma_n}) - H(\mu_{\theta_{k,n}})| \mathbf{1}_{d_{\square}(\mu_{\sigma_n}, \mu_{\theta_{k,n}}) \leq 16k^{-1/4}}\right] \\ &\leq \mathbb{E}\left[\omega(d_{\square}(\mu_{\sigma_n}, \mu_{\theta_{k,n}})) \mathbf{1}_{d_{\square}(\mu_{\sigma_n}, \mu_{\theta_{k,n}}) \leq 16k^{-1/4}}\right] \leq \omega(16k^{-1/4}). \end{aligned}$$

As for the second term, for k large enough, Lemma 3.2.2 yields

$$\begin{aligned} &\mathbb{E}\left[|H(\mu_{\sigma_n}) - H(\mu_{\theta_{k,n}})| \mathbf{1}_{d_{\square}(\mu_{\sigma_n}, \mu_{\theta_{k,n}}) > 16k^{-1/4}}\right] \\ &\leq \mathbb{E}\left[2 \sup |H| \mathbf{1}_{d_{\square}(\mu_{\sigma_n}, \mu_{\theta_{k,n}}) > 16k^{-1/4}}\right] \leq \frac{1}{2} e^{-\sqrt{k}} 2 \sup |H|. \end{aligned}$$

Putting things together, we obtain

$$(3.7) \quad |\mathbb{E}[H(\mu_{\sigma_n})] - \mathbb{E}[H(\mu_{\theta_{k,n}})]| \leq \omega(16k^{-1/4}) + \frac{1}{2} e^{-\sqrt{k}} 2 \sup |H|.$$

Assume that $(\mu_{\sigma_n})_n$ has a subsequence converging in distribution to a random permuton $\boldsymbol{\mu}'$. Taking the limit when $n \rightarrow \infty$ of (3.7) along this subsequence, we get

$$|\mathbb{E}[H(\boldsymbol{\mu}')] - \mathbb{E}[H(\mu_{\rho_k})]| \leq \omega(16k^{-1/4}) + e^{-\sqrt{k}} \sup |H|.$$

(Recall indeed that $(\theta_{k,n})_n$ converges to $\boldsymbol{\rho}_k$ in distribution.) The right-hand side tends to 0 when k tends to infinity, which proves that $(\mu_{\rho_k})_k$ converges to $\boldsymbol{\mu}'$ in distribution as well.

Therefore, all converging subsequences of $(\mu_{\sigma_n})_n$ converge to the same limit $\boldsymbol{\mu}'$, which is the limit of $(\mu_{\rho_k})_{k \geq 1}$. Thanks to the compactness of the space of probability distributions on \mathcal{M} , this is enough to conclude that (μ_{σ_n}) has indeed a limit. Item (a) is proved.

Proof of additional statements. Assume that (a)–(d) hold. That $(\boldsymbol{\Lambda}_{\pi})_{\pi} \stackrel{d}{=} (\widetilde{\text{occ}}(\pi, \boldsymbol{\mu}))_{\pi}$ follows from the proof of (a) \Rightarrow (b). Fix any integer k , and any permutation π of size k . The above equality in distribution implies $\mathbb{E}[\boldsymbol{\Lambda}_{\pi}] = \mathbb{E}[\widetilde{\text{occ}}(\pi, \boldsymbol{\mu})]$. That $\Delta_{\pi} = \mathbb{E}[\boldsymbol{\Lambda}_{\pi}]$ is clear from the proof of (b) \Rightarrow (c). The equality $\mathbb{P}(\boldsymbol{\rho}_k = \pi) = \Delta_{\pi}$ follows from the proof of (c) \Rightarrow (d). Finally, $\mathbb{E}[\widetilde{\text{occ}}(\pi, \boldsymbol{\mu})] = \mathbb{P}(\text{Perm}_k(\boldsymbol{\mu}) = \pi)$ comes from Equation (3.5). \square

Remark 3.3.4. This theorem is analogous in every aspect, to the main theorem of [DJ08] for convergence of random graphons. In some sense, Theorem 3.3.2 can also be seen as an analogue of a theorem of Aldous for random trees [Ald93, Theorem 18]. Both in permutations and trees, there is a natural way to construct a smaller structure from k elements of a big structure (induced subpermutations or subtrees). The goal is then to reduce the convergence of the big structure to the convergence, for each k , of the induced substructures. For trees, we need an extra tightness assumption (that the family of trees is “leaf-tight” in Aldous’ terminology). In our case, since the space of permutons is compact, we do not need such an assumption.

We finish this section by a comment on the existence of random permutons with prescribed induced subpermutations.

Definition 3.3.5. A family of random permutations $(\boldsymbol{\rho}_n)_{n \geq 1}$ is *consistent* if

- i) for every $n \geq 1$, $\boldsymbol{\rho}_n \in \mathfrak{S}_n$,

ii) for every $n \geq k \geq 1$, $\mathbf{Perm}_k(\rho_n) \stackrel{d}{=} \rho_k$.

It turns out that consistent families of random permutations and random permutations are essentially equivalent:

Proposition 3.3.6. *If μ is a random permutation, then the family defined by $\rho_k \stackrel{d}{=} \mathbf{Perm}_k(\mu)$ is consistent. Conversely, for every consistent family of random permutations $(\rho_k)_{k \geq 1}$, there exists a random permutation μ whose distribution is uniquely determined, such that $\mathbf{Perm}_k(\mu) \stackrel{d}{=} \rho_k$. In that case, $\mu_{\rho_n} \xrightarrow[n \rightarrow \infty]{d} \mu$.*

PROOF. Set $n \geq k \geq 1$. The first assertion follows from a coupled construction of $\mathbf{Perm}_k(\mu)$ and $\mathbf{Perm}_n(\mu)$, whereas the conditionally i.i.d. sequence used to build $\mathbf{Perm}_k(\mu)$ is constructed as a uniform random subsequence of size k of that used to build $\mathbf{Perm}_n(\mu)$. It follows that $\mathbf{Perm}_k(\mu) = \text{pat}_{I_{n,k}}(\mathbf{Perm}_n(\mu))$. By construction, the distribution of $I_{n,k}$ is uniform and independent of $\mathbf{Perm}_n(\mu)$. Hence the consistency follows.

The converse is immediate, by applying the implication (d) \Rightarrow (a) and the last assertion of Theorem 3.3.2 to the sequence $(\rho_k)_{k \geq 1}$. Consistency ensures that we get the prescribed induced subpermutations, and uniqueness in distribution follows by Proposition 3.3.1. \square

On the Brownian separable permuton

This chapter reproduces the article [Maa20], with minor changes of notation.

ABSTRACT. We show that, almost surely, the Brownian separable permuton is the push-forward of the Lebesgue measure on the graph of a random measure-preserving function associated to a Brownian excursion whose strict local minima are decorated with i.i.d. signs. As a consequence, its support is almost surely totally disconnected, has Hausdorff dimension one, and enjoys self-similarity properties inherited from those of the Brownian excursion. The density function of the averaged permuton is computed and a connection with the shuffling of the Brownian continuum random tree is explored.

4.1. Introduction

For $n \geq 1$, let \mathfrak{S}_n be the set of permutations of $\llbracket 1, n \rrbracket$, and $\mathfrak{S} = \sqcup_{n \geq 1} \mathfrak{S}_n$. We use the one line notation $\sigma = (\sigma(1) \sigma(2) \cdots \sigma(n))$ for $\sigma \in \mathfrak{S}_n$. A *pattern* in a permutation $\sigma \in \mathfrak{S}_n$ induced by the indices $1 \leq i_1 < \dots < i_k \leq n$ is the permutation $\pi \in \mathfrak{S}_k$ that is order-isomorphic to the word $(\sigma(i_1), \dots, \sigma(i_k))$. The *density* of the pattern $\pi \in \mathfrak{S}_k$ in $\sigma \in \mathfrak{S}_n$ is the proportion of increasing k -uples in $\llbracket 1, n \rrbracket$ that induce π in σ . A *class* of permutations is a subset of \mathfrak{S} that is stable by pattern extraction, and is characterized by the pattern avoidance of some minimal family of permutations called its *basis* [Bón12a, p. 5.1.2]. There is a large literature on the asymptotics of the pattern densities and diagram shape of a large typical permutation in several classes. This type of results can, to some extent, be encoded as convergence to a *permuton*. In [Bas+18] (to which we refer the reader for an extensive review of literature), Bassino, Bouvel, Féray, Gerin and Pierrot studied the class of *separable permutations* and showed the convergence of a uniform large separable permutation to a *Brownian separable permuton*, of which the present paper is a detailed study. Let us start with a few definitions.

4.1.1. Limits of permutations. A probability measure on the unit square $[0, 1]^2$ is called a *permuton* if both its marginals on $[0, 1]$ are uniform. With every permutation $\sigma \in \mathfrak{S}_n$ we associate a permuton μ_σ by setting $\mu_\sigma(dxdy) = n \mathbb{1}[\sigma(\lfloor xn \rfloor) = \lfloor yn \rfloor] dxdy$. The set of permutons is equipped with the weak convergence of probability measures, which makes it compact. A sequence of permutations $(\sigma_n)_n$ is said to converge to a permuton μ if and only if μ_{σ_n} converges weakly to μ . This theory was introduced by Hoppen, Kohayakawa, Moreira, Ráth, Sampaio in [Hop+13], where it is shown that convergence of a sequence of permutations to a permuton is equivalent to convergence of all pattern densities. As a result, permutons can be alternatively constructed as the completion of the space of permutations w.r.t. convergence of all pattern densities. This theory is similar to graphons as limits of dense graphs, and unifies the study of the limit shape of the permutation diagram with that of the limit of pattern densities.

4.1.2. The case of separable permutations. A permutation is separable if it does not have (2413) and (3142) as an induced pattern. Separable permutations were introduced in [BBL93], but appeared earlier in the literature [AN81; SS91]. They are counted by the large Schröder numbers: 1, 2, 6, 22, 90, 394, ... and enjoy many simple characterizations [BBL93; AN81; SS91; Ghy17]

The one most relevant to this paper is in terms of trees. A signed tree t is an rooted plane tree whose internal nodes are decorated with signs in $\{\oplus, \ominus\}$. We label its leaves

$1, \dots, k$ according to the natural ordering of t . The signs can be interpreted as coding a different ordering of the rooted tree t : we call \tilde{t} the tree obtained from t by reversing the order of the children of each node with a minus sign. The order of the leaves is changed by this procedure, and we set $\sigma(i)$ to be the position in \tilde{t} of the leaf i . We call $\text{perm}(t)$ this permutation $\sigma \in \mathfrak{S}_k$. It turns out [BBL93, Lemma 3.1] that separable permutations are exactly the ones that can be obtained this way.

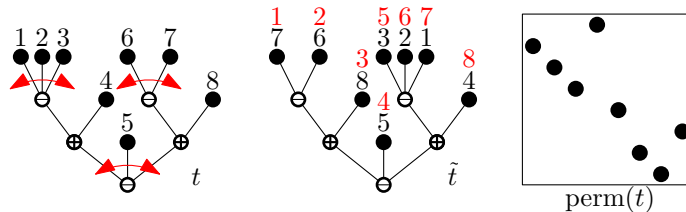

FIGURE 4.1. The permutation associated to a signed tree.

The article [Bas+18] shows that separable permutations have a permuton limit in distribution, yielding the first example of a nondeterministic permuton limit of a permutation class. The representation by signed trees is fundamental in their proof.

Theorem 4.1.1 (theorem 1.6 of [Bas+18]). *If σ_n is a uniform separable permutation of size n , then μ_{σ_n} converges in distribution, in the weak topology, to a non-deterministic permuton $\mu^{1/2}$ called the Brownian separable permuton of parameter $1/2$.*

This result comes with a characterization of $\mu^{1/2}$ (which we recall in section 2) which suggests that it can be realized as a measurable functional of a *signed Brownian excursion* (see Remark 4.2.7). The authors of [Bas+18] left providing an explicit such construction, along with the study of the support of $\mu^{1/2}$, as open questions that the present paper aims at addressing.

Let us mention that Theorem 4.1.1 was generalized in [Bas+20; Bas+19b] by the same authors along with the present author to various families of permutation classes. These results yield, among others, a one-parameter family $(\mu^p)_{p \in (0,1)}$ of possible limits, called the *biased Brownian separable permutons*. We set our paper in this generality and fix once and for all $p \in (0,1)$. We postpone a precise definition of μ^p to Section 4.2.

4.1.3. The signed Brownian excursion. We call *continuous excursion* a nonnegative continuous function $g : [0,1] \rightarrow \mathbb{R}_+$ that is positive on $(0,1)$. The *inner local minima* of g are the points of $(0,1)$ in which g is locally minimal, and we say that $x \in (0,1)$ is *not a one-sided minimum* of g if

$$\forall \epsilon > 0, \exists x_1 \in (x - \epsilon, x), x_2 \in (x, x + \epsilon) \text{ s.t. } g(x_1) < g(x) \text{ and } g(x_2) < g(x).$$

A *CRT excursion* is a continuous excursion $g : [0,1] \rightarrow \mathbb{R}_+$ such that:

- (CRT1) the inner local minima of g are dense in $[0,1]$,
- (CRT2) the values at the inner local minima are all different,
- (CRT3) the set of times that are not one-sided minima has Lebesgue measure 1.

In a CRT excursion, all inner local minima are necessarily strict local minima, and hence countable. It will be useful for our purposes to enumerate them in a well-defined manner.

Definition 4.1.2. A *measurable enumeration* is a sequence $(b_i)_{i \in \mathbb{N}}$ of functions from the set \mathcal{E}_{CRT} of CRT excursions to $[0,1]$ such that

- (ME1) for every $g \in \mathcal{E}_{\text{CRT}}$, $i \mapsto b_i(g)$ is a bijection between \mathbb{N} and the inner local minima of g ,
- (ME2) for every $i \in \mathbb{N}$, $g \mapsto b_i(g)$ is measurable,

(ME3) the function which maps $(g, u, v) \in \mathcal{E}_{\text{CRT}} \times [0, 1]^2$ to $i \in \mathbb{N}$ if $b_i \in (u, v)$ is the unique point in $[u, v]$ in which the minimum of g on $[u, v]$ is reached, and ∞ otherwise, is measurable.

We fix once and for all a measurable enumeration (see Section 4.2 for an explicit construction of one, which comes from [Bas+18]). We call *signed excursion* a pair (g, s) , where g is a CRT excursion and s is a sequence in $\{\oplus, \ominus\}^{\mathbb{N}}$. The sign s_i is to be considered as attached to the inner local minimum b_i .

Let (g, s) be a signed excursion. If $x < y \in [0, 1]$, we say that x and y are g -comparable if and only if the minimum of g on $[x, y]$ is reached at a unique point which is a strict local minimum $b_i \in (x, y)$. In this case, if $s_i = \oplus$, we say $x \triangleleft_g^s y$, otherwise $y \triangleleft_g^s x$.

The relation \triangleleft_g^s is a strict order, but it is not total. However, two distinct points which are not one-sided minima are always g -comparable, hence \triangleleft_g^s is total on a set of measure 1. See Lemma 4.2.4 for the proof of these claims. Moreover we will see later (Section 4.1.6) a natural extension to a total preorder on $[0, 1]$.

In what follows, we consider the signed excursion (e, S) , where e is the normalized Brownian excursion, and S is an independent sequence of independent signs with bias p , that is probability p of being \oplus and $1 - p$ of being \ominus . It is the main ingredient in building μ^p .

4.1.4. Construction of the permuton. If (g, s) is a signed excursion, we define

$$(4.1) \quad \varphi_{g,s}(t) = \text{Leb}\{u \in [0, 1], u \triangleleft_g^s t\}, \quad t \in [0, 1]$$

and

$$\mu_{g,s} = (\text{Id}, \varphi_{g,s})_* \text{Leb}.$$

Here $H_*\nu$ denotes the pushforward measure $\nu(H^{-1}(\cdot))$, whenever H and ν are respectively a measurable function and a measure defined on the same space. The reader may report to Figure 2.4, disregarding for now the vertical excursion \tilde{e} , to see a simulation of e, S and $\varphi_{e,S}$. Our main theorem is the following:

Theorem 4.1.3. *The maps $(t, g, s) \mapsto \varphi_{g,s}(t)$ and $(g, s) \mapsto \mu_{g,s}$ are measurable, and the random measure $\mu_{e,S}$ is distributed like μ^p , the biased Brownian separable permuton of parameter p .*

This theorem is proved in Section 4.3, along with a corollary which shows that the convergence of Theorem 4.1.1 can be rewritten without permutons, only in terms of functional convergence. To any permutation $\sigma \in \mathfrak{S}_n$, we associate a càdlàg, piecewise affine, measure-preserving function $\varphi_\sigma : [0, 1] \rightarrow [0, 1]$ with $\varphi_\sigma(t) = \frac{1}{n}(\sigma(\lfloor nt \rfloor + 1) - 1) + \frac{1}{n}\{\lfloor nt \rfloor\}$.

Corollary 4.1.4. *Let σ_n be a random permutation in \mathfrak{S}_n for every $n \in \mathbb{N}$. If μ_{σ_n} converges in distribution to μ^p , then for every $q \in [1, \infty)$, we have the convergence in distribution in the space $L^q([0, 1])$:*

$$\varphi_{\sigma_n} \xrightarrow[n \rightarrow \infty]{d} \varphi_{e,S}$$

4.1.5. Properties of the permuton. This continuum construction allows us to derive several properties of μ^p . In Section 4.4, we prove the following result.

Theorem 4.1.5. *Almost surely, the support of μ^p is totally disconnected¹, and its Hausdorff dimension is 1 (with one-dimensional Hausdorff measure bounded above by $\sqrt{2}$).*

The claim that the Hausdorff dimension is 1 also comes as a special case of a result of Riera [Rie]: any permuton limit in distribution of random permutation in a proper class, if it exists, almost surely has a support of Hausdorff dimension 1.

In Section 4.5, we show that μ^p inherits the self-similarity properties of e , in that μ^p contains a lot of rescaled distributional copies of itself. In particular, we get the following theorem, illustrated in Figure 2.1, which states that μ^p can be obtained by cut-and-pasting three independent Brownian separable permutons.

1. i.e. its only connected components are singletons

Theorem 4.1.6. *Let $(\Delta_0, \Delta_1, \Delta_2)$ be a random variable of Dirichlet($\frac{1}{2}, \frac{1}{2}, \frac{1}{2}$) distribution. Let μ_0, μ_1, μ_2 be independent and distributed like μ^p , and conditionally on μ_0 , let (X_0, Y_0) be a random point of distribution μ_0 . Let β be an independent Bernoulli r.v. of parameter p . We define the piecewise affine maps of the unit square into itself:*

$$(4.2) \quad \begin{aligned} \theta_0(x, y) &= (\eta_0(x), \zeta_0(y)) = \Delta_0(x, y) + (1 - \Delta_0)(\mathbb{1}_{[x > X_0]}, \mathbb{1}_{[y > Y_0]}) \\ \theta_1(x, y) &= (\eta_1(x), \zeta_1(y)) = \Delta_1(x, y) + \Delta_0(X_0, Y_0) + \Delta_2(0, \beta) \\ \theta_2(x, y) &= (\eta_2(x), \zeta_2(y)) = \Delta_2(x, y) + \Delta_0(X_0, Y_0) + \Delta_1(1, 1 - \beta) \end{aligned}$$

Then

$$(4.3) \quad \Delta_0 \theta_{0*} \mu_0 + \Delta_1 \theta_{1*} \mu_1 + \Delta_2 \theta_{2*} \mu_2 \stackrel{d}{=} \mu^p,$$

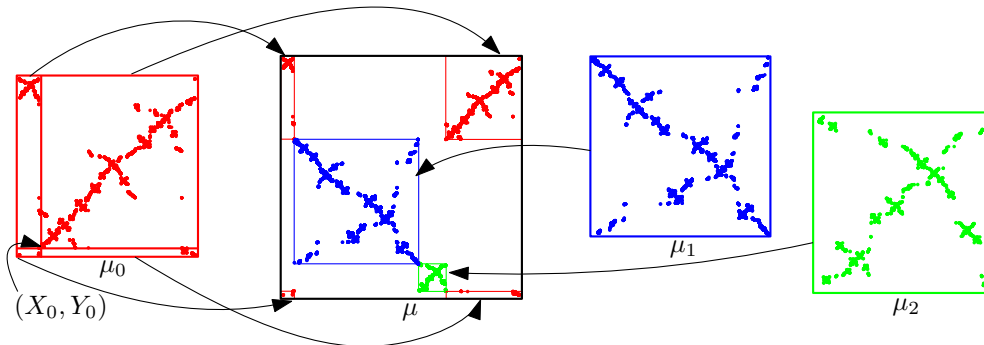

FIGURE 4.2. The construction of μ from three independent permutons distributed like μ . Here $\beta = 0$ and $(\Delta_0, \Delta_1, \Delta_2) \approx (0.4, 0.5, 0.1)$.

We believe that a result by Albenque and Goldschmidt [AG15] about the Brownian CRT can be adapted to show that the *distributional identity* (4.3) characterizes μ^p (see Remark 4.5.5.)

Secondly, we believe that a converse result to Theorem 4.1.6 can be obtained, in that it is possible to uniquely recover such a decomposition into three permutons provided a sample of μ^p and two independent points drawn from it. Such a result is present in [Ald94a].

Finally, our construction allows us to compute the averaged permuton $\mathbb{E} \mu^p$, obtained by taking $\mathbb{E} \mu^p(A) = \mathbb{E}[\mu^p(A)]$ for every Borel set A . We get the following result.

Theorem 4.1.7. *The permuton $\mathbb{E} \mu^p$ is the measure $\alpha_p(x, y) dx dy$, where $\alpha_p(x, y)$ equals*

$$\int_{\max(0, x+y-1)}^{\min(x, y)} \frac{3p^2(1-p)^2 da}{2\pi(a(x-a)(1-x-y+a)(y-a))^{3/2} \left(\frac{p^2}{a} + \frac{(1-p)^2}{(x-a)} + \frac{p^2}{(1-x-y+a)} + \frac{(1-p)^2}{(y-a)} \right)^{5/2}}.$$

Plots for different values of p are provided on Figure 2.2. The function α_p is a priori a rather complicated elliptic integral involving the root of a polynomial of degree 3 in a . However the case $p = 1/2$ is special: first of all $\alpha_{1/2}$ has all the symmetries of the square, so that we may restrict to $0 \leq x \leq \min(y, 1 - y)$. Furthermore thanks to some cancellations, the polynomial under the root is only of degree 2, and the integral can be solved for instance with a computer algebra system, yielding

$$(4.4) \quad \alpha_{1/2}(x, y) = \frac{1}{\pi}(\beta(x, y) + \beta(x, 1 - y)), \quad 0 \leq x \leq \min(y, 1 - y),$$

where $\beta(x, y) = \frac{3xy - 2x - 2y + 1}{(1-x)(1-y)} \sqrt{\frac{1-x-y}{xy}} + 3 \arctan \sqrt{\frac{xy}{1-x-y}}.$

The function α already appeared in a different form in the work of Dokos and Pak [DP14] as the expected shape of doubly-alternating Baxter permutons. We give more details about this at the end of the introduction.

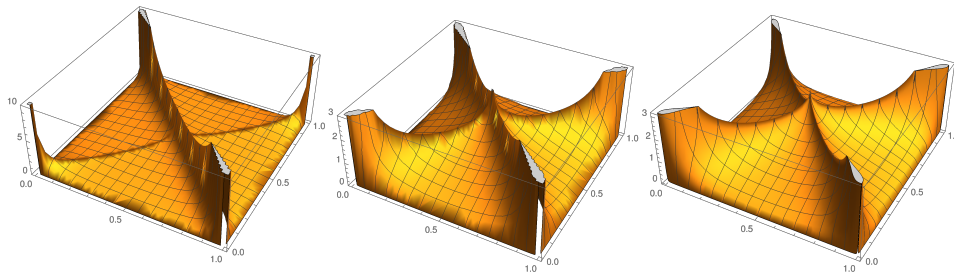

FIGURE 4.3. The function α_p for $p \in \{0.3, 0.45, 0.5\}$.

4.1.6. Shuffling of continuous trees. Through a classical construction (which goes back to Aldous [Ald93]), a Brownian excursion e encodes a continuous (rooted and ordered) tree \mathcal{T}_e called the Brownian CRT. This encoding puts inner minima of e in correspondence with branching points of \mathcal{T}_e , so that the pair (\mathcal{T}_e, S) may be seen as a continuous signed tree.

The next few results make this rigorous and explain how the random function $\varphi_{e,S}$ relates to the tree (\mathcal{T}_e, S) , much like separable permutations relate to signed trees. Those results, and the notation introduced here, are not needed for the rest of the paper, albeit the fact that e encodes a tree is an idea that underlies most of the arguments of the paper.

We recall the construction of continuous trees from continuous excursions, in the formalism of Le Gall and Duquesne [Le 05; Duq06]. Let g be a continuous excursion. Set $d_g(x, y) = g(x) + g(y) - 2 \min_{[x,y]} g$ for $x, y \in [0, 1]$. The function d_g is a pseudo-distance. Identifying points $x, y \in [0, 1]$ such that $d_g(x, y) = 0$ yields a quotient metric space (\mathcal{T}_g, d_g) with a continuous canonical surjection $p_g : [0, 1] \mapsto \mathcal{T}_g$. Let $\rho_g = p_g(0)$ be the root of \mathcal{T}_g , and define a total order \leq_g on \mathcal{T}_g by setting $x \leq_g y \iff \inf p_g^{-1}(x) \leq \inf p_g^{-1}(y)$. Define a probability measure $\lambda_g = p_{g*} \text{Leb}_{[0,1]}$. When $g = e$, we get the well-known Brownian CRT.

Section 4.7 is devoted to the proof of the following theorem, illustrated in Figure 4.4.

Theorem 4.1.8. *There exists a random CRT excursion \tilde{e} , defined on the same probability space as (e, S) , with the following properties:*

- i) The excursion \tilde{e} has the distribution of a normalized Brownian excursion, with the same field of local times at time 1 as e .*
- ii) Almost surely, the function $\varphi_{e,S}$ is an isometry between the pseudo-distances d_e and $d_{\tilde{e}}$. In particular, $\tilde{e} \circ \varphi_{e,S} = e$.*

This result has an interpretation in terms of shuffling of continuous trees, mirroring the construction of separable permutations described in Section 4.1.2.

When g is a CRT excursion, the construction of \mathcal{T}_g puts the inner local minima of g in bijection with the branching points of \mathcal{T}_g . Hence, when (g, s) is a signed excursion, the order \leq_g^s can be defined on the tree \mathcal{T}_g by inverting at all branching points with a minus sign, as follows. Let $x, y \in \mathcal{T}_g$ such that $x \leq_g y$. If there exists a strict local minimum b_i such that $\sup p_g^{-1}(x) < b_i < \inf p_g^{-1}(y)$, with $g(b_i) = \inf\{g(t), \sup p_g^{-1}(x) \leq t \leq \inf p_g^{-1}(y)\}$, and $s(b_i) = \ominus$, then set $x \geq_g^s y$. Otherwise, set $x \leq_g^s y$. This defines a total order compatible with the relation on $[0, 1]$ defined in the previous section: whenever x and y are g -comparable, then $x \prec_g^s y \iff p_g(x) <_g^s p_g(y)$. This construction is illustrated in Figure 4.5.

This allows us to give an interpretation of Theorem 2.1.8 in terms of trees. If we consider the tree $(\mathcal{T}_{\tilde{e}}, d_{\tilde{e}}, \rho_{\tilde{e}}, \leq_{\tilde{e}}, \lambda_{\tilde{e}})$, Theorem 2.1.8(2) says that, for $x, y \in [0, 1]$, $d_e(x, y) = 0 \iff d_{\tilde{e}}(\varphi_{e,S}(x), \varphi_{e,S}(y)) = 0$. We deduce that $p_e(x) = p_e(y) \iff p_{\tilde{e}}(\varphi_{e,S}(x)) = p_{\tilde{e}}(\varphi_{e,S}(y))$, which implies that the map $\varphi_{e,S}$ factorizes through p_e and $p_{\tilde{e}}$, that is there is a unique map $j : \mathcal{T}_e \rightarrow \mathcal{T}_{\tilde{e}}$ such that $j \circ p_e = p_{\tilde{e}} \circ \varphi_{e,S}$. It is immediate that j is an isometry $(\mathcal{T}_e, d_e) \leftrightarrow (\mathcal{T}_{\tilde{e}}, d_{\tilde{e}})$. Moreover, j maps the root of \mathcal{T}_e to the root of $\mathcal{T}_{\tilde{e}}$, is

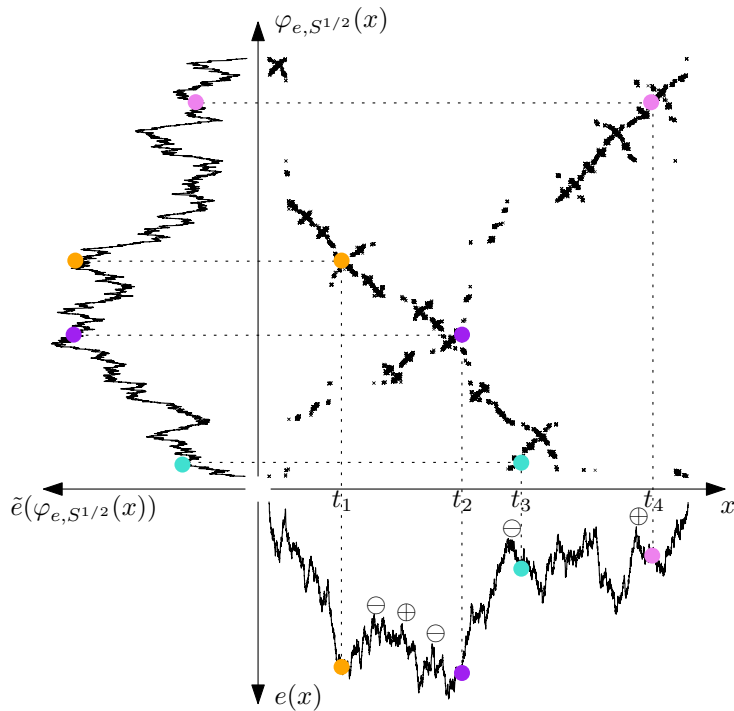

FIGURE 4.4. A realization of (e, S) (here $p = 1/2$), and the associated functions $\varphi_{e, S}$ and \tilde{e} , highlighting the property $\tilde{e} \circ \varphi_{e, S} = e$. Four points $t_1 < \dots < t_4$ are specified.

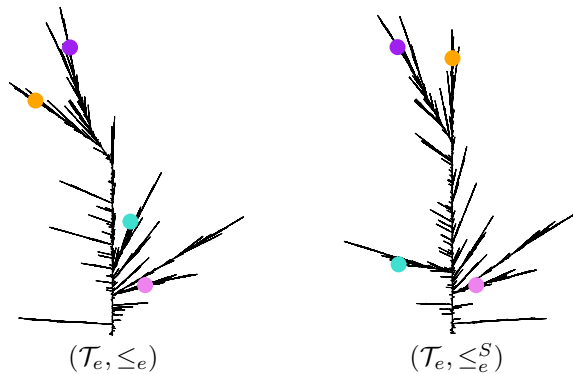

FIGURE 4.5. The tree \mathcal{T}_e , drawn according to the two orders \leq_e and \leq_e^S . Four points have been marked. The data is the same as in Figure 2.4.

measure preserving and increasing w.r.t. $(\leq_e^S, \leq_{\tilde{e}})$. This discussion can be summarized in the following corollary of Theorem 4.1.8.

Proposition 4.1.9. *The map $j : \mathcal{T}_e \leftrightarrow \mathcal{T}_{\tilde{e}}$ provides an isomorphism (of pointed, ordered, measured metric spaces) between the tree $(\mathcal{T}_e, d_e, \rho_e, \leq_e^S, \lambda_e)$ and the Brownian CRT $(\mathcal{T}_{\tilde{e}}, d_{\tilde{e}}, \rho_{\tilde{e}}, \leq_{\tilde{e}}, \lambda_{\tilde{e}})$ constructed from the Brownian excursion \tilde{e} .*

Combining this with the result of Duquesne on the uniqueness of coding functions of trees [Duq06, Thm 1.1], we directly get an abstract construction of $\mu_{e, S}$.

Proposition 4.1.10. *Almost surely, the functions \tilde{e} and j are uniquely determined by the fact that \tilde{e} is continuous and j is an isomorphism between $(\mathcal{T}_e, d_e, \rho_e, \leq_e^S, \lambda_e)$ and $(\mathcal{T}_{\tilde{e}}, d_{\tilde{e}}, \rho_{\tilde{e}}, \leq_{\tilde{e}}, \lambda_{\tilde{e}})$. Any function ϕ which verifies $p_{\tilde{e}} \circ \phi = j \circ p_e$ must coincide with $\varphi_{e, S}$ on a set of measure 1, hence still verifies $\mu_{e, S} = (\text{Id}, \phi)_* \text{Leb}$.*

4.1.7. Comments and perspectives. Let us mention another natural family of permutations: the doubly-alternating Baxter permutations, which are also the doubly-alternating separable permutations [Ouc05], and are counted by the Catalan numbers. The fact that they enjoy a tree decomposition similar to separable permutations, along with simulations [DP14], allows to boldly conjecture that they converge to the Brownian separable permuton of parameter $1/2$.

Dokos and Pak [DP14, Thm 1.1] compute the expected shape of doubly-alternating Baxter permutations: their result implies that for every Borel subset A of the unit square, if σ_n is a uniform doubly-alternating permutation of size n , then $\mathbb{E}[\mu_{\sigma_n}(A)] \rightarrow \int_A \psi$, where ψ has symmetries of the square and $\psi(x, y) = \frac{1}{4\pi} \int_0^x du \int_0^{x-u} \frac{dv}{[(u+v)(y-v)(1-y-u)]^{3/2}}$ for $0 \leq x \leq y \wedge 1 - y$. We can show that this function is the same as the one we computed for the expectation of the Brownian permuton of parameter $1/2$, further strengthening the conjecture. Indeed,

$$\begin{aligned} \psi(x, y) &= \frac{1}{4\pi} \int_0^x du \int_0^u \frac{dv}{[u(y-v)(1-y-u+v)]^{3/2}} \\ &= \frac{1}{4\pi} \int_0^x du \left[\frac{2(-u+2v-2y+1)}{(u-1)^2 u^{3/2} \sqrt{(y-v)(1-y-u+v)}} \right]_{v=0}^{v=u} \\ &= \frac{1}{\pi} \int_0^x (\gamma(u, y) + \gamma(u, 1-y)) du \end{aligned}$$

where $\gamma(x, y) = \frac{x+2y-1}{2(1-x)^2 x^{3/2} \sqrt{(y-x)(1-y-x)}}$. We recall the definition of $\alpha_{1/2}$ and β from (4.4).

We can check that $\partial_x \beta(x, y) = \gamma(x, y)$, implying that $\psi = \alpha_{1/2}$.

As already mentioned, the article [Bas+20] considers *substitution-closed classes*, which are natural generalizations of the class of separable permutations. Depending on the class, several possible limits appear, among which are the μ^p for p possibly different from $1/2$. Another family of possible limits is *the α -stable permuton driven by ν* , for $\alpha \in (1, 2)$ and ν itself a random permuton. We believe a continuum construction similar to the one presented here is possible, by considering a α -stable tree, with an independent copy of ν at each branching point, driving the reordering of the (countably infinite number of) branches stemming from that point. We do believe that the support would still be almost surely of Hausdorff dimension 1 in that case.

The structure of the paper is as follows. Section 4.2 contains various definitions that will be needed in the rest of the paper, notably the definition of μ^p and a characterization through its finite-dimensional marginals that highlights the link with the signed excursion. Section 4.3 contains the proof of Theorem 4.1.3, along with some facts about the random function $\varphi_{e,S}$ that are reused later. Sections 4.4 to 4.6 are respectively devoted to the proofs of Theorems 4.1.5 to 4.1.7, and Section 4.7 to the one of Theorem 2.1.8.

Acknowledgements of [Maa20]. I warmly thank Grégory Miermont for his dedicated supervision, enlightening discussions and his detailed reading of this paper. Many thanks to Mathilde Bouvel, Valentin Féray and Sébastien Martineau for enriching discussions and useful comments. Thanks to an anonymous referee for very helpful comments.

I am grateful for the hospitality and support of the Forschungsinstitut für Mathematik at ETH Zürich during a stay where part of this research was conducted.

4.2. Definitions

We recall the notion of random subpermutation $\mathbf{Perm}_k(\mu)$ of a random permuton μ defined in the previous chapter of this thesis (see Equation (3.3)). The biased Brownian separable permuton is defined as follows.

Definition 4.2.1. The permuton μ^p is determined by the relations

$$(4.5) \quad \forall k \geq 1, \quad \mathbf{Perm}_k(\mu^p) \stackrel{d}{=} \text{perm}(t_{k,p}),$$

where $t_{k,p}$ is a uniform binary tree with k leaves whose internal vertices are decorated with i.i.d. signs of bias p .

In the rest of the section, we make apparent a connection with the signed Brownian excursion.

4.2.1. A few facts about excursions. We start by constructing a measurable enumeration as defined in Definition 4.1.2. Let $(p_i, q_i)_{i \in \mathbb{N}}$ be a fixed enumeration of $\mathbb{Q}^2 \cap [0, 1]^2$. Let g be a CRT excursion. For $i \geq 1$, define $w_i = \min\{t \in [p_i, q_i] : g(t) = \min_{[p_i, q_i]} g\}$, $i_0 = 0$, and for $k \geq 1$, set recursively

$$i_k = \inf\{i > i_{k-1}, w_i \in (p_i, q_i), w_i \notin \{w_1, \dots, w_{i_{k-1}}\}\}.$$

Finally, for $k \in \mathbb{N}$, set $b_k(g) = w_{i_k}$.

Lemma 4.2.2. *This construction defines a measurable enumeration.*

PROOF. It is immediate that all inner local minima will appear in the sequence $(w_i)_i$. The way the subsequence $(b_i(g))_i$ of $(w_i)_i$ is chosen guarantees that only inner local minima appear, and only once, in $(b_i(g))_i$.

Measurability of $g \mapsto b_i(g)$ for every i follows from that of $g \mapsto w_i(g)$ and $k \mapsto i_k$.

To prove (ME3) we see that thanks to Item (CRT2), the function $\mathcal{E}_{\text{CRT}} \times [0, 1]^2 \rightarrow \mathbb{N} \cup \{\infty\}$

$$(g, x, y) \mapsto \min \left\{ i \in \mathbb{N}, g(b_i(g)) = \min_{[x,y]} g \text{ and } b_i(g) \in (x, y) \text{ and } \min_{[x,y]} g < \min(g(x), g(y)) \right\}$$

is a measurable functional that maps (g, x, y) to $i \in \mathbb{N}$ whenever $b_i(g)$ is the point in (x, y) that is the only global minimum of g on $[x, y]$, and ∞ if no such $i \in \mathbb{N}$ exists. \square

We now collect a few facts about CRT excursions. In Section 4.1.6 we saw that such functions encode continuous trees. So we borrow the vocabulary of trees in a way that is coherent with this encoding: the $x \in [0, 1]$ which are not one-sided local minima are called *leaves of g* . The $b_i(g)$ for $i \in \mathbb{N}$ are called *branching points of g* and are identified with \mathbb{N} . Set

$$\begin{aligned} a_i(g) &= \sup\{t < b_i : g(t) = g(b_i(g))\}, \\ c_i(g) &= \inf\{t > b_i : g(t) = g(b_i(g))\}; \\ h_i(g) &= g(b_i(g)) = g(c_i(g)) = g(a_i(g)). \end{aligned}$$

It is clear that a_i, b_i, c_i, h_i are measurable functionals on the set of CRT excursions. For instance, $\{a_i(g) \leq t\}$ is clearly a measurable set.

In many instances in this paper where an arbitrary CRT excursion g is fixed, the dependency of a_i, b_i, c_i, h_i in g shall be dropped. Let us indeed fix such a g .

By definition, for $x \in (a_i, b_i) \cup (b_i, c_i)$, $g(x) \geq h_i$, defining two subexcursions at respectively the left and the right of b_i . We collect an immediate consequence of (CRT2), which states that these subexcursions are nested, with a binary tree structure (which comes from that of \mathcal{T}_g).

Lemma 4.2.3. *For every i, j either $[a_i, c_i] \subset [a_j, c_j]$ or $[a_j, c_j] \subset [a_i, c_i]$ or $[a_i, c_i] \cap [a_j, c_j] = \emptyset$.*

Furthermore, if $[a_j, c_j] \subset [a_i, c_i]$, then either $j = i$, $[a_j, c_j] \subset (a_i, b_i)$ or $[a_j, c_j] \subset (b_i, c_i)$.

If $x < y$ are g -comparable, the b_i in which g reaches its minimum between x and y is called the *most recent common ancestor* of x and y . We extend this notion to branching points: if $[a_i, c_i] \cap [a_j, c_j] = \emptyset$, then b_i and b_j are g -comparable. We can always assume by symmetry that $b_i < b_j$ and call *most recent common ancestor* of i and j the $k \in \mathbb{N}$ such that $[a_i, c_i] \subset (a_k, b_k)$ and $[a_j, c_j] \subset (b_k, c_k)$.

4.2.2. Extraction of permutations and trees from a signed excursion. Let (g, s) be a signed excursion. Recall that x and y are g -comparable if the minimum of g on $[x, y]$ is reached at a unique point, and that point b is a strict local minimum with $b \in (x, y)$. We start by collecting elementary facts on comparability.

Lemma 4.2.4. *Let g be a CRT excursion and s a sequence of signs.*

- i) *Two leaves of g are always g -comparable. Hence almost every pair of points in $[0, 1]$ is g -comparable.*
- ii) *The relation \triangleleft_g^s is a strict partial order.*
- iii) *For almost every $x, y \in [0, 1]$,*

$$x \triangleleft_g^s y \implies \varphi_{g,s}(x) \leq \varphi_{g,s}(y).$$

PROOF. The first claim is immediate: between two leaves, the minimum of the function g cannot be reached at the endpoints and consequently is reached at some unique point, which is a inner minimum of g .

It is clear by definition that \triangleleft_g^s is antisymmetric. To show transitivity suppose $x \triangleleft_g^s y \triangleleft_g^s z$. Let b_i (resp. b_j) be the most recent common ancestor of x and y (resp. y and z). Since $[a_i, c_i] \cap [a_j, c_j]$ contains y , it is nonempty and by Lemma 4.2.3, either $[a_i, c_i] \subset [a_j, c_j]$ or the symmetric case. Let us treat only the first one.

- In the case $i = j$, then x and z must be on the same side of b_i , opposite y . Since $x \triangleleft_g^s y$, then $z \triangleleft_g^s y$, which is impossible.
- In the case $[a_i, c_i] \subset (a_j, b_j)$, then $x, y \in (a_j, b_j)$ and $z \in (b_j, c_j)$.
- In the case $[a_i, c_i] \subset (b_j, c_j)$, then $x, y \in (b_j, c_j)$ and $z \in (a_j, b_j)$

In these last two cases, x and y are on the same side of b_j , opposite z . Since $y \triangleleft_g^s z$, then $x \triangleleft_g^s z$ too. This proves transitivity.

The third claim is an immediate consequence of the first two. \square

If x_1, \dots, x_n are points of $[0, 1]$, pairwise g -comparable, denote by $x_{(1)} < \dots < x_{(n)}$ their order statistic (for the usual order on $[0, 1]$). We then define

$$\text{Perm}_{g,s}(x_1, \dots, x_n) = \text{rank}_{\triangleleft_g^s}(x_{(1)}, \dots, x_{(n)}).$$

Observe for instance Figure 4.4. In this instance, $\text{Perm}_{e,S}(t_1, \dots, t_4) = (3214)$.

To understand the structure of these permutations, let us define the (signed) trees extracted from a (signed) excursion. Following Le Gall [Le 05], when g is a CRT excursion and $t_1 < \dots < t_k$ are pairwise g -comparable², the discrete plane tree with edge-lengths $\tau(g, t_1, \dots, t_k)$ is constructed recursively as follows:

- If $k = 1$, then $\tau(g, t_1)$ is a leaf labeled t_1 .
- If $k \geq 2$, then the minimum of g on $[t_1, t_k]$ is reached at a strict local minimum b_i for some i , and there is $j \in \llbracket 2, k \rrbracket$ such that $\{t_1, \dots, t_{j-1}\} \subset (a_i, b_i)$, and $\{t_j, \dots, t_k\} \subset (b_i, c_i)$. Then $\tau(g, t_1, \dots, t_k)$ is a root labeled i , spanning two subtrees $\tau(g, t_1, \dots, t_{j-1})$ and $\tau(g, t_j, \dots, t_k)$.

This yields a binary tree whose internal vertices are put in correspondence with branching points of g . Then, if (g, s) is a signed excursion, we set $\tau^\pm(g, s, t_1, \dots, t_k)$ to be the tree $\tau(g, t_1, \dots, t_k)$, to which we add, at each internal node labeled i , the sign s_i . The following observation is capital: (recall the definition of perm from Section 4.1.2)

Observation 4.2.5. For any signed excursion (g, s) and g -comparable x_1, \dots, x_n ,

$$\text{Perm}_{g,s}(x_1, \dots, x_n) = \text{perm}(\tau^\pm(g, s, x_{(1)}, \dots, x_{(n)})).$$

² The definition there is stated differently and covers any continuous function g and choice of points t_1, \dots, t_k

Going back to the example of Figure 4.4, we see that $\tau^\pm(e, S, t_1, \dots, t_4)$ is the tree , whose associated permutation is indeed (3214).

If U_1, \dots, U_k are independent uniform random variables in $[0, 1]$, then they are almost surely pairwise g -comparable. We recall that the signed Brownian excursion (e, S) is built by taking e to be a normalized Brownian excursion, and S an independent i.i.d. sequence of signs of bias p . Then a consequence of [Le 05, Theorem 2.11] is that the tree $\tau^\pm(e, S, U_{(1)}, \dots, U_{(k)})$ is a uniform binary tree with k leaves, independently decorated with i.i.d. signs of bias p . From Definition 4.2.1 and Observation 4.2.5 follows a new characterization of μ^p , which we use in this paper.

Proposition 4.2.6. *The permuton μ^p is determined by the relations*

$$(4.6) \quad \forall k \geq 1, \quad \mathbf{Perm}_k(\mu^p) \stackrel{d}{=} \text{Perm}_{e,S}(U_1, \dots, U_k).$$

Remark 4.2.7. This connection with the Brownian excursion was present in [Bas+18] for $p = 1/2$. The main result of that paper actually goes further: the conditional distribution of the l.h.s. given $\mu^{1/2}$ equals (in distribution) the conditional distribution of the r.h.s. given (e, S) , jointly for all k (see [Bas+18, thm. 1.6] and its proof). This indeed strongly hinted at the existence of a direct construction of $\mu^{1/2}$ from (e, S) , made explicit in the present paper.

4.3. The function φ

Theorem 4.1.3 follows from the next two propositions.

Proposition 4.3.1. *If g is a CRT excursion and s a sequence of signs, then $(g, s, t) \mapsto \varphi_{g,s}(t)$ and $(g, s) \mapsto \mu_{g,s}$ are measurable. Furthermore, $\varphi_{g,s*} \text{Leb} = \text{Leb}$, hence $\mu_{g,s}$ is a permuton.*

PROOF. For the measurability, remark that $((g, s, t), u) \mapsto \mathbb{1}[u \triangleleft_g^s t]$ is a measurable function, as a result of Item (ME3). Then Fubini's theorem implies that its partial integral over u is a measurable function of (g, s, t) .

Now we only have to prove that $\varphi_* \text{Leb} = \text{Leb}$. Let $(Z_i)_{i \geq 1}$ be independent uniformly distributed random variables in $[0, 1]$. For $k \geq 2$, let $U_{1,k} = \frac{1}{k-1} \#\{i \in \llbracket 2, k \rrbracket : Z_i \triangleleft_g^s Z_1\}$ and $U_1 = \lim_{k \rightarrow \infty} U_{1,k}$. We can apply the law of large numbers conditionally on Z_1 to the sequence $\mathbb{1}_{Z_2 \triangleleft_g^s Z_1}, \mathbb{1}_{Z_3 \triangleleft_g^s Z_1}, \dots$ (which is i.i.d. given Z_1) to show that this limit is well defined and equal almost surely to $\text{Leb}\{t : t \triangleleft_g^s Z_1\} = \varphi(Z_1)$. This means that U_1 has distribution $\varphi_* \text{Leb}$. On the other hand, by exchangeability of the Z_i , the $U_{1,k}$ are uniform over $\{\frac{1}{k-1}, \dots, \frac{k-1}{k-1}\}$ so the distribution of the limit U_1 must be uniform. This means precisely that $\varphi_* \text{Leb} = \text{Leb}$. \square

Proposition 4.3.2. *The Brownian separable permuton μ^p is distributed like $\mu_{e,S}$.*

PROOF. By definition of $\mu_{g,s}$, $\mathbf{Perm}_k(\mu_{e,S})$ can be realized as $\text{rank}(\mathbf{Y}) \circ \text{rank}(\mathbf{X})^{-1}$ where X_1, \dots, X_k are independent uniform in $[0, 1]$ and $Y_i = \varphi_{e,S}(X_i)$ for $i \in \llbracket 1, k \rrbracket$. Since $x \triangleleft_e^s y$ implies $\varphi_{e,S}(x) \leq \varphi_{e,S}(y)$, and moreover since the Y_i are almost surely distinct, then almost surely $\mathbf{Perm}_k(\mu_{e,S}) = \text{Perm}_{e,S}(X_1, \dots, X_k)$. According to Proposition 4.2.6, this property characterizes μ^p among permutons. \square

We now collect a few results about the excursion and the function φ . The first one states that $[0, 1]$ can almost be covered by a union of small subexcursions.

Lemma 4.3.3. *Let g be a CRT excursion, and $\delta > 0$, $\epsilon > 0$. There exists a finite $I \subset \mathbb{N}$ such that the $([a_i, c_i])_{i \in I}$ are disjoint, $c_i - a_i \leq \epsilon$ for every i , and $\text{Leb}(\bigsqcup_{i \in I} [a_i, c_i]) = \sum (c_i - a_i) > 1 - \delta$.*

PROOF. Let x be a leaf of the excursion g . Let $x_0 < x$ be another leaf. Define recursively b_{k_n} to be the most recent common ancestor of x_n and x , and x_{n+1} to be a leaf in $(\max\{b_{k_n}, x - \frac{1}{n}\}, x)$. This is possible by density of the leaves. Then necessarily

$x \in [a_{k_n}, c_{k_n}]$ and a_{k_n} converges to x . Hence $g(c_{k_n}) = g(a_{k_n})$ converges to $g(x)$, which implies that $c_{k_n} - a_{k_n}$ converges to 0 (otherwise x couldn't be a leaf). Hence there must be a i such that $|c_i - a_i| \leq \epsilon$ and $x \in [a_i, c_i]$.

We deduce that $\bigcup_{i: c_i - a_i \leq \epsilon} [a_i, c_i]$ has measure 1. So a finite union can be found with measure $\geq 1 - \delta$. Now thanks to Lemma 4.2.3, this union can be readily rewritten as a disjoint union. \square

Now we want to characterize how the function $\varphi_{g,s}$ behaves on a pair of sibling sub-cursions defined by an interval of the form $[a_i, c_i]$. Set $a'_i = \varphi_{g,s}(a_i)$, $c'_i = a'_i + c_i - a_i$, $b'_i = a'_i + (b_i - a_i) \mathbb{1}[s_i = \oplus] + (c_i - b_i) \mathbb{1}[s_i = \ominus]$. The numbers $a'_i, b'_i, c'_i \in [0, 1]$ can be interpreted as the equivalent of a_i, b_i, c_i for the shuffled order.

Lemma 4.3.4. *For $i \in \mathbb{N}$, we have*

$$\begin{aligned} \text{if } t \in [a_i, b_i] \text{ and } s_i = \oplus, \text{ then } & \varphi_{g,s}(t) = a'_i + \text{Leb}\{x \in [a_i, b_i] : x \triangleleft_g^s t\} \in [a'_i, b'_i]. \\ \text{if } t \in [b_i, c_i] \text{ and } s_i = \oplus, \text{ then } & \varphi_{g,s}(t) = b'_i + \text{Leb}\{x \in [b_i, c_i] : x \triangleleft_g^s t\} \in [b'_i, c'_i]. \\ \text{if } t \in [a_i, b_i] \text{ and } s_i = \ominus, \text{ then } & \varphi_{g,s}(t) = b'_i + \text{Leb}\{x \in [a_i, b_i] : x \triangleleft_g^s t\} \in [b'_i, c'_i]. \\ \text{if } t \in [b_i, c_i] \text{ and } s_i = \ominus, \text{ then } & \varphi_{g,s}(t) = a'_i + \text{Leb}\{x \in [b_i, c_i] : x \triangleleft_g^s t\} \in [a'_i, b'_i]. \end{aligned}$$

If $t \in [0, a_i) \cup (c_i, 1]$, then

$$\varphi_{g,s}(t) = \text{Leb}\{x \in [0, a_i) \cup (c_i, 1] : x \triangleleft_g^s t\} + \mathbb{1}[a_i \triangleleft_g^s t](c_i - a_i) \in [0, a'_i] \cup [c'_i, 1]$$

PROOF. We prove the first and last equalities, as the others have a symmetric proof. If $s_i = \oplus$, $t \in [a_i, b_i]$ and u is a leaf, then $u \triangleleft_g^s t$ if and only if $u \in [0, a_i) \cup (c_i, 1]$ and $u \triangleleft_g^s a_i$, or $u \in [a_i, b_i]$ and $u \triangleleft_g^s t$. The first claim follows by taking the measure of such u .

For the last equality, we see that if $t \in [0, a_i) \cup (c_i, 1]$ and $u \in [a_i, c_i]$, then $u \triangleleft_g^s t$ if and only if $a_i \triangleleft_g^s t$. \square

Lemma 4.3.5. *If $[a_j, c_j] \subset (a_i, b_i)$, then either $s_i = \oplus$ and $[a'_j, c'_j] \subset [a'_i, b'_i]$, or $s_i = \ominus$ and $[a'_j, c'_j] \subset [b'_i, c'_i]$.*

If $[a_j, c_j] \subset (b_i, c_i)$, then either $s_i = \oplus$ and $[a'_j, c'_j] \subset [b'_i, c'_i]$, or $s_i = \ominus$ and $[a'_j, c'_j] \subset [a'_i, b'_i]$.

PROOF. The four claims have a symmetrical proof, hence we only prove the first. If $s_i = \oplus$ and $[a_j, c_j] \subset (a_i, b_i)$, then the previous lemma implies readily $a'_i \leq a'_j$. We need to prove $c'_j \leq b'_i$, that is $a'_j + c_j - a_j \leq a'_i + b_i - a_i$, which is equivalent to $a'_j - a'_i \leq a_j - a_i + b_i - c_j$. This is exactly the inequality of measures derived from the inclusion $\{x, a_i \triangleleft_g^s x \triangleleft_g^s a_j\} \subset [a_i, a_j] \sqcup [c_j, b_i]$ \square

Now we can prove Corollary 4.1.4.

PROOF OF COROLLARY 4.1.4. We consider the Kolmogorov distance between probability measures, which is the uniform distance on the bivariate CDFs ($d_K(\nu, \pi) = \sup_{0 \leq x, y \leq 1} |\nu - \pi|([0, x] \times [0, y])$). We use the fact that convergence of permutons is metrized by d_K [Hop+13, lemma 5.3], and the following result:

Lemma 4.3.6. *If $\sigma \in \mathfrak{S}_n$, $d_K(\mu_\sigma, (\text{Id}, \varphi_\sigma)_* \text{Leb}) \leq \frac{2}{n}$*

PROOF. It is enough to notice that both CDFs coincide on points whose coordinates are entire multiples of $1/n$ and use the fact that CDFs of permutons are 1-Lipschitz [Hop+13, eq. 7] \square

All together, this implies $(\text{Id}, \varphi_{\sigma_n})_* \text{Leb} \xrightarrow{d} (\text{Id}, \varphi_{e,S})_* \text{Leb}$. With the Skorokhod coupling we can assume without loss of generality, that the convergence is in fact almost sure.

Let ϵ and δ be positive real numbers, and apply Lemma 4.3.3. Then

$$\begin{aligned} \text{Leb}(x : |\varphi_{\sigma_n}(x) - \varphi_{e,S}(x)| > \epsilon) &\leq \text{Leb}(x : x \notin \bigsqcup_{i \in I} [a_i, c_i]) \\ &\quad + \sum_i \text{Leb}(x : x \in [a_i, c_i], \varphi_{\sigma_n}(x) \notin [a'_i, c'_i]) \end{aligned}$$

The first term is smaller than δ by construction, and the second term converges to $\sum_i \text{Leb}(x : x \in [a_i, c_i], \varphi_{e,S}(x) \notin [a'_i, c'_i]) = 0$ because of the narrow convergence of $(\text{Id}, \varphi_{\sigma_n})$ to $(\text{Id}, \varphi_{e,S})$ and the Portmanteau theorem (indeed permutons put no mass on the boundary of rectangles, because they have uniform marginals). So for $q \geq 1$, $\|\varphi_{\sigma_n} - \varphi_{e,S}\|_{L^q}^q \leq \epsilon^q + \delta + o(1)$. This last quantity can be made arbitrary small by choosing first ϵ and δ small enough and then n large enough. We have proven almost sure convergence of $\varphi_{\sigma_n} \xrightarrow{L^p} \varphi_{e,S}$ in some coupling, hence the corollary. \square

We end this section by considering the following property of signed excursions (g, s) :

$$\begin{aligned} \text{(A)} \quad \forall i \neq j, \quad [a'_j, c'_j] \subset [a'_i, c'_i] &\implies \{h_l : l \geq 1, [a'_l, c'_l] \subset [a'_i, c'_i] \text{ and } [a'_j, c'_j] \subset [b'_l, c'_l]\} \\ &\text{and } \{h_l : l \geq 1, [a'_l, c'_l] \subset [a'_i, c'_i] \text{ and } [a'_j, c'_j] \subset [a'_l, b'_l]\} \text{ are dense in } [h_i, h_j] \end{aligned}$$

It is very similar to the "order-leaf-tight" property of continuum trees defined in [Ald93]. Loosely said, it means that it is impossible to find a nontrivial ancestral path in the tree \mathcal{T}_g without a density of points both on the right and on the left where a subtree is grafted. "left" and "right" are understood with regard to the shuffled order \leq_g^s . This is crucial to the proof of Theorem 4.1.8. We show that it holds almost surely in our setting.

Proposition 4.3.7. *Let g be a CRT excursion, $p \in (0, 1)$ and S be a random i.i.d. sequence of signs with bias p . Then with probability one, (g, S) verifies property (A).*

PROOF. By symmetry we prove only the first claim and by countable union we fix i and j . Let $K = \{l \geq 1 : [a_l, c_l] \subset [a_i, c_i] \text{ and } [a_j, c_j] \subset [b_l, c_l]\}$, and $\tilde{K} = \{l : l \geq 1, [a'_l, c'_l] \subset [a'_i, c'_i] \text{ and } [a'_j, c'_j] \subset [b'_l, c'_l]\}$. For $y \in (h_i, h_j) \cap \mathbb{Q}$, consider $x = \sup\{t \in [a_i, a_j] : g(t) = y\}$. Then by definition $g(x) = y$ and $g(t) > y$ for $t > x$. Consider a sequence of leaves $x_n \nearrow x$ and the minimum b_{k_n} of g between x_n and a_i . Then necessarily $k_n \in K$ and $x_n < b_{k_n} < x$. So $h_{k_n} \rightarrow y$.

Now with probability one a subsequence $(k'_n)_n$ of $(k_n)_n$ can be found with $s_{k'_n} = \oplus$ for every n . Then Lemma 4.3.5 implies that $k'_n \in \tilde{K}$, and $h_{k'_n} \rightarrow y$. By countable union over y we have shown that $\{h_l, l \in \tilde{K}\}$ contains $(h_i, h_j) \cap \mathbb{Q}$. So it contains $[h_i, h_j]$ from which the proposition follows. \square

An immediate consequence of property (A) is the following improvement on Lemma 4.3.5, with strict inclusions.

Lemma 4.3.8. *Suppose (g, s) verifies (A). Let $i \neq j$.*

If $[a_j, c_j] \subset (a_i, b_i)$, then either $s_i = \oplus$ and $[a'_j, c'_j] \subset (a'_i, b'_i)$, or $s_i = \ominus$ and $[a'_j, c'_j] \subset (b'_i, c'_i)$.

If $[a_j, c_j] \subset (b_i, c_i)$, then either $s_i = \oplus$ and $[a'_j, c'_j] \subset (b'_i, c'_i)$, or $s_i = \ominus$ and $[a'_j, c'_j] \subset (a'_i, b'_i)$.

If $[a_i, c_i] \cap [a_j, c_j] = \emptyset$, then $[a'_i, c'_i] \cap [a'_j, c'_j] = \emptyset$.

4.4. The support of the permuton

Theorem 4.1.5 follows readily from the two propositions of this section.

Proposition 4.4.1. *For every signed excursion (g, s) , $\mu_{g,s}$ has Hausdorff dimension 1 and its 1-dimensional Hausdorff measure is $\leq \sqrt{2}$.*

PROOF. Let π_1, π_2 denote the two coordinate projections of the unit square. For $U \subset [0, 1]^2$, we write $\text{width}(U) = \sup \pi_1(U) - \inf \pi_1(U)$ and $\text{height}(U) = \sup \pi_2(U) - \inf \pi_2(U)$.

We start by showing that $\dim_H(\text{supp}(\mu)) \geq 1$. If π_1 is the projection of the unit square to its first coordinate, then $\pi_1(\text{supp}(\mu)) = [0, 1]$, otherwise μ couldn't have a uniform marginal. We conclude with the following lemma, which is immediate from the definition of Hausdorff dimension:

Lemma 4.4.2. *If $\theta : (E, d_E) \rightarrow (F, d_F)$ is a contraction, then for $X \subset E$, $\dim_H(X) > \dim_H(\theta(X))$*

To prove the upper bound, we apply Lemma 4.3.3 for some choice of $\epsilon > \delta > 0$. Let I be the set of indices provided by the lemma. Let $J = \{k : \exists i, j \in I, [a_i, c_i] \subset (a_k, b_k), [a_j, c_j] \subset (b_k, c_k)\}$. Let $K = I \sqcup J$. We have the following fact, which is a direct consequence of the nested structure of the $[a_i, c_i]$.

Fact 4.4.3. For every $i \in J$, there exists an $i_l \in K$ such that for every $j \in K$, $[a_j, c_j] \subset [a_i, b_i]$ implies $[a_j, c_j] \subset [a_{i_l}, c_{i_l}] \subset [a_i, b_i]$. Similarly for every $i \in J$, there exists an $i_r \in K$ such that for every $j \in K$, $[a_j, c_j] \subset [b_i, c_i]$ implies $[a_j, c_j] \subset [a_{i_r}, c_{i_r}] \subset [b_i, c_i]$. Also there exists $\star \in J$ such that for every $k \in K$, $[a_k, c_k] \subset [a_\star, c_\star]$.

We can define the following subsets of the unit square, which we use to cover $\text{supp}(\mu_{g,s})$:

$$\begin{aligned} A_i &= ([a_i, a_{i_l}] \cup [c_{i_l}, b_i]) \times ([a'_i, a'_{i_l}] \cup [c'_{i_l}, b'_i]) \\ &\quad \cup ([b_i, a_{i_r}] \cup [c_{i_r}, c_i]) \times ([b'_i, a'_{i_r}] \cup [c'_{i_r}, c'_i]) && \text{if } i \in J \text{ and } s_i = \oplus \\ A_i &= ([a_i, a_{i_l}] \cup [c_{i_l}, b_i]) \times ([b'_i, a'_{i_l}] \cup [c'_{i_l}, c'_i]) \\ &\quad \cup ([b_i, a_{i_r}] \cup [c_{i_r}, c_i]) \times ([a'_i, a'_{i_r}] \cup [c'_{i_r}, b'_i]) && \text{if } i \in J \text{ and } s_i = \ominus \\ A_i &= [a_i, c_i] \times [a'_i, c'_i] && \text{if } i \in I \\ A_0 &= ([0, a_\star] \cup [c_\star, 1]) \times ([0, a'_\star] \cup [c'_\star, 1]) \end{aligned}$$

By construction and Fact 4.4.3, $\bigcup_{i \in K \cup \{0\}} \pi_1(A_i) = [0, 1]$, and Lemma 4.3.4 implies that for $x \in \pi_1(A_i)$, $(x, \varphi_{g,s}(x)) \in A_i$. This one has:

$$(4.7) \quad (\text{Id}, \varphi_{g,s})[0, 1] \subset \bigcup_{i \in K \cup \{0\}} A_i.$$

The rest of the proof is devoted to rewriting the right-hand side of (4.7) as an union of

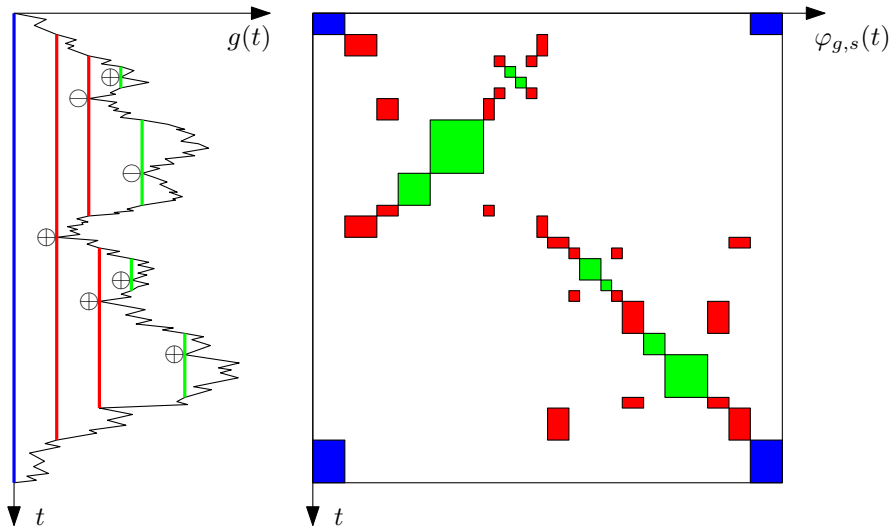

FIGURE 4.6. A_0 in blue, A_i for $i \in I$ in green, and A_i for $i \in J$ in red.

sets in which we control the sum of diameters. Now, for $i \in I$, $\text{diam}(A_i) = \text{diam}([a_i, c_i] \times$

$[a'_i, c'_i]) = \sqrt{2}(c_i - a_i)$. We deduce that

$$(4.8) \quad \sum_{i \in I} \text{diam}(A_i) \leq \sqrt{2}.$$

For $i \in J$, A_i is the union of 8 rectangles A_i^1, \dots, A_i^8 . We have that

$$\begin{aligned} \sum_{j=1}^8 \text{width}(A_i^j) &= 2[(c_i - a_i) - (c_{i_l} - a_{i_l}) - (c_{i_r} - a_{i_r})] \\ \sum_{j=1}^8 \text{height}(A_i^j) &= 2[(c'_i - a'_i) - (c'_{i_l} - a'_{i_l}) - (c'_{i_r} - a'_{i_r})]. \end{aligned}$$

And both these quantities are equal and their value is $2 \text{Leb}(\pi_1(A_i))$. Similarly, A_0 is the union of 4 rectangles A_0^1, \dots, A_0^4 whose widths and heights both sum to $2 \text{Leb}(\pi_1(A_0))$. Hence

$$\begin{aligned} \sum_{j=1}^4 \text{diam}(A_0^j) + \sum_{i \in J} \sum_{j=1}^8 \text{diam}(A_i^j) &\leq \sum_{j=1}^4 (\text{width} + \text{height})(A_0^j) + \sum_{i \in J} \sum_{j=1}^8 (\text{width} + \text{height})(A_i^j) \\ &= 4 \text{Leb}(\pi_1(A_0)) + 4 \sum_{i \in J} \text{Leb}(\pi_1(A_i)) \\ (4.9) \quad &= 4 \text{Leb}([0, 1] \setminus \bigcup_{i \in I} [a_i, c_i]) \leq 4\delta \end{aligned}$$

By taking the closure and rewriting the right-hand side in Equation (4.7), we get

$$(4.10) \quad \text{supp}(\mu_{g,s}) \subset \overline{(\text{Id}, \varphi_{g,s})[0, 1]} \subset \left(\bigcup_{i \in I} A_i \right) \cup \left(\bigcup_{j=0}^4 A_0^j \right) \cup \left(\bigcup_{i \in J} \bigcup_{j=1}^8 A_i^j \right)$$

Summing (4.8) and (4.9) shows that the sum of diameters in the cover (4.10) can't exceed $4\delta + \sqrt{2}$. Moreover, each square and rectangle in the cover has diameter bounded by $\sqrt{2}\epsilon$. This implies that $\text{supp}(\mu)$ has 1-dimensional Hausdorff measure bounded above by $\sqrt{2}$. \square

Proposition 4.4.4. *If S is an i.i.d sequence of nondeterministic signs, then $\text{supp}(\mu_{g,S})$ is almost surely totally disconnected.*

PROOF. We re-use the notations of the last proof, with $\epsilon > \delta > 0$. We now show that almost surely, we can build sets $\bar{I} \supset I$ and $\bar{J} \supset J$ such that

- i) the statement of Fact 4.4.3 is still true when J is replaced by \bar{J} and K by $\bar{K} = \bar{I} \sqcup \bar{J}$,
- ii) for all $i \in \bar{I}$, $c_i - a_i \leq \epsilon$,
- iii) $\text{Leb}([0, 1] \setminus \bigsqcup_{i \in \bar{I}} [a_i, c_i]) < \delta$,

with the following added constraint:

$$(4.11) \quad \forall i \in J, \quad s(b_{i_r}) = s(b_{i_l}) \neq s(b_i).$$

This is done by adding successively indices to I in order to create new branching points in between two branching points of the same sign. Consider $i \in J$ and its left child i_l , with $s_i = s_{i_l} = \epsilon$. We can build, as in the proof of Lemma 4.3.3, an infinite sequence $(b_{r_n})_n$ such that $[a_{r_n}, c_{r_n}] \subset [a_i, b_i]$ and $[b_{r_k}, c_{r_k}] \supset [a_{i_l}, c_{i_l}]$. Almost surely, one of the r_n , which we denote $j = j(i, i_l)$, is such that $s_j \neq \epsilon$. We can then find, by the same reasoning, a $k = k(j(i, i_l))$ such that $[a_k, c_k] \subset [a_j, c_j]$ and $s_k = \epsilon$. We proceed similarly for every $i \in J$ such that $s_i = s_{i_r}$. We can now set

$$\begin{aligned} \bar{I} &= I \cup \{k(i, i_l) : i \in J, s_i \neq s_{i_l}\} \cup \{k(i, i_r) : i \in J, s_i \neq s_{i_r}\} \\ \bar{J} &= J \cup \{j(i, i_l) : i \in J, s_i \neq s_{i_l}\} \cup \{j(i, i_r) : i \in J, s_i \neq s_{i_r}\}. \end{aligned}$$

By construction, Fact 4.4.3 applies to \bar{I} and \bar{J} , and (4.11) is verified.

Now we can define the sets $(A_i)_{i \in \bar{K} \cup \{0\}}$ as in the previous proof, and we still have

$$\text{supp } \mu_{e,S} \subset C = \bigcup_{i \in \bar{K} \cup \{0\}} A_i.$$

We will show that the diameter of any connected component of C is almost surely bounded by $4\epsilon + 2\delta$. This is enough to show that $\text{supp}(\mu_{g,S})$ is totally disconnected.

For $x \in C$, let us denote by $\mathcal{C}(x)$ the connected component of C containing x , and for $X \subset C$, set $\mathcal{C}(X) = \cup_{x \in X} \mathcal{C}(x)$. We now set, for $i \in \bar{I}$, $B_i = \mathcal{C}(A_i)$, for $i \in \bar{J}$ $B_i = \mathcal{C}(A_i) \setminus \mathcal{C}(A_{i_l}) \setminus \mathcal{C}(A_{i_r})$, and $B_0 = \mathcal{C}(A_0) \setminus \mathcal{C}(A_*)$. Then, immediate induction yields

$$C = \bigsqcup_{i \in \bar{K} \cup \{0\}} B_i.$$

Now remark that the sets B_i were obtained by inclusion and exclusion of full connected components of C . Hence each connected component of C appears as a connected component of one of the B_i , that we now consider.

It turns out (see Figure 4.7) that for $i \in \bar{I}$, B_i has only one connected component, and its diameter is bounded above by $4\epsilon + 2\delta$. For $i \in \bar{J}$, B_i has three connected components, whose diameter is bounded above by 2δ . For $i = 0$, B_0 has two connected components, and their diameter is also bounded above by 2δ . \square

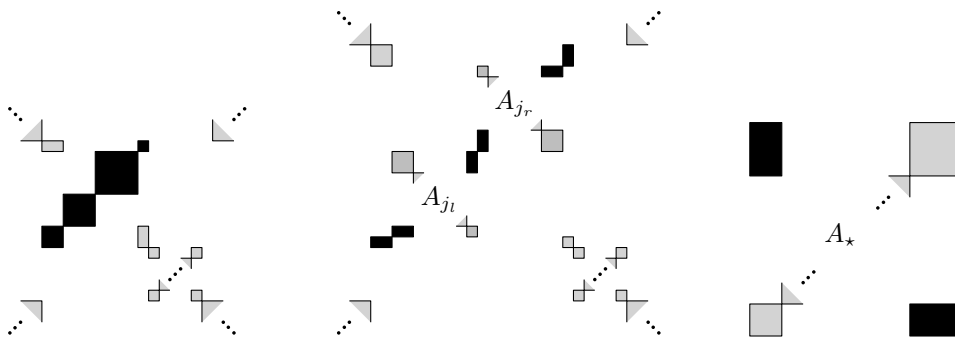

FIGURE 4.7. Left: B_i for $i \in I$, in the case $s_i = \oplus$, $i = j_l$ for some j . Center: B_j for $j \in J$, in the case $s_j = \oplus$, $j = j'_l$ for some j' . Right: B_0 , in the case $s_* = \oplus$.

4.5. Self-similarity

Given a CRT excursion g and one of its branching points b , one can build three subexcursions by cut-and-pasting, which encode the three connected components of $\mathcal{T}_g \setminus \{p_g(b)\}$. The goal of this section is to do the same procedure on signed excursions, and observe the consequences on the associated permutons. This will allow us to prove Theorem 4.1.6 in a "reversed" fashion: we start from μ , build μ_1 , μ_2 and μ_3 by cutting along a suitably chosen branching point, as to be able to use a result of Aldous [Ald94a] and identify the distribution and relative sizes of the subexcursions.

Let (g, s) be a signed excursion. Given $\bar{i} \in \mathbb{N}$, we can obtain 3 excursions by looking at the values of g on $[a_{\bar{i}}, b_{\bar{i}}]$, $[b_{\bar{i}}, c_{\bar{i}}]$ and $[0, a_{\bar{i}}] \sqcup [c_{\bar{i}}, 1]$. More precisely, following [Ald94a], we define

$$(4.12) \quad \Delta_0 = 1 - c_{\bar{i}} + a_{\bar{i}}, \Delta_1 = b_{\bar{i}} - a_{\bar{i}}, \Delta_2 = c_{\bar{i}} - b_{\bar{i}}, X_0 = \frac{a_{\bar{i}}}{\Delta_0}, Y_0 = \frac{a'_{\bar{i}}}{\Delta_0}, \beta = s_{\bar{i}}.$$

Given these constants, we can define the contractions $\theta_k, \eta_k, \zeta_k$ for $k \in \{0, 1, 2\}$, as in (4.2), and

$$(4.13) \quad g_k = \frac{1}{\sqrt{\Delta_k}} g \circ \eta_k, \quad k \in \{0, 1, 2\}.$$

Because each η_k is a piecewise affine function, it pulls back the strict local minima of g that are in the interior of $\text{Im}(\eta_k)$ onto strict local minima of g_k . This is made explicit in the following result:

Proposition 4.5.1. *For $k \in \{0, 1, 2\}$, there is an injective map $\vartheta_k : \mathbb{N} \rightarrow \mathbb{N}$, such that*

$$\forall i \in \mathbb{N}, \quad \eta_k(b_i(g_k)) = b_{\vartheta_k(i)}(g).$$

Moreover, the $\vartheta_k(\mathbb{N})$, for $k \in \{0, 1, 2\}$, form a partition of $\mathbb{N} \setminus \{\bar{i}\}$. Finally, for $k \in \{0, 1, 2\}$, the map $(g, \bar{i}, i) \mapsto \vartheta_k(i)$ is measurable.

PROOF. We set $\vartheta_k(i) = \min\{j \in \mathbb{N} : \eta_k(b_i(g_k)) = b_j(g)\}$, and the measurability claim follows from measurability of $(i, g) \mapsto b_i(g)$, $(\bar{i}, g) \mapsto \eta_k$ and $(\bar{i}, g) \mapsto g_k$. The other claims are immediate by construction and from the definition of a measurable enumeration. \square

We can now transport the signs of g onto signs of the g_k by setting $s_i^k = s_{\vartheta_k(i)}$ for $k \in \{0, 1, 2\}$ and $i \in \mathbb{N}$. A result of this construction is the following crucial observations:

Observation 4.5.2. For $x < y \in [0, 1]$, and $k \in \{0, 1, 2\}$, $x \triangleleft_{g_k}^s y$ if and only if $\eta_k(x) \triangleleft_g^s \eta_k(y)$.

Observation 4.5.3. The map $(g, \bar{i}, (s_i)_{i \in \mathbb{N}}) \mapsto s_i^k$ is measurable for every $i \in \mathbb{N}$ and $k \in \{0, 1, 2\}$

Now we want to use Lemma 4.3.4 to show that our function $\varphi_{g,s}$ can be cut out into rescaled copies of φ_{g_k, s^k} , which translates immediately in terms of measures.

Proposition 4.5.4. *For $\bar{i} \in \mathbb{N}$, $k \in \{0, 1, 2\}$ and $t \in [0, 1]$,*

$$(4.14) \quad \varphi_{g,s} \circ \eta_k(t) = \zeta_k \circ \varphi_{g_k, s^k}(t).$$

As a consequence,

$$\mu_{g,s} = \sum_{k=0}^2 \Delta_k \cdot (\theta_k * \mu_{g_k, s^k}).$$

PROOF. Let us prove (4.14) for $k = 0$.

$$\begin{aligned} \varphi_{g,s}(\eta_0(t)) &= \text{Leb}\{x \in [0, a_{\bar{i}}] \cup (c_{\bar{i}}, 1] : x \triangleleft_g^s \eta_0(t)\} + \mathbb{1}[a_{\bar{i}} \triangleleft_g^s t](c_{\bar{i}} - a_{\bar{i}}) \\ &= \text{Leb}\{x \in [0, a_{\bar{i}}] \cup (c_{\bar{i}}, 1] : x \triangleleft_g^s \eta_0(t)\} \\ &\quad + (c_{\bar{i}} - a_{\bar{i}}) \mathbb{1}[\text{Leb}\{x \in [0, a_{\bar{i}}] \cup (c_{\bar{i}}, 1] : x \triangleleft_g^s \eta_0(t)\} > a_{\bar{i}}'] \\ &= \Delta_0 \text{Leb}\{y \in [0, 1] : y \triangleleft_{e_0}^{s^0} t\} + (1 - \Delta_0) \mathbb{1}[\Delta_0 \text{Leb}\{y \in [0, 1] : y \triangleleft_{e_0}^{s^0} t\} > \Delta_0 Y_0] \\ &= \zeta_0(\varphi_{e_0, s^0}(t)) \end{aligned}$$

Where the first two equalities come from Lemma 4.3.4 and the third is the result of the change of variable $x = \eta_0(y)$. Now, for $k = 1$,

$$\begin{aligned} \varphi_{g,s}(\eta_1(t)) &= a_{\bar{i}}' + (b_{\bar{i}}' - a_{\bar{i}}') \mathbb{1}[s_{\bar{i}} = \ominus] + \text{Leb}\{x \in [a_{\bar{i}}, b_{\bar{i}}] : x \triangleleft_g^s \eta_1(t)\} \\ &= \Delta_0 Y_0 + \Delta_2 \beta + (b_{\bar{i}} - a_{\bar{i}}) \text{Leb}\{y \in [0, 1] : y \triangleleft_{g_1}^{s^1} t\} \\ &= \zeta_1(\varphi_{g_1, s^1}(t)) \end{aligned}$$

where the first equality comes from Lemma 4.3.4 and the second is the result of the change of variable $x = \eta_1(y)$. The case $k = 2$ is similar. \square

This is all we need to show Theorem 4.1.6.

PROOF OF THEOREM 4.1.6. If e is an Brownian excursion, and $X_l < X_r$ are reordered uniform independent random variables in $[0, 1]$, independent of e , then almost surely there is a \bar{i} such that $b_{\bar{i}} = \text{argmin}_{[X_l, X_r]} e$. Define $\Delta_0, \Delta_1, \Delta_2, X_0, Y_0, \beta$ as in (4.12). This allows us to define the θ_k as in (4.2) and the e_k, s^k as before.

A result of Aldous [Ald94a, cor. 5] states that e_0, e_1, e_2 are Brownian excursions, $(\Delta_0, \Delta_1, \Delta_2)$ is a Dirichlet $(\frac{1}{2}, \frac{1}{2}, \frac{1}{2})$ partition of 1, and X_0 is uniform in $[0, 1]$, all these random variables being independent.

Now, as a consequence of Observation 4.5.3, for $k \in \{0, 1\}$ and $i \in \mathbb{N}$, S_i^k is a random variable. Given e and \bar{i} , the S^k for $k \in \{0, 1\}$ and β are permutations of disjoint subsequences of S . As a result, the S^k and β are independent (and independent of (e, X_l, X_r)), and distributed as i.i.d. sequences of signs of bias p .

We finally set $\mu_k = \mu_{e_k, S^k}$ for $k \in \{0, 1, 2\}$ and need only prove

$$(4.15) \quad Y_0 = \varphi_{e_0, S^0}(X_0) \text{ a.s.}$$

to show that the collection of random variables $((\Delta_k)_{k \in \{0, 1, 2\}}, (\mu_k)_{k \in \{0, 1, 2\}}, (X_0, Y_0), \beta)$ has the joint distribution assumed in Theorem 4.1.6. Proposition 4.5.4 then yields the theorem.

Let us now prove (4.15).

$$\begin{aligned} \Delta_0 Y_0 = a'_i &= \text{Leb}\{x \in [0, a_i] \cup (c_i, 1) : x \leq_e^S a_i\} = \Delta_0 \text{Leb}\{y \in [0, 1] : y \leq_{e_0}^{S_0} \eta_0^{-1}(a_i)\} \\ &= \Delta_0 \text{Leb}\{y \in [0, 1] : y \leq_{e_0}^{S_0} X_0\} \\ &= \Delta_0 \varphi_{e_0, S^0}(X_0). \quad \square \end{aligned}$$

Remark 4.5.5. As seen in the proof, Theorem 4.1.6 is a direct consequence of the self-similarity property of the Brownian CRT [Ald94a, thm. 2]. It was shown [AG15] that this property actually characterizes the Brownian CRT in the space of measured \mathbb{R} -trees. We believe that the arguments of Albenque and Goldschmidt can be transposed in our setting, to show that the law of μ^p is the only distribution on permutons which verifies (4.3). The main reason backing that claim is the following: permutons are characterized by their finite-dimensional marginals, just like measured \mathbb{R} -trees are determined by their reduced trees (see section 3 in [AG15]).

4.6. Expectation of the permuton

In this section we shall compute the density function of the averaged permuton $\mathbb{E} \mu^p$ for $p \in (0, 1)$, proving Theorem 4.1.7.

We know that $\mu^p = \mu_{e, S}$, where e is a normalized Brownian excursion and S is an independent sequence of i.i.d. signs with bias p . Since for fixed (g, s) , the measure $\mu_{g, s}$ is the distribution of the random pair $(U, \varphi_{g, s}(U))$ with U uniform in $[0, 1]$, then by Fubini's theorem, we get the following:

Lemma 4.6.1. *$\mathbb{E} \mu^p$ is the distribution of the random pair $(U, \varphi_{e, S}(U))$, where e is a normalized Brownian excursion, S is an independent sequence of i.i.d. signs with bias p , and U is uniform, those three random variables being independent.*

Let $(B_t)_{0 \leq t \leq 1}$ be a normalized Brownian bridge between 0 and 0. Define its local time at 0 as follows: for $t \in [0, 1]$, set $L_t = \lim_{\varepsilon \rightarrow 0} \frac{1}{2\varepsilon} \int_0^t \mathbb{1}_{0 \leq |B_s| \leq \varepsilon} ds$ in probability. Define also its right-continuous inverse $(T_l)_{l \geq 0}$. We set $\Delta T_l = T_l - T_{l-}$ for $l \geq 0$. We suppose that each $l \geq 0$ such that $\Delta T_l > 0$ is equipped with an independent sign ϵ_l with bias p . We will use a result of Bertoin and Pitman [BP94] to rewrite the measure $\mathbb{E} \mu^p$ as the distribution of some functional of B .

Lemma 4.6.2. *The measure $\mathbb{E} \mu^p$ is the distribution of $\left(\frac{P_1 + P_2}{P_1 + P_2 + P_3 + P_4}, \frac{P_1 + P_4}{P_1 + P_2 + P_3 + P_4} \right)$, where*

$$(4.16) \quad \begin{aligned} P_1 &= \sum_{l < L_1/2, \epsilon_l = \oplus} \Delta T_l, & P_2 &= \sum_{l < L_1/2, \epsilon_l = \ominus} \Delta T_l \\ P_3 &= \sum_{l > L_1/2, \epsilon_l = \oplus} \Delta T_l, & P_4 &= \sum_{l > L_1/2, \epsilon_l = \ominus} \Delta T_l \end{aligned}$$

PROOF. We will build a suitable coupling of (e, S, U) on one hand, and (B, ϵ) on the other hand. Start with the bridge B , and set $U = T_{L_1/2}$. Define $(K_t)_{0 \leq t \leq 1}$ as follows: $K_t = L_t$ for $0 \leq t \leq U$ and $K_t = L_1 - L_t$ when $U \leq t \leq 1$. Theorem 3.2 of [BP94] tells us that if we set $e = K + |B|$, then (e, U) is distributed as a Brownian excursion with an

independent uniform variable in $[0, 1]$. Moreover, the following holds almost surely: for $0 \leq t \leq U$, $K_t = \inf_{t \leq s \leq U} e_s$ and for $U \leq t \leq 1$, $K_t = \inf_{U \leq s \leq t} e_s$. Finally let S be a sequence of i.i.d. signs with bias p , independent of (B, e, U) . The triple (e, S, U) has the desired distribution. We can transfer some of the signs of S to form the marking process $(\epsilon_l)_{l \geq 0, \Delta_l > 0}$. First remark that almost surely, U is not a one-sided local minimum of e . For $l \geq 0$ such that $\Delta T_l > 0$,

- either $l < L_1/2$ and then $T_{l-} < T_l < U$, in which case T_l is an inner local minimum b_{ι_l} of e for some $\iota_l \in \mathbb{N}$. We then set $\epsilon_l = S_{\iota_l}$.
- either $l > L_1/2$ and then $T_{l-} < T_l < U$, in which case T_{l-} is an inner local minimum b_{ι_l} of e for some $\iota_l \in \mathbb{N}$. We then set $\epsilon_l = S_{\iota_l}$.

The sequence $(\iota_l)_{l: \Delta T_l > 0}$ is a random injection into \mathbb{N} that solely depends on B . So conditional on B , the signs in $(\epsilon_l)_{l: \Delta T_l > 0}$ are i.i.d. and of bias p . Then (B, ϵ) has the desired distribution.

We now show that in this coupling we have the almost sure equality $(U, \varphi_{e,S}(U)) = \left(\frac{P_1+P_2}{P_1+P_2+P_3+P_4}, \frac{P_1+P_4}{P_1+P_2+P_3+P_4} \right)$. Then Lemma 4.6.1 implies the present lemma. If we define

$$\begin{aligned} \hat{P}_1 &= \text{Leb}\{t : 0 \leq t \leq U, t \triangleleft_e^S U\}, & \hat{P}_2 &= \text{Leb}\{t : 0 \leq t \leq U, t \triangleright_e^S U\}, \\ \hat{P}_3 &= \text{Leb}\{t : U \leq t \leq 1, t \triangleright_e^S U\}, & \hat{P}_4 &= \text{Leb}\{t : U \leq t \leq 1, t \triangleleft_e^S U\}, \end{aligned}$$

then it is immediate that almost surely, $\hat{P}_1 + \hat{P}_2 + \hat{P}_3 + \hat{P}_4 = 1$, $\hat{P}_1 + \hat{P}_2 = U$ and $\hat{P}_1 + \hat{P}_4 = \varphi_{e,S}(U)$. Now we need only show that the $P_i = \hat{P}_i$ for $1 \leq i \leq 4$. For instance for $i = 1$, we need to observe that $t \in [0, 1]$ is such that $t < U$ and $t \triangleleft_e^S U$ if and only if there is a $b_i \in (t, U)$ such that b_i is the unique minimum of e on $[t, U]$ and $S_i = \oplus$. Such b_i is necessarily equal to T_l for some $l < L_1/2$ such that $T_{l-} < t < T_l$, and then $S_i = \epsilon_l$. We have shown the following logical equivalence for $t \in [0, 1]$:

$$t \leq U \text{ and } t \triangleleft_e^S U \iff \exists l < L_1/2 \text{ s.t. } T_{l-} < t < T_l \text{ and } \epsilon_l = \oplus.$$

Taking the Lebesgue measure on both sides yields $\hat{P}_1 = P_1$. For $i = 2, 3, 4$, the proof is symmetric. \square

Let \mathcal{U} be the set of continuous excursions of variable length, with $R : \mathcal{U} \rightarrow \mathbb{R}^+$ denoting the length statistic. Let N be the Itô excursion measure of Brownian motion. For $\theta \geq 0$, define the measure $\Lambda^\theta(dr) = e^{-\theta r} N(R \in dr)$. Denote by $(X_l^\theta)_{l \geq 0}$ the process of sums up to time l of a Poisson point process of intensity $dt \Lambda^\theta$. This is a well-defined process because $\int \Lambda^\theta(dr)(r \wedge 1)$ is finite. We can state the following rewriting of the distribution $\mathbb{E} \mu^p$.

Lemma 4.6.3. *For any $\theta > 0$, $\mathbb{E} \mu^p$ is the distribution of $\left(\frac{P_1+P_2}{P_1+P_2+P_3+P_4}, \frac{P_1+P_4}{P_1+P_2+P_3+P_4} \right)$, where conditional on a random variable λ_Y with exponential distribution of parameter $\sqrt{2\theta}$, we define the variables $\mathcal{P}_1, \mathcal{P}_2, \mathcal{P}_3$ and \mathcal{P}_4 to be independent with $\mathcal{P}_1 \stackrel{d}{=} \mathcal{P}_3 \stackrel{d}{=} X_{p\lambda_Y/2}^\theta$ and $\mathcal{P}_2 \stackrel{d}{=} \mathcal{P}_4 \stackrel{d}{=} X_{(1-p)\lambda_Y/2}^\theta$.*

PROOF. Let us reuse the notations of Lemma 4.6.2. We make use of the results of Perman and Wellner [PW14], which show that the most tractable object in terms of its excursions is not the normalized Brownian bridge, but the random-length bridge $(\beta_t)_{t \geq 0}$ defined as follows: $\beta_t = \mathbf{1}_{0 \leq t \leq Y} \sqrt{Y} B_{t/Y}$ where Y is a random variable of distribution $\Gamma(1/2, \theta)$ independent of B . Its local time λ , inverse local time τ and jump process $\Delta\tau$ are related to those of B by $\lambda_t = \sqrt{Y} L_{t/Y}$, $\tau_l = Y T_{l/\sqrt{Y}}$ and $\Delta\tau_l = Y \Delta T_{l/\sqrt{Y}}$. The marking process ϵ can be modified accordingly by setting $\epsilon_l = \epsilon_{l/\sqrt{Y}}$ for $l \geq 0$ such that $\Delta\tau_l > 0$.

Now if we set

$$\begin{aligned} \mathcal{P}_1 &= \sum_{l < \lambda_1/2, \epsilon_l = \oplus} \Delta\tau_l, & \mathcal{P}_2 &= \sum_{l < \lambda_1/2, \epsilon_l = \ominus} \Delta\tau_l \\ \mathcal{P}_3 &= \sum_{l > \lambda_1/2, \epsilon_l = \oplus} \Delta\tau_l, & \mathcal{P}_4 &= \sum_{l > \lambda_1/2, \epsilon_l = \ominus} \Delta\tau_l \end{aligned}$$

then by construction, $\left(\frac{P_1+P_2}{P_1+P_2+P_3+P_4}, \frac{P_1+P_4}{P_1+P_2+P_3+P_4}\right) = \left(\frac{P_1+P_2}{P_1+P_2+P_3+P_4}, \frac{P_1+P_4}{P_1+P_2+P_3+P_4}\right)$.

We now have to identify the joint distribution of the \mathcal{P}_i . It results from [PW14, thm 1 and 4] that λ_Y is distributed as an exponential random variable of parameter $\sqrt{2\theta}$, and that, conditional on λ_Y , the excursions of β away from 0, parametrized by the local time, form a Poisson point process of intensity $dle^{-\theta R(w)}N(dw)$ over $[0, \lambda_Y] \times \mathcal{U}$. The random set $\{(l, \Delta\tau_l), l \geq 0, \Delta_l > 0\}$, which is just the point process of excursion lengths, is then also Poisson with intensity $d\Lambda^\theta(dt)$ over $[0, \lambda_Y] \times \mathbb{R}_+$. This results from the mapping property of Poisson processes. Now, since the marking process $(\varepsilon_l)_{l \geq 0}$ is a choice of i.i.d. marks, chosen independent of B , the marking property of point processes [Kin93, sect. 2.3] tells us that $\{(l, \Delta\tau_l, \varepsilon_l), l \geq 0, \Delta_l > 0\}$ is itself a Poisson process of intensity $d\Lambda^\theta(dt)(p\delta_\oplus + (1-p)\delta_\ominus)(d\varepsilon)$ over $[0, \lambda_Y] \times \mathbb{R}_+ \times \{\oplus, \ominus\}$.

Since they are functionals of the same Poisson process restricted to disjoint subsets, the processes $\{\Delta\tau_l, 0 \leq l \leq \lambda_Y/2, \Delta_l > 0, \varepsilon_l = \oplus\}$, $\{\Delta\tau_l, 0 \leq l \leq \lambda_Y/2, \Delta_l > 0, \varepsilon_l = \ominus\}$, $\{\Delta\tau_l, \lambda_Y/2 \leq l \leq \lambda_Y, \Delta_l > 0, \varepsilon_l = \oplus\}$ and $\{\Delta\tau_l, \lambda_Y/2 \leq l \leq \lambda_Y, \Delta_l > 0, \varepsilon_l = \ominus\}$, are independent. Moreover, by the mapping property, they are themselves Poisson, with respective intensity measures $\frac{p\lambda_Y}{2}\Lambda_\theta(dr)$, $\frac{(1-p)\lambda_Y}{2}\Lambda_\theta(dr)$, $\frac{p\lambda_Y}{2}\Lambda_\theta(dr)$ and $\frac{(1-p)\lambda_Y}{2}\Lambda_\theta(dr)$. The lemma follows. \square

PROOF OF THEOREM 4.1.7. By a classical argument using Girsanov's theorem³, X_l^θ is distributed as the hitting time of level l by a Brownian motion with positive drift θ , hence its density is $\frac{d}{dt}\mathbb{P}(X_l^\theta \in dt) = y_l^\theta(t) = \mathbf{1}_{t \geq 0} \frac{e^{-\theta t} l e^{-l^2/(2t)}}{e^{-\sqrt{2\theta}t} \sqrt{2\pi t^3}}$ (see [BS02, ch. II.1, eq. 2.0.2]).

Then, going back to the notations of Lemma 4.6.3, the joint density of $(\mathcal{P}_1, \mathcal{P}_2, \mathcal{P}_3, \mathcal{P}_4)$ at $(t_1, t_2, t_3, t_4) \in (\mathbb{R}_+)^4$ equals

$$\begin{aligned} & \int_0^\infty d\lambda \sqrt{2\theta} e^{-\sqrt{2\theta}\lambda} y_{p\lambda/2}^\theta(dt_1) y_{(1-p)\lambda/2}^\theta(dt_2) y_{(1-p)\lambda/2}^\theta(dt_3) y_{p\lambda/2}^\theta(dt_4) \\ &= \frac{\sqrt{2\theta} p^2 (1-p)^2 e^{-\theta(t_1+t_2+t_3+t_4)}}{2^4 (\sqrt{2\pi})^4 (t_1 t_2 t_3 t_4)^{3/2}} \int_0^\infty \lambda^4 e^{-\lambda^2/2 \left(\frac{p^2}{4t_1} + \frac{(1-p)^2}{4t_2} + \frac{p^2}{4t_3} + \frac{(1-p)^2}{4t_4} \right)} d\lambda \\ &= \frac{\sqrt{2\theta} p^2 (1-p)^2 e^{-\theta(t_1+t_2+t_3+t_4)}}{2^4 (\sqrt{2\pi})^4 (t_1 t_2 t_3 t_4)^{3/2}} \frac{3\sqrt{2\pi}}{2 \left(\frac{p^2}{4t_1} + \frac{(1-p)^2}{4t_2} + \frac{p^2}{4t_3} + \frac{(1-p)^2}{4t_4} \right)^{5/2}}. \end{aligned}$$

Now we define the random variables $S = \mathcal{P}_1 + \mathcal{P}_2 + \mathcal{P}_3 + \mathcal{P}_4$, $Q = \mathcal{P}_1/S$, $U = (\mathcal{P}_1 + \mathcal{P}_2)/S$ and $V = (\mathcal{P}_1 + \mathcal{P}_4)/S$. According to Lemma 4.6.3, $\mathbb{E}\mu^p$ is the distribution of the pair (U, V) . It follows from the Lebesgue change of variables theorem that the joint density of (S, Q, U, V) at $(s, q, u, v) \in (\mathbb{R}_+ \times \mathbb{R}^+ \times [0, 1] \times [0, 1])$ is equal to

$$\frac{s^3 \mathbf{1}_{\max(0, u+v-1) \leq q \leq \min(u, v)} \frac{3\sqrt{2\theta} p^2 (1-p)^2}{2^5 (\sqrt{2\pi})^3} e^{-\theta s}}{(sq s(u-q) s(1-u-v+q) s(v-q))^{3/2} \left(\frac{p^2}{4sq} + \frac{(1-p)^2}{4s(u-q)} + \frac{p^2}{4s(1-u-v+q)} + \frac{(1-p)^2}{4s(v-q)} \right)^{5/2}},$$

which we rewrite as

$$\left(\frac{\sqrt{\theta} e^{-\theta s}}{\sqrt{\pi} \sqrt{s}} \right) \frac{\frac{3p^2(1-p)^2}{2\pi} \mathbf{1}_{\max(0, u+v-1) \leq q \leq \min(u, v)}}{(q(u-q)(1-u-v+q)(v-q))^{3/2} \left(\frac{p^2}{q} + \frac{(1-p)^2}{(u-q)} + \frac{p^2}{(1-u-v+q)} + \frac{(1-p)^2}{(v-q)} \right)^{5/2}}.$$

Now we get the joint distribution of (U, V) by integrating with respect to s and q , which immediately yields Theorem 4.1.7. \square

3. It also follows from Campbell's formula [Kin93, sect. 3.2] and [BS02, ch. II.1, eq. 2.0.1]

4.7. Shuffling of excursions and trees.

The goal of this section is to build, from a signed excursion (g, s) , a shuffled excursion $f_{g,s}$, that verifies the conclusions of Theorem 4.1.8 after setting $\tilde{e} = f_{e,S}$. This will not be possible for every choice of deterministic signed excursion, but we will show that it is possible for signed excursions with property (A), which is the case of (e, S) with probability 1.

We start from the following observation: for every CRT excursion g , if we define the a_i, b_i, c_i, h_i as before, then by density of the branching points it is easy to see that

$$g(t) = \sup_i h_i \mathbb{1}_{[a_i, c_i]}(t).$$

Hence, given a sequence of signs s , which provides us the numbers a'_i, b'_i, c'_i , it is natural to define a shuffled version as such:

$$f_{g,s}(t) = \sup_i h_i \mathbb{1}_{[a'_i, c'_i]}(t)$$

The map $(g, s, t) \mapsto f_{g,s}(t)$ is measurable because the $g(a_i)$, a'_i and c'_i are measurable functions of g and s .

From now on, we will drop the dependency in (g, s) in the proofs. So we set $f = f_{g,s}$ and $\varphi = \varphi_{g,s}$. The first step is to show that f is continuous whenever (g, s) verifies (A). We start with two lemmas. Let $\omega(g, \delta)$ stand for the modulus of continuity of g at radius δ .

Lemma 4.7.1. *For $a'_k \leq u \leq b'_k$, $h_k \leq f(u) \leq h_k + \omega(g, b'_k - a'_k)$.*

For $b'_k \leq u \leq c'_k$, $h_k \leq f(u) \leq h_k + \omega(g, c'_k - b'_k)$.

PROOF. The two claims are symmetric, thus only the first is proved. Recall that $f(u) = \sup_{[a'_i, c'_i] \ni u} h_i$ and suppose $u \in [a'_k, b'_k]$. For i such that $[a'_i, c'_i] \ni u$, either $h_i \leq h_k$, or $h_i > h_k$. In the latter case, $[a'_i, c'_i] \subset [a'_k, b'_k]$. Hence $|a_i - b_k| < |b'_k - a'_k|$, and $h_i - h_k = g(a_i) - g(a_k) \leq \omega(g, b_k - a_k) = \omega(g, b'_k - a'_k)$.

This shows that for every i such that $[a'_i, c'_i] \ni u$, $h_i < h_k + \omega(g, b'_k - a'_k)$. Taking the supremum gives the claim of the lemma. \square

Lemma 4.7.2. *The b'_i , for $i \in \mathbb{N}$, are dense in $[0, 1]$.*

PROOF. The leaves of g are of full Lebesgue measure. If x and y are leaves, there is a i such that $a_i < x < b_i < y < c_i$. As a result of Lemma 4.3.4, b'_i must lie between $\varphi(x)$ and $\varphi(y)$. Since φ is measure-preserving, the images of leaves of g by φ are of full measure, and hence dense in $[0, 1]$. So the b'_i are dense. \square

Proposition 4.7.3. *Under (A), the function f is continuous.*

PROOF. Let t be in $[0, 1]$ and $\delta > 0$. By Lemma 4.7.2, we can find $b'_i < t < b'_j$ with $(b'_j - b'_i) \leq \delta$. Let k be the most recent common ancestor of i and j , so that $b'_i < b'_k < b'_j$. We shall show that there is a continuous function \underline{f} such that for $u \in [b'_i, b'_j]$,

$$(4.17) \quad \underline{f}(u) \leq f(u) \leq \underline{f}(u) + \omega(g, \delta)$$

Which is enough, since δ was arbitrary, to show continuity in t . We build \underline{f} and show (4.17) on $[b'_k, b'_j]$ only. The interval $[b'_i, b'_k]$ can be treated with a symmetric proof.

Set $\underline{f} : [b'_k, b'_j] \rightarrow \mathbb{R}_+$, with

$$\underline{f} = \sup\{h_l \mathbb{1}_{[a'_l, c'_l]} \mid l : [a'_k, c'_k] \supset [a'_l, c'_l] \supset [a'_j, c'_j]\}.$$

Clearly, $\underline{f} \leq f$. It is also clear that \underline{f} is increasing from h_k to h_j , because the indicator functions are nested and h_l increases as a'_l decreases. Lemma 4.3.8 implies that the a'_l are all distinct, while property (A) implies that the h_l are dense in $[h_k, h_j]$. This implies continuity of \underline{f} .

Now we shall show (4.17) for u in $[b'_k, b'_j]$.

Case 1: for every l s.t. $u \in [a'_l, c'_l]$, we have $[a'_l, c'_l] \supset [a'_j, c'_j]$. Then $f(u) = \underline{f}(u)$.

Case 2: there exists l s.t. $x \in [a'_l, c'_l]$ and $[a'_l, c'_l] \not\supseteq [a'_j, c'_j]$. Then consider the most recent common ancestor m of l and j . Necessarily,

$$b'_k < a'_m < a'_l < u < c'_l < b'_m < a'_j < c'_j < c'_m.$$

Then Lemma 4.7.1 gives $h_m \leq g(u) \leq h_m + \omega(g, \delta)$. It is clear that $h_m = \underline{f}(u)$, proving (4.17). \square

Now that we have shown that f is continuous, it becomes possible to define the distance d_f on $[0, 1]$ and the structured real tree \mathcal{T}_f .

Proposition 4.7.4. *Under (A), we have $g = f \circ \varphi$, and furthermore, φ is a $([0, 1], d_g) \rightarrow ([0, 1], d_f)$ isometry.*

PROOF. Let $t \in [0, 1]$. To show $g(t) = f(\varphi(t))$ it is enough to see that

$$(4.18) \quad \{k : t \in [a_k, c_k]\} = \{k : \varphi(t) \in [a'_k, c'_k]\}.$$

because $e(t)$ and $f(\varphi(t))$ are just the respective suprema of $i \mapsto h_i$ over these two sets. If k is such that $t \in [a_k, c_k]$, then by Lemma 4.3.4, $\varphi(t) \in [a'_k, c'_k]$. If on the other hand k is such that $t \notin [a_k, c_k]$, by symmetry suppose $t < a_k$. It is then possible to find i such that $t < a_i < a_k < c_k \leq c_i$. Then Lemmas 4.3.4 and 4.3.8 imply that $\varphi(t) \notin [a'_k, c'_k]$.

Now to show that φ is a (d_g, d_f) isometry, we need only show that for $x < y$,

$$\min_{[x,y]} g = \min_{[\varphi(x), \varphi(y)]} f.$$

Case 1: $\min_{[x,y]} g = g(x)$. Then for every i , $x \in [a_i, c_i]$ implies $y \in [a_i, c_i]$. So $\varphi(x) \in [a'_i, c'_i]$ implies $\varphi(y) \in [a'_i, c'_i]$ and then $[\varphi(x), \varphi(y)] \subset [a'_i, c'_i]$. The definition of f then yields $f(t) \geq f(\varphi(x))$ for every $t \in [\varphi(x), \varphi(y)]$. Hence

$$\min_{[\varphi(x), \varphi(y)]} f = f(\varphi(x)) = g(x) = \min_{[x,y]} g.$$

Case 2: $\min_{[x,y]} g = g(y)$. This case is similar by symmetry.

Case 3: $\min_{[x,y]} g = b_i$ for some $b_i \in (x, y)$. Then we conclude immediately by applying case 2 on $[x, b_i]$ and case 1 on $[b_i, y]$. \square

Proposition 4.7.5. *The random continuous function $f_{e,S}$ has the distribution of a Brownian excursion with the same local times at 1 as e .*

PROOF. The claim on the local times is an immediate consequence of the fact that for every $y \geq 0$, $\text{Leb}\{t, f_{g,s}(t) \leq y\} = \text{Leb}\{t, f_{g,s}(\varphi_{g,s}(t)) \leq y\} = \text{Leb}\{t, g(t) \leq y\}$.

To show that the random continuous functions e and $f = f_{e,S}$ have the same distribution, we shall show that for every $k \geq 1$, if $U_{(1)} < \dots < U_{(k)}$ are reordered uniform variables in $[0, 1]$, independent of e, S , then

$$(4.19) \quad (e(U_{(1)}), \dots, e(U_{(k)})) \stackrel{d}{=} (f(U_{(1)}), \dots, f(U_{(k)})).$$

Deriving $e \stackrel{d}{=} f$ from there is classical, see for instance the end of the proof of the direct implication of [Ald93, thm. 20].

Let us consider $U_{(1)} < \dots < U_{(k)}$ the order statistics of k uniform random variables in $[0, 1]$, independent of e, S . Set $V_i = \varphi(U_{(i)})$ for every $1 \leq i \leq k$. Then there exists $\alpha \in \mathfrak{S}_k$ such that $W_1 = V_{\alpha(1)} < \dots < V_{\alpha(k)} = W_k$. Since φ preserves the Lebesgue measure, (W_1, \dots, W_k) has the distribution of the order statistic of k uniform variables.

We consider the *marked trees*, as per the definition of [Le 05, sect. 2.5], associated to a CRT excursion and a finite number of points. For any set $\mathbf{t} = (t_1 < \dots < t_k)$ of leaves of g , $\theta(g; \mathbf{t})$ is built from the tree $\tau(g; \mathbf{t})$ by adding edge-lengths compatible with the distances in the tree \mathcal{T}_g . Since the root of $\tau(g; \mathbf{t})$ has a positive height, a new root \emptyset is added below it. It is characterized (among plane trees with edge-lengths up to isomorphism) by the following fact:

$$(4.20) \quad d_{\theta(g; \mathbf{t})}(\ell_i, \ell_j) = d_g(t_i, t_j), \quad d_{\theta(g; \mathbf{t})}(\emptyset, \ell_i) = g(t_i),$$

where $d_{\theta(g;\mathbf{t})}$ denotes the graph distance, taking edge-lengths into account, and in any plane tree ℓ_1, \dots, ℓ_k is an enumeration of the leaves in the natural ordering.

Let $T = \theta(e; \mathbf{U})$, and let \tilde{T} be obtained from T by inverting the order of the children at each branching point corresponding to a b_i where the sign s_i is a \ominus . By definition there is an isomorphism of rooted trees with edge-lengths $\tilde{T} \leftrightarrow T$. This isomorphism necessarily permutes the leaves: set $\beta \in \mathfrak{S}_k$ such that $\ell_i(\tilde{T}) \leftrightarrow \ell_{\beta(i)}(T)$. Then by construction β is such that $\varphi_{e,S}(U_{\beta(1)}) < \dots < \varphi_{e,S}(U_{\beta(k)})$. We deduce $\beta = \alpha$, and hence

$$\begin{aligned} d_{\tilde{T}}(\ell_i, \ell_j) &= d_T(\ell_{\alpha(i)}, \ell_{\alpha(j)}) = d_e(U_{\alpha(i)}, U_{\alpha(j)}) = d_f(\varphi(U_{\alpha(i)}), \varphi(U_{\alpha(j)})) = d_{\theta(f;\mathbf{W})}(\ell_i, \ell_j) \\ d_{\tilde{T}}(\ell_i, \emptyset) &= d_T(\ell_{\alpha(i)}, \emptyset) = g(U_{\alpha(i)}) = g(W_i) = d_{\theta(f;\mathbf{W})}(\ell_i, \emptyset). \end{aligned}$$

So $\tilde{T} = \theta(f, \mathbf{W})$.

Finally we consider the distribution of \tilde{T} . Theorem 2.11 of [Le 05] tells us that the structure of T is that of a uniform planted binary tree with k leaves, and the edge-lengths are exchangeable. So an independent shuffling of T is still distributed like T , and this is the case of \tilde{T} . We deduce $\theta(e; \mathbf{U}) = T \stackrel{d}{=} \tilde{T} = \theta(f; \mathbf{W})$. From there, (4.20) implies that we can recover (4.19). \square

Now Theorem 4.1.8 follows from Propositions 4.3.7 and 4.7.3 to 4.7.5, after setting $\tilde{e} = f_{e,S}$.

A toolbox of substitution trees and tree-specifications

This chapter is extracted from [Bas+19b], which became Chapter 7 of this thesis. It contains combinatorial results that are used both in Chapters 6 and 7. In Section 5.1, we define the encoding of permutation by trees through the substitution decomposition, and see how pattern extraction is equivalent to taking induced subtrees. In Section 5.2, we define what is a finite specification with regards to the substitution decomposition. Counting how many trees with marked leaves in a given specification induce a given subtree is thus an important step towards proving permuton convergence for uniform elements of finitely specified families. Section 5.3 is devoted to Proposition 5.3.7, a tractable decomposition of such objects. Finally, Section 5.4 contains general singularity analysis theorems for systems of functional equations derived from finite specifications. Those theorems are present in the literature, but for our purposes we present a version that makes explicit the constants in front of the singular parts.

5.1. Substitution trees and pattern extraction

We start with defining substitution of permutations.

Definition 5.1.1. Let $\theta = \theta(1) \cdots \theta(d)$ be a permutation of size d , and let $\pi^{(1)}, \dots, \pi^{(d)}$ be d other permutations. The *substitution* of $\pi^{(1)}, \dots, \pi^{(d)}$ in θ is the permutation of size $|\pi^{(1)}| + \cdots + |\pi^{(d)}|$ obtained by replacing each $\theta(i)$ by a sequence of integers isomorphic to $\pi^{(i)}$ while keeping the relative order induced by θ between these subsequences. This permutation is denoted by $\theta[\pi^{(1)}, \dots, \pi^{(d)}]$.

We point out that the operators \oplus and \ominus defined earlier correspond to substitution into the monotone increasing or decreasing permutation of appropriate size. Examples of substitution are conveniently presented representing permutations by their diagrams (see Figure 1.4 and Figure 2.5 in the introduction).

It will be interesting to consider nested substitutions, starting from permutations of size 1. The corresponding succession of operations is then encoded by a tree, called *substitution tree*.

Definition 5.1.2. A *substitution tree* of size n is a rooted plane tree with n leaves, where any internal node with $k \geq 2$ children is labeled by a permutation of size k . Internal nodes with only one child are forbidden. In the labels, increasing (resp. decreasing) permutations are often replaced by \oplus (resp. \ominus).

Definition 5.1.3. Let t be a substitution tree. We define inductively the permutation $\text{perm}(t)$ associated with t :

- if t is just a leaf, then $\text{perm}(t) = 1$;
- if the root of t has $r \geq 2$ children with corresponding fringe subtrees t_1, \dots, t_r (from left to right), and is labeled with the permutation θ , then $\text{perm}(t)$ is the permutation obtained as the substitution of $\text{perm}(t_1), \dots, \text{perm}(t_r)$ in θ :

$$\text{perm}(t) = \theta[\text{perm}(t_1), \dots, \text{perm}(t_r)].$$

Figure 5.1 illustrates this construction. When $\text{perm}(t) = \sigma$, we say that t is a tree that *encodes* σ , or a tree *associated with* σ . By construction, any tree associated with σ has exactly $|\sigma|$ leaves.

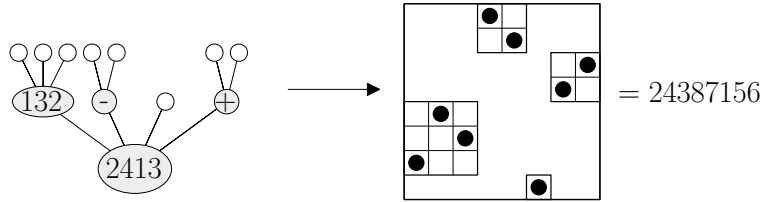

FIGURE 5.1. A substitution tree encoding a permutation.

In general, permutations may be encoded by several substitution trees. In what follows, we recall how to exhibit a particular substitution tree associated with each permutation σ . To this end, we need the notion of simple permutations.

Definition 5.1.4. A *simple permutation* is a permutation σ of size $n > 2$ that does not map any nontrivial interval (*i.e.* a range in $[n]$ containing at least two and at most $n - 1$ elements) onto an interval.

For example, 451326 is not simple as it maps $[3; 5]$ onto $[1; 3]$. The smallest simple permutations are 2413 and 3142 (there is no simple permutation of size 3). We can now define the notion of standard trees.

Definition 5.1.5. A *standard tree* is a substitution tree in which internal nodes satisfy the following constraints:

- Internal nodes are labeled by \oplus (representing 12), \ominus (representing 21), or by a simple permutation.
- Every node labeled by \oplus, \ominus has degree¹ two. The left-child of a node labeled by \oplus (resp. \ominus) cannot be labeled by \oplus (resp. \ominus).
- A node labeled by a simple permutation α has degree $|\alpha|$.

The following proposition is an easy consequence of [AA05, Proposition 2].

Proposition 5.1.6. *The mapping perm of Definition 5.1.3 defines a bijection from standard trees to permutations that maps the number of leaves of the tree to the size of the permutation.*

From now on, we identify a permutation σ and its associated standard tree.

Remark 5.1.7 (regarding the terminology). In most papers in the literature, simple permutations may have size 2 or more. With this definition, 12 and 21 are both simple permutations. In the context of substitution trees, they however play a different role than other simple permutations. This explains why we take another convention here.

The standard trees that we consider here differ from the canonical trees considered in [Bas+20]; in the latter, nodes labeled by \ominus (resp. \oplus) can be of any degree (representing respectively permutations $12 \dots k$ and $k \dots 21$ for any $k \geq 2$) but none of their children may have a label \ominus (resp. \oplus). Signed Schröder trees are special cases of canonical trees. Going from one convention to the other is straightforward.

Since permutations are encoded by trees and since we are interested in patterns in permutations, we consider an analogue of patterns in trees: this leads to the notion of *induced trees*.

Definition 5.1.8 (First common ancestor). Let t be a tree, and u and v be two nodes (internal nodes or leaves) of t . The *first common ancestor* of u and v is the node furthest away from the root \emptyset that appears on both paths from \emptyset to u and from \emptyset to v in t .

¹. Throughout the paper, by *degree* of a node in a tree, we mean the number of its children (which is sometimes called arity or out-degree in other works). Note that it is different from the graph-degree: for us, the edge to the parent (if it exists) is not counted in the degree.

Definition 5.1.9 (Induced tree). Let t be a substitution tree, and let \mathcal{I} be a subset of the leaves of t . The tree $t_{\mathcal{I}}$ induced by \mathcal{I} is the substitution tree of size $|\mathcal{I}|$ defined as follows. The tree structure of $t_{\mathcal{I}}$ is given by:

- the nodes of $t_{\mathcal{I}}$ are in correspondence with the union of \mathcal{I} and of the set of first common ancestors of two (or more) nodes in \mathcal{I} ;
- the ancestor-descendant relation in $t_{\mathcal{I}}$ is inherited from the one in t ;
- the order between the children of an internal node of $t_{\mathcal{I}}$ is inherited from t .

The label of an internal node v of $t_{\mathcal{I}}$ is defined as follows:

- if v is labeled by a permutation θ in t , the label of v in $t_{\mathcal{I}}$ is given by the pattern of θ induced by the children of v having a descendant that belongs to \mathcal{I} (or equivalently, to \mathcal{I}).

A detailed example of the induced tree construction is given in Figure 5.2.

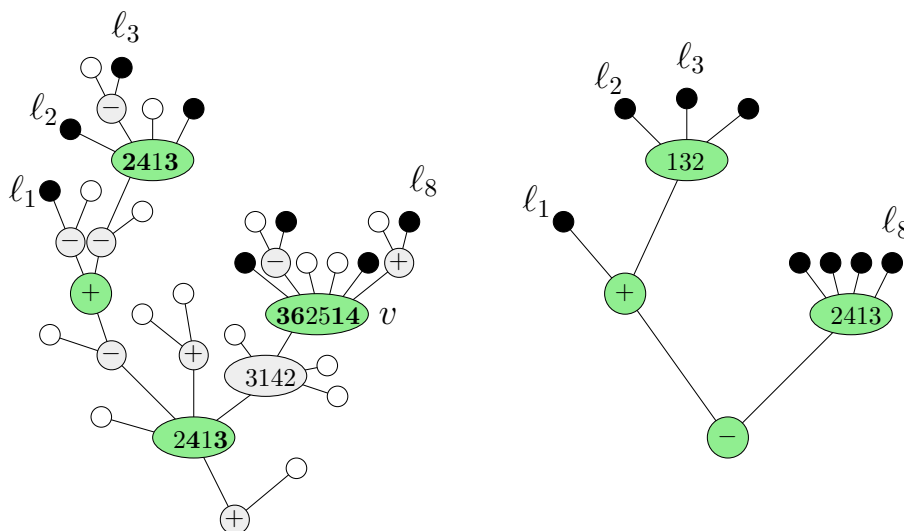

FIGURE 5.2. On the left: A substitution tree t of size $n = 24$ (which happens to be a standard tree), where leaves are indicated both by \circ and \bullet . Among these 24 leaves, $|\mathcal{I}| = 8$ leaves are marked and indicated by \bullet . In green are shown the internal nodes of t which are first common ancestors of these 8 marked leaves. On the right: The substitution tree induced by the 8 marked leaves. Observe that the node v labeled by 362514 in t is labeled by 2413 in $t_{\mathcal{I}}$. This is because only the first, second, fifth and sixth children of v have descendants that belong to \mathcal{I} , and $\text{pat}_{\{1,2,5,6\}}(362514) = 2413$. The induced tree is not standard since 132 is not simple.

For a substitution tree with n leaves, it is convenient to identify the leaves of t from left to right with $[n] = \{1 \dots n\}$.

Observation 5.1.10. By definition, for any substitution tree t with n leaves and subset \mathcal{I} of $[n]$, $t_{\mathcal{I}}$ is a substitution tree. However, if t is a standard tree, $t_{\mathcal{I}}$ is a substitution tree which is not necessarily standard (see for example Figure 5.2).

Moreover, we have the following important feature (illustrated by Figure 5.3).

Lemma 5.1.11. Let t be a substitution tree with a subset \mathcal{I} of marked leaves. We have

$$\text{pat}_{\mathcal{I}}(\text{perm}(t)) = \text{perm}(t_{\mathcal{I}}).$$

This lemma is essential, since it allows to replace the counting of the number of occurrences of a given pattern in some family of permutations by that of induced trees equal to a given tree t_0 in the corresponding family of standard trees.

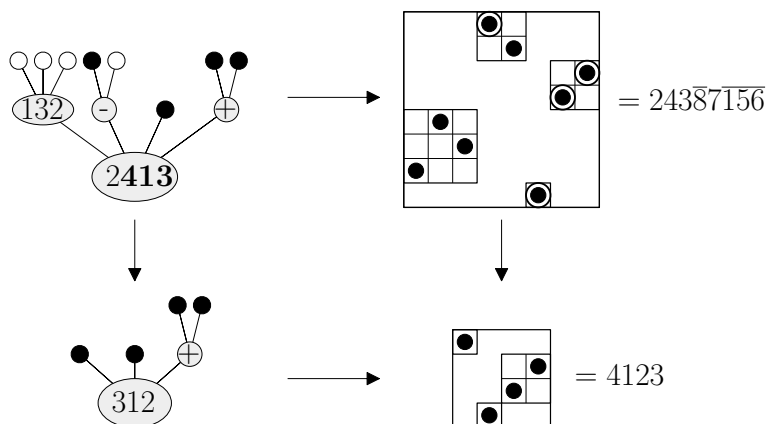

FIGURE 5.3. Illustration of Lemma 5.1.11. Top: A substitution tree t with marked leaves (in this example $\mathcal{I} = \{4, 6, 7, 8\}$), and the permutation $\text{perm}(t)$ it encodes, with the corresponding $|\mathcal{I}|$ marked elements (at positions in \mathcal{I}). Bottom: The induced tree $t_{\mathcal{I}}$ and the induced pattern $\text{pat}_{\mathcal{I}}(\text{perm}(t)) = \text{perm}(t_{\mathcal{I}})$.

5.2. Tree-specifications

The starting point of our study of a permutation class \mathcal{C} is a *combinatorial specification* for \mathcal{C} , or rather for the family of standard trees of permutations of \mathcal{C} . The specifications we will consider involve not only permutation classes, but also more general families of permutations and we may as well consider specifications for these more general families. We identify any such family of permutations with the family of corresponding standard trees, \mathcal{T} . For any such \mathcal{T} , we denote by $\mathcal{S}_{\mathcal{T}}$ the set of simple permutations in \mathcal{T} . Throughout this article we will only consider families of permutations with a particular type of specification, called a *tree-specification*, which we now define.

Definition 5.2.1 (Tree-specifications).

Let I be a finite set and for $i \in I$, let \mathcal{T}_i be a family of permutations. A *tree-specification* of $(\mathcal{T}_i)_{i \in I}$ is a system of combinatorial equations

$$(\mathcal{E}_{\mathcal{T}}) \quad \mathcal{T}_i = \varepsilon_i \{\bullet\} \uplus \bigsqcup_{\pi \in \mathcal{S}_{\mathcal{T}_i} \uplus \{\oplus, \ominus\}} \bigsqcup_{(k_1, \dots, k_{|\pi|}) \in K_{\pi}^i} \pi[\mathcal{T}_{k_1}, \dots, \mathcal{T}_{k_{|\pi|}}], \quad i \in I.$$

where the symbol \uplus denotes disjoint union, \bullet is the permutation of size 1 and for every $i \leq d$, $\varepsilon_i \in \{0, 1\}$ (so that $\varepsilon_i \{\bullet\}$ is either \emptyset or $\{\bullet\}$) and K_{π}^i is a subset of $\{0, \dots, d\}^{|\pi|}$.

Note that we extended the notation for substitution to sets of permutations in the obvious way: $\pi[\mathcal{T}_{k_1}, \dots, \mathcal{T}_{k_{|\pi|}}]$ is the set of permutations $\pi[\theta^{(1)}, \dots, \theta^{(|\pi|)}]$ where for each i , $\theta^{(i)} \in \mathcal{T}_{k_i}$.

In order to avoid trivial cases, in this thesis we consider only tree-specifications such that every family \mathcal{T}_i is nonempty, at least one family \mathcal{T}_i is infinite and at least one ε_i is nonzero.

Definition 5.2.2. Given a permutation class \mathcal{C} , a *specification* for \mathcal{C} is a tree-specification that contains $\mathcal{T} = \mathcal{T}_{\emptyset}$, the set of standard trees of \mathcal{C} .

For instance, in Chapter 6 below we shall consider the following specification for substitution-closed classes.

$$(5.1) \quad \begin{cases} \mathcal{T} &= \{\bullet\} \uplus \oplus[\mathcal{T}^{\text{not}\oplus}, \mathcal{T}] \uplus \ominus[\mathcal{T}^{\text{not}\ominus}, \mathcal{T}] \uplus (\bigsqcup_{\pi \in \mathcal{S}} \pi[\mathcal{T}, \dots, \mathcal{T}]) \\ \mathcal{T}^{\text{not}\oplus} &= \{\bullet\} \uplus \ominus[\mathcal{T}^{\text{not}\oplus}, \mathcal{T}] \uplus (\bigsqcup_{\pi \in \mathcal{S}} \pi[\mathcal{T}, \dots, \mathcal{T}]) \\ \mathcal{T}^{\text{not}\ominus} &= \{\bullet\} \uplus \oplus[\mathcal{T}^{\text{not}\oplus}, \mathcal{T}] \uplus (\bigsqcup_{\pi \in \mathcal{S}} \pi[\mathcal{T}, \dots, \mathcal{T}]). \end{cases}$$

5.2.1. System of equations, dependency graph, In the following, we adopt some notational convention to guide the reading.

As above, curly letters (like \mathcal{T}) and capital letters (like T) denote respectively combinatorial families and their generating series. Moreover, vectors of generating series are denoted by bold letters (like \mathbf{T}) and matrices of such by thick letters (like \mathbb{M}).

The specification $(\mathcal{E}_{\mathcal{T}})$ of Definition 5.2.1 induces a system of $|I|$ equations for the vector $\mathbf{T} = (T_i)_{i \in I}$, written in vector notation as follows

$$(E_T) \quad \mathbf{T}(z) = \Phi(z, \mathbf{T}(z))$$

where

$$(5.2) \quad \Phi_i(z, (y_i)_{i \in I}) = \varepsilon_i z + \sum_{\pi \in \mathcal{S}_{\mathcal{T}_i} \uplus \{\oplus, \ominus\}} \sum_{(k_1, \dots, k_{|\pi|}) \in K_{\pi}^i} y_{k_1} \cdots y_{k_{|\pi|}} \quad i \in I.$$

We also introduce, for future use, the Jacobian matrix of the system.

$$(5.3) \quad \mathbb{M}(z, \mathbf{y}) = \text{Jac}_{\mathbf{y}} \Phi(z, \mathbf{y}), \text{ i.e. } M_{i,j} = \frac{\partial}{\partial y_j} \Phi_i(z, (y_i)_{i \in I}).$$

5.2.2. Type of a node. A tree-specification like $(\mathcal{E}_{\mathcal{T}})$ allows to build the elements of the families \mathcal{T}_i recursively in a canonical way. In this recursive construction of a tree t of \mathcal{T}_i , every fringe subtree is taken in one of the \mathcal{T}_j . We will say that the subtree, or equivalently its root, is of type j . More formally, the type of a node in a tree t in \mathcal{T}_i can be recursively defined as follows.

Definition 5.2.3 (Type of a node). Consider a specification of the form of $(\mathcal{E}_{\mathcal{T}})$ (see p.72). Let t be a tree in some \mathcal{T}_i , and let v be a node in t . The *type* of v in t for \mathcal{T}_i is defined as follows.

- If v is the root of t , then the type of v in t in \mathcal{T}_i is i .
- Otherwise, there is a unique $\pi \in \mathcal{S}_{\mathcal{T}_i} \uplus \{\oplus, \ominus\}$ and a unique $|\pi|$ -tuple $(k_1, \dots, k_{|\pi|}) \in K_{\pi}^i$ such that t can be decomposed as:

$$t = \begin{array}{c} t_1 \quad t_2 \quad \dots \quad t_{|\pi|} \\ \diagdown \quad \diagup \quad \dots \quad \diagdown \\ \circlearrowleft \pi \end{array},$$

where each $t_j \in \mathcal{T}_{k_j}$. Let $\ell \leq |\pi|$ be such that $v \in t_{\ell}$, then the type of v in t in \mathcal{T}_i is the type of v in t_{ℓ} in $\mathcal{T}_{k_{\ell}}$.

Remark 5.2.4. It may happen that $\mathcal{T}_i \cap \mathcal{T}_j \neq \emptyset$. For example, in the specification (5.1) p.72 for substitution-closed classes, all trees whose root is labeled by a simple permutation belong to all three classes. In such a case, caution is needed: the type of a node v in a tree $t \in \mathcal{T}_i \cap \mathcal{T}_j$ is defined differently depending on whether t is seen as a tree of \mathcal{T}_i or of \mathcal{T}_j .

Example 5.2.5. Consider a substitution-closed class \mathcal{T} with its tree-specification given by (5.1). The three families of trees \mathcal{T} , $\mathcal{T}^{\text{not}\oplus}$ and $\mathcal{T}^{\text{not}\ominus}$ appear in this specification. Let t be a tree in any of \mathcal{T} , $\mathcal{T}^{\text{not}\oplus}$ or $\mathcal{T}^{\text{not}\ominus}$. The type of the node of t is either \emptyset , $\text{not}\oplus$, or $\text{not}\ominus$. Moreover, it is easy to see that the type of a non-root node v in t is $\text{not}\oplus$ (resp. $\text{not}\ominus$) if the node is the left child of a node labeled with \oplus (resp. \ominus), and is \emptyset otherwise. Only the type of the root of t depends on which family t is (considered to be) an element of. The type of the root of t is by definition \emptyset (resp. $\text{not}\oplus$, $\text{not}\ominus$) when t is (considered as) a tree of \mathcal{T} (resp. $\mathcal{T}^{\text{not}\oplus}$, $\mathcal{T}^{\text{not}\ominus}$).

5.3. Decomposition of trees inducing a given tree

5.3.1. Blossoming trees. The main result of this chapter is Proposition 5.3.7 that gives an expression for the generating function of trees of type \mathcal{T}_i with k marked leaves which induce a given subtree t_0 . This expression results from a decomposition into some families of *blossoming trees*, that we now define.

Definition 5.3.1. For $0 \leq i, j \leq d$, we define \mathcal{T}_i^j as the family of trees t with one marked leaf ℓ , called the *blossom* and represented by $*$, such that the tree obtained by replacing $*$ by a tree of \mathcal{T}_j belongs to \mathcal{T}_i , with the additional condition that the type in \mathcal{T}_i of the node that used to be the blossom is j .

Observe that in general, a tree in \mathcal{T}_i^j does not belong to \mathcal{T}_i . The terminology *blossoming* overlaps the existing literature of planar map bijections (see [FG20] and the references therein), we point out that the different varieties of blossoming trees defined in this chapter have a fixed number of blossoms.

In the following proposition, we show that families \mathcal{T}_i^j 's inherit a combinatorial specification from the one of the \mathcal{T}_i 's.

Proposition 5.3.2 (Specification of the \mathcal{T}_i^j 's). *Assume that the equation for \mathcal{T}_i in the specification $(\mathcal{E}_{\mathcal{T}})$ is*

$$\mathcal{T}_i = \varepsilon_i\{\bullet\} \uplus \biguplus_{\pi \in \mathcal{S}_{\mathcal{T}_i} \uplus \{\oplus, \ominus\}} \biguplus_{(k_1, \dots, k_{|\pi|}) \in K_{\pi}^i} \pi[\mathcal{T}_{k_1}, \mathcal{T}_{k_2}, \dots, \mathcal{T}_{k_{|\pi|}}] \quad (0 \leq i \leq d),$$

where \bullet is the trivial tree made of just one leaf. Then we have:

(5.4)

$$\mathcal{T}_i^j = \mathbf{1}_{i=j}\{*\} \uplus \biguplus_{\pi \in \mathcal{S}_{\mathcal{T}_i} \uplus \{\oplus, \ominus\}} \biguplus_{(k_1, \dots, k_{|\pi|}) \in K_{\pi}^i} \biguplus_{\ell=1}^{|\pi|} \pi[\mathcal{T}_{k_1}, \dots, \mathcal{T}_{k_{\ell}}^j, \dots, \mathcal{T}_{k_{|\pi|}}] \quad (0 \leq i, j \leq d),$$

where $*$ is the trivial tree reduced to the blossom.

PROOF. Trivially, the class \mathcal{T}_i^j contains the tree reduced to a blossom if and only if $i = j$. This explains the term $\mathbf{1}_{i=j}\{*\}$.

Let $t \in \mathcal{T}_i^j$. We now restrict to the case where the blossom of t is not at the root. Let $t_j \in \mathcal{T}_j$. Denote by tt_j the tree obtained by replacing the blossom of t with t_j . By definition of the class \mathcal{T}_i^j , the tree tt_j is in \mathcal{T}_i . As a result, tt_j belongs to the union

$$\mathcal{T}_i = \varepsilon_i\{\bullet\} \uplus \biguplus_{\pi \in \mathcal{S}_{\mathcal{T}_i} \uplus \{\oplus, \ominus\}} \biguplus_{(k_1, \dots, k_{|\pi|}) \in K_{\pi}^i} \pi[\mathcal{T}_{k_1}, \mathcal{T}_{k_2}, \dots, \mathcal{T}_{k_{|\pi|}}].$$

We cannot have $tt_j = \bullet$, because then necessarily the blossom of t is its root. Hence tt_j belongs to a term of the form $\pi[\mathcal{T}_{k_1}, \dots, \mathcal{T}_{k_{|\pi|}}]$ for $\pi \in \mathcal{S}_{\mathcal{T}_i} \uplus \{\oplus, \ominus\}$ and $(k_1, \dots, k_{|\pi|}) \in K_{\pi}^i$. Then the blossom (and the copy of t_j) must be contained in one of the fringe subtrees rooted at a child of the root of tt_j , say the ℓ -th one, with $1 \leq \ell \leq |\pi|$. Hence t , which is recovered by removing the copy of t_j in tt_j and replacing it by a blossom, belongs to $\pi[\mathcal{T}_{k_1}, \dots, \mathcal{T}_{k_{\ell}}^j, \dots, \mathcal{T}_{k_{|\pi|}}]$.

This proves the direct inclusion in the statement of the proposition. For the reverse inclusion, consider a tree t belonging to the right hand side of Equation (5.4), and replace the blossom by a tree t_j of \mathcal{T}_j . This immediately yields a tree in \mathcal{T}_i . Hence $t \in \mathcal{T}_i^j$. \square

For $0 \leq i \leq d$, let T_i^j be the generating function of the family \mathcal{T}_i^j , where trees are counted by the number of leaves (we take the convention that the blossom is not counted). Proposition 5.3.2 has the following consequence (recall that series \mathbb{M} is defined in (5.3)).

Proposition 5.3.3. *Let $\mathbb{T}(z)$ be the matrix of generating functions $\mathbb{T} = (T_i^j)_{0 \leq i, j \leq d}$. It holds that*

$$(5.5) \quad \mathbb{T}(z) = \mathbb{M}(z, \mathbf{T}(z)) \cdot \mathbb{T}(z) + \text{Id},$$

Moreover, we have

$$(5.6) \quad \mathbf{T}'(z) = \mathbb{T}(z) \cdot (\varepsilon_1, \dots, \varepsilon_d)$$

PROOF. The first claim is the translation into generating functions of the previous proposition. Then differentiation of the relation Equation (E_T) gives

$$\mathbf{T}'(z) = \frac{\partial}{\partial z} \Phi(z, \mathbf{y})|_{\mathbf{y}=\mathbf{T}(z)} + \mathbb{M}(z, \mathbf{T}(z))\mathbf{T}'(z)$$

from which the second claim follows. \square

5.3.2. Multiply blossoming trees. We move to the other type of objects involved in our decomposition.

Definition 5.3.4. Let $r \geq 2$, $i, j_1, \dots, j_r \in I$ and $\pi \in \mathfrak{S}_r$. The class $\mathcal{E}_{ij_1 \dots j_r}^\pi$ is the class of trees with r ordered marked leaves **required to be children of the root**, call the blossoms, with the following conditions:

- the blossoms are ordered from left to right;
- upon replacing the ℓ -th blossom by a tree of \mathcal{T}_{j_ℓ} for every $1 \leq \ell \leq r$ one obtains a tree of \mathcal{T}_i ;
- the pattern induced by the blossoms on the permutation labeling the root is π .

Proposition 5.3.5. For $r \geq 2$, $i, j_1, \dots, j_r \in I$ and $\pi \in \mathfrak{S}_r$, there exists a power series $R_{ij_1 j_r}^\pi$ with nonnegative coefficients such that

$$E_{ij_1 \dots j_r}^\pi(z) = R_{ij_1 \dots j_r}^\pi(\mathbf{T}(z)),$$

and

$$\sum_{\pi \in \mathfrak{S}_r} \sum_{\rho \in \mathfrak{S}_r} R_{ij_{\rho(1)} \dots j_{\rho(r)}}^\pi(\mathbf{y}) = \frac{\partial^r \Phi_i(0, \mathbf{y})}{\partial y_{j_1} \dots \partial y_{j_r}}.$$

PROOF. We start from the specification of the class \mathcal{T}_i given in (\mathcal{E}_T) , and deduce that

$$(5.7) \quad \mathcal{E}_{i, j_1, \dots, j_r}^\tau = \biguplus_{\pi \in \mathcal{S}_{\mathcal{T}_i} \uplus \{\oplus, \ominus\}} \biguplus_{(k_1, \dots, k_{|\pi|}) \in K_\pi^i} \biguplus_{\substack{1 \leq \ell_1 < \dots < \ell_r \leq |\pi| \\ \text{pat}_{\vec{\ell}}(\pi) = \tau \\ k_{\ell_1} = j_1, \dots, k_{\ell_r} = j_r}} \pi \left[\mathcal{F}_{k_1}(\mathbb{1}_{1 \notin \vec{\ell}}), \dots, \mathcal{F}_{k_r}(\mathbb{1}_{r \notin \vec{\ell}}) \right]$$

where $\mathcal{F}_k(1)$ is shorthand for the family \mathcal{T}_k and $\mathcal{F}_k(0)$ for the family $\{*\}$ that only contains the tree reduced to a single blossom.

As a result, indeed $E_{i, j_1, \dots, j_r}^\tau = R_{i, j_1, \dots, j_r}^\tau(\mathbf{T})$ with

$$(5.8) \quad R_{i, j_1, \dots, j_r}^\tau(\mathbf{y}) = \sum_{\pi \in \mathcal{S}_{\mathcal{T}_i} \uplus \{\oplus, \ominus\}} \sum_{(k_1, \dots, k_{|\pi|}) \in K_\pi^i} \sum_{\substack{1 \leq \ell_1 < \dots < \ell_r \leq |\pi| \\ \text{pat}_{\vec{\ell}}(\pi) = \tau \\ k_{\ell_1} = j_1, \dots, k_{\ell_r} = j_r}} \prod_{1 \leq i \leq |\pi|, i \notin \vec{\ell}} y_{k_i}$$

So

$$(5.9) \quad \sum_{\tau \in \mathfrak{S}_r} \sum_{\rho \in \mathfrak{S}_r} R_{i, j_{\sigma(1)} \dots j_{\sigma(r)}}^\tau = \sum_{\pi \in \mathcal{S}_{\mathcal{T}_i} \uplus \{\oplus, \ominus\}} \sum_{(k_1, \dots, k_{|\pi|}) \in K_\pi^i} \sum_{\substack{(\ell_1, \dots, \ell_r) \in [|\pi|] \\ \text{distinct} \\ k_{\ell_1} = j_1, \dots, k_{\ell_r} = j_r}} \prod_{1 \leq i \leq |\pi|, i \notin \vec{\ell}} y_i$$

in which we recognize $\frac{\partial^r \Phi_i(0, \mathbf{y})}{\partial y_{j_1} \dots \partial y_{j_r}}$, recalling (5.2). \square

5.3.3. The main decomposition result. Let us fix a substitution tree t_0 with k leaves. Let $V(t_0)$ denote the set of vertices of t_0 . Let $\text{Int}(t_0)$ (resp. $\text{Lf}(t_0)$) denote the set of internal nodes (resp. leaves) of t_0 , so that $V(t_0) = \text{Int}(t_0) \uplus \text{Lf}(t_0)$. For $v \in \text{Int}(t_0)$ we set

- $\varepsilon(v)$ the permutation labeling the node v in t_0 ;
- $v.1, \dots, v.d(v)$ the children of v in t_0 .

We also use the convention that $\emptyset \in \text{Int}(t_0)$ denotes the root of t_0 . In view of proving permuton convergence of uniform random elements of \mathcal{T}_i , recalling Theorem 3.3.2 and Lemma 5.1.11, the class we wish to enumerate is the following.

Definition 5.3.6. For $i \in I$, let \mathcal{T}_{i,t_0} be the class of trees in \mathcal{T}_i with k unordered marked leaves that induce the subtree t_0 .

Note that if a marked tree $(t, (\ell_1, \dots, \ell_k)) \in \mathcal{T}_{i,t_0}$ then, as a result of Lemma 5.1.11, $\text{pat}_{\ell_1, \dots, \ell_k}(\text{perm}(t)) = \text{perm}(t_0)$. Our decomposition result is the following.

Proposition 5.3.7. We have, for every $i_0 \in I$,

$$(5.10) \quad T_{i_0, t_0} = \sum_{j \in I^{\text{Int}(t_0)}} \sum_{\substack{i \in I^{V(t_0)} \\ i(\emptyset) = i_0}} \left[\prod_{v \in \text{Int}(t_0)} T_{i(v)}^{j(v)} \prod_{v \in \text{Lf}(t_0)} T'_{i(v)} \prod_{v \in \text{Int}(t_0)} E_{j(v)i(v.1)\dots i(v.d(v))}^{\varepsilon(v)} \right].$$

The above sum runs over pairs of functions $i : V(t_0) \rightarrow I$ and $j : \text{Int}(t_0) \rightarrow I$ with the assumption that $i(\emptyset) = t_0$.

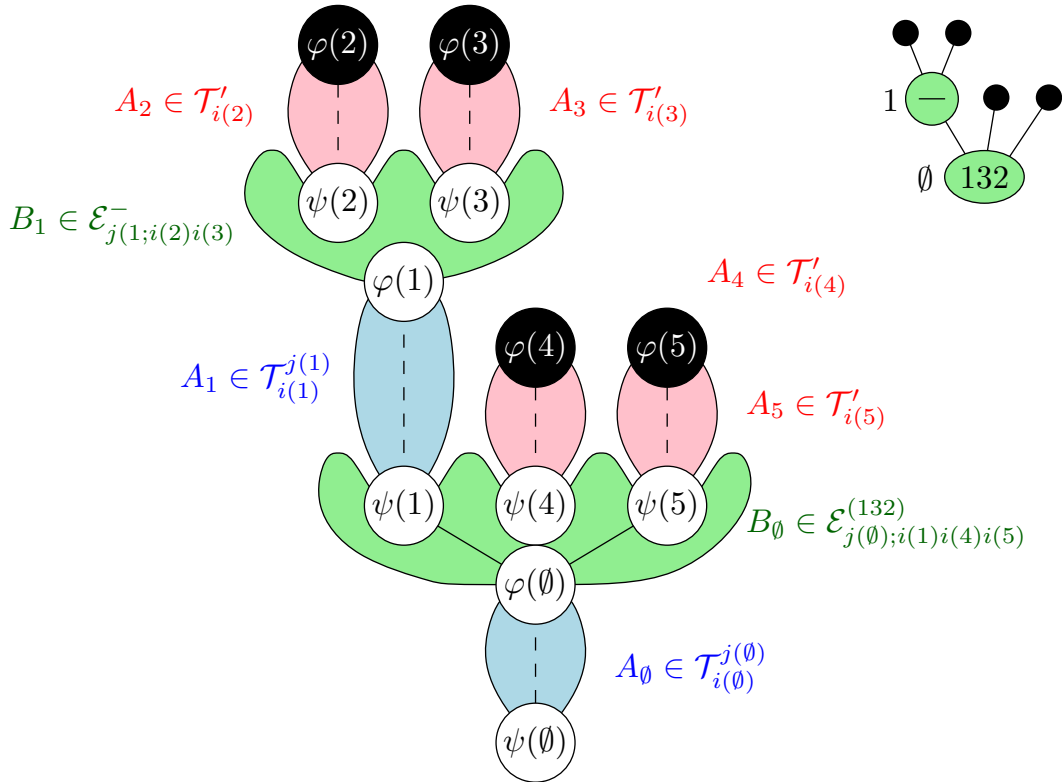

FIGURE 5.4. Right: a permutation tree t_0 with $k = 5$ leaves. Left: the decomposition of an arbitrary element of $\Omega_{i,j}^{t_0}$.

PROOF. (The main notation of the proof is summarized in Figure 5.4.)

Consider a marked tree $t \in \mathcal{T}_{i_0, t_0}$. Every node v of t_0 corresponds to a node $\varphi_t(v)$ of t . Moreover φ_t sends internal nodes of t_0 to internal nodes of t , and leaves of t_0 onto marked leaves of t . For every $v \in V(t_0)$, consider the node $\psi_t(v)$ of t defined as follows:

- i) If v is the root of t_0 , then $\psi_t(v)$ is the root of t .
- ii) If v is not the root of t_0 , in which case v has a parent $w \in t_0$, we set $\psi_t(v)$ to be the child of $\varphi_t(w)$ in t which is an ancestor of $\varphi_t(v)$.

Let i be a map $V(t_0) \rightarrow I$ such that $i(\emptyset) = i_0$, and $j : \text{Int}(t_0) \rightarrow I$. Denote $\Omega_{i,j}^{t_0}$ the set of trees $t \in \mathcal{T}_{i_0, t_0}$ such that for every $v \in \text{Int}(t_0)$, $j(v)$ is the type of $\varphi_t(v)$ and such that for every $v \in V(t_0)$, $i(v)$ is the type of $\psi_t(v)$.

We have as a result

$$(5.11) \quad \mathcal{T}_{i_0, t_0} = \bigsqcup_{j \in I^{\text{Int}(t_0)}} \bigsqcup_{\substack{i \in I^{V(t_0)} \\ i(\emptyset) = i_0}} \Omega_{i, j}^{t_0}$$

Let $t \in \Omega_{i, j}^{t_0}$. We now decompose t successively, cutting at the nodes $\varphi_t(v)$, $\psi_t(v)$ for all $v \in V(t_0)$, and for every non-trivial cut (cuts at leaves have no consequence), we replace the cut vertex by a blossom in the bottom part. The top part retains the cut vertex along with its type. This yields three types of pieces, and we refer the reader to Figure 5.4 for an illustration.

- i) For all $v \in V(t_0)$, we denote by A_v the piece under $\varphi_t(v)$, and on top of $\psi_t(v)$, where we see $\psi_t(v)$ as a root, and $\varphi_t(v)$ as a marked leaf. There are two cases
 - (a) (red) Either v is a leaf, and A_v is simply the fringe subtree of t rooted at $\psi_t(v)$; this tree contains one marked leaf, namely $\varphi_t(v)$, and its root is of type $i(v)$. Hence $A_v \in \mathcal{T}'_{i(v)}$.
 - (b) (blue) Or v is an internal node of t_0 , in which case A_v is the fringe subtree of t rooted at $\psi_t(v)$ in which the fringe subtree rooted at $\varphi_t(v)$ has been replaced by a blossom. Hence $A_v \in \mathcal{T}_{i(v)}^{j(v)}$.
- ii) (green) For all $v \in \text{Int}(t_0)$, we denote by B_v the piece rooted at $\varphi_t(v)$. This piece is exactly the fringe subtree of t rooted at $\varphi_t(v)$ in which the fringe subtrees rooted at $\psi_t(v.1), \dots, \psi_t(v.d(v))$ have been replaced by blossoms. Hence it has type $j(v)$ at the root, and contains $d(v)$ blossoms that are children of the root, of respective types $i(v.1), \dots, i(v.d(v))$. These blossoms induce the permutation $\varepsilon(v)$ on the root. So $B_v \in \mathcal{E}_{j(v)i(v.1)\dots i(v.d(v))}^{\varepsilon(v)}$.

As a result, we have a map associating to t its tuple of pieces

$$(5.12) \quad \begin{cases} \Omega_{i, j}^{t_0} & \rightarrow \prod_{v \in \text{Int}(t_0)} \mathcal{T}_{i(v)}^{j(v)} \times \prod_{v \in \text{Lf}(t_0)} \mathcal{T}'_{i(v)} \times \prod_{v \in \text{Int}(t_0)} \mathcal{E}_{j(v)i(v.1)\dots i(v.d(v))}^{\varepsilon(v)} \\ t & \mapsto \left((A_v)_{v \in \text{Int}(t_0)}, (A_v)_{v \in \text{Lf}(t_0)}, (B_v)_{v \in \text{Int}(t_0)} \right) \end{cases}$$

The map is size-preserving, because each unmarked leaf in t becomes an unmarked leaf in one of the pieces, and no other unmarked leaf is created (recall that blossoms and marked leaves do not contribute to the size). It admits an inverse, which consists in gluing the pieces following the blueprint given by t_0 , recovering the original tree. Conversely, in performing this gluing procedure from an arbitrary element of $\prod_{v \in \text{Int}(t_0)} \mathcal{T}_{i(v)}^{j(v)} \times \prod_{v \in \text{Lf}(t_0)} \mathcal{T}'_{i(v)} \times \prod_{v \in \text{Int}(t_0)} \mathcal{E}_{j(v)i(v.1)\dots i(v.d(v))}^{\varepsilon(v)}$, type compatibility conditions are respected when a blossom is replaced by a tree, and we see by induction from the leaves that we do produce a tree in $\Omega_{i, j}^{t_0}$. Hence (5.12) is a size-preserving bijection, and translating (5.11), (5.12) in generating functions yields (5.10). \square

5.4. Analysis of systems of functional equations

It is clear that the system of equations (E_T) is a specific instance of the following general case.

Definition 5.4.1. Let I be a finite set. Let $\mathbf{Y} = (Y_i)_{i \in I}$ be a vector of $|I|$ formal power series in the variable z . Let $\Phi = (\Phi_i(z, \mathbf{y}))_{i \in I}$ be a vector of $|I|$ formal power series in the variables z and y_i for $i \in I$. A system of equations of the form

$$(E) \quad \mathbf{Y}(z) = \Phi(z, \mathbf{Y}(z))$$

is called a *proper equation of multitype leaf-counted trees* if

- i) $\Phi(0, \mathbf{0}) = \mathbf{0}$, $\Phi(z, \mathbf{0}) \neq \mathbf{0}$ and there are no monomials of the form ky_i in any of the Φ_i ,
- ii) $Y_i(0) = 0$ and $Y_i \neq 0$ for all $i \in I$.

For such a system there is a unique solution \mathbf{Y} in the ring of vectors of $|I|$ power series with no constant terms. Indeed, the map $\mathbf{Y} \mapsto \Phi(z, \mathbf{Y})$ shifts the valuation in z by at least one, so the fixed point theorem applies. In the analysis of such systems it is usual to introduce the following vocabulary.

Definition 5.4.2. The *dependency graph* of the system (E) is the directed graph $G_{(\mathbf{E})}$ over I defined by $i \rightarrow j$ if y_i appears in Φ_j . We say that the system is *irreducible* if the dependency graph is strongly connected. We say that an irreducible system of equations is *linear* if Φ is an affine function of the vector \mathbf{y} , and *nonlinear* otherwise.

The dependency graph is a classical tool to study the radius of convergence and the period (see Appendix A.1) of the series in \mathbf{Y} . In particular, for irreducible systems, all series Y_i have a common radius of convergence.

Lemma 5.4.3. *Assume that there is an edge $j \rightarrow i$ in the dependency graph $G_{(\mathbf{E})}$. Then the radius of convergence of the series Y_i is smaller or equal to that of Y_j . Moreover, the period of Y_i divides that of Y_j .*

PROOF. If there is an edge $j \rightarrow i$, then the equation $Y_i = \Phi_i(z, \mathbf{Y})$ implies that there exists a nonzero power series $F(z)$ such that Y_i dominates coefficientwise $F(z)Y_j(z)$. The claim follows. \square

For such implicit equations, it is classic [FS09, §B.5] to introduce the Jacobian matrix of the system:

$$(5.13) \quad \mathbb{M}(z, \mathbf{y}) = \text{Jac}_{\mathbf{y}} \Phi(z, \mathbf{y}), \text{ i.e. } M_{i,j} = \frac{\partial}{\partial y_j} \Phi_i(z, (y_i)_{i \in I})$$

By properness, $\mathbb{M}(0, \mathbf{0}) = \mathbb{O}$. We remark that the system is irreducible if and only if the matrix \mathbb{M} itself is irreducible (in the terminology of the Perron-Frobenius theorem)

Under suitable analyticity conditions, the singular behavior of irreducible systems is determined along the linear/nonlinear dichotomy. The rest of this section is devoted to stating the two corresponding theorems, both in the linear and nonlinear case.

5.4.1. Linear systems. In this section we assume that Φ is a linear function of its second argument, in the sense that Equation (E) reduces to $\mathbf{Y}(z) = \mathbb{M}(z)\mathbf{Y}(z) + \mathbf{V}(z)$ where $\mathbf{V}(z) = \Phi(z, \mathbf{0})$ and the $c \times c$ -matrix \mathbb{M} is the Jacobian of Φ in its second argument. Note that under the linear assumption \mathbb{M} does not depend on \mathbf{y} .

The following proposition is an adaptation of known results: it extends Theorem V.7 (p.342) and Lemma V.1 (p.346) in [FS09] (which establish that, when $\mathbb{M}(z) = z\mathbb{M}$, then ρ is a simple pole of $(\text{Id} - \mathbb{M}(z))^{-1}$ and this quantity tends to $C/(z - \rho)$ where C is a rank 1 matrix), and Lemma 2 in [BD15] (where $\mathbb{M}(z)$ is a matrix with polynomial coefficients in z , but constants corresponding to dominating terms of the asymptotic behavior are not computed). The proof is mostly adapted from this last reference.

Theorem 5.4.4. *Let $\mathbb{M}(z)$ be an irreducible matrix of power series with nonnegative coefficients, and assume that $\mathbb{M}(0) = \mathbb{O}$. Then all entries of $(\text{Id} - \mathbb{M}(z))^{-1}$ have the same radius of convergence $\rho \in (0, \infty]$. The following assertions are then equivalent:*

- i) *There exists $t \geq 0$ strictly smaller than the radius of convergence of all entries of \mathbb{M} , such that $\det(\text{Id} - \mathbb{M}(t)) = 0$;*
- ii) *The radius of convergence of all entries of \mathbb{M} is strictly larger than ρ .*

If they hold, then

- iii) *$\mathbb{M}(\rho)$ is an irreducible matrix with Perron eigenvalue 1. We denote by \mathbf{u} and \mathbf{v} the corresponding left and right positive eigenvectors normalized so that $\mathbf{v}\mathbf{u} = 1$ and $\mathbf{v}\mathbf{1} = 1$;*

iv) $(\text{Id} - \mathbb{M})^{-1}$ is analytic on a Δ -neighborhood of ρ , and as $z \rightarrow \rho$, denoting coefficient-wise asymptotic equivalence by \sim ,

$$(5.14) \quad (\text{Id} - \mathbb{M}(z))^{-1} \sim \left(\frac{1}{\tau \mathbf{u} \mathbb{M}'(\rho) \mathbf{v}} \right) \frac{\mathbf{v} \tau \mathbf{u}}{\rho - z}.$$

Moreover, if the g.c.d. of the periods of the series in \mathbb{M} is 1, then there are no other singularities on the circle of convergence for the entries of $(\text{Id} - \mathbb{M})^{-1}$, and those series are analytic on a Δ -domain at ρ .

PROOF. The invertibility of $\text{Id} - \mathbb{M}(z)$ near zero follows from the fact that the spectral radius of $\mathbb{M}(z)$ is continuous in z and $\mathbb{M}(0) = \mathbb{O}$.

Fix $1 \leq i, j, l \leq c$. By the irreducibility condition, there exists k such that $\mathbb{M}(z)_{i,j}^k \neq 0$. Moreover

$$(\text{Id} - \mathbb{M}(z))^{-1} = \text{Id} + \mathbb{M}(z) + \cdots + \mathbb{M}(z)^{k-1} + \mathbb{M}(z)^k (\text{Id} - \mathbb{M}(z))^{-1}.$$

As a result, $((\text{Id} - \mathbb{M}(z))^{-1})_{i,l}$ depends positively on $((\text{Id} - \mathbb{M}(z))^{-1})_{j,l}$. Since $\mathbb{M}(z)^k (\text{Id} - \mathbb{M}(z))^{-1} = (\text{Id} - \mathbb{M}(z))^{-1} \mathbb{M}(z)^k$, it also implies that $((\text{Id} - \mathbb{M}(z))^{-1})_{l,j}$ depends positively on $((\text{Id} - \mathbb{M}(z))^{-1})_{l,i}$. Denote ρ_{ij} , the radius of convergence of $((\text{Id} - \mathbb{M}(z))^{-1})_{i,j}$ for all i, j . Then we have for all i, j, k, l , $\rho_{ij} \leq \rho_{il} \leq \rho_{kl}$. Hence all entries of $(\text{Id} - \mathbb{M}(z))^{-1}$ have the same radius of convergence.

By Perron-Frobenius theorem, the spectral radius $\lambda(t) = \text{SR}_{\mathbb{M}(t)}$, called *the Perron eigenvalue*, is a simple eigenvalue of $\mathbb{M}(t)$ and forms a continuous and strictly increasing function of t on $[0, R_{\mathbb{M}})$, where $R_{\mathbb{M}}$ is the smallest radius of convergence of the entries of \mathbb{M} .

Now assume statement ii). If $\lambda(\rho) < 1$, then $\text{Id} - \mathbb{M}(z)$ would be analytically invertible around ρ thanks to the comatrix formula, since the entries of \mathbb{M} are analytic near ρ . But this negates Pringsheim's theorem [FS09, Theorem IV.6 p.240]. As a result $\lambda(\rho) \geq 1$ which implies statement i).

Conversely assume statement i). Then $\alpha = \inf\{t \geq 0, \lambda(t) = 1\}$ is well-defined. Since $\lambda(0) = 0$, then $\alpha > 0$, and by continuity, $\lambda(\alpha) = 1$. Since the coefficients of \mathbb{M} are series with nonnegative coefficients, then for $|z| < \alpha$, $|\mathbb{M}(z)| \leq \mathbb{M}(|z|)$ coefficient-wise, hence $\text{SR}_{\mathbb{M}(z)} < 1$. Because furthermore the radius of convergence of \mathbb{M} is larger than α , then $(\text{Id} - \mathbb{M}(z))^{-1}$ is defined and analytic on $D(0, \alpha)$ and $\rho \geq \alpha$. We will now compute their asymptotics as $z \rightarrow \alpha$. They will turn up to be divergent, which will imply $\alpha = \rho$ and hence statement ii).

By hypothesis, the Perron eigenvalue of $\mathbb{M}(\alpha)$ is 1. Denote by \mathbf{u} and \mathbf{v} the corresponding left and right positive eigenvectors normalized so that $\tau \mathbf{u} \mathbf{v} = 1$. Let \mathbb{P} be a Jordanization basis for $\mathbb{M}(\alpha)$, so that $\mathbb{P}^{-1} \mathbb{M}(\alpha) \mathbb{P} = \text{diag}(1, \mathbb{J})$, where \mathbb{J} is some $(c-1) \times (c-1)$ Jordan matrix that does not admit the eigenvalue 1. (We write $\text{diag}(A, B)$ for the block-diagonal concatenation of two square matrices A, B .)

Necessarily $\mathbb{P} \mathbf{e}_1 = \mathbf{v}$. Moreover, $\tau \mathbf{e}_1 \mathbb{P}^{-1}$ is a left eigenvector of \mathbb{M} and $\tau \mathbf{e}_1 \mathbb{P}^{-1} \mathbf{v} = 1$. Therefore $\tau \mathbf{u} = \tau \mathbf{e}_1 \mathbb{P}^{-1}$.

We also have that

$$\mathbb{P}^{-1} (\text{Id}_c - \mathbb{M}(\alpha)) \mathbb{P} = \text{diag}(0, \text{Id}_{c-1} - \mathbb{J})$$

where Id_d is the identity matrix of size d . Of course $\det(\text{Id}_{c-1} - \mathbb{J}) \neq 0$. Recall that \mathbb{M} is analytic at α . Hence as $z \rightarrow \alpha$,

$$\mathbb{P}^{-1} (\text{Id}_c - \mathbb{M}(z)) \mathbb{P} = \begin{bmatrix} C(\alpha - z) + o(\alpha - z) & \mathcal{O}(\alpha - z) \\ \mathcal{O}(\alpha - z) & (\text{Id}_{c-1} - \mathbb{J}) + \mathcal{O}(\alpha - z) \end{bmatrix},$$

where $C = (\mathbb{P}^{-1} \mathbb{M}'(\alpha) \mathbb{P})_{11} = \tau \mathbf{e}_1 \mathbb{P}^{-1} \mathbb{M}'(\alpha) \mathbb{P} \mathbf{e}_1 = \tau \mathbf{u} \mathbb{M}'(\alpha) \mathbf{v}$, $\mathbb{M}'(z)$ being the component-wise derivative of $\mathbb{M}(z)$. This last quantity is positive since \mathbf{u} and \mathbf{v} have positive coefficients and $\mathbb{M}'(\alpha)$ is a nonnegative matrix and is not equal to zero. Now we deduce that

$$\det(\text{Id}_c - \mathbb{M}(z)) = C \det(\text{Id}_{c-1} - \mathbb{J})(\alpha - z) + o(\alpha - z).$$

This implies that we can find a neighborhood $B(\alpha, \epsilon)$ of α such that $(\text{Id} - \mathbb{M}(z))^{-1}$ can be analytically continued on $B(\rho, \epsilon) \setminus \{\rho\}$. We also estimate the transpose of the cofactor matrix as follows:

$$\text{Com}(\mathbb{P}^{-1}(\text{Id}_c - \mathbb{M}(z))\mathbb{P})^t = \begin{bmatrix} \det(\text{Id}_{c-1} - \mathbb{J}) + \mathcal{O}(\alpha - z) & \mathcal{O}(\alpha - z) \\ \mathcal{O}(\alpha - z) & \mathcal{O}(\alpha - z) \end{bmatrix}.$$

Now we can estimate the inverse of our matrix:

$$(\mathbb{P}^{-1}(\text{Id}_c - \mathbb{M}(z))\mathbb{P})^{-1} = \frac{\text{Com}(\mathbb{P}^{-1}(\text{Id}_c - \mathbb{M}(z))\mathbb{P})^t}{\det(\text{Id}_c - \mathbb{M}(z))} \sim \frac{1}{C(\alpha - z)} \begin{bmatrix} 1 + o(1) & o(1) \\ o(1) & o(1) \end{bmatrix}$$

And

$$(\text{Id}_c - \mathbb{M}(z))^{-1} = \frac{1}{C(\alpha - z)} \mathbb{P}^{-1} \left(\begin{bmatrix} 1 & 0 \\ 0 & 0 \end{bmatrix} + o(1) \right) \mathbb{P} = \frac{\mathbf{v}^\top \mathbf{u} + o(1)}{C(\alpha - z)}.$$

Consequently the entries are divergent series at $z = \alpha$, therefore $\alpha = \rho$. This gives the asymptotics in Equation (5.14) for $(\text{Id}_c - \mathbb{M}(z))^{-1}$ near ρ .

We are left to show that the aperiodicity condition implies that there is no other singularity than ρ on the circle of convergence for $(\text{Id}_c - \mathbb{M}(z))^{-1}$. Let $z \neq \rho$, $|z| = \rho$. We just need to show that $(\text{Id}_c - \mathbb{M}(z))$ is invertible. Since we only have positive series, we have the coefficient-wise inequality $|\mathbb{M}(z)| \leq \mathbb{M}(\rho)$. Since the g.c.d. of the periods of the coefficients of \mathbb{M} is 1, it follows from the Daffodil lemma lemma A.1.1 the inequality is strict in at least one coefficient. Then from Perron-Frobenius theorem we know that $\text{SR}_{|\mathbb{M}(z)|} < \text{SR}_{\mathbb{M}(\rho)} = 1$. Using $\text{SR}_{\mathbb{M}} \leq \text{SR}_{|\mathbb{M}|}$ we conclude on the invertibility of $(\text{Id} - \mathbb{M}(z))$ around z .

The existence of a Δ -domain at ρ follows from a classic compactness argument (see e.g. [Drm09, end of proof of Theorem 2.19]). \square

5.4.2. Nonlinear systems and Drmota-Lalley-Woods theorem. In this section we state and prove a version of the Drmota-Lalley-Woods theorem. In a classical form [FS09, Theorem VII.6, p.489], it entails that polynomial, irreducible and nonlinear tree-specifications lead to a common square-root singularity for all series. Our result (Theorem 5.4.5) is based on a version by Drmota [Drm09, Theorem 2.33], which is stated for analytic specifications, under a suitable analyticity condition. We explicitly computed the constants of the square-root term $\sqrt{\rho - z}$ for the tree series, along with asymptotics written as a rank one matrix times $(\rho - z)^{-1/2}$ for the natural transfer matrix associated to the system.

The version of Drmota considers series with an additional counting parameter, which we dropped as it is not needed for our purposes. Also, the combinatorial assumptions on the system that ensure uniqueness of the solution differ from ours, as will be discussed in the proof of Theorem 5.4.5.

Theorem 5.4.5. *Consider a proper system of equations Equation (E) for multitype leaf-counted trees. Assume it is irreducible and nonlinear. Let ρ be the common radius of convergence of the series in \mathbf{Y} . Then $\rho \in (0, \infty)$ and $\mathbf{Y}(\rho) < \infty$.*

The two following assertions are then equivalent:

- i) There exists (z_0, \mathbf{y}_0) in the region of convergence of Φ , such that $\mathbf{y}_0 = \Phi(z_0, \mathbf{y}_0)$ and $\mathbb{M}(z_0, \mathbf{y}_0)$ has dominant eigenvalue 1.*
- ii) $(\rho, \mathbf{Y}(\rho))$ belongs to the interior of the region of convergence of Φ .*

And if these conditions hold, then $z_0 = \rho$ and $\mathbf{y}_0 = \mathbf{Y}(\rho)$, and

- iii) $\mathbb{M}(\rho, \mathbf{Y}(\rho))$ is an irreducible matrix with Perron eigenvalue 1.*
- iv) all entries of \mathbf{Y} and $(\text{Id} - \mathbb{M}(z, \mathbf{Y}(z)))^{-1}$ have radius of convergence ρ and are analytic on a Δ -neighborhood of ρ .*

Denote by \mathbf{u} and \mathbf{v} the left and right eigenvectors of $\mathbb{M}(\rho, \mathbf{Y}(\rho))$ for the eigenvalue 1, chosen positive and normalized so that $\mathbf{u}^\top \mathbf{u} = 1$ and $\mathbf{v}^\top \mathbf{u} = 1$. Let

$$\forall 1 \leq i, j, j' \leq c, \quad H_{i,j,j'}(z) = \left. \frac{\partial^2 \Phi_i}{\partial y_j \partial y_{j'}}(z, \mathbf{y}) \right|_{\mathbf{y}=\mathbf{Y}(z)} \quad \text{and} \quad \mathbf{U}(z) = \left. \frac{\partial \Phi}{\partial z}(z, \mathbf{y}) \right|_{\mathbf{y}=\mathbf{Y}(z)}$$

Defining the following positive constants,

$$\beta = \sqrt{\mathbf{u}^\top \mathbf{U}(\rho)}, \quad Z = \frac{1}{2} \sum_{i,j,j' \leq c} u_i v_j v_{j'} H_{i,j,j'}(\rho), \quad \zeta = \sqrt{Z},$$

we then have the following asymptotics near ρ :

$$(5.15) \quad \mathbf{Y}(z) = \mathbf{Y}(\rho) - \frac{\beta \mathbf{v}}{\zeta} \sqrt{\rho - z} + o(\sqrt{\rho - z}),$$

$$(5.16) \quad \mathbf{Y}'(z) \sim \frac{\beta \mathbf{v}}{2\zeta \sqrt{\rho - z}},$$

$$(5.17) \quad (\text{Id} - \mathbb{M}(z, \mathbf{Y}(z)))^{-1} \sim \frac{\mathbf{v}^\top \mathbf{u}}{2\beta \zeta \sqrt{\rho - z}}.$$

Finally if all series $Y_i(z)$ are aperiodic, then ρ is the unique dominant singularity of the Y_i 's and of the series in $(\text{Id} - \mathbb{M}(z, \mathbf{Y}(z)))^{-1}$, and these series are analytic on a Δ -domain at ρ .

PROOF. Firstly $\rho > 0$ because the equation is analytically invertible near $z = 0$ by virtue of the analytic implicit function theorem [FS09, Thm B.6] and $\mathbb{M}(0) = \mathbb{O}$. Iterating Φ enough and using irreducibility and the branching property, we get that each Y_i depends positively and nonlinearly on every other Y_j 's. More precisely for each Y_i , there exist $c > 0$ and $k \geq 0$ such that $cz^k Y_i^2$ is coefficient-wise dominated by Y_i . So $Y_i(\rho)$ must be finite hence ρ too.

For $0 \leq t \leq \rho$, let us now set $\lambda(t) = \text{SR}_{\mathbb{M}(t, \mathbf{Y}(t))}$. By Perron-Frobenius theorem, this is an increasing, continuous function. We will show that statement ii) implies statement i). Assume that Φ is analytic at $(\rho, \mathbf{Y}(\rho))$, and suppose that $\lambda(\rho) < 1$. Then $\det(\text{Id} - \mathbb{M}(\rho, \mathbf{Y}(\rho))) \neq 0$, and the analytic implicit function theorem would imply that \mathbf{Y} could be continued on a neighborhood of ρ . Thanks to Pringsheim's theorem [FS09, Thm IV.5], this is in contradiction with the fact that ρ is the radius of convergence of \mathbf{Y} . Hence the $\lambda(\rho) \geq 1$, and there exists $z_0 \leq \rho$ such that $\lambda(z_0) = 1$ as stated in i).

For the rest of the proof, we assume statement i). We apply Theorem 2.33 of [Drm09]. The hypotheses of this theorem are all verified, except (in our notation) $\Phi(0, \mathbf{y}) = 0$, which we replaced by the weaker one $\mathbb{M}(0, \mathbf{0}) = 0$. In the proof of Drmota, this hypothesis was only used to guarantee the uniqueness of the solution \mathbf{Y} as a formal power series in z . However as we saw, proper system of equations for multitype leaf-counted trees enjoy uniqueness of the solution, when restricted to series with no constant term. As a result, Theorem 2.33 of [Drm09] guarantees that $z_0 = \rho$ and $\mathbf{y}_0 = \mathbf{Y}(\rho)$ (hence statements ii) and iii)), and that \mathbf{Y} can be continued on a Δ -neighborhood of ρ . It also implies that there exists a positive vector \mathbf{c} such that the following asymptotics holds:

$$(5.18) \quad \mathbf{Y}(z) = \mathbf{Y}(\rho) - (\mathbf{c} + o(1))\sqrt{\rho - z}.$$

Since $\lambda(\rho) = 1$, the radius of convergence of $(\text{Id} - \mathbb{M}(z, \mathbf{Y}(z)))^{-1}$ is at least ρ . We will now compute the precise asymptotics of $(\text{Id} - \mathbb{M}(z, \mathbf{Y}(z)))^{-1}$ and $\mathbf{Y}(z)$ when z is near ρ . The fact that $(\text{Id} - \mathbb{M}(z, \mathbf{Y}(z)))^{-1}$ can be analytically continued on a Δ -neighborhood of ρ will be obtained as a byproduct of this derivation.

Let us denote $\mathbb{A} = \mathbb{M}(\rho, \mathbf{Y}(\rho))$. This is an irreducible nonnegative matrix with Perron eigenvalue 1. As in the linear case, the Perron-Frobenius theorem provides corresponding left and right positive eigenvectors \mathbf{u} and \mathbf{v} normalized so that $\mathbf{v}^\top \mathbf{u} = 1$. Let also \mathbb{P} be a Jordanization basis for \mathbb{A} , so that $\mathbb{P}^{-1} \mathbb{A} \mathbb{P} = \text{diag}(1, \mathbb{T})$, and \mathbb{T} is some Jordan matrix

with spectral radius ≤ 1 that does not admit 1 as an eigenvalue. Necessarily $\mathbb{P}\mathbf{e}_1 = \mathbf{v}$ and ${}^t\mathbf{u} = {}^t\mathbf{e}_1\mathbb{P}^{-1}$.

We get that $\mathbb{P}^{-1}(\text{Id}_c - \mathbb{A})\mathbb{P} = \text{diag}(0, \text{Id}_{c-1} - \mathbb{T})$, and $\det(\text{Id}_{c-1} - \mathbb{T}) \neq 0$. Recall that each coefficient of the matrix $\mathbb{M}(z, \mathbf{y})$ is analytic at $(\rho, \mathbf{Y}(\rho))$. Hence as $z \rightarrow \rho$,

$$\begin{aligned} M_{i,j}(z, \mathbf{Y}(z)) &= M_{i,j}(\rho, \mathbf{Y}(\rho)) - \frac{\partial M_{i,j}}{\partial z}(\rho, \mathbf{Y}(\rho))(\rho - z)(1 + o(1)) \\ &\quad - \sum_{j'=1}^c \frac{\partial M_{i,j}}{\partial y_{j'}}(\rho, \mathbf{Y}(\rho))(Y_{j'}(\rho) - Y_{j'}(z))(1 + o(1)) \end{aligned}$$

The second term, which is linear, is dominated by the third one, whose square-root behavior is given by Equation (5.18). Also, we have

$$\frac{\partial M_{i,j}}{\partial y_{j'}}(z, \mathbf{Y}(z)) = \frac{\partial \Phi_i}{\partial y_j \partial y_{j'}}(z, \mathbf{Y}(z)) = H_{i,j,j}(z).$$

Note that the nonlinearity of Φ implies that at least one of the series $H_{i,j,j}$ is nonzero.

Collecting everything we get the following asymptotics near ρ for entries of the matrix $\mathbb{M}(z, \mathbf{Y}(z))$:

$$M_{i,j}(z, \mathbf{Y}(z)) = A_{ij} - \sqrt{\rho - z} \sum_{j'=1}^c H_{i,j,j'}(\rho) c_{j'} + o(\sqrt{\rho - z}).$$

Hence as $\rho \rightarrow z$, we have the following asymptotics written in block-decomposition:

$$\begin{aligned} \mathbb{P}^{-1}(\text{Id}_c - \mathbb{M}(z, \mathbf{Y}(z)))\mathbb{P} &= \begin{bmatrix} 0 & 0 \\ 0 & \text{Id}_{c-1} - \mathbb{T} \end{bmatrix} + \mathbb{P}^{-1}(\mathbb{A} - M(z, \mathbf{Y}(z)))\mathbb{P} \\ &= \begin{bmatrix} (C + o(1))\sqrt{\rho - z} & \mathcal{O}(\sqrt{\rho - z}) \\ \mathcal{O}(\sqrt{\rho - z}) & (\text{Id}_{c-1} - \mathbb{T}) + \mathcal{O}(\sqrt{\rho - z}) \end{bmatrix}, \end{aligned}$$

where

$$C = \lim_{z \rightarrow \rho} \left(\mathbb{P}^{-1} \frac{\mathbb{A} - \mathbb{M}(z, \mathbf{Y}(z))}{\sqrt{\rho - z}} \mathbb{P} \right)_{11} = \lim_{z \rightarrow \rho} {}^t\mathbf{u} \frac{\mathbb{A} - \mathbb{M}(z, \mathbf{Y}(z))}{\sqrt{\rho - z}} \mathbf{v} \approx \sum_{i,j,j' \leq c} u_i v_j c_{j'} H_{i,j,j'}(\rho).$$

We then proceed as in the linear case. The asymptotic estimate of the determinant near ρ

$$\det(\text{Id}_c - \mathbb{M}(z)) = C \det(\text{Id}_{c-1} - \mathbb{T}) \sqrt{\rho - z} + o(\sqrt{\rho - z}).$$

shows it does not vanish on a punctured neighborhood of ρ . Hence $(\text{Id} - \mathbb{M}(z, \mathbf{Y}(z)))$ is invertible on a (possibly smaller) Δ -neighborhood of ρ . Then using the comatrix formula for the inverse, we obtain

$$(5.19) \quad (\text{Id} - \mathbb{M}(z, \mathbf{Y}(z)))^{-1} \sim \frac{\mathbf{v} {}^t\mathbf{u}}{C \sqrt{\rho - z}}.$$

We proceed to transfer this asymptotics into asymptotics for $\mathbf{Y}'(z)$. Differentiation of the relation (E) yields

$$\begin{aligned} \mathbf{Y}'(z) &= \frac{\partial \Phi}{\partial z}(z, \mathbf{y}) \Big|_{\mathbf{y}=\mathbf{Y}(z)} + \text{Jac}_{\mathbf{y}} \Phi(z, \mathbf{y}) \Big|_{\mathbf{y}=\mathbf{Y}(z)} \cdot \mathbf{Y}'(z) \\ &= \mathbf{U}(z) + \mathbb{M}(z, \mathbf{Y}(z)) \mathbf{Y}'(z). \end{aligned}$$

Note that the assumptions on our system in Definition 5.4.1 guarantee that $\mathbf{U}(z)$ is nonzero. Hence

$$(5.20) \quad \mathbf{Y}'(z) = (\text{Id} - \mathbb{M}(z, \mathbf{Y}(z)))^{-1} \mathbf{U}(z).$$

Now, since \mathbf{U} is convergent at ρ , with Equation (5.19), we obtain

$$(5.21) \quad \mathbf{Y}'(z) \sim \frac{{}^t\mathbf{u} \mathbf{U}(\rho)}{C} \frac{\mathbf{v}}{\sqrt{\rho - z}} = \frac{\beta^2}{C} \frac{\mathbf{v}}{\sqrt{\rho - z}}.$$

Since \mathbf{Y} is analytic on a Δ -neighborhood at ρ , singular differentiation theorem A.3.1 of Equation (5.18) yields

$$\mathbf{Y}'(z) \sim \frac{\mathbf{c}}{2\sqrt{\rho-z}}.$$

We can identify the constants in the two expressions and get $\mathbf{c} = \frac{2\beta^2}{C}\mathbf{v}$, which can be reinjected in the definition of C , yielding $C^2 = 2\beta^2 \sum_{i,j,j' \leq c} u_i v_j v_{j'} H_{i,j,j}(\rho) = 4\beta^2 Z$ and then $C = 2\beta\zeta$. Substituting this value for C into Equations (5.18), (5.19) and (5.21) yields the desired asymptotics.

We shall now show that there is no other singularity on the circle of convergence under the aperiodicity condition, in a similar fashion to the linear case. Let $z \neq \rho$ be such that $|z| = \rho$. By the Daffodil lemma lemma A.1.1, we have $|\mathbf{Y}(z)| < \mathbf{Y}(\rho)$. Hence $\text{SR}_{\mathbb{M}(z, \mathbf{Y}(z))} \leq \text{SR}_{\mathbb{M}(|z|, |\mathbf{Y}(z)|)} < \text{SR}_{\mathbb{M}(\rho, \mathbf{Y}(\rho))} = 1$. By the multivariate analytic implicit function theorem [FS09, Thm B.6], this implies that \mathbf{Y} is analytic near z . And $(\text{Id} - \mathbb{M}(w, \mathbf{Y}(w)))$ is then invertible near z . The existence of a Δ -domain at ρ once again follows from a classic compactness argument. \square

Universal limits of substitution-closed permutation classes

This chapter comes from the article [Bas+20], a joint work with F. Bassino, M. Bouvel, V. Féray, L. Gerin et A. Pierrot. It was thoroughly rewritten to take advantage of the framework developed in our subsequent article [Bas+19b], already presented in Chapter 5.

ABSTRACT. We consider uniform random permutations in proper substitution-closed classes and study their limiting behavior in the sense of permutons. The limit depends on the generating series of the simple permutations in the class. Under a mild sufficient condition, the limit belongs to the one-parameter family of biased Brownian separable permutons. This limiting object is therefore in some sense universal. We identify two other regimes with different limiting objects. The first one is degenerate; the second one is nontrivial and related to stable trees.

These results are obtained thanks to a characterization of the convergence of random permutons through the convergence of their expected pattern densities. The limit of expected pattern densities is then computed by using the substitution tree encoding of permutations and performing singularity analysis on the tree series.

6.1. Introduction

In this chapter, we consider substitution-closed families of permutations $\mathcal{T} = [\mathcal{S}]$, where \mathcal{S} is a subset of the simple permutations. By definition, such families enjoy the following specification with regards to the substitution-decomposition:

$$(6.1) \quad \begin{cases} \mathcal{T} &= \{\bullet\} \uplus \oplus[\mathcal{T}^{\text{not}\oplus}, \mathcal{T}] \uplus \ominus[\mathcal{T}^{\text{not}\ominus}, \mathcal{T}] \uplus (\uplus_{\pi \in \mathcal{S}} \pi[\mathcal{T}, \dots, \mathcal{T}]) \\ \mathcal{T}^{\text{not}\oplus} &= \{\bullet\} \uplus \ominus[\mathcal{T}^{\text{not}\ominus}, \mathcal{T}] \uplus (\uplus_{\pi \in \mathcal{S}} \pi[\mathcal{T}, \dots, \mathcal{T}]) \\ \mathcal{T}^{\text{not}\ominus} &= \{\bullet\} \uplus \oplus[\mathcal{T}^{\text{not}\oplus}, \mathcal{T}] \uplus (\uplus_{\pi \in \mathcal{S}} \pi[\mathcal{T}, \dots, \mathcal{T}]). \end{cases}$$

These families are actually more general than substitution-closed permutation classes. More precisely, the following result holds:

Proposition 6.1.1 (Proposition 3 and Corollary 3, [AA05]). *Let \mathcal{C} be a family of permutations. The following assertions are equivalent.*

- i) \mathcal{C} is a permutation class closed under the substitution operation, which is neither $\text{Av}(12)$ nor $\text{Av}(21)$.*
- ii) $\mathcal{C} = [\mathcal{S}]$ with \mathcal{S} a downwards-closed set of simple permutations, that is if $\alpha \in \mathcal{S}$, and α' is a simple permutation such that $\alpha' \preceq \alpha$, then $\alpha' \in \mathcal{S}$.*
- iii) $\mathcal{C} = \text{Av}(B)$ with B a set of simple permutations.*

Among substitution-closed classes, we see that the case of $\text{Av}(12)$ and $\text{Av}(21)$ is left aside. However their limiting behavior in terms of permutons is trivial: the anti-diagonal and the diagonal respectively. Similarly, we shall always make the assumption that the radius of convergence $R_{\mathcal{S}}$ of the generating function $S(u) = \sum_{\alpha \in \mathcal{S}_{\mathcal{T}}} u^{|\alpha|}$ of \mathcal{S} is nonzero. This is not a very restrictive assumption for substitution-closed classes. Indeed, $\mathcal{S} \subset [\mathcal{S}]$, and thanks to the Marcus-Tardös Theorem [MT04], the only class that grows superexponentially is \mathfrak{S} , whose limit permuton is the uniform measure on the square. These assumptions are not trivial for general families $[\mathcal{S}]$, but we leave these cases open.

We may now state our main theorem, starting with a small combinatorial definition. For a permutation θ , we set

$$(6.2) \quad \text{Occ}_\theta(z) = \sum_{\alpha \in \mathcal{S}} \text{occ}(\theta, \alpha) z^{|\alpha| - |\theta|}.$$

Observation 6.1.2. For $d \geq 1$ and any fixed α , $\sum_{\theta \in \mathfrak{S}_d} \text{occ}(\theta, \alpha) = \binom{|\alpha|}{d}$. Therefore $\sum_{\theta \in \mathfrak{S}_d} \text{Occ}_\theta$ is related to the d -th derivative of S by $\sum_{\theta \in \mathfrak{S}_d} \text{Occ}_\theta = \frac{S^{(d)}}{d!}$. This implies that the radius of convergence of each Occ_θ is at least R_S , the radius of convergence of S .

Theorem 6.1.3. *Let \mathcal{S} be a set of simple permutations such that*

$$(H1) \quad R_S > 0 \quad \text{and} \quad S'(R_S) > \frac{2}{(1 + R_S)^2} - 1.$$

For every $n \geq 1$, let σ_n be a uniform permutation in $\langle \mathcal{S} \rangle_n$, and let μ_{σ_n} be the random permuton associated with σ_n . The sequence $(\mu_{\sigma_n})_n$ tends in distribution in the weak convergence topology to the biased Brownian separable permuton $\mu^{(p_{12})}$ of parameter p_{12} (see Definition 4.2.1) where

$$(6.3) \quad p_\varepsilon = \frac{(1 + \kappa)^3 \text{Occ}_\varepsilon(\kappa) + 1}{(1 + \kappa)^3 (\text{Occ}_{12}(\kappa) + \text{Occ}_{21}(\kappa)) + 2}, \varepsilon \in \{12, 21\}$$

and κ is the unique point such that $S'(\kappa) = \frac{2}{(1 + \kappa)^2} - 1$ (by condition (H1), $0 < \kappa < R_S$)

We now give several cases in which Condition (H1) of Theorem 6.1.3 is satisfied.

- If S is a generating function with radius of convergence $R_S > \sqrt{2} - 1$, (H1) is satisfied. Indeed, the condition $R_S > \sqrt{2} - 1$ implies $\frac{2}{(1 + R_S)^2} - 1 < 0$, and $S'(R_S)$ is nonnegative since S' (like S) is a series with nonnegative coefficients. In particular, the situation where $R_S > \sqrt{2} - 1$ covers the cases where there are finitely many simple permutations in the class (then S is a polynomial and $R_S = \infty$), and more generally where $R_S = 1$ (i.e. the number of simple permutations of size n grows subexponentially).
- If S' is divergent at R_S , (H1) is trivially verified. In particular, this happens when S is a rational generating function, or when S has a square root singularity at R_S .

In the literature, there are quite a few examples of permutations classes whose set \mathcal{S} of simple permutations has been enumerated. We can therefore ask whether Condition (H1) applies to them. In most examples we could find, it is indeed satisfied, and this follows from the discussion above. We record these examples here.

- Classes with finitely many simple permutations have attracted a fair amount of attention, see [AA05] and subsequently [BBPR15; BMN20; BRV08].
- Several families of simple permutations with a bounded number of elements of each size have appeared in the literature: the family of exceptional simple permutations (also called simple parallel alternations in [Bri10]), the family of wedge simple permutations (see also [Bri10]), the families of oscillations and quasi-oscillations (see [BBR11]), and the families of simple permutations contained in the following three classes: $\text{Av}(4213, 3142)$, $\text{Av}(4213, 1342)$ and $\text{Av}(4213, 3124)$ – see [AAV14].
- The family of simple pin-permutations has a rational generating function – see [BBR11].
- The generating function S is also rational when \mathcal{S} is the set of simple permutations contained in several permutation classes defined by the avoidance of two patterns of size 4, namely $\text{Av}(3124, 4312)$ – see [Pan17], $\text{Av}(2143, 4312)$ and $\text{Av}(1324, 4312)$ – see [AAB12], $\text{Av}(2143, 4231)$ – see [AAB11], $\text{Av}(1324, 4231)$ – see [AAV09], $\text{Av}(4312, 3142)$ and $\text{Av}(4231, 3124)$ – see [AAV14].

- The set \mathcal{S} of simple permutations of the class $\text{Av}(4231, 35142, 42513, 351624)$ enumerated in [AB14] is also rational.
- We come back to the above example, where \mathcal{C} is the substitution of $\text{Av}(321)$. This class has been studied in [ARS11], where an explicit basis of avoided patterns is given. In this case, \mathcal{S} is the set of simple permutations avoiding 321, whose generating function S is computed in [AV13]: it has a square-root singularity at $R_S = \frac{1}{3}$, which proves that (H1) is fulfilled.

On the contrary, we know that the substitution-closed class $\text{Av}(2413)$ cannot belong to this standard case. We discuss this in further details below, in Remark 6.5.3.

In addition to verifying Condition (H1), we are able to compute the numerical value of the parameter p for some of the above-mentioned sets \mathcal{S} of simple permutations;

Example 6.1.4. In many cases $\text{Occ}_{12} = \text{Occ}_{21}$, and then $p = 1/2$ and $\mu^{(p)}$ is the unbiased Brownian separable permutation. This is the case with separable permutations ($\mathcal{S} = \emptyset$), with $\mathcal{S} = \{2413\}$ or $\mathcal{S} = \{3142\}$, and with any set of simple permutations stable by taking reverse or complement, like $\mathcal{S} = \{2413, 3142, 24153, 42513\}$ in the figure above.

Example 6.1.5. When \mathcal{S} is the family of increasing oscillations (see for instance [BBR11]), we can compute

$$S(z) = \frac{2z^4}{1-z}; \quad \text{Occ}_{12}(z) = \frac{2z^2(3-3z+z^2)}{(1-z)^3}; \quad \text{Occ}_{21}(z) = \frac{2z^2(3-2z)}{(1-z)^2}.$$

We get through numerical approximation $\kappa \approx 0.2709$ and deduce $p \approx 0.5353$.

Example 6.1.6. Taking \mathcal{S} to be the family of simple permutations in $\text{Av}(321)$, we are interested in the class $\mathcal{C} = \langle \mathcal{S} \rangle$ which is the substitution-closure of $\text{Av}(321)$. In this case, [AV13] gives

$$S(z) = \frac{1-z-2z^2-2z^3-\sqrt{1-2z-3z^2}}{2+2z}.$$

We get through numerical approximation $\kappa \approx 0.2486$. It seems hard to compute the generating series Occ_{12} , but we can locate its value at κ by exhaustively computing the number of inversions of each permutation in \mathcal{S} up to a certain order N , and controlling the rest of the series using the fact that a permutation of size n in $\text{Av}(321)$ cannot have more than $n^2/4$ inversions¹. Performing this with $N = 12$ yields $p \in [0.577, 0.622]$.

Outline of the chapter. In Section 6.2, we examine the specification Equation (6.1) in the framework of Chapter 5. In Section 6.3, we prove Theorem 6.1.3, along with a discussion about the rate of growth of pattern densities in this case (Section 6.3.3). In Section 6.4, we state and analyze the additional assumptions that allow us to provide an asymptotic behavior when the hypotheses of the main theorem are not met. Under these strong assumptions, the degenerate and critical case are treated in respectively Section 6.5 and Section 6.6. Finally, Section 6.7 contains the analytic combinatorics lemmas that we use in our proofs. We will often deal with singularity exponents of generating series using the terminology and stability results exposed in Appendix A.4 in the appendix of this thesis.

Acknowledgements of [Bas+20]. The authors are grateful to the referees for suggestions which improved the presentation of the paper. MB and VF are partially supported by the Swiss National Science Foundation, under grants number 200021-172536 and 200020-172515. LG's research is supported by ANR grants GRAAL (ANR-14-CE25-0014) and PPPP (ANR-16-CE40-0016).

1. Permutations avoiding 321 consist of two increasing subsequences. The number of inversions of $\sigma \in \text{Av}(321)$ of size n is therefore at most $\max_{0 \leq k \leq n} k(n-k) \leq \frac{n^2}{4}$. The claim follows.

6.2. Generalities

The specification (6.1) is a specific instance of the tree-specifications studied in Chapter 5 (see Definition 5.2.1). If we write $\mathbf{T} = (T, T_{\text{not}\oplus}, T_{\text{not}\ominus}) = (T_i)_{i \in I}$ with $I = \{\emptyset, \text{not}\oplus, \text{not}\ominus\}$, then we have a translation into generating functions:

$$(6.4) \quad \mathbf{T}(z) = \Phi(z, \mathbf{T}(z)) \iff \begin{cases} T & = z + T^{\text{not}\oplus}T + T^{\text{not}\ominus}T + S(T) \\ T^{\text{not}\oplus} & = z + T^{\text{not}\ominus}T + S(T) \\ T^{\text{not}\ominus} & = z + T^{\text{not}\oplus}T + S(T). \end{cases},$$

Recalling the definition of \mathbb{M} from Equation (5.3), we have

$$(6.5) \quad \mathbb{M}(z, \mathbf{T}(z)) = \begin{pmatrix} T_{\text{not}\oplus} + T_{\text{not}\ominus} + S'(T) & T & T \\ T_{\text{not}\ominus} + S'(T) & 0 & T \\ T_{\text{not}\oplus} + S'(T) & T & 0 \end{pmatrix}.$$

Recalling the definition of multiply blossoming trees from Definition 5.3.4, we easily see that for $\ell \geq 2$ and $i, j_1, \dots, j_\ell \in I$,

$$(6.6) \quad E_{i, j_1, \dots, j_\ell}^\pi = \begin{cases} \text{Occ}_\pi(T) & \text{if } j_1 = \dots = j_\ell = \emptyset \\ 1 & \text{if } \pi = \ominus, i \neq \text{not}\ominus, j_1 = \text{not}\ominus \text{ and } j_2 = \emptyset \\ 1 & \text{if } \pi = \oplus, i \neq \text{not}\oplus, j_1 = \text{not}\ominus \text{ and } j_2 = \emptyset \\ 0 & \text{otherwise} \end{cases}$$

Recall the definition of simply blossoming trees and the matrix of series $\mathbb{T} = (T_i^j)_{i, j \in I}$ from Definition 5.3.1. We recall equation (5.5):

$$(6.7) \quad \mathbb{T} = (\text{Id} - \mathbb{M}(z, \mathbf{T}(z)))^{-1}$$

and observe that equation (5.6) has the following interesting consequence in our case (observing that $\varepsilon_\emptyset = \varepsilon_{\text{not}\oplus} = \varepsilon_{\text{not}\ominus} = 1$):

$$(6.8) \quad T' = T_\emptyset^\emptyset + T_\emptyset^{\text{not}\oplus} + T_\emptyset^{\text{not}\ominus}.$$

6.3. The standard case $S'(R_S) > 2/(1 + R_S)^2 - 1$

We now move to the proof of Theorem 6.1.3.

6.3.1. Asymptotics of series of blossoming trees. The first step is to apply the Drmota-Lalley-Wood theorem to the system (6.4), the consequences of which we collect in the following lemma.

Lemma 6.3.1. *Assume hypothesis (H1). Then all entries $\mathbb{T}(z)$ and $\mathbf{T}(z)$ have a unique dominant singularity at ρ and the following asymptotics hold on a Δ -neighborhood of ρ :*

$$(6.9) \quad \mathbf{T}(z) = \mathbf{T}(\rho) - \frac{\mathbf{v}}{\zeta} \sqrt{\rho - z} + o(\sqrt{\rho - z})$$

$$(6.10) \quad (\mathbf{T})'(z) \sim \frac{\mathbf{v}}{2\zeta \sqrt{\rho - z}}$$

$$(6.11) \quad \mathbb{T}(z) \sim \frac{\mathbf{v}^\top \mathbf{u}}{2\zeta \sqrt{\rho - z}}$$

Here $\mathbf{T}(\rho) = (\kappa, \frac{\kappa}{1+\kappa}, \frac{\kappa}{1+\kappa})$, \mathbf{u} and \mathbf{v} are the positive vectors that verify the normalizations ${}^\top \mathbf{u} \mathbf{1} = 1$ and ${}^\top \mathbf{u} \mathbf{v} = 1$ such that

$$(6.12) \quad \mathbf{u} \propto (1, \kappa/(1 + \kappa), \kappa/(1 + \kappa)), \quad \mathbf{v} \propto ((1 + \kappa)^2, 1, 1).$$

and

$$(6.13) \quad Z = \frac{1}{2} \sum_{i, j, j' \in I} u_i v_j v_{j'} \frac{\partial \Phi_i}{\partial y_j \partial y_{j'}}(\rho, \mathbf{T}(\rho)), \quad \zeta = \sqrt{Z}.$$

(recall that κ was defined in the statement of Theorem 6.1.3, and Φ in (6.4))

PROOF. We apply Theorem 5.4.5 to the system (6.4), which is a proper system for leaf-counted multitype trees, as is any system of the form Equation (E_T) (see the discussion under Definition 5.4.1). By direct examination, it is clearly irreducible and nonlinear. Now one needs to find (z_0, \mathbf{y}_0) as in hypothesis i) of Theorem 5.4.5.

By algebraic manipulation of the system (6.4), one notices that $T_{\text{not}\oplus} = T_{\text{not}\ominus} = \frac{T}{1+T}$. As a result, T verifies the equation $z + \frac{2T^2}{1+T} + S(T) - T = 0$. The derivative of this system in the variable T is $2\frac{T^2+2T}{(1+T)^2} + S'(T) - 1 = 1 - \frac{2}{(1+T)^2} - S'(T)$. We remark that under hypothesis (H1), setting $T = \kappa$ makes this derivative vanish. In view of the analytic implicit function theorem (Lemma A.5.1), such a point is a good candidate for being the value of T at the singularity ρ .

This discussion leads us to consider $z_0 = \frac{2\kappa^2}{1+\kappa} + S(\kappa) - \kappa$ and $\mathbf{y} = (\kappa, \frac{\kappa}{1+\kappa}, \frac{\kappa}{1+\kappa})$. Since $\kappa < R_S$, it is immediate that the region of convergence of Φ contains (z_0, \mathbf{y}_0) . Moreover, we indeed have that $\mathbf{y}_0 = \Phi(z_0, \mathbf{y}_0)$ by plugging into (6.4).

Plugging (z_0, \mathbf{y}_0) into (6.5), we get that

$$\mathbb{M}(z_0, \mathbf{y}_0) = \begin{pmatrix} \frac{2\kappa}{1+\kappa} + \frac{2}{(1+\kappa)^2} - 1 & \kappa & \kappa \\ \frac{\kappa}{1+\kappa} + \frac{2}{(1+\kappa)^2} - 1 & 0 & \kappa \\ \frac{\kappa}{1+\kappa} + \frac{2}{(1+\kappa)^2} - 1 & \kappa & 0 \end{pmatrix}.$$

A computer algebra system gives us that the eigenvalues are $(1, \kappa, \kappa \frac{(\kappa-1)^2}{(\kappa+1)^2})$. Since $\kappa \in (0, 1)$, the dominant eigenvalue is 1. As a result, Theorem 5.4.5 applies, and the claims of the lemma follow, upon remarking that the eigenvalue 1 admits \mathbf{u} and \mathbf{v} as left and right eigenvectors, and that $\partial_z \Phi = (1, 1, 1)$ in our case, so $\beta = 1$. \square

6.3.2. Probability of tree patterns. Let t_0 be a substitution tree with $k \geq 2$ leaves and e edges.

We denote by $\text{db}(t_0)$ the default of binarity of t_0 , defined as follows:

$$(6.14) \quad \text{db}(t_0) = e - 2k + 2 = \sum_{v \in \text{Int}(t_0)} (\deg(v) - 2).$$

Proposition 6.3.2. *Assume hypothesis (H1). Let \mathbf{t}_n be a uniform random tree of size n in \mathcal{T} . Let $\mathbf{I}_{n,k}$ be an independent uniform random subset of $[1, n]$ of size k . If $\text{Occ}_\alpha > 0$ for every $\alpha \notin \{\oplus, \ominus\}$ that appears on an internal node of t_0 , then there is a positive constant C_{t_0} such that*

$$\mathbb{P}(\mathbf{t}_n | \mathbf{I}_{n,k} = t_0) \sim C_{t_0} n^{-\text{db}(t_0)/2}$$

Otherwise, $\mathbb{P}(\mathbf{t}_n | \mathbf{I}_{n,k} = t_0) = 0$ for all n . In particular, if t_0 is binary, then recalling the definition of p_\pm in (6.3) we have

$$(6.15) \quad \mathbb{P}(\mathbf{t}_n | \mathbf{I}_{n,k} = t_0) \xrightarrow{n \rightarrow +\infty} \frac{1}{\text{Cat}_{k-1}} \prod_{v \in \text{Int}(t_0)} p_{\varepsilon(v)}.$$

PROOF. By definition,

$$(6.16) \quad \mathbb{P}(\mathbf{t}_n | \mathbf{I}_{n,k} = t_0) = \frac{[z^{n-k}]T_{\emptyset, t_0}}{[z^{n-k}] \frac{1}{k!} T^{(k)}}.$$

We start with the denominator. By singular differentiation (Theorem A.3.1) of Equation (6.10), $T^{(k)}$ is Δ -analytic and

$$\begin{aligned} \frac{T_i^{(k)}}{k!} &\sim (\rho - z)^{1/2-k} \frac{v_\emptyset}{2\zeta} \frac{1}{2} \frac{3}{2} \cdots \frac{2k-3}{2} = (\rho - z)^{1/2-k} \frac{v_\emptyset}{\zeta} \frac{(2k-2)!}{2^k (k-1)! 2^{k-1} k!} \\ &= (\rho - z)^{1/2-k} \frac{v_\emptyset}{2^{2k-1} \zeta} \text{Cat}_{k-1}. \end{aligned}$$

We now deal with the numerator and recall the decomposition of T_{\emptyset, t_0} given by Proposition 5.3.7:

$$(6.17) \quad T_{\emptyset, t_0} = \sum_{j \in I^{\text{Int}(t_0)}} \sum_{\substack{i \in I^V(t_0) \\ i(\emptyset) = i_0}} \left[\prod_{v \in \text{Int}(t_0)} T_{i(v)}^{j(v)} \prod_{v \in \text{Lf}(t_0)} T'_{i(v)} \prod_{v \in \text{Int}(t_0)} E_{j(v)i(v.1)\dots i(v.d(v))}^{\varepsilon(v)} \right].$$

By Lemma 6.3.1, every series of the form T_i^j or T'_i is Δ -analytic with exponent $-1/2$, while every series of the form $E_{i_{j_1}, \dots, j_\ell}^\pi$ is Δ -analytic and convergent at ρ by subcritical composition (Lemma A.4.2), recalling Equation (6.6), Observation 6.1.2, and $T(\rho) = \kappa < R_S$. Hence each term of the sum T_{\emptyset, t_0} is Δ -analytic with exponent² at most $-1/2 \times (e+1)$.

Moreover, considering the term of the sum where

$$j \equiv \emptyset, \quad i(v) = \begin{cases} \text{not} \oplus & \text{if } v \text{ is the left child of a node } \oplus \\ \text{not} \ominus & \text{if } v \text{ is the left child of a node } \ominus \\ \emptyset & \text{otherwise,} \end{cases}$$

we see that none of the $E_{i_{j_1}, \dots, j_\ell}^\pi$ vanish, because by assumption $\text{Occ}_\alpha > 0$ for every α that appears in t_0 . This implies that T_{\emptyset, t_0} is Δ -analytic with exponent exactly $-1/2 \times (e+1)$.

In the specific case where t_0 is binary, we end up with

$$\begin{aligned} T_{\emptyset, t_0} &= \sum_{j \in I^{\text{Int}(t_0)}} \sum_{\substack{i \in I^V(t_0) \\ i(\emptyset) = \emptyset}} \left[\prod_{v \in \text{Int}(t_0)} T_{i(v)}^{j(v)} \prod_{v \in \text{Lf}(t_0)} T'_{i(v)} \prod_{v \in \text{Int}(t_0)} E_{j(v)i(v.1)\dots i(v.d(v))}^{\varepsilon(v)} \right] \\ &\sim \frac{1}{(\sqrt{\rho - z})^{2k-1}} \sum_{j \in I^{\text{Int}(t_0)}} \sum_{\substack{i \in I^V(t_0) \\ i(\emptyset) = \emptyset}} \left[\prod_{v \in \text{Int}(t_0)} \frac{v_{i(v)} u_{j(v)}}{2\zeta} \prod_{v \in \text{Lf}(t_0)} \frac{v_{i(v)}}{2\zeta} \prod_{v \in \text{Int}(t_0)} E_{j(v)i(v.1)i(v.2)}^{\varepsilon(v)}(\rho) \right] \\ &= \frac{v_\emptyset}{(\sqrt{\rho - z})^{2k-1} (2\zeta)^{2k-1}} \sum_{j, r, s \in I^{\text{Int}(t_0)}} \prod_{v \in \text{Int}(t_0)} E_{j(v)r(v)s(v)}^{\varepsilon(v)}(\rho) u_{j(v)} v_{r(v)} v_{s(v)} \\ &= (\rho - z)^{1/2-k} \frac{v_\emptyset}{2^{2k-1} \zeta} \prod_{v \in \text{Int}(t_0)} \frac{1}{Z} \sum_{j, r, s \in I} E_{jrs}^{\varepsilon(v)}(\rho) u_j v_r v_s \end{aligned}$$

where in the third line, the change of variable $r(v) = i(v.1)$, $s(v) = i(v.2)$ was performed, and in the fourth line, sum and product were exchanged. By examining the values of E_{jrs}^ε (6.6) and \mathbf{u} and \mathbf{v} (6.12) on one hand, and of p_ε on the other hand, we see that

$$(6.18) \quad \frac{1}{Z} \sum_{j, r, s \in I} E_{jrs}^\varepsilon(\rho) u_j v_r v_s \propto (1 + \kappa)^3 \text{Occ}_\varepsilon(\kappa) + 1 \propto p_\varepsilon, \quad \varepsilon \in \{12, 21\}$$

Moreover, by Proposition 5.3.5,

$$\sum_{\varepsilon \in \{12, 21\}} \sum_{j, r, s \in I} E_{jrs}^\varepsilon(\rho) u_j v_r v_s = \frac{1}{2} \sum_{j, r, s \in I} u_j v_r v_s \frac{\partial \Psi_j}{\partial y_r \partial y_s}(\rho, \mathbf{T}(\rho)) = Z.$$

As a result, both sides of (6.18), summed over $\varepsilon \in \{12, 21\}$, yield 1. Hence they are equal. As a result,

$$T_{\emptyset, t_0} \sim (\rho - z)^{1/2-k} \frac{v_\emptyset}{2^{2k-1} \zeta} \prod_{v \in \text{Int}(t_0)} p_{\varepsilon(v)}.$$

Finally, applying the transfer theorem in the numerator and denominator of (6.16) gives the proposition. \square

² In this chapter, we use the vocabole of singular exponents of dominant singularity explained in Appendix A.

PROOF OF THEOREM 6.1.3. We reuse the notation of the previous proposition. We notice that the right-hand side of (6.15) sums to one, when summed over binary signed trees. Hence (6.15) means that $\mathbf{t}_n|_{\mathcal{I}_{n,k}}$ converges in distribution to \mathbf{b}_{k,p_+} , a uniform binary tree with signs of bias p_+ . Now define $\sigma_n = \text{perm}(\mathbf{t}_n)$. Thanks to Lemma 5.1.11, we have

$$\text{pat}_{\mathcal{I}_{n,k}}(\sigma_n) = \text{perm}(\mathbf{t}_n|_{\mathcal{I}_{n,k}}) \xrightarrow[n \rightarrow \infty]{d} \text{perm}(\mathbf{b}_{k,p_+}).$$

Hence the theorem, thanks to Theorem 1.2.1 and Definition 4.2.1. \square

6.3.3. Occurrences of nonseparable patterns. Because of Theorem 1.2.1, a corollary of Theorem 6.1.3 is the joint convergence in distribution of the variables $\widetilde{\text{occ}}(\pi, \sigma_n)$. Because of the definition of the Brownian permuton, the limit is 0 if π is not separable. Here, we discuss more precisely the asymptotic behavior of $\widetilde{\text{occ}}(\pi, \sigma_n)$ in this case. We shall compute the order of magnitude of its moments; then present a consequence for the random variable itself.

Remark 6.3.3. We point out that for π separable, the results in this section are direct consequences of Theorem 6.1.3.

Let π be a permutation, assumed to be a subpermutation of some permutation in $[\mathcal{S}]$. We defined in the previous section the default of binarity of a tree. The default of binarity of π , denoted $\text{db}(\pi)$ is taken to be $\text{db}(t_0)$, where t_0 is the standard tree of π . Remark that $\text{db}(\pi) = 0$ if and only if π is separable. Moreover, we have the following easy result:

Lemma 6.3.4. *If t_0 is a substitution tree of π , then $\text{db}(t_0) \leq \text{db}(\pi)$. If $\sigma \preceq \tau$, then $\text{db}(\sigma) \leq \text{db}(\tau)$.*

Proposition 6.3.5. *Under the notation and hypothesis of Theorem 6.1.3, for every π that is a subpermutation of some permutation in $[\mathcal{S}]$.*

$$\mathbb{E}[\widetilde{\text{occ}}(\pi, \sigma_n)] \sim C_\pi n^{-\text{db}(\pi)/2}.$$

PROOF. Let t_0 be a decomposition tree of π . Reusing the notation of the proof above, we have

$$\mathbb{E}[\widetilde{\text{occ}}(\pi, \sigma_n)] = \mathbb{P}(\text{pat}_{\mathcal{I}_{n,k}} = \pi) = \sum_{t_0: \text{perm}(t_0) = \pi} \mathbb{P}(\mathbf{t}_n|_{\mathcal{I}_{n,k}} = t_0)$$

By Proposition 6.3.2, each term in the sum is of order no more than $n^{-\text{db}(t_0)/2}$, which is no more than $n^{-\text{db}(\pi)/2}$ by Lemma 6.3.4.

Let t_0 be the standard tree of π . Every nonbinary node α of t_0 is a subpermutation of π hence by assumption a subpermutation of an element of $[\mathcal{S}]$. Being also simple, it must be a subpermutation of an element of \mathcal{S} . Hence $\text{Occ}_\alpha > 0$ and again by Proposition 6.3.2, the order of the term corresponding to t_0 is exactly $n^{-\text{db}(t_0)/2} = n^{-\text{db}(\pi)/2}$. \square

Proposition 6.3.6. *For $\pi \in [\mathcal{S}]$ and $m \geq 1$, $\mathbb{E}[(\widetilde{\text{occ}}(\pi, \sigma_n))^m] = \Theta(n^{-\text{db}(\pi)/2})$.*

PROOF. By definition, $\widetilde{\text{occ}}(\pi, \sigma_n) = \binom{n}{k}^{-1} \sum_{I \subset [n], |I|=k} \mathbb{1}_{\text{pat}_I(\sigma_n) = \pi}$, where we use k for the size of the pattern π , as usual. Consequently,

$$\mathbb{E}[\widetilde{\text{occ}}(\pi, \sigma_n)^m] = \binom{n}{k}^{-m} \mathbb{E} \left[\sum_{\substack{I_1, \dots, I_m \subset [n] \\ \forall i, |I_i|=k}} \mathbb{1}_{\forall i, \text{pat}_{I_i}(\sigma_n) = \pi} \right].$$

We split the sum according to the different possible values of $K = \bigcup_i I_i$ and $j = |K|$. Denoting $B_{k,m}^K$ the set of possible ordered covers of K by m sets of size k , this gives

$$\mathbb{E}[\widetilde{\text{occ}}(\pi, \sigma_n)^m] = \binom{n}{k}^{-m} \mathbb{E} \left[\sum_{j=k}^{mk} \sum_{\substack{K \subset [n] \\ |K|=j}} \sum_{(I_1, \dots, I_m) \in B_{k,m}^K} \mathbb{1}_{\forall i, \text{pat}_{I_i}(\sigma_n) = \pi} \right].$$

Let us now remark that the unique increasing bijection between K and $[j]$ induces a bijection between $B_{k,m}^K$ and $B_{k,m}^{[j]}$. Let $(J_i)_{1 \leq i \leq m}$ denote the image of $(I_i)_{1 \leq i \leq m}$ by this bijection. Clearly,

$$(6.19) \quad \text{pat}_{I_i}(\boldsymbol{\sigma}_n) = \pi \iff \text{pat}_{J_i}(\text{pat}_K(\boldsymbol{\sigma}_n)) = \pi.$$

The sum can now be decomposed according to the different values of $\rho = \text{pat}_K(\boldsymbol{\sigma}_n)$ yielding

$$\begin{aligned} \mathbb{E}[\widetilde{\text{occ}}(\pi, \boldsymbol{\sigma}_n)^m] &= \binom{n}{k}^{-m} \mathbb{E} \left[\sum_{j=k}^{mk} \sum_{\substack{K \subset [n] \\ |K|=j}} \sum_{(J_1, \dots, J_m) \in B_{k,m}^{[j]}} \sum_{\rho \in \mathfrak{S}_j} \mathbb{1}_{\text{pat}_K(\boldsymbol{\sigma}_n) = \rho} \mathbb{1}_{\forall i, \text{pat}_{J_i}(\rho) = \pi} \right] \\ &= \sum_{j=k}^{mk} \sum_{(J_1, \dots, J_m) \in B_{k,m}^{[j]}} \sum_{\substack{\rho \in \mathfrak{S}_j \\ \forall i, \text{pat}_{J_i}(\rho) = \pi}} \binom{n}{k}^{-m} \binom{n}{j} \mathbb{E}[\widetilde{\text{occ}}(\rho, \boldsymbol{\sigma}_n)]. \end{aligned}$$

Since the summation index sets do not depend on n , it is enough to consider each summand separately to get the asymptotics. According to Proposition 6.3.5, the summand $\binom{n}{k}^{-m} \binom{n}{j} \mathbb{E}[\widetilde{\text{occ}}(\rho, \boldsymbol{\sigma}_n)]$ is of order $n^{j-km-\text{db}(\rho)/2}$.

Whenever Equation (6.19) holds, π is a pattern of $\rho = \text{pat}_K(\boldsymbol{\sigma}_n)$. By Lemma 6.3.4, $\text{db}(\rho) \geq \text{db}(\pi)$. Since additionally $j \leq km$, we deduce that $j - km - \text{db}(\rho)/2 \leq -\text{db}(\pi)/2$ which gives $\mathbb{E}[\widetilde{\text{occ}}(\pi, \boldsymbol{\sigma}_n)^m] = \mathcal{O}(n^{-\text{db}(\pi)/2})$.

To prove that $\mathbb{E}[\widetilde{\text{occ}}(\pi, \boldsymbol{\sigma}_n)^m] = \Theta(n^{-\text{db}(\pi)/2})$, it is then enough to find one summand, which grows as $n^{-\text{db}(\pi)/2}$ for large n . This is achieved considering the summand indexed by

$$j = km; J_i = \{mq + i : 0 \leq q \leq k-1\}; \rho = \pi[1 \cdots m, \dots, 1 \cdots m].$$

Indeed in this case, $\text{db}(\rho) = \text{db}(\pi)$, so that $j - km - \text{db}(\rho)/2 = -\text{db}(\pi)/2$, which concludes the proof of the proposition. \square

Corollary 6.3.7. *For $\pi \in [\mathcal{S}]$ and $\varepsilon > 0$ small enough, $\mathbb{P}(\widetilde{\text{occ}}(\pi, \boldsymbol{\sigma}_n) > \varepsilon) = \Theta(n^{-\text{db}(\pi)/2})$, where the constant in the Θ symbol depends on ε .*

PROOF. The upper bound is an immediate consequence of Markov's inequality. For the lower bound, let X be a random variable in $[0, 1]$, we have

$$\mathbb{E}[X^2] \leq \mathbb{E}[\varepsilon \mathbb{1}_{(X < \varepsilon)} X + \mathbb{1}_{(X \geq \varepsilon)}] \leq \varepsilon \mathbb{E}[X] + \mathbb{P}(X \geq \varepsilon).$$

The corollary follows by taking $X = \widetilde{\text{occ}}(\pi, \boldsymbol{\sigma}_n)$ and ε small enough. \square

6.4. Generalities for the analysis of the non-standard cases

6.4.1. Reduction to an equation of monotype trees. Outside of hypothesis (H1), the assumptions of the Drmota-Lalley-Woods theorem are not met anymore. Extensions of this theorem to such settings are still lacking in the literature. However, in our specific case, we saw in the proof of Lemma 6.3.1 that it is possible to reduce the system of equations Equation (6.4) to one equation in T . This equation involved series with positive and negative coefficients, which is not ideal for the framework of analytic combinatorics. It is much more comfortable to work with the following rewriting in terms of $T_{\text{not}\oplus}$:

$$(6.20) \quad \begin{cases} T &= \frac{T_{\text{not}\oplus}}{1 - T_{\text{not}\oplus}} \\ T_{\text{not}\ominus} &= T_{\text{not}\oplus} \\ T_{\text{not}\oplus} &= z + \Lambda(T_{\text{not}\oplus}), \text{ where} \\ \Lambda(t) &= \frac{t^2}{1-t} + S\left(\frac{t}{1-t}\right) \end{cases}$$

Observation 6.4.1. The generating series $T_{\text{not}\oplus}$ verifies the equation

$$(6.21) \quad T_{\text{not}\oplus} = z + \Lambda(T_{\text{not}\oplus}(z)),$$

which is a proper equation of monotype leaf-counted trees (see Section 6.7), in particular Λ has nonnegative coefficients. Moreover, Λ is aperiodic (see Appendix A.1).

We point out that this rewriting witnesses a bijection between the family $\mathcal{T}_{\text{not}\oplus}$ and a family of decorated monotype trees, exploited in [BBFS19] to reprove Theorem 6.1.3 in a more probabilistic way.

The results of Section 6.7 provide the singular behavior of $T_{\text{not}\oplus}$ according to the sign of $\Lambda'(R_\Lambda) - 1$. The standard case corresponds to $\Lambda'(R_\Lambda) > 1$. The other two cases are more subtle, and require regularity conditions on the function Λ . For our purposes, it is useful to transfer those conditions in terms of S and T . Recall that we use the vocable of singular exponent and singular constants set forth in Appendix A.

Lemma 6.4.2. *The following claims hold.*

i) For $u \in [0, R_\Lambda]$,

$$(6.22) \quad \Lambda'(u) - 1 = \left(1 + \frac{u}{1-u}\right)^2 \left(1 + S'\left(\frac{u}{1-u}\right)\right) - 2,$$

in particular

$$(6.23) \quad \text{sgn}(\Lambda'(R_\Lambda) - 1) = \text{sgn}(S'(R_S) - 2/(1 + R_S)^2 + 1)$$

ii) We have $R_\Lambda = \frac{R_S}{1+R_S} \leq 1$. Moreover, if $R_S < \infty$ and S has a dominant singularity of exponent δ in R_S , with singular constant C_S , then Λ has a unique dominant singularity of exponent δ in R_Λ with singular constant

$$C_\Lambda = \frac{C_S}{(1 - R_\Lambda)^{2\delta}}$$

iii) Denote ρ the radius of convergence of $T_{\text{not}\oplus}$ and assume that $T_{\text{not}\oplus}(\rho) < 1$ (which will turn out to always be the case in practice). If $T_{\text{not}\oplus}$ has a unique dominant singularity of exponent δ in $\rho < \infty$ with singular constant $C_{\text{not}\oplus}$, then T also has a unique dominant singularity of exponent δ in ρ with $T(\rho) = \frac{T_{\text{not}\oplus}(\rho)}{1 - T_{\text{not}\oplus}(\rho)}$ and singular constant

$$(6.24) \quad C_T = \frac{C_{T_{\text{not}\oplus}}}{(1 - T(\rho))^2}.$$

PROOF. Claim i) is a mere computation. Claim ii) follows by supercritical composition (Lemma A.4.2) of S with the map $\frac{t}{1-t}$. Claim iii) follows by subcritical composition (Lemma A.4.2) of the map $\frac{t}{1-t}$ with $T_{\text{not}\oplus}$. \square

6.4.2. Hypothesis (CS) and convergence of simple permutations. Recall that the function Occ_θ was defined in Equation (6.2) by $\text{Occ}_\theta(z) = \sum_{\alpha \in \mathcal{S}} \text{occ}(\theta, \alpha) z^{|\alpha| - |\theta|}$.

In the critical and degenerate cases, the functions $\text{Occ}_\theta(z)$ will appear in the asymptotic behaviors, thus we need some additional assumptions on them. First, as noticed in Observation 6.1.2, we have

$$(6.25) \quad \sum_{\theta \in \mathfrak{S}_k} \text{Occ}_\theta(z) = \frac{1}{k!} S^{(k)}(z),$$

which has a dominant singularity of exponent $\delta - k$ in R_S (see Lemma A.4.3, about singular differentiation). The following hypothesis is thus reasonable.

Definition 6.4.3 (Hypothesis (CS)). Let S have a dominant singularity of exponent $\delta > 1$ in R_S . The family of simple permutations \mathcal{S} satisfies the hypothesis (CS) if, for each pattern θ of size k , the corresponding series $\text{Occ}_\theta(z)$ has a dominant singularity of exponent at least $\delta - k$ in R_S .

As recalled in Appendix A.4, the hypothesis (CS) is equivalent to the following: for every $k \geq 1$ and every permutation θ of size k , there exists an analytic function g_θ and a constant C_θ (possibly equal to 0) such that, on an Δ -neighborhood of R_S , it holds that

$$(6.26) \quad \text{Occ}_\theta(z) = g_\theta(z) + (C_\theta + o(1))(R_S - z)^{\delta - k}.$$

We may wish to replace the hypothesis (CS) with a less technical hypothesis, such as the convergence of a random *simple* permutation in our set \mathcal{S} to some random permuton $\mu_{\mathcal{S}}$. We show here that, though not equivalent, these hypotheses are strongly related. Remark that we do not assume (H2) or (H3) here.

Proposition 6.4.4. *Suppose that S has a dominant singularity of exponent $\delta > 1$ and assume condition (CS). Then there exists a permuton $\mu_{\mathcal{S}}$ such that*

$$(6.27) \quad \mathbb{E}[\widetilde{\text{occ}}(\pi, \mu_{\mathcal{S}})] = \Delta_{\pi} := \frac{C_{\pi}}{\sum_{\theta \in \mathcal{S}_k} C_{\theta}} = \frac{C_{\pi}}{(-1)^{|\pi|} \binom{\delta}{|\pi|} C_{\mathcal{S}}},$$

where the C_{π} are given by Equation (6.26) (which holds under hypothesis (CS)).

Let α_n be a uniform random permutation of size n in \mathcal{S} . If (μ_{α_n}) converges in distribution, then its limit is $\mu_{\mathcal{S}}$. Conversely, if we assume that S and all series Occ_{θ} have a unique dominant singularity, then (μ_{α_n}) converges in distribution (and the limit must be $\mu_{\mathcal{S}}$, using the first part of the proposition).

PROOF. First of all, the last equality in (6.27) follows from relation (6.25) and singular differentiation of S .

We move on to the existence of $\mu_{\mathcal{S}}$. For every $k \geq 1$, let ρ_k be a random permutation in \mathfrak{S}_k such that $\mathbb{P}(\rho_k = \pi) = C_{\pi} / (\sum_{\theta \in \mathcal{S}_k} C_{\theta})$. By Proposition 3.3.6, we only need to show that $(\rho_k)_k$ forms a consistent family. Let $1 \leq k \leq n$, then for $\pi \in \mathfrak{S}_k$,

$$(6.28) \quad \mathbb{P}(\text{pat}_{\mathbf{I}_{n,k}}(\rho_n) = \pi) = \frac{1}{\binom{n}{k} \sum_{\theta \in \mathcal{S}_k} C_{\theta}} \sum_{\sigma \in \mathfrak{S}_n} \text{occ}(\pi, \sigma) C_{\sigma}.$$

On the other hand, the following combinatorial identity can be derived from the definition of the $(\text{Occ}_{\theta})_{\theta \in \mathfrak{S}}$:

$$(6.29) \quad \frac{1}{(n-k)!} \text{Occ}_{\pi}^{(n-k)}(z) = \sum_{\sigma \in \mathfrak{S}_n} \text{occ}(\pi, \sigma) \text{Occ}_{\sigma}(z).$$

Indeed, the left-hand side is the series of simple permutations in \mathcal{S} whose entries are partitioned into a set of k marked entries forming a pattern π and a set of $n-k$ marked entries. The right-hand side counts the same object, according to the pattern σ formed by all the n marked entries. To distinguish the marked entries of the first set from the ones of the second set, we need to specify a subpattern π inside the pattern σ , which explains the factor $\text{occ}(\pi, \sigma)$.

We now differentiate both sides of Equation (6.29) m times so that $\delta - n - m < 0$, and replace all series with their asymptotic estimates obtained thanks to hypothesis (CS), Equation (6.26) and singular differentiation (Theorem A.3.1)³.

$$\begin{aligned} g_{\pi}^{(m)}(z) + (-1)^{m+n-k} (\delta - k)_{m+n-k} (C_{\pi} + o(1)) (R_{\mathcal{S}} - z)^{\delta - m - n} \\ = (n-k)! \sum_{\sigma \in \mathfrak{S}_n} \text{occ}(\pi, \sigma) \left[g_{\sigma}^{(m)}(z) + (-1)^m (\delta - n)_m (C_{\sigma} + o(1)) (R_{\mathcal{S}} - z)^{\delta - m - n} \right] \end{aligned}$$

As only the singular parts diverge, taking the limit in $z \rightarrow R_{\mathcal{S}}$ allows to identify the singular constants, yielding $\sum_{\sigma \in \mathfrak{S}_n} \text{occ}(\pi, \sigma) C_{\sigma} = (-1)^{n-k} \binom{\delta - k}{n-k} C_{\pi}$. Plugging this back in Equation (6.28) yields

$$\mathbb{P}(\text{pat}_{\mathbf{I}_{n,k}}(\rho_n) = \pi) \propto C_{\pi}, \pi \in \mathfrak{S}_k.$$

As probabilities sum to 1, we get $\mathbb{P}(\text{pat}_{\mathbf{I}_{n,k}}(\rho_n) = \pi) = \mathbb{P}(\rho_k = \pi)$, proving the consistency of $(\rho_k)_k$.

As a result of Theorem 3.3.2, the convergence of (μ_{α_n}) to $\mu_{\mathcal{S}}$ is equivalent to the following: for k large enough and any $\pi \in \mathfrak{S}_k$, the limit $\lim_{n \rightarrow \infty} \mathbb{E}[\widetilde{\text{occ}}(\pi, \alpha_n)]$ exists and

3. For $x \in \mathbb{C}$ and $r \in \mathbb{N}$, we denote by $(x)_r$ the falling factorial $x(x-1) \cdots (x-r+1)$

is proportional to C_π for $\pi \in \mathfrak{S}_k$. Directly from the definitions, we have

$$(6.30) \quad \mathbb{E}[\widetilde{\text{occ}}(\pi, \alpha_n)] = \frac{k! [z^{n-k}] \text{Occ}_\pi(z)}{[z^{n-k}] S^{(k)}(z)}.$$

For the proof of the direct implication, we assume that μ_{α_n} converges in distribution. From Theorem 3.3.2, this means that $\mathbb{E}[\widetilde{\text{occ}}(\pi, \alpha_n)]$ has a limit Θ_π for every π of size $k \geq 2$. Then when n goes to infinity,

$$[z^n] \text{Occ}_\pi(z) = \frac{\Theta_\pi + o(1)}{k!} [z^n] S^{(k)}(z).$$

As a consequence, for any fixed π and $\varepsilon > 0$, there exists polynomials g_-, g_+ such that for any real z in $[0, R_S)$,

$$(6.31) \quad \left(\frac{\Theta_\pi}{k!} - \varepsilon \right) S^{(k)}(z) + g_-(z) \leq \text{Occ}_\pi(z) \leq \left(\frac{\Theta_\pi}{k!} + \varepsilon \right) S^{(k)}(z) + g_+(z).$$

Hypothesis (CS) implies that in R_S we have $\text{Occ}_\pi(z) = g_\pi(z) + (C_\pi + o(1))(R_S - z)^{\delta-k}$ for some analytic function g_π . Also $S^{(k)}$ has a dominant singularity of exponent $\delta - k$ in R_S so $S^{(k)}(z) = g_{S^{(k)}}(z) + (C_{S^{(k)}} + o(1))(R_S - z)^{\delta-k}$ for some analytic function $g_{S^{(k)}}$ and constant $C_{S^{(k)}} > 0$. Plugging these asymptotic estimates into (6.31) yields

$$\begin{aligned} \left(\frac{\Theta_\pi}{k!} - \varepsilon \right) \left[(C_{S^{(k)}} + o(1))(R_S - z)^{\delta-k} + g_{S^{(k)}} \right] + g_- \\ \leq (C_\pi + o(1)) \left[(R_S - z)^{\delta-k} + g_\pi \right] \\ \leq \left(\frac{\Theta_\pi}{k!} + \varepsilon \right) \left[(C_{S^{(k)}} + o(1))(R_S - z)^{\delta-k} + g_{S^{(k)}} \right] + g_+. \end{aligned}$$

Let k be such that $\delta - k < 0$, so that the singular parts are the only diverging quantities when $z \rightarrow R_S$. After taking the limit we get $\left| C_\pi - \frac{C_{S^{(k)}}}{k!} \Theta_\pi \right| \leq \varepsilon$ for every ε and hence equality. We have proven that $(\Theta_\pi)_{\pi \in \mathfrak{S}_k}$ is proportional to $(C_\pi)_{\pi \in \mathfrak{S}_k}$ for large k , as desired.

For the converse, we start from Equation (6.30). Theorem A.2.2 (which we can apply because of the hypotheses on S and Occ_θ) gives the following asymptotic behavior when $n \rightarrow \infty$:

$$\mathbb{E}[\widetilde{\text{occ}}(\pi, \alpha_n)] = k! n^{-k} \frac{(C_\pi + o(1)) R_S^{-n+k} n^{-\delta+k-1}}{C_S R_S^{-n} n^{-\delta-1}}.$$

For fixed k , the limit of the right-hand side is proportional to C_π , which concludes the proof of the proposition. \square

6.5. The degenerate case $S'(R_S) < 2/(1 + R_S)^2 - 1$

In this section, we are interested in the case where the generating function S of simple permutations in \mathcal{S} satisfies the following condition.

Definition 6.5.1 (Hypothesis (H2)). The generating function S of a family \mathcal{S} of simple permutations is said to satisfy hypothesis (H2) if S meets the following conditions at its radius of convergence $R_S > 0$:

i) S' is convergent at R_S and

$$(6.32) \quad S'(R_S) < \frac{2}{(1 + R_S)^2} - 1;$$

ii) S has a dominant singularity of exponent $\delta > 1$ in R_S .

Note that the assumption $\delta > 1$ is redundant with the convergence of S' at R_S .

Theorem 6.5.2. Let σ_n be a uniform random permutation in $[\mathcal{S}]_n$. We assume hypotheses (H2) and (CS). Then $(\mu_{\sigma_n})_n$ tends to $\mu_{\mathcal{S}}$ in distribution, where $\mu_{\mathcal{S}}$ was defined in Proposition 6.4.4.

Recall the statement of Proposition 6.4.4. Assuming that a uniform random *simple* permutation in the class converges in distribution to some random permuton, then this random permuton is μ_S , the same limit as the limit of a uniform permutation in the class. This justifies a claim in the introduction.

Remark 6.5.3. As already mentioned, the additional hypothesis (CS) here is hard to verify in practice, and we have no example where we know Theorem 6.5.2 applies. Nevertheless, consider $\text{Av}(2413)$, enumerated in [Sta94; Bón97]. It is obviously substitution-closed. Since its generating function is asymptotic to $C(\rho - z)^{3/2}$ near the singularity $\rho = 1/8$. This singular behavior is only compatible with the degenerate case (see Proposition 6.4.4). However for the lack of combinatorial description of the simple permutations in this class, we can't verify the hypotheses of Theorem 6.5.2. For simulation of large (near-)uniform random permutations in this class, see fig. 1.3

Remark 6.5.4. The phenomenon observed in the degenerate case (a large simple permutation dominates in the substitution decomposition of a random permutation) is usual in permutation families whose behavior is not well-captured by the substitution decomposition. For instance, it is observed in a dramatic way in many classes with an infinite number of simple permutations, like \mathfrak{S} , or $\text{Av}(321)$.

We now turn to the proof of the theorem, starting with the singular behavior of the series T .

Lemma 6.5.5. *Assume that S satisfies hypothesis (H2). Then T has a unique dominant singularity of exponent δ in ρ . Moreover, $T(\rho) = R_S$ and the singular constant C_T verifies $C_T = C_S T'(\rho)^{\delta+1}$.*

PROOF. The series $T_{\text{not}\oplus}$ verifies Equation (6.21). The function Λ is aperiodic, and Lemma 6.4.2 gives us that $\Lambda'(R_\Lambda) < 1$ and Λ has a dominant singularity of exponent δ . We are then in position to apply Lemma 6.7.1, and obtain that $T_{\text{not}\oplus}$ has a unique dominant singularity of exponent δ in ρ , $T_{\text{not}\oplus}(\rho) = R_\Lambda < 1$, $T'_{\text{not}\oplus}(\rho) = (1 - \Lambda'(R_\Lambda))^{-1}$ and the singular constant $C_{\text{not}\oplus}$ verifies $C_{\text{not}\oplus} = C_\Lambda(1 - \Lambda'(R_\Lambda))^{-\delta-1}$. Using Lemma 6.4.2, we obtain the desired result. \square

PROOF OF THEOREM 6.5.2. Let $k \geq 2$, $\pi \in \mathfrak{S}_k$, and t_0 be the substitution tree with k leaves and only one internal node bearing the label π . Fix $k \geq 0$ and a substitution tree t_0 . We start with Proposition 5.3.7. We have

$$\begin{aligned} E_{i,j_1,\dots,j_\ell}^\pi &= \mathbf{1}_{j_1=\dots=j_\ell=\emptyset} \text{Occ}_\pi(T) + \mathbf{1}_{\ell=2, i \neq \text{not}\ominus, j_1=\text{not}\ominus, j_2=\emptyset} + \mathbf{1}_{\ell=2, i \neq \text{not}\oplus, j_1=\text{not}\oplus, j_2=\emptyset} \\ &\geq \mathbf{1}_{j_1=\dots=j_\ell=\emptyset} \text{Occ}_\pi(T). \end{aligned}$$

The symbol \geq here denotes coefficient-wise domination. Plugging this inequality in Proposition 5.3.7 just selects the terms for which $i \equiv \emptyset$.

$$\begin{aligned} (6.33) \quad T_{\emptyset, t_0} &\geq \sum_{j \in J^{\text{Int}(t_0)}} \left[\prod_{v \in \text{Int}(t_0)} T_\emptyset^{j(v)} \prod_{v \in \text{Lf}(t_0)} T' \prod_{v \in \text{Int}(t_0)} \text{Occ}_{\varepsilon(v)}(T) \right] \\ &= \prod_{v \in \text{Lf}(t_0)} T' \prod_{v \in \text{Int}(t_0)} (T_\emptyset^\circ + T_\emptyset^{\text{not}\oplus} + T_\emptyset^{\text{not}\ominus}) \text{Occ}_{\varepsilon(v)}(T) \\ &= (T')^{k+1} \text{Occ}_\pi(T), \end{aligned}$$

where we have used (6.8).

Now by singular differentiation (Theorem A.3.1), T' has a unique dominant singularity in ρ of exponent $\delta - 1 > 0$. Also, by Lemma A.4.2 (critical case-A), $\text{Occ}_\pi(T)$ has a unique dominant singularity of exponent $\delta - k$ and singular constant $C_\pi T'(\rho)^{\delta-k}$. The product $(T')^{k+1} \text{Occ}_\pi(T)$ thus inherits the singularity of the latter, and has a unique dominant

singularity of exponent $\delta - k$ with constant

$$(T'(\rho))^{k+1} C_\pi T'(\rho)^{\delta-k} = T'(\rho)^{\delta+1} C_\pi = T'(\rho) (-1)^k \binom{\delta}{k} \Delta_\pi C_S = C_T (-1)^k \binom{\delta}{k} \Delta_\pi,$$

recalling (6.27) and the computation of the constant in Lemma 6.5.5.

By singular differentiation, $\frac{T^{(k)}}{k!}$ has a unique dominant singularity of exponent $\delta - k$ with singular constant $C_T (-1)^k \binom{\delta}{k}$.

Finally, let \mathbf{t}_n be a uniform element of \mathcal{T} of size n , $\sigma_n = \text{perm}(\mathbf{t}_n)$ and $\mathbf{I}_{n,k}$ an uniform random subset of $[1, n]$ of size k . Then

$$\mathbb{P}(\mathbf{t}_n | \mathbf{I}_{n,k} = t_0) = \frac{[z^{n-k}] T_{\emptyset, t_0}}{[z^{n-k}] \frac{1}{k!} T^{(k)}} \geq \frac{[z^{n-k}] (T')^{k+1} \text{Occ}_\pi(T)}{[z^{n-k}] \frac{1}{k!} T^{(k)}}.$$

Applying the transfer theorem to the numerator and denominator yields

$$\liminf_{n \rightarrow \infty} \mathbb{P}(\mathbf{t}_n | \mathbf{I}_{n,k} = t_0) \geq \Delta_\pi.$$

Summing over t_0 proves that this is actually an equality and that $\mathbf{t}_n | \mathbf{I}_{n,k}$ converges in distribution to a tree with only one internal node decorated by a permutation of distribution $(\Delta_\pi)_\pi$. Finally by Lemma 5.1.11, $\text{pat}_{\mathbf{I}_{n,k}}(\sigma_n) = \text{perm}(\mathbf{t}_n | \mathbf{I}_{n,k})$ converges in distribution to a permutation of distribution $(\Delta_\pi)_{\pi \in \mathfrak{S}_k}$, which proves the theorem thanks to Theorem 1.2.1. \square

6.6. The critical case $S'(R_S) = 2/(1 + R_S)^2 - 1$

The goal of this section is to describe the limiting permuton of a uniform permutation in a substitution-closed class \mathcal{C} , whose set of simple permutations satisfies the following hypothesis.

Definition 6.6.1 (Hypothesis (H3)). A family \mathcal{S} of simple permutations is said to satisfy hypothesis (H3) if the generating function S meets the following conditions at its radius of convergence $R_S > 0$:

- S has a dominant singularity of exponent $\delta > 1$ in R_S ;
- S' is convergent at R_S and

$$S'(R_S) = \frac{2}{(1 + R_S)^2} - 1.$$

In the following, we denote $\delta_* = \min(\delta, 2)$. The behavior of $T_{\text{not}\oplus}$ is given in the following lemma.

Lemma 6.6.2. *Under hypothesis (H3), T has a unique dominant singularity of exponent δ^* in ρ , and $T(\rho) = R_\Lambda$. Moreover the singular constant verifies*

$$C_T = -C_S^{-1/\delta}.$$

in the case $\delta \in (1, 2)$.

The proof is just a matter of applying Lemma 6.7.2 to $T_{\text{not}\oplus}$, translating hypothesis and conclusions from $(T_{\text{not}\oplus}, \Lambda)$ to (T, S) using Lemma 6.4.2, as for Lemma 6.5.5. Therefore we skip it.

6.6.1. The case $\delta \in (1, 2)$. We start by describing the limit permuton in this case. Fix $\delta \in (1, 2)$. For every k the following probability distribution on unlabeled plane trees with k leaves was introduced by Duquesne and Le Gall in [DL02, Thm 3.3.3] and is the distribution of the subtree induced by k uniform points in the δ -stable tree:

$$\rho_{\delta,k}(t_0) = \frac{k!}{(\delta-1) \cdots ((k-1)\delta-1)} \prod_{v \in \text{Int}(t_0)} \mathbf{1}_{d_v \geq 2} \frac{(d_v - 1 - \delta) \cdots (2 - \delta)(\delta - 1)}{d_v!}.$$

Now if we fix the distribution of a random permuton ν , for every $n \geq 1$, we build a random substitution tree $\mathbf{t}_n^{(\delta, \nu)}$ as follows: the tree is chosen according to $\rho_{\delta,n}$, and conditional on

that choice, all internal nodes v are independently labeled by a permutation distributed like $\mathbf{Perm}_k(\boldsymbol{\nu})$.

Now we can define the permutations $\tau_n^{(\delta, \boldsymbol{\nu})} = \text{perm}(t_n^{(\delta, \boldsymbol{\nu})})$. This family of permutations is consistent: we omit the proof of this fact, which follows from the consistency of the family $(\mathbf{Perm}_k(\boldsymbol{\nu}))_k$ (Proposition 3.3.6) and the fact that $(\rho_{\delta, n})_n$ is a consistent family of distribution on trees, which results from an immediate coupling coming from their appearance as induced subtrees of the stable tree (see also Marchal's algorithm [Mar08]). We deduce the following lemma.

Lemma 6.6.3. *For every $\delta \in (1, 2)$ and random permuton $\boldsymbol{\nu}$, there exists a random permuton $\boldsymbol{\mu}^{(\delta, \boldsymbol{\nu})}$, whose induced subpermutations are the $\tau_n^{(\delta, \boldsymbol{\nu})}$ (i.e. for all n , $\tau_n^{(\delta, \boldsymbol{\nu})} \stackrel{d}{=} \mathbf{Perm}(\boldsymbol{\mu}^{(\delta, \boldsymbol{\nu})})$). We call $\boldsymbol{\mu}^{(\delta, \boldsymbol{\nu})}$ the δ -stable permuton driven by $\boldsymbol{\nu}$.*

Theorem 6.6.4. *Let \mathcal{S} be a family of simple permutations verifying hypothesis (H3) and (CS), with $\delta \in (1, 2)$. Recall the definition of the random permuton $\boldsymbol{\mu}_{\mathcal{S}}$ in Proposition 6.4.4. If σ_n is a uniform permutation in $[S]_n$, then μ_{σ_n} converges in distribution to the random permuton $\boldsymbol{\mu}^{(\delta, \boldsymbol{\mu}_{\mathcal{S}})}$.*

Remark 6.6.5. In this case, all possible patterns, in particular nonseparable ones, appear with positive probability in the limit (as long as they appear with positive probability in a uniform simple permutation in the class). More precisely, the proof will show the following: k random leaves in a uniform canonical tree induce substitution trees with arbitrary large node degrees, and the first common ancestors of those leaves are all simple permutations with probability tending to 1.

PROOF. Fix $k \geq 0$ and a substitution tree t_0 . We start with Proposition 5.3.7. Using the lower bound

$$E_{i, j_1, \dots, j_\ell}^\pi \geq \mathbf{1}_{j_1 = \dots = j_\ell = \emptyset} \text{Occ}_\pi(T),$$

selects only the terms of (5.10) for which $i \equiv \emptyset$.

$$\begin{aligned} (6.34) \quad T_{\emptyset, t_0} &\geq \sum_{j \in J^{\text{Int}(t_0)}} \left[\prod_{v \in \text{Int}(t_0)} T^{j(v)} \prod_{v \in \text{Lf}(t_0)} T' \prod_{v \in \text{Int}(t_0)} \text{Occ}_{\varepsilon(v)}(T) \right] \\ &= \prod_{v \in \text{Lf}(t_0)} T' \prod_{v \in \text{Int}(t_0)} (T^\emptyset + T^{\text{not}\oplus} + T^{\text{not}\ominus}) \text{Occ}_{\varepsilon(v)}(T) \\ &= (T')^{v(t_0)} \prod_{v \in \text{Int}(t_0)} \text{Occ}_{\varepsilon(v)}(T), \end{aligned}$$

where we have used (6.8). Starting from the estimate of Lemma 6.6.2, Singular differentiation gives

$$T'(z) = \left(\frac{1}{\delta}(-C_T) + o(1)\right)(\rho - z)^{1/\delta - 1};$$

while hypothesis (CS) and Lemma A.4.2 (critical case) gives

$$\text{Occ}_\theta(T(z)) = (C_\theta(-C_T)^{\delta - |\theta|} + o(1))(\rho - z)^{\delta - |\theta|},$$

Hence the following asymptotics hold:

$$\begin{aligned} (T')^{v(t_0)} \prod_v \text{Occ}_{\theta_v}(T) &= \left[\left(\frac{-C_T}{\delta} \right)^{|E|+1} \prod_{v \in \text{Int}(t_0)} C_{\theta_v} (-C_T)^{\delta-d_v} + o(1) \right] (\rho - z)^{1/\delta-k} \\ &= \left[\frac{-C_T}{\delta^k} \prod_{v \in \text{Int}(t_0)} \frac{1}{\delta} C_{\theta_v} (-C_T)^{\delta} + o(1) \right] (\rho - z)^{1/\delta-k} \\ &= \left[\frac{-C_T}{\delta^k} \prod_{v \in \text{Int}(t_0)} \frac{C_{\theta_v}}{\delta C_S} + o(1) \right] (\rho - z)^{1/\delta-k} \end{aligned}$$

where we have used the equality $C_T = -C_S^{1/\delta}$ from Lemma 6.4.2. On the other hand, by singular differentiation, for $k \geq 2$

$$T^{(k)} = \left[-C_T(1/\delta)(1 - 1/\delta) \cdots (k - 1 - 1/\delta) + o(1) \right] (\rho - z)^{1/\delta-k}$$

From the transfer theorem (Theorem A.2.2) applied to both those series,

$$\begin{aligned} \mathbb{P}(\mathbf{t}_I^{(n)} = t_0) &\geq \frac{[z^n](T')^{v(t_0)} \prod_v \text{Occ}_{\theta_v}(T)}{[z^n]T^{(k)}/k!} \\ (6.35) \quad &= \frac{k!}{(\delta - 1) \cdots ((k - 1)\delta - 1)} \prod_{v \in \text{Int}(t_0)} \frac{C_{\theta_v}}{\delta C_S} + o(1). \end{aligned}$$

By Equation (6.27), we have

$$\frac{C_{\theta_v}}{\delta C_S} = \frac{1}{\delta C_S} \Delta_{\theta_v} C_S \binom{\delta}{d_v} = \Delta_{\theta_v} \frac{(\delta - 1)(2 - \delta) \cdots (d_v - 1 - \delta)}{d_v!}.$$

Hence we recognize (6.35) taking the following form

$$\liminf_{n \rightarrow \infty} \mathbb{P}(\mathbf{t}_I^{(n)} = t_0) \geq \mathbb{P}(\mathbf{t}_k^{(\delta, \mu_S)} = t_0).$$

The argument carries on as in the proof of Theorem 6.6.6. \square

6.6.2. The case $\delta > 2$.

Theorem 6.6.6. *Let \mathcal{S} be a family of simple permutations verifying hypotheses (H3) and (CS), with $\delta > 2$. If σ_n is a uniform permutation in $[\mathcal{S}]_n$, then σ_n converges in distribution to the biased Brownian separable permuton of parameter p , where*

$$p = \frac{(1 + R_S)^3 \text{Occ}_{12}(R_S) + 1}{(1 + R_S)^3 (\text{Occ}_{12}(R_S) + \text{Occ}_{21}(R_S)) + 2}.$$

Remark 6.6.7. While the limiting permuton in this case is independent of $\delta > 2$ and is the same as in the standard case, the fine details of this convergence might be different. In particular, if π is a nonseparable pattern, the order of magnitude of $\mathbb{E}[\widetilde{\text{occ}}(\pi, \sigma_n)]$ depends on δ and is in general bigger than in the standard case.

PROOF. We claim that in this case, the conclusions of Lemma 6.3.1 still hold, up to replacing κ by R_S (observe that the correct singularity exponent for T is given by Lemma 6.6.2) This could result from a careful adaptation of Theorem 5.4.5 in the case where Φ has a singularity in $(\rho, \mathbf{T}(\rho))$ but is still twice-differentiable at this point. Another route (which could have been followed for the standard case also, as was done originally in the article version [Bas+20] of this chapter) is to provide explicit expressions for the entries of \mathbb{T} by manual inversion of the matrix $(\text{Id} - \mathbb{M})$, and perform elementary analysis (using *ad nauseam* Lemma A.4.2, critical case).

We also observe that hypothesis (CS) and Proposition 5.3.5 grants that the series $E_{ijj'}^\varepsilon$, for $\varepsilon \in \{\oplus, \ominus\}$, converge at their singularity. Hence all the ingredients used in the proof of

Theorem 6.1.3 are available. As the reader might have guessed from the hasty explanation above, the details are left to him/her. \square

6.7. Singularity analysis of leaf-counted monotype trees

Let $U(z), \Lambda(u)$ be power series with non-negative coefficients. We say that the equation

$$(6.36) \quad U(z) = z + \Lambda(U(z))$$

is a proper equation for leaf-counted monotype-trees, if $U(0) = \Lambda(0) = \Lambda'(0) = 0$. In this case the solution $U(z)$ of (6.36) is unique in the ring of formal power series with non-negative coefficients and no constant term. This notion is just a specialization of Definition 5.4.1 to systems of only one equation. Such equations were also considered in [PR15, Prop. 8] and many other probabilistic works on trees counted by their number of leaves.

From the singularity analysis of such an equation, a trichotomy stands out, according to the sign of $\Lambda'(R_\Lambda)$. The case $\Lambda'(R_\Lambda) > 1$, corresponding to our *standard case* is the easiest, is studied for instance in [BMN20, Th. 1], comes off as a special case of the *smooth implicit function schema* of [FS09, Def. VII.4], or of our Drmota-Lalley-Wood Theorem 5.4.5. The other two cases are more subtle, and this section is devoted to studying them.

Lemma 6.7.1. *Let U be the solution of a proper equation for leaf-counted monotype-trees. Suppose that $\Lambda'(R_\Lambda) < 1$ and that Λ has a dominant singularity of exponent δ in R_Λ . Then U has a dominant singularity of exponent δ in $\rho \in (0, \infty)$, $U(\rho) = R_\Lambda$, and the singular constant verifies*

$$C_U = \frac{C_\Lambda}{(1 - \Lambda'(R_\Lambda))^{\delta+1}}.$$

PROOF. Let R_U be the radius of convergence of U . Assume $U(R_U) < R_\Lambda$. We apply Lemma A.5.1. The bivariate function we consider is $(z, w) \mapsto z - w + \Lambda(w)$. It vanishes at the point $(R_U, U(R_U))$ and the derivative with respect to w at that point is nonzero since

$$\Lambda'(U(R_U)) < \Lambda'(R_\Lambda) < 1.$$

Therefore, U has an analytic continuation on a neighborhood of R_U . Since it has positive coefficients, by Pringsheim's theorem [FS09, Th. IV.6 p. 240], this is in contradiction with the fact that R_U is the radius of convergence of U .

By contradiction we have proved $U(R_U) \geq R_\Lambda$, and by intermediate value theorem, we know that there exists ρ such that $U(\rho) = R_\Lambda$. Note that it implies the relation $\rho = R_\Lambda - \Lambda(R_\Lambda)$.

We now consider U around $z = \rho$. Equation (6.36) defining $U(z)$ can be rewritten as $U(z) = G(z, U(z))$, where

$$G(z, w) = w + \frac{1}{1 - \Lambda'(R_\Lambda)}(z - w + \Lambda(w)).$$

Since Λ has a dominant singularity of exponent $\delta > 1$ in R_Λ , Equation (A.2), together with elementary computations, yield the following: for w in a Δ -neighborhood D_Δ of R_Λ ,

$$(6.37) \quad G(z, w) = R_\Lambda + \frac{z - \rho}{1 - \Lambda'(R_\Lambda)} + \mathcal{O}((R_\Lambda - w)^{\delta*}).$$

We now use Picard's method of successive approximants to show the existence and analyticity of U on a Δ -neighborhood D_T of ρ . We refer to [FS09, Appendix B.5 p. 753] for a synthetic description of the method in the case where Λ is analytic in R_Λ ; we have to adapt it carefully to our setting.

Define $\phi_0(z) = R_\Lambda$ and $\phi_{j+1}(z) = G(z, \phi_j(z))$ whenever $\phi_j(z)$ is in D_Λ . We have $\phi_1(z) - \phi_0(z) = \frac{z-\rho}{1-\Lambda'(R_\Lambda)}$. Also, Theorem A.3.1 of singular differentiation applied to Equation (6.37) implies that

$$\frac{\partial G(z,w)}{\partial w} = \mathcal{O}((R_\Lambda - w)^{\delta_*-1}).$$

Therefore⁴ for $j \geq 1$, if $\phi_j(z)$ and $\phi_{j+1}(z)$ are defined and lie in D_Λ , we have

$$\phi_{j+1}(z) - \phi_j(z) = \mathcal{O}(\eta^{\delta_*-1} |\phi_j(z) - \phi_{j-1}(z)|),$$

where $\eta = \sup_{w \in D_\Lambda} |R_\Lambda - w|$. Fix $\varepsilon > 0$. Up to reducing the radius of D_Λ , we can therefore assume that

$$(6.38) \quad |\phi_{j+1}(z) - \phi_j(z)| \leq \varepsilon |\phi_j(z) - \phi_{j-1}(z)|.$$

Thus, if $\phi_j(z)$ is in D_Λ for every $i \leq m$, then $\phi_M(z)$ is defined and we have

$$(6.39) \quad |(\phi_M(z) - R_\Lambda) - \frac{z-\rho}{1-\Lambda'(R_\Lambda)}| = |\phi_M(z) - \phi_1(z)| \\ \leq \frac{\varepsilon}{1-\varepsilon} |\phi_1(z) - \phi_0(z)| = \frac{\varepsilon}{1-\varepsilon} \left| \frac{z-\rho}{1-\Lambda'(R_\Lambda)} \right|.$$

If we take ε small enough, the argument of $\phi_M(z) - R_\Lambda$ is close to the one of $z - \rho$. Furthermore if the modulus of $z - \rho$ is small so is the one of $\phi_M(z) - R_\Lambda$. This ensures the existence of a Δ -neighborhood D_T of ρ (not depending on M and z), such that for $z \in D_T$ and $M \geq 1$, $\phi_M(z)$ is in D_Λ as long as it is defined. In particular, $\phi_{M+1}(z)$ is also defined and by immediate induction, all ϕ_j are defined and analytic on D_T .

Equation (6.38) also implies that ϕ_j converges locally uniformly on D_T . The limit is the unique solution w in D_Λ of the fixed point equation $w = G(z, w)$ (the uniqueness of the solution comes from the fact that for every $z \in D_T$, $w \mapsto G(z, w)$ is a contraction for w in D_Λ). This limit is therefore an analytic continuation of $U(z)$ to D_T . Note also that from Equation (6.39), the following estimate holds on D_T :

$$U(z) - R_\Lambda = \frac{z-\rho}{1-\Lambda'(R_\Lambda)} + o(|z - \rho|).$$

Using the expansion given in Equation (A.1) of Λ around R_Λ , we have for $z \in D_T$,

$$U(z) = z + g_\Lambda(U(z)) + (C'_\Lambda + o(1)) (U(z) - R_\Lambda)^\delta.$$

As $\text{id} - g_\Lambda$ is analytic at R_Λ with a nonzero derivative $1 - \Lambda'(R_\Lambda)$, it can be inverted analytically around R_Λ by an analytic function h_Λ and hence

$$U(z) = h_\Lambda \left(z + (C_\Lambda + o(1)) (U(z) - R_\Lambda)^\delta \right) \\ = h_\Lambda \left(z + \frac{C_\Lambda + o(1)}{(1 - \Lambda'(R_\Lambda))^\delta} (\rho - z)^\delta \right) \\ = (\text{analytic}) + \left(\frac{h'_\Lambda(\rho) C_\Lambda}{(1 - \Lambda'(R_\Lambda))^\delta} + o(1) \right) (\rho - z)^\delta,$$

The last equality resulting from Lemma A.4.2 (subcritical case). In particular U has a singularity of exponent δ in ρ , and the constant in front of the singular term is

$$C_U = \frac{h'_\Lambda(\rho) C_\Lambda}{(1 - \Lambda'(R_\Lambda))^\delta} = \frac{C_\Lambda}{(1 - \Lambda'(R_\Lambda))^{\delta+1}}$$

4. There is a slight subtlety here: we would like to apply the classical inequality $|f(w) - f(w')| \leq \|f'\|_\infty |w - w'|$, but this is not possible since the domain D_Λ is not convex. Note however that a Δ -neighborhood D is always a *quasi-convex set*, in the sense that we can always find a path between w and w' whose length is smaller than $K|w - w'|$, where K depends on the angle defining D but not on w and w' . Therefore the following weaker inequality holds: $|f(w) - f(w')| \leq K \|f'\|_\infty |w - w'|$, which is good enough for our purpose (the constant K disappears in the \mathcal{O} symbol).

We now prove that U has no singularity ζ with $|\zeta| \leq \rho$, except $\zeta = \rho$. By a classical compactness argument (see *e.g.* [Drm09, end of proof of Theorem 2.19]), this implies that U is analytic on a Δ -domain at ρ .

Take such a singularity. Since U has nonnegative coefficients, the triangular inequality gives $|U(\zeta)| \leq U(\rho)$ and since $U(z)$ is aperiodic, from Lemma A.1.1 we have a strict inequality unless $\zeta = \rho$. Therefore, if $|\zeta| \leq \rho$ and $\zeta \neq \rho$, we have $|\Lambda'(U(\zeta))| < \Lambda'(R_\Lambda) < 1$ and we can apply Lemma A.5.1 as above as in the second paragraph of this proof to argue that ζ cannot be a singularity. \square

Lemma 6.7.2. *Let U be the solution of a proper equation for leaf-counted monotone-trees. Suppose that $\Lambda'(R_\Lambda) = 1$ and that Λ has a dominant singularity of exponent $\delta > 1$ in R_Λ . Then U has a dominant singularity of exponent $1/\delta_*$ in $\rho = R_U$, where $\delta_* = \min(2, \delta)$. Moreover, $U(\rho) = R_\Lambda$, and the singular constant C_U verifies*

$$C_U = -(C'_\Lambda)^{-1/\delta_*}, \quad C'_\Lambda = \begin{cases} C_\Lambda & \text{if } \delta \in (1, 2) \\ \Lambda''(R_\Lambda)/2 & \text{if } \delta > 2 \end{cases}$$

PROOF. As in the proof of Lemma 6.7.1, the existence of ρ and the fact that the convergence radius of U is at least ρ is straightforward. The key point is to prove that U has an analytic continuation to a Δ -neighborhood of ρ .

By assumption, Λ is analytic on a Δ -neighborhood $D_\Lambda = \Delta(\varphi_\Lambda, r_\Lambda, R_\Lambda)$ of R_Λ , and the following approximation holds:

$$\Lambda(w) = \Lambda(R_\Lambda) - (R_\Lambda - w) + C'_\Lambda (R_\Lambda - w)^{\delta_*} (1 + \varepsilon(w)),$$

and $\varepsilon(w)$ is an analytic function on D_Λ tending to 0 in R_Λ .

Fix z in a Δ neighborhood D_T of ρ , whose parameters r_T and φ_T will be made precise later. The equation $w = z + \Lambda(w)$ then rewrites as

$$(6.40) \quad \rho - z = C'_\Lambda (R_\Lambda - w)^{\delta_*} (1 + \varepsilon(w)),$$

or, as a fixed point equation $w = G(z, w)$ for

$$G(z, w) := R_\Lambda - \left(\frac{1}{C'_\Lambda} (\rho - z) \cdot \frac{1}{1 + \varepsilon(w)} \right)^{1/\delta_*}.$$

We again use Picard's method of successive approximants to find an analytic solution $w(z)$ for (6.40), which will be the analytic continuation of $U(z)$ that we are looking for. For $z \in D_T$, set $\phi_0(z) = R_\Lambda$ and, whenever $\phi_i(z)$ lies in $D_\Lambda \cup \{R_\Lambda\}$, set $\phi_{i+1}(z) = G(z, \phi_i(z))$. In particular,

$$R_\Lambda - \phi_1(z) = \left(\frac{1}{C'_\Lambda} (\rho - z) \right)^{1/\delta_*}.$$

Since $1/\delta_* < 1$, we have $\text{Arg}(R_\Lambda - \phi_1(z)) = \frac{1}{\delta_*} \text{Arg}(\rho - z)$. We choose the parameters defining the Δ -neighborhood D_T of ρ to be $\varphi_T = \varphi_\Lambda$ and $r_T = C'_\Lambda \left(\frac{r_\Lambda}{2}\right)^{\delta_*}$. In this way, if z is in D_T , then $\phi_1(z)$ lives in $\widetilde{D}_\Lambda = \Delta(\widetilde{\varphi}_\Lambda, \frac{r_\Lambda}{2}, R_\Lambda)$, for some $\widetilde{\varphi}_\Lambda < \varphi_\Lambda$.

We define an intermediate Δ -neighborhood $D'_\Lambda = \Delta\left(\frac{\varphi_\Lambda + \widetilde{\varphi}_\Lambda}{2}, \frac{3r_\Lambda}{4}, R_\Lambda\right)$. This ensures that we have a constant $0 < r_0 < 1$, depending only on φ_Λ and $\widetilde{\varphi}_\Lambda$, such that the circle γ_w of center w and radius $r_0 |R_\Lambda - w|$ is contained in D_Λ for every $w \in D'_\Lambda$ and in D'_Λ for every $w \in \widetilde{D}_\Lambda$ (cf. Figure 6.1).

Consider the partial derivative

$$(6.41) \quad \frac{\partial G}{\partial w}(z, w) = \frac{\varepsilon'(w)}{\delta_*} \cdot \left(\frac{1}{C'_\Lambda} (\rho - z) \right)^{1/\delta_*} \cdot \left(\frac{1}{1 + \varepsilon(w)} \right)^{1/\delta_* + 1}.$$

We take w in the domain D'_Λ . The quantity $\varepsilon'(w)$ can now be evaluated through a contour integral on $\gamma_w \subset D_\Lambda$:

$$\varepsilon'(w) = \frac{1}{2\pi i} \oint_{\gamma_w} \frac{\varepsilon(u) du}{(u - w)^2}.$$

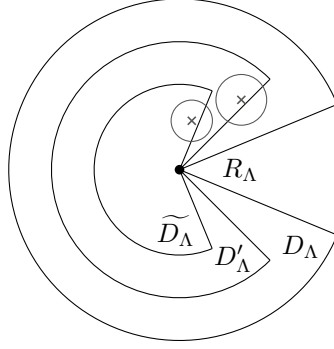

FIGURE 6.1. Illustration of $D_\Lambda, D'_\Lambda, \widetilde{D}_\Lambda$, with two examples of circles γ_w represented in gray.

This yields the inequality

$$|\varepsilon'(w)| = \mathcal{O} \left(\frac{\sup_{u \in D_\Lambda} |\varepsilon(u)|}{|R_\Lambda - w|} \right).$$

Plugging this back in Equation (6.41), we get, for w in D'_Λ

$$(6.42) \quad \left| \frac{\partial G}{\partial w}(z, w) \right| = \mathcal{O} \left(\frac{|z - \rho|^{1/\delta_*} \cdot \sup_{u \in D_\Lambda} |\varepsilon(u)|}{|R_\Lambda - w|} \right).$$

Now we shall find a domain where we have enough control on $|\frac{\partial G}{\partial w}(z, w)|$ as to guarantee the stability of the iterates. A subtlety here is that this control is impossible near $\phi_0(z) = R_\Lambda$. So we need to consider a domain around $\phi_1(z)$, hence that depends on z . For every $z \in D_T$, we have $\phi_1(z) \in \widetilde{D}_\Lambda$, so the disk

$$\Gamma_z := \{w : |w - \phi_1(z)| \leq \frac{1}{r_0} |\phi_1(z) - R_\Lambda|\}$$

is included in D'_Λ . For w in Γ_z , we have

$$|R_\Lambda - w| = \Theta(|\phi_1(z) - R_\Lambda|) = \Theta(|\rho - z|^{1/\delta_*}),$$

which implies after plugging back into Equation (6.42)

$$\left| \frac{\partial G}{\partial w}(z, w) \right| = \mathcal{O} \left(\sup_{u \in D_\Lambda} |\varepsilon(u)| \right).$$

By possibly reducing the radius r_Λ of D_Λ , we can make $\sup_{u \in D_\Lambda} |\varepsilon(u)|$ as small as wanted: for any w in Γ ,

$$(6.43) \quad \left| \frac{\partial G}{\partial w}(z, w) \right| \leq \frac{1}{r_0 + 1}.$$

Similarly,

$$|\phi_2(z) - \phi_1(z)| = \left(\frac{1}{C'_\Lambda} |\rho - z| \right)^{1/\delta_*} \cdot \left| \left(\frac{1}{1 + \varepsilon(\phi_1(z))} \right)^{1/\delta_*} - 1 \right|$$

can be made smaller than $\frac{1}{r_0+1} |\phi_1(z) - R_\Lambda|$ by reducing r_Λ . In particular, $\phi_2(z)$ is in Γ_z .

For $m \geq 2$, assume that $\phi_1(z), \dots, \phi_m(z)$ lie in Γ_z . Then for each $i \leq m$, using (6.43),

$$(6.44) \quad |\phi_{i+1}(z) - \phi_i(z)| \leq \left(\frac{1}{r_0+1} \right) |\phi_i(z) - \phi_{i-1}(z)| \leq \dots \leq \left(\frac{1}{r_0+1} \right)^{i-1} |\phi_2(z) - \phi_1(z)|.$$

Since $\phi_m(z)$ lies in $\Gamma_z \subset D_\Lambda$, the next term $\phi_{m+1}(z)$ is defined and

$$\begin{aligned} |\phi_{m+1}(z) - \phi_1(z)| &\leq \sum_{i=1}^m |\phi_{i+1}(z) - \phi_i(z)| \leq \left[\sum_{i=1}^m \left(\frac{1}{r_0+1} \right)^{i-1} \right] |\phi_2(z) - \phi_1(z)| \\ &\leq \frac{1}{r_0} |\phi_1(z) - R_\Lambda|. \end{aligned}$$

In particular, $\phi_{m+1}(z)$ also lies in Γ_z and an immediate induction shows that this is indeed the case for all $m \geq 1$.

By (6.44), the series $\sum_{i \geq 0} \phi_{i+1}(z) - \phi_i(z)$ is uniformly bounded by a geometric series and converges towards an analytic function ϕ on D_T . The limit $\phi(z)$ is a solution of $\phi(z) = z + \Lambda(\phi(z))$ and is the analytic continuation of $U(z)$ that we were looking for.

A small modification of the above argument shows that, when r_T , or equivalently r_Λ , tends to 0, the quotient

$$\frac{|\phi_{m+1}(z) - \phi_1(z)|}{|\phi_1(z) - R_\Lambda|}$$

also tends to 0. This proves that

$$(6.45) \quad \phi(z) - R_\Lambda = (\phi_1(z) - R_\Lambda)(1 + o(1)) = -\left(\frac{1}{c_\Lambda}(\rho - z)\right)^{1/\delta_*} (1 + o(1)).$$

The proof that $U(z)$ has no other singularities than ρ on the circle of convergence is similar to that of Lemma 6.7.1. \square

Scaling limits of permutation classes with a finite specification

This chapter builds on the previous Chapter 5, and they together form the article [Bas+19b], joint work with F. Bassino, M. Bouvel, V. Féray, L. Gerin et A. Pierrot.

ABSTRACT. We study a general finite specification for a family of permutations, which is known [BHV08b; Bas+17] to exist for permutation classes with a finite number of simple permutations. The limit depends on the structure of the specification restricted to families with the largest growth rate. When it is strongly connected, two cases occur. If the associated system of equations is linear, the limiting permuton is a deterministic X -shape. Otherwise, the limiting permuton is the Brownian separable permuton, a random object that already appeared as the limit of most substitution-closed permutation classes, among which the separable permutations. In both cases we assume analyticity conditions that correspond to the standard case of the previous chapter. Moreover these results can be combined to study some non strongly connected cases.

In section 7.1, we will introduce a classification of finite tree-specifications for permutation families, which is needed to state the results of this chapter. In section 7.2, we state and prove theorem 7.2.1, which is a result of convergence to the biased Brownian separable permuton for *essentially branching* specifications. In section 7.3, we state and prove theorem 7.3.2, which considers *essentially linear* specifications, for which the limit-shape is deterministic. In section 7.4, we consider specifications that don't verify the strong connectivity assumption of the two previous sections and provide a toolkit to reduce the study to such specifications. In section 7.5, we give more details on the various examples considered throughout the chapter.

7.1. Classification of specifications

The study of finite specifications started in Chapter 5. We recall the form taken by such a specification.

$$(E_{\mathcal{T}}) \quad \mathcal{T}_i = \varepsilon_i\{\bullet\} \uplus \bigsqcup_{\pi \in \mathcal{S}_{\mathcal{T}_i} \uplus \{\oplus, \ominus\}} \bigsqcup_{(k_1, \dots, k_{|\pi|}) \in K_{\pi}^i} \pi[\mathcal{T}_{k_1}, \dots, \mathcal{T}_{k_{|\pi|}}], \quad i \in I.$$

Such specifications may be obtained in the case of classes with a finite number of simple permutations by the algorithm of [Bas+17].

We have seen that such a specification induces a *proper system of equations for leaf-counted multitype trees*, in the sense of Definition 5.4.1 (\mathbf{T} is just the vector $(T_i)_{i \in I}$ and Φ was defined in (5.2).

$$(E_{\mathbf{T}}) \quad \mathbf{T}(z) = \Phi(z, \mathbf{T}(z)).$$

This system is automatically nonlinear (see Definition 5.4.2), and in the case of a finite number of simple permutations, is polynomial. Hence, under the additional assumption of irreducibility, it would be amenable to the analysis of the Drmota-Lalley-Wood Theorem 5.4.5. The analysis could then be carried exactly as in the proof of Theorem 6.1.3, giving convergence to a biased Brownian permuton.

Alas, we observe in examples that the dependency graph of the specification is never strongly connected except in the case of substitution-closed classes, and this is the difficulties we need to deal with in this chapter.

We fix once and for all a tree-specification of the form $(\mathcal{E}_{\mathcal{T}})$, verifying the hypotheses of Definition 5.2.1, for a finite vector of permutation families $(\mathcal{T}_i)_{i \in I}$.

7.1.1. Non-irreducible systems. For $i \in I$, let $\rho_i \in [0, +\infty]$ be the radius of convergence of T_i . We set $\rho = \min_i \{\rho_i\}$. The series with minimal radius of convergence are central to our analysis.

Definition 7.1.1. The type i , the family \mathcal{T}_i and its generating series T_i are said *critical* if $\rho_i = \rho$, and *subcritical* if $\rho_i > \rho$.

We recall the dependency graph $G = G_{(\mathcal{E}_{\mathcal{T}})}$ of the system Equation $(\mathcal{E}_{\mathcal{T}})$, defined in Definition 5.4.2. By abuse of notation, we may see it alternatively as a graph on the set of families $(\mathcal{T}_i)_{i \in I}$, or on the set I . Recall also Lemma 5.4.3; if $i \rightarrow j$ and i is critical, then j is critical too. Denote by $I^* \subseteq I$ the set of critical types. We denote $\mathbf{T}^* = (T_i)_{i \in I^*}$ the vector of critical series and assume for simplicity that when $(T_i)_{i \in I}$ is written in vector notation, the subcritical families follow the critical families, i.e. $\mathbf{T} = (\mathbf{T}^*, (T_i)_{i \notin I^*})$.

We assume that in this graph there is a path from every family to the family of interest \mathcal{T} . This is always the case in specifications obtained from the algorithm of [Bas+17]. In particular, the family \mathcal{T} is critical.

Let G^* denote the subgraph of G consisting of all critical families \mathcal{T}_i . Our main results will be based on the following strong assumption.

HYPOTHESIS (SC). We assume that G^* is strongly connected.

In Section 7.4 we will see how to combine our results in each strongly connected component in order to relax Hypothesis (SC).

7.1.2. Essentially linear and essentially branching specifications. We consider the restriction of the system $(E_{\mathcal{T}})$ to critical series and regard subcritical series as parameters (note that the superscript \star indicates a restriction to critical families or critical series):

$$(7.1) \quad \mathbf{T}^*(z) = \Phi^*(z, \mathbf{T}^*(z)),$$

where

$$(7.2) \quad \Phi^*(z, \mathbf{y}^*) = \Phi(z, \mathbf{y}^*, (T_i(z))_{i \notin I^*})$$

Observation 7.1.2. The system (7.1) is also a proper system of leaf-counted monotype trees. Under hypothesis (SC), it is irreducible. However, contrary to $(E_{\mathcal{T}})$, it may be linear.

Definition 7.1.3. We say that the specification $(\mathcal{E}_{\mathcal{T}})$ is *essentially branching* if (7.1) is nonlinear, and *essentially linear* if (7.1) is linear.

Equivalently, the specification is essentially branching if and only if there exist $i, j, j' \in I^*$ such that the equation defining \mathcal{T}_i in $(\mathcal{E}_{\mathcal{T}})$ involves a term of the form $\pi[\dots, \mathcal{T}_j, \dots, \mathcal{T}_{j'}, \dots]$.

As per Equation (5.3), denote $\mathbb{M}^*(z, \mathbf{y}^*)$ the Jacobian matrix of Φ^* with regards to the vector \mathbf{y}^* . In the essentially linear case, \mathbb{M}^* depends only on z (so we denote it $\mathbb{M}^*(z)$ by abuse of notation), and denoting $\mathbf{V}^*(z) = \Phi^*(z, \mathbf{0})$, we have the following rewriting of the system (7.1):

$$(7.3) \quad \mathbf{T}^*(z) = \mathbb{M}^*(z) \mathbf{T}^*(z) + \mathbf{V}^*(z).$$

Finally, to apply the Drmota-Lalley-Woods theorem, an additional assumption is needed, and we denote it as follows:

HYPOTHESIS (AR). We assume that for all $i \in I^*$, Φ_i^* is analytic in $(\rho, \mathbf{T}^*(\rho))$

In the linear case, the regularity assumptions of our singularity analysis theorem (Theorem 5.4.4) are slightly different and are as follows.

HYPOTHESIS (RC). All entries of \mathbb{M}^* and \mathbf{V}^* (which appear in (7.3)), are analytic at ρ .

Observation 7.1.4. When there is a finite number of simple permutations in the (\mathcal{T}_i) 's, then the Φ_i^* 's are polynomials partially applied in some subcritical series, and (RC) and (AR) are automatically satisfied.

7.2. The essentially branching case

The following theorem says that in the essentially branching case, provided one can apply the Drmota-Lalley-Wood theorem 5.4.5 to the restricted system, the conclusion of Theorem 6.1.3 still holds.

Theorem 7.2.1 (Main Theorem: the essentially branching case). *Consider a tree-specification $(\mathcal{E}\mathcal{T})$ for $(\mathcal{T}_i)_{i \in I}$ that verifies Hypothesis (SC) (p.106). We assume that*

- i) the specification is essentially branching,*
- ii) Hypothesis (AR) (p.106) holds,*
- iii) at least one series (either critical or subcritical) is aperiodic.*

Then all critical families converge to the same Brownian separable permuton. More precisely, there exists $p_+ \in [0, 1]$ such that for every $i \in I^$, letting σ_n be a uniform permutation of size n in \mathcal{T}_i ,*

$$\mu_{\sigma_n} \xrightarrow{(d)} \mu^{p_+}.$$

Furthermore, the bias parameter p_+ can be explicitly computed with Equation (7.7) p.109.

Remark 7.2.2. Recall that Hypothesis (AR) holds in particular if there are only finitely many simple permutations in the \mathcal{T}_i 's.

Item iii) is a weak assumption. Permutation classes (and more general restrictions such as all families that can be studied with the algorithm of [Bas+17], see [DP16]) are aperiodic by definition. As a result, every essentially branching specification obtained with the algorithm of [Bas+17] verifies the hypotheses of theorem.

7.2.1. Examples. We show two examples of classes having an essentially branching decomposition, whose limits are Brownian separable permutons of explicit parameters. The first example is build on purpose to display a limiting behavior of this kind for a class which is not substitution-closed. The second example is the famous class $Av(132)$. Its limiting permuton, which is supported by the antidiagonal, is a degenerate Brownian separable permuton.

7.2.1.1. *A non-degenerate branching case.*

We consider the class $\mathcal{T}_0 = Av(2413, 31452, 41253, 41352, 531642)$. The only simple permutation in the class is 3142, so that we apply the algorithm of [Bas+17]. In Section 7.5.5, we give the specification of this class and apply Theorem 7.2.1, to get that the limit is the biased Brownian separable permuton of parameter p_+ , where $p_+ \approx 0.4748692376\dots$ is the only real root of the polynomial

$$z^9 - 3z^8 + \frac{232819}{62348}z^7 - \frac{78093}{31174}z^6 + \frac{243697}{249392}z^5 - \frac{54293}{249392}z^4 + \frac{24529}{997568}z^3 - \frac{125}{62348}z^2 + \frac{45}{62348}z - \frac{2}{15587}.$$

7.2.1.2. *A degenerate branching case: $Av(132)$.* We continue the study of this Catalan class, which we started in Example 2.3.1 in the introduction of the thesis. Recall that this class has an essentially branching specification, with a single strongly connected component among the critical series. Hence we can apply Theorem 7.2.1: there exists some parameter p_+ such that the limiting permuton of $Av(132)$ is the biased Brownian separable permuton of parameter p_+ . Moreover, we can read directly from the specification that for all i, j, j' , we have $E_{i,j,j'}^+ = 0$ where $E_{i,j,j'}^\varepsilon$ are defined in Definition 5.3.4. It follows from Equation (7.7) p.109 that $p_+ = 0$ and $p_- = 1$: the limiting permuton is the antidiagonal.

We point out that for this particular class $Av(132)$, much more is known regarding the limiting shape [MP14; HRS17a] and the limiting distributions of pattern occurrences [Jan17]. We chose to present here this class to show a degenerate example which converges to a diagonal.

Remark 7.2.3. In Section 7.3.1.4 we will see another permutation class whose limiting permuton is supported by a diagonal. The example $Av(132)$ is however very different: the limit is a degenerate Brownian separable permuton while the limit of the layered permutations of Section 7.3.1.4 is a degenerate X -permuton, and we point out that the fine details of convergence are different in the two cases.

7.2.2. Proof of Theorem 7.2.1. The proof will look very much like the proof of Theorem 6.1.3. The starting point will be, once again, Proposition 5.3.7, so that we need the asymptotic behavior of the series T_i and T_i^j that appear in the right-hand-side of Equation (5.10). It will turn out later that focusing on the critical types is enough.

Hence we are interested in \mathbf{T}^* , and \mathbb{T}^* , which we can estimate by applying the Drmota-Lalley-Wood theorem (Theorem 5.4.5) to the restricted system (7.1), recalling from Equation (6.7) the identity $\mathbb{T}^*(z) = (\text{Id} - \mathbb{M}^*(z, \mathbf{T}^*(z)))^{-1}$. The results are collected in the following lemma. Recall that ρ is the common radius of convergence of the critical series.

Lemma 7.2.4. *Assume that the specification $(\mathcal{E}_{\mathcal{T}})$ is essentially branching and satisfies hypotheses (SC) and (AR). Assume also that one of the series T_i , critical or subcritical, is aperiodic.*

Then all entries of $(\text{Id} - \mathbb{M}^(z, \mathbf{T}^*(z)))^{-1}$ and $\mathbf{T}^*(z)$ are analytic on a Δ -domain at ρ . Moreover, the matrix $\mathbb{M}^*(\rho, \mathbf{T}^*(\rho))$ is irreducible and has Perron eigenvalue 1, and denoting \mathbf{u} and \mathbf{v} the corresponding left and right positive eigenvectors normalized so that $\mathbf{v}^\top \mathbf{u} = 1$, we have the following asymptotics¹ near ρ :*

$$(7.4) \quad \mathbf{T}^*(z) = \mathbf{T}^*(\rho) - \frac{\beta \mathbf{v}}{\zeta} \sqrt{\rho - z} + o(\sqrt{\rho - z})$$

$$(7.5) \quad (\mathbf{T}^*)'(z) \sim \frac{\beta \mathbf{v}}{2\zeta \sqrt{\rho - z}}$$

$$(7.6) \quad \mathbb{T}^*(z) = (\text{Id} - \mathbb{M}^*(z, \mathbf{T}^*(z)))^{-1} \sim \frac{\mathbf{v}^\top \mathbf{u}}{2\beta\zeta \sqrt{\rho - z}}$$

where

$$Z = \frac{1}{2} \sum_{i,j,j' \in I^*} u_i v_j v_{j'} \frac{\partial \Phi_i^*}{\partial y_j \partial y_{j'}}(\rho, \mathbf{T}^*(\rho)), \quad \zeta = \sqrt{Z},$$

and $\beta > 0$ is some positive constant.

PROOF OF LEMMA 7.2.4. According to Observation 7.1.2, under hypothesis (SC), in the essentially branching case, the system Equation (7.1) is a proper, irreducible, nonlinear system of equations for multitype leaf-counted trees. Hypothesis (AR) grants the analyticity assumption of Theorem 5.4.5. Moreover, if one of the series T_i is aperiodic, then the critical series are also aperiodic by Lemma 5.4.3. The result follows from Theorem 5.4.5. \square

Recall the definition of the series $E_{ijj'}^\varepsilon$ from Definition 5.3.4.

Proposition 7.2.5. *Under hypothesis (AR), for $i, j, j' \in I_*$, the series $E_{ijj'}^\varepsilon$ has radius of convergence at least ρ , is convergent at ρ and Δ -analytic at ρ . Moreover, we have*

$$\sum_{\varepsilon \in \{\pm\}} \sum_{i,j,j' \in I^*} E_{ijj'}^\varepsilon(\rho) u_i v_j v_{j'} = Z,$$

where u_i, v_j and Z are defined in Lemma 7.2.4.

PROOF. From Proposition 5.3.5, we know that the series $E_{ijj'}^\varepsilon$ are of the form $R_{ijj'}^\varepsilon(z, \mathbf{T}(z))$, where $R_{ijj'}^\varepsilon$ is coefficient-wise dominated by $\frac{\partial \Phi_i}{\partial y_j \partial y_{j'}}$. Denote $S(z, \mathbf{y}^*) = R_{ijj'}^\varepsilon(z, \mathbf{y}^*, (T_i(z))_{i \notin I_*})$, so that $E_{ijj'}^\varepsilon = S(z, \mathbf{T}^*(z))$. Then S is coefficient-wise dominated by

$$\frac{\partial \Phi_i}{\partial y_j \partial y_{j'}}(z, \mathbf{y}^*, (T_i(z))_{i \notin I_*}) = \frac{\partial \Phi_i^*}{\partial y_j \partial y_{j'}}.$$

1. In the above equations \sim stands for coefficient-wise asymptotic equivalence.

By hypothesis (AR), S is thus analytic around $(\rho, \mathbf{T}^*(\rho))$, and by subcritical composition (Lemma A.4.2), $E_{ijj'}^\varepsilon$ is Δ -analytic at ρ and convergent. Finally,

$$\begin{aligned} & \sum_{\varepsilon \in \{\pm\}} \sum_{i,j,j' \in I^*} E_{ijj'}^\varepsilon(\rho) u_i v_j v_{j'} \\ &= \frac{1}{2} \sum_{i,j,j' \in I^*} [E_{ijj'}^+(\rho) + E_{ijj'}^-(\rho) + E_{ijj'}^-(\rho) + E_{ijj'}^-(\rho)] u_i v_j v_{j'} \\ &= \frac{1}{2} \sum_{i,j,j' \in I^*} \frac{\partial^2 \Phi_i}{\partial y_j \partial y_{j'}}(0, \mathbf{T}(\rho)) u_i v_j v_{j'} = \frac{1}{2} \sum_{i,j,j' \in I^*} \frac{\partial^2 \Phi_i}{\partial y_j \partial y_{j'}}(\rho, \mathbf{T}(\rho)) u_i v_j v_{j'} \\ &= \frac{1}{2} \sum_{i,j,j' \in I^*} \frac{\partial^2 \Phi_i^*}{\partial y_j \partial y_{j'}}(\rho, \mathbf{T}^*(\rho)) \mathbf{u}_i \mathbf{v}_j \mathbf{v}_{j'} = \mathbf{Z} \end{aligned}$$

where Proposition 5.3.5, then the fact that derivatives of Φ_i with regards to \mathbf{y} do not depend on z , was used in the third line. \square

7.2.3. Probabilities of tree patterns. We now set

$$(7.7) \quad \begin{cases} p_+ &= \frac{1}{Z} \sum_{i,j,j' \in I^*} E_{ijj'}^{12}(\rho) u_i v_j v_{j'} \\ p_- &= \frac{1}{Z} \sum_{i,j,j' \in I^*} E_{ijj'}^{21}(\rho) u_i v_j v_{j'}, \end{cases}$$

where $E_{ijj'}^\varepsilon$ are defined in Definition 5.3.4 and u_i, v_j and Z are defined in Lemma 7.2.4. Thanks to Proposition 7.2.5, $p_+ + p_- = 1$.

Proposition 7.2.6. *We assume that we are in the essentially branching case, that Hypotheses (SC) and (AR) are satisfied, and that at least one series (either critical or subcritical) is aperiodic.*

Let t_0 be a signed binary tree with k leaves. Let $i_0 \in I^$ and let $\mathbf{t}_{i_0, n}$ be a uniform tree of size n in \mathcal{T}_{i_0} . Let $\mathbf{I}_{n,k}$ be an independent uniform subset of $[1, n]$ of size k . Then*

$$\mathbb{P}(\mathbf{t}_{i_0, n} | \mathbf{I}_{n,k} = t_0) \xrightarrow{n \rightarrow +\infty} \frac{1}{\text{Cat}_{k-1}} \prod_{v \in \text{Int}(t_0)} p_{\varepsilon(v)}.$$

In the above expression the limiting probabilities do not depend on i_0 and add up to 1 (summing over all signed binary trees t_0 with k leaves). We deduce that k marked leaves in a large uniform tree in \mathcal{T}_i induce a binary tree with high probability² when n goes to infinity, and that this signed binary tree is asymptotically distributed like a uniform binary tree with i.i.d. signs of bias p_+ (independently of the critical type i_0 that we consider).

PROOF. We fix t_0 a signed binary tree with k leaves and $i_0 \in I^*$ throughout the proof. By Proposition 5.3.7,

$$(7.8) \quad \mathbb{P}(\mathbf{t}_{i_0, n} | \mathbf{I}_{n,k} = t_0) = \frac{[z^{n-k}] T_{i_0, t_0}}{[z^{n-k}] \frac{1}{k!} T_{i_0}^{(k)}} \geq \frac{[z^{n-k}] U}{[z^{n-k}] \frac{1}{k!} T_{i_0}^{(k)}}$$

where

$$U = \sum_{j \in I^* \text{Int}(t_0)} \sum_{\substack{i \in I^* V(t_0) \\ i(\emptyset) = i_0}} \left[\prod_{v \in \text{Int}(t_0)} T_{i(v)}^{j(v)} \prod_{v \in \text{Lf}(t_0)} T'_{i(v)} \prod_{v \in \text{Int}(t_0)} E_{j(v)i(v.1)\dots i(v.d(v))}^{\varepsilon(v)} \right].$$

is the restriction of the right-hand side of Proposition 5.3.7 to terms where all types i and j are critical. We want to apply the transfer theorem to the series U and $T_i^{(k)}$.

We first check that those series are analytic on a Δ -domain at ρ . It is the case of T_i (and all its derivatives) by Lemma 7.2.4. In addition, for all critical types i, j and j' , the series T_j^i and $E_{ijj'}^\varepsilon$ also are analytic on a Δ -domain at ρ (by Lemma 7.2.4 and Proposition 7.2.5 respectively). Hence by multiplication the same holds for U .

2. Throughout the paper, we say that an event holds *with high probability* if its probability tends to 1.

We now look for asymptotic equivalents. For U , we plug in the values at ρ of the convergent series (E_{ijj}^ε , is convergent thanks to Proposition 7.2.5) and the asymptotics near ρ of the divergent series given by Equations (7.5) and (7.6). The rest is exactly as in the proof of Proposition 6.3.2. The asymptotic rank-one-ness of \mathbb{T} near ρ provides many simplifications, yielding

$$T_{i,t_0}(z) \sim (\rho - z)^{1/2-k} \frac{v_i \beta}{2^{2k-1} \zeta} \prod_{v \in \text{Int}(t_0)} p_{\varepsilon(v)}.$$

For $T_i^{(k)}$, singular differentiation of Equation (7.5) yields

$$\frac{T_i^{(k)}}{k!} \sim (\rho - z)^{1/2-k} \frac{v_i \beta}{2^{2k-1} \zeta} \text{Cat}_{k-1}.$$

Applying the transfer theorem and using Equation (7.8) yields

$$(7.9) \quad \liminf_{n \rightarrow \infty} \mathbb{P}(\mathbf{t}_{i_0,n} |_{\mathbf{I}_{n,k}} = t_0) \geq \frac{1}{\text{Cat}_{k-1}} \prod_{v \in \text{Int}(t_0)} p_{\varepsilon(v)}.$$

Consider the sum over all signed binary tree t_0 . The right-hand side sums to 1 (recall that $p_+ + p_- = 1$). On the other hand, for each fixed n , the sum of $\mathbb{P}(\mathbf{t}_{i_0,n} |_{\mathbf{I}_{n,k}} = t_0)$ over t_0 is at most 1. This forces the infimum limit in (7.9) to be an actual limit and the inequality to be an equality, proving the proposition. \square

Theorem 7.2.1 follows immediately. Indeed, by Proposition 7.2.6 and Lemma 5.1.11, we have the following convergence in distribution:

$$\text{pat}_{\mathbf{I}_{n,k}}(\boldsymbol{\sigma}_n) = \text{perm}(\mathbf{t}_{i,n} |_{\mathbf{I}_{n,k}}) \xrightarrow{n \rightarrow +\infty} \text{perm}(\mathbf{b}_k),$$

where \mathbf{b}_k is a uniform binary tree of size k whose internal nodes carry i.i.d. signs with bias p_+ . We conclude thanks to Theorem 1.2.1 (characterization of convergence of random permutons) and Definition 4.2.1 (definition of the biased Brownian separable permuton). \square

7.3. The essentially linear case

We introduce the necessary material to state our second main theorem.

Definition 7.3.1. Let $\mathbf{p} = (p_+^{\text{left}}, p_+^{\text{right}}, p_-^{\text{left}}, p_-^{\text{right}}) \in [0, 1]^4$ be a quadruple with sum 1. The X -permuton with parameter \mathbf{p} is the following probability measure on the unit square

$$\mu_{\mathbf{p}}^X = \sum_{\substack{e \in \{\text{left}, \text{right}\}, \\ \varepsilon \in \{-, +\}}} p_\varepsilon^e \nu(z_\varepsilon^e, (a, b)),$$

where

$$\begin{aligned} z_+^{\text{left}} &= (0, 0), & z_-^{\text{left}} &= (0, 1), & z_-^{\text{right}} &= (1, 0), & z_+^{\text{right}} &= (1, 1), \\ a &= p_+^{\text{left}} + p_-^{\text{left}}, & b &= p_+^{\text{left}} + p_-^{\text{right}}, \end{aligned}$$

and $\nu(X, Y)$ denotes the normalized one-dimensional Lebesgue measure on the segment (X, Y) in the plane (see Figure 7.1).

Let us verify that the above defined $\mu_{\mathbf{p}}^X$ is indeed a permuton, *i.e.* that its marginals are uniform. We first observe that $\mu_{\mathbf{p}}^X([0, a] \times [0, 1]) = p_+^{\text{left}} + p_-^{\text{left}} = a$. By proportionality, for each subinterval $[x_1, x_2]$ of $[0, a]$, we have $\mu_{\mathbf{p}}^X([x_1, x_2] \times [0, 1]) = x_2 - x_1$. The same holds for subintervals of $[a, 1]$, and hence for any subinterval of $[0, 1]$. This proves that the marginal distribution on the horizontal axis is uniform. The marginal distribution on the vertical axis is treated similarly.

Theorem 7.3.2 (Main Theorem: the essentially linear case). *Consider a tree-specification $(\mathcal{E}_{\mathcal{T}})$ for $(\mathcal{T}_i)_{i \in I}$ that verifies Hypothesis (SC) (p.106). We assume that*

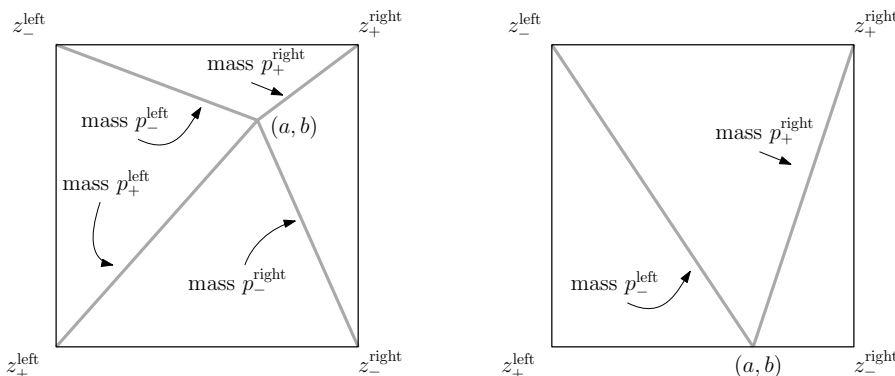

FIGURE 7.1. The support of the X -permuton with parameter $\mathbf{p} = (p_+^{\text{left}}, p_+^{\text{right}}, p_-^{\text{left}}, p_-^{\text{right}})$, denoting $a = p_+^{\text{left}} + p_-^{\text{left}}$ and $b = p_+^{\text{left}} + p_-^{\text{right}}$. Left: The generic case. Right: A degenerate case $b = 0$.

- i) the specification is essentially linear,
- ii) Hypothesis (RC) (p.106) holds,
- iii) there is at least one subcritical series which is aperiodic.

Then all critical families converge to the same X -permuton. More precisely, there exists a parameter $\mathbf{p} = (p_+^{\text{left}}, p_+^{\text{right}}, p_-^{\text{left}}, p_-^{\text{right}})$ such that for every $i \in I^*$, letting σ_n be a uniform permutation of size n in \mathcal{T}_i , we have

$$\mu_{\sigma_n} \xrightarrow{(d)} \mu_{\mathbf{p}}^X.$$

Furthermore, \mathbf{p} can be explicitly computed with Equation (7.15) p.117.

Remark 7.3.3. Recall that Hypothesis (RC) holds in particular if there are only finitely many simple permutations in the \mathcal{T}_i 's.

In item iii), the existence of some subcritical series is necessary for an essentially linear specification. Aperiodicity of at least one of them is a weak assumption, and it will be easily checked in all examples of the present paper. Actually, most examples considered are tree-specifications for classes with finitely many simple permutations obtained by the algorithm of [Bas+17]. In such specifications all T_i 's are of the form $T_{(\sigma_1, \dots, \sigma_k), (\tau_1, \dots, \tau_\ell)}^{\text{not } \delta}$. And it was proved in [DP16] that for such specifications, if T_i is not a polynomial, then it is necessarily aperiodic.

7.3.1. Examples. We now present several examples of classes where Theorem 7.3.2 applies.

7.3.1.1. *A centered X -permuton:* $\mathcal{T} = \text{Av}(2413, 3142, 2143, 3412)$. This class is known as the X -class [Eli11]. It is not substitution-closed and contains no simple permutation. The algorithm of [Bas+17] gives the following specification³:

$$(7.10) \quad \left\{ \begin{array}{l} \mathcal{T}_0 = \{\bullet\} \uplus \oplus[\mathcal{T}_1, \mathcal{T}_2] \uplus \oplus[\mathcal{T}_1, \mathcal{T}_3] \uplus \oplus[\mathcal{T}_4, \mathcal{T}_2] \uplus \ominus[\mathcal{T}_1, \mathcal{T}_5] \uplus \ominus[\mathcal{T}_1, \mathcal{T}_6] \uplus \ominus[\mathcal{T}_7, \mathcal{T}_5] \\ \mathcal{T}_1 = \{\bullet\} \\ \mathcal{T}_2 = \{\bullet\} \uplus \oplus[\mathcal{T}_1, \mathcal{T}_2] \\ \mathcal{T}_3 = \oplus[\mathcal{T}_1, \mathcal{T}_3] \uplus \oplus[\mathcal{T}_4, \mathcal{T}_2] \uplus \ominus[\mathcal{T}_1, \mathcal{T}_5] \uplus \ominus[\mathcal{T}_1, \mathcal{T}_6] \uplus \ominus[\mathcal{T}_7, \mathcal{T}_5] \\ \mathcal{T}_4 = \ominus[\mathcal{T}_1, \mathcal{T}_5] \uplus \ominus[\mathcal{T}_1, \mathcal{T}_6] \uplus \ominus[\mathcal{T}_7, \mathcal{T}_5] \\ \mathcal{T}_5 = \{\bullet\} \uplus \ominus[\mathcal{T}_1, \mathcal{T}_5] \\ \mathcal{T}_6 = \oplus[\mathcal{T}_1, \mathcal{T}_2] \uplus \oplus[\mathcal{T}_1, \mathcal{T}_3] \uplus \oplus[\mathcal{T}_4, \mathcal{T}_2] \uplus \ominus[\mathcal{T}_1, \mathcal{T}_6] \uplus \ominus[\mathcal{T}_7, \mathcal{T}_5] \\ \mathcal{T}_7 = \oplus[\mathcal{T}_1, \mathcal{T}_2] \uplus \oplus[\mathcal{T}_1, \mathcal{T}_3] \uplus \oplus[\mathcal{T}_4, \mathcal{T}_2]. \end{array} \right.$$

3. See the companion Jupyter notebook `examples/X.ipynb`

The specification (7.10) translates into a system on the series $(T_i)_{0 \leq i \leq 7}$, whose resolution gives

$$\begin{cases} T_0 = \frac{-z(2z-1)}{(2z^2-4z+1)} \\ T_1 = z \\ T_2 = T_5 = \frac{-z}{(z-1)} \\ T_3 = T_6 = \frac{-z^2}{(z-1)(2z^2-4z+1)} \\ T_4 = T_7 = \frac{z^2(-z+1)}{(2z^2-4z+1)} \end{cases}$$

The factor $2z^2 - 4z + 1$ in the denominator determines the criticality here, and the critical series (of radius of convergence $\rho = 1 - \sqrt{2}/2 \approx 0.2929$) are T_0, T_3, T_4, T_6 and T_7 . The critical strongly connected components are $\{0\}$ and $\{3, 4, 6, 7\}$. Removing the equation for T_0 , we obtain a specification for the other families satisfying Hypothesis (SC), and essentially linear.

The Hypothesis (RC) holds trivially since we have a finite number of simple permutations (Observation 7.1.4) and it is immediate to see that the subcritical series T_2 and T_5 are aperiodic. We can therefore apply Theorem 7.3.2: there exists a parameter \mathbf{p} such that a uniform permutation in any of the class $\mathcal{T}_3, \mathcal{T}_4, \mathcal{T}_6$ and \mathcal{T}_7 tends towards $\mu_{\mathbf{p}}^X$.

We now use a little trick to prove that the same holds for \mathcal{T}_0 as well. We observe that $\mathcal{T}_0 = \mathcal{T}_2 \uplus \mathcal{T}_3$ and \mathcal{T}_2 is the set of increasing permutations. Hence when n tends towards $+\infty$, a uniform permutation in \mathcal{T}_0 belongs to \mathcal{T}_3 with probability tending to one. Consequently, a uniform random permutation in the X -class \mathcal{T}_0 also converges to the X -permuton of parameter \mathbf{p} .

Since the X -class has all symmetries of the square, we necessarily have $p_+^{\text{left}} = p_+^{\text{right}} = p_-^{\text{left}} = p_-^{\text{right}} = 1/4$ (we do not need Equation (7.15) to compute the parameter \mathbf{p} in this case).

7.3.1.2. *A non-centered X -permuton:* $\mathcal{T} = \text{Av}(2413, 3142, 2143, 34512)$. This is a variant of the previous example: again, this class is not substitution-closed and contains no simple permutation. This case is handled as the previous one, except for the computation of the parameter \mathbf{p} , since the symmetry argument does not apply. In Section 7.5.2, we give a specification for \mathcal{T} and use Theorem 7.3.2 and Equation (7.15) to show that the limit is the permuton $\mu_{\mathbf{p}}^X$ where

$$\mathbf{p} \approx (0.200258808255625, 0.200258808255625, 0.431332891374616, 0.168149492114135)$$

is a quadruplet of algebraic numbers of degree 3. This is illustrated in Figure 7.2

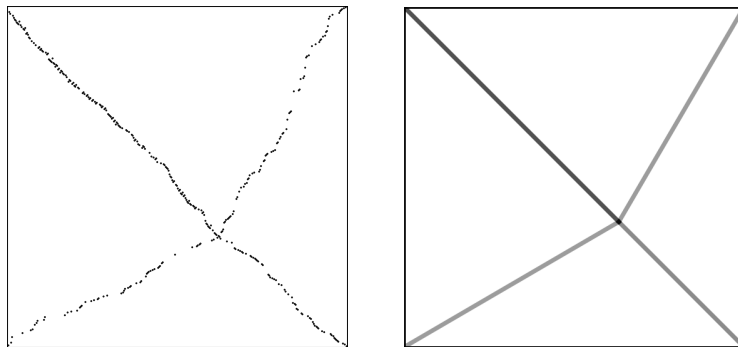

FIGURE 7.2. Left: A simulation of a uniform permutation of size 342 in $\text{Av}(2413, 3142, 2143, 34512)$. Right: The limiting permuton, as predicted by Theorem 7.3.2.

7.3.1.3. *A V shape:* $\mathcal{T} = \text{Av}(2413, 1243, 2341, 41352, 531642)$. The example we consider next is the one chosen in [Bas+17] to illustrate the computation of the specification. It is for us a benchmark to test the applicability of our results.

The only simple permutation in the class is 3142, so that the algorithm of [Bas+17] applies. In this case the combinatorial specification gives a system of 13 equations, which we recall in Section 7.5.3. Also in this appendix, we use Theorem 7.3.2 to show that the limit is the permuton $\mu_{\mathbf{p}}^X$ where $p_{\text{left}}^+ = p_{\text{right}}^- = 0$, $p_{\text{right}}^+ = 1 - p_{\text{left}}^-$, and $p_{\text{left}}^- \approx 0.818632668576995$ is the only real root of the polynomial

$$19168z^5 - 86256z^4 + 155880z^3 - 141412z^2 + 64394z - 11773.$$

This is illustrated in Figure 7.3.

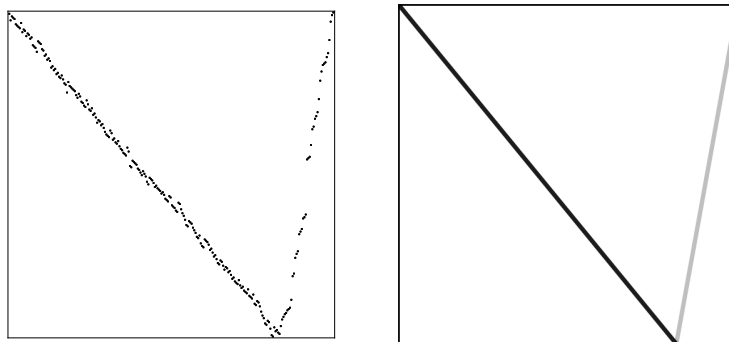

FIGURE 7.3. Left: A simulation of a uniform permutation of size 248 in $\text{Av}(2413, 1243, 2341, 41352, 531642)$. Right: The limiting permuton, as predicted by Theorem 7.3.2.

7.3.1.4. *A diagonal:* $\mathcal{T} = \text{Av}(231, 312)$. This is the class of so-called layered permutations. It contains no simple permutation and admits the following tree-specification:

$$\mathcal{T}_0 = \{\bullet\} \uplus \oplus[\mathcal{T}_1, \mathcal{T}_0] \uplus \ominus[\mathcal{T}_2, \mathcal{T}_1], \quad \mathcal{T}_1 = \{\bullet\} \uplus \ominus[\mathcal{T}_2, \mathcal{T}_1], \quad \mathcal{T}_2 = \{\bullet\}.$$

The associated equations can be solved explicitly and \mathcal{T}_0 turns out to be the only critical family. So the specification is essentially linear, and Theorem 7.3.2 applies. We compute the parameters of the limit using Equation (7.15). Looking at the specification, $D_-^{\text{left}} = D_+^{\text{right}} = D_-^{\text{right}} = 0$, so that the scaling limit for $\text{Av}(231, 312)$ is the X -permuton with parameters

$$p_+^{\text{left}} = 1, \quad p_-^{\text{left}} = p_+^{\text{right}} = p_-^{\text{right}} = 0,$$

i.e. the permuton supported by the main diagonal $\{x = y\}$.

This convergence could also be proved easily in a more direct way, since layered permutations are direct sums of decreasing permutations (*i.e.* $\oplus[d_1, \dots, d_r]$, for decreasing permutations d_1, \dots, d_r of various sizes). Nevertheless, we briefly commented on this example to illustrate that the diagonal permuton can appear as a degenerate case of the X -permuton.

7.3.1.5. *An example with infinitely many simple permutations: pin-permutations.* The class of pin-permutations has been introduced and used in the framework of decision problems in the papers [BHV08a; BRV08]. This class contains an infinite number of simple permutations (and has an infinite basis), so that the algorithm of [Bas+17] does not apply to give a tree-specification.

However, the class was enumerated in [BBR11, Section 5] using a recursive description of their substitution tree. This recursive description can be translated into a tree-specification. Note that Observation 7.1.4 does not apply and hypothesis (RC) needs to be checked manually. This is done in Section 7.5.4, where we use Theorem 7.3.2 to show that the limiting shape of a uniform random pin-permutation is a centered X -permuton.

7.3.2. Caterpillar and associated permutations. Because of the existence of a critical spine, some particular trees will play a significant role in the analysis: these are the *caterpillars*.

We say that a tree is *binary* when every internal node has *exactly* 2 children.

Definition 7.3.4. A *caterpillar* of size k is a binary plane tree with

- $k - 1$ internal nodes labeled by either \oplus or \ominus ;
- a special leaf, called the *head*;

such that all internal nodes are on the path from the root to the head.

A caterpillar is drawn in Figure 7.4. Since a caterpillar is binary, the number of leaves in a caterpillar of size k is k .

We take the following convention:

- internal nodes are ordered from v_1 to v_{k-1} according to their distance to the root (namely, v_r is at distance $r - 1$ from the root);
- leaves are ordered as such: ℓ_k is the head, while for $1 \leq r \leq k - 1$, the r -th leaf ℓ_r is a child of the r -th internal node v_r (ℓ_{k-1} is not the head).

To a caterpillar t_0 of size $k \geq 1$ we associate its code word $(e_1, \varepsilon_1) \dots (e_{k-1}, \varepsilon_{k-1})$, defined as follows: for each $1 \leq r \leq k - 1$

- $e_r \in \{\text{left}, \text{right}\}$ indicates whether ℓ_r is a left or a right child of v_r , ε_r is the sign of the internal node v_r of t_0 .

Remark that a caterpillar is completely determined by its code word.

Remark 7.3.5. In the graph theory literature, caterpillars are usually trees seen as unrooted graphs whose internal nodes form a path. Our caterpillars are, on the contrary, rooted, plane, and binary, that is, every internal node has *exactly* 2 children.

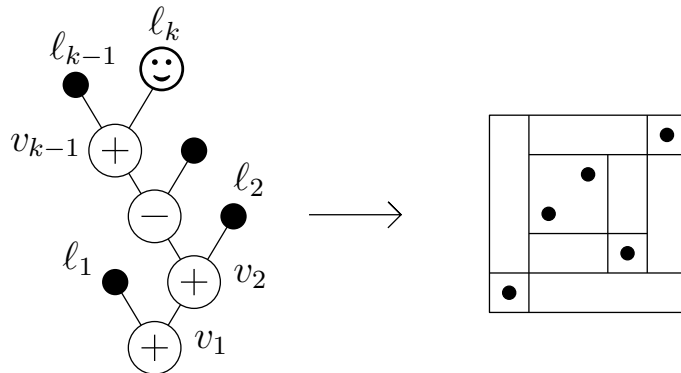

FIGURE 7.4. Left: A caterpillar t_0 with $k = 5$ regular leaves and one head. Its code word is (left, +)(right, +)(right, -)(left, +)(left, +). Middle: The associated substitution tree $\text{Red}(t_0)$. Right: The permutation $\text{perm}(\text{Red}(t_0))$.

We now define what it means for k leaves in a substitution tree to induce a caterpillar.

Definition 7.3.6. Fix a caterpillar t_0 of size k . For $i \in I^*$, the family \mathcal{T}_{i,t_0} is the set of pairs (t, \mathcal{I}) where t is a tree in \mathcal{T}_i and \mathcal{I} is a subset of k leaves in t (called *marked* leaves, and taken without any order on them) such that

- the k marked leaves induce the tree t_0 ;
- moreover, denoting ϕ the embedding of t_0 in t , the child of $\phi(v_{k-1})$ leading to $\phi(\ell_k)$ should be of a critical type.

Remark 7.3.7. In the linear case, a node of a tree in \mathcal{T}_i can have at most one child of critical type. Hence the \mathcal{T}_{i,t_0} are disjoint.

Remark 7.3.8. When t_0 is a caterpillar, membership to \mathcal{T}_{i,t_0} is more restricted than if t_0 were viewed as just a substitution tree (forgetting about which leaf is the head). This additional restriction is useful to simplify some proofs later.

Our next step towards the enumeration of \mathcal{T}_{i,t_0} (Proposition 7.3.10) is to adapt Proposition 5.3.7 to this special case. To that end, we introduce the following generating functions:

$$(7.11) \quad D_{i,j}^{e,\varepsilon} = \begin{cases} \sum_{j' \in I} E_{i,j,j'}^\varepsilon T'_{j'} & \text{if } e = \text{right} \\ \sum_{j' \in I} E_{i,j',j}^\varepsilon T'_{j'} & \text{if } e = \text{left} \end{cases}$$

recalling doubly blossoming trees and their generating series $E_{ijj'}^\varepsilon$ from Definition 5.3.4.

Proposition 7.3.9. *For all $i, j \in I^*$, we have*

$$\sum_{e,\varepsilon} D_{i,j}^{e,\varepsilon}(z) = \frac{\partial}{\partial z} \mathbb{M}_{i,j}^*(z).$$

If Hypothesis (RC) holds, this implies in particular that all $D_{i,j}^{e,\varepsilon}(z)$ have radius of convergence $> \rho$, and converge at $z = \rho$.

PROOF. Assume i and j_1 are critical types. We have, using Proposition 5.3.5 on the second line,

$$\begin{aligned} \sum_{e,\varepsilon} D_{i,j_1}^{e,\varepsilon}(z) &= \sum_{j_2 \in I} T'_{j_2} \sum_{\pi \in \mathfrak{S}_2} \sum_{\rho \in \mathfrak{S}_2} E_{i,j_{\rho(1)},j_{\rho(2)}}^\pi \\ &= \sum_{j_2 \in I} T'_{j_2} \frac{\partial^2 \Phi_i(0, \mathbf{y})}{\partial y_{j_1} \partial y_{j_2}} \Big|_{\mathbf{y}=\mathbf{T}} = \sum_{j_2 \in I \setminus I^*} T'_{j_2} \frac{\partial^2 \Phi_i(0, \mathbf{y})}{\partial y_{j_1} \partial y_{j_2}} \Big|_{(y_i)_{i \notin I^*} = (T_i)_{i \notin I^*}} \end{aligned}$$

the last rewriting following because j_1 is critical and the essentially linear assumption: after differentiation with regards to y_{j_1} , Φ_i is independent of other critical types. Moreover, differentiation with regards to y_{j_1} commutes with substitution of subcritical series by their actual value, and with multiplication by T'_{j_2} which is a function of z . Hence

$$\begin{aligned} \sum_{e,\varepsilon} D_{i,j_1}^{e,\varepsilon}(z) &= \sum_{j_2 \in I \setminus I^*} T'_{j_2} \frac{\partial}{\partial y_{j_1}} \frac{\partial \Phi_i(0, \mathbf{y})}{\partial y_{j_2}} \Big|_{(y_i)_{i \notin I^*} = (T_i)_{i \notin I^*}} \\ &= \frac{\partial}{\partial y_{j_1}} \sum_{j_2 \in I \setminus I^*} T'_{j_2} \frac{\partial \Phi_i(0, \mathbf{y})}{\partial y_{j_2}} \Big|_{(y_i)_{i \notin I^*} = (T_i)_{i \notin I^*}} = \frac{\partial}{\partial y_{j_1}} \frac{\partial}{\partial z} (\Phi_i^*(z, \mathbf{y}) - \varepsilon_i z) \\ &= \frac{\partial}{\partial z} \mathbb{M}_{i,j}^*(z) \quad \square \end{aligned}$$

We denote by $\mathbb{D}^{e,\varepsilon}$ the matrix $(D_{i,j}^{e,\varepsilon})_{i,j \in I^*}$.

Proposition 7.3.10 (Enumeration of trees with marked leaves inducing a given caterpillar). *Let t_0 be a caterpillar with k leaves of code word $(e_1, \varepsilon_1) \dots (e_{k-1}, \varepsilon_{k-1})$. Then the vector $\mathbf{T}_{t_0}^* = (T_{i,t_0})_{i \in I^*}$ is given by*

$$(7.12) \quad \mathbf{T}_{t_0}^* = \mathbf{T}^* \mathbb{D}^{e_1, \varepsilon_1} \mathbf{T}^* \mathbb{D}^{e_2, \varepsilon_2} \dots \mathbf{T}^* \mathbb{D}^{e_{k-1}, \varepsilon_{k-1}} (\mathbf{T}^*)',$$

where $\mathbb{D}^{e,\varepsilon}$ denotes the matrix $(D_{i,j}^{e,\varepsilon})_{i,j \in I^*}$.

PROOF. Let $i_0 \in I^*$. We start from the equality (5.10) of Proposition 5.3.7. Examining its proof makes it clear that adding the constraint that the child of $\phi(v_{k-1})$ leading to $\phi(\ell_k)$ is of a critical type amounts to selecting the terms of the sum where $j(v) \in I^*$ for

$v \in \text{Int}(t_0)$, and $i(v) \in I^*$ for $v \in \{\text{head}\} \cap \text{Int}(t_0)$.

$$\begin{aligned}
T_{i_0, t_0} &= \sum_{j \in I^* \cap \text{Int}(t_0)} \sum_{\substack{j \in I^V(t_0) \\ i|_{\text{Int}(t_0)} \in I^* \\ i(\text{head}) \in I^*}} \left[\prod_{v \in \text{Int}(t_0)} T_{i(v)}^{j(v)} \prod_{v \in \text{Lf}(t_0)} T'_{i(v)} \prod_{v \in \text{Int}(t_0)} E_{j(v)i(v.1)i(v.2)}^{\varepsilon(v)} \right] \\
&= \sum_{\substack{r_1, \dots, r_{k-1} \in I^* \\ s_0, \dots, s_{k-1} \in I^*, s_0 = i_0 \\ t_1, \dots, t_{k-1} \in I}} \left[\prod_{\ell=1}^{k-1} T_{s_{\ell-1}}^{r_{\ell}} \times T'_{s_{k-1}} \prod_{\ell=1}^{k-1} T'_{t_{\ell}} \times \prod_{\ell=1}^{k-1} (E_{r_{\ell} s_{\ell} t_{\ell}}^{\varepsilon_{\ell}} \mathbf{1}_{e_{\ell}=\text{right}} + E_{r_{\ell} t_{\ell} s_{\ell}}^{\varepsilon_{\ell}} \mathbf{1}_{e_{\ell}=\text{left}}) \right] \\
&= \sum_{\substack{r_1, \dots, r_{k-1} \in I^* \\ s_1, \dots, s_{k-1} \in I^*}} T_{i_0}^{r_1} D_{r_1, s_1}^{e_1, \varepsilon_1} T_{s_1}^{r_2} D_{r_2, s_2}^{e_2, \varepsilon_2} \dots T_{s_{k-2}}^{r_{k-1}} D_{r_{k-1}, s_{k-1}}^{e_{k-1}, \varepsilon_{k-1}} T'_{s_{k-1}}.
\end{aligned}$$

where the following change of variables was performed: $t_p = i(\ell_p)$ for $1 \leq p \leq k-1$, $s_{p-1} = i(v_p)$ for $1 \leq p \leq k-1$, $s_{k-1} = i(\ell_k)$, and $r_p = j(v_p)$ for $1 \leq p \leq k-1$. Written in matrix notation this is exactly (7.12). \square

Our goal here is to describe the singular behavior of the series in $\mathbf{T}_{t_0}^*$. Hence (from Proposition 7.3.10), we need information on the singular behavior of the series that are the entries of $\mathbf{T}^*(z)$ and $\mathbb{T}^*(z)$.

The following lemma is a consequence of a general result on linear systems proved in Chapter 5 (Theorem 5.4.4). Recall that ρ is the common radius of convergence of the critical series.

Lemma 7.3.11. *In the essentially linear case, under Hypotheses (SC) and (RC) (p.106), assuming moreover that at least one subcritical series is aperiodic, we have the following results.*

All entries of $\mathbb{T}^*(z) = (\text{Id} - \mathbb{M}^*)^{-1}$ and \mathbf{T}^* are analytic on a Δ -domain at ρ .

Moreover, the matrix $\mathbb{M}^*(\rho)$ has Perron eigenvalue 1. Denoting \mathbf{u} and \mathbf{v} the corresponding left and right positive eigenvectors normalized so that $\mathbf{u} \mathbf{v} = 1$ (\mathbf{u} stands for the transpose of the vector \mathbf{u}), we also have the following asymptotics near ρ :

$$(7.13) \quad \mathbb{T}^*(z) = (\text{Id} - \mathbb{M}^*(z))^{-1} \sim \left(\frac{1}{\mathbf{u}(\mathbb{M}^*)'(\rho)\mathbf{v}} \right) \frac{1}{\rho - z} \mathbf{v} \mathbf{u}.$$

$$(7.14) \quad \mathbf{T}^*(z) \sim \left(\frac{\mathbf{u} \mathbf{V}^*(\rho)}{\mathbf{u}(\mathbb{M}^*)'(\rho)\mathbf{v}} \right) \frac{1}{\rho - z} \mathbf{v}.$$

In the above equations \sim stands for coefficient-wise asymptotic equivalence. Observe that the factors preceding $\frac{1}{\rho - z}$ are real numbers.

PROOF. We check that the system (7.1) satisfies all hypotheses of Theorem 5.4.4.

- By Observation 7.1.2, it is an essentially linear irreducible system for multitype leaf-counted trees.
- Hypothesis (RC) ensures that the radius of convergence of all entries of \mathbb{M}^* is strictly larger than ρ .
- By assumption, there is at least one subcritical series T_{i_0} which is aperiodic. Moreover there is a path $T_{i_0} \rightarrow T_{i_1} \rightarrow \dots \rightarrow T_{i_{\ell}}$ in $G(\mathcal{E}_{\mathcal{T}})$ from T_{i_0} to the critical strongly connected component (see Section 7.1.2). We choose this path such that $T_{i_{\ell-1}}$ is subcritical and $T_{i_{\ell}}$ is critical, therefore the series $T_{i_{\ell-1}}$ is aperiodic thanks to Lemma 5.4.3. And as $T_{i_{\ell-1}}$ appears in at least one coefficient of \mathbb{M}^* (at line i_{ℓ}) this ensures that the g.c.d. of the periods of the series in \mathbb{M}^* is 1.
- Moreover by Equation (5.5) (p.74), $\mathbb{T}^*(z) = (\text{Id} - \mathbb{M}^*(z))^{-1}$.

Theorem 5.4.4 gives us the desired result. \square

7.3.3. Probabilities of caterpillars. For all $e \in \{\text{left}, \text{right}\}$, $\varepsilon \in \{+, -\}$, we set

$$(7.15) \quad p_\varepsilon^e = \frac{\tau_{\mathbf{u}} \mathbb{D}^{\varepsilon, e}(\rho) \mathbf{v}}{\tau_{\mathbf{u}}(\mathbb{M}^*)'(\rho) \mathbf{v}},$$

where the matrix $\mathbb{D}^{\varepsilon, e}$ is defined according to Equation (7.11), \mathbb{M}^* , \mathbf{u} and \mathbf{v} are given in Lemma 7.3.11.

Then from Proposition 7.3.9,

$$(7.16) \quad p_+^{\text{left}} + p_+^{\text{right}} + p_-^{\text{left}} + p_-^{\text{right}} = 1.$$

Hence we can see $\mathbf{p} = (p_+^{\text{left}}, p_+^{\text{right}}, p_-^{\text{left}}, p_-^{\text{right}})$ as a probability distribution on $\{\text{left}, \text{right}\} \times \{+, -\}$. We will prove that the limiting object of the class \mathcal{T}_i (with $i \in I^*$) is the X -permuton of parameter \mathbf{p} . An important step is the following proposition.

Proposition 7.3.12 (Occurrences of a given caterpillar). *Fix $i \in I^*$ and $k \geq 2$. Consider a uniform random tree \mathbf{t}_n with n leaves in \mathcal{T}_i , and an independent random subset \mathbf{I}_n^k of $[1, n]$ of size k , so that $(\mathbf{t}_n, \mathbf{I}_n^k)$ is a uniform random element of $\mathcal{T}^{(k)}$. Let t_0 be a caterpillar of size k and code word $(e_1, \varepsilon_1) \dots (e_{k-1}, \varepsilon_{k-1})$.*

In the essentially linear case, under Hypotheses (SC) and (RC), assuming moreover that at least one subcritical series is aperiodic, we have:

$$(7.17) \quad \mathbb{P}((\mathbf{t}_n, \mathbf{I}_n^k) \in \mathcal{T}_{i, t_0}) \xrightarrow{n \rightarrow +\infty} p_{\varepsilon_1}^{e_1} p_{\varepsilon_2}^{e_2} \dots p_{\varepsilon_{k-1}}^{e_{k-1}},$$

where p_ε^e 's are defined by Equation (7.15).

PROOF. By definition,

$$(7.18) \quad \mathbb{P}((\mathbf{t}_n, \mathbf{I}_n^k) \in \mathcal{T}_{i, t_0}) = \frac{[z^{n-k}] T_{i, t_0}}{[z^{n-k}] \frac{1}{k!} T_i^{(k)}}.$$

We want to apply the transfer theorem (Theorem A.2.2) to the series T_{i, t_0} and $\frac{T_i^{(k)}}{k!}$. Recall Equation (7.12):

$$\mathbf{T}_{t_0}^* = \mathbb{T}^* \mathbb{D}^{e_1, \varepsilon_1} \mathbb{T}^* \mathbb{D}^{e_2, \varepsilon_2} \dots \mathbb{T}^* \mathbb{D}^{e_{k-1}, \varepsilon_{k-1}} (\mathbf{T}^*)'.$$

We first justify that T_{i, t_0} and $T_i^{(k)}$ have radius of convergence ρ and are Δ -analytic at ρ . For $T_i^{(k)}$, this follows from the first claim of Lemma 7.3.11. For T_{i, t_0} , we need to use this same lemma, together with the analyticity of $D_{i, j}^{\varepsilon, e}$ at ρ (Proposition 7.3.9).

We now establish the asymptotics of these series near ρ .

We can plug in the value of the series $D_{i, j}^{\varepsilon, e}$'s, since they converge at ρ from Proposition 7.3.9, and the asymptotics near ρ of $\mathbb{T}^* \mathbf{T}^*, (\mathbf{T}^*)'$ (see Equations (7.13) and (7.14) and recall the singular differentiation Theorem A.3.1). We get

$$(7.19) \quad \begin{aligned} \mathbf{T}_{t_0}^* &\stackrel{z \rightarrow \rho}{\sim} \frac{1}{(\rho - z)^{k+1}} \left(\frac{1}{\tau_{\mathbf{u}}(\mathbb{M}^*)'(\rho) \mathbf{v}} \right) \mathbf{v} \tau_{\mathbf{u}} \mathbb{D}^{e_1, \varepsilon_1}(\rho) \left(\frac{1}{\tau_{\mathbf{u}}(\mathbb{M}^*)'(\rho) \mathbf{v}} \right) \mathbf{v} \tau_{\mathbf{u}} \mathbb{D}^{e_2, \varepsilon_2}(\rho) \\ &\quad \dots \mathbb{D}^{e_{k-1}, \varepsilon_{k-1}}(\rho) \mathbf{v} \left(\frac{\tau_{\mathbf{u}} \mathbf{V}^*(\rho)}{\tau_{\mathbf{u}}(\mathbb{M}^*)'(\rho) \mathbf{v}} \right) \\ &= \frac{1}{(\rho - z)^{k+1}} \left(\frac{1}{\tau_{\mathbf{u}}(\mathbb{M}^*)'(\rho) \mathbf{v}} \right) \mathbf{v} \left(\prod_{\ell=1}^{k-1} \frac{\tau_{\mathbf{u}} \mathbb{D}^{e_\ell, \varepsilon_\ell}(\rho) \mathbf{v}}{\tau_{\mathbf{u}}(\mathbb{M}^*)'(\rho) \mathbf{v}} \right) \tau_{\mathbf{u}} \mathbf{V}^*(\rho) \\ &= \frac{1}{(\rho - z)^{k+1}} \frac{\tau_{\mathbf{u}} \mathbf{V}^*(\rho)}{\tau_{\mathbf{u}}(\mathbb{M}^*)'(\rho) \mathbf{v}} \left(\prod_{\ell=1}^{k-1} p_{\varepsilon_\ell}^{e_\ell} \right) \mathbf{v}. \end{aligned}$$

We turn to $\frac{T_i^{(k)}}{k!}$. From Equation (7.14), applying singular differentiation again to \mathbf{T}^* we obtain

$$\frac{1}{k!} (\mathbf{T}^*)^{(k)}(z) \stackrel{z \rightarrow \rho}{\sim} \frac{1}{(\rho - z)^{k+1}} \left(\frac{\tau_{\mathbf{u}} \mathbf{V}^*(\rho)}{\tau_{\mathbf{u}}(\mathbb{M}^*)'(\rho) \mathbf{v}} \right) \mathbf{v}.$$

Applying the transfer theorem (Theorem A.2.2) to T_{i,t_0} and $\frac{1}{k!}T_i^{(k)}$ yields

$$\frac{[z^{n-k}]T_{i,t_0}}{[z^{n-k}]\frac{1}{k!}T_i^{(k)}} \xrightarrow{n \rightarrow \infty} \prod_{\ell=1}^{k-1} p_{\varepsilon_\ell}^{e_\ell},$$

concluding the proof. \square

7.3.4. Permutations induced by the X -permuton. The X -permuton $\mu_{\mathbf{P}}^X$ was defined in Definition 7.3.1. In this section we describe the permutations induced by the X -permuton, *i.e.*, for each $k \geq 1$, the random permutation formed by k independent points in $[0, 1]^2$ with common distribution $\mu_{\mathbf{P}}^X$.

For a set $\{(x_i, y_i), 1 \leq i \leq k\}$ of k points in the unit square (assumed to have pairwise distinct x - (resp. y -)coordinates), we denote by $\text{std}(\{(x_i, y_i), 1 \leq i \leq k\})$ the permutation whose diagram is the (suitably normalized) set of these points.

We start by a lemma, illustrated in Figure 7.5.

Lemma 7.3.13. *Let $(e_1, \varepsilon_1) \dots (e_k - 1, \varepsilon_k - 1)$ be the code word of a caterpillar t_0 . Fix arbitrarily $(e_k, \varepsilon_k) \in \{\text{left}, \text{right}\} \times \{+, -\}$. Fix $(a, b) \in (0, 1)^2$, $0 < u_1 < \dots < u_k < 1$ and set*

$$(7.20) \quad (x_i, y_i) = (1 - u_i)z_{\varepsilon_i}^{e_i} + u_i(a, b), \quad 1 \leq i \leq k$$

Then $\text{std}(\{(x_i, y_i), 1 \leq i \leq k\}) = \text{perm}(t_0)$.

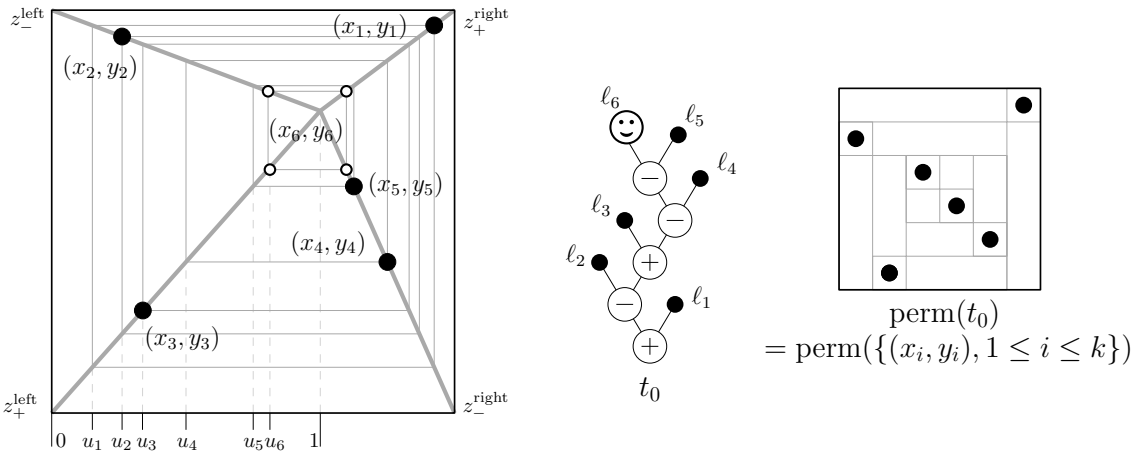

FIGURE 7.5. An example illustrating Lemma 7.3.13, with a caterpillar of code word $((\text{right}, +), (\text{left}, -), (\text{left}, +), (\text{right}, -), (\text{right}, -))$. There are four different positions for the central point according to the arbitrary choice of (e_6, ε_6) .

PROOF. Let $\tau = \text{std}(\{(x_i, y_i), 1 \leq i \leq k\})$. Let α be the permutation such that $x_{\alpha(1)} < \dots < x_{\alpha(k)}$. Then by definition

$$\forall 1 \leq i < j \leq k, \quad \tau(i) > \tau(j) \iff y_{\alpha(i)} > y_{\alpha(j)}.$$

By case analysis, from Equation (7.20), we can prove that

$$(7.21) \quad \forall 1 \leq i < j \leq k, \quad (e_i = \text{left}) \iff x_i < x_j \iff \alpha^{-1}(i) < \alpha^{-1}(j).$$

Similarly, and again by case analysis from Equation (7.20), we can prove that for $1 \leq i < j \leq k$, we have

$$(\varepsilon_i = -) \iff (x_j - x_i)(y_j - y_i) < 0.$$

Hence for $1 \leq i < j \leq k$, $\varepsilon_{\min(\alpha(i), \alpha(j))} = -$ if and only if $(x_{\alpha(j)} - x_{\alpha(i)})(y_{\alpha(j)} - y_{\alpha(i)}) < 0$, which reduces to $y_{\alpha(j)} < y_{\alpha(i)}$. All in all, we have shown

$$(7.22) \quad \forall 1 \leq i < j \leq k, \quad \varepsilon_{\min(\alpha(i), \alpha(j))} = - \iff \tau(i) > \tau(j).$$

Now let $\pi = \text{perm}(t_0)$ and denote $\ell_{\gamma(1)}, \dots, \ell_{\gamma(k)}$ the reordering of the leaves of t_0 according to the depth-first search. By definition of t_0 , for $1 \leq i < j \leq k$, the following equivalence holds: $(\gamma^{-1}(i) < \gamma^{-1}(j)) \iff (e_i = \text{left})$. Together with Equation (7.21), this shows $\gamma = \alpha$.

Finally, looking at the way the permutation π is constructed, we see that for $1 \leq i < j \leq k$, $\pi(j) < \pi(i)$ if and only if there is a sign \ominus on the first common ancestor $v_{\min(\gamma(i), \gamma(j))}$ of $\ell_{\gamma(i)}$ and $\ell_{\gamma(j)}$, if and only if $\varepsilon_{\min(\gamma(i), \gamma(j))} = -$. Since $\gamma = \alpha$, together with Equation (7.22), this shows $\pi = \tau$, *i.e.* the lemma. \square

Recall from Section 1.2.1 some notation regarding permutons. For a fixed permuton μ and a fixed integer k , we denote by $(\vec{\mathbf{x}}, \vec{\mathbf{y}})$ a k -tuple of i.i.d. points distributed according to μ . This k -tuple, seen as a *set* of points in the unit square, induces a permutation $\text{std}(\{(\mathbf{x}_i, \mathbf{y}_i), 1 \leq i \leq k\})$ that we denote $\mathbf{Perm}_k(\mu)$.

Proposition 7.3.14. *For every $k \geq 1$, we have*

$$\mathbf{Perm}_k(\mu_{\mathbf{p}}^X) \stackrel{(d)}{=} \text{perm}(\mathbf{t}_0),$$

where \mathbf{t}_0 is a random caterpillar whose code word is a $(k-1)$ -uple of i.i.d. random variables of distribution \mathbf{p} .

The fact that $\mathbf{Perm}_k(\mu_{\mathbf{p}}^X)$ is a permutation encoded by the reduced tree of a caterpillar is illustrated in Figure 7.5.

PROOF. Because of the construction of $\mu_{\mathbf{p}}^X$, an i.i.d. sequence $((\mathbf{x}_1, \mathbf{y}_1), \dots, (\mathbf{x}_k, \mathbf{y}_k))$ drawn according to $\mu_{\mathbf{p}}^X$ can be represented as

$$(\mathbf{x}_i, \mathbf{y}_i) = (1 - \mathbf{u}_i)z_{\varepsilon_i}^{\mathbf{e}_i} + \mathbf{u}_i(a, b), \quad 1 \leq i \leq k,$$

where $\mathbf{u}_1, \dots, \mathbf{u}_k$ are uniform in $[0, 1]$, $(\mathbf{e}_1, \varepsilon_1), \dots, (\mathbf{e}_k, \varepsilon_k)$ are random variables according to the measure \mathbf{p} , all of these being independent from each other. By definition $\mathbf{Perm}_k(\mu_{\mathbf{p}}^X)$ is distributed like the permutation $\text{std}(\{(\mathbf{x}_i, \mathbf{y}_i), 1 \leq i \leq k\})$.

Consider the permutation σ such that $\mathbf{u}_{\sigma(1)} < \dots < \mathbf{u}_{\sigma(k)}$. Clearly,

$$\text{std}(\{(\mathbf{x}_i, \mathbf{y}_i), 1 \leq i \leq k\}) = \text{std}(\{(\mathbf{x}_{\sigma(i)}, \mathbf{y}_{\sigma(i)}), 1 \leq i \leq k\}),$$

and from Lemma 7.3.13, this is the permutation associated to the caterpillar whose code word is $(\mathbf{e}_{\sigma(1)}, \varepsilon_{\sigma(1)}) \dots (\mathbf{e}_{\sigma(k)}, \varepsilon_{\sigma(k)})$. But the sequence $((\mathbf{e}_{\sigma(i)}, \varepsilon_{\sigma(i)}))_{1 \leq i \leq k}$ is an i.i.d. sample of the measure \mathbf{p} . Indeed, it is a shuffling of an i.i.d. sequence by the independent random permutation σ . This concludes the proof. \square

We can now conclude the proof of the main theorem for the essentially linear case.

CONCLUSION OF THE PROOF OF THEOREM 7.3.2. Consider a tree specification $(\mathcal{E}_{\mathcal{T}})$ satisfying the hypotheses of Theorem 7.3.2. Let $i \in I^*$ be the index of a critical family and let $k \geq 1$. Let $\sigma_n = \text{perm}(\mathbf{t}_n)$ be a uniform permutation of size n in \mathcal{T}_i and $\mathbf{I}_{n,k}$ an independent uniform subset of $[1, n]$ of size k . Then

$$\text{pat}_{\mathbf{I}_{n,k}}(\sigma_n) = \text{perm}(\mathbf{t}_n|_{\mathbf{I}_{n,k}}).$$

Let \mathbf{t}_0 be the random caterpillar whose code word is given by a $(k-1)$ -tuple of i.i.d. random variables of distribution \mathbf{p} . According to Proposition 7.3.12, $\mathbf{t}_n|_{\mathbf{I}_{n,k}}$ converges in distribution to \mathbf{t}_0 . Therefore we have the convergence in distribution $\text{pat}_{\mathbf{I}_{n,k}}(\sigma_n) \rightarrow \text{perm}(\mathbf{t}_0)$. Theorem 7.3.2 then follows from Theorem 1.2.1 (characterization of convergence of random permutons) and Proposition 7.3.14 (giving the distribution of $\mathbf{Perm}_k(\mu_{\mathbf{p}}^X)$). \square

7.4. Beyond the strongly connected case

The goal of this section is to provide some tools to describe the typical behavior of permutations in some families \mathcal{T}_0 having a tree-specification which does not satisfy Hypothesis (SC). We do not provide general theorems, because of the many possible situations that can occur. Instead, we present a method with some generic lemmas, and illustrate it on examples.

Recall that G^* denotes the dependency graph of the tree-specification restricted to the critical families. We first find its strongly connected components with no edge pointing towards them. Such a component has a vertex set $\{\mathcal{T}_i\}_{i \in J}$, for some $J \subset I^*$. Restricting the tree-specification to $\{\mathcal{T}_i\}_{i \in J} \uplus \{\mathcal{T}_i\}_{i \notin I^*}$, we obtain a new tree-specification satisfying Hypothesis (SC). Then Theorem 7.3.2 or Theorem 7.2.1 gives us the limiting permutation of uniform permutations in any of the families $(\mathcal{T}_i)_{i \in J}$.

We now discuss the case of a strongly connected component $C = \{\mathcal{T}_i\}_{i \in J}$ of G^* that has some incoming edges, originating from the strongly connected components C_1, \dots, C_h of G^* . Consider a family \mathcal{T} in C and a tree in \mathcal{T} . This tree consists of a root and fringe subtrees whose type are either subcritical or in one of the C_j 's or in C . Recursively, we may assume that we know the limiting permutation of trees with types in C_1, \dots, C_h . To deduce from there a limiting result for trees in \mathcal{T} , we need to know if one of the fringe subtrees is giant or whether there are typically several macroscopic ones.

7.4.1. Sufficient conditions for having a giant subtree. Let $\mathcal{T}_0, \mathcal{T}_1, \dots, \mathcal{T}_r$ be combinatorial classes whose generating series have the same radius of convergence ρ and are analytic on a Δ -domain. We assume that \mathcal{T}_0 is related to $\mathcal{T}_1, \dots, \mathcal{T}_r$ through an equation $\mathcal{T}_0 = \mathcal{F}(\mathcal{Z}, \mathcal{T}_1, \dots, \mathcal{T}_r)$. Here, \mathcal{Z} is the class with a single combinatorial structure, of size 1, classically called *atom*; in this paper, we rather refer to the atoms which constitute a combinatorial structure as its *elements*. In combinatorial terms, a structure in \mathcal{T}_0 is an \mathcal{F} -structure of size s and a list of s substructures that are either atoms or belong to one of \mathcal{T}_i . This translates on generating series as $T_0 = F(z, T_1, \dots, T_r)$.

We now present two results which ensure, under appropriate assumptions, that k uniformly marked elements in a large random uniform structure in \mathcal{T}_0 belong with high probability to the same \mathcal{T}_i substructure; in this case we speak of a *giant substructure*.

- In our first lemma, the singularities of the T_i 's are simple poles and F is linear in the T_i 's (with coefficients depending on z).
- In our second lemma, the T_i 's have square-root singularities and F is analytic on a neighborhood of $(\rho, T_1(\rho), \dots, T_r(\rho))$.

Let us set up notation for the first lemma. We assume that the singularities of the generating series T_1, \dots, T_r are simple poles, namely, that for some reals δ_i ,

$$(7.23) \quad T_i(z) = \frac{\delta_i}{\rho - z} + \mathcal{O}(1) \quad , \quad 1 \leq i \leq r.$$

Assume in addition that

$$(7.24) \quad F(z, T_1, \dots, T_r) = \sum_{i=1}^r G_i(z) T_i + G(z),$$

where $G(z)$ and the $G_i(z)$'s are convergent in ρ (they may be subcritical, or critical and convergent in ρ , e.g. with a square-root singularity in ρ).

From a combinatorial point of view, this identity of generating series means the following. There exist combinatorial classes \mathcal{G} and \mathcal{G}_i (for $1 \leq i \leq r$), whose generating functions are G and the G_i 's, respectively, and such that a \mathcal{T}_0 -structure is either a pair of structures in $\mathcal{G}_i \times \mathcal{T}_i$, for some i , or a \mathcal{G} -structure.

Lemma 7.4.1 (Giant component: the simple pole case). *Let $\mathcal{T}_0, \mathcal{T}_1, \dots, \mathcal{T}_r$ be combinatorial classes whose generating series have the same radius of convergence ρ and are analytic on a Δ -domain. Assume that $T_0 = F(z, T_1, \dots, T_r)$ and Equations (7.23) and (7.24) hold.*

Let \mathbf{t}_n be a uniform random structure of size n in \mathcal{T}_0 , with a set of k marked elements, chosen uniformly at random. For $j \in \{1, \dots, r\}$, we call $E_j^{(n)}$ the event that \mathbf{t}_n is a pair of substructures in $\mathcal{G}_j \times \mathcal{T}_j$ and that all k marked elements belong to the \mathcal{T}_j -substructure. Then, we have

$$(7.25) \quad \mathbb{P}(E_j^{(n)}) \xrightarrow{n \rightarrow +\infty} \frac{\delta_j G_j(\rho)}{\sum_{i=1}^r \delta_i G_i(\rho)}.$$

Note that the right-hand side of Equation (7.25) above sums to 1. Informally, the lemma says that, with high probability, the structure \mathbf{t}_n has a giant substructure of some type \mathcal{T}_j . This type (*i.e.* the value of j) is however random and Equation (7.25) gives the limiting probabilities. When the \mathcal{T}_i are families of permutations and assuming that we know the limiting permutons of the \mathcal{T}_j , $j > 0$, we can conclude that the limiting permuton of \mathcal{T}_0 is taken at random among those of the \mathcal{T}_j with probabilities given by Equation (7.25).

PROOF. We fix $j \in \{1, \dots, r\}$. The generating series of structures in \mathcal{T}_0 with a set of k marked elements is given by $T_0^{(k)}/k!$. On the other hand, the generating series of structures in $\mathcal{G}_j \times \mathcal{T}_j$ with a set of k marked elements, *all in the \mathcal{T}_j -substructure*, is $G_j(z)T_j^{(k)}(z)/k!$. Therefore

$$(7.26) \quad \mathbb{P}(E_j^{(n)}) = \frac{[z^n]G_j(z)T_j^{(k)}(z)}{[z^n]T_0^{(k)}(z)}.$$

We now evaluate the limit of the above quantity when n tends to infinity using singularity analysis. From the assumptions (7.23) and (7.24), we get that, for z in a Δ -neighborhood of ρ ,

$$T_0(z) = \frac{1}{\rho - z} \left(\sum_{i=1}^r \delta_i G_i(\rho) \right) + \mathcal{O}(1).$$

By singular differentiation, in a Δ -neighborhood of ρ ,

$$T_0^{(k)}(z) = \frac{k!}{(\rho - z)^{k+1}} \left(\sum_{i=1}^r \delta_i G_i(\rho) \right) + \mathcal{O}\left(\frac{1}{(\rho - z)^k}\right).$$

Similarly,

$$T_j^{(k)}(z) = \frac{k! \delta_j}{(\rho - z)^{k+1}} + \mathcal{O}\left(\frac{1}{(\rho - z)^k}\right).$$

By the transfer theorem (Theorem A.2.2), we obtain

$$\begin{aligned} [z^n] \left(T_0^{(k)}(z) \right) &\sim \frac{n^k}{\rho^{n+k+1}} \sum_{i=1}^r \delta_i G_i(\rho); \\ [z^n] \left(G_j(z) T_j^{(k)}(z) \right) &\sim \frac{n^k}{\rho^{n+k+1}} \delta_j G_j(\rho). \end{aligned}$$

Plugging these estimates back into (7.26), we have

$$\mathbb{P}(E_j^{(n)}) = \frac{[z^n]G_j(z)T_j^{(k)}(z)}{[z^n]T_0^{(k)}(z)} \xrightarrow{n \rightarrow +\infty} \frac{\delta_j G_j(\rho)}{\sum_{i=1}^r \delta_i G_i(\rho)}. \quad \square$$

We now give a similar statement when all T_i have square-root singularities.

Lemma 7.4.2 (Giant component: the square-root case). *Let $\mathcal{T}_0, \mathcal{T}_1, \dots, \mathcal{T}_r$ be combinatorial classes whose generating series have the same radius of convergence ρ and are analytic on a Δ -domain. We assume that $T_0 = F(z, T_1, \dots, T_r)$ for some function F which is analytic on a neighborhood of $\{|z| \leq \rho, |y_i| \leq T_i(\rho)\}$ and that there exist β_i 's such that*

$$(7.27) \quad T_i(z) = T_i(\rho) - \beta_i \sqrt{\rho - z} + \mathcal{O}(\rho - z), \quad 1 \leq i \leq r.$$

Let \mathbf{t}_n be a uniform random structure of size n in \mathcal{T}_0 , with a set of k marked elements, chosen uniformly at random. Let $E_j^{(n)}$ be the event that all k marked elements belong to the same \mathcal{T}_j -substructure. Then

(7.28)

$$\mathbb{P}(E_j^{(n)}) \xrightarrow{n \rightarrow +\infty} \beta_j \frac{\partial F(y_0, \dots, y_d)}{\partial y_j} \Big|_{(\rho, T_1(\rho), \dots, T_r(\rho))} \times \left(\sum_{i=1}^r \beta_i \frac{\partial F(y_0, \dots, y_d)}{\partial y_j} \Big|_{(\rho, T_1(\rho), \dots, T_r(\rho))} \right)^{-1}.$$

Contrary to the simple pole case, we do not assume that F is linear. Consequently, a structure in \mathcal{T}_0 might be composed of an \mathcal{F} -structure with several \mathcal{T}_i -substructures. Since the limiting probabilities in Equation (7.28) sum to one, the above lemma states that, with high probability, the structure has a giant substructure of some type \mathcal{T}_j . Equation (7.28) gives us the limiting distribution of this random type \mathcal{T}_j . As for Lemma 7.4.1, when the \mathcal{T}_j are families of permutations, this lemma can be used to infer the limiting permutation of \mathcal{T}_0 from those of the \mathcal{T}_j .

PROOF. We fix $\{1, \dots, r\}$. Similarly to the proof of Lemma 7.4.1, we can express $\mathbb{P}(E_j^{(n)})$ as a quotient of coefficients of generating series: in this case,

$$\mathbb{P}(E_j^{(n)}) = \frac{1}{[z^n] T_0^{(k)}(z)} \cdot [z^n] \left(T_j^{(k)}(z) \frac{\partial F(y_0, \dots, y_d)}{\partial y_j} \Big|_{(z, T_1(z), \dots, T_r(z))} \right).$$

From assumption (7.27) and the analyticity of F , we get that, for z in a Δ -neighborhood of ρ ,

$$T_0(z) = T_0(\rho) - \sqrt{\rho - z} \left(\sum_{i=1}^r \beta_i \frac{\partial F(y_0, \dots, y_d)}{\partial y_j} \Big|_{(\rho, T_1(\rho), \dots, T_r(\rho))} \right) + \mathcal{O}(\rho - z).$$

By singular differentiation, we have, on a Δ -neighborhood of ρ ,

$$T_0^{(k)}(z) = (\rho - z)^{1/2-k} C_k \left(\sum_{i=1}^r \beta_i \frac{\partial F(y_0, \dots, y_d)}{\partial y_j} \Big|_{(\rho, T_1(\rho), \dots, T_r(\rho))} \right) + \mathcal{O}((\rho - z)^{1-k}),$$

where $C_1 = 1/2$ and $C_k = 1 \cdot 3 \dots (2k - 3)/2^k$ for $k \geq 2$. Similarly,

$$T_j^{(k)}(z) = (\rho - z)^{1/2-k} C_k \beta_j + \mathcal{O}((\rho - z)^{1-k}).$$

Since F is analytic in $(\rho, T_1(\rho), \dots, T_r(\rho))$, the series $\frac{\partial F(y_0, \dots, y_d)}{\partial y_j} \Big|_{(z, T_1(z), \dots, T_r(z))}$ converge in ρ and we have

$$T_j^{(k)}(z) \frac{\partial F(y_0, \dots, y_d)}{\partial y_j} \Big|_{(z, T_1(z), \dots, T_r(z))} = (\rho - z)^{1/2-k} C_k \beta_j \frac{\partial F(y_0, \dots, y_d)}{\partial y_j} \Big|_{(\rho, T_1(\rho), \dots, T_r(\rho))} + \mathcal{O}((\rho - z)^{1-k}).$$

We conclude using the transfer theorem, as in the proof of Lemma 7.4.1. \square

Lemmas 7.4.1 and 7.4.2 can also be applied in the particular situation where one \mathcal{T}_i is equal to \mathcal{T}_0 . In such cases, the lemma yields the existence of a giant substructure that is of type \mathcal{T}_0 with a probability p , typically in $(0, 1)$. When this occurs, we apply recursively Lemma 7.4.1 (or 7.4.2) to this substructure. After a random and almost surely finite number of iterations, we find a giant substructure of a different type. In the permutation case, this idea can be used to find the limiting permutation of \mathcal{T}_0 ; see an example in Section 7.4.3.2.

7.4.2. Several macroscopic substructures. We now describe a framework where several macroscopic substructures appear: we assume that the generating series T_1, \dots, T_r have singularities which are simple poles and that F is a polynomial. Writing F as a sum of monomials decomposes \mathcal{T}_0 into a disjoint union of subfamilies, one corresponding to each monomial. We therefore focus on the case where F is a monomial.

We assume that the generating series T_1, \dots, T_r have singularities which are simple poles, *i.e.*,

$$(7.29) \quad T_i(z) = \frac{\delta_i}{\rho - z} + \mathcal{O}(1).$$

Assume in addition that

$$(7.30) \quad F(z, T_1, \dots, T_r) = G(z)T_1T_2 \dots T_r,$$

where $G(z)$ is convergent at ρ ; since there can be repetitions in the list (T_1, \dots, T_r) , this covers the case of a general monomial. Let \mathcal{G} be a combinatorial class with generating series G .

A structure in \mathcal{T}_0 can be identified with a list consisting of substructures in $\mathcal{G}, \mathcal{T}_1, \dots, \mathcal{T}_r$ (one structure from each class).

Lemma 7.4.3 (Several macroscopic components: the monomial case). *Let $\mathcal{T}_0, \mathcal{T}_1, \dots, \mathcal{T}_r$ be combinatorial classes whose generating series have the same radius of convergence ρ and are analytic on a Δ -domain. We assume that $T_0 = F(z, T_1, \dots, T_r)$ and Equations (7.29) and (7.30) hold. We mark a set of k elements, taken uniformly at random, in a uniform random \mathcal{T}_0 -structure of size n , and denote by ℓ_i ($1 \leq i \leq r$) the (random) number of marked elements lying in the \mathcal{T}_i -substructure.*

Then (ℓ_1, \dots, ℓ_r) is asymptotically uniformly distributed in the set $\{\ell_1 + \dots + \ell_r = k\}$.

PROOF. From the assumptions (7.29) and (7.30), we get that, for z in a Δ -neighborhood of ρ ,

$$T_0(z) = G(\rho) \frac{\delta_1 \dots \delta_r}{(\rho - z)^r} + \mathcal{O}\left(\frac{1}{(\rho - z)^{r-1}}\right).$$

By singular differentiation, on a Δ -neighborhood of ρ , we have

$$T_0^{(k)}(z) = G(\rho) \frac{(r+k-1)!}{(r-1)!} \frac{\delta_1 \dots \delta_r}{(\rho - z)^{r+k}} + \mathcal{O}\left(\frac{1}{(\rho - z)^{r+k-1}}\right).$$

Similarly,

$$T_i^{(\ell_i)}(z) = \frac{\ell_i! \delta_i}{(\rho - z)^{\ell_i+1}} + \mathcal{O}\left(\frac{1}{(\rho - z)^{\ell_i}}\right).$$

Combining both equations, we can write

$$\begin{aligned} G(\rho) \sum_{\ell_1 + \dots + \ell_r = k} \binom{k}{\ell_1, \dots, \ell_r} \prod_{i=1}^r T_i^{(\ell_i)}(z) &= G(\rho) \sum_{\ell_1 + \dots + \ell_r = k} \binom{k}{\ell_1, \dots, \ell_r} \prod_{i=1}^r \left(\frac{\ell_i! \delta_i}{(\rho - z)^{\ell_i+1}} \right) + \mathcal{O}\left(\frac{1}{(\rho - z)^{r+k-1}}\right) \\ &= G(\rho) \frac{\delta_1 \dots \delta_r}{(\rho - z)^{r+k}} \left(\sum_{\ell_1 + \dots + \ell_r = k} k! \right) \mathcal{O}\left(\frac{1}{(\rho - z)^{r+k-1}}\right) \\ &= T_0^{(k)}(z) + \mathcal{O}\left(\frac{1}{(\rho - z)^{r+k-1}}\right), \end{aligned}$$

where in the last line we used that the number of (ℓ_1, \dots, ℓ_r) such that $\ell_1 + \dots + \ell_r = k$ is $\binom{k+r-1}{r-1}$.

By the transfer theorem, we obtain (for $\ell_1 + \dots + \ell_r = k$),

$$\begin{aligned} [z^n] \left(G(z) \binom{k}{\ell_1, \dots, \ell_r} \prod_{i=1}^r T_i^{(\ell_i)}(z) \right) &\sim G(\rho) \binom{k}{\ell_1, \dots, \ell_r} \frac{n^{r+k-1}}{\rho^{n+k+r}} \frac{1}{(k+r-1)!} \left(\prod_{i=1}^r \ell_i! \delta_i \right) \\ &\sim G(\rho) \frac{n^{r+k-1}}{\rho^{n+k+r}} \frac{k!}{(k+r-1)!} \left(\prod_{i=1}^r \delta_i \right). \end{aligned}$$

The right-hand side does not depend on ℓ_i 's. Summing over the $\binom{k+r-1}{r-1}$ possible values for the ℓ_i 's we obtain

$$[z^n] \left(T_0^{(k)}(z) \right) \sim G(\rho) \frac{n^{r+k-1}}{\rho^{n+k+r}} \frac{1}{(r-1)!} \left(\prod_{i=1}^r \delta_i \right).$$

Recall that we consider a uniform random structure \mathbf{t}_n of size n in \mathcal{T}_0 with a uniform set of k marked elements. Let $E_{\ell_1, \dots, \ell_r}^{(n)}$ denote the event that for every $1 \leq i \leq r$, exactly ℓ_i of these marked elements lie in the \mathcal{T}_i -substructure. Its probability can be computed by

$$\mathbb{P}(E_{\ell_1, \dots, \ell_r}^{(n)}) = \frac{[z^n] \left(G(z) \binom{k}{\ell_1, \dots, \ell_r} \prod_{i=1}^r T_i^{(\ell_i)}(z) \right)}{[z^n] \left(T_0^{(k)}(z) \right)} \rightarrow \frac{1}{\binom{k+r-1}{r-1}}.$$

This concludes the proof. \square

We now discuss briefly the more general case where $T_0 = F(z, T_1, \dots, T_r)$, with F a polynomial in T_1, \dots, T_r (not necessarily a monomial) with coefficients converging at $z = \rho$ (the T_i 's are still assumed to have a simple pole in ρ). Each monomial has a pole at the singularity, whose multiplicity equals the degree of the monomial. Therefore, only monomials of maximal degree contribute to the limit. We will use this principle to determine permuton limits of some families of permutations in two different cases.

- An example with exactly one monomial of maximal degree (namely one monomial of degree 2 and one of degree 1) is given in Section 7.4.3.3.
- When there are several monomial of maximal degree, a random element in \mathcal{T}_0 belongs asymptotically with positive probability to each of the classes corresponding to these monomials. We will see an example of this kind of behavior in Section 7.4.3.2.

7.4.3. Examples.

7.4.3.1. *Four classes \mathcal{T} with a single strongly connected component pointing to \mathcal{T} .* We consider the X -class already analyzed in Section 7.3.1.1. As explained in Section 7.3.1.1, we can use Theorem 7.3.2 to prove that all critical classes except for \mathcal{T}_0 , namely \mathcal{T}_3 , \mathcal{T}_4 , \mathcal{T}_6 and \mathcal{T}_7 , converge to an X -permuton. We can prove that \mathcal{T}_0 has the same limit using Lemma 7.4.1 instead of the little trick used in Section 7.3.1.1. Indeed, the first equation of the specification (7.10) expresses \mathcal{T}_0 as a linear combination of \mathcal{T}_3 , \mathcal{T}_4 , \mathcal{T}_6 and \mathcal{T}_7 (the coefficients involving subcritical classes). Moreover, all series \mathcal{T}_3 , \mathcal{T}_4 , \mathcal{T}_6 and \mathcal{T}_7 have a simple pole at $\rho = 1 - \sqrt{2}/2$. Therefore, by Lemma 7.4.1, with probability tending to 1, a uniform random tree in \mathcal{T}_0 has a giant substructure in either \mathcal{T}_3 , \mathcal{T}_4 , \mathcal{T}_6 or \mathcal{T}_7 . Since the latter all tend to an X -permuton (with the same parameters), so does \mathcal{T}_0 .

Similarly, we can replace our previous trick by Lemma 7.4.1 for the classes discussed in Sections 7.3.1.2, 7.3.1.3 and 7.3.1.5.

7.4.3.2. *A class with many strongly connected components.* The example that we consider now is the class

$$\mathcal{T} = \text{Av}(2413, 3142, 2314, 3241, 21453, 45213).$$

This class is not substitution-closed and contains no simple permutation.

For this class, we obtain⁴ a specification with 13 families $\mathcal{T} = \mathcal{T}_0, \dots, \mathcal{T}_9, \mathcal{T}_{11}, \mathcal{T}_{12}, \mathcal{T}_{13}$ (the family \mathcal{T}_{10} being empty, see Remark 7.5.1 in Appendix). The corresponding system on series can be explicitly solved, showing that all series except \mathcal{T}_1 and \mathcal{T}_{11} are critical and have a common square-root singularity. The complete specification and the explicit solution of the associated system can be found in Section 7.5.1. The dependency graph restricted to the critical \mathcal{T}_i is shown in Figure 7.6 and has nine strongly connected components.

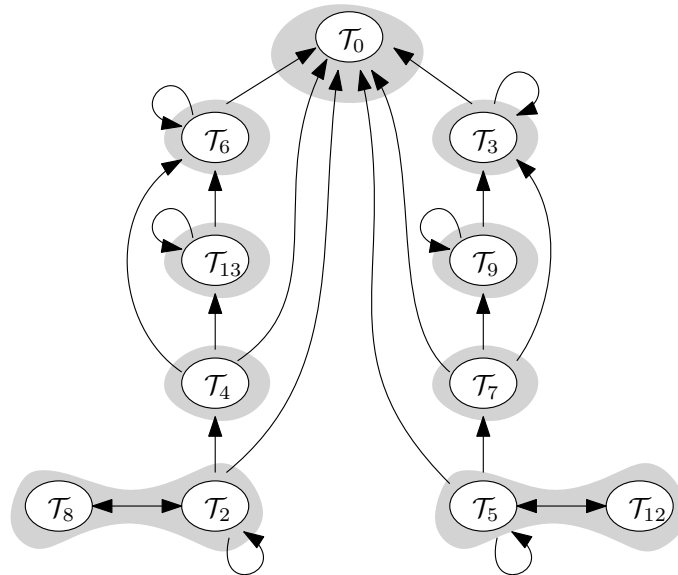

FIGURE 7.6. The subgraph restricted to critical families \mathcal{T}_i , for the specification (7.33) of the class $\text{Av}(2413, 3142, 2314, 3241, 21453, 45213)$. It has nine strongly connected components.

Remark 7.4.4. This example has been built on purpose to show a graph G^* with many strongly connected components. This has been ensured by considering the class $\text{Av}(213) \cup \text{Av}(231)$, for which it is easy to check that the basis is $\{2413, 3142, 2314, 3241, 21453, 45213\}$ given above. We are aware that studying this class *via* its tree-specification (given in Appendix) is neither the most natural nor the simplest thing to do. Our goal with this example is to illustrate that, even without the knowledge of the simple “union” structure of our class, our approach would still work.

We now determine the limiting permuton of a uniform random permutation in \mathcal{T} , using the specification; see Figure 7.7 for a simulation.

Proposition 7.4.5. *A uniform random permutation in the class $\text{Av}(2413, 3142, 2314, 3241, 21453, 45213)$ converges in distribution to the random permuton, which is the diagonal with probability $1/2$ and the antidiagonal with probability $1/2$.*

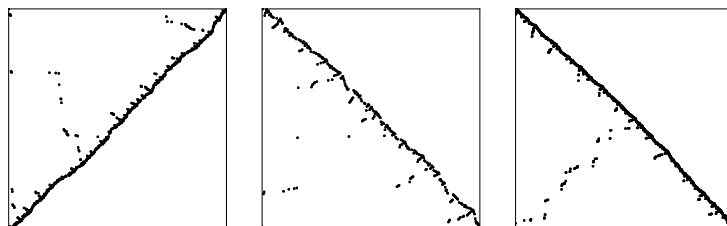

FIGURE 7.7. Three large permutations in \mathcal{T} , drawn uniformly at random.

⁴ See the companion Jupyter notebook `examples/Union.ipynb`

PROOF. The strategy is to proceed step by step, determining the limiting permuton of uniform random permutations in each of the critical families, navigating in the dependency graph of Figure 7.6 from bottom to top.

We first consider the strongly connected component $\{\mathcal{T}_2, \mathcal{T}_8\}$. Taking the equations for \mathcal{T}_1 , \mathcal{T}_2 and \mathcal{T}_8 in the specification (7.33) for \mathcal{T} given in Section 7.5.1, we have a specification for \mathcal{T}_2 . This restricted specification satisfies Hypothesis (SC) and is essentially branching. We can therefore apply Theorem 7.2.1 (the other hypotheses are straightforward to check) and we get that a uniform random permutation in \mathcal{T}_2 converge to a biased Brownian separable permuton with some parameter p in $[0, 1]$. Since the only quadratic term in the system is $\oplus[\mathcal{T}_8, \mathcal{T}_2]$, which corresponds to a \oplus node, we have $p_+ = 1$, which means that the limit is in fact the main diagonal of $[0, 1]^2$.

We now consider \mathcal{T}_4 . It is given by the equation $\mathcal{T}_4 = \ominus[\mathcal{T}_1, \mathcal{T}_2]$. The family \mathcal{T}_1 is subcritical, while \mathcal{T}_2 has a square-root singularity in ρ (as easily seen on the explicit expression given in Section 7.5.1). Applying Lemma 7.4.2, we know that a uniform random permutation of \mathcal{T}_4 has a giant substructure in \mathcal{T}_2 , and therefore, also converges to the diagonal permuton.

Moving on to \mathcal{T}_{13} , it is given by the equation

$$\mathcal{T}_{13} = \oplus[\mathcal{T}_4, \mathcal{T}_{13}] \uplus \oplus[\mathcal{T}_1, \mathcal{T}_{13}] \uplus \oplus[\mathcal{T}_4, \mathcal{T}_{11}] \uplus \ominus[\mathcal{T}_1, \mathcal{T}_{13}].$$

An important difference with the equation of \mathcal{T}_4 is that it involves also \mathcal{T}_{13} itself on the right-hand side. We can still apply Lemma 7.4.2 and conclude that a uniform random permutation of \mathcal{T}_{13} has a giant substructure in either \mathcal{T}_4 or \mathcal{T}_{13} . Iterating this argument (see the discussion at the end of Section 7.4.1), after a finite number of steps, we find a giant substructure of type \mathcal{T}_4 . We conclude that a uniform random permutation in \mathcal{T}_{13} has the same limiting permuton as one in \mathcal{T}_4 , *i.e.* the diagonal permuton. With the exact same reasoning, we prove that a uniform random permutation in \mathcal{T}_6 also converges to the diagonal permuton (which appears here as the Brownian separable permuton of parameter $p_+ = 0$).

On the other hand, and following the same steps, we show that a uniform random permutation in any of the classes \mathcal{T}_5 , \mathcal{T}_7 , \mathcal{T}_9 and \mathcal{T}_3 converges to the antidiagonal permuton.

Finally, we consider \mathcal{T}_0 . It is given by the equation

$$\mathcal{T}_0 = \{\bullet\} \uplus \oplus[\mathcal{T}_1, \mathcal{T}_2] \uplus \oplus[\mathcal{T}_1, \mathcal{T}_3] \uplus \oplus[\mathcal{T}_4, \mathcal{T}_2] \uplus \ominus[\mathcal{T}_1, \mathcal{T}_5] \uplus \ominus[\mathcal{T}_1, \mathcal{T}_6] \uplus \ominus[\mathcal{T}_7, \mathcal{T}_5].$$

In the above equation \mathcal{T}_1 is convergent in ρ and all other classes are critical (with square-root singularities). By Lemma 7.4.2, a uniform random permutation in \mathcal{T}_0 contains a giant substructure of type \mathcal{T}_j , where j follows asymptotically some distribution on $\{2, 3, 4, 5, 6, 7\}$. For each j_0 in this set, we denote $p_{j_0} = \mathbb{P}(j = j_0)$. We can then conclude that a uniform random permutation in \mathcal{T}_0 converges in distribution to the random permuton, which is the diagonal with probability $p_+ := p_2 + p_4 + p_6$ and the antidiagonal with probability $p_- := p_3 + p_5 + p_7$. Using the explicit expression of the p_j 's in Lemma 7.4.2 or observing the symmetry, we see that $p_+ = p_- = 1/2$. \square

7.4.3.3. A “compound” class. Our goal here is to illustrate the emergence of several macroscopic substructures in the limit, as described in Section 7.4.2. To this effect, we consider the class \mathcal{C} which can be defined as the downward closure of $\oplus[\mathcal{X}, \mathcal{X}]$, where \mathcal{X} denotes the X -class (see Section 7.3.1.1). This class has no simple permutation and has therefore a tree-specification. We explain below an easy way to construct one such specification. However the obtained specification does not satisfy Hypothesis (SC) (p.106). We explain here how to determine nevertheless the limiting permuton of a uniform random permutation in \mathcal{C} .

We first define the limiting permuton.

Definition 7.4.6. Let U be a uniform random variable in $[0, 1]$. We construct the random permuton $\mu^{\oplus[X, X]}$ as follows:

— on $[0, \mathbf{U}] \times [0, \mathbf{U}]$, we take a rescaled copy of $\mu_{(\frac{1}{4}, \frac{1}{4}, \frac{1}{4}, \frac{1}{4})}^X$, *i.e.*

$$\mu^{\oplus[X, X]}([\mathbf{U}a, \mathbf{U}b] \times [\mathbf{U}c, \mathbf{U}d]) = \mathbf{U} \cdot \mu_{(\frac{1}{4}, \frac{1}{4}, \frac{1}{4}, \frac{1}{4})}^X([a, b] \times [c, d]);$$

— similarly, on $[1 - \mathbf{U}, 1] \times [1 - \mathbf{U}, 1]$, we take a rescaled copy of $\mu_{(\frac{1}{4}, \frac{1}{4}, \frac{1}{4}, \frac{1}{4})}^X$;

— $\mu^{\oplus[X, X]}([0, \mathbf{U}] \times [1 - \mathbf{U}, 1]) = \mu^{\oplus[X, X]}([1 - \mathbf{U}, 1] \times [0, \mathbf{U}]) = 0$.

We now describe the distribution of the permutation constructed from k random points in this permuton.

Lemma 7.4.7. *Let (ℓ_1, ℓ_2) be a uniform random variable in the set $\{(\ell_1, \ell_2) \in \mathbb{Z}_{\geq 0}^2 : \ell_1 + \ell_2 = k\}$. Conditionally on (ℓ_1, ℓ_2) , we take π_i (for i in $\{1, 2\}$) to be independent random permutations distributed as $\mathbf{Perm}_{\ell_i}(\mu_{(\frac{1}{4}, \frac{1}{4}, \frac{1}{4}, \frac{1}{4})}^X)$. Then*

$$\mathbf{Perm}_k(\mu^{\oplus[X, X]}) \stackrel{(d)}{=} \oplus[\pi_1, \pi_2].$$

PROOF. Denote as in Section 1.2.1 $(\mathbf{x}_1, \mathbf{y}_1), \dots, (\mathbf{x}_k, \mathbf{y}_k)$ the coordinates of the k i.i.d. points drawn with distribution $\mu^{\oplus[X, X]}$ in order to define $\mathbf{Perm}_k(\mu^{\oplus[X, X]})$. It suffices to notice that

$$\text{card}\{1 \leq i \leq k; \mathbf{x}_i \leq \mathbf{U}\}$$

is uniformly distributed in $\{0, 1, \dots, k\}$. Moreover, conditionally on \mathbf{U} and on the event $\{\mathbf{x}_i < \mathbf{U}\}$, \mathbf{x}_i is uniform in $(0, \mathbf{U})$. Therefore the permutation induced by points $\{(\mathbf{x}_i, \mathbf{y}_i); \mathbf{x}_i \leq \mathbf{U}\}$ (resp. $> \mathbf{U}$) has the same distribution as π_1 (resp. π_2). We conclude that the permutation induced by the whole set $\{(\mathbf{x}_i, \mathbf{y}_i); 1 \leq i \leq k\}$ has the same distribution as $\oplus[\pi_1, \pi_2]$, which is what we wanted to prove. \square

We can now state and prove our convergence result, illustrated in Figure 7.8.

Proposition 7.4.8. *Let \mathcal{C} be the downward closure of $\oplus[\mathcal{X}, \mathcal{X}]$ and σ_n be a uniform random permutation of size n in \mathcal{C} . Then σ_n converges in distribution to the random permuton $\mu^{\oplus[X, X]}$.*

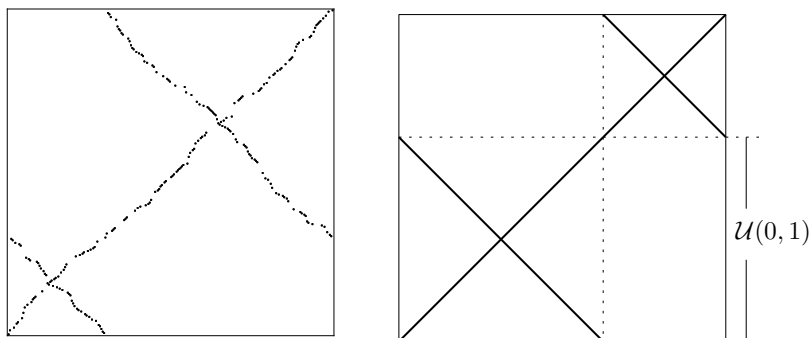

FIGURE 7.8. Left: A simulation of a uniform permutation of size 242 in \mathcal{C} . Right: The limiting permuton, as predicted by Proposition 7.4.8 ($\mathcal{U}(0, 1)$ stands for the uniform distribution on $(0, 1)$).

PROOF. Clearly, \mathcal{C} can be written as $\mathcal{X} \cup \oplus[\mathcal{X}, \mathcal{X}]$, but this equation is essentially ambiguous, hence does not fit in the tree-specification framework. Instead, writing that

$$\mathcal{C} = \mathcal{X}^{\text{not}\oplus} \uplus \oplus[\mathcal{X}^{\text{not}\oplus}, \mathcal{X}]$$

provides an unambiguous description of \mathcal{C} .

We can therefore build a specification for \mathcal{C} , starting from that of the X -class, Equation (7.10) (p.111). Note that the families \mathcal{X} and $\mathcal{X}^{\text{not}\oplus}$ correspond to \mathcal{T}_0 and $\mathcal{T}_1 \uplus \mathcal{T}_4$

in specification (7.10), respectively. A specification for \mathcal{C} can thus be obtained from the specification (7.10) of the X -class, by adding to it the two equations

$$(7.31) \quad \mathcal{C} = \mathcal{X}^{\text{not}\oplus} \uplus \oplus[\mathcal{X}^{\text{not}\oplus}, \mathcal{T}_0];$$

$$(7.32) \quad \mathcal{X}^{\text{not}\oplus} = \mathcal{T}_1 \uplus \mathcal{T}_4.$$

These equations are not exactly of the form required in tree-specifications, but are easily modified to achieve a proper tree-specification. The above form is however practical to apply the tools of this section. In particular, we see that the series of $\mathcal{X}^{\text{not}\oplus}$ and \mathcal{C} both have the same radius of convergence ρ as the critical series of specification (7.10) (namely $\mathcal{T}_0, \mathcal{T}_3, \mathcal{T}_4, \mathcal{T}_6$ and \mathcal{T}_7)

We recall from Section 7.3.1.1 that a uniform random permutation in any of the critical classes ($\mathcal{T}_0, \mathcal{T}_3, \mathcal{T}_4, \mathcal{T}_6$ and \mathcal{T}_7) converges to the centered X -permuton. We then note that $\mathcal{X}^{\text{not}\oplus}$ is the disjoint union of a subcritical class and the critical class \mathcal{T}_4 . Therefore a uniform permutation in $\mathcal{X}^{\text{not}\oplus}$ behaves asymptotically as one in \mathcal{T}_4 , and also converges to the centered X -permuton $\mu_{(\frac{1}{4}, \frac{1}{4}, \frac{1}{4}, \frac{1}{4})}^X$.

We now focus on $\mathcal{C} = \mathcal{X}^{\text{not}\oplus} \uplus \oplus[\mathcal{X}^{\text{not}\oplus}, \mathcal{T}_0]$. The generating series of $\mathcal{X}^{\text{not}\oplus}$ has a simple pole at ρ (this follows from \mathcal{T}_4 having a simple pole at ρ , see the equations p.Equation (7.10)). On the contrary, the generating series of $\oplus[\mathcal{X}^{\text{not}\oplus}, \mathcal{T}_0]$ has a double pole at ρ , since both $\mathcal{X}^{\text{not}\oplus}$ and \mathcal{T}_0 have a simple pole. Using the transfer theorem, and up to multiplicative constants, the coefficients of the generating series of $\mathcal{X}^{\text{not}\oplus}$ and $\oplus[\mathcal{X}^{\text{not}\oplus}, \mathcal{T}_0]$ behave asymptotically as ρ^{-n} and $n\rho^{-n}$ respectively. Therefore a uniform random permutation of size n in \mathcal{C} is, with probability tending to 1, in $\oplus[\mathcal{X}^{\text{not}\oplus}, \mathcal{T}_0]$.

Let us take a uniform random set of k elements in a uniform random permutation σ_n in \mathcal{C} , or equivalently, in $\oplus[\mathcal{X}^{\text{not}\oplus}, \mathcal{T}_0]$. Then the number ℓ_1 (resp. ℓ_2) of these elements that are in the $\mathcal{X}^{\text{not}\oplus}$ - (resp. \mathcal{T}_0 -)substructure is random. Since the series of $\mathcal{X}^{\text{not}\oplus}$ and \mathcal{T}_0 have both simple poles at ρ , we can apply Lemma 7.4.3 and (ℓ_1, ℓ_2) is uniformly distributed on the set $\{\ell_1 + \ell_2 = k\}$. Since the permuton limit of elements in $\mathcal{X}^{\text{not}\oplus}$ is $\mu_{(\frac{1}{4}, \frac{1}{4}, \frac{1}{4}, \frac{1}{4})}^X$, the ℓ_1 elements in the $\mathcal{X}^{\text{not}\oplus}$ -substructure induce a pattern π_1 , which is asymptotically distributed like $\mathbf{Perm}_{\ell_1}(\mu_{(\frac{1}{4}, \frac{1}{4}, \frac{1}{4}, \frac{1}{4})}^X)$. Similarly the ℓ_2 elements in the \mathcal{T}_0 -substructure induce a pattern π_2 , which is asymptotically distributed like $\mathbf{Perm}_{\ell_2}(\mu_{(\frac{1}{4}, \frac{1}{4}, \frac{1}{4}, \frac{1}{4})}^X)$.

Comparing with Lemma 7.4.7, the pattern $\oplus[\pi_1, \pi_2]$ induced by the k random elements in σ_n is asymptotically distributed as $\mathbf{Perm}_k(\mu^{\oplus[X, X]})$. We conclude with Theorem 1.2.1 that a uniform random permutation σ_n in \mathcal{C} converges towards $\mu^{\oplus[X, X]}$. \square

7.5. Details on the examples

7.5.1. The class $\text{Av}(2413, 3142, 2314, 3241, 21453, 45213)$. The algorithm of [Bas+17] gives for this class a specification⁵ with 14 equations, for families $\mathcal{T} = \mathcal{T}_0, \dots, \mathcal{T}_{13}$. The family \mathcal{T}_{10} is however empty, as we will explain in Remark 7.5.1 below. Removing it from the obtained specification yields the following one:

5. See the companion Jupyter notebook `examples/Union.ipynb`

$$(7.33) \left\{ \begin{array}{l} \mathcal{T} = \mathcal{T}_0 = \{\bullet\} \uplus \oplus[\mathcal{T}_1, \mathcal{T}_2] \uplus \oplus[\mathcal{T}_1, \mathcal{T}_3] \uplus \oplus[\mathcal{T}_4, \mathcal{T}_2] \uplus \ominus[\mathcal{T}_1, \mathcal{T}_5] \uplus \ominus[\mathcal{T}_1, \mathcal{T}_6] \uplus \ominus[\mathcal{T}_7, \mathcal{T}_5] \\ \mathcal{T}_1 = \{\bullet\} \\ \mathcal{T}_2 = \{\bullet\} \uplus \oplus[\mathcal{T}_8, \mathcal{T}_2] \uplus \ominus[\mathcal{T}_1, \mathcal{T}_2] \\ \mathcal{T}_3 = \oplus[\mathcal{T}_1, \mathcal{T}_3] \uplus \ominus[\mathcal{T}_7, \mathcal{T}_9] \uplus \ominus[\mathcal{T}_1, \mathcal{T}_9] \uplus \ominus[\mathcal{T}_7, \mathcal{T}_{11}] \\ \mathcal{T}_4 = \ominus[\mathcal{T}_1, \mathcal{T}_2] \\ \mathcal{T}_5 = \{\bullet\} \uplus \oplus[\mathcal{T}_1, \mathcal{T}_5] \uplus \ominus[\mathcal{T}_{12}, \mathcal{T}_5] \\ \mathcal{T}_6 = \oplus[\mathcal{T}_4, \mathcal{T}_{13}] \uplus \oplus[\mathcal{T}_1, \mathcal{T}_{13}] \uplus \oplus[\mathcal{T}_4, \mathcal{T}_{11}] \uplus \ominus[\mathcal{T}_1, \mathcal{T}_6] \\ \mathcal{T}_7 = \oplus[\mathcal{T}_1, \mathcal{T}_5] \\ \mathcal{T}_8 = \{\bullet\} \uplus \ominus[\mathcal{T}_1, \mathcal{T}_2] \\ \mathcal{T}_9 = \oplus[\mathcal{T}_1, \mathcal{T}_9] \uplus \ominus[\mathcal{T}_7, \mathcal{T}_9] \uplus \ominus[\mathcal{T}_1, \mathcal{T}_9] \uplus \ominus[\mathcal{T}_7, \mathcal{T}_{11}] \\ \mathcal{T}_{11} = \{\bullet\} \uplus \oplus[\mathcal{T}_1, \mathcal{T}_{11}] \uplus \ominus[\mathcal{T}_1, \mathcal{T}_{11}] \\ \mathcal{T}_{12} = \{\bullet\} \uplus \oplus[\mathcal{T}_1, \mathcal{T}_5] \\ \mathcal{T}_{13} = \oplus[\mathcal{T}_4, \mathcal{T}_{13}] \uplus \oplus[\mathcal{T}_1, \mathcal{T}_{13}] \uplus \oplus[\mathcal{T}_4, \mathcal{T}_{11}] \uplus \ominus[\mathcal{T}_1, \mathcal{T}_{13}]. \end{array} \right.$$

Remark 7.5.1. In the specification obtained from the algorithm of [Bas+17] (not displayed), the family abbreviated \mathcal{T}_{10} is actually $\mathcal{T}_{(213,231)}$, which consists of permutations of the class \mathcal{T} forced to contain the patterns 213 and 231. From the characterization of \mathcal{T} as $\text{Av}(213) \cup \text{Av}(231)$, it is clear \mathcal{T}_{10} has to be empty. The algorithm of [Bas+17] is however not able to detect this simplification, and we had to perform this simplification by hand.

Translating this specification into a system on the corresponding series, and solving this system, we get

$$\left\{ \begin{array}{l} T = T_0 = \frac{-3z^2 - 2z\sqrt{-4z+1} + 4z + \sqrt{-4z+1} - 1}{z(2z-1)} \\ T_1 = z \\ T_2 = T_5 = \frac{-2z - \sqrt{-4z+1} + 1}{2z} \\ T_3 = T_6 = T_9 = T_{13} = \frac{-z^2 - z\sqrt{-4z+1} + 2z + \sqrt{-4z+1}/2 - 1/2}{z(2z-1)} \\ T_4 = T_7 = -z - \frac{\sqrt{-4z+1}}{2} + \frac{1}{2} \\ T_8 = T_{12} = -\frac{\sqrt{-4z+1}}{2} + \frac{1}{2} \\ T_{11} = \frac{-z}{2z-1} \end{array} \right.$$

The dominant singularity is of square-root type, coming from $\sqrt{-4z+1}$. All series above except T_1 and T_{11} are critical, with radius of convergence $\rho = 1/4$. Due to the presence of (for instance) the term $T_4 T_2$ in the equation for T_0 , the specification (7.33) is essentially branching. Its dependency graph restricted to the critical \mathcal{T}_i is shown in Figure 7.6 (p.125) and has nine strongly connected components. From this specification and this system, we obtained the limiting permuton of this class in Section 7.4.3.2.

7.5.2. The class $\text{Av}(2413, 3142, 2143, 34512)$. The specification for this class that we obtain applying the algorithm of [Bas+17] is⁶

$$(7.34) \quad \left\{ \begin{array}{l} \mathcal{T} = \mathcal{T}_0 = \{\bullet\} \uplus \oplus[\mathcal{T}_1, \mathcal{T}_2] \uplus \oplus[\mathcal{T}_1, \mathcal{T}_3] \uplus \oplus[\mathcal{T}_4, \mathcal{T}_2] \uplus \ominus[\mathcal{T}_5, \mathcal{T}_6] \uplus \ominus[\mathcal{T}_5, \mathcal{T}_7] \uplus \ominus[\mathcal{T}_8, \mathcal{T}_6] \\ \mathcal{T}_1 = \{\bullet\} \\ \mathcal{T}_2 = \{\bullet\} \uplus \oplus[\mathcal{T}_1, \mathcal{T}_2] \\ \mathcal{T}_3 = \oplus[\mathcal{T}_1, \mathcal{T}_3] \uplus \oplus[\mathcal{T}_4, \mathcal{T}_2] \uplus \ominus[\mathcal{T}_5, \mathcal{T}_6] \uplus \ominus[\mathcal{T}_5, \mathcal{T}_7] \uplus \ominus[\mathcal{T}_8, \mathcal{T}_6] \\ \mathcal{T}_4 = \ominus[\mathcal{T}_5, \mathcal{T}_6] \uplus \ominus[\mathcal{T}_5, \mathcal{T}_7] \uplus \ominus[\mathcal{T}_8, \mathcal{T}_6] \\ \mathcal{T}_5 = \{\bullet\} \uplus \oplus[\mathcal{T}_1, \mathcal{T}_1] \uplus \oplus[\mathcal{T}_1, \mathcal{T}_9] \uplus \oplus[\mathcal{T}_9, \mathcal{T}_1] \\ \mathcal{T}_6 = \{\bullet\} \uplus \ominus[\mathcal{T}_1, \mathcal{T}_6] \\ \mathcal{T}_7 = \oplus[\mathcal{T}_1, \mathcal{T}_2] \uplus \oplus[\mathcal{T}_1, \mathcal{T}_3] \uplus \oplus[\mathcal{T}_4, \mathcal{T}_2] \uplus \ominus[\mathcal{T}_{10}, \mathcal{T}_6] \uplus \ominus[\mathcal{T}_{10}, \mathcal{T}_7] \uplus \ominus[\mathcal{T}_1, \mathcal{T}_7] \uplus \ominus[\mathcal{T}_8, \mathcal{T}_6] \\ \mathcal{T}_8 = \oplus[\mathcal{T}_1, \mathcal{T}_{11}] \uplus \oplus[\mathcal{T}_1, \mathcal{T}_{12}] \uplus \oplus[\mathcal{T}_{13}, \mathcal{T}_{11}] \uplus \oplus[\mathcal{T}_9, \mathcal{T}_{11}] \uplus \oplus[\mathcal{T}_{13}, \mathcal{T}_1] \\ \mathcal{T}_9 = \ominus[\mathcal{T}_1, \mathcal{T}_6] \\ \mathcal{T}_{10} = \oplus[\mathcal{T}_1, \mathcal{T}_1] \uplus \oplus[\mathcal{T}_1, \mathcal{T}_9] \uplus \oplus[\mathcal{T}_9, \mathcal{T}_1] \\ \mathcal{T}_{11} = \oplus[\mathcal{T}_1, \mathcal{T}_2] \\ \mathcal{T}_{12} = \oplus[\mathcal{T}_1, \mathcal{T}_3] \uplus \oplus[\mathcal{T}_4, \mathcal{T}_2] \uplus \ominus[\mathcal{T}_{10}, \mathcal{T}_6] \uplus \ominus[\mathcal{T}_{10}, \mathcal{T}_7] \uplus \ominus[\mathcal{T}_1, \mathcal{T}_7] \uplus \ominus[\mathcal{T}_8, \mathcal{T}_6] \\ \mathcal{T}_{13} = \ominus[\mathcal{T}_{10}, \mathcal{T}_6] \uplus \ominus[\mathcal{T}_{10}, \mathcal{T}_7] \uplus \ominus[\mathcal{T}_1, \mathcal{T}_7] \uplus \ominus[\mathcal{T}_8, \mathcal{T}_6]. \end{array} \right.$$

Solving the system on the series $(T_i)_{0 \leq i \leq 13}$ resulting from Equation (7.34) gives

$$\left\{ \begin{array}{l} T = T_0 = \frac{-z(z^3 - z^2 + 3z - 1)}{(z-1)(z^3 - z^2 + 4z - 1)} \\ T_1 = z \\ T_2 = T_6 = \frac{-z}{(z-1)} \\ T_3 = T_7 = \frac{z^2}{(z-1)(z^3 - z^2 + 4z - 1)} \\ T_4 = \frac{z^2(z-1)}{(z^3 - z^2 + 4z - 1)} \\ T_5 = \frac{-z(z^2 + 1)}{(z-1)} \\ T_8 = \frac{z^3(z^3 - z^2 + 3z + 1)}{(z-1)(z^3 - z^2 + 4z - 1)} \\ T_9 = T_{11} = \frac{-z^2}{(z-1)} \\ T_{10} = \frac{-z^2(z+1)}{(z-1)} \\ T_{12} = \frac{z^3(z^2 - z + 4)}{(z-1)(z^3 - z^2 + 4z - 1)} \\ T_{13} = \frac{z^3(z^2 + 2)}{(z-1)(z^3 - z^2 + 4z - 1)}. \end{array} \right.$$

The critical series are $T_0, T_3, T_4, T_7, T_8, T_{12}$ and T_{13} . Their common root ρ is the only real root of the polynomial $z^3 - z^2 + 4z - 1$, namely

$$\rho = -\frac{(7/2 + 3\sqrt{597}/2)^{1/3}}{3} + \frac{1}{3} + \frac{11}{3(7/2 + 3\sqrt{597}/2)^{1/3}} \approx 0.26272.$$

It follows that the specification (7.34) is essentially linear. The dependency graph shows that the critical series are organized into two strongly connected components, one of which consists of the class \mathcal{T}_0 alone. However, as for the X -class (see Section 7.3.1.1), $\mathcal{T}_0 = \mathcal{T}_3 \uplus \{12 \dots n \mid n \geq 1\}$ and we study the specification where the equation for \mathcal{T}_0 is removed. Again similarly to the X -class, the limit of a uniform random permutation of size n in \mathcal{T}_3 will also be the limit of a uniform random permutation in \mathcal{T}_0 .

6. See the companion Jupyter notebook `examples/AsymmetricX.ipynb`

From the specification we are able to compute the matrices \mathbb{M}^* , $\mathbb{D}^{\text{left},+}$, \dots , $\mathbb{D}^{\text{right},-}$. Namely,

$$\mathbb{M}^*(z) = \begin{pmatrix} z & -\frac{z}{z-1} & -\frac{z^3+z}{z-1} & -\frac{z}{z-1} & 0 & 0 \\ 0 & 0 & -\frac{z^3+z}{z-1} & -\frac{z}{z-1} & 0 & 0 \\ z & -\frac{z}{z-1} & z - \frac{z^3+z^2}{z-1} & -\frac{z}{z-1} & 0 & 0 \\ 0 & 0 & 0 & 0 & z & z - \frac{z^2}{z-1} \\ z & -\frac{z}{z-1} & z - \frac{z^3+z^2}{z-1} & -\frac{z}{z-1} & 0 & 0 \\ 0 & 0 & z - \frac{z^3+z^2}{z-1} & -\frac{z}{z-1} & 0 & 0 \end{pmatrix},$$

$$\mathbb{D}^{\text{left},+} = \begin{pmatrix} 1 & 0 & 0 & 0 & 0 & 0 \\ 0 & 0 & 0 & 0 & 0 & 0 \\ 1 & 0 & 0 & 0 & 0 & 0 \\ 0 & 0 & 0 & 0 & 1 & 0 \\ 1 & 0 & 0 & 0 & 0 & 0 \\ 0 & 0 & 0 & 0 & 0 & 0 \end{pmatrix}, \quad \mathbb{D}^{\text{left},-} = \begin{pmatrix} 0 & 0 & -\frac{3z^2+1}{z-1} + \frac{z^3+z}{(z-1)^2} & 0 & 0 & 0 \\ 0 & 0 & -\frac{3z^2+1}{z-1} + \frac{z^3+z}{(z-1)^2} & 0 & 0 & 0 \\ 0 & 0 & -\frac{3z^2+2z}{z-1} + \frac{z^3+z^2}{(z-1)^2} + 1 & 0 & 0 & 0 \\ 0 & 0 & 0 & 0 & 0 & 0 \\ 0 & 0 & -\frac{3z^2+2z}{z-1} + \frac{z^3+z^2}{(z-1)^2} + 1 & 0 & 0 & 0 \\ 0 & 0 & -\frac{3z^2+2z}{z-1} + \frac{z^3+z^2}{(z-1)^2} + 1 & 0 & 0 & 0 \end{pmatrix}$$

$$\mathbb{D}^{\text{right},+} = \begin{pmatrix} 0 & -\frac{1}{z-1} + \frac{z}{(z-1)^2} & 0 & 0 & 0 & 0 \\ 0 & 0 & 0 & 0 & 0 & 0 \\ 0 & -\frac{1}{z-1} + \frac{z}{(z-1)^2} & 0 & 0 & 0 & 0 \\ 0 & 0 & 0 & 0 & 0 & -\frac{2z}{z-1} + \frac{z^2}{(z-1)^2} + 1 \\ 0 & -\frac{1}{z-1} + \frac{z}{(z-1)^2} & 0 & 0 & 0 & 0 \\ 0 & 0 & 0 & 0 & 0 & 0 \end{pmatrix}$$

$$\text{and } \mathbb{D}^{\text{right},-} = \begin{pmatrix} 0 & 0 & 0 & -\frac{1}{z-1} + \frac{z}{(z-1)^2} & 0 & 0 \\ 0 & 0 & 0 & -\frac{1}{z-1} + \frac{z}{(z-1)^2} & 0 & 0 \\ 0 & 0 & 0 & -\frac{1}{z-1} + \frac{z}{(z-1)^2} & 0 & 0 \\ 0 & 0 & 0 & 0 & 0 & 0 \\ 0 & 0 & 0 & -\frac{1}{z-1} + \frac{z}{(z-1)^2} & 0 & 0 \\ 0 & 0 & 0 & -\frac{1}{z-1} + \frac{z}{(z-1)^2} & 0 & 0 \end{pmatrix}$$

By performing the computations in the field $\mathbb{Q}(\rho)$, we are able to compute those matrices at $z = \rho$. We verify that the dominant eigenvalue of $\mathbb{M}^*(\rho)$ is 1 and compute the corresponding left and right eigenvectors. and the vector \mathbf{p} :

$$\mathbf{p} = \frac{1}{597} (51\rho^2 + 42\rho + 105, 51\rho^2 + 42\rho + 105, -113\rho^2 + 24\rho + 259, 11\rho^2 - 108\rho + 128).$$

A numerical approximation gives

$$\mathbf{p} \approx (0.200258808255625, 0.200258808255625, 0.431332891374616, 0.168149492114135).$$

Those numbers are algebraic of degree 3 since ρ is.

7.5.3. The V-shape: $\text{Av}(2413, 1243, 2341, 531642, 41352)$. The specification for this class that we obtain applying the algorithm of [Bas+17]⁷ is

$$\left\{ \begin{array}{l} \mathcal{T}_0 = \{\bullet\} \uplus \oplus[\mathcal{T}_1, \mathcal{T}_2] \uplus \oplus[\mathcal{T}_1, \mathcal{T}_3] \uplus \oplus[\mathcal{T}_4, \mathcal{T}_2] \uplus \ominus[\mathcal{T}_5, \mathcal{T}_0] \uplus 3142[\mathcal{T}_1, \mathcal{T}_1, \mathcal{T}_1, \mathcal{T}_6] \\ \mathcal{T}_1 = \{\bullet\} \uplus \ominus[\mathcal{T}_7, \mathcal{T}_1] \\ \mathcal{T}_2 = \{\bullet\} \uplus \oplus[\mathcal{T}_7, \mathcal{T}_2] \\ \mathcal{T}_3 = \oplus[\mathcal{T}_8, \mathcal{T}_2] \uplus \ominus[\mathcal{T}_9, \mathcal{T}_6] \\ \mathcal{T}_4 = \ominus[\mathcal{T}_{10}, \mathcal{T}_{11}] \uplus \ominus[\mathcal{T}_{10}, \mathcal{T}_1] \uplus \ominus[\mathcal{T}_7, \mathcal{T}_{11}] \uplus 3142[\mathcal{T}_1, \mathcal{T}_1, \mathcal{T}_1, \mathcal{T}_6] \\ \mathcal{T}_5 = \{\bullet\} \uplus \oplus[\mathcal{T}_1, \mathcal{T}_1] \uplus 3142[\mathcal{T}_1, \mathcal{T}_1, \mathcal{T}_1, \mathcal{T}_1] \\ \mathcal{T}_6 = \{\bullet\} \uplus \oplus[\mathcal{T}_{12}, \mathcal{T}_2] \uplus \ominus[\mathcal{T}_9, \mathcal{T}_6] \\ \mathcal{T}_7 = \{\bullet\} \\ \mathcal{T}_8 = \ominus[\mathcal{T}_9, \mathcal{T}_6] \\ \mathcal{T}_9 = \{\bullet\} \uplus \oplus[\mathcal{T}_1, \mathcal{T}_7] \\ \mathcal{T}_{10} = \oplus[\mathcal{T}_1, \mathcal{T}_1] \uplus 3142[\mathcal{T}_1, \mathcal{T}_1, \mathcal{T}_1, \mathcal{T}_1] \\ \mathcal{T}_{11} = \oplus[\mathcal{T}_1, \mathcal{T}_2] \uplus \oplus[\mathcal{T}_1, \mathcal{T}_3] \uplus \oplus[\mathcal{T}_4, \mathcal{T}_2] \uplus \ominus[\mathcal{T}_{10}, \mathcal{T}_{11}] \uplus \ominus[\mathcal{T}_{10}, \mathcal{T}_1] \uplus \ominus[\mathcal{T}_7, \mathcal{T}_{11}] \uplus 3142[\mathcal{T}_1, \mathcal{T}_1, \mathcal{T}_1, \mathcal{T}_6] \\ \mathcal{T}_{12} = \{\bullet\} \uplus \ominus[\mathcal{T}_9, \mathcal{T}_6] \end{array} \right.$$

and the solutions of the associated system are

$$\left\{ \begin{array}{l} T_0 = -\frac{z^7 - 7z^6 + 20z^5 - 28z^4 + 20z^3 - 7z^2 + z}{2z^7 - 13z^6 + 37z^5 - 62z^4 + 59z^3 - 32z^2 + 9z - 1} \\ T_1 = T_2 = T_9 = -\frac{z}{z-1} \\ T_3 = -\frac{z^2}{z^3 - 4z^2 + 4z - 1} \\ T_4 = \frac{z^8 - 4z^7 + 11z^6 - 13z^5 + 8z^4 - 2z^3}{2z^7 - 13z^6 + 37z^5 - 62z^4 + 59z^3 - 32z^2 + 9z - 1} \\ T_5 = \frac{z^5 - 2z^4 + 4z^3 - 3z^2 + z}{z^4 - 4z^3 + 6z^2 - 4z + 1} \\ T_6 = -\frac{z^2 - z}{z^2 - 3z + 1} \\ T_7 = z \\ T_8 = \frac{z^2}{z^2 - 3z + 1} \\ T_{10} = \frac{2z^4 - 2z^3 + z^2}{z^4 - 4z^3 + 6z^2 - 4z + 1} \\ T_{11} = \frac{z^8 - 5z^7 + 10z^6 - 14z^5 + 11z^4 - 5z^3 + z^2}{2z^8 - 15z^7 + 50z^6 - 99z^5 + 121z^4 - 91z^3 + 41z^2 - 10z + 1} \\ T_{12} = \frac{z^3 - 2z^2 + z}{z^2 - 3z + 1} \end{array} \right.$$

The critical series are T_0, T_4 and T_{11} , whose radius of convergence ρ is the only real root of the polynomial

$$2z^5 - 7z^4 + 14z^3 - 13z^2 + 6z - 1.$$

The graph of critical series is not strongly connected: $\{\mathcal{T}_4, \mathcal{T}_{11}\}$ forms a connected component which does not involve \mathcal{T}_0 , hence we can study the specification where \mathcal{T}_0 is removed. It is essentially linear, verifies Hypotheses (SC) and (RC), and involves aperiodic subcritical series. Hence Theorem 7.3.2 applies and there exists a parameter \mathbf{p} such that uniform random permutations of size n in either \mathcal{T}_4 or \mathcal{T}_{11} converges to the X -permuton with parameter \mathbf{p} .

Furthermore, we know from the design of the algorithm of [Bas+17] that all families appearing in the system are included in \mathcal{T}_0 , in particular $\mathcal{T}_{11} \subseteq \mathcal{T}_0$. A quick computer-assisted computation (done in the companion notebook) shows that $T_0 - T_{11} = z/(1-z)$, *i.e.*, for each n , there is exactly one permutation of size n in $\mathcal{T}_0 \setminus \mathcal{T}_{11}$. Hence, uniform random permutations of size n in \mathcal{T}_0 also converge to the X -permuton with parameter \mathbf{p} .

7. See the companion Jupyter notebook `examples/V.ipynb`

We now turn to the computation of the parameter \mathbf{p} , using Equation (7.15). From the specification we directly compute

$$\begin{aligned} M^*(z) &= \begin{pmatrix} 0 & z + \frac{2z^4 - 2z^3 + z^2}{z^4 - 4z^3 + 6z^2 - 4z + 1} \\ -\frac{z}{z-1} & z + \frac{2z^4 - 2z^3 + z^2}{z^4 - 4z^3 + 6z^2 - 4z + 1} \end{pmatrix}, \quad \mathbb{D}^{\text{left},+} = \mathbb{D}^{\text{right},-} = \mathbb{O}, \\ \mathbb{D}^{\text{left},-} &= \begin{pmatrix} 0 & z + \frac{2z^4 - 2z^3 + z^2}{z^4 - 4z^3 + 6z^2 - 4z + 1} \\ -\frac{z}{z-1} & z + \frac{2z^4 - 2z^3 + z^2}{z^4 - 4z^3 + 6z^2 - 4z + 1} \end{pmatrix}, \quad \mathbb{D}^{\text{right},+} = \begin{pmatrix} 0 & 0 \\ -\frac{1}{z-1} + \frac{z}{(z-1)^2} & 0 \end{pmatrix}. \end{aligned}$$

This implies that $p_{\text{left}}^+ = p_{\text{right}}^- = 0$, hence $p_{\text{right}}^+ = 1 - p_{\text{left}}^-$. As a result, the associated X -permuton will degenerate into a V shape based at the point $(p_{\text{left}}^-, 0)$. We can now perform computations in $\mathbb{Q}(\rho)$ to obtain that $p_{\text{left}}^- = -\frac{192}{599}\rho^4 + \frac{600}{599}\rho^3 - \frac{1119}{599}\rho^2 + \frac{1507}{1198}\rho + \frac{343}{599}$. This algebraic number is the only real root of the polynomial

$$19168z^5 - 86256z^4 + 155880z^3 - 141412z^2 + 64394z - 11773$$

and a numerical evaluation gives $p_{\text{left}}^- \approx 0.818632668576995$.

7.5.4. The class of pin-permutations. The recursive description given in [BBR11] can be translated into a tree-specification as in Definition 5.2.1.

As in [BBR11], we denote by (see [BBR11] for the definitions):

- \mathcal{S} the set of all pin-permutations;
- \mathcal{E}^+ (resp. \mathcal{E}^-) the set of increasing (resp. decreasing) oscillations;
- \mathcal{N}^+ (resp. \mathcal{N}^-) the set of pin-permutations that are not increasing (resp. decreasing) oscillations, and whose root is not \oplus (resp. \ominus);
- $\mathcal{T}_{\mathcal{E}^+}$ (resp. $\mathcal{T}_{\mathcal{E}^-}$) the set of direct sums of at least two increasing (resp. decreasing) oscillations;
- $\mathcal{T}_{\mathcal{E}^+, \mathcal{N}^+}$ (resp. $\mathcal{T}_{\mathcal{E}^-, \mathcal{N}^-}$) the set of direct sums of at least two permutations, one being in \mathcal{N}^+ , the others in \mathcal{E}^+ (resp. \mathcal{N}^- and \mathcal{E}^-);
- Si the set of simple pin-permutations α and Si^* the set of pairs (α, a) where α is in Si and a an active point of α ;
- QE^+ (resp. QE^-) the set of triples (β, m, a) , where β is an increasing (resp. decreasing) quasi-oscillation and m and a are its main and auxiliary substitution points, respectively.

The set of (marked) simple permutations Si^* , Si , QE^+ and QE^- in the above list are characterized and enumerated in [BBR11].

Then there is a tree-specification for the following 19 families: \mathcal{S} , $\mathcal{S} \setminus \{1\}$, \mathcal{E}^+ , $\mathcal{E}^+ \setminus \{1\}$, $\mathcal{E}^+ \setminus \{1, 21\}$, \mathcal{E}^- , $\mathcal{E}^- \setminus \{1\}$, $\mathcal{E}^- \setminus \{1, 12\}$, \mathcal{N}^+ , \mathcal{N}^- , $\mathcal{T}_{\mathcal{E}^+}$, $\mathcal{T}_{\mathcal{E}^-}$, $\mathcal{T}_{\mathcal{E}^+, \mathcal{N}^+}$, $\mathcal{T}_{\mathcal{E}^-, \mathcal{N}^-}$, $\mathcal{T}_{\mathcal{E}^+}^* := \mathcal{T}_{\mathcal{E}^+} \setminus \{12, 132, 213\}$, $\mathcal{T}_{\mathcal{E}^-}^* := \mathcal{T}_{\mathcal{E}^-} \setminus \{21, 231, 312\}$, $\{12\}$, $\{21\}$ and $\{1\}$.

Below are the equations for \mathcal{S} , $\mathcal{T}_{\mathcal{E}^+}$, $\mathcal{T}_{\mathcal{E}^+, \mathcal{N}^+}$ and \mathcal{N}^+ . Some other follow by symmetry or by excluding small permutations.

(7.35)

$$\left\{ \begin{aligned} \mathcal{S} &= \{\bullet\} \uplus \mathcal{T}_{\mathcal{E}^+} \uplus \mathcal{T}_{\mathcal{E}^+, \mathcal{N}^+} \uplus \mathcal{T}_{\mathcal{E}^-} \uplus \mathcal{T}_{\mathcal{E}^-, \mathcal{N}^-} \\ &\quad \uplus \biguplus_{\alpha \in \text{Si}} \alpha[1, \dots, 1] \uplus \biguplus_{(\alpha, i) \in \text{Si}^*} \alpha[1, \dots, 1, \mathcal{S} \setminus \{1\}, 1, \dots, 1] \\ &\quad \uplus \biguplus_{(\beta, m, a) \in \text{QE}^+} \beta[1, \dots, 1, \mathcal{S} \setminus \{1\}, 1, \dots, 1, 12, 1, \dots, 1] \\ &\quad \uplus \biguplus_{(\beta, m, a) \in \text{QE}^-} \beta[1, \dots, 1, \mathcal{S} \setminus \{1\}, 1, \dots, 1, 21, 1, \dots, 1] \\ \mathcal{T}_{\mathcal{E}^+} &= \oplus[\mathcal{E}^+, \mathcal{E}^+] \uplus \oplus[\mathcal{E}^+, \mathcal{T}_{\mathcal{E}^+}] \\ \mathcal{T}_{\mathcal{E}^+, \mathcal{N}^+} &= \oplus[\mathcal{N}^+, \mathcal{E}^+] \uplus \oplus[\mathcal{N}^+, \mathcal{T}_{\mathcal{E}^+}] \uplus \oplus[\mathcal{E}^+, \mathcal{N}^+] \uplus \oplus[\mathcal{E}^+, \mathcal{T}_{\mathcal{E}^+, \mathcal{N}^+}] \\ \mathcal{N}^+ &= \mathcal{T}_{\mathcal{E}^-}^* \uplus \mathcal{T}_{\mathcal{E}^-, \mathcal{N}^-} \\ &\quad \uplus \biguplus_{\alpha \in \text{Si} \setminus \mathcal{E}^+} \alpha[1, \dots, 1] \uplus \biguplus_{(\alpha, i) \in \text{Si}^*} \alpha[1, \dots, 1, \mathcal{S} \setminus \{1\}, 1, \dots, 1] \\ &\quad \uplus \biguplus_{(\beta, m, a) \in \text{QE}^+} \beta[1, \dots, 1, \mathcal{S} \setminus \{1\}, 1, \dots, 1, 12, 1, \dots, 1] \\ &\quad \uplus \biguplus_{(\beta, m, a) \in \text{QE}^-} \beta[1, \dots, 1, \mathcal{S} \setminus \{1\}, 1, \dots, 1, 21, 1, \dots, 1] \end{aligned} \right.$$

Finally, the families \mathcal{E}^+ and \mathcal{E}^- are explicit sets of permutations, each consisting of 1 permutation of size 1, 1 permutation of size 2, and 2 permutations of each size $n \geq 3$.

The corresponding system is solved explicitly in [BBR11]. The critical families are \mathcal{S} , $\mathcal{S} \setminus \{1\}$, \mathcal{N}^+ , \mathcal{N}^- , $\mathcal{T}_{\mathcal{E}^+, \mathcal{N}^+}$, $\mathcal{T}_{\mathcal{E}^-, \mathcal{N}^-}$. From the equations, we see that the system is essentially linear. Here is the dependency graph of the system restricted to critical families.

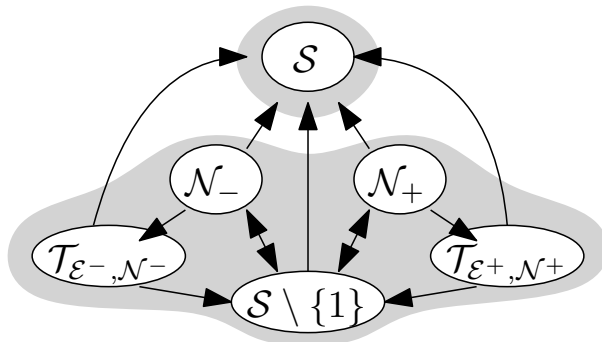

FIGURE 7.9. The dependency graph of the pin-permutations class.

As in other essentially linear examples, we observe that there are two strongly connected components, one constituted of \mathcal{S} alone. The other one contains the family $\mathcal{S} \setminus \{1\}$, whose asymptotics is equivalent to that of \mathcal{S} .

As this specification has infinitely many simple permutations, we need to argue that Hypothesis (RC) holds. It is easily observed from the equations that all entries of \mathbf{V}^* and \mathbf{M}^* are polynomials in the subcritical series and in the series \mathcal{S}_i , \mathcal{S}_i^* , $\mathcal{Q}\mathcal{E}^+$, $\mathcal{Q}\mathcal{E}^-$ counting the families of simple permutations appearing in (7.35). It is shown in [BBR11] that the latter series are all analytic at the radius of convergence of \mathcal{S} , implying (RC).

Moreover, the aperiodicity is clear, so that we can apply Theorem 7.3.2 to the tree-specification without the class \mathcal{S} and its equation. We conclude that a uniform random permutation of size n in $\mathcal{S} \setminus \{1\}$ (or equivalently in \mathcal{S}) tends to the X -permuton with some parameters $p_+^{\text{left}}, p_+^{\text{right}}, p_-^{\text{left}}, p_-^{\text{right}}$. Since the class \mathcal{S} has all symmetries of the square, we know without computation that $p_+^{\text{left}} = p_+^{\text{right}} = p_-^{\text{left}} = p_-^{\text{right}} = 1/4$.

7.5.5. A non-degenerate essentially branching class. We consider the class \mathcal{T} of permutations avoiding the patterns 31452 and 41253 whose standard tree has nodes labeled only by \oplus , \ominus and 3142. This class has the following tree-specification⁸:

$$\left\{ \begin{array}{l} \mathcal{T} = \mathcal{T}_0 = \{\bullet\} \uplus \oplus[\mathcal{T}_1, \mathcal{T}_0] \uplus \ominus[\mathcal{T}_2, \mathcal{T}_0] \uplus 3142[\mathcal{T}_0, \mathcal{T}_3, \mathcal{T}_3, \mathcal{T}_0] \\ \mathcal{T}_1 = \{\bullet\} \uplus \ominus[\mathcal{T}_2, \mathcal{T}_0] \uplus 3142[\mathcal{T}_0, \mathcal{T}_3, \mathcal{T}_3, \mathcal{T}_0] \\ \mathcal{T}_2 = \{\bullet\} \uplus \oplus[\mathcal{T}_1, \mathcal{T}_0] \uplus 3142[\mathcal{T}_0, \mathcal{T}_3, \mathcal{T}_3, \mathcal{T}_0] \\ \mathcal{T}_3 = \{\bullet\} \uplus \ominus[\mathcal{T}_4, \mathcal{T}_3] \\ \mathcal{T}_4 = \{\bullet\} \end{array} \right.$$

Clearly, $T_4 = z$ and $T_3 = \frac{z}{1-z}$. Since \mathcal{T}_0 contains the separable permutations, the radius of convergence of T_0 is smaller than 1. Hence T_3 and T_4 are subcritical. Moreover, T_0, T_1 and T_2 form a connected component of the dependency graph. Thus T_0, T_1 and T_2 are critical and Hypothesis (SC) is satisfied. In addition, \mathcal{T}_0 and thus all \mathcal{T}_i contain finitely many simple permutations, so that Hypothesis (AR) holds from Observation 7.1.4. One can see that the specification is essentially branching (*e.g.*, the equation of T_0 involves a factor $T_1 T_0$). Finally, $T_3 = \frac{z}{1-z}$ is aperiodic. We can therefore apply Theorem 7.2.1: there exists some parameter p_+ such that the limiting permuton of \mathcal{T}_0 is the Brownian separable permuton of parameter p_+ .

8. See the companion Jupyter notebook `examples/Branching.ipynb`

We move on to the computation of the parameter p_+ . We did not explicitly solve the system, but rather reduced it to a cubic equation in T_0 , and, playing with Cardano's formulas, obtained that the radius of convergence ρ of T_0 is the only real root of the equation

$$-4z^9 + 41z^8 - 230z^7 + 507z^6 - 582z^5 + 403z^4 - 186z^3 + 58z^2 - 12z + 1$$

while the values of the critical series at the radius of convergence can be expressed in terms of ρ as follows:

$$T_0(\rho) = \frac{-21\rho^5 + 30\rho^4 + 12\rho^3 - 33\rho^2 + 15\rho - 3}{18\rho^5 - 78\rho^4 + 102\rho^3 - 66\rho^2 + 24\rho - 6}, \quad T_1(\rho) = T_2(\rho) = \frac{T_0(\rho)}{1 + T_0(\rho)}.$$

We obtain directly from the specification

$$\mathbb{M}^*(z, y_0, y_1, y_2) = \begin{pmatrix} y_1 + y_2 + 2y_0\left(\frac{z}{1-z}\right)^2 & y_0 & y_0 \\ y_2 + 2y_0\left(\frac{z}{1-z}\right)^2 & 0 & y_0 \\ y_1 + 2y_0\left(\frac{z}{1-z}\right)^2 & y_0 & 0 \end{pmatrix},$$

and

$$E_{i,j,j'}^+ = \begin{cases} 1 & \text{if } i \in \{0, 2\}, j = 1, j' = 0 \\ 0 & \text{otherwise.} \end{cases}$$

$$E_{i,j,j'}^- = \begin{cases} 1 & \text{if } i \in \{0, 1\}, j = 2, j' = 0 \\ T_3^2 = \left(\frac{z}{1-z}\right)^2 & \text{if } i \in \{0, 1, 2\}, j = j' = 0 \\ 0 & \text{otherwise.} \end{cases}$$

We can now perform computations in $\mathbb{Q}(\rho)$ to find the dominant eigenvectors of the matrix $\mathbb{M}^*(\rho, T_0(\rho), T_1(\rho), T_2(\rho))$ and use Equation (7.7) to compute p_+ . We get that $p_+ \approx 0.474869237650240$ is the only real root of the polynomial

$$z^9 - 3z^8 + \frac{232819}{62348}z^7 - \frac{78093}{31174}z^6 + \frac{243697}{249392}z^5 - \frac{54293}{249392}z^4 + \frac{24529}{997568}z^3 - \frac{125}{62348}z^2 + \frac{45}{62348}z - \frac{2}{15587}.$$

Random cographs: Brownian graphon limit and asymptotic degree distribution

This chapter reproduces, with minor modifications, the article [Bas+19a], joint work with F. Bassino, M. Bouvel, V. Féray, L. Gerin et A. Pierrot.

ABSTRACT. We consider uniform random cographs (either labeled or unlabeled) of large size. Our first main result is the convergence towards a Brownian limiting object in the space of graphons. We then show that the degree of a uniform random vertex in a uniform cograph is of order n , and converges after normalization to the Lebesgue measure on $[0, 1]$. We finally analyze the vertex connectivity (*i.e.* the minimal number of vertices whose removal disconnects the graph) of random connected cographs, and show that this statistics converges in distribution without renormalization. Unlike for the graphon limit and for the degree of a random vertex, the limiting distribution of the vertex connectivity is different in the labeled and unlabeled settings.

Our proofs rely on the classical encoding of cographs via cotrees. We then use mainly combinatorial arguments, including the symbolic method and singularity analysis.

8.1. Introduction

8.1.1. Motivation. Random graphs are arguably the most studied objects at the interface of combinatorics and probability theory. One aspect of their study consists in analyzing a uniform random graph of large size n in a prescribed family, *e.g.* perfect graphs [MY19], planar graphs [Noy14], graphs embeddable in a surface of given genus [DKMS19], graphs in subcritical classes [PSW16], hereditary classes [HJS18] or addable classes [MSW06; CP16]. The present paper focuses on uniform random *cographs* (both in the labeled and unlabeled settings).

Cographs were introduced in the seventies by several authors independently, see *e.g.* [Sei74] and further references on the Wikipedia page [Wik20]. They enjoy several equivalent characterizations. Among others, cographs are

- the graphs avoiding P_4 (the path with four vertices) as an induced subgraph;
- the graphs which can be constructed from graphs with one vertex by taking disjoint unions and joins;
- the graphs whose modular decomposition does not involve any prime graph;
- the inversion graphs of separable permutations.

Cographs have been extensively studied in the algorithmic literature. They are recognizable in linear time [CPS85; HP05; BHP08] and many computationally hard problems on general graphs are solvable in polynomial time when restricted to cographs [CLB81, and several subsequent works citing this article]. In these works, as well as in the present paper, a key ingredient is the encoding of cographs by some trees, called *cotrees*. These cotrees witness the construction of cographs using disjoint unions and joins (mentioned in the second item above).

To our knowledge, cographs have however not been studied from a probabilistic perspective so far. Our motivation to the study of random cographs comes from our previous work [Bas+18; Bas+20; BBFS19; Bas+19b] which exhibits a Brownian limiting object for separable permutations (and various other permutation classes). The first main result of this paper (Theorem 8.1.1) is the description of a Brownian limit for cographs. Although

cographs are the inversion graphs of separable permutations, this result is not a consequence of the previous one on permutations: indeed the inversion graph is not an injective mapping, hence a uniform cograph is not the cograph of a uniform separable permutation.

Our convergence result holds in the space of *graphons*. Graphon convergence has been introduced in [Bor+08] and has since then been a major topic of interest in graph combinatorics – see [Lov12] for a broad perspective on the field. The question of studying graphon limits of uniform random graphs (either labeled or unlabeled) in a given class is raised by Janson in [Jan16] (see Remark 1.6 there). Some general results have been recently obtained for hereditary¹ classes in [HJS18]. However, these results (in particular Theorem 3 in [HJS18]) do not apply to cographs, since the class of cographs contain $e^{o(n^2)}$ graphs of size n .

The graphon limit of cographs found here, which we call the *Brownian cographon*, is constructed from a Brownian excursion. By analogy with the realm of permutations [Bas+20; BBFS19], we expect that the Brownian cographon (or a one-parameter deformation of it) is a universal limiting object for uniform random graphs in classes of graphs which are small² and closed under the substitution operation at the core of the modular decomposition.

8.1.2. Main results.

From now on, for every $n \geq 1$, we let \mathbf{G}_n and \mathbf{G}_n^u be uniform random labeled and unlabeled cographs of size n , respectively. It is classical (see also Definition 8.3.2 below) to associate with any graph a graphon, and we denote by $W_{\mathbf{G}_n}$ and $W_{\mathbf{G}_n^u}$ the graphons associated with \mathbf{G}_n and \mathbf{G}_n^u .

We note that the graphons associated with a labeled graph and its unlabeled version are the same. However, $W_{\mathbf{G}_n}$ and $W_{\mathbf{G}_n^u}$ have different distributions, since the number of possible labelings of an unlabeled cograph of a given size varies (see Figure 8.3 p.143 for an illustration).

Theorem 8.1.1. *We have the following convergences in distribution as n tends to $+\infty$:*

$$W_{\mathbf{G}_n} \rightarrow W^{1/2}, \quad W_{\mathbf{G}_n^u} \rightarrow W^{1/2},$$

where $W^{1/2}$ is the Brownian cographon introduced below in Definition 8.4.2.

Roughly speaking, the graphon convergence is the convergence of the rescaled adjacency matrix with a unusual metric, the *cut metric*, see Section 8.3.1. To illustrate Theorem 8.1.1, we show on Figure 8.1 the adjacency matrix of a large random uniform labeled cograph. Entries 1 in the matrix are represented as black dots, entries 0 as white dots. It was obtained by using the encoding of cographs by cotrees and sampling a large uniform cotree using Boltzmann sampling [DFLS04] of the equation (8.9), p. 153. Note that the order of vertices in the axis of Figure 8.1 is not the order of labels but is given by the depth-first search of the associated cotree. The fractal aspect of the figure – appearance of imbricated squares at various scale – is consistent with the convergence to a Brownian limiting object, since the Brownian excursion enjoys some self-similarity properties.

We now present further results. It is well-known that the graphon convergence entails the convergence of many graph statistics, like subgraph densities, the spectrum of the adjacency matrix, the normalized degree distribution (see [Lov12; DHJ08] and Section 8.3 below). Hence, Theorem 8.1.1 implies that these statistics have the same limit in the labeled and unlabeled cases, and that this limit may (at least in principle) be described in terms of the Brownian cographon. Among these, the degree distribution of the Brownian cographon (or to be precise, its *intensity*³) is surprisingly nice: it is simply the Lebesgue

1. A class of graphs is hereditary if any induced subgraph of a graph in the class is in the class as well.

2. A class of labeled (resp. unlabeled) graphs is *small* when its exponential (resp. ordinary) generating series has positive radius of convergence.

3. The degree distribution of a graphon is a measure, and therefore that of the Brownian cographon is a *random* measure. Following Kallenberg [Kal17a, Chapter 2], we call *intensity* of a random measure μ the (deterministic) measure $I[\mu]$ defined by $I[\mu](A) = \mathbb{E}[\mu(A)]$ for all measurable sets A . In other words,

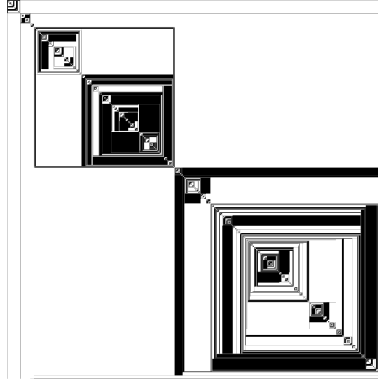

FIGURE 8.1. The adjacency matrix of a uniform labeled random cograph of size 4482.

measure on $[0, 1]$. We therefore have the following result, where we denote by $\deg_G(v)$ the degree of a vertex v in a graph G .

Theorem 8.1.2. *For every $n \geq 1$, let \mathbf{v} and \mathbf{v}^u be uniform random vertices in \mathbf{G}_n and \mathbf{G}_n^u , respectively. We have the following convergences in distribution as n tends to $+\infty$:*

$$\frac{1}{n} \deg_{\mathbf{G}_n}(\mathbf{v}) \rightarrow U, \quad \frac{1}{n} \deg_{\mathbf{G}_n^u}(\mathbf{v}^u) \rightarrow U,$$

where U is a uniform random variable in $[0, 1]$.

On the other hand, other graph statistics are not continuous for the graphon topology, and therefore can have different limits in the labeled and unlabeled cases. We illustrate this phenomenon with the *vertex connectivity* κ (defined as the minimum number of vertices whose removal disconnects the graph). Our third result is the following.

Theorem 8.1.3. *There exist different probability distributions $(\pi_j)_{j \geq 1}$ and $(\pi_j^u)_{j \geq 1}$ such that, for every fixed $j \geq 1$, as n tends to $+\infty$, we have*

$$(8.1) \quad \mathbb{P}(\kappa(\mathbf{G}_n) = j) \rightarrow \pi_j, \quad \mathbb{P}(\kappa(\mathbf{G}_n^u) = j) \rightarrow \pi_j^u.$$

Formulas for π_j and π_j^u are given in Theorem 8.7.2.

Remark 8.1.4. A part of these results (Theorem 8.1.1) has been independently derived in [Stu19] during the preparation of this paper. The proof method is however different.

8.1.3. Proof strategy. We first discuss the proof of Theorem 8.1.1. For any graphs g and G of size k and n respectively, we denote by $\text{Dens}(g, G)$ the number of copies of g in G as induced subgraph normalized by n^k . Equivalently, let \vec{V}^k be a k -tuple of i.i.d. uniform random vertices in G , then $\text{Dens}(g, G) = \mathbb{P}(\text{SubGraph}(\vec{V}^k, G) = g)$, where $\text{SubGraph}(I, G)$ is the subgraph of G induced by the vertices of I . (All subgraphs in this article are induced subgraphs, and we sometimes omit the word “induced”.)

From a theorem of Diaconis and Janson [DJ08, Theorem 3.1], the graphon convergence of any sequence of random graphs (\mathbf{H}_n) is characterized by the convergence of $\mathbb{E}[\text{Dens}(g, \mathbf{H}_n)]$ for all graphs g . In the case of \mathbf{G}_n (the uniform random labeled cographs of size n), for any graph g of size k , we have

$$\mathbb{E}[\text{Dens}(g, \mathbf{G}_n)] = \frac{\left| \left\{ (G, I) : \begin{array}{l} G=(V,E) \text{ labeled cograph of size } n, \\ I \in V^k \text{ and } \text{SubGraph}(I, G)=g \end{array} \right\} \right|}{|\{G \text{ labeled cograph of size } n\}| \cdot n^k},$$

and a similar formula holds in the unlabeled case.

we consider here the “averaged” degree distribution of the Brownian cographon, where we average on all realizations of the Brownian cographon.

Both in the labeled and unlabeled cases, the asymptotic behavior of the denominator follows from the encoding of cographs as cotrees, standard application of the symbolic method of Flajolet and Sedgewick [FS09] and singularity analysis (see Propositions 8.5.4 and 8.6.5). The same methods can be used to determine the asymptotic behavior of the numerator, counting cotrees with marked leaves inducing a given subtree. This requires more involved combinatorial decompositions, which are performed in Sections 8.5 and 8.6.

We note that we already used a similar proof strategy in the framework of permutations in [Bas+20]. The adaptation to the case of *labeled* cographs does not present major difficulties. The *unlabeled* case is however more subtle, since we have to take care of symmetries when marking leaves in cotrees (see the discussion in Section 8.6.1 for details). We overcome this difficulty using the $n!$ -to-1 mapping that maps a pair (G, a) (where G is a labeled cograph and a an automorphism of G) to the unlabeled version of G . We then make combinatorial decompositions of such pairs (G, a) with marked vertices inducing a given subgraph (or more precisely, of the associated cotrees, with marked leaves inducing a given subtree). Our analysis shows that symmetries have a negligible influence on the asymptotic behavior of the counting series. This is similar – though we have a different and more combinatorial presentation – to the techniques developed in the papers [PS18; GJW18], devoted to the convergence of unordered unlabeled trees to the *Brownian Continuum Random Tree*.

With Theorem 8.1.1 in our hands, proving Theorem 8.1.2 amounts to proving that the intensity of the degree distribution of the Brownian cographon is the Lebesgue measure on $[0, 1]$. Rather than working in the continuous, we exhibit a discrete approximation \mathbf{G}_n^b of the Brownian cographon, which has the remarkable property that the degree of a uniform random vertex in \mathbf{G}_n^b is *exactly* distributed as a uniform random variable in $\{0, 1, \dots, n-1\}$. The latter is proved by purely combinatorial arguments (see Proposition 8.4.5).

To prove Theorem 8.1.3, we start with a simple combinatorial lemma, which relates the vertex connectivity of a connected cograph to the sizes of the subtrees attached to the root in its cotree. Based on that, we can use again the symbolic method and singularity analysis as in the proof of Theorem 8.1.1.

8.1.4. Outline of the paper. Section 8.2 explains the standard encoding of cographs by cotrees and the relation between taking induced subgraphs and subtrees. Section 8.3 presents the necessary material on graphons; results stated there are quoted from the literature, except the continuity of the degree distribution, for which we could not find a reference. Section 8.4 introduces the limit object of Theorem 8.1.1, namely the Brownian cographon. It is also proved that the intensity of its degree distribution is uniform (which is the key ingredient for Theorem 8.1.2). Theorems 8.1.1 and 8.1.2 are proved in Section 8.5 for the labeled case and in Section 8.6 for the unlabeled case. Finally, Theorem 8.1.3 is proved in Section 8.7.

8.2. Cographs, cotrees and induced subgraphs

8.2.1. Terminology and notation for graphs. All graphs considered in this paper are *simple* (*i.e.* without multiple edges, nor loops) and not directed. A *labeled graph* G is a pair (V, E) , where V is its vertex set (consisting of distinguishable vertices, each identified by its label) and E is its edge set. Two labeled graphs (V, E) and (V', E') are isomorphic if there exists a bijection from V to V' which maps E to E' . Equivalence classes of labeled graphs for the above relation are *unlabeled graphs*.

Throughout this paper, the *size* of a graph is its number of vertices. Note that there are finitely many unlabeled graphs with n vertices, so that the uniform random unlabeled graph of size n is well defined. For labeled graphs, there are finitely many graphs with any given vertex set V . Hence, to consider a uniform random labeled graph of size n , we need to fix a vertex set V of size n . The properties we are interested in do not depend on the choice of this vertex set, so that we can choose V arbitrarily, usually $V = \{1, \dots, n\}$.

As a consequence, considering a subset (say \mathcal{C}) of the set of all graphs, we can similarly define the *uniform random unlabeled graph of size n in \mathcal{C}* (resp. the uniform random labeled graph with vertex set $\{1, \dots, n\}$ in \mathcal{C} – which we simply denote by *uniform random labeled graph of size n in \mathcal{C}*). The restricted family of graphs considered in this paper is that of *cographs*.

8.2.2. Cographs and cotrees. Let $G = (V, E)$ and $G' = (V', E')$ be labeled graphs with disjoint vertex sets. We define their *disjoint union* as the graph $(V \uplus V', E \uplus E')$ (the symbol \uplus denoting as usual the disjoint union of two sets). We also define their *join* as the graph $(V \uplus V', E \uplus E' \uplus (V \times V'))$: namely, we take copies of G and G' , and add all edges from a vertex of G to a vertex of G' . Both definitions readily extend to more than two graphs (adding edges between any two vertices originating from different graphs in the case of the join operation).

Definition 8.2.1. A *labeled cograph* is a labeled graph that can be generated from single-vertex graphs applying join and disjoint union operations. An *unlabeled cograph* is the underlying unlabeled graph of a labeled cograph.

It is classical to encode cographs by their *cotrees*.

Definition 8.2.2. A labeled *cotree* of size n is a rooted tree t with n leaves labeled from 1 to n such that:

- t is not plane (*i.e.* the children of every internal node are not ordered);
- every internal node has at least two children;
- every internal node in t is decorated with a 0 or a 1.

An *unlabeled cotree* of size n is a labeled cotree of size n where we forget the labels on the leaves.

Remark 8.2.3. In the literature, cotrees are usually required to satisfy the property that decorations 0 and 1 should alternate along each branch from the root to a leaf. In several proofs, our work needs also to consider trees in which this alternation assumption is relaxed, hence the choice of diverging from the usual terminology. Cotrees which do satisfy this alternation property are denoted *canonical cotrees* in this paper (see Definition 8.2.4).

For an unlabeled cotree t , we denote by $\mathbf{Cograph}(t)$ the unlabeled graph defined recursively as follows (see an illustration in Figure 8.2):

- If t consists of a single leaf, then $\mathbf{Cograph}(t)$ is the graph with a single vertex.
- Otherwise, the root of t has decoration 0 or 1 and has subtrees t_1, \dots, t_d attached to it ($d \geq 2$). Then, if the root has decoration 0, we let $\mathbf{Cograph}(t)$ be the *disjoint union* of $\mathbf{Cograph}(t_1), \dots, \mathbf{Cograph}(t_d)$. Otherwise, when the root has decoration 1, we let $\mathbf{Cograph}(t)$ be the *join* of $\mathbf{Cograph}(t_1), \dots, \mathbf{Cograph}(t_d)$.

Note that the above construction naturally entails a one-to-one correspondence between the leaves of the cotree t and the vertices of its associated graph $\mathbf{Cograph}(t)$. Therefore, it maps the size of a cotree to the size of the associated graph. Another consequence is that we can extend the above construction to a *labeled* cotree t , and obtain a *labeled* graph (also denoted $\mathbf{Cograph}(t)$), with vertex set $\{1, \dots, n\}$: each vertex of $\mathbf{Cograph}(t)$ receives the label of the corresponding leaf of t .

By construction, for all cotrees t , the graph $\mathbf{Cograph}(t)$ is a cograph. Conversely, each cograph can be obtained in this way, albeit not from a unique tree t . It is however possible to find a canonical cotree representing a cograph G . This tree was first described in [CLB81]. The presentation of [CLB81], although equivalent, is however a little bit different, since cographs are generated using exclusively “complemented unions” instead of disjoint unions and joins. The presentation we adopt has since been used in many algorithmic papers, see *e.g.* [HP05; BCHP08].

Definition 8.2.4. A cotree is *canonical* if every child of a node decorated by 0 (resp. 1) is either decorated by 1 (resp. 0) or a leaf.

Proposition 8.2.5. Let G be a labeled (resp. unlabeled) cograph. Then there exists a unique labeled (resp. unlabeled) canonical cotree t such that $\text{Cograph}(t) = G$.

Example of cographs and their canonical cotree are given in Figures 8.2 and 8.3.

From a graph G , the canonical cotree t such that $\text{Cograph}(t) = G$ is recursively built as follows. If G consists of a single vertex, t is the unique cotree with a single leaf. If G has at least two vertices, we distinguish cases depending on whether G is connected or not.

- If G is not connected, the root of t is decorated with 0 and the subtrees attached to it are the cographs associated with the connected components of G .
- If G is connected, the root of t is decorated with 1 and the subtrees attached to it are the cographs associated with the induced subgraphs of G whose vertex sets are those of the connected components of \bar{G} , where \bar{G} is the complement of G (graph on the same vertices with complement edge set).

Important properties of cographs which justify the correctness of the above construction are the following: cographs are stable by induced subgraph and by complement, and a cograph G of size at least two is not connected exactly when its complement \bar{G} is connected.

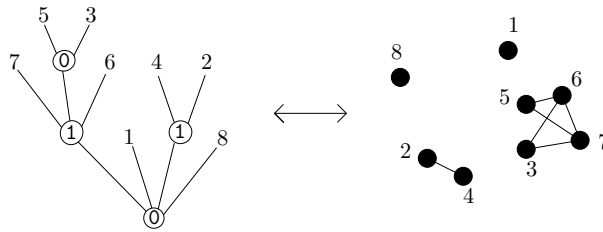

FIGURE 8.2. Left: A labeled canonical cotree t with 8 leaves. Right: The associated labeled cograph $\text{Cograph}(t)$ of size 8.

8.2.3. Subgraphs and induced trees. Let G be a graph of size n (which may or not be labeled), and let $I = (v_1, \dots, v_k)$ be a k -tuple of vertices of G . Recall that the *subgraph of G induced by I* , which we denote by $\text{SubGraph}(I, G)$, is the graph with vertex set $\{v_1, \dots, v_k\}$ and which contains the edge $\{v_i, v_j\}$ if and only if $\{v_i, v_j\}$ is an edge of G . In case of repetitions of vertices in I , we take as many copies of each vertex as times it appears in I and do not connect copies of the same vertex. There is a canonical way of labeling $\text{SubGraph}(I, G)$, by giving label i to vertex v_i for $i \in [k]$. We thus regard $\text{SubGraph}(I, G)$ as a *labeled* graph.

In the case of cographs, the (induced) subgraph operation can also be realized on the cotrees, through *induced trees*, which we now present. We start with a preliminary definition.

Definition 8.2.6 (First common ancestor). Let t be a rooted tree, and u and v be two nodes (internal nodes or leaves) of t . The *first common ancestor* of u and v is the node furthest away from the root \emptyset that appears on both paths from \emptyset to u and from \emptyset to v in t .

For any cograph G , and any vertices i and j of G , the following simple observation allows to read in any cotree encoding G if $\{i, j\}$ is an edge of G .

Observation 8.2.7. Let $i \neq j$ be two leaves of a cotree t and $G = \text{Cograph}(t)$. We also denote by i and j the corresponding vertices in G . Let v be the first common ancestor of i and j in t . Then $\{i, j\}$ is an edge of G if and only if v has label 1 in t .

Unlabeled canonical cotree	
Corresponding unlabeled cograph	
Number of associated labeled cographs	1 6 4 12 3
Unlabeled canonical cotree	
Corresponding unlabeled cograph	
Number of associated labeled cographs	1 6 4 12 3

FIGURE 8.3. All unlabeled cographs of size 4 with their corresponding (unlabeled) canonical cotrees and their number of distinct labelings.

Definition 8.2.8 (Induced cotree). Let t be a cotree (which may or not be labeled), an $I = (\ell_1, \dots, \ell_k)$ a k -tuple of **distinct** leaves of t , which we call the *marked leaves* of t . The *tree induced by* (t, I) , denoted t_I , is the **always labeled** cotree of size k defined as follows. The tree structure of t_I is given by:

- the leaves of t_I are the marked leaves of t ;
- the internal nodes of t_I are the nodes of t that are first common ancestors of two (or more) marked leaves;
- the ancestor-descendant relation in t_I is inherited from the one in t ;
- the decoration of an internal node v of t_I is inherited from the one in t ;
- for each $i \leq k$, the leaf of t_I corresponding to leaf ℓ_i in t is labeled i in t_I .

We insist on the fact that we **always** define the induced cotree t_I as a **labeled** cotree, regardless of whether the original cotree t is labeled or not, just as $\text{SubGraph}(I, G)$ is always a labeled graph, whether G is labeled or not. The labeling of the induced structure is related to the order of the marked elements in the tuple I (a tuple is an *ordered* collection), and not to their labels in the case t (resp. G) was labeled. A detailed example of the induced cotree construction is given in Figure 8.4.

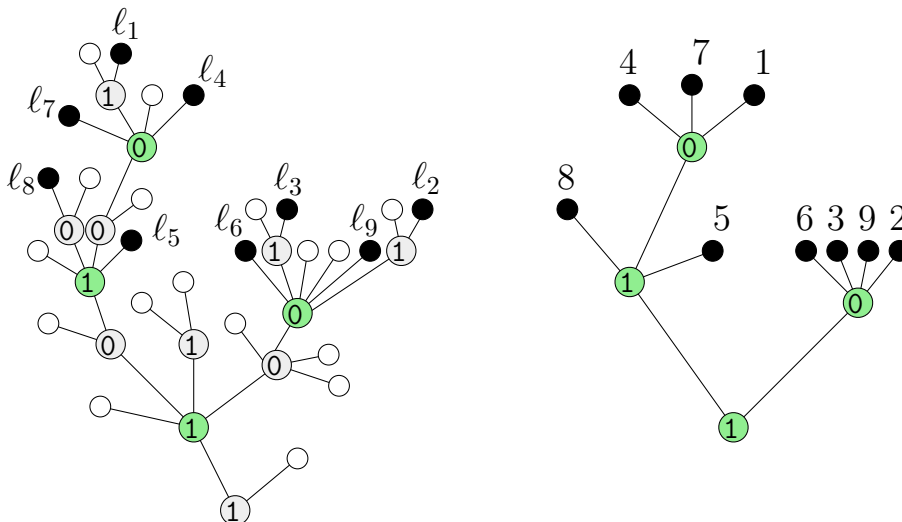

FIGURE 8.4. On the left: A cotree t of size $n = 26$, where leaves are indicated both by \circ and \bullet . We also fix a 9-tuple $I = (\ell_1, \dots, \ell_9)$ of marked leaves (indicated by \bullet). In green, we indicate the internal nodes of t which are first common ancestors of these 9 marked leaves. On the right: The labeled cotree t_I induced by the 9 marked leaves.

Proposition 8.2.9. *Let t be a cotree and $G = \text{Cograph}(t)$ the associated cograph. Let I be a k -tuple of distinct leaves in t , which identifies a k -tuple of distinct vertices in G . Then, as unlabeled graphs, we have $\text{SubGraph}(I, G) = \text{Cograph}(t_I)$.*

PROOF. This follows immediately from Observation 8.2.7 and the fact that the induced cotree construction (Definition 8.2.8) preserves first common ancestors and their decorations. \square

8.3. Graphons

Graphons are continuum limit objects for sequences of graphs. We present here the theory relevant to our work. We recall basic notions from the literature, following mainly Lovász’ book [Lov12], then we recall results of Diaconis and Janson [DJ08] regarding convergence of random graphs to random graphons. Finally, we prove a continuity result for the degree distribution with respect to graphon convergence.

The theory of graphons classically deals with unlabeled graphs. Consequently, unless specified otherwise, all graphs in this section are considered unlabeled. When considering labeled graphs, graphon convergence is to be understood as the convergence of their unlabeled versions.

8.3.1. The space of graphons.

Definition 8.3.1. A graphon is an equivalence class of symmetric functions $[0, 1]^2 \rightarrow [0, 1]$, under the equivalence relation \sim , where $w \sim u$ if there exists an invertible measurable and Lebesgue-preserving function $\phi : [0, 1] \rightarrow [0, 1]$ such that $w(\phi(x), \phi(y)) = u(x, y)$ for almost every $x, y \in [0, 1]$.

Intuitively, a graphon is a continuous analogue of the adjacency matrix of a graph, viewed up to relabelings of its continuous vertex set.

Definition 8.3.2. The graphon W_G associated to a labeled graph G with n vertices (labeled from 1 to n) is the equivalence class of the function $w_G : [0, 1]^2 \rightarrow [0, 1]$ where

$$w_G(x, y) = A_{\lceil nx \rceil, \lceil ny \rceil} \in \{0, 1\}$$

and A is the adjacency matrix of the graph G .

Since any relabeling of the vertex set of G gives the same graphon W_G , the above definition immediately extends to unlabeled graphons.

We now define the so-called *cut metric*, first on functions, and then on graphons. We note that it is different than usual metrics on spaces of functions (L^1 , supremum norms, ...), see [Lov12, Chapter 8] for details. For a real-valued symmetric function w on $[0, 1]^2$, its *cut norm* is defined as

$$\|w\|_{\square} = \sup_{S, T \subseteq [0, 1]} \left| \int_{S \times T} w(x, y) dx dy \right|$$

Identifying as usual functions equal almost-everywhere, this is indeed a norm. It induces the following *cut distance* on the space of graphons

$$\delta_{\square}(W, W') = \inf_{w \in W, w' \in W'} \|w - w'\|_{\square}.$$

While the symmetry and triangular inequalities are immediate, this “distance” δ_{\square} *does not* separate points, *i.e.* there exist different graphons at distance zero. Call $\widetilde{\mathcal{W}}_0$ the space of graphons, quotiented by the equivalence relation $W \equiv W'$ if $\delta_{\square}(W, W') = 0$. This is a metric space with distance δ_{\square} . This definition is justified by the following deep result, see, *e.g.*, [Lov12, Theorem 9.23].

Theorem 8.3.3. *The metric space $(\widetilde{\mathcal{W}}_0, \delta_{\square})$ is compact.*

In the sequel, we think of graphons as elements in $\widetilde{\mathcal{W}}_0$ and convergences of graphons are to be understood with respect to the distance δ_{\square} .

8.3.2. Subgraph densities and samples.

An important feature of graphons is that one can extend the notion of density of a given subgraph g in a graph G to density in a graphon W . Moreover, convergence of graphons turns to be equivalent to convergence of all subgraph densities.

To present this, we start by recalling from the introduction the definition of subgraph densities in graphs. We recall that, if I is a tuple of vertices of G , then we write $\text{SubGraph}(I, G)$ for the induced subgraph of G on vertex set I .

Definition 8.3.4 (Density of subgraphs). The density of a labeled graph g of size k in a graph G of size n (which may or not be labeled) is defined as follows: let \vec{V}^k be a k -tuple of i.i.d. uniform random vertices in G , then

$$\text{Dens}(g, G) = \mathbb{P}(\text{SubGraph}(\vec{V}^k, G) = g).$$

We remark that this definition does not depend on the labeling chosen for g . As a result, this definition immediately extends to the case where g is an unlabeled graph.

We now extend this to graphons. Consider a graphon W and one of its representatives w . We denote by $\text{Sample}_k(W)$ the labeled random graph built as follows: $\text{Sample}_k(W)$ has vertex set $\{1, 2, \dots, k\}$ and, letting $\vec{X}^k = (X_1, \dots, X_k)$ be i.i.d. uniform random variables in $[0, 1]$, we connect vertices i and j with probability $w(X_i, X_j)$ (these events being independent, conditionally on (X_1, \dots, X_k)). Since the X_i 's are independent and uniform in $[0, 1]$, the distribution of this random graph is the same if we replace w by a function $w' \sim w$ in the sense of Definition 8.3.1. It turns out that this distribution also stays the same if we replace w by a function w' such that $\|w - w'\|_{\square} = 0$ (it can be seen as a consequence of Theorem 8.3.6 below), so that the construction is well-defined on graphons.

Definition 8.3.5. The density of a labeled graph $g = ([k], E)$ of size k in a graphon W is

$$\begin{aligned} \text{Dens}(g, W) &= \mathbb{P}(\text{Sample}_k(W) = g) \\ &= \int_{[0, 1]^k} \prod_{i, j \in [k]} w(x_v, x_{v'}) \prod_{\{v, v'\} \notin E} (1 - w(x_v, x_{v'})) \prod_{v \in V} dx_v, \end{aligned}$$

where, in the second expression, we choose an arbitrary representative w in W .

As in the discrete case above, $\text{Dens}(\cdot, W)$ is constant across all possible labelings of a given unlabeled graph g , which allows us to define $\text{Dens}(g, W)$ for an unlabeled graph g . This definition extends that of the density of subgraphs in (finite) graphs in the following sense. For every finite graphs g and G , denoting by \vec{V}^k a k -tuple of i.i.d. uniform random vertices in G ,

$$\text{Dens}(g, W_G) = \mathbb{P}(\text{Sample}_k(W_G) = g) = \mathbb{P}(\text{SubGraph}(\vec{V}^k, G) = g) = \text{Dens}(g, G).$$

The following theorem is a prominent result in the theory of graphons, see *e.g.* [Lov12, Theorem 11.5].

Theorem 8.3.6. *Let W_n (for all $n \geq 0$) and W be graphons. Then the following are equivalent:*

- (a) (W_n) converges to W (for the distance δ_{\square});
- (b) for any fixed finite graph g , we have $\text{Dens}(g, W_n) \rightarrow \text{Dens}(g, W)$.

Classically, when (H_n) is a sequence of graphs, we say that (H_n) converges to a graphon W when (W_{H_n}) converges to W .

8.3.3. Random graphons.

We now discuss convergence of a sequence of random graphs \mathbf{H}_n (equivalently, of the associated random graphons $W_{\mathbf{H}_n}$) towards a possibly random limiting graphon \mathbf{W} . In this context, the densities $\text{Dens}(g, \mathbf{H}_n)$ are random variables. This was studied in [DJ08] and it turns out that it is enough to consider the expectations $\mathbb{E}[\text{Dens}(g, \mathbf{H}_n)]$ and $\mathbb{E}[\text{Dens}(g, \mathbf{W})]$ to extend Theorem 8.3.6 to this random setting. Note first that $\mathbb{E}[\text{Dens}(g, \mathbf{H}_n)] = \mathbb{P}(\text{SubGraph}(\vec{V}^k, \mathbf{H}_n) = g)$, where both \mathbf{H}_n and \vec{V}^k are random, and that similarly $\mathbb{E}[\text{Dens}(g, \mathbf{W})] = \mathbb{P}(\text{Sample}_k(\mathbf{W}) = g)$, where the randomness comes both from \mathbf{W} and the operation Sample_k .

A first result states that the distributions of random graphons are characterized by expected subgraph densities.

Proposition 8.3.7 (Corollary 3.3 of [DJ08]). *Let \mathbf{W}, \mathbf{W}' be two random graphons, seen as random variables in $\widetilde{\mathcal{W}}_0$. The following are equivalent:*

- $\mathbf{W} \stackrel{d}{=} \mathbf{W}'$;
- for every finite graph g , $\mathbb{E}[\text{Dens}(g, \mathbf{W})] = \mathbb{E}[\text{Dens}(g, \mathbf{W}')]$;
- for every $k \geq 1$, $\text{Sample}_k(\mathbf{W}) \stackrel{d}{=} \text{Sample}_k(\mathbf{W}')$.

The next result, which is essentially [DJ08, Theorem 3.1], characterizes the convergence in distribution of random graphs to random graphons.

Theorem 8.3.8. *For any n , let \mathbf{H}_n be a random graph of size n . Denote by $W_{\mathbf{H}_n}$ the graphon associated to \mathbf{H}_n by Definition 8.3.2. The following assertions are equivalent.*

- (a) *The sequence of random graphons $(W_{\mathbf{H}_n})_n$ converges in distribution to some random graphon \mathbf{W} .*
- (b) *The random infinite vector $(\text{Dens}(g, \mathbf{H}_n))_{g \text{ finite graph}}$ converges in distribution in the product topology to some random infinite vector $(\Delta_g)_{g \text{ finite graph}}$.*
- (c) *For every finite graph g , there is a constant $\Delta_g \in [0, 1]$ such that*

$$\mathbb{E}[\text{Dens}(g, \mathbf{H}_n)] \xrightarrow{n \rightarrow \infty} \Delta_g.$$

- (d) *For every $k \geq 1$, denote by $\vec{V}'^k = (V'_1, \dots, V'_k)$ a uniform k -tuple of distinct vertices of \mathbf{H}_n . Then the induced graph $\text{SubGraph}(\vec{V}'^k, \mathbf{H}_n)$ converges in distribution to some random graph \mathbf{g}_k .*

Whenever these assertions are verified, we have

$$(8.2) \quad (\mathbf{\Lambda}_g)_g \text{ finite graphs} \stackrel{d}{=} (\text{Dens}(g, \mathbf{W}))_g \text{ finite graphs.}$$

and, for every labeled graph g of size k ,

$$(8.3) \quad \Delta_g = \mathbb{E}[\mathbf{\Lambda}_g] = \mathbb{E}[\text{Dens}(g, \mathbf{W})] = \mathbb{P}(\mathbf{g}_k = g).$$

Using the identity $\mathbb{E}[\text{Dens}(g, \mathbf{W})] = \mathbb{P}(\text{Sample}_k(\mathbf{W}) = g)$, we note that Equation (8.3) implies that, for all $k \geq 1$, we have

$$(8.4) \quad \text{Sample}_k(\mathbf{W}) \stackrel{d}{=} \mathbf{g}_k$$

PROOF. The equivalence of the first three items, Equation (8.2) and the first two equalities in Equation (8.3) are all proved in [DJ08]; see Theorem 3.1 there. Thus, we only prove (c) \Leftrightarrow (d) and the related equality $\mathbb{P}(\mathbf{g}_k = g) = \Delta_g$.

For any graphs g, G of respective sizes $k \leq n$, we define their *injective density* $\text{Dens}^{\text{inj}}(g, G) = \mathbb{P}(\text{SubGraph}(\vec{V}^k, G) = g)$ where \vec{V}^k is a uniform k -tuple of *distinct* vertices of G . As explained in [DJ08] (and standard in the graphon literature), Assertion (c) is equivalent, for the same limits (Δ_g) , to its analogue with injective densities, which is: for every graph g ,

$$(8.5) \quad \mathbb{E}[\text{Dens}^{\text{inj}}(g, \mathbf{H}_n)] \xrightarrow{n \rightarrow \infty} \Delta_g.$$

Moreover, we note that, if (\mathbf{H}_n) is a sequence of random graphs, then, for any graph g of size k ,

$$(8.6) \quad \mathbb{E}[\text{Dens}^{\text{inj}}(g, \mathbf{H}_n)] = \mathbb{P}(\text{SubGraph}(\vec{V}^k, \mathbf{H}_n) = g),$$

where both \vec{V}^k and \mathbf{H}_n are random. Since $\text{SubGraph}(\vec{V}^k, \mathbf{H}_n)$ takes value in a finite set, its convergence in distribution (Assertion (d)) is equivalent to the convergence of its point probabilities, *i.e.* of the right-hand side of Equation (8.6). Recalling Equation (8.5), this proves the equivalence of Assertions (c) and (d). Furthermore, when these assertions hold, we have

$$\mathbb{P}(\mathbf{g}_k = g) = \lim_{n \rightarrow \infty} \mathbb{P}[\text{SubGraph}(\vec{V}^k, \mathbf{H}_n) = g] = \lim_{n \rightarrow \infty} \mathbb{E}[\text{Dens}^{\text{inj}}(g, \mathbf{H}_n)] = \Delta_g,$$

as wanted. \square

We finally collect an immediate corollary.

Lemma 8.3.9. *If \mathbf{W} is a random graphon, then $W_{\text{Sample}_n(\mathbf{W})}$ converges in distribution to \mathbf{W} as $n \rightarrow \infty$.*

PROOF. Recall that $\text{Sample}_n(\mathbf{W})$ is the random graph on vertex set $\{1, \dots, n\}$ obtained by taking X_1, \dots, X_n i.i.d. uniform in $[0, 1]$ and joining i and j with probability $w(X_i, X_j)$ where w is a representative of \mathbf{W} . Fix k in $\{1, \dots, n\}$. As in the previous theorem, let $\vec{V}^k = (h_1, \dots, h_k)$ be a uniform random k -tuple of distinct vertices of $\text{Sample}_n(\mathbf{W})$. Then $\text{SubGraph}(\vec{V}^k, \text{Sample}_n(\mathbf{W}))$ is the random graph on vertex set $\{1, \dots, k\}$ obtained by, conditionally on $(X_{(h_1)}, \dots, X_{(h_k)})$, joining 1 and k with probability $w(X_{h_i}, X_{h_j})$. Clearly, $(X_{(h_1)}, \dots, X_{(h_k)})$ is an i.i.d. sequence of uniform random variables in $[0, 1]$. Up to renaming X_{h_i} as X_i , this matches the construction of $\text{Sample}_k(\mathbf{W})$. Therefore we have the following equality in distribution of random labeled graphs:

$$\text{SubGraph}(\vec{V}^k, \text{Sample}_n(\mathbf{W})) \stackrel{d}{=} \text{Sample}_k(\mathbf{W}).$$

Thus, Assertion (d) of Theorem 8.3.8 is fulfilled for the graph sequence $(\text{Sample}_n(\mathbf{W}))_n$ and for $\mathbf{g}_k \stackrel{d}{=} \text{Sample}_k(\mathbf{W})$. Therefore Assertion (a) holds and the graphon sequence $(W_{\text{Sample}_n(\mathbf{W})})_n$ has a limit in distribution \mathbf{W}' , which satisfies, for all k (see Equation (8.4)):

$$\text{Sample}_k(\mathbf{W}') \stackrel{d}{=} \mathbf{g}_k \stackrel{d}{=} \text{Sample}_k(\mathbf{W}).$$

From Proposition 8.3.7, we have $\mathbf{W} \stackrel{d}{=} \mathbf{W}'$, concluding the proof of the lemma. \square

8.3.4. Graphons and degree distribution. In this section, we define the degree distribution of a graphon, and recall from [DHJ08, Theorem 4.2] that it defines a continuous functional from the space of graphons to that of probability measures on $[0, 1]$ (equipped with the weak topology). We include our own proof of this fact.

We then discuss an immediate consequence, which is the convergence of the degree distribution of *random* graph/graphon sequences. The convergence of the degree distribution of some random graph models to that of their graphon limit has been previously studied in [BM17] for permutation graphs, and in [BCL11; DDS18] (where a central limit theorem is also shown).

The *degree distribution* of a graphon W is the measure D_W on $[0, 1]$ defined as follows: for every continuous bounded function $f : [0, 1] \rightarrow \mathbb{R}$, we have

$$\int_{[0,1]} f(x) D_W(dx) = \int_{[0,1]} f \left(\int_{[0,1]} w(u, v) dv \right) du,$$

where w is, as usual, an arbitrary representative of W (the resulting measure does not depend on the chosen representative).

For the graphon W_G associated to a graph G of size n , the measure D_{W_G} is simply the empirical distribution of the rescaled degrees:

$$D_{W_G} = \frac{1}{n} \sum_{v \in G} \delta_{\deg_G(v)/n}$$

where δ_u is the Dirac measure concentrated at u . It is known that the map $W \mapsto D_W$ from $\widetilde{\mathcal{W}}_0$ equipped with graphon convergence, to $\mathcal{M}_1([0, 1])$ equipped with weak convergence, is continuous [DHJ08]. This reference was not known to the authors at the time of writing the article version [Bas+19a] of this paper, so we include our proof below, which additionally proves this map is Lipschitz for a suitable metric.

To that end, we endow the space $\mathcal{M}_1([0, 1])$ of Borel probability measures on $[0, 1]$ with the so-called Wasserstein metric (see *e.g.* [Ros11, Section 1.2]), defined as

$$d_{\text{Wass}}(\mu, \nu) = \sup_f \left| \int_{[0,1]} f(x) \mu(dx) - \int_{[0,1]} f(x) \nu(dx) \right|,$$

where the infimum runs over all 1-Lipschitz functions f from $[0, 1]$ to \mathbb{R} . We recall that this distance metrizes weak convergence (see *e.g.* [Bog07, Sec. 8.3]).

Lemma 8.3.10. *The map $W \mapsto D_W$ from $(\widetilde{\mathcal{W}}_0, \delta_\square)$ to $(\mathcal{M}_1([0, 1]), d_{\text{Wass}})$ is 2-Lipschitz. Consequently, if (W_n) converges to W in $\widetilde{\mathcal{W}}_0$, then the sequence of associated measures (D_{W_n}) converges weakly to D_W .*

PROOF. Let W and W' be graphons with representatives w and w' . Let $f : [0, 1] \rightarrow \mathbb{R}$ be 1-Lipschitz. We have

$$\begin{aligned} d_{\text{Wass}}(D_W, D_{W'}) &\leq \left| \int_{[0,1]} f(x) D_W(dx) - \int_{[0,1]} f(x) D_{W'}(dx) \right| \\ &= \left| \int_{[0,1]} f \left(\int_{[0,1]} w(u, v) dv \right) - f \left(\int_{[0,1]} w'(u, v) dv \right) du \right| \\ &\leq \int_{[0,1]} \left| \int_{[0,1]} (w(u, v) - w'(u, v)) dv \right| du \\ &= \int_S \int_{[0,1]} (w(u, v) - w'(u, v)) dv du - \int_{[0,1] \setminus S} \int_{[0,1]} (w(u, v) - w'(u, v)) dv du \end{aligned}$$

where $S = \left\{ u \in [0, 1] : \int_{[0,1]} (w(u, v) - w'(u, v)) dv \geq 0 \right\}$. But, from the definition of $\|\cdot\|_{\square}$, each of the two summands has modulus bounded by $\|w - w'\|_{\square}$. We finally get

$$d_{\text{Wass}}(D_{\mathbf{W}}, D_{\mathbf{W}'}) \leq 2\|w - w'\|_{\square}.$$

which ends the proof by definition of δ_{\square} since the choice of representatives w, w' was arbitrary. \square

Remark that when \mathbf{W} is a random graphon, $D_{\mathbf{W}}$ is a random measure. We recall, see e.g. [Kal17a, Lemma 2.4], that given a random measure μ on some space B , its *intensity measure* $I[\mu]$ is the deterministic measure on B defined by: $I[\mu](A) = \mathbb{E}[\mu(A)]$ for any measurable subset A of B .

To get an intuition of what $I[D_{\mathbf{W}}]$ is for a random graphon \mathbf{W} , it is useful to consider the case where $\mathbf{W} = W_{\mathbf{G}}$ is the graphon associated with a random graph \mathbf{G} of size n . In this case, for any measurable subset A of $[0, 1]$,

$$D_{W_{\mathbf{G}}}(A) = \mathbb{P}\left(\frac{1}{n} \deg_{\mathbf{G}}(\mathbf{v}) \in A \mid \mathbf{G}\right),$$

where \mathbf{v} is a uniform random vertex in \mathbf{G} . Therefore

$$I[D_{W_{\mathbf{G}}}] (A) = \mathbb{E}[D_{W_{\mathbf{G}}}(A)] = \mathbb{P}\left(\frac{1}{n} \deg_{\mathbf{G}}(\mathbf{v}) \in A\right),$$

so that $I[D_{W_{\mathbf{G}}}]$ is the law of the normalized degree of a uniform random vertex \mathbf{v} in the random graph \mathbf{G} .

We sum up the results of this section into the following proposition.

Proposition 8.3.11. *Let \mathbf{H}_n be a random graph of size n for every n , and \mathbf{W} be a random graphon, such that $W_{\mathbf{H}_n} \xrightarrow[n \rightarrow \infty]{d} \mathbf{W}$. Then we have the following convergence in distribution of random measures:*

$$\frac{1}{n} \sum_{v \in \mathbf{H}_n} \delta_{\deg_{\mathbf{H}_n}(v)/n} \xrightarrow[n \rightarrow \infty]{d} D_{\mathbf{W}}.$$

Furthermore, denoting \mathbf{v}_n a uniform vertex in \mathbf{H}_n and \mathbf{Z} a random variable with law $I[D_{\mathbf{W}}]$,

$$\frac{1}{n} \deg_{\mathbf{H}_n}(\mathbf{v}_n) \xrightarrow[n \rightarrow \infty]{d} \mathbf{Z}.$$

PROOF. From Lemma 8.3.10, we immediately obtain $D_{W_{\mathbf{H}_n}} \xrightarrow{d} D_{\mathbf{W}}$, which is by definition of $D_{W_{\mathbf{G}}}$ exactly the first of the stated convergences. The second one follows from the first, combining Lemma 4.8 and Theorem 4.11 of [Kal17a]⁴. \square

8.4. The Brownian cogrAPHON

8.4.1. Construction. Let e denote a Brownian excursion of length one. We start by recalling a technical result on the local minima of e : the first two assertions below are well-known, we refer to [Maa20, Lemma 2.3] for the last one.

Lemma 8.4.1. *With probability one, the following assertions hold. First, all local minima of e are strict, and hence form a countable set. Moreover, the values of e at two distinct local minima are different. Finally, there exists an enumeration $(b_i)_i$ of the local minima of e , such that for every $i \in \mathbb{N}, x, y \in [0, 1]$, the event $\{b_i \in (x, y), e(b_i) = \min_{[x,y]} e\}$ is measurable.*

4. Theorem 4.11 tells us that if random measures (ξ_n) converge in distribution to ξ then, for any compactly supported continuous function f , we have $\xi_n f \xrightarrow[n \rightarrow \infty]{d} \xi f$. But since those variables are bounded (by $\|f\|_{\infty}$), this convergence also holds in L^1 , i.e. $\xi_n \xrightarrow{L^1} \xi$ in the notation of [Kal17a]. By Lemma 4.8, this implies the convergence of the corresponding intensity measures.

Let $\mathbf{S}^p = (s_1, \dots)$ be a sequence of i.i.d. random variables in $\{0, 1\}$, independent of e , with $\mathbb{P}(s_1 = 0) = p$ (in the sequel, we simply speak of i.i.d. decorations of bias p). We call (e, \mathbf{S}^p) a *decorated Brownian excursion*, thinking of the decoration s_i as attached to the local minimum b_i . For $x, y \in [0, 1]$, we define $\text{Dec}(x, y; e, \mathbf{S}^p)$ to be the decoration of the minimum of e on the interval $[x, y]$ (or $[y, x]$ if $y \leq x$; we shall not repeat this precision below). If this minimum is not unique or attained in x or y and therefore not a local minimum, $\text{Dec}(x, y; e, \mathbf{S}^p)$ is ill-defined and we take the convention $\text{Dec}(x, y; e, \mathbf{S}^p) = 0$. Note however that, for uniform random x and y , this happens with probability 0, so that the object constructed in Definition 8.4.2 below is independent from this convention.

Definition 8.4.2. The Brownian cographon \mathbf{W}^p of parameter p is the equivalence class of the random function⁵

$$\begin{aligned} \mathbf{w}^p : [0, 1]^2 &\rightarrow \{0, 1\}; \\ (x, y) &\mapsto \text{Dec}(x, y; e, \mathbf{S}^p). \end{aligned}$$

In most of this article, we are interested in the case $p = 1/2$; in particular, as claimed in Theorem 8.1.1, $\mathbf{W}^{1/2}$ is the limit of uniform random (labeled or unlabeled) cographs, justifying its name.

8.4.2. Sampling from the Brownian cographon. We now compute the distribution of the random graph $\text{Sample}_k(\mathbf{W}^p)$.

Proposition 8.4.3. *If \mathbf{W}^p is the Brownian cographon of parameter p , then for every $k \geq 2$, $\text{Sample}_k(\mathbf{W}^p)$ is distributed like $\text{Cograph}(\mathbf{b}_k^p)$, where the cotree \mathbf{b}_k^p is a uniform labeled binary tree with k leaves equipped with i.i.d. decorations of bias p .*

Let us note that \mathbf{b}_k^p is not necessarily a canonical cotree.

PROOF. We use a classical construction (see [Le 05, Section 2.5]) which associates to an excursion e and real numbers x_1, \dots, x_k a plane tree, denoted $\text{Tree}(e; x_1, \dots, x_k)$, which has the following properties:

- its leaves are labeled with $1, \dots, k$ and correspond to x_1, \dots, x_k respectively;
- its internal nodes correspond to the local minima of e on intervals $[x_i, x_j]$;
- the first common ancestor of the leaves i and j corresponds to the local minimum of e on $[x_i, x_j]$.

The tree $\text{Tree}(e; x_1, \dots, x_k)$ is well-defined with probability 1 when e is a Brownian excursion and x_1, \dots, x_k i.i.d. uniform random variables in $[0, 1]$. Moreover, in this setting, it has the distribution of a uniform random plane and labeled binary tree with k leaves [Le 05, Theorem 2.11]. Forgetting the plane structure, it is still uniform among binary trees with k labeled leaves, because the number of plane embeddings of a *labeled binary tree* depends only on its size.

We now let (e, \mathbf{S}) be a decorated Brownian excursion, and X_1, \dots, X_k denote a sequence of i.i.d. uniform random variables in $[0, 1]$, independent from (e, \mathbf{S}) . We make use of the decorations \mathbf{S} of the local minima of e to turn $\text{Tree}(e; X_1, \dots, X_k)$ into a cotree. Namely, since its internal nodes correspond to local minima of e , we can simply report these decorations on the tree, and we get a decorated tree $\text{Tree}_{0/1}(e, \mathbf{S}; X_1, \dots, X_k)$. When the decorations in \mathbf{S} are i.i.d. of bias p , then $\text{Tree}_{0/1}(e, \mathbf{S}; X_1, \dots, X_k)$ is a uniform labeled binary tree with k leaves, equipped with i.i.d. decorations of bias p .

Finally, recall that $\text{Sample}_k(\mathbf{W}^p)$ is built by considering X_1, \dots, X_k i.i.d. uniform in $[0, 1]$ and connecting vertices v_i and v_j if and only if $\mathbf{w}^p(X_i, X_j) = 1$ (since a representative \mathbf{w}^p of \mathbf{W}^p takes value in $\{0, 1\}$, there is no extra randomness here). By definition of \mathbf{w}^p , $\mathbf{w}^p(X_i, X_j) = 1$ means that the decoration of the minimum of e on $[X_i, X_j]$ is 1. But, by construction of $\text{Tree}_{0/1}(e, \mathbf{S}; X_1, \dots, X_k)$, this decoration is that of the first common ancestor of the leaves i and j in $\text{Tree}_{0/1}(e, \mathbf{S}; X_1, \dots, X_k)$. So it is equal to 1 if and only if

⁵. Of course, in the image set of \mathbf{w}^p , the *real values* 0 and 1 correspond to the *decorations* 0 and 1 respectively.

i and j are connected in the associated cograph (see Observation 8.2.7). Summing up, we get the equality of labeled random graphs

$$\text{Sample}_k(\mathbf{W}^p) = \text{Cograph}(\text{Tree}_{0/1}(e, \mathbf{S}, X_1, \dots, X_k)),$$

ending the proof of the proposition. \square

8.4.3. Criterion of convergence to the Brownian cographon. The results obtained so far yield a very simple criterion for convergence to the Brownian cographon. For simplicity and since this is the only case we need in the present paper, we state it only in the case $p = 1/2$.

Lemma 8.4.4. *Let $\mathbf{t}^{(n)}$ be a random cotree of size n for every n (which may be labeled or not). For $n \geq k \geq 1$, denote by $\mathbf{t}_k^{(n)}$ the subtree of $\mathbf{t}^{(n)}$ induced by a uniform k -tuple of distinct leaves. Suppose that for every k and for every labeled binary cotree t_0 with k leaves,*

$$(8.7) \quad \mathbb{P}(\mathbf{t}_k^{(n)} = t_0) \xrightarrow{n \rightarrow \infty} \frac{(k-1)!}{(2k-2)!}.$$

Then $W_{\text{Cograph}(\mathbf{t}^{(n)})}$ converges as a graphon to $\mathbf{W}^{1/2}$.

PROOF. We first remark that $\frac{(k-1)!}{(2k-2)!} = \frac{1}{\text{card}(\mathcal{C}_k)}$, where \mathcal{C}_k is the set of labeled binary cotrees with k leaves. Indeed the number of plane labeled binary trees with k leaves is given by $k! \text{Cat}_{k-1}$ where $\text{Cat}_{k-1} = \frac{1}{k} \binom{2k-2}{k-1}$ is the $(k-1)$ -th Catalan number. Decorations on internal nodes induce the multiplication by a factor 2^{k-1} while considering non-plane trees yields a division by the same factor in order to avoid symmetries. Therefore $\text{card}(\mathcal{C}_k) = k! \text{Cat}_{k-1} = \frac{(2k-2)!}{(k-1)!}$.

Consequently, Equation (8.7) states that $\mathbf{t}_k^{(n)}$ converges in distribution to a uniform element of \mathcal{C}_k . Moreover, a uniform element of \mathcal{C}_k is distributed as $\mathbf{b}_k^{1/2}$ where $\mathbf{b}_k^{1/2}$ is a uniform labeled binary tree with k leaves equipped with i.i.d. decorations of bias $1/2$. Hence, as n tends to $+\infty$, we have the following convergence of random labeled graphs of size k ,

$$\text{Cograph}(\mathbf{t}_k^{(n)}) \xrightarrow{d} \text{Cograph}(\mathbf{b}_k^{1/2}).$$

The left-hand side is $\text{SubGraph}(\vec{V}^k, \text{Cograph}(\mathbf{t}^{(n)}))$, where \vec{V}^k is a uniform tuple of k distinct vertices of $\text{Cograph}(\mathbf{t}^{(n)})$; see the definition of $\mathbf{t}_k^{(n)}$ in the statement of the lemma and Proposition 8.2.9. Moreover, thanks to Proposition 8.4.3, the right-hand side has the same distribution as $\text{Sample}_k(\mathbf{W}^{1/2})$. This proves the lemma, using Theorem 8.3.8 (namely, the implication $(d) \Rightarrow (a)$, and Equation (8.4) together with Proposition 8.3.7 to identify the limit in item (a) with $\mathbf{W}^{1/2}$). \square

8.4.4. The degree distribution of the Brownian cographon. In this section we are interested in the degree distribution $D_{\mathbf{W}^p}$ of the Brownian cographon. It turns out that, in the special case $p = 1/2$, the intensity $I[D_{\mathbf{W}^{1/2}}]$ is particularly simple.

Proposition 8.4.5. $I[D_{\mathbf{W}^{1/2}}] \stackrel{d}{=} U$, where U is the Lebesgue measure on $[0, 1]$.

PROOF. Rather than working in the continuous, we exhibit a discrete approximation \mathbf{G}_n^b of the Brownian cographon, which has the remarkable property that the degree of a uniform random vertex v_n in \mathbf{G}_n^b is *exactly* distributed as a uniform random variable in $\{0, 1, \dots, n-1\}$.

To construct \mathbf{G}_n^b , we let \mathbf{b}_n be a uniform 0/1-decorated plane labeled binary tree with n leaves. Forgetting the plane structure, it is still uniform among labeled binary cotrees with n leaves. Set $\mathbf{G}_n^b = \text{Cograph}(\mathbf{b}_n)$. From Proposition 8.4.3, \mathbf{G}_n^b has the same distribution as $\text{Sample}_n(\mathbf{W}^{1/2})$, so that $W_{\mathbf{G}_n^b}$ converges in distribution to $\mathbf{W}^{1/2}$ (Lemma 8.3.9).

Consider a uniform random vertex \mathbf{v}_n in \mathbf{G}_n^b . Thanks to Proposition 8.3.11, Law($\frac{1}{n} \deg_{\mathbf{G}_n^b}(\mathbf{v}_n)$) converges to $I[D_{\mathbf{W}^{1/2}}]$. Proving the following claim will therefore conclude the proof of the proposition.

Claim. The law of $\deg(\mathbf{v}_n)$ in \mathbf{G}_n^b is the uniform law in $\{0, 1, \dots, n-1\}$.

Proof of the claim. We start by defining two operations for deterministic 0/1-decorated plane labeled binary trees b .

- First, we consider a (seemingly unnatural⁶) order on the leaves of b . To compare two leaves ℓ and r , we look at their first common ancestor u and assume w.l.o.g. that ℓ and r are descendants of its left and right children, respectively. If u has decoration 0, we declare ℓ to be smaller than r ; if it has decoration 1, then r is smaller than ℓ . It is easy to check that this defines a total order on the leaves of b (if we flip the left and right subtrees of internal nodes with decoration 1, this is simply the left-to-right depth-first order of the leaves). We write $\text{rank}_b(\ell)$ for the rank of a leaf ℓ in this order.
- Second, we define an involution Φ on the set of 0/1-decorated plane labeled binary trees b with a distinguished leaf ℓ . We keep the undecorated structure of the tree, and simply flip the decorations of all the ancestors of ℓ which have ℓ as a descendant of *their right child*. This gives a new decorated plane labeled binary tree b' and we set $\Phi(b, \ell) = (b', \ell)$.

Consider b as above, with two distinguished leaves ℓ and $\tilde{\ell}$. The corresponding vertices v and \tilde{v} in $G = \text{Cograph}(b)$ are connected if and only if the first common ancestor u of ℓ and $\tilde{\ell}$ in b has decoration 1. Setting $\Phi(b, \ell) = (b', \ell)$, this happens in two cases:

- either ℓ is a descendant of the left child of u , and u has decoration 1 in b' ;
- or ℓ is a descendant of the right child of u , and u has decoration 0 in b' ;

This corresponds exactly to ℓ being bigger than $\tilde{\ell}$ in the order associated to b' . Consequently, $\deg_G(v)$ is the number of leaves smaller than ℓ in that order, *i.e.*

$$(8.8) \quad \deg_G(v) = \text{rank}_{b'}(\ell) - 1.$$

Recall now that $\mathbf{G}_n^b = \text{Cograph}(\mathbf{b}_n)$, where \mathbf{b}_n is a uniform 0/1-decorated plane labeled binary tree with n leaves. The uniform random vertex \mathbf{v}_n in \mathbf{G}_n^b corresponds to a uniform random leaf ℓ_n in \mathbf{b}_n . Set $(\mathbf{b}'_n, \ell_n) = \Phi(\mathbf{b}_n, \ell_n)$. Since Φ is an involution, (\mathbf{b}'_n, ℓ_n) is a uniform 0/1-decorated plane labeled binary tree of size n with a uniform random leaf ℓ_n . Conditioning on \mathbf{b}'_n , the rank $\text{rank}_{\mathbf{b}'_n}(\ell_n)$ is a uniform random variable in $\{1, \dots, n\}$. The same holds taking \mathbf{b}'_n at random, and, using Equation (8.8), we conclude that $\deg_{\mathbf{G}_n^b}(\mathbf{v}_n)$ is a uniform random variable in $\{0, \dots, n-1\}$.

This proves the claim, and hence the proposition. \square

Remark 8.4.6. It seems likely that this result can also be proved by working uniquely in the continuous. In particular, using a result of Bertoin and Pitman [BP94, Theorem 3.2], the degree $D(x) = \int_y \mathbf{W}^{1/2}(x, y) dy$ of a uniform random x in $[0, 1]$ in the Brownian cographon corresponds to the cumulated length of a half of the excursions in a Brownian bridge.

8.5. Convergence of labeled cographs to the Brownian cographon

In this section, we are interested in labeled cographs with n vertices, which are in one-to-one correspondence with labeled canonical cotrees with n leaves (Proposition 8.2.5).

To study these objects, we use the framework of labeled combinatorial classes, as presented in the seminal book of Flajolet and Sedgewick [FS09, Chapter II]. In this framework, an object of size n has n atoms, which are labeled bijectively with integers

⁶ This order is actually very natural if we interpret b as the separation tree of a separable permutation (see [Bas+18] for the definition). It is simply the value order on the elements of the permutation.

from 1 to n . For us, the atoms are simply the leaves of the trees, which is consistent with Definition 8.2.2.

We will also consider (co)trees with marked leaves and, here, more care is needed. Indeed, in some instances, those marked leaves have a label (and thus should be seen as atoms and counted in the size of the objects), while, in other instances, they do not have a label (and are therefore not counted in the size of the object). To make the distinction, we will refer to marked leaves of the latter type (*i.e.* without labels) as *blossoms* and reserve *marked leaves* for those carrying labels.

8.5.1. Enumeration of labeled canonical cotrees. Let \mathcal{L} be the family of non-plane labeled rooted trees in which internal nodes have at least two children. For $n \geq 1$, let ℓ_n be the number of trees with n leaves in \mathcal{L} . Let $L(z)$ denote the corresponding exponential generating function:

$$L(z) = \sum_{n \geq 1} \frac{\ell_n}{n!} z^n.$$

Proposition 8.5.1. *The series $L(z)$ is the unique formal power series without constant term solution of*

$$(8.9) \quad L(z) = z + \exp(L(z)) - 1 - L(z).$$

PROOF. (This series is treated in [FS09, Example VII.12 p.472].) A tree in \mathcal{L} consists of:

- either a single leaf (counted by z) ;
- or a root to which is attached an unordered sequence of at least two trees of \mathcal{L} (counted by $\sum_{k \geq 2} L^k/k! = e^L - 1 - L$).

This justifies that $L(z)$ satisfies Equation (8.9). The uniqueness is straightforward, since Equation (8.9) determines for every n the coefficient of z^n in $L(z)$ from those of z^k for $k < n$. □

Computing the first coefficients, we find

$$L(z) = z + \frac{z^2}{2!} + 4\frac{z^3}{3!} + 26\frac{z^4}{4!} + 236\frac{z^5}{5!} + 2752\frac{z^6}{6!} + \mathcal{O}(z^7).$$

These numbers correspond to the fourth Schröder’s problem (see Sequence A000311 in [OEIS]).

Let m_n be the number of labeled canonical cotrees with n leaves. We have $m_1 = 1$ and $m_n = 2\ell_n$ for $n \geq 2$. Indeed to each tree of \mathcal{L} containing internal nodes (*i.e.*, with at least two leaves) correspond two canonical cotrees: one with the root decorated by 0 and one with the root decorated by 1 (the other decorations are then determined by the alternation condition). The exponential generating series $M(z) = \sum_{n \geq 1} \frac{m_n}{n!} z^n$ of labeled canonical cotrees (or equivalently of labeled cographs) thus satisfies $M(z) = 2L(z) - z$. Combining this with Proposition 8.5.1, we have that

$$(8.10) \quad M(z) = \exp(L(z)) - 1.$$

It is standard (and easy to see) that the series

$$L'(z) = \sum_{n \geq 1} \frac{\ell_n}{(n-1)!} z^{n-1} \quad \text{and} \quad L^\bullet(z) = zL'(z) = \sum_{n \geq 1} \frac{\ell_n}{(n-1)!} z^n$$

counts trees of \mathcal{L} with a blossom or a marked leaf, respectively. In the subsequent analysis we need to consider the generating function L^{even} (resp. L^{odd}) counting trees of \mathcal{L} having a blossom at even (resp. odd) distance from the root. Obviously, $L^{\text{even}} + L^{\text{odd}} = L'$.

Proposition 8.5.2. *We have the following identities:*

$$(8.11) \quad L^{even} = \frac{1}{e^L(2 - e^L)},$$

$$(8.12) \quad L^{odd} = \frac{e^L - 1}{e^L(2 - e^L)}.$$

PROOF. We first claim that

$$(8.13) \quad \begin{cases} L^{even} &= 1 + (e^L - 1)L^{odd}, \\ L^{odd} &= (e^L - 1)L^{even}. \end{cases}$$

We prove the first identity, the second one is proved similarly. A tree counted by L^{even} is:

- either reduced to a blossom (therefore the tree has size 0, *i.e.* is counted by 1);
- or has a root to which are attached
 - a tree with a blossom at odd height (counted by L^{odd}), and
 - an unordered sequence of at least one unmarked trees (counted by $\sum_{k \geq 1} L^k/k! = e^L - 1$).

We obtain the proposition by solving Equation (8.13). □

8.5.2. Enumeration of canonical cotrees with marked leaves inducing a given cotree. For a labeled (not necessarily canonical) cotree t_0 of size k , we consider the family \mathcal{M}_{t_0} of tuples $(t; \ell_1, \dots, \ell_k)$ where

- t is a labeled canonical cotree;
- (ℓ_1, \dots, ℓ_k) is a k -tuple of distinct leaves of t ;
- the subtree of t induced by (ℓ_1, \dots, ℓ_k) is t_0 .

We denote by M_{t_0} the associated exponential generating function.

Theorem 8.5.3. *Let t_0 be a labeled cotree with k leaves. Denote by n_v its number of internal nodes, by $n_ =$ its number of edges of the form $0 - 0$ or $1 - 1$, and by n_{\neq} its number of edges of the form $0 - 1$ or $1 - 0$. We have the identity*

$$(8.14) \quad M_{t_0} = (L')(\exp(L))^{n_v} (L^\bullet)^k (L^{odd})^{n_ =} (L^{even})^{n_{\neq}}.$$

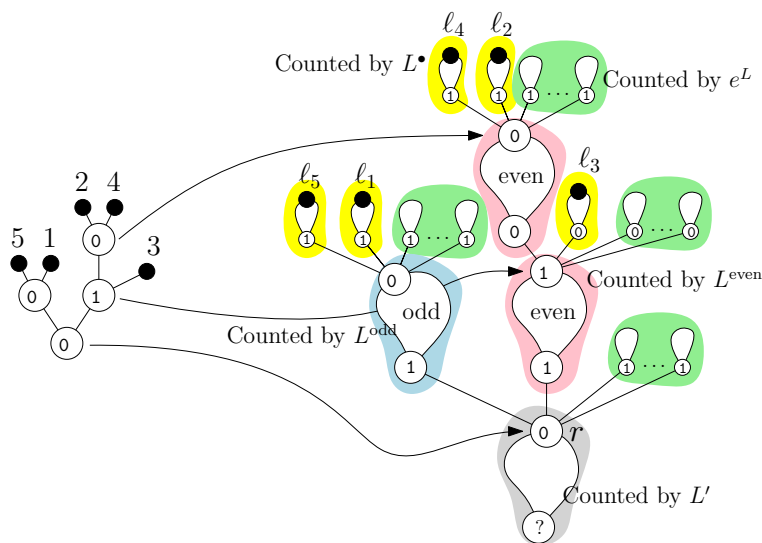

FIGURE 8.5. On the left: a (non-canonical) labeled cotree t_0 of size 5. On the right: a schematic view of a canonical cotree in \mathcal{M}_{t_0} .

PROOF. (Main notations of the proof are summarized in Figure 8.5.)

Let $(t; \ell_1, \dots, \ell_k) \in \mathcal{M}_{t_0}$. There is a correspondence between the nodes of t_0 and some nodes of t , mapping leaves to marked leaves and internal nodes to first common ancestors of marked leaves. These first common ancestors of marked leaves in t will be referred to as *branching nodes* below. In order to prove Equation (8.14) we will decompose each such t into subtrees, called *pieces*, of five different types: *pink*, *blue*, *yellow*, *green* and *gray* (see the color coding in Figure 8.5). Our decomposition has the following property: to reconstruct an element of \mathcal{M}_{t_0} , we can choose each piece independently in a set depending on its color only, so that the generating series of \mathcal{M}_{t_0} writes as a product of the generating series of the pieces.

In this decomposition, there is exactly one gray piece obtained by pruning t at the node r of t corresponding to the root of t_0 . In this piece, r is replaced by a blossom. We note that, by definition of induced cotree, the decoration of r has to match that of the root of t_0 . Since decorations in canonical cotrees must alternate, this determines all decorations in the gray piece. Possible choices for the gray piece are therefore counted by the same series as undecorated trees with a blossom, that is L' .

For the rest of the decomposition, we consider branching nodes v of t (including r), and look at all children w of such nodes v .

- If such a node w has exactly one descendant (possibly, w itself) which is a marked leaf, we build a piece, colored yellow, by taking the fringe subtree rooted at w . Yellow pieces are labeled canonical cotrees with one marked leaf. However, the decoration within the yellow piece is forced by the alternation of decorations in t and by the decoration of the parent v of w , which has to match the decoration of the corresponding node in t_0 (see Figure 8.5). So the generating function for yellow pieces is L^\bullet .

Of course, we have a yellow piece for each marked leaf of t , *i.e.* for each leaf of t_0 .

- If a node w child of a branching node in t has at least two marked leaves among its descendants, it must also have a descendant (possibly equal to w) that is a branching node. We define v' as the branching node descending from w (possibly equal to it) which is the closest to w . This implies that the node of t_0 corresponding to v' (denoted v'_0) is a child of the one corresponding to v (denoted v_0). We build a piece rooted at w , which corresponds to the edge (v_0, v'_0) of t_0 . This piece is the fringe subtree rooted at w pruned at v' , *i.e.* where v' is replaced by a blossom. We color it blue if the blossom is at odd distance from w , pink otherwise. The generating functions for blue and pink pieces are therefore L^{odd} and L^{even} , respectively (since again all decorations in the piece are determined by the one of v_0).

Because of the alternation of decoration, the piece is blue if and only if w and v' have different decorations in t , which happens if and only if v and v' (or equivalently, v_0 and v'_0) have the same decoration. We therefore have a blue piece for each internal edge of t_0 with extremities with the same decoration, and a pink piece for each internal edge of t_0 with extremities with different decorations.

- All other nodes w have no marked leaf among their descendants. We group all such nodes w that are siblings to build a single green piece, attached to their common parent v . Namely, for each branching node v , we consider all its children w having no marked leaf as a descendant (possibly, there are none), and we define the green piece attached to v as the (possibly empty) forest of fringe subtrees of t rooted at these nodes w . Green pieces are forest, *i.e.* unordered set of labeled canonical cotrees. The decoration within the green piece is forced by the alternation of decorations in t and by the decoration of v , which as before has to match the decoration of the corresponding node in t_0 . Therefore, choosing a

green piece amounts to choosing an unordered set of undecorated trees in \mathcal{L} . We conclude that possible choices for each green piece are counted by e^L .

Finally, we recall that there is one (possibly empty) green piece for each branching node of t , *i.e.* for each internal node of t_0 .

Since t_0 is a labeled cotree, leaves / internal nodes / edges of t_0 can be ordered in a canonical way. Since yellow (resp. green, resp. blue and pink) pieces in the above decomposition are indexed by leaves (resp. internal nodes, resp. edges) of t_0 , they can be ordered in a canonical way as well. Moreover, the correspondence between marked trees $(t; \ell_1, \dots, \ell_k)$ in \mathcal{M}_{t_0} and tuples of colored pieces is one-to-one. This completes the proof of Equation (8.14). \square

8.5.3. Asymptotic analysis. Following Flajolet and Sedgewick, see appendix A, we say that a power series is Δ -analytic if it is analytic in some Δ -domain $\Delta(\phi, \rho)$, where ρ is its radius of convergence. This is a technical hypothesis, which enables to apply the transfer theorem; all series in this paper are Δ -analytic.

Proposition 8.5.4. *The series $L(z)$ has radius of convergence $\rho = 2 \log(2) - 1$ and is Δ -analytic. Moreover, the series L is convergent at $z = \rho$ and we have*

$$(8.15) \quad L(z) \underset{z \rightarrow \rho}{=} \log(2) - \sqrt{\rho} \sqrt{1 - \frac{z}{\rho}} + \mathcal{O}(1 - \frac{z}{\rho}).$$

PROOF. Using Proposition 8.5.1, Proposition 8.5.4 is a direct application of [BMN20, Theorem 1]. \square

It follows from Proposition 8.5.4 that L' , $\exp(L)$, L^{even} and L^{odd} also have radius of convergence $\rho = 2 \log(2) - 1$, are all Δ -analytic and that their behaviors near ρ are

$$(8.16) \quad L'(z) \underset{z \rightarrow \rho}{\sim} \frac{1}{2\sqrt{\rho}} \left(1 - \frac{z}{\rho}\right)^{-1/2}; \quad \exp(L(z)) \underset{z \rightarrow \rho}{\sim} 2;$$

$$(8.17) \quad L^{\text{even}}(z) \underset{z \rightarrow \rho}{\sim} \frac{1}{4\sqrt{\rho}} \left(1 - \frac{z}{\rho}\right)^{-1/2}; \quad L^{\text{odd}}(z) \underset{z \rightarrow \rho}{\sim} \frac{1}{4\sqrt{\rho}} \left(1 - \frac{z}{\rho}\right)^{-1/2}.$$

Indeed, the first estimate follows from Equation (8.15) by singular differentiation theorem A.3.1, while the third and fourth ones are simple computations using Equation (8.11) and Equation (8.12).

8.5.4. Distribution of induced subtrees of uniform cotrees. We take a uniform labeled canonical cotree $\mathbf{t}^{(n)}$ with n leaves. We also choose uniformly at random a k -tuple (ℓ_1, \dots, ℓ_k) of distinct leaves of $\mathbf{t}^{(n)}$. Equivalently, $(\mathbf{t}^{(n)}; \ell_1, \dots, \ell_k)$ is chosen uniformly at random among labeled canonical cotrees of size n with k marked leaves. We denote by $\mathbf{t}_k^{(n)}$ the labeled cotree induced by the k marked leaves.

Proposition 8.5.5. *Let $k \geq 2$, and let t_0 be a labeled binary cotree with k leaves. Then*

$$(8.18) \quad \mathbb{P}(\mathbf{t}_k^{(n)} = t_0) \underset{n \rightarrow +\infty}{\rightarrow} \frac{(k-1)!}{(2k-2)!}.$$

PROOF. We fix a labeled binary cotree t_0 with k leaves. From the definitions of $\mathbf{t}_k^{(n)}$, M and M_{t_0} we have for $n \geq k$ (we use the standard notation $[z^n]A(z)$ for the n -th coefficient of a power series A):

$$(8.19) \quad \mathbb{P}(\mathbf{t}_k^{(n)} = t_0) = \frac{n! [z^n] M_{t_0}(z)}{n \cdots (n-k+1) n! [z^n] M(z)}.$$

Indeed, the denominator counts the total number of labeled canonical cotrees $(t; \ell_1, \dots, \ell_k)$ of size n with k marked leaves. The numerator counts those tuples, for which (ℓ_1, \dots, ℓ_k) induce the subtree t_0 . The quotient is therefore the desired probability.

By Theorem 8.5.3, and using the notation introduced therein, we have

$$M_{t_0} = (L')(\exp(L))^{n_v} (L^\bullet)^k (L^{\text{odd}})^{n_e} (L^{\text{even}})^{n_\neq}.$$

Since t_0 is binary, we have $n_v = k-1$ and $n_+ + n_- = k-2$. We now consider the asymptotics around $z = \rho$. Using Equation (8.16) and (8.17) and recalling that $L^\bullet(z) = zL'(z)$, we get

$$\begin{aligned} M_{t_0}(z) &\underset{z \rightarrow \rho}{\sim} \rho^k \left(\frac{1}{2\sqrt{\rho}} \left(1 - \frac{z}{\rho}\right)^{-1/2} \right)^{k+1} 2^{k-1} \left(\frac{1}{4\sqrt{\rho}} \left(1 - \frac{z}{\rho}\right)^{-1/2} \right)^{k-2} \\ &\underset{z \rightarrow \rho}{\sim} \frac{\rho^{1/2}}{2^{2k-2}} \left(1 - \frac{z}{\rho}\right)^{-(k-1/2)}. \end{aligned}$$

By the transfer theorem (theorem A.2.2) we obtain

$$[z^n]M_{t_0}(z) \underset{n \rightarrow +\infty}{\sim} \frac{\rho^{1/2}}{2^{2k-2}\rho^n} \frac{n^{k-3/2}}{\Gamma(k-1/2)} = \frac{(k-1)!}{\sqrt{\pi}(2k-2)!} \frac{n^{k-3/2}}{\rho^{n-1/2}}.$$

Applying again the transfer theorem to $M(z) = 2L(z) - z$ whose asymptotics is given in Equation (8.15), we also have

$$n(n-1)\dots(n-k+1)[z^n]M(z) \underset{n \rightarrow +\infty}{\sim} n^k(-2\sqrt{\rho}) \frac{n^{-3/2}}{\rho^n \Gamma(-1/2)} \sim \frac{n^{k-3/2}}{\rho^{n-1/2}\sqrt{\pi}}.$$

Finally, $\mathbb{P}(\mathbf{t}_k^{(n)} = t_0) \rightarrow \frac{(k-1)!}{(2k-2)!}$. □

8.5.5. Proof of Theorems 8.1.1 and 8.1.2 in the labeled case. Since labeled canonical cotrees and labeled cographs are in bijection, $\text{Cograph}(\mathbf{t}^{(n)})$ is a uniform labeled cograph of size n , *i.e.* is equal to \mathbf{G}_n in distribution. Thus Theorem 8.1.1 follows from Lemma 8.4.4 and Proposition 8.5.5. Theorem 8.1.2 is now a consequence of Theorem 8.1.1, combined with Propositions 8.3.11 and 8.4.5.

8.6. Convergence of unlabeled cographs to the Brownian cographon

8.6.1. Reducing unlabeled canonical cotrees to labeled objects. In this section, we are interested in unlabeled cographs. They are in one-to-one correspondence with unlabeled canonical cotrees. We denote by $\overline{\mathcal{V}}$ the class of unlabeled canonical cotrees and by $\overline{\mathcal{U}}$ the class of rooted non-plane unlabeled trees with no unary nodes, counted by the number of leaves. If V and U are their respective ordinary generating functions, then clearly, $V(z) = 2U(z) - z$.

The class $\overline{\mathcal{U}}$ may be counted using the multiset construction and the Pólya exponential [FS09, Thm. I.1]: a tree of $\overline{\mathcal{U}}$ is either a single leaf or a multiset of cardinality at least 2 of trees of $\overline{\mathcal{U}}$, yielding the following equation:

$$(8.20) \quad U(z) = z + \exp\left(\sum_{r \geq 1} \frac{1}{r} U(z^r)\right) - 1 - U(z).$$

As in the labeled case, we want to count the number of pairs (t, I) where t is a cotree of $\overline{\mathcal{V}}$ with n leaves, and I is a k -tuple of leaves of t (considered labeled by the order in which they appear in the tuple), such that the subtree induced by I in t is a given labeled cotree t_0 .

To that end, we would need to refine Equation (8.20) to count trees with marked leaves, inducing a given subtree, in a similar spirit as in Theorem 8.5.3. There is however a major difficulty here, which we now explain. There are two ways of looking at tuples of marked leaves in unlabeled trees.

- We consider pairs (t, I) , where t is a labeled tree and I a k -tuple of leaves of t . Then we look at orbits $(\overline{t}, \overline{I})$ of such pairs under the natural relabeling action.
- Or we first consider orbits \overline{t} of labeled trees under the relabeling action, *i.e.* unlabeled trees. For each such orbit we fix a representative and consider pairs (\overline{t}, I) , where I is a k -tuple of leaves of the representative of \overline{t} .

In the second model, every unlabeled tree has exactly $\binom{n}{k}$ marked versions, which is not the case in the first model⁷. Consequently, if we take an element uniformly at random in the second model, the underlying unlabeled tree is a uniform unlabeled tree, while this property does not hold in the first model.

Our goal is to study uniform random unlabeled cographs of size n , where we next choose a uniform random k -tuple of leaves. This corresponds exactly to the second model.

The problem is that combinatorial decomposition of unlabeled combinatorial classes is suited to study the first model (unlabeled objects are orbits of labeled objects under relabeling). In particular, Theorem 8.5.3 has an easy analogue for counting unlabeled trees with marked leaves inducing a given labeled cotree in the first sense, but not in the second sense.

To overcome this difficulty, we consider the following labeled combinatorial class:

$$\mathcal{U} = \{(t, a) : t \in \mathcal{L}, a \text{ a root-preserving automorphism of } t\}$$

where \mathcal{L} is the family of non-plane labeled rooted trees in which internal nodes have at least two children, studied in Section 8.5. We define the size of an element (t, a) of \mathcal{U} as the number of leaves of t . This set is relevant because of the following easy but key observation.

Proposition 8.6.1. *Let Φ denote the operation of forgetting both the labels and the automorphism. Then, $\Phi(\mathcal{U}) = \overline{\mathcal{U}}$ and every $t \in \overline{\mathcal{U}}$ of size n has exactly $n!$ preimages by Φ . As a result, the ordinary generating series U of $\overline{\mathcal{U}}$ equals the exponential generating function of \mathcal{U} and the image by Φ of a uniform random element of size n in \mathcal{U} is a uniform random element of size n in $\overline{\mathcal{U}}$.*

PROOF. The number of preimages of $t \in \overline{\mathcal{U}}$ is the number of automorphisms of t times the number of distinct labelings of t , which equals $n!$ by the orbit-stabilizer theorem. The other claims follow immediately. \square

Working with \mathcal{U} instead of $\overline{\mathcal{U}}$ solves the issue raised above concerning marking, since we have labeled objects. However the additional structure (the automorphism) has to be taken into account in combinatorial decompositions, but this turns out to be tractable (at least asymptotically).

8.6.2. Combinatorial decomposition of \mathcal{U} . We first describe a method for decomposing pairs (t, a) in \mathcal{U} at the root of t , which explains *combinatorially* why the exponential generating function U of \mathcal{U} satisfies Equation (8.20). This combinatorial interpretation of Equation (8.20) is necessary for the refinement with marked leaves done in the next section.

Let $(t, a) \in \mathcal{U}$. Then t is a non-plane rooted labeled tree with no unary nodes and a is one of its root-preserving automorphisms. Assuming t is of size at least two, we denote by v_1, \dots, v_d the children of the root, and t_1, \dots, t_d the fringe subtrees rooted at these nodes, respectively.

Because a is a root-preserving automorphism, it preserves the set of children of the root, hence there exists a permutation $\pi \in \mathfrak{S}_d$ such that $a(v_i) = v_{\pi(i)}$ for all $1 \leq i \leq d$. Moreover, we have necessarily $a(t_i) = t_{\pi(i)}$ for all $1 \leq i \leq d$.

Let $\pi = \prod_{s=1}^p c_s$ be the decomposition of π into disjoint cycles, including cycles of length one. Let $c_s = (i_1, \dots, i_r)$ be one of them. We consider the forest $t(c_s)$ formed by the trees t_{i_1}, \dots, t_{i_r} . Then the pair $(t(c_s), a|_{t(c_s)})$ lies in the class \mathcal{C}_r of pairs (f, a) , where f is a forest of r trees and a an automorphism of f acting cyclically on the components of f .

The tree t can be recovered by adding a root to $\bigsqcup_{s=1}^p t(c_s)$. Moreover, a is clearly determined by $(a|_{t(c_s)})_{1 \leq s \leq p}$. So we can recover (t, a) knowing $(t(c_s), a|_{t(c_s)})_{1 \leq s \leq p}$. Recall that the cycles c_s indexing the latter vector are the cycles of the permutation π , which has size at least 2 (the root of t has degree at least 2). Since permutations π are sets of

⁷ E.g., the tree with three leaves all attached to the root, two of which are marked, has only one marked version in the first model.

cycles, we get the following decomposition of \mathcal{U} (using as usual \mathcal{Z} for the atomic class, representing here the single tree with one leaf):

$$(8.21) \quad \mathcal{U} = \mathcal{Z} \uplus \text{SET}_{\geq 1} \left(\bigoplus_{r \geq 1} \mathcal{C}_r \right) \setminus \mathcal{C}_1,$$

We then relate \mathcal{C}_r to \mathcal{U} to turn Equation (8.21) into a recursive equation. Let (f, a) be an element of \mathcal{C}_r , and t be one of the component of f . We write $f = \{t_1, \dots, t_r\}$ such that $t_1 = t$ and a acts on these components by $t_1 \xrightarrow{a} t_2 \xrightarrow{a} \dots \xrightarrow{a} t_r \xrightarrow{a} t_1$ (this numbering of the components of f is uniquely determined by t). We then encode (f, a) by a unique tree \widehat{t} isomorphic to t_1 , with multiple labelings, *i.e.* each leaf $\widehat{v} \in \widehat{t}$, corresponding to $v \in t_1$, is labeled by $(v, a(v), a^2(v), \dots, a^{r-1}(v))$. Finally, a^r induces an automorphism of \widehat{t} . Consequently, (\widehat{t}, a^r) is an element of the combinatorial class $\mathcal{U} \circ \mathcal{Z}^r$, *i.e.* an element of \mathcal{U} where each atom (here, each leaf of the tree) carries a vector of r labels; the size of an element of $\mathcal{U} \circ \mathcal{Z}^r$ is the total number of labels, *i.e.* r times the number of leaves of \widehat{t} . The forest f and its marked component t are trivially recovered from (\widehat{t}, a^r) . Since a forest automorphism is determined by its values on leaves, we can recover a as well.

This construction defines a size-preserving bijection between triples (f, a, t) , where (f, a) is in \mathcal{C}_r and t one of the component of f , and elements of $\mathcal{U} \circ \mathcal{Z}^r$. Forgetting the marked component t , this defines an r -to-1 size-preserving correspondence from \mathcal{C}_r to $\mathcal{U} \circ \mathcal{Z}^r$. Together with Equation (8.21), this gives the desired combinatorial explanation to the fact that the exponential generating function of \mathcal{U} satisfies Equation (8.20).

We now introduce the combinatorial class \mathcal{D} of trees in \mathcal{U} with size ≥ 2 such that no child of the root is fixed by the automorphism. This means that there is no cycle of size 1 in the above decomposition of π into cycles. Therefore, the exponential generating function of \mathcal{D} satisfies

$$(8.22) \quad D(z) = \exp \left(\sum_{r \geq 2} \frac{1}{r} U(z^r) \right) - 1.$$

Note that introducing the series D is classical when applying the method of singularity analysis on unlabeled unrooted structures (aka Pólya structures), see, *e.g.*, [FS09, p 476]. However, interpreting it combinatorially with objects of \mathcal{D} is not standard, but necessary for our purpose.

In the sequel, for $k \geq 0$, we write $\exp_{\geq k}(z) = \sum_{z \geq k} \frac{z^k}{k!}$. Algebraic manipulations from Equation (8.20) allow to rewrite the equation for U as:

$$(8.23) \quad U = z + \exp_{\geq 2}(U) + D \exp(U).$$

Moreover, Equation (8.23) has a combinatorial interpretation. Indeed, pairs (t, a) in \mathcal{U} of size at least 2 can be split into two families as follows.

- The first family consists in pairs (t, a) , for which all children of the root are fixed by the automorphism a ; adapting the above combinatorial argument, we see that the generating series of this family is $\exp_{\geq 2}(U)$ (recall that the root has at least 2 children).
- The second family consists in pairs (t, a) , where some children of the root are moved by the automorphism a . Taking the root, its children moved by a and their descendants give a tree t_1 such that $(t_1, a|_{t_1})$ is in \mathcal{D} . Each child c of the root fixed by a with its descendants form a tree t_c such that $(t_c, a|_{t_c})$ is in \mathcal{U} . We have a (possibly empty) unordered set of such children. Therefore, elements in this second family are described as pairs consisting of an element of \mathcal{D} and a (possibly empty) unordered set of elements of \mathcal{U} , so that the generating series of this second family is $D \exp(U)$.

Bringing the two cases together, we obtain a combinatorial interpretation of Equation (8.23). Again, this combinatorial interpretation will be important later, when refining with marked leaves.

We can now turn to defining the combinatorial classes that will appear in our decomposition. Similarly to the case of labeled cographs, we will need to consider objects of \mathcal{U} (recall that these are *labeled* objects) where some leaves are marked. Here again, we need to distinguish marked leaves carrying a label (contributing to the size of the objects), and leave not carrying any label (not counted in the size). We keep the terminology of our section on labeled cographs, namely we call *blossoms* marked leaves of the latter type (*i.e.* without labels) and we reserve *marked leaves* for those carrying labels.

We let \mathcal{U}^\bullet (resp. \mathcal{U}') be the combinatorial class of pairs (t, a) in \mathcal{U} with a marked leaf (resp. blossom) in t . Their exponential generating functions are respectively $zU'(z)$ and $U'(z)$ (the derivative of $U(z)$). We also define $\mathcal{U}^\star \subset \mathcal{U}'$ as the class of pairs (t, a) in \mathcal{U} with a blossom in t which is fixed by a . Finally, we decompose \mathcal{U}^\star as $\mathcal{U}^\star = \mathcal{U}^{\text{even}} \uplus \mathcal{U}^{\text{odd}}$, according to the parity of the distance from the root to the blossom. We denote by U^\star , U^{even} and U^{odd} the exponential generating functions of these classes, respectively.

Proposition 8.6.2. *We have the following equations:*

$$(8.24) \quad U^\star = 1 + U^\star \exp_{\geq 1}(U) + U^\star D \exp(U),$$

$$(8.25) \quad \begin{cases} U^{\text{even}} &= 1 + U^{\text{odd}} \exp_{\geq 1}(U) + U^{\text{odd}} D \exp(U), \\ U^{\text{odd}} &= U^{\text{even}} \exp_{\geq 1}(U) + U^{\text{even}} D \exp(U). \end{cases}$$

PROOF. Note that if a blossom is required to be fixed by the automorphism, then all of its ancestors are also fixed by the automorphism. Then, the equation of U^\star is obtained by the same decomposition as for Equation (8.23), imposing that the blossom belongs to a subtree attached to a child of the root which is fixed by the automorphism. The other two equations follow immediately. \square

8.6.3. Enumeration of canonical cotrees with marked leaves inducing a given cotree. We first define \mathcal{V} as the class of pairs (t, a) , where t is a labeled canonical cotree and a a root-preserving automorphism of t . As for \mathcal{U} and $\overline{\mathcal{U}}$, we have a $n!$ -to-1 map from \mathcal{V} to $\overline{\mathcal{V}}$ and V can be seen either as the ordinary generating function of $\overline{\mathcal{V}}$ or the exponential generating function of \mathcal{V} .

We would like to find a combinatorial decomposition of pairs in \mathcal{V} with marked leaves inducing a given cotree. It turns out that it is simpler and sufficient for us to work with a smaller class, which we now define.

Definition 8.6.3. Let t_0 be a labeled cotree of size k . Let \mathcal{V}_{t_0} be the class of tuples $(t, a; \ell_1, \dots, \ell_k)$, where (t, a) is in \mathcal{V} and ℓ_1, \dots, ℓ_k are distinct leaves of t (referred to as *marked leaves*) such that

- the marked leaves induce the subtree t_0 ;
- the following nodes are fixed by a : all first common ancestors of the marked leaves, and their children leading to a marked leaf.

We note that, because of the second item in the above definition, not all tuples $(t, a; \ell_1, \dots, \ell_k)$ (where (t, a) is in \mathcal{V} and ℓ_1, \dots, ℓ_k are leaves of t) belong to some \mathcal{V}_{t_0} . However, we will see below (as a consequence of Proposition 8.6.7) that asymptotically almost all tuples $(t, a; \ell_1, \dots, \ell_k)$ do belong to some \mathcal{V}_{t_0} (even if we restrict to binary cotrees t_0 , which is similar to the previous section).

Let V_{t_0} be the exponential generating series of \mathcal{V}_{t_0} ; it is given by the following result.

Theorem 8.6.4. *Let t_0 be a labeled cotree with k leaves, n_v internal nodes, $n_=\$ edges of the form $0 - 0$ or $1 - 1$, n_\neq edges of the form $0 - 1$ or $1 - 0$. We have the identity*

$$V_{t_0} = (U^\star)(2U + 1 - z)^{n_v} (U^\bullet)^k (U^{\text{odd}})^{n_=} (U^{\text{even}})^{n_\neq}.$$

PROOF. Let $(t, a; \ell_1, \dots, \ell_k)$ be a tree in \mathcal{V}_{t_0} . The tree t with its marked leaves ℓ_1, \dots, ℓ_k can be decomposed in a unique way as in the proof of Theorem 8.5.3 into pieces: pink trees, blue trees, yellow trees, gray trees and green forests.

As soon as a node of t is fixed by the automorphism a , then the set of its descendants is stable by a . Therefore, the second item of Definition 8.6.3 ensures that each colored piece in the decomposition of t is stable by a , so that a can be decomposed uniquely into a collection of automorphisms, one for each colored piece. Consequently, from now on, we think at pieces as trees/forests *with an automorphism*.

As in Theorem 8.5.3, each piece can be chosen independently in a set depending on its color. Moreover, since t_0 is labeled, the pieces can be ordered in a canonical way, so that the generating series of V_{t_0} is the product of the generating series of the pieces.

- The gray subtree is a tree with an automorphism and a blossom which is fixed by the automorphism (because of the second item of Definition 8.6.3). As in Theorem 8.5.3, the decoration is forced by the context, so that we can consider the gray subtree as not decorated. The possible choices for the gray subtrees are therefore counted by U^* .
- The possible choices for each green forest (and its automorphism) are counted by $1 + U + (U - z)$: the first term corresponds to the empty green piece, the second one to exactly one tree in the green forest, and the third one to a set of at least two green trees (which can be seen as a non-trivial tree in \mathcal{U} by adding a root).
- The possible choices for each yellow piece are counted by U^\bullet , since these trees have a marked leaf which is not necessarily fixed by the automorphism.
- The possible choices for each pink piece are counted U^{even} : the blossom must be at even distance from the root of the piece (for the same reason as in Theorem 8.5.3) and must be fixed by the automorphism (because of the second item of Definition 8.6.3).
- Similarly, the possible choices for each blue piece are counted U^{odd} .

Bringing everything together gives the formula in the theorem. □

8.6.4. Asymptotic analysis. Let ρ be the radius of convergence of U . It is easily seen that we have $0 < \rho < 1$, see, *e.g.*, [Gen16], where the numerical approximation $\rho \approx 0.2808$ is given.

Proposition 8.6.5. *The series $U, U', U^*, U^{\text{even}}, U^{\text{odd}}$ all have the same radius of convergence ρ , are Δ -analytic and admit the following expansions around ρ :*

$$U(z) \underset{z \rightarrow \rho}{\sim} \frac{1 + \rho}{2} - \beta \sqrt{\rho - z} + o(\sqrt{\rho - z}), \quad U'(z) \underset{z \rightarrow \rho}{\sim} \frac{\beta}{2\sqrt{\rho - z}},$$

$$2U^{\text{even}}(z) \sim 2U^{\text{odd}}(z) \sim U^*(z) \underset{z \rightarrow \rho}{\sim} \frac{1}{2\beta\sqrt{\rho - z}},$$

for some constant $\beta > 0$.

To prove the proposition, we need the following lemma, which is standard in the analysis of Pólya structures.

Lemma 8.6.6. *The radius of convergence of D is $\sqrt{\rho} > \rho$.*

PROOF. Since U has no constant term, for every $x \geq 1$ and $0 < z < 1$ we have $U(z^x) \leq U(z)z^{x-1}$. Hence for $0 < t < \rho$,

$$D(\sqrt{t}) = \exp_{\geq 1} \left(\sum_{r \geq 2} \frac{1}{r} U(t^{r/2}) \right) \leq \exp \left(\sum_{r \geq 2} U(t)t^{r/2-1} \right) \leq \exp \left(U(t) \frac{1}{1 - \sqrt{t}} \right) < \infty.$$

This implies that the radius of convergence of D is at least $\sqrt{\rho}$. Looking at Equation (8.22), we see that D termwise dominates $\frac{1}{2}U(z^2)$, whose radius of convergence is $\sqrt{\rho}$. Therefore, the radius of convergence of D is exactly $\sqrt{\rho}$. □

PROOF OF PROPOSITION 8.6.5. Set $F(z, u) = z + \exp_{\geq 2}(u) + D(z) \exp(u)$. Then U verifies the equation $U = F(z, U)$, which is the setting of Theorem 5.4.5⁸ (in the one dimensional case, which is then just a convenient rewriting of [FS09, Theorem VII.3]). The only non-trivial hypothesis to check is the analyticity of F at $(\rho, U(\rho))$. This holds because \exp has infinite radius of convergence, while D has radius of convergence $\sqrt{\rho} > \rho$ from Lemma 8.6.6.

From items vi) and vii) of [Bas+19b, Theorem A.6], we have that U and $(1 - \partial_u F(z, U(z)))^{-1}$ have radius of convergence ρ , are Δ -analytic and that $\partial_u F(\rho, U(\rho)) = 1$. Moreover,

$$U(z) \underset{z \rightarrow \rho}{=} U(\rho) - \frac{\beta}{\zeta} \sqrt{\rho - z} + o(\sqrt{\rho - z}), \quad U'(z) \underset{z \rightarrow \rho}{\sim} \frac{\beta}{2\zeta \sqrt{\rho - z}}$$

$$(1 - \partial_u F(z, U(z)))^{-1} \underset{z \rightarrow \rho}{\sim} \frac{1}{2\beta\zeta \sqrt{\rho - z}},$$

where $\beta = \sqrt{\partial_z F(\rho, U(\rho))}$ and $\zeta = \sqrt{\frac{1}{2} \partial_u^2 F(\rho, U(\rho))}$.

We have $\partial_u F(z, u) = \exp_{\geq 1}(u) + D(z) \exp(u) = F(z, u) + u - z$. Hence $\partial_u F(z, U(z)) = 2U(z) - z$. Recalling that $\partial_u F(\rho, U(\rho)) = 1$, we get $U(\rho) = \frac{1+\rho}{2}$. In addition, $\partial_u^2 F(z, u) = \exp(u) + D(z) \exp(u) = \partial_u F(z, u) + 1$. Therefore, $\partial_u^2 F(\rho, U(\rho)) = 2$ and $\zeta = 1$. The asymptotics of U and U' follow.

Regarding U^* , Equation (8.24) implies that $U^* = (1 - \partial_u F(z, U(z)))^{-1}$. Similarly solving the system of equations (8.25) we get $U^{\text{even}} = (1 - (\partial_u F(z, U(z)))^2)^{-1}$ and $U^{\text{odd}} = \partial_u F(z, U(z)) U^{\text{even}}$. By the daffodil lemma lemma A.1.1, we have $|\partial_u F(z, U(z))| < 1$ for $|z| \leq \rho$ and $z \neq \rho$. In particular, $\partial_u F(z, U(z))$ avoids the value 1 and -1 for such z . Therefore U^* , U^{even} and U^{odd} are Δ -analytic. The asymptotics of U^* follows from the above results. Finally, since $\partial_u F(\rho, U(\rho)) = 1$, we have $U^{\text{even}} \sim U^{\text{odd}}$ when z tends to ρ . And, since $U^* = U^{\text{even}} + U^{\text{odd}}$, their asymptotics follow. \square

8.6.5. Distribution of induced subtrees of uniform cotrees. We take a uniform unlabeled canonical cotree $\mathbf{t}^{(n)}$ with n leaves, *i.e.* a uniform element of size n in $\bar{\mathcal{V}}$. We also choose uniformly at random a k -tuple of distinct leaves of $\mathbf{t}^{(n)}$. We denote by $\mathbf{t}_k^{(n)}$ the labeled cotree induced by the k marked leaves.

Proposition 8.6.7. *Let $k \geq 2$, and let t_0 be a labeled binary cotree with k leaves. Then*

$$(8.26) \quad \mathbb{P}(\mathbf{t}_k^{(n)} = t_0) \underset{n \rightarrow +\infty}{\rightarrow} \frac{(k-1)!}{(2k-2)!}.$$

PROOF. We take a uniform random pair $(\mathbf{T}^{(n)}, \mathbf{a})$ of \mathcal{V} of size n with a k -tuple of distinct leaves of $\mathbf{T}^{(n)}$, also chosen uniformly. We denote by $\mathbf{T}_k^{(n)}$ the cotree induced by the k marked leaves. Since the forgetting map from \mathcal{V} to $\bar{\mathcal{V}}$ is $n!$ -to-1, $\mathbf{T}_k^{(n)}$ is distributed as $\mathbf{t}_k^{(n)}$. Hence, similarly as in Equation (8.19), we have:

$$\mathbb{P}(\mathbf{t}_k^{(n)} = t_0) = \mathbb{P}(\mathbf{T}_k^{(n)} = t_0) \geq \frac{n! [z^n] V_{t_0}(z)}{n \dots (n-k+1) n! [z^n] V(z)}.$$

The inequality comes from the fact that \mathcal{V}_{t_0} does not consist of all pairs in \mathcal{V} with a k -tuple of marked leaves inducing t_0 , but only of some of them (see the additional constraint in the second item of Definition 8.6.3).

From Theorem 8.6.4, we have

$$V_{t_0} = (U^*)(2U + 1 - z)^{n_v} (U^\bullet)^k (U^{\text{odd}})^{n_=} (U^{\text{even}})^{n_\neq}.$$

Recalling that $U^\bullet(z) = zU'(z)$, we use the asymptotics for $U, U', U^*, U^{\text{even}}, U^{\text{odd}}$ (given in Proposition 8.6.5) and furthermore the equalities $n_v = k - 1$ and $n_+ + n_\neq = k - 2$ (which

⁸ We warn the reader that the function U appearing in Theorem 5.4.5 is unrelated to the quantity $U(z)$ in the present article (which corresponds instead to $Y(z)$ in Theorem 5.4.5).

hold since t_0 is binary) to obtain:

$$\begin{aligned} V_{t_0}(z) &\underset{z \rightarrow \rho}{\sim} \frac{1}{2\beta} 2^{k-1} \left(\frac{\beta}{2} \cdot \rho\right)^k \left(\frac{1}{4\beta}\right)^{k-2} (\rho - z)^{-(k-1/2)} \\ &\underset{z \rightarrow \rho}{\sim} \frac{\beta \rho^k}{2^{2k-2}} (\rho - z)^{-(k-1/2)} = \frac{\beta \sqrt{\rho}}{2^{2k-2}} \left(1 - \frac{z}{\rho}\right)^{-(k-1/2)}. \end{aligned}$$

By the transfer theorem (theorem A.2.2) we have that

$$[z^n]V_{t_0}(z) \underset{n \rightarrow +\infty}{\sim} \frac{\beta \sqrt{\rho}}{2^{2k-2} \rho^n} \frac{n^{k-3/2}}{\Gamma(k-1/2)} = \beta \frac{(k-1)!}{\sqrt{\pi}(2k-2)!} \frac{n^{k-3/2}}{\rho^{n-1/2}}$$

Besides, using $V(z) = 2U(z) - z$, Proposition 8.6.5, and the transfer theorem as above, we have

$$n(n-1) \dots (n-k+1) [z^n]V(z) \underset{n \rightarrow +\infty}{\sim} n^k (-2\beta \sqrt{\rho}) \frac{n^{-3/2}}{\rho^n \Gamma(-1/2)} \sim \beta \frac{n^{k-3/2}}{\rho^{n-1/2} \sqrt{\pi}}.$$

Finally, $\liminf_{n \rightarrow \infty} \mathbb{P}(\mathbf{t}_k^{(n)} = t_0) \geq \frac{(k-1)!}{(2k-2)!}$. To conclude, recall (as seen in the proof of Lemma 8.4.4) that summing the right-hand-side over all labeled binary cotrees t_0 of size k gives 1, from which the proposition follows. \square

8.6.6. Proof of Theorems 8.1.1 and 8.1.2 in the unlabeled case. The argument is identical to the labeled case. Recall that $\mathbf{t}^{(n)}$ is a uniform unlabeled canonical cotree of size n , so that $\text{Cograph}(\mathbf{t}^{(n)})$ is a uniform unlabeled cograph of size n , *i.e.* has the same distribution as \mathbf{G}_n^u . Thus Theorem 8.1.1 follows from Lemma 8.4.4 and Proposition 8.6.7, and Theorem 8.1.2 is then a consequence of Theorem 8.1.1 and propositions 8.3.11 and 8.4.5.

8.7. Vertex connectivity

A connected graph G is said to be k -connected if it does not contain a set of $k - 1$ vertices whose removal disconnects the graph. The *vertex connectivity* $\kappa(G)$ is defined as the largest k such that G is k -connected.

Throughout this section, \mathbf{G}_n (resp. \mathbf{G}_n^u) is a uniform random labeled (resp. unlabeled) cograph of size n , *conditioned to be connected*. The aim of this section is to prove that the random variable $\kappa(\mathbf{G}_n)$ (resp. $\kappa(\mathbf{G}_n^u)$) converges in distribution to a non-trivial random variable (without renormalizing). The limiting distributions in the labeled and unlabeled cases are different.

A cograph G (of size at least 2) is connected if and only if the root of its canonical cotree is decorated by 1. (This implies that in both cases a uniform cograph of size n is connected with probability 1/2 for every n .) Therefore, any connected cograph G (of size at least 2) can be uniquely decomposed as the join of F_1, \dots, F_k where each F_i is either a disconnected cograph or a one-vertex graph. Moreover, the cographs F_i are those whose canonical cotrees are the fringe subtrees attached to the root of the canonical cotree of G . Throughout this section, we refer to the F_i 's as the *components* of G . The following lemma, illustrated by Figure 8.6, gives a simple characterization of $\kappa(G)$ when G is a cograph.

Lemma 8.7.1. *Let G be a connected cograph which is not a complete graph. Let F_1, \dots, F_k be the components of G . It holds that*

$$\kappa(G) = |G| - \max_{1 \leq i \leq k} \{|F_i|\}.$$

PROOF. We reorder the components such that $|F_1| = \max_i |F_i|$. Because G is not a complete graph, F_1 is not a one-vertex graph, and therefore is disconnected. Let us denote by v_1, \dots, v_r the vertices of $F_2 \cup F_3 \cup \dots \cup F_k$. We have to prove that $\kappa(G) = r$.

Proof of $\kappa(G) \leq r$. If we remove all vertices v_1, \dots, v_r then we are left with F_1 which is disconnected.

Proof of $\kappa(G) \geq r$. If we remove only $r - 1$ vertices then there remains at least one v_j among v_1, \dots, v_r . Let us denote by F_i the component of v_j . There also remains at least a

vertex $v \notin F_i$ (or $|F_i|$ would be larger than $|F_1|$). Consequently, v and v_j are connected by an edge, and every remaining vertex is connected to v_j (when not in F_i) or to v (when not in the component containing v), so that G remains connected. Therefore we must remove at least r points to disconnect G . \square

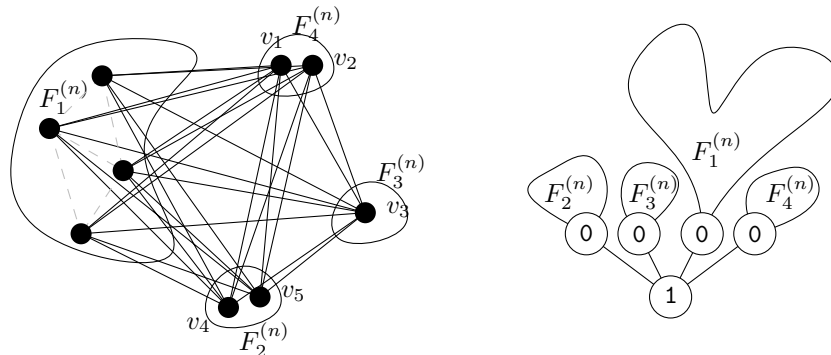

FIGURE 8.6. A connected cograph and the corresponding cotree. The connectivity degree of this graph is $|F_2| + |F_3| + |F_4| = 2 + 2 + 1 = 5$.

Theorem 8.7.2. *Let $M(z)$ (resp. $V(z)$) be the exponential (resp. ordinary) generating series of labeled (resp. unlabeled) cographs. Their respective radii of convergence are $\rho = 2 \log(2) - 1$ and $\rho_u \approx 0.2808$. For $j \geq 1$, set*

$$\pi_j = \rho^j [z^j] M(z), \quad \pi_j^u = \rho_u^j [z^j] V(z).$$

Then $(\pi_j)_{j \geq 1}$ and $(\pi_j^u)_{j \geq 1}$ are probability distributions and, for every fixed $j \geq 1$,

$$(8.27) \quad \mathbb{P}(\kappa(\mathbf{G}_n) = j) \xrightarrow{n \rightarrow +\infty} \pi_j, \quad \mathbb{P}(\kappa(\mathbf{G}_n^u) = j) \xrightarrow{n \rightarrow +\infty} \pi_j^u.$$

Remark 8.7.3. Readers acquainted with Boltzmann samplers may note that $(\pi_j)_{j \geq 1}$ and $(\pi_j^u)_{j \geq 1}$ are distributions of sizes of Boltzmann-distributed random labeled and unlabeled cographs, respectively. The Boltzmann parameters are chosen to be the radii of convergence. We do not have a direct explanation of this fact.

PROOF. Recall from Sections 8.5 and 8.6 that $M(z) = 2L(z) - z$ and $V(z) = 2U(z) - z$. It follows from Propositions 8.5.4 and 8.6.5 that $\rho = 2 \log(2) - 1$ and $\rho_u \approx 0.2808$ are their respective radii of convergence. We first prove that (π_j) (resp. (π_j^u)) sum to one:

$$\begin{aligned} \sum_{j \geq 1} \pi_j &= \sum_{j \geq 1} \rho^j [z^j] M(z) = M(\rho) = 2L(\rho) - \rho = 1, \\ \sum_{j \geq 1} \pi_j^u &= \sum_{j \geq 1} \rho_u^j [z^j] V(z) = V(\rho_u) = 2U(\rho_u) - \rho_u = 1, \end{aligned}$$

using Propositions 8.5.4 and 8.6.5 for the last equalities.

For the remaining of the proof, we fix $j \geq 1$. In the labeled case, let \mathbf{T}_n be the canonical cotree of \mathbf{G}_n . Since \mathbf{G}_n is conditioned to be connected, \mathbf{T}_n is a uniform labeled canonical cotree of size n conditioned to have root decoration 1. Forgetting the decoration, we can see it as a uniform random element of size n in \mathcal{L} .

Let $n > 2j$. As the components of \mathbf{G}_n correspond to the subtrees attached to the root of \mathbf{T}_n , using Lemma 8.7.1 we have $\kappa(\mathbf{G}_n) = j$ if and only if \mathbf{T}_n is composed of a tree of \mathcal{L} of size $n - j$ and $k \geq 1$ trees of \mathcal{L} of total size j , all attached to the root. Since $n > 2j$, the fringe subtree of size $n - j$ is uniquely defined, and there is only one such decomposition. Therefore, for every fixed $j \geq 1$ and $n > 2j$, we have:

$$\mathbb{P}(\kappa(\mathbf{G}_n) = j) = \frac{[z^{n-j}]L(z) [z^j](e^{L(z)} - 1)}{[z^n]L(z)}.$$

From Proposition 8.5.4, the series $L(z)$ has radius of convergence ρ , is Δ -analytic and has a singular expansion amenable to singularity analysis. Thus, the transfer theorem ensures that $\frac{[z^{n-j}]L(z)}{[z^n]L(z)}$ tends to ρ^j , so that

$$\mathbb{P}(\kappa(\mathbf{G}_n) = j) \xrightarrow{n \rightarrow +\infty} \rho^j [z^j] (e^{L(z)} - 1) = \pi_j,$$

where we used $M(z) = e^{L(z)} - 1$ (see Equation (8.10)).

In the unlabeled case, let \mathbf{T}_n^u be the canonical cotree of \mathbf{G}_n^u . Like in the labeled case, forgetting the decoration, it is a uniform element of \bar{U} of size n . Let $n > 2j$. We have $\kappa(\mathbf{G}_n^u) = j$ if and only if \mathbf{T}_n^u has a fringe subtree of size $n - j$ at the root.

Let us count the number of trees of \bar{U} of size n that have a fringe subtree of size $n - j$ at the root. Since $n - j > n/2$, there must be exactly one such fringe subtree, and there are $[z^{n-j}]U(z)$ choices for it. Removing it, the rest of the tree contains j leaves, and is either a tree of \bar{U} of size ≥ 2 (if the root still has degree at least 2), or a tree formed by a root and a single tree of \bar{U} attached to it. So the number of choices for the rest is $[z^j](2U(z) - z)$. We deduce that for $j \geq 1$ and $n > 2j$,

$$\mathbb{P}(\kappa(\mathbf{G}_n^u) = j) = \frac{[z^{n-j}]U(z) [z^j](2U(z) - z)}{[z^n]U(z)}.$$

From Proposition 8.6.5, the series $U(z)$ has radius of convergence ρ_u , is Δ -analytic and has a singular expansion amenable to singularity analysis. The transfer theorem ensures that $\frac{[z^{n-j}]U(z)}{[z^n]U(z)}$ tends to ρ_u^j , so that

$$\mathbb{P}(\kappa(\mathbf{G}_n^u) = j) \xrightarrow{n \rightarrow +\infty} \rho_u^j [z^j](2U(z) - z) = \pi_j^u$$

where we used $V(z) = 2U(z) - z$. □

Remark 8.7.4. In the labeled case, we could have used Lemma 8.7.1 and local limit results for trees instead of the generating series approach above. Indeed, the canonical cotree of \mathbf{G}_n (without its decorations) is distributed as a Galton-Watson tree with an appropriate offspring distribution conditioned on having n leaves. Such conditioned Galton-Watson trees converge in the local sense near the root towards a Kesten's tree [AD15, Section 2.3.13]. Since Kesten's trees have a unique infinite path from the root, this convergence implies the convergence (without renormalization) of the sizes of all components of \mathbf{G}_n but the largest one. Therefore the sum $\kappa(\mathbf{G}_n)$ of these sizes also converges (without renormalization); the limit can be computed (at least in principle) using the description of Kesten's trees.

In the unlabeled case, the canonical cotree of \mathbf{G}_n^u (without its decorations) belongs to the family of random *Pólya* trees. Such trees are *not* conditioned Galton-Watson trees. For scaling limits, it has been proven they can be approximated by conditioned Galton-Watson trees and hence converge under suitable conditions to the Brownian Continuum Random Tree [PS18], but we are not aware of any local limit result for such trees.

Acknowledgments of [Bas+19a]. MB is partially supported by the Swiss National Science Foundation, under grant number 200021-172536.

Scaling and local limit of Baxter permutations

This chapter reproduces the article [BM20a], joint work with Jacopo Borga, of which a short version [BM20b] was presented at AofA.

ABSTRACT. Baxter permutations, plane bipolar orientations, and a specific family of walks in the non-negative quadrant, called *tandem walks*, are well-known to be related to each other through several bijections. We introduce a further new family of discrete objects, called *coalescent-walk processes* and we relate it to the three families mentioned above.

We prove joint Benjamini–Schramm convergence (both in the annealed and quenched sense) for uniform objects in the four families. Furthermore, we explicitly construct a new random measure of the unit square, called the *Baxter permuton* and we show that it is the scaling limit (in the permuton sense) of uniform Baxter permutations. On top of that, we relate the limiting objects of the four families to each other, both in the local and scaling limit case.

The scaling limit result is based on the convergence of the trajectories of the coalescent-walk process to the *coalescing flow* – in the terminology of Le Jan and Raimond (2004) – of a perturbed version of the Tanaka stochastic differential equation. Our scaling result entails joint convergence of the tandem walks of a plane bipolar orientation and its dual, extending the main result of Gwynne, Holden, Sun (2016), and answering more precisely Conjecture 4.4 of Kenyon, Miller, Sheffield, Wilson (2019).

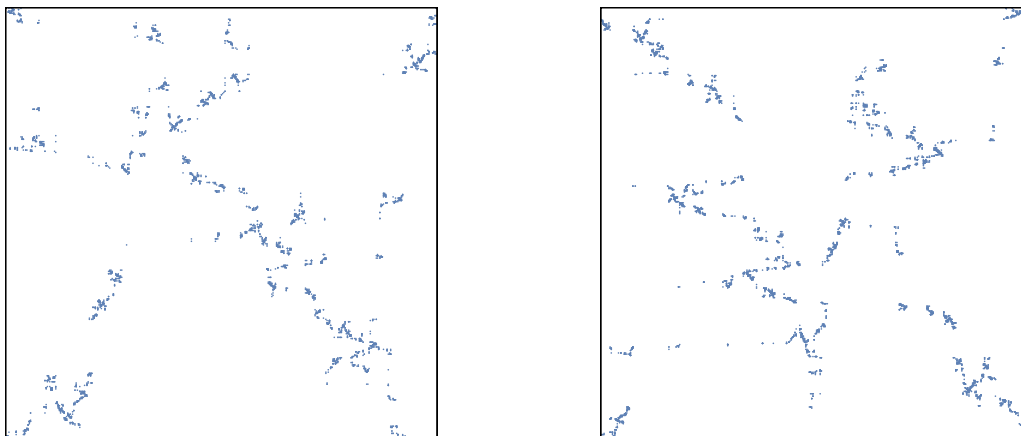

FIGURE 9.1. The diagrams of two uniform Baxter permutations of size 3253 and 4520. The underlying generating algorithm is discussed in Section 9.C.

9.1. Introduction and main results

In the last 30 years, several bijections between Baxter permutations, plane bipolar orientations and certain walks in the plane have been discovered. These relations between discrete objects of different nature are a *beautiful piece of combinatorics*¹, that we aim at investigating from a more probabilistic point of view.

1. Quoting the abstract of [FFNO11].

These bijective results come from the enumerative works of Gire [Gir93] and later Bousquet-Mélou [Bou03], where they explored the connection between Baxter permutations and generating trees with two-dimensional labels. Bousquet-Mélou noticed that Baxter permutations were equinumerous to plane bipolar orientations. A remarkable bijection (denoted OP in the present paper) between plane bipolar orientations with n edges and Baxter permutations of size n was then given by Bonichon, Bousquet-Mélou and Fusy [BBF11].

Later Felsner, Fusy, Noy and Orden [FFNO11] gave a unified presentation of some other (partially already-known) bijections between Baxter permutations, 2-orientations of planar quadrangulations, certain pairs of binary trees, and triples of non-intersecting lattice paths.

Kenyon, Miller, Sheffield and Wilson [KMSW19] introduced a bijection (denoted OW in the present paper) between plane bipolar orientations and a family of two-dimensional walks in the non-negative quadrant. The latter has been used in [BFR19] to enumerate plane bipolar orientations together with the number of faces of degree r for every $r \in \mathbb{Z}_{>0}$.

In this paper we explore local and scaling limits of some of these objects and we study the relations between their limits. Indeed, since these objects are related by several bijections at the discrete level, we expect that most of the relations among them also hold in the “limiting discrete and continuous worlds”.

In the next three sections we introduce the precise definitions of the objects involved in our work and we describe some of the bijections mentioned above.

9.1.1. Baxter permutations and permuton convergence. Baxter permutations were introduced by Glen Baxter in 1964 [Bax64] to study fixed points of commuting functions. A permutation σ is Baxter if it is not possible to find $i < j < k$ such that $\sigma(j+1) < \sigma(i) < \sigma(k) < \sigma(j)$ or $\sigma(j) < \sigma(k) < \sigma(i) < \sigma(j+1)$. Baxter permutations are well-studied from a combinatorial point of view by the *permutation patterns* community (see for instance [Boy67; CGHK78; Mal79; BGR18]). They are a particular example of family of permutations avoiding *vincular patterns* (see [BP12] for more details). We denote by \mathcal{P} the set of Baxter permutations².

The study of random permutations, especially uniform permutations in *permutation classes*, which are families of permutations avoiding classical patterns, is an emerging topic at the interface of combinatorics and discrete probability theory. There are two main approaches to it: the first is the study of statistics on permutations, and the second, more recent, looks for limits of permutations themselves. For instance, one can study the shape of the rescaled diagram of a random permutation (i.e. the sets of points of the Cartesian plane at coordinates $(i, \sigma(i))$) using the formalism of *permutons*, developed by [Hop+13]. This approach is a rapidly developing field in discrete probability theory, see for instance [ML10; MP14; MP16a; HRS17a; Bas+18; Bas+20; Bas+19b; BBFS19; BDS19; BS19; HRS19; KKRW19; Maa20].

A permuton μ is a Borel probability measure on the unit square $[0, 1]^2$ with uniform marginals, that is $\mu([0, 1] \times [a, b]) = \mu([a, b] \times [0, 1]) = b - a$, for all $0 \leq a \leq b \leq 1$. Any permutation σ of size $n \geq 1$ may be interpreted as the permuton μ_σ given by the sum of Lebesgue area measures

$$\mu_\sigma(A) = n \sum_{i=1}^n \text{Leb} \left(\left[\frac{i-1}{n}, \frac{i}{n} \right] \times \left[\frac{\sigma(i)-1}{n}, \frac{\sigma(i)}{n} \right] \cap A \right),$$

for all Borel measurable set A of $[0, 1]^2$.

Let \mathcal{M} be the set of permutons equipped with the topology of weak convergence of measures: a sequence of (deterministic) permutons $(\mu_n)_n$ converges to μ if $\int_{[0,1]^2} f d\mu_n \rightarrow \int_{[0,1]^2} f d\mu$, for every (bounded and) continuous function $f : [0, 1]^2 \rightarrow \mathbb{R}$. With this topology,

2. We also denote by \mathcal{P}_n the set of Baxter permutations of size n . This convention will be used for all combinatorial classes studied in the paper.

\mathcal{M} is a compact metric space (we refer the reader to Chapter 3 for a complete introduction to permutons).

A sequence of random permutations σ_n converges in distribution in the permuton sense, if the associated sequence of permutons μ_{σ_n} converges. Permuton convergence is a statement about the first-order geometry of the diagram of σ_n . Nevertheless, permuton convergence is equivalent to joint convergence in distribution of all *pattern density* statistics (see Theorem 3.3.2).

Permuton convergence was investigated for some remarkable subclasses of Baxter permutations. Separable permutations, i.e. permutations avoiding the two classical patterns 2413 and 3142, converge to the *Brownian separable permuton* [Bas+18]. This result provided the first example of a sequence of uniform permutations in a class converging to a non-deterministic permuton. Dokos and Pak [DP14] explored the expected limit shape of the so-called *doubly alternating Baxter permutations*. In their article they claimed that “it would be interesting to compute the limit shape of random Baxter permutations”. The present paper answers this open question (see Figure 9.1 for some simulations of the diagram of uniform Baxter permutations of large size).

9.1.2. Plane bipolar orientations, tandem walks, and bijections with Baxter permutations. *Plane bipolar orientations*, or *bipolar orientations* for short, are planar maps (i.e. connected graphs properly embedded in the plane up to continuous deformation) equipped with an acyclic orientation of the edges with exactly one source (i.e. a vertex with only outgoing edges) and one sink (i.e. a vertex with only incoming edges), both on the outer face. We denote by \mathcal{O} the set of bipolar orientations. The size of a bipolar orientation m is its number of edges and it is denoted by $|m|$.

Every bipolar orientation can be plotted in the plane with every edge oriented from bottom to top (this is a consequence for instance of [BBF11, Proposition 1]; see the left-hand side of Figure 9.2 for an example). We think of the outer face as split in two: the *left outer face*, and the *right outer face*. The orientation of the edges around each vertex/face is constrained: we sum up these local constraints, settling some vocabulary, on the right-hand side of Figure 9.2. We call *indegree/outdegree* of a vertex the number of incoming/outgoing edges around this vertex. We call *left degree* (resp. *right degree*) of an inner face the number of left (resp. right) edges around that face.

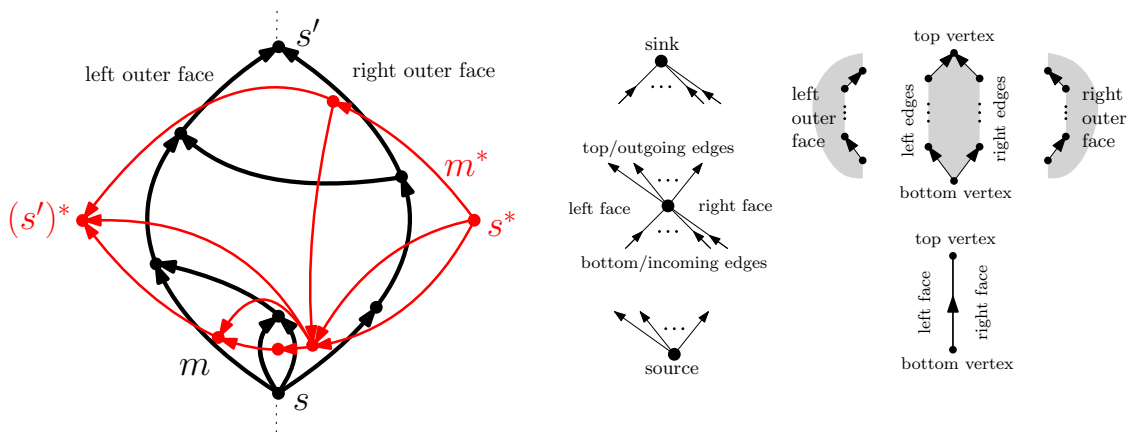

FIGURE 9.2. On the left-hand side, in black, a bipolar orientation m of size 10 drawn with every edge oriented from bottom to top. In red, its dual map m^* (defined below), drawn with every edge oriented from right to left. On the right-hand side, the behavior of the orientation around each vertex/face/edge. Note for instance that in the cyclic ordering around each vertex different from the source and the sink there are top/outgoing edges, a right face, bottom/incoming edges, and a left face.

The dual map m^* of a bipolar orientation m (the *primal*) is obtained by putting a vertex in each face of m , and an edge between two faces separated by an edge in m , oriented from the right face to the left face. The primal right outer face becomes the dual source, and the primal left outer face becomes the dual sink. Then m^* is also a bipolar orientation (see the left-hand side of Figure 9.2). The map m^{**} is just m with the orientation reversed, and $m^{****} = m$.

We now define a notion at the heart of the two bijections OW and OP mentioned before. Let m be a bipolar orientation. Disconnecting every incoming edge but the rightmost one at every vertex turns the map m into a plane tree $T(m)$ rooted at the source, which we call the *down-right tree* of the map (see the left-hand side of Figure 9.3 for an example). The tree $T(m)$ contains every edge of m , and the clockwise contour exploration of $T(m)$ identifies an ordering of the edges of m . We denote by $e_1, \dots, e_{|m|}$ the edges of m in this order (see again Figure 9.3). The tree $T(m^{**})$ can be obtained similarly from m by disconnecting every outgoing edge but the leftmost, and is rooted at the sink. The following remarkable facts hold: *The contour exploration of $T(m^{**})$ visits edges of m in the order $e_{|m|}, \dots, e_1$. Moreover, one can draw $T(m)$ and $T(m^{**})$ in the plane, one next to the other, in such a way that the interface between the two trees traces a path, called interface path³, from the source to the sink visiting edges $e_1, \dots, e_{|m|}$ in this order (see the middle picture of Figure 9.3 for an example).*

The following bijection between bipolar orientations and a specific family of two-dimensional walks in the non-negative quadrant was discovered by Kenyon, Miller, Sheffield and Wilson [KMSW19].

Definition 9.1.1. Let $n \geq 1$, $m \in \mathcal{O}_n$. We define $\text{OW}(m) = (X_t, Y_t)_{1 \leq t \leq n} \in (\mathbb{Z}_{\geq 0}^2)^n$ as follows: for $1 \leq t \leq n$, X_t is the height in the tree $T(m)$ of the bottom vertex of e_t (i.e. its distance in $T(m)$ from the source s), and Y_t is the height in the tree $T(m^{**})$ of the top vertex of e_t (i.e. its distance in $T(m^{**})$ from the sink s').

An example is given in the right-hand side of Figure 9.3.

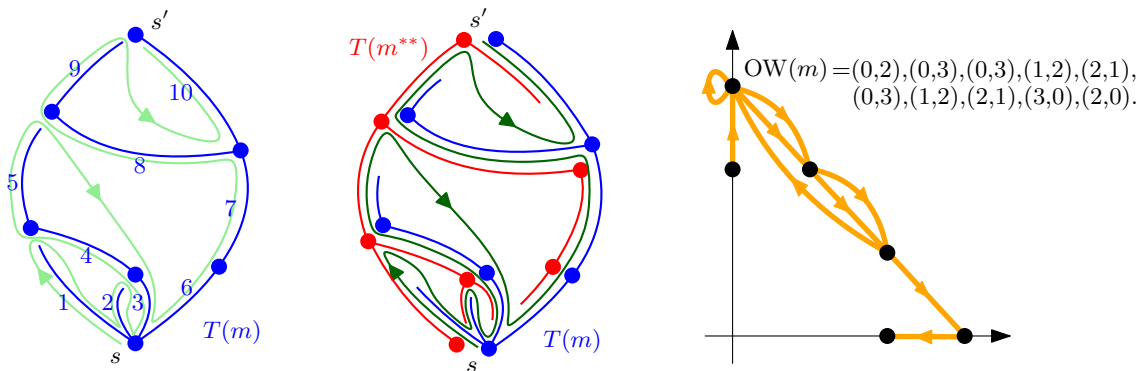

FIGURE 9.3. On the left-hand side the tree $T(m)$ built by disconnecting the bipolar orientation m from Figure 9.2 with the edges ordered according to the exploration process (in light green). In the middle, the two trees $T(m)$ and $T(m^{**})$ with the *interface path* tracking the interface between the two trees (in dark green). On the right-hand side, the two-dimensional walk $\text{OW}(m)$ defined in Definition 9.1.1.

Theorem 9.1.2 (Theorem 1 of [KMSW19]). *The mapping OW is a size-preserving bijection between \mathcal{O} and the set \mathcal{W} of walks in the non-negative quadrant $\mathbb{Z}_{\geq 0}^2$ starting on the y-axis, ending on the x-axis, and with increments in*

$$(9.1) \quad A = \{(+1, -1)\} \cup \{(-i, j), i \in \mathbb{Z}_{\geq 0}, j \in \mathbb{Z}_{\geq 0}\}.$$

3. Note that the interface path coincides with the clockwise contour exploration of $T(m)$, an example is given in the first two pictures of Figure 9.3.

We call \mathcal{W} the set of *tandem walks*, as done in [BFR19]. For more explanations on the bijection OW and the set \mathcal{W} we refer to Section 9.2.2.

We now introduce a second bijection, fundamental for our results, between bipolar orientations and Baxter permutations, discovered by Bonichon, Bousquet-Mélou and Fusy [BBF11].

Definition 9.1.3. Let $n \geq 1, m \in \mathcal{O}_n$. Recall that every edge of the map m corresponds to its dual edge in the dual map m^* . Let $\text{OP}(m)$ be the only permutation π such that for every $1 \leq i \leq n$, the i -th edge to be visited in the exploration of $T(m)$ corresponds to the $\pi(i)$ -th edge to be visited in the exploration of $T(m^*)$.

An example is given in Figure 9.4.

Theorem 9.1.4 (Theorem 2 of [BBF11]). *The mapping OP is a size-preserving bijection between the set \mathcal{O} of bipolar orientations and the set \mathcal{P} of Baxter permutations.*

The definition given in Definition 9.1.3 is a simple reformulation of the bijection presented in [BBF11], for more details see Section 9.2.3.

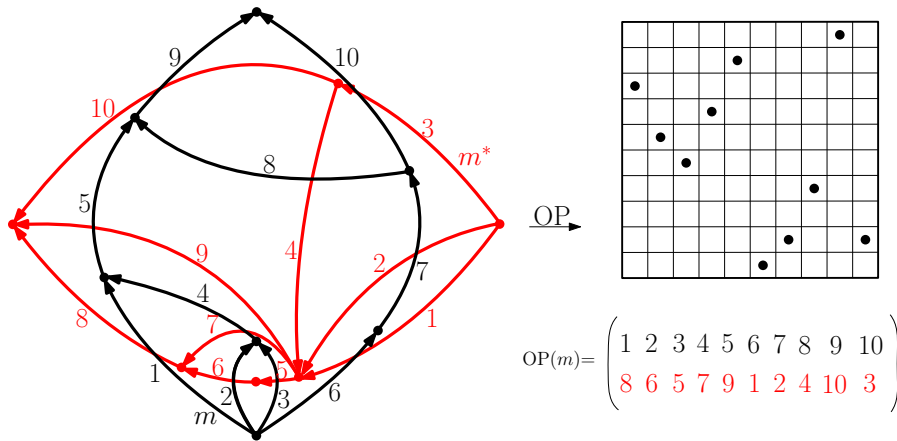

FIGURE 9.4. A schema explaining the mapping OP. On the left-hand side, the bipolar orientation m and its dual m^* , from Figure 9.2. We plot in black the labeling of the edges of m obtained in Figure 9.3 and in red the labeling of the edges of m^* obtained by the same procedure. On the right-hand side, the permutation $\text{OP}(m)$ (together with its diagram) obtained by pairing the labels of the corresponding primal and dual edges between m and m^* .

9.1.3. Coalescent-walk processes. So far we have considered three families of objects: Baxter permutations (\mathcal{P}), tandem walks (\mathcal{W}), and bipolar orientations (\mathcal{O}). We saw that they are linked by the mappings OW and OP.

To investigate local and scaling limits of Baxter permutations, it is natural to first prove local and scaling limits results for tandem walks (these results are standard, and some already available in the literature) and then try to transfer these convergences to permutations through the mapping $\text{OP} \circ \text{OW}^{-1}$. However, the definition of this composite mapping makes it not very tractable, and our first combinatorial result is a rewriting of it.

Consider a tandem walk $W = (X, Y) \in \mathcal{W}_n$ and the corresponding Baxter permutation $\sigma = \text{OP} \circ \text{OW}^{-1}(W)$. We introduce the *coalescent-walk process* driven by W . It is a family of discrete walks $Z = \{Z^{(i)}\}_{1 \leq i \leq n}$, where $Z^{(i)} = Z_t^{(i)}$ has time indexes $t \in \{i, \dots, n\}$ and it is informally defined as follows: $Z^{(i)}$ starts at 0 at time i , takes the same steps as Y when it is non-negative, takes the same steps as $-X$ when it is negative unless such a step would force $Z^{(i)}$ to become non-negative. If the latter case happens at time j , then $Z^{(i)}$ is forced to coalesce with $Z^{(j)}$ at time $j + 1$. For a precise definition we refer the reader

to Section 9.2.4. An illustration of a coalescent-walk process is given on the left-hand side of Figure 9.5. We denote by \mathcal{C}_n the set of coalescent-walk processes obtained in this way

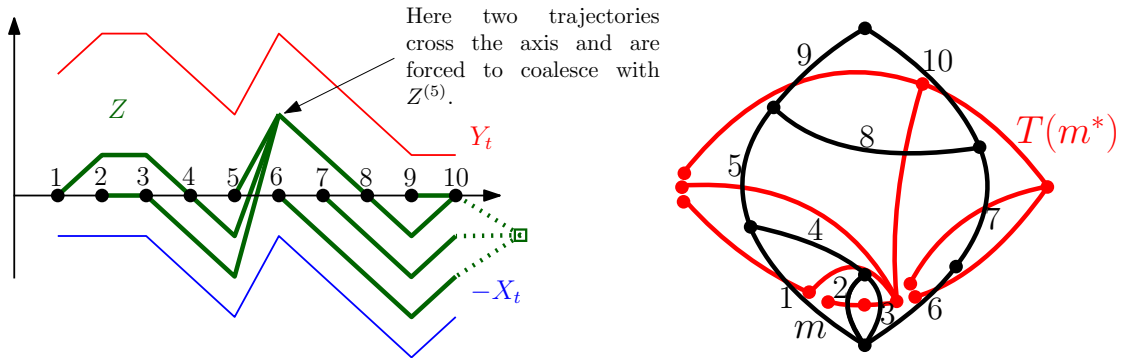

FIGURE 9.5. The coalescent-walk process $Z = \text{WC}(W)$ associated with the walk $W = (X, Y) = \text{OW}(m)$. The walk Y is plotted in red and $-X$ is plotted in blue. On the right-hand side, the map m together with the tree $T(m^*)$ drawn in red.

from tandem walks in \mathcal{W}_n , and we define $\text{WC} : \mathcal{W}_n \rightarrow \mathcal{C}_n$ to be the mapping that associate a tandem walk W with the corresponding coalescent-walk process Z .

In a coalescent-walk process, trajectories do not cross, hence the name. As a result, one can order them from bottom to top, defining a permutation of the integers. We denote by \mathfrak{S}_n the set of permutations of size n . If $Z \in \mathcal{C}_n$, we denote $\text{CP}(Z)$ the only permutation $\pi \in \mathfrak{S}_n$ such that for $i, j \in [n]$ with $i < j$, $\sigma(i) < \sigma(j)$ if and only if $Z_j^{(i)} < 0$. Note that $\text{CP} : \mathcal{C}_n \rightarrow \mathcal{P}_n$. The reader can check that in the case of Figure 9.5 we have $\text{CP}(Z) = 86579124103$, which corresponds to $\text{OP} \circ \text{OW}^{-1}(W)$ (see Figures 9.3 and 9.4) witnessing an instance of our main combinatorial result.

Theorem 9.1.5. *For all $n \in \mathbb{Z}_{>0}$, the following bijective diagram commutes*

$$(9.2) \quad \begin{array}{ccc} \mathcal{W}_n & \xrightarrow{\text{WC}} & \mathcal{C}_n \\ \text{OW} \uparrow & & \downarrow \text{CP} \\ \mathcal{O}_n & \xrightarrow{\text{OP}} & \mathcal{P}_n \end{array} .$$

Note that the mappings involved in the diagram are denoted using two letters that refer to the domain and co-domain. The proof of Theorem 9.1.5 is given in Section 9.2.5. The key-step is the following fact, proved in Proposition 9.2.17: *Given a bipolar orientation m , then the “branching structure” of the trajectories of the coalescent-walk process $\text{WC} \circ \text{OW}(m)$ is equal to the tree $T(m^*)$.* The reader is invited to verify it in Figure 9.5.

9.1.4. Local limit results. We can now consider local limits, more precisely Benjamini–Schramm limits, of the four families in Equation (9.2). Informally, Benjamini–Schramm convergence for discrete objects looks at the convergence of the neighborhoods of any fixed size of a uniformly distinguished point, called the root of the object. In order to properly define the Benjamini–Schramm convergence for the four families, we need to present the spaces of infinite objects and the respective local topologies. This is done in Sections 9.3.2 and 9.3.3, but we give a quick summary here.

- $\widetilde{\mathfrak{W}}_\bullet$ is the space of two-dimensional walks indexed by a finite or infinite interval of \mathbb{Z} containing zero, with value $(0, 0)$ at time 0, local convergence being finite-dimensional convergence.
- $\widetilde{\mathfrak{C}}_\bullet$ is the space of coalescent-walk processes indexed by a finite or infinite interval of \mathbb{Z} containing zero, local convergence being finite-dimensional convergence.

- The space $\tilde{\mathfrak{S}}_\bullet$ of infinite permutations and its local topology were defined in [Bor20b]. In this context, an infinite permutation is a total ordering on a finite or infinite interval of \mathbb{Z} containing zero.
- The space $\tilde{\mathfrak{m}}_\bullet$ of infinite rooted maps is equipped with the local topology derived from the local convergence of graphs of Benjamini and Schramm. See for instance [Cur18] for an introduction.

In the first three items, the index 0 has to be understood as the root of the infinite object, and comparison between a rooted finite object and an infinite one is done after applying the appropriate shift.

We define below the candidate local random limiting objects. Let ν denote the probability distribution on \mathbb{Z}^2 given by:

$$(9.3) \quad \nu = \frac{1}{2}\delta_{(+1,-1)} + \sum_{i,j \geq 0} 2^{-i-j-3}\delta_{(-i,j)}, \quad \text{where } \delta \text{ denotes the Dirac measure,}$$

and let⁴ $\overline{\mathbf{W}} = (\overline{\mathbf{X}}, \overline{\mathbf{Y}}) = (\overline{\mathbf{W}}_t)_{t \in \mathbb{Z}}$ be a two-sided random two-dimensional walk with step distribution ν , having value $(0, 0)$ at time 0. Remark that $\overline{\mathbf{W}}$ is not confined to the non-negative quadrant.

A formal definition of the other limiting objects requires an extension of the mappings in Equation (9.2) to infinite-volume objects⁵ which is done in Section 9.2.4, Section 9.3.1 and Section 9.3.2. Nevertheless, let $\overline{\mathbf{Z}} = \text{WC}(\overline{\mathbf{W}})$ be the corresponding infinite coalescent-walk process, $\overline{\sigma} = \text{CP}(\overline{\mathbf{Z}})$ the corresponding infinite permutation on \mathbb{Z} , and $\overline{\mathbf{m}} = \text{OW}^{-1}(\overline{\mathbf{W}})$ the corresponding infinite map. For every $n \in \mathbb{Z}_{>0}$, let $\mathbf{W}_n, \mathbf{Z}_n, \sigma_n$, and \mathbf{m}_n denote uniform objects of size n in $\mathcal{W}_n, \mathcal{C}_n, \mathcal{P}_n$, and \mathcal{O}_n respectively, related by the four bijections in the commutative diagram in Equation (9.2).

Theorem 9.1.6 (Quenched Benjamini–Schramm convergence). *Consider the sigma-algebra $\mathfrak{B}_n := \sigma(\mathbf{W}_n) = \sigma(\mathbf{Z}_n) = \sigma(\sigma_n) = \sigma(\mathbf{m}_n)$. Let \mathbf{i}_n be an independently chosen uniform index of $[n]$. We have the following convergence in probability in the space of probability measures on $\tilde{\mathfrak{W}}_\bullet \times \tilde{\mathfrak{C}}_\bullet \times \tilde{\mathfrak{S}}_\bullet \times \tilde{\mathfrak{m}}_\bullet$,*

$$(9.4) \quad \mathcal{L}\left(\left((\mathbf{W}_n, \mathbf{i}_n), (\mathbf{Z}_n, \mathbf{i}_n), (\sigma_n, \mathbf{i}_n), (\mathbf{m}_n, \mathbf{i}_n)\right) \middle| \mathfrak{B}_n\right) \xrightarrow[n \rightarrow \infty]{P} \mathcal{L}(\overline{\mathbf{W}}, \overline{\mathbf{Z}}, \overline{\sigma}, \overline{\mathbf{m}}),$$

where $\mathcal{L}(\cdot)$ denotes the law of a random variable.

We note that the mapping OW^{-1} naturally endows the map \mathbf{m}_n with an edge labeling and the root \mathbf{i}_n of \mathbf{m}_n is chosen according to this labeling. An immediate corollary, which follows by averaging, is the simpler *annealed* statement.

Corollary 9.1.7 (Annealed Benjamini–Schramm convergence). *We have the following convergence in distribution in the space $\tilde{\mathfrak{W}}_\bullet \times \tilde{\mathfrak{C}}_\bullet \times \tilde{\mathfrak{S}}_\bullet \times \tilde{\mathfrak{m}}_\bullet$,*

$$(9.5) \quad \left((\mathbf{W}_n, \mathbf{i}_n), (\mathbf{Z}_n, \mathbf{i}_n), (\sigma_n, \mathbf{i}_n), (\mathbf{m}_n, \mathbf{i}_n)\right) \xrightarrow[n \rightarrow \infty]{d} (\overline{\mathbf{W}}, \overline{\mathbf{Z}}, \overline{\sigma}, \overline{\mathbf{m}}).$$

Using the theory developed in [Bor20b], quenched convergence of permutations is equivalent to a statement on *consecutive patterns densities*. For $\pi \in \mathfrak{S}_k$ and $\sigma \in \mathfrak{S}_n$, denote $\widetilde{c\text{-occ}}(\pi, \sigma)$ the proportion of the $n - k + 1$ sets of k consecutive indices of $[n]$ that induce the pattern π in σ . Denote $\widetilde{c\text{-occ}}(\pi, \overline{\sigma})$ the probability that the restriction of the total order $\overline{\sigma}$ to an interval of size $|\pi|$ induces the pattern π (the choice of the interval is not relevant since $\overline{\sigma}$ is *shift-invariant*, for more details see [Bor20b, Section 2.6]). By [Bor20b, Corollary 2.38], quenched convergence of Baxter permutations implies the following.

4. Here and throughout the paper we denote random quantities using **bold** characters.

5. The terminology *finite/infinite-volume* refers to the fact that the objects are defined in a compact/non-compact set. For instance a Brownian motion with time space \mathbb{R} is a infinite-volume object and a Brownian excursion with time space $[0, 1]$ is a finite-volume object.

Corollary 9.1.8. *We have the following convergence in probability w.r.t. the product topology on $[0, 1]^{\mathfrak{S}}$.*

$$(9.6) \quad (\widehat{c\text{-occ}}(\pi, \sigma_n))_{\pi \in \mathfrak{S}} \xrightarrow{P} (\widehat{c\text{-occ}}(\pi, \bar{\sigma}))_{\pi \in \mathfrak{S}}.$$

We collect a few comments on these results.

- i) Equations (9.4) and (9.6) witness a concentration phenomenon. Indeed, in both instances, the left-hand side is random, and the right-hand side is deterministic.
- ii) The fact that the four convergences are joint follows from the fact that the extensions of the mappings in Equation (9.2) to infinite-volume objects are a.e. continuous.
- iii) The annealed Benjamini-Schramm convergence for bipolar orientations to the so-called *Uniform Infinite Bipolar Map* was already proven in [GHS17, Prop. 3.10] (see Section 9.1.6 for the relations between our work and existing works in the theory of planar maps).

9.1.5. Scaling limit results. We now turn to our main result. For $n \geq 1$, let σ_n be a uniform Baxter permutation of size n and $\mathbf{m}_n = \text{OP}^{-1}(\sigma_n)$ the corresponding uniform bipolar orientation with n edges. Let $\mathbf{W}_n = \text{OW}(\mathbf{m}_n)$ and $\mathbf{W}_n^* = \text{OW}(\mathbf{m}_n^*)$ be the two tandem walks associated with \mathbf{m}_n and to its dual \mathbf{m}_n^* . Let \mathcal{W}_n and \mathcal{W}_n^* be the two continuous functions from $[0, 1]$ to $\mathbb{R}_{\geq 0}^2$ that linearly interpolate between the points $\mathcal{W}_n^\theta(\frac{k}{n}) = \frac{1}{\sqrt{2n}} \mathbf{W}_n^\theta(k)$ for $1 \leq k \leq n$ and $\theta \in \{\emptyset, *\}$.

Let $\mathcal{W} = (\mathcal{X}(t), \mathcal{Y}(t))_{t \geq 0}$ be a *standard two-dimensional Brownian motion of correlation $-1/2$* , that is a continuous two-dimensional Gaussian process such that the components \mathcal{X} and \mathcal{Y} are standard one-dimensional Brownian motions, and $\text{Cov}(\mathcal{X}(t), \mathcal{Y}(s)) = -1/2 \cdot (t \wedge s)$. Let \mathcal{W}_e be a *two-dimensional Brownian excursion of correlation $-1/2$ in the non-negative quadrant*, that is the process $(\mathcal{W}(t))_{0 \leq t \leq 1}$ conditioned on $\mathcal{W}(1) = (0, 0)$ and on staying in the non-negative quadrant $\mathbb{R}_{\geq 0}^2$. A rigorous definition is given in Section 9.A.

Consider the time-reversal and coordinates-swapping mapping $s : \mathcal{C}([0, 1], \mathbb{R}^2) \rightarrow \mathcal{C}([0, 1], \mathbb{R}^2)$ defined by $s(f, g) = (g(1 - \cdot), f(1 - \cdot))$. Consider also the mapping $R : \mathcal{M} \rightarrow \mathcal{M}$ that rotates a permuton by an angle $-\pi/2$, that is $R(\mu)(A) = \mu\left(\begin{pmatrix} 0 & -1 \\ 1 & 0 \end{pmatrix} \cdot A\right)$ for every Borel set $A \subseteq [0, 1]^2$.

Theorem 9.1.9. *There exist two measurable mappings $r : \mathcal{C}([0, 1], \mathbb{R}_{\geq 0}^2) \rightarrow \mathcal{C}([0, 1], \mathbb{R}_{\geq 0}^2)$ and $\phi : \mathcal{C}([0, 1], \mathbb{R}_{\geq 0}^2) \rightarrow \mathcal{M}$ such that we have the convergence in distribution*

$$(9.7) \quad (\mathcal{W}_n, \mathcal{W}_n^*, \mu_{\sigma_n}) \rightarrow (\mathcal{W}_e, \mathcal{W}_e^*, \mu_B),$$

where $\mathcal{W}_e^* = r(\mathcal{W}_e)$, and $\mu_B = \phi(\mathcal{W}_e)$. In particular, we have $r(\mathcal{W}_e) \stackrel{d}{=} \mathcal{W}_e$. Moreover, we have the following equalities that hold at $\mathbb{P}_{\mathcal{W}_e}$ -almost every point of $\mathcal{C}([0, 1], \mathbb{R}_{\geq 0}^2)$,

$$r^2 = s, \quad r^4 = \text{Id}, \quad \phi \circ r = R \circ \phi.$$

We give a few remarks on this result:

- i) The convergence of the first or second marginal was obtained in [KMSW19] as an immediate application of the results of [DW15b] on walks in cones.
- ii) Our strategy of proof is based on coalescent-walk processes, which describe the relation between \mathcal{W}_n , \mathcal{W}_n^* and σ_n in a way that lends itself to take limits. In the remainder of this section we explain what is the scaling limit of coalescent-walk processes, providing the reader with some insights in how the coupling of the right-hand side of Equation (9.7) is constructed. Precise statements, including explicit constructions of the mappings r and ϕ , are given in Section 9.5 (see in particular Theorems 9.5.6 and 9.5.8).

- iii) The limiting permuton μ_B , called the *Baxter permuton*, is a new fractal random measure on the unit square (see Definition 9.5.4 for a precise definition and an explicit construction of the mapping ϕ).
- iv) Recall that each coordinate of \mathbf{W}_n or \mathbf{W}_n^* records the height function of a tree which can be drawn on \mathbf{m}_n or its dual. So this statement can be interpreted as joint convergence of four trees to a coupling of four Brownian CRTs. We discuss the relation with Conjecture 4.4 of [KMSW19], the main result of [GHS16], and other related works, in Section 9.1.6.

The proof of Theorem 9.1.9 is based on a result on scaling limits of the coalescent-walk processes $\mathbf{Z}_n = \text{WC}(\mathbf{W}_n)$, which appears to be of independent interest. We give here some brief explanations and we refer the reader to Section 9.4 for more precise results.

The definition of the coalescent-walk processes $Z = \text{WC}(W)$ associated with a two-dimensional walk W is a sort of “discretized” version of the following family of stochastic differential equation driven by *the same* two-dimensional process $\mathcal{W} = (\mathcal{X}, \mathcal{Y})$ and defined for $u \in \mathbb{R}$ by

$$(9.8) \quad \begin{cases} d\mathbf{z}^{(u)}(t) = \mathbb{1}_{\{\mathbf{z}^{(u)}(t) > 0\}} d\mathcal{Y}(t) - \mathbb{1}_{\{\mathbf{z}^{(u)}(t) \leq 0\}} d\mathcal{X}(t), & t \geq u, \\ \mathbf{z}^{(u)}(t) = 0, & t \leq u. \end{cases}$$

This equation, that goes under the name of *perturbed Tanaka’s SDE*, has already been studied in the literature [Pro13; CHK18] in the case where \mathcal{W} is a two-dimensional Brownian motion of correlation ρ with $\rho \in (-1, 1)$, and more generally when the correlation coefficient varies with time. In particular, pathwise uniqueness and existence of a strong solution are known. Since the scaling limit of \mathbf{W}_n (that is conditioned to start on the x -axis and end on the y -axis) is a two-dimensional Brownian excursion \mathcal{W}_e of correlation $-1/2$, one can expect that the scaling limit for the coalescent-walk process $\mathbf{Z}_n = \text{WC}(\mathbf{W}_n)$ is a sort of flow of solutions $\{\mathbf{z}^{(u)}(t)\}_{u \in [0,1]}$ of the SDEs in Equation (9.8) driven by \mathcal{W}_e (instead of \mathcal{W}). This intuition is made precise in Theorem 9.4.10 and it is the key-step for proving Theorem 9.1.9.

The study of flows of solutions driven by the same *noise* is the subject of the theory of coalescing flows of Le Jan and Raimond, specifically that of *flows of mappings*. See [LR04] and the references therein. We point out that since in our proof of Theorem 9.1.9 we consider solutions of Equation (9.8) for only a countable number of distinct u at a time for a specific equation which admits strong solutions, we do not need to make use of this theory. In particular, Theorem 9.4.10 gives convergence of a countable number of trajectories in the product topology. Stronger convergence results, such as the ones obtained for the *Brownian web* (see [SSS17] for a comprehensive survey) would be desirable.

We now turn on discussing the implications of Theorem 9.1.9 on the scaling limit of bipolar orientations and their trees.

9.1.6. Scaling limits of bipolar orientations and relations with other works.

Scaling limits of random planar maps have been thoroughly studied with motivations from string theory and conformal field theory. Convergence results for many models of random planar maps were obtained, both as random metric spaces (with the celebrated theorems of Le Gall and Miermont [Le 13; Mie13] showing convergence to the *Brownian map*) and, very recently, as random Riemann surfaces (to $\sqrt{8/3}$ -*Liouville quantum gravity* [HS19]).

The number of bipolar orientations of a given planar map is computed by coefficient extraction in the Tutte polynomial. This makes bipolar orientations one of the various combinatorially tractable models of *planar maps with additional structure*, like spanning-tree decorated maps, loop-decorated maps, and so on. Uniform objects in such combinatorial classes are not uniform planar maps anymore. Their scaling limit is expected to differ, and be connected to γ -*Liouville quantum gravity* (γ -LQG for short) for some $\gamma \neq \sqrt{8/3}$. While convergence results as random surfaces remain open, weaker topologies such as *Peanosphere*

convergence have been investigated with success. We refer to [GHS19] for a comprehensive survey.

The specific case of bipolar orientations was first studied by Kenyon, Miller, Sheffield and Wilson [KMSW19], using their bijection OW interpreted as a *mating-of-trees* encoding of bipolar orientations. Using the remarkable works of Denisov and Wachtel [DW15a] and Duraj and Wachtel [DW15b] on scaling limits of random walks conditioned to stay in a cone, they showed that the random tandem walk associated with a random bipolar orientation converges to a two-dimensional Brownian excursion of correlation $-1/2$ in the non-negative quadrant (this corresponds to the convergence of the first marginal in Equation (9.7)). This is called *Peanosphere convergence* of the maps decorated by their interface path to a $\sqrt{4/3}$ -LQG sphere together with a SLE_{12} curve.

A stronger result was given by Gwynne, Holden and Sun [GHS16], in the specific case of the *uniform infinite-volume bipolar triangulation (UIBT)*. They show a joint scaling limit result for the coding two-dimensional walks of this map and of its dual. The limit is a coupling of two plane Brownian motions defined by LQG and imaginary geometry theory.

The convergence of the first two marginals in Theorem 9.1.9 gives a parallel result for *finite-volume bipolar orientations* instead of *infinite-volume bipolar triangulations*. This answers Conjecture 4.4 of [KMSW19] more accurately than [GHS16]. The similarities and differences between our and their methods are discussed extensively in Section 9.B.2. At this stage, we merely point out that, while our discrete coalescent-walk processes is an extension (to general bipolar orientations) of one of their combinatorial constructions (for bipolar triangulations), the use of SDEs to describe the limiting process is new and sheds a different light on an intricate imaginary geometry coupling. We wish to explore consequences in further works.

We also mention the work of Li, Sun, and Watson [LSW17]: working in the setting of Schnyder woods, which can be understood as a biased model of bipolar orientations, they show a similar result to Theorem 9.1.9. In particular, they treat finite-volume objects coded by excursions. Their technique is similar to that of [GHS16].

9.1.7. Generality of our techniques and open problems. We discuss here some problems that we would like to address in future projects and some possible further applications of the techniques that we developed in the current paper.

Properties of the Baxter permuton. The Baxter permuton μ_B is a new fractal random measure of the unit square. We think it might be worth it to investigate its properties. The first two natural questions that we would like to answer are the following:

- What is the density of the intensity measure $\mathbb{E}[\mu_B]$?
- What is the Hausdorff dimension of the support of μ_B ?

We point out that similar questions were solved for the Brownian separable permuton (i.e. the permuton limit for separable permutations) in a recent work of the second author, see Chapter 4.

Strong convergence for coalescent-walk processes. As already mentioned, it would be desirable to improve the convergence of discrete coalescent-walk processes to continuous coalescent-walk processes in a stronger topology. As in the case of the Brownian web, this would allow to study coalescence points, non-uniqueness points, and the interaction between the coalescent process and its backwards version, features that are not captured in our results.

Generality of our techniques. We strongly believe that our techniques used for proving scaling limit results for uniform bipolar orientations would still apply (with minor modifications) to the weighted models of bipolar orientations considered in [KMSW19, Thm 2.6], including in particular uniform bipolar k -angulations for every $k \geq 3$. We point out that this weighting is not very natural in terms of the corresponding Baxter permutations.

Universality of the Baxter permuton and possible generalizations. We believe that the robustness of our techniques goes further, and hope to apply them to many other families of permutations, showing that the Baxter permuton μ_B is a *universal limiting object*.

- We will observe in Section 9.B.1 that the case of separable permutations can be treated with coalescent-walk processes too. In particular, we will explain that their limiting permutation, i.e. the Brownian separable permutation mentioned in Section 9.1.1, is related to the Tanaka’s SDE, which is Equation (9.8) when the driving process \mathbf{W} is a two-dimensional Brownian excursion of correlation $\rho = 1$.
- Recall that in the case of Baxter permutations, we had $\rho = -1/2$. It would be interesting to find families of permutations that correspond to yet other values of ρ . Baxter permutations avoiding the pattern 2413, which form a subset of Baxter permutations, and a superset of separable permutations, could be a good candidate for a first answer to this question above. In [BBF11, Proposition 5], they are shown to be in bijection, through OP, with rooted non-separable planar maps.
- We would like to explore several other families of permutations where a bijection with two-dimensional walks is available. A technique is presented in a recent work of the first author [Bor20a] to sample uniform permutations in families enumerated through generating trees with d -dimensional labels as conditioned random colored walks in \mathbb{Z}^d . Examples of families of permutations with two-dimensional labels can be found for instance in [Bou03; Eli07; BGRR18; BBGR19].
- In Section 9.B.2, we show how the LQG literature [GHS16; LSW17] suggests a more general version of the SDE (9.8) with an additional parameter p and a local time term (for more details see the SDE (9.61)). The SDE (9.8) corresponds to the special case $p = 1/2$. Such a generality might be needed to treat some of the models cited above.

The study of Schnyder woods by [LSW17] correspond to $\rho = -\frac{\sqrt{2}}{2}$ and $p = \frac{\sqrt{2}}{1+\sqrt{2}}$. However, the corresponding model of permutations is not natural (it is a weighted model of Baxter permutations). It would also be interesting to study the generalizations of Schnyder woods described in [BF12].

9.1.8. Outline of the paper. Section 9.2. After setting some definitions and recalling some properties of the bijection OW, we properly define coalescent-walk processes and prove Theorem 9.1.5. This section contains all discrete arguments used in the rest of the paper.

Section 9.3. This section is devoted to the proof of Theorem 9.1.6. We first define the local topologies and the infinite-volume objects. Then the argument follows readily from local convergence of uniform tandem walks \mathbf{W}_n to the random walk $\overline{\mathbf{W}}$, and local continuity of the mappings OW^{-1} , WC, CP. In particular, the local limit of Baxter permutations is defined from the infinite-volume coalescent-walk process $\mathbf{Z} = \text{WC}(\overline{\mathbf{W}})$, which enjoys the nice property that its trajectories are random walks (Proposition 9.3.3). This turns out to be useful also in the following sections.

Section 9.4. To proceed with the proof of Theorem 9.1.9, we need to show that the trajectories of the coalescent-walk process $\mathbf{Z}_n = \text{WC}(\mathbf{W}_n)$ converge in distribution, jointly with \mathbf{W}_n . We prove this for coalescent-walk processes driven by unconditioned random walks (Theorem 9.4.5). The proof relies on the pathwise uniqueness property of the SDE (9.8). We then transfer this result to two-dimensional excursions in the non-negative quadrant, culminating in Theorem 9.4.10, which is the basis for the next section.

Section 9.5. We finally state and prove Theorems 9.5.6 and 9.5.8, which are more precise versions of Theorem 9.1.9.

Section 9.A. This section contains absolute continuity results and local limits theorem used in the study of conditioned walks in the non-negative quadrant, extracted from [DW15a; DW15b; BFR19] or stated in a different form when needed.

Section 9.B. This section contains comments on possible generalizations.

Section 9.C. In this final section we explain how the simulations for Baxter permutations presented in the first page of this paper are obtained.

Acknowledgments of [BM20a]. Thanks to Mathilde Bouvel, Valentin Féray and Grégory Miermont for their dedicated supervision and enlightening discussions. Thanks to Nicolas Bonichon, Emmanuel Jacob, Jason Miller, Kilian Raschel, Olivier Raimond and Vitali Wachtel for enriching discussions and pointers.

9.2. Bipolar orientations, walks in cones, Baxter permutations and coalescent-walk processes

This section contains the combinatorial material relevant to our arguments. We first settle in Section 9.2.1 some definitions and terminology related to planar maps and rooted trees. Then in Section 9.2.2 we describe the reverse OW bijection and in Section 9.2.3 we show that the definition of OP given in Definition 9.1.3 is equivalent to the one presented in [BBF11]. Finally, Section 9.2.4 is the combinatorial heart of the paper: we properly introduce coalescent-walk processes and the mappings CP and WC, proving Theorem 9.1.5.

9.2.1. Planar maps and rooted trees. A *planar map* is a finite connected graph embedded in the plane with no edge-crossings, considered up to orientation-preserving homeomorphisms of the plane. A map has vertices, edges, and faces, the latter being the connected components of the plane remaining after deleting the edges. The outer face is unbounded, the inner faces are bounded⁶.

Alternatively, a planar map is a finite collection of finite polygons (the inner faces), glued along some pairs of edges, so that the resulting surface has the topology of the disc, i.e. is simply connected and has one boundary. We call finite map an arbitrary gluing of a finite collection of finite polygons. A submap m' of a planar map m is a subset of the inner faces of m , where gluing of faces in m' inherits from the gluing in m . The submap m' is in general a finite map, and it is a planar map if and only if it is simply connected.

For our purposes, we view rooted plane trees with the root at the bottom. A rooted plane tree may be seen as a set of edges equipped with a parent-child relation, where each edge has at most one parent. The children of each edge are ordered as well as the parentless edges, that are the edges on top of the root. Other edges sit on top of their respective parent in the prescribed ordering.

The *down-right tree* $T(m)$ of a bipolar orientation m was defined informally in the introduction. In this context, we have the following more rigorous definition:

- The edges of $T(m)$ are the edges of m .
- Let $e \in m$ and v its bottom vertex. The parent of e in $T(m)$ is the right-most incoming edge of v , if it exists.
- The ordering of edges on top of e in $T(m)$ is inherited from their ordering on top of their common bottom vertex in m .

We conclude this section recalling that the *exploration* of a tree T is the visit of its vertices (or its edges) starting from the root and following the contour of the tree in the clockwise order. Moreover, the *height process* of a tree T is the sequence of integers obtained by recording for each visited vertex (following the exploration of T) its distance to the root.

9.2.2. The Kenyon-Miller-Sheffield-Wilson bijection. We recall the definition of the mapping $\text{OW} : \mathcal{O} \rightarrow \mathcal{W}$ given in the introduction since it is fundamental for what follows.

⁶. The outer face plays a special role in the maps we consider. In the usual terminology of the literature, they are *planar maps with one boundary*.

Definition 9.2.1. Let $n \geq 1$, $m \in \mathcal{O}_n$. We define $\text{OW}(m) = (X_t, Y_t)_{1 \leq t \leq n} \in (\mathbb{Z}_{\geq 0}^2)^n$ as follows: for $1 \leq t \leq n$, X_t is the height in the tree $T(m)$ of the bottom vertex of e_t (i.e. its distance in $T(m)$ from the source s), and Y_t is the height in the tree $T(m^{**})$ of the top vertex of e_t (i.e. its distance in $T(m^{**})$ from the sink s').

Recall also that \mathcal{W} is the set of tandem walks, i.e. two-dimensional walks in the non-negative quadrant, starting at $(0, h)$ and ending at $(k, 0)$ for some $h \geq 0, k \geq 0$, with increments in $A = \{(+1, -1)\} \cup \{(-i, j), i \in \mathbb{Z}_{\geq 0}, j \in \mathbb{Z}_{\geq 0}\}$.

An equivalent way of understanding OW is as follows.

Remark 9.2.2. Let $m \in \mathcal{O}$ and $\text{OW}(m) = ((X_t, Y_t))_{1 \leq t \leq n}$. The walk $(0, X_1+1, \dots, X_{|m|}+1)$ is the height process of the tree $T(m)$. The walk $(0, Y_{|m|}+1, Y_{|m|-1}+1, \dots, Y_1+1)$ is the height process of the tree $T(m^{**})$.

We now explain some properties of the mapping OW. Let $m \in \mathcal{O}$ and $\text{OW}(m) = ((X_t, Y_t))_{1 \leq t \leq n}$. Suppose that the left outer face of m has $h+1$ edges and the right outer face of m has $k+1$ edges, for some $h, k \geq 0$. Then the walk $(X_t, Y_t)_{t \in [|m|]}$ starts at $(0, h)$, ends at $(k, 0)$, and stays by definition in the non-negative quadrant $\mathbb{Z}_{\geq 0}^2$.

We give an interpretation to the increments of the walk, i.e. the values of $(X_{t+1}, Y_{t+1}) - (X_t, Y_t)$. We say that two edges of a tree are consecutive if one is the parent of the other. The interface path of the map m , defined in Section 9.1.2, has two different behaviors:

- either it is following two edges e_t and e_{t+1} that are consecutive, both in $T(m)$ and $T(m^{**})$, in which case the increment is $(+1, -1)$;
- or it is first following e_t , then it is traversing a face of m , and finally is following e_{t+1} , in which case the increment is $(-i, +j)$ with $i, j \in \mathbb{Z}_{\geq 0}$, and the traversed face has left degree $i+1$ and right degree $j+1$.

Example 9.2.3. Consider the map m in Fig. 9.3. The corresponding walk $\text{OW}(m)$ plotted on the right-hand side of Figure 9.3 is:

$$\begin{aligned} W_1 &= (0, 2), W_2 = (0, 3), W_3 = (0, 3), W_4 = (1, 2), W_5 = (2, 1), \\ W_6 &= (0, 3), W_7 = (1, 2), W_8 = (2, 1), W_9 = (3, 0), W_{10} = (2, 0). \end{aligned}$$

Note, for instance, that $W_6 - W_5 = (-2, 2)$, indeed between the edges 5 and 6 the interface path is traversing a face with 3 edges on the left boundary and 3 edges on the right boundary. On the other hand $W_9 - W_8 = W_8 - W_7 = W_7 - W_6 = (+1, -1)$. Indeed, in these cases, the interface path is following consecutive edges.

We finish this section by describing the inverse bijection OW^{-1} . We actually construct a mapping Θ on a larger space of walks, whose restriction to \mathcal{W} is the inverse of OW.

Let I be an interval (finite or infinite) of \mathbb{Z} . Let $\mathfrak{W}(I)$ be the set of two-dimensional walks with time space I (considered up to an additive constant). More precisely $\mathfrak{W}(I)$ is the quotient $(\mathbb{Z}^2)^I / \sim$, where $w \sim w'$ if and only if there exists $x \in \mathbb{Z}^2$ such that $w(i) = w'(i) + x$ for all $i \in I$. We usually take an explicit representant of elements of $\mathfrak{W}(I)$, chosen according to context. For instance, if $0 \in I$, we often take the representant that verifies $w(0) = (0, 0)$, called “pinned at zero”. Let $\mathfrak{W}_A(I) \subset \mathfrak{W}(I)$ be the restriction to two-dimensional walks with increments in A . For every $n \geq 1$, \mathcal{W}_n is naturally embedded in $\mathfrak{W}_A([n])$, with an explicit representant.

Let $I = [j, k]$ be a finite integer interval. We shall define Θ on every walk in $\mathfrak{W}_A(I)$ by induction on the size of I , and denote by $\mathfrak{m}(I)$ the image of $\mathfrak{W}_A(I)$ by Θ . An element $m \in \mathfrak{m}(I)$ is a bipolar orientation, together with a subinterval of the interface path, started on the left boundary, and ended on the right boundary, labeled in sequence by j, \dots, k . The edges labeled j, \dots, k are called *explored edges*, and the edge labeled k is called *active*. The other edges, called *unexplored*, are either below j on the left boundary, or above k on the right boundary. Bipolar orientations of size $n \geq 1$ are the elements of $\mathfrak{m}([n])$ with no unexplored edges. The elements of $\mathfrak{m}(I)$ are called *marked bipolar orientations* by [BFR19].

The only element W of $\mathfrak{W}_A(\{j\})$ is mapped to a single edge with label j . If $W \in \mathfrak{W}_A([j, k])$ with $k > j$, then denote by $m' = \Theta(W|_{[j, k-1]})$ and

- i) if $W_k - W_{k-1} = (1, -1)$, then $\Theta(W)$ is obtained from m' , by giving label $k + 1$ to the edge immediately above the edge of label k . If no such edge exists, a new edge is added on top of the sink with label $k + 1$.
- ii) If $W_k - W_{k-1} = (-i, j)$, then $\Theta(W)$ is obtained from m' by adding a face of left-degree $i + 1$ and right-degree $j + 1$. Its left boundary is glued to the right boundary of m' , starting with identifying the top-left edge of the new face with e_k , and continuing with edges below. The bottom-right edge of the new face is given label $k + 1$, hence is now active. All other edges that were not present in m' are unexplored.

An example of this construction (inductively building $\Theta(W)$ with $W \in \mathcal{W}$) is given in Figure 9.6. For an example of application of the mapping Θ to a walk that is not a tandem walk see Figure 9.7.

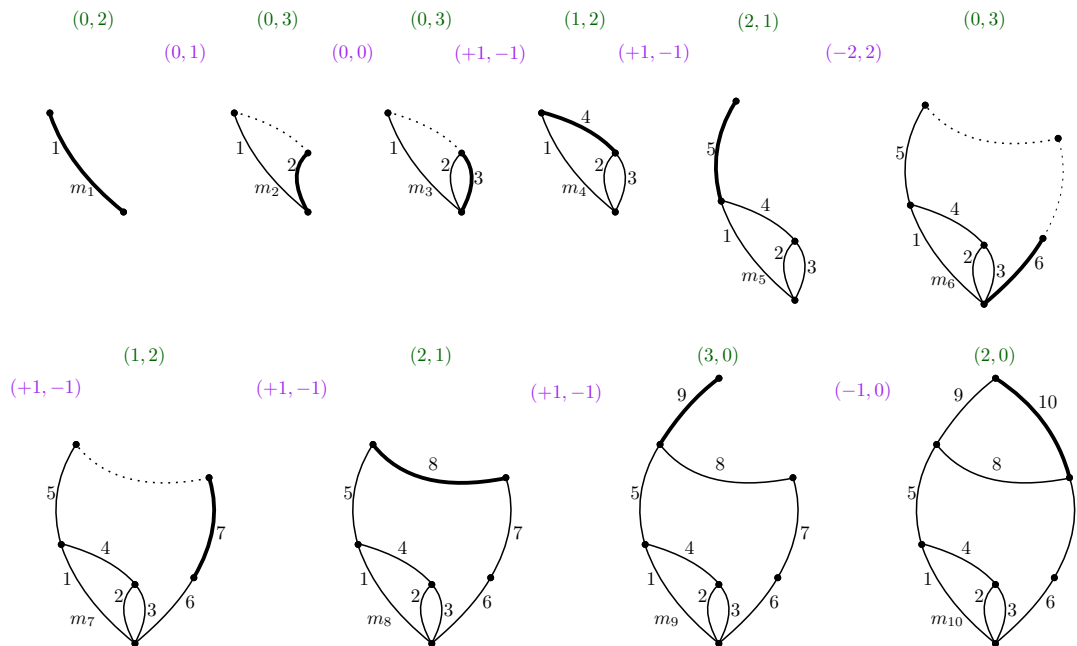

FIGURE 9.6. The sequence of bipolar orientations $m_k = \Theta(W|_{[1,k]})$ determined by the walk W considered in Example 9.2.3. Note that m_{10} is exactly the map m in Figure 9.2 and Figure 9.3. For each map m_k , we indicate on top of it (in green) the value W_k . Between two maps m_k and m_{k+1} , we report (in purple) the corresponding increment $W_{k+1} - W_k$. For every map m_k , we draw the explored edges with full lines, the unexplored edges with dotted lines, and we additionally highlight the active edge e_k in bold.

Proposition 9.2.4 (Theorem 1 of [KMSW19]). *For every finite interval I , the mapping $\Theta : \mathfrak{W}_A(I) \rightarrow \mathfrak{m}(I)$ is a bijection. Moreover, for every $n \geq 1$, $\Theta(\mathcal{W}_n) = \mathcal{O}_n$ and $\text{OW}^{-1} : \mathcal{W}_n \rightarrow \mathcal{O}_n$ coincides with Θ . Finally, if $W \in \mathfrak{W}_A(I)$ and $[j, k] \subset I$, then the map $\Theta(W|_{[j,k]})$ is the submap obtained from $\Theta(W)$ by keeping*

- i) edges with label j, \dots, k (explored edges);
- ii) faces that have explored edges on both their left and right boundary (explored faces);
- iii) other edges incident to explored faces (unexplored edges).

9.2.3. Baxter permutations and bipolar orientations. We first explain here why our mapping OP given in Definition 9.1.3 is the same as the bijection Ψ of Bonichon, Bousquet-Mélou and Fusy [BBF11, Section 3.2].

The definition of Ψ can be rephrased in our setting as follows. Let $m \in \mathcal{O}_n$ be a bipolar orientation. We denote by m^{-1} the symmetric image of m along the vertical axis. Consider

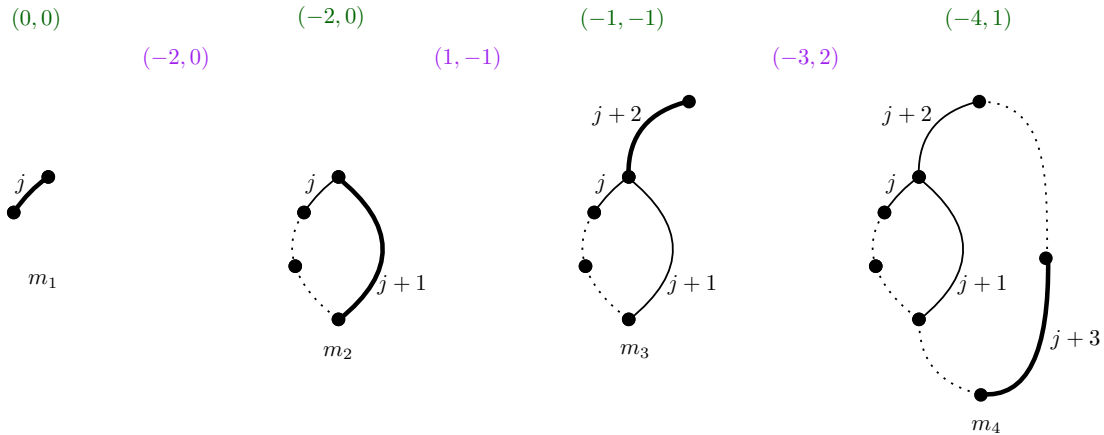

FIGURE 9.7. The sequence of bipolar orientations $m_k = \Theta(W|_{[j, j+k-1]})$ determined by the walk $W_j = (0, 0), W_{j+1} = (-2, 0), W_{j+2} = (-1, -1), W_{j+3} = (-4, 1)$, that is an element of the set $\mathfrak{W}_A([j, j+3])$. This walk is not a tandem walk. We used the same notation used in Figure 9.6.

the tree $T(m^{-1})$, and set $\Psi(m)$ to be the only permutation $\pi \in \mathfrak{S}_n$ such that for every $1 \leq i \leq n$, the i -th edge to be visited in the exploration of $T(m)$ corresponds to the $\pi(i)$ -th edge to be visited in the exploration of $T(m^{-1})$. It was observed in [BBF11, Remark 11] that the exploration of $T(m^{-1})$ visits edges of m in the same⁷ order as the exploration of $T(m^*)$, justifying that $\text{OP}(m) = \Psi(m)$.

We have the following additional properties of the mapping OP .

Theorem 9.2.5 ([BBF11], Theorems 2 and 3, and Propositions 1 and 4). *One can draw m on the diagram of $\text{OP}(m)$ in such a way that every edge of m passes through the corresponding point of $\text{OP}(m)$. Moreover, we have the following symmetry properties:*

- i) denoting by σ^* the permutation obtained by rotating the diagram of $\sigma \in \mathfrak{S}_n$ clockwise by angle $\pi/2$, we have $\text{OP}(m^*) = \text{OP}(m)^*$;
- ii) we have $\text{OP}(m^{-1}) = \text{OP}(m)^{-1}$.

9.2.4. Discrete coalescent-walk processes. This subsection is devoted to defining coalescent-walk processes and our specific model of coalescent-walk processes obtained from tandem walks by the mapping WC . We then define the permutation and forest naturally associated with a coalescent-walk process.

Definition 9.2.6. Let I be a (finite or infinite) interval of \mathbb{Z} . We call *coalescent-walk process* on I a family $\{(Z_s^{(t)})_{s \geq t, s \in I}\}_{t \in I}$ of one-dimensional walks such that:

- for every $t \in I$, $Z_t^{(t)} = 0$;
- for $t' \geq t \in I$, if $Z_k^{(t)} \geq Z_k^{(t')}$ (resp. $Z_k^{(t)} \leq Z_k^{(t')}$) then $Z_{k'}^{(t)} \geq Z_{k'}^{(t')}$ (resp. $Z_{k'}^{(t)} \leq Z_{k'}^{(t')}$) for every $k' \geq k$.

Note that, as a consequence, if there is a time k such that $Z_k^{(t)} = Z_k^{(t')}$, then $Z_{k'}^{(t)} = Z_{k'}^{(t')}$ for every $k' \geq k$. In this case, we say that $Z^{(t)}$ and $Z^{(t')}$ are *coalescing* and we call *coalescent point* of $Z^{(t)}$ and $Z^{(t')}$ the point $(\ell, Z_\ell^{(t)})$ such that $\ell = \min\{k \geq \max\{t, t'\} \mid Z_k^{(t)} = Z_k^{(t')}\}$.

We denote by $\mathfrak{C}(I)$ the set of coalescent-walk processes on some interval I .

7. Actually a stronger result holds: $T(m^{-1})$ and $T(m^{**})$ are related by a classic bijection of the set of finite trees, which is the counterpart of the *Kreweras complement* for non-crossing partitions: the Lukasiewicz walk of $T(m^{**})$ is the reversal of the height function of $T(m^{-1})$. In particular they have the same scaling limit. This is similar to [GHS16, Lemma 2.4].

9.2.4.1. *The coalescent-walk process associated with a two-dimensional walk.* We introduce formally the coalescent-walk processes driven by some specific two-dimensional walks that include tandem walks. Let I be a (finite or infinite) interval of \mathbb{Z} . Recall that $\mathfrak{W}_A(I)$ denotes the set of walks (considered up to an additive constant) indexed by I , and that take their increments in A , defined in Equation (9.1) page 170.

Definition 9.2.7. Let $W \in \mathfrak{W}_A(I)$ and denote by $W_t = (X_t, Y_t)$ for $t \in I$. The *coalescent-walk process associated with W* is the family of walks $\text{WC}(W) = \{Z^{(t)}\}_{t \in I}$, defined for $t \in I$ by $Z_t^{(t)} = 0$, and for all $\ell \geq t$ such that $\ell + 1 \in I$,

- if $W_{\ell+1} - W_\ell = (1, -1)$ then $Z_{\ell+1}^{(t)} - Z_\ell^{(t)} = -1$;
- if $W_{\ell+1} - W_\ell = (-i, j)$, for some $i, j \geq 0$, then

$$Z_{\ell+1}^{(t)} - Z_\ell^{(t)} = \begin{cases} j, & \text{if } Z_\ell^{(t)} \geq 0, \\ i, & \text{if } Z_\ell^{(t)} < 0 \text{ and } Z_\ell^{(t)} < -i, \\ j - Z_\ell^{(t)}, & \text{if } Z_\ell^{(t)} < 0 \text{ and } Z_\ell^{(t)} \geq -i. \end{cases}$$

Note that this definition is invariant by addition of a constant to W . We check easily that $\text{WC}(W)$ is a coalescent process meaning that WC is a mapping $\mathfrak{W}_A(I) \rightarrow \mathfrak{C}(I)$. We also set $\mathcal{C}_n = \text{WC}(\mathcal{W}_n)$ and $\mathcal{C} = \cup_{n \in \mathbb{Z}_{\geq 0}} \mathcal{C}_n$. For two examples, we refer the reader to the left-hand side of Figure 9.5 and to Figure 9.8. We finally suggest to the reader to compare the formal Definition 9.2.7 with the more intuitive definition given in Section 9.1.3.

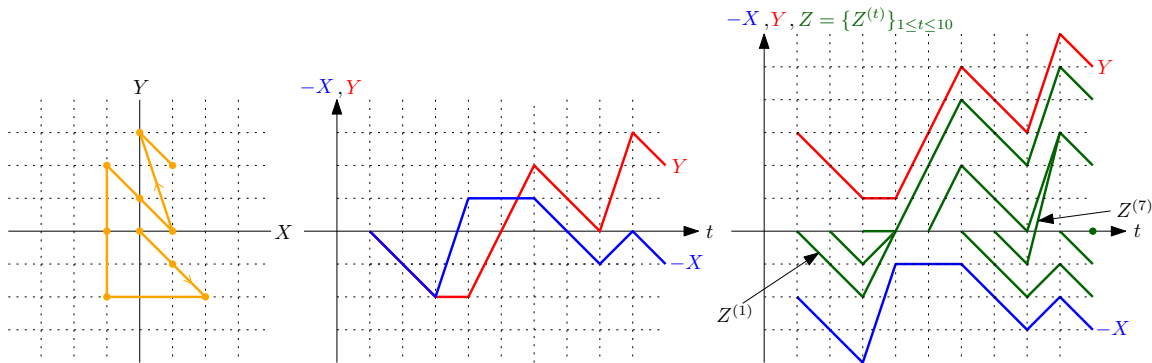

FIGURE 9.8. Construction of the coalescent-walk process associated with the orange walk $W = (W_t)_{1 \leq t \leq 10}$ on the left-hand side. In the middle diagram the two walks Y (in red) and $-X$ (in blue) are plotted. Finally, on the right-hand side the two walks are shifted (one towards the top and one to the bottom) and the ten walks of the coalescent-walk process are plotted in green.

Observation 9.2.8. The y -coordinates of the coalescent points of a coalescent-walk process obtained in this fashion are non-negative.

9.2.4.2. *The permutation associated with a coalescent-walk process.* Given a coalescent-walk process on $Z = \{Z^{(t)}\}_{t \in I} \in \mathfrak{C}(I)$ defined on a (finite or infinite) interval I , we can define a binary relation \leq_Z on I as follows:

$$(9.9) \quad \begin{cases} i \leq_Z i, \\ i \leq_Z j, & \text{if } i < j \text{ and } Z_j^{(i)} < 0, \\ j \leq_Z i, & \text{if } i < j \text{ and } Z_j^{(i)} \geq 0. \end{cases}$$

Proposition 9.2.9. \leq_Z is a total order on I .

PROOF. Since every pair in I is comparable by definition, we just have to check that \leq_Z is an order. By construction it is antisymmetric and reflexive. For transitivity, take $i < j < k$. If $Z_k^{(i)}$ and $Z_k^{(j)}$ are both negative, then $i \leq_Z k$ and $j \leq_Z k$ and whatever the relative ordering between i and j , transitivity holds on $\{i, j, k\}$. If they are both non-negative, the same reasoning holds. If one of them is non-negative, and one of them is negative, say $Z_k^{(i)} < 0 \leq Z_k^{(j)}$ (the other case is similar), then $i \leq_Z k$ and $k \leq_Z j$. Now by definition of coalescent-walk process, it must be that $Z_j^{(i)} < Z_j^{(j)} = 0$, so that $i \leq_Z j$ and transitivity holds on $\{i, j, k\}$. \square

This definition allows to associate a permutation with a coalescent-walk process on the interval $[n]$.

Definition 9.2.10. Fix $n \in \mathbb{Z}_{\geq 0}$. Let $Z = \{Z^{(t)}\}_{t \in [n]} \in \mathfrak{C}([n])$ be a coalescent-walk process on $[n]$. Denote $\text{CP}(Z)$ the unique permutation $\sigma \in \mathfrak{S}_n$ such that for all $1 \leq i, j \leq n$,

$$\sigma(i) \leq \sigma(j) \iff i \leq_Z j.$$

We will furnish an example that clarifies the definition above in Example 9.2.16 below.

We have that pattern extraction in the permutation $\text{CP}(Z)$ depends only on a finite number of trajectories (see Proposition 9.2.11 below), a key step towards proving permuton convergence for uniform Baxter permutations.

If x_1, \dots, x_n is a sequence of distinct numbers, let $\text{std}(x_1, \dots, x_n)$ be the unique permutation π in \mathfrak{S}_n that is in the same relative order as x_1, \dots, x_n , i.e., $\pi(i) < \pi(j)$ if and only if $x_i < x_j$. Given a permutation $\sigma \in \mathfrak{S}_n$ and a subset of indices $I \subseteq [n]$, let $\text{pat}_I(\sigma)$ be the permutation induced by $(\sigma(i))_{i \in I}$, namely, $\text{pat}_I(\sigma) := \text{std}((\sigma(i))_{i \in I})$. For example, if $\sigma = 87532461$ and $I = \{2, 4, 7\}$ then $\text{pat}_{\{2,4,7\}}(87532461) = \text{std}(736) = 312$.

Proposition 9.2.11. Let σ be a permutation obtained from a coalescent-walk process $Z = \{Z^{(t)}\}_{1 \leq t \leq N}$ via the mapping CP . Let $I = \{i_1 < \dots < i_k\} \subseteq [n]$. Then $\text{pat}_I(\sigma) = \pi$ if and only if the following condition holds: for all $1 \leq \ell < s \leq k$,

$$Z_{i_s}^{(i_\ell)} \geq 0 \iff \pi(s) < \pi(\ell).$$

This proposition is immediate once one notes that

$$Z_{i_s}^{(i_\ell)} \geq 0 \iff i_s \leq_Z i_\ell \iff \sigma(i_s) \leq \sigma(i_\ell) \iff \pi(s) < \pi(\ell).$$

9.2.4.3. *The coalescent forest of a coalescent-walk process.* Note that given a coalescent-walk process on $[n]$, the plane drawing of the family of the trajectories $\{Z^{(t)}\}_{t \in I}$ identifies a natural tree structure, more precisely, a \mathbb{Z} -planted plane forest, as per the following definition.

Definition 9.2.12. A \mathbb{Z} -planted plane tree is a rooted plane tree such that the root has an additional parent-less edge that is equipped with a number in \mathbb{Z} called its (root-)index.

A \mathbb{Z} -planted plane forest is an ordered sequence of \mathbb{Z} -planted plane trees (T_1, \dots, T_ℓ) such that the (root-)indexes are weakly increasing along the sequence of trees. A \mathbb{Z} -planted plane forest admits an exploration process, which is the concatenation of the exploration processes of all the trees, following the order of the sequence.

An example of a \mathbb{Z} -planted plane forest is given on the right-hand side of Figure 9.9 (each tree is drawn with the root on the right; trees are ordered from bottom to top; the root-indexes are indicated on the right of each tree).

We give here a formal definition of the \mathbb{Z} -planted plane forest corresponding to a coalescent-walk process. For a more informal description, we suggest to look at Figure 9.9 and at the description given in Example 9.2.16.

Definition 9.2.13. Let Z be a coalescent-walk process on a finite interval I . Its forest, denoted $\text{LFor}(Z)$ for "labeled forest", is a \mathbb{Z} -planted plane forest with additional edge labels in I , defined as follows:

- the edge-set is I , vertices are identified with their parent edge, and the edge $i \in I$ is understood as bearing the label i .
- For any pair of edges (i, j) with $i < j$, i is a child of j if $(j, 0)$ is the coalescent point of $Z^{(i)}$ and $Z^{(j)}$.
- Children of a given parent are ordered by \leq_Z .
- The different trees of the forests are ordered such that their root-edges are in increasing \leq_Z -order.
- The index of the tree whose root-edge has label i is the value $Z_{\max I}^{(i)}$.

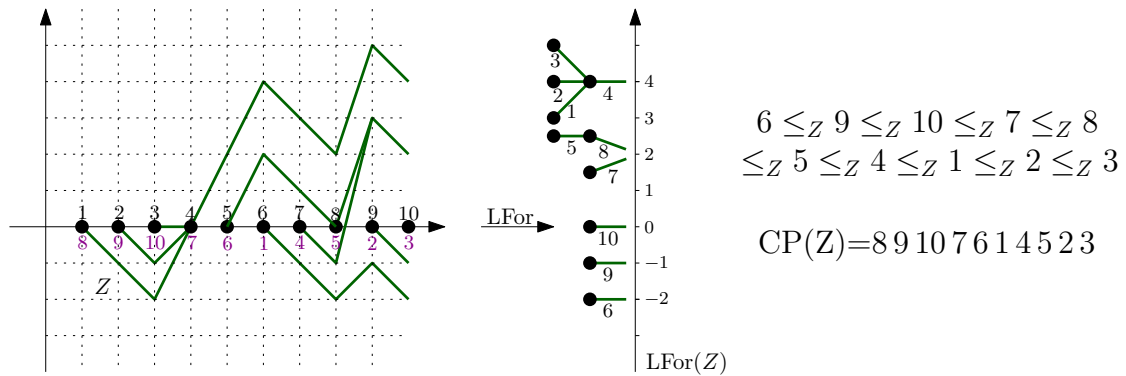

FIGURE 9.9. In the middle of the picture, the forest $\text{LFor}(Z)$ corresponding to the coalescent-walk process represented on the left that was obtained in Figure 9.8. How this forest is constructed is explained in Example 9.2.16. On the right-hand side we also draw the associated total order \leq_Z and the associated permutation $\text{CP}(Z)$.

We have the following result, which is immediate from the properties of a coalescent-walk process.

Proposition 9.2.14. $\text{LFor}(Z)$ is a \mathbb{Z} -planted plane forest, equipped with a labeling of its edges by the values of I . Moreover the total order \leq_Z on I coincides with the total order given by the exploration process of the forest $\text{LFor}(Z)$.

Remark 9.2.15. In the case where $I = [n]$ for some $n \in \mathbb{Z}_{\geq 0}$, the permutation $\pi = \text{CP}(Z)$ is readily obtained from $\text{LFor}(Z)$: for $1 \leq i \leq n$, $\pi(i)$ is the position in the exploration of $\text{LFor}(Z)$ of the edge with label i .

Example 9.2.16. Figure 9.9 shows the forest of trees $\text{LFor}(Z)$ corresponding to the coalescent-walk process $Z = \{Z^{(t)}\}_{t \in [10]}$ plotted on the left-hand side (where the forest is plotted from bottom to top). It can be obtained by marking with ten dots the points $\{(t, Z_t^{(t)} = 0)\}_{t \in [10]}$. The edge structure of the trees in $\text{LFor}(Z)$ is given by the green lines starting at each dot, and interrupted at the next dot. The lines that go to the end uninterrupted (for example this is the case of the line starting at the fourth dot), correspond to the root-edges of the different trees. The plane structure of $\text{LFor}(Z)$ is inherited from the drawing of Z in the plane.

We determine the order \leq_Z by considering the exploration process of the forest: $6 \leq_Z 9 \leq_Z 10 \leq_Z 7 \leq_Z 8 \leq_Z 5 \leq_Z 4 \leq_Z 1 \leq_Z 2 \leq_Z 3$. As a result, $\text{CP}(Z) = 89107614523$.

Equivalently, we can pull back (on the points $(t, Z_t^{(t)} = 0)$ of the coalescent-walk process) the position of the edges in the exploration process (these positions are written in purple), and then $\text{CP}(Z)$ is obtained by reading these numbers from left to right.

9.2.5. From walks to Baxter permutations via coalescent-walk processes.

We are now in position to prove the main result of this section, that is Theorem 9.1.5.

We are going to show that $OP = CP \circ WC \circ OW$. The key ingredient is to show that the dual tree $T(m^*)$ of a bipolar orientation can be recovered from its encoding two-dimensional walk by building the associated coalescent-walk process Z and looking at the coalescent forest $LFor(Z)$. More precisely, let $W = (W_t)_{t \in [n]} = OW(m)$ be the walk encoding a given bipolar orientation m , and $Z = WC(W)$ be the corresponding coalescent-walk process. Then the following result holds.

Proposition 9.2.17. *The following are equal:*

- the dual tree $T(m^*)$ with edges labeled according to the order given by the exploration of $T(m)$;
- the tree obtained by attaching all the edge-labeled trees of $LFor(Z)$ to a common root.

Theorem 9.1.5 then follows immediately, by construction of $OP(m)$ from $T(m^*)$ and $T(m)$ (Theorem 9.1.4) and of $CP(Z)$ from $LFor(Z)$ (Remark 9.2.15). Proposition 9.2.17 is illustrated in an example in Figure 9.10.

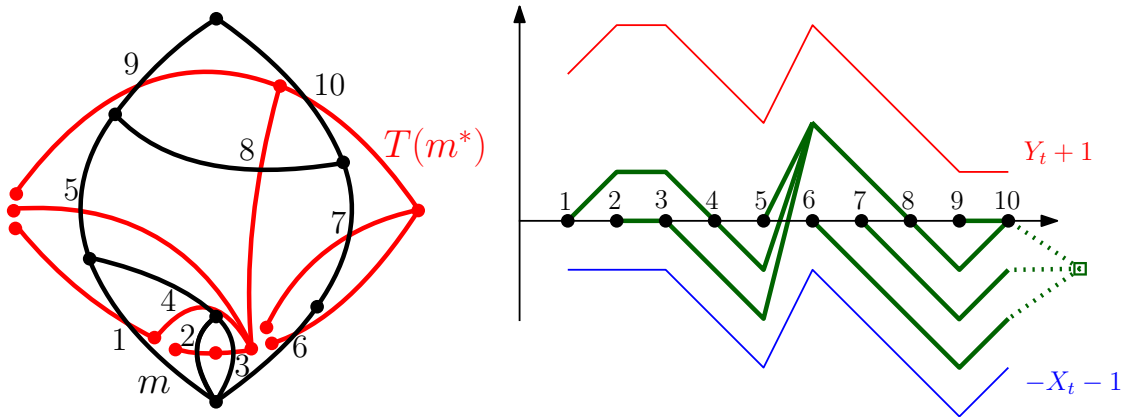

FIGURE 9.10. In the left-hand side the map m from Figure 9.4 with the dual tree $T(m^*)$ in red with edges labeled according to the order given by the exploration of $T(m)$. In the right-hand side the associated coalescent-walk process $Z = WC \circ OW(m)$. Note that the red tree (with its labeling) and the green tree (with its labeling) are equal.

An interesting corollary of Proposition 9.2.17, useful for later purposes (see for instance Section 9.2.6), is the following result. Given a coalescent-walk process Z , we introduce the discrete local time process $L_Z = (L_Z^{(i)}(j))$, $1 \leq i \leq j \leq n$, defined by

$$(9.10) \quad L_Z^{(i)}(j) = \# \left\{ k \in [i, j] \mid Z_k^{(i)} = 0 \right\}.$$

Corollary 9.2.18. *Let (m, W, Z, σ) be objects of size n in $\mathcal{O} \times \mathcal{W} \times \mathcal{C} \times \mathcal{P}$ connected by the commuting diagram in Equation (9.2). Then the height process $(X_i^*)_{i \in [n]}$ of $T(m^*)$ is equal to $(L_Z^{(\sigma^{-1}(i))}(n))_{i \in [n]}$. In other words,*

$$X_{\sigma(i)}^* = L_Z^{(i)}(n) - 1, \quad i \in [n].$$

We make the following observation useful for later purposes.

Observation 9.2.19. Consider the tree $T(m^*)$ with edges labeled according to its exploration process. Let P_i be the ancestry line in $T(m^*)$ of the edge $\sigma(i)$, i.e. the sequence of edges in the unique path in $T(m^*)$ from the edge $\sigma(i)$ to the root of $T(m^*)$. Then, for $1 \leq i \leq j \leq n$, $L_Z^{(i)}(j)$ is equal to the number of edges in P_i with a $T(m)$ -label weakly smaller than j .

The rest of this section is devoted to proving Proposition 9.2.17. We will proceed by induction on the size of m . Because a restriction of a walk in \mathcal{W} is not necessarily in \mathcal{W} , we will work on the larger space \mathfrak{M}_A and the corresponding space of maps $\mathfrak{m}(I)$.

We start with a few definitions. Let I be a finite interval and take $m \in \mathfrak{m}(I)$, recalling the definition of $\mathfrak{m}(I)$ from Section 9.2.2. In particular, m is a bipolar orientation with explored edges labeled by I , and possibly unexplored edges at the top of its right boundary and at the bottom of its left boundary. The edge labeled by $\max I$ is called active. For $i \in I$, denote by e_i the explored edge bearing label i in m . Denote e_i^* its dual edge in the map m^* .

Definition 9.2.20. The \mathbb{Z} -planted, edge-labeled, plane forest $\text{DualF}(m)$ is the restriction of $T(m^*)$ to edges $(e_i^*)_{i \in I}$. More precisely,

- i) The edge-set of $\text{DualF}(m)$ is $(e_i^*)_{i \in I}$.
- ii) An edge e_i^* is on top of e_j^* if it is the case in $T(m^*)$.
- iii) Parent-less edges are planted in \mathbb{Z} according to the following rule:
 - (a) if e_i^* is dual to an explored edge on the right boundary of m , then it is indexed by its non-positive height relative to the active edge;
 - (b) otherwise, e_i is at the left of an inner face f of m , so that the parent of e_i^* in $T(m^*)$ must be dual to an unexplored edge which is at the top-right edge of f . We index e_i^* by the (positive) height of this edge relative to the active edge.

This construction is illustrated in Figure 9.11. We remark that if $m \in \mathcal{O}$ (this is for

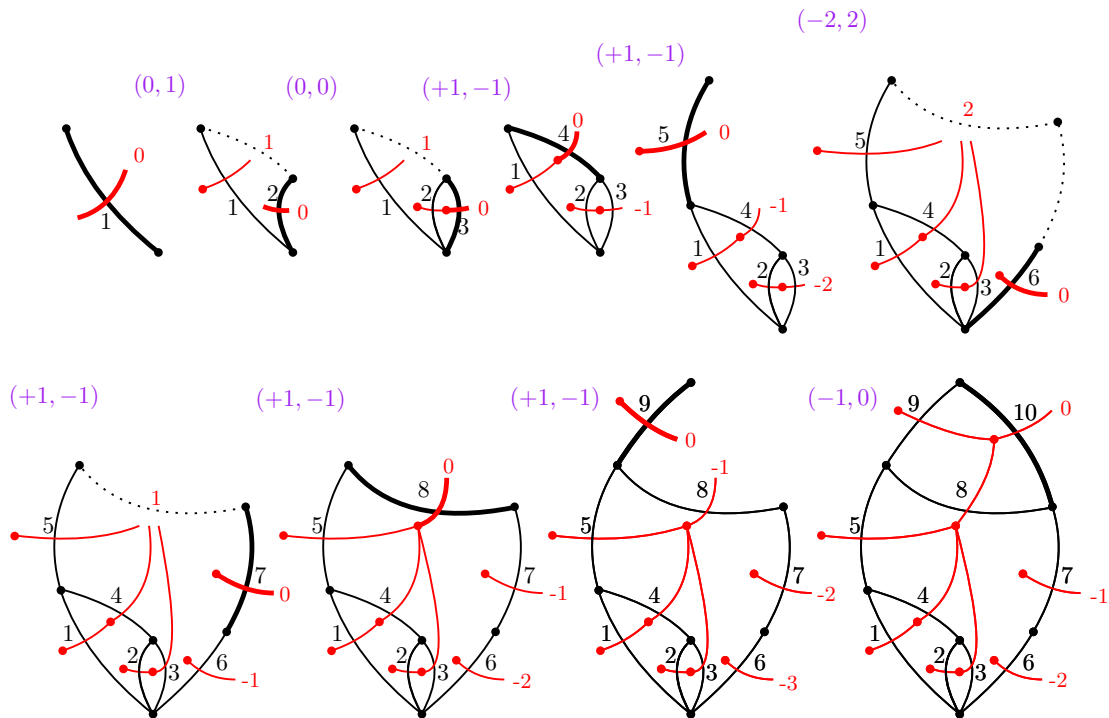

FIGURE 9.11. The forests $\text{DualF}(m_1), \dots, \text{DualF}(m_{10})$ drawn on top of the maps m_1, \dots, m_{10} of Figure 9.6, with the increments of the walk W in purple. We notice that for $m_{10} = m \in \mathcal{O}$, $\text{DualF}(m)$ is just $T(m^*)$ disconnected at its root.

instance the case of the last picture in Figure 9.11), then $\text{DualF}(m)$ is simply obtained by disconnecting $T(m^*)$ at its root, labeling all edges according to their position in the exploration of $T(m)$, and indexing root-edges by their (non-positive) height on the right boundary of m . Thus, the next result implies Proposition 9.2.17.

Proposition 9.2.21. *Let I be a finite interval and $W \in \mathfrak{W}_A(I)$. Set $Z = \text{WC}(W)$ and $m = \Theta(W)$. Then*

$$\text{DualF}(m) = \text{LFor}(Z).$$

PROOF. We will proceed by induction on the size of I . If $I = \{k\}$, both $\text{DualF}(m)$ and $\text{LFor}(Z)$ consist of a single edge planted at 0 with label k . For the induction step, assume $I = [j, k + 1]$ with $j \leq k$, and let $m' = \Theta(W|_{[j,k]})$. We will compare how $F = \text{DualF}(m)$ is obtained from $F' = \text{DualF}(m')$ and how $\text{LFor}(Z)$ is obtained from $\text{LFor}(Z|_{[j,k]})$, distinguishing two cases according to the increment $W_{k+1} - W_k$.

First case: $W_{k+1} - W_k = (+1, -1)$. In this case, m is obtained from m' by moving the active edge up by one. So that F has an additional edge (dual to e_{k+1}) compared to F' . This edge is parent-less, has index 0, and is now the parent of all (previously parent-less) edges that used to have index 1. All other parent-less edges remain parent-less and their indices decrease by 1.

Second case: $W_{k+1} - W_k = (-i, j)$, for $i \geq 0, j \geq 0$. In this case, m is obtained from m' by gluing a face f of left-degree $i + 1$ and right-degree $j + 1$ to the right boundary of m' . The previous active edge e_k is at the top-left of f , and the new active edge e_{k+1} at the bottom-right of f . Parent-less edges of positive index in F' are still parent-less edges in F , and their index increases by j . Parent-less edges of index smaller than $-i$ are still parent-less edges, and their index increases by i . Parent-less edges of F' with index $0, -1, \dots, -i$ are children in $T(m^*)$ of the edge dual to the top-right edge \bar{e} of f . We now have two sub-cases.

- i) If $h = 0$, then $\bar{e} = e_{k+1}$ is the new active edge, so parent-less edges of F' with index $0, \dots, -i$ are now children of the new parent-less edge e_{k+1} at height 0.
- ii) If $h > 0$, then \bar{e} is not an explored edge, so parent-less edges of F' with index $0, \dots, -i$ are still parent-less edges, but their index is now the height of \bar{e} which is h . Finally, e_{k+1} is a new parent-less edge of index 0 with no children.

Comparing this with the evolution between $\text{LFor}(Z|_{[j,k]})$ and $\text{LFor}(Z)$ (see Figure 9.12 and Definition 9.2.20) yields the proposition. \square

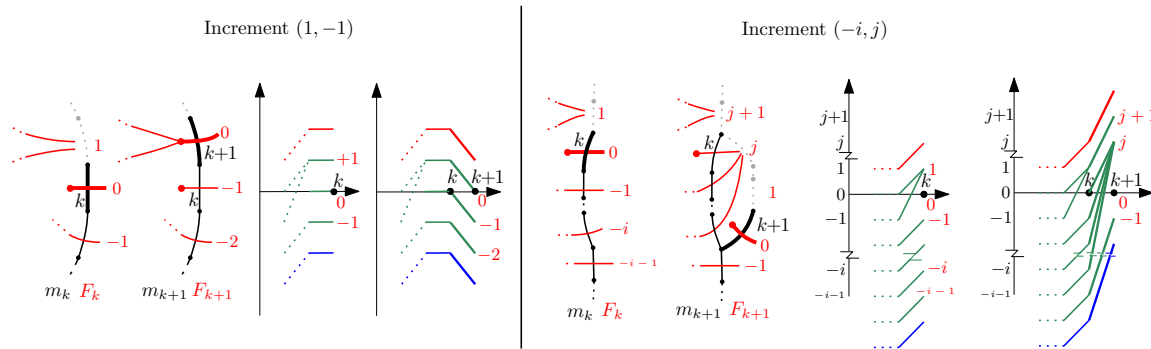

FIGURE 9.12. The evolution between the forests $F = F_k$ and $F' = F_{k+1}$ in parallel with the increments of the coalescent-walk process Z between times k and $k + 1$. On the left-hand side the first case of the proof of Proposition 9.2.21 and on the right-hand side the second one (subcase 2).

We collect for future use the following consequence.

Corollary 9.2.22. *Let I be a finite interval and $W \in \mathfrak{W}_A(I)$. Set $Z = \text{WC}(W)$ and $m = \Theta(W)$. Fix $i \in I$ and call e the corresponding edge in m . Let v the top vertex of e .*

If $j > i$ is the smallest index greater than i such that $Z_j^{(i)} = 0$ and $Z_{j+1}^{(i)} < 0$ (provided that such a j exists), and $s > j + 1$ is the smallest index greater than $j + 1$ such that $Z_s^{(i)} \geq 0$ (provided that such an s exists) then the number of outgoing edges of v in m is bounded by $s - j - 1$.

PROOF. It is enough to note that the only edges of m that can be outgoing edges of v are the ones corresponding to the indices $j + 1, j + 2, \dots, s - 1$. \square

9.2.6. Anti-involutions for discrete coalescent-walk processes and the trees of bipolar orientations. We now want to investigate the relations between the four trees $T(m), T(m^*), T(m^{**}), T(m^{***})$ of a bipolar orientation m (and its dual maps) and some corresponding coalescent-walk processes. The results presented in this section will be also useful for Section 9.5.

9.2.6.1. *The reversed coalescent-walk process.* Let m be a bipolar orientation, $W = \text{OW}(m)$ be the corresponding tandem walk, and $Z = \text{WC} \circ \text{OW}(m) = \text{WC}(W)$ be the corresponding coalescent-walk process. We set

- $LT(m^*)$ to be the tree $T(m^*)$ with edges labeled according to the order given by the exploration of $T(m)$.
- $\text{LTr}(Z)$ to be the tree obtained by attaching all the edge-labeled trees of $\text{LFor}(Z)$ to a common root.

We saw in Proposition 9.2.17 that $LT(m^*) = \text{LTr}(Z)$. We now want to recover from the walk W (and a new associated coalescent-walk process) the tree $LT(m^{***})$, i.e. the tree $T(m^{***})$ with edges labeled according to the order given by the exploration of $T(m^{**})$. For that, we have to consider the following.

Definition 9.2.23. Fix $n \in \mathbb{Z}_{>0}$. Given a one dimensional walk $X = (X_t)_{t \in [n]}$ we denote by \tilde{X} the time reversed walk $(X_{n+1-t})_{t \in [n]}$. Given a two-dimensional walk $W = (X, Y) = (X_t, Y_t)_{t \in [n]}$, we denote by \tilde{W} the time reversed and coordinates swapped walk (\tilde{Y}, \tilde{X}) .

Proposition 9.2.24. *Let m be a bipolar orientation and $W = \text{OW}(m)$ be the corresponding walk. Consider the walk \tilde{W} and the corresponding coalescent-walk process $\tilde{Z} := \text{WC}(\tilde{W})$. Then*

$$\text{OW}(m^{**}) = \tilde{W} \quad \text{and} \quad LT(m^{***}) = \text{LTr}(\tilde{Z}).$$

An example of the coalescent-walk process $\tilde{Z} = \text{WC}(\tilde{W})$ is given on the left-bottom side of Figure 9.13 in the case of the bipolar orientation m considered in Figure 9.2, that is the map that we always used for our examples.

PROOF OF PROPOSITION 9.2.24. Note that using Proposition 9.2.17 with the map m^{**} (instead of m) and the walk $W^{**} = \text{OW}(m^{**})$ (instead of $W = \text{OW}(m)$) we obtain that $LT(m^{***}) = \text{LTr}(Z^{**})$, where $Z^{**} = \text{WC}(W^{**})$. In order to conclude, it is enough to note that $W^{**} = \tilde{W}$ and so $\text{LTr}(Z^{**}) = \text{LTr}(\tilde{Z})$. \square

9.2.6.2. *Two anti-involution mappings.* We now know that given a bipolar orientation m and the corresponding walk $W = \text{OW}(m)$, we can read the trees $LT(m^*)$ and $LT(m^{***})$ in the coalescent-walk processes $Z = \text{WC}(W)$ and $\tilde{Z} = \text{WC}(\tilde{W})$ respectively. Obviously, considering the bipolar map m^* and the corresponding walk $W^* = \text{OW}(m^*)$, we can read the trees $LT(m^{**})$ and $LT(m^{****}) = LT(m)$ in the coalescent-walk processes $Z^* = \text{WC}(W^*)$ and $\tilde{Z}^* = \text{WC}(\tilde{W}^*)$ respectively.

Actually, we can determine the walk $W^* = \text{OW}(m^*)$ directly from the coalescent-walk processes Z and \tilde{Z} , as explained in Proposition 9.2.25 below. We recall that the discrete local time process $L_Z = \left(L_Z^{(i)}(j) \right)$, $1 \leq i \leq j \leq n$, was defined by $L_Z^{(i)}(j) = \# \left\{ k \in [i, j] \mid Z_k^{(i)} = 0 \right\}$. We also recall (see Theorem 9.2.5) that σ^* denotes the permutation obtained by rotating the diagram of a permutation σ clockwise by angle $\pi/2$.

Proposition 9.2.25. *Let m be a bipolar orientation of size n . Set $W^* = (X^*, Y^*) = \text{OW}(m^*)$, $\sigma = \text{OP}(m)$, $W = \text{OW}(m)$, $Z = \text{WC}(W)$ and $\tilde{Z} = \text{WC}(\tilde{W})$. Then*

$$(X_i^*)_{i \in [n]} = \left(L_Z^{(\sigma^{-1}(i))}(n) - 1 \right)_{i \in [n]} \quad \text{and} \quad (Y_i^*)_{i \in [n]} = \left(L_{\tilde{Z}}^{(\sigma^*(i))}(n) - 1 \right)_{i \in [n]}.$$

PROOF. The fact that $(X_i^*)_{i \in [n]} = \left(L_Z^{(\sigma^{-1}(i))}(n) - 1 \right)_{i \in [n]}$ follows from Corollary 9.2.18. Let $Z^{**} = \text{WC} \circ \text{OW}(m^{**})$. Using Corollary 9.2.18 with the map m^{**} (instead of m) and Remark 9.2.2 we obtain that $(Y_{n+1-i}^*)_{i \in [n]} = \left(L_{Z^{**}}^{OP(m^{**})^{-1}(i)}(n) - 1 \right)_{i \in [n]}$, and so, since we know from Proposition 9.2.24 that $Z^{**} = \tilde{Z}$, we conclude that $(Y_i^*)_{i \in [n]} = \left(L_{\tilde{Z}}^{OP(m^{**})^{-1}(n+1-i)}(n) - 1 \right)_{i \in [n]}$. It remains to show that $OP(m^{**})^{-1}(n+1-i) = \sigma^*(i)$. From Theorem 9.2.5 we have that

$$OP(m^{**})^{-1}(n+1-i) = (OP(m)^{**})^{-1}(n+1-i) = OP(m)^*(i) = \sigma^*(i),$$

where in the second equality we used that, for any permutation π of size n , $\pi(n+1-i) = (\pi^{-1})^{***}(i)$. This ends the proof. \square

From the above proposition it is meaningful to consider the following two mappings. We set WPC to be the mapping from the set of walks \mathcal{W} to the set of pairs of discrete coalescent-walk processes $\mathcal{C} \times \mathcal{C}$, defined by

$$\text{WPC}(W) = (\text{WC}(W), \text{WC}(\tilde{W})) \quad \text{for all } W \in \mathcal{W}.$$

We also set PCW to be the mapping from the set of pairs of coalescent-walk processes in $\text{WPC}(\mathcal{W}) \subseteq \mathcal{C} \times \mathcal{C}$ to the set of walks \mathcal{W} , defined by

$$\text{PCW}(Z, \tilde{Z}) = \left(L_Z^{(\sigma^{-1}(i))}(|Z|) - 1, L_{\tilde{Z}}^{(\sigma^*(i))}(|Z|) - 1 \right)_{i \in [|Z|]}, \quad \text{for all } (Z, \tilde{Z}) \in \text{WPC}(\mathcal{W}),$$

where, if $(Z, \tilde{Z}) = \text{WPC}(W)$, then $\sigma = \text{OP} \circ \text{OW}^{-1}(W) = \text{CP} \circ \text{WC}(W)$, i.e. σ is the Baxter permutation associated with W .

From our constructions and Propositions 9.2.24 and 9.2.25 we have the following.

Theorem 9.2.26. *Fix $W^0 \in \mathcal{W}$. Consider the following sequence*

$$W^0 \xrightarrow{\text{WPC}} (Z_1, \tilde{Z}_1) \xrightarrow{\text{PCW}} W^1 \xrightarrow{\text{WPC}} (Z_2, \tilde{Z}_2) \xrightarrow{\text{PCW}} W^2 \xrightarrow{\text{WPC}} \dots \xrightarrow{\text{WPC}} (Z_4, \tilde{Z}_4) \xrightarrow{\text{PCW}} W^4.$$

Then setting $m = \text{OW}^{-1}(W^0)$, i.e. the bipolar map associated with W^0 , we have that

$$W^i = \text{OW} \left(m^{*^i} \right), \quad \text{for } i = 0, 1, 2, 3, 4,$$

$$\left(\text{LTr}(Z_i), \text{LTr}(\tilde{Z}_i) \right) = \left(\text{LT} \left(m^{*^i} \right), \text{LT} \left(m^{*^{i+2}} \right) \right), \quad \text{for } i = 1, 2, 3, 4.$$

*Therefore (since $m = m^{****}$) $W^0 = W^4$ and so $(\text{PCW} \circ \text{WPC})^4 = \text{Id} = (\text{WPC} \circ \text{PCW})^4$.*

The coalescent-walk processes Z_1, \tilde{Z}_1, Z_2 and \tilde{Z}_2 , and the corresponding edge-labeled trees $\text{LT}(m^*)$, $\text{LT}(m^{***})$, $\text{LT}(m^{**})$ and $\text{LT}(m)$, in the specific case of our running example, are plotted in Figure 9.13.

9.3. Local limit results

The goal of this section is to prove Theorem 9.1.6, a joint quenched local convergence for the four families of objects put in correspondence by the mappings in the commutative diagram in Equation (9.2).

9.3.1. Mappings of the commutative diagram in the infinite-volume. Let I be a (finite or infinite) interval of \mathbb{Z} . Recall that $\mathfrak{W}_A(I)$ is the subset of two-dimensional walks with time space I and with increments in A (that was defined in Equation (9.1) page 170). Recall also that $\mathfrak{C}(I)$ is the set of coalescent-walk processes on I , and that the mapping $\text{WC} : \mathfrak{W}_A(I) \rightarrow \mathfrak{C}(I)$ sends walks to coalescent-walk processes, both in the finite and infinite-volume case.

In this section we extend the mappings CP and Θ defined earlier to infinite-volume objects. Recall that the mapping Θ was defined on a set of unconditioned walks in such a way that the restriction to \mathcal{W} is the inverse of OW (see Section 9.2.2).

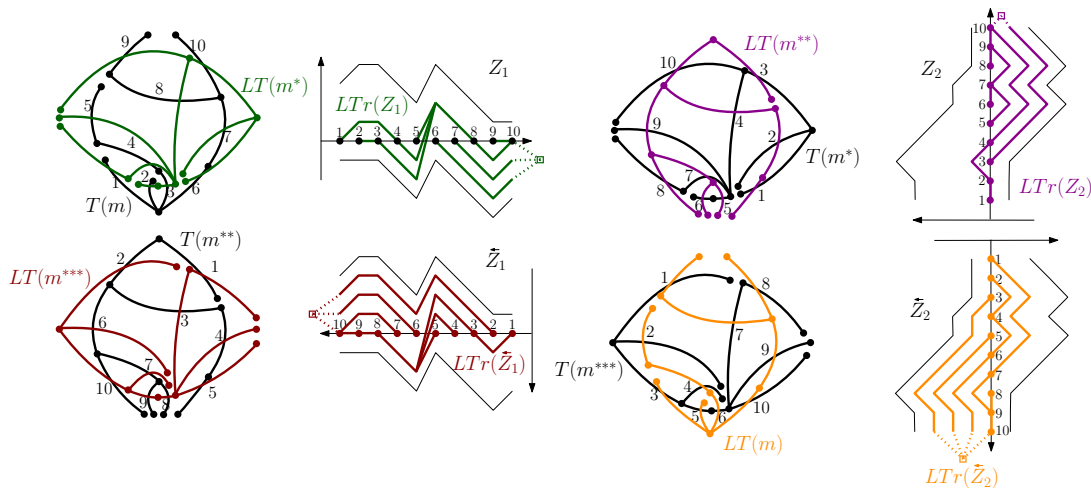

FIGURE 9.13. On the left-hand side the coalescent-walk processes Z_1 and \tilde{Z}_1 and the corresponding edge-labeled trees $LT(m^*)$ and $LT(m^{***})$. On the right-hand side the coalescent-walk processes Z_2 and \tilde{Z}_2 , and the corresponding edge-labeled trees $LT(m^{**})$ and $LT(m)$. We oriented the coalescent-walk processes in such a way that the comparison between trees is convenient.

We start with the mapping CP. We denote by $\mathfrak{S}(I)$ the set of total orders on I , which we call permutations on I . This terminology makes sense because for $n \geq 1$, the set \mathfrak{S}_n of permutations of size n is readily identified with $\mathfrak{S}([n])$, by the mapping $\sigma \mapsto \preceq_\sigma$, where

$$i \preceq_\sigma j \quad \text{if and only if} \quad \sigma(i) \leq \sigma(j).$$

Then we can extend $CP : \mathfrak{C}(I) \rightarrow \mathfrak{S}(I)$ to the case when I is infinite, by setting $CP(Z)$ to be the total order \preceq_Z on I defined in Section 9.2.4.2. This is consistent, through the stated identification, with our previous definition of CP when $I = [n]$.

Finally, we also extend Θ to the infinite-volume case. We need first to clarify what is our definition of *infinite planar maps*. From now on, a planar map is a gluing along edges of a finite number of finite polygons.

Definition 9.3.1. An *infinite oriented quasi-map* is an infinite collection of finite polygons with oriented edges, glued along some of their edges in such a way that the orientation is preserved. In the case the graph corresponding to an infinite oriented quasi-map is locally finite (i.e. every vertex has finite degree) then we say that it is an *infinite oriented map*.

We call *boundary* of an infinite oriented map, the collection of edges of the finite polygons that are not glued with any other edge. An infinite oriented map m is

- *simply connected* if for every finite submap $f \subset m$ there exists a finite submap $f' \subset m$ which is a planar map (i.e. is simply connected) with $f \subset f' \subset m$;
- *boundaryless* if the boundary of m is empty.

When these two conditions are verified, we say that m is an *infinite map of the plane*⁸.

Let I be an infinite interval and $w \in \mathfrak{W}(I)$. We recall that we can view a finite bipolar orientation as a finite collection of finite inner faces, together with an adjacency relation on the oriented edges of these faces. This allows us to construct $\Theta(w)$ as a projective limit, as follows: from Proposition 9.2.4, if J and J' are finite intervals and $J' \subset J \subset I$ then $\Theta(w|_{J'})$ is a submap of $\Theta(w|_J)$ defined in a unique way. This means that the face set of $\Theta(w|_{J'})$ is included in that of $\Theta(w|_J)$, and that two faces of $\Theta(w|_{J'})$ are adjacent if and

8. We point out that when the map is locally finite, it is well-defined as a topological manifold, and the combinatorial notions of simple connectivity and boundarylessness defined above are equivalent to the topological ones. By the classification of two-dimensional surfaces, m is an infinite map of the plane if and only if it is homeomorphic to the plane.

only if they are adjacent through the same edge in $\Theta(w|_J)$. Then, taking J_n a growing sequence of finite intervals such that $I = \cup_n J_n$, we set $\Theta(w) := \bigsqcup_{n \geq 0} \Theta(w|_{J_n})$ to be an infinite collection of finite polygons, together with a gluing relation between the edges of these faces, i.e. $\Theta(w)$ is an infinite oriented quasi-map.

9.3.2. Random infinite limiting objects. We define here what will turn out to be our local limiting objects. Recall that ν denotes the following probability distribution on A (defined in Equation (9.1) page 170):

$$(9.11) \quad \nu = \frac{1}{2} \delta_{(+1, -1)} + \sum_{i, j \geq 0} 2^{-i-j-3} \delta_{(-i, j)}, \quad \text{where } \delta \text{ denotes the Dirac measure,}$$

and recall that $\overline{\mathbf{W}} = (\overline{\mathbf{X}}, \overline{\mathbf{Y}}) = (\overline{\mathbf{W}}_t)_{t \in \mathbb{Z}}$ is a bi-directional random two-dimensional walk with step distribution ν , having value $(0, 0)$ at time zero. The interest of introducing the probability measure ν resides in the following way of obtaining uniform elements of \mathcal{W}_n as conditioned random walks. For all $n \geq 1$, let $\mathfrak{W}_{A, \text{exc}}^n \subset \mathfrak{W}_A([0, n-1])$ be the set of two-dimensional walks in the non-negative quadrant $W = (W_t)_{0 \leq t \leq n-1}$ of length n , starting and ending at $(0, 0)$, with increments in A . Notice that for $n \geq 1$, the mapping $\mathfrak{W}_{A, \text{exc}}^{n+2} \rightarrow \mathcal{W}_n$ removing the first and the last step, i.e. $W \mapsto (W_t)_{1 \leq t \leq n}$, is a bijection. An simple calculation then gives the following (obtained also in [KMSW19, Remark 2]):

Proposition 9.3.2. *Conditioning on $\{(\overline{\mathbf{W}}_t)_{0 \leq t \leq n+1} \in \mathfrak{W}_{A, \text{exc}}^{n+2}\}$, the law of $(\overline{\mathbf{W}}_t)_{0 \leq t \leq n+1}$ is the uniform distribution on $\mathfrak{W}_{A, \text{exc}}^{n+2}$, and the law of $(\overline{\mathbf{W}}_t)_{1 \leq t \leq n}$ is the uniform distribution on \mathcal{W}_n .*

Let $\overline{\mathbf{Z}} = \text{WC}(\overline{\mathbf{W}})$ be the corresponding coalescent-walk process, $\overline{\sigma} = \text{CP}(\overline{\mathbf{Z}})$ be the corresponding permutation on \mathbb{Z} , and $\overline{\mathbf{m}} = \Theta(\overline{\mathbf{W}})$ be the corresponding infinite quasi-map. Let us show some properties of these limiting objects.

Proposition 9.3.3. *For every $t \in \mathbb{Z}$, $\overline{\mathbf{Z}}^{(t)}$ has the distribution of a random walk with the same step distribution as $\overline{\mathbf{Y}}$ (which is the same as that of $-\overline{\mathbf{X}}$).*

Remark 9.3.4. Recall that the increments of a walk of a coalescent-walk process are not always equal to the increments of the corresponding walk (see the last case considered in Definition 9.2.7). The statement of Proposition 9.3.3 is a sort of ‘‘miracle’’ of the geometric distribution.

PROOF OF PROPOSITION 9.3.3. Let us fix $k \geq t$. By construction, $(\overline{\mathbf{Z}}_s^{(t)})_{t \leq s \leq k}$ is a measurable functional of $(\overline{\mathbf{W}}_s)_{t \leq s \leq k}$. As a result, $\overline{\mathbf{W}}_{k+1} - \overline{\mathbf{W}}_k = (\overline{\mathbf{X}}_{k+1} - \overline{\mathbf{X}}_k, \overline{\mathbf{Y}}_{k+1} - \overline{\mathbf{Y}}_k)$ is independent of $(\overline{\mathbf{Z}}_s^{(t)})_{t \leq s \leq k}$. We can rewrite $\overline{\mathbf{W}}_{k+1} - \overline{\mathbf{W}}_k = \mathbf{B} \times (1, -1) + (1 - \mathbf{B}) \times (-\mathbf{U}, \mathbf{V})$ where \mathbf{B} is a Bernoulli random variable of parameter $1/2$, \mathbf{U}, \mathbf{V} are geometric of parameter $1/2$, i.e. $\mathfrak{P}(\mathbf{U} = \ell) = 2^{-\ell-1}$, for all $\ell \geq 0$, altogether independent, and independent of $(\overline{\mathbf{Z}}_s^{(t)})_{t \leq s \leq k}$.

Now from the definition of $\overline{\mathbf{Z}}$ (Definition 9.2.7), we get

$$\overline{\mathbf{Z}}_{k+1}^{(t)} - \overline{\mathbf{Z}}_k^{(t)} = -\mathbf{B} + (1 - \mathbf{B}) \left[\mathbb{1}_{\overline{\mathbf{Z}}_k^{(t)} \geq 0} \mathbf{V} + \mathbb{1}_{\overline{\mathbf{Z}}_k^{(t)} < 0} \left(\mathbf{U} \mathbb{1}_{\mathbf{U} < -\overline{\mathbf{Z}}_k^{(t)}} + (\mathbf{V} - \overline{\mathbf{Z}}_k^{(t)}) \mathbb{1}_{\mathbf{U} \geq -\overline{\mathbf{Z}}_k^{(t)}} \right) \right],$$

So the law of $(\overline{\mathbf{Z}}_{k+1}^{(t)} - \overline{\mathbf{Z}}_k^{(t)} \mid (\overline{\mathbf{Z}}_s^{(t)})_{t \leq s \leq k})$ is equal to

$$\begin{cases} \mathcal{L}(-\mathbf{B} + (1 - \mathbf{B})\mathbf{V}), & \text{if } \overline{\mathbf{Z}}_k^{(t)} \geq 0, \\ \mathcal{L} \left(-\mathbf{B} + (1 - \mathbf{B}) \cdot (\mathbf{U} \mathbb{1}_{\mathbf{U} < q} + (\mathbf{V} + q) \mathbb{1}_{\mathbf{U} \geq q}) \right) \Big|_{q = -\overline{\mathbf{Z}}_k^{(t)}}, & \text{if } \overline{\mathbf{Z}}_k^{(t)} < 0. \end{cases}$$

By the memoryless property of the geometric distribution, $\mathbf{U} \mathbb{1}_{\mathbf{U} < q} + (\mathbf{V} + q) \mathbb{1}_{\mathbf{U} \geq q}$ is distributed like \mathbf{V} regardless of q . As a result, since $\overline{\mathbf{Z}}_{k+1}^{(t)} - \overline{\mathbf{Z}}_k^{(t)}$ is independent of $(\overline{\mathbf{Z}}_s^{(t)})_{s \leq k}$, we have that

$$\mathcal{L} \left(\overline{\mathbf{Z}}_{k+1}^{(t)} - \overline{\mathbf{Z}}_k^{(t)} \mid (\overline{\mathbf{Z}}_s^{(t)})_{s \leq k} \right) = \mathcal{L}(-\mathbf{B} + (1 - \mathbf{B})\mathbf{V}) = \mathcal{L}(\overline{\mathbf{Y}}_{k+1} - \overline{\mathbf{Y}}_k) = \mathcal{L}(-\overline{\mathbf{X}}_{k+1} + \overline{\mathbf{X}}_k).$$

This implies the result in the statement of the proposition. \square

Let us now consider $\overline{\mathbf{m}} = \Theta(\overline{\mathbf{W}})$. Recall that it is an infinite quasi-map, i.e. a countable union of finite polygons, glued along edges.

Proposition 9.3.5. *Almost surely, $\overline{\mathbf{m}}$ is an infinite map of the plane. In particular it is locally finite.*

PROOF. We show that a.s. every vertex of $\overline{\mathbf{m}}$ has finite degree, i.e. that $\overline{\mathbf{m}}$ is a.s. locally finite. Let $i \in \mathbb{Z}$ be the index of some edge $e \in \overline{\mathbf{m}}$ and denote by v its top vertex. Let $\mathbf{j} \geq i$ be the smallest index such that $\overline{\mathbf{Z}}_{\mathbf{j}}^{(i)} = 0$, $\overline{\mathbf{Z}}_{\mathbf{j}+1}^{(i)} < 0$, and $\mathbf{s} \geq \mathbf{j} + 1$ be the smallest index such that $\overline{\mathbf{Z}}_{\mathbf{s}}^{(i)} \geq 0$. The indexes \mathbf{j} and \mathbf{s} exist a.s. thanks to Proposition 9.3.3. These conditions, together with Corollary 9.2.22, imply that the number of outgoing edges of v is bounded by $\mathbf{s} - \mathbf{j} - 1$. Repeating the same argument with the map $\overline{\mathbf{m}}^{**} \stackrel{d}{=} \overline{\mathbf{m}}$ (recall that $\overline{\mathbf{m}}^{**}$ denotes $\overline{\mathbf{m}}$ with the orientation of the edges reversed) we can prove the same result for the number of ingoing edges of v , proving that v has a.s. finite degree. Since this argument can be done for all vertices of $\overline{\mathbf{m}}$ we can conclude that $\overline{\mathbf{m}}$ is a.s. locally finite.

Let us now show that a.s. every edge of $\overline{\mathbf{m}}$ is adjacent to two faces, i.e. that $\overline{\mathbf{m}}$ is a.s. boundaryless. Let $i \in \mathbb{Z}$ be the index of some edge $e \in \overline{\mathbf{m}}$, and $\mathbf{j} \geq i$ be the smallest index after i where $\overline{\mathbf{Z}}_{\mathbf{j}}^{(i)} = 0$, which exists a.s. thanks to Proposition 9.3.3. Considering the finite map $\Theta(\overline{\mathbf{W}}|_{[i,\mathbf{j}]})$, we see using Proposition 9.2.21 that e has a.s. a face at its right and so this happens also in $\overline{\mathbf{m}}$. By countable intersection, this is a.s. true for every edge of $\overline{\mathbf{m}}$. The same property is also a.s. true at the left because $(\overline{\mathbf{m}})^{**}$ has the same distribution as $\overline{\mathbf{m}}$. So $\overline{\mathbf{m}}$ is a.s. boundaryless.

The infinite map $\overline{\mathbf{m}}$ being a.s. simply connected is immediate: by definition of $\overline{\mathbf{m}}$, every finite submap $\mathbf{f} \subset \overline{\mathbf{m}}$ is included in one of the finite planar maps $\mathbf{f}_n = \Theta(\overline{\mathbf{W}}|_{J_n})$. \square

9.3.3. Local topologies. We define a (finite or infinite) *rooted walk* (resp. *rooted coalescent-walk process*, *rooted permutation*) as a walk (resp. coalescent-walk process, permutation) on a (finite or infinite) interval of \mathbb{Z} containing 0. More formally, we define the following sets (with the corresponding notions of size):

$$\begin{aligned} \widetilde{\mathfrak{W}}_{\bullet} &:= \bigsqcup_{I \ni 0} \mathfrak{W}(I), & \text{where } |W| &:= |I| \text{ if } W \in \mathfrak{W}(I), \\ \widetilde{\mathfrak{C}}_{\bullet} &:= \bigsqcup_{I \ni 0} \mathfrak{C}(I), & \text{where } |Z| &:= |I| \text{ if } Z \in \mathfrak{C}(I), \\ \widetilde{\mathfrak{S}}_{\bullet} &:= \bigsqcup_{I \ni 0} \mathfrak{S}(I), & \text{where } |\sigma| &:= |I| \text{ if } \sigma \in \mathfrak{S}(I). \end{aligned}$$

Of course, 0 has to be understood as the root of any object in one of these classes. For $n \in \mathbb{Z}_{>0} \cup \{\infty\}$, \mathfrak{W}_{\bullet}^n is the subset of objects in $\widetilde{\mathfrak{W}}_{\bullet}$ of size n , i.e. $\mathfrak{W}_{\bullet}^n = \bigcup_{I \ni 0, |I|=n} \mathfrak{W}(I)$, and \mathfrak{W}_{\bullet} denotes the set of finite-size objects. We also define analogs for $\widetilde{\mathfrak{C}}_{\bullet}$, $\widetilde{\mathfrak{S}}_{\bullet}$.

We justify the terminology. A rooted object of size n can be also understood as an unrooted object of size n together with an index in $[n]$ which identifies the root through the following identifications⁹:

$$\begin{aligned} \mathfrak{W}^n \times [n] &\longrightarrow \mathfrak{W}_{\bullet}^n, & (W, i) &\longmapsto (W_{i+t})_{t \in [-i+1, n-i]} \in \mathfrak{W}([-i+1, n-i]), \\ \mathfrak{C}^n \times [n] &\longrightarrow \mathfrak{C}_{\bullet}^n, & ((Z_t^{(s)})_{s,t \in [n]}, i) &\longmapsto (Z_{i+t}^{(i+s)})_{s,t \in [-i+1, n-i]} \in \mathfrak{C}([-i+1, n-i]), \\ \mathfrak{S}^n \times [n] &\longrightarrow \mathfrak{S}_{\bullet}^n, & (\sigma, i) &\longmapsto \preceq_{\sigma, i} \in \mathfrak{S}([-i+1, n-i]), \quad \text{where } \ell \preceq_{\sigma, i} j \iff \sigma_{\ell+i} \leq \sigma_{j+i}. \end{aligned}$$

9. Note that the natural identification for walks would be $(W, i) \mapsto (W_{i+t} - W_i)_{t \in [-i+1, n-i]}$, but since we are considering walks up to an additive constant then the identification $(W, i) \mapsto (W_{i+t})_{t \in [-i+1, n-i]}$ is equivalent.

We may now define *restriction functions*: for $h \geq 1$, I an interval of \mathbb{Z} containing 0, and $\square \in \mathfrak{W}(I)$, $\mathfrak{C}(I)$ or $\mathfrak{S}(I)$, we define

$$r_h(\square) = \square|_{I \cap [-h, h]}.$$

So, for all $h \geq 1$, r_h is a well-defined function $\widetilde{\mathfrak{W}}_\bullet \rightarrow \mathfrak{W}_\bullet$, $\widetilde{\mathfrak{C}}_\bullet \rightarrow \mathfrak{C}_\bullet$, and $\widetilde{\mathfrak{S}}_\bullet \rightarrow \mathfrak{S}_\bullet$. Finally local distances on either \mathfrak{W}_\bullet , \mathfrak{C}_\bullet or \mathfrak{S}_\bullet are defined by a common formula:

$$(9.12) \quad d(\square_1, \square_2) = 2^{-\sup\{h \geq 1 : r_h(\square_1) = r_h(\square_2)\}},$$

with the conventions that $\sup \emptyset = 0$, $\sup \mathbb{Z}_{>0} = +\infty$ and $2^{-\infty} = 0$.

The metric space $(\widetilde{\mathfrak{S}}_\bullet, d)$ is a compact space (see [Bor20b, Theorem 2.16]) and so complete and separable, i.e. it is a Polish space. On the other hand, $(\mathfrak{W}_\bullet, d)$ and $(\mathfrak{C}_\bullet, d)$ are Polish, but not compact (see for instance [Cur18, Section 1.2.1]).

For the case of planar maps, the theory is slightly different. For a finite interval I , we denote by $\mathfrak{m}(I)$ the set of planar oriented maps with edges labeled by the integers in the interval I . We point out that we do not put any restriction on the possible choices for the labeling. We also define the set of finite rooted maps $\mathfrak{m}_\bullet = \bigsqcup_{I \ni 0, |I| < \infty} \mathfrak{m}(I)$, where the edge labeled by 0 is called root.

A finite rooted map is obtained by rooting (i.e. distinguishing an edge) a finite unrooted map, by the identification $\mathfrak{m}([n]) \times [n] \rightarrow \mathfrak{m}_\bullet^n$ which sends (m, i) to the map obtained from m by shifting all labels by $-i$. The distance is defined similarly as in Equation (9.12). Let $B_h(m)$ be the ball of radius h in m , that is the submap of m consisting of the faces of m that contain a vertex at distance less than h from the tail of the root-edge. We set $d(m, m') = 2^{-\sup\{h \geq 1 : B_h(m) = B_h(m')\}}$, with the same conventions as before. We do not describe the set of possible limits, but simply take $\widetilde{\mathfrak{m}}_\bullet$ to be the completion of the metric space $(\mathfrak{m}_\bullet, d)$. In particular, it is easily seen that $\widetilde{\mathfrak{m}}_\bullet$ contains all the infinite rooted planar maps.

Proposition 9.3.6. *The mappings $\text{WC} : \widetilde{\mathfrak{W}}_\bullet \rightarrow \widetilde{\mathfrak{C}}_\bullet$ and $\text{CP} : \widetilde{\mathfrak{C}}_\bullet \rightarrow \widetilde{\mathfrak{S}}_\bullet$ are 1-Lipschitz.*

PROOF. This is immediate since by definition, $r_h(\text{WC}(W)) = \text{WC}(r_h(W))$ and $r_h(\text{CP}(Z)) = \text{CP}(r_h(Z))$. \square

Proposition 9.3.7. *The mapping $\Theta : \widetilde{\mathfrak{W}}_\bullet \rightarrow \widetilde{\mathfrak{m}}_\bullet$ is almost surely continuous at \overline{W} .*

PROOF. Assume we have a realization \overline{W} of \overline{W} such that $\overline{m} = \Theta(\overline{W})$ is a rooted infinite oriented planar map, in particular is locally finite (this holds for almost all realizations thanks to Proposition 9.3.5). Let $h > 0$. The ball $B_h(\overline{m})$ is a finite subset of \overline{m} . Since $\overline{m} = \bigcup_n \Theta(\overline{W}|_{[-n, n]})$, there must be n such that $\Theta(\overline{W}|_{[-n, n]}) \supset B_h(\overline{m})$. As a result, for all $W' \in \widetilde{\mathfrak{W}}_\bullet$ such that $d(W', \overline{W}) < 2^{-n}$, then $B_h(\Theta(W')) = B_h(\Theta(\overline{W}))$. This shows a.s. continuity. \square

9.3.4. Proofs of the local limit results. We turn to the proof of Theorem 9.1.6. We will prove local convergence for walks and then transfer to the other objects by continuity of the mappings WC, CP, Θ . Let us recall that thanks to Proposition 9.3.2, \mathbf{W}_n is distributed like $\overline{W}|_{[n]}$ under a suitable conditioning. This will allow us to prove the following technical lemmas.

Lemma 9.3.8. *Fix $h \in \mathbb{Z}_{>0}$ and $W \in \mathfrak{W}([-h, h]) \subset \mathfrak{W}_\bullet^{2h+1}$. Fix $0 < \varepsilon < 1$. Then, uniformly for all i such that $\lfloor n\varepsilon \rfloor + h < i < \lfloor (1 - \varepsilon)n \rfloor - h$,*

$$\mathbb{P}(r_h(\mathbf{W}_n, i) = W) \rightarrow \mathbb{P}(r_h(\overline{W}) = W).$$

Lemma 9.3.9. *Fix $h \in \mathbb{Z}_{>0}$ and $W \in \mathfrak{W}([-h, h]) \subset \mathfrak{W}_\bullet^{2h+1}$. Fix $0 < \varepsilon < 1$. Then, uniformly for all i, j such that $\lfloor n\varepsilon \rfloor + h < i, j < \lfloor (1 - \varepsilon)n \rfloor - h$ and $|i - j| > 2h$,*

$$(9.13) \quad \mathbb{P}(r_h(\mathbf{W}_n, i) = r_h(\mathbf{W}_n, j) = W) \rightarrow \mathbb{P}(r_h(\overline{W}) = W)^2.$$

We just prove the second lemma, the proof of the first one is similar and simpler. Before doing that, we do the following observation, useful for the proof of Lemma 9.3.9. In what follows, if $W = (X, Y)$ is a two-dimensional walk, then $\inf W = (\inf X, \inf Y)$.

Observation 9.3.10. Let $x = (x_i)_{i \in [0, n]} = (\sum_{j=1}^i y_j)_{i \in [n]}$ be a one-dimensional deterministic walk starting at zero of size n , i.e. $y_j \in \mathbb{Z}$ for all $j \in [n]$. Let $h\vec{\ell}n$ and consider a second deterministic one-dimensional walk $x' = (x'_i)_{i \in [0, h]} = (\sum_{j=1}^i y'_j)_{i \in [0, h]}$. Fix also k, ℓ such that $0 \leq k < \ell \leq n$ and consider the walk $x'' = (x''_i)_{i \in [0, n+2h]}$ obtained by inserting two copies of the walk x' in the walk x at time k and ℓ . That is, for all $i \in [0, n+2h]$,

$$x''_i = \sum_{j=1}^k y_j \cdot \mathbb{1}_{j \leq i} + \sum_{j=1}^h y'_j \cdot \mathbb{1}_{j+k \leq i} + \sum_{j=k+1}^{\ell} y_j \cdot \mathbb{1}_{j+k+h \leq i} + \sum_{j=1}^h y'_j \cdot \mathbb{1}_{j+\ell+h \leq i} + \sum_{j=\ell+1}^n y_j \cdot \mathbb{1}_{j+\ell+2h \leq i}.$$

Then

$$\inf_{i \in [0, n+2h]} \{x''_i\} = \inf_{i \in [0, n]} \{x_i\} + \Delta,$$

where $\Delta = \Delta(x, k, \ell, x') \in \mathbb{R}^2$ and it is bounded by twice the total variation of x' .

PROOF OF LEMMA 9.3.9. Set $E := \{r_h(\overline{W}|_{[n]}, i) = r_h(\overline{W}|_{[n]}, j) = W\}$. By Proposition 9.3.2, the left-hand side of Equation (9.13) can be rewritten as $\mathbb{P}\left(E \mid (\overline{W}_t)_{0 \leq t \leq n+1} \in \mathfrak{W}_{A, \text{exc}}^{n+2}\right)$. Using Lemma 9.A.2, we have that

$$(9.14) \quad \mathbb{P}\left(E \mid (\overline{W}_t)_{0 \leq t \leq n+1} \in \mathfrak{W}_{A, \text{exc}}^{n+2}\right) = \mathbb{E} \left[\mathbb{1}_{\tilde{E}} \cdot \alpha_{n+2, [n\varepsilon]}^{0,0} \left(\inf_{0 \leq k \leq n+2-2[n\varepsilon]} \overline{W}_k, \overline{W}_{n+2-2[n\varepsilon]} \right) \right],$$

where $\alpha_{n+2, [n\varepsilon]}^{0,0}(a, b)$ is a function defined in Equation (9.52) and

$$\tilde{E} := \{r_h(\overline{W}|_{[n]}, i - [n\varepsilon]) = r_h(\overline{W}|_{[n]}, j - [n\varepsilon]) = W\}.$$

From Observation 9.3.10, conditioning on \tilde{E} , we have that

$$(9.15) \quad \left(\inf_{0 \leq k \leq n+2-2[n\varepsilon]} \overline{W}_k, \overline{W}_{n+2-2[n\varepsilon]} \right) \\ = \left(\inf_{0 \leq k \leq n+2-2[n\varepsilon]-2(2h+1)} \overline{S}_k + \Delta, \overline{S}_{n+2-2[n\varepsilon]-2(2h+1)} + 2\delta \right),$$

where $\overline{S} = (\overline{S}_t)_{t \in \mathbb{Z}}$ is the walk obtained from $(\overline{W}_t)_{t \in \mathbb{Z}}$ removing the $2h+1$ steps around $i - [n\varepsilon]$ and $j - [n\varepsilon]$, $\delta = W_h - W_{-h}$ and Δ is a deterministic function of $(\overline{S}_t)_{t \in \mathbb{Z}}$, i, j and W , bounded by twice the total variation of W . Using the relation in Equation (9.15) we can rewrite the right-hand side of Equation (9.14) as

$$\mathbb{P}(\tilde{E}) \cdot \mathbb{E} \left[\alpha_{n+2, [n\varepsilon]}^{0,0} \left(\inf_{0 \leq k \leq n-2[n\varepsilon]-2(2h+1)} \overline{S}_k + \Delta, \overline{S}_{n-2[n\varepsilon]-2(2h+1)} + 2\delta \right) \right],$$

where we used the independence between \tilde{E} and the right-hand side of Equation (9.15). Note that $\mathfrak{P}(\tilde{E}) = \mathbb{P}(r_h(\overline{W}) = W)^2$ since $|i - j| > 2h$ by assumption. We now show that the second factor of the equation above converges to 1 uniformly for all i, j . Set for simplicity of notation

$$f(\overline{S}) = \left(\inf_{0 \leq k \leq n-2[n\varepsilon]-2(2h+1)} \overline{S}_k + \Delta, \overline{S}_{n-2[n\varepsilon]-2(2h+1)} + 2\delta \right).$$

By Lemma 9.A.3 we have

$$\sup_{i, j} \left| \mathbb{E} \left[\alpha_{n+2, [n\varepsilon]}^{0,0} (f(\overline{S})) \right] - \mathbb{E} [\alpha_\varepsilon (g(\overline{S}))] \right| \rightarrow 0,$$

where $\alpha_\varepsilon(\cdot)$ is defined in Equation (9.53) and

$$g(\overline{\mathbf{S}}) = \left(\frac{1}{\sqrt{n}} \left(\inf_{0 \leq k \leq n-2\lfloor n\varepsilon \rfloor - 2(2h+1)} \overline{\mathbf{S}}_k \right) + \frac{\Delta}{\sqrt{n}}, \frac{1}{\sqrt{n}} \overline{\mathbf{S}}_{n-2\lfloor n\varepsilon \rfloor - 2(2h+1)} + \frac{\delta}{\sqrt{n}} \right).$$

Therefore, in order to conclude, it is enough to show that $\mathbb{E}[\alpha_\varepsilon(g(\overline{\mathbf{S}}))] \rightarrow 1$.

We have that $\mathbb{E}[\alpha_\varepsilon(g(\overline{\mathbf{S}}))] \rightarrow \mathbb{E}[\alpha_\varepsilon(g(\mathbf{W}))]$, where $\mathbf{W} = (\mathbf{X}, \mathbf{Y})$ is a standard two-dimensional Brownian motion of correlation $-1/2$. This follows from the fact that Δ is bounded, that α_ε is a continuous and bounded function (see Lemma 9.A.3), and that

$$\left(\frac{1}{\sqrt{n}} \overline{\mathbf{S}}_{\lfloor nt \rfloor} \right)_{t \in [0,1]} \xrightarrow{d} (\mathbf{W}_t)_{t \in [0,1]}.$$

The latter claim is a consequence of Donsker's theorem and the basic computation $\text{Var}(\nu) = \begin{pmatrix} 2 & -1 \\ -1 & 2 \end{pmatrix}$. In addition, we have that $\mathbb{E}[\alpha_\varepsilon(g(\mathbf{W}))] = 1$ by Proposition 9.A.4 (used with $h = 1$), and so we can conclude the proof. \square

We can now prove the main result of this section, i.e. the quenched local limit result presented in the introduction.

PROOF OF THEOREM 9.1.6. We start by proving that

$$(9.16) \quad \mathcal{L}\left((\mathbf{W}_n, \mathbf{i}_n) \mid \mathbf{W}_n\right) \xrightarrow{P} \mathcal{L}(\overline{\mathbf{W}}).$$

For that it is enough (see for instance [Bor20b, Corollary 2.38] for an argument in the case of permutations) to show that, for any $h \geq 1$ and fixed finite rooted walk $W \in \mathfrak{W}([-h, h]) \subset \mathfrak{W}_\bullet$,

$$(9.17) \quad \mathbb{P}(r_h(\mathbf{W}_n, \mathbf{i}_n) = W \mid \mathbf{W}_n) \xrightarrow{P} \mathbb{P}(r_h(\overline{\mathbf{W}}) = W).$$

Note that

$$\mathbb{P}(r_h(\mathbf{W}_n, \mathbf{i}_n) = W \mid \mathbf{W}_n) = \frac{\#\{j \in [n] : r_h(\mathbf{W}_n, j) = W\}}{n} = \frac{1}{n} \sum_{j \in [n]} \mathbb{1}_{\{r_h(\mathbf{W}_n, j) = W\}}.$$

We use the second moment method to prove that this sum converges in probability to $\mathbb{P}(r_h(\overline{\mathbf{W}}) = W)$. We first compute the first moment:

$$\mathbb{E} \left[\frac{1}{n} \sum_{j \in [n]} \mathbb{1}_{\{r_h(\mathbf{W}_n, j) = W\}} \right] = \frac{1}{n} \sum_{j \in [n]} \mathbb{P}(r_h(\mathbf{W}_n, j) = W) \rightarrow \mathbb{P}(r_h(\overline{\mathbf{W}}) = W),$$

where for the limit we used Lemma 9.3.8. We now compute the second moment:

$$\begin{aligned} \mathbb{E} \left[\left(\frac{1}{n} \sum_{j \in [n]} \mathbb{1}_{\{r_h(\overline{\mathbf{W}}_t)_{t \in [n], j} = W\}} \right)^2 \right] \\ = \frac{1}{n^2} \sum_{i, j \in [n], |i-j| > 2h} \mathfrak{P}(r_h(\mathbf{W}_n, i) = r_h(\mathbf{W}_n, j) = W) + O(1/n). \end{aligned}$$

This converges to $\mathbb{P}(r_h(\overline{\mathbf{W}}) = W)^2$ by Lemma 9.3.9. The computations of the first and second moment, together with Chebyshev's inequality lead to the proof of Equation (9.17) and so to the quenched convergence of walks.

Now to extend the result to other objects, we will use continuity of the mappings WC, CP, Θ (see Proposition 9.3.6 and Proposition 9.3.7). Using a combination of the results stated in [Kal17b, Theorem 4.11, Lemma 4.12]¹⁰ we have that Equation (9.16)

10. The specific result that we need is a generalization of the *mapping theorem* for random measures: Let $(\mu_n)_{n \in \mathbb{Z}_{>0}}$ be a sequence of random measures on a space E that converges in distribution to a random measure μ on E . Let F be a function from E to a second space H such that the set D_F of discontinuity points of F has measure $\mu(D_F) = 0$ a.s.. Then the sequence of pushforward random measures $(\mu_n \circ F^{-1})_{n \in \mathbb{Z}_{>0}}$ converges in distribution to the pushforward random measure $\mu \circ F^{-1}$.

implies the following convergence

$$(9.18) \quad \mathcal{L}\left(\left((\mathbf{W}_n, \mathbf{i}_n), (\text{WC}(\mathbf{W}_n), \mathbf{i}_n), (\text{CP}(\mathbf{W}_n), \mathbf{i}_n), (\Theta(\mathbf{W}_n), \mathbf{i}_n)\right) \Big| \mathfrak{B}_n\right) \xrightarrow{P} \mathcal{L}(\overline{\mathbf{W}}, \overline{\mathbf{Z}}, \overline{\boldsymbol{\sigma}}, \overline{\mathbf{m}}),$$

and so Equation (9.4) holds. \square

9.4. Scaling limits of coalescent-walk processes

In this section we deal with scaling limits of coalescent-walk processes both in the finite and infinite-volume case. The results in this section culminate in Theorem 9.4.10, upon which the proofs of the two main theorems in Section 9.5 rely, namely Theorem 9.5.6 and Theorem 9.5.8. Nevertheless, we believe that our intermediate results, Theorem 9.4.5 and Proposition 9.4.8, are of independent interest.

All the spaces of continuous functions considered below are implicitly endowed with the topology of uniform convergence on every compact set.

9.4.1. The continuous coalescent-walk process. We start by defining the (potential) continuous limiting object: it is formed by the solutions of the following family of stochastic differential equations (SDEs) indexed by $u \in \mathbb{R}$ and driven by a two-dimensional process $\mathbf{W} = (\mathbf{X}, \mathbf{Y})$:

$$(9.19) \quad \begin{cases} d\mathbf{Z}^{(u)}(t) = \mathbb{1}_{\{\mathbf{Z}^{(u)}(t) > 0\}} d\mathbf{Y}(t) - \mathbb{1}_{\{\mathbf{Z}^{(u)}(t) \leq 0\}} d\mathbf{X}(t), & t \geq u, \\ \mathbf{Z}^{(u)}(t) = 0, & t \leq u. \end{cases}$$

Existence and uniqueness of a solution of the SDE above (for $u \in \mathbb{R}$ fixed) were already studied in the literature in the case where the driving process \mathbf{W} is a Brownian motion, in particular with the following result.

We recall that a *standard two-dimensional Brownian motion of correlation ρ* is a continuous two-dimensional Gaussian process such that the components \mathbf{X} and \mathbf{Y} are standard one-dimensional Brownian motions, and $\text{Cov}(\mathbf{X}(t), \mathbf{Y}(s)) = \rho \cdot (t \wedge s)$.

Theorem 9.4.1 (Theorem 2 of [Pro13], Proposition 2.2 of [CHK18]). *Fix $\rho \in (-1, 1)$. Let $T \in (0, \infty]$ and let $\mathbf{W} = (\mathbf{X}, \mathbf{Y})$ be a standard two-dimensional Brownian motion of correlation ρ and time-interval $[0, T]$. We have pathwise uniqueness and existence of a strong solution for the SDE:*

$$(9.20) \quad \begin{cases} d\mathbf{Z}(t) = \mathbb{1}_{\{\mathbf{Z}(t) > 0\}} d\mathbf{Y}(t) - \mathbb{1}_{\{\mathbf{Z}(t) \leq 0\}} d\mathbf{X}(t), & 0 \leq t < T, \\ \mathbf{Z}(0) = 0. \end{cases}$$

Namely, letting $(\Omega, \mathcal{F}, (\mathcal{F}_t)_{0 \leq t < T}, \mathbb{P})$ be a filtered probability space satisfying the usual conditions, and assuming that \mathbf{W} is an $(\mathcal{F}_t)_t$ -Brownian motion,

- i) if $\mathbf{Z}, \tilde{\mathbf{Z}}$ are two $(\mathcal{F}_t)_t$ -adapted continuous processes that verify Equation (9.20) almost surely, then $\mathbf{Z} = \tilde{\mathbf{Z}}$ almost surely.*
- ii) There exists an $(\mathcal{F}_t)_t$ -adapted continuous processes \mathbf{Z} which verifies Equation (9.20) almost surely.*

In particular, there exists for every $t \in (0, T]$ a measurable mapping $F_t : \mathcal{C}([0, t]) \rightarrow \mathcal{C}([0, t])$, called the solution mapping, such that

- iii) setting $\mathbf{Z} = F_t(\mathbf{W}|_{[0, t]})$, then \mathbf{Z} verifies Equation (9.20) almost surely on the interval $[0, t]$.*
- iv) For every $0 \leq s \leq t \leq T$, then $F_t(\mathbf{W}|_{[0, t]})|_{[0, s]} = F_s(\mathbf{W}|_{[0, s]})$ almost surely.*

Assume from now on that $\mathbf{W} = (\mathbf{X}, \mathbf{Y})$ is a standard two-dimensional Brownian motion of correlation $-1/2$ and time-interval \mathbb{R} . Let $(\mathcal{F}_t)_{t \in \mathbb{R}}$ be the canonical filtration of \mathbf{W} . For every $u \in \mathbb{R}$ we define

$$\mathbf{z}^{(u)}(t) = \begin{cases} (F_\infty((\mathbf{W}(u+s) - \mathbf{W}(u))_{0 \leq s < \infty}))(t-u), & t \geq u, \\ 0, & t < u. \end{cases}$$

It is clear that $\mathfrak{Z}^{(u)}$ is $(\mathcal{F}_t)_t$ -adapted. Because Equation (9.19) is invariant by addition of a constant to \mathfrak{W} , and because $(\mathfrak{W}(u+s) - \mathfrak{W}(u))$ is a Brownian motion with time-interval \mathbb{R}_+ , we see that for every fixed $u \in \mathbb{R}$, $\mathfrak{Z}^{(u)}$ verifies Equation (9.19) almost surely.

Our construction makes the mapping $(\omega, u) \mapsto \mathfrak{Z}^{(u)}$ jointly measurable. Hence by Tonelli's theorem, for almost every ω , $\mathfrak{Z}^{(u)}$ is a solution for almost every u .

Remark 9.4.2. Given ω (even restricted to a set of probability one), we cannot say that $\{\mathfrak{Z}^{(u)}\}_{u \in \mathbb{R}}$ forms a whole field of solutions to Equation (9.19) driven by \mathfrak{W} . Indeed, we cannot guarantee that the SDE holds for all $u \in \mathbb{R}$ simultaneously. In fact, we expect thanks to intuition coming from Liouville Quantum Gravity, that there exist exceptional times $u \in \mathbb{R}$ where uniqueness fails, with two or three distinct solutions. This phenomenon is also observed in another coalescing flows of an SDE [BK04], and in the Brownian web [SSS17].

Remark 9.4.3. By Lévy's characterization theorem [RY99, Theorem 3.6], for every fixed $u \in \mathbb{R}$, the process $\mathfrak{Z}^{(u)}$ is a standard one-dimensional Brownian motion on $[u, \infty)$ with $\mathfrak{Z}^{(u)}(u) = 0$. Note however that the coupling of $\mathfrak{Z}^{(u)}$ for different values of $u \in \mathbb{R}$ is highly nontrivial.

Definition 9.4.4. We call *continuous coalescent-walk process* (driven by \mathfrak{W}) the collection of stochastic processes $\{\mathfrak{Z}^{(u)}\}_{u \in \mathbb{R}}$.

Since for all $u \in \mathbb{R}$, $(\mathfrak{Z}^{(u)}(t))_{t \geq u}$ is a Brownian motion, one can define almost surely its local time process at zero $\mathcal{L}^{(u)}$ (see [RY99, Chapter VI]) namely for $t \geq u$, $\mathcal{L}^{(u)}(t)$ is the limit in probability of

$$\frac{1}{2\varepsilon} \text{Leb} \left(\left\{ s \in [u, t] : |\mathfrak{Z}^{(u)}(s)| < \varepsilon \right\} \right).$$

By convention we set $\mathcal{L}^{(u)}(t) = 0$ for $t < u$ so that $\mathcal{L}^{(u)}$ is a continuous process on \mathbb{R} .

In the next section we show that the *continuous coalescent-walk process* is the scaling limit of the discrete infinite-volume coalescent-walk processes defined in Section 9.2.4.1.

9.4.2. The unconditioned scaling limit result. Let $\overline{\mathfrak{W}} = (\overline{\mathfrak{X}}, \overline{\mathfrak{Y}}) = (\overline{\mathfrak{X}}_k, \overline{\mathfrak{Y}}_k)_{k \in \mathbb{Z}}$ be the random two-dimensional walk (with step distribution ν) defined below Equation (9.3) page 173, and let $\overline{\mathfrak{Z}} = \text{WC}(\overline{\mathfrak{W}})$ be the corresponding discrete coalescent-walk process. Let also $(\overline{\mathcal{L}}^{(i)}(j))_{-\infty < i \leq j < \infty} = L_{\overline{\mathfrak{Z}}}$ be the local time process of $\overline{\mathfrak{Z}}$ as defined in Equation (9.10) page 185. By convention, from now on we extend trajectories of $\overline{\mathfrak{Z}}$ and $\overline{\mathcal{L}}$ to the whole \mathbb{Z} by setting $\overline{\mathfrak{Z}}^{(j)}(i) = \overline{\mathcal{L}}^{(j)}(i) = 0$ for $i, j \in \mathbb{Z}$, $i < j$. We define rescaled versions: for all $n \geq 1, u \in \mathbb{R}$, let $\overline{\mathfrak{W}}_n : \mathbb{R} \rightarrow \mathbb{R}^2$, $\overline{\mathfrak{Z}}_n^{(u)} : \mathbb{R} \rightarrow \mathbb{R}$ and $\overline{\mathcal{L}}_n^{(u)} : \mathbb{R} \rightarrow \mathbb{R}$ be the continuous functions defined by linearly interpolating the following points:

$$(9.21) \quad \overline{\mathfrak{W}}_n \left(\frac{k}{n} \right) = \frac{1}{\sqrt{2n}} \overline{\mathfrak{W}}_k, \quad \overline{\mathfrak{Z}}_n^{(u)} \left(\frac{k}{n} \right) = \frac{1}{\sqrt{2n}} \overline{\mathfrak{Z}}_k^{(\lceil nu \rceil)}, \quad \overline{\mathcal{L}}_n^{(u)} \left(\frac{k}{n} \right) = \frac{1}{\sqrt{2n}} \overline{\mathcal{L}}^{(\lceil nu \rceil)}(k), \quad k \in \mathbb{Z}.$$

Our first scaling limit result for infinite-volume coalescent-walk processes is the following result that deals with a single trajectory.

Theorem 9.4.5. Fix $u \in \mathbb{R}$. We have the following joint convergence in $(\mathcal{C}(\mathbb{R}, \mathbb{R}))^4$:

$$(9.22) \quad \left(\overline{\mathfrak{W}}_n, \overline{\mathfrak{Z}}_n^{(u)}, \overline{\mathcal{L}}_n^{(u)} \right) \xrightarrow[n \rightarrow \infty]{d} \left(\mathfrak{W}, \mathfrak{Z}^{(u)}, \mathcal{L}^{(u)} \right).$$

The end of this subsection is devoted to the proof of this result.

Convergence of $\overline{\mathfrak{W}}_n$ and of $(\overline{\mathfrak{Z}}_n^{(u)}, \overline{\mathcal{L}}_n^{(u)})$. The first step in the proof is to establish component-wise convergence in Equation (9.22). By Donsker's theorem, upon computing $\text{Var}(\nu) = \begin{pmatrix} 2 & -1 \\ -1 & 2 \end{pmatrix}$, we get that the rescaled random walk $\overline{\mathfrak{W}}_n = (\overline{\mathfrak{X}}_n, \overline{\mathfrak{Y}}_n)$ converges to $\mathfrak{W} = (\mathfrak{X}, \mathfrak{Y})$ in distribution. Using Proposition 9.3.3, we know that a single trajectory of the discrete coalescent-walk process has the distribution of a random walk,

and applying again an invariance principle such as [Bor82, Theorem 1.1], we get that $(\bar{\mathcal{Z}}_n^{(u)}(u+t), \bar{\mathcal{L}}_n^{(u)}(u+t))_{t \geq 0}$ converges to a one-dimensional Brownian motion and its local time, which is indeed distributed like $(\mathcal{Z}^{(u)}, \mathcal{L}^{(u)})$ thanks to Remark 9.4.3.

Proof of joint convergence. The second step in the proof is to establish joint convergence. By Prokhorov's theorem, both $\bar{\mathcal{W}}_n$ and of $(\bar{\mathcal{Z}}_n^{(u)}, \bar{\mathcal{L}}_n^{(u)})$ are tight sequences of random variables. Since the product of two compact sets is compact, then the left-hand side of Equation (9.22) forms a tight sequence. Therefore, again by Prokhorov's theorem, it is enough to identify the distribution of all joint subsequential limits in order to show the convergence in Equation (9.22). Assume that along a subsequence, we have

$$(9.23) \quad \left(\bar{\mathcal{W}}_n, \bar{\mathcal{Z}}_n^{(u)}, \bar{\mathcal{L}}_n^{(u)} \right) \xrightarrow[n \rightarrow \infty]{d} \left(\mathcal{W}, \tilde{\mathcal{Z}}, \tilde{\mathcal{L}} \right),$$

where $\tilde{\mathcal{Z}}$ is a Brownian motion started at time u , and $\tilde{\mathcal{L}}$ is its local time process at zero. The joint distribution of the right-hand side is unknown for now, but we will show that $\tilde{\mathcal{Z}} = \mathcal{Z}^{(u)}$ almost surely, which will complete the proof. Using Skorokhod's theorem, we may define all involved variables on the same probability space and assume that the convergence in Equation (9.23) is in fact almost sure.

Let $(\mathcal{G}_t)_t$ be the smallest complete filtration to which \mathcal{W} and $\tilde{\mathcal{Z}}$ are adapted, i.e. \mathcal{G}_t is the completion of $\sigma(\mathcal{W}(s), \tilde{\mathcal{Z}}(s), s \leq t)$ by the negligible events of \mathfrak{N} . We shall show that \mathcal{W} is a $(\mathcal{G}_t)_t$ -Brownian motion, that is for $t \in \mathbb{R}, s \in \mathbb{R}_{\geq 0}$,

$$(\mathcal{W}(t+s) - \mathcal{W}(t)) \perp\!\!\!\perp \mathcal{G}_t.$$

For fixed n , by definition of random walk, $(\bar{\mathcal{W}}_n(t+s) - \bar{\mathcal{W}}_n(t)) \perp\!\!\!\perp \sigma(\bar{\mathcal{W}}_k, k \leq \lfloor nt \rfloor)$. Therefore,

$$(9.24) \quad (\bar{\mathcal{W}}_n(t+s) - \bar{\mathcal{W}}_n(t)) \perp\!\!\!\perp \left(\bar{\mathcal{W}}_n(r), \bar{\mathcal{Z}}_n^{(u)}(r) \right)_{r \leq n^{-1} \lfloor nt \rfloor}.$$

By convergence, we obtain that $(\mathcal{W}(t+s) - \mathcal{W}(t))$ is independent of $\left(\mathcal{W}(r), \tilde{\mathcal{Z}}(r) \right)_{r \leq t}$, completing the claim that \mathcal{W} is a $(\mathcal{G}_t)_t$ -Brownian motion.

Now fix a rational $\varepsilon > 0$ and an open interval with rational endpoints (\mathbf{a}, \mathbf{b}) on which $\tilde{\mathcal{Z}}(t) > \varepsilon$. Note that the interval (\mathbf{a}, \mathbf{b}) depends on $\tilde{\mathcal{Z}}(t)$. By almost sure convergence, there is N_0 such that for $n \geq N_0$, $\bar{\mathcal{Z}}_n^{(u)} > \varepsilon/2$ on (\mathbf{a}, \mathbf{b}) . On the interval $(\mathbf{a} + 1/n, \mathbf{b})$, the process $\bar{\mathcal{Z}}_n^{(u)} - \bar{\mathcal{Y}}_n$ is constant by construction of the coalescent-walk process (see Section 9.2.4.1). Hence the limit $\tilde{\mathcal{Z}} - \mathcal{Y}$ is constant too on (\mathbf{a}, \mathbf{b}) almost surely. We have shown that almost surely $\tilde{\mathcal{Z}} - \mathcal{Y}$ is locally constant on $\{t > u : \tilde{\mathcal{Z}}(t) > \varepsilon\}$. This translates into the following almost sure equality:

$$\int_u^t \mathbf{1}_{\{\tilde{\mathcal{Z}}(r) > \varepsilon\}} d\tilde{\mathcal{Z}}(r) = \int_u^t \mathbf{1}_{\{\tilde{\mathcal{Z}}(r) > \varepsilon\}} d\mathcal{Y}(r), \quad t \geq u.$$

The stochastic integrals are well-defined: on the left-hand side by considering the canonical filtration of $\tilde{\mathcal{Z}}$, on the right-hand side by considering $(\mathcal{G}_t)_t$. The same can be done for negative values, leading to

$$\int_u^t \mathbf{1}_{\{\tilde{\mathcal{Z}}(r) > \varepsilon\}} d\tilde{\mathcal{Z}}(r) = \int_u^t \mathbf{1}_{\{\tilde{\mathcal{Z}}(r) > \varepsilon\}} d\mathcal{Y}(r) - \int_u^t \mathbf{1}_{\{\tilde{\mathcal{Z}}(r) < -\varepsilon\}} d\mathcal{X}(r).$$

By stochastic dominated convergence theorem, one can take the limit as $\varepsilon \rightarrow 0$, [RY99, Thm. IV.2.12], and obtain

$$\int_u^t \mathbf{1}_{\{\tilde{\mathcal{Z}}(r) \neq 0\}} d\tilde{\mathcal{Z}}(r) = \int_u^t \mathbf{1}_{\{\tilde{\mathcal{Z}}(r) > 0\}} d\mathcal{Y}(r) - \int_u^t \mathbf{1}_{\{\tilde{\mathcal{Z}}(r) < 0\}} d\mathcal{X}(r).$$

Thanks to the fact that $\tilde{\mathcal{Z}}$ is a Brownian motion, $\int_u^t \mathbf{1}_{\{\tilde{\mathcal{Z}}(r) = 0\}} d\tilde{\mathcal{Z}}(r) = 0$, so that the left-hand side of the equation above equals $\tilde{\mathcal{Z}}(t)$. As a result $\tilde{\mathcal{Z}}$ verifies Equation (9.20) almost

surely and we can apply pathwise uniqueness (Theorem 9.4.1, item 1) to complete the proof that $\tilde{\mathbf{Z}} = \mathbf{Z}^{(u)}$ almost surely. \square

9.4.3. The conditioned scaling limit result. In the previous section we saw a scaling limit result for infinite-volume coalescent-walk processes. We now deal with the finite-volume case, the one that we need for our results.

For all $n \geq 1$, let \mathbf{W}_n be a uniform element of the space of tandem walks \mathcal{W}_n and $\mathbf{Z}_n = \text{WC}(\mathbf{W}_n)$ be the corresponding uniform coalescent-walk process. Let also $\mathbf{L}_n = (\mathbf{L}_n^{(i)}(j))_{1 \leq i \leq j \leq n} = L_{\mathbf{Z}_n}$ be the local time process of \mathbf{Z}_n as defined in Equation (9.10) page 185. For all $n \geq 1, u \in (0, 1)$, let $\mathbf{W}_n : [0, 1] \rightarrow \mathbb{R}^2, \mathbf{Z}_n^{(u)} : [0, 1] \rightarrow \mathbb{R}$ and $\mathcal{L}_n^{(u)} : [0, 1] \rightarrow \mathbb{R}$ be the continuous functions defined by linearly interpolating the following points defined for all $k \in [n]$,

$$(9.25) \quad \mathbf{W}_n \left(\frac{k}{n} \right) = \frac{1}{\sqrt{2n}} \mathbf{W}_n(k), \quad \mathbf{Z}_n^{(u)} \left(\frac{k}{n} \right) = \frac{1}{\sqrt{2n}} \mathbf{Z}_n^{(\lceil nu \rceil)}(k), \quad \mathcal{L}_n^{(u)} \left(\frac{k}{n} \right) = \frac{1}{\sqrt{2n}} \mathbf{L}_n^{(\lceil nu \rceil)}(k).$$

Our goal is to obtain a scaling limit result for these processes in the fashion of Theorem 9.4.5.

Let \mathcal{W}_e denote a two-dimensional Brownian excursion of correlation $-1/2$ in the non-negative quadrant and denote by $(\Omega, \mathcal{F}, (\mathcal{F}_t)_{0 \leq t \leq 1}, \mathbb{P}_{\text{exc}})$ the completed canonical probability space of \mathcal{W}_e . From now on we work in this space. The law of the process \mathcal{W}_e is characterized (for instance) by Proposition 9.A.4 below. Using Proposition 9.3.2 and Proposition 9.A.1, we have that \mathcal{W}_e is the scaling limit of \mathbf{W}_n . Then, the scaling limit of \mathbf{Z}_n should be the continuous coalescent-walk process driven by \mathcal{W}_e , i.e. the collection (indexed by $u \in [0, 1]$) of solutions of Equation (9.19) driven by \mathcal{W}_e .

Let us remark that since Brownian excursions are semimartingales [RY99, Exercise 3.11], it makes sense to consider stochastic integrals against such processes, so the SDE in Equation (9.19) driven by \mathcal{W}_e is well-defined. We can also transport existence and uniqueness of strong solutions from Theorem 9.4.1 using absolute continuity arguments as follows.

Denote by $\mathcal{F}_t^{(u)}$ the sigma-algebra generated by $\mathcal{W}_e(s) - \mathcal{W}_e(u)$ for $u \leq s \leq t$ and completed by negligible events of \mathbb{P}_{exc} .

Theorem 9.4.6. *For every $u \in (0, 1)$, there exists a continuous $\mathcal{F}_t^{(u)}$ -adapted stochastic process $\mathbf{Z}_e^{(u)}$ on $[u, 1)$, such that*

- i) *the mapping $(\omega, u) \mapsto \mathbf{Z}_e^{(u)}$ is jointly measurable.*
- ii) *For every $0 < u < r < 1$, $\mathbf{Z}_e^{(u)}$ verifies Equation (9.19) with driving motion \mathcal{W}_e , restricted to the interval $[u, r]$, almost surely.*
- iii) *If $0 < u < r < 1$ and $\tilde{\mathbf{Z}}$ is an $\mathcal{F}_t^{(u)}$ -adapted stochastic process that verifies Equation (9.19) with driving motion \mathcal{W}_e on interval $[u, r]$, then $\tilde{\mathbf{Z}} = \mathbf{Z}_e^{(u)}$ on $[u, r]$ almost surely.*

PROOF. Recall the solution mappings F_t defined in Theorem 9.4.1. For $0 < u < r < 1$, we define the process $\mathcal{R}_{u,r} \in \mathcal{C}([u, r])$ as follows:

$$\mathcal{R}_{u,r}(t) := F_{r-u}((\mathcal{W}_e(u+s) - \mathcal{W}_e(u))_{0 \leq s \leq r-u})(t-u), \quad u \leq t \leq r.$$

By definition, $\mathcal{R}_{u,r}$ is measurable with regards to $\mathcal{F}_r^{(u)}$. By Proposition 9.A.4, the distribution of $((\mathcal{W}_e(u+s) - \mathcal{W}_e(u))_{0 \leq s \leq r-u})$ is absolutely continuous with regards to that of a Brownian motion with time-interval $[0, r-u]$. Hence thanks to items 3 and 4 of Theorem 9.4.1,

- i) $\mathcal{R}_{u,r}$ almost surely verifies Equation (9.19) driven by \mathcal{W}_e on interval $[u, r]$;
- ii) for $0 < u < r < r' < 1$, we have $\mathcal{R}_{u,r} = (\mathcal{R}_{u,r'})|_{[u,r]}$ almost surely.

Moreover, $(u, r, \omega) \mapsto \mathfrak{R}_{u,r}$ is measurable by construction.

Finally, this holds simultaneously for all rational r, r' such that $0 < u < r < r' < 1$, so that there almost surely exists $\mathfrak{Z}^{(u)} \in \mathcal{C}([u, 1])$ whose restriction coincides with $\mathfrak{R}_{u,r}$ for every rational r . Hence it almost surely verifies Equation (9.19) driven by \mathfrak{W}_e . For fixed $r_0 \in (u, 1)$, $\mathfrak{Z}^{(u)}|_{[u, r_0]} = \mathfrak{R}_{u, r_0}$, which is $\mathcal{F}_{r_0}^{(u)}$ -measurable. Hence $\mathfrak{Z}^{(u)}$ is $\mathcal{F}^{(u)}$ -adapted. This proves existence of a strong solution.

We now move to the uniqueness claim. Consider two $\mathcal{F}^{(u)}$ -adapted solutions $\mathfrak{Z}^{(u)}, \tilde{\mathfrak{Z}}^{(u)}$ of the SDE in Equation (9.19) driven by \mathfrak{W}_e . By assumption $r < 1$. There must be $H, \tilde{H} : \mathcal{C}([u, r]) \rightarrow \mathcal{C}([u, r])$ so that almost surely,

$$\mathfrak{Z}^{(u)} = H(\mathfrak{W}_e(s) - \mathfrak{W}_e(u), u \leq s \leq r) \quad \text{and} \quad \tilde{\mathfrak{Z}}^{(u)} = \tilde{H}(\mathfrak{W}_e(s) - \mathfrak{W}_e(u), u \leq s \leq r).$$

By absolute continuity (Proposition 9.A.4), given a two-dimensional Brownian motion \mathfrak{B} , the processes $H(\mathfrak{B})$ and $\tilde{H}(\mathfrak{B})$ are solutions of the SDE in Equation (9.19) driven by \mathfrak{B} . By pathwise uniqueness (Theorem 9.4.1, item 2), $H(\mathfrak{B}) = \tilde{H}(\mathfrak{B})$ almost surely so that by absolute continuity, $\mathfrak{Z}^{(u)} = \tilde{\mathfrak{Z}}^{(u)}$ almost surely. \square

Now for $u \in (0, 1)$ denote by $\mathfrak{Z}_e^{(u)}$ the strong solution of Equation (9.19) driven by \mathfrak{W}_e provided by the previous theorem. Note that the process $\mathfrak{Z}_e^{(u)}$ is a continuous process on the interval $[u, 1)$. Since $\mathfrak{Z}_e^{(u)}(u) = 0$, we extend continuously $\mathfrak{Z}_e^{(u)}$ on $[0, 1)$ by setting $\mathfrak{Z}_e^{(u)}(t) = 0$ for $0 \leq t \leq u$. It will turn out (see Proposition 9.4.8) that $\mathfrak{Z}_e^{(u)}$ can also be extended continuously at time 1.

A remark similar to Remark 9.4.2 holds for the family $\{\mathfrak{Z}_e^{(u)}\}_{u \in (0, 1)}$, that is, we can only guarantee that for almost every ω , $\mathfrak{Z}_e^{(u)}$ is a solution of Equation (9.19) for almost every $u \in (0, 1)$. Denote by $(\mathcal{L}_e^{(u)})_{u \leq t < 1}$ the local time process at zero of the semimartingale $\mathfrak{Z}_e^{(u)}$ on $[u, 1)$. By convention, set $\mathcal{L}_e^{(u)}(t) = 0$ for $0 \leq t < u$.

Definition 9.4.7. We call *continuous coalescent-walk process* (driven by \mathfrak{W}_e) the collection of stochastic processes $\left\{ \mathfrak{Z}_e^{(u)} \right\}_{u \in (0, 1)}$.

We can now prove a scaling limit result for finite-volume coalescent-walk processes. We first deal with the case of a single trajectory $\mathfrak{Z}_n^{(u)}$. Then we consider a more general case in Theorem 9.4.10.

Proposition 9.4.8. *Fix $u \in (0, 1)$. The stochastic process $\mathfrak{Z}_e^{(u)}$ can be extended to a continuous function on $[0, 1]$ by setting $\mathfrak{Z}_e^{(u)}(1) = 0$, and we have the following joint convergence in the product space of continuous functions $\mathcal{C}([0, 1], \mathbb{R}^2) \times \mathcal{C}([0, 1], \mathbb{R}) \times \mathcal{C}([0, 1], \mathbb{R})$:*

$$(9.26) \quad \left(\mathfrak{W}_n, \mathfrak{Z}_n^{(u)}, \mathcal{L}_n^{(u)} \right) \xrightarrow[n \rightarrow \infty]{d} \left(\mathfrak{W}_e, \mathfrak{Z}_e^{(u)}, \mathcal{L}_e^{(u)} \right).$$

Remark 9.4.9. Note that the convergence of local times does not go up to time one. This will be corrected later in Lemma 9.5.12 for a uniformly random starting point, using a combinatorial argument.

PROOF. The convergence in distribution $\mathfrak{W}_n \xrightarrow[n \rightarrow \infty]{d} \mathfrak{W}_e$ is Proposition 9.A.1. Now let $0 < \varepsilon < u \wedge (1 - u)$. By construction, $\left((\mathfrak{W}_n - \mathfrak{W}_n(u))|_{[u, 1-\varepsilon]}, \mathfrak{Z}_n^{(u)}|_{[u, 1-\varepsilon]}, \mathcal{L}_n^{(u)}|_{[u, 1-\varepsilon]} \right)$ is a measurable functional of $(\mathfrak{W}_n(k) - \mathfrak{W}_n(\lfloor \varepsilon n \rfloor))_{\lfloor \varepsilon n \rfloor \leq k \leq \lfloor (1-\varepsilon)n \rfloor}$. Using Theorem 9.4.5 together with Lemmas 9.A.2 and 9.A.3 and proposition 9.A.4, we get that (the arguments are similar to the ones used in the proof of Proposition 9.A.1)

$$\begin{aligned} & \left((\mathfrak{W}_n - \mathfrak{W}_n(u))|_{[u, 1-\varepsilon]}, \mathfrak{Z}_n^{(u)}|_{[u, 1-\varepsilon]}, \mathcal{L}_n^{(u)}|_{[u, 1-\varepsilon]} \right) \\ & \xrightarrow[n \rightarrow \infty]{d} \left((\mathfrak{W}_e - \mathfrak{W}_e(u))|_{[u, 1-\varepsilon]}, \mathfrak{Z}_e^{(u)}|_{[u, 1-\varepsilon]}, \mathcal{L}_e^{(u)}|_{[u, 1-\varepsilon]} \right). \end{aligned}$$

As in the proof of Theorem 9.4.5, we use Prokhorov's theorem twice, and obtain that the sequence

$$(9.27) \quad \left(\mathbf{W}_n, \left((\mathbf{W}_n - \mathbf{W}_n(u))|_{[u, 1-\varepsilon]}, \mathbf{Z}_n^{(u)}|_{[u, 1-\varepsilon]}, \mathbf{L}_n^{(u)}|_{[u, 1-\varepsilon]} \right)_{\varepsilon \in \mathbb{Q} \cap (0, u \wedge 1-u)} \right)$$

is tight. The only possible limit in distribution is

$$(9.28) \quad \left(\mathbf{W}_e, \left((\mathbf{W}_e - \mathbf{W}_e(u))|_{[u, 1-\varepsilon]}, \mathbf{Z}_e^{(u)}|_{[u, 1-\varepsilon]}, \mathbf{L}_e^{(u)}|_{[u, 1-\varepsilon]} \right)_{\varepsilon \in \mathbb{Q} \cap (0, u \wedge 1-u)} \right)$$

because the processes $\mathbf{Z}_n^{(u)}|_{[u, 1-\varepsilon]}$ and $\mathbf{L}_n^{(u)}|_{[u, 1-\varepsilon]}$ are measurable functionals of $(\mathbf{W}_n(k) - \mathbf{W}_n(\lfloor \varepsilon n \rfloor))_{\lfloor \varepsilon n \rfloor \leq k \leq \lfloor (1-\varepsilon)n \rfloor}$ and the restriction mapping that sends \mathbf{W}_n to $(\mathbf{W}_n - \mathbf{W}_n(u))|_{[u, 1-\varepsilon]}$ is continuous (and so this relation must carry over to the limit). Hence there is convergence in distribution of the sequence in Equation (9.27) to the limit in Equation (9.28). We may now use Skorokhod's theorem to obtain a large probability space where almost surely, we have uniform convergence on $[0, 1]$ of \mathbf{W}_n to \mathbf{W}_e , uniform convergence on $[u, 1-\varepsilon]$ of $\mathbf{Z}_n^{(u)}$ to $\mathbf{Z}_e^{(u)}$ and $\mathbf{L}_n^{(u)}$ to $\mathbf{L}_e^{(u)}$ for every rational $\varepsilon > 0$.

We can now use the deterministic bound $-\mathbf{X}_n \leq \mathbf{Z}_n^{(k)} \leq \mathbf{Y}_n$ (easily proven by induction) which implies that

$$\begin{aligned} \sup_{k, \ell \geq n} \|\mathbf{Z}_k^{(u)} - \mathbf{Z}_\ell^{(u)}\|_{[0, 1]} &\leq 2 \sup_{k \geq n} \|\mathbf{Z}_k^{(u)} - \mathbf{Z}_e^{(u)}\|_{[0, 1-\varepsilon]} + 2 \sup_{k \geq n} \|\mathbf{Z}_k^{(u)}\|_{[1-\varepsilon, 1]} \\ &\leq 2 \sup_{k \geq n} \|\mathbf{Z}_k^{(u)} - \mathbf{Z}_e^{(u)}\|_{[0, 1-\varepsilon]} + 2 \|\mathbf{W}_e\|_{[1-\varepsilon, 1]} + 2 \sup_{k \geq n} \|\mathbf{W}_k - \mathbf{W}_e\|_{[1-\varepsilon, 1]}. \end{aligned}$$

Taking n to infinity yields $\limsup_{n \geq 1} \sup_{k, \ell \geq n} \|\mathbf{Z}_k^{(u)} - \mathbf{Z}_\ell^{(u)}\|_{[0, 1]} \leq \|\mathbf{W}_e\|_{[1-\varepsilon, 1]}$. Since ε is arbitrary, $(\mathbf{Z}_n^{(u)})_n$ is actually a Cauchy sequence in $\mathcal{C}([0, 1], \mathbb{R})$ and converges uniformly to a continuous function, which necessarily takes value zero at time 1 and coincides with $\mathbf{Z}^{(u)}$ on $[0, 1]$. \square

We finish by stating a version of the previous result, for several uniform starting points. This is the foundation upon which the next section is built.

Theorem 9.4.10. *Let $(\mathbf{u}_i)_{i \in \mathbb{Z}_{>0}}$ be a sequence of i.i.d. uniform random variables on $[0, 1]$, independent of all other variables. We have the following joint convergence in the product space of continuous functions $\mathcal{C}([0, 1], \mathbb{R}^2) \times (\mathcal{C}([0, 1], \mathbb{R}) \times \mathcal{C}([0, 1], \mathbb{R}))^{\mathbb{Z}_{>0}}$:*

$$\left(\mathbf{W}_n, \left(\mathbf{Z}_n^{(\mathbf{u}_i)}, \mathbf{L}_n^{(\mathbf{u}_i)} \right)_{i \in \mathbb{Z}_{>0}} \right) \xrightarrow[n \rightarrow \infty]{d} \left(\mathbf{W}_e, \left(\mathbf{Z}_e^{(\mathbf{u}_i)}, \mathbf{L}_e^{(\mathbf{u}_i)} \right)_{i \in \mathbb{Z}_{>0}} \right).$$

PROOF. Fix $u_1, \dots, u_k \in (0, 1)$. Joint tightness and the fact that $\mathbf{Z}_e^{(u)}$ and $\mathbf{L}_e^{(u)}$ are measurable functions of \mathbf{W}_e , imply that convergence in distribution in Equation (9.26) holds jointly for $u \in \{u_1, \dots, u_k\}$. This means that for every bounded continuous $\varphi : \mathcal{C}([0, 1], \mathbb{R}^2) \times (\mathcal{C}([0, 1], \mathbb{R}) \times \mathcal{C}([0, 1], \mathbb{R}))^{\mathbb{Z}_{>0}} \rightarrow \mathbb{R}$,

$$\mathbb{E} \left[\varphi \left(\mathbf{W}_n, \left(\mathbf{Z}_n^{(\mathbf{u}_i)}, \mathbf{L}_n^{(\mathbf{u}_i)} \right)_{1 \leq i \leq k} \right) \right] \rightarrow \mathbb{E} \left[\varphi \left(\mathbf{W}_e, \left(\mathbf{Z}_e^{(\mathbf{u}_i)}, \mathbf{L}_e^{(\mathbf{u}_i)} \right)_{1 \leq i \leq k} \right) \right].$$

With dominated convergence one can integrate this over $u_1, \dots, u_k \in [0, 1]$, which by Fubini–Tonelli's theorem gives

$$\mathbb{E} \left[\varphi \left(\mathbf{W}_n, \left(\mathbf{Z}_n^{(\mathbf{u}_i)}, \mathbf{L}_n^{(\mathbf{u}_i)} \right)_{1 \leq i \leq k} \right) \right] \rightarrow \mathbb{E} \left[\varphi \left(\mathbf{W}_e, \left(\mathbf{Z}_e^{(\mathbf{u}_i)}, \mathbf{L}_e^{(\mathbf{u}_i)} \right)_{1 \leq i \leq k} \right) \right].$$

As k is arbitrary, this is the claim of convergence in distribution in the product topology. \square

9.5. Scaling limits of Baxter permutations and bipolar orientations

This section is split in two parts: in the first one, we construct the Baxter permuton (see Definition 9.5.4) from the continuous coalescent-walk process $\mathfrak{Z}_e = \{\mathfrak{Z}_e^{(u)}\}_{u \in [0,1]}$ introduced in Definition 9.4.7, and we show that it is the limit of uniform Baxter permutations (see Theorem 9.5.6). We also show that this convergence holds jointly with the one for the coalescent-walk process (proved in Theorem 9.4.10). Building on these results, in the second part, we prove a joint (scaling limit) convergence result for all the objects considered in this paper, i.e. tandem walks, Baxter permutations, bipolar orientations and coalescent-walk processes (see Theorem 9.5.8). In both cases, a key ingredient is the convergence of the discrete coalescent-walk process to its continuous counterpart (Theorem 9.4.10).

9.5.1. The permuton limit of Baxter permutations. We recall some basic results on permuton limits that we need for this section. For a complete introduction we refer the reader to Chapter 3 and references therein.

Firstly, the space of permutons \mathcal{M} , equipped with the topology of weak convergence of measures, is compact and metrizable by the metric d_\square defined as follows: for every pair of permutons (μ, μ') ,

$$d_\square(\mu, \mu') := \sup_{R \in \mathcal{R}} |\mu(R) - \mu'(R)|,$$

where \mathcal{R} denotes the set of rectangles contained in $[0, 1]^2$.

We need now to define the permutation induced by k points in the square $[0, 1]^2$. Take a sequence of k points $(X, Y) = ((x_1, y_1), \dots, (x_k, y_k))$ in $[0, 1]^2$ in general position, i.e. with distinct x and y coordinates. We denote by $((x_{(1)}, y_{(1)}), \dots, (x_{(k)}, y_{(k)}))$ the x -reordering of (X, Y) , i.e. the unique reordering of the sequence $((x_1, y_1), \dots, (x_k, y_k))$ such that $x_{(1)} < \dots < x_{(k)}$. Then the values $(y_{(1)}, \dots, y_{(k)})$ are in the same relative order as the values of a unique permutation of size k , that we call the *permutation induced by (X, Y)* .

Let μ be a random permuton and $((\mathbf{X}_i, \mathbf{Y}_i))_{i \geq 1}$ be an i.i.d. sequence with distribution μ conditionally¹¹ on μ . On this space, we denote by $\mathbf{Perm}_k(\mu)$ the permutation induced by $((\mathbf{X}_i, \mathbf{Y}_i))_{1 \leq i \leq k}$. The following concentration result shows that μ is close to $\mathbf{Perm}_k(\mu)$ in probability when k is large.

Lemma 9.5.1 (Approximation of a random permuton by a random permutation Lemma 3.2.2). *There exists k_0 such that if $k > k_0$,*

$$\mathbb{P} \left[d_\square(\mu_{\mathbf{Perm}_k(\nu)}, \nu) \geq 16k^{-1/4} \right] \leq \frac{1}{2} e^{-\sqrt{k}}, \quad \text{for any random permuton } \nu.$$

This lemma may be used to prove a nice characterization of permuton convergence in distribution: μ_n converges to μ in distribution if and only if $\mathbf{Perm}_k(\mu_n)$ converges to $\mathbf{Perm}_k(\mu)$ in distribution for every $k \geq 1$ Theorem 3.3.2. We will not use this result here but rather directly refer to the lemma above.

We now introduce the candidate limiting permuton for Baxter permutations. Its definition is rather straightforward by analogy with the discrete case (see Section 9.2.4.2). We consider the continuous coalescent-walk process $\mathfrak{Z}_e = \{\mathfrak{Z}_e^{(t)}\}_{t \in [0,1]}$. Actually $\mathfrak{Z}_e^{(t)}$ was not defined for $t \in \{0, 1\}$ (see Definition 9.4.7). As what happens on a negligible subset of $[0, 1]$ is irrelevant to the arguments to come, this poses no problems.

We first define a random binary relation $\leq_{\mathfrak{Z}_e}$ on $[0, 1]^2$ as follows (this is an analogue of the definition given in Equation (9.9) page 182 in the discrete case):

$$(9.29) \quad \begin{cases} t \leq_{\mathfrak{Z}_e} t & \text{for every } t \in [0, 1], \\ t \leq_{\mathfrak{Z}_e} s & \text{for every } 0 \leq t < s \leq 1 \text{ such that } \mathfrak{Z}_e^{(t)}(s) < 0, \\ s \leq_{\mathfrak{Z}_e} t, & \text{for every } 0 \leq t < s \leq 1 \text{ such that } \mathfrak{Z}_e^{(t)}(s) \geq 0. \end{cases}$$

Note that the map $(\omega, t, s) \mapsto \mathbb{1}_{t \leq_{\mathfrak{Z}_e} s}$ is measurable.

¹¹. Constructed by enriching the probability space as explained in Chapter 3.

Proposition 9.5.2. *The relation $\leq_{\mathbf{z}_e}$ is antisymmetric and reflexive. Moreover, there exists a random set $\mathbf{A} \subset [0, 1]^2$ of a.s. zero Lebesgue measure, i.e. $\mathfrak{P}(\text{Leb}(\mathbf{A}) = 0) = 1$, such that the restriction of $\leq_{\mathbf{z}_e}$ to $[0, 1]^2 \setminus \mathbf{A}$ is transitive almost surely.*

PROOF. Antisimmetry and reflexivity are immediate by definition. Therefore we just have to prove transitivity.

Let us start by showing that, almost surely, two distinct trajectories of the coalescent-walk process $\mathbf{Z}_e = \{\mathbf{Z}_e^{(t)}\}_{t \in [0, 1]}$ do not cross. That is, if $0 \leq r \leq s \leq t < 1$, and $\mathbf{Z}_e^{(r)}(s) \leq \mathbf{Z}_e^{(s)}(s)$, then $\mathbf{Z}_e^{(r)}(t) \leq \mathbf{Z}_e^{(s)}(t)$ almost surely. By contradiction, if $\mathbf{Z}_e^{(r)}(t) > \mathbf{Z}_e^{(s)}(t)$, then upon exchanging the trajectories when they first meet, one provides another solution of the SDE (9.19) page 196 started at time r , in negation of the uniqueness claim (Theorem 9.4.6, item 3).

By Fubini–Tonelli’s theorem, there exists a random set \mathbf{A} with $\mathfrak{P}(\text{Leb}(\mathbf{A}) = 0) = 1$, such that this non-crossing property holds on $[0, 1]^2 \setminus \mathbf{A}$ almost surely. From this result, the proof that $\leq_{\mathbf{z}_e}$ is transitive on $[0, 1]^2 \setminus \mathbf{A}$ is the same as in the discrete case (see Proposition 9.2.9). \square

We now define a random function that encodes the total order $\leq_{\mathbf{z}_e}$:

$$(9.30) \quad \varphi_{\mathbf{z}_e}(t) := \text{Leb}(\{x \in [0, 1] \mid x \leq_{\mathbf{z}_e} t\}) \\ = \text{Leb}\left(\{x \in [0, t] \mid \mathbf{Z}_e^{(x)}(t) < 0\} \cup \{x \in [t, 1] \mid \mathbf{Z}_e^{(t)}(x) \geq 0\}\right),$$

where here $\text{Leb}(\cdot)$ denotes the one-dimensional Lebesgue measure. Note that since the mapping $(\omega, t, s) \mapsto \mathbf{1}_{t \leq_{\mathbf{z}_e} s}$ is measurable, the mapping $(\omega, t) \mapsto \varphi_{\mathbf{z}_e}(t)$ is measurable too.

Observation 9.5.3. Note that the function defined in Equation (9.30) is inspired by the following: if σ is the Baxter permutation associated with a coalescent-walk process $Z = \{Z^{(t)}\}_{t \in [n]} \in \mathcal{C}$, then $\sigma(i) = \#\{j \in [n] \mid j \leq_Z i\}$.

Definition 9.5.4. The *Baxter permuton* is the push-forward of the Lebesgue measure on $[0, 1]$ via the mapping $(\text{Id}, \varphi_{\mathbf{z}_e})$, that is

$$(9.31) \quad \boldsymbol{\mu}_B(\cdot) := (\text{Id}, \varphi_{\mathbf{z}_e})_* \text{Leb}(\cdot) = \text{Leb}(\{t \in [0, 1] \mid (t, \varphi_{\mathbf{z}_e}(t)) \in \cdot\}).$$

The Baxter permuton $\boldsymbol{\mu}_B$ is a random measure on the unit square $[0, 1]^2$ and the terminology is justified by the following lemma, that also states some results useful for the proof of Theorem 9.5.6. The second item of the lemma is proved using similar ideas as for Proposition 4.3.1.

Lemma 9.5.5. *The following claims hold:*

- i) *For $0 < t < s < 1$, $\mathbf{Z}^{(t)}(s) \neq 0$ almost surely.*
- ii) *The random measure $\boldsymbol{\mu}_B$ is a.s. a permuton.*
- iii) *Almost surely, for almost every $t < s \in [0, 1]$, either $\mathbf{Z}_e^{(t)}(s) > 0$ and $\varphi_{\mathbf{z}_e}(s) < \varphi_{\mathbf{z}_e}(t)$, or $\mathbf{Z}_e^{(t)}(s) < 0$ and $\varphi_{\mathbf{z}_e}(s) > \varphi_{\mathbf{z}_e}(t)$.*

PROOF. We start by proving the first claim. Let $\varepsilon > 0$ be such that $0 < t < s < 1 - \varepsilon < 1$. As we have seen in the proof of Theorem 9.4.6, $(\mathbf{Z}^{(t)}(t + r))_{0 \leq r \leq 1 - t - \varepsilon}$ is absolutely continuous with regards to a Brownian motion of lifetime $1 - t - \varepsilon$. As a result, $\mathbf{Z}^{(t)}(s) \neq 0$ almost surely, proving claim 1.

For the second claim, by definition, the measure $\boldsymbol{\mu}_B$ is a probability measure on the unit square and its first marginal is almost surely uniform. As such, to prove claim 2 we simply have to check that

$$(9.32) \quad (\varphi_{\mathbf{z}_e})_* \text{Leb} = \text{Leb} \text{ a.s.}$$

Let $(\mathbf{U}_i)_{i \in \mathbb{Z}_{>0}}$ be i.i.d. uniform random variables on $[0, 1]$. Set for $k \geq 2$,

$$\mathbf{U}_{1,k} := \frac{1}{k-1} \#\left\{i \in [2, k] \mid \mathbf{U}_i \leq_{\mathbf{z}_e} \mathbf{U}_1\right\}.$$

The random variables $\left(\mathbb{1}_{\{U_i \leq z_e U_1\}}\right)_{i \geq 2}$ are i.i.d., conditionally on (\mathcal{W}_e, U_1) . Thus by the law of large numbers $U_{1,k}$ converges almost surely as k tends to infinity to

$$\mathbb{P}[U_2 \leq z_e U_1 \mid \mathcal{W}_e, U_1] = \text{Leb}(\{x \in [0, 1] \mid x \leq z_e U_1\}) = \varphi_{z_e}(U_1).$$

On the other hand, by the exchangeability of the U_i , and using claim 1, the random variable $U_{1,k}$ is uniform in $\left\{\frac{0}{k-1}, \dots, \frac{k-1}{k-1}\right\}$, conditionally on \mathcal{W}_e . Therefore $\varphi_{z_e}(U_1)$ is uniform on $[0, 1]$ conditionally on \mathcal{W}_e . This proves Equation (9.32) and claim 2.

For the third claim, consider a pair of independent uniform random variables U and V independent of \mathcal{W}_e . It is immediate from Proposition 9.5.2 that if $U \leq V$ and $\mathcal{Z}_e^{(U)}(V) > 0$ then $\varphi_{z_e}(U) \leq \varphi_{z_e}(V)$ a.s., and if $U \leq V$ and $\mathcal{Z}_e^{(U)}(V) < 0$ then $\varphi_{z_e}(U) \geq \varphi_{z_e}(V)$ a.s. The equality case $\mathcal{Z}_e^{(U)}(V) = 0$ is almost surely excluded by claim 1, and the equality case $\varphi_{z_e}(U) = \varphi_{z_e}(V)$ is almost surely excluded by the fact that $\varphi_{z_e}(U)$ and $\varphi_{z_e}(V)$ are two independent uniform random variables thanks to Equation (9.32). This proves claim 3. \square

We can now prove that Baxter permutations converge in distribution to the Baxter permuton. Since it will be useful in the next section, we also show that this convergence is joint with the convergence of the corresponding walk and the corresponding coalescent-walk process.

We reuse the notation of Section 9.4.3. In particular, \mathbf{W}_n is a uniform element of the space of tandem walks \mathcal{W}_n , $\mathbf{Z}_n = \text{WC}(\mathbf{W}_n)$ is the associated uniform coalescent-walk process, and $\sigma_n = \text{CP}(\mathbf{Z}_n)$ is the associated uniform Baxter permutation.

Theorem 9.5.6. *Jointly with the convergence of Theorem 9.4.10, we have that $\mu_{\sigma_n} \xrightarrow{d} \mu_B$.*

PROOF. Recall the convergence result of Theorem 9.4.10. Assume that there is a subsequence along which μ_{σ_n} jointly converges in distribution to some random permuton $\tilde{\mu}$, i.e.

$$(9.33) \quad \left(\mathcal{W}_n, \left(\mathcal{Z}_n^{(\mathbf{u}_i)}, \mathcal{L}_n^{(\mathbf{u}_i)}\right)_{i \in \mathbb{Z}_{>0}}, \mu_{\sigma_n}\right) \xrightarrow[n \rightarrow \infty]{d} \left(\mathcal{W}_e, \left(\mathcal{Z}_e^{(\mathbf{u}_i)}, \mathcal{L}_e^{(\mathbf{u}_i)}\right)_{i \in \mathbb{Z}_{>0}}, \tilde{\mu}\right).$$

We shall show that on the probability space of the right-hand-side of Equation (9.33), $\tilde{\mu} = \mu_B$ almost surely, where μ_B is constructed from the coalescent process \mathcal{Z}_e . By virtue of Prokhorov's theorem and compactness of the metric space \mathcal{M} , this is enough to prove the joint convergence claim. To simplify things, we assume that the subsequential convergence is almost sure using Skorokhod's theorem. In particular, almost surely as $n \rightarrow \infty$, $\mu_{\sigma_n} \rightarrow \tilde{\mu}$ in the space of permutons, and for every $i \geq 1$, $\mathcal{Z}_n^{(\mathbf{u}_i^{(n)})} \rightarrow \mathcal{Z}_e^{(\mathbf{u}_i)}$ uniformly on $[0, 1]$, where $(\mathbf{u}_i)_{i \geq 1}$ is independent of \mathcal{W}_e , each of $(\mathbf{u}_i^{(n)})_{i \geq 1}$ is independent of \mathcal{W}_n , and all are sequences of i.i.d. uniform random variables on $[0, 1]$.

Fix $k \in \mathbb{Z}_{>0}$. We denote by ρ_n^k the pattern induced by σ_n on the indices $\lceil n\mathbf{u}_1^{(n)} \rceil, \dots, \lceil n\mathbf{u}_k^{(n)} \rceil$ (ρ_n^k is undefined if two indices are equal). From the uniform convergence above, and recalling that $\mathcal{Z}_n^{(\mathbf{u})} \left(\frac{k}{n}\right) = \frac{1}{\sqrt{2n}} \mathcal{Z}_n^{(\lceil nu \rceil)}(k)$, we have for all $1 \leq i < j \leq k$ that

$$\text{sgn} \left(\mathcal{Z}_n^{(\lceil n\mathbf{u}_i^{(n)} \rceil \wedge \lceil n\mathbf{u}_j^{(n)} \rceil)}(\lceil n\mathbf{u}_i^{(n)} \rceil \vee \lceil n\mathbf{u}_j^{(n)} \rceil) \right) \xrightarrow[n \rightarrow \infty]{} \text{sgn}(\mathcal{Z}_e^{(\mathbf{u}_i \wedge \mathbf{u}_j)}(\mathbf{u}_j \vee \mathbf{u}_i)) \quad \text{a.s.}$$

Note that the function sgn is not continuous, but by the first claim of Lemma 9.5.5, the random variable $\mathcal{Z}_e^{(\mathbf{u}_i \wedge \mathbf{u}_j)}(\mathbf{u}_j \vee \mathbf{u}_i)$ is almost surely nonzero, hence a continuity point of sgn . By Proposition 9.2.11 and the third claim of Lemma 9.5.5, this means that $\rho_n^k \xrightarrow[n \rightarrow \infty]{} \rho^k$, where ρ^k denotes the permutation $\text{Perm}_k(\mu_B)$ induced by $(\mathbf{u}_i, \varphi_{z_e}(\mathbf{u}_i))_{i \in [k]}$. Using Lemma 9.5.1, we have for k large enough that

$$(9.34) \quad \mathbb{P} \left[d_{\square}(\mu_{\rho_n^k}, \mu_{\sigma_n}) > 16k^{-1/4} \right] \leq \frac{1}{2} e^{-\sqrt{k}} + O(n^{-1}),$$

where the error term $O(n^{-1})$ comes from the fact that ρ_n^k might be undefined. Since $\rho_n^k \xrightarrow[n \rightarrow \infty]{} \rho^k$ and $\mu_{\sigma_n} \rightarrow \tilde{\mu}$, then taking the limit as $n \rightarrow \infty$, we obtain that

$$\mathbb{P} \left[d_{\square}(\mu_{\rho^k}, \tilde{\mu}) > 16k^{-1/4} \right] \leq \frac{1}{2} e^{-\sqrt{k}},$$

and so $\mu_{\rho^k} \xrightarrow[k \rightarrow \infty]{P} \tilde{\mu}$. Another application of Lemma 9.5.1 gives that $\mu_{\rho^k} \xrightarrow[k \rightarrow \infty]{P} \mu_B$. The last two limits yield $\tilde{\mu} = \mu_B$ almost surely. This concludes the proof. \square

9.5.2. Joint convergence of the four trees of bipolar orientations. Fix $n \geq 1$. Let \mathbf{m}_n be a uniform bipolar orientation of size n , and consider its iterates $\mathbf{m}_n^*, \mathbf{m}_n^{**}, \mathbf{m}_n^{***}$ by the dual operation. Denote $\star = \{\emptyset, *, **, ***\}$ the group of dual operations, that is isomorphic to $\mathbb{Z}/4\mathbb{Z}$. For $\theta \in \star$, let $\mathbf{W}_n^\theta = (\mathbf{X}_n^\theta, \mathbf{Y}_n^\theta)$, \mathbf{Z}_n^θ and σ_n^θ be the uniform objects corresponding to \mathbf{m}_n^θ via the commutative diagram in Equation (9.2) page 172. We also denote by \mathbf{L}_n^θ the local time process of \mathbf{Z}_n^θ (see Equation (9.10) page 185 for a definition). We define rescaled versions as usual: for $u \in [0, 1]$, let $\mathcal{W}_n^\theta : [0, 1] \rightarrow \mathbb{R}^2$, $\mathcal{Z}_n^{\theta,(u)} : [0, 1] \rightarrow \mathbb{R}$ and $\mathcal{L}_n^{\theta,(u)} : [0, 1] \rightarrow \mathbb{R}$ be the continuous functions obtained by linearly interpolating the following families of points defined for all $k \in [n]$:

$$\mathcal{W}_n^\theta \left(\frac{k}{n} \right) = \frac{1}{\sqrt{2n}} \mathbf{W}_n^\theta(k), \quad \mathcal{Z}_n^{\theta,(u)} \left(\frac{k}{n} \right) = \frac{1}{\sqrt{2n}} \mathbf{Z}_n^{\theta,(\lceil nu \rceil)}(k), \quad \mathcal{L}_n^{\theta,(u)} \left(\frac{k}{n} \right) = \frac{1}{\sqrt{2n}} \mathbf{L}_n^{\theta,(\lceil nu \rceil)}(k).$$

Finally, for each $n \in \mathbb{Z}_{>0}$, let $((\mathbf{u}_{n,i}, \mathbf{u}_{n,i}^*))_{i \geq 1}$ be an i.i.d. sequence of distribution $\mu_{\sigma_n^\theta}$ conditionally on \mathbf{m}_n . Let also $\mathbf{u}_{n,i}^{**} = 1 - \mathbf{u}_{n,i}$ and $\mathbf{u}_{n,i}^{***} = 1 - \mathbf{u}_{n,i}^*$ for $n, i \in \mathbb{Z}_{>0}$. The first and second marginal of a permuton are uniform irregardless of the permuton, which implies that for all $n \in \mathbb{Z}_{>0}$ and $\theta \in \star$, $(\mathbf{u}_{n,i}^\theta)_{i \geq 1}$ is an i.i.d. sequence of uniform random variables on $[0, 1]$ independent of \mathbf{m}_n^θ (but for every fixed $n \in \mathbb{Z}_{>0}$, the joint distribution of $((\mathbf{u}_{n,i}^\theta)_{i \geq 1})_{\theta \in \star}$ depends on $(\mathbf{m}_n^\theta)_{\theta \in \star}$).

We can now state one of the main theorems of this paper which is in some sense (made precise later) a joint scaling limit convergence result for all these objects. Recall the time-reversal and coordinates-swapping mapping $s : \mathcal{C}([0, 1], \mathbb{R}^2) \rightarrow \mathcal{C}([0, 1], \mathbb{R}^2)$ defined by $s(f, g) = (g(1 - \cdot), f(1 - \cdot))$.

Theorem 9.5.8. *Let \mathcal{W}_e be a two-dimensional Brownian excursion of correlation $-1/2$ in the non-negative quadrant. Let \mathcal{Z}_e be the associated continuous coalescent-walk process and \mathcal{L}_e be its local-time process. Let \mathbf{u} denote a uniform random variable in $[0, 1]$ independent of \mathcal{W}_e . Then*

- i) *almost surely, $\mathcal{L}_e^{(\mathbf{u})} \in \mathcal{C}([0, 1], \mathbb{R})$ has a limit at 1, and we still denote by $\mathcal{L}_e^{(\mathbf{u})} \in \mathcal{C}([0, 1], \mathbb{R})$ its extension.*
- ii) *There exists a measurable mapping $r : \mathcal{C}([0, 1], \mathbb{R}^2) \rightarrow \mathcal{C}([0, 1], \mathbb{R}^2)$ such that almost surely, denoting $(\tilde{\mathcal{X}}, \tilde{\mathcal{Y}}) = r(\mathcal{W}_e)$,*

$$(9.35) \quad \tilde{\mathcal{X}}(\varphi_{\mathcal{Z}_e}(\mathbf{u})) = \mathcal{L}_e^{(\mathbf{u})}(1) \quad \text{and} \quad r(s(\mathcal{W}_e)) = s(r(\mathcal{W}_e)).$$

These properties uniquely determine the mapping r $\mathbb{P}_{\mathcal{W}_e}$ -almost everywhere. Moreover,

$$(9.36) \quad r(\mathcal{W}_e) \stackrel{d}{=} \mathcal{W}_e, \quad r^2 = s \quad \text{and} \quad r^4 = \text{Id}, \quad \mathbb{P}_{\mathcal{W}_e} - a.e.$$

- iii) *Let $(\mathbf{u}_i)_{i \geq 1}$ be an auxiliary i.i.d. sequence of uniform random variables on $[0, 1]$, independent of \mathcal{W}_e . For each $\theta \in \{\emptyset, *, **, ***\}$, let $\mathcal{W}_e^{\theta*} = r(\mathcal{W}_e^\theta)$ and $\mathbf{u}_i^{\theta*} = \varphi_{\mathcal{Z}_e}(\mathbf{u}_i^\theta)$ for $i \geq 1$. Let also \mathcal{Z}_e^θ be the associated continuous coalescent-walk process, \mathcal{L}_e^θ be its local-time process and $\mu_{\mathcal{Z}_e^\theta}$ be the associated Baxter permuton. Then we have*

joint convergence in distribution

$$(9.37) \quad \left(\mathbf{W}_n^\theta, \left(\mathbf{u}_{n,i}^\theta, \mathbf{z}_n^{\theta,(\mathbf{u}_{n,i}^\theta)}, \mathcal{L}_n^{\theta,(\mathbf{u}_{n,i}^\theta)} \right)_{i \in \mathbb{Z}_{>0}}, \mu_{\sigma_n^\theta} \right)_{\theta \in \star} \\ \xrightarrow[n \rightarrow \infty]{d} \left(\mathbf{W}_e^\theta, \left(\mathbf{u}_i^\theta, \mathbf{z}_e^{\theta,(\mathbf{u}_i^\theta)}, \mathcal{L}_e^{\theta,(\mathbf{u}_i^\theta)} \right)_{i \in \mathbb{Z}_{>0}}, \mu_{\mathbf{z}_e^\theta} \right)_{\theta \in \star}$$

in the space

$$\left(\mathcal{C}([0, 1], \mathbb{R}^2) \times ([0, 1] \times C([0, 1], \mathbb{R}) \times C([0, 1], \mathbb{R}))^{\mathbb{Z}_{>0}} \times \mathcal{M} \right)^4.$$

iv) In this coupling, we almost surely have, for $\theta \in \star$,

$$(9.38) \quad \varphi_{\mathbf{z}_e^{\theta*}} \circ \varphi_{\mathbf{z}_e^\theta} = 1 - \text{Id}, \quad \mathbb{P}_{\mathbf{W}_e} - a.e.$$

Remark 9.5.9. As in the discrete case, we point out that even though the joint distribution of $((\mathbf{u}_i^\theta)_{i \geq 1})_{\theta \in \star}$ depends on $(\mathbf{W}_e^\theta)_{\theta \in \star}$, we have that $(\mathbf{u}_i^\theta)_{i \geq 1}$ is independent of \mathbf{W}_e^θ for every fixed $\theta \in \star$.

Remark 9.5.10. We highlight that the results presented in the theorem above (in particular in Equations (9.35) and (9.36)) are a continuous analog of the results obtained in Section 9.2.6 for discrete objects (see in particular Theorem 9.2.26). The specific connections between the results for continuous and discrete objects are made clear in the proof of the theorem.

PROOF OF THEOREM 9.5.8. We start by showing that the left-hand side of Equation (9.37) is tight. Theorem 9.4.10 and Theorem 9.5.6 give us tightness of all involved random variables, with the caveat that $(\mathcal{L}_n^{\theta,(\mathbf{u}_i^\theta)})_n$ is a priori only tight in the space $\mathcal{C}([0, 1], \mathbb{R})$. Tightness in $\mathcal{C}([0, 1], \mathbb{R})$ results from Lemma 9.5.12, whose statement and proof is postponed to the end of this section, proving in passing item 1.

We now consider a subsequence of

$$\left(\mathbf{W}_n^\theta, \left(\mathbf{u}_i^\theta, \mathbf{z}_n^{\theta,(\mathbf{u}_{n,i}^\theta)}, \mathcal{L}_n^{\theta,(\mathbf{u}_{n,i}^\theta)} \right)_{i \geq i}, \mu_{\sigma_n^\theta} \right)_{\theta \in \star}$$

converging in distribution. For fixed $\theta \in \star$, we know the distribution of the limit thanks to Theorem 9.4.10 and Theorem 9.5.6 (the limit of $\mathcal{L}_n^{\theta,(\mathbf{u}_i^\theta)}$, being a random continuous function on $[0, 1]$, is determined by its restriction to $[0, 1)$). Henceforth, it is legitimate to denote by

$$(9.39) \quad \left(\mathbf{W}_e^\theta, \left(\mathbf{u}_i^\theta, \mathbf{z}_e^{\theta,(\mathbf{u}_i^\theta)}, \mathcal{L}_e^{\theta,(\mathbf{u}_i^\theta)} \right)_{i \geq 1}, \mu_{\mathbf{z}_e^\theta} \right)_{\theta \in \star}$$

the limit, keeping in mind that the coupling for varying θ is undetermined at the moment. We shall determine it to complete the proof of items 2 and 3. We start by proving the following identities:

$$(9.40) \quad \mathbf{W}_e^{**} = s(\mathbf{W}_e), \quad \mathbf{W}_e^{***} = s(\mathbf{W}_e^*),$$

$$(9.41) \quad \mathbf{u}_i^{\theta*} = \varphi_{\mathbf{z}_e^\theta}(\mathbf{u}_i^\theta), \quad i \geq 1, \theta \in \star,$$

$$(9.42) \quad \mathbf{x}_e^{\theta*}(\mathbf{u}_i^{\theta*}) = \mathcal{L}_e^{\theta,(\mathbf{u}_i^\theta)}(1), \quad i \geq 1, \theta \in \star.$$

The claim in Equation (9.40) is the easiest. Thanks to Proposition 9.2.24, we have that $\mathbf{W}_n^{**} = s(\mathbf{W}_n)$ and $\mathbf{W}_n^{***} = s(\mathbf{W}_n^*)$, for every $n \in \mathbb{Z}_{>0}$. Since s is continuous on $\mathcal{C}([0, 1], \mathbb{R}^2)$, the same result holds in the limit, proving Equation (9.40).

To prove Equation (9.41), we use the following lemma, whose proof is skipped. It follows rather directly from the definition of weak convergence of measures.

Lemma 9.5.11. *Suppose that for $n \in \mathbb{Z}_{>0} \cup \{\infty\}$, μ_n is a random measure on a Polish space and $(\mathbf{X}_i^n)_{i \geq 1}$ an i.i.d. sequence of elements with distribution μ_n conditionally on μ_n . Assume that $\mu_n \rightarrow \mu_\infty$ in distribution for the weak topology. Then we have the joint convergence in distribution*

$$(\mu_n, (\mathbf{X}_i^n)_{i \geq 1}) \xrightarrow[n \rightarrow \infty]{d} (\mu_\infty, (\mathbf{X}_i^\infty)_{i \geq 1}).$$

In view of the construction of $(\mu_{\sigma_n^\theta}, (\mathbf{u}_{n,i}^\theta, \mathbf{u}_{n,i}^{\theta*})_{i \geq 1})$, it implies that the joint distribution of $(\mu_{\mathfrak{z}_e^\theta}, (\mathbf{u}_i^\theta, \mathbf{u}_i^{\theta*})_{i \geq 1})$ is that of $\mu_{\mathfrak{z}_e^\theta}$ together with an i.i.d. sequence of elements with distribution $\mu_{\mathfrak{z}_e^\theta}$ conditionally on $\mu_{\mathfrak{z}_e^\theta}$. In particular, we must have $\mathbf{u}_i^{\theta*} = \varphi_{\mathfrak{z}_e^\theta}(\mathbf{u}_i^\theta)$ almost surely. This proves Equation (9.41).

Finally, we have the discrete identity $\mathcal{X}_n^{\theta*}(n^{-1} \lceil n \mathbf{u}_i^{\theta*} \rceil) = \mathcal{L}_n^{\theta, (\mathbf{u}_i^\theta)}(1) - \frac{1}{\sqrt{2n}}$ for every $n \geq 1$ thanks to Corollary 9.2.18. By convergence in distribution, we obtain Equation (9.42).

The continuous stochastic process $\mathcal{X}_e^{\theta*}$ is almost surely determined by its values on the dense sequence $(\mathbf{u}_i^{\theta*})_{i \geq i_0}$. By Equation (9.42) and 0-1 law, we have that $\mathcal{X}_e^{\theta*} \in \sigma(\mathcal{W}_e^\theta)$. This together with Equation (9.40) implies that $\sigma(\mathcal{Y}_e^{\theta*}) = \sigma(\mathcal{X}_e^{\theta***}) \subset \sigma(\mathcal{W}_e^{\theta**}) = \sigma(\mathcal{W}_e^\theta)$. As a result $\mathcal{W}_e^{\theta*} \in \sigma(\mathcal{W}_e^\theta)$ and so there exists a measurable mapping $r : \mathcal{C}([0, 1], \mathbb{R}^2) \rightarrow \mathcal{C}([0, 1], \mathbb{R}^2)$ such that

$$(9.43) \quad r(\mathcal{W}_e^\theta) = \mathcal{W}_e^{\theta*}.$$

Then the claims in Equations (9.35) and (9.36) are an immediate consequence of Equations (9.40) and (9.42). The fact that Equation (9.35) uniquely determines r $\mathbb{P}_{\mathcal{W}_e}$ -almost everywhere also results from the fact that a continuous function is uniquely determined by its values on a set of full Lebesgue measure. This completes the proof of item 2.

Additionally, Equations (9.41) and (9.43) show that the coupling in Equation (9.39) is the one announced in the statement of item 3, and in particular is independent of the subsequence. Together with tightness, this proves item 3.

For item 4, we observe that $\mathbf{u}_{n,1}^\theta = 1 - \mathbf{u}_{n,1}^{\theta**} + 1/n$, so that by passing to the limit, $\mathbf{u}_1^{\theta**} = 1 - \mathbf{u}_1^\theta$. Then item 4 follows from Equation (9.41). \square

We now move to the tightness lemma that was left aside. The proof relies heavily on the relation between the coalescent-walk process and the dual map presented in Corollary 9.2.18.

Lemma 9.5.12. *Let \mathbf{u} be a uniform random variable on $[0, 1]$, independent of \mathbf{W}_n . The sequence $(\mathcal{L}_n^{(\mathbf{u})}(1))_n$ is tight, and for every $\varepsilon, \delta > 0$, there exists $x \in (0, 1)$ and $n_0 \geq 1$ such that*

$$(9.44) \quad \mathbb{P} \left(\mathcal{L}_n^{(\mathbf{u})}(1) - \mathcal{L}_n^{(\mathbf{u})}(1-x) \geq \delta \right) \leq \varepsilon, \quad \text{for all } n \geq n_0.$$

Therefore $(\mathcal{L}_n^{(\mathbf{u})})_n$ is tight in the space $\mathcal{C}([0, 1], \mathbb{R})$.

PROOF OF LEMMA 9.5.12. Let us denote by $\mathbf{U}_n = \lceil n \mathbf{u} \rceil$, and $\mathbf{V}_n = \sigma_n(\mathbf{U}_n)$, where we recall that $\sigma_n = \text{CP} \circ \text{WC}(\mathbf{W}_n)$. Both \mathbf{U}_n and \mathbf{V}_n are separately independent of \mathbf{W}_n . Using Corollary 9.2.18, we have $\mathcal{L}_n^{(\mathbf{u})}(1) = \frac{1}{\sqrt{2n}}(\mathbf{X}_n^*(\mathbf{V}_n) + 1)$, from which tightness for $(\mathcal{L}_n^{(\mathbf{u})}(1))_n$ follows. We turn to the analysis of

$$(9.45) \quad \mathcal{L}_n^{(\mathbf{u})}(1) - \mathcal{L}_n^{(\mathbf{u})}(1-x) \leq \frac{1}{\sqrt{2n}} \left(\mathbf{L}_n^{(\mathbf{U}_n)}(n) - \mathbf{L}_n^{(\mathbf{U}_n)}(\lfloor (1-x)n \rfloor) \right).$$

We now consider the tree $T(\mathbf{m}_n^*)$ with edges labeled by its exploration process. From Observation 9.2.19, the quantity $(\mathbf{L}_n^{(\mathbf{U}_n)}(n) - \mathbf{L}_n^{(\mathbf{U}_n)}(\lfloor (1-x)n \rfloor))$ counts the number of edges on the ancestry line of the edge \mathbf{V}_n in $T(\mathbf{m}_n^*)$ with a $T(\mathbf{m}_n)$ -label strictly greater than $\lfloor (1-x)n \rfloor$. The idea of the proof is to show the existence of an edge on this ancestry

line of height less than $\delta\sqrt{2n}$ and of $T(\mathbf{m}_n)$ -label less than $\lfloor(1-x)n\rfloor$ with high probability. As $T(\mathbf{m}_n)$ -labels decrease going up an ancestry line of $T(\mathbf{m}_n^*)$, this will be enough (see Equation (9.47) below).

Let us make this more precise. Let Δ_n a random quantity to be determined later (see Equation (9.50) below), but that will turn out to be smaller than $\delta\sqrt{2n}$ with probability bounded below. Set

$$(9.46) \quad \mathbf{B}_n = \sup\{k \leq \mathbf{V}_n : \mathbf{X}_n^*(k) = \Delta_n\} \quad \text{and} \quad \tau_n = \inf\{k > \mathbf{V}_n : \mathbf{X}_n^*(k) \leq \Delta_n\}.$$

On the event $\mathcal{E}_n = \{\mathbf{X}_n^*(\mathbf{V}_n) \geq \Delta_n\} = \{\tau_n \neq \infty\} = \{\mathbf{B}_n \neq -\infty\}$, the edge \mathbf{B}_n is an ancestor of the edge \mathbf{V}_n in $T(\mathbf{m}_n^*)$, of height $\mathbf{X}_n^*(\mathbf{B}_n) = \Delta_n$. We denote by $\mathbf{A}_n = \sigma_n^{-1}(\mathbf{B}_n)$ the $T(\mathbf{m}_n)$ -label of this edge (see Figure 9.14 for a schema of the notation).

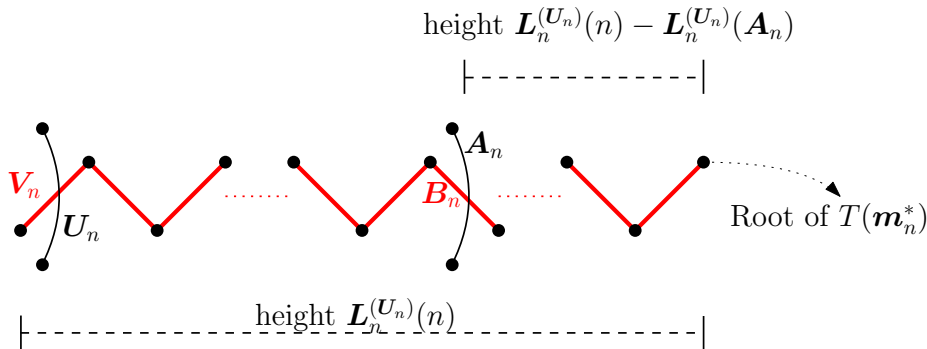

FIGURE 9.14. The ancestry line of \mathbf{V}_n in $T(\mathbf{m}_n^*)$ is (partially) plotted in red together with the different quantities involved in the proof. Recall that the $T(\mathbf{m}_n)$ -labels along this ancestry line increase from left to right.

By Observation 9.2.19, $\mathbf{X}_n^*(\mathbf{B}_n) = \Delta_n = \left(L_n^{(U_n)}(n) - L_n^{(U_n)}(\mathbf{A}_n)\right)$. Since $L_n^{(U_n)}(\cdot)$ is increasing and non-negative, it is clear that $L_n^{(U_n)}(n) - L_n^{(U_n)}(\lfloor(1-x)n\rfloor)$ is bounded by Δ_n unless the event \mathcal{E}_n is realized and $\mathbf{A}_n \geq \lceil n(1-x) \rceil$. Translating into probabilities,

$$(9.47) \quad \mathbb{P}\left(\mathcal{L}_n^{(u)}(1) - \mathcal{L}_n^{(u)}(1-x) \geq \delta\right) \leq \mathbb{P}\left(\mathcal{E}_n, \mathbf{A}_n \geq \lceil n(1-x) \rceil\right) + \mathbb{P}\left(\Delta_n \geq \delta\sqrt{2n}\right).$$

We focus on the first term in the right-hand side of the equation above. The quantity \mathbf{A}_n is the index of the walk \mathbf{W}_n corresponding to an edge of \mathbf{m}_n whose definition is clearer from the walk \mathbf{W}_n^* . Hence it would be more tractable to rewrite the condition $\mathbf{A}_n \geq \lceil n(1-x) \rceil$ in terms of the walk \mathbf{W}_n^* . To that end, we introduce $\eta > 0$ and assume that $\max_{\lceil n(1-x) \rceil, n} \mathbf{Y}_n \leq \eta\sqrt{2n}$. If $\mathbf{A}_n \geq \lceil n(1-x) \rceil$ then necessarily $\mathbf{Y}_n(\mathbf{A}_n) \leq \eta\sqrt{2n}$. This trick is very useful to our purposes, as $\mathbf{Y}_n(\mathbf{A}_n) = L_n^{*(\mathbf{B}_n)}(n) - 1$ (this follows once again by Corollary 9.2.18 together with Theorem 9.2.26). Finally, we have the following inequality:

$$(9.48) \quad \mathbb{P}\left(\mathcal{E}_n, \mathbf{A}_n \geq \lceil n(1-x) \rceil\right) \leq \mathbb{P}\left(\mathcal{E}_n, L_n^{*(\mathbf{B}_n)}(n) \leq \eta\sqrt{2n} + 1\right) + \mathbb{P}\left(\max_{\lceil n(1-x) \rceil, n} \mathbf{Y}_n \geq \eta\sqrt{2n}\right).$$

The first term in the right-hand side is, as desired, solely about the walk \mathbf{W}_n^* and its corresponding coalescent process, and we now focus on controlling it. By definition of \mathbf{B}_n and τ_n (see Equation (9.46)), the walk \mathbf{X}_n^* takes a positive excursion between times \mathbf{B}_n and τ_n so that by construction of the coalescent-walk process, the walk $\mathbf{Z}_n^{(\mathbf{B}_n)}$ takes a negative excursion between these times and weakly crosses zero upwards between times $\tau_n - 1$ and τ_n . Hence, denoting $\mathbf{G}_n := \mathbf{Z}_n^{(\mathbf{B}_n)}(\tau_n)$ and $\mathbf{R}_n(k) := \mathbf{Z}_n^{(\mathbf{B}_n)}(\tau_n + k) - \mathbf{G}_n$, $k \geq 0$, we have

$$\begin{aligned} \mathbf{G}_n &= \mathbf{Y}_n(\tau_n) - \mathbf{Y}_n(\tau_n - 1), \\ L_n^{*(\mathbf{B}_n)}(\tau_n + k) &= 1 + \#\{i \in [0, k], \mathbf{R}_n(i) = -\mathbf{G}_n\}. \end{aligned}$$

As a result, $\mathbf{L}_n^{*,(\mathbf{B}_n)}(n) = \#\{i \in [0, n - \tau_n], \mathbf{R}_n(i) = -\mathbf{G}_n\} + 1$, and

$$(9.49) \quad \mathbb{P}\left(\mathcal{E}_n, \mathbf{L}_n^{*,(\mathbf{B}_n)}(n) \leq \eta\sqrt{2n} + 1\right) \leq \\ \mathbb{P}\left(\mathcal{E}_n, \inf_{j \in [0, n^{1/4}]} \#\{i \in [0, n - \tau_n], \mathbf{R}_n(i) = -j\} \leq \eta\sqrt{2n}\right) + \mathbb{P}\left(\max_{0 \leq k \leq n} |\mathbf{Y}_n(k) - \mathbf{Y}_n(k-1)| \geq n^{1/4}\right) \\ \leq \mathbb{P}\left(\mathcal{E}_n, \inf_{j \in [0, n^{1/4}]} \#\{i \in [0, n - \tau_n], \mathbf{R}_n(i) = -j\} \leq \eta\sqrt{2n}\right) + o(1).$$

The second term in the second line was easily treated by removing the excursion conditioning using Equation (9.57) of Lemma 9.A.5 and then using a union bound, yielding

$$\mathbb{P}\left(\max_{0 \leq k \leq n} |\mathbf{Y}_n(k) - \mathbf{Y}_n(k-1)| \geq n^{1/4}\right) \leq Cn^4 n 2^{-n^{1/4}}.$$

We turn to the first term in the right-hand side of Equation (9.49). We use the idea that \mathbf{R}_n is close in distribution to a random walk, which implies that its local time near zero in a time interval of order n is indeed of order \sqrt{n} , and so the first term can be made small by taking η small. Actually, thanks to Proposition 9.3.3, \mathbf{R}_n would exactly be a random walk if there were no excursion conditioning on \mathbf{W}_n^* and if Δ_n were defined so that τ_n is a stopping time of \mathbf{W}_n^* . We shall use an absolute continuity argument to compare our current situation to this ideal one. Let $0 < 2u < y$ and set

$$(9.50) \quad \Delta_n := \mathbf{X}_n^*(\lfloor yn \rfloor).$$

Then

$$(9.51) \quad \mathbb{P}\left(\mathcal{E}_n, \inf_{j \in [0, n^{1/4}]} \#\{i \in [0, n - \tau_n], \mathbf{R}_n(i) = -j\} \leq \eta\sqrt{2n}\right) \\ \leq \mathbb{P}\left(\mathbf{V}_n \geq yn, \tau_n \leq (1 - 2u)n, \inf_{j \in [0, n^{1/4}]} \#\{i \in [0, un], \mathbf{R}_n(i) = -j\} \leq \eta\sqrt{2n}\right) \\ + y + \mathbb{P}(\tau_n \geq (1 - 2u)n).$$

Our choice of definition for Δ_n makes the event in the first term in the right-hand side of the equation above measurable with respect to $\sigma((\mathbf{W}_{n, \lfloor nu \rfloor + k}^* - \mathbf{W}_{n, \lfloor nu \rfloor}^*)_{0 \leq k \leq n - 2\lfloor nu \rfloor}, \mathbf{V}_n)$. By Lemma 9.A.2 and proposition 9.3.2, its probability is bounded independently of n by a constant C_u times the same probability under the unconditioned law (for which \mathbf{W}_n^* is a random walk of step distribution ν). Under the unconditioned law, τ_n is a stopping time. Applying the strong Markov property and using Proposition 9.3.3, we have that \mathbf{R}_n is a random walk of step distribution ν . So using an invariance principle for random walk local times [Bor82, Theorem 1.1], the quantity $\frac{1}{\sqrt{n}} \inf_{j \in [0, n^{1/4}]} \#\{i \in [0, un], \mathbf{R}_n(i) = -j\}$ converges in distribution to the local time at zero of a standard Brownian motion \mathbf{B} during the interval $[0, u]$, which is distributed like $|\mathbf{B}_u|$. Hence the first term in the right-hand side of Equation (9.51) is bounded by $C_u(\mathbb{P}(|\mathbf{B}_u| \leq \eta) + o_{u,\eta}(1))$. Combining this with the estimates in Equations (9.45), (9.47) to (9.49) and (9.51), we obtain:

$$\mathbb{P}\left(\mathcal{L}_n^{(u)}(1) - \mathcal{L}_n^{(u)}(1-x) \geq \delta\right) \\ \leq \mathbb{P}\left(\Delta_n \geq \delta\sqrt{2n}\right) + \mathbb{P}\left(\max_{[\lfloor n(1-x) \rfloor, n]} \mathbf{Y}_n \geq \eta\sqrt{2n}\right) + o(1) \\ + y + \mathbb{P}\left(\tau_n \geq (1 - 2u)n\right) + C_u \mathbb{P}\left(|\mathbf{B}_u| \leq \eta\right) + o_{u,\eta}(1).$$

The probability of each term is readily bounded as follows

$$\begin{aligned} & \mathbb{P} \left(\mathcal{L}_n^{(u)}(1) - \mathcal{L}_n^{(u)}(1-x) \geq \delta \right) \\ & \leq \mathbb{P} \left(\max_{[0,y]} \mathbf{X}_n^* \geq \delta \right) + \mathbb{P} \left(\max_{[1-x,1]} \mathbf{Y}_n \geq \eta \right) + o(1) \\ & \quad + y + \mathbb{P} \left(\mathbf{X}_n^*(1-2u) \geq \max_{[0,y]} \mathbf{X}_n^* \right) + C_u \mathbb{P} \left(|\mathcal{B}_u| \leq \eta \right) + o_{u,\eta}(1). \end{aligned}$$

As both \mathbf{Y}_n and \mathbf{X}_n^* converge to Brownian excursions, we can make this estimate arbitrarily small for large n upon choosing y small enough, then u small enough, then η small enough, and then x small enough. This proves the lemma. \square

9.A. Walks in the two-dimensional non-negative quadrant

9.A.1. Statements of the technical results. Let $\mathbf{W} = (\mathbf{W}_t)_{t \in \mathbb{Z}_{\geq 0}}$ be a two-dimensional random walk with step distribution ν (defined in Equation (9.3) page 173), started at a point $x \in \mathbb{Z}^2$. We denote this measure by \mathbb{P}_x . Let $\mathbf{W} = (\mathbf{X}, \mathbf{Y})$ be a standard two-dimensional Brownian motion of correlation $-1/2$. After the simple computation $\text{Var}(\nu) = \begin{pmatrix} 2 & -1 \\ -1 & 2 \end{pmatrix}$, the classical Donsker's theorem implies that the process $\left(\frac{1}{\sqrt{2n}} \mathbf{W}_{[nt]} \right)_{t \in [0,1]}$ converges in distribution to the process $(\mathbf{W}_t)_{t \in [0,1]}$. In this section we are interested in the behavior of \mathbf{W} under the conditioning of starting and ending close to the origin, and staying in the non-negative quadrant $Q = \mathbb{Z}_{\geq 0}^2$. This has been treated in much wider generality in [DW15a] and [DW15b], and specialized in [BFR19] to families of walks with steps in A (defined in Equation (9.1) page 170). The following convergence in distribution can be found in [KMSW19], as an immediate consequence of [DW15b, Thm 4].

Proposition 9.A.1. *Let $x, y \in Q$. Then*

$$\mathbb{P}_x \left(\left(\frac{1}{\sqrt{2n}} \mathbf{W}_{nt} \right)_{0 \leq t \leq 1} \in \cdot \mid \mathbf{W}_{[0,n]} \subset Q, \mathbf{W}_n = y \right) \xrightarrow{n \rightarrow \infty} \mathbb{P}(\mathbf{W}_e \in \cdot),$$

where \mathbf{W}_e is some process that we call the two-dimensional Brownian excursion of correlation $-1/2$ in the non-negative quadrant.

We will now go through the initial steps of a slightly different proof of this result, one that highlights an absolute continuity phenomenon between a conditioned walk away of its starting and ending points and an unconditioned one. The two lemmas that we prove here (absolute continuity of the walk and local limit estimate of the density factor) are needed in this paper to show convergence of a coalescent-walk process driven by a conditioned random walk.

In what follows, we recall that if $W = (X, Y)$ is a two-dimensional walk, then $\inf W = (\inf X, \inf Y)$. We also use the *hat* to denote reversal of coordinates, so that $\widehat{(i, j)} = (j, i)$.

Lemma 9.A.2. *Let $h : \mathbb{Z}^2 \rightarrow \mathbb{R}$ be a bounded measurable function. Let $x, y \in Q$ and $1 \leq m < n/2$. Then*

$$\begin{aligned} & \mathbb{E}_x [h((\mathbf{W}_{i+m} - \mathbf{W}_m)_{0 \leq i \leq n-2m}) \mid \mathbf{W}_{[0,n]} \subset Q, \mathbf{W}_n = y] \\ & = \mathbb{E}_0 \left[h(\mathbf{W}_i)_{0 \leq i \leq n-2m} \cdot \alpha_{n,m}^{x,y} \left(\inf_{0 \leq i \leq n-2m} \mathbf{W}_i, \mathbf{W}_{n-2m} \right) \right], \end{aligned}$$

where

$$(9.52) \quad \alpha_{n,m}^{x,y}(a, b) = \sum_{z \in Q: z+a \in Q} \frac{\mathbb{P}_x(\mathbf{W}_m = z, \mathbf{W}_{[0,m]} \subset Q) \mathbb{P}_{\widehat{y}}(\mathbf{W}_m = \widehat{z} + \widehat{b}, \mathbf{W}_{[0,m]} \subset Q)}{\mathbb{P}_x(\mathbf{W}_n = y, \mathbf{W}_{[0,n]} \subset Q)}.$$

Lemma 9.A.3. Fix $x, y \in Q$. For all $1/2 > \varepsilon > 0$,

$$\lim_{n \rightarrow \infty} \sup_{a \geq 0, b \in \mathbb{Z}} \left| \alpha_{n, \lfloor n\varepsilon \rfloor}^{x, y}(a, b) - \alpha_\varepsilon \left(\frac{a}{\sqrt{2n}}, \frac{b}{\sqrt{2n}} \right) \right| = 0,$$

where α_ε is a bounded continuous function on $(\mathbb{R}_+)^2 \times \mathbb{R}^2$ defined by

$$(9.53) \quad \alpha_\varepsilon(a, b) = \frac{\sqrt{3}}{8\varepsilon^5} \int_{x: x+a \in \mathbb{R}_+^2} g(x)g(x+b)dx$$

and

$$(9.54) \quad g(x_1, x_2) = \frac{1}{\sqrt{3\pi}} x_1 x_2 (x_1 + x_2) \exp \left(-\frac{1}{3} (x_1^2 + x_2^2 + x_1 x_2) \right).$$

A byproduct of this approach is a different characterization of the law of \mathbf{W}_e , which is immediate from Proposition 9.A.1 and lemmas 9.A.2 and 9.A.3.

Proposition 9.A.4. For every $\varepsilon > 0$, the distribution of $(\mathbf{W}_e(\varepsilon + t) - \mathbf{W}_e(\varepsilon))_{0 \leq t \leq 1-2\varepsilon}$ is absolutely continuous with regards to the distribution of $\mathbf{W}_{[0, 1-2\varepsilon]}$. The density function is the map

$$\mathcal{C}([0, 1-2\varepsilon], \mathbb{R}^2) \rightarrow \mathbb{R}, \quad f \mapsto \alpha_\varepsilon \left(\inf_{[0, 1-2\varepsilon]} f, f(1-2\varepsilon) \right).$$

In particular, for every $\varepsilon > 0$ and for every integrable function $h : \mathcal{C}([0, 1-2\varepsilon], \mathbb{R}^2) \rightarrow \mathbb{R}$,

$$\mathbb{E} \left[h((\mathbf{W}_e(\varepsilon + t) - \mathbf{W}_e(\varepsilon))_{0 \leq t \leq 1-2\varepsilon}) \right] = \mathbb{E} \left[h(\mathbf{W}_{[0, 1-2\varepsilon]}) \alpha_\varepsilon \left(\inf_{[0, 1-2\varepsilon]} \mathbf{W}, \mathbf{W}(1-2\varepsilon) \right) \right].$$

9.A.2. Proof of the technical results.

PROOF OF LEMMA 9.A.2. We write

$$\begin{aligned} & \mathbb{1}\{\mathbf{W}_{[0, n]} \subset Q, \mathbf{W}_n = y\} = \mathbb{1}\{\mathbf{W}_m + \inf_{m \leq i \leq n-m} (\mathbf{W}_i - \mathbf{W}_m) \geq (0, 0)\} \cdot \mathbb{1}\{\inf_{0 \leq i \leq m} \mathbf{W}_i \geq (0, 0)\} \\ & \cdot \mathbb{1}\{\inf_{0 \leq i \leq m} (\mathbf{W}_{n-i} - \mathbf{W}_n + y) \geq (0, 0)\} \cdot \mathbb{1}\{(\mathbf{W}_{n-m} - \mathbf{W}_n + y) = \mathbf{W}_m + (\mathbf{W}_{n-m} - \mathbf{W}_m)\}. \end{aligned}$$

We introduce a decomposition over the values of \mathbf{W}_m , yielding

$$\begin{aligned} & \mathbb{1}\{\mathbf{W}_{[0, n]} \subset Q, \mathbf{W}_n = y\} = \sum_{z: z + \inf_{m \leq i \leq n-m} (\mathbf{W}_i - \mathbf{W}_m) \geq (0, 0)} \mathbb{1}\{\mathbf{W}_m = z\} \cdot \mathbb{1}\{\inf_{0 \leq i \leq m} \mathbf{W}_i \geq (0, 0)\} \\ & \cdot \mathbb{1}\{\inf_{0 \leq i \leq m} (\mathbf{W}_{n-i} - \mathbf{W}_n + y) \geq (0, 0)\} \cdot \mathbb{1}\{(\mathbf{W}_{n-m} - \mathbf{W}_n + y) = z + (\mathbf{W}_{n-m} - \mathbf{W}_m)\}. \end{aligned}$$

Using the independence of increments of the random walk, along with the fact that $\mathbf{W}_{n-i} - \mathbf{W}_n$ is a random walk of step distribution $(x, y) \mapsto \nu(-x, -y) = \nu(y, x)$, we obtain

$$\begin{aligned} & \mathbb{P}_x(\mathbf{W}_{[0, n]} \subset Q, \mathbf{W}_n = y \mid (\mathbf{W}_{i+m} - \mathbf{W}_m)_{0 \leq i \leq n-2m}) \\ & = \sum_{z \in Q: z + \inf_{0 \leq i \leq n-2m} (\mathbf{W}_i) \in Q} \mathbb{P}_x(\mathbf{W}_m = z, \mathbf{W}_{[0, m]} \subset Q) \mathbb{P}_{\hat{y}}(\mathbf{W}_m = \hat{z} + \widehat{\mathbf{W}_{n-2m}}, \mathbf{W}_{[0, m]} \subset Q). \end{aligned}$$

From that we can conclude using Equation (9.52) that

$$\begin{aligned} & \mathbb{E}_x[h((\mathbf{W}_{i+m} - \mathbf{W}_m)_{0 \leq i \leq n-2m}) \mid \mathbf{W}_{[0, n]} \subset Q, \mathbf{W}_n = y] = \\ & \mathbb{E}_x \left[h((\mathbf{W}_{i+m} - \mathbf{W}_m)_{0 \leq i \leq n-2m}) \frac{\mathbb{P}_x(\mathbf{W}_{[0, n]} \subset Q, \mathbf{W}_n = y \mid (\mathbf{W}_i - \mathbf{W}_m)_{m \leq i \leq n-m})}{\mathbb{P}(\mathbf{W}_{[0, n]} \subset Q, \mathbf{W}_n = y)} \right] \\ & = \mathbb{E}_0 \left[h(\mathbf{W}_i)_{0 \leq i \leq n-2m} \cdot \alpha_{n, m}^{x, y} \left(\inf_{0 \leq i \leq n-2m} \mathbf{W}_i, \mathbf{W}_{n-2m} \right) \right]. \end{aligned}$$

This concludes the proof. \square

Finally we prove the estimate given in Lemma 9.A.3 for the density factor $\alpha_{n, m}^{x, y}(a, b)$. It relies on local limit results one can find in [BFR19, Prop. 28, Prop. 29, Prop. 32]. These are specializations of the results of [DW15a]. We collect those estimates in the following lemma.

Lemma 9.A.5. *Fix $x \in Q$. There exists a positive function V on Q such that as $n \rightarrow \infty$ the following asymptotics hold*

$$(9.55) \quad \mathbb{P}_x(\mathbf{W}_{[0,n]} \subset Q) \sim \frac{1}{4\sqrt{\pi}} V(x) n^{-3/2} \text{ as } n \rightarrow \infty,$$

$$(9.56) \quad \delta_1(x, n) := \sup_{y \in Q} \left| n^{5/2} \cdot \mathbb{P}_x(\mathbf{W}_n = y, \mathbf{W}_{[0,n]} \subset Q) - \frac{V(x)}{8\sqrt{\pi}} g\left(\frac{y}{\sqrt{2n}}\right) \right| \rightarrow 0,$$

$$(9.57) \quad \mathbb{P}_x(\mathbf{W}_n = y, \mathbf{W}_{[0,n]} \subset Q) \sim \frac{1}{8\sqrt{3}\pi} \cdot \frac{V(x)V(\hat{y})}{n^4},$$

where g was defined in Equation (9.54) above.

From Lemma 9.A.5, the proof of Lemma 9.A.3 is similar to the proof of Equation (9.57) from Equations (9.55) and (9.56) in [BFR19, Prop. 29] or [DW15a, Theorem 5].

PROOF OF LEMMA 9.A.3. In what follows, $m = \lfloor n\varepsilon \rfloor$ for some $\varepsilon > 0$. Let us consider $\alpha_{n,m}^{x,y}(a, b)$ defined in Equation (9.52). By Equation (9.57), the denominator (which is independent of a, b) is of order n^{-4} . This is the scale to which we need to estimate the numerator.

We first deal with the infiniteness of the sum by cutting it off at $t\sqrt{n}$, for some $t > 0$, and bound the remainder. Using Equation (9.56) for one factor (note that g is bounded) and Equation (9.55) for the other, there is a constant C depending only on x, y such that

$$\begin{aligned} R_n &:= \sum_{|z| > t\sqrt{n}} \mathbb{P}_x(\mathbf{W}_m = z, \mathbf{W}_{[0,m]} \subset Q) \mathbb{P}_{\hat{y}}(\mathbf{W}_m = \hat{z} + \hat{b}, \mathbf{W}_{[0,m]} \subset Q) \\ &\leq C n^{-3/2} n^{-5/2} \sum_{|z| > t\sqrt{n}} \mathbb{P}_x(\mathbf{W}_m = z \mid \mathbf{W}_{[0,m]} \subset Q) \\ &= C n^{-4} \mathbb{P}_x(|\mathbf{W}_{[n\varepsilon]}| > t\sqrt{n} \mid \mathbf{W}_{[0, [n\varepsilon]]} \subset Q). \end{aligned}$$

So that thanks to the central limit theorem for \mathbf{W} under the meander conditioning [BFR19, Prop. 31], we can find a function $\delta_2(x, y, \varepsilon, n, t)$ independent of a, b such that

$$(9.58) \quad n^4 R_n \leq \delta_2(x, y, \varepsilon, n, t) \quad \text{and} \quad \lim_{t \rightarrow \infty} \limsup_{n \rightarrow \infty} \delta_2(x, y, \varepsilon, n, t) = 0.$$

Now set

$$B_n := \sum_{z: z+a \in Q, |z| \leq t\sqrt{n}} \mathbb{P}_x(\mathbf{W}_m = z, \mathbf{W}_{[0,m]} \subset Q) \cdot \mathbb{P}_{\hat{y}}(\mathbf{W}_m = \hat{z} + \hat{b}, \mathbf{W}_{[0,m]} \subset Q).$$

Using Equation (9.56) and symmetry of g , we have for fixed x and y that

$$\begin{aligned} B_n &= m^{-5} \cdot \frac{V(x)V(\hat{y})}{(8\sqrt{\pi})^2} \sum_{z: z+a \in Q, |z| \leq t\sqrt{n}} g\left(\frac{z}{\sqrt{2\varepsilon n}}\right) g\left(\frac{z+b}{\sqrt{2\varepsilon n}}\right) \\ &\quad + O(1)(t\sqrt{n})^2 m^{-5} (\delta_1(x, m) + \delta_1(\hat{y}, m)). \end{aligned}$$

Collecting this estimate of the numerator with the estimate in Equation (9.57) of the denominator, both uniform in (a, b) , we have

$$\begin{aligned} \alpha_{n, \lfloor n\varepsilon \rfloor}^{x,y}(a, b) &= O(1)n^4 R_n + o(1) + \frac{\sqrt{3} + o(1)}{8\varepsilon^5} \times \frac{1}{(\sqrt{n})^2} \sum_{z \geq a, |z| \leq t\sqrt{n}} g\left(\frac{z}{\sqrt{2\varepsilon n}}\right) g\left(\frac{z+b}{\sqrt{2\varepsilon n}}\right) \\ &= O(1)n^4 R_n + o(1) + \frac{\sqrt{3} + o(1)}{8\varepsilon^5} \int_{w \geq \frac{a}{\sqrt{n}}, |w| \leq t} g\left(\frac{w}{\sqrt{2\varepsilon n}}\right) g\left(\frac{w+b}{\sqrt{2\varepsilon n}}\right) dw + o(1), \end{aligned}$$

where the last $o(1)$ corresponds to the uniform modulus of continuity of g at the scale $n^{-1/2}$ resulting from Riemann summation. All error terms are uniform in (a, b) . Finally,

$$\left| \alpha_{n, \lfloor n\varepsilon \rfloor}(a, b) - \alpha_\varepsilon\left(\frac{1}{\sqrt{n}}a, \frac{1}{\sqrt{n}}b\right) \right| = O(1)n^4 R_n + o(1) + O(1) \int_{|w| > t} g(w).$$

By integrability of g and Equation (9.58), this last term can be made negligible by taking $n \rightarrow \infty$ and then $t \rightarrow \infty$. \square

9.B. Generalizations

9.B.1. A coalescent-walk process for separable permutations. We return here to the class of separable permutations, a well-known subclass of the Baxter permutations, defined by avoidance of the two classical patterns 2413 and 3142. As we already mentioned in the introduction, the scaling limit of this class of permutations, called the *Brownian separable permuton*, was introduced in [Bas+18]. We also point out that the mapping OP puts separable permutation in bijection with *rooted series-parallel non-separable maps* [BBF11, Prop. 6].

In this section, we explain an encoding of separable permutations by a discrete coalescent-walk process, different from the one given by $WC \circ OW \circ OP^{-1}$, but more suitable for our purposes. We will also present what we believe to be the scaling limit of this coalescent-walk process, and relate it to the construction of the Brownian separable permuton given in Chapter 4.

We first recall another definition of separable permutations more suited to our goals. A *signed tree* t is a rooted plane tree whose internal vertices are decorated with signs in $\{\oplus, \ominus\}$ (see the first picture of Figure 9.15 for an example). We label its leaves with the integers from 1 to k according to the exploration process of t . The signs can be interpreted as coding a different ordering of the rooted tree t : we call \tilde{t} the tree obtained from t by reversing the order of the children of each vertex with a minus sign (see the second picture of Figure 9.15). The order of the leaves is changed by this procedure, and we set $\sigma(i)$ to be the position in \tilde{t} (w.r.t. its exploration process) of the leaf i . We call $\text{perm}(t)$ this permutation $\sigma \in \mathfrak{S}_k$ (see the third picture of Figure 9.15). Separable permutations are exactly the ones obtained from a signed tree through this procedure.

We now introduce the discrete coalescent-walk process associated with a separable permutation. Let t be a signed tree with k leaves and e edges, and let $C = (C_0, \dots, C_{2e})$ be its contour function. For every $j \in [1, 2e - 1]$ which is a local minimum of C , we denote s_j the sign of the internal vertex of t which is visited by C at time j . For every i which is a local maximum of C (a visit-time of a leaf of t), we construct a walk $Z^{(i)}$ starting at time i at 0, i.e. $Z_i^{(i)} = 0$, and that stays equal to zero until time ℓ_i , where ℓ_i is the first local minimum of C after time i . The walk is then defined inductively by the following: for all $\ell_i \leq j \leq 2e - 1$,

$$Z_{j+1}^{(i)} - Z_j^{(i)} := \begin{cases} (C_{j+1} - C_j), & \text{if } Z_j^{(i)} > 0, \\ -(C_{j+1} - C_j), & \text{if } Z_j^{(i)} < 0, \\ -1, & \text{if } Z_j^{(i)} = 0 \text{ and } s_j = \oplus, \\ 1, & \text{if } Z_j^{(i)} = 0 \text{ and } s_j = \ominus, \\ 0, & \text{if } Z_j^{(i)} = 0 \text{ and } j \text{ is not a local minimum of } C. \end{cases}$$

We set $Z_t = \{Z^{(i)}, i \text{ local maximum of } C\}$, that is the coalescent-walk process associated with the separable permutation $\text{perm}(t)$ (see the fourth picture of Figure 9.15 for an example). We observe that Z_t is a coalescent-walk process on $[0, 2e]$ in the sense of Definition 9.2.6, except that the trajectories do not start at every point of the interval, which is irrelevant to the rest of the discussion.

We leave to the reader the following observation (similar to Proposition 9.2.17) that justifies the construction of Z_t . We denote by $\text{LTr}(Z_t)$ the labeled tree induced by the trajectories of the coalescent-walk process Z_t (see the fifth picture of Figure 9.15 for an example).

Observation 9.B.1. The tree $\text{LTr}(Z_t)$ is the same as the tree \tilde{t} (forgetting the signs). Consequently, using Proposition 9.2.14, we have that $\text{CP}(Z_t) = \text{perm}(t)$.

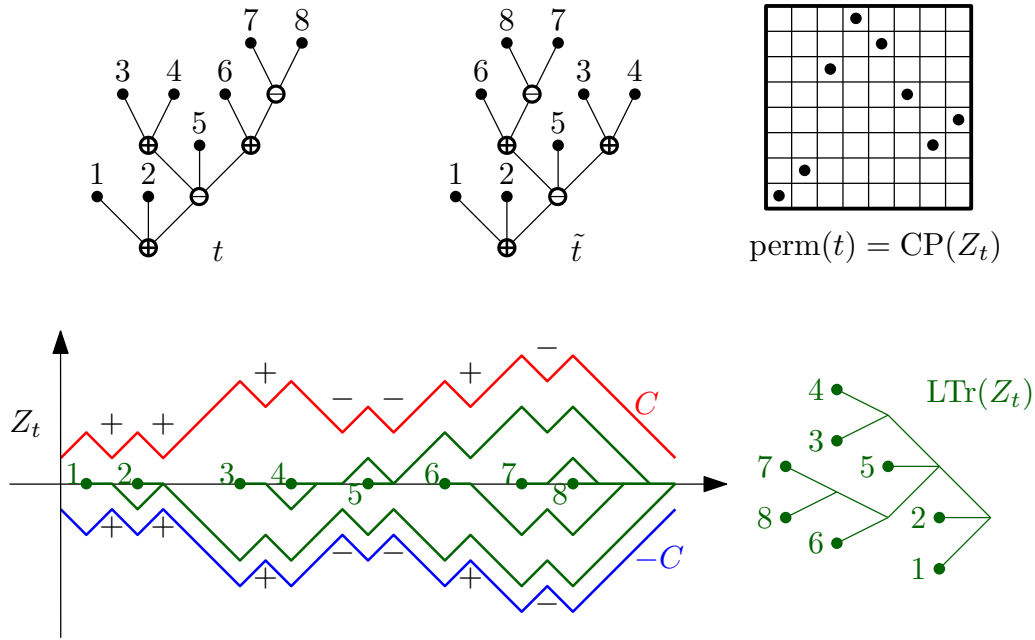

FIGURE 9.15. An example of a coalescent-walk process driven by the signed excursion of a signed tree.

Hence we see that separable permutations may be constructed using a coalescent-walk process driven by the discrete contour function (and its reflection) of a signed tree.

An *alternating Schröder tree* is a signed tree with no vertices of outdegree one, and the additional property that signs alternate along ancestry lines. A uniform separable permutation of size n corresponds to a uniform alternating signed tree with n leaves [Bas+18, Proposition 2.13]. Upon rescaling, the contour function of the uniform alternating Schröder tree converges to a Brownian excursion [Bas+18, Proposition 2.23]. A small leap of faith leads us to believe that the scaling limit of the discrete coalescent-walk process should be the continuous coalescent-walk process given by the following family of SDEs defined for all $u \in [0, 1]$,

$$(9.59) \quad \begin{cases} d\mathfrak{Z}^{(u)}(t) = \text{sgn}(\mathfrak{Z}^{(u)}(t)) d\mathbf{e}(t), & 0 < u \leq t \leq 1, \\ \mathfrak{Z}^{(u)}(u) = 0, \end{cases}$$

where \mathbf{e} is a Brownian excursion on $[0, 1]$. This is the coalescing flow of the well-known *Tanaka SDE*, driven by an excursion instead of a Brownian motion. The characteristic feature of this equation is the absence of pathwise uniqueness: solutions are not measurable functions of the driving process \mathbf{e} , but incorporate also additional randomness, taking in this instance (see [LR04, §4.4.3]) the form of independent uniform signs $\mathbf{s}(\ell) \in \{\oplus, \ominus\}$ for every $\ell \in (0, 1)$ that is a local minimum¹² of \mathbf{e} . The solutions are then constructed explicitly as follows. For $0 \leq u \leq t \leq 1$, set $\mathbf{m}(u, t) := \inf_{[u, t]} \mathbf{e}$, and $\boldsymbol{\mu}(u, t) = \inf\{s \geq t : \mathbf{e}(s) = \mathbf{m}(u, t)\}$. Then

$$\mathfrak{Z}^{(u)}(t) := (\mathbf{e}(t) - \mathbf{m}(u, t))\mathbf{s}(\boldsymbol{\mu}(u, t)).$$

This construction is reminiscent of the discrete setting. Moreover we leave to the reader the following:

Observation 9.B.2. Let $\mu_{\mathfrak{Z}}$ be the permuton built (as in Section 9.5) from the continuous coalescent-walk process \mathfrak{Z} defined by Equation (9.59). Then $\mu_{\mathfrak{Z}}$ coincides with the

¹². For the technicalities involved in indexing an i.i.d. sequence by this random countable set, see Definition 4.1.2.

permuton constructed from (e, s) in Chapter 4. In particular, it has the distribution of the Brownian separable permuton.

This shows that the Brownian separable permuton falls in the framework of continuous coalescent-walk processes. We believe an approach similar to the one of this paper would be doable to rigorously prove the convergence from discrete to continuous coalescent-walk processes.

As separable permutations form a subset of the Baxter permutations, another route would be to specialize the bijections given for Baxter permutations in Theorem 9.1.5. Let σ be a uniform separable permutation of size n , $(\mathbf{X}, \mathbf{Y}) = \text{OW} \circ \text{OP}^{-1}(\sigma)$ and $\mathbf{Z} = \text{WC}(\mathbf{X}, \mathbf{Y})$. Simulations lead us to believe that when the size of σ is large, both \mathbf{X} and \mathbf{Y} concentrate around the contour function of the alternating signed tree coding σ . We also believe that the discrete coalescent-walk process \mathbf{Z} should converge, in the limit, to the continuous coalescent-walk process \mathbf{Z} defined by the Tanaka's SDEs in Equation (9.59).

9.B.2. Liouville quantum gravity and mating-of-trees. As mentioned in the introduction, uniform infinite bipolar triangulations were studied in [GHS16]. Their key lemma is [GHS16, Proposition 4.1], which is similar to our Theorem 9.4.5. To state it using our notation, let $(\tilde{\mathbf{X}}_n, \tilde{\mathbf{Y}}_n)$ be the continuous rescaling (at scale n) of the bi-infinite two-dimensional random walk defining (through Θ) a uniform infinite-volume bipolar triangulation, and $\tilde{\mathbf{Z}}_n$ the continuous rescaling of the corresponding coalescent process¹³. Then [GHS16, Proposition 4.1] states that¹⁴

$$(9.60) \quad (\tilde{\mathbf{X}}_n, \tilde{\mathbf{Y}}_n, \tilde{\mathbf{Z}}_n^{(0)}) \xrightarrow[n \rightarrow \infty]{d} (\tilde{\mathbf{X}}, \tilde{\mathbf{Y}}, \tilde{\mathbf{Z}}^{(0)}).$$

The process $(\tilde{\mathbf{X}}, \tilde{\mathbf{Y}}, \tilde{\mathbf{Z}}^{(0)})$ on the right-hand side of the equation above is a special case (for $\kappa' = 12$ and $\theta = \pi/2$) of the general process $(\tilde{\mathbf{X}}_{\kappa'}, \tilde{\mathbf{Y}}_{\kappa'}, \tilde{\mathbf{Z}}_{\kappa', \theta}^{(0)})$ defined in terms of two parameters $\kappa' \in (4, \infty)$ and $\theta \in [0, 2\pi)$ that they construct using Liouville quantum gravity, imaginary geometry and mating of trees. We can describe it roughly as follows: let μ be a $\sqrt{16/\kappa'}$ -LQG quantum plane, \mathbf{h} be a Gaussian free field independent of μ , and η be the space-filling SLE $_{\kappa'}$ curve of angle zero generated (in the sense of imaginary geometry) by \mathbf{h} .

- The process $(\tilde{\mathbf{X}}_{\kappa'}, \tilde{\mathbf{Y}}_{\kappa'})$ is a standard two-dimensional Brownian motion of correlation $\rho = -\cos(4\pi/\kappa')$ given by the *mating-of-tree* encoding of (μ, η) .
- The process $\tilde{\mathbf{Z}}_{\kappa', \theta}^{(0)}$ tracks, in some sense, the interaction between η and another SLE $_{16/\kappa'}$ curve of angle θ also generated by \mathbf{h} .

Gwynne, Holden and Sun prove that there exists a constant¹⁵ $p = p(\kappa', \theta)$, with $p(\kappa', \pi/2) \equiv 1/2$, so that $\tilde{\mathbf{Z}}_{\kappa', \theta}^{(0)}$ is a skew Brownian motion of parameter p (see [Lej06]) and they describe the conditional distribution of $(\tilde{\mathbf{X}}_{\kappa'}, \tilde{\mathbf{Y}}_{\kappa'})$ given $\tilde{\mathbf{Z}}_{\kappa', \theta}^{(0)}$ (see [GHS16, Proposition 3.2]). They also note that $\tilde{\mathbf{Z}}_{\kappa', \theta}^{(0)}$ is a measurable functional of (μ, \mathbf{h}) , which turns to be completely determined by $(\tilde{\mathbf{X}}_{\kappa'}, \tilde{\mathbf{Y}}_{\kappa'})$. Nevertheless, they do not explicit the measurable mapping $(\tilde{\mathbf{X}}_{\kappa'}, \tilde{\mathbf{Y}}_{\kappa'}) \mapsto \tilde{\mathbf{Z}}_{\kappa', \theta}^{(0)}$.

13. The uniform infinite-volume bipolar triangulation is properly defined in [GHS16, Section 1.3.3]. The corresponding bi-infinite two-dimensional random walk is denoted by $\mathcal{Z} = (\mathcal{L}_n, \mathcal{R}_n)_{n \in \mathbb{Z}}$ in their article. The trajectory of the coalescent process starting at time 0 is denoted by \mathcal{X} .

14. The process $(\tilde{\mathbf{X}}, \tilde{\mathbf{Y}}, \tilde{\mathbf{Z}}^{(0)})$ is denoted (L, R, X) in [GHS16].

15. The explicit expression of $p(\kappa', \theta)$ is not known.

In the case $\kappa' = 12$ and $\theta = \pi/2$, after comparing¹⁶ Equation (9.60) and Equation (9.22) in Theorem 9.4.5, one sees that our approach provides the explicit mapping $(\tilde{\mathbf{X}}, \tilde{\mathbf{Y}}) \mapsto \tilde{\mathbf{Z}}^{(0)}$ through solving the SDE (9.8) driven by $(\tilde{\mathbf{X}}, \tilde{\mathbf{Y}})$ for $u = 0$.

For general $\kappa' \in (4, \infty)$ and $\theta \in [0, 2\pi)$, we believe that a related SDE provides the explicit mapping $(\tilde{\mathbf{X}}_{\kappa'}, \tilde{\mathbf{Y}}_{\kappa'}) \mapsto \tilde{\mathbf{Z}}_{\kappa', \theta}^{(0)}$. More precisely, let $\mathbf{Z}_{\kappa', \theta}^* = \{\mathbf{Z}_{\kappa', \theta}^{*(u)}\}_{u \in \mathbb{R}}$ be defined by the solutions of the following SDEs for $u \in \mathbb{R}$,

$$(9.61) \quad \begin{cases} d\mathbf{Z}_{\kappa', \theta}^{*(u)}(t) = \mathbb{1}_{\{\mathbf{Z}_{\kappa', \theta}^{*(u)}(t) > 0\}} d\mathbf{Y}_{\kappa'}^*(t) - \mathbb{1}_{\{\mathbf{Z}_{\kappa', \theta}^{*(u)}(t) \leq 0\}} d\mathbf{X}_{\kappa'}^*(t) + (2p - 1)d\mathcal{L}_{\kappa', \theta}^{*(u)}(t), & t > u, \\ \mathbf{Z}_{\kappa', \theta}^{*(u)}(t) = 0, & t \leq u, \end{cases}$$

where $p = p(\kappa', \theta)$ is the constant mentioned above, $(\mathbf{X}_{\kappa'}^*, \mathbf{Y}_{\kappa'}^*)$ is a standard two-dimensional Brownian motion of correlation ρ with $\rho = -\cos(4\pi/\kappa')$, and $\mathcal{L}_{\kappa', \theta}^{*(u)}(t)$ is the local time at zero of $\mathbf{Z}_{\kappa', \theta}^{*(u)}$ accumulated during the time interval $[u, t]$.

Conjecture 9.B.3. For all $\kappa' \in (4, \infty)$ and $\theta \in [0, 2\pi)$, the following equality in distribution holds

$$\left(\mathbf{X}_{\kappa'}^*, \mathbf{Y}_{\kappa'}^*, \mathbf{Z}_{\kappa', \theta}^{*(0)} \right) \stackrel{d}{=} \left(\tilde{\mathbf{X}}_{\kappa'}, \tilde{\mathbf{Y}}_{\kappa'}, \tilde{\mathbf{Z}}_{\kappa', \theta}^{(0)} \right).$$

In particular the SDE (9.61) for $u = 0$ explicitly defines the mapping $(\tilde{\mathbf{X}}_{\kappa'}, \tilde{\mathbf{Y}}_{\kappa'}) \mapsto \tilde{\mathbf{Z}}_{\kappa', \theta}^{(0)}$.

In support of this conjecture, we point out that a local time term appears in the analysis of the case $\kappa' = 16$ and $\theta = \pi/3$ in [LSW17]. Moreover, the Lévy's characterization theorem guarantees that $\mathbf{Z}_{\kappa', \theta}^{*(u)} - (2p - 1)\mathcal{L}_{\kappa', \theta}^{*(u)}$ is a Brownian motion, so that $\mathbf{Z}_{\kappa', \theta}^{*(u)}$ is indeed a skew Brownian motion of parameter p .

In the case $p = 1/2$, we recover the perturbed Tanaka SDE (9.20) of [Pro13; CHK18], which has pathwise unique solutions for $\rho \in (-1, 1)$. The edge case $\rho = 1$ (i.e. $\kappa' = 4$, the underlying geometry being the critical 2-LQG) corresponds to the Tanaka SDE (9.59) which does not have pathwise uniqueness.

When $\rho = 1$ (i.e. $\kappa' = 4$) but $p \neq 1/2$, going back to the finite-volume case and denoting by e_* a one-dimensional Brownian excursion on $[0, 1]$, we obtain the following SDEs defined for all $u \in \mathbb{R}$,

$$(9.62) \quad d\mathbf{Z}_{4, \theta}^{*(u)}(t) = \text{sgn}(\mathbf{Z}_{4, \theta}^{*(u)}(t)) de_*(t) + (2p - 1)d\mathcal{L}_{4, \theta}^{*(u)}(t), \quad t \geq u,$$

which we believe to give rise (using the same procedure described above Definition 9.5.4) to the *biased Brownian separable permuton of parameter $1 - p$* defined in Definition 4.2.1. The opposite edge case $\rho = -1$ (i.e. $\kappa' = \infty$, the underlying geometry being 0-LQG, that is Euclidean geometry) is Harrison and Shepp's equation defining skew Brownian motion, whose solutions are pathwise unique [Lej06], and whose coalescing flow was studied by Burdzy and his coauthors (see [BK04] and the references therein).

Although the cases $p \neq 1/2$ and $\rho \neq -1$ are not present in the literature, we expect pathwise uniqueness of Equation (9.61) to hold for every $p \in [0, 1]$ and $\rho \in [-1, 1)$.

9.C. Simulations of large Baxter permutations

The simulations for Baxter permutations presented in the first page of this paper have been obtained in the following way:

- i) first, we have sampled a uniform random walk of size $n + 2$ in the non-negative quadrant starting at $(0, 0)$ and ending at $(0, 0)$ with increments in the set A (defined in Equation (9.1) page 170). This has been done using a "rejection algorithm": it is enough to sample a walk W starting at $(0, 0)$ with increments

¹⁶ More precisely one would need to show that Theorem 9.4.5 works also in the case of bipolar triangulations. This is a special case of the generality conjecture of Section 9.1.7, about which we are very confident.

distribution given by Equation (9.11), up to the first time it leaves the non-negative quadrant. Then one has to check if the last step inside the non-negative quadrant is at the origin $(0, 0)$. When this is the case (otherwise we resample a new walk), the part of the walk W inside the non-negative quadrant, denoted \widetilde{W} , is a uniform walk conditionally to its size in the non-negative quadrant starting at $(0, 0)$ and ending at $(0, 0)$ with increments in the set A .

- ii) Removing the first and the last step of \widetilde{W} , thanks to Proposition 9.3.2, we obtained a uniform random walk in \mathcal{W}_n .
- iii) Finally, applying the mapping $\text{CP} \circ \text{WC}$ to the walk given by the previous step, we obtained a uniform Baxter permutation of size n (thanks to Theorem 9.1.5).

Note that our algorithm gives a random Baxter permutation which, conditioned on its size to be equal to n , is uniformly distributed among all Baxter permutations of size n .

Analytic combinatorics toolbox

A.1. Aperiodicity and Daffodil Lemma

To study the asymptotic behavior of combinatorial generating functions, it is important to locate dominant singularities. The following lemma is useful to this purpose.

Recall that a function A analytic at 0 is *aperiodic* if there do not exist two integers $r \geq 0$ and $d \geq 2$ and a function B analytic at 0 such that $A(z) = z^r B(z^d)$.

Lemma A.1.1 (Daffodil Lemma). *Let A be a generating function (with nonnegative coefficients) analytic in $|z| < R_A$. If A is aperiodic, then $|A(z)| < A(|z|) \leq A(R_A)$ for $|z| \leq R_A$ and $z \neq |z|$. (The case $|z| = R_A$ can only be considered if $A(R_A) < \infty$.)*

This lemma can be found in [FS09, Lemma IV.1, p. 266]. Note that this reference does not consider the case of z on the circle of convergence, *i.e.* $|z| = R_A$ (although this case is used later in the book, *e.g.* in the proof of Theorem VI.6, p. 405); the proof of the lemma in this case is similar to $|z| < R_A$. The complete statement of Daffodil Lemma in [FS09] also deals with cases where the function A is periodic, but we do not need these cases in our work.

A.2. Transfer theorem

We start by defining the notion of Δ -domain. We use $\text{Arg}(z)$ for the principal determination of the argument of z in $\mathbb{C} \setminus \mathbb{R}^-$ taking its values in $(-\pi, \pi)$.

Definition A.2.1 (Δ -domain and Δ -neighborhood). A domain Δ is a Δ -domain at 1 if there exist two real numbers $R > 1$ and $\pi/2 < \phi < \pi$ such that

$$\Delta = \{z \in \mathbb{C} \mid |z| < R, z \neq 1, |\text{Arg}(1 - z)| < \phi\}.$$

By extension, for a complex number $\rho \neq 0$, a domain is a Δ -domain at ρ if it the image by the mapping $z \rightarrow \rho z$ of a Δ -domain at 1. A Δ -neighborhood of ρ is the intersection of a neighborhood of ρ and a Δ -domain at ρ .

We will make use of the following family of Δ -neighborhoods: for $\rho \neq 0 \in \mathbb{C}$, $0 < r < |\rho|$, $\varphi > \pi/2$, set $\Delta(\varphi, r, \rho) = \{z \in \mathbb{C}, |\rho - z| < r, |\text{Arg}(\rho - z)| < \varphi\}$.

When a function A is analytic on a Δ -domain at some ρ , the asymptotic behavior of its coefficients is closely related to the behavior of the function near the singularity ρ . The following theorem is a corollary of [FS09, Theorem VI.3 p. 390].

Theorem A.2.2 (Transfer Theorem). *Let A be a function analytic on a Δ -domain Δ at R_A , δ be an arbitrary real number in $\mathbb{R} \setminus \mathbb{Z}_{\geq 0}$ and C_A a constant possibly equal to 0.*

Suppose $A(z) = (C_A + o(1))(1 - \frac{z}{R_A})^\delta$ when z tends to R_A in Δ . Then the coefficient of z^n in A satisfies

$$[z^n]A(z) = (C_A + o(1)) \frac{1}{R_A^n} \frac{n^{-(\delta+1)}}{\Gamma(-\delta)}.$$

A.3. Singular differentiation

The next result is also useful to us.

Theorem A.3.1 (Singular differentiation). *Let A be an analytic function defined in a Δ -neighborhood of R_A with the following singular expansion near its singularity R_A :*

$$A(z) = \sum_{j=0}^J C_j (R_A - z)^{\delta_j} + \mathcal{O}((R_A - z)^\delta),$$

where $\delta_j, \delta \in \mathbb{C}$.

Then, for each $k > 0$, the k -th derivative $A^{(k)}$ is analytic in some Δ -domain at R_A and

$$A^{(k)}(z) = (-1)^k \sum_{j=0}^J C_j \delta_j (\delta_j - 1) \cdots (\delta_j - k + 1) (R_A - z)^{\delta_j - k} + \mathcal{O}((R_A - z)^{\delta - k}).$$

We refer the reader to [FS09, Theorem VI.8 p. 419] for a proof of this theorem (this reference considers functions defined on a Δ -domain, but the proof still works with functions defined on a Δ -neighborhood).

A.4. Exponents of dominant singularity

In this section, we introduce some compact terminology and easy lemmas to keep track of the exponent δ of the singularities and of the shape of the domain of analyticity without computing the functions explicitly.

Recall that the radius of convergence R_A of an analytic function A is the modulus of the singularities closest to the origin, called *dominant singularities*. Recall also that for series with positive real coefficients, by Pringsheim's theorem [FS09, Th. IV.6 p. 240], R_A is necessarily a dominant singularity. This justifies the following definition:

Let δ be a real, which is not an integer. We say that a series A with radius of convergence R_A has a *dominant singularity of exponent δ in R_A* (resp. *of exponent at least δ*) if A has an analytic continuation on a Δ -neighborhood Δ_A of R_A and, on Δ_A , we have

$$(A.1) \quad A(z) = g_A(z) + (C_A + o(1)) (R_A - z)^\delta,$$

where $g_A(z)$ is an analytic function on a neighbourhood of R_A (called the *analytic part*), and C_A a nonzero constant (resp. any constant); $(C_A + o(1)) (R_A - z)^\delta$ is sometimes referred to as the *singular part*, and C_A is referred to as the *singular constant*.

If furthermore, A has no other singularity on the disk of convergence, we say that it has a *unique dominant singularity of exponent δ* (resp. *at least δ*) in R_A . Since we assumed that A has an analytic continuation on a Δ -neighborhood Δ_A of R_A , by a standard compactness argument, this is equivalent to say that A can be extended to a Δ -domain in R_A .

We make the following observation. According to the value of δ , we may move (part of) $g_A(z)$ in the error term and write Equation (A.1) in a simpler form, still on a Δ -neighborhood of R_A .

- For $\delta < 0$, $g_A(z) = o((R_A - z)^\delta)$ so $A(z) = (C_A + o(1)) (R_A - z)^\delta$.
- For $0 < \delta < 1$, considering the constant term is the Taylor series expansion of $g_A(z)$ we find that $A(z) = A(R_A) + (C_A + o(1)) (R_A - z)^\delta$.
- Similarly, for $\delta > 1$, we obtain

$$A(z) = A(R_A) + A'(R_A)(z - R_A) + \cdots + (C_A + o(1)) (R_A - z)^\delta,$$

in which the third dominant term (after the constant and the linear term) depends on how δ compares with 2. But in each case, we have

$$(A.2) \quad A(z) = A(R_A) + A'(R_A)(z - R_A) + \mathcal{O}((R_A - z)^{\delta_*}),$$

where $\delta_* = \min(\delta, 2)$.

We now record a few easy lemmas to manipulate these notions. First consider the stability by product.

Lemma A.4.1. *Let F and G be series with nonnegative coefficients and the same radius of convergence $R = R_F = R_G \in (0, \infty)$. Assume they have each a dominant singularity of exponent δ_F and δ_G respectively in R . Then $F \cdot G$ has a dominant singularity in R of exponent δ defined by*

- $\delta = \delta_F + \delta_G$ if both δ_F and δ_G are negative;
- $\delta = \min(\delta_F, \delta_G)$ otherwise.

Moreover, if both F and G have unique dominant singularities, so has $F \cdot G$.

PROOF. The proof is easy. The analytic function $F \cdot G$ can be extended to the intersection of the domain of F and G . The exponent of the singular expansion around R is obtained by multiplying singular expansion of F and G : note that, if δ_F is negative, the series F is divergent and the singular part is the dominant part around R . On the opposite, when δ_F is positive, the dominant part of the expansion is the value $F(R)$ of the analytic part at point R , which is always positive, since the series has nonnegative coefficients. The same holds of course for G , which explains the case distinction in the lemma. \square

We now consider the composition $F \circ G$. We should differentiate cases where $G(R_G) > R_F$, $G(R_G) < R_F$ or $G(R_G) = R_F$ (called sometimes supercritical, subcritical and critical cases [FS09, Sec. VI.9]).

Lemma A.4.2 (Dominant singularity of $F \circ G$). *Let F and G be series with nonnegative coefficients with radii of convergence R_F, R_G in $(0, \infty)$.*

Supercritical case: *Assume that $G(0) < R_F < G(R_G)$ ($G(R_G)$ may be finite or infinite). Call $\rho < R_G$ the unique positive number with $G(\rho) = R_F$.*

We assume that F has a dominant singularity of exponent δ_F in R_F . Then:

- i) $F \circ G$ has also a dominant singularity of exponent δ_F in ρ with $C_{F \circ G} = C_F G'(\rho)^{\delta_F}$
- ii) Moreover, if G is aperiodic, then the dominant singularity of $F \circ G$ is unique.

Subcritical case: *Assume that $G(R_G) < R_F$.*

We assume that G has a dominant singularity of exponent δ_G in R_G . Then:

- i) $F \circ G$ has also a dominant singularity of exponent δ_G in R_G with $C_{F \circ G} = C_G F'(G(R_G))$
- ii) Moreover, if the dominant singularity of G is unique, then the dominant singularity of $F \circ G$ is unique.

Critical case-A: *Assume that $G(R_G) = R_F$.*

We assume that F and G both have a dominant singularity of respective exponents δ_F and δ_G . Suppose furthermore $\delta_G > 1$. Then:

- i) $F \circ G$ has also a dominant singularity of exponent $\min(\delta_G, \delta_F)$ in R_G . If $\delta_F < \delta_G$, then $C_{F \circ G} = C_F G'(\rho)^{\delta_F}$.
- ii) Moreover, if G is aperiodic, then the dominant singularity of $F \circ G$ is unique.

Critical case-B: *Assume again that $G(R_G) = R_F$. We assume that F and G both have a dominant singularity of respective exponents δ_F and δ_G . Suppose furthermore $\delta_G \in (0, 1)$. Then:*

- i) $F \circ G$ has a dominant singularity of exponent $\min(\delta_F, 1)\delta_G$ in R_G . If $\delta_F < \delta_G$, then $C_{F \circ G} = C_F (-C_G)^{\delta_F}$.
- ii) Moreover, if G is aperiodic, then the singularity is unique.

PROOF. **Supercritical case:** It is clear that $F \circ G$ is analytic around any $r \in [0, \rho)$ and has nonnegative coefficients, hence it has radius of convergence at least ρ .

To show that $F \circ G$ is defined in a Δ -neighborhood Δ of ρ , we show that $G(\Delta)$ is included in Δ_F . This follows easily from the fact that G is analytic in ρ and has a derivative $G'(\rho)$ which is a positive real number.

When z is close to ρ , plugging $G(z)$ in the expansion (A.1) of F we obtain

$$(A.3) \quad F(G(z)) = g_F(G(z)) + (C_F + o(1))(R_F - G(z))^{\delta_F}.$$

The first term $g_F(G(z))$ is analytic at ρ . Since $G(\rho) = R_F$ and G is differentiable at ρ we have

$$(A.4) \quad R_F - G(z) = (G'(\rho) + o(1))(\rho - z).$$

Combining these two expansions yields

$$(A.5) \quad F(G(z)) = g_F(G(z)) + (C_F G'(\rho)^{\delta_F} + o(1))(\rho - z)^{\delta_F},$$

which proves i).

Item ii) is also easy. In the case where we assume G aperiodic, we need Lemma A.1.1, which ensures that $|G(\zeta)| < R_F$ for $|\zeta| \leq |\rho|$, $\zeta \neq \rho$.

Subcritical case. Most arguments are similar to the ones of the supercritical case. Therefore we only explain the differences in the singular expansion of $F(G(z))$. Using the singular expansion (A.1) of G , we have

$$F(G(z)) = F[g_G(z) + (C_G + o(1))(R_G - z)^{\delta_G}].$$

Since $G(R_G) < R_F < +\infty$, the exponent δ_G is positive and the term $(R_G - z)^{\delta_G}$ tends to 0 at R_G . Both $G(z)$ and $g_G(z)$ tend to $G(R_G)$ as $z \rightarrow R_G$, so that, by standard calculus arguments, we have

$$(A.6) \quad \begin{aligned} F(G(z)) &= F(g_G(z)) + F'(G(R_G))(C_G + o(1))(R_G - z)^{\delta_G} + o((R_G - z)^{\delta_G}) \\ &= F(g_G(z)) + (C_G F'(G(R_G)) + o(1))(R_G - z)^{\delta_G}. \end{aligned}$$

Since F and g_G are analytic at $G(R_G)$ and R_G respectively, this expansion is of the desired form.

Critical case-A. As above, we focus on the expansion of $F(G(z))$. Since $\delta_G > 1$, G is differentiable at $\rho = R_G$ and Equation (A.5) still holds. The difference is that $g_F(G(z))$ is not analytic anymore. Namely, when z is close to ρ ,

$$(A.7) \quad \begin{aligned} g_F(G(z)) &= g_F(g_G(z)) + g'_F(g_G(R_G))(C_G + o(1))(R_G - z)^{\delta_G} \\ &= g_F(g_G(z)) + F(R_F)(C_G + o(1))(\rho - z)^{\delta_G}. \end{aligned}$$

Then

$$F(G(z)) = g_F(g_G(z)) + F'(R_F)(C_G + o(1))(\rho - z)^{\delta_G} + (C_F G'(\rho)^{\delta_F} + o(1))(\rho - z)^{\delta_F}.$$

Since $g_F(g_G(z))$ is analytic at ρ , the exponent of the dominant singularity of $F \circ G$ is $\min(\delta_F, \delta_G)$. Note that the singular terms cannot cancel each other since when $\delta_F = \delta_G$ the constants have the same sign.

Critical case-B. Again, we focus on the singular expansion of $F(G(z))$. Now, since $\delta_G < 1$, G is not differentiable at $\rho = R_G$. Instead of (A.4) we have

$$R_F - G(z) = -(C_G + o(1))(\rho - z)^{\delta_G}.$$

Eq. (A.5) becomes

$$F(G(z)) = g_F(G(z)) + (C_F(-C_G)^{\delta_F} + o(1))(\rho - z)^{\delta_F \delta_G}.$$

(In this case, C_G must be negative, otherwise G cannot be convex.) As for $g_F(G(z))$, (A.7) still holds. We obtain

$$\begin{aligned} F(G(z)) &= g_F(g_G(z)) + (g'_F(g_G(R_G)) C_G + o(1))(R_G - z)^{\delta_G} \\ &\quad + (C_F(-C_G)^{\delta_F} + o(1))(\rho - z)^{\delta_F \delta_G}. \end{aligned}$$

We conclude that the exponent of the dominant singularity is $\min(\delta_F, 1)\delta_G$. \square

Finally, we state the following result, which follows from Theorem A.3.1.

Lemma A.4.3 (Singular differentiation). *If F has a (unique) dominant singularity of exponent (at least) δ in ρ , then its k -th derivative $F^{(k)}$ has a (unique) dominant singularity of exponent (at least) $\delta - k$ in ρ .*

A.5. An analytic implicit function theorem

The following theorem allows to locate the dominant singularity of series defined by an implicit equation.

Lemma A.5.1 (Analytic Implicit Functions). *Let $F(z, w)$ be a bivariate function analytic at (z_0, w_0) , we denote $F_w = \frac{\partial F}{\partial w}$. If $F(z_0, w_0) = 0$ and $F_w(z_0, w_0) \neq 0$, then there exists a unique function $\phi(z)$ analytic in a neighbourhood of z_0 such that $\phi(z_0) = w_0$ and $F(z, \phi(z)) = 0$.*

We refer the reader to [FS09, Lemma VII.2, p. 469] for a proof of this result.

Bibliography

- [AA05] M. H. Albert and M. D. Atkinson. “Simple permutations and pattern restricted permutations”. In: *Discrete Math.* 300.1-3 (2005), pp. 1–15. ISSN: 0012-365X. URL: <https://doi.org/10.1016/j.disc.2005.06.016>.
- [AAB11] M. H. Albert, M. D. Atkinson, and R. Brignall. “The enumeration of permutations avoiding 2143 and 4231”. In: *Pure Math. Appl. (P.U.M.A.)* 22.2 (2011), pp. 87–98. ISSN: 1218-4586.
- [AAB12] M. H. Albert, M. D. Atkinson, and R. Brignall. “The enumeration of three pattern classes using monotone grid classes”. In: *Electron. J. Combin.* 19.3 (2012), Paper 20, 34. URL: <https://doi.org/10.37236/2442>.
- [AAV09] M. H. Albert, M. D. Atkinson, and V. Vatter. “Counting 1324, 4231-avoiding permutations”. In: *Electron. J. Combin.* 16.1 (2009), Research Paper 136, 9. URL: http://www.combinatorics.org/Volume_16/Abstracts/v16i1r136.html.
- [AAV14] M. H. Albert, M. D. Atkinson, and V. Vatter. “Inflations of geometric grid classes: three case studies”. In: *Australas. J. Combin.* 58 (2014), pp. 24–47. ISSN: 1034-4942.
- [AB14] M. H. Albert and R. Brignall. “Enumerating indices of Schubert varieties defined by inclusions”. In: *J. Combin. Theory Ser. A* 123 (2014), pp. 154–168. ISSN: 0097-3165. URL: <https://doi.org/10.1016/j.jcta.2013.12.003>.
- [ABF20] M. Albert, M. Bouvel, and V. Féray. “Two first-order logics of permutations”. In: *J. Combin. Theory Ser. A* 171 (2020), pp. 105158, 46. ISSN: 0097-3165. URL: <https://doi.org/10.1016/j.jcta.2019.105158>.
- [ABG12] L. Addario-Berry, N. Broutin, and C. Goldschmidt. “The continuum limit of critical random graphs”. In: *Probab. Theory Related Fields* 152.3-4 (2012), pp. 367–406. ISSN: 0178-8051. URL: <https://doi.org/10.1007/s00440-010-0325-4>.
- [ABGM17] L. Addario-Berry, N. Broutin, C. Goldschmidt, and G. Miermont. “The scaling limit of the minimum spanning tree of the complete graph”. In: *Ann. Probab.* 45.5 (2017), pp. 3075–3144. ISSN: 0091-1798. URL: <https://doi.org/10.1214/16-AOP1132>.
- [ABT03] R. Arratia, A. D. Barbour, and S. Tavaré. *Logarithmic combinatorial structures: a probabilistic approach*. EMS Monographs in Mathematics. European Mathematical Society (EMS), Zürich, 2003, pp. xii+363. ISBN: 3-03719-000-0. URL: <https://doi.org/10.4171/000>.
- [AD15] R. Abraham and J.-F. Delmas. *An introduction to Galton-Watson trees and their local limits*. 2015. arXiv: 1506.05571 [math.PR].
- [AG15] M. Albenque and C. Goldschmidt. “The Brownian continuum random tree as the unique solution to a fixed point equation”. In: *Electron. Commun. Probab.* 20 (2015), no. 61, 14. URL: <https://doi.org/10.1214/ECP.v20-4250>.
- [Ald91] D. Aldous. “The continuum random tree. II. An overview”. In: *Stochastic analysis (Durham, 1990)*. Vol. 167. London Math. Soc. Lecture Note Ser. Cambridge Univ. Press, Cambridge, 1991, pp. 23–70. URL: <https://doi.org/10.1017/CB09780511662980.003>.

- [Ald93] D. Aldous. “The continuum random tree. III”. In: *Ann. Probab.* 21.1 (1993), pp. 248–289. ISSN: 0091-1798. URL: [http://links.jstor.org/sici?sici=0091-1798\(199301\)21:1%3C248:TCRTI%3E2.0.CO;2-1&origin=MSN](http://links.jstor.org/sici?sici=0091-1798(199301)21:1%3C248:TCRTI%3E2.0.CO;2-1&origin=MSN).
- [Ald94a] D. Aldous. “Recursive self-similarity for random trees, random triangulations and Brownian excursion”. In: *Ann. Probab.* 22.2 (1994), pp. 527–545. ISSN: 0091-1798. URL: [http://links.jstor.org/sici?sici=0091-1798\(199404\)22:2%3C527:RSFRTR%3E2.0.CO;2-A&origin=MSN](http://links.jstor.org/sici?sici=0091-1798(199404)22:2%3C527:RSFRTR%3E2.0.CO;2-A&origin=MSN).
- [Ald94b] D. Aldous. “Triangulating the circle, at random”. In: *Amer. Math. Monthly* 101.3 (1994), pp. 223–233. ISSN: 0002-9890. URL: <https://doi.org/10.2307/2975599>.
- [Ald97] D. Aldous. “Brownian excursions, critical random graphs and the multiplicative coalescent”. In: *Ann. Probab.* 25.2 (1997), pp. 812–854. ISSN: 0091-1798. URL: <https://doi.org/10.1214/aop/1024404421>.
- [AM14] M. Atapour and N. Madras. “Large deviations and ratio limit theorems for pattern-avoiding permutations”. In: *Combin. Probab. Comput.* 23.2 (2014), pp. 161–200. ISSN: 0963-5483. URL: <https://doi.org/10.1017/S0963548313000576>.
- [AN81] D. Avis and M. Newborn. “On pop-stacks in series”. In: *Utilitas Math.* 19 (1981), pp. 129–140. ISSN: 0315-3681.
- [ARS11] M. D. Atkinson, N. Ruškuc, and R. Smith. “Substitution-closed pattern classes”. In: *J. Combin. Theory Ser. A* 118.2 (2011), pp. 317–340. ISSN: 0097-3165. URL: <https://doi.org/10.1016/j.jcta.2010.10.006>.
- [AV13] M. H. Albert and V. Vatter. “Generating and enumerating 321-avoiding and skew-merged simple permutations”. In: *Electron. J. Combin.* 20.2 (2013), Paper 44, 11. URL: <https://doi.org/10.37236/3058>.
- [Bas+17] F. Bassino, M. Bouvel, A. Pierrot, C. Pivoteau, and D. Rossin. “An algorithm computing combinatorial specifications of permutation classes”. In: *Discrete Appl. Math.* 224 (2017), pp. 16–44. ISSN: 0166-218X. URL: <https://doi.org/10.1016/j.dam.2017.02.013>.
- [Bas+18] F. Bassino, M. Bouvel, V. Féray, L. Gerin, and A. Pierrot. “The Brownian limit of separable permutations”. In: *Ann. Probab.* 46.4 (2018), pp. 2134–2189. ISSN: 0091-1798. URL: <https://doi.org/10.1214/17-AOP1223>.
- [Bas+19a] F. Bassino, M. Bouvel, V. Féray, L. Gerin, M. Maazoun, and A. Pierrot. *Random cographs: Brownian graphon limit and asymptotic degree distribution*. 2019. arXiv: 1907.08517 [math.CO].
- [Bas+19b] F. Bassino, M. Bouvel, V. Féray, L. Gerin, M. Maazoun, and A. Pierrot. “Scaling limits of permutation classes with a finite specification: a dichotomy”. [arXiv:1903.07522]. 2019.
- [Bas+20] F. Bassino, M. Bouvel, V. Féray, L. Gerin, M. Maazoun, and A. Pierrot. “Universal limits of substitution-closed permutation classes”. In: *J. Eur. Math. Soc.* to appear [arXiv:1706.08333] (2020). URL: <https://hal.archives-ouvertes.fr/hal-01653572>.
- [Bax64] G. Baxter. “On fixed points of the composite of commuting functions”. In: *Proc. Amer. Math. Soc.* 15 (1964), pp. 851–855. ISSN: 0002-9939. URL: <https://doi.org/10.2307/2034894>.
- [BBEP20] D. Bevan, R. Brignall, A. Elvey Price, and J. Pantone. “A structural characterisation of $Av(1324)$ and new bounds on its growth rate”. In: *European J. Combin.* 88 (2020), pp. 103115, 29. ISSN: 0195-6698. URL: <https://doi.org/10.1016/j.ejc.2020.103115>.
- [BBF11] N. Bonichon, M. Bousquet-Mélou, and É. Fusy. “Baxter permutations and plane bipolar orientations”. In: *Sém. Lothar. Combin.* 61A (2009/11), Art. B61Ah, 29. ISSN: 1286-4889.
- [BBFS19] J. Borga, M. Bouvel, V. Féray, and B. Stuffer. “A decorated tree approach to random permutations in substitution-closed classes”. In: *arXiv preprint:1904.07135* (2019).

- [BBGR19] N. R. Beaton, M. Bouvel, V. Guerrini, and S. Rinaldi. “Enumerating five families of pattern-avoiding inversion sequences; and introducing the powered Catalan numbers”. In: *Theoret. Comput. Sci.* 777 (2019), pp. 69–92. ISSN: 0304-3975. URL: <https://doi.org/10.1016/j.tcs.2019.02.003>.
- [BBL93] P. Bose, J. F. Buss, and A. Lubij. “Pattern matching for permutations”. In: *Algorithms and data structures (Montreal, PQ, 1993)*. Vol. 709. Lecture Notes in Comput. Sci. Springer, Berlin, 1993, pp. 200–209. URL: https://doi.org/10.1007/3-540-57155-8_248.
- [BBPR15] F. Bassino, M. Bouvel, A. Pierrot, and D. Rossin. “An algorithm for deciding the finiteness of the number of simple permutations in permutation classes”. In: *Adv. in Appl. Math.* 64 (2015), pp. 124–200. ISSN: 0196-8858. URL: <https://doi.org/10.1016/j.aam.2014.12.001>.
- [BBR11] F. Bassino, M. Bouvel, and D. Rossin. “Enumeration of pin-permutations”. In: *Electron. J. Combin.* 18.1 (2011), Paper 57, 39. URL: <https://doi.org/10.37236/544>.
- [BCHP08] A. Bretscher, D. Corneil, M. Habib, and C. Paul. “A simple linear time LexBFS cograph recognition algorithm”. In: *SIAM J. Discrete Math.* 22.4 (2008), pp. 1277–1296. ISSN: 0895-4801. URL: <https://doi.org/10.1137/060664690>.
- [BCL11] P. J. Bickel, A. Chen, and E. Levina. “The method of moments and degree distributions for network models”. In: *Ann. Statist.* 39.5 (2011), pp. 2280–2301. ISSN: 0090-5364. URL: <https://doi.org/10.1214/11-AOS904>.
- [BD15] C. Banderier and M. Drmota. “Formulae and asymptotics for coefficients of algebraic functions”. In: *Combin. Probab. Comput.* 24.1 (2015), pp. 1–53. ISSN: 0963-5483. URL: <https://doi.org/10.1017/S0963548314000728>.
- [BDS19] J. Borga, E. Duchi, and E. Slivken. “Almost square permutations are typically square”. In: *arXiv preprint:1910.04813* (2019).
- [Ber18] G. H. Berzunza Ojeda. “On scaling limits of multitype Galton-Watson trees with possibly infinite variance”. In: *ALEA Lat. Am. J. Probab. Math. Stat.* 15.1 (2018), pp. 21–48. URL: <https://doi.org/10.30757/alea.v15-02>.
- [Bev15] D. Bevan. *On the growth of permutation classes*. 2015. arXiv: 1506.06688 [math.CO].
- [BF12] O. Bernardi and É. Fusy. “Schnyder decompositions for regular plane graphs and application to drawing”. In: *Algorithmica* 62.3-4 (2012), pp. 1159–1197. ISSN: 0178-4617. URL: <https://doi.org/10.1007/s00453-011-9514-5>.
- [BFR19] M. Bousquet-Mélou, É. Fusy, and K. Raschel. “Plane bipolar orientations and quadrant walks”. In: *arXiv preprint arXiv:1905.04256* (2019).
- [BGRR18] M. Bouvel, V. Guerrini, A. Rechnitzer, and S. Rinaldi. “Semi-Baxter and strong-Baxter: two relatives of the Baxter sequence”. In: *SIAM J. Discrete Math.* 32.4 (2018), pp. 2795–2819. ISSN: 0895-4801. URL: <https://doi.org/10.1137/17M1126734>.
- [BHV08a] R. Brignall, S. Huczynska, and V. Vatter. “Decomposing simple permutations, with enumerative consequences”. In: *Combinatorica* 28.4 (2008), pp. 385–400. ISSN: 0209-9683. URL: <https://doi.org/10.1007/s00493-008-2314-0>.
- [BHV08b] R. Brignall, S. Huczynska, and V. Vatter. “Simple permutations and algebraic generating functions”. In: *J. Combin. Theory Ser. A* 115.3 (2008), pp. 423–441. ISSN: 0097-3165. URL: <https://doi.org/10.1016/j.jcta.2007.06.007>.
- [Bil99] P. Billingsley. *Convergence of probability measures*. Second. Wiley Series in Probability and Statistics: Probability and Statistics. A Wiley-Interscience Publication. John Wiley & Sons, Inc., New York, 1999, pp. x+277. ISBN: 0-471-19745-9. URL: <https://doi.org/10.1002/9780470316962>.

- [BK04] K. Burdzy and H. Kaspi. “Lenses in skew Brownian flow”. In: *Ann. Probab.* 32.4 (2004), pp. 3085–3115. ISSN: 0091-1798. URL: <https://doi.org/10.1214/009117904000000711>.
- [BM17] B. B. Bhattacharya and S. Mukherjee. “Degree sequence of random permutation graphs”. In: *Ann. Appl. Probab.* 27.1 (2017), pp. 439–484. ISSN: 1050-5164. URL: <https://doi-org.acces.bibliotheque-diderot.fr/10.1214/16-AAP1207>.
- [BM20a] J. Borga and M. Maazoun. *Scaling and local limits of Baxter permutations and bipolar orientations through coalescent-walk processes*. 2020.
- [BM20b] J. Borga and M. Maazoun. “Scaling and Local Limits of Baxter Permutations Through Coalescent-Walk Processes”. In: *31st International Conference on Probabilistic, Combinatorial and Asymptotic Methods for the Analysis of Algorithms (AofA 2020)*. Ed. by M. Drmota and C. Heuberger. Vol. 159. Leibniz International Proceedings in Informatics (LIPIcs). Dagstuhl, Germany: Schloss Dagstuhl–Leibniz-Zentrum für Informatik, 2020, 7:1–7:18. ISBN: 978-3-95977-147-4. URL: <https://drops.dagstuhl.de/opus/volltexte/2020/12037>.
- [BMN20] M. Bouvel, M. Mishna, and C. Nicaud. “Some Families of Trees Arising in Permutation Analysis”. In: *The Electronic Journal of Combinatorics* (2020), P2–20.
- [Bog07] V. I. Bogachev. *Measure theory. Vol. I, II*. Springer-Verlag, Berlin, 2007, Vol. I: xviii+500 pp., Vol. II: xiv+575. ISBN: 978-3-540-34513-8; 3-540-34513-2. URL: <https://doi.org/10.1007/978-3-540-34514-5>.
- [Bón10] M. Bóna. “The absence of a pattern and the occurrences of another”. In: *Discrete Math. Theor. Comput. Sci.* 12.2 (2010), pp. 89–102.
- [Bón12a] M. Bóna. *Combinatorics of permutations*. Second. Discrete Mathematics and its Applications (Boca Raton). With a foreword by Richard Stanley. CRC Press, Boca Raton, FL, 2012, pp. xiv+458. ISBN: 978-1-4398-5051-0. URL: <https://doi.org/10.1201/b12210>.
- [Bón12b] M. Bóna. “Surprising symmetries in objects counted by Catalan numbers”. In: *Electron. J. Combin.* 19.1 (2012), Paper 62, 11.
- [Bón97] M. Bóna. “Exact enumeration of 1342-avoiding permutations: a close link with labeled trees and planar maps”. In: *J. Combin. Theory Ser. A* 80.2 (1997), pp. 257–272. ISSN: 0097-3165. URL: <https://doi.org/10.1006/jcta.1997.2800>.
- [Bor+08] C. Borgs, J. T. Chayes, L. Lovász, V. T. Sós, and K. Vesztegombi. “Convergent sequences of dense graphs. I. Subgraph frequencies, metric properties and testing”. In: *Adv. Math.* 219.6 (2008), pp. 1801–1851. ISSN: 0001-8708. URL: <https://doi.org/10.1016/j.aim.2008.07.008>.
- [Bor20a] J. Borga. “Asymptotic normality of consecutive patterns in permutations encoded by generating trees with one-dimensional labels”. In: (*in preparation*) (2020+).
- [Bor20b] J. Borga. “Local convergence for permutations and local limits for uniform ρ -avoiding permutations with $|\rho| = 3$ ”. In: *Probab. Theory Related Fields* 176.1-2 (2020), pp. 449–531. ISSN: 0178-8051. URL: <https://doi.org/10.1007/s00440-019-00922-4>.
- [Bor82] A. N. Borodin. “On the Asymptotic Behavior of Local Times of Recurrent Random Walks with Finite Variance”. In: *Theory of Probability & Its Applications* 26.4 (1982), pp. 758–772. eprint: <https://doi.org/10.1137/1126082>. URL: <https://doi.org/10.1137/1126082>.
- [Bou03] M. Bousquet-Mélou. “Four classes of pattern-avoiding permutations under one roof: generating trees with two labels”. In: *Electron. J. Combin.* 9.2 (2002/03). Permutation patterns (Otago, 2003), Research paper 19, 31. ISSN: 1077-8926.

- URL: http://www.combinatorics.org/Volume_9/Abstracts/v9i2r19.html.
- [Boy67] W. M. Boyce. “Generation of a class of permutations associated with commuting functions”. In: *Math. Algorithms 2 (1967)*, 19–26; addendum, *ibid.* 3 (1967), pp. 25–26.
- [BP12] A. M. Baxter and L. K. Pudwell. “Enumeration schemes for vincular patterns”. In: *Discrete Math.* 312.10 (2012), pp. 1699–1712. ISSN: 0012-365X. URL: <https://doi.org/10.1016/j.disc.2012.01.021>.
- [BP94] J. Bertoin and J. Pitman. “Path transformations connecting Brownian bridge, excursion and meander”. In: *Bull. Sci. Math.* 118.2 (1994), pp. 147–166. ISSN: 0007-4497.
- [Bri10] R. Brignall. “A survey of simple permutations”. In: *Permutation patterns*. Vol. 376. London Math. Soc. Lecture Note Ser. Cambridge Univ. Press, Cambridge, 2010, pp. 41–65. URL: <https://doi.org/10.1017/CB09780511902499.003>.
- [BRV08] R. Brignall, N. Ruškuc, and V. Vatter. “Simple permutations: decidability and unavoidable substructures”. In: *Theoret. Comput. Sci.* 391.1-2 (2008), pp. 150–163. ISSN: 0304-3975. URL: <https://doi.org/10.1016/j.tcs.2007.10.037>.
- [BS02] A. N. Borodin and P. Salminen. *Handbook of Brownian motion—facts and formulae*. Second. Probability and its Applications. Birkhäuser Verlag, Basel, 2002, pp. xvi+672. ISBN: 3-7643-6705-9. URL: <https://doi.org/10.1007/978-3-0348-8163-0>.
- [BS19] J. Borga and E. Slivken. “Square permutations are typically rectangular”. In: *Annals of Applied Probability, to appear* (2019).
- [CEF07] S.-E. Cheng, S.-P. Eu, and T.-S. Fu. “Area of Catalan paths on a checkerboard”. In: *European J. Combin.* 28.4 (2007), pp. 1331–1344. ISSN: 0195-6698. URL: <https://doi.org/10.1016/j.ejc.2006.01.006>.
- [CGHK78] F. R. K. Chung, R. L. Graham, V. E. Hoggatt Jr., and M. Kleiman. “The number of Baxter permutations”. In: *J. Combin. Theory Ser. A* 24.3 (1978), pp. 382–394. ISSN: 0097-3165. URL: [https://doi.org/10.1016/0097-3165\(78\)90068-7](https://doi.org/10.1016/0097-3165(78)90068-7).
- [Cha+19] T. F. N. Chan, D. Kral, J. A. Noel, Y. Pehova, M. Sharifzadeh, and J. Volec. *Characterization of quasirandom permutations by a pattern sum*. 2019. arXiv: 1909.11027 [math.CO].
- [ÇHK18] M. Çağlar, H. Hajri, and A. H. Karakuş. “Correlated coalescing Brownian flows on \mathbb{R} and the circle”. In: *ALEA Lat. Am. J. Probab. Math. Stat.* 15.2 (2018), pp. 1447–1464. ISSN: 1980-0436.
- [Cib] J. Cibulka. *Growth rates of permutation classes with certain forbidden patterns*. URL: <https://kam.mff.cuni.cz/~cibulka/forbperm/>.
- [CLB81] D. G. Corneil, H. Lerchs, and L. S. Burlingham. “Complement reducible graphs”. In: *Discrete Appl. Math.* 3.3 (1981), pp. 163–174. ISSN: 0166-218X. URL: [https://doi.org/10.1016/0166-218X\(81\)90013-5](https://doi.org/10.1016/0166-218X(81)90013-5).
- [CP16] G. Chapuy and G. Perarnau. “Connectivity in bridge-addable graph classes: the McDiarmid-Steger-Welsh conjecture”. In: *Proceedings of the Twenty-Seventh Annual ACM-SIAM Symposium on Discrete Algorithms*. ACM, New York, 2016, pp. 1580–1588. URL: <https://doi.org/10.1137/1.9781611974331.ch107>.
- [CPS85] D. G. Corneil, Y. Perl, and L. K. Stewart. “A linear recognition algorithm for cographs”. In: *SIAM J. Comput.* 14.4 (1985), pp. 926–934. ISSN: 0097-5397. URL: <https://doi.org/10.1137/0214065>.
- [Cur18] N. Curien. “Random graphs: the local convergence point of view”. In: *Unpublished lecture notes. Available at https://www.math.u-psud.fr/~curien/enseignement.html* (2018).

- [DDS18] J.-F. Delmas, J.-S. Dhersin, and M. Sciaudeau. *Asymptotic for the cumulative distribution function of the degrees and homomorphism densities for random graphs sampled from a graphon*. 2018. arXiv: 1807.09989 [math.PR].
- [DFLS04] P. Duchon, P. Flajolet, G. Louchard, and G. Schaeffer. “Boltzmann samplers for the random generation of combinatorial structures”. In: *Combin. Probab. Comput.* 13.4-5 (2004), pp. 577–625. ISSN: 0963-5483. URL: <https://doi.org/10.1017/S0963548304006315>.
- [DHJ08] P. Diaconis, S. Holmes, and S. Janson. “Threshold graph limits and random threshold graphs”. In: *Internet Math.* 5.3 (2008), 267–320 (2009). ISSN: 1542-7951. URL: <http://projecteuclid.org.access.bibliotheque-diderot.fr/euclid.im/1259095581>.
- [DJ08] P. Diaconis and S. Janson. “Graph limits and exchangeable random graphs”. In: *Rend. Mat. Appl. (7)* 28.1 (2008), pp. 33–61. ISSN: 1120-7183.
- [DKMS19] C. Dowden, M. Kang, M. Mosshammer, and P. Sprüßel. “The evolution of random graphs on surfaces of non-constant genus”. In: *Acta Math. Univ. Comenian. (N.S.)* 88.3 (2019), pp. 631–636. ISSN: 0862-9544.
- [DL02] T. Duquesne and J.-F. Le Gall. “Random trees, Lévy processes and spatial branching processes”. In: *Astérisque* 281 (2002), pp. vi+147. ISSN: 0303-1179.
- [DP14] T. Dokos and I. Pak. “The expected shape of random doubly alternating Baxter permutations”. In: *Online J. Anal. Comb.* 9 (2014), p. 12.
- [DP16] M. Drmota and A. Pierrot. “Permutation classes with finitely many simple permutations have a growth rate.” In: *Proceedings of Permutation Patterns*. 2016, pp. 54–56. URL: <https://permutationpatterns2016.wordpress.com/program/>.
- [Drm09] M. Drmota. *Random trees. An interplay between combinatorics and probability*. SpringerWienNewYork, Vienna, 2009, pp. xviii+458. ISBN: 978-3-211-75355-2. URL: <https://doi.org/10.1007/978-3-211-75357-6>.
- [Duq03] T. Duquesne. “A limit theorem for the contour process of conditioned Galton-Watson trees”. In: *Ann. Probab.* 31.2 (2003), pp. 996–1027. ISSN: 0091-1798. URL: <https://doi.org/10.1214/aop/1048516543>.
- [Duq06] T. Duquesne. “The coding of compact real trees by real valued functions”. [math/0604106]. 2006. eprint: math/0604106.
- [DW15a] D. Denisov and V. Wachtel. “Random walks in cones”. In: *Ann. Probab.* 43.3 (2015), pp. 992–1044. ISSN: 0091-1798. URL: <https://doi.org/10.1214/13-AOP867>.
- [DW15b] J. Duraj and V. Wachtel. “Invariance principles for random walks in cones”. In: *arXiv preprint arXiv:1508.07966* (2015).
- [Eli07] S. Elizalde. “Generating trees for permutations avoiding generalized patterns”. In: *Ann. Comb.* 11.3-4 (2007), pp. 435–458. ISSN: 0218-0006. URL: <https://doi.org/10.1007/s00026-007-0328-8>.
- [Eli11] S. Elizalde. “The X-class and almost-increasing permutations”. In: *Ann. Comb.* 15.1 (2011), pp. 51–68. ISSN: 0218-0006. URL: <https://doi.org/10.1007/s00026-011-0082-9>.
- [Eve18] C. Even-Zohar. *Patterns in Random Permutations*. 2018. arXiv: 1811.07883 [math.CO].
- [FFNO11] S. Felsner, É. Fusy, M. Noy, and D. Orden. “Bijections for Baxter families and related objects”. In: *J. Combin. Theory Ser. A* 118.3 (2011), pp. 993–1020. ISSN: 0097-3165. URL: <https://doi.org/10.1016/j.jcta.2010.03.017>.
- [FG20] É. Fusy and E. Guitter. *Maps of unfixed genus and blossoming trees*. 2020. arXiv: 2003.00885 [math.CO].
- [FK18] V. Féray and I. Kortchemski. “The geometry of random minimal factorizations of a long cycle via biconditioned bitype random trees”. In: *Ann. H. Lebesgue* 1 (2018), pp. 149–226. URL: <https://doi.org/10.5802/ahl.5>.

- [FS09] P. Flajolet and R. Sedgewick. *Analytic combinatorics*. Cambridge University Press, Cambridge, 2009, pp. xiv+810. ISBN: 978-0-521-89806-5. URL: <https://doi.org/10.1017/CB09780511801655>.
- [Gen16] A. Genitrini. “Full asymptotic expansion for Pólya structures”. In: *Proceedings of the 27th International Conference on Probabilistic, Combinatorial and Asymptotic Methods for the Analysis of Algorithms—AofA’16*. Jagiellonian Univ., Dep. Theor. Comput. Sci., Kraków, 2016, p. 12.
- [GGKK15] R. Glebov, A. Grzesik, T. Klimošová, and D. Král’. “Finitely forcible graphons and permutons”. In: *J. Combin. Theory Ser. B* 110 (2015), pp. 112–135. ISSN: 0095-8956. URL: <https://doi.org/10.1016/j.jctb.2014.07.007>.
- [GHS16] E. Gwynne, N. Holden, and X. Sun. “Joint scaling limit of a bipolar-oriented triangulation and its dual in the Peanosphere sense”. In: *arXiv preprint:1603.01194* (2016).
- [GHS17] E. Gwynne, N. Holden, and X. Sun. “A mating-of-trees approach for graph distances in random planar maps”. In: *arXiv preprint arXiv:1711.00723* (2017).
- [GHS19] E. Gwynne, N. Holden, and X. Sun. “Mating of trees for random planar maps and Liouville quantum gravity: a survey”. In: *arXiv preprint:1910.04713* (2019).
- [Ghy17] É. Ghys. *A singular mathematical promenade*. ENS Éditions, Lyon, 2017, pp. viii+302. ISBN: 978-2-84788-939-0.
- [Gir93] S. Gire. “Arbres, permutations à motifs exclus et cartes planaires: quelques problèmes algorithmiques et combinatoires”. PhD thesis. Bordeaux 1, 1993.
- [GJW18] B. Gittenberger, E. Y. Jin, and M. Wallner. “On the shape of random Pólya structures”. In: *Discrete Math.* 341.4 (2018), pp. 896–911. ISSN: 0012-365X. URL: <https://doi.org/10.1016/j.disc.2017.12.016>.
- [Gle+17] R. Glebov, C. Hoppen, T. Klimošová, Y. Kohayakawa, D. Král’, and H. Liu. “Densities in large permutations and parameter testing”. In: *European J. Combin.* 60 (2017), pp. 89–99. ISSN: 0195-6698. URL: <https://doi.org/10.1016/j.ejc.2016.09.006>.
- [Gon42] W. Gontcharoff. “Sur la distribution des cycles dans les permutations”. In: *C. R. (Doklady) Acad. Sci. URSS (N.S.)* 35 (1942), pp. 267–269.
- [GWG59] S. W. Golomb, L. R. Welch, and R. M. Goldstein. *Cycles from nonlinear shift registers*. Tech. rep. Jet Propulsion Lab, Pasadena, CA, 1959.
- [HJS18] H. Hatami, S. Janson, and B. Szegedy. “Graph properties, graph limits, and entropy”. In: *J. Graph Theory* 87.2 (2018), pp. 208–229. ISSN: 0364-9024. URL: <https://doi.org/10.1002/jgt.22152>.
- [Hom12] C. Homberger. “Expected patterns in permutation classes”. In: *Electron. J. Combin.* 19.3 (2012), Paper 43, 12.
- [Hop+13] C. Hoppen, Y. Kohayakawa, C. G. Moreira, B. Ráth, and R. Menezes Sampaio. “Limits of permutation sequences”. In: *J. Combin. Theory Ser. B* 103.1 (2013), pp. 93–113. ISSN: 0095-8956. URL: <https://doi.org/10.1016/j.jctb.2012.09.003>.
- [HP05] M. Habib and C. Paul. “A simple linear time algorithm for cograph recognition”. In: *Discrete Appl. Math.* 145.2 (2005), pp. 183–197. ISSN: 0166-218X. URL: <https://doi.org/10.1016/j.dam.2004.01.011>.
- [HRS17a] C. Hoffman, D. Rizzolo, and E. Slivken. “Pattern-avoiding permutations and Brownian excursion Part I: shapes and fluctuations”. In: *Random Structures Algorithms* 50.3 (2017), pp. 394–419. ISSN: 1042-9832. URL: <https://doi.org/10.1002/rsa.20677>.
- [HRS17b] C. Hoffman, D. Rizzolo, and E. Slivken. “Pattern-avoiding permutations and Brownian excursion, part II: fixed points”. In: *Probab. Theory Related Fields* 169.1-2 (2017), pp. 377–424. ISSN: 0178-8051. URL: <https://doi.org/10.1007/s00440-016-0732-2>.

- [HRS19] C. Hoffman, D. Rizzolo, and E. Slivken. “Scaling limits of permutations avoiding long decreasing sequences”. In: *arXiv preprint:1911.04982* (2019).
- [HS19] N. Holden and X. Sun. *Convergence of uniform triangulations under the Cardy embedding*. 2019. arXiv: 1905.13207 [math.PR].
- [Jan06] S. Janson. “Limit theorems for triangular urn schemes”. In: *Probab. Theory Related Fields* 134.3 (2006), pp. 417–452. ISSN: 0178-8051. URL: <https://doi.org/10.1007/s00440-005-0442-7>.
- [Jan12] S. Janson. “Simply generated trees, conditioned Galton-Watson trees, random allocations and condensation”. In: *Probab. Surv.* 9 (2012), pp. 103–252. URL: <https://doi.org/10.1214/11-PS188>.
- [Jan16] S. Janson. “Graph limits and hereditary properties”. In: *European J. Combin.* 52.part B (2016), pp. 321–337. ISSN: 0195-6698. URL: <https://doi.org/10.1016/j.ejc.2015.07.010>.
- [Jan17] S. Janson. “Patterns in random permutations avoiding the pattern 132”. In: *Combin. Probab. Comput.* 26.1 (2017), pp. 24–51. ISSN: 0963-5483. URL: <https://doi.org/10.1017/S0963548316000171>.
- [Jan19] S. Janson. “Patterns in random permutations avoiding the pattern 321”. In: *Random Structures Algorithms* 55.2 (2019), pp. 249–270. ISSN: 1042-9832. URL: <https://doi.org/10.1002/rsa.20806>.
- [Jan20] S. Janson. “Patterns in random permutations avoiding some sets of multiple patterns”. In: *Algorithmica* 82.3 (2020), pp. 616–641. ISSN: 0178-4617. URL: <https://doi.org/10.1007/s00453-019-00586-5>.
- [JNZ15] S. Janson, B. Nakamura, and D. Zeilberger. “On the asymptotic statistics of the number of occurrences of multiple permutation patterns”. In: *J. Comb.* 6.1-2 (2015), pp. 117–143. ISSN: 2156-3527. URL: <https://doi.org/10.4310/JOC.2015.v6.n1.a8>.
- [JS11] T. Jonsson and S. Ö. Stefánsson. “Condensation in nongeneric trees”. In: *J. Stat. Phys.* 142.2 (2011), pp. 277–313. ISSN: 0022-4715. URL: <https://doi.org/10.1007/s10955-010-0104-8>.
- [Kal17a] O. Kallenberg. *Random measures, theory and applications*. Vol. 77. Probability Theory and Stochastic Modelling. Springer, Cham, 2017, pp. xiii+694. ISBN: 978-3-319-41596-3; 978-3-319-41598-7. URL: <https://doi.org/10.1007/978-3-319-41598-7>.
- [Kal17b] O. Kallenberg. *Random measures, theory and applications*. Vol. 77. Springer, 2017.
- [Ken38] M. G. Kendall. “A New Measure of Rank Correlation”. In: *Biometrika* 30.1/2 (1938), pp. 81–93. ISSN: 00063444. URL: <http://www.jstor.org/stable/2332226>.
- [Kin93] J. F. C. Kingman. *Poisson processes*. Vol. 3. Oxford Studies in Probability. Oxford Science Publications. The Clarendon Press, Oxford University Press, New York, 1993, pp. viii+104. ISBN: 0-19-853693-3.
- [Kit11] S. Kitaev. *Patterns in permutations and words*. Monographs in Theoretical Computer Science. An EATCS Series. With a foreword by Jeffrey B. Remmel. Springer, Heidelberg, 2011, pp. xxii+494. ISBN: 978-3-642-17332-5; 978-3-642-17333-2. URL: <https://doi.org/10.1007/978-3-642-17333-2>.
- [KKRW19] R. Kenyon, D. Král’, C. Radin, and P. Winkler. “Permutations with fixed pattern densities”. In: *Random Structures & Algorithms* (2019). eprint: <https://onlinelibrary.wiley.com/doi/pdf/10.1002/rsa.20882>. URL: <https://onlinelibrary.wiley.com/doi/abs/10.1002/rsa.20882>.
- [KKRW20] R. Kenyon, D. Král’, C. Radin, and P. Winkler. “Permutations with fixed pattern densities”. In: *Random Structures Algorithms* 56.1 (2020), pp. 220–250. ISSN: 1042-9832. URL: <https://doi.org/10.1002/rsa.20882>.

- [KMSW19] R. Kenyon, J. Miller, S. Sheffield, and D. B. Wilson. “Bipolar orientations on planar maps and SLE_{12} ”. In: *Ann. Probab.* 47.3 (2019), pp. 1240–1269. ISSN: 0091-1798. URL: <https://doi.org/10.1214/18-AOP1282>.
- [Knu69] D. E. Knuth. *The art of computer programming. Vol. 1: Fundamental algorithms*. Second printing. Addison-Wesley Publishing Co., Reading, Mass.-London-Don Mills, Ont, 1969, pp. xxi+634.
- [Kol86] V. F. Kolchin. *Random mappings*. Translation Series in Mathematics and Engineering. Translated from the Russian, With a foreword by S. R. S. Varadhan. Optimization Software, Inc., Publications Division, New York, 1986, pp. xiv + 207. ISBN: 0-911575-16-2.
- [Kor12] I. Kortchemski. “Invariance principles for Galton-Watson trees conditioned on the number of leaves”. In: *Stochastic Process. Appl.* 122.9 (2012), pp. 3126–3172. ISSN: 0304-4149. URL: <https://doi.org/10.1016/j.spa.2012.05.013>.
- [Kor14] I. Kortchemski. “Random stable laminations of the disk”. In: *Ann. Probab.* 42.2 (2014), pp. 725–759. ISSN: 0091-1798. URL: <https://doi.org/10.1214/12-AOP799>.
- [KP13] D. Král’ and O. Pikhurko. “Quasirandom permutations are characterized by 4-point densities”. In: *Geom. Funct. Anal.* 23.2 (2013), pp. 570–579. ISSN: 1016-443X. URL: <https://doi.org/10.1007/s00039-013-0216-9>.
- [Le 05] J.-F. Le Gall. “Random trees and applications”. In: *Probab. Surv.* 2 (2005), pp. 245–311. URL: <https://doi.org/10.1214/154957805100000140>.
- [Le 13] J.-F. Le Gall. “Uniqueness and universality of the Brownian map”. In: *Ann. Probab.* 41.4 (2013), pp. 2880–2960. ISSN: 0091-1798. URL: <https://doi.org/10.1214/12-AOP792>.
- [Lej06] A. Lejay. “On the constructions of the skew Brownian motion”. In: *Probab. Surv.* 3 (2006), pp. 413–466. URL: <https://doi.org/10.1214/154957807000000013>.
- [Lov12] L. Lovász. *Large networks and graph limits*. Vol. 60. American Mathematical Society Colloquium Publications. American Mathematical Society, Providence, RI, 2012, pp. xiv+475. ISBN: 978-0-8218-9085-1. URL: <https://doi.org/10.1090/coll/060>.
- [LR04] Y. Le Jan and O. Raimond. “Flows, coalescence and noise”. In: *Ann. Probab.* 32.2 (2004), pp. 1247–1315. ISSN: 0091-1798. URL: <https://doi.org/10.1214/009117904000000207>.
- [LSW17] Y. Li, X. Sun, and S. S. Watson. *Schnyder woods, $SLE(16)$, and Liouville quantum gravity*. 2017. arXiv: 1705.03573 [math.PR].
- [Maa19] M. Maazoun. *Specifer, a sage program to compute the specification of permutation classes with a finite number of simples*. 2019. URL: <https://plmlab.math.cnrs.fr/maazoun/specifier>.
- [Maa20] M. Maazoun. “On the Brownian separable permuton”. In: *Combin. Probab. Comput.* 29.2 (2020), pp. 241–266. ISSN: 0963-5483. URL: <https://doi.org/10.1017/s0963548319000300>.
- [Mal79] C. L. Mallows. “Baxter permutations rise again”. In: *J. Combin. Theory Ser. A* 27.3 (1979), pp. 394–396. ISSN: 0097-3165. URL: [https://doi.org/10.1016/0097-3165\(79\)90034-7](https://doi.org/10.1016/0097-3165(79)90034-7).
- [Mar08] P. Marchal. “A note on the fragmentation of a stable tree”. In: *Fifth Colloquium on Mathematics and Computer Science*. Discrete Math. Theor. Comput. Sci. Proc., AI. Assoc. Discrete Math. Theor. Comput. Sci., Nancy, 2008, pp. 489–499.
- [Mie08] G. Miermont. “Invariance principles for spatial multitype Galton-Watson trees”. In: *Ann. Inst. Henri Poincaré Probab. Stat.* 44.6 (2008), pp. 1128–1161. ISSN: 0246-0203. URL: <https://doi.org/10.1214/07-AIHP157>.
- [Mie13] G. Miermont. “The Brownian map is the scaling limit of uniform random plane quadrangulations”. In: *Acta mathematica* 210.2 (2013), pp. 319–401.

- [ML10] N. Madras and H. Liu. “Random pattern-avoiding permutations”. In: *Algorithmic probability and combinatorics*. Vol. 520. Contemp. Math. Amer. Math. Soc., Providence, RI, 2010, pp. 173–194. URL: <https://doi.org/10.1090/conm/520/10259>.
- [MM78] A. Meir and J. W. Moon. “On the altitude of nodes in random trees”. In: *Canadian J. Math.* 30.5 (1978), pp. 997–1015. ISSN: 0008-414X. URL: <https://doi.org/10.4153/CJM-1978-085-0>.
- [Mon14] P. R. de Montmort. *Essai d’analyse sur les jeux de hazards*. Chez Claude Jombert... et Jacque Quillau, 1714.
- [MP14] S. Miner and I. Pak. “The shape of random pattern-avoiding permutations”. In: *Adv. in Appl. Math.* 55 (2014), pp. 86–130. ISSN: 0196-8858. URL: <https://doi.org/10.1016/j.aam.2013.12.004>.
- [MP16a] N. Madras and L. Pehlivan. “Large deviations for permutations avoiding monotone patterns”. In: *Electron. J. Combin.* 23.4 (2016), Paper 4.36, 20. ISSN: 1077-8926.
- [MP16b] N. Madras and L. Pehlivan. “Structure of random 312-avoiding permutations”. In: *Random Structures Algorithms* 49.3 (2016), pp. 599–631. ISSN: 1042-9832. URL: <https://doi.org/10.1002/rsa.20601>.
- [MSW06] C. McDiarmid, A. Steger, and D. J. A. Welsh. “Random graphs from planar and other addable classes”. In: *Topics in discrete mathematics*. Vol. 26. Algorithms Combin. Springer, Berlin, 2006, pp. 231–246. URL: https://doi.org/10.1007/3-540-33700-8_15.
- [MT04] A. Marcus and G. Tardos. “Excluded permutation matrices and the Stanley-Wilf conjecture”. In: *J. Combin. Theory Ser. A* 107.1 (2004), pp. 153–160. ISSN: 0097-3165. URL: <https://doi.org/10.1016/j.jcta.2004.04.002>.
- [Muk16a] S. Mukherjee. “Estimation in exponential families on permutations”. In: *Ann. Statist.* 44.2 (2016), pp. 853–875. ISSN: 0090-5364. URL: <https://doi.org/10.1214/15-AOS1389>.
- [Muk16b] S. Mukherjee. “Fixed points and cycle structure of random permutations”. In: *Electron. J. Probab.* 21 (2016), Paper No. 40, 18. URL: <https://doi.org/10.1214/16-EJP4622>.
- [MY17] N. Madras and G. Yildirim. “Longest monotone subsequences and rare regions of pattern-avoiding permutations”. In: *Electron. J. Combin.* 24.4 (2017), Paper No. 4.13, 29. URL: <https://doi.org/10.37236/6402>.
- [MY19] C. McDiarmid and N. YOLOV. “Random perfect graphs”. In: *Random Structures Algorithms* 54.1 (2019), pp. 148–186. ISSN: 1042-9832. URL: <https://doi.org/10.1002/rsa.20770>.
- [MY20] T. Mansour and G. Yildirim. “Permutations avoiding 312 and another pattern, Chebyshev polynomials and longest increasing subsequences”. In: *Adv. in Appl. Math.* 116 (2020), pp. 102002, 17. ISSN: 0196-8858. URL: <https://doi.org/10.1016/j.aam.2020.102002>.
- [Noy14] M. Noy. “Random planar graphs and beyond”. In: *Proceedings of the International Congress of Mathematicians—Seoul 2014. Vol. IV*. Kyung Moon Sa, Seoul, 2014, pp. 407–430.
- [OEIS] O. Foundation. *N. J. A. Sloane. The Encyclopedia of Integer Sequences*. <https://oeis.org/>.
- [Ouc05] E. Ouchterlony. “Pattern avoiding doubly alternating permutations”. In: *Proceedings of FPSAC 2005* (San Diego). 2005.
- [Pan17] J. Pantone. “The enumeration of permutations avoiding 3124 and 4312”. In: *Ann. Comb.* 21.2 (2017), pp. 293–315. ISSN: 0218-0006. URL: <https://doi.org/10.1007/s00026-017-0352-2>.
- [Pit06] J. Pitman. *Combinatorial stochastic processes*. Vol. 1875. Lecture Notes in Mathematics. Lectures from the 32nd Summer School on Probability Theory held in Saint-Flour, July 7–24, 2002, With a foreword by Jean Picard.

- Springer-Verlag, Berlin, 2006, pp. x+256. ISBN: 978-3-540-30990-1; 3-540-30990-X.
- [PR15] J. Pitman and D. Rizzolo. “Schröder’s problems and scaling limits of random trees”. In: *Trans. Amer. Math. Soc.* 367.10 (2015), pp. 6943–6969. ISSN: 0002-9947. URL: <https://doi.org/10.1090/S0002-9947-2015-06254-0>.
- [Pro13] V. Prokaj. “The solution of the perturbed Tanaka-equation is pathwise unique”. In: *Ann. Probab.* 41.3B (2013), pp. 2376–2400. ISSN: 0091-1798. URL: <https://doi.org/10.1214/11-AOP716>.
- [PS10] C. B. Presutti and W. Stromquist. “Packing rates of measures and a conjecture for the packing density of 2413”. In: *Permutation patterns*. Vol. 376. London Math. Soc. Lecture Note Ser. Cambridge Univ. Press, Cambridge, 2010, pp. 287–316. URL: <https://doi.org/10.1017/CB09780511902499.015>.
- [PS18] K. Panagiotou and B. Stuffer. “Scaling limits of random Pólya trees”. In: *Probab. Theory Related Fields* 170.3-4 (2018), pp. 801–820. ISSN: 0178-8051. URL: <https://doi.org/10.1007/s00440-017-0770-4>.
- [PSW16] K. Panagiotou, B. Stuffer, and K. Weller. “Scaling limits of random graphs from subcritical classes”. In: *Ann. Probab.* 44.5 (2016), pp. 3291–3334. ISSN: 0091-1798. URL: <https://doi.org/10.1214/15-AOP1048>.
- [PV20] J. Pantone and V. Vatter. “Growth rates of permutation classes: categorization up to the uncountability threshold”. In: *Israel J. Math.* 236.1 (2020), pp. 1–43. ISSN: 0021-2172. URL: <https://doi.org/10.1007/s11856-020-1964-5>.
- [PW14] M. Perman and J. A. Wellner. “An excursion approach to maxima of the Brownian bridge”. In: *Stochastic Process. Appl.* 124.9 (2014), pp. 3106–3120. ISSN: 0304-4149. URL: <https://doi.org/10.1016/j.spa.2014.04.008>.
- [Rie] A. Riera. personal communication.
- [Ros11] N. Ross. “Fundamentals of Stein’s method”. In: *Probab. Surv.* 8 (2011), pp. 210–293. URL: <https://doi.org/10.1214/11-PS182>.
- [RS67] A. Rényi and G. Szekeres. “On the height of trees”. In: *J. Austral. Math. Soc.* 7 (1967), pp. 497–507. ISSN: 0263-6115.
- [Rud13] K. Rudolph. “Pattern popularity in 132-avoiding permutations”. In: *Electron. J. Combin.* 20.1 (2013), Paper 8, 15.
- [RVV19] M. Rahman, B. Virág, and M. Vizer. “Geometry of permutation limits”. In: *Combinatorica* 39.4 (2019), pp. 933–960. ISSN: 0209-9683. URL: <https://doi.org/10.1007/s00493-019-3817-6>.
- [RY99] D. Revuz and M. Yor. *Continuous martingales and Brownian motion*. Third. Vol. 293. Grundlehren der Mathematischen Wissenschaften [Fundamental Principles of Mathematical Sciences]. Springer-Verlag, Berlin, 1999, pp. xiv+602. ISBN: 3-540-64325-7. URL: <https://doi.org/10.1007/978-3-662-06400-9>.
- [Sei74] D. Seinsche. “On a property of the class of n -colorable graphs”. In: *J. Combinatorial Theory Ser. B* 16 (1974), pp. 191–193. ISSN: 0095-8956. URL: [https://doi.org/10.1016/0095-8956\(74\)90063-x](https://doi.org/10.1016/0095-8956(74)90063-x).
- [SS91] L. Shapiro and A. B. Stephens. “Bootstrap percolation, the Schröder numbers, and the N -kings problem”. In: *SIAM J. Discrete Math.* 4.2 (1991), pp. 275–280. ISSN: 0895-4801. URL: <https://doi.org/10.1137/0404025>.
- [SSS17] E. Schertzer, R. Sun, and J. M. Swart. “The Brownian web, the Brownian net, and their universality”. In: *Advances in disordered systems, random processes and some applications*. Cambridge Univ. Press, Cambridge, 2017, pp. 270–368.
- [Sta94] Z. E. Stankova. “Forbidden subsequences”. In: *Discrete Math.* 132.1-3 (1994), pp. 291–316. ISSN: 0012-365X. URL: [https://doi.org/10.1016/0012-365X\(94\)90242-9](https://doi.org/10.1016/0012-365X(94)90242-9).
- [Ste18] R. Stephenson. “Local convergence of large critical multi-type Galton-Watson trees and applications to random maps”. In: *J. Theoret. Probab.* 31.1 (2018),

- pp. 159–205. ISSN: 0894-9840. URL: <https://doi.org/10.1007/s10959-016-0707-3>.
- [Stu19] B. Stuffer. *Graphon convergence of random cographs*. 2019. arXiv: 1906.10355 [math.PR].
- [Tak80] L. Takács. “The problem of coincidences”. In: *Arch. Hist. Exact Sci.* 21.3 (1979/80), pp. 229–244. ISSN: 0003-9519. URL: <https://doi.org/10.1007/BF00327875>.
- [Thé20a] P. Thévenin. *A geometric representation of fragmentation processes on stable trees*. 2020. arXiv: 1910.04508 [math.PR].
- [Thé20b] P. Thévenin. *Random stable type minimal factorizations of the n -cycle*. 2020. arXiv: 2002.12027 [math.PR].
- [Tsi06] B. Tsirelson. “Brownian local minima, random dense countable sets and random equivalence classes”. In: *Electron. J. Probab.* 11 (2006), no. 7, 162–198. ISSN: 1083-6489. URL: <https://doi-org.access.bibliotheque-diderot.fr/10.1214/EJP.v11-309>.
- [Vat15] V. Vatter. “Permutation classes”. In: *Handbook of enumerative combinatorics*. Discrete Math. Appl. (Boca Raton). CRC Press, Boca Raton, FL, 2015, pp. 753–833.
- [VK77] A. M. Vershik and S. V. Kerov. “ASYMPTOTICS OF PLANCHEREL MEASURE OF SYMMETRICAL GROUP AND LIMIT FORM OF YOUNG TABLES”. In: *Doklady Akademii Nauk SSSR* 233.6 (1977), pp. 1024–1027.
- [Wik20] Wikipedia. *Cograph* — *Wikipedia, The Free Encyclopedia*. <http://en.wikipedia.org/w/index.php?title=Cograph&oldid=951620484>. [Online; accessed 10-July-2020]. 2020.