



HAL
open science

Computational descriptions of higher categories

Simon Forest

► **To cite this version:**

Simon Forest. Computational descriptions of higher categories. Category Theory [math.CT]. Institut Polytechnique de Paris, 2021. English. NNT : 2021IPPAX003 . tel-03155192

HAL Id: tel-03155192

<https://theses.hal.science/tel-03155192>

Submitted on 1 Mar 2021

HAL is a multi-disciplinary open access archive for the deposit and dissemination of scientific research documents, whether they are published or not. The documents may come from teaching and research institutions in France or abroad, or from public or private research centers.

L'archive ouverte pluridisciplinaire **HAL**, est destinée au dépôt et à la diffusion de documents scientifiques de niveau recherche, publiés ou non, émanant des établissements d'enseignement et de recherche français ou étrangers, des laboratoires publics ou privés.

NNT : 2021IPPAX003

Thèse de doctorat



Descriptions calculatoires de catégories supérieures

Thèse de doctorat de l'Institut Polytechnique de Paris
préparée à l'École Polytechnique et l'Université de Paris

École doctorale n°626 : École Doctorale de
l'Institut Polytechnique de Paris (ED IP Paris)
Spécialité de doctorat : Informatique

Thèse présentée et soutenue en visioconférence, le 8 Janvier 2021, par

SIMON FOREST

Composition du Jury :

Dominic Verity Professeur, Macquarie University	Président et rapporteur
Tom Hirschowitz Chargé de recherche, Univ. Savoie Mont Blanc (LAMA)	Rapporteur
François Métayer Maître de conférences, Université de Paris (IRIF)	Examineur
Viktoriya Ozornova Professeure assistante, Ruhr-Universität Bochum	Examinatrice
Ross Street Professeur émérite, Macquarie University	Examineur
Jamie Vicary <i>Senior research fellow</i> , University of Oxford	Examineur
Samuel Mimram Professeur, École Polytechnique (LIX)	Directeur de thèse
Yves Guiraud Chargé de recherche, Université de Paris (Inria)	Co-directeur de thèse

COMPUTATIONAL DESCRIPTIONS
of
HIGHER CATEGORIES

a PhD thesis in four chapters by

Simon Forest

in the field of

COMPUTER SCIENCE

under the supervision of

Samuel Mimram
École Polytechnique

Yves Guiraud
Université de Paris

Contents

Contents	v
Résumé en français	ix
Remerciements	xiii
Notations	xv
Introduction	xvii
General background	xvii
Topics of this thesis	xxiii
1 Higher categories	1
Introduction	1
1.1 Finite presentability	3
1.1.1 Presentability	3
1.1.2 Essentially algebraic theories	5
1.2 Higher categories as globular algebras	9
1.2.1 Algebras over a monad	10
1.2.2 Globular sets	12
1.2.3 Globular algebras	14
1.2.4 Truncable globular monads	31
1.3 Free higher categories on generators	37
1.3.1 Pullbacks in CAT	38
1.3.2 Cellular extensions	40
1.3.3 Polygraphs	46
1.4 Strict categories and precategories	57
1.4.1 Strict categories	57
1.4.2 Precategories	65
1.4.3 Categories as precategories	70
1.5 Higher categories as enriched categories	77
1.5.1 Enrichment	77
1.5.2 The funny tensor product	79

1.5.3	Enriched definition of precategories	82
2	The word problem on strict categories	87
	Introduction	87
2.1	Measures on polygraphs	88
2.1.1	n -globular groups and n -groups	89
2.1.2	Measures on polygraphs	97
2.1.3	Elementary properties of free categories	102
2.2	Free categories through categorical actions	104
2.2.1	Categorical actions	104
2.2.2	Contexts and contexts classes	106
2.2.3	Free action on a cellular extension	114
2.2.4	Free $(n+1)$ -categories on n -categorical actions	122
2.2.5	Another description of free categories on cellular extensions	128
2.3	Computable free extensions	130
2.3.1	Computability with encodings	131
2.3.2	Computable free cellular extensions	141
2.3.3	The case of polygraphs	152
2.4	Word problem on polygraphs	154
2.4.1	Terms and word problem	155
2.4.2	Solution to the word problem on finite polygraphs	157
2.4.3	Solution to the word problem on general polygraphs	162
2.4.4	An implementation in OCAML	167
2.5	Non-existence of some measure on polygraphs	173
2.5.1	Plexes and polyplexes	174
2.5.2	Inexistence of the measure	181
3	Pasting diagrams	189
	Introduction	189
3.1	The formalisms of pasting diagrams	193
3.1.1	Hypergraphs	193
3.1.2	Parity complexes	195
3.1.3	Pasting schemes	201
3.1.4	Augmented directed complexes	205
3.1.5	Torsion-free complexes	208
3.2	The category of cells	213
3.2.1	Movement properties	213
3.2.2	Gluing sets on cells	216
3.2.3	$\text{Cell}(P)$ is an ω -category	222
3.3	The freeness property	225
3.3.1	Cell decompositions	225
3.3.2	Freeness of decompositions of length one	229
3.3.3	Freeness of general decompositions	234
3.4	Relating formalisms	237
3.4.1	Closed and maximal cells	238
3.4.2	Embedding parity complexes	250
3.4.3	Embedding pasting schemes	252
3.4.4	Embedding augmented directed complexes	256
3.4.5	Absence of other embeddings	262

4 Coherence for Gray categories	265
Introduction	265
4.1 Precategories for computations and presentations	266
4.1.1 Whiskers	266
4.1.2 Free precategories	270
4.1.3 Presentations of precategories	274
4.2 Gray categories	277
4.2.1 The Gray tensor products	278
4.2.2 Gray categories	283
4.2.3 Gray presentations	285
4.2.4 Correctness of Gray presentations	288
4.3 Rewriting	298
4.3.1 Coherence in Gray categories	299
4.3.2 Rewriting on 3-prepolygraphs	301
4.3.3 Termination	303
4.3.4 Critical branchings	305
4.3.5 Finiteness of critical branchings	307
4.4 Applications	314
4.4.1 Pseudomonoids	314
4.4.2 Pseudoadjunctions	318
4.4.3 Frobenius pseudomonoid	324
4.4.4 Self-dualities	324
Bibliography	333
Index	339
Glossary	343

Résumé en français

As required by the French law concerning PhD manuscripts written in English, here are some paragraphs written in French which summarize the content of this manuscript. English speakers can safely skip this section.

La sophistication des mathématiques modernes incite à représenter divers objets mathématiques ainsi que les constructions associées de façon unifiée par un langage commun. Depuis les travaux de MacLane et Eilenberg dans les années 1940, un tel point de vue unifiant est fourni par la théorie des catégories. En effet, initialement développées dans le cadre de la topologie algébrique, les *catégories* permettent de représenter des objets mathématiques différents de la même façon : ensembles, groupes, anneaux, espaces topologiques, variétés différentiables, *etc.* Loin de se restreindre aux mathématiques « pures », les catégories peuvent être utilisées pour fournir un point de vue simple pour des objets venant d'autres domaines, comme la physique et l'informatique.

Cependant, pour décrire certaines situations que l'on peut rencontrer en mathématiques (et, *a fortiori*, dans d'autres domaines), la structure élémentaire de catégorie peut s'avérer insuffisante. En effet, tandis que les catégories ne permettent que de représenter des interactions de « bas niveau » entre des objets mathématiques, on cherche souvent à comprendre les interactions de plus « haut niveau » (les interactions entre les interactions, les interactions entre ces dernières, *etc.*). Dans ce genre de situation, il est ainsi utile d'avoir recours aux *catégories supérieures*. Ces dernières sont des généralisations multidimensionnelles des catégories simples. En effet, tandis que l'on peut voir les catégories simples comme des structures avec des cellules de dimension 0 et 1, les catégories supérieures peuvent avoir des cellules de dimensions arbitraires. Ces cellules de différentes dimensions peuvent alors être composées par diverses opérations qui satisfont divers axiomes qui varient suivant la théorie de catégories supérieures considérée.

La complexité des différentes axiomatiques fait que les catégories supérieures sont des structures complexes, et le but de cette thèse est d'introduire plusieurs outils informatiques facilitant la manipulation et l'étude de ces structures.

Catégories supérieures

Une première tâche de ce travail fut de développer un cadre unifié pour considérer les catégories supérieures permettant de donner des définitions génériques à un certain nombre de constructions

sur ces structures. Un tel programme fut partiellement mis en œuvre par Batanin [Bat98a] afin de généraliser à toute une classe de catégories supérieures la notion de *polygraphe*. Cette dernière structure fut en effet initialement introduite uniquement dans le cadre des catégories supérieures strictes par Street [Str76] (sous le nom de *computad*) et par Burroni [Bur93]. Les polygraphes sont des structures particulièrement intéressantes par rapport au sujet de cette thèse dans la mesure où elles fournissent un moyen d'encoder finement des catégories supérieures potentiellement infinies, permettant ainsi de les transmettre comme entrées à des programmes. Le travail de Batanin généralise ces polygraphes à toute la classe des catégories supérieures dites globulaires algébriques finitaires, qui englobe la plupart des catégories supérieures usuelles. Cependant, plusieurs constructions intervenant dans la définition des polygraphes de catégories strictes et qui apparaissaient chez Burroni n'ont pas été considérées par Batanin, qui s'est strictement focalisé sur les polygraphes. Étant donné que ces constructions interviennent fréquemment dans l'étude des catégories supérieures, il parut utile de donner une définition générique de ces constructions en utilisant le cadre de Batanin.

Dans ce dernier, une théorie de catégories supérieures de dimension n est simplement vue comme une monade

$$T: \mathbf{Glob}_n \rightarrow \mathbf{Glob}_n$$

sur la catégorie \mathbf{Glob}_n des ensembles n -globulaires. Les n -catégories qui sont les instances de cette théorie de catégories supérieures sont alors les algèbres de la catégorie d'Eilenberg-Moore \mathbf{Alg}_n associée à T . De plus, à partir de T , on peut obtenir des théories de catégories supérieures de dimensions $0, \dots, n-1$ en tronquant la monade T en dimensions $0, \dots, n-1$ respectivement. On obtient ainsi des monades T^0, \dots, T^{n-1} sur les catégories $\mathbf{Glob}_0, \dots, \mathbf{Glob}_{n-1}$, qui induisent donc des catégories $\mathbf{Alg}_0, \dots, \mathbf{Alg}_{n-1}$ d'algèbres sur ces monades. Nous définissons alors des foncteurs de troncations et d'inclusions

$$(-)_{\leq k, l}^{\mathbf{Alg}}: \mathbf{Alg}_l \rightarrow \mathbf{Alg}_k \quad \text{et} \quad (-)_{\uparrow l, k}^{\mathbf{Alg}}: \mathbf{Alg}_k \rightarrow \mathbf{Alg}_l$$

qui forment naturellement une adjonction pour $k, l \in \mathbb{N}_n$ avec $k < l$.

Une opération que l'on cherche souvent à faire dans les catégories supérieures est la définition d'une $(k+1)$ -catégorie en ajoutant librement des $(k+1)$ -générateurs à une k -catégorie. Il est possible d'écrire cette construction dans ce cadre. Pour cela, on introduit les catégories \mathbf{Alg}_k^+ des k -catégories équipées d'ensembles de $(k+1)$ -générateurs. On parvient alors à définir un foncteur

$$-[-]^k: \mathbf{Alg}_k^+ \rightarrow \mathbf{Alg}_{k+1}$$

qui représente la construction libre de $(k+1)$ -catégories à partir d'objets de \mathbf{Alg}_k^+ . On donne aussi des propriétés plus précises de ce foncteur dans le cas où la monade T est *troncable*. Cette dernière définition apparaissait déjà chez Batanin et stipule la compatibilité de T avec la troncation sur les ensembles globulaires. En utilisant cette construction, on obtient alors une autre définition générique des polygraphes pour toute la classe de catégories supérieures évoquée plus tôt. On énonce ensuite quelques propriétés de ces polygraphes et de leurs catégories qui n'apparaissent pas chez Batanin, comme la présentabilité localement finie. Pour finir, on instancie ces propriétés et constructions pour deux exemples de catégories supérieures : les *catégories strictes* et les *précatégories*.

Le problème du mot

Comme énoncé plus tôt, une théorie de catégories supérieures consiste en un certain nombre d'opérations pour composer les cellules de différentes dimensions, ainsi que des axiomes que satisfont ces différentes opérations. Étant donné un ensemble de cellules d'une catégorie supérieure,

il est souvent possible de les composer formellement de plusieurs manières. Le *problème du mot* consiste alors à déterminer si deux composées formelles de cellules représente la même cellule d'après la théorie considérée.

Une solution à ce problème a été donnée par Makkai dans le cas des catégories strictes [Mak05]. Cependant, sa solution est relativement inefficace et ne permet pas de résoudre des instances concrètes qui sont trop sophistiquées. Une partie du travail de cette thèse a consisté à améliorer l'algorithme proposé par Makkai en donnant une meilleure description calculatoire des catégories strictes libres. Pour cela, il a fallu clarifier la notion de calculabilité dans le cadre des catégories supérieures, ce que nous avons fait en utilisant le formalisme des fonctions récursives. Finalement, nous avons produit une implémentation utilisable de notre algorithme résolvant le problème du mot pour les catégories strictes.

Diagrammes de recollement

Les diagrammes de recollement (*pasting diagrams* en anglais) sont un outil standard dans l'étude des catégories strictes et, plus généralement, d'un certain nombre de catégories supérieures. Ils permettent de désigner une cellule d'une catégorie supérieure simplement en dessinant la façon de recoller les cellules qui la composent sur un diagramme comme le suivant :

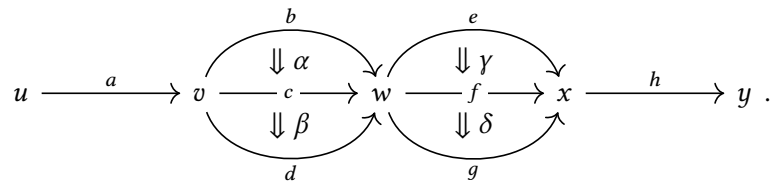

Il est en effet possible de vérifier que toutes les façons de composer les cellules de ce diagramme induisent la même cellule, et donc que ce diagramme permet bien de représenter une unique cellule sans que l'on ait besoin de préciser une composée formelle des cellules la constituant. Cependant, cette propriété n'est pas satisfaite par tous les diagrammes de cellules : certains sont associés à plusieurs compositions formelles différentes, et d'autres sont associés à aucune composition. Ainsi, afin de pouvoir utiliser des diagrammes dans l'étude des catégories strictes, il est important de pouvoir distinguer les diagrammes qui sont associés à une unique composition. Pour cela, trois formalismes différents ont été introduits jusqu'à présent : les complexes de parité de Street [Str91], les schémas de recollement de Johnson [Joh89] et les complexes dirigés augmentés de Steiner [Ste04].

Une partie du travail de cette thèse a consisté à essayer de mieux comprendre les liens entre ces différents formalismes ainsi que les différences entre leurs expressivités. Durant cette étude, il fut découvert que l'axiomatique des complexes de parité et des schémas de recollement étaient défectueuses, dans le sens où ces formalismes acceptaient des diagrammes qui n'étaient pas associés à des compositions formelles uniques. Cela motiva l'introduction d'un nouveau formalisme, appelé *complexes sans torsion*, généralisant les trois introduits et corrigeant les défauts des complexes de parité et des schémas de recollement. Nous avons prouvé en détail la correction de ce nouveau formalisme en adaptant et complétant les preuves données par Street pour les complexes de parité. Nous avons ensuite effectué la comparaison avec les autres formalismes et montré, selon des restrictions raisonnables, que ceux-ci étaient des cas particuliers de complexes sans torsion. Pour finir, nous avons illustré l'utilité de cette nouvelle structure en en fournissant une implémentation qui permet de faciliter l'interaction avec le programme résolvant le problème du mot évoqué plus haut.

Cohérence dans les catégories de Gray

Les définitions des structures algébriques usuelles, comme celle des monoïdes, peuvent être généralisées dans des catégories supérieures. On s'intéresse généralement aux définitions qui sont *cohérentes*, c'est-à-dire où tous les diagrammes commutent. Par exemple, on peut généraliser la définition des monoïdes aux 2-catégories monoïdales. Les conditions d'unitarité et d'associativité des monoïdes sont alors exprimées sous forme d'isomorphismes de dimension 2. Le célèbre théorème de cohérence de MacLane nous dit qu'une définition cohérente est obtenue en demandant la commutativité de deux classes de diagrammes, dont le fameux pentagone de MacLane

$$\begin{array}{ccccc}
 & & (W \otimes X) \otimes (Y \otimes Z) & & \\
 & \nearrow & & \searrow & \\
 ((W \otimes X) \otimes Y) \otimes Z & & & & W \otimes (X \otimes (Y \otimes Z)) \\
 & \searrow & & \nearrow & \\
 & & (W \otimes (X \otimes Y)) \otimes Z & \longrightarrow & W \otimes ((X \otimes Y) \otimes Z)
 \end{array}$$

La question se pose alors de comment trouver de telles classes de diagrammes, appelés *diagrammes de cohérence*, pour les autres structures algébriques afin de rendre les définitions cohérentes.

Généralisant un résultat de Squier sur les monoïdes, Guiraud et Malbos [GM09] ont introduit une technique permettant de trouver de tels diagrammes de confluence pour des structures algébriques exprimées dans des catégories strictes. Ils ont montré que, dans le cas où les axiomes de ces structures pouvaient être orientés de façon à constituer un système de réécriture convergent, les diagrammes de cohérence pouvaient être obtenus comme étant les diagrammes de confluence de ce système de réécriture.

Une partie du travail de cette thèse a consisté à adapter cette technique aux catégories de Gray. Ces dernières sont des catégories 3-dimensionnelles qui sont intéressantes car assez simples et qui pourtant sont équivalentes aux tricatégories, qui modélisent tous les types d'homotopie de dimension 3. Pour faire cette adaptation, nous avons développé un cadre permettant de faire de la réécriture dans les catégories de Gray basé sur les précatégories. L'utilisation de ces dernières est justifiée par le fait qu'elles permettent d'avoir de meilleures propriétés calculatoires que les catégories strictes par exemple. Nous obtenons ainsi un résultat analogue à celui de Guiraud et Malbos qui stipule que, dans le cas où les 3-cellules d'une catégories de Gray induisent un système de réécriture convergent, les diagrammes de confluence de ce système de réécriture peuvent être choisis comme diagrammes de cohérence pour la structure algébrique considérée. Nous appliquons ensuite ce résultat sur quelques exemples, ce qui nécessite entre autres de développer des résultats de terminaison pour les systèmes de réécriture dans ce cadre.

Remerciements

J'aimerais tout d'abord remercier mes deux directeurs de thèse, Samuel et Yves, qui ont accepté de m'encadrer pendant ces trois années de thèse. Leur disponibilité et leur écoute durant cette période ont sûrement fait de moi un thésard privilégié. Aussi, mes échanges avec eux m'ont beaucoup appris, notamment sur mon domaine de recherche, mais aussi sur le monde de la recherche en général. J'aimerais en particulier remercier Yves pour son soutien lors de la rédaction de mon premier article, et Samuel pour ses blagues qui n'étaient pas toujours mauvaises.

Then, I would like to thank the different people who agreed to be part of my defense jury: Tom Hirschowitz, François Métayer, Viktoriya Ozornova, Ross Street, Dominic Verity and Jamie Vicary. I am particularly grateful for the attendance of Ross and Dominic given the ten-hour difference between our two time zones. I am also grateful for the work done by Tom and Dominic, who agreed to be my rapporteurs and to read my lengthy manuscript in full details. I would also like to thank Ross for agreeing to be rapporteur in the first place, before being refused by my graduate school. I would also like to thank Dimitri Ara for agreeing to be in the jury at some point, even though it was not possible for him to attend in the end.

J'aimerais maintenant remercier les gens du laboratoire d'informatique de Polytechnique et, plus particulièrement, les gens de l'équipe CoSyNuS avec qui j'ai passé la partie la plus importante de mon temps de doctorat. Je voudrais d'abord remercier Patrick et Thibaut avec qui j'ai partagé un bureau et eu des conversations très intéressantes sur HASKELL, HoTT ou autres. Je voudrais aussi remercier Emmanuel pour ses sélections de thés et pour ses anecdotes toujours croustillantes. Un merci aussi à François pour s'être assuré que nous mangions tous en venant nous chercher tous les midis pour aller à la cantine. J'aimerais enfin remercier Bibek, Éric, Maria, Nan, Roman, Sergio, Sylvie et Uli pour les échanges intéressants que l'on a pu avoir, que ce soit au bureau ou lors de sessions Zoom après une journée de travail.

Une pensée aussi pour les gens de l'IRIF à l'Université de Paris (anciennement Paris Diderot) que j'aurais aimé voir plus souvent et mieux connaître. Notamment le sympathique groupe de doctorants qui était présent à ce moment : Axel, Cédric, Chaitanya, Jules, Léo, Léonard, Pierre, Rémi, Théo, Zeinab, et les autres. Des remerciements aussi aux membres permanents, comme François, Pierre-Louis, et Paul-André, qui m'ont aidé à plusieurs reprises et m'ont fait profiter de leurs lumières sur les sujets sur lesquels je travaillais.

Ensuite, j'aimerais remercier les gens que j'ai connus avant ma thèse. Je pense d'abord aux personnes avec qui j'ai fait mes années d'études en informatique à l'ENS : Andreea, Antoine, Antonin, Baptiste, Christophe, Florent, Ken, Maxime, Thomas, Vincent, et les autres. Je garde un

bon souvenir des moments que l'on a passés ensemble, notamment les sorties au sushi du coin qui furent vraiment (trop) nombreuses, ainsi que les soirées en Info4 que l'on passait à finir des projets pour lesquels on était à la bourre. J'aimerais aussi remercier les gens du A6, avec qui j'ai vécu une belle expérience de vie en communauté durant l'année 2015-2016 : Axel, Benjamin, Charles, Chloé, Jean₁, Jean₂, Paul, Quentin, Romain, Salim. J'aimerais en particulier remercier Quentin pour avoir toujours su trouver le courage pour cuisiner pour l'été en dépit de l'apathie générale qu'il pouvait y avoir pour la préparation des repas du soir quelques fois. Nous ne te méritons pas, Quentin ! J'aimerais aussi remercier Salim de nous avoir invités à passer de très belles vacances au Maroc, malgré les différents problèmes d'intoxication alimentaire que nous avons pu y rencontrer. J'aimerais de plus remercier Jean₂ pour l'organisation des différentes après-midis ou soirées de l'été pour les diverses occasions qui se sont présentées dans l'année. Je le remercie d'avoir continué cet effort après la dissolution forcée du A6 en organisant les « séminaires de la tour Tokyo ». Merci aussi aux personnes extérieures mais assimilées au A6 avec qui j'ai pu partager des conversations amicales intéressantes : Anne, Julien, Pierre « W. », Vèrène, et les autres.

J'aimerais aussi remercier les gens du Chœur PSL, avec qui j'ai vécu des moments musicaux mémorables : Anne, Armine, Arthur₁, Arthur₂, Avril, Florence, Gabriel, Julia, Marie, Mathieu, Mathilde, Philomène, Pierre, et les autres. Je pense notamment au concert où nous avons chanté la *Passion selon Saint-Jean* de Bach, à celui où nous avons chanté le *Requiem* de Brahms, ainsi que les tournées en Bretagne et à Londres. J'espère pouvoir revivre des expériences musicales aussi intenses un jour mais cela risque d'être difficile. Je souhaite bien sûr remercier Johan, le chef d'orchestre, pour nous avoir fait découvrir tous ces beaux morceaux.

La famille maintenant. J'aimerais d'abord remercier ma mère pour son soutien indéfectible durant cette période, malgré les soucis beaucoup plus graves qui l'affligeaient par ailleurs. J'aimerais aussi remercier ma sœur, qui a aussi toujours été présente pour moi et avec qui j'ai pu trouver des moments pour me détendre à Paris à l'occasion de séances de cinéma ou de dégustation de pâtisseries dans des salons de thé. Merci aussi au reste de ma famille pour les différents moments qu'on a passés ensemble durant ces dernières années : Jean-Luc, Bernard et Angelica, Stéphane, Jérôme et Barbara et la famille de Nice.

Pour terminer, j'aimerais remercier quelques inclassables : Charlène, pour toutes les fois où l'on s'est marré depuis le lycée ; Vincent, pour avoir été un colocataire décent et m'avoir dépanné plusieurs fois en \LaTeX ; Philippe Malbos, pour son aide dans ma recherche infructueuse de post-doc à Lyon ; Spacemacs, pour avoir rendu techniquement possible d'écrire ce manuscrit en quelques mois ; Philipp H. Poll, pour avoir conçu et mis à disposition sous licence publique la police Linux Libertine qu'utilise ce document ; et enfin, SRAS-CoV-2/COVID-19 pour m'avoir fourni des conditions optimales pour la rédaction de ce manuscrit, sans distractions extérieures possibles, et donné l'occasion de passer de longues semaines en famille à la campagne.

Notations

In this thesis, we use the following notations:

- ω denotes the smallest infinite ordinal,
- \mathbb{N} denotes the set of natural integers and \mathbb{N}^* denotes the set $\mathbb{N} \setminus \{0\}$,
- given $n \in \mathbb{N}$, \mathbb{N}_n denotes the set $\{0, \dots, n\}$ and \mathbb{N}_n^* denotes the set $\{1, \dots, n\}$,
- we extend the previous notation to infinity by putting $\mathbb{N}_\omega = \mathbb{N}$ and $\mathbb{N}_\omega^* = \mathbb{N}^*$,
- in accordance with the above notations, given $n \in \mathbb{N} \cup \{\omega\}$, we often write $\mathbb{N}_n \cup \{n\}$ to denote either \mathbb{N}_n when $n \in \mathbb{N}$, or $\mathbb{N} \cup \{\omega\}$ when $n = \omega$,
- given a product $\prod_{i \in I} X_i$ of objects X_i of some category indexed by the elements of a set I , we write $\pi_j: \prod_{i \in I} X_i \rightarrow X_j$ for the projection on the j -component for $j \in I$,
- given a coproduct $\coprod_{i \in I} X_i$ of objects X_i of some category indexed by the elements of a set I , we write $\iota_j: \coprod_{i \in I} X_i \rightarrow X_j$ for the coprojection on the j -component for $j \in I$.

Introduction

The sophistication of modern mathematics incites to take into account not only the mathematical objects at stake, but also the way they interact, the interaction between those interactions, and so on. We have entered a higher-dimensional approach to the mathematical world. The algebraic structures involved in such studies, called *higher categories*, are becoming more and more complex and computationally involved. The aim of this PhD thesis is to introduce several computational tools to assist with the manipulation of some of these higher categories.

We shall first give some general background about this work before introducing the topics of this thesis in more details.

General background

Higher categories. The beginnings of category theory can be traced back to the 1940s, with the work of Eilenberg and MacLane in algebraic topology, when they investigated the notion of natural transformation [EM42; EM45]. A category is a simple structure: objects (or 0-cells) and arrows (or 1-cells) between them that can be composed associatively by a binary operation, together with an identity arrow for each object. Yet, its generality allowed it to become an important abstraction tool in modern mathematics, physics and computer science, for considering algebraic structures equipped with some notion of composition [BS10].

Even though the scope of categories is broad, there are some situations where they fail to apply. One kind of such situations is when there is additional structure, such as other composition operations, that does not fit in the structure of a category. This is the case when describing categories themselves: categories and functors form a category, but this description does not encompass the natural transformations between functors and the associated composition operations (the one with between functors and natural transformations, and the one between natural transformations). Another kind of situations is when the unitality and associativity properties of the composition operation of categories are too strong. For example, when considering the paths on some topological space X , two paths can be composed by concatenation, but this operation is then neither unital nor associative. Of course, one can instead consider the paths *up to homotopy*, for which the above composition operation is unital and associative, and obtain the category of paths up to homotopy of X , called the fundamental groupoid of X . But one might still be interested in representing the structure of these homotopies, for which categories are not expressive enough, so that we fall back into the first situation.

A better treatment of the two above situations can be obtained by considering generalizations of the notion of category that have higher cells, *i.e.*, $(i+1)$ -cells between i -cells for $i \geq 1$, and several composition operations for the different cells that can satisfy multiple axioms. We call *higher category* an instance of this informal class of structures, and call *n-category* a higher category that has cells up to dimension n . The two above situations can then be properly represented by considering the adequate notion of higher category. For instance, the categories, functors, natural transformations and the different compositions between them fit in a *strict 2-category*, which is a 2-category with unital and associative compositions of the 1- and 2-cells, first introduced by Ehresmann [Ehr65]; the paths on the space X and their homotopies fit in a *bicategory*, which is 2-category whose composition of 1-cells is associative up to a 2-cell, introduced by Bénabou [Bén67].

By definition, there is an infinity of notions of higher categories. Indeed, the different notions can differ with regard to the maximal dimension of cells which are handled, the shape of the cells (globular, cubical, simplicial, *etc.*), the operations allowed on these cells, and the axioms satisfied by these operations. Each notion of higher category is usually informally situated in the strict-weak spectrum: the higher categories whose axiomatic consists of equalities between composites of cells are called *strict*, whereas the ones whose axiomatic consists of the existence of *coherence cells* between two composites of cells are called *weak*. For example, categories and strict 2-categories require that the composition of 1-cells be strictly associative, and thus lie on the ‘strict’ side of the strict-weak spectrum, whereas bicategories require the mere existence of invertible 2-cells between 1-cells composed using different parenthesizing schemes (*e.g.*, there exists a coherence 2-cell between $(u *_0 v) *_0 w$ and $u *_0 (v *_0 w)$ for composable 1-cells u, v, w), and thus lie on the ‘weak’ side of the strict-weak spectrum. Strict higher categories have usually simpler definitions and are easier to work with, but, as suggested above, they are not adequate for encoding homotopical information, and one usually turns to weak higher categories for such matters. The downside is that the axiomatics of weak higher categories are usually technically quite involved, the situation becoming worse and worse as the dimension of the considered categories increases because of the multiple coherence cells between the composition operations [GPS95]. Indeed, in addition to the already evoked coherence cells for associativity, particular definitions of weak categories can also involve coherence cells for identities, that witness that identities are weakly unital, and exchange coherence cell, that witness that two parallel cells that appear one after the other in some cell can be exchanged, and many more. All these coherence cells should moreover satisfy several compatibility conditions which are difficult to list exhaustively.

In between those two ends of the spectrum, there is the so-called *semi-strict* definitions of higher categories, which involve a balanced mixture of strict equations and coherence cells, so that such higher categories are expressive enough for encoding homotopical information, while keeping the complexity of the axiomatic at bay. Notably, in dimension 3, a fundamental result of Gordon, Power and Street [GPS95] is that *tricatogories*, the 3-dimensional analogues of bicategories, are equivalent (for the right notion of equivalence) to semi-strict 3-categories called *Gray categories*. The latter are ‘strict’ in every respect except for the exchange of 2-cells. Other interesting semi-strict 3-categories are the ones that we call *Kock categories*, which were shown to correctly model 3-dimensional homotopical properties [JK06]. Those are ‘strict’ in every respect except that identities are only weakly unital. See Figure 1 for a comparison of the axiomatics of the 3-dimensional categories introduced so far. Similar semi-strict definitions are still looked for in higher dimensions, even though some propositions were made [BV17].

The case for strict categories. Even though strict categories do not represent as well homotopical properties as weak categories, there are still interesting objects that are worth studying. First, they have already found several applications. As remarked by Burroni [Bur93], strict 3-categories

3-categories	unitality	associativity	exchange
strict categories	equality	equality	equality
Gray categories	equality	equality	coherence cell
Kock categories	coherence cell	equality	equality
weak categories	coherence cell	coherence cell	coherence cell

Figure 1 – Strict-weak characteristics of some 3-dimensional categories

can be used as a framework which generalizes classical term rewriting systems, and this fact motivated the interpretation of n -categories for $n \geq 4$ as “higher rewriting systems”. This idea led to several developments and applications [Laf03; Mim14; CM17]. In a related manner, strict categories found some applications in the study of homological properties of monoids, mainly in the work of Guiraud and Malbos [GMM13; GGM15; GM18]. Moreover, strict categories play a role in the definition of other (possibly weak) higher categories. For example, Gray categories can be defined from the *Gray tensor product*, which is a construction on strict 2-categories. Another example is the notion of *globular operad*, developed by Batanin and Leinster [Bat98b; Lei98], which is a device based on strict categories that allows defining other higher categories. In particular, weak categories admit an elegant definition in this setting [Lei04]. In a related manner, Henry was able to define semi-strict higher categories which exhibit the same good homotopical properties of weak categories using several constructions on strict categories [Hen18]. Finally, as suggested by Ara and Maltsiniotis [AM18], since weak categories are quite complicated objects which are hard to manipulate, the study of properties and constructions on strict categories, as a simpler case, seems a necessary step before considering the general case of weak categories.

In addition to the above motivations and applications, strict categories exhibit some nice properties which make them more pleasant to work with than other higher categories. In particular, they possess a graphical language which enables to easily consider cells that are composites of other cells. Indeed, whereas one introduces such composites in a general higher-dimensional category by expressions which precisely state how some given cells are composed, it is often enough, in strict categories, to simply *draw* these cells. For example, in usual categories, *i.e.*, strict 1-categories, a diagram like

$$x_0 \xrightarrow{f_1} x_1 \xrightarrow{f_2} \dots \xrightarrow{f_{n-1}} x_{n-1} \xrightarrow{f_n} x_n \tag{1}$$

which represents a sequence of 1-cells f_1, \dots, f_n of some category C unambiguously defines “the” composite of f_1, \dots, f_n . This is simply a consequence of the fact that the composition of 1-cells is associative, so that all the expressions one can think of to compose the f_i ’s together are equivalent. This property, which is rather trivial for 1-categories, generalizes to higher dimensions, so that, for example, a diagram like

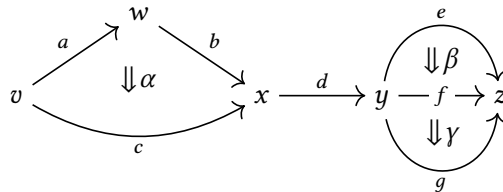

can be used to define unambiguously a 2-cell in some strict 2-category, thus without the need for an explicit expression which states precisely how to compose the generators of the diagram together. Such diagrams are called *pasting diagrams*, since they express how a given set of cells of

a strict category are “pasted” together. They first appeared for strict 2-categories in the work of Bénabou [Bén67]. The use of such pasting diagrams facilitate the manipulation of strict categories and is widespread in the literature about these categories.

Computability. The notion of computation appeared long before the first modern computers. Written calculation procedures were identified on Babylonian clay tablets [Knu72] (*circa* 1600 B.C.) and some well-known arithmetical algorithms still used today were invented in ancient Greece, like Euclid’s algorithm and the sieve of Eratosthenes (*circa* 300 B.C.). But it was only in the 20th century that the notions of computation and computability were seriously formalized. In 1923, Skolem first defined a class of functions that can be computed by finite procedures [Sko23], now known as *primitive recursive functions*. Later, Gödel gave a more general class of computable functions [Göd34], now known as *recursive functions*. Other models of computation were proposed at the time, like Church’s *lambda calculus* [Chu36] and *Turing machines* [Tur36], that in fact turned out to be equivalent to recursive functions. This led to the introduction of the *Church-Turing thesis*, which asserts that any “computable procedure” can be expressed in one of these models.

The latter were introduced in order to provide answers to foundational problems of mathematics raised by Hilbert and others at the time. On the one hand, Hilbert’s *second problem* asked whether the axiomatic of arithmetics could be shown consistent, considering the advances in the logical aspects of mathematics at the time. Using his formalism of primitive recursive functions, Gödel provided a negative answer to this question, in the form of his famous *incompleteness theorem*. On the other hand, Hilbert and Ackermann’s *Entscheidungsproblem* (“decision problem”) asked whether there existed a general computable procedure that would decide whether a given mathematical statement is true or false. Church and Turing gave two different negative answers to this question, by showing more generally the existence of *undecidable problems*, *i.e.*, problems that can not be solved by computable procedures. In particular, Turing showed that the *halting problem*, *i.e.*, the problem that consists in deciding whether a given Turing machine stops after a finite number of steps, was undecidable.

Since then, a lot of other undecidable problems were discovered. The proof of undecidability of a given problem usually relies on reducing the halting problem or some other known undecidable problem to it. A common source for undecidable problems are the *word problems* associated with *presentations*. Recall that mathematical objects are often defined by means of presentations, *i.e.*, as sets of generators that can be combined into terms, or *words*, such that the evaluation of these terms satisfy several equations. In particular, monoids can be defined by presentations, where the words that appear in the equations are simply sequences of generators. For example, the monoid $(\mathbb{N}^2, (0, 0), +)$ can be presented as the monoid induced by two generators a and b satisfying the equation $ab = ba$. Instances other algebraic theories (groups, rings, *etc.*) can be presented by a similar fashion. In fact, theories themselves are usually defined by means of presentations. The words in this case are finite trees which represent expressions that can be written in the considered theory. For example, the theory of monoids can be presented as the theory of structures consisting in a unit e and a binary operation \bullet such that the equations

$$e \bullet x = x \quad x \bullet e = x \quad (x \bullet y) \bullet z = x \bullet (y \bullet z)$$

are satisfied for all elements x, y, z of the structure. Other algebraic theories can be presented in a similar fashion. Given any kind of presentation, the word problem consists in deciding whether two given words are equal with regard to the equations of the presentation. Before the appearance of recursive functions and the other computation models, it was already asked whether there existed a procedure to decide the word problem for presentations of groups by Dehn [Deh11], and for presentation of monoids by Thue [Thu14]. It was shown not to be the case, since there

are examples of presentations with undecidable word problems: this was shown by Post [Pos47] and Markov [Mar47] for monoids, and by Novikov [Nov55] for groups.

Rewriting. Even though there is no general procedure to solve the word problem for all presentations of monoids, groups, theories, *etc.* solutions might exist for some presentations. In particular, one can derive a solution to the word problem when the considered presentation is associated with a *rewriting system* with good properties. Formally, one obtains a rewriting system from a presentation by simply orienting the equations of the presentation. Such orientations should be thought as defining a set of allowed moves, or *rewrite rules*, from a word to another. In order for the rewriting system to exhibit good properties, the orientations of the equations should be chosen so that the word obtained after applying a rewrite rule is simpler than the word one started from. The definition of “simpler” here is relative to each situation. It can mean for example “being smaller” or “being better bracketed” (on the left or on the right, depending on convention). By combining all the rewrite rules, one then obtains a *rewrite relation* on the words. For example, one can orient the equations of the theory of monoids as follows:

$$e \bullet x \Rightarrow x \quad x \bullet e \Rightarrow x \quad (x \bullet y) \bullet z \Rightarrow x \bullet (y \bullet z).$$

The above rewrite rules induce a rewrite relation \Rightarrow for which we have the rewrite sequence

$$(x \bullet (y \bullet e)) \bullet (z \bullet e) \Rightarrow (x \bullet y) \bullet (z \bullet e) \Rightarrow (x \bullet y) \bullet z \Rightarrow x \bullet (y \bullet z)$$

where the final word is simpler than the one we started from.

Once a rewriting system is introduced for a presentation, one can try a *normal form strategy* to solve the word problem: given two words that are to be compared, we reduce both words with the rewrite relation until they can not be reduced further, and then compare the resulting *normal forms*. For this strategy to work, several additional conditions should be satisfied. First, the rewriting system should have a finite number of rewrite rules, so that we are able to detect when we have found a normal form. Moreover, the rewrite relation \Rightarrow should be *terminating*, *i.e.*, it should not allow infinite rewrite sequences. Finally, the relation \Rightarrow should satisfy a property of *confluence*, which states that all the different possible rewrite sequences starting from a given word lead to the same normal form. When these conditions are satisfied, the normal form strategy provides a computational procedure which solves the word problem.

The aim of rewriting theory is, among others, to provide generic criteria for showing several properties of rewrite relations, including termination and confluence, even though such properties are undecidable in general [Ter03]. In particular, as a consequence of two classical results, namely *Newman’s lemma* and the *critical pair lemma*, the confluence of a terminating rewrite relation reduces to the confluence of rewrite sequences associated to the *critical branchings* of the rewriting system: those are pairs of the generating rewrite rules that are minimally overlapping. The confluence of the theory of monoids can be deduced this way, since the associated rewrite relation can be shown terminating, and since moreover each of its critical branching can be shown confluent. For example, this theory admits the critical branching

$$(w \bullet (x \bullet y)) \bullet z \Leftarrow ((w \bullet x) \bullet y) \bullet z \Rightarrow (w \bullet x) \bullet (y \bullet z)$$

and this branching is witnessed confluent by the diagram

$$\begin{array}{ccccc}
 & & & (w \bullet x) \bullet (y \bullet z) & & \\
 & & & \nearrow & & \\
 ((w \bullet x) \bullet y) \bullet z & & & & & w \bullet (x \bullet (y \bullet z)) \\
 & \searrow & & & \nearrow & \\
 & & (w \bullet (x \bullet y)) \bullet z & \xrightarrow{\quad} & w \bullet ((x \bullet y) \bullet z) & . \quad (2)
 \end{array}$$

The use of confluent and terminating rewriting systems for providing a decidable solution to the word problem naturally led to the question, initially raised by Jantzen [Jan84], of whether any monoid with decidable word problem can be presented by a finite terminating confluent rewriting system, so that the normal form strategy apply. This question was answered by Squier [Squ87]. He showed that monoids which can be presented with finite terminating confluent rewriting systems satisfy a finiteness homological property which does not depend on the presentation. He then gave an example of a monoid which has a decidable word problem but does not satisfy this homological condition, answering negatively Jantzen's question. The work of Squier on this problem had deep consequences, since it establishes a link between presentations and homological invariants of monoids. In fact, this connection extends to homotopical invariants of monoids, as was shown in a posthumous article [SOK94]. The latter result formalizes the idea that confluence diagrams of critical branchings like (2) are the elementary "holes" of a space associated to a presented monoid.

Coherence. In mathematics, coherence properties are an informal class of results which can appear in various contexts and take different forms. Maybe one of the first coherence result is the coherence of an associative binary operation [Bou07, Théorème 1]. This result states that, given a binary operation \bullet on a set which satisfies that $(x \bullet y) \bullet z = x \bullet (y \bullet z)$, one does not need to parenthesize an expression $x_1 \bullet \cdots \bullet x_n$ since all parenthesizing schemes induce the same result. This is a fundamental fact about associative operations that is used daily by most mathematicians. More generally, coherence properties assert that the choices we can have in using the operations of some structure do not matter in the end, since all possible choices lead to the same result.

Coherence results are particularly present in (higher) category theory. They usually appear when considering weakened versions of algebraic structures expressed in some category. Such weakened versions are obtained by replacing the equalities of the algebraic theories by isomorphisms. A classical example is monoidal categories, which are weakened monoids, or *pseudomonoids*, expressed in the category of categories. The "associativity" here takes the form of isomorphisms

$$(X \otimes Y) \otimes Z \rightarrow X \otimes (Y \otimes Z)$$

which allow to change the bracketing. Given a sequence of objects X_1, \dots, X_n , there are then different possible ways one can use the above associativity morphisms to relate the left and right bracketings

$$((\cdots (X_1 \otimes X_2) \otimes \cdots) \otimes X_{n-1}) \otimes X_n \quad X_1 \otimes (X_2 \otimes (\cdots \otimes (X_{n-1} \otimes X_n) \cdots)).$$

MacLane's coherence theorem for monoidal categories [Mac63] asserts that all the different isomorphisms one can build between the two above objects using the associativity isomorphisms are equal. The proof of this fact reduces to the commutation of the pentagon diagrams

$$\begin{array}{ccc}
 & & (W \otimes X) \otimes (Y \otimes Z) & & \\
 & & \nearrow & & \searrow \\
 ((W \otimes X) \otimes Y) \otimes Z & & & & W \otimes (X \otimes (Y \otimes Z)) \\
 & \searrow & & & \nearrow \\
 (W \otimes (X \otimes Y)) \otimes Z & \longrightarrow & & & W \otimes ((X \otimes Y) \otimes Z)
 \end{array} \quad (3)$$

which is required by the definition of monoidal categories. Several coherence results were proved for other weak structures: symmetric monoidal categories [Mac63], braided monoidal categories [JS93], Frobenius pseudomonoids [DV16], *etc.* Like MacLane's theorem, these coherence properties are the consequence of the commutation of a finite number of classes of diagrams, that we call *coherence tiles*, which are required by the definitions of the structures. In fact, the

coherence tiles of the definitions of these structures are chosen *so that* the coherence properties hold.

Coherence properties are particularly interesting in higher category theory, since they often imply strictification results, which state that the considered weak structures are equivalent to stricter ones (for a case-dependent notion of “equivalent”). Such results are useful since they allow replacing weak structures by stricter ones, the latter being simpler in practice. For example, from the coherence property for monoidal categories, one can deduce that monoidal categories are equivalent to stricter versions where the associativity isomorphisms are identities [Mac13]. Similarly, one can derive the equivalence between bicategories and strict 2-categories [MP85; Lei04], and the equivalence between tricategories and Gray categories [GPS95] from coherence results. This justifies that we are mainly interested in finding *coherent definitions* of weak structures, *i.e.*, definitions for which the coherence properties hold.

Topics of this thesis

Higher categories as globular algebras. As we have seen, there are various ways of axiomatizing the notion of higher category. In order to unify several shared constructions among the different theories, it is necessary to set some common ground. Here, we mostly focus on the approach laid out by Batanin [Bat98a], in which a particular theory of globular higher categories is encoded as an algebraic theory on globular sets. More precisely, a theory of n -categories is described there as a monad on the category of n -globular sets, and the category of n -categories that are instances of this theory is then simply the Eilenberg-Moore category on this monad. Sadly, this definition does not exhaust the concept of higher category since, in particular, there are definitions of higher categories that are not algebraic [Lei04; Gur06]. Still, this perspective encompasses a lot of higher categories that are frequently encountered. In particular, theories of globular higher categories with equational definitions, like strict n -categories, fit in this description.

The formalism of Batanin is interesting for us since it allows defining for all globular algebraic theory of higher categories the notion of *polygraph*. An n -polygraph is a system of generating i -cells, also called *i -generators*, for $i \in \mathbb{N}_k$ from which a free n -category can be constructed. Such structure allows extending to higher categories the classical notion of presentation by generators and relations. In particular, it enables to encode higher categories with possibly infinitely many cells as finite data, which can then be given as input to a program. Before their general definitions for all globular algebraic higher categories given by Batanin [Bat98a], polygraphs were first introduced by Street [Str76] for strict 2-categories under the name *computad*, and then extended to arbitrary dimension by Power [Pow91]. The definition (for strict categories) was later rediscovered by Burroni [Bur93], who introduced the name *polygraph*.

The article of Batanin is mainly concerned with the generalization of polygraphs to other globular categories and does not say much more about other constructions that can be done in the setting he introduced. In particular, even though it is noted that a notion of n -category (*i.e.*, a monad on n -globular sets) automatically induces notions of $0, \dots, (n-1)$ -categories, no functors relating the different dimensions is introduced. Moreover, since the definition of polygraph of Batanin is rather direct, it does not involve a structure, that we call *cellular extension*, which appears in the definition of polygraphs of strict categories of Burroni. This structure encodes a strict n -category equipped with a set of $(n+1)$ -generators from which one can consider the strict $(n+1)$ -category obtained by freely extending the n -category with the $(n+1)$ -generators.

Another concern about the setting of Batanin is that it relies on the monad on globular sets associated to a given notion of higher category in order to define the structure of polygraph. However, a notion of higher categories is rarely introduced by a monad. Instead, it is usually

presented, like other algebraic theories, as a structure with operations satisfying several equations. Even though the task of describing the associated monad is not conceptually difficult, it is still tedious and one usually prefers avoiding it. But some properties introduced by Batanin often require verifying that the considered monad is *truncable*, *i.e.*, exhibits some compatibility with the truncation operations on globular sets, so that it seems difficult to escape an explicit description of the monad at first glance. These technicalities likely hinder a wider use of the general results that can be formulated in the setting of Batanin.

Word problem. Like usual free algebraic objects, the cells of the n -category freely generated on an n -polygraph can be described by words which combine the generators of the polygraphs with the operations the considered theory of n -category. Since these operations can be required to satisfy several axioms, there are usually several words that can represent the same cell. The *word problem on polygraphs of higher categories* consists in deciding whether two words represent the same cell. Solving this problem is important for providing efficient computational descriptions and helping with the study of higher categories.

Given the role that strict categories play in higher categories, finding an efficient and usable solution to the word problem on (polygraphs of) strict categories is particularly important. In this context, it seems that the usual normal form strategy can not be applied, since there is no known orientation of the axioms of strict categories that would induce a confluent and terminating rewriting system. In [Mak05], Makkai gave a solution to this problem. He showed that, even though there is no known unique normal form for the words, they still admit canonical forms. Moreover, the canonical forms of two equivalent words can be related by a sequence of moves, and these canonical forms can be enumerated by a terminating procedure. This solves the word problem, since two words are equivalent if and only if they have canonical forms which can be related by a sequence of moves. However, the resulting procedure is computationally expensive and quickly overwhelmed by rather simple instances (Makkai deemed himself its procedure as “infeasible”), which prevents its use on concrete instances.

The work of Makkai revealed that the canonical forms for the cells exist for a more primitive structure than the one of strict n -category, that we call *n -precategory*: the latter are a variant of strict categories that do not satisfy the exchange identity of strict categories (*c.f.* Figure 1). The word problem on polygraphs of precategories then admits a simple solution: two words are equivalent if they have the same unique canonical form. These good computational properties motivate searching for other situations in which n -precategories can be used. Interestingly, they are already the underlying structure of Globular, a diagrammatic proof assistant for higher categories [BKV16; BV17].

The article of Makkai on the word problem [Mak05] introduced several notions and tools that are of more general interest to the study of strict categories. In particular, he introduced a “content function”, that we call *Makkai’s measure*, which assesses the complexity of the cells of strict categories freely generated on polygraphs. More precisely, this function gives some account on how many times each generator of the polygraph is used in the definition of a given cell. This function admits a simple inductive definition and moreover possesses several good properties. Makkai used it to show that his procedure which computes all the canonical forms of a given word terminates. His measure appears to have one shortcoming though: it counts multiple times low-dimensional generators. This defect raised the question, formulated by Makkai, of the existence of another measure that would not display this bad behavior. The existence of such a measure would be useful, since it could help to characterize a class of polygraphs called *computopes* by Makkai, and later studied by Henry [Hen17] under the name *polyplexes*, which seem to play an important role in the study of polygraphs. In particular, they were used to show that some subcategories of the category of polygraphs are presheaf categories or not [Mak05; Hen17].

Pasting diagrams. Even though the word problem for polygraphs of strict n -categories is decidable, using words to manipulate the cells of strict n -categories can be cumbersome in practice. As already mentioned, one can instead use pasting diagrams to describe cells of such categories. However, not all cells can be unambiguously described this way, since not all diagrams are pasting diagrams. A first issue is that some diagrams might be associated to several possible cells. For example, in dimension 1, given the diagram

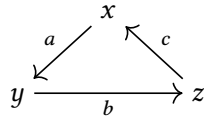

the “composite of a, b, c ” is not uniquely defined because of the loop. It could denote

$$\text{either } a *_0 (b *_0 c), \text{ or } (b *_0 c) *_0 a, \text{ or } (a *_0 b) *_0 (c *_0 a), \text{ etc.}$$

that are not the same cells. Another issue is that it might not be possible to compose the generators of a given diagram at all. For example, given the diagram

$$w \xrightarrow{a} x \qquad y \xrightarrow{b} z$$

the “composite of a and b ” does not make any sense. Still, the pasting diagrams are easily characterized in dimension 1: they are finite connected linear diagrams without loops like (1).

However, it is harder to characterize precisely what a 2-dimensional pasting diagram is and, more generally, what an n -dimensional pasting diagram is. We can only say that the latter is a diagram that satisfy conditions which ensure that the generators it is made of can be composed together in a unique way (up to the axioms of strict n -categories). As suggested by the 1-dimensional case, one can expect n -dimensional pasting diagrams to be finite set of generators that are at least “without loops” and “connected” (for the right generalizations of these notions). But these conditions can be shown insufficient already in dimension 2.

Several formalisms for pasting diagrams were introduced until now, which aim at helping identify pasting diagrams among general diagrams. The three most important of them are *parity complexes* [Str91], *pasting schemes* [Joh89], and *augmented directed complexes* [Ste04]. Each of these formalisms introduces a structure to represent general diagrams and provides a set of conditions under which a diagram is to be considered as a pasting diagram. Moreover, each formalism defines a structure of ω -category on the set of sub-pasting diagrams of a diagram, and proves that this ω -category is freely generated on the generators of the diagram, which formalizes the property that pasting diagrams describe cells of strict categories unambiguously. Even though the ideas underlying the definitions of these pasting diagram formalisms are quite similar, they differ on many subtle points and comparing them precisely is uneasy, and actually, to the best of our knowledge, no comparison of the formalisms was ever made.

Pasting diagrams appear as important tools in the study of strict n -categories and, indirectly, of other higher categories. First, they provide a simpler solution to the word problem on strict categories: two words are equal if their associated pasting diagrams (when they exist) are the same. They also allow defining ω -categories from structures that satisfy combinatorial properties. This way, Street [Str87; Str91] was able to define a higher-dimensional analogue of simplices, called orientals, from which he derived a nerve functor for strict ω -categories. Moreover, pasting diagrams are dense in strict ω -categories, so that the definitions of constructions on general strict ω -categories can often be reduced to their definitions on pasting diagrams. This way, Steiner [Ste04] sketched a simple definition of the Gray tensor product on ω -categories, which was later completed by Ara and Maltsiniotis [AM16]. In a related manner, Kapranov and Voevodsky, after extending the theory of pasting schemes [KV91b], attempted to give a description of weak ω -groupoids using pasting diagrams [KV91a], but their results were shown paradoxical [Sim98].

Coherence for Gray categories. In order to make a weakened definition of some algebraic structure expressed in a higher category coherent, one faces the problem of finding a correct set of coherence tiles. Recently, it was shown by Guiraud and Malbos [GM09] that, in the context of strict categories, these coherence tiles can be found using an extension of Squier theorems to “higher rewriting systems” on strict categories.

A higher rewriting system in their setting is simply a polygraph of strict categories. Indeed, it was noted by Burroni when he introduced his definition of polygraphs [Bur93] that polygraphs generalize the classical notion of rewriting system. For example, one can encode the earlier introduced rewriting system of the theory of monoids as the 3-polygraph with two 2-generators

$$\circlearrowleft \text{ and } \nabla$$

representing the generating operations of the theory of monoids, and three 3-generators

$$L: \circlearrowleft \Rightarrow | \quad R: \nabla \circlearrowleft \Rightarrow | \quad A: \nabla \nabla \Rightarrow \nabla \nabla$$

representing the rewrite rules of the rewriting system. This motivated the interpretation of polygraphs of higher dimensions as higher-dimensional rewriting systems, for which the classical results from rewriting theory, and even Squier theorems, can be adapted.

In particular, when searching for a coherent definition of a weakened algebraic theory expressed in strict categories, if this theory is presented by a finite, confluent and terminating higher rewriting system, one can choose the coherence tiles to be the confluence diagrams of the critical branchings of this rewriting system. For instance, Guiraud and Malbos showed that the coherence tiles of monoidal categories can be derived from the critical branchings of an associated rewriting system, as already suggested by the resemblance between (2) and (3). Even though several additional conditions need to be proved in each situation, like the termination and the confluence of the associated rewriting system, this still provides a generic method for finding coherent weakened definitions of algebraic structures expressed in strict categories.

Adaptations of this method would be useful in order to find coherent definitions in other higher categories, in particular weak categories. Since bicategories (*i.e.*, weak 2-categories) are equivalent to strict 2-categories, which are already handled by the framework of Guiraud and Malbos, tricategories are the first interesting case. But tricategories are complicated objects, for which the development of rewriting techniques might prove difficult. However, since tricategories are equivalent to the simpler Gray categories, it is enough to adapt the tools of Guiraud and Malbos for the latter. These tools could be used to recover existing coherent definitions of weak structures for Gray categories, like pseudomonoids or pseudoadjunctions [Lac00; Dos18] and find new ones.

In order to adapt these tools, the development of a rewriting framework for Gray categories is required. Since the latter have exchange coherence cells (*c.f.* Figure 1) that might interact with the operations of the studied weakened definitions, it is useful to consider a more primitive structure as the underlying rewriting setting. A good candidate are precategories, which we already mentioned earlier. Indeed, they admit a simple computational representation and their word problem is trivial. Moreover, they do not require the exchange identity of strict categories, which was shown problematic in the context of higher rewriting since it allows a finite rewriting system to have an infinite number of critical branchings [Laf03; Mim14], which prevents their exhaustive enumeration by a computer.

Outline of the thesis. The object of this thesis is the introduction of several computational tools for strict categories and Gray categories. It is organized around three main topics: the word problem for strict categories, the pasting diagram formalisms, and the coherence problem for Gray categories. The detailed structure of this manuscript follows.

In Chapter 1, we recall the formalization, given by Batanin [Bat98a], of higher categories as globular algebras, and derive several constructions and definitions, like the one of polygraph. Then, we introduce the equational definitions of the two theories of higher categories that will mainly concern us during this thesis: strict n -categories and n -precategories. In order to obtain all the properties and constructions given by the framework of Batanin, we will have to show that these theories are derived from monads on globular with sufficient properties. In order to avoid the tedious task of explicitly describing the monads of each theory, we introduce criteria on the categories of algebras to decide whether these algebras are derived from adequate monads on globular sets.

In Chapter 2, we revisit the solution to the word problem on strict n -categories given by Makkai in [Mak05]. For this purpose, we recall the definition of Makkai's measure for such polygraphs, by deriving it from another measure defined by Henry [Hen18]. Using an equivalent description of strict categories as precategories satisfying some exchange condition, we provide a syntactical description of the free n -categories which is amenable to computation. From this description, we derive a solution to the word problem which is a more efficient version of the one given by Makkai, and give an implementation for it. Finally, we answer the question raised by Makkai and show by the mean of a counter-example the nonexistence of a measure on polygraphs that does not double-count generators.

In Chapter 3, we study the pasting diagrams for strict categories and consider the three main existing formalisms for them, namely parity complexes, pasting schemes and augmented directed complexes. We show that the axiomatics of parity complexes and pasting schemes are flawed, in the sense that they do not guarantee that the cells of strict categories can be represented faithfully by the diagrams which these formalisms consider as pasting diagrams. This motivates the introduction of a new formalism, called *torsion-free complexes*, based on parity complexes, for which we give a detailed proof of correctness as a pasting diagram formalism. We illustrate the interest of this formalism by implementing a pasting diagram extension based on torsion-free complexes for the solver of the word problem whose implementation was introduced in the previous chapter. Finally, we prove that this new formalism generalizes augmented directed complexes and fixed versions of parity complexes and pasting schemes, in the sense that the class of pasting diagrams it accepts is larger than the classes accepted by those other formalisms.

In Chapter 4, we study the problem of coherence of several algebraic structures expressed in Gray categories. For this purpose, we define a higher rewriting framework based on precategories. First, we show how Gray categories can be presented by *prepolygraphs*, *i.e.*, polygraphs for precategories. Then, interpreting prepolygraphs as higher rewriting systems, we translate the classical results of rewriting theory, like Newman's lemma and the critical pair lemma to this prepolygraph setting. Next, adapting the results of Squier [SOK94], Guiraud and Malbos [GM09] to our context, we show that the coherence tiles for weakened definitions expressed in Gray categories can be chosen to be the confluence diagrams of the critical branchings of a confluent and terminating rewriting system. We finally illustrate the use of this result on several examples and give coherent weakened definitions of several algebraic structures expressed in Gray categories.

Higher categories

Introduction

The notion of “higher category” encompasses informally all the structures that have higher-dimensional cells which can be composed together with several operations. Such structures can differ on many points. First, there are several possible shapes for the cells of higher categories. For example, *globular higher categories* have 0-cells, 1-cells, 2-cells, 3-cells, *etc.* of the form

$$x, \quad x \xrightarrow{f} y, \quad \begin{array}{ccc} & f & \\ x & \Downarrow \phi & y \\ & g & \end{array}, \quad \begin{array}{ccc} & f & \\ x & \phi \Downarrow \cong \Downarrow \psi & y \\ & g & \end{array}, \quad \text{etc.}$$

But one can consider higher categories with other shapes than the globular ones. Common variants include *cubical* [ABS00] and *simplicial* [Joy02] higher categories, whose 2-cells for example are respectively of the form

$$\begin{array}{ccc} x & \xrightarrow{f} & y \\ g \downarrow & \Downarrow \phi & \downarrow h \\ x' & \xrightarrow{f'} & y' \end{array} \quad \text{and} \quad \begin{array}{ccc} & y & \\ f \nearrow & \Downarrow \phi & \searrow g \\ x & \xrightarrow{h} & z \end{array}.$$

Moreover, higher categories have several operations which satisfy axioms that can take different forms, according to their position in the strict/weak spectrum (*c.f.* the general introduction). For example, a *strict 2-category* is a globular 2-dimensional category that have, among others, an operation $*_0$ to compose 1-cells in dimension 0, as in

$$x \xrightarrow{f} y *_0 y \xrightarrow{g} z = x \xrightarrow{f*_0g} z,$$

and operations $*_0$ and $*_1$ to compose 2-cells in dimensions 0 and 1 respectively, as in

$$\begin{array}{ccc} \begin{array}{ccc} & f & \\ x & \Downarrow \phi & y \\ & g & \end{array} *_0 \begin{array}{ccc} & f' & \\ y & \Downarrow \phi' & z \\ & g' & \end{array} = \begin{array}{ccc} & f*_0f' & \\ x & \Downarrow \phi*_0\phi' & z \\ & g*_0g' & \end{array} \end{array}$$

and

$$\begin{array}{c}
 \begin{array}{ccc}
 & f & \\
 x & \curvearrowright & y \\
 & \Downarrow \phi & \\
 & \curvearrowleft & \\
 & g &
 \end{array}
 *_{1}
 \begin{array}{ccc}
 & g & \\
 x & \curvearrowright & y \\
 & \Downarrow \psi & \\
 & \curvearrowleft & \\
 & h &
 \end{array}
 =
 \begin{array}{ccc}
 & f & \\
 x & \curvearrowright & y \\
 & \Downarrow \phi *_{1} \psi & \\
 & \curvearrowleft & \\
 & h &
 \end{array}
 \end{array}$$

These operations are required to satisfy several axioms consisting in equalities, like the associativity axiom: given 0-composable 1- or 2-cells u, v, w ,

$$(u *_0 v) *_0 w = u *_0 (v *_0 w)$$

and, given 1-composable 2-cells ϕ, ψ, χ ,

$$(\phi *_1 \psi) *_1 \chi = \phi *_1 (\psi *_1 \chi).$$

An example of a weak higher category is given by a *bicategory*, which is a globular 2-dimensional category that has operations similar to a strict 2-category but which satisfy axioms in the form of “weak equalities”. For example, the 0-composition of 1-cells is only required to be weakly associative, in the sense that, given 0-composable 1-cells

$$w \xrightarrow{f} x \xrightarrow{g} y \xrightarrow{h} z,$$

the equality $(f *_0 g) *_0 h = f *_0 (g *_0 h)$ does not hold necessarily, but there should exist a *coherence cell* between the two sides, i.e., an invertible 2-cell $\alpha_{f,g,h}$ as in

$$\begin{array}{ccc}
 & (f *_0 g) *_0 h & \\
 w & \curvearrowright & z \\
 & \Downarrow \alpha_{f,g,h} & \\
 & \curvearrowleft & \\
 & f *_0 (g *_0 h) &
 \end{array}$$

Finally, a subtle difference between the different kinds higher categories is the *algebraicity* of their definition [Lei04; Gur13]. This notion essentially pertains to weak higher categories. Informally, a definition of some sort of higher categories is algebraic when it can be equivalently described by means of a monad. Concretely, algebraic definitions of weak higher categories involve coherence cells that are *distinguished* (like the definition of bicategories, which requires that “there exists an invertible 2-cell $\alpha_{f,g,h}$ between $(f *_0 g) *_0 h$ and $f *_0 (g *_0 h)$ ”), whereas non-algebraic definitions of weak higher categories involve coherence cells that are not (a non-algebraic definition of bicategories would only require that “there exists *some* invertible 2-cell between $(f *_0 g) *_0 h$ and $f *_0 (g *_0 h)$ ”).

In order to factor out several common constructions and properties across the different possible higher categories, it is useful to consider a restriction of this general notion to a more formal class of theories. This was done by Batanin [Bat98a], who introduced a unified formalism for algebraic globular higher categories. The latter are very common, since they include all the globular higher categories defined by a set of operations and equations between them. Moreover, the instances of such higher categories form *locally finitely presentable categories* and, as such, have very good properties, like being complete and cocomplete [AR94]. The setting of Batanin then enables to derive several common constructions for such higher categories. In particular, one can generalize to those the notion of *polygraph*, originally defined by Street [Str76] for strict 2-categories. However, the drawback of the Batanin’s setting is that one has to work with the monad associated to a given higher category theory. This can be problematic since concrete definitions of higher categories usually involve equations and existences of coherence cells (like for strict 2-categories and bicategories), from which the description of the associated monad is usually tedious [Pen99].

Outline. The object of this chapter is to recall and introduce several notions of higher categories that we will need in the following chapters. Even though we only consider strict and semi-strict higher categories in this work, we will use Batanin’s general formalism to derive several common constructions for them. This chapter is organized as follows. First, we recall the notion of locally finitely presentable category (Section 1.1), of which most of the structures we will consider are instances. Then, we recall the setting of Batanin of “higher categories as globular algebras”, *i.e.*, categories of algebras of a monad on globular sets (Section 1.2). In order to better relate this setting with classical equational definitions of higher categories, we introduce criteria to recognize whether some particular definition of higher categories fits in this setting (Theorem 1.2.3.20 and Theorem 1.2.4.11). Next, we introduce constructions of free higher categories that can be derived in the setting of Batanin (Section 1.3). In particular, we define the notion of polygraph for any algebraic globular higher category. Our definition is less direct than the one of Batanin since it uses the intermediate notion of *free extension*. We instantiate all these notions and constructions when defining *strict categories* and *precategories*, that are strict higher categories that will concern us in the next chapters (Section 1.4). Finally, we also mention enriched definitions for higher categories (Section 1.5), and prove an enriched definition for precategories (Theorem 1.5.3.1).

1.1 Finite presentability

Locally presentable categories are a standard tool for deriving elementary properties on categories of algebraic structures (monoids, groups, but also categories, 2-categories, *etc.*). They are those categories where every object is a directed colimit of “finitely presentable” objects, which are a generalization of the notions of finitely presentable monoids or groups. Knowing that some categories are locally finitely presentable category is helpful since those categories are complete, cocomplete and satisfy other nice properties. In this thesis, most of the categories we consider are locally presentable categories, which motivates recalling some of their properties. For a more complete presentation, we refer to the existing literature [GU06; AR94; Bor94b].

We first recall the definition of locally finitely presentable categories (Section 1.1.1) and then introduce *essentially algebraic theories*, which are a standard tool to show that some categories are locally finitely presentable (Section 1.1.2).

1.1.1 Presentability

In this section, we define the notion of locally finitely presentable category, after recalling directed colimits and presentable objects of categories.

1.1.1.1 – Directed colimits. A partial order (D, \leq) is *directed* when $D \neq \emptyset$ and for all $x, y \in D$, there exists $z \in D$ such that $x \leq z$ and $y \leq z$. A small category I is called *directed* when it is isomorphic to a directed partial order (D, \leq) .

Given a category $C \in \mathbf{CAT}$, a *diagram* in C is the data of a functor $d: I \rightarrow C$ where I is a small category. We say that it is a *directed diagram* when I is moreover directed. A *directed colimit* of C is a colimit cocone $(p_i: d(i) \rightarrow X)_{i \in I}$ on a directed diagram $d: I \rightarrow C$.

Example 1.1.1.2. A set is a directed colimit of its finite subsets. A monoid is a directed colimit of its finitely generated submonoids.

In \mathbf{Set} , we have the following characterization of directed colimits:

Proposition 1.1.1.3. *Let $d: I \rightarrow \mathbf{Set}$ be a directed diagram in \mathbf{Set} and $(p_i: d(i) \rightarrow C)_{i \in I}$ be a cocone on d . Then, $(p_i: d(i) \rightarrow C)_{i \in I}$ is a directed colimit on d if and only if*

- (i) for all $x \in C$, there is $i \in I$ and $x' \in d(i)$ such that $p_i(x') = x$,
- (ii) for all $i_1, i_2 \in I$, $x_1 \in d(i_1)$ and $x_2 \in d(i_2)$, if $p_{i_1}(x_1) = p_{i_2}(x_2)$, then there exists $i \in I$ such that $i_1 \rightarrow i \in I$, $i_2 \rightarrow i \in I$ and $d(i_1 \rightarrow i)(x_1) = d(i_2 \rightarrow i)(x_2)$.

Proof. See for example [Bor94a, Proposition 2.13.3]. □

1.1.1.4 – Finitely presentable objects. Let $C \in \mathbf{CAT}$. An object $P \in C$ is *finitely presentable* when its hom-functor

$$C(P, -): C \rightarrow \mathbf{Set}$$

commutes with directed colimits. By Proposition 1.1.1.3, it means that, given a directed colimit

$$(p_i: d(i) \rightarrow X)_{i \in I}$$

on a directed diagram $d: I \rightarrow C$, we have

- (i) for every $X \in C$ and $f: P \rightarrow X$, there is a *factorization of f through d* , i.e., there exists $i \in I$ and $g: P \rightarrow d(i)$ such that $f = p_i \circ g$;
- (ii) this factorization is *essentially unique*, i.e., if there exist others $i' \in I$ and $g': P \rightarrow d(i')$ such that $f = p_{i'} \circ g'$, then there exist $j \in I$, $h: i \rightarrow j \in I$ and $h': i' \rightarrow j \in I$ such that

$$d(h) \circ g = d(h') \circ g'.$$

Example 1.1.1.5. Given a set S , S is finitely presentable if and only if it is finite. See [AR94, Example 1.2(1)] for details.

Example 1.1.1.6. A monoid is *finitely presentable* when it admits a presentation consisting of a finite number of generators and equations. A similar description of finitely presentable objects holds for the other categories of algebraic structures (groups, rings, etc.). See [AR94, Theorem 3.12] for details.

1.1.1.7 – Locally finitely presentable categories. A locally small category $C \in \mathbf{CAT}$ is *locally finitely presentable* when

- (i) it has all small colimits,
- (ii) every object of C is a directed colimit of locally finitely presentable objects,
- (iii) the full subcategory of C whose objects are the finitely presentable objects is essentially small.

Example 1.1.1.8. The category \mathbf{Set} is locally finitely presentable. Indeed, it is cocomplete and every set is a directed colimit of its finite subsets, which are finitely presentable objects of \mathbf{Set} .

Example 1.1.1.9. The category \mathbf{Mon} of monoids is locally finitely presentable. More generally, the categories of algebraic structures (groups, rings, etc.) are locally finitely presentable. This is the consequence of the fact that such categories can be described by means of essentially algebraic theories, as we will see in the next section.

Identifying a category as locally finitely presentable enables to derive several elementary properties, like completeness:

Proposition 1.1.1.10. *A locally presentable category is complete.*

Proof. See [AR94, Corollary 1.28, Remark 1.56(1), Theorem 1.58] for details. \square

Moreover, showing that a functor between two locally finitely presentable categories is a left or right adjoint is easier than in the general case, since we do not need the existence of solution set like in Freyd's adjoint theorem ([Bor94a, Theorem 3.3.3]):

Proposition 1.1.1.11. *Given a functor $F: C \rightarrow \mathcal{D}$ between two locally presentable categories C and \mathcal{D} , the following hold:*

- (i) *F is left adjoint if and only if it preserves colimits,*
- (ii) *if F preserves limits and directed colimits, then it is right adjoint.*

Finally, there is a simple criterion for a category of algebras on a monad to be locally finitely presentable. We recall that a functor F is *finitary* when F preserves directed colimits, and a monad (T, η, μ) on a category C is *finitary* when T is finitary. We then have:

Proposition 1.1.1.12. *Given a locally finitely presentable category C and a finitary monad (T, η, μ) on C , the category of algebras C^T is locally finitely presentable. Moreover, the canonical forgetful functor $C^T \rightarrow C$ preserves directed colimits.*

Proof. The category C^T is finitely locally presentable by [AR94, Theorem 2.78 and the following remark]. Moreover, since T is finitary, the directed colimits of C^T are computed in C , so that the mentioned forgetful functor preserves directed colimits. \square

Example 1.1.1.13. The category **Mon** is equivalent to the category of algebras \mathbf{Set}^T where (T, η, μ) is the free monoid functor on **Set**. It can be shown that T is finitary, so that we obtain another proof that **Mon** is locally finitely presentable using Proposition 1.1.1.12.

1.1.2 Essentially algebraic theories

Verifying that some category is locally finitely presentable with the above definition can be tedious. A simpler way consists in describing it as the category of models of some *essentially algebraic theory*. The latter is similar to an algebraic theory (theory of monoids, theory of groups, *etc.*), except that operations with partial domains are allowed, as long as those domains are specified by equations. Another interesting property is that morphisms between such theories induce functors between the associated categories of model, and those functors are moreover right adjoints and preserve directed colimits. The main reference here is [AR94, Section 3.D].

1.1.2.1 – Definition. Given a set S , an *S -sorted signature* is the data of a set Σ of *symbols* such that each $\sigma \in \Sigma$ has an *arity* under the form of a finite sequence $(s_i)_{i \in \mathbb{N}_n^*}$ of elements of S for some $n \in \mathbb{N}$, and a *target* in the form of an element $s \in S$ and we write

$$\sigma: s_1 \times \cdots \times s_n \rightarrow s$$

such a symbol σ of Σ with such arity and target.

Let $(x_i)_{i \in \mathbb{N}}$ be a chosen sequence of distinct variable names. Given a set S , an *S -sorted context* is the data of a finite sequence $\Gamma = (s_i)_{i \in \mathbb{N}_n^*}$ of elements of S for some $n \in \mathbb{N}$. Under the context Γ , the variable x_i should be thought “of type s_i ” for $i \in \mathbb{N}_n$ so that we often write

$$x_1: s_1, \dots, x_n: s_n$$

for such a context Γ .

Given a set S and S -sorted signature Σ and context Γ , we define Σ -terms on Γ together with judgements $\Gamma \vdash t: s$ where t is a Σ -term and $s \in S$, inductively as follows:

- if $\Gamma = (s_i)_{i \in \mathbb{N}_n^*}$ for some $n \in \mathbb{N}$ and $s_1, \dots, s_n \in S$, then, for every $i \in \mathbb{N}_n^*$, $\Gamma \vdash x_i : s_i$,
- given $\sigma : s_1 \times \dots \times s_n \rightarrow s \in \Sigma$ and Σ -terms t_1, \dots, t_n such that $\Gamma \vdash t_i : s_i$ for $i \in \mathbb{N}_n^*$, then $\Gamma \vdash \sigma(t_1, \dots, t_n) : s$.

Note that s is uniquely determined by t in a judgement $\Gamma \vdash t : s$.

An *essentially algebraic theory* is a tuple

$$\mathbf{T} = (S, \Sigma, E, \Sigma_t, \text{Def})$$

where

- S is a set,
- Σ is an S -sorted signature,
- E is a set of triples (Γ, t_1, t_2) where Γ is an S -sorted context, and t_1, t_2 are Σ -terms on Γ such that there exists $s \in S$ so that $\Gamma \vdash t_i : s$ for $i \in \{1, 2\}$,
- Σ_t is a subset of Σ ,
- Def is a function which maps $\sigma : s_1 \times \dots \times s_n \rightarrow s \in \Sigma \setminus \Sigma_t$ to a set of pairs (t_1, t_2) of Σ_t -terms such that there exists $s \in S$ so that $(x_1 : s_1, \dots, x_n : s_n) \vdash t_i : s$ for $i \in \{1, 2\}$.

The set S represents the different *sorts* of the theory, the set Σ the different operations that appear in the theory, the set E the global equations satisfied by the theory, the set Σ_t the operations whose domains are total, and the function Def the equations that define the domains of the partial operations. Given such an essentially algebraic theory \mathbf{T} , a *model of \mathbf{T}* , or *\mathbf{T} -model*, is the data of

- for all $s \in S$, a set M_s ,
- for all $\sigma : s_1 \times \dots \times s_n \rightarrow s \in \Sigma_t$, a function

$$M_\sigma : M_{s_1} \times \dots \times M_{s_n} \rightarrow M_s,$$

- for all $\sigma : s_1 \times \dots \times s_n \rightarrow s \in \Sigma \setminus \Sigma_t$, a partial function

$$M_\sigma : M_{s_1} \times \dots \times M_{s_n} \rightarrow M_s,$$

such that

- for all $\sigma : s_1 \times \dots \times s_n \rightarrow s \in \Sigma \setminus \Sigma_t$, M_σ is defined at $\bar{y} = (y_1, \dots, y_n) \in M_{s_1} \times \dots \times M_{s_n}$ if and only if, for all $(t_1, t_2) \in \text{Def}(\sigma)$, we have $\llbracket t_1 \rrbracket_{\bar{y}} = \llbracket t_2 \rrbracket_{\bar{y}}$,
- for every triple $(\Gamma, t_1, t_2) \in E$ where $\Gamma = (s_i)_{i \in \mathbb{N}_n^*}$ for some $n \in \mathbb{N}$ and sorts $s_1, \dots, s_n \in S$, given a tuple $\bar{y} = (y_1, \dots, y_n) \in M_{s_1} \times \dots \times M_{s_n}$, if both $\llbracket t_1 \rrbracket_{\bar{y}}$ and $\llbracket t_2 \rrbracket_{\bar{y}}$ are defined, then $\llbracket t_1 \rrbracket_{\bar{y}} = \llbracket t_2 \rrbracket_{\bar{y}}$,

where, given an S -sorted context $\Gamma = (s_i)_{i \in \mathbb{N}_n^*}$, a sort $s \in S$, a Σ -term t such that $\Gamma \vdash t : s$, and a tuple $\bar{y} = (y_1, \dots, y_n) \in M_{s_1} \times \dots \times M_{s_n}$, the *evaluation of t at \bar{y}* , denoted $\llbracket t \rrbracket_{\bar{y}}$, is either undefined or an element of M_s , and is defined by induction on t by

- if $t = x_i$ for some $i \in \mathbb{N}_n^*$, then $\llbracket t \rrbracket_{\bar{y}}$ is defined and

$$\llbracket t \rrbracket_{\bar{y}} = y_i,$$

- if $t = \sigma(t_1, \dots, t_k)$ for some $k \in \mathbb{N}^*$ and Σ_t -terms t_1, \dots, t_k , then $\llbracket t \rrbracket_{\bar{y}}$ is defined if and only if $\llbracket t_1 \rrbracket_{\bar{y}}, \dots, \llbracket t_k \rrbracket_{\bar{y}}$ are defined and M_σ is defined at $\llbracket t_1 \rrbracket_{\bar{y}}, \dots, \llbracket t_k \rrbracket_{\bar{y}}$ and, in this case,

$$\llbracket t \rrbracket_{\bar{y}} = M_\sigma(\llbracket t_1 \rrbracket_{\bar{y}}, \dots, \llbracket t_k \rrbracket_{\bar{y}}).$$

Given two models M and M' of \mathbf{T} , a *morphism of \mathbf{T} -model* between M and M' is a family of functions $f = (f_s: M_s \rightarrow M'_s)_{s \in S}$ such that

- for all $\sigma: s_1 \times \dots \times s_n \rightarrow s \in \Sigma_t$, $f_s \circ M_\sigma = M'_\sigma \circ (f_{s_1} \times \dots \times f_{s_n})$,
- for all $\sigma: s_1 \times \dots \times s_n \rightarrow s \in \Sigma \setminus \Sigma_t$ and $\bar{y} = (y_1, \dots, y_n) \in M_{s_1} \times \dots \times M_{s_n}$ such that M_σ is defined on \bar{y} , $f_s \circ M_\sigma(\bar{y}) = M'_\sigma(f_{s_1}(y_1), \dots, f_{s_n}(y_n))$.

We then write $\text{Mod}(\mathbf{T})$ for the category of \mathbf{T} -models and their morphisms. We say that a (big) category $C \in \text{CAT}$ is *essentially algebraic* when it is equivalent to the category of models of some essentially algebraic theory.

Identifying a category as essentially algebraic enables to deduce that it is locally finitely presentable, since the two notions are the same:

Theorem 1.1.2.2. *Given a category $C \in \text{CAT}$, C is essentially algebraic if and only if it is locally finitely presentable.*

Proof. See the proof of [AR94, Theorem 3.36]. □

Example 1.1.2.3. The category **Set** is essentially algebraic since it is the category of models of the essentially algebraic theory $(\{s\}, \emptyset, \emptyset, \emptyset, \perp)$.

Example 1.1.2.4. The category **Mon** is essentially algebraic since it is the category of models of the essentially algebraic theory

$$\mathbf{T}^{\text{mon}} = (\{s\}, \{e: 1 \rightarrow s, m: s \times s \rightarrow s\}, E, \{e, m\}, \perp)$$

where E consists of three equations

- $m(e, x_1) = x_1$ in the context $(x_1: s)$,
- $m(x_1, e) = x_1$ in the context $(x_1: s)$,
- $m(m(x_1, x_2), x_3) = m(x_1, m(x_2, x_3))$ in the context $(x_1: s, x_2: s, x_3: s)$.

In particular, it gives a simple proof that **Mon** is locally finitely presentable.

Example 1.1.2.5. The category **Cat** of small categories is essentially algebraic since it is the category of models of the essentially algebraic theory $\mathbf{T}^{\text{cat}} = (S, \Sigma, E, \Sigma_t, \text{Def})$ defined as follows. The set S consists of two sorts c_0 and c_1 corresponding to 0-cells and 1-cells, and

$$\Sigma = \{\partial_0^-: c_1 \rightarrow c_0, \quad \partial_0^+: c_1 \rightarrow c_0, \quad \text{id}^1: c_0 \rightarrow c_1, \quad *: c_1 \times c_1 \rightarrow c_1\}.$$

Moreover, E consists of the equations

- $\partial_0^-(\text{id}^1(x_1)) = x_1$ and $\partial_0^+(\text{id}^1(x_1)) = x_1$ in the context $(x_1: c_0)$,

- $\partial_0^-(*(x_1, x_2)) = \partial_0^-(x_1)$ and $\partial_0^+(*(x_1, x_2)) = \partial_0^+(x_2)$ in the context $(x_1 : c_1, x_2 : c_1)$,
- $*(\text{id}^1(\partial_0^-(x_1)), x_1) = x_1$ and $*(x_1, \text{id}^1(\partial_0^+(x_1))) = x_1$ in the context $(x_1 : c_1)$,
- $*(*(x_1, x_2), x_3) = *(x_1, *(x_2, x_3))$ in the context $(x_1 : c_1, x_2 : c_1, x_3 : c_1)$.

Finally, $\Sigma_t = \{\partial_0^-, \partial_0^+, \text{id}^1\}$, and $\text{Def}(*)$ is the singleton set containing the equation $\partial_0^+(x_1) = \partial_0^-(x_2)$. This shows that \mathbf{Cat} is a locally finitely presentable category.

1.1.2.6 – Morphisms of theories. Given two essentially algebraic theories

$$\mathbf{T} = (S, \Sigma, E, \Sigma_t, \text{Def}) \quad \text{and} \quad \mathbf{T}' = (S', \Sigma', E', \Sigma'_t, \text{Def}')$$

a *morphism of essential algebraic theories* between \mathbf{T} and \mathbf{T}' is the data of

- a function $f: S \rightarrow S'$,
- a function $g: \Sigma \rightarrow \Sigma'$,

such that

- given $\sigma: s_1 \times \cdots \times s_n \rightarrow s \in \Sigma$, we have $g(\sigma): f(s_1) \times \cdots \times f(s_n) \rightarrow f(s) \in \Sigma'$,
- given $\sigma \in \Sigma$, $\sigma \in \Sigma_t$ if and only if $g(\sigma) \in \Sigma'_t$,
- given $(\Gamma, t_1, t_2) \in E$, we have $(f(\Gamma), g(t_1), g(t_2)) \in E'$,
- given $\sigma \in \Sigma \setminus \Sigma_t$ and two Σ_t -terms t_1 and t_2 , we have that $(t_1, t_2) \in \text{Def}(\sigma)$ if and only if $(g(t_1), g(t_2)) \in \text{Def}'(g(\sigma))$,

where, given $\Gamma = (s_i)_{i \in \mathbb{N}_n^*}$, we write $f(\Gamma)$ for $(f(s_i))_{i \in \mathbb{N}_n^*}$ and, given a Σ -term t , we write $g(t)$ for the Σ' -term defined by induction on t by

- for all variable x_i ,

$$g(x_i) = x_i,$$

- for all $\sigma: s_1 \times \cdots \times s_n \rightarrow s \in \Sigma$ and Σ -terms t_1, \dots, t_n ,

$$g(\sigma(t_1, \dots, t_n)) = g(\sigma)(g(t_1), \dots, g(t_n)).$$

Such a morphism $(f, g): \mathbf{T} \rightarrow \mathbf{T}'$ induces a functor

$$\text{Mod}((f, g)): \text{Mod}(\mathbf{T}') \rightarrow \text{Mod}(\mathbf{T})$$

which maps a model $M' \in \text{Mod}(\mathbf{T}')$ to a model $M \in \text{Mod}(\mathbf{T})$ defined by

- for all $s \in S$, $M_s = M'_{f(s)}$,
- for all $\sigma \in \Sigma$, $M_\sigma = M'_{g(\sigma)}$,

and which maps morphisms of models as expected. The functors induced this way by morphisms between theories have good properties:

Theorem 1.1.2.7. *Given a morphism $(f, g): \mathbf{T} \rightarrow \mathbf{T}'$ between two essentially algebraic theories \mathbf{T} and \mathbf{T}' , the functor $\text{Mod}((f, g))$ is a right adjoint which preserves directed colimits.*

Proof. The fact that it is a right adjoint is given by [PV07, Theorem 5.4]. Moreover, one easily verifies that the directed colimits are computed pointwise in both $\text{Mod}(\mathbf{T})$ and $\text{Mod}(\mathbf{T}')$, so that they are preserved by $\text{Mod}((f, g))$. \square

Remark 1.1.2.8. A more general definition of morphisms between essentially algebraic theories for which Theorem 1.1.2.7 holds can be defined. However, it would require the introduction of formal deduction systems, which would be quite long and technical. This would be in vain since our definition of morphisms is enough for our purposes.

Example 1.1.2.9. One can define the essentially algebraic theory \mathbf{T}^{grp} of groups from the one of monoids given in Example 1.1.2.4 by adding a symbol $i: s \rightarrow s$ representing a total function, and by adding the equations $m(i(x_1), x_1) = e$ and $m(x_1, i(x_1)) = e$ in the context $(x_1: s)$. The canonical embedding $\mathbf{T}^{\text{mon}} \rightarrow \mathbf{T}^{\text{grp}}$ induces a functor $\mathbf{Grp} \rightarrow \mathbf{Mon}$ between the categories of groups and monoids which is the expected forgetful functor. This functor is a right adjoint and preserves directed colimits by Theorem 1.1.2.7.

Example 1.1.2.10. The essentially algebraic theory

$$\mathbf{T}^{\text{gph}} = (\{c_0, c_1\}, \{d_0^-: c_1 \rightarrow c_0, d_0^+: c_1 \rightarrow c_0\}, \emptyset, \{d_0^-, d_0^+\}, \perp)$$

exhibits the category \mathbf{Gph} of graphs as an essentially algebraic category. Recalling from Example 1.1.2.5 the definition of \mathbf{T}^{cat} , the mappings $d_0^- \mapsto \partial_0^-$ and $d_0^+ \mapsto \partial_0^+$ define a morphism of essentially algebraic theories $\mathbf{T}^{\text{gph}} \rightarrow \mathbf{T}^{\text{cat}}$, which induces a functor $\mathbf{Cat} \rightarrow \mathbf{Gph}$ that is the expected forgetful functor. This functor is a right adjoint and preserves directed colimits by Theorem 1.1.2.7.

1.2 Higher categories as globular algebras

In this section, we recall and extend the setting for globular algebraic higher categories introduced by Batanin in [Bat98a]. In this setting, a particular theory of k -categories is a monad on the category of k -globular sets. Most globular higher categories that one usually encounters fit in this setting: strict k -categories, bicategories, precategories (defined later in this chapter), Gray categories, *etc.* From this unifying viewpoint, several notions and constructions can be defined once for all theories, like the notion of k -polygraph and the associated free k -category construction as we will see in the next section. Moreover, a notion of k -category defined in this setting canonically induces notions of 0-, ..., $(k-1)$ -categories with associated truncation and inclusion functors between the different dimensions. Among the broad class of theories of higher categories that are captured by this setting, one can distinguish the theories that are associated with a *truncable monad*. Such theories are better behaved in some aspects and more closely match the idea that one can have of higher categories. Indeed, the general setting of Batanin allows defining notions of higher categories with unusual operations. This can be problematic since these operations can induce too much interaction between cells of different dimensions, so that for example the construction of free instances can not be done dimensionwise. This motivates the consideration of truncable monads, that do not allow this kind of operations.

The setting of Batanin offers a nice abstraction of the different higher category theories. However, the textbook definitions of the different higher categories are generally not given by a monad. Instead, notions of k -categories are usually defined by sets of operations (identities, compositions) that satisfy several equations. Moreover, the definitions of several natural operations, like the truncation and inclusion functors, are usually additional boilerplate that is not explicitly derived from general constructions. It is quite simple to show that an equational definition of higher categories induces a monad, but to give an explicit description of this monad in order to apply the

general results and constructions of Batanin's setting can be quite tedious. Thus, there is a gap between Batanin's abstract viewpoint on higher categories and actual definitions, and it deserves to be filled.

The plan for this section is as follows. First, we recall the definitions of an algebra over a monad and the associated Eilenberg-Moore category, using some abstract reformulations for these objects coming from the formal theory of monads of Street [Str72] (Section 1.2.1). Then, we recall the definition of globular sets and some operations on these objects (Section 1.2.2). Next, we recall Batanin's setting of higher categories as globular algebras, *i.e.*, the Eilenberg-Moore categories derived from a monad on globular sets (Section 1.2.3). We show how a monad on k -globular set induces globular algebras from dimension 0 to k and define truncation and inclusion functors between the different dimensions. We moreover introduce a criterion that enables to relate actual definitions of higher categories to the ones obtained with this setting without having to explicitly describe the underlying monads (Theorem 1.2.3.20). Finally, we recall from [Bat98a] the notion of truncable monad and give several additional properties that they have over general monads on globular sets (Section 1.2.4). We moreover introduce a criterion to recognize that the underlying monads of globular algebras are truncable, without having to explicitly describe those monads (Theorem 1.2.4.11).

1.2.1 Algebras over a monad

In this section, we recall the definition of an algebra over a monad, together with the associated notion of Eilenberg-Moore category, taking the formal perspective introduced by Street [Str72]. We moreover recall the related notions of monadicity and of monad morphism.

1.2.1.1 – Algebras. Given a monad (T, η, μ) on a category \mathcal{C} , a T -algebra is the data of an object $X \in \mathcal{C}$ together with a morphism $h: TX \rightarrow X$ such that

$$h \circ \eta_X = \text{id}_X \quad \text{and} \quad h \circ \mu_X = h \circ T(h).$$

A *morphism* between two algebras (X, h) and (X', h') is the data of a morphism $f: X \rightarrow X'$ of \mathcal{C} satisfying

$$f \circ h = h' \circ T(f).$$

We write \mathcal{C}^T for the category of T -algebras, also called *Eilenberg-Moore category of T* . There is a canonical forgetful functor

$$\mathcal{U}^T: \mathcal{C}^T \rightarrow \mathcal{C}$$

which maps the T -algebra (X, h) to X . This functor has a canonical left adjoint

$$\mathcal{F}^T: \mathcal{C} \rightarrow \mathcal{C}^T$$

which maps $X \in \mathcal{C}$ to the T -algebra (TX, μ_X) , such that the unit of $\mathcal{F}^T \dashv \mathcal{U}^T$ is η , and the associated counit, denoted ϵ^T , is such that $\epsilon_{(X, h)}^T = h$ for a given T -algebra (X, h) . The monad induced by $\mathcal{F}^T \dashv \mathcal{U}^T$ is then exactly (T, η, μ) .

In order to study functors of the form $\mathcal{D} \rightarrow \mathcal{C}^T$, it is useful to introduce an abstract characterization for such functors, which is a specialization in CAT of the general description of Eilenberg-Moore objects given by Street in his formal theory of monads [Str72]. To give some intuition, note that T -algebra can be equivalently described as a functor $F: 1 \rightarrow \mathcal{C}$ together with a natural transformation $\alpha: TF \Rightarrow F$ such that

$$\alpha \circ (\eta F) = \text{id}_F \quad \text{and} \quad \alpha \circ (\mu F) = \alpha \circ (T\alpha)$$

This correspondence extends to more general functors to \mathcal{C}^T in the form of the following property, that can be derived from [Str72, Theorem 1]:

Theorem 1.2.1.2. *Given a category \mathcal{D} , the operation which maps a functor $G: \mathcal{D} \rightarrow C^T$ to the pairs $(\mathcal{U}^T G, \mathcal{U}^T \epsilon^T G)$ induces a natural bijective correspondence between the functors $\mathcal{D} \rightarrow C^T$ and the pairs (F, α) where $F: \mathcal{D} \rightarrow C$ is a functor and $\alpha: TF \Rightarrow F$ is a natural transformation such that*

$$\alpha \circ (\eta F) = \text{id}_F \quad \text{and} \quad \alpha \circ (\mu F) = \alpha \circ (T\alpha).$$

In fact, the correspondence of [Str72, Theorem 1] relies on a 2-adjunction, so that it extends to natural transformations as well:

Theorem 1.2.1.3. *Given a category \mathcal{D} and functors $G, G': \mathcal{D} \rightarrow C^T$, the operation which maps a natural transformation $\beta: G \Rightarrow G'$ to $\mathcal{U}^T \beta$ induces a bijective correspondence between the natural transformation $G \Rightarrow G'$ and the natural transformations $\bar{\beta}: \mathcal{U}^T G \Rightarrow \mathcal{U}^T G'$ such that*

$$\beta \circ (\mathcal{U}^T \epsilon^T G) = (\mathcal{U}^T \epsilon^T G') \circ (T\beta)$$

1.2.1.4 – Monadicity. Let (T, η, μ) be a monad on a category C . Given a category \mathcal{D} and an adjunction $\mathcal{F} \dashv \mathcal{U}: \mathcal{D} \rightarrow C$ such that the monad induced by this adjunction is exactly (T, η, μ) , recall that there is a canonical functor $\mathcal{H}: \mathcal{D} \rightarrow C^T$, called *comparison functor*, derived from this adjunction (c.f. [Mac13, Theorem VI.3.1]). This functor can also be defined in the setting of Street using Theorem 1.2.1.2:

Theorem 1.2.1.5 ([Str72, Theorem 3]). *There is a unique functor $\mathcal{H}: \mathcal{D} \rightarrow C^T$ such that*

$$\mathcal{U}^T \mathcal{H} = \mathcal{U} \quad \text{and} \quad \mathcal{U}^T \epsilon^T \mathcal{H} = \mathcal{U} \epsilon$$

where ϵ is the counit of $\mathcal{F} \dashv \mathcal{U}$. The functor \mathcal{H} moreover satisfies that $\mathcal{F}^T = \mathcal{H}\mathcal{F}$ and $\epsilon^T \mathcal{H} = \mathcal{H}\epsilon$.

A functor $\bar{\mathcal{U}}: \bar{\mathcal{D}} \rightarrow \bar{C}$ is said *monadic* when it has a right adjoint $\bar{\mathcal{F}}: \bar{C} \rightarrow \bar{\mathcal{D}}$ such that the comparison functor $\bar{\mathcal{H}}: \bar{\mathcal{D}} \rightarrow \bar{C}^T$ is an equivalence of categories, where $(\bar{T}, \bar{\eta}, \bar{\mu})$ is the monad induced by the adjunction $\bar{\mathcal{F}} \dashv \bar{\mathcal{U}}$. Monadic functors can be characterized by Beck's monadicity theorem that we introduce later (c.f. Theorem 1.4.1.6).

1.2.1.6 – Morphisms of monads. Finally, we shall describe some functoriality property between monads and their associated Eilenberg-Moore categories. Given two monads (S, γ, ν) and (T, η, μ) on a category C , a *morphism of monads* between (S, γ, ν) and (T, η, μ) is the data of a natural transformation $\phi: S \Rightarrow T$ such that

$$\phi \circ \gamma = \eta \quad \text{and} \quad \phi \circ \nu = \mu \circ (\phi\phi).$$

Such a morphism induces a functor

$$C^\phi: C^T \rightarrow C^S$$

defined by the following lemma:

Lemma 1.2.1.7. *Given a morphism of monad $\phi: (S, \gamma, \nu) \rightarrow (T, \eta, \mu)$ on a category C , there is a functor*

$$C^\phi: C^T \rightarrow C^S$$

characterized by

$$\mathcal{U}^S C^\phi = \mathcal{U}^T \quad \text{and} \quad \mathcal{U}^S \epsilon^S C^\phi = (\mathcal{U}^T \epsilon^T) \circ (\phi \mathcal{U}^T).$$

Proof. It is sufficient to show that the conditions of Theorem 1.2.1.2 are satisfied. Let

$$\alpha = (\mathcal{U}^T \epsilon^T) \circ (\phi \mathcal{U}^T)$$

By the equations satisfied by adjunctions, we have

$$\alpha \circ (\gamma \mathcal{U}^T) = (\mathcal{U}^T \epsilon^T) \circ (\phi \mathcal{U}^T) \circ (\gamma \mathcal{U}^T) = (\mathcal{U}^T \epsilon^T) \circ (\eta \mathcal{U}^T) = \text{id}_{\mathcal{U}^T}$$

Moreover

$$\begin{aligned} \alpha \circ (v \mathcal{U}^T) &= (\mathcal{U}^T \epsilon^T) \circ (\phi \mathcal{U}^T) \circ (v \mathcal{U}^T) \\ &= (\mathcal{U}^T \epsilon^T) \circ (\mu \mathcal{U}^T) \circ (\phi \phi \mathcal{U}^T) \\ &= (\mathcal{U}^T \epsilon^T) \circ (\mathcal{U}^T \epsilon^T \mathcal{F}^T \mathcal{U}^T) \circ (\phi \phi \mathcal{U}^T) \\ &= (\mathcal{U}^T \epsilon^T) \circ (\mathcal{U}^T \mathcal{F}^T \mathcal{U}^T \epsilon^T) \circ (\phi \phi \mathcal{U}^T) && \text{(by naturality)} \\ &= (\mathcal{U}^T \epsilon^T) \circ (\phi \mathcal{U}^T) \circ (\mathcal{U}^S \mathcal{F}^S \mathcal{U}^T \epsilon^T) \circ (\mathcal{U}^S \mathcal{F}^S \phi \mathcal{U}^T) && \text{(by naturality)} \\ &= \alpha \circ (S\alpha) \end{aligned}$$

Thus, using Theorem 1.2.1.2, there is a unique functor $C^\phi: C^T \rightarrow C^S$ as wanted. \square

1.2.2 Globular sets

Here, we recall the classical notion of *globular set*. It is the underlying structure of a globular higher category which describes *globes* of different dimensions together with their sources and targets. We moreover define the truncation and inclusion functors between globular sets of different dimensions.

1.2.2.1 – Definition. Given $n \in \mathbb{N} \cup \{\omega\}$, an n -globular set $(X, \partial^-, \partial^+)$ (often simply denoted X) is the data of sets X_k for $k \in \mathbb{N}_n$ together with functions $\partial_i^-, \partial_i^+: X_{i+1} \rightarrow X_i$ for $i \in \mathbb{N}_{n-1}$ as in

$$X_0 \begin{array}{c} \xleftarrow{\partial_0^-} \\ \xrightarrow{\partial_0^+} \end{array} X_1 \begin{array}{c} \xleftarrow{\partial_1^-} \\ \xrightarrow{\partial_1^+} \end{array} X_2 \begin{array}{c} \xleftarrow{\partial_2^-} \\ \xrightarrow{\partial_2^+} \end{array} \cdots \begin{array}{c} \xleftarrow{\partial_{k-1}^-} \\ \xrightarrow{\partial_{k-1}^+} \end{array} X_k \begin{array}{c} \xleftarrow{\partial_k^-} \\ \xrightarrow{\partial_k^+} \end{array} X_{k+1} \begin{array}{c} \xleftarrow{\partial_{k+1}^-} \\ \xrightarrow{\partial_{k+1}^+} \end{array} \cdots$$

such that

$$\partial_i^- \circ \partial_{i+1}^- = \partial_i^- \circ \partial_{i+1}^+ \quad \text{and} \quad \partial_i^+ \circ \partial_{i+1}^- = \partial_i^+ \circ \partial_{i+1}^+ \quad \text{for } i \in \mathbb{N}_{n-1}.$$

When there is no ambiguity on i , we often write ∂^- and ∂^+ for ∂_i^- and ∂_i^+ . An element u of X_i is called an i -globe of X and, for $i > 0$, the globes $\partial_{i-1}^-(u)$ and $\partial_{i-1}^+(u)$ are respectively called the *source* and *target* of u . Given n -globular sets X and Y , a *morphism of n -globular set* between X and Y is a family of functions $F = (F_k: X_k \rightarrow Y_k)_{k \in \mathbb{N}_n}$, such that

$$\partial_i^- \circ F_{i+1} = F_i \circ \partial_i^- \quad \text{for } i \in \mathbb{N}_{n-1}.$$

We write \mathbf{Glob}_n for the category of n -globular sets.

Remark 1.2.2.2. The above definition directly translates to an essentially algebraic theory, so that \mathbf{Glob}_n is essentially algebraic. In particular, \mathbf{Glob}_n is locally finitely presentable, complete and cocomplete by Theorem 1.1.2.2 and Proposition 1.1.1.10.

For $\epsilon \in \{-, +\}$ and $j \geq 0$, we write

$$\partial_{i,j}^\epsilon = \partial_i^\epsilon \circ \partial_{i+1}^\epsilon \circ \cdots \circ \partial_{i+j-1}^\epsilon$$

for the *iterated source* (when $\epsilon = -$) and *target* (when $\epsilon = +$) operations. We generally omit the index j when there is no ambiguity and simply write $\partial_i^\epsilon(u)$ for $\partial_{i,j}^\epsilon(u)$. Given $i, k, l \in \mathbb{N}_n$ with $i < \min(k, l)$, we write $X_k \times_i X_l$ for the pullback

$$\begin{array}{ccc} X_k \times_i X_l & \cdots \cdots \rightarrow & X_l \\ \downarrow & \lrcorner & \downarrow \partial_i^- \\ X_k & \xrightarrow{\partial_i^+} & X_i \end{array} .$$

Given $p \geq 2$ and $k_1, \dots, k_p \in \mathbb{N}_n$, a sequence of globes $u_1 \in X_{k_1}, \dots, u_p \in X_{k_p}$ is said *i-composable* for some $i < \min(k_1, \dots, k_p)$, when $\partial_i^+(u_j) = \partial_i^-(u_{j+1})$ for $j \in \mathbb{N}_{p-1}^*$. Given $k \in \mathbb{N}_n$ and $u, v \in X_k$, u and v are said *parallel* when $k = 0$ or $\partial_{k-1}^\epsilon(u) = \partial_{k-1}^\epsilon(v)$ for $\epsilon \in \{-, +\}$. To remove the side condition $k = 0$, we use the convention that X_{-1} is the set $\{*\}$ and that $\partial_{-1}^-, \partial_{-1}^+$ are the unique function $X_0 \rightarrow X_{-1}$.

For $u \in X_{i+1}$, we sometimes write $u: v \rightarrow w$ to indicate that $\partial_i^-(u) = v$ and $\partial_i^+(u) = w$. In low dimension, we use n -arrows such as $\Rightarrow, \Rrightarrow, \Rrightarrow, \text{etc.}$ to indicate the sources and the targets of n -globes in several dimensions. For example, given a 2-globular set X and $\phi \in X$, we sometimes write $\phi: f \Rrightarrow g: x \rightarrow y$ to indicate that

$$\phi \in X_2, \quad \partial_1^-(\phi) = f, \quad \partial_1^+(\phi) = g, \quad \partial_0^-(\phi) = x \quad \text{and} \quad \partial_0^+(\phi) = y.$$

We also use these arrows in graphical representations to picture the elements of a globular set X . For example, given an n -globular set X with $n \geq 2$, the drawing

$$\begin{array}{c} \begin{array}{ccccc} & & f & & \\ & & \downarrow \phi & \searrow & \\ x & \xrightarrow{g} & y & \xrightarrow{k} & z \\ & & \downarrow \psi & \swarrow & \\ & & h & & \end{array} \end{array} \quad (1.1)$$

figures two 2-cells $\phi, \psi \in X_2$, four 1-cells $f, g, h, k \in X_1$ and three 0-cells $x, y, z \in X_0$ such that

$$\begin{aligned} \partial_1^-(\phi) = f, & \quad \partial_1^+(\phi) = \partial_1^-(\psi) = g, & \quad \partial_1^+(\psi) = h, \\ \partial_0^-(\phi) = \partial_0^-(g) = \partial_0^-(h) = x, & \quad \partial_0^+(\phi) = \partial_0^+(g) = \partial_0^+(h) = y, & \quad \partial_0^+(k) = z. \end{aligned}$$

1.2.2.3 – Truncation and inclusion functors. Given $m \in \mathbb{N}_n$ and $X \in \mathbf{Glob}_n$, we denote by $X_{\leq m}$ the *m-truncation of X*, i.e., the m -globular set obtained from X by removing the i -globes for $i \in \mathbb{N}_n$ with $i > m$. This operation extends to a functor

$$(-)_{\leq m, n}^{\text{Glob}}: \mathbf{Glob}_n \rightarrow \mathbf{Glob}_m$$

often denoted $(-)_{\leq m}^{\text{Glob}}$ when there is no ambiguity. This functor admits a left adjoint

$$(-)_{\uparrow n, m}^{\text{Glob}}: \mathbf{Glob}_m \rightarrow \mathbf{Glob}_n$$

often denoted $(-)_{\uparrow n}^{\text{Glob}}$ when there is no ambiguity, and which maps an m -globular set X to the n -globular set $X_{\uparrow n}$, called *n-inclusion of X*, and which is defined by $(X_{\uparrow n})_{\leq m} = X$ and $(X_{\uparrow n})_i = \emptyset$ for $i \in \mathbb{N}_n$ with $i > m$. The unit of the adjunction $(-)_{\uparrow n}^{\text{Glob}} \dashv (-)_{\leq m}^{\text{Glob}}$ is the identity and the counit is the natural transformation denoted $i_X^{m, n}$, or simply i^m when there is no ambiguity, which is given by the family of canonical morphisms

$$i_X^m: (X_{\leq m})_{\uparrow n} \rightarrow X$$

for $X \in \mathbf{Glob}_n$. The functor $(-)^{\mathbf{Glob}}_{\leq m, n}$ also admits a right adjoint

$$(-)^{\mathbf{Glob}}_{\uparrow m, n} : \mathbf{Glob}_m \rightarrow \mathbf{Glob}_n$$

denoted $(-)^{\mathbf{Glob}}_{\uparrow m}$ when there is no ambiguity, and which maps an m -globular set to the n -globular set $X_{\uparrow n}$ defined by $(X_{\uparrow n})_{\leq m} = X$, and, for $i \in \mathbb{N}_n$ with $i > m$,

$$(X_{\uparrow n})_i = \{(u, v) \in X_m \mid u \text{ and } v \text{ are parallel}\}$$

such that, for $(u, v) \in (X_{\uparrow n})_i$,

$$\partial_m^-(u, v) = u \quad \text{and} \quad \partial_m^+(u, v) = v$$

and

$$\partial_j^-(u, v) = \partial_j^+(u, v) = (u, v) \quad \text{for } j \in \mathbb{N}_{i-1}.$$

Note that, since they are left adjoints, the functors $(-)^{\mathbf{Glob}}_{\uparrow n, m}$ and $(-)^{\mathbf{Glob}}_{\leq m, n}$ preserves colimits.

1.2.3 Globular algebras

We now introduce categories of *globular algebras*, i.e., the Eilenberg-Moore categories induced by monads on globular sets, as were first introduced by Batanin in [Bat98a]. We moreover give several additional constructions and properties on these objects.

1.2.3.1 – Definition. Let $n \in \mathbb{N} \cup \{\omega\}$ and (T, η, μ) be a finitary monad on \mathbf{Glob}_n . We write \mathbf{Alg}_n for the category of T -algebras \mathbf{Glob}_n^T and

$$\mathcal{U}_n : \mathbf{Alg}_n \rightarrow \mathbf{Glob}_n \quad \mathcal{F}_n : \mathbf{Glob}_n \rightarrow \mathbf{Alg}_n$$

for the induced left and right adjoints, that were denoted \mathcal{U}^T and \mathcal{F}^T in Section 1.2.1. Explicitly, given $(X, h) \in \mathbf{Alg}_n$, the image of (X, h) by \mathcal{U}_n is X and, given $Y \in \mathbf{Glob}_n$, $\mathcal{F}_n Y$ is the free T -algebra

$$(TY, \mu_Y : TTY \rightarrow TY).$$

Given $k \in \mathbb{N}_n$, there is a monad (T^k, η^k, μ^k) on \mathbf{Glob}_k defined from (T, η, μ) by

$$T^k = (-)^{\mathbf{Glob}}_{\leq k} T (-)^{\mathbf{Glob}}_{\uparrow n}$$

and such that $\eta^k : \text{id}_{\mathbf{Glob}_k} \rightarrow T^k$ is the composite

$$\text{id}_{\mathbf{Glob}_k} \xlongequal{\quad} (-)^{\mathbf{Glob}}_{\leq k} (-)^{\mathbf{Glob}}_{\uparrow n} \xrightarrow{(-)^{\mathbf{Glob}}_{\leq k} \eta (-)^{\mathbf{Glob}}_{\uparrow n}} T^k$$

i.e., $\eta_X^k = (\eta_{X_{\uparrow n}})_{\leq k}$ for $X \in \mathbf{Glob}_k$, and such that $\mu_k : T^k T^k \rightarrow T^k$ is the composite

$$T^k T^k \xrightarrow{(-)^{\mathbf{Glob}}_{\leq k} T^k (-)^{\mathbf{Glob}}_{\uparrow n}} (-)^{\mathbf{Glob}}_{\leq k} T T (-)^{\mathbf{Glob}}_{\uparrow n} \xrightarrow{(-)^{\mathbf{Glob}}_{\leq k} \mu (-)^{\mathbf{Glob}}_{\uparrow n}} T^k.$$

The axioms of monads are easily verified for (T^k, η^k, μ^k) using the fact that (T, η, μ) is a monad. So, for $k \in \mathbb{N}_n$, there is a category of algebra $\mathbf{Glob}_k^{T^k}$, that we denote \mathbf{Alg}_k , and canonical functors

$$\mathcal{U}_k : \mathbf{Alg}_k \rightarrow \mathbf{Glob}_k \quad \mathcal{F}_k : \mathbf{Glob}_k \rightarrow \mathbf{Alg}_k$$

defined like \mathcal{U}_n and \mathcal{F}_n above. The objects of \mathbf{Alg}_k are called *k-categories*. Moreover, given a k -category $C = (X, h)$, the elements of X_i are called the *i-cells of C* for $i \in \mathbb{N}_k$. We can already derive several properties of the categories \mathbf{Alg}_k :

Proposition 1.2.3.2. *For $k \in \mathbb{N} \cup \{n\}$, the category \mathbf{Alg}_k is locally finitely presentable. In particular, it is complete and cocomplete. Moreover, the functor \mathcal{U}_k preserves and creates directed colimits, and creates limits.*

Proof. The category \mathbf{Alg}_k is locally finitely presentable as a consequence of Proposition 1.1.1.12 since \mathbf{Glob}_k is locally finitely presentable by Remark 1.2.2.2. The functor \mathcal{U}_k preserves directed colimits by Proposition 1.1.1.12. Moreover, since \mathcal{U}_k reflects isomorphisms and \mathbf{Alg}_k is cocomplete, \mathcal{U}_k creates directed colimits. Finally, it is well-known that the forgetful functor associated to an Eilenberg-Moore category creates limits (see [Bor94b, Proposition 4.3.1] for example). \square

We can usually derive monads from equational definitions of higher categories as illustrated by the following examples.

Example 1.2.3.3. Since 1-globular sets are graphs, the finitary forgetful functor $\mathbf{Cat} \rightarrow \mathbf{Gph}$ defined in Example 1.1.2.10 induces a finitary monad (T, η, μ) on \mathbf{Glob}_1 . This monad maps a 1-globular set G seen as a graph to the underlying 1-globular set of the category of paths on G . Using Beck's monadicity theorem (Theorem 1.4.1.6), one can verify that the functor $\mathbf{Cat} \rightarrow \mathbf{Gph}$ is monadic, so that $\mathbf{Alg}_1 \simeq \mathbf{Cat}$. Moreover, the monad (T^0, η^0, μ^0) is essentially the identity monad on \mathbf{Glob}_0 , and thus $\mathbf{Alg}_0 \simeq \mathbf{Set}$. More generally, we will see in Section 1.4.1 that the monads of strict k -categories for $k \in \mathbb{N}$ are derived from the monad of strict ω -categories.

Example 1.2.3.4. We define a notion of *weird 2-category* as follows: a weird 2-category is a 2-globular set C equipped with an operation

$$*: C_2 \times C_2 \rightarrow C_0.$$

Note that we do not require the composability of the arguments of $*$, and we do not enforce any axiom on $*$. A morphism between two weird 2-categories is then a morphism between the underlying 2-globular sets that is compatible with $*$. The category \mathbf{Weird} of weird 2-categories and their morphisms is essentially algebraic, and the functor which maps a weird 2-category to its underlying 2-globular set is induced by an essentially algebraic theory morphism, so that it is a right adjoint and finitary by Theorem 1.1.2.7. From the adjunction, we derive a finitary monad (T, η, μ) on \mathbf{Glob}_2 , and, given $X \in \mathbf{Glob}_2$, we have that

$$(TX)_0 \simeq X_0 \sqcup (X_2 \times X_2) \quad (TX)_1 \simeq X_1 \quad (TX)_2 \simeq X_2$$

so that, for \mathbf{Alg}_2 derived from the monad T , $\mathbf{Alg}_2 \simeq \mathbf{Weird}$. Moreover, the monads (T^0, η^0, μ^0) and (T^1, η^1, μ^1) are essentially the identity monads on \mathbf{Glob}_0 and \mathbf{Glob}_1 respectively, so that the associated notions of weird 0- and 1-categories are simply 0- and 1-globular sets.

The last example moreover illustrates the unusual operations that notions of higher categories defined in the setting of Batanin can have. It is also an example of a monad on globular sets which is not truncable (*c.f.* Example 1.2.4.3).

Remark 1.2.3.5. In the above definition, we require that the monad (T, η, μ) is finitary in order to prove later the existence of several free constructions on the k -categories. This is not too restrictive, since it includes all the monads of algebraic globular higher categories that have operations with finite arities, *i.e.*, most theories of algebraic globular higher categories.

1.2.3.6 – Truncation and inclusion functors. We now introduce truncation and inclusion functors between the categories \mathbf{Alg}_k together with some of their properties. Let $n \in \mathbb{N} \cup \{\omega\}$ and (T, η, μ) be a finitary monad on \mathbf{Glob}_n . Given $k, l \in \mathbb{N}_n \cup \{n\}$ with $k < l$ and a T^l -algebra

$$(X, h: T^l X \rightarrow X),$$

there is a canonical T^k -algebra $(X_{\leq k}, h')$, where h' is defined as the composite

$$T^k(X_{\leq k}) \xrightarrow{((-)_{\leq k, l}^{\text{Glob}} T^l i^{k, l})_X} (T^l X)_{\leq k} \xrightarrow{h_{\leq k}} X_{\leq k}$$

and the operation $(X, h) \mapsto (X_{\leq k}, h')$ extends to a functor

$$(-)_{\leq k, l}^{\text{Alg}} : \mathbf{Alg}_l \rightarrow \mathbf{Alg}_k$$

often simply denoted $(-)_{\leq k}^{\text{Alg}}$. The image of (X, h) in \mathbf{Alg}_l by $(-)_{\leq k}^{\text{Alg}}$ is called the k -truncation of (X, h) and we denote it $(X, h)_{\leq k}$. Note that the image of a morphism $f: (X, h) \rightarrow (X', h')$ by $(-)_{\leq k}^{\text{Alg}}$ is $f_{\leq k}$ (the globular k -truncation of f). The finitary assumption on T enables the existence of a left adjoint to truncation functors:

Proposition 1.2.3.7. *Given $k, l \in \mathbb{N}_n \cup \{n\}$ with $k < l$, the functor $(-)_{\leq k, l}^{\text{Alg}}$ admits a left adjoint.*

Proof. The functor $(-)_{\leq k, l}^{\text{Alg}}$ is finitary since, by Proposition 1.2.3.2, \mathcal{U}_k creates directed colimits and the functor

$$\mathcal{U}_k(-)_{\leq k, l}^{\text{Alg}} = (-)_{\leq k}^{\text{Glob}} \mathcal{U}_l$$

preserves directed colimits. Moreover, $(-)_{\leq k, l}^{\text{Alg}}$ preserves limits since \mathcal{U}_k creates limits and the functor $\mathcal{U}_k(-)_{\leq k, l}^{\text{Alg}} = (-)_{\leq k}^{\text{Glob}} \mathcal{U}_l$ preserves limits (both $(-)_{\leq k, l}^{\text{Glob}}$ and \mathcal{U}_l are right adjoints). Then, by Proposition 1.1.1.11, the functor $(-)_{\leq k, l}^{\text{Alg}}$ admits a left adjoint. \square

Given $k, l \in \mathbb{N}_n \cup \{n\}$ with $k < l$, we write

$$(-)_{\uparrow l, k}^{\text{Alg}} : \mathbf{Alg}_k \rightarrow \mathbf{Alg}_l$$

for the left adjoint to $(-)_{\leq k, l}^{\text{Alg}}$, or even $(-)_{\uparrow l}^{\text{Alg}}$ when there is no ambiguity on k . The image of (X, h) in \mathbf{Alg}_k by $(-)_{\uparrow l}^{\text{Alg}}$ is called the l -inclusion of (X, h) and we denote it $(X, h)_{\uparrow l}$.

We verify that the different truncation functors are compatible between themselves:

Proposition 1.2.3.8. *Given $j, k, l \in \mathbb{N}_n \cup \{n\}$ with $j < k < l$, we have*

$$(-)_{\leq j, k}^{\text{Alg}} \circ (-)_{\leq k, l}^{\text{Alg}} = (-)_{\leq j, l}^{\text{Alg}}$$

Proof. Let $(X, h) \in \mathbf{Alg}_l$ and h', h'', \bar{h} be the globular morphisms such that

$$(X_{\leq k}, h') = (X, h)_{\leq k}, \quad (X_{\leq j}, h'') = (X_{\leq k}, h')_{\leq j}, \quad \text{and} \quad (X_{\leq j}, \bar{h}) = (X, h)_{\leq j}$$

We compute that

$$\begin{aligned} h'' &= h'_{\leq j} \circ ((-)_{\leq j, k}^{\text{Glob}} T^k i^{j, k})_{X_{\leq k}} \\ &= (h_{\leq k} \circ ((-)_{\leq k, l}^{\text{Glob}} T^l i^{k, l})_X)_{\leq j} \circ ((-)_{\leq j, k}^{\text{Glob}} T^k i^{j, k})_{X_{\leq k}} \\ &= h_{\leq j} \circ ((-)_{\leq j, l}^{\text{Glob}} T^l i^{k, l})_X \circ ((-)_{\leq j, k}^{\text{Glob}} T^k i^{j, k})_{X_{\leq k}} \\ &= h_{\leq j} \circ ((-)_{\leq j, n}^{\text{Glob}} T(-)_{\uparrow n, l}^{\text{Glob}} (i_X^{k, l} \circ ((-)_{\uparrow l, k}^{\text{Glob}} i^{j, k} (-)_{\leq k, j}^{\text{Glob}})_X)) \\ &= h_{\leq j} \circ ((-)_{\leq j, n}^{\text{Glob}} T(-)_{\uparrow n, l}^{\text{Glob}} (i_X^{j, l})) \\ &= \bar{h} \end{aligned}$$

so that the property holds. \square

1.2.3.9 – \mathbf{Alg}_ω as a limit. Let (T, η, μ) be a finitary monad on \mathbf{Glob}_ω . The purpose of this paragraph is to characterize \mathbf{Alg}_ω as a limit on the categories \mathbf{Alg}_k for $k \in \mathbb{N}$ using the truncation functors $(-)^{\mathbf{Alg}}_{\leq k}$. Before showing this property, we need to recall the notion of cofinal functor. First, given a category C , we define a relation \sim^C on the objects on C as the smallest equivalence relation such that, for every $f: x \rightarrow y \in C$, we have $x \sim^C y$. The category C is then said *connected* when $x \sim^C y$ for all $x, y \in C_0$. A functor $F: I \rightarrow J$ between two categories I and J is *cofinal* when, for each $i \in I_0$, the arrow category $i \downarrow F$ is connected. The interesting fact about cofinal functors is that they witness that two diagrams have the same colimit:

Proposition 1.2.3.10. *Let $F: I \rightarrow J$ be a cofinal functor between two categories I and J , $d: J \rightarrow C$ be a functor into a category C and $p: d \Rightarrow \Delta l$ be a cocone on d of vertex $l \in C_0$ (where Δl is the constant functor $J \rightarrow C$ of value l). Then, p is a colimit cocone on d if and only if pF is a colimit cocone on $d \circ F$.*

Proof. See [Mac13, Section IX.3] or [KS06, Section 2.5]. □

The cofinal functors between two directed categories are easily characterized:

Proposition 1.2.3.11. *Let $F: I \rightarrow J$ be a functor between two directed categories I and J . Then, F is cofinal if and only if, for each $j \in J$, there exists $i \in I$ and a morphism $j \rightarrow F(i) \in J$.*

Proof. The implication is clear. Conversely, suppose that for each $j \in J$, there exists $i \in I$ and a morphism $j \rightarrow F(i) \in J$. Then, given $j \in J$, the category $j \downarrow F$ is not empty. Moreover, given two morphisms $f_1: j \rightarrow F(i_1)$ and $f_2: j \rightarrow F(i_2)$ in J for some $i_1, i_2 \in I$, since I is directed, there exist morphisms $g_1: i_1 \rightarrow i$ and $g_2: i_2 \rightarrow i$ for some $i \in I$, that induce morphisms

$$g_1: (i_1, f_1) \rightarrow (i, g_1 \circ f_1) \quad \text{and} \quad g_2: (i_2, f_2) \rightarrow (i, g_2 \circ f_2)$$

in $j \downarrow F$. Since J is directed, we have $g_1 \circ f_1 = g_2 \circ f_2$. Thus, $j \downarrow F$ is connected. Hence, F is cofinal. □

We can now characterize \mathbf{Alg}_ω as a limit:

Proposition 1.2.3.12. $((-)^{\mathbf{Alg}}_{\leq k}: \mathbf{Alg}_\omega \rightarrow \mathbf{Alg}_k)_{k \in \mathbb{N}}$ is a limit cone in \mathbf{CAT} on the diagram

$$\mathbf{Alg}_0 \xleftarrow{(-)^{\mathbf{Alg}}_{\leq 0}} \mathbf{Alg}_1 \xleftarrow{(-)^{\mathbf{Alg}}_{\leq 1}} \mathbf{Alg}_2 \xleftarrow{(-)^{\mathbf{Alg}}_{\leq 2}} \dots \xleftarrow{(-)^{\mathbf{Alg}}_{\leq k-1}} \mathbf{Alg}_k \xleftarrow{(-)^{\mathbf{Alg}}_{\leq k}} \mathbf{Alg}_{k+1} \xleftarrow{(-)^{\mathbf{Alg}}_{\leq k+1}} \dots$$

Proof. Let $A^k = (X^k, g^k: T^k X^k \rightarrow X) \in \mathbf{Alg}_k$ for $k \in \mathbb{N}$ be such that $A^{k+1} = A^k$. Then, in particular, we have $X_{\leq k}^{k+1} = X^k$, so that there exists $X \in \mathbf{Glob}_\omega$ such that $X^k = X_{\leq k}$ for $k \in \mathbb{N}$. Let R^k be the functor

$$R^k = (-)^{\mathbf{Glob}}_{\uparrow \omega} (-)^{\mathbf{Glob}}_{\leq k}: \mathbf{Glob}_\omega \rightarrow \mathbf{Glob}_\omega$$

and $T^{l,k}$ be the functor

$$T^{l,k} = R^l T R^k: \mathbf{Glob}_\omega \rightarrow \mathbf{Glob}_\omega$$

and j^k be the natural transformation

$$j^k = (-)^{\mathbf{Glob}}_{\uparrow \omega} i^{k,k+1} (-)^{\mathbf{Glob}}_{\leq k+1}: R^k \Rightarrow R^{k+1}$$

for $k, l \in \mathbb{N}$. Note that, for all $Y \in \mathbf{Glob}_\omega$, $(i_Y^{k,\omega}: R^k Y \rightarrow Y)_{k \in \mathbb{N}}$ is a colimit cocone in \mathbf{Glob}_ω on the diagram

$$R^0 Y \xrightarrow{j_Y^0} R^1 Y \xrightarrow{j_Y^1} \dots \xrightarrow{j_Y^{k-1}} R^k Y \xrightarrow{j_Y^k} R^{k+1} Y \xrightarrow{j_Y^{k+1}} \dots$$

Since T is finitary, $((T i^{k,\omega})_X : T(X_{\leq k})_{\uparrow\omega} \rightarrow TX)_{k \in \mathbb{N}}$ is a colimit cocone on the diagram

$$TR^0 X \xrightarrow{(T j^0)_X} TR^1 X \xrightarrow{(T j^1)_X} \dots \xrightarrow{(T j^{k-1})_X} TR^k X \xrightarrow{(T j^k)_X} TR^{k+1} X \xrightarrow{(T j^{k+1})_X} \dots$$

By commutation of colimits, $((i^{l,\omega} T i^{k,\omega})_X : T^{l,k} X \rightarrow TX)_{k,l \in \mathbb{N}}$ is a colimit cocone of the grid diagram

$$\begin{array}{ccccc} & & \vdots & & \vdots \\ & & \uparrow & & \uparrow \\ & & (j^{l+1} TR^k)_X & & (j^{l+1} TR^{k+1})_X \\ & & | & & | \\ \dots & \xrightarrow{(R^{l+1} T j^{k-1})_X} & T^{l+1,k} X & \xrightarrow{(R^{l+1} T j^k)_X} & T^{l+1,k+1} X \xrightarrow{(R^{l+1} T j^{k+1})_X} \dots \\ & & \uparrow & & \uparrow \\ & & (j^l TR^k)_X & & (j^l TR^{k+1})_X \\ \dots & \xrightarrow{(R^l T j^{k-1})_X} & T^{l,k} X & \xrightarrow{(R^l T j^k)_X} & T^{l,k+1} X \xrightarrow{(R^l T j^{k+1})_X} \dots \\ & & \uparrow & & \uparrow \\ & & (j^{l-1} TR^k)_X & & (j^{l-1} TR^{k+1})_X \\ & & | & & | \\ & & \vdots & & \vdots \end{array}$$

Note that the diagonal functor $\Delta : (\mathbb{N}, \leq) \rightarrow (\mathbb{N} \times \mathbb{N}, \leq \times \leq)$ is cofinal by Proposition 1.2.3.11, so that, by Proposition 1.2.3.10, the cocone $((i^{k,\omega} T i^{k,\omega})_X : T^{k,k} X \rightarrow TX)_{k \in \mathbb{N}}$ is a colimit cocone on the diagram

$$T^{0,0} X \xrightarrow{(j^0 T j^0)_X} \dots \xrightarrow{(j^{k-1} T j^{k-1})_X} T^{k,k} X \xrightarrow{(j^k T j^k)_X} T^{k+1,k+1} X \xrightarrow{(j^{k+1} T j^{k+1})_X} \dots \quad (1.2)$$

where $T^{k,k} X$ is exactly $(T^k X^k)_{\uparrow\omega}$ for $k \in \mathbb{N}$ and, by the definition of $(-)^{\text{Alg}}_{\leq k}$, we have

$$g^k = g_{\leq k}^{k+1} \circ ((-)^{\text{Glob}}_{\leq k} T j^k)_X$$

so that

$$\begin{aligned} j_X^k \circ g_{\uparrow\omega}^k &= ((-)^{\text{Glob}}_{\uparrow\omega} i^{k,k+1} (-)^{\text{Glob}}_{\leq k+1})_X \circ (g_{\leq k}^{k+1})_{\uparrow\omega} \circ (R^k T j^k)_X \\ &= ((-)^{\text{Glob}}_{\uparrow\omega} i^{k,k+1})_{X^{k+1}} \circ (g_{\leq k}^{k+1})_{\uparrow\omega} \circ (R^k T j^k)_X \\ &= g_{\uparrow\omega}^{k+1} \circ ((-)^{\text{Glob}}_{\uparrow\omega} i^{k,k+1})_{T^{k+1} X^{k+1}} \circ (R^k T j^k)_X && \text{(by naturality of } (-)^{\text{Glob}}_{\uparrow\omega} i^{k,k+1}) \\ &= g_{\uparrow\omega}^{k+1} \circ (j^k TR^{k+1})_X \circ (R^k T j^k)_X \\ &= g_{\uparrow\omega}^{k+1} \circ (j^k T j^k)_X. \end{aligned}$$

Thus, we obtain a diagram

$$\begin{array}{ccccccc} (T^0(X_{\leq 0}))_{\uparrow\omega} & \xrightarrow{(j^0 T j^0)_X} & \dots & \xrightarrow{(j^{k-1} T j^{k-1})_X} & (T^k(X_{\leq k}))_{\uparrow\omega} & \xrightarrow{(j^k T j^k)_X} & (T^{k+1}(X_{\leq k+1}))_{\uparrow\omega} \xrightarrow{(j^{k+1} T j^{k+1})_X} \dots \\ \downarrow g_{\uparrow\omega}^0 & & & & \downarrow g_{\uparrow\omega}^k & & \downarrow g_{\uparrow\omega}^{k+1} \\ (X_{\leq 0})_{\uparrow\omega} & \xrightarrow{j_X^0} & \dots & \xrightarrow{j_X^{k-1}} & (X_{\leq k})_{\uparrow\omega} & \xrightarrow{j_X^k} & (X_{\leq k+1})_{\uparrow\omega} \xrightarrow{j_X^{k+1}} \dots \end{array}$$

where each square commutes, and it induces a morphism $g : TX \rightarrow X \in \mathbf{Glob}_\omega$. By a similar argument as above, we have a colimit cocone

$$((i^{k,\omega} T i^{k,\omega} T i^{k,\omega})_X : (T^k T^k X^k)_{\uparrow\omega} \rightarrow TTX)_{k \in \mathbb{N}}$$

on a diagram analogous to (1.2). We compute that, for $k \in \mathbb{N}$,

$$\begin{aligned}
& g \circ \mu_X \circ (i^{k,\omega} T i^{k,\omega} T i^{k,\omega})_X \\
&= g \circ \mu_X \circ (i^{k,\omega} T T i^{k,\omega})_X \circ (R^k T i^{k,\omega} T R^k)_X && \text{(by naturality)} \\
&= g \circ (i^{k,\omega} T i^{k,\omega})_X \circ (R^k \mu R^k)_X \circ (R^k T i^{k,\omega} T R^k)_X && \text{(by naturality)} \\
&= i_X^{k,\omega} \circ g_{\uparrow\omega}^k \circ ((-)\uparrow\omega^{\text{Glob}} \mu^k (-)\uparrow\omega^{\text{Glob}})_{X_{\leq k}} && \text{(by definition of } g \text{ and } \mu^k) \\
&= i_X^{k,\omega} \circ g_{\uparrow\omega}^k \circ ((-)\uparrow\omega^{\text{Glob}} \mu^k)_{X_{\leq k}} \\
&= i_X^{k,\omega} \circ (g^k \circ \mu_{X_{\leq k}}^k)_{\uparrow\omega} \\
&= i_X^{k,\omega} \circ (g^k \circ T^k(g^k))_{\uparrow\omega} && \text{(since } (X^k, g^k) \text{ is an algebra)} \\
&= g \circ (i^{k,\omega} T i^{k,\omega})_X \circ (T^k(g^k))_{\uparrow\omega} && \text{(by definition of } g) \\
&= g \circ (i^{k,\omega} T)_X \circ R^k T(i_X^{k,\omega} \circ g_{\uparrow\omega}^k) \\
&= g \circ (i^{k,\omega} T)_X \circ R^k T(g \circ (i^{k,\omega} T i^{k,\omega})_X) && \text{(by definition of } g) \\
&= g \circ (i^{k,\omega} T)_X \circ R^k T(g) \circ (R^k T i^{k,\omega} T i^{k,\omega})_X \\
&= g \circ T(g) \circ (i^{k,\omega} T)_X \circ (R^k T i^{k,\omega} T i^{k,\omega})_X && \text{(by naturality)} \\
&= g \circ T(g) \circ (i^{k,\omega} T i^{k,\omega} T i^{k,\omega})_X
\end{aligned}$$

so that $g \circ \mu_X = g \circ T(g)$. Moreover, for $k \in \mathbb{N}$, we have

$$\begin{aligned}
g \circ \eta_X \circ i_X^{k,\omega} &= g \circ \eta_X \circ i_X^{k,\omega} \circ (R^k i^{k,\omega})_X && \text{(since } (R^k i^{k,\omega})_X = \text{id}_{R^k X}) \\
&= g \circ \eta_X \circ (i^{k,\omega} i^{k,\omega})_X \\
&= g \circ (i^{k,\omega} T i^{k,\omega})_X \circ (R^k \eta R^k)_X && \text{(by naturality)} \\
&= i_X^{k,\omega} \circ g_{\uparrow\omega}^k \circ ((-)\uparrow\omega^{\text{Glob}} \eta^k (-)\uparrow\omega^{\text{Glob}})_{X^k} \\
&= i_X^{k,\omega} \circ g_{\uparrow\omega}^k \circ ((-)\uparrow\omega^{\text{Glob}} \eta^k)_{X^k} \\
&= i_X^{k,\omega} \circ (g^k \circ \eta_{X^k}^k)_{\uparrow\omega} \\
&= i_X^{k,\omega} && \text{(since } (X^k, g^k) \text{ is an algebra)}
\end{aligned}$$

thus, since $(i^{k,\omega} : R^k X \rightarrow X)_k$ is a colimit cocone, we have $g \circ \eta_X = \text{id}_X$. Hence, $(X, g) \in \mathbf{Alg}_\omega$. For $k \in \mathbb{N}$, let $(X^k, \tilde{g}^k : T^k(X_{\leq k}) \rightarrow X_{\leq k})$ be the image of (X, g) by $(-)\uparrow\omega^{\text{Alg}}$. We have

$$\begin{aligned}
i_X^{k,\omega} \circ \tilde{g}_{\uparrow\omega}^k &= i_X^{k,\omega} \circ R^k(g) \circ (R^k T i^{k,\omega})_X && \text{(by definition of } (-)\uparrow\omega^{\text{Alg}}) \\
&= g \circ i_{TX}^{k,\omega} \circ (R^k T i^{k,\omega})_X && \text{(by naturality of } i^{k,\omega}) \\
&= g \circ (i^{k,\omega} T i^{k,\omega})_X \\
&= i_X^{k,\omega} \circ g_{\uparrow\omega}^k && \text{(by definition of } g)
\end{aligned}$$

thus, since $i^{k,\omega}$ is a monomorphism and $(-)\uparrow\omega^{\text{Glob}}$ is faithful, we have $\tilde{g}^k = g^k$. Moreover, given an algebra $(X, \tilde{g}) \in \mathbf{Alg}_\omega$ such that $(X, \tilde{g})_{\leq k} = (X^k, g^k)$ for every $k \in \mathbb{N}$, we have

$$\begin{aligned}
\tilde{g} \circ (i^{k,\omega} T i^{k,\omega})_X &= \tilde{g} \circ i_{TX}^{k,\omega} \circ (R^k T i^{k,\omega})_X \\
&= i_X^{k,\omega} \circ R^k(\tilde{g}) \circ (R^k T i^{k,\omega})_X && \text{(by naturality of } i_X^{k,\omega}) \\
&= i_X^{k,\omega} \circ g_{\uparrow\omega}^k && \text{(by definition of } (-)\uparrow\omega^{\text{Alg}}) \\
&= g \circ (i^{k,\omega} T i^{k,\omega})_X
\end{aligned}$$

so that $\tilde{g} = g$ by the colimit definition of TX .

Now, let $(Y, h) \in \mathbf{Glob}_\omega$, (Y^k, h^k) be the image of (Y, h) by the functor $(-)^{\mathbf{Alg}_{\leq k}}$ for $k \in \mathbb{N}$, and a morphism $f: X \rightarrow Y \in \mathbf{Glob}_\omega$ such that $f_{\leq l}$ induces a morphism between (X^l, g^l) and (Y^l, h^l) in \mathbf{Alg}_l for $l \in \mathbb{N}$. We compute that, for $k \in \mathbb{N}$,

$$\begin{aligned}
h \circ T(f) \circ (i^{k,\omega} T i^{k,\omega})_X &= h \circ (i^{k,\omega} T i^{k,\omega})_Y \circ R^k T R^k(f) && \text{(by naturality)} \\
&= i_Y^{k,\omega} \circ h_{\uparrow\omega}^k \circ R^k T R^k(f) && \text{(by definition of } h) \\
&= i_Y^{k,\omega} \circ (h^k \circ T^k(f_{\leq k}))_{\uparrow\omega} && \\
&= i_Y^{k,\omega} \circ (f_{\leq k} \circ g^k)_{\uparrow\omega} && \text{(since } f_{\leq k} \in \mathbf{Alg}_k) \\
&= i_Y^{k,\omega} \circ R^k(f) \circ g_{\uparrow\omega}^k && \\
&= f \circ i_X^{k,\omega} \circ g_{\uparrow\omega}^k && \text{(by naturality)} \\
&= f \circ g \circ (i^{k,\omega} T i^{k,\omega})_X && \text{(by definition of } g)
\end{aligned}$$

so that, by the colimit definition of TX , we have $h \circ T(f) = f \circ g$. Thus, the ω -globular morphism f induces a morphism $f: (X, g) \rightarrow (Y, h)$ of \mathbf{Alg}_ω . Finally, a morphism f' of \mathbf{Alg}_ω is completely characterized by its images by the functors $(-)^{\mathbf{Alg}_{\leq k}}$ for $k \in \mathbb{N}$, which concludes the proof that $((-)^{\mathbf{Alg}_{\leq k}}: \mathbf{Alg}_\omega \rightarrow \mathbf{Alg}_k)_{k \in \mathbb{N}}$ is a limit cone of \mathbf{CAT} . \square

1.2.3.13 – A criterion for globular algebras. Usually, a specific notion of higher category and the associated truncation and inclusion functors are not directly derived from a monad. Instead, we often manipulate higher categories that are defined, in each dimension $k \in \mathbb{N}$, as structures with operations satisfying some equations, and the truncation and inclusion functors are defined by hand. Such equational definitions surely induce monads on k -globular sets, but it is not clear that the monad in dimension l_1 is obtained by truncating the monad in dimension l_2 for $l_1 < l_2$, as in Paragraph 1.2.3.1. Moreover, it is not immediate that the boilerplate definitions of truncation and inclusion functors correspond to the ones from Paragraph 1.2.3.6. Verifying the equivalences of these definitions is required in order to use general constructions for globular algebras, like the ones of the next section. But, without a generic argument, the verification can be tedious since it involves, among others, an explicit description of the different monads. In this paragraph, we give a criterion, in the form of Theorem 1.2.3.20, to recognize that some functor between two categories is the truncation functor as defined in Paragraph 1.2.3.6 derived from some monad on globular sets. It will allow us to show in Section 1.4 that the equational definitions of strict k -categories and k -precategories and their truncation and inclusion functors are equivalent to the ones derived as in Paragraphs 1.2.3.1 and 1.2.3.6 from a monad on \mathbf{Glob}_ω .

The proofs of this criterion will involve showing several equalities on natural transformations between left and right adjoints. In order to allow for simpler manipulations of these equalities, we use string diagrams. We quickly remind the reader the rules of this graphical calculus for adjunctions. Recall that an *adjunction* in \mathbf{CAT} can be described as the data of two functors

$$L: C \rightarrow D \quad \text{and} \quad R: D \rightarrow C$$

between categories C and D , together with natural transformations

$$\gamma: \text{id}_C \Rightarrow RL \quad \text{and} \quad \epsilon: LR \Rightarrow \text{id}_D$$

that satisfy the “zigzag equations”

$$(\epsilon L) \circ (L \gamma) = \text{id}_L \quad \text{and} \quad (R \epsilon) \circ (\gamma R) = \text{id}_R. \quad (1.3)$$

One can represent the above situation using string diagrams as follows: the natural transformations γ and ϵ can be pictured as

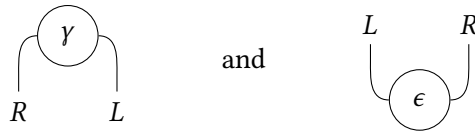

and the zigzag equations can be pictured by

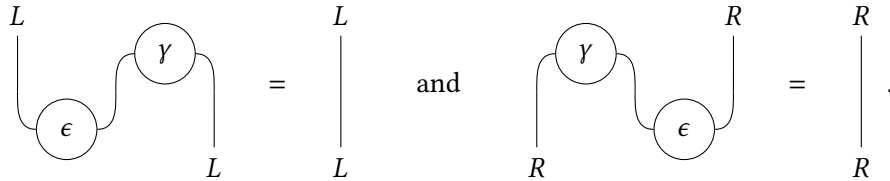

Note that the above equations generate a congruence: they apply as well when both sides appear as subdiagrams of a bigger string diagram. Using this language, we graphically show the elementary property that an isomorphism between two left adjoints induces an isomorphism between the two right adjoints (and *vice versa*):

Proposition 1.2.3.14. *Let*

$$L \dashv R: C \rightarrow D \quad \text{and} \quad L' \dashv R': C \rightarrow D$$

be two adjunctions with respective unit-counit pairs (γ, ϵ) and (γ', ϵ') , and

$$\theta: L \Rightarrow L' \quad \text{and} \quad \bar{\theta}: R' \Rightarrow R$$

be two natural transformations such that $\theta = (\epsilon L') \circ (L \bar{\theta} L') \circ (L \gamma')$, i.e., graphically:

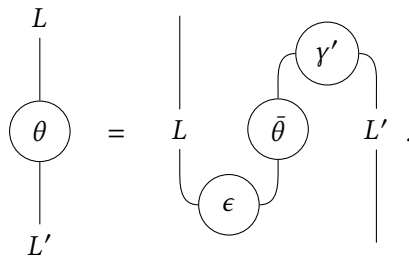

Then, θ is an isomorphism if and only if $\bar{\theta}$ is an isomorphism.

Proof. Suppose first that θ is an isomorphism. Note that, by the zigzag equations satisfied by (γ, ϵ) and (γ', ϵ') , we have

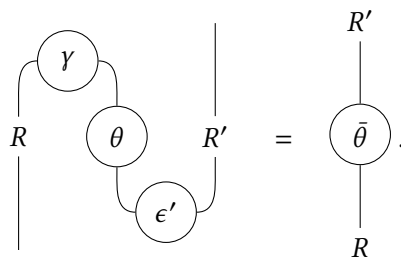

By the same zigzag equations, one then easily verifies that the morphism depicted by the following string diagram is an inverse to $\bar{\theta}$:

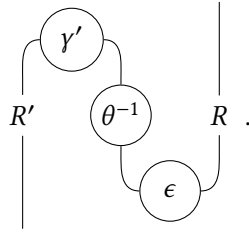

Conversely, suppose that $\bar{\theta}$ is an isomorphism. Then, by the zigzag equations, one easily verifies that the diagram

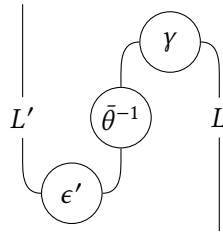

defines an inverse of θ , which concludes the proof. □

Moreover, we recall how to derive an adjunction from the composition of two adjunctions, using the graphical language:

Proposition 1.2.3.15. *Given two adjunctions $L_1 \dashv R_1: C_1 \rightarrow C_2$ and $L_2 \dashv R_2: C_2 \rightarrow C_3$ with unit-counit pairs (γ_1, ϵ_1) and (γ_2, ϵ_2) respectively, there is a canonical adjunction $L_1 L_2 \dashv R_2 R_1$ whose unit and counit are respectively*

$$(R_2 \gamma_1 L_2) \circ \gamma_2 \quad \text{and} \quad \epsilon_1 \circ (L_1 \epsilon_2 R_1)$$

that can be represented by

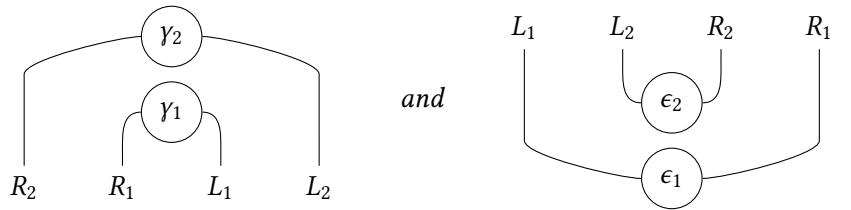

Proof. Using the zigzag equations satisfied by (γ_1, ϵ_1) and (γ_2, ϵ_2) , we easily verify that

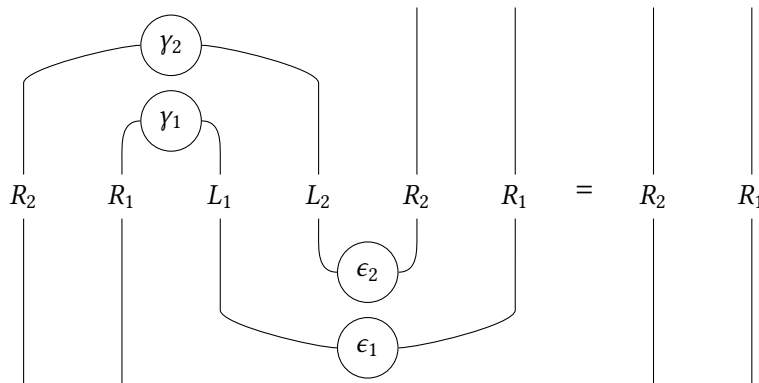

and

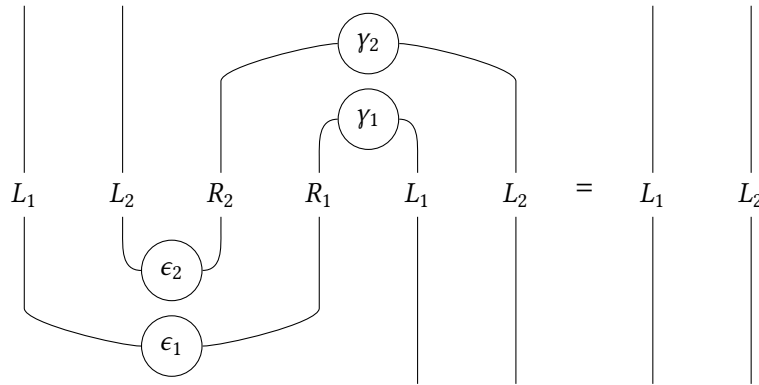

so that $(R_2\gamma_1L_2) \circ \gamma_2$ and $\epsilon_1 \circ (L_1\epsilon_2R_1)$ equip the functors L_1L_2 and R_2R_1 with a structure of an adjunction $L_1L_2 \dashv R_2R_1: C_1 \rightarrow C_3$. \square

Note that Proposition 1.2.3.15 generalizes to compositions of sequences of adjunctions

$$L_1 \dashv R_1: C_1 \rightarrow C_2, \quad \dots, \quad L_k \dashv R_k: C_k \rightarrow C_{k+1}$$

for every $k \in \mathbb{N}^*$. We now show several technical lemmas that we will use in the proof of Theorem 1.2.3.20 below.

Lemma 1.2.3.16. *Let the (not necessarily commutative) diagram of functors in CAT*

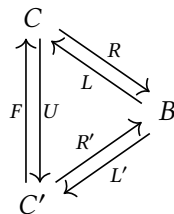

where $L \dashv R, L' \dashv R'$ and $F \dashv U$ are adjunctions such that $R'U = R$, and write (S, γ, ν) and (S', γ', ν') for the monads associated to $L \dashv R$ and $L' \dashv R'$ respectively. Then, the unit of the adjunction $F \dashv U$ induces a morphism of monads $\phi: S' \Rightarrow S$ such that the following diagram commutes

$$\begin{array}{ccc} C & \xrightarrow{H} & B^S \\ U \downarrow & & \downarrow B^\phi \\ C' & \xrightarrow{H'} & B^{S'} \end{array}$$

where H and H' are the comparison functors associated to the adjunctions $L \dashv R$ and $L' \dashv R'$.

Proof. Let $(\alpha, \delta), (\beta, \epsilon), (\beta', \epsilon')$ be the unit-counit pairs of the adjunctions $F \dashv U, L \dashv R$, and $L' \dashv R'$ respectively. Note that $\beta = \gamma$ and $\beta' = \gamma'$. Since $R'U = R$, the natural transformation $\theta: FL' \Rightarrow L$ defined as the composite

$$\theta = (\delta L) \circ (F\epsilon'UL) \circ (FL'\gamma)$$

which can be represented as

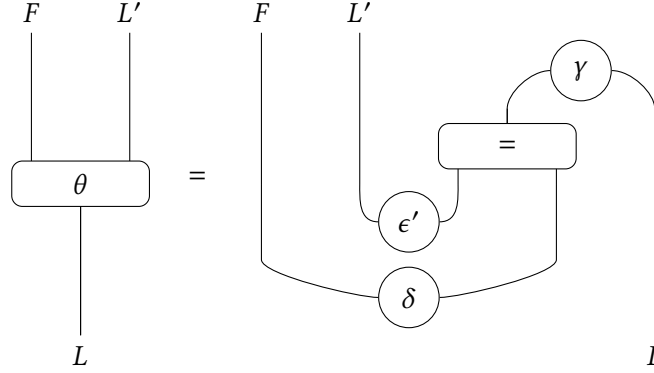

is an isomorphism by Propositions 1.2.3.14 and 1.2.3.15. Moreover, one easily checks with the zigzags equations satisfied by (α, δ) , (γ, ϵ) and (γ', ϵ') that we have

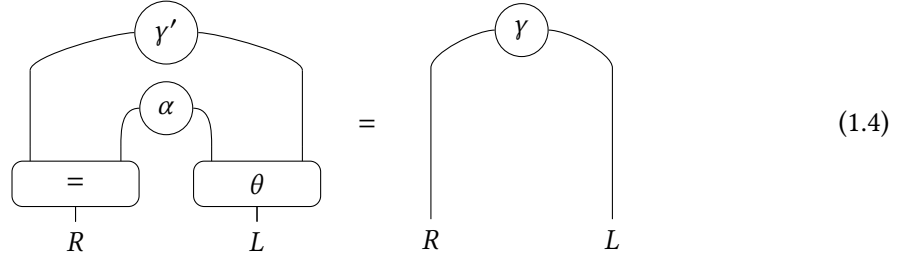

and

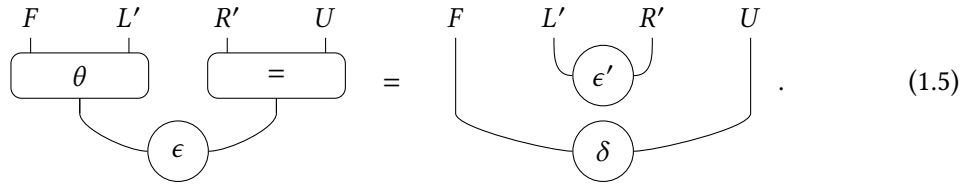

Now let $\phi: S' \Rightarrow S$ be the natural transformation defined as the composite

$$\phi: S' = R'L' \xrightarrow{R'\alpha L'} R'UFL' = RFL' \xrightarrow{R\theta} RL = S$$

which can be pictured by

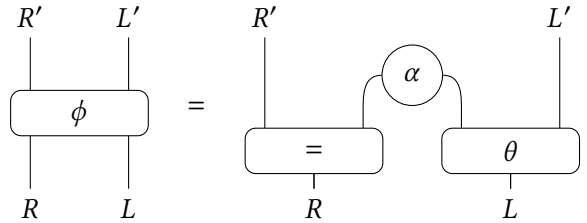

By (1.4), we have $\phi \circ \gamma' = \gamma$. Moreover, since $v = R\epsilon L$ and $v' = R'\epsilon' L'$, we have $\phi \circ v' = v \circ (\phi\phi)$ (see Figure 1.1). Thus, ϕ is a morphism of monads between (S, γ, v) and (S', γ', v') . By Lemma 1.2.1.7, the functor $B^\phi: B^{S'} \rightarrow B^S$ is characterized by

$$\mathcal{U}^{S'} B^\phi = \mathcal{U}^S \quad \text{and} \quad \mathcal{U}^{S'} \epsilon^{S'} B^\phi = \mathcal{U}^S \epsilon^S \circ (\phi \mathcal{U}^S).$$

Remember from Theorem 1.2.1.5 that the comparison functors

$$H: C \rightarrow B^S \quad \text{and} \quad H': C' \rightarrow B^{S'}$$

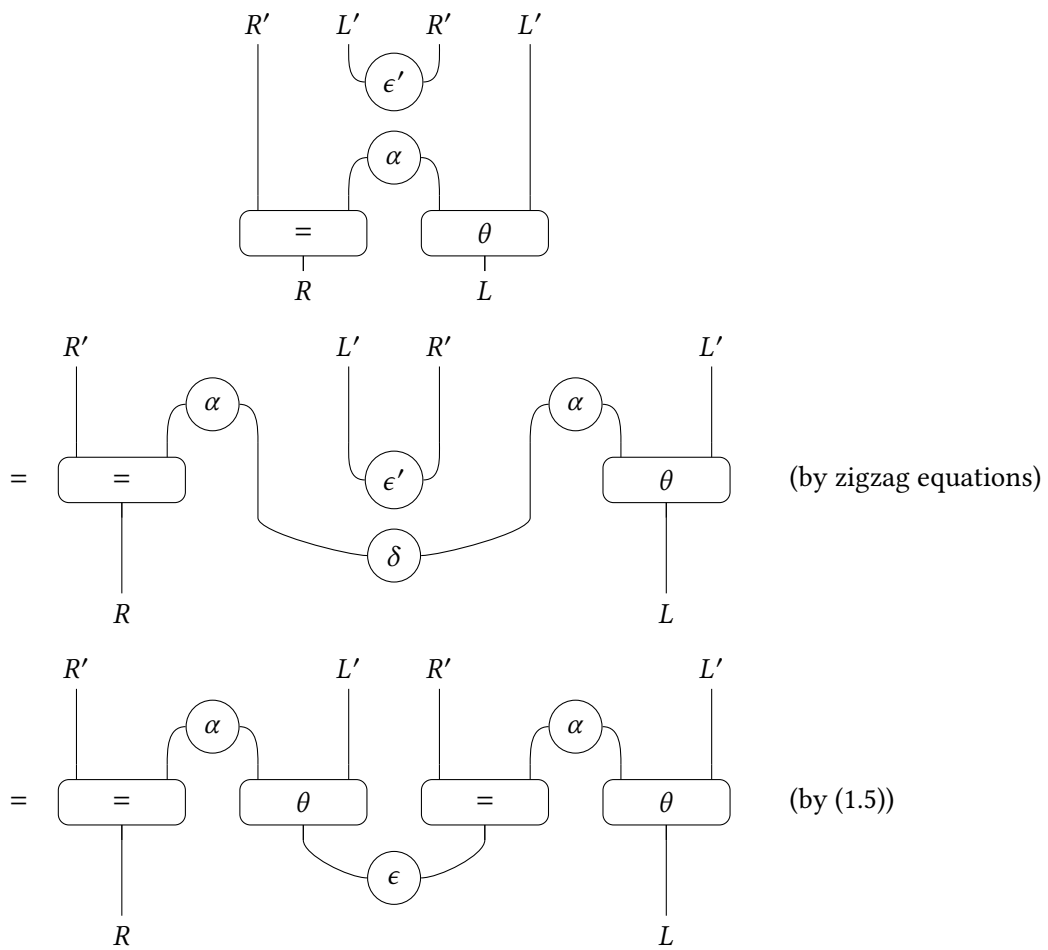

Figure 1.1 – Proof that $\phi \circ v' = v \circ (\phi\phi)$

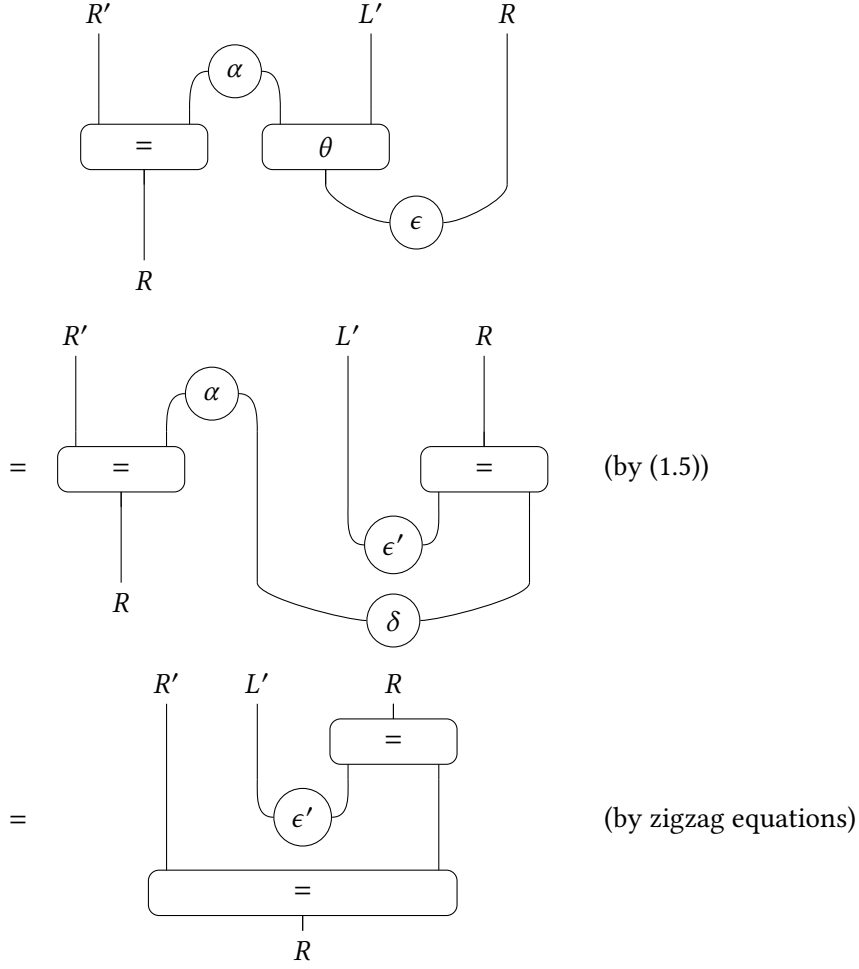

Figure 1.2 – Proof that $(R\epsilon) \circ (\phi R) = R'\epsilon'U$

are the unique functors such that

$$\begin{aligned} \mathcal{U}^S H &= R & \mathcal{U}^{S'} H' &= R' \\ \mathcal{U}^S \epsilon^S H &= R\epsilon & \mathcal{U}^{S'} \epsilon^{S'} H' &= R'\epsilon'. \end{aligned}$$

Thus,

$$\mathcal{U}^{S'} B^\phi H = \mathcal{U}^S H = R = R'U = \mathcal{U}^{S'} H'U.$$

Moreover, we have $(R\epsilon) \circ (\phi R) = R'\epsilon'U$ (see Figure 1.2), so that

$$\mathcal{U}^{S'} \epsilon^{S'} B^\phi H = (\mathcal{U}^S \epsilon^S H) \circ (\phi \mathcal{U}^S H) = (R\epsilon) \circ (\phi R) = R'\epsilon'U = \mathcal{U}^{S'} \epsilon^{S'} H'U.$$

We conclude by Theorem 1.2.1.2 that $B^\phi H = H'U$. □

Lemma 1.2.3.17. *Let $F_1 \dashv U_1$ and $I' \dashv \mathcal{T}'$ be adjunctions as in*

$$C_1 \begin{array}{c} \xrightarrow{U_1} \\ \xleftarrow{F_1} \end{array} D_1 \begin{array}{c} \xrightarrow{\mathcal{T}'} \\ \xleftarrow{I'} \end{array} D_2$$

and write

$$(T_1, \eta_1, \mu_1) \quad \text{and} \quad (S', \gamma', \nu')$$

for the monads associated to the adjunctions $F_1 \dashv U_1$ and $F_1 I' \dashv \mathcal{T}' U_1$. The comparison functor

$$\mathcal{T}'' : D_1^{T_1} \rightarrow D_2^{S'}$$

induced by the adjunction $\mathcal{F}^{T_1} I' \dashv \mathcal{T}' \mathcal{U}^{T_1} : D_1^{T_1} \rightarrow D_2$ makes the following diagram commutes

$$\begin{array}{ccccc} C_1 & \xrightarrow{H_1} & D_1^{T_1} & \xrightarrow{\mathcal{U}^{T_1}} & D_1 \\ & \searrow H' & \downarrow \mathcal{T}'' & & \downarrow \mathcal{T}' \\ & & D_2^{S'} & \xrightarrow{\mathcal{U}^{S'}} & D_2 \end{array}$$

where H_1 and H' are the comparison functors induced by the adjunctions $F_1 \dashv U_1$ and $F_1 I' \dashv \mathcal{T}' U_1$ respectively.

Proof. By the definition of \mathcal{T}'' (given in Theorem 1.2.1.5), the right square commutes. In order to show that the left triangle commutes, we use the characterization of functors $C \rightarrow D_2^{S'}$ given by Theorem 1.2.1.2. First, we compute that

$$\mathcal{U}^{S'} H' = \mathcal{T}' U_1 = \mathcal{T}' \mathcal{U}^{T_1} H_1 = \mathcal{U}^{S'} \mathcal{T}'' H_1.$$

Moreover, writing ϵ_1 and ϵ' for the counit of $F_1 \dashv U_1$ and $I' \dashv \mathcal{T}'$ respectively, we have

$$\begin{aligned} \mathcal{U}^{S'} \epsilon^{S'} H' &= (\mathcal{T}' U_1 \epsilon_1) \circ (\mathcal{T}' T_1 \epsilon' U_1) && \text{(by definition of } H' \text{ and Proposition 1.2.3.15)} \\ &= \mathcal{T}' \mathcal{U}^{T_1} \epsilon^{T_1} H_1 && \text{(by definition of } H_1) \\ &= \mathcal{U}^{S'} \epsilon^{S'} \mathcal{T}'' H_1 && \text{(by definition of } \mathcal{T}''). \end{aligned}$$

Thus $\mathcal{T}'' H_1 = H'$ by Theorem 1.2.1.2. □

Lemma 1.2.3.18. *Let a commutative square*

$$\begin{array}{ccc} C_1 & \xrightarrow{U_1} & D_1 \\ \mathcal{T} \downarrow & & \downarrow \mathcal{T}' \\ C_2 & \xrightarrow{U_2} & D_2 \end{array}$$

where $U_1, U_2, \mathcal{T}, \mathcal{T}'$ are right adjoints with associated left adjoints $F_1, F_2, \mathcal{I}, \mathcal{I}'$, such that U_1, U_2 are monadic and \mathcal{I} is fully faithful. Write

$$(T_1, \eta_1, \mu_1) \quad (T_2, \eta_2, \mu_2) \quad (S, \gamma, \nu) \quad (S', \gamma', \nu')$$

for the monads associated with the adjunctions

$$F_1 \dashv U_1 \quad F_2 \dashv U_2 \quad \mathcal{I} F_2 \dashv U_2 \mathcal{T} \quad F_1 I' \dashv \mathcal{T}' U_1$$

respectively, and write

$$H_1 : C_1 \rightarrow D_1^{T_1} \quad \text{and} \quad \mathcal{T}'' : D_1^{T_1} \rightarrow D_2^{S'}$$

for the comparison functors associated to the adjunctions $F_1 \dashv U_1$ and $\mathcal{F}^{T_1} \mathcal{I}' \dashv \mathcal{T}' \mathcal{U}^{T_1}$ respectively. Then, there exists an equivalence of categories $H_2: C_2 \rightarrow D_2^{S'}$ such that the diagram

$$\begin{array}{ccc} C_1 & \xrightarrow{H_1} & D_1^{T_1} \\ \mathcal{T} \downarrow & & \downarrow \mathcal{T}'' \\ C_2 & \xrightarrow{H_2} & D_2^{S'} \end{array}$$

commutes and $\mathcal{U}^{S'} H_2 = U_2$.

Proof. By Lemma 1.2.3.17, we have a commutative diagram

$$\begin{array}{ccc} C_1 & \xrightarrow{H_1} & D_1^{T_1} \\ & \searrow H' & \downarrow \mathcal{T}'' \\ & & D_2^{S'} \end{array}$$

where H' and \mathcal{T}'' are the comparison functors induced by the adjunctions

$$F_1 \mathcal{I}' \dashv \mathcal{T}' U_1 \quad \text{and} \quad \mathcal{F}^{T_1} \mathcal{I}' \dashv \mathcal{T}' \mathcal{U}^{T_1}$$

respectively. Let α be the unit of the adjunction $\mathcal{I} \dashv \mathcal{T}$, and ϵ_1, ϵ' be the counits of the adjunctions $F_1 \dashv U_1$ and $\mathcal{I}' \dashv \mathcal{T}'$ respectively. Since $\mathcal{T}' U_1 = U_2 \mathcal{T}$ by hypothesis, the natural transformation $\theta: F_1 \mathcal{I}' \Rightarrow \mathcal{I} F_2$ defined as the composite

$$\theta = (\epsilon_1 \mathcal{I} F_2) \circ (F_1 \epsilon' U_1 \mathcal{I} F_2) \circ (F_1 \mathcal{I}' U_2 \beta F_2) \circ (F_1 \mathcal{I}' \eta_2)$$

which can be represented as

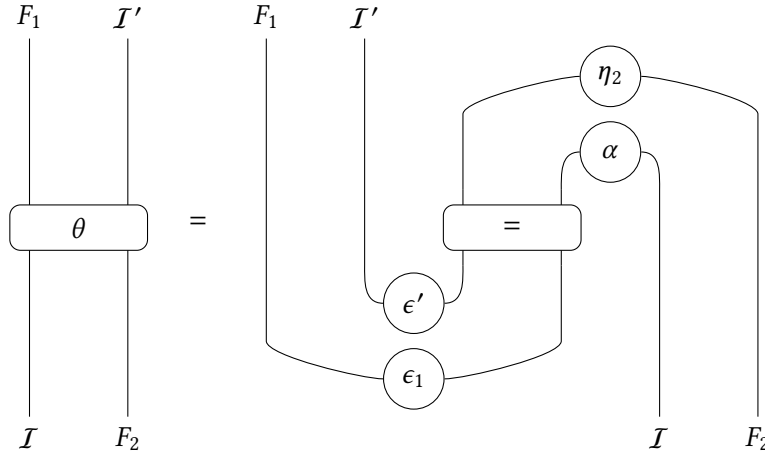

is an isomorphism by Proposition 1.2.3.14. One can then verify with the zigzag equations that the natural transformation $\phi: S' \Rightarrow S$ defined by $\phi = U_2 \mathcal{T} \theta$ is an isomorphism of monads. Moreover, writing H for the comparison functor induced by the adjunction $\mathcal{I} F_2 \dashv U_2 \mathcal{T}$, we have the diagram

$$\begin{array}{ccccc} C_1 & \xrightarrow{H'} & D_2^{S'} & \xrightarrow{\mathcal{U}^{S'}} & D_2 \\ & \searrow H & \uparrow D_2^\phi & \nearrow \mathcal{U}^S & \\ & & D_2^S & & \end{array}$$

where the left triangle commutes by the definitions of H, H', D_2^ϕ and the characterization of functors $C_1 \rightarrow D_2^S$ (c.f. Theorem 1.2.1.2), and the right triangle commutes by Lemma 1.2.1.7. Writing $\psi: T_2 \Rightarrow S$ for the morphism of monads induced by the unit of $\mathcal{I} \dashv \mathcal{T}$, by Lemmas 1.2.1.7 and 1.2.3.16, we have a commutative diagram

$$\begin{array}{ccccc} C_1 & \xrightarrow{H} & D_2^S & \xrightarrow{\mathcal{U}^S} & D_2 \\ \tau \downarrow & & D_2^\psi \downarrow & \nearrow \mathcal{U}^{T_2} & \\ C_2 & \xrightarrow{\bar{H}_2} & D_2^{T_2} & & \end{array}$$

where \bar{H}_2 is the comparison functor induced by the adjunction $F_2 \dashv U_2$. Since \mathcal{I} is supposed fully faithful, the unit of $\mathcal{I} \dashv \mathcal{T}$ is an isomorphism, so that D_2^ψ is an isomorphism. Write H_2 for

$$H_2 = D_2^\phi (D_2^\psi)^{-1} \bar{H}_2.$$

From the above commutative diagrams, we deduce that

$$\begin{array}{ccc} C_1 & \xrightarrow{H_1} & D_1^{T_1} \\ \tau \downarrow & & \downarrow \mathcal{T}'' \\ C_2 & \xrightarrow{H_2} & D_2^{S'} \end{array}$$

commutes. Moreover, since U_1 and U_2 were supposed monadic, H_1 and \bar{H}_2 are equivalence of categories (and so is H_2). By the definition of H_1 and \bar{H}_2 , we have $\mathcal{U}^{T_1} H_1 = U_1$ and $\mathcal{U}^{T_2} \bar{H}_2 = U_2$. From the later equality and the above commutative diagrams, we deduce that $\mathcal{U}^{S'} H_2 = U_2$. \square

Lemma 1.2.3.19. *Let $k, n \in \mathbb{N} \cup \{\omega\}$ with $k < n$ and (T, η, μ) be a finitary monad on \mathbf{Glob}_n . The comparison functor associated to the adjunction*

$$\mathcal{F}_n(-)_{\uparrow n}^{\mathbf{Glob}} \dashv (-)_{\leq k}^{\mathbf{Glob}} \mathcal{U}_n : \mathbf{Alg}_n \rightarrow \mathbf{Glob}_k$$

is $(-)_{\leq k}^{\mathbf{Alg}} : \mathbf{Alg}_n \rightarrow \mathbf{Alg}_k$.

Proof. By definition of $(-)_{\leq k}^{\mathbf{Alg}}$, we have

$$\mathcal{U}_k(-)_{\leq k}^{\mathbf{Alg}} = (-)_{\leq k}^{\mathbf{Glob}} \mathcal{U}_n.$$

Moreover, given $(X, h: T^n X \rightarrow X) \in \mathbf{Alg}_n$, recall that the image of (X, h) by $(-)_{\leq k}^{\mathbf{Alg}}$ is $(X_{\leq k}, h')$, where

$$h' = h_{\leq k} \circ ((-)_{\leq k}^{\mathbf{Glob}} T i^{k,n})_X.$$

Writting ϵ^n for the counit of $\mathcal{F}_n \dashv \mathcal{U}_n$ and δ for the counit of $\mathcal{F}_n(-)_{\uparrow n}^{\mathbf{Glob}} \dashv (-)_{\leq k}^{\mathbf{Glob}} \mathcal{U}_n$, we have

$$h' = ((-)_{\leq k}^{\mathbf{Glob}} \mathcal{U}_n \epsilon^n)_{(X, h)} \circ ((-)_{\leq k}^{\mathbf{Glob}} \mathcal{U}_n \mathcal{F}_n i^{k,n} \mathcal{U}_n)_{(X, h)} = ((-)_{\leq k}^{\mathbf{Glob}} \mathcal{U}_n \delta)_{(X, h)}.$$

Thus, writting ϵ^k for the counit of $\mathcal{F}_k \dashv \mathcal{U}_k$, we have

$$(\mathcal{U}_k \epsilon^k (-)_{\leq k}^{\mathbf{Alg}})_{(X, h)} = h' = ((-)_{\leq k}^{\mathbf{Glob}} \mathcal{U}_n \delta)_{(X, h)}$$

so that $(-)_{\leq k}^{\mathbf{Alg}}$ is the comparison functor associated to $\mathcal{F}_n(-)_{\uparrow n}^{\mathbf{Glob}} \dashv (-)_{\leq k}^{\mathbf{Glob}} \mathcal{U}_n$ as a consequence of Theorem 1.2.1.5. \square

We have now enough material to show the following criterion for recognizing that some functor between two categories is equivalent to the truncation functor between two categories of globular algebras as defined in Paragraph 1.2.3.6:

Theorem 1.2.3.20. *Let $k, n \in \mathbb{N} \cup \{\omega\}$ with $k < n$, and a diagram in CAT*

$$\begin{array}{ccc} C & \begin{array}{c} \xrightarrow{U_1} \\ \xleftarrow{F_1} \end{array} & \mathbf{Glob}_n \\ \mathcal{I} \uparrow \downarrow \mathcal{T} & & \downarrow (-)_{\leq k}^{\mathbf{Glob}} \\ C' & \begin{array}{c} \xrightarrow{U_2} \\ \xleftarrow{F_2} \end{array} & \mathbf{Glob}_k \end{array}$$

such that $(-)_{\leq k}^{\mathbf{Glob}} U_1 = U_2 \mathcal{T}$ and such that we have adjunctions

$$F_1 \dashv U_1 \quad F_2 \dashv U_2 \quad \mathcal{I} \dashv \mathcal{T}$$

where \mathcal{I} is fully faithful and U_1, U_2 are monadic. Write (T, η, μ) for the monad induced by $F_1 \dashv U_1$, and \mathbf{Alg}_n and \mathbf{Alg}_k for the globular algebras defined from T , and $H: C \rightarrow \mathbf{Alg}_n$ for the comparison functor induced by $F_1 \dashv U_1$. Then, there exists an equivalence of categories

$$H': C' \rightarrow \mathbf{Alg}_k$$

making the following diagram commute

$$\begin{array}{ccc} C & \xrightarrow{H} & \mathbf{Alg}_n \\ \mathcal{T} \downarrow & & \downarrow (-)_{\leq k}^{\mathbf{Alg}} \\ C' & \xrightarrow{H'} & \mathbf{Alg}_k \end{array}$$

and such that $\mathcal{U}_k H' = U_2$.

Remark 1.2.3.21. By its definition as comparison functor, H satisfies that $\mathcal{U}_n H = U_1$. Since U_1 is monadic, H is moreover an equivalence of categories.

Proof. By Theorem 1.2.1.5, we have $\mathcal{U}_n H = U_1$. The last part of the statement is a consequence of Lemmas 1.2.3.18 and 1.2.3.19. \square

In the above theorem, C and C' should be thought as categories of n -categories and k -categories, and \mathcal{T} as a truncation functor, all defined “by hand” outside Batanin’s setting. The theorem then gives a criterion to know whether these objects are equivalent to the ones defined in Paragraphs 1.2.3.1 and 1.2.3.6. In particular, we will use this theorem to show that the equational definitions of strict categories and precategories, and their truncation functors, are equivalent to the ones given by Batanin’s setting (*c.f.* Theorems 1.4.2.8 and 1.4.1.10). For now, we illustrate the use of Theorem 1.2.3.20 on a dummy example:

Example 1.2.3.22. Consider the monad (T, η, μ) on \mathbf{Glob}_1 defined in Example 1.2.3.3. Write $\tilde{\mathcal{U}}_1$ for the monadic functor $\mathbf{Cat} \rightarrow \mathbf{Glob}_1$ defined in Example 1.1.2.10 (where we identify the category of graphs \mathbf{Gph} with the category of 1-globular sets \mathbf{Glob}_1), and write $\tilde{\mathcal{U}}_0$ for the identity functor between \mathbf{Set} and \mathbf{Glob}_0 , which is monadic too. Consider the canonical functor $\mathcal{T}: \mathbf{Cat} \rightarrow \mathbf{Set}$ which maps a small category C to its underlying set of 0-cells C_0 . This functor makes the following diagram commute:

$$\begin{array}{ccc} \mathbf{Cat} & \xrightarrow{\tilde{\mathcal{U}}_1} & \mathbf{Glob}_1 \\ \mathcal{T} \downarrow & & \downarrow (-)_{\leq 0}^{\mathbf{Glob}} \\ \mathbf{Set} & \xrightarrow{\tilde{\mathcal{U}}_0} & \mathbf{Glob}_0 \end{array}$$

Moreover, \mathcal{T} has a left adjoint \mathcal{I} which maps a set S to the small category whose set of 0-cells is S and whose only 1-cells are the identity cells id_s^1 for $s \in S$. The functor \mathcal{I} is then fully faithful since $\mathcal{T}\mathcal{I} = \text{id}_{\text{Set}}$ and the unit of the adjunction $\mathcal{I} \dashv \mathcal{T}$ is the identity on id_{Set} . Thus, Theorem 1.2.3.20 applies and, writing $H_1: \text{Cat} \rightarrow \text{Alg}_1$ for the comparison functor associated with the functor $\bar{\mathcal{U}}_1$, there exists an equivalence of categories $H_0: \text{Set} \rightarrow \text{Alg}_0$ such that the diagram

$$\begin{array}{ccc} \text{Cat} & \xrightarrow{H_1} & \text{Alg}_1 \\ \mathcal{T} \downarrow & & \downarrow (-)_{\leq 0}^{\text{Alg}} \\ \text{Set} & \xrightarrow{H_0} & \text{Alg}_0 \end{array}$$

commutes and we moreover have $\mathcal{U}_0 H_0 = \bar{\mathcal{U}}_0$ and $\mathcal{U}_1 H_1 = \bar{\mathcal{U}}_1$. Note that H_1 is an equivalence of categories too since $\bar{\mathcal{U}}_1$ is monadic.

1.2.4 Truncable globular monads

The general setting of higher category theories as monads over globular sets allows defining theories with unusual operations, like compositions of l -cells that produce unrelated l' -cells for some $l' < l$ (c.f. Example 1.2.3.4). Anticipating the next section, such theories are badly behaved when it comes to freely adding new $(k+1)$ -generators to k -categories, since the underlying k -categories will not be preserved in the process. In order not to allow such monads, we recall from [Bat98a] the notion of *truncable monad* which forbids those problematic operations and still includes most usual theories for higher categories: those are the monads which “commute with truncation” in a suitable sense. As we will see in the next section, the k -categories of these theories are preserved when freely adding $(k+1)$ -generators.

1.2.4.1 – Truncability. Let $n \in \mathbb{N} \cup \{\omega\}$ and (T, η, μ) be a finitary monad on \mathbf{Glob}_n . For $k \in \mathbb{N}_n$, the counit of the truncation and inclusion functors between n - and k -globular sets

$$i^{k,n}: (-)_{\uparrow n}^{\text{Glob}} (-)_{\leq k}^{\text{Glob}} \rightarrow \text{id}_{\mathbf{Glob}_n}$$

induces a natural transformation t^k where

$$t^k = (-)_{\leq k}^{\text{Glob}} T i^{k,n}: T^k (-)_{\leq k}^{\text{Glob}} \Rightarrow (-)_{\leq k}^{\text{Glob}} T: \mathbf{Glob}_n \rightarrow \mathbf{Glob}_k$$

The monad T is said *weakly truncable* when t^k is an isomorphism for each $k \in \mathbb{N}$; it is *truncable* when $T_k (-)_{\leq k}^{\text{Glob}} = (-)_{\leq k}^{\text{Glob}} T$ and t^k is the identity natural transformation for each $k \in \mathbb{N}$.

Example 1.2.4.2. The monad (T, η, μ) of categories on \mathbf{Glob}_1 defined in Example 1.2.3.3 is weakly truncable. By choosing adequately the left adjoint $\mathbf{Glob}_1 \rightarrow \text{Cat}$ that defines T , we can even suppose that T is truncable. More generally, we will see in Section 1.4.1 that the monad of strict ω -categories is weakly truncable, and even truncable up to an isomorphism of monads.

Example 1.2.4.3. The monad (T, η, μ) of weird 2-categories on \mathbf{Glob}_2 defined in Example 1.2.3.4 is not truncable since, for $X \in \mathbf{Glob}_2$, we have

$$(TX)_0 \simeq X_0 \sqcup (X_2 \times X_2) \quad \text{and} \quad (T^0(X_{\leq 0}))_0 \simeq X_0.$$

The following property justifies that we only handle the case of truncable monads:

Proposition 1.2.4.4. *If (T, η, μ) is weakly truncable, then it is isomorphic to a monad which is truncable.*

Proof. We define a truncable monad $(\bar{T}, \bar{\eta}, \bar{\mu})$ on \mathbf{Glob}_n and an isomorphism of monad $\phi: T \rightarrow \bar{T}$ from their truncations

$$(-)_{\leq k}^{\text{Glob} \bar{T}} \quad \text{and} \quad \phi_{\leq k}: (-)_{\leq k}^{\text{Glob} T} \rightarrow (-)_{\leq k}^{\text{Glob} \bar{T}}$$

and we define those using an induction on k for $k \in \mathbb{N}_n$. In dimension 0, we put

$$(-)_{\leq 0}^{\text{Glob} \bar{T}} = T^0(-)_{\leq 0}^{\text{Glob}} \quad \text{and} \quad \phi_0 = (\mathfrak{t}^0)^{-1}$$

Then, given $k \in \mathbb{N}_n$ and a $(k+1)$ -globular set X , we define $(\bar{T}X)_{\leq k+1}$ as the $(k+1)$ -globular set Y where

$$Y_{\leq k} = (\bar{T}X)_{\leq k} \quad \text{and} \quad Y_{k+1} = (T^{k+1}(X_{\leq k+1}))_{k+1}$$

and the operation $\partial_k^\epsilon: Y_{k+1} \rightarrow Y_k$ is defined as the composite

$$Y_{k+1} = (T^{k+1}(X_{\leq k+1}))_{k+1} \xrightarrow{\partial_k^\epsilon} (T^{k+1}(X_{\leq k+1}))_k \xrightarrow{(\mathfrak{t}^{k+1})_k} (TX)_k \xrightarrow{(\phi_k)_k} (\bar{T}X)_k$$

for $\epsilon \in \{-, +\}$. Our definition extends canonically to a functor

$$(-)_{\leq k+1}^{\text{Glob} \bar{T}}: \mathbf{Glob}_n \rightarrow \mathbf{Glob}_{k+1}.$$

We also extend $\phi_{\leq k}$ on dimension $k+1$ by putting, for $X \in \mathbf{Glob}_n$,

$$(\phi_X)_{k+1} = ((\mathfrak{t}_X^{k+1})^{-1})_{k+1}: (TX)_{k+1} \rightarrow (\bar{T}X)_{k+1}$$

So we defined $\bar{T}: \mathbf{Glob}_n \rightarrow \mathbf{Glob}_n$ together with an isomorphism $\phi: T \rightarrow \bar{T}$. Finally, we put

$$\bar{\eta} = \phi \circ \eta \quad \text{and} \quad \bar{\mu} = \phi \circ \mu \circ (\phi^{-1} \phi^{-1})$$

so that $(\bar{T}, \bar{\eta}, \bar{\mu})$ is a monad. By the definition of \bar{T} , we easily verify that $(\bar{T}, \bar{\eta}, \bar{\mu})$ is truncable. \square

When T is truncable, the T^k , η^k and μ^k can be related through the equations given by the following lemma:

Lemma 1.2.4.5. *If T is truncable, then, for $k, l \in \mathbb{N}_n \cup \{n\}$ with $k < l$, we have*

$$T^k(-)_{\leq k, l}^{\text{Glob}} = (-)_{\leq k, l}^{\text{Glob}} T^l \quad \text{and} \quad (-)_{\leq k, l}^{\text{Glob}} \eta^l = \eta^k(-)_{\leq k, l}^{\text{Glob}} \quad \text{and} \quad (-)_{\leq k, l}^{\text{Glob}} \mu^l = \mu^k(-)_{\leq k, l}^{\text{Glob}}$$

Proof. We compute that

$$\begin{aligned} T^k(-)_{\leq k, l}^{\text{Glob}} &= T^k(-)_{\leq k, n}^{\text{Glob}}(-)_{\uparrow n, l}^{\text{Glob}} \\ &= (-)_{\leq k, n}^{\text{Glob}} T(-)_{\uparrow n, l}^{\text{Glob}} \\ &= (-)_{\leq k, l}^{\text{Glob}} T^l \end{aligned}$$

and

$$\begin{aligned} (-)_{\leq k, l}^{\text{Glob}} \eta^l &= (-)_{\leq k, l}^{\text{Glob}}(-)_{\leq l, n}^{\text{Glob}} \eta(-)_{\uparrow n, l}^{\text{Glob}} && \text{(by definition of } \eta^l) \\ &= ((-)_{\leq k, n}^{\text{Glob}} \eta(-)_{\uparrow n, l}^{\text{Glob}}) \circ ((-)_{\leq k, n}^{\text{Glob}} \mathfrak{i}^{k, n}(-)_{\uparrow n, l}^{\text{Glob}}) \\ &= ((-)_{\leq k, n}^{\text{Glob}} T \mathfrak{i}^{k, n}(-)_{\uparrow n, l}^{\text{Glob}}) \circ ((-)_{\leq k, n}^{\text{Glob}} \eta(-)_{\uparrow n, k}^{\text{Glob}}(-)_{\leq k, n}^{\text{Glob}}(-)_{\uparrow n, l}^{\text{Glob}}) && \text{(by naturality)} \\ &= (-)_{\leq k, n}^{\text{Glob}} \eta(-)_{\uparrow n, k}^{\text{Glob}}(-)_{\leq k, l}^{\text{Glob}} && \text{(by truncability)} \\ &= \eta^k(-)_{\leq k, l}^{\text{Glob}} && \text{(by definition of } \eta^k) \end{aligned}$$

and

$$\begin{aligned}
(-)_{\leq k, l}^{\text{Glob}} \mu^l &= ((-)_{\leq k, l}^{\text{Glob}} (-)_{\leq l, n}^{\text{Glob}} \mu(-)_{\uparrow n, l}^{\text{Glob}}) \circ ((-)_{\leq k, l}^{\text{Glob}} (-)_{\leq l, n}^{\text{Glob}} T i^{l, n} T (-)_{\uparrow n, l}^{\text{Glob}}) && \text{(by definition of } \mu^l \text{)} \\
&= ((-)_{\leq k, n}^{\text{Glob}} \mu(-)_{\uparrow n, l}^{\text{Glob}}) \circ ((-)_{\leq k, l}^{\text{Glob}} (-)_{\leq l, n}^{\text{Glob}} T i^{l, n} T (-)_{\uparrow n, l}^{\text{Glob}}) \\
&= ((-)_{\leq k, n}^{\text{Glob}} \mu(-)_{\uparrow n, l}^{\text{Glob}}) && \text{(by truncability)} \\
&= ((-)_{\leq k, n}^{\text{Glob}} \mu(-)_{\uparrow n, l}^{\text{Glob}}) \circ ((-)_{\leq k, n}^{\text{Glob}} T i^{k, n} T (-)_{\uparrow n, l}^{\text{Glob}}) && \text{(by truncability)} \\
&= ((-)_{\leq k, n}^{\text{Glob}} \mu(-)_{\uparrow n, l}^{\text{Glob}}) \circ ((-)_{\leq k, n}^{\text{Glob}} T i^{k, n} T (-)_{\uparrow n, l}^{\text{Glob}}) \\
&\quad \circ ((-)_{\leq k, n}^{\text{Glob}} T (-)_{\uparrow n, k}^{\text{Glob}} (-)_{\leq k, n}^{\text{Glob}} T i^{k, n} (-)_{\uparrow n, l}^{\text{Glob}}) && \text{(by truncability)} \\
&= ((-)_{\leq k, n}^{\text{Glob}} \mu(-)_{\uparrow n, l}^{\text{Glob}}) \circ ((-)_{\leq k, n}^{\text{Glob}} T T i^{k, n} (-)_{\uparrow n, l}^{\text{Glob}}) \\
&\quad \circ ((-)_{\leq k, n}^{\text{Glob}} T i^{k, n} T (-)_{\uparrow n, k}^{\text{Glob}} (-)_{\leq k, n}^{\text{Glob}} (-)_{\uparrow n, l}^{\text{Glob}}) && \text{(by naturality)} \\
&= ((-)_{\leq k, n}^{\text{Glob}} T i^{k, n} (-)_{\uparrow n, l}^{\text{Glob}}) \circ ((-)_{\leq k, n}^{\text{Glob}} \mu(-)_{\uparrow n, k}^{\text{Glob}} (-)_{\leq k, n}^{\text{Glob}} (-)_{\uparrow n, l}^{\text{Glob}}) \\
&\quad \circ ((-)_{\leq k, n}^{\text{Glob}} T i^{k, n} T (-)_{\uparrow n, k}^{\text{Glob}} (-)_{\leq k, n}^{\text{Glob}} (-)_{\uparrow n, l}^{\text{Glob}}) && \text{(by naturality)} \\
&= ((-)_{\leq k, n}^{\text{Glob}} \mu(-)_{\uparrow n, k}^{\text{Glob}} (-)_{\leq k, l}^{\text{Glob}}) \circ ((-)_{\leq k, n}^{\text{Glob}} T i^{k, n} T (-)_{\uparrow n, k}^{\text{Glob}} (-)_{\leq k, l}^{\text{Glob}}) && \text{(by truncability)} \\
&= \mu^k(-)_{\leq k, l}^{\text{Glob}} && \text{(by definition of } \mu^k \text{)}
\end{aligned}$$

which concludes the proof. \square

We now prove several properties of truncable monads regarding truncation of algebras. First, the truncation of algebras has now a simpler definition:

Proposition 1.2.4.6. *If T is truncable, then given $k, l \in \mathbb{N}_n \cup \{n\}$ such that $k < l$, and an l -algebra $(X, h) \in \mathbf{Alg}_l$, we have $(X, h)_{\leq k} = (X_{\leq k}, h_{\leq k})$.*

Proof. Indeed, since T is truncable, we have

$$((-)_{\leq k, l}^{\text{Glob}} T^l i^{k, l})_X = (T^k (-)_{\leq k, l}^{\text{Glob}} i^{k, l})_X = \text{id}_{T^k X}$$

so that $(X, h)_{\leq k} = (X_{\leq k}, h_{\leq k})$. \square

Moreover, the operation of truncation of algebras is now a left adjoint:

Proposition 1.2.4.7. *If T is truncable, then, given $k, l \in \mathbb{N}_n \cup \{n\}$ with $k < l$, the functor*

$$(-)_{\leq k, l}^{\text{Alg}} : \mathbf{Alg}_l \rightarrow \mathbf{Alg}_k$$

is a left adjoint. In particular, it preserves colimits.

Proof. Given $(Y, h : T^k Y \rightarrow Y)$ an element of \mathbf{Alg}_k , we define a T^l -algebra

$$(Y', h' : T^l Y' \rightarrow Y')$$

that will represent the functor

$$\mathbf{Alg}_k((-)_{\leq k}^{\text{Alg}}, (Y, h)) : \mathbf{Alg}_l^{\text{op}} \rightarrow \mathbf{Set}$$

We put $Y' = Y_{\uparrow l}$ and we define $h' : T^l Y' \rightarrow Y'$, by the universal property of the adjunction

$$(-)_{\leq k}^{\text{Glob}} \dashv (-)_{\uparrow l}^{\text{Glob}}$$

as the unique morphism such that $h'_{\leq k} = h$. We verify that $(Y', h') \in \mathbf{Alg}_l$. By Lemma 1.2.4.5, we have

$$(T^l(h'))_{\leq k} = T^k(h), \quad (-)_{\leq k}^{\text{Glob}} \eta^l = \eta^k (-)_{\leq k}^{\text{Glob}} \quad \text{and} \quad (-)_{\leq k}^{\text{Glob}} \mu^l = \mu^k (-)_{\leq k}^{\text{Glob}}$$

so that

$$\begin{aligned} (h' \circ \eta_{Y'}^l)_{\leq k} &= h \circ \eta_Y^k \\ &= \text{id}_Y \\ &= (\text{id}_{Y'})_{\leq k} \end{aligned}$$

and

$$\begin{aligned} (h' \circ \mu_{Y'}^l)_{\leq k} &= h \circ \mu_Y^k \\ &= h \circ T^k(h) \\ &= (h' \circ T^l(h'))_{\leq k}. \end{aligned}$$

By the universal property of $Y' = Y_{\uparrow l}$, this implies

$$h' \circ \eta_{Y'}^l = \text{id}_{Y'}, \quad \text{and} \quad h' \circ T^l(h') = h' \circ \mu_{Y'}^l$$

so that (Y', h') is a T^l -algebra. Now, since T is truncable, given a T^l -algebra (X, g) and a T^l -algebra morphism $f: (X, g) \rightarrow (Y', h')$, the globular k -truncation of f induces a T^k -algebra morphism

$$f_{\leq k}: (X, g)_{\leq k} \rightarrow (Y, h).$$

Conversely, given a T^k -algebra morphism $f: (X, g)_{\leq k} \rightarrow (Y, h)$, by the universal property of Y' , there is a unique morphism $f': X \rightarrow Y'$ of \mathbf{Glob}_l such that $f'_{\leq k} = f$. Moreover, we have

$$\begin{aligned} (h' \circ T^l(f'))_{\leq k} &= h \circ T^k(f) \\ &= f \circ g_{\leq k} && \text{(by Proposition 1.2.4.6)} \\ &= (f' \circ g)_{\leq k} \end{aligned}$$

so that $h' \circ T^l(f') = f' \circ g$ by the same argument as above. Thus, f' is a T^l -algebra morphism. Hence, there is a bijection

$$\Phi_{(X,g)}: \mathbf{Alg}_k((X, g)_{\leq k}, (Y, h)) \rightarrow \mathbf{Alg}_l((X, g), (Y', h'))$$

which is natural in (X, g) . We conclude that $(-)_{\leq k}^{\text{Alg}}$ is a left adjoint. \square

1.2.4.8 – Characterization of truncable monads. Earlier, we introduced Theorem 1.2.3.20 that allows to recognize that some categories and functors between them are equivalent to the categories of globular algebras and the associated truncation functors derived from a monad T on globular sets, without having to explicitly describe this monad. But, by the current definition of truncability, in order to show that the monad T is truncable, a direct proof would require to show that the natural transformations $(-)_{\leq l}^{\text{Glob}} T i^{l,n}$ are isomorphisms, so that a description of T is still needed. Below, we introduce a characterization of the truncability of T that does not rely on such tedious description.

We start by proving the following lemma, relating the functors \mathcal{F}_k :

Lemma 1.2.4.9. *Let $n \in \mathbb{N} \cup \{\omega\}$ and (T, η, μ) be a finitary monad on \mathbf{Glob}_n . Given $k \in \mathbb{N}$ such that $k < n$, we have*

$$(-)_{\leq k}^{\text{Alg}} \mathcal{F}_n (-)_{\uparrow n,k}^{\text{Glob}} = \mathcal{F}_k.$$

Proof. We first compute that

$$\begin{aligned} \mathcal{U}_k(-)_{\leq k}^{\text{Alg}} \mathcal{F}_n(-)_{\uparrow n, k}^{\text{Glob}} &= (-)_{\leq k}^{\text{Glob}} \mathcal{U}_n \mathcal{F}_n(-)_{\uparrow n, k}^{\text{Glob}} \\ &= (-)_{\leq k}^{\text{Glob}} T^n(-)_{\uparrow n, k}^{\text{Glob}} \\ &= T^k \\ &= \mathcal{U}_k \mathcal{F}_k. \end{aligned}$$

Moreover, witting ϵ^k and ϵ^n for the counit of the adjunctions

$$\mathcal{F}_k \dashv \mathcal{U}_k \quad \text{and} \quad \mathcal{F}_n \dashv \mathcal{U}_n$$

respectively, we have

$$\begin{aligned} \epsilon^k(-)_{\leq k}^{\text{Alg}} \mathcal{F}_n(-)_{\uparrow n, k}^{\text{Glob}} &= (-)_{\leq k}^{\text{Glob}} ((\mathcal{U}_n \epsilon^n) \circ (T^n i^{k, n} \mathcal{U}_n)) \mathcal{F}_n(-)_{\uparrow n, k}^{\text{Glob}} \quad (\text{by definition of } (-)_{\leq k, n}^{\text{Alg}}) \\ &= (-)_{\leq k}^{\text{Glob}} ((\mathcal{U}_n \epsilon^n \mathcal{F}_n) \circ (T^n i^{k, n} T^n)) (-)_{\uparrow n, k}^{\text{Glob}} \\ &= (-)_{\leq k}^{\text{Glob}} (\mu^n \circ (T^n i^{k, n} \mathcal{F}_n)) (-)_{\uparrow n, k}^{\text{Glob}} \\ &= \mu^k \quad (\text{by definition of } \mu^k) \\ &= \epsilon^k \mathcal{F}_k \end{aligned}$$

so that

$$(-)_{\leq k}^{\text{Alg}} \mathcal{F}_n(-)_{\uparrow n, k}^{\text{Glob}} = \mathcal{F}_k$$

by Theorem 1.2.1.2. □

Now, we prove that truncable monads can be characterized through the associated globular algebras:

Proposition 1.2.4.10. *Let $n \in \mathbb{N} \cup \{\omega\}$ and (T, η, μ) be a finitary monad on \mathbf{Glob}_n . Then, the monad (T, η, μ) is weakly truncable (resp. truncable) if and only if, for $k \in \mathbb{N}_{n-1}$, the natural transformation*

$$(-)_{\leq k}^{\text{Alg}} \mathcal{F}_n i^{k, n} : \mathcal{F}_k(-)_{\leq k}^{\text{Glob}} \Rightarrow (-)_{\leq k}^{\text{Alg}} \mathcal{F}_n$$

is an isomorphism (resp. an identity).

Proof. Note that the domain of $(-)_{\leq k}^{\text{Alg}} \mathcal{F}_n i^{k, n}$ is the claimed one by Lemma 1.2.4.9. For $k \in \mathbb{N}_{n-1}$, we have that

$$\begin{aligned} \mathcal{U}_k(-)_{\leq k}^{\text{Alg}} \mathcal{F}_n i^k &= (-)_{\leq k}^{\text{Glob}} \mathcal{U}_n \mathcal{F}_n i^k \\ &= (-)_{\leq k}^{\text{Glob}} T i^k. \end{aligned}$$

The proposition follows from the fact that \mathcal{U}_k reflects isomorphisms (resp. identities). □

Given $k \in \mathbb{N}$, we write

$$j^{k, n} : \text{id}_{\mathbf{Glob}_n} \Rightarrow (-)_{\uparrow n, k}^{\text{Glob}} (-)_{\leq k, n}^{\text{Glob}}$$

or simply j^k , for the unit of the adjunction $(-)_{\leq k, n}^{\text{Glob}} \dashv (-)_{\uparrow n, k}^{\text{Glob}} : \mathbf{Glob}_k \rightarrow \mathbf{Glob}_n$. We have the following criterion for showing the truncability of monads through their globular algebras:

Theorem 1.2.4.11. *Let $n \in \mathbb{N} \cup \{\omega\}$ and (T, η, μ) be a finitary monad on \mathbf{Glob}_n . The monad (T, η, μ) is weakly truncable if and only if, for $k \in \mathbb{N}_{n-1}$, the functor $(-)_{\leq k, n}^{\text{Alg}}$ has a right adjoint, that we write $(-)_{\uparrow n, k}^{\text{Alg}}$, which satisfies that $j^k \mathcal{U}_n(-)_{\uparrow n, k}^{\text{Alg}}$ is an isomorphism.*

Proof. By Proposition 1.2.4.7, if T is weakly truncable, $(-)^{\text{Alg}}_{\leq k, n}$ has a right adjoint, so we can suppose that it is the case and denote it by $(-)^{\text{Alg}}_{\uparrow n, k}$. Then, the morphism $(-)^{\text{Alg}}_{\leq k} \mathcal{F}_n i^k$, pictured by

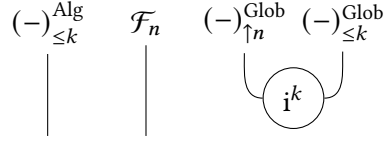

is a natural transformation between two composites of left adjoints. Then, by Proposition 1.2.3.15 and (the dual of) Proposition 1.2.3.14, the latter natural transformation is an isomorphism if and only if the morphism depicted by the string diagram

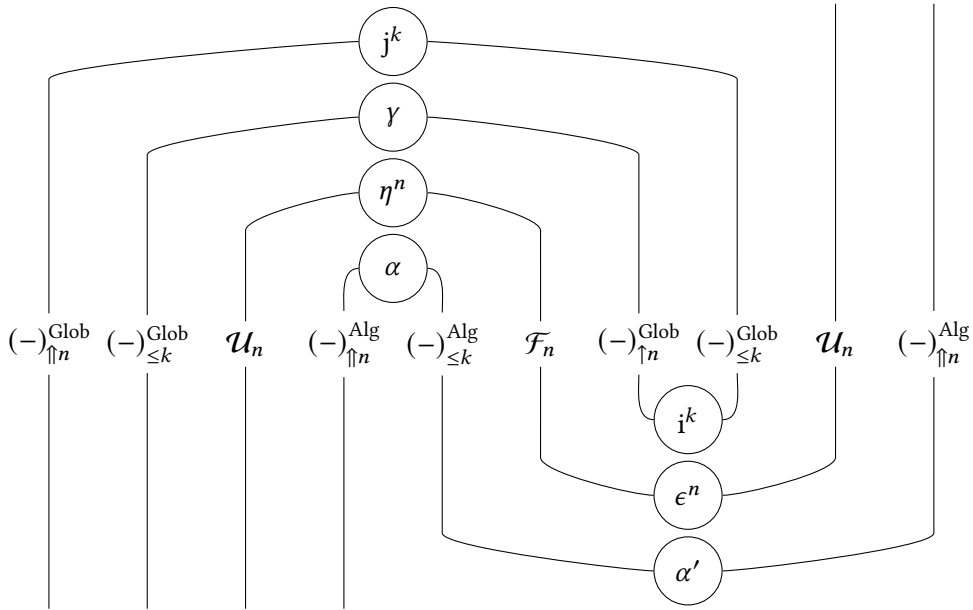

is an isomorphism, where (α, α') , (η^n, ϵ^n) , (γ, i^k) are the pairs of units and counits associated with the adjunctions $(-)^{\text{Alg}}_{\leq k} \dashv (-)^{\text{Alg}}_{\uparrow n}$, $\mathcal{F}_n \dashv \mathcal{U}_n$ and $(-)^{\text{Glob}}_{\uparrow n} \dashv (-)^{\text{Glob}}_{\leq k}$ respectively. Using the equations satisfied by adjunctions to reduce the above diagram, we obtain

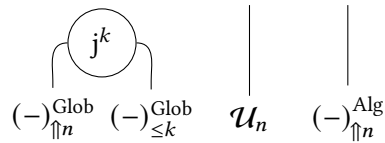

which is the diagram associated to the morphism $j^k \mathcal{U}_k (-)^{\text{Alg}}_{\uparrow k}$. Thus, $(-)^{\text{Alg}}_{\leq k} \mathcal{F}_n i^k$ is an isomorphism if and only if $j^k \mathcal{U}_k (-)^{\text{Alg}}_{\uparrow k}$ is an isomorphism. We conclude with Lemma 1.2.4.10. \square

We will use the above criterion to show that the monads associated to the theories of strict categories and precategories are weakly truncable (*c.f.* Theorems 1.4.2.9 and 1.4.1.11). For now, we illustrate its use by showing that the simple monad from Example 1.2.3.3 is weakly truncable:

Example 1.2.4.12. Consider the monad (T, η, μ) on \mathbf{Glob}_1 from Example 1.2.3.3. Recall from Example 1.2.3.22 the definitions of the functors

$$\mathcal{T} : \mathbf{Cat} \rightarrow \mathbf{Set} \quad \bar{\mathcal{U}}_0 : \mathbf{Set} \rightarrow \mathbf{Glob}_0 \quad \bar{\mathcal{U}}_1 : \mathbf{Cat} \rightarrow \mathbf{Glob}_1.$$

One easily verifies that the functor $\mathcal{T} : \mathbf{Cat} \rightarrow \mathbf{Set}$ has a right adjoint $\mathcal{G} : \mathbf{Set} \rightarrow \mathbf{Cat}$ which is the canonical functor mapping a set S to the category whose set of 0-cells is S and which has exactly one 1-cell between every pair of 0-cells. For this definition and the one of j^0 , we have that $j^0 \bar{\mathcal{U}}_1 \mathcal{G}$ is an isomorphism. Since, from Example 1.2.3.22, we have a commutative diagram

$$\begin{array}{ccc} \mathbf{Cat} & \xrightarrow{H_1} & \mathbf{Alg}_1 \\ \mathcal{T} \downarrow & & \downarrow (-)_{\leq 0}^{\mathbf{Alg}} \\ \mathbf{Set} & \xrightarrow{H_0} & \mathbf{Alg}_0 \end{array}$$

where H_0 and H_1 are equivalences of categories such that $\mathcal{U}_0 H_0 = \bar{\mathcal{U}}_0$ and $\mathcal{U}_1 H_1 = \bar{\mathcal{U}}_1$, the functor $(-)_{\leq 0,1}^{\mathbf{Alg}}$ has a right adjoint $(-)_{\uparrow 1,0}^{\mathbf{Alg}}$ such that $j^0 \mathcal{U}_1 (-)_{\uparrow 1,0}^{\mathbf{Alg}}$ is an isomorphism. Thus, the monad T is truncable by Theorem 1.2.4.11.

1.3 Free higher categories on generators

Given some theory of higher categories, an important construction is the one that builds a k -category which is freely generated on a set of generators. Indeed, like for other algebraic theories, a k -category can be described by means of a *presentation*, *i.e.*, by quotienting a free k -category by a set of relations. Such presentations are all the more interesting from a computational perspective since they allow encoding higher categories with possibly infinite number of cells as finite data. For example, a formal adjunction can be described as the strict 2-category generated by two 0-cells x and y , two 1-cells $l : y \rightarrow x$ and $r : x \rightarrow y$, and two 2-cells $\gamma : \text{id}_y \Rightarrow l *_0 r$ and $\epsilon : r *_0 l \Rightarrow \text{id}_x$ satisfying the zigzag equations (1.3). Given a theory of higher categories expressed in Batanin's setting, *i.e.*, as a monad (T, η, μ) on \mathbf{Glob}_n for some $n \in \mathbb{N} \cup \{\omega\}$, there are several free constructions that one can consider. First, the functors $\mathcal{F}_k : \mathbf{Glob}_k \rightarrow \mathbf{Alg}_k$ already enable to construct the free k -category on a k -globular set. Moreover, there is a construction which produces a $(k+1)$ -category from a k -cellular extension, *i.e.*, a pair consisting of a k -category and a set of $(k+1)$ -generators. Such construction was introduced for strict categories in [Bur93]. Finally, one can consider the free k -category on a k -polygraph: the latter is a system of i -generators for $i \in \mathbb{N}_n$ which is organized inductively as cellular extensions. It differs from a mere k -globular set in the sense that a k -polygraph allows generators to have complex sources and targets that are composites of other generators, whereas the sources and targets of generators organized in a k -globular set can only be globes. Polygraphs were first introduced by Street [Str76] and Burroni [Bur93] for strict categories, and then generalized to any finitary monad on globular sets by Batanin [Bat98a].

The aim of this section is to introduce the definitions of *cellular extensions* and *polygraphs* together with the associated free constructions. Since most of the definitions rely on pullbacks in CAT, we first recall some properties of these pullbacks (Section 1.3.1). Then, we introduce *cellular extensions* together with the associated free construction for any finitary monad on globular sets, and, in the case of a truncable monad, we show that this construction is stable, *i.e.*, that freely adding $(k+1)$ -generators does not change the underlying k -category (Section 1.3.2). Finally, we introduce *polygraphs* together with the associated free construction for any finitary monad on globular sets (Section 1.3.3). Our definition differs from the one of Batanin since ours is based on cellular extensions, whereas the one of Batanin is more direct. We moreover prove a local finite presentability result for the categories of polygraphs.

1.3.1 Pullbacks in CAT

In the following sections, we define the categories of cellular extensions and polygraphs using pullbacks in \mathbf{CAT} . We will be interested in showing that these categories are cocomplete and that several of the projection functors are left or right adjoints. Such properties are consequence of general properties of pullbacks that we recall below. In particular, a pullback of an *isofibration*, *i.e.*, a functor which lifts isomorphisms, has good properties with regard to cocompleteness and preservation of colimits. This is convenient since, as we will see below, all the truncation functors introduced until now are isofibrations.

In the following, given $C \in \mathbf{CAT}$, we write id_C^2 for the identity natural transformation on the identity functor $\text{id}_C: C \rightarrow C$. We begin with a property of compatibility of pullbacks in \mathbf{CAT} with left and right adjoints:

Proposition 1.3.1.1. *Given a pullback in CAT*

$$\begin{array}{ccc} C' & \xrightarrow{F'} & C \\ G' \downarrow & & \downarrow G \\ D' & \xrightarrow{F} & D \end{array}$$

and a functor $H: D \rightarrow C$ such that $GH = \text{id}_D$, then there exists a canonical $H': D' \rightarrow C'$ such that $G'H' = \text{id}_{D'}$. Moreover, if there is an adjunction $H \dashv G$ (resp. $G \dashv H$) whose unit (resp. counit) is id_D^2 , then there is an adjunction $H' \dashv G'$ (resp. $H \dashv G$) whose unit (resp. counit) is $\text{id}_{D'}^2$.

Proof. We define H' using the universal property of pullbacks by

$$\begin{array}{ccccc} & & & & H \circ F \\ & & & & \searrow \\ D' & \xrightarrow{H'} & C' & \xrightarrow{F'} & C \\ & \searrow & G' \downarrow & & \downarrow G \\ & \text{id}_{D'} & D' & \xrightarrow{F} & D \end{array}$$

which satisfies $G'H' = \text{id}_{D'}$ by definition. Moreover, suppose that there is an adjunction $H \dashv G$ whose unit is id_D^2 . Then, since C' is defined by a pullback, a morphism $f: H'X \rightarrow Y \in C'$ is the data of morphisms $f_l: X \rightarrow G'Y$ and $f_r: HFX \rightarrow F'Y$ with $F(f_l) = G(f_r)$. But, since the unit of $H \dashv G$ is id_D^2 , G induces a bijective correspondence between $C(HFX, F'Y)$ and $D(FX, GF'Y)$, so that f_r is uniquely defined by $F(f_l)$. Thus, G' induces a bijective natural correspondence between $C'(H'X, Y)$ and $D'(X, G'Y)$ for all $X \in D'$ and $Y \in C'$, so that there is an adjunction $H' \dashv G'$ with unit $\text{id}_{D'}^2$. The case where G is left adjoint is similar. \square

Moreover, we prove that isofibrations are well-behaved regarding pullbacks in \mathbf{CAT} . We recall that a functor $G: C \rightarrow D \in \mathbf{CAT}$ is an *isofibration* when it lifts isomorphisms, *i.e.*, for all $X \in C$ and $\tilde{Y} \in D$, given an isomorphism $\tilde{f}: GX \rightarrow \tilde{Y}$ in D , there exists $Y \in C$ and an isomorphism $f: X \rightarrow Y$ such that $GY = \tilde{Y}$ and $G(f) = \tilde{f}$. We then have:

Proposition 1.3.1.2. *Given a pullback in CAT*

$$\begin{array}{ccc} C' & \xrightarrow{F'} & C \\ G' \downarrow & & \downarrow G \\ D' & \xrightarrow{F} & D \end{array}$$

such that G is an isofibration, the following hold:

- (i) G' is an isofibration,
- (ii) given a small category I , if C and D' have all I -colimits and F and G preserve them, then C' has all I -colimits and F' and G' preserve them.

Proof. Proof of (i): Let $X \in C'$, $Y_L \in D'$ and $\theta_L: G'X \rightarrow Y_L$ be an isomorphism. Then, since G is an isofibration, there is $Y_R \in C$ and an isomorphism $\theta_R: F'X \rightarrow Y_R$ such that $F(\theta_L) = G(\theta_R)$. Moreover, $F(\theta_L^{-1}) = G(\theta_R^{-1})$ so that $(\theta_L, \theta_R): X \rightarrow (Y_L, Y_R)$ is an isomorphism of C' .

Proof of (ii): Let $d: I \rightarrow C'$ be a functor, which is the data of $d_L: I \rightarrow D'$ and $d_R: I \rightarrow C$. Then, there are colimit cocones $(p_{L,i}: d_L(i) \rightarrow X_L)_{i \in I}$ and $(p_{R,i}: d_R(i) \rightarrow X_R)_{i \in I}$. Since both F and G preserve colimits, both

$$(F(p_{L,i}): F(d_L(i)) \rightarrow F(X_L))_{i \in I} \quad \text{and} \quad (G(p_{R,i}): F(d_L(i)) \rightarrow G(X_R))_{i \in I}$$

are colimit cocones for $F \circ d_L$. So there exists an isomorphism $\theta: F(X_L) \rightarrow G(X_R)$ between the two cocones. Since G is an isofibration, we can suppose that $F(X_L) = G(X_R)$ and $\theta = \text{id}_{F(X_L)}$. Thus, we have a cocone $((p_{L,i}, p_{R,i}): d(i) \rightarrow (X_L, X_R))_i$ on d , and we easily verify that it is a colimit cocone. \square

Remark 1.3.1.3. Pullbacks in **CAT** should normally raise suspicion since strict limits are not well-behaved in **CAT** in general. Indeed, a limit cone in **CAT** on a diagram is not stable when replacing some functors of the diagram by isomorphic functors. Moreover, the limit cone is defined up to isomorphism, and not up to equivalence of categories. To solve this problem, one usually considers a weaker notion of limits, where the triangles of cones commute only up to isomorphisms, as with weighted bilimits [MP89]. But the strict limit on a diagram is generally not equivalent to the associated weighted bilimit. However, introducing weighted bilimits here would be an unnecessary pain for what we want to do, since the pullbacks along isofibrations are equivalent to the weighted bipullbacks (see [MP89, Proposition 5.1.1]).

We now verify that several functors of interest to us are isofibrations:

Proposition 1.3.1.4. *Given $k \in \mathbb{N}$, the functor $(-)^{\text{Glob}}_{\leq k, k+1}$ is an isofibration.*

Proof. Given $X \in \mathbf{Glob}_{k+1}$ and an isomorphism $\tilde{F}: X_{\leq k} \rightarrow \tilde{Y}$ in \mathbf{Glob}_k , we define $Y \in \mathbf{Glob}_{k+1}$ by $Y_{\leq k} = \tilde{Y}$ and $Y_{k+1} = X_{k+1}$ and such that the k -source and k -target operations of Y are defined as $F \circ \partial_k^-$ and $F \circ \partial_k^+$ respectively. Then, \tilde{F} is lifted by the isomorphism $F: X \rightarrow Y$ of \mathbf{Glob}_{k+1} defined by $F_{\leq k} = \tilde{F}$ and $F_{k+1} = 1_{X_{k+1}}$. \square

Proposition 1.3.1.5. *Let $n \in \mathbb{N} \cup \{\omega\}$ and (T, η, μ) be a finitary monad on \mathbf{Glob}_n . Given $k \in \mathbb{N}_{n-1}$, the functor $(-)^{\text{Alg}}_{\leq k, k+1}$ is an isofibration.*

Proof. Given an object $(X, g: T^{k+1}X \rightarrow X)$ of \mathbf{Alg}_{k+1} and an isomorphism $\tilde{F}: (X, g)_{\leq k} \rightarrow (\tilde{Y}, \tilde{h})$ of \mathbf{Alg}_k , by Proposition 1.3.1.4, there is $Y \in \mathbf{Glob}_{k+1}$ and an isomorphism $F: X \rightarrow Y$ in \mathbf{Glob}_{k+1} such that $F_{\leq k} = \tilde{F}$. We can equip Y with a structure of T^{k+1} -algebra by defining $h: T^{k+1}Y \rightarrow Y$ as

$$h = F \circ g \circ (T^{k+1}(F))^{-1}$$

so that $F: (X, g) \rightarrow (Y, h)$ is a morphism of \mathbf{Alg}_{k+1} . It remains to show that $(Y, h)_{\leq k} = (\tilde{Y}, \tilde{h})$. By definition of Y , we have $Y_{\leq k} = \tilde{Y}$. Moreover, we compute that

$$\begin{aligned} & h_{\leq k} \circ ((-)^{\text{Glob}}_{\leq k} T^{k+1} i^k)_Y \circ T^k(\tilde{F}) \\ &= h_{\leq k} \circ (T^{k+1}(F))_{\leq k} \circ ((-)^{\text{Glob}}_{\leq k} T^{k+1} i^k)_X && \text{(by naturality of } i^k) \\ &= \tilde{F} \circ g_{\leq k} \circ ((-)^{\text{Glob}}_{\leq k} T^{k+1} i^k)_X && \text{(since } F \text{ is a morphism of } \mathbf{Alg}_{k+1}) \\ &= \tilde{h} \circ T^k(\tilde{F}) && \text{(since } \tilde{F} \text{ is a morphism of } \mathbf{Alg}_k) \end{aligned}$$

so that $h_{\leq k} \circ ((-)^{\text{Glob}}_{\leq k} T^{k+1} i^k)_Y = \tilde{h}$, i.e., $(Y, h)_{\leq k} = (\tilde{Y}, \tilde{h})$. Thus, \tilde{F} , as a morphism of \mathbf{Alg}_k , is lifted by F . Hence, $(-)^{\text{Alg}}_{\leq k, k+1}$ is an isofibration. \square

1.3.2 Cellular extensions

In this section, we introduce the notion of k -cellular extension, which describes a k -category (for some theory of higher categories) equipped with a set of $(k+1)$ -generators. We moreover give the construction of the free $(k+1)$ -category on a k -cellular extension together with more specific results when the theory we are considering is associated with a truncable monad.

1.3.2.1 – Definition. Let $n \in \mathbb{N} \cup \{\omega\}$ and (T, η, μ) be a finitary monad on \mathbf{Glob}_n . Given $k \in \mathbb{N}_{n-1}$, we define the category \mathbf{Alg}_k^+ of k -cellular extensions as the pullback

$$\begin{array}{ccc} \mathbf{Alg}_k^+ & \xrightarrow{\mathcal{G}_{k+1}} & \mathbf{Glob}_{k+1} \\ \mathcal{A}_k \downarrow & & \downarrow (-)^{\text{Glob}}_{\leq k} \\ \mathbf{Alg}_k & \xrightarrow{u_k} & \mathbf{Glob}_k \end{array}$$

We verify that:

Proposition 1.3.2.2. *The functor \mathcal{A}_k is an isofibration and has both left and right adjoints.*

Proof. This is a consequence of Proposition 1.3.1.4 and Proposition 1.3.1.2. \square

There is a functor $\mathcal{V}_k: \mathbf{Alg}_{k+1} \rightarrow \mathbf{Alg}_k^+$ defined as the factorization arrow

$$\begin{array}{ccccc} & & & & \mathbf{Alg}_{k+1} \\ & & & & \downarrow \mathcal{V}_k \\ & & & & \mathbf{Alg}_k^+ \\ & & & & \downarrow \mathcal{A}_k \\ & & & & \mathbf{Alg}_k \\ & & & & \downarrow (-)^{\text{Alg}}_{\leq k} \\ & & & & \mathbf{Glob}_k \\ & & & & \downarrow (-)^{\text{Glob}}_{\leq k} \\ & & & & \mathbf{Glob}_{k+1} \end{array}$$

(Note: The diagram above is a simplified representation of the commutative diagram in the image. The image shows a more complex diagram with arrows from \mathbf{Alg}_{k+1} to \mathbf{Alg}_k^+ and \mathbf{Glob}_{k+1} , and from \mathbf{Alg}_k^+ to \mathbf{Glob}_{k+1} and \mathbf{Alg}_k . The arrow from \mathbf{Alg}_{k+1} to \mathbf{Glob}_{k+1} is labeled u_{k+1} . The arrow from \mathbf{Alg}_k^+ to \mathbf{Glob}_{k+1} is labeled \mathcal{G}_{k+1} . The arrow from \mathbf{Alg}_k^+ to \mathbf{Alg}_k is labeled \mathcal{A}_k . The arrow from \mathbf{Alg}_k to \mathbf{Glob}_k is labeled u_k . The arrow from \mathbf{Glob}_k to \mathbf{Glob}_{k+1} is labeled $(-)^{\text{Glob}}_{\leq k}$. The arrow from \mathbf{Alg}_{k+1} to \mathbf{Glob}_{k+1} is labeled $(-)^{\text{Alg}}_{\leq k}$.

There is an operation which produces a $(k+1)$ -category from a k -cellular extension. It is the left adjoint to \mathcal{V}_k , that exists by the following property:

Theorem 1.3.2.3. *\mathcal{V}_k has a left adjoint.*

Proof. Let α^k be the unit of the adjunction $(-)\uparrow_{k+1,k}^{\text{Alg}} \dashv (-)\leq_{k,k+1}^{\text{Alg}}$, and ϵ^l be the counit of the adjunction $\mathcal{F}_l \dashv \mathcal{U}_l$ for $l \in \{k, k+1\}$. Let

$$\begin{aligned} \Phi^L: \quad \mathbf{Alg}_{k+1}((-)\uparrow_{k+1}^{\text{Alg}}, -) &\Rightarrow \mathbf{Alg}_k(-, (-)\leq_k^{\text{Alg}}) \\ \Psi^L: \quad \mathbf{Alg}_k((-)\uparrow_{k+1}^{\text{Alg}} \mathcal{F}_k(-), -) &\Rightarrow \mathbf{Glob}_k(-, \mathcal{U}_k(-)\leq_{k,k+1}^{\text{Alg}}) \\ \Phi^R: \quad \mathbf{Alg}_{k+1}(\mathcal{F}_{k+1}(-), -) &\Rightarrow \mathbf{Glob}_{k+1}(-, \mathcal{U}_{k+1}(-)) \\ \Psi^R: \quad \mathbf{Glob}_{k+1}(\mathcal{F}_{k+1}(-)\uparrow_{k+1,k}^{\text{Glob}}, -) &\Rightarrow \mathbf{Glob}_k(-, (-)\leq_k^{\text{Glob}} \mathcal{U}_{k+1}(-)) \end{aligned}$$

be the natural bijections derived from the associated adjunctions defined in Paragraphs 1.2.2.3, 1.2.3.1 and 1.2.3.6. Note that these bijections can be defined using the units of the adjunctions. For example, given $C \in \mathbf{Alg}_k$ and $D \in \mathbf{Alg}_{k+1}$, Φ^L maps a morphism $f: C \uparrow_{k+1} \rightarrow D \in \mathbf{Alg}_{k+1}$ to the morphism $f \leq_k \circ \alpha^k: C \rightarrow D \leq_k \in \mathbf{Alg}_k$. Since

$$\mathcal{F}_{k+1}(-)\uparrow_{k+1}^{\text{Glob}} \quad \text{and} \quad (-)\uparrow_{k+1}^{\text{Alg}} \mathcal{F}_k$$

are both left adjoint to $\mathcal{U}_k(-)\leq_{k,k+1}^{\text{Alg}} = (-)\leq_k^{\text{Glob}} \mathcal{U}_{k+1}$, the natural morphism

$$\theta: \mathcal{F}_{k+1}(-)\uparrow_{k+1,k}^{\text{Glob}} \Rightarrow (-)\uparrow_{k+1}^{\text{Alg}} \mathcal{F}_k$$

defined as the composite

$$\theta = (\epsilon^{k+1}(-)\uparrow_{k+1,k}^{\text{Alg}} \mathcal{F}_k) \circ (\mathcal{F}_{k+1} i^k \mathcal{U}_{k+1}(-)\uparrow_{k+1,k}^{\text{Alg}} \mathcal{F}_k) \circ (\mathcal{F}_{k+1}(-)\uparrow_{k+1,k}^{\text{Glob}} \mathcal{U}_k \alpha^k \mathcal{F}_k) \circ (\mathcal{F}_{k+1}(-)\uparrow_{k+1,k}^{\text{Glob}} \eta^k)$$

which can be represented by

is an isomorphism as a consequence of Propositions 1.2.3.14 and 1.2.3.15. In the following, given a morphism $f: X \rightarrow Y$ of a category \mathcal{C} , we write $f^*: \mathcal{C}(Y, Z) \rightarrow \mathcal{C}(X, Z)$ for the function $g \mapsto g \circ f$ for all $Z \in \mathcal{C}$. One can verify using the zigzag equations that the natural transformation θ makes the diagram

$$\begin{array}{ccc} \mathbf{Alg}_{k+1}((\mathcal{F}_k Z)\uparrow_{k+1}, A) & \xrightarrow{\Psi_{Z,A}^L} & \mathbf{Glob}_k(Z, \mathcal{U}_k(A)\leq_k) \\ (\theta_Z)^* \downarrow & & \parallel \\ \mathbf{Alg}_{k+1}(\mathcal{F}_{k+1}(Z\uparrow_{k+1}), A) & \xrightarrow{\Psi_{Z,A}^R} & \mathbf{Glob}_k(Z, (\mathcal{U}_{k+1}A)\leq_k) \end{array} \quad (1.6)$$

commutes for all $Z \in \mathbf{Glob}_k$ and $A \in \mathbf{Alg}_{k+1}$. Let $(C, X) \in \mathbf{Alg}_k^+$, $D \in \mathbf{Alg}_{k+1}$ and $(D_{\leq k}, Y)$ be $\mathcal{V}_k D$. Since

$$\mathcal{U}_k C = X_{\leq k} \quad \text{and} \quad \mathcal{U}_k D = Y_{\leq k}$$

and by the properties of adjunctions, we have a diagram

$$\begin{array}{ccc}
 \mathbf{Alg}_{k+1}(C_{\uparrow k+1}, D) & \xrightarrow{\Phi_{C,D}^L} & \mathbf{Alg}_k(C, D_{\leq k}) \\
 (e_{(C,X)}^L)^* \downarrow & & \downarrow \mathcal{U}_k \\
 \mathbf{Alg}_{k+1}((\mathcal{F}_k \mathcal{U}_k C)_{\uparrow k+1}, D) & \xrightarrow{\Psi_{\mathcal{U}_k C, D}^L} & \mathbf{Glob}_k(\mathcal{U}_k C, \mathcal{U}_k(D_{\leq k})) \\
 (\theta_{X_{\leq k}})^* \downarrow & & \parallel \\
 \mathbf{Alg}_{k+1}(\mathcal{F}_{k+1}((X_{\leq k})_{\uparrow k+1}), D) & \xrightarrow{\Psi_{X_{\leq k}, D}^R} & \mathbf{Glob}_k(X_{\leq k}, Y_{\leq k}) \\
 (e_{(C,X)}^R)^* \uparrow & & \uparrow (-)_{\leq k}^{\text{Glob}} \\
 \mathbf{Alg}_{k+1}(\mathcal{F}_{k+1} X, D) & \xrightarrow{\Phi_{X,D}^R} & \mathbf{Glob}_{k+1}(X, Y)
 \end{array} \tag{1.7}$$

such that each square commutes and where e^L and e^R are the natural transformations

$$e^L = (-)_{\uparrow k+1}^{\text{Alg}} \epsilon^k \mathcal{A}_k \quad \text{and} \quad e^R = \mathcal{F}_{k+1} i^k \mathcal{G}_{k+1}$$

respectively. Indeed, the middle square commutes by (1.6) and the top and bottom squares commute by the zigzag equations. By definition of \mathbf{Alg}_k^+ , the set $\mathbf{Alg}_k^+((C, X), \mathcal{V}_k D)$ is the pullback

$$\begin{array}{ccc}
 \mathbf{Alg}_k^+((C, X), \mathcal{V}_k D) & \xrightarrow{\mathcal{G}_{k+1}} & \mathbf{Glob}_{k+1}(X, \mathcal{G}_{k+1} \mathcal{V}_k D) \\
 \mathcal{A}_k \downarrow \lrcorner & & \downarrow (-)_{\leq k}^{\text{Glob}} \\
 \mathbf{Alg}_k(C, \mathcal{A}_k \mathcal{V}_k D) & \xrightarrow{\mathcal{U}_k} & \mathbf{Glob}_k(X_{\leq k}, (\mathcal{G}_{k+1} \mathcal{V}_k D)_{\leq k})
 \end{array}$$

Since

$$(-)_{\leq k}^{\text{Alg}} = \mathcal{A}_k \mathcal{V}_k \quad \text{and} \quad \mathcal{U}_{k+1} = \mathcal{G}_{k+1} \mathcal{V}_k$$

and by the commutative diagram (1.7), the following diagram is also a pullback:

$$\begin{array}{ccc}
 \mathbf{Alg}_k^+((C, X), \mathcal{V}_k D) & \xrightarrow{(\Phi_{X,D}^R)^{-1} \circ \mathcal{G}_{k+1}} & \mathbf{Alg}_{k+1}(\mathcal{F}_{k+1} X, D) \\
 (\Phi_{C,D}^L)^{-1} \circ \mathcal{A}_k \downarrow \lrcorner & & \downarrow (e_{(C,X)}^R)^* \\
 \mathbf{Alg}_{k+1}(C_{\uparrow k+1}, D) & \xrightarrow{(e_{(C,X)}^L \circ \theta_{X_{\leq k}})^*} & \mathbf{Alg}_{k+1}(\mathcal{F}_{k+1}((X_{\leq k})_{\uparrow k+1}), D)
 \end{array}$$

Since \mathbf{Alg}_{k+1} is cocomplete by Proposition 1.2.3.2, the diagram

$$\begin{array}{ccc}
 \mathbf{Alg}_{k+1}(C[X], D) & \xrightarrow{(p_{(C,X)}^R)^*} & \mathbf{Alg}_{k+1}(\mathcal{F}_{k+1} X, D) \\
 (p_{(C,X)}^L)^* \downarrow \lrcorner & & \downarrow (e_{(C,X)}^R)^* \\
 \mathbf{Alg}_{k+1}(C_{\uparrow k+1}, D) & \xrightarrow{(e_{(C,X)}^L \circ \theta_{X_{\leq k}})^*} & \mathbf{Alg}_{k+1}(\mathcal{F}_{k+1}((X_{\leq k})_{\uparrow k+1}), D)
 \end{array}$$

is also a pullback, where $C[X]$, $p_{(C,X)}^L$ and $p_{(C,X)}^R$ are defined as the pushout

$$\begin{array}{ccc}
 C[X] & \xleftarrow{\dots \dots \dots p_{(C,X)}^R \dots \dots \dots} & \mathcal{F}_{k+1} X \\
 p_{(C,X)}^L \uparrow \lrcorner & & \uparrow e_{(C,X)}^R \\
 C_{\uparrow k+1} & \xleftarrow{e_{(C,X)}^L \circ \theta_{X_{\leq k}}} & \mathcal{F}_{k+1}((X_{\leq k})_{\uparrow k+1})
 \end{array}$$

Thus, there is an isomorphism

$$\mathbf{Alg}_{k+1}(C[X], D) \simeq \mathbf{Alg}_k^+((C, X), \mathcal{V}_k D)$$

which is natural in D . Hence, \mathcal{V}_k admits a left adjoint. \square

The operation $(C, X) \mapsto C[X]$ defined in the proof of Theorem 1.3.2.3 extends to a functor

$$-[-]^k: \mathbf{Alg}_k^+ \rightarrow \mathbf{Alg}_{k+1}$$

that we often write $-[-]$ when there is no ambiguity on k , and which is left adjoint to \mathcal{V}_k . The image $C[X]$ of some $(C, X) \in \mathbf{Alg}_k^+$ is called the *free extension on* (C, X) .

Example 1.3.2.4. Consider the monad (T, η, μ) on \mathbf{Glob}_1 defined in Example 1.2.3.3. A 0-cellular extension (C, X) is then essentially the data of a set C_0 of 0-cells, a set X_1 of 1-generators, and functions $d_0^-, d_0^+: X_1 \rightarrow C_0$, i.e., a graph. Moreover, the 1-category $C[X]$ is the image of (C, X) seen as a graph by the left adjoint to the functor $\mathbf{Cat} \rightarrow \mathbf{Gph}$ defined in Example 1.1.2.10.

Remark 1.3.2.5. Theorem 1.3.2.3 is a particular case of the fact that the category of locally presentable categories and right adjoints are closed under weak limits (see [Bir84] and the end of [MP89, §5.1]). Since we did not introduce those limits, we explicitly described the construction of the left adjoint of \mathcal{V}_k in the case of a strict pullback.

1.3.2.6 – The truncable case. Let $n \in \mathbb{N} \cup \{\omega\}$ and (T, η, μ) be a finitary monad on \mathbf{Glob}_n . In this paragraph, we consider the case where T is a truncable monad, and show that the underlying k -category of a k -cellular extension is preserved by $-[-]^k$. For this purpose, we first prove that the functor $(-)^{\mathbf{Alg}}_{\uparrow k+1, k}$ preserves the underlying k -category. A direct proof method for this would be to explicitly describe the functor $(-)^{\mathbf{Alg}}_{\uparrow k+1, k}$, but that would be tedious and tiresome. We prefer an indirect method based on a monadicity argument. We start by giving another description of the images of free k -categories by $(-)^{\mathbf{Alg}}_{\uparrow k+1}$:

Proposition 1.3.2.7. *If T is truncable, then, given $k \in \mathbb{N}_{n-1}$ and $X \in \mathbf{Glob}_k$, $(-)^{\mathbf{Alg}}_{\leq k, k+1}$ induces a natural isomorphism*

$$\mathbf{Alg}_{k+1}(\mathcal{F}_{k+1}(X_{\uparrow k+1}), -) \rightarrow \mathbf{Alg}_k(\mathcal{F}_k(X), (-)^{\mathbf{Alg}}_{\leq k}).$$

Proof. Given $(Y, h: T^{k+1}Y \rightarrow Y) \in \mathbf{Alg}_{k+1}$, consider the function

$$\Theta_{(Y, h)}: \mathbf{Alg}_{k+1}(\mathcal{F}_{k+1}(X_{\uparrow k+1}), (Y, h)) \rightarrow \mathbf{Alg}_k(\mathcal{F}_k(X), (Y, h)_{\leq k})$$

induced by $(-)^{\mathbf{Alg}}_{\leq k}$. This function is well-defined, since, by the definitions of \mathcal{F}_k and \mathcal{F}_{k+1} , and by the fact that T is truncable, we have $(-)^{\mathbf{Alg}}_{\leq k} \mathcal{F}_{k+1} = \mathcal{F}_k (-)^{\mathbf{Glob}}_{\leq k}$, so that $(-)^{\mathbf{Alg}}_{\leq k} \mathcal{F}_{k+1} (-)^{\mathbf{Glob}}_{\uparrow k+1} = \mathcal{F}_k$. We first show that $\Theta_{(Y, h)}$ is a monomorphism. Let $f: \mathcal{F}_{k+1}(X_{\uparrow k+1}) \rightarrow (Y, h)$ be a morphism of \mathbf{Alg}_{k+1} . We compute that

$$\begin{aligned} & (T^{k+1} i^k T^{k+1} (-)^{\mathbf{Glob}}_{\uparrow k+1})_X \circ (T^{k+1} (-)^{\mathbf{Glob}}_{\uparrow k+1} \eta^k)_X \\ &= (T^{k+1} i^k T^{k+1} (-)^{\mathbf{Glob}}_{\uparrow k+1})_X \circ (T^{k+1} (-)^{\mathbf{Glob}}_{\uparrow k+1} (-)^{\mathbf{Glob}}_{\leq k} \eta^{k+1} (-)^{\mathbf{Glob}}_{\uparrow k+1})_X && \text{(by definition of } \eta^k \text{)} \\ &= (T^{k+1} \eta^{k+1} (-)^{\mathbf{Glob}}_{\uparrow k+1})_X \circ (T^{k+1} i^k (-)^{\mathbf{Glob}}_{\uparrow k+1})_X && \text{(by naturality)} \\ &= (T^{k+1} \eta^{k+1} (-)^{\mathbf{Glob}}_{\uparrow k+1})_X && \text{(since } i^k (-)^{\mathbf{Glob}}_{\uparrow k+1} = \text{id}_{(-)^{\mathbf{Glob}}_{\uparrow k+1}} \text{)} \end{aligned}$$

and

$$h \circ T^{k+1}(f) \circ (T^{k+1}\eta^{k+1}(-)_{\uparrow k+1}^{\text{Glob}})_X = f \circ \mu_{X_{\uparrow k+1}}^{k+1} \circ (T^{k+1}\eta^{k+1})_{X_{\uparrow k+1}} = f.$$

Thus, there is a diagram

$$\begin{array}{ccccc} T^{k+1}(X_{\uparrow k+1}) & \xrightarrow{(T^{k+1}(-)_{\uparrow k+1}^{\text{Glob}}\eta^k)_X} & T^{k+1}((T^k X)_{\uparrow k+1}) & \xrightarrow{T^{k+1}((f_{\leq k})_{\uparrow k+1})} & T^{k+1}(Y_{\leq k})_{\uparrow k+1} \\ \parallel & & \downarrow (T^{k+1}i^k T^{k+1}(-)_{\uparrow k+1}^{\text{Glob}})_X & & \downarrow (T^{k+1}i^k)_Y \\ T^{k+1}(X_{\uparrow k+1}) & \xrightarrow{(T^{k+1}\eta^{k+1}(-)_{\uparrow k+1}^{\text{Glob}})_X} & T^{k+1}T^{k+1}(X_{\uparrow k+1}) & \xrightarrow{T^{k+1}(f)} & T^{k+1}Y \xrightarrow{h} Y \end{array}$$

where the first square commutes by the first calculation, the second square commutes by naturality and the bottom row is equal to f by the second computation. Thus, f can be recovered from $f_{\leq k}$, which proves that $\Theta_{(Y,h)}$ is injective.

We now show that $\Theta_{(Y,h)}$ is surjective. Let $f: (T^k X, \mu_X) \rightarrow (Y, h)_{\leq k}$ be a morphism in \mathbf{Alg}_k . We define a morphism $f': T^{k+1}(X_{\uparrow k+1}) \rightarrow Y$ of \mathbf{Glob}_{k+1} as the composite

$$T^{k+1}(X_{\uparrow k+1}) \xrightarrow{(T^{k+1}(-)_{\uparrow k+1}^{\text{Glob}}\eta^k)_X} T^{k+1}((T^k X)_{\uparrow k+1}) \xrightarrow{T^{k+1}(f_{\uparrow k+1})} T^{k+1}((Y_{\leq k})_{\uparrow k+1}) \xrightarrow{(T^{k+1}i^k)_Y} T^{k+1}Y \xrightarrow{h} Y.$$

We compute that

$$\begin{aligned} h \circ T^{k+1}(f') &= h \circ T^{k+1}(h) \circ T^{k+1}T^{k+1}(i_Y^k \circ f_{\uparrow k+1} \circ (\eta_X^k)_{\uparrow k+1}) \\ &= h \circ \mu_Y^{k+1} \circ T^{k+1}T^{k+1}(i_Y^k \circ f_{\uparrow k+1} \circ (\eta_X^k)_{\uparrow k+1}) && \text{(since } h \in \mathbf{Alg}_{k+1}\text{)} \\ &= h \circ T^{k+1}(i_Y^k \circ f_{\uparrow k+1} \circ (\eta_X^k)_{\uparrow k+1}) \circ \mu_{X_{\uparrow k+1}}^{k+1} && \text{(by naturality of } \mu^{k+1}\text{)} \\ &= f' \circ \mu_{X_{\uparrow k+1}}^{k+1} \end{aligned}$$

so f' induces a morphism in \mathbf{Alg}_{k+1} . Moreover, we have

$$\begin{aligned} f'_{\leq k} &= h_{\leq k} \circ (T^{k+1}(i_Y^k))_{\leq k} \circ T^k(f) \circ (T^k\eta^k)_X \\ &= h_{\leq k} \circ T^k((i_Y^k)_{\leq k}) \circ T^k(f) \circ (T^k\eta^k)_X && \text{(since } T \text{ is truncable)} \\ &= h_{\leq k} \circ T^k(f) \circ (T^k\eta^k)_X && \text{(since } (-)_{\leq k}^{\text{Glob}} i^k = \text{id}_{(-)_{\leq k}^{\text{Glob}}}\text{)} \\ &= f \circ \mu_X^k \circ (T^k\eta^k)_X && \text{(by Proposition 1.2.4.6)} \\ &= f \end{aligned}$$

so that $f'_{\leq k} = f$, which proves that $\Theta_{(Y,h)}$ is surjective. Finally, it is clear from the definition of $\Theta_{(Y,h)}$ that it is natural in Y , which concludes the proof. \square

Given $k \in \mathbb{N}_{n-1}$, let $\eta^{A,k}$ be the natural transformation

$$\eta^{A,k}: \text{id}_{\mathbf{Alg}_k} \Rightarrow (-)_{\leq k}^{\text{Alg}} (-)_{\uparrow k+1}^{\text{Alg}}$$

often simply denoted η^A , which is the unit of the adjunction $(-)_{\uparrow k+1}^{\text{Alg}} \dashv (-)_{\leq k}^{\text{Alg}}$. We are going to show that η^A is an isomorphism when T is truncable. First, Proposition 1.3.2.7 implies that the restriction of η^A to free k -algebras is an isomorphism:

Proposition 1.3.2.8. *If T is truncable, then, given $k \in \mathbb{N}_n$, $\eta^A \mathcal{F}_k$ is a natural isomorphism.*

Proof. Given $X \in \mathbf{Glob}_k$, we prove that $(\eta^A \mathcal{F}_k)_X$ is an isomorphism. By adjunction properties, the functor

$$\mathbf{Alg}_k(\mathcal{F}_k X, (-)_{\leq k}^{\mathbf{Alg}}): \mathbf{Alg}_{k+1} \rightarrow \mathbf{Set}$$

is representable by the pair $((\mathcal{F}_k X)_{\uparrow k+1}, (\eta^A \mathcal{F}_k)_X)$, and, by Proposition 1.3.2.7, it is also representable by the pair $(\mathcal{F}_{k+1}(X_{\uparrow k+1}), \text{id}_{\mathcal{F}_k X})$. The sequence of bijections

$$\mathbf{Alg}_{k+1}((\mathcal{F}_k X)_{\uparrow k+1}, (\mathcal{F}_k X)_{\uparrow k+1}) \simeq \mathbf{Alg}_k(\mathcal{F}_k X, ((\mathcal{F}_k X)_{\uparrow k+1})_{\leq k}) \simeq \mathbf{Alg}_{k+1}(\mathcal{F}_{k+1}(X_{\uparrow k+1}), (\mathcal{F}_k X)_{\uparrow k+1})$$

sends $\text{id}_{(\mathcal{F}_k X)_{\uparrow k+1}}$ to a morphism $\phi: \mathcal{F}_{k+1}(X_{\uparrow k+1}) \rightarrow (\mathcal{F}_k X)_{\uparrow k+1}$, and one can verify that the latter is an isomorphism by constructing its inverse in a dual manner. Moreover, by representability and naturality, we have $(\eta^A \mathcal{F}_k)_X = \phi_{\leq k} \circ \text{id}_{\mathcal{F}_k X} = \phi_{\leq k}$, so that $(\eta^A \mathcal{F}_k)_X$ is an isomorphism. \square

Since \mathbf{Alg}_k is the category of algebras of (T^k, η^k, μ^k) , every object of \mathbf{Alg}_k can be expressed as a quotient of free k -algebras, so that the isomorphism of Proposition 1.3.2.8 extends to \mathbf{Alg}_k as a whole:

Proposition 1.3.2.9. *If T is truncable, then η^A is an isomorphism.*

Proof. Given $B \in \mathbf{Alg}_k$, we prove that η_B^A is an isomorphism. Let ϵ^k be the counit of the adjunction $\mathcal{F}_k \dashv \mathcal{U}_k$ (concretely, $\epsilon_{(X,h)}^k = h$ for $(X, h) \in \mathbf{Alg}_k$). By the naturality of η^A , we have a diagram

$$\begin{array}{ccccc} \mathcal{F}_k \mathcal{U}_k \mathcal{F}_k \mathcal{U}_k A & \xrightarrow[\epsilon^k \mathcal{F}_k \mathcal{U}_k]{{\mathcal{F}_k \mathcal{U}_k \epsilon^k}_B} & \mathcal{F}_k \mathcal{U}_k B & \xrightarrow{\epsilon_B^k} & B \\ \downarrow (\eta^A \mathcal{F}_k \mathcal{U}_k \mathcal{F}_k \mathcal{U}_k)_B & & \downarrow (\eta^A \mathcal{F}_k \mathcal{U}_k)_B & & \downarrow \eta_B^A \\ ((\mathcal{F}_k \mathcal{U}_k \mathcal{F}_k \mathcal{U}_k B)_{\uparrow k+1})_{\leq k} & \xrightarrow[\text{((-)}_{\leq k}^{\mathbf{Alg}} \text{((-)}_{\uparrow k+1}^{\mathbf{Alg}} \epsilon^k \mathcal{F}_k \mathcal{U}_k)_B]{{\text{((-)}_{\leq k}^{\mathbf{Alg}} \text{((-)}_{\uparrow k+1}^{\mathbf{Alg}} \mathcal{F}_k \mathcal{U}_k \epsilon^k)_B}} & ((\mathcal{F}_k \mathcal{U}_k B)_{\uparrow k+1})_{\leq k} & \xrightarrow[\text{((-)}_{\leq k}^{\mathbf{Alg}} \text{((-)}_{\uparrow k+1}^{\mathbf{Alg}} \epsilon^k)_B]{{\text{((-)}_{\leq k}^{\mathbf{Alg}} \text{((-)}_{\uparrow k+1}^{\mathbf{Alg}} \epsilon^k)_B}} & (B_{\uparrow k+1})_{\leq k} \end{array}$$

where the two squares on the left corresponding to $\mathcal{F}_k \mathcal{U}_k \epsilon^k$ and $\epsilon^k \mathcal{F}_k \mathcal{U}_k$ respectively, and the square on the right commute. Since the functor \mathcal{U}_k is monadic by definition, the top row is a coequalizer (see [Bor94b, Lemma 4.3.3] for example). Moreover, since both $(-)_{\leq k}^{\mathbf{Alg}}$ and $(-)_{\uparrow k}^{\mathbf{Alg}}$ preserves colimits (both are left adjoints by Propositions 1.2.3.7 and 1.2.4.7), the bottom row is a coequalizer too. By Proposition 1.3.2.8, the two vertical arrows on the left are isomorphisms, so that η_B^A is an isomorphism. \square

We can conclude a conservation result for the underlying k -category of $(k+1)$ -categories produced by $-[-]^k$:

Proposition 1.3.2.10. *If T is truncable, then, given $k \in \mathbb{N}_n$ and $(C, X) \in \mathbf{Alg}_k^+$, there is an isomorphism $C \simeq C[X]_{\leq k}$ which is natural in (C, X) .*

Proof. Recall that $C[X]$ was defined in the proof of Theorem 1.3.2.3 as the pushout

$$\begin{array}{ccc} C[X] & \xleftarrow{p_{(C,X)}^R} & \mathcal{F}_{k+1} X \\ p_{(C,X)}^L \uparrow \lrcorner & & \uparrow e_{(C,X)}^R \\ C_{\uparrow k+1} & \xleftarrow{e_{(C,X)}^L \circ \theta_{X_{\leq k}}} & \mathcal{F}_{k+1}((X_{\leq k})_{\uparrow k+1}) \end{array} .$$

By Proposition 1.2.4.7, the following diagram is also a pushout

$$\begin{array}{ccc}
C[X]_{\leq k} & \xleftarrow{(p_{(C,X)}^R)_{\leq k}} & (\mathcal{F}_{k+1}X)_{\leq k} \\
(p_{(C,X)}^L)_{\leq k} \uparrow \lrcorner & & \uparrow (e_{(C,X)}^R)_{\leq k} \\
(C\uparrow_{k+1})_{\leq k} & \xleftarrow{(e_{(C,X)}^L \circ \theta_{X_{\leq k}})_{\leq k}} & (\mathcal{F}_{k+1}((X_{\leq k})\uparrow_{k+1}))_{\leq k}
\end{array}$$

Since T is truncable, we have $(-)^{\text{Alg}}_{\leq k} \mathcal{F}_{k+1} = \mathcal{F}_k(-)^{\text{Glob}}_{\leq k}$. Thus,

$$\begin{aligned}
(e^R)_{\leq k} &= (-)^{\text{Alg}}_{\leq k} \mathcal{F}_{k+1} i^k \mathcal{G}_{k+1} \\
&= \mathcal{F}_k(-)^{\text{Glob}}_{\leq k} i^k \mathcal{G}_{k+1} \\
&= \text{id}_{\mathcal{F}_k(-)^{\text{Glob}}_{\leq k} \mathcal{G}_{k+1}} \quad (\text{since } (i^k)_{\leq k} = \text{id}_{\text{Glob}_k})
\end{aligned}$$

so that $(e^R_{(C,X)})_{\leq k} = \text{id}_{\mathcal{F}_k(X_{\leq k})}$. Hence, $(p^L_{(C,X)})_{\leq k}$ is an isomorphism, since the pushout of an isomorphism is an isomorphism. By Proposition 1.3.2.9, we conclude that the composite

$$C \xrightarrow{\eta_C^A} (C\uparrow_{k+1})_{\leq k} \xrightarrow{(p^L_{(C,X)})_{\leq k}} C[X]_{\leq k}$$

is an isomorphism. \square

Remark 1.3.2.11. If T is truncable, given $k \in \mathbb{N}_n$, by Proposition 1.3.1.5, we can suppose that we chose $-[-]_k$ so that the isomorphism of Proposition 1.3.2.10 is the identity. When such a choice is made, we have $C[X]_{\leq k} = C$ for all k -cellular extension (C, X) .

1.3.3 Polygraphs

In this section we recall the definition and several properties of *polygraphs*, that were first introduced by Street [Str76] for strict 2-categories (under the name *computads*), and then rediscovered and extended by Burroni [Bur93] to strict k -categories, and finally generalized by Batanin [Bat98a] to all algebraic globular higher categories. Polygraphs are structures that are inductively cellular extensions, and which allow to specify a system of generators for k -categories whose sources and targets are composites of other generators. They will play an important role in the following chapters.

1.3.3.1 – Another definition of cellular extensions. Let $n \in \mathbb{N} \cup \{\omega\}$ and (T, η, μ) be a finitary monad on Glob_n . Before defining polygraphs, we first provide an alternative definition of Alg_k which is simpler than the one based on pullbacks given in Paragraph 1.3.2.1.

Proposition 1.3.3.2. *Given $k \in \mathbb{N}_{n-1}$, the category Alg_k^+ is isomorphic to the category*

- whose objects are the pairs (C, S) where $C \in \text{Alg}_k$ and S is a set, equipped with two functions

$$d_k^-, d_k^+ : S \rightarrow C_k$$

such that $\partial_{k-1}^\epsilon \circ d_k^- = \partial_{k-1}^\epsilon \circ d_k^+$ for $\epsilon \in \{-, +\}$,

- and whose morphisms between two such pairs (C, S) and (C', S') are the pairs (F, f) where

$$F : C \rightarrow C' \in \text{Alg}_k \quad \text{and} \quad f : S \rightarrow S' \in \text{Set}$$

and such that $d_k^\epsilon \circ f = F_k \circ d_k^\epsilon$ for $\epsilon \in \{-, +\}$.

Proof. Write $\bar{\mathbf{Alg}}_k^+$ for the category described in the statement. An isomorphism between \mathbf{Alg}_k^+ and $\bar{\mathbf{Alg}}_k^+$ can be described as follows. Given $(C, X) \in \mathbf{Alg}_k^+$, we map (C, X) to the pair (C, X_{k+1}) and, for $\epsilon \in \{-, +\}$ and $x \in X_{k+1}$, we put $d_k^\epsilon(x) = \partial_k^\epsilon(x)$ (where ∂_k^ϵ is the operation of the globular structure on X), and we extend this mapping to morphisms of \mathbf{Alg}_k^+ as expected. Since $\mathcal{U}_k C = X_{\leq k}$ for $(C, X) \in \mathbf{Alg}_k^+$, the resulting functor is an isomorphism of categories. \square

In the following, we will prefer the definition of cellular extensions given by the above proposition instead of the one of Paragraph 1.3.2.1. In particular, we use it to show that \mathbf{Alg}_k^+ is cocomplete:

Proposition 1.3.3.3. \mathbf{Alg}_k^+ has all colimits.

Proof. Given a diagram $d: I \rightarrow \mathbf{Alg}_k^+$, where $d(i) = (A^i, S^i)$ for $i \in I$, we define the colimit of d as follows. Let $(F^i: A^i \rightarrow A)_{i \in I}$ be a colimit cocone of the diagram $i \mapsto A^i$ in \mathbf{Alg}_k (which exists since \mathbf{Alg}_k is cocomplete by Proposition 1.1.1.12) and let $(f^i: S^i \rightarrow S)_{i \in I}$ be a colimit cocone of the diagram $i \mapsto S^i$ in \mathbf{Set} . We define functions $d_k^-, d_k^+: S \rightarrow A_k$ by the universal property of S as the functions such that, for $\epsilon \in \{-, +\}$ and $i \in I$,

$$d_k^\epsilon \circ f^i = F_k^i \circ d_k^\epsilon$$

so that they make (A, S) an object of \mathbf{Alg}_k^+ . From such a definition, one can easily verify that the cocone $((F^i, f^i): (A^i, S^i) \rightarrow (A, S))_{i \in I}$ is a colimit cocone in \mathbf{Alg}_k^+ . \square

1.3.3.4 – Categories of polygraphs. Let $n \in \mathbb{N} \cup \{\omega\}$ and (T, η, μ) be a finitary monad on \mathbf{Glob}_n . For $k \in \mathbb{N}_n$, we define the category \mathbf{Pol}_k of k -polygraphs by induction on k , together with a functor

$$(-)^{*,k}: \mathbf{Pol}_k \rightarrow \mathbf{Alg}_k$$

simply denoted $(-)^*$ when there is no ambiguity on k , that maps a k -polygraph P to the free k -category on P . First, we put

$$\mathbf{Pol}_0 = \mathbf{Glob}_0 \quad \text{and} \quad (-)^{*,0} = \mathcal{F}_0.$$

Now suppose that \mathbf{Pol}_k and $(-)^{*,k}$ are defined for some $k \in \mathbb{N}_{n-1}$. We define \mathbf{Pol}_{k+1} as the pullback

$$\begin{array}{ccc} \mathbf{Pol}_{k+1} & \xrightarrow{\mathcal{E}_{k+1}} & \mathbf{Alg}_k^+ \\ \downarrow (-)_{\leq k, k+1}^{\mathbf{Pol}} & & \downarrow \mathcal{A}_k \\ \mathbf{Pol}_k & \xrightarrow{(-)^{*,k}} & \mathbf{Alg}_k \end{array}$$

and $(-)^{*,k+1}$ as the composite

$$\mathbf{Pol}_{k+1} \xrightarrow{\mathcal{E}_{k+1}} \mathbf{Alg}_k^+ \xrightarrow{-[\]^k} \mathbf{Alg}_{k+1}.$$

Like for globular sets and algebras, we write $P_{\leq k}$ for the image of $P \in \mathbf{Pol}_{k+1}$ by $(-)^{\mathbf{Pol}}_{\leq k, k+1}$, and we often simply write $(-)^{\mathbf{Pol}}_{\leq k}$ for the latter functor.

Using the simpler definition of \mathbf{Alg}_k^+ from Proposition 1.3.3.2, we can give a more concrete description of \mathbf{Pol}_k for $k \in \mathbb{N}_n$. A 0-polygraph P is the data of a set P_0 of 0-generators, and a morphism $P \rightarrow P'$ in \mathbf{Pol}_0 is the data of a function $F_0: P_0 \rightarrow P'_0$. Given $k \in \mathbb{N}_{n-1}$, a $(k+1)$ -polygraph is the data of a pair

$$P = (P_{\leq k}, P_{k+1})$$

where $P_{\leq k}$ is a k -polygraph and P_{k+1} is a set of $(k+1)$ -generators, together with functions

$$d_k^-, d_k^+ : P_{k+1} \rightarrow ((P_{\leq k})^*)_k$$

such that

$$\partial_{k-1}^\epsilon \circ d_k^- = \partial_{k-1}^\epsilon \circ d_k^+$$

for $\epsilon \in \{-, +\}$, where $\partial_{k-1}^-, \partial_{k-1}^+ : ((P_{\leq k})^*)_{k-1} \rightarrow ((P_{\leq k})^*)_{k-1}$ are the source and target operations of the k -category $(P_{\leq k})^*$. Moreover, a morphism $P \rightarrow P'$ in \mathbf{Pol}_{k+1} is the data of a pair $(F_{\leq k}, F_{n+1})$ where $F_{\leq k} : P_{\leq k} \rightarrow P'_{\leq k}$ is a morphism of \mathbf{Pol}_k and $F_{n+1} : P_{n+1} \rightarrow P'_{n+1}$ is a function such that

$$d_k^\epsilon \circ F_{n+1} = (F_{\leq k})^* \circ d_k^\epsilon$$

for $\epsilon \in \{-, +\}$, i.e., a $(k+1)$ -generator g is mapped by F_{n+1} to a generator g' whose k -source and k -target are exactly the images of the k -source and k -target of g by $(F_{\leq k})^*$.

Remark 1.3.3.5. Note that the diagram

$$\begin{array}{ccc} \mathbf{Pol}_{k+1} & \xrightarrow{\mathcal{G}_{k+1} \mathcal{E}_{k+1}} & \mathbf{Glob}_{k+1} \\ \downarrow (-)_{\leq k}^{\mathbf{Pol}} & & \downarrow (-)_{\leq k}^{\mathbf{Glob}} \\ \mathbf{Pol}_k & \xrightarrow{\mathcal{U}_k (-)^{*,k}} & \mathbf{Glob}_k \end{array} \quad (1.8)$$

is a pullback, since \mathbf{Alg}_k^+ is defined as a pullback and the concatenation of two pullbacks is still a pullback.

In order to better handle side conditions, we use the convention that

$$\mathbf{Alg}_{-1}^+ = \mathbf{Glob}_0, \quad \mathcal{E}_0 = \text{id}_{\mathbf{Glob}_0}, \quad \text{and} \quad -[-]^0 = \mathcal{F}_0$$

so that $(-)^{*,0} = -[-]^0 \circ \mathcal{E}_0$. We then have:

Proposition 1.3.3.6. *For $k \in \mathbb{N}_n$, the following hold:*

- (i) \mathbf{Pol}_k is cocomplete,
- (ii) the functors $(-)^{*,k}$ and \mathcal{E}_k preserve colimits,
- (iii) when $k > 0$, the functor $(-)_{\leq k-1, k}^{\mathbf{Pol}}$ lifts isomorphisms and has both a left and a right adjoint.

Proof. We show this property by induction on k . The category $\mathbf{Pol}_0 = \mathbf{Glob}_0$ is certainly cocomplete and, since \mathcal{F}_0 is a left adjoint, the functor $(-)^{*,0} = \mathcal{F}_0$ preserves colimits and so does the functor $\mathcal{E}_0 = \text{id}_{\mathbf{Glob}_0}$. So suppose that $k > 0$. By induction hypothesis and Proposition 1.3.3.3, both \mathbf{Pol}_{k-1} and \mathbf{Alg}_k^+ are cocomplete. Moreover, by Proposition 1.3.2.2, the functor \mathcal{A}_{k-1} preserves colimits, lifts isomorphisms and has both a left and a right adjoint. So, by Proposition 1.3.1.2, we deduce that \mathbf{Pol}_k is cocomplete, the functor \mathcal{E}_k preserves colimits, and the functor $(-)_{\leq k-1, k}^{\mathbf{Pol}}$ lift isomorphisms and has both a left and a right adjoint. Finally, since $-[-]^{k-1}$ is a left adjoint, the functor $(-)^{*,k+1} = (-)^* \circ \mathcal{E}_k$ preserves colimits. \square

Given $i, k \in \mathbb{N}$ such that $i \leq k < n+1$, we write

$$(-)_i^k : \mathbf{Pol}_k \rightarrow \mathbf{Set}$$

or simply $(-)_i$ when there is no ambiguity on k , for the functor which maps a k -polygraph P to its set of i -generators P_i . We can refine Proposition 1.3.3.6(i) and say that colimits are computed dimensionwise:

Proposition 1.3.3.7. *Given $i, k \in \mathbb{N}_n$ such that $i \leq k$, the functor $(-)_i^k$ preserves colimits.*

Proof. We show this property by induction on $k - i$. When $k = i$, we have that $(-)_i^k = F \circ \mathcal{E}_k$ where F is the functor

$$F: \mathbf{Alg}_k^+ \rightarrow \mathbf{Set}$$

which maps $(C, X) \in \mathbf{Alg}_k^+$ to the set of $(k+1)$ -generators X . By Proposition 1.3.3.6 and the proof of Proposition 1.3.3.3, both \mathcal{E}_k and F preserve colimits, so that $(-)_i^k$ preserves colimits. Otherwise, if $k > i$, then note that $(-)_i^k = (-)_i^{k-1} \circ (-)_{\leq k-1}^{\text{Pol}}$ where, by Proposition 1.3.3.6 and induction hypothesis, both $(-)_i^{\text{Pol}}$ and $(-)_i^{k-1}$ preserve colimits, so that $(-)_i^k$ preserves colimits, which concludes the induction. \square

In the case where T is truncable, given $k, l \in \mathbb{N}$ with $k < l$, the underlying k -category of the free l -category on an l -polygraph is only determined by the underlying k -polygraph, as stated by the following proposition:

Proposition 1.3.3.8. *If T is truncable, then, given $k \in \mathbb{N}$ such that $k < n$ and a $(k+1)$ -polygraph, there exists an isomorphism $(P^*)_{\leq k} \simeq (P_{\leq k})^*$.*

Proof. By definition of $(-)^{*k}$, we have

$$P^* = (P_{\leq k})^* [P_{k+1}]$$

so that the wanted isomorphism comes from Proposition 1.3.2.10. \square

Remark 1.3.3.9. When T is truncable, under the assumption of Remark 1.3.2.11, the isomorphism given by Proposition 1.3.3.8 is the identity. This enables to simplify some notations: given $k, l \in \mathbb{N}_n$ with $k \leq l$ and an l -polygraph P , we write directly $P_{\leq k}^*$ for both $(P^*)_{\leq k}$ and $(P_{\leq k})^*$, and P_k^* for both $(P^*)_k$ and $((P_{\leq k})^*)_k$.

Remark 1.3.3.10. When T is truncable, given $k \in \mathbb{N}_n$, a k -polygraph P can be alternatively described as a diagram in \mathbf{Set} of the form

$$\begin{array}{ccccccc} P_0 & & P_1 & & P_2 & & \dots & & P_{k-1} & & P_k \\ \downarrow e_0 & \swarrow d_0^- & \downarrow e_1 & \swarrow d_1^- & \downarrow e_2 & & & & \downarrow e_k & \swarrow d_{k-1}^- & \\ P_0^* & \xleftarrow{\partial_0^-} & P_1^* & \xleftarrow{\partial_1^-} & \dots & & & & P_{k-1}^* & \xleftarrow{\partial_{k-2}^-} & P_{k-1}^* \\ \swarrow \partial_0^+ & & \swarrow \partial_1^+ & & & & & & \swarrow \partial_{k-2}^+ & & \swarrow \partial_{k-1}^+ \end{array}$$

where, for $i \in \mathbb{N}_{k-1}$, e_i is the embedding of the i -generators in the i -cells induced by the unit of the adjunction $-[-]^i \dashv \mathcal{V}_{i-1}$ at $((P_{\leq i-1})^*, P_i)$, such that

$$\partial_i^- \circ d_{i+1}^- = \partial_i^- \circ d_{i+1}^+ \quad \text{and} \quad \partial_i^+ \circ d_{i+1}^- = \partial_i^+ \circ d_{i+1}^+$$

for $i \in \mathbb{N}_{k-1}$. The above description of polygraphs can already be found in the original paper of Burroni [Bur93] for polygraphs of strict categories.

1.3.3.11 – ω -polygraphs. Let (T, η, μ) be a finitary monad on \mathbf{Glob}_ω . We define the category of ω -polygraphs \mathbf{Pol}_ω as the limit in \mathbf{CAT}

$$((-)_{\leq k, \omega}^{\text{Pol}} : \mathbf{Pol}_\omega \rightarrow \mathbf{Pol}_k)_{k \in \mathbb{N}}$$

on the diagram

$$\mathbf{Pol}_0 \xleftarrow{(-)_{\leq 0}^{\text{Pol}}} \mathbf{Pol}_1 \xleftarrow{(-)_{\leq 1}^{\text{Pol}}} \dots \xleftarrow{(-)_{\leq k-1}^{\text{Pol}}} \mathbf{Pol}_k \xleftarrow{(-)_{\leq k}^{\text{Pol}}} \mathbf{Pol}_{k+1} \xleftarrow{(-)_{\leq k+1}^{\text{Pol}}} \dots$$

Concretely, an ω -polygraph P is the data of a sequence $(P^k)_{k \in \mathbb{N}}$, where P^k is a k -polygraph, such that $(P^{k+1})_{\leq k} = P^k$ for $k \in \mathbb{N}$. We verify that the truncation functors $(-)_{\leq k, \omega}^{\text{Pol}}$ have left and right adjoint, just like the functors $(-)_{\leq l, l+1}^{\text{Pol}}$:

Proposition 1.3.3.12. *For $k \in \mathbb{N}$, the functor $(-)_{\leq k, \omega}^{\text{Pol}} : \mathbf{Pol}_\omega \rightarrow \mathbf{Pol}_k$ has both a left and a right adjoint.*

Proof. Let $k \in \mathbb{N}$. Define $(-)_{\uparrow \omega, k}^{\text{Pol}} : \mathbf{Pol}_k \rightarrow \mathbf{Pol}_\omega$ to be the unique functor such that

$$(-)_{\leq l, \omega}^{\text{Pol}} (-)_{\uparrow \omega, k}^{\text{Pol}} = \begin{cases} (-)_{\uparrow l, k}^{\text{Pol}} & \text{if } k < l, \\ \text{id}_{\mathbf{Pol}_k} & \text{if } k = l, \\ (-)_{\leq l, k}^{\text{Pol}} & \text{if } k > l. \end{cases}$$

We have that $(-)_{\uparrow \omega, k}^{\text{Pol}}$ is a left adjoint for $(-)_{\leq k, \omega}^{\text{Pol}}$. Indeed, a morphism $P_{\uparrow \omega, k} \rightarrow Q$ is the data of a sequence of morphisms $F^l : (P_{\uparrow \omega, k})_{\leq l} \rightarrow Q_{\leq l}$ for $l \in \mathbb{N}$ with $l \geq k$ such that $(F^{l+1})_{\leq l} = F^l$. But, for $l \in \mathbb{N}$ with $l > k$, we have $(P_{\uparrow \omega, k})_{\leq l} = P_{\uparrow l, k}$ and, by the universal property of $P_{\uparrow l, k}$, F^l is completely determined by $F^l_{\leq k} = F^k$. So there is a natural correspondence between $\mathbf{Pol}_\omega(P_{\uparrow \omega, k}, Q)$ and $\mathbf{Pol}_k(P, Q_{\leq k})$. Thus, $(-)_{\uparrow \omega, k}^{\text{Pol}}$ is a left adjoint for $(-)_{\leq k, \omega}^{\text{Pol}}$.

Dually, let $(-)_{\uparrow \omega, k}^{\text{Pol}} : \mathbf{Pol}_k \rightarrow \mathbf{Pol}_\omega$ be the functor such that

$$(-)_{\leq l, \omega}^{\text{Pol}} (-)_{\uparrow \omega, k}^{\text{Pol}} = \begin{cases} (-)_{\uparrow l, k}^{\text{Pol}} & \text{if } k < l, \\ \text{id}_{\mathbf{Pol}_k} & \text{if } k = l, \\ (-)_{\leq l, k}^{\text{Pol}} & \text{if } k > l. \end{cases}$$

By a similar proof as above, we have that $(-)_{\uparrow \omega, k}^{\text{Pol}}$ is a right adjoint for $(-)_{\leq k, \omega}^{\text{Pol}}$. \square

Moreover, in the truncable case, we can easily define the free ω -category on an ω -polygraph, just like for finite-dimensional polygraphs:

Proposition 1.3.3.13. *If T is truncable, there is a functor $(-)^{*, \omega} : \mathbf{Pol}_\omega \rightarrow \mathbf{Alg}_\omega$ which is uniquely defined by*

$$(-)_{\leq k, \omega}^{\text{Alg}} \circ (-)^{*, \omega} = (-)^{*, k} \circ (-)_{\leq k, \omega}^{\text{Pol}}$$

for $k \in \mathbb{N}$.

Proof. By Remark 1.3.2.11 and Remark 1.3.3.9, we have a commutative diagram

$$\begin{array}{ccccccc} \mathbf{Pol}_0 & \xleftarrow{(-)_{\leq 0}^{\text{Pol}}} & \mathbf{Pol}_1 & \xleftarrow{(-)_{\leq 1}^{\text{Pol}}} & \dots & \xleftarrow{(-)_{\leq k-1}^{\text{Pol}}} & \mathbf{Pol}_k & \xleftarrow{(-)_{\leq k}^{\text{Pol}}} & \mathbf{Pol}_{k+1} & \xleftarrow{(-)_{\leq k+1}^{\text{Pol}}} & \dots \\ \downarrow (-)^{*, 0} & & \downarrow (-)^{*, 1} & & & & \downarrow (-)^{*, k} & & \downarrow (-)^{*, k+1} & & \\ \mathbf{Alg}_0 & \xleftarrow{(-)_{\leq 0}^{\text{Alg}}} & \mathbf{Alg}_1 & \xleftarrow{(-)_{\leq 1}^{\text{Alg}}} & \dots & \xleftarrow{(-)_{\leq k-1}^{\text{Alg}}} & \mathbf{Alg}_k & \xleftarrow{(-)_{\leq k}^{\text{Alg}}} & \mathbf{Alg}_{k+1} & \xleftarrow{(-)_{\leq k+1}^{\text{Alg}}} & \dots \end{array}$$

which, by the definition of \mathbf{Pol}_ω and Proposition 1.2.3.12, induces a functor $(-)^{*, \omega}$ which satisfies the wanted properties. \square

Remark 1.3.3.14. We can still define a functor $(-)^{*, \omega} : \mathbf{Pol}_\omega \rightarrow \mathbf{Alg}_\omega$ in the case where T is not truncable. However, this functor is not expected to be compatible with the functors $(-)_{\leq k}^{\text{Alg}}$ as in Proposition 1.3.3.13. Indeed, in this case, the functor $-[-]^k$ does not preserve the underlying k -category C of a k -cellular extension $(C, S) \in \mathbf{Alg}_k^+$.

We moreover derive the cocompleteness of \mathbf{Pol}_ω from the cocompleteness of the categories \mathbf{Pol}_k :

Proposition 1.3.3.15. *The category \mathbf{Pol}_ω is cocomplete.*

Proof. Given a diagram $d: I \rightarrow \mathbf{Pol}_\omega$, for $k \in \mathbb{N}$, the diagrams $(-)^{\mathbf{Pol}_{\leq k, \omega}} \circ d$ admits a colimit

$$(F^{k,i}: d(i)_{\leq k} \rightarrow P^k)_{i \in I}$$

By Proposition 1.3.3.6(iii), we have that $P^k \simeq (P^{k+1})_{\leq k}$ for $k \geq 0$. Moreover, since $(-)^{\mathbf{Pol}_{\leq k}}$ lifts isomorphisms, we can suppose that

$$P^k = (P^{k+1})_{\leq k} \quad \text{and} \quad F^{k,i} = (F^{k+1,i})_{\leq k}$$

for $k \geq 0$ and $i \in I$. Then, by the definition of \mathbf{Pol}_ω , this induces a cone

$$(F^i: d(i) \rightarrow P)_{i \in I}$$

in \mathbf{Pol}_ω and we can easily verify that it is a limit cone in \mathbf{Pol}_ω . \square

1.3.3.16 – Presentability. Let $n \in \mathbb{N} \cup \{\omega\}$ and (T, η, μ) be a finitary monad on \mathbf{Glob}_n . We conclude this section by showing that associated categories of polygraphs of various dimensions are locally finitely presentable. Given $k \in \mathbb{N} \cup \{n\}$, a k -polygraph P is *finite* when the set $\sqcup_{i \in \mathbb{N}_k} P_i$ is finite. Note that the full subcategory of \mathbf{Pol}_k whose objects are the finite k -polygraph is essentially small, *i.e.*, there is a set $S \subseteq (\mathbf{Pol}_k)_0$ such that every finite k -polygraph P is isomorphic to an element of S . We prove that \mathbf{Pol}_k is locally finitely presentable by showing that every k -polygraph is a directed colimit of finite k -polygraphs, and that those finite k -polygraphs are precisely the finitely presentable objects of \mathbf{Pol}_k . We start with the case $k \in \mathbb{N}_n$.

Proposition 1.3.3.17. *Given $k \in \mathbb{N}_n$, every k -polygraph is a directed colimit of finite k -polygraphs.*

Proof. We prove this property by induction on k . If $k = 0$ the property holds, since every set is the directed colimit of its finite subsets. So suppose that $k > 0$. Let (P, S) be a k -polygraph and, by induction hypothesis, let $P^{(-)}: I \rightarrow \mathbf{Pol}_{k-1}$ be a diagram on \mathbf{Pol}_{k-1} together with colimit cocone

$$(F^i: P^i \rightarrow P)_{i \in I}.$$

We write J for the small category whose objects are the tuples (i, U, g^-, g^+) where $i \in I$, U is a finite subset of S , and g^-, g^+ are functions of type $U \rightarrow (P^i)_{k-1}^*$ such that

$$\begin{array}{ccc} U & \hookrightarrow & S \\ g^\epsilon \downarrow & & \downarrow d_{k-1}^\epsilon \\ (P^i)_{k-1}^* & \xrightarrow{(F^i)_{k-1}^*} & P_{k-1}^* \end{array}$$

commutes for $\epsilon \in \{-, +\}$, and whose morphisms $(i_1, U_1, g_1^-, g_1^+) \rightarrow (i_2, U_2, g_2^-, g_2^+)$ are the morphisms $h: i_1 \rightarrow i_2 \in I$ such that $U_1 \subseteq U_2$ and

$$\begin{array}{ccc} U_1 & \hookrightarrow & U_2 \\ g_1^\epsilon \downarrow & & \downarrow g_2^\epsilon \\ (P^{i_1})_{k-1}^* & \xrightarrow{(P^h)_{k-1}^*} & (P^{i_2})_{k-1}^* \end{array}$$

commutes for $\epsilon \in \{-, +\}$.

We now prove that J is directed. There is a canonical functor $V: I \rightarrow J$ which maps $i \in I$ to $(i, \emptyset, \perp, \perp) \in J$. Thus, J is not empty since I is directed. Now, given

$$t_1 = (i_1, U_1, g_1^-, g_1^+) \quad \text{and} \quad t_2 = (i_2, U_2, g_2^-, g_2^+)$$

in J , we show that there are morphisms $h_1: t_1 \rightarrow t$ and $h_2: t_2 \rightarrow t$ in J for some $t \in J$. Since I is directed, there exist $i \in I$ and morphisms $h_1: i_1 \rightarrow i$ and $h_2: i_2 \rightarrow i$ in I , so we can suppose that $i_1 = i_2 = i$. We then have

$$(F^i)^*(g_1^\epsilon(x)) = d_{k-1}^\epsilon(x) = (F^i)^*(g_2^\epsilon(x))$$

for all $x \in U_1 \cap U_2$. Note that, since T is finitary, \mathcal{U}_{k-1} preserves directed colimits. Thus, by Proposition 1.3.3.6(ii), $\mathcal{U}_{k-1} \circ (-)^{*,k-1}$ preserves directed colimits, so that, since U_1 and U_2 are finite, there is $i' \in I$ and a morphism $h': i \rightarrow i' \in I$ such that

$$(P^{h'})^*(g_1^\epsilon(x)) = (P^{h'})^*(g_2^\epsilon(x)).$$

Let $g^-, g^+: U_1 \cup U_2 \rightarrow (P^{i'})_{k-1}^*$ be the functions such that

$$g^\epsilon(x) = \begin{cases} g_1^\epsilon(x) & \text{if } x \notin U_2 \\ g_2^\epsilon(x) & \text{if } x \in U_2 \end{cases}$$

for $\epsilon \in \{-, +\}$ and $x \in U_1 \cup U_2$. We then have a tuple $t = (i', U_1 \cup U_2, g^-, g^+) \in J$, and h' induces morphisms of J between t_1 and t , and between t_2 and t . Thus, J is directed.

Now, we consider the functor

$$Q^{(-)}: J \rightarrow \mathbf{Pol}_k$$

which maps $t = (i, U, g^-, g^+) \in J$ to the k -polygraph $Q^t = (P^i, S^t)$ defined by $S^t = U$ and such that $d_{k-1}^-, d_{k-1}^+: S^t \rightarrow (P^i)^*$ are the functions g^- and g^+ respectively. There is then a cocone

$$((F^i, i^t): (P^i, S^t) \rightarrow (P, S))_{t=(i,U,g^-,g^+) \in J} \quad (1.9)$$

where $i^t: S^t \rightarrow S$ is the inclusion function $U \hookrightarrow S$ for $t = (i, U, g^-, g^+) \in J$.

We now prove that (1.9) is a colimit cocone. Given $x \in S$, since $\mathcal{U}_{k-1}(-)^{*,k-1}$ preserves directed colimits, there are $i_-, i_+ \in I$, $u_- \in (P^{i_-})_{k-1}^*$ and $u_+ \in (P^{i_+})_{k-1}^*$ such that

$$(F^{i_\epsilon})^*(u_\epsilon) = d_{k-1}^\epsilon(x) \quad \text{for } \epsilon \in \{-, +\}.$$

Since I is directed, we can suppose that $i_- = i_+ = i$ for some $i \in I$. Moreover, we have

$$(F^i)^*(\partial_{k-2}^\delta(u_-)) = \partial_{k-2}^\delta \circ d_{k-1}^-(x) = \partial_{k-2}^\delta \circ d_{k-1}^+(x) = (F^i)^*(\partial_{k-2}^\delta(u_+))$$

for $\delta \in \{-, +\}$, so that we can suppose that we chose i big enough such that $\partial_{k-2}^\delta(u_-) = \partial_{k-2}^\delta(u_+)$. Hence, there is $t = (i, \{x\}, g^-, g^+) \in J$ with g^-, g^+ defined by $g^\epsilon(x) = d_{k-1}^\epsilon(x)$ for $\epsilon \in \{-, +\}$, so that $x = i^t(x)$. Moreover, if $x = i^{t_1}(x) = i^{t_2}(x)$ for some $t_1, t_2 \in J$, then, since J is directed, there exists $t' \in J$ and morphisms $h_1: t_1 \rightarrow t'$ and $h_2: t_2 \rightarrow t'$ in J so that both $x \in S^{t_1}$ and $x \in S^{t_2}$ are mapped to $x \in S^{t'}$. Thus, by Proposition 1.1.1.3 and Proposition 1.3.3.7, we have

$$(\operatorname{colim}_{t \in J} Q^t)_k \simeq S.$$

Now, write $W: J \rightarrow I$ for the functor which maps $(i, U, g^-, g^+) \in J$ to i . In particular, for every $i \in I$, we have $i = W(i, \emptyset, \perp, \perp)$ so that W is a cofinal functor by Proposition 1.2.3.11. Then, since

$$(-)_{\leq k-1}^{\text{Pol}} Q^{(-)} = P^{(-)} W$$

and $(-)_{\leq k-1}^{\text{Pol}}$ preserves colimits, we have $(\operatorname{colim}_{t \in J} Q^t)_{\leq k-1} \simeq P$. Finally, since $(-)_{\leq k-1}^{\text{Pol}}$ and $(-)_{\leq k}$ are jointly conservative, we have $\operatorname{colim}_{t \in J} Q^t \simeq (P, S)$. \square

We now characterize the presentable objects of finite-dimensional polygraphs:

Proposition 1.3.3.18. *Given $k \in \mathbb{N}_n$ and $P \in \mathbf{Pol}_k$, P is finitely presentable if and only if it is finite.*

Proof. Suppose first that P is finitely presentable. By Proposition 1.3.3.17, there is a colimit cocone

$$(F^i : P^i \rightarrow P)_{i \in I}$$

on some directed diagram $P^{(-)} : I \rightarrow \mathbf{Pol}_k$ where P^i is finite for $i \in I$. Since P is finitely presentable, there is a factorization of $\text{id}_P : P \rightarrow P$ through some P^i , so that we have $F^i \circ F = \text{id}_P$ for some $i \in I$ and $F : P \rightarrow P^i$. Then, for every $j \in \mathbb{N}_k$, we have $(F^i)_j \circ F_j = \text{id}_{P_j}$ in \mathbf{Set} . Since $(P^i)_j$ finite, we deduce that P_j is finite for $j \in \mathbb{N}_k$.

We show converse implication by induction on k . If $k = 0$, the property holds since $\mathbf{Pol}_0 = \mathbf{Set}$ (see Example 1.1.1.5). So suppose that $k > 0$. Let

$$(G^i : Q^i \rightarrow Q)_{i \in I}$$

be a colimit cocone in \mathbf{Pol}_k on a directed diagram

$$d : I \rightarrow \mathbf{Pol}_k$$

and $F : P \rightarrow Q$ be a morphism in \mathbf{Pol}_k . By Proposition 1.3.3.6(iii), $(-)^{\text{Pol}}_{\leq k-1, k}$ preserves colimits. Thus, by induction hypothesis, there is $j_1 \in I$ and $\bar{F} : P_{\leq k-1} \rightarrow Q_{\leq k-1}^{j_1} \in \mathbf{Pol}_{k-1}$ such that

$$G_{\leq k-1}^{j_1} \circ \bar{F} = F_{\leq k-1}.$$

By Proposition 1.3.3.7 and since P_k is finite, there exists $j_2 \in I$ and a function $f : P_k \rightarrow Q_k^{j_2} \in \mathbf{Set}$ such that

$$G_k^{j_2} \circ f = F_k.$$

Since I is directed, we can suppose $j_1 = j_2 = j$ for some $j \in I$. Moreover, since T is finitary, \mathcal{U}_{k-1} preserves directed colimits. Thus, by Proposition 1.3.3.6(ii), $\mathcal{U}_{k-1} \circ (-)^{*, k-1}$ preserves directed colimits, so that we have a colimit cocone

$$((G_{\leq k-1}^i)^*_{k-1} : (Q_{\leq k-1}^i)^*_{k-1} \rightarrow (Q_{\leq k-1}^j)^*_{k-1})_{i \in I}$$

on $(-)^*_{k-1} \mathcal{U}_{k-1} (-)^{*, k-1} Q^{(-)}$. Note that, for $\epsilon \in \{-, +\}$, the diagram

$$\begin{array}{ccc} P_k & \xrightarrow{f} & Q_k^j \\ \text{d}_{k-1}^\epsilon \downarrow & & \downarrow \text{d}_{k-1}^\epsilon \\ (P_{\leq k-1})^*_{k-1} & \xrightarrow{\bar{F}_{k-1}^*} & (Q_{\leq k-1}^j)^*_{k-1} \end{array}$$

commutes when postcomposed with $(G_{\leq k-1}^j)^*_{k-1}$ since

$$\begin{aligned} (G_{\leq k-1}^j)^*_{k-1} \circ \text{d}_{k-1}^\epsilon \circ f &= \text{d}_{k-1}^\epsilon \circ G_k^j \circ f \\ &= \text{d}_{k-1}^\epsilon \circ F_k \\ &= (F_{\leq k-1})^*_{k-1} \circ \text{d}_{k-1}^\epsilon \\ &= (G_{\leq k-1}^j)^*_{k-1} \circ \bar{F}_{k-1}^* \circ \text{d}_{k-1}^\epsilon. \end{aligned}$$

Thus, by the properties of directed colimits and since P_k is finite, up to choosing a bigger $j \in I$, we can suppose that the above diagram commutes for $\epsilon \in \{-, +\}$. So, (\bar{F}, f) is a morphism of \mathbf{Pol}_k of type $P \rightarrow Q^j$ satisfying

$$F = G^j \circ (\bar{F}, f)$$

and this factorization can be shown essentially unique using the fact that the factorizations

$$F_{\leq k-1} = G_{\leq k-1}^j \circ \bar{F} \quad \text{and} \quad F_k = G_k^j \circ f$$

are essentially unique. Hence, P is finitely presentable. \square

Theorem 1.3.3.19. *For every $k \in \mathbb{N}_n$, \mathbf{Pol}_k is locally finitely presentable.*

Proof. The category \mathbf{Pol}_k has all colimits by Proposition 1.3.3.6(i) and, by Proposition 1.3.3.17, every k -polygraph is a directed colimit of finite k -polygraphs (that are finitely presentable by Proposition 1.3.3.18), and the subcategory of finite k -polygraphs is essentially small. Thus, \mathbf{Pol}_k is finitely presentable. \square

Until the end of the paragraph, we suppose that $n = \omega$. We now verify that \mathbf{Pol}_ω is locally finitely presentable by showing properties similar to the ones of finite-dimensional polygraphs.

Proposition 1.3.3.20. *Every ω -polygraph is a directed colimit of finite ω -polygraphs.*

Proof. Let P be an ω -polygraph. Using the proof of Proposition 1.3.3.17, we can define, by induction on $k \in \mathbb{N}$, small directed categories I^k and diagrams $P^{k,(-)} : I^k \rightarrow \mathbf{Pol}_k$ where $P^{k,i}$ is finite for $i \in I^k$, with colimit cocones

$$(F^{k,i} : P^{k,i} \rightarrow P_{\leq k})_{i \in I^k}.$$

In the following, given $k \in \mathbb{N}$, a category C and $x \in C_0$, we denote the constant functor $I^k \rightarrow C$ of value x by Δ_x^k . For $k \in \mathbb{N}$, the proof of Proposition 1.3.3.17 moreover gives functors

$$V^k : I^k \rightarrow I^{k+1} \quad \text{and} \quad W^k : I^{k+1} \rightarrow I^k$$

such that $W^k V^k = \text{id}_{I^k}$ (in particular, W^k is cofinal by Proposition 1.2.3.11) and such that

$$P^{k+1,(-)} \circ V^k = (-)_{\uparrow_{k+1,k}}^{\text{Pol}} \circ P^{k,(-)}, \quad (1.10)$$

$$P^{k,(-)} \circ W^k = (-)_{\leq k,k+1}^{\text{Pol}} \circ P^{k+1,(-)}, \quad (1.11)$$

$$F^k W^k = (-)_{\leq k,k+1}^{\text{Pol}} F^{k+1} \quad (1.12)$$

where $F^k = (F^{k,i})_{i \in I^k}$ is seen as a natural transformation $P^{k,(-)} \Rightarrow \Delta_{P_{\leq k}}^k$. Let

$$(\bar{V}^k : I^k \rightarrow I)_{k \in \mathbb{N}} \quad (1.13)$$

be a colimit on the diagram

$$I^0 \xrightarrow{V^0} I^1 \xrightarrow{V^1} I^2 \xrightarrow{V^2} I^3 \xrightarrow{V^3} \dots$$

We prove that I is directed. First, I is not empty since every I^k is not empty. Now, given $x_1, x_2 \in I$, since the colimit (1.13) is directed, there is $k \in \mathbb{N}$, $x'_1, x'_2 \in I^k$ such that $\bar{V}^k(x'_i) = x_i$ for $i \in \{1, 2\}$. Thus, since I^k is directed, there exists $x' \in I^k$ and morphisms $h'_i : x'_i \rightarrow x'$ for $i \in \{1, 2\}$. Thus, we have morphisms $\bar{V}^k(h'_i) : x_i \rightarrow \bar{V}^k(x')$ for $i \in \{1, 2\}$. Finally, given $x, y \in I_0$ and $f_1, f_2 : x \rightarrow y \in I$, since (1.13) is a colimit cocone, there exist $k_i \in \mathbb{N}$, objects x'_i, y'_i and morphisms $f'_i : x'_i \rightarrow y'_i$ of I^{k_i}

such that $\bar{V}^{k_i}(f'_i) = f_i$ for $i \in \{1, 2\}$. Since (1.13) is directed, we can suppose that $k_1 = k_2$, $x'_1 = x'_2$ and $y'_1 = y'_2$. Thus, since I^{k_1} is directed, we have $f'_1 = f'_2$, so that $f_1 = f_2$. Hence, I is directed.

For $k \in \mathbb{N}$, we define a functor $\bar{W}^k : I \rightarrow I^k$ using the colimit (1.13) as the unique functor such that

$$\bar{W}^k \circ \bar{V}^l = W^k \circ \dots \circ W^{l-1}$$

for $l \in \mathbb{N}$ with $l \geq k$. In particular, we have $\bar{W}^k \circ \bar{V}^k = \text{id}_{I^k}$, so that \bar{W}^k is cofinal by Proposition 1.2.3.11).

In the following, given $k \in \mathbb{N}$ and $l \in \{k+1, \omega\}$, we write $\epsilon^{k,l}$ for the counit of the adjunction

$$(-)_{\uparrow l, k}^{\text{Pol}} \dashv (-)_{\leq k, l}^{\text{Pol}}$$

given by Proposition 1.3.3.6(iii) and Proposition 1.3.3.12. Then, given $k \in \mathbb{N}$, the cocone F^k induces another cocone

$$(\bar{F}^{k,i} : (\mathbf{P}^{k,i})_{\uparrow \omega} \rightarrow \mathbf{P})_{i \in I^k}$$

on the diagram $(-)_{\uparrow \omega, k}^{\text{Pol}} \circ \mathbf{P}^{k,(-)}$, where

$$\bar{F}^k = (\epsilon^{k,\omega} \Delta_{\mathbf{P}}^k) \circ ((-)_{\uparrow \omega, k}^{\text{Pol}} F^k).$$

By (1.10), we have

$$(-)_{\uparrow \omega, k+1}^{\text{Pol}} \circ \mathbf{P}^{k+1,(-)} \circ V^k = (-)_{\uparrow \omega, k}^{\text{Pol}} \circ \mathbf{P}^{k,(-)}$$

so that, by the colimit (1.13), there exists a unique functor $\mathbf{P}^{(-)} : I \rightarrow \mathbf{Pol}_{\omega}$ such that, for $k \in \mathbb{N}$,

$$\mathbf{P}^{(-)} \circ \bar{V}^k = (-)_{\uparrow \omega, k}^{\text{Pol}} \circ \mathbf{P}^{k,(-)}.$$

In particular, since $\mathbf{P}^{k,i}$ is finite for $k \in \mathbb{N}$ and $i \in I^k$, we have that \mathbf{P}^i is a finite ω -polygraph for $i \in I$. Given a category C and $x \in C_0$, we write Δ_x for the constant functor $I \rightarrow \mathbf{Pol}_{\omega}$ of value x . For $k \in \mathbb{N}$, we compute that

$$\begin{aligned} \bar{F}^{k+1} V^k &= (\epsilon^{k+1,\omega} \Delta_{\mathbf{P}}^{k+1} V^k) \circ ((-)_{\uparrow \omega, k+1}^{\text{Pol}} F^{k+1} V^k) \\ &= (\epsilon^{k+1,\omega} \Delta_{\mathbf{P}}^k) \circ ((-)_{\uparrow \omega, k+1}^{\text{Pol}} F^{k+1} V^k) \circ ((-)_{\uparrow \omega, k+1}^{\text{Pol}} \epsilon^{k,k+1} (-)_{\uparrow k+1, k}^{\text{Pol}} \circ \mathbf{P}^{k,(-)}) \\ &\quad \text{(by (1.10) and since } \partial_1^-(F^{k+1}) = \mathbf{P}^{k+1,(-)} \text{ and } \epsilon^{k,k+1} (-)_{\uparrow k+1, k}^{\text{Pol}} = \text{id}_{(-)_{\uparrow k+1, k}^{\text{Pol}}}) \\ &= (\epsilon^{k+1,\omega} \Delta_{\mathbf{P}}^k) \circ ((-)_{\uparrow \omega, k+1}^{\text{Pol}} \epsilon^{k,k+1} (-)_{\leq k+1, \omega}^{\text{Pol}} \Delta_{\mathbf{P}}^k) \circ ((-)_{\uparrow \omega, k}^{\text{Pol}} (-)_{\leq k, k+1}^{\text{Pol}} F^{k+1} V^k) \\ &\quad \text{(by naturality)} \\ &= (\epsilon^{k,\omega} \Delta_{\mathbf{P}}^k) \circ ((-)_{\uparrow \omega, k}^{\text{Pol}} F^k W^k V^k) \\ &\quad \text{(since } \epsilon^{k+1,\omega} \circ ((-)_{\uparrow \omega, k+1}^{\text{Pol}} \epsilon^{k,k+1} (-)_{\leq k+1, \omega}^{\text{Pol}}) = \epsilon^{k,\omega}) \\ &= (\epsilon^{k,\omega} \Delta_{\mathbf{P}}^k) \circ ((-)_{\uparrow \omega, k}^{\text{Pol}} F^k) \\ &= \bar{F}^k. \end{aligned}$$

Thus, by the colimit (1.13), there exists a unique cocone $\bar{F} : \mathbf{P}^{(-)} \Rightarrow \Delta_{\mathbf{P}}$ such that, for $k \in \mathbb{N}$,

$$\bar{F} \bar{V}^k = \bar{F}^k.$$

We verify that it is a colimit cocone. For $k, l \in \mathbb{N}$ with $k \leq l$, we have

$$\begin{aligned}
(-)_{\leq k, \omega}^{\text{Pol}} \bar{F} \bar{V}^l &= (-)_{\leq k, \omega}^{\text{Pol}} \bar{F}^l \\
&= ((-)_{\leq k, \omega}^{\text{Pol}} \epsilon^{l, \omega} \Delta_{\mathbf{P}}^l) \circ ((-)_{\leq k, \omega}^{\text{Pol}} (-)_{\uparrow \omega, l}^{\text{Pol}} F^l) \\
&= (-)_{\leq k, l}^{\text{Pol}} F^l && \text{(since } (-)_{\leq l, \omega}^{\text{Pol}} \epsilon^{l, \omega} = \text{id}_{(-)_{\leq l, \omega}^{\text{Pol}}} \text{)} \\
&= F^k W^k \dots W^{l-1} && \text{(by (1.12))} \\
&= F^k \bar{W}^k \bar{V}^l
\end{aligned}$$

so that, by the colimit (1.13), we have $(-)_{\leq k, \omega}^{\text{Pol}} \bar{F} = F^k \bar{W}^k$ for every $k \in \mathbb{N}$. Since F^k is a colimit cocone and \bar{W}^k is cofinal,

$$(-)_{\leq k, \omega}^{\text{Pol}} \bar{F}: (-)_{\leq k, \omega}^{\text{Pol}} \mathbf{P}^{(-)} \Rightarrow \Delta_{\mathbf{P}_{\leq k}}$$

is a colimit cocone by Proposition 1.2.3.10. Since \mathbf{Pol}_{ω} is cocomplete by Proposition 1.3.3.15, and $(-)_{\leq k, \omega}^{\text{Pol}}$ preserves colimits by Proposition 1.3.3.12 for every $k \in \mathbb{N}$, and the functors $(-)_{\leq \omega, l}^{\text{Pol}}$ are jointly conservative for $l \in \mathbb{N}$, the latter jointly reflects colimits. Thus, $\bar{F}: \mathbf{P}^{(-)} \Rightarrow \Delta_{\mathbf{P}}$ is a colimit cocone. Hence, \mathbf{P} is a directed colimit of finite ω -polygraphs. \square

Proposition 1.3.3.21. *Given $\mathbf{P} \in \mathbf{Pol}_{\omega}$, \mathbf{P} is finitely presentable if and only if it is finite.*

Proof. The proof of the first implication is similar to the one of Proposition 1.3.3.18. So suppose that \mathbf{P} is finite. Let

$$(F^i: \mathbf{Q}^i \rightarrow \mathbf{Q})_{i \in I}$$

be a directed colimit on a diagram $\mathbf{Q}^{(-)}: I \rightarrow \mathbf{Pol}_{\omega}$. Since \mathbf{P} is finite, $\mathbf{P} = \bar{\mathbf{P}}_{\uparrow \omega}$ for some $k \in \mathbb{N}$ and k -polygraph $\bar{\mathbf{P}}$. Then, since there is an adjunction $(-)_{\uparrow \omega, k}^{\text{Pol}} \dashv (-)_{\leq k, \omega}^{\text{Pol}}$ by Proposition 1.3.3.12, we have an isomorphism

$$\mathbf{Pol}_{\omega}(\mathbf{P}, \mathbf{Q}) \simeq \mathbf{Pol}_k(\bar{\mathbf{P}}, \mathbf{Q}_{\leq k})$$

Since $(-)_{\leq k, \omega}^{\text{Pol}}$ is a left adjoint by Proposition 1.3.3.12,

$$(F_{\leq k}^i: \mathbf{Q}_{\leq k}^i \rightarrow \mathbf{Q}_{\leq k})_{i \in I}$$

is a directed colimit on $(-)_{\leq k, \omega}^{\text{Pol}} \circ \mathbf{Q}^{(-)}$. By Proposition 1.3.3.18, since $\bar{\mathbf{P}}$ is finite, we have an isomorphism

$$\mathbf{Pol}_k(\bar{\mathbf{P}}, \mathbf{Q}_{\leq k}) \simeq \text{colim}_{i \in I} \mathbf{Pol}_k(\bar{\mathbf{P}}, \mathbf{Q}_{\leq k}^i)$$

and, by the properties of the adjunction $(-)_{\uparrow \omega, k}^{\text{Pol}} \dashv (-)_{\leq k, \omega}^{\text{Pol}}$, we have

$$\text{colim}_{i \in I} \mathbf{Pol}_k(\bar{\mathbf{P}}, \mathbf{Q}_{\leq k}^i) \simeq \text{colim}_{i \in I} \mathbf{Pol}_{\omega}(\mathbf{P}, \mathbf{Q}^i).$$

Hence, \mathbf{P} is finitely presentable. \square

We can conclude that:

Theorem 1.3.3.22. *The category \mathbf{Pol}_{ω} is locally finitely presentable.*

Proof. It has all colimits by Proposition 1.3.3.15. Moreover, every ω -polygraph can be written as a directed colimit of finite ω -polygraphs by Proposition 1.3.3.20, that are finitely presentable by Proposition 1.3.3.21. Finally, it is clear that the full subcategory of finite ω -polygraphs is essentially small. Hence, \mathbf{Pol}_{ω} is locally finitely presentable. \square

1.4 Strict categories and precategories

In this section, we introduce the definitions for the two principal notions of higher categories that we will encounter in the following chapters: *strict categories* and *precategories*. Starting from their equational definitions, we show that they fit in Batanin’s framework of “higher categories as globular algebras” developed in the previous sections. More precisely, we prove that both theories are associated with truncable monads on globular sets using the criteria proved in the previous sections (Theorem 1.2.3.20 and Theorem 1.2.4.11). This allows us to derive a notion of polygraph for both. Finally, we recall from Makkai [Mak05] the relation between the two structures and show how strict categories can be described as precategories which satisfy some exchange condition (Section 1.4.3).

1.4.1 Strict categories

Strict categories, as their name suggests, are a classical example of a theory for higher categories that lies on the strict side of the strict/weak spectrum of higher categories. As such, they do not represent faithfully the homotopical information of topological spaces (see [Sim98] or [Ber99]). Nevertheless, they admit a relatively simpler axiomatization than weak higher categories, and can be encountered in several situations of interest. Below, we recall their equational definition, show that they are globular algebras associated with a truncable monad, and derive the associated notion of polygraph for them.

1.4.1.1 – Equational definition. Given $n \in \mathbb{N} \cup \{\omega\}$, a *strict n -category* $(C, \partial^-, \partial^+, \text{id}, *)$ (often simply denoted C) is an n -globular set $(C, \partial^-, \partial^+)$ together with, for $k \in \mathbb{N}$ with $k < n$, identity operations

$$\text{id}^{k+1}: C_k \rightarrow C_{k+1}$$

often written id when there is no ambiguity on k , and, for $i, k \in \mathbb{N}_n$ with $i < k$, composition operations

$$*_{i,k}: C_k \times_i C_k \rightarrow C_k$$

often denoted $*_i$ when there is no ambiguity on k , which satisfy the axioms (S-i) to (S-vi) below. Given $k, l \in \mathbb{N}_n$ such that $k \leq l$ and $u \in C_k$, we extend the notations for identity operations and write $\text{id}^l(u)$ for

$$\text{id}^l(u) = \text{id}^l \circ \dots \circ \text{id}^{k+1}(u)$$

and, for the sake of conciseness, we often write id_u^l for $\text{id}^l(u)$, or even id_u when $l = k + 1$. The axioms are the following:

(S-i) for $k \in \mathbb{N}_{n-1}$ and $u \in C_k$,

$$\partial_k^-(\text{id}_u^{k+1}) = \partial_k^+(\text{id}_u^{k+1}) = u,$$

(S-ii) for $i, k \in \mathbb{N}_n$ with $i < k$, $(u, v) \in C_k \times_i C_k$ and $\epsilon \in \{-, +\}$,

$$\partial_{k-1}^\epsilon(u *_i v) = \begin{cases} \partial_{k-1}^\epsilon(u) *_i \partial_{k-1}^\epsilon(v) & \text{if } i < k - 1, \\ \partial_{k-1}^\epsilon(u) & \text{if } i = k - 1 \text{ and } \epsilon = -, \\ \partial_{k-1}^+(v) & \text{if } i = k - 1 \text{ and } \epsilon = +, \end{cases}$$

(S-iii) for $i, k \in \mathbb{N}_n$ such that $i < k$, and $u \in C_k$,

$$\text{id}^k(\partial_i^-(u)) *_i u = u = u *_i \text{id}^k(\partial_i^+(u)),$$

(S-iv) for $i, k \in \mathbb{N}_n$ such that $i < k$, and i -composable $u, v, w \in C_k$,

$$(u *_i v) *_i w = u *_i (v *_i w),$$

(S-v) for $i, k \in \mathbb{N}_{n-1}$ such that $i < k$, and $(u, v) \in C_k \times_i C_k$,

$$\text{id}^{k+1}(u *_i v) = \text{id}_u^{k+1} *_i \text{id}_v^{k+1},$$

(S-vi) for $i, j, k \in \mathbb{N}_n$ such that $i < j < k$, and $u, u', v, v' \in C_k$ such that u, v are i -composable, and u, u' are j -composable, and v, v' are j -composable,

$$(u *_i v) *_j (u' *_i v') = (u *_j u') *_i (v *_j v').$$

Note that the composition that appear in Axioms (S-iii), (S-iv), (S-v) and (S-vi) are well-defined as a consequence of Axioms (S-i) and (S-ii) and the equations satisfied by the source and target operations of a globular set. The Axiom (S-vi) is frequently called the *exchange law* of strict categories.

Example 1.4.1.2. Given a 2-category C and $x, y, z \in C_0$, $f_1, f_2, f_3, g_1, g_2, g_3 \in C_1$ and $u, u', v, v' \in C_2$ in the following configuration

$$\begin{array}{ccccc} & & \begin{array}{c} \xrightarrow{f_1} \\ \Downarrow u \\ \xrightarrow{f_2} \\ \Downarrow u' \\ \xrightarrow{f_3} \end{array} & & \\ x & \xrightarrow{f_2} & y & \xrightarrow{g_2} & z \\ & & \begin{array}{c} \xrightarrow{g_1} \\ \Downarrow v \\ \xrightarrow{g_2} \\ \Downarrow v' \\ \xrightarrow{g_3} \end{array} & & \end{array}$$

we have $(u *_0 v) *_1 (u' *_0 v') = (u *_1 u') *_0 (v *_1 v')$ by Axiom (S-vi).

Our definition of strict categories involves sets, but we could have written a similar definition using classes to define *large* strict categories. For such alternative definition, we have the following classical example:

Example 1.4.1.3. There is a large strict 2-category Cat whose 0-cells are the small categories, whose 1-cells are the functors between the 1-categories, and whose 2-cells are the natural transformations between functors, and where the operations $*_{0,1}$ is the composition of functors, and the operations $*_{0,2}$ and $*_{1,2}$ are respectively the horizontal and vertical compositions of natural transformations. Note that the exchange law Axiom (S-vi) in this setting corresponds to the usual *exchange law* for natural transformations.

Given two strict n -categories C and D , a *morphism* F between C and D is the data of an n -globular morphism $F: C \rightarrow D$ which moreover satisfies that

- $F(\text{id}_u^{k+1}) = \text{id}_{F(u)}^{k+1}$ for every $k \in \mathbb{N}_{n-1}$ and $u \in C_k$,
- $F(u *_i v) = F(u) *_i F(v)$ for every $i, k \in \mathbb{N}_n$ with $i < k$ and i -composable $u, v \in C_k$.

We often call such morphisms *n-functors*. We write Cat_n for the category of strict n -categories.

There is a functor

$$\bar{\mathcal{U}}_n: \text{Cat}_n \rightarrow \text{Glob}_n$$

which maps a strict n -category to its underlying n -globular set. The above definition of strict n -categories directly translates into an essentially algebraic theory, so that the functor $\bar{\mathcal{U}}_n$ is induced by a morphism between the essentially algebraic theory of n -globular sets (*c.f.* Remark 1.2.2.2) and the one of strict n -categories. Thus, we get:

Proposition 1.4.1.4. *For every $n \in \mathbb{N} \cup \{\omega\}$, the category \mathbf{Cat}_n is locally finitely presentable, complete and cocomplete. Moreover, the functor $\bar{\mathcal{U}}_n$ is a right adjoint which preserves directed colimits.*

Proof. The category \mathbf{Cat}_n is locally finitely presentable by Theorem 1.1.2.2 and in particular cocomplete. It is moreover complete by Proposition 1.1.1.10. The required properties on $\bar{\mathcal{U}}_n$ are a consequence of Theorem 1.1.2.7. \square

1.4.1.5 – Monadicity. We prove here that the functors $\bar{\mathcal{U}}_n$ are monadic. For this purpose, we use Beck's monadicity theorem, that we first recall quickly. Given a category C and morphisms $f, g: X \rightarrow Y$ and $h: Y \rightarrow Z$ in C , we say that h is a *split coequalizer of f and g* when there exist $s: Z \rightarrow Y$ and $t: Y \rightarrow X$ as in

$$\begin{array}{ccc} & \begin{array}{c} \curvearrowright t \\ \curvearrowright s \end{array} & \\ & \begin{array}{c} f \\ h \end{array} & \\ X & \begin{array}{c} \rightrightarrows \\ \rightrightarrows \end{array} & Y \longrightarrow Z \end{array}$$

such that $h \circ f = h \circ g$, $h \circ s = \text{id}_Z$, $f \circ t = \text{id}_Y$, and $s \circ h = t \circ g$. From this data, it can be shown that h is a coequalizer of f and g . Beck's monadicity theorem is then:

Theorem 1.4.1.6. *Given a functor $R: C \rightarrow D$, the functor R is monadic if and only if the following conditions are satisfied:*

- (i) *R is a right adjoint,*
- (ii) *R reflects isomorphisms,*
- (iii) *for every pair of morphisms $f, g: X \rightarrow Y$ in C , if $R(f), R(g)$ have a split coequalizer, then f, g have a coequalizer which is preserved by R .*

Proof. See [Bor94b, Theorem 4.4.4] or the original work of Beck [Bec67]. \square

We can then prove the following:

Proposition 1.4.1.7. *Given $n \in \mathbb{N} \cup \{\omega\}$, the functor $\bar{\mathcal{U}}_n$ is monadic.*

Proof. By Proposition 1.4.1.4, $\bar{\mathcal{U}}_n$ is a right adjoint. Moreover, given a morphism

$$F: C \rightarrow D \in \mathbf{Cat}_n,$$

if $F_k: C_k \rightarrow D_k$ is a bijection for $k \in \mathbb{N}_n$, then there is a morphism

$$F^{-1}: D \rightarrow C \in \mathbf{Cat}_n$$

defined by $(F^{-1})_k = (F_k)^{-1}$ for $k \in \mathbb{N}_n$, so that $\bar{\mathcal{U}}_n$ reflects isomorphisms. Now, let $F, G: X \rightarrow Y$ be two morphisms of \mathbf{Cat}_n such that there exist $Z \in \mathbf{Glob}_n$, and morphisms

$$H: \bar{\mathcal{U}}_n Y \rightarrow Z, \quad S: Z \rightarrow \bar{\mathcal{U}}_n Y \quad \text{and} \quad T: \bar{\mathcal{U}}_n Y \rightarrow \bar{\mathcal{U}}_n X$$

of \mathbf{Glob}_n , as in

$$\begin{array}{ccc} & \begin{array}{c} \curvearrowright T \\ \curvearrowright S \end{array} & \\ & \begin{array}{c} \bar{\mathcal{U}}_n(F) \\ H \end{array} & \\ \bar{\mathcal{U}}_n X & \begin{array}{c} \rightrightarrows \\ \rightrightarrows \end{array} & \bar{\mathcal{U}}_n Y \longrightarrow Z \end{array}$$

that witness that $\bar{\mathcal{U}}_n(F), \bar{\mathcal{U}}_n(G)$ is a split coequalizer. We prove that F, G has a coequalizer which is preserved by $\bar{\mathcal{U}}_n$. For this purpose, we shall equip Z with a structure of a strict n -category. For $i, k \in \mathbb{N}_n$ with $i < k$ and $(u, v) \in Z_k \times_i Z_k$, we put

$$u *_i v = H(S(u) *_i S(v))$$

and, given $k \in \mathbb{N}_{n-1}$ and $u \in C_k$, we put

$$\text{id}_u^{k+1} = H(\text{id}_{S(u)}^{k+1})$$

We verify that the axioms of strict n -categories are verified. Let $k \in \mathbb{N}_{n-1}$, $u \in Z_k$ and $\epsilon \in \{-, +\}$. We have

$$\begin{aligned} \partial_k^\epsilon(\text{id}_u^{k+1}) &= \partial_k^\epsilon(H(\text{id}_{S(u)}^{k+1})) \\ &= H(\partial_k^\epsilon(\text{id}_{S(u)}^{k+1})) \\ &= H(S(u)) = u \end{aligned}$$

so that Axiom (S-i) is satisfied. Now, let $i, k \in \mathbb{N}_n$ such that $i < k$, $(u, v) \in Z_k \times_i Z_k$ and $\epsilon \in \{-, +\}$. We have

$$\begin{aligned} \partial_{k-1}^\epsilon(u *_i v) &= H(\partial_{k-1}^\epsilon(S(u) *_i S(v))) \\ &= \begin{cases} H(\partial_{k-1}^\epsilon(S(u)) *_i \partial_{k-1}^\epsilon(S(v))) & \text{if } i < k-1, \\ H(\partial_{k-1}^\epsilon(S(u))) & \text{if } i = k-1 \text{ and } \epsilon = -, \\ H(\partial_{k-1}^+(S(v))) & \text{if } i = k-1 \text{ and } \epsilon = +, \end{cases} \end{aligned}$$

so that, by reducing the last expressions, we see that Axiom (S-ii) is satisfied. Now, let $i, k \in \mathbb{N}_n$ such that $i < k$, and $u \in Z_k$. We have

$$\begin{aligned} \text{id}^k(\partial_i^-(u)) *_i u &= H(S(H(\text{id}_{S(\partial_i^-(u))}^k)) *_i S(u)) \\ &= H(S(H(\text{id}_{\partial_i^-(S(u))}^k)) *_i SHS(u)) \\ &= H(GT(\text{id}_{\partial_i^-(S(u))}^k) *_i GTS(u)) \\ &= HG(T(\text{id}_{\partial_i^-(S(u))}^k) *_i TS(u)) \\ &= HF(T(\text{id}_{\partial_i^-(S(u))}^k) *_i TS(u)) \\ &= H(FT(\text{id}_{\partial_i^-(S(u))}^k) *_i FTS(u)) \\ &= H(\text{id}_{\partial_i^-(S(u))}^k *_i S(u)) \\ &= H(S(u)) = u \end{aligned}$$

and, similarly, $u *_i \text{id}^k(\partial_i^+(u)) = u$, so that Axiom (S-iii) holds. Now, let $i, k \in \mathbb{N}_n$ such that $i < k$, and i -composable $u, v, w \in C_k$. We have

$$\begin{aligned} (u *_i v) *_i w &= H(S(H(S(u) *_i S(v))) *_i S(w)) \\ &= H(SH(S(u) *_i S(v)) *_i SHS(w)) \\ &= H(GT(S(u) *_i S(v)) *_i GTS(w)) \\ &= HG(T(S(u) *_i S(v)) *_i TS(w)) \\ &= HF(T(S(u) *_i S(v)) *_i TS(w)) \end{aligned}$$

$$\begin{aligned}
&= H(FT(S(u) *_i S(v)) *_i FTS(w)) \\
&= H((S(u) *_i S(v)) *_i S(w)) \\
&= H(S(u) *_i S(v) *_i S(w))
\end{aligned}$$

and, similarly, $u *_i (v *_i w) = H(S(u) *_i S(v) *_i S(w))$. So that Axiom (S-iv) is satisfied. Axioms (S-v) and (S-vi) are proved similarly, so Z is equipped with a structure of a strict n -category.

We now verify that H is a strict n -category morphism. Given $k \in \mathbb{N}_{n-1}$ and $u \in Y_k$, we have

$$\text{id}_{H(u)}^k = H(\text{id}_{SH(u)}^k) = H(\text{id}_u^k)$$

and, given $i, k \in \mathbb{N}_n$ with $i < k$, and $(u, v) \in Y_k \times_i Y_k$, we have

$$\begin{aligned}
H(u) *_i H(v) &= H(SH(u) *_i SH(v)) \\
&= H(GT(u) *_i GT(v)) \\
&= HG(T(u) *_i T(v)) \\
&= HF(T(u) *_i T(v)) \\
&= H(FT(u) *_i FT(v)) \\
&= H(u *_i v)
\end{aligned}$$

so that H is a strict n -category morphism.

We now prove that H is the coequalizer of F and G in \mathbf{Cat}_n . Let $K: Y \rightarrow W$ be an n -functor such that $KF = KG$. Then, since H is the coequalizer of $\bar{\mathcal{U}}_n(F)$ and $\bar{\mathcal{U}}_n(G)$, there is a unique morphism

$$K': \bar{\mathcal{U}}_n Z \rightarrow \bar{\mathcal{U}}_n W$$

of \mathbf{Glob}_n such that $K'H = K$. We are only left to prove that K' is an n -functor. First, note that we have

$$K' = K'HS = KS \quad \text{and} \quad KSH = KGT = KFT = K.$$

Now, given $k \in \mathbb{N}_{n-1}$ and $u \in C_k$, we have

$$\begin{aligned}
KS(\text{id}_u^{k+1}) &= KSH(\text{id}_{S(u)}^{k+1}) \\
&= K(\text{id}_{S(u)}^{k+1}) \\
&= \text{id}_{KS(u)}^{k+1}.
\end{aligned}$$

Moreover, given $i, k \in \mathbb{N}_n$ with $i < k$, and $(u, v) \in C_k \times C_k$, we have

$$\begin{aligned}
KS(u *_i v) &= KSH(S(u) *_i S(v)) \\
&= K(S(u) *_i S(v)) \\
&= KS(u) *_i KS(v),
\end{aligned}$$

so that K' is an n -functor. Hence, H is the coequalizer in \mathbf{Cat}_n of F and G . We can conclude with Theorem 1.4.1.6. \square

1.4.1.8 – Truncation and inclusion functors. Let $k, l \in \mathbb{N} \cup \{\omega\}$ such that $k < l$. There is a truncation functor

$$(-)_{\leq k, l}^{\text{Cat}}: \mathbf{Cat}_l \rightarrow \mathbf{Cat}_k$$

which maps a strict l -category C to its evident underlying strict k -category, denoted $C_{\leq k}$, and called the k -truncation of C .

Conversely, there is an inclusion functor

$$(-)_{\uparrow l, k}^{\text{Cat}}: \mathbf{Cat}_k \rightarrow \mathbf{Cat}_l$$

which maps a strict k -category C to the strict l -category $C_{\uparrow l}$, called the l -inclusion of C , and defined by

$$(C_{\uparrow l})_{\leq k} = C \quad \text{and} \quad (C_{\uparrow l})_m = C_k$$

for $m \in \mathbb{N}_l$ with $k < m$, and such that

- for $m \in \mathbb{N}_{l-1}$ with $k \leq m$ and $u \in (C_{\uparrow l})_{m+1}$, $\partial_m^-(u) = \partial_m^+(u) = u$,
- for $m \in \mathbb{N}_{l-1}$ with $k \leq m$ and $u \in (C_{\uparrow l})_m$, $\text{id}_u^{m+1} = u$,
- for $i, m \in \mathbb{N}_l$ with $i < k < m$ and $(u, v) \in (C_{\uparrow l})_m \times_i (C_{\uparrow l})_m$, $u *_{i, m} v = u *_{i, k} v$,
- for $i, m \in \mathbb{N}_l$ with $k \leq i < m$ and $(u, v) \in (C_{\uparrow l})_m \times_i (C_{\uparrow l})_m$, $u *_{i, m} v = u = v$.

There is an adjunction $(-)_{\uparrow l, k}^{\text{Cat}} \dashv (-)_{\leq k, l}^{\text{Cat}}$ whose unit is the identity and whose counit $i^{k, l}$ is such that, given a strict l -category C , the l -functor $i_C^{k, l}: (C_{\leq k})_{\uparrow l} \rightarrow C$ is defined by $(i_C^{k, l})_{\leq k} = \text{id}_{C_{\leq k}}$ and, for $m \in \mathbb{N}_l$ with $m > k$, $i_C^{k, l}$ maps $u \in ((C_{\leq k})_{\uparrow l})_m = C_k$ to id_u^m .

1.4.1.9 – Globular algebras. By Proposition 1.4.1.4, each functor $\bar{\mathcal{U}}_n$ admits a left adjoint $\bar{\mathcal{F}}_n$ for $n \in \mathbb{N} \cup \{\omega\}$. In particular, the adjunction $\bar{\mathcal{F}}_\omega \dashv \bar{\mathcal{U}}_\omega$ defines a monad (T, η, μ) , which is finitary by Proposition 1.4.1.4, and it induces categories of algebras \mathbf{Alg}_n for $n \in \mathbb{N} \cup \{\omega\}$ as explained in Section 1.2.3. By Proposition 1.4.1.7, the comparison functor $H_\omega: \mathbf{Cat}_\omega \rightarrow \mathbf{Alg}_\omega$ is an equivalence of categories, that moreover satisfies that $\mathcal{U}_\omega H_\omega = \bar{\mathcal{U}}_\omega$. Using the criterion introduced in Paragraph 1.2.3.13, we prove that the other categories \mathbf{Cat}_n are, up to equivalence, the categories of algebras \mathbf{Alg}_n :

Theorem 1.4.1.10. *For every $n \in \mathbb{N}$, there exists an equivalence*

$$H_n: \mathbf{Cat}_n \rightarrow \mathbf{Alg}_n$$

making the following diagram commute

$$\begin{array}{ccc} \mathbf{Cat}_\omega & \xrightarrow{H_\omega} & \mathbf{Alg}_\omega \\ (-)_{\leq n}^{\text{Cat}} \downarrow & & \downarrow (-)_{\leq n}^{\text{Alg}} \\ \mathbf{Cat}_n & \xrightarrow{H_n} & \mathbf{Alg}_n \end{array}$$

and such that $\mathcal{U}_n H_n = \bar{\mathcal{U}}_n$. Moreover, we have a commutative diagram

$$\begin{array}{ccc} \mathbf{Cat}_{n+1} & \xrightarrow{H_{n+1}} & \mathbf{Alg}_{n+1} \\ (-)_{\leq n}^{\text{Cat}} \downarrow & & \downarrow (-)_{\leq n}^{\text{Alg}} \\ \mathbf{Cat}_n & \xrightarrow{H_n} & \mathbf{Alg}_n \end{array} .$$

Proof. For the first part, note that the unit of the adjunction $(-)\xrightarrow{\omega,n}^{\text{Cat}} \dashv (-)\xrightarrow{\leq n}^{\text{Cat}}$ is the identity, so that $(-)\xrightarrow{\omega,n}^{\text{Cat}}$ is fully faithful and Theorem 1.2.3.20 applies. For the second part, we compute that

$$\begin{aligned} H_n(-)\xrightarrow{\leq n,n+1}^{\text{Cat}} &= H_n(-)\xrightarrow{\leq n,n+1}^{\text{Cat}}(-)\xrightarrow{\leq n+1,\omega}^{\text{Cat}}(-)\xrightarrow{\omega,n+1}^{\text{Cat}} \\ &= H_n(-)\xrightarrow{\leq n,\omega}^{\text{Cat}}(-)\xrightarrow{\omega,n+1}^{\text{Cat}} \\ &= (-)\xrightarrow{\leq n,\omega}^{\text{Alg}} H_\omega(-)\xrightarrow{\omega,n+1}^{\text{Cat}} \\ &= (-)\xrightarrow{\leq n,n+1}^{\text{Alg}}(-)\xrightarrow{\leq n+1,\omega}^{\text{Alg}} H_\omega(-)\xrightarrow{\omega,n+1}^{\text{Cat}} \\ &= (-)\xrightarrow{\leq n,n+1}^{\text{Alg}} H_{n+1}(-)\xrightarrow{\leq n+1,\omega}^{\text{Cat}}(-)\xrightarrow{\omega,n+1}^{\text{Cat}} \\ &= (-)\xrightarrow{\leq n,n+1}^{\text{Alg}} H_{n+1} \end{aligned}$$

which concludes the proof. \square

Finally, we prove the truncability of the monad of strict ω -categories:

Theorem 1.4.1.11. *The monad (T, η, μ) on \mathbf{Glob}_ω derived from $\bar{\mathcal{F}}_\omega \dashv \bar{\mathcal{U}}_\omega$ is weakly truncable.*

Proof. By Theorem 1.2.4.11 and Theorem 1.4.1.10, it is enough to show that, for every $k \in \mathbb{N}$, the functors $(-)\xrightarrow{\leq k,\omega}^{\text{Cat}}$ have right adjoints such that $j^k \mathcal{U}_\omega(-)\xrightarrow{\omega,k}^{\text{Cat}}$ is an isomorphism, where j^k is the counit of $(-)\xrightarrow{\leq k,\omega}^{\text{Glob}} \dashv (-)\xrightarrow{\omega,k}^{\text{Glob}}$. So let $k \in \mathbb{N}$. Given a strict k -category C , we define a strict ω -category C' whose underlying globular set is the image the underlying k -globular set of C by $(-)\xrightarrow{\omega,k}^{\text{Glob}}$, i.e.,

$$C'_{\leq k} = C \quad \text{and} \quad C'_l = \{(u, v) \in C_k^2 \mid u, v \text{ are parallel}\} \text{ for } l > k,$$

and we equip C' with a structure of a strict ω -category that extends the one on C by putting

$$\text{id}_u^{k+1} = (u, u) \quad \text{for } u \in C_k, \quad \text{id}_{(u,v)}^{l+1} = (u, v) \quad \text{for } l \in \mathbb{N} \text{ with } l > k \text{ and } (u, v) \in C'_l,$$

and moreover, for $i, l \in \mathbb{N}$ with $\max(i, k) < l$ and i -composable $(u, v), (u', v') \in C'_l$,

$$(u, v) *_{i,l} (u', v') = \begin{cases} (u *_{i,k} u', v *_{i,k} v') & \text{if } i < k, \\ (u, v') & \text{if } i \geq k. \end{cases}$$

One can show that the axioms of strict ω -categories are verified by C' . Now, let D be a strict ω -category and $F: D_{\leq k} \rightarrow C$ be a k -functor. By the properties of the adjunction $(-)\xrightarrow{\leq k,\omega}^{\text{Glob}} \dashv (-)\xrightarrow{\omega,k}^{\text{Glob}}$, there is a unique ω -globular morphism $F': D \rightarrow C'$ such that $F'_{\leq k} = F$, which is defined by

$$F'(u) = (F(\partial_k^-(u)), F(\partial_k^+(u)))$$

for every $l \in \mathbb{N}$ with $k < l$ and $u \in D_l$. We verify that F' is an ω -functor by checking the compatibility with the id^l and $*_{i,l}$ operations. Given $l \in \mathbb{N}$ with $l \geq k$ and $u \in D_l$, we have

$$F'(\text{id}_u^{l+1}) = (F(\partial_k^-(u)), F(\partial_k^+(u))) = \text{id}_{F'(u)}^{k+1}.$$

Moreover, given $i, l \in \mathbb{N}$ with $\max(i, k) < l$ and i -composable $u, v \in D_l$, we have

$$\begin{aligned} F'(u *_{i,l} v) &= \begin{cases} (F(\partial_k^-(u)) *_{i,l} F(\partial_k^-(v)), F(\partial_k^+(u)) *_{i,l} F(\partial_k^+(v))) & \text{if } i < k \\ (F(\partial_k^-(u)), F(\partial_k^+(v))) & \text{if } i \geq k \end{cases} \\ &= F'(u) *_{i,l} F'(v). \end{aligned}$$

Thus, F' is an ω -functor. Hence, the natural bijective correspondence

$$(-)_{\leq k, \omega}^{\text{Glob}} : \mathbf{Glob}_{\omega}(D, C') \rightarrow \mathbf{Glob}_k(D_{\leq k}, C)$$

restricts to a bijective correspondence

$$(-)_{\leq k, \omega}^{\text{Cat}} : \mathbf{Cat}_{\omega}(D, C') \rightarrow \mathbf{Cat}_k(D_{\leq k}, C)$$

so that the operation $C \mapsto C'$ extends to a functor $(-)_{\uparrow \omega, k}^{\text{Cat}}$ which is right adjoint to $(-)_{\leq k, \omega}^{\text{Cat}}$. Moreover, by the definition of C' above, the natural morphism $j^k \mathcal{U}_{\omega}(-)_{\uparrow \omega, k}^{\text{Cat}}$ is an isomorphism. Hence, Theorem 1.2.4.11 applies and (T, η, μ) is a weakly truncable monad. \square

Remark 1.4.1.12. We highlight that the criterions given by Theorem 1.2.3.20 and Theorem 1.2.4.11 enabled us to prove that the categories \mathbf{Cat}_n are globular algebras derived from a truncable monad on \mathbf{Glob}_{ω} without giving an explicit description of this monad, which could have been a tedious exercise [Pen99].

1.4.1.13 – Free constructions. Using Theorem 1.4.1.10 and Theorem 1.4.1.11, we can instantiate the definitions and properties developed in Section 1.3 to define free constructions on strict n -categories. In particular, for every $n \in \mathbb{N}$, there is a notion of n -cellular extension, with associated category \mathbf{Cat}_n^+ defined like \mathbf{Alg}_n^+ . Moreover, there is a canonical forgetful functor $\mathbf{Cat}_{n+1} \rightarrow \mathbf{Cat}_n^+$ which has a left adjoint

$$-[-]^n : \mathbf{Cat}_n^+ \rightarrow \mathbf{Cat}_{n+1}$$

which can be chosen such that $C[X]_{\leq n} = C$ for $(C, X) \in \mathbf{Cat}_n^+$. As was shown in [Mét08], the $(n+1)$ -cells of a free extension admit a syntactical description consisting of “well-typed” terms considered up to the axioms of strict categories (*c.f.* Paragraph 1.4.1.1). We shall give a more precise definition of “well-typed” in Section 2.4 when we introduce the exact formulation of the word problem for strict categories. Up to this definition, the result of Métayer is the following:

Proposition 1.4.1.14 ([Mét08]). *Given $(C, X) \in \mathbf{Cat}_n^+$, the set $C[X]_{n+1}$ is the quotient by the axioms of $(n+1)$ -categories of the “well-typed” subset of terms defined inductively as follows:*

- given $g \in X$, there is a term $\overline{\text{gen}}(g)$,
- given $u \in C_n$, there is a term $\overline{\text{id}}_n^{n+1}(u)$,
- given $i \in \mathbb{N}_n$ and two terms t_1, t_2 , there is a term $t_1 \overline{*}_i t_2$.

Remark 1.4.1.15. In the above property, $\overline{\text{id}}_n^{n+1}$ and $\overline{*}_i$ are syntactical symbols which represent the operations id_n^{n+1} and $*_i$ of a strict category.

Using the functors $-[-]^k$, we can define, for every $n \in \mathbb{N} \cup \{\omega\}$, a notion of n -polygraph with associated category \mathbf{Pol}_n , and a functor

$$(-)^{*,n} : \mathbf{Pol}_n \rightarrow \mathbf{Cat}_n$$

which maps an n -polygraph P to the free strict n -category P^* induced by the generators contained in P . Note that, when $n > 0$, as a consequence of the compatibility of $-[-]^{n-1}$ with truncation, the underlying strict $(n-1)$ -category $(P^*)_{\leq n-1}$ of P^* is exactly $(P_{\leq n-1})^*$. Proposition 1.4.1.14 extends to a syntactical description of the cells of free categories on polygraphs:

Proposition 1.4.1.16. *Given an n -polygraph P and $k \in \mathbb{N}_n$, the set P_k^* of k -cells of P^* is the quotient by the axioms of k -categories of the “well-typed” subset of k -terms where*

- given $k \in \mathbb{N}_n$ and $g \in P_k$, there is a k -term $\overline{\text{gen}}_k(g)$,
- given $k \in \mathbb{N}_{n-1}$ and a k -term t , there is a $(k+1)$ -term $\overline{\text{id}}_k^{k+1}(t)$,
- given $i, k \in \mathbb{N}_n$ with $i < k$ and two k -terms t_1, t_2 , there is a k -term $t_1 \bar{*}_i t_2$.

Remark 1.4.1.17. In particular, given an n -polygraph P , every cell of P^* can be written as a finite expression involving identity and composition operations on generators of P .

Example 1.4.1.18. Given the 1-polygraph P with $P_0 = \{x\}$ and $P_1 = \{f: x \rightarrow x\}$, the strict 1-category P^* is the monoid of natural numbers $(\mathbb{N}, 0, +)$.

Example 1.4.1.19. We define a 3-polygraph P that aims at encoding the structure of a pseudomonoid in a 2-monoidal category as follows. We put

$$P_0 = \{x\} \quad P_1 = \{\bar{1}: x \rightarrow x\} \quad P_2 = \{\mu: \bar{2} \Rightarrow \bar{1}, \eta: \bar{0} \Rightarrow \bar{1}\}$$

where, given $n \in \mathbb{N}$, we write \bar{n} for the composite $\bar{1} *_0 \dots *_0 \bar{1}$ of n copies of $\bar{1}$, and we define P_3 as the set with the following three elements

$$\begin{aligned} L: (\eta *_0 \text{id}_1^2) *_1 \mu &\Rightarrow \text{id}_1^2 \\ R: (\text{id}_1^2 *_0 \eta) *_1 \mu &\Rightarrow \text{id}_1^2 \\ A: (\mu *_0 \text{id}_1^2) *_1 \mu &\Rightarrow (\text{id}_1^2 *_0 \mu) *_1 \mu. \end{aligned}$$

It is convenient to represent the 2-cells of P^* using string diagrams. In this representation, the 2-generators η and μ are represented by \heartsuit and \spadesuit respectively, and the 2-cells of the form id_n^2 are represented by sequences of n wires $| \dots |$ for $n \in \mathbb{N}$. Moreover, given $u, v \in P_2^*$, when u, v are 0-composable (resp. 1-composable), a representation of the 2-cell $u *_0 v$ (resp. $u *_1 v$) is obtained by concatenating horizontally (resp. vertically) representations of u and v . For example, using this representation, the 3-generators L , R and A , can be pictured by

$$\begin{aligned} L: \heartsuit \spadesuit &\Rightarrow | \\ R: \spadesuit \heartsuit &\Rightarrow | \\ A: \spadesuit \spadesuit &\Rightarrow \spadesuit \spadesuit. \end{aligned}$$

Note that, by Axiom (S-vi), a 2-cell can admit several representations as string diagrams. For example, the 2-cell

$$\mu *_0 \text{id}_3^2 *_0 \mu = (\mu *_0 \text{id}_5^2) *_1 (\text{id}_4^2 *_0 \mu) = (\text{id}_5^2 *_0 \mu) *_1 (\mu *_0 \text{id}_4^2)$$

can be represented by the three string diagrams

$$\spadesuit | | | \heartsuit \quad \text{and} \quad \heartsuit | | | \spadesuit \quad \text{and} \quad \spadesuit | | | \spadesuit.$$

1.4.2 Precategories

We now introduce *precategories*. They can be described, in a sense that will be made precise in Section 1.4.3, as “strict categories without exchange law” and generalize in higher dimensions the 2-dimensional theory of sesquicategories defined by Street in [Str96]. The absence of exchange makes precategories more amenable to computational treatment than strict categories, as witnessed by their use as the underlying structure of the Globular proof assistant [BV17; BKV16]. Following this observation, in the coming chapters, we will use precategories as a better syntactic representation of strict categories introduced Chapter 2, and as the underlying structure of an extension of rewriting theory to Gray categories in Chapter 4. Below, like for strict categories, we introduce their equational definition, show that they are the globular algebras of a truncable monad on globular sets, and derive the associated notion of polygraph for them.

1.4.2.1 – Equational definition. Given $n \in \mathbb{N} \cup \{\omega\}$, an n -precategory C is an n -globular set together with, for $k \in \mathbb{N}_{n-1}$, identity operations

$$\text{id}^{k+1}: C_k \rightarrow C_{k+1}$$

for which we use the same notation conventions than the identity operations on strict categories, and, for $k, l \in \mathbb{N}_n^*$, composition operations

$$\bullet_{k,l}: C_k \times_{\min(k,l)-1} C_l \rightarrow C_{\max(k,l)}$$

which satisfy the axioms below. Given $i, k, l \in \mathbb{N}_n$ with $i = \min(k, l)$, since the dimensions of the cells determine the functions to be used, we often write \bullet_i for $\bullet_{k,l}$. This way, we still display the most important information which is the dimension i of composition. The axioms of n -precategories are the following:

(P-i) for $k \in \mathbb{N}_{n-1}$ and $u \in C_k$,

$$\partial_k^-(\text{id}_u^{k+1}) = u = \partial_k^+(\text{id}_u^{k+1}),$$

(P-ii) for $i, k, l \in \mathbb{N}_n$ such that $i = \min(k, l) - 1$, $(u, v) \in C_k \times_i C_l$, and $\epsilon \in \{-, +\}$,

$$\partial^\epsilon(u \bullet_i v) = \begin{cases} u \bullet_i \partial^\epsilon(v) & \text{if } k < l, \\ \partial^\epsilon(u) & \text{if } k = l \text{ and } \epsilon = -, \\ \partial^\epsilon(v) & \text{if } k = l \text{ and } \epsilon = +, \\ \partial^\epsilon(u) \bullet_i v & \text{if } k > l, \end{cases}$$

(P-iii) for $i, k, l \in \mathbb{N}_n$ with $i = \min(k, l) - 1$, given $(u, v) \in C_{k-1} \times_i C_l$,

$$\text{id}_u \bullet_i v = \begin{cases} v & \text{if } k \leq l, \\ \text{id}_{u \bullet_i v} & \text{if } k > l, \end{cases}$$

and, given $(u, v) \in C_k \times_i C_{l-1}$,

$$u \bullet_i \text{id}_v = \begin{cases} u & \text{if } l \leq k, \\ \text{id}_{u \bullet_i v} & \text{if } l > k, \end{cases}$$

(P-iv) for $i, k, l, m \in \mathbb{N}_n$ with $i = \min(k, l) - 1 = \min(l, m) - 1$, and $u \in C_k$, $v \in C_l$ and $w \in C_w$ such that u, v, w are i -composable,

$$(u \bullet_i v) \bullet_i w = u \bullet_i (v \bullet_i w),$$

(P-v) for $i, j, k, l, l' \in \mathbb{N}_n$ such that

$$i = \min(k, \max(l, l')) - 1, \quad j = \min(l, l') - 1 \quad \text{and} \quad i < j,$$

given $u \in C_k$ and $(v, v') \in C_l \times_j C_{l'}$ such that u, v are i -composable,

$$u \bullet_i (v \bullet_j v') = (u \bullet_i v) \bullet_j (u \bullet_i v')$$

and, given $(u, u') \in C_l \times_j C_{l'}$ and $v \in C_k$ such that u, v are i -composable,

$$(u \bullet_j u') \bullet_i v = (u \bullet_i v) \bullet_j (u' \bullet_i v).$$

Remark 1.4.2.2. Provided that the Axioms (P-i) to (P-iv) are satisfied, Axiom (P-v) can be shown equivalent to the more symmetrical axiom

(P-v)' for every $i, j, k \in \mathbb{N}_n$ satisfying $i < j < k$, and cells $u_1, u_2 \in C_{i+1}$, $v_1, v_2 \in C_{j+1}$ and $w \in C_k$ such that u_1, w, u_2 are i -composable and v_1, w, v_2 are j -composable, we have

$$u_1 \bullet_i (v_1 \bullet_j w \bullet_j v_2) \bullet_i u_2 = (u_1 \bullet_i v_1 \bullet_i u_2) \bullet_j (u_1 \bullet_i w \bullet_i u_2) \bullet_j (u_1 \bullet_i v_2 \bullet_i u_2).$$

Example 1.4.2.3. Given a 2-precategory C with two 2-cells ϕ and ψ as in

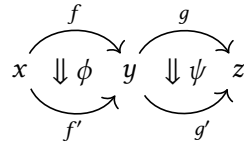

there are two ways to compose ϕ and ψ together, given by

$$(\phi \bullet_0 g) \bullet_1 (f' \bullet_0 \psi) \quad \text{and} \quad (f \bullet_0 \psi) \bullet_1 (\phi \bullet_0 g')$$

that can be represented using string diagrams by

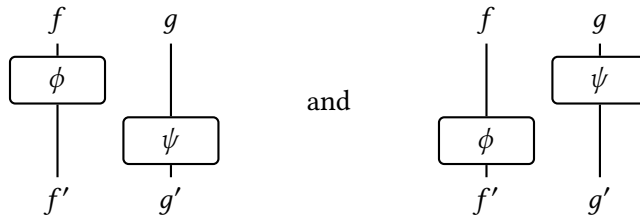

and these two composites are not expected to be equal in C . Moreover, by our definition of precategories, there is no such thing as a valid cell $\phi \bullet_0 \psi$, and the string diagram

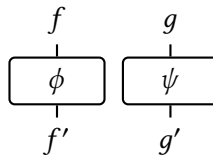

makes no sense in this setting.

Given two n -precategories C and D , a *morphism of n -precategories between C and D* (also called *n -prefunctor*), is a morphism of n -globular sets $F: C \rightarrow D$ such that

- $F(\text{id}_u^{k+1}) = \text{id}_{F(u)}^{k+1}$ for $k \in \mathbb{N}_{n-1}$ and $u \in C_k$,
- $F(u \bullet_i v) = F(u) \bullet_i F(v)$ for $i, k, l \in \mathbb{N}_n$ with $i = \min(k, l) - 1$ and $(u, v) \in C_k \times_i C_l$.

We write PCat_n for the category of n -precategories.

There is a functor

$$\bar{\mathcal{U}}_n: \text{PCat}_n \rightarrow \text{Glob}_n$$

which maps an n -precategory to its underlying n -globular set. Like for strict categories, the above definition of n -precategories directly translates into an essentially algebraic theory, so that the functor $\bar{\mathcal{U}}_n$ is induced by a morphism between the essentially algebraic theory of n -globular sets (c.f. Remark 1.2.2.2) and the one of n -precategories. Thus:

Proposition 1.4.2.4. *The category \mathbf{PCat}_n is locally finitely presentable, complete and cocomplete. Moreover, the functor $\bar{\mathcal{U}}_n$ is a right adjoint which preserves directed colimits.*

Proof. This is a consequence of Theorem 1.1.2.2, Proposition 1.1.1.10 and Theorem 1.1.2.7. \square

Like for strict categories, the functor $\bar{\mathcal{U}}_n$ can be shown monadic using the monadicity theorem:

Proposition 1.4.2.5. *For every $n \in \mathbb{N} \cup \{\omega\}$, the functor $\bar{\mathcal{U}}_n$ is monadic.*

Proof. By a direct adaptation of Proposition 1.4.2.5. \square

1.4.2.6 – Truncation and inclusion functors. Let $k, l \in \mathbb{N} \cup \{\omega\}$ such that $k < l$. There is a *k-truncation functor*

$$(-)_{\leq k, l}^{\mathbf{PCat}} : \mathbf{PCat}_l \rightarrow \mathbf{PCat}_k$$

which maps an *l*-precategory *C* to its evident underlying *k*-precategory, denoted $C_{\leq k}$, called the *k-truncation of C*.

Conversely, there is an *l-inclusion functor*

$$(-)_{\uparrow l, k}^{\mathbf{PCat}} : \mathbf{Cat}_k \rightarrow \mathbf{Cat}_l$$

which maps a *k*-precategory *C* to the *l*-precategory $C_{\uparrow l}$, called the *l-inclusion of C*, and defined by

$$(C_{\uparrow l})_{\leq k} = C \quad \text{and} \quad (C_{\uparrow l})_m = C_k$$

for $m \in \mathbb{N}_l$ with $k < m$ and such that

- for $m \in \mathbb{N}_{l-1}$ with $k \leq m$ and $u \in (C_{\uparrow l})_{m+1}$, $\partial_m^-(u) = \partial_m^+(u) = u$,
- for $m \in \mathbb{N}_{l-1}$ with $k \leq m$ and $u \in (C_{\uparrow l})_m$, $\text{id}_u^{m+1} = u$,
- for $i, m, m' \in \mathbb{N}_l$ with $i = \min(m, m') - 1 < k$ and $(u, v) \in (C_{\uparrow l})_m \times_i (C_{\uparrow l})_{m'}$,

$$u \bullet_{m, m'} v = u \bullet_{\min(m, k), \min(m', k)} v,$$

- for $i, m, m' \in \mathbb{N}_l$ with $k \leq i = \min(m, m') - 1$ and $(u, v) \in C_m \times_i C_m$,

$$u \bullet_{m, m'} v = u = v.$$

There is an adjunction $(-)_{\uparrow l, k}^{\mathbf{PCat}} \dashv (-)_{\leq k, l}^{\mathbf{PCat}}$ whose unit is the identity and whose counit $i_C^{k, l}$ is such that, given an *l*-precategory *C*, the *l*-functor $i_C^{k, l} : (C_{\leq k})_{\uparrow l} \rightarrow C$ is defined by $(i_C^{k, l})_{\leq k} = \text{id}_{C_{\leq k}}$ and, for $m \in \mathbb{N}_l$ with $m > k$, $i_C^{k, l}$ maps $u \in ((C_{\leq k})_{\uparrow l})_m = C_k$ to id_u^m .

1.4.2.7 – Globular algebras. By Proposition 1.4.1.4, each functor $\bar{\mathcal{U}}_n$ admits a left adjoint $\bar{\mathcal{F}}_n$ for $n \in \mathbb{N} \cup \{\omega\}$. In particular, the adjunction $\bar{\mathcal{F}}_\omega \dashv \bar{\mathcal{U}}_\omega$ defines a monad (T, η, μ) , which is finitary by Proposition 1.4.1.4, and it induces categories of algebras \mathbf{Alg}_n for $n \in \mathbb{N} \cup \{\omega\}$. By Proposition 1.4.1.7, the comparison functor $H_\omega : \mathbf{PCat}_\omega \rightarrow \mathbf{Alg}_\omega$ is an equivalence of categories, that moreover satisfies that $\mathcal{U}_\omega H_\omega = \bar{\mathcal{U}}_\omega$. By adapting the proof of Theorem 1.4.1.10, we obtain an equivalent statement for precategories:

Theorem 1.4.2.8. *For every $n \in \mathbb{N}$, there exists an equivalence*

$$H_n: \mathbf{PCat}_n \rightarrow \mathbf{Alg}_n$$

making the following diagram commute

$$\begin{array}{ccc} \mathbf{PCat}_\omega & \xrightarrow{H_\omega} & \mathbf{Alg}_\omega \\ (-)_{\leq n}^{\mathbf{PCat}} \downarrow & & \downarrow (-)_{\leq n}^{\mathbf{Alg}} \\ \mathbf{PCat}_n & \xrightarrow{H_n} & \mathbf{Alg}_n \end{array}$$

and such that $\mathcal{U}_n H_n = \bar{\mathcal{U}}_n$. Moreover, we have a commutative diagram

$$\begin{array}{ccc} \mathbf{PCat}_{n+1} & \xrightarrow{H_{n+1}} & \mathbf{Alg}_{n+1} \\ (-)_{\leq n}^{\mathbf{PCat}} \downarrow & & \downarrow (-)_{\leq n}^{\mathbf{Alg}} \\ \mathbf{PCat}_n & \xrightarrow{H_n} & \mathbf{Alg}_n \end{array} .$$

Finally, by a direct adaptation of the proof of Theorem 1.4.1.11, we obtain the truncability of the monad for precategories:

Theorem 1.4.2.9. *The monad (T, η, μ) derived from $\bar{\mathcal{F}}_\omega \dashv \bar{\mathcal{U}}_\omega$ is weakly truncable.*

1.4.2.10 – Free constructions. Like for strict categories, using Theorem 1.4.2.8 and Theorem 1.4.2.9, we can instantiate the constructions and properties developed in Section 1.3 to define free constructions on n -precategories. In particular, for every $n \in \mathbb{N}$, there is a notion of n -cellular extension for strict n -precategories, with associated category \mathbf{PCat}_n^+ defined like \mathbf{Alg}_n^+ . Moreover, the canonical forgetful functor $\mathbf{PCat}_{n+1} \rightarrow \mathbf{PCat}_n^+$ has a left adjoint

$$-[-]^n: \mathbf{PCat}_n^+ \rightarrow \mathbf{PCat}_{n+1}$$

which can be chosen such that $C[X]_{\leq n} = C$ for $(C, X) \in \mathbf{PCat}_n^+$.

Using the functors $-[-]^k$, we can define, for every $n \in \mathbb{N} \cup \{\omega\}$, a notion of n -polygraph for precategories, called n -prepolygraph, with associated category \mathbf{PPol}_n , and a functor

$$(-)^{*,n}: \mathbf{PPol}_n \rightarrow \mathbf{PCat}_n$$

which maps an n -prepolygraph P to the free n -precategory P^* induced by the generators contained in P . Note that, when $n > 0$, as a consequence of the compatibility of $-[-]^{n-1}$ with truncation, the underlying $(n-1)$ -precategory $(P^*)_{\leq n-1}$ of P^* is exactly $(P_{\leq n-1})^*$.

Remark 1.4.2.11. By adapting the results of Métayer [Mét08], one can obtain analogues of Proposition 1.4.1.14 and Proposition 1.4.1.16 for precategories, so that the cells of the free precategories on cellular extensions and prepolygraphs can be described by “well-typed” terms considered up to the axioms of precategories given in Paragraph 1.4.2.1. In the case of prepolygraphs, the definition of these terms can be found in Paragraph 4.1.2.7.

Example 1.4.2.12. By adapting the 3-polygraph of Example 1.4.1.19, we define a 3-prepolygraph P that aims at encoding the structure of a pseudomonoid in a 2-monoidal precategory as follows. We put

$$P_0 = \{x\} \qquad P_1 = \{\bar{1}: x \rightarrow x\} \qquad P_2 = \{\mu: \bar{2} \Rightarrow \bar{1}, \eta: \bar{0} \Rightarrow \bar{1}\}$$

where, given $n \in \mathbb{N}$, we write \bar{n} for the composite $\bar{1} *_0 \cdots *_0 \bar{1}$ of n copies of $\bar{1}$, and we define P_3 as the set with the following three elements

$$\begin{aligned} L: (\eta \bullet_0 \bar{1}) \bullet_1 \mu &\Rightarrow \text{id}_1^2 \\ R: (\bar{1} \bullet_0 \eta) \bullet_1 \mu &\Rightarrow \text{id}_1^2 \\ A: (\mu \bullet_0 \bar{1}) \bullet_1 \mu &\Rightarrow (\bar{1} \bullet_0 \mu) \bullet_1 \mu. \end{aligned}$$

Like for Example 1.4.1.19, we can represent the 2-cells of P^* using string diagrams. In this representation, the 2-generators η and μ are represented by \circlearrowleft and ∇ respectively. Moreover, a 2-cell of the form $\bar{m} \bullet_0 u \bullet_0 \bar{n}$ for some $m, n \in \mathbb{N}$ and $u \in P_2^*$ is represented by adding m wires on the left and n wires on the right of a representation of u . Finally, given 1-composable $u, v \in P_2^*$, a representation of $u \bullet_1 v$ is obtained by concatenating vertically representations of u and v . For example, using this representation, the 3-generators L , R and A can be pictured by

$$\begin{aligned} L: \begin{array}{c} \circlearrowleft \\ | \\ \nabla \end{array} &\Rightarrow \begin{array}{c} | \\ | \\ | \end{array} \\ R: \begin{array}{c} \nabla \\ | \\ \circlearrowleft \end{array} &\Rightarrow \begin{array}{c} | \\ | \\ | \end{array} \\ A: \begin{array}{c} \nabla \\ | \\ \nabla \end{array} &\Rightarrow \begin{array}{c} \nabla \\ | \\ \nabla \end{array}. \end{aligned}$$

Since precategories do not satisfy any exchange law (unlike strict categories), it can be shown that the 2-cells of P^* admit a unique representation as string diagrams (see Theorem 4.1.2.4 and Corollary 4.1.2.5 in Chapter 4). In particular, the two string diagrams

$$\begin{array}{c} \nabla \\ | \\ | \\ | \\ \nabla \end{array} \quad \text{and} \quad \begin{array}{c} \nabla \\ | \\ | \\ | \\ \nabla \end{array}$$

represent the different 2-cells

$$(\mu \bullet_0 \bar{5}) \bullet_1 (\bar{4} \bullet_0 \mu) \quad \text{and} \quad (\bar{5} \bullet_0 \mu) \bullet_1 (\mu \bullet_0 \bar{4})$$

of P^* . Note moreover that the diagram

$$\begin{array}{c} \nabla \\ | \\ | \\ | \\ \nabla \end{array}$$

makes no sense in the precategorical setting.

1.4.3 Categories as precategories

In this section, we justify the definition of precategories as “strict categories without the exchange law” and recall from [Mak05] how strict categories can be expressed as precategories satisfying a condition analogous to the exchange law. This equivalent definition will be used in particular in the next chapter to give an effective description of the free extension on an n -cellular extension, ultimately leading to an efficient algorithm which solves the word problem on polygraphs of strict categories.

1.4.3.1 – Categories as precategories. For $n \in \mathbb{N} \cup \{\omega\}$ and $C \in \text{PCat}_n$, we write (E) for the following property on C :

- (E) for $i, k, l \in \mathbb{N}_n$ with $1 \leq i = \min(k, l) - 1$, $u \in C_k$ and $v \in C_l$, if u, v are $(i-1)$ -composable, then

$$(u \bullet_{i-1} \partial_i^-(v)) \bullet_i (\partial_i^+(u) \bullet_{i-1} v) = (\partial_i^-(u) \bullet_{i-1} v) \bullet_i (u \bullet_{i-1} \partial_i^+(v)).$$

Let $\mathbf{PCat}_n^{(E)}$ be the full subcategory of \mathbf{PCat}_n of those n -precategories C that satisfy (E). The condition (E) can be thought as an equivalent for precategories of the exchange law (S-vi) of strict categories. We now introduce a functor from strict n -categories to n -precategories which satisfy (E) with the following proposition:

Proposition 1.4.3.2. *Given $n \in \mathbb{N} \cup \{\omega\}$, there is a canonical functor $\Theta^n: \mathbf{Cat}_n \rightarrow \mathbf{PCat}_n^{(E)}$.*

Proof. Given $C \in \mathbf{Cat}_n$, we define a structure of n -precategory on the underlying n -globular set of C . We keep the identities given by the strict n -category structure and define the composition operations $\bullet_{(-)}$ on C based on the composition operations $*_{(-)}$. Given $i, k, l \in \mathbb{N}_n$ with $i = \min(k, l) - 1$, $u \in C_k$ and $v \in C_l$ such that u, v are i -composable, we put

$$u \bullet_i v = \text{id}_u^m *_i \text{id}_v^m$$

where $m = \max(k, l)$. Axioms (P-ii), (P-i), (P-iii), (P-iv) are then direct consequences of the axioms of strict n -categories. We only prove the first part of (P-v) since the other is symmetrical. Let $i, j, k, l, l' \in \mathbb{N}_n$ with $i = \min(k, \max(l, l')) - 1$, $j = \min(l, l') - 1$ and $i < j$, $u \in C_k$, and $v \in C_l, v' \in C_{l'}$ such that u, v are i -composable and v, v' are j -composable. Writing m for $\max(l, l')$, we have

$$\begin{aligned} u \bullet_i (v \bullet_j v') &= \text{id}_u^m *_i \text{id}^m(\text{id}_v^m *_j \text{id}_{v'}^m) && \text{(by definition of } \bullet_{(-}) \text{)} \\ &= \text{id}_u^m *_i (\text{id}_v^m *_j \text{id}_{v'}^m) \\ &= (\text{id}_u^m *_j \text{id}_u^m) *_i (\text{id}_v^m *_j \text{id}_{v'}^m) && \text{(by Axiom (S-iii))} \\ &= (\text{id}_u^m *_i \text{id}_v^m) *_j (\text{id}_u^m *_i \text{id}_{v'}^m) && \text{(by Axiom (S-vi))} \\ &= \text{id}^m(\text{id}_u^{j+1} *_i v) *_j \text{id}^m(\text{id}_u^{l'+1} *_i v') && \text{(by Axiom (S-v))} \\ &= (u \bullet_i v) \bullet_j (u \bullet_i v') && \text{(by definition of } \bullet_{(-}) \text{)} \end{aligned}$$

which concludes the proof of (P-v). Thus, C is an n -precategory. We now show that it satisfies the condition (E) above. So let $i, k, l \in \mathbb{N}_n$ with $1 \leq i = \min(k, l) - 1$, $u \in C_k$ and $v \in C_l$ such that u, v are $(i-1)$ -composable. Writing m for $\max(k, l)$, we have

$$\begin{aligned} (u \bullet_{i-1} \partial_i^-(v)) \bullet_i (\partial_i^+(u) \bullet_{i-1} v) &= \text{id}^m(u *_i \text{id}_{\partial_i^-(v)}^k) *_i \text{id}^m(\text{id}_{\partial_i^+(u)}^l *_i v) && \text{(by definition of } \bullet_{(-}) \text{)} \\ &= (\text{id}_u^m *_i \text{id}_{\partial_i^-(v)}^m) *_i (\text{id}_{\partial_i^+(u)}^m *_i v) && \text{(by Axiom (S-v))} \\ &= (\text{id}_u^m *_i \text{id}_{\partial_i^+(u)}^m) *_i (\text{id}_{\partial_i^-(v)}^m *_i v) && \text{(by Axiom (S-vi))} \\ &= \text{id}_u^m *_i \text{id}_v^m && \text{(by Axiom (S-iii))} \\ &= (\text{id}_{\partial_i^-(u)}^m *_i \text{id}_u^m) *_i (\text{id}_v^m *_i \text{id}_{\partial_i^+(v)}^m) && \text{(by Axiom (S-iii))} \\ &= (\text{id}_{\partial_i^-(u)}^m *_i \text{id}_v^m) *_i (\text{id}_u^m *_i \text{id}_{\partial_i^+(v)}^m) && \text{(by Axiom (S-vi))} \\ &= \text{id}^m(\text{id}_{\partial_i^-(u)}^l *_i v) *_i \text{id}^m(u *_i \text{id}_{\partial_i^+(v)}^k) && \text{(by Axiom (S-v))} \\ &= (\partial_i^-(u) \bullet_{i-1} v) \bullet_i (u \bullet_{i-1} \partial_i^+(v)) && \text{(by definition of } \bullet_{(-}) \text{)} \end{aligned}$$

which concludes the proof of (E).

Thus, for $n \in \mathbb{N} \cup \{\omega\}$, we have defined a mapping Θ^n between the objects of \mathbf{Cat}_n and the objects of $\mathbf{PCat}_n^{(E)}$. We show that Θ^n extends to a functor $\Theta^n: \mathbf{Cat}_n \rightarrow \mathbf{PCat}_n^{(E)}$. Given an n -functor $F: C \rightarrow C'$ between two strict n -categories C and C' , it is sufficient to show that F is compatible with the composition operations $\bullet_{(-)}$. But this is a direct consequence of the definition of $u \bullet_i v$ as $\text{id}_u^m *_i \text{id}_v^m$ for $i, k, l, m \in \mathbb{N}_n$ with $i = \min(k, l) - 1$ and $m = \max(k, l)$, and $u \in C_k, v \in C_l$ with u, v i -composable, since F is compatible with id^m and $*_i$. \square

1.4.3.3 – Precategories as categories. In this section, we prove the converse property, *i.e.*, that precategories satisfying (E) are canonically strict categories. For this purpose, we introduce a functor from $\mathbf{PCat}_n^{(E)}$ to \mathbf{Cat}_n with the following property:

Proposition 1.4.3.4. *Given $n \in \mathbb{N} \cup \{\omega\}$, there is a canonical functor $\bar{\Theta}^n: \mathbf{PCat}_n^{(E)} \rightarrow \mathbf{Cat}_n$.*

Proof. Given $C \in \mathbf{PCat}_n^{(E)}$, we define a structure of strict n -category on the underlying n -globular set of C . We keep the identities given by the structure of n -precategory of C and define the multiple composition operations $*_{(-)}$ based on the precategorical composition operations $\bullet_{(-)}$. For $i, k \in \mathbb{N}_n$ with $i < k$, we define $u *_i v$ for i -composable $u, v \in C_k$ by induction on $k - i$. In the cases where $i > 0$, we moreover prove that

$$(\tilde{u} \bullet_{i-1} \partial_i^-(\tilde{v})) *_i (\partial_i^+(\tilde{u}) \bullet_{i-1} \tilde{v}) = (\partial_i^-(\tilde{u}) \bullet_{i-1} \tilde{v}) *_i (\tilde{u} \bullet_{i-1} \partial_i^+(\tilde{v})) \quad (1.14)$$

for $(i-1)$ -composable $\tilde{u}, \tilde{v} \in C_k$. If $i = k - 1$, we put $u *_i v = u \bullet_i v$, and the equation (1.14) is an instance of (E). Otherwise, if $i < k - 1$, we define $u *_i v$ inductively by

$$u *_i v = (u \bullet_i \partial_{i+1}^-(v)) *_i (\partial_{i+1}^+(u) \bullet_i v).$$

By induction hypothesis, using (1.14), the above definition is equivalent to

$$u *_i v = (\partial_{i+1}^-(u) \bullet_i v) *_i (\partial_{i+1}^+(u) \bullet_i v).$$

Moreover, if $i > 0$, then given $(i-1)$ -composable $\tilde{u}, \tilde{v} \in C_k$, we have

$$\begin{aligned} & (\tilde{u} \bullet_{i-1} \partial_i^-(\tilde{v})) *_i (\partial_i^+(\tilde{u}) \bullet_{i-1} \tilde{v}) \\ &= [(\tilde{u} \bullet_{i-1} \partial_i^-(\tilde{v})) \bullet_i \partial_{i+1}^-(\partial_i^+(\tilde{u}) \bullet_{i-1} \tilde{v})] *_i [(\partial_{i+1}^+(\tilde{u} \bullet_{i-1} \partial_i^-(\tilde{v})) \bullet_i (\partial_i^+(\tilde{u}) \bullet_{i-1} \tilde{v}))] \\ & \hspace{15em} \text{(by definition of } *_i) \\ &= [(\tilde{u} \bullet_{i-1} \partial_i^-(\tilde{v})) \bullet_i (\partial_i^+(\tilde{u}) \bullet_{i-1} \partial_{i+1}^-(\tilde{v}))] *_i [(\partial_{i+1}^+(\tilde{u} \bullet_{i-1} \partial_i^-(\tilde{v})) \bullet_i (\partial_i^+(\tilde{u}) \bullet_{i-1} \tilde{v}))] \\ & \hspace{15em} \text{(by compatibility of } \partial_{i+1}^\epsilon \text{ with } \bullet_{i-1}) \\ &= [(\partial_i^-(\tilde{u}) \bullet_{i-1} \partial_{i+1}^-(\tilde{v})) \bullet_i (\tilde{u} \bullet_{i-1} \partial_i^+(\tilde{v}))] *_i [(\partial_i^-(\tilde{u}) \bullet_{i-1} \tilde{v}) \bullet_i (\partial_{i+1}^+(\tilde{u}) \bullet_{i-1} \partial_i^+(\tilde{v}))] \\ & \hspace{15em} \text{(by the condition (E))} \\ &= [\partial_{i+1}^-(\partial_i^-(\tilde{u}) \bullet_{i-1} \tilde{v}) \bullet_i (\tilde{u} \bullet_{i-1} \partial_i^+(\tilde{v}))] *_i [(\partial_i^-(\tilde{u}) \bullet_{i-1} \tilde{v}) \bullet_i \partial_{i+1}^+(\tilde{u} \bullet_{i-1} \partial_i^+(\tilde{v}))] \\ & \hspace{15em} \text{(by compatibility of } \partial_{i+1}^\epsilon \text{ with } \bullet_{i-1}) \\ &= (\partial_i^-(\tilde{u}) \bullet_{i-1} \tilde{v}) *_i (\tilde{u} \bullet_{i-1} \partial_i^+(\tilde{v})) \\ & \hspace{15em} \text{(by the equivalent definition of } *_i). \end{aligned}$$

We now prove that the axioms of strict categories are satisfied (*c.f.* Paragraph 1.4.1.1). Axiom (S-i) is a consequence of the precategory Axiom (P-i). Given $i, k \in \mathbb{N}_{n-1}$ with $i < k$, $\epsilon \in \{-, +\}$ and i -composable $u, v \in C_k$, if $i = k - 1$, then we have

$$\partial_{k-1}^\epsilon(u *_i v) = \partial_{k-1}^\epsilon(u \bullet_i v) = \begin{cases} \partial_{k-1}^-(u) & \text{if } \epsilon = -, \\ \partial_{k-1}^+(v) & \text{if } \epsilon = +, \end{cases}$$

and otherwise, if $i < k - 1$, we have

$$\partial_{k-1}^\epsilon(u *_i v) = \partial_{k-1}^\epsilon((u \bullet_i \partial_{i+1}^-(v)) *_i (\partial_{i+1}^+(u) \bullet_i v))$$

so that, if $i + 1 = k - 1$, when $\epsilon = -$ we have

$$\partial_{k-1}^\epsilon(u *_i v) = \partial_{k-1}^-(u \bullet_i \partial_{i+1}^-(v)) = \partial_{k-1}^-(u) \bullet_i \partial_{k-1}^-(v) = \partial_{k-1}^-(u) *_i \partial_{k-1}^-(v)$$

and similarly $\partial_{k-1}^\epsilon(u *_i v) = \partial_{k-1}^+(u) *_i \partial_{k-1}^+(v)$ when $\epsilon = +$, and finally, if $i + 1 < k - 1$, then

$$\begin{aligned} \partial_{k-1}^\epsilon(u *_i v) &= \partial_{k-1}^\epsilon(u \bullet_i \partial_{i+1}^-(v)) *_i \partial_{k-1}^\epsilon(\partial_{i+1}^+(u) \bullet_i v) \\ &= (\partial_{k-1}^\epsilon(u) \bullet_i \partial_{i+1}^-(v)) *_i (\partial_{i+1}^+(u) \bullet_i \partial_{k-1}^\epsilon(v)) \\ &= \partial_{k-1}^\epsilon(u) *_i \partial_{k-1}^\epsilon(v). \end{aligned}$$

Thus, Axiom (S-ii) holds.

We now prove Axiom (S-iii), *i.e.*, that for $i, k \in \mathbb{N}_n$ with $i < k$ and $u \in C_k$, we have $\text{id}_{\partial_i^-(u)}^k *_i u = u$, by induction on $k - i$ (the dual property can be shown similarly). If $i = k - 1$, then the equality is a consequence of the unitality of \bullet_i , by the precategory Axiom (P-iii). Otherwise, if $i < k - 1$, we have

$$\begin{aligned} \text{id}_{\partial_i^-(u)}^k *_i u &= (\text{id}_{\partial_i^-(u)}^k \bullet_i \partial_{i+1}^-(u)) *_i (\text{id}_{\partial_i^-(u)}^{i+1} \bullet_i u) && \text{(by definition of } *_i \text{)} \\ &= \text{id}^k (\text{id}_{\partial_i^-(u)}^{i+1} \bullet_i \partial_{i+1}^-(u)) *_i u && \text{(by Axiom (P-iii))} \\ &= \text{id}_{\partial_{i+1}^-(u)}^k *_i u && \text{(by Axiom (P-iii))} \\ &= u && \text{(by induction hypothesis)} \end{aligned}$$

so that Axiom (S-iii) holds.

In order to show Axiom (S-iv), we first prove a distributivity property of $\bullet_{(-)}$ over $*_{(-)}$, *i.e.*, that for $i, j, k \in \mathbb{N}_n$ with $i < j < k$, given j -composable $u, v \in C_k$, and $w \in C_{i+1}$ such that u, w are i -composable, then

$$(u *_j v) \bullet_i w = (u \bullet_i w) *_j (v \bullet_i w). \quad (1.15)$$

We prove this property by induction on $k - j$. If $j = k - 1$, then

$$\begin{aligned} (u *_j v) \bullet_i w &= (u \bullet_j v) \bullet_i w \\ &= (u \bullet_i w) \bullet_j (v \bullet_i w) && \text{(by Axiom (P-v))} \\ &= (u \bullet_i w) *_j (v \bullet_i w). \end{aligned}$$

Otherwise, if $j < k - 1$, then

$$\begin{aligned} (u *_j v) \bullet_i w &= [(u \bullet_j \partial_{j+1}^-(v)) *_j (\partial_{j+1}^+(u) \bullet_j v)] \bullet_i w && \text{(by definition of } *_j \text{)} \\ &= [(u \bullet_j \partial_{j+1}^-(v)) \bullet_i w] *_j [(\partial_{j+1}^+(u) \bullet_j v) \bullet_i w] && \text{(by the induction hypothesis)} \\ &= [(u \bullet_i w) \bullet_j (\partial_{j+1}^-(v) \bullet_i w)] *_j [(\partial_{j+1}^+(u) \bullet_i w) \bullet_j (v \bullet_i w)] && \text{(by distributivity of } \bullet_i \text{ over } \bullet_j \text{)} \\ &= (u \bullet_i w) *_j (v \bullet_i w) && \text{(by (1.15)).} \end{aligned}$$

We can now show that $(u *_i v) *_i w = u *_i (v *_i w)$ for i -composable $u, v, w \in C_k$, for some $i, k \in \mathbb{N}_n$ with $i < k$, by induction on $k - i$. If $i = k - 1$, then $(u *_i v) *_i w = u *_i (v *_i w)$ by Axiom (P-iv).

Otherwise, if $i < k - 1$, we have

$$\begin{aligned}
(u *_i v) *_i w &= [(u \bullet_i \partial_{i+1}^-(v)) *_i (\partial_{i+1}^+(u) \bullet_i v)] *_i w && \text{(by definition of } *_i) \\
&= \{ [(u \bullet_i \partial_{i+1}^-(v)) *_i (\partial_{i+1}^+(u) \bullet_i v)] \bullet_i \partial_{i+1}^-(w) \} \\
&\quad *_i [(\partial_{i+1}^+(u) \bullet_i \partial_{i+1}^-(v)) \bullet_i w] && \text{(by definition of } *_i) \\
&= [(u \bullet_i \partial_{i+1}^-(v) \bullet_i \partial_{i+1}^-(w)) *_i (\partial_{i+1}^+(u) \bullet_i v \bullet_i \partial_{i+1}^-(w))] \\
&\quad *_i (\partial_{i+1}^+(u) \bullet_i \partial_{i+1}^-(v) \bullet_i w) && \text{(by (1.15))} \\
&= (u \bullet_i \partial_{i+1}^-(v) \bullet_i \partial_{i+1}^-(w)) \\
&\quad *_i [(\partial_{i+1}^+(u) \bullet_i v \bullet_i \partial_{i+1}^-(w)) *_i (\partial_{i+1}^+(u) \bullet_i \partial_{i+1}^-(v) \bullet_i w)] \\
&\quad \text{(by associativity of } *_i \text{ from induction hypothesis)} \\
&= [u \bullet_i (\partial_{i+1}^-(v) \bullet_i \partial_{i+1}^-(w))] \\
&\quad *_i \{ \partial_{i+1}^+(u) \bullet_i [(v \bullet_i \partial_{i+1}^-(w)) *_i (\partial_{i+1}^-(v) \bullet_i w)] \} \\
&\quad \text{(by (1.15))} \\
&= u *_i [(v \bullet_i \partial_{i+1}^-(w)) *_i (\partial_{i+1}^-(v) \bullet_i w)] \\
&\quad \text{(by definition of } *_i) \\
&= u *_i (v *_i w) && \text{(by definition of } *_i)
\end{aligned}$$

which concludes the proof of Axiom (S-iv).

We now prove (S-v), *i.e.*, that for $i, k \in \mathbb{N}_{n-1}$ with $i < k$, and i -composable $u, v \in C_k$, we have $\text{id}_u^{k+1} *_i \text{id}_v^{k+1} = \text{id}_{u *_i v}^{k+1}$ by induction on $k - i$. If $i = k - 1$, then

$$\begin{aligned}
\text{id}_u^{k+1} *_i \text{id}_v^{k+1} &= (\text{id}_u^{k+1} \bullet_i v) *_i (\text{id}_v^{k+1}) && \text{(by definition of } *_i) \\
&= \text{id}_{u *_i v}^{k+1} \bullet_i \text{id}_{u *_i v}^{k+1} && \text{(by (P-iii))} \\
&= \text{id}_{u *_i v}^{k+1} && \text{(by (P-iii)).}
\end{aligned}$$

Otherwise, if $i < k - 1$, then

$$\begin{aligned}
\text{id}_u^{k+1} *_i \text{id}_v^{k+1} &= (\text{id}_u^{k+1} \bullet_i \partial_{i+1}^-(v)) *_i (\partial_{i+1}^+(u) \bullet_i \text{id}_v^{k+1}) && \text{(by definition of } *_i) \\
&= \text{id}^{k+1}(u \bullet_i \partial_{i+1}^-(v)) *_i \text{id}^{k+1}(\partial_{i+1}^+(u) \bullet_i v) && \text{(by (P-iii))} \\
&= \text{id}^{k+1}((u \bullet_i \partial_{i+1}^-(v)) *_i (\partial_{i+1}^+(u) \bullet_i v)) && \text{(by induction hypothesis)} \\
&= \text{id}_{u *_i v}^{k+1} && \text{(by definition of } *_i)
\end{aligned}$$

so that Axiom (S-v) holds.

Finally, we show Axiom (S-vi), *i.e.*, that for $i, j, k \in \mathbb{N}_n$ with $i < j < k$, j -composable $u, u' \in C_k$ and j -composable $v, v' \in C_k$ such that u, v are i -composable, we have

$$(u *_j u') *_i (v *_j v') = (u *_i v) *_j (u' *_i v')$$

by induction on $j - i$. If $i = j - 1$, then we have

$$(u *_j u') *_i (v *_j v') = [(u *_i u') \bullet_i \partial_{i+1}^-(v)] *_i [(\partial_{i+1}^+(u') \bullet_i (v *_i v'))]$$

$$\begin{aligned}
& \text{(by definition of } *_i) \\
& = (u \bullet_i \partial_{i+1}^-(v)) *_{i+1} (u' \bullet_i \partial_{i+1}^-(v)) *_{i+1} (\partial_{i+1}^+(u') \bullet_i v) *_{i+1} (\partial_{i+1}^+(u') \bullet_i v') \\
& \quad \text{(by (1.15))} \\
& = (u \bullet_i \partial_{i+1}^-(v)) *_{i+1} (\partial_{i+1}^-(u') \bullet_i v) *_{i+1} (u' \bullet_i \partial_{i+1}^+(v)) *_{i+1} (\partial_{i+1}^+(u') \bullet_i v') \\
& \quad \text{(by (1.14))} \\
& = (u *_i v) *_j (u' *_i v') \\
& \quad \text{(by definition of } *_i).
\end{aligned}$$

Otherwise, if $i < j - 1$, then we have

$$\begin{aligned}
(u *_j u') *_i (v *_j v') &= [(u *_j u') \bullet_i \partial_{i+1}^-(v)] *_{i+1} [\partial_{i+1}^+(u') \bullet_i (v *_j v')] \\
& \quad \text{(by definition of } *_i) \\
&= [(u \bullet_i \partial_{i+1}^-(v)) *_j (u' \bullet_i \partial_{i+1}^-(v))] *_{i+1} [(\partial_{i+1}^+(u') \bullet_i v) *_j (\partial_{i+1}^+(u') \bullet_i v')] \\
& \quad \text{(by (1.15))} \\
&= [(u \bullet_i \partial_{i+1}^-(v)) *_{i+1} (\partial_{i+1}^+(u') \bullet_i v)] *_j [(u' \bullet_i \partial_{i+1}^-(v)) *_{i+1} (\partial_{i+1}^+(u') \bullet_i v')] \\
& \quad \text{(by the induction hypothesis)} \\
&= [(u \bullet_i \partial_{i+1}^-(v)) *_{i+1} (\partial_{i+1}^+(u) \bullet_i v)] *_j [(u' \bullet_i \partial_{i+1}^-(v')) *_{i+1} (\partial_{i+1}^+(u') \bullet_i v')] \\
& \quad \text{(by } j\text{-composability of } u, u' \text{ and } v, v' \text{ and the globular structure)} \\
&= (u *_i v) *_j (u' *_i v') \\
& \quad \text{(by definition of } *_i)
\end{aligned}$$

which concludes the proof of Axiom (S-vi). Hence, C is equipped with a structure of strict n -category.

Thus, for $n \in \mathbb{N} \cup \{\omega\}$, we have defined a mapping $\bar{\Theta}^n$ between the objects of $\text{PCat}_n^{(E)}$ and the objects of Cat_n . We show that $\bar{\Theta}^n$ extends to a functor $\bar{\Theta}^n: \text{PCat}_n^{(E)} \rightarrow \text{Cat}_n$. Given an n -pre-functor $F: C \rightarrow C'$ between two n -precategories C and C' which satisfy (E), it is sufficient to show that F is compatible with the $*_{(-)}$ operations. Given $i, k \in \mathbb{N}_n$ with $i < k$, and $u, v \in C_k$ such that u, v are i -composable, we prove that $F(u *_i v) = F(u) *_i F(v)$ by induction on $k - i$. If $i = k - 1$, we have

$$F(u *_i v) = F(u \bullet_i v) = F(u) \bullet_i F(v) = F(u) *_i F(v).$$

Otherwise, if $i < k - 1$, we have

$$\begin{aligned}
F(u *_i v) &= F((u \bullet_i \partial_{i+1}^-(v)) *_{i+1} (\partial_{i+1}^+(u) \bullet_i v)) \\
&= (F(u) \bullet_i F(\partial_{i+1}^-(v))) *_{i+1} (F(\partial_{i+1}^+(u)) F(\bullet_i v)) \quad \text{(by induction hypothesis)} \\
&= F(u) *_i F(v)
\end{aligned}$$

which concludes the proof that F induces an n -functor. \square

1.4.3.5 – Equivalence of the definitions. In this section, we conclude that, for $n \in \mathbb{N} \cup \{\omega\}$, n -categories can be equivalently described as n -precategories satisfying (E). More precisely, we show Θ^n and $\bar{\Theta}^n$ witness that Cat_n and $\text{PCat}_n^{(E)}$ isomorphic to each other. We first show that:

Proposition 1.4.3.6. *Given $n \in \mathbb{N} \cup \{\omega\}$ and $C \in \text{Cat}_n$, we have $\bar{\Theta}^n \Theta^n C = C$.*

Proof. Let $*_{(-)}$ be the composition operations of C , $\bullet_{(-)}$ be the composition operations of $\Theta^n C$, and $*'_{(-)}$ be the composition operations of $\bar{\Theta}^n \Theta^n C$. Given $i, k \in \mathbb{N}$ with $i < k \leq n$, and $u, v \in C_k$ such that u, v are i -composable, we prove that $u *'_i v = u *_{i-1} v$ by induction on $k - i$. If $i = k - 1$, we have

$$u *'_i v = u \bullet_i v = u *_{i-1} v.$$

Otherwise, if $i < k - 1$, we have

$$\begin{aligned} u *'_i v &= (u \bullet_i \partial_{i+1}^-(v) *'_{i+1} (\partial_{i+1}^+(u) \bullet_i v)) \\ &= (u \bullet_i \partial_{i+1}^-(v)) *_{i+1} (\partial_{i+1}^+(u) \bullet_i v) && \text{(by induction hypothesis)} \\ &= (u *_{i+1} \text{id}^k(\partial_{i+1}^-(v))) *_{i+1} (\text{id}^k(\partial_{i+1}^+(u)) *_{i+1} v) \\ &= (u *_{i+1} \text{id}^k(\partial_{i+1}^-(v))) *_{i+1} (\text{id}^k(\partial_{i+1}^-(v)) *_{i+1} v) && \text{(by Axiom (S-vi))} \\ &= u *_{i+1} v. \end{aligned}$$

Hence, $*_{(-)} = *'_{(-)}$. □

We now prove the converse property:

Proposition 1.4.3.7. *Given $n \in \mathbb{N} \cup \{\omega\}$ and $C \in \text{PCat}_n^{(E)}$, we have $\Theta^n \bar{\Theta}^n C = C$.*

Proof. Let $\bullet_{(-)}$ be the composition operations of C , $*_{(-)}$ be the composition operations of $\bar{\Theta}^n C$, and $\bullet'_{(-)}$ be the composition operations of $\Theta^n \bar{\Theta}^n C$. We show that $\bullet_{(-)} = \bullet'_{(-)}$. Given $i, k, l \in \mathbb{N}_n$ with $i = \min(k, l) - 1$ and $\max(k, l) \leq n$, and $u \in C_k, v \in C_l$ such that u, v are i -composable, we show that $u \bullet_i v = u \bullet'_i v$. We can suppose that $k \leq l$ (the case $k \geq l$ is symmetric). If $k = l$, then

$$u \bullet'_i v = u *_{i-1} v = u \bullet_i v$$

Otherwise, if $k < l$, then

$$\begin{aligned} u \bullet'_i v &= \text{id}_u^l *_{i+1} v \\ &= (\text{id}_u^l \bullet_i \partial_{i+1}^-(v)) *_{i+1} (\partial_{i+1}^+(u) \bullet_i v) \\ &= (\text{id}^l(u \bullet_i \partial_{i+1}^-(v))) *_{i+1} (u \bullet_i v) && \text{(by Axiom (P-iii))} \\ &= u \bullet_i v && \text{(by Axiom (S-iii)).} \end{aligned}$$

Hence, $\bullet_{(-)} = \bullet'_{(-)}$. □

By the two above properties, we can conclude that:

Theorem 1.4.3.8. *For $n \in \mathbb{N} \cup \{\omega\}$, $\Theta^n: \text{Cat}_n \rightarrow \text{PCat}_n^{(E)}$ is an isomorphism of categories, with inverse given by $\bar{\Theta}^n$.*

Thus, for $n \in \mathbb{N} \cup \{\omega\}$, a strict n -category C is canonically an n -precategory satisfying (E) (and *vice versa*). In the following, we will often use the precategory compositions $\bullet_{(-)}$ of C without invoking Theorem 1.4.3.8.

1.5 Higher categories as enriched categories

The setting of “higher categories as globular algebras” shall be enough for most of the concerns of the next chapters. Still, an interesting perspective on notions of higher categories that we will encounter is given by *enriched definitions*. In dimension 1, the motivation for enriched definitions is to represent the additional structure that the morphisms of some particular categories might have. For example, in the category \mathbf{Vect}_K of vector spaces and linear functions on some field K , the set of morphisms $\mathbf{Vect}_K(A, B)$ between two vector spaces A and B has itself a structure of vector space, *i.e.*, $\mathbf{Vect}_K(A, B) \in \mathbf{Vect}_K$. In this situation, we say that \mathbf{Vect}_K is enriched in \mathbf{Vect}_K . Enrichment can be used seamlessly in the context of higher categories, allowing to define a theory of $(n+1)$ -categories as categories enriched in a particular notion of n -categories equipped with an adequate tensor product. Below, we recall the definition of enrichment and how strict categories fit in this setting. Moreover, after introducing the funny tensor product of precategories, we give an enriched definition of the latter. For a more complete view of enriched categories, we refer the reader to Kelly’s monograph [Kel82].

1.5.1 Enrichment

The notion of category enriched in some category \mathcal{V} is derived from a monoidal category structure on \mathcal{V} , the latter we shall recall first.

1.5.1.1 – Monoidal categories. A *monoidal category* $(\mathcal{V}, I, \otimes, \lambda, \rho, \alpha)$ is the data of a category \mathcal{V} , an object $I \in \mathcal{V}$, a bifunctor $\otimes: \mathcal{V} \times \mathcal{V} \rightarrow \mathcal{V}$ (often called *tensor product*) and natural isomorphisms

$$\begin{aligned} \lambda &= (\lambda_X: I \otimes X \rightarrow X)_{X \in \mathcal{V}} \\ \rho &= (\rho_X: X \otimes I \rightarrow X)_{X \in \mathcal{V}} \\ \alpha &= (\alpha_{X,Y,Z}: (X \otimes Y) \otimes Z \rightarrow X \otimes (Y \otimes Z))_{X,Y,Z \in \mathcal{V}} \end{aligned}$$

such that, given objects $W, X, Y, Z \in \mathcal{V}$, the diagrams

$$\begin{array}{ccc} (X \otimes I) \otimes Y & \xrightarrow{\alpha_{X,I,Y}} & X \otimes (I \otimes Y) \\ & \searrow \rho_X \otimes Y & \swarrow X \otimes \lambda_Y \\ & X \otimes Y & \end{array} \quad (1.16)$$

and

$$\begin{array}{ccccc} & & (W \otimes X) \otimes (Y \otimes Z) & & \\ & \nearrow \alpha_{W \otimes X, Y, Z} & & \searrow \alpha_{W, X, Y \otimes Z} & \\ ((W \otimes X) \otimes Y) \otimes Z & & & & W \otimes (X \otimes (Y \otimes Z)) \\ & \searrow \alpha_{W, X, Y \otimes Z} & & \nearrow W \otimes \alpha_{X, Y, Z} & \\ & (W \otimes (X \otimes Y)) \otimes Z & \xrightarrow{\alpha_{W, X \otimes Y, Z}} & W \otimes ((X \otimes Y) \otimes Z) & \end{array} \quad (1.17)$$

are commutative.

Example 1.5.1.2. The tensor product \otimes on abelian groups equips the category \mathbf{Ab} of abelian groups and group morphisms with a structure of monoidal category.

Given a category \mathcal{V} , if \mathcal{V} has all products, then it admits a canonical structure of monoidal category $(\mathcal{V}, 1, \times, \lambda, \rho, \alpha)$ called the *cartesian monoidal structure*, where 1 is the terminal object of \mathcal{V} , \times is the product operation and λ, ρ and α are the canonical isomorphisms

$$\begin{aligned}\lambda &= (\lambda_X: 1 \times X \rightarrow X)_{X \in \mathcal{V}} \\ \rho &= (\rho_X: X \times 1 \rightarrow X)_{X \in \mathcal{V}} \\ \alpha &= (\alpha_{X,Y,Z}: (X \times Y) \times Z \rightarrow X \times (Y \times Z))_{X,Y,Z \in \mathcal{V}}\end{aligned}$$

and a similar statement holds if \mathcal{V} has all coproducts.

Example 1.5.1.3. The category **Set** admits the cartesian monoidal structure $(\mathbf{Set}, 1, \times, \alpha, \lambda, \rho)$ defined as above.

1.5.1.4 – Enriched categories. Given a monoidal category $(\mathcal{V}, I, \otimes, \lambda, \rho, \alpha)$, a *category enriched in \mathcal{V}* is the data of a set C_0 and, for all $x, y \in C_0$, an object $C(x, y) \in \mathcal{V}$, together with, for all $x \in C_0$, a morphism

$$i_x: I \rightarrow C(x, x) \in \mathcal{V}$$

and, for all $x, y, z \in C_0$, a morphism

$$c_{x,y,z}: C(x, y) \otimes C(y, z) \rightarrow C(x, z) \in \mathcal{V}$$

such that, for all $w, x, y, z \in C_0$, the diagrams

$$\begin{array}{ccc} I \otimes C(x, y) & \xrightarrow{i_x \otimes C(x, y)} & C(x, x) \otimes C(x, y) \\ & \searrow \lambda_{C(x, y)} & \swarrow c_{x, x, y} \\ & & C(x, y) \end{array} \quad (1.18)$$

and

$$\begin{array}{ccc} C(x, y) \otimes I & \xrightarrow{C(x, y) \otimes i_y} & C(x, y) \otimes C(y, y) \\ & \searrow \rho_{C(x, y)} & \swarrow c_{x, y, y} \\ & & C(x, y) \end{array} \quad (1.19)$$

and

$$\begin{array}{ccccc} & & C(w, y) \otimes C(y, z) & & \\ & \nearrow c_{w, x, y} \otimes C(y, z) & & \searrow c_{w, y, z} & \\ (C(w, x) \otimes C(x, y)) \otimes C(y, z) & & & & C(w, z) \\ & \searrow \alpha_{C(w, x), C(x, y), C(y, z)} & & \nearrow c_{w, x, z} & \\ & & C(w, x) \otimes (C(x, y) \otimes C(y, z)) & \xrightarrow{C(w, x) \otimes c_{x, y, z}} & C(w, x) \otimes C(x, z) \end{array} \quad (1.20)$$

are commutative. Given two categories C and D enriched in \mathcal{V} , a *morphism between C and D* is the data of a function

$$F_0: C_0 \rightarrow D_0$$

and, for every $x, y \in C_0$, a morphism

$$F_{x,y}: C(x, y) \rightarrow D(F_0(x), F_0(y)) \in \mathcal{V}$$

such that the diagrams

$$\begin{array}{ccc}
 & I & \\
 i_x \swarrow & & \searrow i_{F_0(x)} \\
 C(x, x) & \xrightarrow{F_{x,x}} & D(F_0(x), F_0(x))
 \end{array}
 \quad \text{and} \quad
 \begin{array}{ccc}
 C(x, y) \otimes C(y, z) & \xrightarrow{F(x,y) \otimes F(y,z)} & D(x, y) \otimes D(y, z) \\
 \downarrow c_{x,y,z} & & \downarrow c_{F_0(x), F_0(y), F_0(z)} \\
 C(x, z) & \xrightarrow{F(x,z)} & D(x, z)
 \end{array}$$

commute for all $x, y, z \in C_0$. We write $\mathcal{V}\text{-Cat}$ for the category of categories enriched in \mathcal{V} . An elementary example of an enriched definition is given by the category Cat of small categories, which is equivalent to Set-Cat where Set is equipped with its cartesian monoidal structure. More generally, it is well-known that the category Cat_{n+1} of strict $(n+1)$ -categories admits an enriched definition based on the cartesian monoidal structure on Cat_n :

Theorem 1.5.1.5. *Given $n \in \mathbb{N}$, considering the cartesian monoidal structure on Cat_n , there is an equivalence of categories between Cat_{n+1} and $(\text{Cat}_n)\text{-Cat}$. Moreover, considering the cartesian monoidal structure on Cat_ω , there is an equivalence of categories between Cat_ω and $(\text{Cat}_\omega)\text{-Cat}$.*

Proof. We refer the reader to the existing literature, like [Lei04, Section 1.4]. □

An analogous result can be shown for precategories by considering a monoidal structure different from the cartesian one. This is the object of the remainder of this section.

1.5.2 The funny tensor product

Here, we introduce the funny tensor product that we will use as part of a monoidal structure to give an enriched definition of precategories. We give a rather direct and concise definition, and we refer the reader to the work of Weber [Web09] for a more theoretical definition. Let $n \in \mathbb{N} \cup \{\omega\}$. Given two n -precategories C and D , the *funny tensor product* of C and D is the pushout in PCat_n

$$\begin{array}{ccc}
 C_{(0)} \times D_{(0)} & \xrightarrow{C_{(0)} \times i_D} & C_{(0)} \times D \\
 i_C \times D_{(0)} \downarrow & & \downarrow r_{C,D} \\
 C \times D_{(0)} & \xrightarrow{l_{C,D}} & C \square D
 \end{array}$$

where $(-)_{(0)}$ denotes the functor

$$(-)_{\uparrow n,0}^{\text{PCat}} (-)_{\leq 0,n}^{\text{PCat}} : \text{PCat}_n \rightarrow \text{PCat}_n$$

and $i = i^{0,n}$ is the counit of $(-)_{\uparrow n,0}^{\text{PCat}} \dashv (-)_{\leq 0,n}^{\text{PCat}}$. Since i is a natural transformation, the funny tensor product can be extended to a bifunctor

$$(-) \square (-) : \text{PCat}_n \times \text{PCat}_n \rightarrow \text{PCat}_n .$$

We show that it equips PCat_n with a structure of monoidal category. First, we prove the two properties of commutation with colimits below. In the following, we write $(\text{PCat}_n, 1^n, \times, \lambda, \rho, \alpha)$ for the cartesian monoidal structure on PCat_n (in particular, 1^n is the terminal object of PCat_n).

Lemma 1.5.2.1. *Given n -precategories C and $(D^i)_{i \in I}$, the canonical morphism*

$$\coprod_{i \in I} (C \times D^i) \rightarrow C \times \left(\coprod_{i \in I} D^i \right)$$

of PCat_n is an isomorphism.

Proof. Write F for this morphism. Note that a morphism between n -precategories is an isomorphism if and only if the underlying morphism of globular sets is an isomorphism. Thus, it is sufficient to show that F induces bijections between the k -cells, *i.e.*, that the images of F under the functors $(-)_k: \mathbf{PCat}_n \rightarrow \mathbf{Set}$ are bijections for $k \in \mathbb{N}_n$. Products and coproducts are computed dimensionwise in \mathbf{PCat}_n , so that the functors $(-)_k$ preserve products and coproducts. Since coproducts distribute over products in \mathbf{Set} , F_k is an isomorphism for $k \in \mathbb{N}_n$, and so is F . \square

Lemma 1.5.2.2. *Given an n -precategory D , the functor $(-) \times D_{(0)}: \mathbf{PCat}_n \rightarrow \mathbf{PCat}_n$ preserves colimits and, dually, the functor $D_{(0)} \times (-): \mathbf{PCat}_n \rightarrow \mathbf{PCat}_n$ preserves colimits.*

Proof. Note that, by the definition of $(-)_{\uparrow n,0}^{\mathbf{PCat}}$, we have $(1^0)_{\uparrow n} \simeq 1^n$. Since, by Proposition 1.2.3.7, the functor $(-)_{\uparrow n,0}^{\mathbf{PCat}}$ preserves colimits, we have

$$D_{(0)} \simeq \coprod_{x \in D_0} 1^n.$$

Thus, given a diagram $C^{(-)}: I \rightarrow \mathbf{PCat}_n$, by Lemma 1.5.2.1, we have

$$\operatorname{colim}_{i \in I} C^i \times D_{(0)} \simeq \coprod_{x \in D_0} \operatorname{colim}_{i \in I} C^i \simeq \operatorname{colim}_{i \in I} \left(\coprod_{x \in D_0} C^i \right) \simeq \operatorname{colim}_{i \in I} (C^i \times D_{(0)}).$$

The dual statement is shown similarly. \square

We can now define the rest of the monoidal structure for \mathbf{PCat}_n . Given an n -precategory C , there are canonical morphisms

$$\lambda_C^f: 1^n \square C \rightarrow C \quad \text{and} \quad \rho_C^f: C \square 1^n \rightarrow C$$

where λ_C^f is defined by

$$\begin{array}{ccc} 1_{(0)}^n \times C_{(0)} & \xrightarrow{1_{(0)}^n \times i_C} & 1_{(0)}^n \times C \\ \downarrow i_{1^n} \times C_{(0)} & & \downarrow r_{1^n, C} \\ 1^n \times C_{(0)} & \xrightarrow{i_{1^n, C}} & 1^n \square C \\ & \searrow i_C \circ \pi_2 & \nearrow \lambda_C^f \\ & & C \end{array}$$

(Note: The diagram also includes a curved arrow π_2 from $1_{(0)}^n \times C$ to C and a dotted arrow λ_C^f from $1^n \square C$ to C .)

and ρ_C^f is defined similarly. Both are natural in C . Moreover, we have:

Lemma 1.5.2.3. *Given $C \in \mathbf{PCat}_n$, λ_C^f and ρ_C^f are isomorphisms.*

Proof. By symmetry, it is sufficient to prove that λ_C^f is an isomorphism. Note that $i_{1^n}: 1_{(0)}^n \rightarrow 1^n$ is an isomorphism, so that, by the pushout definition of $1^n \square C$, $r_{1^n, C}$ is an isomorphism. Moreover, since $1_{(0)}^n \simeq 1^n$, we have that $\pi_2: 1_{(0)}^n \times C \rightarrow C$ is an isomorphism. Thus, $\lambda_C^f = r_{1^n, C} \circ \pi_2^{-1}$ is an isomorphism. \square

Furthermore, we introduce the associativity isomorphism with the following lemma:

Lemma 1.5.2.4. *Given n -precategories C, D, E , there is an isomorphism*

$$\alpha_{C,D,E}^f: (C \square D) \square E \xrightarrow{\sim} C \square (D \square E)$$

natural in C, D, E .

Proof. The n -precategory $(C \sqcup D) \sqcup E$ is defined by the pushout

$$\begin{array}{ccc} (C_{(0)} \times D_{(0)}) \times E_{(0)} & \xrightarrow{(C_{(0)} \times D_{(0)}) \times i_E} & (C_{(0)} \times D_{(0)}) \times E \\ i_{C \sqcup D} \times E_{(0)} \downarrow & & \downarrow r_{C \sqcup D, E} \\ (C \sqcup D) \times E_{(0)} & \xrightarrow{l_{C \sqcup D, E}} & (C \sqcup D) \sqcup E \end{array} \cdot$$

Since, by Lemma 1.5.2.2, $(-)\times E_{(0)}$ preserves colimits, the following diagram is also a pushout

$$\begin{array}{ccc} (C_{(0)} \times D_{(0)}) \times E_{(0)} & \xrightarrow{(C_{(0)} \times i_D) \times E_{(0)}} & (C_{(0)} \times D) \times E_{(0)} \\ (i_C \times D_{(0)}) \times E_{(0)} \downarrow & & \downarrow r_{C, D} \times E_{(0)} \\ (C \times D_{(0)}) \times E_{(0)} & \xrightarrow{l_{C, D} \times E_{(0)}} & (C \sqcup D) \times E_{(0)} \end{array} \cdot$$

So, by expanding the first pushout with the second, $(C \sqcup D) \sqcup E$ can be expressed as the colimit

$$\begin{array}{ccccc} & & (C \times D_{(0)}) \times E_{(0)} & & \\ & \nearrow^{(i_C \times D_{(0)}) \times E_{(0)}} & & \searrow_{l_{C \sqcup D, E} \circ (l_{C, D} \times E_{(0)})} & \\ (C_{(0)} \times D_{(0)}) \times E_{(0)} & \xrightarrow{(C_{(0)} \times i_D) \times E_{(0)}} & (C_{(0)} \times D) \times E_{(0)} & \xrightarrow{l_{C \sqcup D, E} \circ (r_{C, D} \times E_{(0)})} & (C \sqcup D) \sqcup E \\ & \searrow_{(C_{(0)} \times D_{(0)}) \times i_E} & & \nearrow_{r_{C \sqcup D, E}} & \\ & & (C_{(0)} \times D_{(0)}) \times E & & \end{array} \quad (1.21)$$

and $C \sqcup (D \sqcup E)$ admits a similar diagram. Thus, the isomorphisms

$$\alpha_{X, Y, Z}: (X \times Y) \times Z \rightarrow X \times (Y \times Z) \in \mathbf{PCat}_n$$

for $X, Y, Z \in \mathbf{PCat}_n$ induce a morphism $\alpha_{C, D, E}^f: (C \sqcup D) \sqcup E \rightarrow C \sqcup (D \sqcup E)$, which is, by the symmetry of the construction, an isomorphism. It is easily checked to be natural in C, D, E . \square

We deduce a monoidal structure for \mathbf{PCat}_n based on the funny tensor product:

Proposition 1.5.2.5. $(C, \sqcup, 1^n, \lambda^f, \rho^f, \alpha^f)$ is a monoidal category.

Proof. Given $A, B, C, D \in \mathbf{PCat}_n$, the commutation of the diagram

$$\begin{array}{ccc} (C \otimes 1^n) \otimes D & \xrightarrow{\alpha_{C, 1^n, D}^f} & C \otimes (1^n \otimes D) \\ & \searrow_{\rho_C^f \otimes D} & \swarrow_{C \otimes \lambda_D^f} \\ & C \otimes D & \end{array}$$

can be shown using the colimit definition of $(C \sqcup 1^n) \sqcup D$ given by (1.21). Moreover, note that the object $((A \sqcup B) \sqcup C) \sqcup D$ admits a definition as colimit on a diagram analogous to (1.21) with four branches. Using this colimit, one can show that the diagram

$$\begin{array}{ccccc} & & (A \sqcup B) \sqcup (C \sqcup D) & & \\ & \nearrow_{\alpha_{A \sqcup B, C, D}^f} & & \searrow_{\alpha_{A, B, C \sqcup D}^f} & \\ ((A \sqcup B) \sqcup C) \sqcup D & & & & A \sqcup (B \sqcup (C \sqcup D)) \\ & \searrow_{\alpha_{A, B, C}^f \sqcup D} & & \nearrow_{A \sqcup \alpha_{B, C, D}^f} & \\ & & (A \sqcup (B \sqcup C)) \sqcup D & \xrightarrow{\alpha_{A, B \sqcup C, D}^f} & A \sqcup ((B \sqcup C) \sqcup D) \end{array}$$

commutes. Thus, $(C, \sqcup, 1^n, \lambda^f, \rho^f, \alpha^f)$ is a monoidal category. \square

1.5.3 Enriched definition of precategories

We now give an enriched definition of precategories using the funny tensor product in the form of the following theorem:

Theorem 1.5.3.1. *Considering the monoidal structure on \mathbf{PCat}_n given by the funny tensor product, there is an equivalence of categories between \mathbf{PCat}_{n+1} and $(\mathbf{PCat}_n)\text{-Cat}$. Moreover, considering the analogous monoidal structure on \mathbf{PCat}_ω , there is an equivalence of categories between \mathbf{PCat}_ω and $(\mathbf{PCat}_\omega)\text{-Cat}$.*

Proof. Given $C \in \mathbf{PCat}_{n+1}$, we define an associated object $D \in (\mathbf{PCat}_n)\text{-Cat}$ as follows. We put

$$D_0 = C_0 \quad \text{and} \quad D(x, y) = C_{\uparrow(x, y)}$$

where $C_{\uparrow(x, y)}$ is the n -precategory such that

$$(C_{\uparrow(x, y)})_i = \{u \in C_{i+1} \mid \partial_0^-(u) = x \text{ and } \partial_0^+(u) = y\}$$

for $i \in \mathbb{N}_n$ and whose composition operation $\bullet_{k, l}$ is the operation $\bullet_{k+1, l+1}$ on C for $k, l \in \mathbb{N}_n^*$. Given $x \in D_0$, we define the identity morphism

$$i_x: 1^n \rightarrow D(x, x)$$

as the morphism which maps the unique 0-cell $*$ of 1^n to $\text{id}_x^1 \in C_1$. Given $x, y, z \in C_0$, we define the composition morphism

$$c_{x, y, z}: D(x, y) \square D(y, z) \rightarrow D(x, z) \in \mathbf{PCat}_n$$

as the unique morphism such that $l_{x, y, z} = c_{x, y, z} \circ l_{D(x, y), D(y, z)}$ is the composite

$$D(x, y) \times D(y, z)_{(0)} \simeq \coprod_{g \in D(y, z)_0} D(x, y) \xrightarrow{[(-) \bullet_0 g]_{g \in D(y, z)_0}} D(x, z)$$

and $r_{x, y, z} = c_{x, y, z} \circ r_{D(x, y), D(y, z)}$ is the composite

$$D(x, y)_{(0)} \times D(y, z) \simeq \coprod_{f \in D(x, y)_0} D(y, z) \xrightarrow{[f \bullet_0 (-)]_{f \in D(x, y)_0}} D(x, z).$$

We verify that the composition morphism is left unital, *i.e.*, given $x, y \in D_0$, the diagram

$$\begin{array}{ccc} 1^n \square D(x, y) & \xrightarrow{i_x \square D(x, y)} & D(x, x) \square D(x, y) \\ & \searrow \lambda_{D(x, y)}^f & \swarrow c_{x, x, y} \\ & D(x, y) & \end{array}$$

commutes. We compute that

$$\begin{aligned} c_{x, x, y} \circ (i_x \square D(x, y)) \circ l_{1^n, D(x, y)} &= c_{x, x, y} \circ l_{D(x, x), D(x, y)} \circ (i_x \times D(x, y)_{(0)}) && \text{(by definition of } \square \text{)} \\ &= l_{x, x, y} \circ (i_x \times D(x, y)_{(0)}) \\ &= i_{D(x, y)} \circ \pi_2 && \text{(by unitality of } \text{id}_x \text{)} \\ &= \lambda_{D(x, y)}^f \circ l_{1^n, D(x, y)} \end{aligned}$$

and

$$\begin{aligned}
c_{x,x,y} \circ (i_x \sqcap D(x,y)) \circ r_{1^n, D(x,y)} &= c_{x,x,y} \circ r_{D(x,x), D(x,y)} \circ ((i_x)_{(0)} \times D(x,y)) \\
&\quad \text{(by definition of } \sqcap \text{)} \\
&= r_{x,x,y} \circ ((i_x)_{(0)} \times D(x,y)) \\
&= \pi_2 \quad \text{(by unitality of } id_x \text{)} \\
&= \lambda_{D(x,y)}^f \circ r_{1^n, D(x,y)}
\end{aligned}$$

Thus, by the colimit definition of $1^n \sqcap D(x,y)$, the above triangle commutes. Similarly, the triangle

$$\begin{array}{ccc}
D(x,y) \sqcap 1^n & \xrightarrow{D(x,y) \sqcap i_y} & D(x,y) \sqcap D(y,y) \\
& \searrow \rho_{D(x,y)}^f & \swarrow c_{x,y,y} \\
& D(x,y) &
\end{array}$$

commutes, so that the composition morphism is right unital. We now verify that it is associative, *i.e.*, given $w, x, y, z \in D_0$, that the diagram

$$\begin{array}{ccc}
& & D(w,y) \sqcap D(y,z) & & \\
& \nearrow c_{w,x,y} \sqcap D(y,z) & & \searrow c_{w,y,z} & \\
(D(w,x) \sqcap D(x,y)) \sqcap D(y,z) & & & & D(w,z) \\
& \searrow \alpha_{D(w,x), D(x,y), D(y,z)}^f & & \nearrow c_{w,x,z} & \\
D(w,x) \sqcap (D(x,y) \sqcap D(y,z)) & \xrightarrow{D(w,x) \sqcap c_{x,y,z}} & D(w,x) \sqcap D(x,z) & &
\end{array} \quad (1.22)$$

commutes. By a colimit definition analogous to (1.21), it is enough to show the commutation of the diagram when precomposing with the morphisms $\iota_1, \iota_2, \iota_3$ where

$$\begin{aligned}
\iota_1 &= l_{D(w,x) \sqcap D(x,y), D(y,z)} \circ (l_{D(w,x), D(x,y)} \times D(y,z)_{(0)}), \\
\iota_2 &= l_{D(w,x) \sqcap D(x,y), D(y,z)} \circ (r_{D(w,x), D(x,y)} \times D(y,z)_{(0)}), \\
\iota_3 &= r_{D(w,x) \sqcap D(x,y), D(y,z)}.
\end{aligned}$$

Writing D^1, D^2, D^3 for $D(w,x), D(x,y), D(y,z)$, we compute that

$$\begin{aligned}
& c_{w,x,z} \circ (D^1 \sqcap c_{x,y,z}) \circ \alpha_{D^1, D^2, D^3}^f \circ \iota_1 \\
&= c_{w,x,z} \circ (D^1 \sqcap c_{x,y,z}) \circ \alpha_{D^1, D^2, D^3}^f \circ l_{D^1 \sqcap D^2, D^3} \circ (l_{D^1, D^2} \times D_{(0)}^3) \\
&= c_{w,x,z} \circ (D^1 \sqcap c_{x,y,z}) \circ l_{D^1, D^2 \sqcap D^3} \circ \alpha_{D^1, D_{(0)}^2, D_{(0)}^3} \\
&= c_{w,x,z} \circ l_{D^1, D(x,z)} \circ (D^1 \times ((-) \bullet_0 (-))) \circ \alpha_{D^1, D_{(0)}^2, D_{(0)}^3} \\
&= ((-) \bullet_0 (-)) \circ (D^1 \times ((-) \bullet_0 (-))) \circ \alpha_{D^1, D_{(0)}^2, D_{(0)}^3} \\
&= ((-) \bullet_0 (-)) \circ (((-) \bullet_0 (-)) \times D_{(0)}^3) \quad \text{(by associativity of } \bullet_0 \text{)} \\
&= c_{w,y,z} \circ l_{D(w,y), D^3} \circ (((-) \bullet_0 (-)) \times D_{(0)}^3) \\
&= c_{w,y,z} \circ l_{D(w,y), D^3} \circ (c_{w,x,y} \times D_{(0)}^3) \circ (l_{D^1, D^2} \times D_{(0)}^3) \\
&= c_{w,y,z} \circ (c_{w,x,y} \sqcap D^3) \circ l_{D^1 \sqcap D^2, D^3} \circ (l_{D^1, D^2} \times D_{(0)}^3) \\
&= c_{w,y,z} \circ (c_{w,x,y} \sqcap D^3) \circ \iota_1
\end{aligned}$$

so that the diagram (1.22) commutes when precomposed with ι_1 and, similarly, it commutes when precomposed with ι_2 and ι_3 . Thus, (1.22) commutes. Hence, D is a category enriched in n -precategories. The operation $C \mapsto D$ can easily be extended to morphisms of $(n+1)$ -precategories, giving a functor

$$F: \mathbf{PCat}_{n+1} \rightarrow (\mathbf{PCat}_n)\text{-Cat}.$$

Conversely, given $C \in (\mathbf{PCat}_n)\text{-Cat}$, we define an associated object $D \in \mathbf{PCat}_{n+1}$. We put

$$D_0 = C_0 \quad \text{and} \quad D_{i+1} = \coprod_{x,y \in C_0} C(x,y)_i$$

for $i \in \mathbb{N}_n$. Given $k \in \mathbb{N}_n$, $\iota_{x,y}(u) \in D_{k+1}$ and $\epsilon \in \{-, +\}$, we put

$$\partial_k^\epsilon(\iota_{x,y}(u)) = \begin{cases} x & \text{if } k = 0 \text{ and } \epsilon = -, \\ y & \text{if } k = 0 \text{ and } \epsilon = +, \\ \iota_{x,y}(\partial_{k-1}^\epsilon(u)) & \text{if } k > 0, \end{cases}$$

so that the operations ∂^-, ∂^+ equips D with a structure of $(n+1)$ -globular set. Given $x \in D_0$, we put

$$\text{id}_x^1 = \iota_{x,x}(i_x(*))$$

and, given $k \in \mathbb{N}_{n-1}$ and $\iota_{x,y}(u) \in D_{k+1}$, we put

$$\text{id}_{\iota_{x,y}(u)}^{k+2} = \iota_{x,y}(\text{id}_u^{k+1}).$$

Given $i, k_1, k_2 \in \mathbb{N}_n$ with $i = \min(k_1, k_2) - 1$, and $u = \iota_{x,y}(\tilde{u}) \in D_{k_1}$, $v = \iota_{x',y'}(\tilde{v}) \in D_{k_2}$ that are i -composable, we put

$$u \bullet_i v = \begin{cases} \iota_{x,y}(\tilde{u} \bullet_i \tilde{v}) & \text{if } i > 0 \\ \iota_{x,y'}(\iota_{x,y,y'}(\tilde{u}, \text{id}_{\tilde{v}}^{k_1-1})) & \text{if } i = 0 \text{ and } k_2 = 1 \\ \iota_{x,y'}(\iota_{x,y,y'}(\text{id}_{\tilde{u}}^{k_2-1}, \tilde{v})) & \text{if } i = 0 \text{ and } k_1 = 1 \end{cases}$$

where $l_{x,y,z}$ is the composite

$$C(x,y) \times C(y,z)_{(0)} \xrightarrow{l_{C(x,y), C(y,z)}} C(x,y) \square C(y,z) \xrightarrow{c_{x,y,z}} C(x,z)$$

and $r_{x,y,z}$ is the composite

$$C(x,y)_{(0)} \times C(y,z) \xrightarrow{r_{C(x,y), C(y,z)}} C(x,y) \square C(y,z) \xrightarrow{c_{x,y,z}} C(x,z).$$

We now have to show that the axioms of $(n+1)$ -precategories are satisfied. Note that, by the definition of D , it is enough to prove the axioms for the id^1 and \bullet_0 operations. Given $x \in D_0$ and $\epsilon \in \{-, +\}$, we have

$$\partial_0^\epsilon(\text{id}_x^1) = \partial_0^\epsilon(\iota_{x,x}(i_x(*))) = x$$

so that Axiom (P-i) holds. For $k \in \mathbb{N}_{n+1}^*$, given $u = \iota_{x,y}(\tilde{u}) \in D_k$ and $v = \iota_{y,z}(\tilde{v}) \in D_1$ such that u, v are 0-composable, if $k = 1$, then

$$\partial_0^-(u \bullet_0 v) = \partial_0^-(\iota_{x,z}(l_{x,y,z}(\tilde{u}, \tilde{v}))) = x,$$

and, similarly, $\partial_0^+(u \bullet_0 v) = z$. Otherwise, if $k > 1$, then, for $\epsilon \in \{-, +\}$,

$$\begin{aligned} \partial_{k-1}^\epsilon(u \bullet_0 v) &= \partial_{k-1}^\epsilon(\iota_{x,z}(l_{x,y,z}(\tilde{u}, \text{id}_{\tilde{v}}^{k-1}))) \\ &= \iota_{x,z}(\partial_{k-2}^\epsilon(l_{x,y,z}(\tilde{u}, \text{id}_{\tilde{v}}^{k-1}))) \\ &= \iota_{x,z}(l_{x,y,z}(\partial_{k-2}^\epsilon(\tilde{u}), \text{id}_{\tilde{v}}^{k-2})) \\ &= \iota_{x,y}(\partial_{k-2}^\epsilon(\tilde{u})) \bullet_0 \iota_{y,z}(\tilde{v}) \\ &= \partial_{k-1}^\epsilon(u) \bullet_0 v. \end{aligned}$$

Analogous equalities are satisfied for 0-composable $u \in D_1$ and $v \in D_k$, so that Axiom (P-ii) holds. Given $k \in \mathbb{N}_{n+1}^*$ and $u = \iota_{x,y}(\tilde{u}) \in D_k$, we have

$$\begin{aligned} u \bullet_0 \text{id}_y^1 &= \iota_{x,y}(l_{x,y,y}(\tilde{u}, \text{id}_{i_y}^{k-1})) \\ &= \iota_{x,y}(c_{x,y,y} \circ (C(x,y) \square i_y) \circ l_{C(x,y),1^n}(\tilde{u}, \text{id}_*^{k-1})) \\ &= \iota_{x,y}(\rho_{C(x,y)}^f \circ l_{C(x,y),1^n}(\tilde{u}, \text{id}_*^{k-1})) \quad (\text{by the axioms of enriched categories}) \\ &= \iota_{x,y}(\pi_1(\tilde{u}, \text{id}_*^{k-1})) \quad (\text{by definition of } \rho^f) \\ &= u. \end{aligned}$$

Moreover, given $k \in \mathbb{N}_n^*$ and 0-composable $u = \iota_{x,y}(\tilde{u}) \in D_1$ and $v = \iota_{y,z}(\tilde{v}) \in D_k$, we have

$$\begin{aligned} u \bullet_0 \text{id}_v^{k+1} &= \iota_{x,z}(r_{x,y,z}(\text{id}_{\tilde{u}}^k, \text{id}_{\tilde{v}}^k)) \\ &= \iota_{x,z}(\text{id}^k(r_{x,y,z}(\text{id}_{\tilde{u}}^{k-1}, \tilde{v}))) \\ &= \text{id}^{k+1}(\iota_{x,z}(r_{x,y,z}(\text{id}_{\tilde{u}}^{k-1}, \tilde{v}))) \\ &= \text{id}_{u \bullet_0 v}^{k+1}. \end{aligned}$$

Analogous equalities hold when composing with identities on the left, so that Axiom (P-iii) holds. Given $k \in \mathbb{N}_{n+1}^*$ and 0-composable $u_1 = \iota_{w,x}(\tilde{u}_1) \in D_k$, $u_2 = \iota_{x,y}(\tilde{u}_2) \in D_1$ and $u_3 = \iota_{y,z}(\tilde{u}_3) \in D_1$, we have

$$(u_1 \bullet_0 u_2) \bullet_0 u_3 = \iota_{w,z}(l_{w,y,z}(l_{w,x,y}(\tilde{u}_1, \text{id}_{\tilde{u}_2}^{k-1}), \text{id}_{\tilde{u}_3}^{k-1})).$$

Writing C^1, C^2, C^3 for $C(w,x), C(x,y), C(y,z)$, we compute that

$$\begin{aligned} &l_{w,y,z} \circ (l_{w,x,y} \times C_{(0)}^3) \\ &= c_{w,y,z} \circ l_{C(w,y),C^3} \circ (c_{w,x,y} \times C_{(0)}^3) \circ (l_{C^1,C^2} \times C_{(0)}^3) \\ &= c_{w,y,z} \circ (c_{w,x,y} \square C^3) \circ l_{C^1 \square C^2, C^3} \circ (l_{C^1,C^2} \times C_{(0)}^3) \\ &\quad (\text{by definition of } \square) \\ &= c_{w,x,z} \circ (C^1 \square c_{x,y,z}) \circ \alpha_{C^1,C^2,C^3}^f \circ l_{C^1 \square C^2, C^3} \circ (l_{C^1,C^2} \times C_{(0)}^3) \\ &\quad (\text{by the axioms of enriched categories}) \\ &= c_{w,x,z} \circ (C^1 \square c_{x,y,z}) \circ l_{C^1,C^2 \square C^3} \circ \alpha_{C^1,C_{(0)}^2,C_{(0)}^3} \\ &\quad (\text{by definition of } \alpha^f) \\ &= c_{w,x,z} \circ l_{C^1,C(x,z)} \circ (C^1 \times (c_{x,y,z})_{(0)}) \circ \alpha_{C^1,C_{(0)}^2,C_{(0)}^3} \\ &= l_{w,x,z} \circ (C^1 \times (l_{x,y,z})_{(0)}) \circ \alpha_{C^1,C_{(0)}^2,C_{(0)}^3}. \end{aligned}$$

Thus,

$$\begin{aligned}
(u_1 \bullet_0 u_2) \bullet_0 u_3 &= \iota_{w,z}(l_{w,x,z}(\tilde{u}_1, (l_{x,y,z})_{(0)}(\text{id}_{\tilde{u}_2}^{k-1}, \text{id}_{\tilde{u}_3}^{k-1}))) \\
&= \iota_{w,z}(l_{w,x,z}(\tilde{u}_1, \text{id}_{(l_{x,y,z})_{(0)}}^{k-1}(\tilde{u}_2, \tilde{u}_3))) \\
&= u_1 \bullet_0 \iota_{x,z}((l_{x,y,z})_{(0)}(\tilde{u}_2, \tilde{u}_3)) \\
&= u_1 \bullet_0 \iota_{x,z}(l_{x,y,z}(\tilde{u}_2, \tilde{u}_3)) \\
&= u_1 \bullet_0 (u_2 \bullet_0 u_3)
\end{aligned}$$

and similar equalities can be shown for $(u_1, u_2, u_3) \in (D_1 \times_0 D_k \times_0 D_1) \sqcup (D_1 \times_0 D_1 \times_0 D_k)$, so that Axiom (P-iv) holds. Finally, for $i, k_1, k_2, k \in \mathbb{N}_{n+1}^*$ such that $i = \min(k_1, k_2) - 1$, $k = \max(k_1, k_2)$, given $u = \iota_{x,y}(\tilde{u}) \in D_1$ and i -composable $v_1 = \iota_{y,z}(\tilde{v}_1) \in D_{k_1}$, $v_2 = \iota_{y,z}(\tilde{v}_2) \in D_{k_2}$, we have

$$\begin{aligned}
u \bullet_0 (v_1 \bullet_i v_2) &= u \bullet_0 \iota_{y,z}(\tilde{v}_1 \bullet_{i-1} \tilde{v}_2) \\
&= \iota_{x,z}(r_{x,y,z}(\text{id}_u^{k-1}, \tilde{v}_1 \bullet_{i-1} \tilde{v}_2)) \\
&= \iota_{x,z}(r_{x,y,z}(\text{id}_u^{k_1-1} \bullet_{i-1} \text{id}_u^{k_2-1}, \tilde{v}_1 \bullet_{i-1} \tilde{v}_2)) \\
&= \iota_{x,z}(r_{x,y,z}(\text{id}_u^{k_1-1}, \tilde{v}_1) \bullet_{i-1} r_{x,y,z}(\text{id}_u^{k_2-1}, \tilde{v}_2)) \\
&= \iota_{x,z}(r_{x,y,z}(\text{id}_u^{k_1-1}, \tilde{v}_1)) \bullet_i \iota_{x,z}(r_{x,y,z}(\text{id}_u^{k_2-1}, \tilde{v}_2)) \\
&= (u \bullet_0 v_1) \bullet_i (u \bullet_0 v_2)
\end{aligned}$$

and an analogous equality can be shown for $((u_1, u_2), v) \in ((D_{k_1} \times_i D_{k_2}) \times_0 D_1)$, so that Axiom (P-v) holds. Hence, D is an $(n+1)$ -precategory. The construction $C \mapsto D$ extends naturally to enriched functors, giving a functor $G: (\mathbf{PCat}_n)\text{-Cat} \rightarrow \mathbf{PCat}_{n+1}$.

Given $C \in \mathbf{PCat}_{n+1}$ and $C' = G \circ F(C)$, there is a morphism $\alpha_C: C \rightarrow C'$ which is the identity between C_0 and C'_0 and, for $k \in \mathbb{N}_n$, maps $u \in C_{k+1}$ to $\iota_{x,y}(u)$ where $x = \partial_0^-(u)$ and $y = \partial_0^+(u)$, and one can verify that it is an isomorphism which is natural in C .

Conversely, given $C \in (\mathbf{PCat}_n)\text{-Cat}$ and $C' = F \circ G(C)$, there is a morphism $\beta: C \rightarrow C'$ which is the identity between C_0 and C'_0 , and, for $x, y \in C_0$, maps $u \in C(x, y)$ to $\iota_{x,y}(u) \in C'(x, y)$, and one can verify that it is an isomorphism which is natural in C . Hence, F is an equivalence of categories.

A similar proof gives an equivalence of categories between \mathbf{PCat}_ω and $(\mathbf{PCat}_\omega)\text{-Cat}$. \square

The word problem on strict categories

Introduction

Given a polygraph of strict categories P , any cell of P^* can be represented by an expression involving generators of P , and identity id and composition $*_i$ operations (*c.f.* Proposition 1.4.1.16). Typically, several such expressions represent the same cells. For example, given a 1-polygraph with four composable 1-generators a, b, c, d as in

$$v \xrightarrow{a} w \xrightarrow{b} x \xrightarrow{c} y \xrightarrow{d} z$$

one can verify that the two words

$$(a *_0 (b *_0 \text{id}_x^1)) *_0 (c *_0 d) \quad \text{and} \quad a *_0 (b *_0 (c *_0 b)) \quad (2.1)$$

denote the same 1-cell in the free strict category associated to this polygraph, as a consequence of the unitality and the associativity of the composition operation. More generally, the *word problem* on a polygraph P consists in, given two words on P , deciding whether they evaluate to the same cell of P^* . In order to provide a better understanding and computational treatment of strict higher categories, having an efficient procedure to solve this problem is important.

As suggested by (2.1), the word problem on strict 1-categories has a quite simple solution. Starting from a word, one obtains a normal form by eliminating the identities and reparenthesizing the word on the right, and this normal form is essentially a list of composable 1-generators of the polygraph. One can then decide whether two words represent the same cell by computing and comparing their normal forms. The word problem in higher dimensions is less simple, since there is no known orientation of the axioms of strict categories that would allow to rewrite a word by a finite sequence of moves to a unique normal form.

Still, in [Mak05], Makkai gave a solution to the above word problem. For this purpose, he used the equivalent description (recalled in Section 1.4.3) of strict categories as precategories satisfying an exchange condition to show that words on strict categories admit a canonical form. More precisely, given an n -polygraph P of strict categories, every n -cell $u \in P^*$ can be represented by a word of the form

$$u_1 \bullet_{n-1} \cdots \bullet_{n-1} u_k \quad (2.2)$$

for some $k \in \mathbb{N}^*$, where

$$u_i = l_{i,n} \bullet_{n-1} (l_{i,n-1} \bullet_{n-2} \cdots \bullet_1 (l_{i,1} \bullet_0 g_i \bullet_0 r_{i,1}) \bullet_1 \cdots \bullet_{n-2} r_{i,n-1}) \bullet_{n-1} r_{i,n}$$

for $i \in \mathbb{N}_k^*$, with $l_{i,j}, r_{i,j} \in P_j^*$ and $g_i \in P_n$. Then, Makkai showed that a cell u as above admits a finite number of canonical forms (2.2) and he introduced a terminating procedure to compute them. This is enough to solve the word problem, since one can then decide whether two words have equivalent canonical forms. However, since a cell can admit a lot of canonical forms (2.2), the resulting algorithm is quite inefficient, which prevents using it to solve too sophisticated instances of the word problem.

In his work on the word problem, Makkai introduced several important notions and properties on polygraphs. Notably, for each polygraph P , he defined a function, that we call *Makkai's measure*, which maps each cell $u \in P^*$ to some element of the free abelian group $\mathbb{Z}P$ and which intuitively counts how many times each generator of P is involved in u . Using this measure, he was able to prove that his procedure for the word problem terminates. Although Makkai's measure has several good properties, Makkai remarked that it has the defect of sometimes "double-counting" the generators in the cells. He then raised the question of the existence of another measure on polygraphs of strict categories which would not display this bad behavior. The existence of such a measure would be interesting since it could help better characterize the words that represent a given cell. It could also help with the study of a special class of polygraphs introduced by Makkai, that he called *computopes*, and later studied by Henry [Hen17] under the names *plexes* and *polyplexes*, following a terminology introduced by Burroni [Bur12]. Intuitively, they are polygraphs whose generators are "as separated as possible". Such polygraphs seem to play an important role in the study of polygraphs. In particular, they can be used to show whether some subcategories of polygraphs are presheaf categories, as witnessed by the works of Makkai and Henry.

Outline. This chapter is mainly concerned with giving an efficient and implementable solution to the word problem on polygraphs of strict categories. It is organized as follows. First, we recall the definition of Makkai's measure and use it to prove several basic properties of free strict categories on polygraphs (Section 2.1). Next, we introduce a description of the cells of free categories which is better suited for solving the word problem than the canonical forms of Makkai (Section 2.2), and, after introducing some computability formalism on higher categories, we show that this description is amenable to computations (Section 2.3). We then deduce a procedure to solve the word problem on finite polygraphs and show how it can be used to solve the word problem on general polygraphs (Section 2.4), and we moreover provide an implementation of it in OCAML (Section 2.4.4). Our procedure strongly resembles the one given by Makkai but with a stronger emphasis put on efficiency, so that the resulting algorithm can be used to solve non-trivial instances of the word problem. Finally, we answer the question raised by Makkai and show that there is no such thing as a measure on polygraphs of strict categories which does not double counts generators (Section 2.5).

2.1 Measures on polygraphs

Given $n \in \mathbb{N}$, considering the number of axioms of strict n -categories, it is actually not trivial to decide simple properties of the free n -category generated on some polygraph P . For example, given two different n -generators α and β of P , it is not immediate that they induce different cells in the n -category P^* . Indeed, it could be the case that a sequence of instances of the axioms of ω -categories leads to an identification of α and β . Another example is that it is not immediate

that generators of P induce undecomposable cells in P^* . Even though it is “well-known” that these two properties hold in free n -categories, the precise argument can be hard to write down. In order to solve quickly this kind of questions, Makkai [Mak05] introduced a function $P^* \rightarrow \mathbb{Z}P$ that assesses the complexity of the cells of P^* ; more precisely, this function gives some account on how many times the generators of P are used to define a specific cell of P^* , so that we call this function a “measure”. It admits a simple inductive definition (*c.f.* Proposition 2.1.2.9) but the proof of its correctness given by Makkai is quite involved. Later, Henry [Hen18] introduced another measure on polygraphs which has a more natural definition, and from which Makkai’s measure can be derived. The latter still display better properties, notably positivity, which make it more convenient to work with in general than Henry’s measure.

In this section, we recall the definition of Makkai’s measure, by deriving it from Henry’s measure, and use it to show several elementary properties of free categories. For this purpose, we follow [Hen18] and introduce the notions of n -globular groups and of n -groups, together with the equivalence between the two (Section 2.1.1). Henry’s measure is then defined as the universal morphism of the free n -globular group on a polygraph, and one derives Makkai’s measure by a change of base (Section 2.1.2). Finally, following [Mak05], we use Makkai’s measure to prove several elementary properties of free n -categories (Section 2.1.3) that will need in the following sections.

2.1.1 n -globular groups and n -groups

Here, we define n -globular groups and n -groups and prove an equivalence between the two. Moreover, we show that there is a free n -globular group on an n -category. These notions will be used to define Henry’s measure as the universal morphism of the free n -group on the strict n -category generated by a polygraph. All the content here can be found in [Hen18].

2.1.1.1 – Definitions. Let $n \in \mathbb{N} \cup \{\omega\}$. An n -globular group is the data of an abelian group G together with group morphisms

$$\bar{\partial}_i^-, \bar{\partial}_i^+ : G \rightarrow G$$

for $i \in \mathbb{N}_{n-1}$ satisfying, for $k, l \in \mathbb{N}_{n-1}$ and $\delta, \epsilon \in \{-, +\}$,

$$\bar{\partial}_k^\delta \circ \bar{\partial}_l^\epsilon = \begin{cases} \bar{\partial}_k^\delta & \text{if } k < l, \\ \bar{\partial}_l^\epsilon & \text{if } k \geq l, \end{cases}$$

and, when $n = \omega$, the following condition is moreover satisfied:

$$\text{for every } u \in G, \text{ there exists } i \in \mathbb{N} \text{ such that } \bar{\partial}_i^-(u) = u. \quad (2.3)$$

Given n -globular groups G and G' , an n -globular groups morphism between G and G' is a group morphism $f : G \rightarrow G'$ such that $\bar{\partial}_i^\epsilon \circ f = f \circ \bar{\partial}_i^\epsilon$ for $i \in \mathbb{N}_{n-1}$ and $\epsilon \in \{-, +\}$. We write \mathbf{gGrp}_n for the category of n -globular groups.

An n -group is an n -category object in the category of abelian groups \mathbf{Ab} , *i.e.*, it is the data of a sequence of abelian groups $(C_k)_{k \in \mathbb{N}_n}$ together with

- group morphisms $\partial_i^-, \partial_i^+ : C_{i+1} \rightarrow C_i$ for $i \in \mathbb{N}_{n-1}$,
- group morphisms $\text{id}^{k+1} : C_k \rightarrow C_{k+1}$ for $k \in \mathbb{N}_{n-1}$,
- group morphisms $*_{i,k} : C_k \times_i C_k \rightarrow C_k$ for $i, k \in \mathbb{N}_n$ with $i < k$,

satisfying the axioms of strict n -categories (c.f. Paragraph 1.4.1.1). Given two n -groups $(C_k)_{k \in \mathbb{N}_n}$ and $(D_k)_{k \in \mathbb{N}_n}$, an n -group morphism from $(C_k)_k$ to $(D_k)_k$ is an n -functor $F: (C_k)_k \rightarrow (D_k)_k$ such that F_k is a group morphism for $k \in \mathbb{N}_n$. We write \mathbf{Grp}_n for the category of n -groups. The n -groups have the property that composition operations can be derived from the rest:

Proposition 2.1.1.2. *Given an n -group $(C_k)_{k \in \mathbb{N}_n}$, $i, j \in \mathbb{N}_n$ with $i < j$ and i -composable $u, v \in C_j$, we have $u *_i v = u + v - \text{id}^j(\partial_i^+(u))$.*

Proof. Indeed, in the abelian group $C_j \times_i C_j$, we have

$$\begin{aligned} (u, v) &= (u, \text{id}^j(\partial_i^+(u))) + (\text{id}^j(\partial_i^-(v)), v) - (\text{id}^j(\partial_i^-(v)), \text{id}^j(\partial_i^+(u))) \\ &= (u, \text{id}^j(\partial_i^+(u))) + (\text{id}^j(\partial_i^-(v)), v) - (\text{id}^j(\partial_i^+(v)), \text{id}^j(\partial_i^+(u))) \end{aligned}$$

so that $u *_i v = u + v - \text{id}_u^j$. □

2.1.1.3 – Equivalence. Let $n \in \mathbb{N} \cup \{\omega\}$. Given an n -group $(C_k)_{k \in \mathbb{N}_n}$, we define an n -globular group G such that $G = C_n$ and $\bar{\partial}_i^\epsilon = \text{id}_i^n \circ \partial_i^\epsilon$ for $i \in \mathbb{N}_{n-1}$ and $\epsilon \in \{-, +\}$ by taking the convention that, when $n = \omega$, the abelian group C_ω is defined as a colimit cocone $(\text{id}_k^\omega: C_k \rightarrow C_\omega)_{k \in \mathbb{N}}$ on the diagram

$$C_0 \xrightarrow{\text{id}_0^1} C_1 \xrightarrow{\text{id}_1^2} \dots \xrightarrow{\text{id}_{k-1}^k} C_k \xrightarrow{\text{id}_k^{k+1}} C_{k+1} \xrightarrow{\text{id}_{k+1}^{k+2}} \dots$$

and that the function $\partial_i^\epsilon: C_\omega \rightarrow C_i$ for $i \in \mathbb{N}$ and $\epsilon \in \{-, +\}$ are defined as the unique functions such that $\partial_i^\epsilon \circ \text{id}_j^\omega = \partial_i^\epsilon$ for $j \in \mathbb{N}$ with $i \leq j$. Indeed, given $k, l \in \mathbb{N}_{n-1}$ and $\delta, \epsilon \in \{-, +\}$, if $k < l$, then

$$\begin{aligned} \bar{\partial}_k^\delta \circ \bar{\partial}_l^\epsilon &= \text{id}_k^n \circ \partial_k^\delta \circ \text{id}_l^n \circ \partial_l^\epsilon \\ &= \text{id}_k^n \circ \partial_k^\delta \circ \partial_l^\epsilon \\ &= \text{id}_k^n \circ \partial_k^\delta \\ &= \bar{\partial}_k^\delta \end{aligned}$$

and, if otherwise $k \geq l$, then

$$\begin{aligned} \bar{\partial}_k^\delta \circ \bar{\partial}_l^\epsilon &= \text{id}_k^n \circ \partial_k^\delta \circ \text{id}_l^n \circ \partial_l^\epsilon \\ &= \text{id}_k^n \circ \text{id}_l^k \circ \partial_l^\epsilon \\ &= \text{id}_l^n \circ \partial_l^\epsilon \\ &= \bar{\partial}_l^\epsilon \end{aligned}$$

so that G is an n -globular group. The construction $(C_k)_k \mapsto G$ extends to a functor

$$\mathcal{H}: \mathbf{Grp}_n \rightarrow \mathbf{gGrp}_n.$$

Conversely, given an n -globular group G , we define an n -group $(C_k)_{k \in \mathbb{N}_n}$ as follows. For $k \in \mathbb{N}_n$, we define the abelian groups C_k as the subgroups of G such that

$$C_k \hookrightarrow G \begin{array}{c} \xrightarrow{\bar{\partial}_k^-} \\ \xrightarrow{1_G} \end{array} G \quad (2.4)$$

is an equalizer, taking the convention that $\bar{\partial}_n^- = 1_G$. When $k \leq n - 2$, for $u \in C_k$, we have

$$\bar{\partial}_{k+1}^-(u) = \bar{\partial}_{k+1}^- \circ \bar{\partial}_k^-(u) = \bar{\partial}_k^-(u) = u$$

so that, by the universal property of the equalizer, there is a morphism $\text{id}_k^{k+1} : C_k \rightarrow C_{k+1}$, and we write $\text{id}_{n-1}^n : C_{n-1} \rightarrow C_n$ for the embedding of C_{n-1} in $G = C_n$. Moreover, for all $\epsilon \in \{-, +\}$ and $k \in \mathbb{N}_{n-1}$, we define $\partial_k^\epsilon : C_{k+1} \rightarrow C_k$ as the unique factorization map in the diagram

$$\begin{array}{ccccc} C_{k+1} & \hookrightarrow & G & \xrightarrow[\cong]{\partial_{k+1}^-} & G \\ \partial_k^\epsilon \downarrow \dots \downarrow & & \partial_k^\epsilon \downarrow & & \downarrow \partial_k^\epsilon \\ C_k & \hookrightarrow & G & \xrightarrow[\cong]{\partial_k^-} & G \end{array} .$$

Finally, for $i, k \in \mathbb{N}_n$ with $i < k$, we define a composition operation $*_{i,k} : C_k \times_i C_k \rightarrow C_k$ by putting

$$u *_{i,k} v = u + v - \text{id}_{\partial_i^+(u)}^k$$

for $(u, v) \in C_k \times_i C_k$, which makes $*_{i,k}$ a group morphism. We verify that:

Proposition 2.1.1.4. *The operations id_i^{i+1} , ∂_i^- , ∂_i^+ for $i \in \mathbb{N}_{n-1}$, and $*_{i,k}$ for $i, k \in \mathbb{N}_n$ with $i < k$, equip $(C_k)_{k \in \mathbb{N}_n}$ with a structure of an n -group.*

Proof. For $i \in \mathbb{N}_{n-2}$ and $\epsilon \in \{-, +\}$, we have $\partial_i^\epsilon \circ \partial_{i+1}^- = \partial_i^\epsilon \circ \partial_{i+1}^+$ from the fact that

$$\bar{\partial}_i^\epsilon \circ \bar{\partial}_{i+1}^- = \bar{\partial}_i^\epsilon = \bar{\partial}_i^\epsilon \circ \bar{\partial}_{i+1}^+$$

so the operations ∂_i^- , ∂_i^+ for $i \in \mathbb{N}_{n-1}$ equip $(C_i)_{i \in \mathbb{N}_n}$ with a structure of globular set in **Ab**. We now show that the axioms of n -category are satisfied with the other operations.

Proof of Axiom (S-i): Let $k \in \mathbb{N}_{n-1}$, $\epsilon \in \{-, +\}$ and $u \in C_k$. We have

$$\begin{aligned} \partial_k^\epsilon(\text{id}_u^{k+1}) &= \bar{\partial}_k^\epsilon(u) && \text{(by definition of } \text{id}_k^{k+1} \text{ and } \partial_k^\epsilon) \\ &= u && \text{(by the equalizer definition of } C_k). \end{aligned}$$

Thus, Axiom (S-i) holds.

Proof of Axiom (S-ii): Let $i, k \in \mathbb{N}_n$ with $i < k$, $(u, v) \in C_k \times_i C_k$ and $\epsilon \in \{-, +\}$. Then,

$$\begin{aligned} \partial_{k-1}^\epsilon(u *_{i,k} v) &= \partial_{k-1}^\epsilon(u + v - \text{id}_{\partial_i^+(u)}^k) \\ &= \partial_{k-1}^\epsilon(u) + \partial_{k-1}^\epsilon(v) - \partial_{k-1}^\epsilon(\text{id}_{\partial_i^+(u)}^k) \end{aligned}$$

so that, if $i < k - 1$, then

$$\begin{aligned} \partial_{k-1}^\epsilon(u *_{i,k} v) &= \partial_{k-1}^\epsilon(u) + \partial_{k-1}^\epsilon(v) - \text{id}_{\partial_i^+(u)}^{k-1} && \text{(by Axiom (S-i))} \\ &= \partial_{k-1}^\epsilon(u) *_{i,k-1} (\partial_{k-1}^\epsilon(v)) \end{aligned}$$

and otherwise if $i = k - 1$, then

$$\partial_{k-1}^\epsilon(u *_{i,k} v) = \begin{cases} \partial_{k-1}^-(u) + \partial_{k-1}^-(v) - \partial_{k-1}^-(u) = \partial_{k-1}^-(v) & \text{if } \epsilon = - , \\ \partial_{k-1}^+(u) + \partial_{k-1}^+(v) - \partial_{k-1}^+(u) = \partial_{k-1}^+(v) & \text{if } \epsilon = + . \end{cases}$$

Thus, Axiom (S-ii) holds.

Proof of Axiom (S-iii): Let $i, k \in \mathbb{N}_n$ with $i < k$ and $u \in C_k$. We have

$$\begin{aligned} \text{id}_{\partial_i^-(u)}^k *_{i,k} u &= \text{id}_{\partial_i^-(u)}^k + u - \text{id}_{\partial_i^-(u)}^k && \text{(by Axiom (S-i))} \\ &= u \end{aligned}$$

and, similarly, $u *_i \text{id}_{\partial_i^+(u)}^k = u$. Thus, Axiom (S-iii) holds.

Proof of Axiom (S-iv): Let $i, k \in \mathbb{N}_n$ with $i < k$ and i -composable $u_1, u_2, u_3 \in C_k$. Then,

$$\begin{aligned} (u_1 *_i u_2) *_i u_3 &= (u_1 *_i u_2) + u_3 - \text{id}_i^k(\partial_i^+(u_1 *_i u_2)) \\ &= (u_1 *_i u_2) + u_3 - \text{id}_i^k(\partial_i^+(u_2)) && \text{(by Axiom (S-ii))} \\ &= u_1 + u_2 + u_3 - \text{id}_i^k(\partial_i^+(u_1)) - \text{id}_i^k(\partial_i^+(u_2)) && \text{(by Axiom (S-ii))} \end{aligned}$$

and, similarly,

$$u_1 *_i (u_2 *_i u_3) = u_1 + u_2 + u_3 - \text{id}_i^k(\partial_i^+(u_1)) - \text{id}_i^k(\partial_i^+(u_2))$$

so that $(u_1 *_i u_2) *_i u_3 = u_1 *_i (u_2 *_i u_3)$. Thus, Axiom (S-iv) holds.

Proof of Axiom (S-v): Let $i, j, k \in \mathbb{N}_n$ with $i < j < k$ and $(u_1, u_2) \in C_j \times_i C_j$. Then,

$$\begin{aligned} \text{id}_{u_1}^k *_i \text{id}_{u_2}^k &= \text{id}_{u_1}^k + \text{id}_{u_2}^k - \text{id}_{\partial_i^+(\text{id}_j^k(u_1))}^k \\ &= \text{id}_{u_1}^k + \text{id}_{u_2}^k - \text{id}_{\partial_i^+(u_1)}^k && \text{(by Axiom (S-i))} \\ &= u_1 + u_2 - \text{id}_{\partial_i^+(u_1)}^j && \text{(since } \text{id}_j^k \text{ is the embedding } C_j \subseteq C_k) \\ &= u_1 *_i u_2 \\ &= \text{id}_{u_1 *_i u_2}^k && \text{(since } \text{id}_j^k \text{ is the embedding } C_j \subseteq C_k). \end{aligned}$$

Thus, Axiom (S-v) holds.

Proof of Axiom (S-vi): Let $i, j, k \in \mathbb{N}_n$ with $i < j < k$, and $u_1, v_1, u_2, v_2 \in C_k$ such that u_l, v_l are j -composable for $l \in \{1, 2\}$ and u_1, u_2 are i -composable. We have

$$\begin{aligned} (u_1 *_j v_1) *_i (u_2 *_j v_2) &= (u_1 *_j v_1) + (u_2 *_j v_2) - \text{id}_i^k(\partial_i^+(u_1)) && \text{(by Axiom (S-ii))} \\ &= u_1 + v_1 - \text{id}_j^k(\partial_j^+(u_1)) + u_2 + v_2 - \text{id}_j^k(\partial_j^+(u_2)) - \text{id}_i^k(\partial_i^+(u_1)) \\ &= u_1 + u_2 - \text{id}_i^k(\partial_i^+(u_1)) + v_1 + v_2 - \text{id}_i^k(\partial_i^+(v_1)) \\ &\quad - \text{id}_j^k(\partial_j^+(u_1)) - \text{id}_j^k(\partial_j^+(u_2)) + \text{id}_i^k(\partial_i^+(u_1)) \\ &= u_1 *_i u_2 + v_1 *_i v_2 - \text{id}_j^k(\partial_j^+(u_1)) *_i \text{id}_j^k(\partial_j^+(u_2)) \\ &= (u_1 *_i u_2) + (v_1 *_i v_2) - \text{id}_j^k(\partial_j^+(u_1 *_i u_2)) && \text{(by Axiom (S-v))} \\ &= (u_1 *_i u_2) *_j (v_1 *_i v_2). \end{aligned}$$

Thus, Axiom (S-vi) is satisfied. Hence, $(C_k)_{k \in \mathbb{N}}$ is equipped with a structure of an n -category. \square

The construction $G \mapsto (C_k)_{k \in \mathbb{N}_n}$ extends to a functor

$$\mathcal{K}: \mathbf{gGrp}_n \rightarrow \mathbf{Grp}_n$$

The two constructions witness that n -globular groups are equivalent to n -groups:

Proposition 2.1.1.5. *The functors \mathcal{H} and \mathcal{K} exhibit an equivalence of categories between n -groups and n -globular groups.*

Proof. Let $C = (C_k)_{k \in \mathbb{N}_n}$ be an n -group and $G = \mathcal{H}C$. Given $k \in \mathbb{N}_n$, since $G = C_n$, C_k can be recovered up to isomorphism as the equalizer

$$C_k \xrightarrow{\text{id}_k^n} G \xrightarrow[\text{1}_G]{\bar{\partial}_k^-} G$$

and, when $k < n$, since

$$\bar{\partial}_{k+1}^- \circ \text{id}_k^n = \bar{\partial}_{k+1}^- \circ \bar{\partial}_k^- \circ \text{id}_k^n = \bar{\partial}_k^- \circ \text{id}_k^n = \text{id}_k^n$$

the morphism $\text{id}_k^{k+1}: C_k \rightarrow C_{k+1}$ is the unique morphism such that $\text{id}_{k+1}^n \circ \text{id}_k^{k+1} = \text{id}_k^n$. Now, given $i \in \mathbb{N}_{n-1}$ and $\epsilon \in \{-, +\}$, $\partial_i^\epsilon: C_{i+1} \rightarrow C_i$ is the unique morphism which makes the left square of

$$\begin{array}{ccccc} C_{i+1} & \xrightarrow{\text{id}_{i+1}^n} & G & \xrightarrow[\text{1}_G]{\bar{\partial}_{i+1}^-} & G \\ \partial_i^\epsilon \downarrow \vdots & & \partial_i^\epsilon \downarrow & & \downarrow \bar{\partial}_i^\epsilon \\ C_i & \xrightarrow{\text{id}_i^n} & G & \xrightarrow[\text{1}_G]{\bar{\partial}_i^-} & G \end{array}$$

commute. Finally, by Proposition 2.1.1.2, the composition operations $*_{i,k}$ for $i, k \in \mathbb{N}_n$ with $i < k$ can be recovered from ∂_i^ϵ and id_i^k . Thus, we have an isomorphism $C \simeq \mathcal{K}HC$ which is natural in C .

Conversely, given an n -globular group G and $C = \mathcal{K}G$, we have $G = C_n$ (when $n = \omega$, we have that $G \simeq C_\omega$ by the condition (2.3)). Moreover, for $i \in \mathbb{N}_{n-1}$ and $\epsilon \in \{-, +\}$, we have $\bar{\partial}_i^\epsilon = \text{id}_i^n \circ \partial_i^\epsilon$. Thus, we have an isomorphism $G \simeq \mathcal{H}KG$ which is natural in G . \square

2.1.1.6 – Free n -groups. Given a set S , we write $\mathbb{Z}^{(S)}$ for the free abelian group on S . Let C be an n -category C . We write $|C|$ for the set

$$|C| = \bigsqcup_{i \in \mathbb{N}_n} C_i.$$

We define the *linearization of C* as the abelian group $\mathbb{Z}C$ which is the quotient of $\mathbb{Z}^{(|C|)}$ by the subgroup generated by

- (i) $u - \text{id}_k^{k+1}(u)$ for $k \in \mathbb{N}_{n-1}$ and $u \in C_k$,
- (ii) $u *_i v - u - v + \text{id}^k(\partial_i^+(u))$ for $i, k \in \mathbb{N}_n$ with $i < k$ and i -composable $u, v \in C_k$.

Moreover, we write

$$\llbracket - \rrbracket: \mathbb{Z}^{(|C|)} \rightarrow \mathbb{Z}C$$

for the canonical projection.

Proposition 2.1.1.7. *There exist group morphisms $\bar{\partial}_i^\epsilon: \mathbb{Z}C \rightarrow \mathbb{Z}C$ for $i \in \mathbb{N}_{n-1}$ and $\epsilon \in \{-, +\}$ that are unique such that, for all $k \in \mathbb{N}_n$ and $u \in C_k$,*

$$\bar{\partial}_i^\epsilon(\llbracket u \rrbracket) = \begin{cases} \llbracket \partial_i^\epsilon(u) \rrbracket & \text{if } i < k, \\ \llbracket u \rrbracket & \text{if } i \geq k, \end{cases}$$

and these morphisms equip $\mathbb{Z}C$ with a structure of n -globular group.

Proof. For $i \in \mathbb{N}_{n-1}$ and $\epsilon \in \{-, +\}$, by the universal property of the free abelian group, there is a unique group morphism $\tilde{\partial}_i^\epsilon$ between $\mathbb{Z}|C|$ and $\mathbb{Z}C$ which satisfies that, for all $k \in \mathbb{N}_n$ and $u \in C_k$,

$$\tilde{\partial}_i^\epsilon(u) = \begin{cases} \llbracket \partial_i^\epsilon(u) \rrbracket & \text{if } i < k, \\ \llbracket u \rrbracket & \text{if } i \geq k. \end{cases}$$

We show that $\tilde{\partial}_i^\epsilon$ can be factored through $\mathbb{Z}C$ by verifying the quotient equations. Given $k \in \mathbb{N}_{n-1}$ and $u \in C_k$, we have

$$\begin{aligned} \tilde{\partial}_i^\epsilon(u - \text{id}_u^{k+1}) &= \tilde{\partial}_i^\epsilon(u) - \tilde{\partial}_i^\epsilon(\text{id}_u^{k+1}) \\ &= \begin{cases} \llbracket \partial_i^\epsilon(u) \rrbracket - \llbracket \partial_i^\epsilon(\text{id}_u^{k+1}) \rrbracket = \llbracket \partial_i^\epsilon(u) \rrbracket - \llbracket \partial_i^\epsilon(u) \rrbracket & \text{if } i \leq k, \\ \llbracket u \rrbracket - \llbracket \text{id}_u^{k+1} \rrbracket & \text{if } i > k, \end{cases} \\ &= 0 \end{aligned}$$

and, given $j, k \in \mathbb{N}_n$ with $j < k$ and j -composable $u, v \in C_k$, we have

$$\tilde{\partial}_i^\epsilon(u *_j v - u - v + \text{id}_j^k(\partial_j^+(u))) = \tilde{\partial}_i^\epsilon(u *_j v) - \tilde{\partial}_i^\epsilon(u) - \tilde{\partial}_i^\epsilon(v) + \tilde{\partial}_i^\epsilon(\text{id}_j^k(\partial_j^+(u))).$$

If $i < j$, then

$$\tilde{\partial}_i^\epsilon(u *_j v - u - v + \text{id}_j^k(\partial_j^+(u))) = \llbracket \partial_i^\epsilon(u) \rrbracket - \llbracket \partial_i^\epsilon(u) \rrbracket - \llbracket \partial_i^\epsilon(u) \rrbracket + \llbracket \partial_i^-(u) \rrbracket = 0$$

else, if $i = j$ and $\epsilon = -$, then, since $\partial_i^+(u) = \partial_i^-(v)$,

$$\tilde{\partial}_i^\epsilon(u *_j v - u - v + \text{id}_j^k(\partial_j^+(u))) = \llbracket \partial_i^-(u) \rrbracket - \llbracket \partial_i^-(u) \rrbracket - \llbracket \partial_i^-(v) \rrbracket + \llbracket \partial_i^+(u) \rrbracket = 0$$

and similarly when $\epsilon = +$. Else, if $j < i < k$, then

$$\tilde{\partial}_i^\epsilon(u *_j v - u - v + \text{id}_j^k(\partial_j^+(u))) = \llbracket \partial_i^\epsilon(u) *_j \partial_i^\epsilon(u) \rrbracket - \llbracket \partial_i^\epsilon(u) \rrbracket - \llbracket \partial_i^\epsilon(v) \rrbracket + \llbracket \text{id}_j^k(\partial_j^+(u)) \rrbracket = 0$$

and otherwise, if $k < i$, then

$$\tilde{\partial}_i^\epsilon(u *_j v - u - v + \text{id}_j^k(\partial_j^+(u))) = \llbracket u *_j v \rrbracket - \llbracket u \rrbracket - \llbracket v \rrbracket + \llbracket \text{id}_j^k(\partial_j^+(u)) \rrbracket = 0$$

so $\tilde{\partial}_i^\epsilon$ factors through $\mathbb{Z}C$, which gives $\bar{\partial}_i^\epsilon: \mathbb{Z}C \rightarrow \mathbb{Z}C$. Moreover, for $\delta, \epsilon \in \{-, +\}$ and $i, j \in \mathbb{N}_n$, given $k \in \mathbb{N}_n$ and $u \in C_k$, if $i < j$, then

$$\bar{\partial}_i^\delta \circ \bar{\partial}_j^\epsilon(\llbracket u \rrbracket) = \begin{cases} \bar{\partial}_i^\delta(\llbracket u \rrbracket) & \text{if } i < k, \\ \llbracket u \rrbracket = \bar{\partial}_i^\delta(\llbracket u \rrbracket) & \text{if } i \geq k, \end{cases}$$

and else, if $i \geq j$, then

$$\bar{\partial}_i^\delta \circ \bar{\partial}_j^\epsilon(\llbracket u \rrbracket) = \begin{cases} \bar{\partial}_j^\epsilon(\llbracket u \rrbracket) & \text{if } j < k, \\ \llbracket u \rrbracket = \bar{\partial}_j^\epsilon(\llbracket u \rrbracket) & \text{if } k \leq j, \end{cases}$$

so that, since $\llbracket u \rrbracket$ generates $\mathbb{Z}C$ for $u \in |C|$,

$$\bar{\partial}_i^\delta \circ \bar{\partial}_j^\epsilon = \begin{cases} \bar{\partial}_i^\delta & \text{if } i < j, \\ \bar{\partial}_j^\epsilon & \text{if } i \geq j. \end{cases}$$

Moreover, when $n = \omega$, we easily see from the definition of $\mathbb{Z}C$ and the functions $\bar{\partial}_i^-, \bar{\partial}_i^+$ that the condition (2.3) is satisfied. Thus, the morphisms $(\bar{\partial}_i^-)_{i \in \mathbb{N}_{n-1}}$ and $(\bar{\partial}_i^+)_{i \in \mathbb{N}_{n-1}}$ equip $\mathbb{Z}C$ with a structure of n -globular group. \square

Using the equivalence of Proposition 2.1.1.5, we write $((\mathbb{Z}C)_k)_{k \in \mathbb{N}_n}$ for the n -group associated to the n -globular group $\mathbb{Z}C$. Given $k \in \mathbb{N}_n$, let $\mathbb{Z}(C_k)$ be the quotient of the free abelian group $\mathbb{Z}^{(C_k)}$ by the subgroup generated by the terms $u *_i v - u - v + \text{id}_i^k(\partial_i^+(u))$ for $i \in \mathbb{N}_{k-1}$ and i -composable $u, v \in C_k$ and let

$$\llbracket - \rrbracket_k : \mathbb{Z}^{(C_k)} \rightarrow \mathbb{Z}(C_k)$$

be the associated projection morphism. The restriction of $\llbracket - \rrbracket : \mathbb{Z}^{(|C|)} \rightarrow \mathbb{Z}C$ to $\mathbb{Z}^{(C_k)}$ induces a morphism

$$\phi_k : \mathbb{Z}(C_k) \rightarrow \mathbb{Z}C$$

which satisfies $\bar{\partial}_k^- \circ \phi_k = \phi_k$ since, for all $u \in C_k$,

$$\bar{\partial}_k^- \circ \phi_k(\llbracket u \rrbracket_k) = \bar{\partial}_k^-(\llbracket u \rrbracket) = \llbracket u \rrbracket = \phi_k(\llbracket u \rrbracket_k).$$

Thus, by the equalizer definition of $(\mathbb{Z}C)_k$ (c.f. (2.4)), this induces a morphism $\psi_k : \mathbb{Z}(C_k) \rightarrow (\mathbb{Z}C)_k$.

Proposition 2.1.1.8. *For all $k \in \mathbb{N}_n$, ψ_k is an isomorphism.*

Proof. We build a retraction $\bar{\phi}_k : \mathbb{Z}C \rightarrow \mathbb{Z}(C_k)$ to ϕ_k as follows. We first define

$$\tilde{\phi}_k : \mathbb{Z}^{(|C|)} \rightarrow \mathbb{Z}(C_k)$$

as the unique morphism such that, for $l \in \mathbb{N}_n$ and $u \in C_l$,

$$\tilde{\phi}_k(u) = \begin{cases} \llbracket \text{id}_l^k(u) \rrbracket_k & \text{if } l < k, \\ \llbracket u \rrbracket_k & \text{if } l = k, \\ \llbracket \partial_k^-(u) \rrbracket_k & \text{if } l > k. \end{cases}$$

We compute that, for $l \in \mathbb{N}_{n-1}$ and $u \in C_l$,

$$\begin{aligned} \tilde{\phi}_k(u - \text{id}_u^{l+1}) &= \begin{cases} \text{id}_u^k - \text{id}_u^k & \text{if } l < k, \\ u - u & \text{if } l = k, \\ \partial_k^-(u) - \partial_k^-(u) & \text{if } l > k, \end{cases} \\ &= 0 \end{aligned}$$

and, for $i, l \in \mathbb{N}_n$ with $i < l$ and i -composable $u, v \in C_l$, if $l < k$, then

$$\tilde{\phi}_k(u *_i v - u - v + \text{id}_i^l(\partial_i^+(u))) = \llbracket \text{id}_u^k *_i \text{id}_v^k \rrbracket_k - \llbracket \text{id}_u^k \rrbracket_k - \llbracket \text{id}_v^k \rrbracket_k + \llbracket \text{id}_{\partial_i^+(\text{id}_u^k)}^k \rrbracket_k = 0$$

else if $i < k \leq l$, then

$$\tilde{\phi}_k(u *_i v - u - v + \text{id}_i^l(\partial_i^+(u))) = \llbracket \partial_k^-(u) *_i \partial_k^-(v) \rrbracket - \llbracket \partial_k^-(u) \rrbracket - \llbracket \partial_k^-(v) \rrbracket + \llbracket \text{id}_i^k(\partial_i^+(u)) \rrbracket = 0$$

and otherwise, if $k \leq i$, then

$$\tilde{\phi}_k(u *_i v - u - v + \text{id}_i^l(\partial_i^+(u))) = \llbracket \partial_k^-(u) \rrbracket - \llbracket \partial_k^-(u) \rrbracket - \llbracket \partial_k^-(v) \rrbracket + \llbracket \partial_k^-(v) \rrbracket = 0.$$

Thus, $\tilde{\phi}_k$ induces a morphism $\bar{\phi}_k : \mathbb{Z}C \rightarrow \mathbb{Z}(C_k)$ and, for $u \in C_k$, we have

$$\bar{\phi}_k \circ \phi_k(\llbracket u \rrbracket_k) = \bar{\phi}_k(\llbracket u \rrbracket) = \llbracket u \rrbracket_k$$

so that $\bar{\phi}_k \circ \phi_k = 1_{\mathbb{Z}(C_k)}$. Moreover, for $l \in \mathbb{N}_{n-1}$ and $u \in |C|$, we compute that

$$\phi_k \circ \bar{\phi}_k \circ \bar{\partial}_k^-(\llbracket u \rrbracket) = \begin{cases} \llbracket \partial_k^-(u) \rrbracket = \bar{\partial}_k^-(\llbracket u \rrbracket) & \text{if } k < l, \\ \llbracket \text{id}_l^k(u) \rrbracket = \llbracket u \rrbracket = \bar{\partial}_k^-(\llbracket u \rrbracket) & \text{if } k \geq l, \end{cases}$$

so that $\phi_k \circ \bar{\phi}_k \circ \bar{\partial}_k^- = \bar{\partial}_k^-$. We then define $\bar{\psi}_k$ as the composite

$$(\mathbb{Z}C)_k \xleftarrow{\iota_k} \mathbb{Z}C \xrightarrow{\bar{\phi}_k} \mathbb{Z}(C_k)$$

where $\iota_k : (\mathbb{Z}C)_k \rightarrow \mathbb{Z}C$ is the embedding of the equalizer (2.4). We have

$$\begin{aligned} \bar{\psi}_k \circ \psi_k &= \bar{\phi}_k \circ \iota_k \circ \psi_k \\ &= \bar{\phi}_k \circ \phi_k \\ &= 1_{\mathbb{Z}(C_k)}. \end{aligned}$$

Conversely, we have

$$\begin{aligned} \iota_k \circ \psi_k \circ \bar{\psi}_k &= \phi_k \circ \bar{\phi}_k \circ \iota_k \\ &= \phi_k \circ \bar{\phi}_k \circ \bar{\partial}_k^- \circ \iota_k && \text{(by the definition of } \iota_k) \\ &= \bar{\partial}_k^- \circ \iota_k && \text{(since } \phi_k \circ \bar{\phi}_k \circ \bar{\partial}_k^- = \bar{\partial}_k^-) \\ &= \iota_k \end{aligned}$$

so that, since ι_k is a monomorphism, we have $\psi_k \circ \bar{\psi}_k = 1_{(\mathbb{Z}C)_k}$. Thus, $\psi_k : \mathbb{Z}(C_k) \rightarrow (\mathbb{Z}C)_k$ is an isomorphism. \square

The above property allows us to implicitly identify $(\mathbb{Z}C)_k$ and $\mathbb{Z}(C_k)$, and denote both by $\mathbb{Z}C_k$. We now write

$$(\delta_C)_k : C_k \rightarrow \mathbb{Z}C_k$$

for the function which maps $u \in C_k$ to $\llbracket u \rrbracket_k \in \mathbb{Z}C_k$. We have:

Proposition 2.1.1.9. *The functions $(\delta_C)_k$ for $k \in \mathbb{N}_n$ define a functor $\delta_C : C \rightarrow \mathbb{Z}C$ of n -categories, which exhibit $\mathbb{Z}C$ as the free n -group on C .*

Proof. We verify that δ_C is a functor. Given $k \in \mathbb{N}_{n-1}$, $\epsilon \in \{-, +\}$ and $u \in C_{k+1}$, we have

$$\delta_C(\bar{\partial}_k^\epsilon(u)) = \llbracket \bar{\partial}_k^\epsilon(u) \rrbracket = \bar{\partial}_k^\epsilon(\llbracket u \rrbracket) = \bar{\partial}_k^\epsilon(\delta_C(u))$$

so δ_C is a morphism of n -globular set. Moreover, given $k \in \mathbb{N}_{n-1}$ and $u \in C_k$, we have

$$\delta_C(\text{id}_k^{k+1}(u)) = \llbracket \text{id}_k^{k+1}(u) \rrbracket = \llbracket u \rrbracket = \text{id}_k^{k+1}(\llbracket u \rrbracket) = \text{id}_k^{k+1}(\delta_C(u))$$

and, given $i, k \in \mathbb{N}_n$ with $i < k$ and i -composable $u, v \in C_k$,

$$\delta_C(u *_i v) = \llbracket u *_i v \rrbracket = \llbracket u \rrbracket + \llbracket v \rrbracket - \llbracket \text{id}_i^k(\partial_i^+(u)) \rrbracket = \llbracket u \rrbracket *_i \llbracket v \rrbracket = \delta_C(u) *_i \delta_C(v).$$

Hence, δ_C defines an n -functor $\delta_C : C \rightarrow \mathbb{Z}C$.

Now let $F : C \rightarrow D$ be an n -functor where D is an n -category equipped with a structure of n -group. For all $k \in \mathbb{N}_{n-1}$ and $u \in C_k$, we have

$$F(\text{id}_u^{k+1}) = \text{id}_{F(u)}^{k+1}$$

and, for $i, k \in \mathbb{N}_n$ with $i < k$ and i -composable $u, v \in C_k$, we have

$$F(u *_i v) = F(u) *_i F(v) = F(u) + F(v) - \text{id}_i^k(\partial_i^+(F(u))).$$

Thus F factor through δ_C , which gives a morphism of n -group $F' : \mathbb{Z}C \rightarrow D$ satisfying $F' \circ \delta_C = F$ and such an F' is uniquely defined by $F' \circ \delta_C(g) = F(g)$ for $g \in C$. Thus, $\mathbb{Z}C$ is the free n -group on C . \square

2.1.2 Measures on polygraphs

In this section, we introduce Henry's and Makkai's measures on polygraphs. Henry's measure is defined as the specialization of the linearization function seen in Paragraph 2.1.1.6 on polygraphs, and Makkai's measure will be derived from Henry's with a change of basis.

2.1.2.1 – Henry's measure. Let $n \in \mathbb{N} \cup \{\omega\}$. Given an n -polygraph P , we write $|P|$ for

$$|P| = \bigsqcup_{k \in \mathbb{N}_n} P_k.$$

We have the following other characterization of the free n -group in the case of a free n -category on an n -polygraph:

Proposition 2.1.2.2. *Let P be an n -polygraph. There exist functions*

$$\bar{\partial}_i^\epsilon : \mathbb{Z}^{(|P|)} \rightarrow \mathbb{Z}^{(|P|)}$$

for $\epsilon \in \{-, +\}$ and $i \in \mathbb{N}_{n-1}$ that equip $\mathbb{Z}^{(|P|)}$ with a structure of n -globular group (or, equivalently, n -group) such that the embedding $|P| \hookrightarrow \mathbb{Z}^{(|P|)}$ induces an n -functor

$$\delta_P : P^* \rightarrow \mathbb{Z}^{(|P|)}$$

which exhibits $\mathbb{Z}^{(|P|)}$ as the free n -group on P^* .

Proof. We show this property by induction on n . When $n = 0$, the property holds since $\mathbb{Z}P^* = \mathbb{Z}^{(|P|)}$ for all 0-polygraph P . So suppose that the property holds for some $n \in \mathbb{N}$. We show that it holds for $n+1$. Let $P = (Q, P_{n+1})$ be an $(n+1)$ -polygraph. By induction hypothesis, there are morphisms

$$\bar{\partial}_i^\epsilon : \mathbb{Z}^{(|Q|)} \rightarrow \mathbb{Z}^{(|Q|)}$$

for $\epsilon \in \{-, +\}$ and $i \in \mathbb{N}_n$ that equip $\mathbb{Z}^{(|Q|)}$ with a structure of n -globular group, and such that the inclusion $Q \hookrightarrow \mathbb{Z}^{(|Q|)}$ induces an n -functor $\delta_Q : Q^* \rightarrow \mathbb{Z}^{(|Q|)}$ (where $\mathbb{Z}^{(|Q|)}$ is equipped with the structure of n -group coming from Proposition 2.1.1.5). For $\epsilon \in \{-, +\}$, let $\bar{\partial}_n^\epsilon : \mathbb{Z}^{(|Q|)} \rightarrow \mathbb{Z}^{(|Q|)}$ be the identity $1_{\mathbb{Z}^{(|Q|)}}$. For $i \in \mathbb{N}_n$ and $\epsilon \in \{-, +\}$, we extend the group morphisms $\bar{\partial}_i^\epsilon : \mathbb{Z}^{(|Q|)} \rightarrow \mathbb{Z}^{(|Q|)}$ to morphisms $\bar{\partial}_i^\epsilon : \mathbb{Z}^{(|P|)} \rightarrow \mathbb{Z}^{(|P|)}$ by putting

$$\bar{\partial}_i^\epsilon(g) = \delta_Q(\partial_i^\epsilon(g))$$

for $g \in P_{n+1}$. We check that, given $i, j \in \mathbb{N}_n$ and $\delta, \epsilon \in \{-, +\}$ and $g \in P_{n+1}$, if $i < j$, then

$$\begin{aligned} \bar{\partial}_i^\delta \circ \bar{\partial}_j^\epsilon(g) &= \bar{\partial}_i^\delta(\delta_Q(\partial_j^\epsilon(g))) \\ &= \delta_Q(\partial_i^\delta(\partial_j^\epsilon(g))) \\ &= \delta_Q(\partial_i^\delta(g)) \\ &= \bar{\partial}_i^\delta(g) \end{aligned}$$

and otherwise, if $i \geq j$, then

$$\begin{aligned} \bar{\partial}_i^\delta \circ \bar{\partial}_j^\epsilon(g) &= \bar{\partial}_i^\delta(\delta_Q(\partial_j^\epsilon(g))) \\ &= \delta_Q(\partial_j^\epsilon(g)) && \text{(since } \delta_Q(\partial_j^\epsilon(g)) \in (\mathbb{Z}^{(|P|)})_j \text{)} \\ &= \bar{\partial}_j^\epsilon(g). \end{aligned}$$

Thus, the functions $\bar{\partial}_i^\epsilon: \mathbb{Z}^{(|P|)} \rightarrow \mathbb{Z}^{(|P|)}$ for $i \in \mathbb{N}_n$ and $\epsilon \in \{-, +\}$ equip $\mathbb{Z}^{(|P|)}$ with a structure of $(n+1)$ -globular group, from which we derive a structure of $(n+1)$ -group using Proposition 2.1.1.5. Since, for $g \in P_{n+1}$ and $\epsilon \in \{-, +\}$, we have

$$\partial_n^\epsilon(\delta_Q(g)) = \bar{\partial}_n^\epsilon(\delta_Q(g)) = \delta_Q(\partial_n^\epsilon(g))$$

the n -functor $\delta_Q: Q^* \rightarrow \mathbb{Z}^{(|Q|)}$ can be extended to an $(n+1)$ -functor $\delta_P: P^* \rightarrow \mathbb{Z}^{(|P|)}$ such that $\delta_P(g) = g$ for every $g \in P$.

We now prove that $\mathbb{Z}^{(|P|)}$ is the free $(n+1)$ -group on P^* . Let $F: P^* \rightarrow C$ be an $(n+1)$ -functor where C is an n -category equipped with a structure of $(n+1)$ -group. By induction hypothesis, there exists a unique n -functor $G': \mathbb{Z}^{(|Q|)} \rightarrow C_{\leq n}$ such that $F_{\leq n} = G' \circ \delta_Q$. Seeing G' as a morphism of \mathbf{gGrp}_n , we extend G' to a group morphism $G: \mathbb{Z}^{(|P|)} \rightarrow C$ by putting $G(g) = F(g)$ for $g \in P_{n+1}$. For $\epsilon \in \{-, +\}$ and $g \in P_{n+1}$, we compute

$$\begin{aligned} G(\bar{\partial}_n^\epsilon(g)) &= G'(\delta_Q(\partial_n^\epsilon(g))) \\ &= F(\partial_n^\epsilon(g)) \\ &= \partial_n^\epsilon(F(g)) \\ &= \bar{\partial}_n^\epsilon(G(g)) \end{aligned}$$

so that $G \circ \bar{\partial}_n^\epsilon = \bar{\partial}_n^\epsilon \circ G$. Thus, G is an $(n+1)$ -globular group morphism, or equivalently, an $(n+1)$ -group morphism. Moreover, since

$$G \circ \delta_P(g) = G(g) = F(g)$$

for all $g \in P$, we have $G \circ \delta_P = F$ and G is uniquely determined by this condition. Hence, $\mathbb{Z}^{(|P|)}$ is the free $(n+1)$ -group on P^* .

Finally, if $n = \omega$, then, since $\mathbb{Z}^{(|P|)} \simeq \bigcup_{k \in \mathbb{N}} \mathbb{Z}^{(|P_{\leq k}|)}$, we derive a structure of ω -globular group on $\mathbb{Z}^{(|P|)}$ from the structures of k -globular groups of $\mathbb{Z}^{(|P_{\leq k}|)}$ for $k \in \mathbb{N}$, for which we have canonical isomorphisms

$$(\mathbb{Z}^{(|P|)})_{\leq k} \simeq \mathbb{Z}^{(|P_{\leq k}|)}$$

as k -groups. By Proposition 1.2.3.12, the k -functors $\delta_{P_{\leq k}}$ induce an ω -functor

$$\delta_P: P^* \rightarrow \mathbb{Z}^{(|P|)}.$$

Moreover, we can verify that, for $k \in \mathbb{N}$, the adjunctions $(-)\uparrow_{\omega, k}^{\text{Cat}} + (-)\downarrow_{\leq k, \omega}^{\text{Cat}}: \mathbf{Cat}_\omega \rightarrow \mathbf{Cat}_k$ restrict to adjunctions $\mathbf{Grp}_\omega \rightarrow \mathbf{Grp}_k$, so that, given $C \in \mathbf{Grp}_\omega$,

$$\begin{aligned} \mathbf{Cat}_\omega(P^*, C) &\simeq \lim_{k \in \mathbb{N}} \mathbf{Cat}_k(P_{\leq k}^*, C_{\leq k}) \\ &\simeq \lim_{k \in \mathbb{N}} \mathbf{Grp}_k(\mathbb{Z}^{(|P_{\leq k}|)}, C_{\leq k}) \\ &\simeq \lim_{k \in \mathbb{N}} \mathbf{Grp}_k((\mathbb{Z}^{(|P|)})_{\leq k}, C_{\leq k}) \\ &\simeq \mathbf{Grp}_\omega(\mathbb{Z}^{(|P|)}, C) \end{aligned}$$

which exhibits $\mathbb{Z}^{(|P|)}$ as the free ω -group on P^* , with δ_P as universal morphism. \square

Thus, given an n -polygraph P , by Proposition 2.1.2.2, $\mathbb{Z}P^*$ is the free abelian group on $|P|$, or equivalently, the free \mathbb{Z} -module on $|P|$, so that we prefer to write $\mathbb{Z}P$ for $\mathbb{Z}P^*$. We equip $\mathbb{Z}P$ with the basis $(\delta_P(g))_{g \in P}$ and, in fact, we simply write g for $\delta_P(g)$. Moreover, given a morphism $F: P \rightarrow Q$

in \mathbf{Pol}_n , we write $\mathbb{Z}F: \mathbb{Z}P \rightarrow \mathbb{Z}Q$ for the n -functor such that $\mathbb{Z}F(g) = F(g)$ for $g \in P$. Given $u \in \mathbb{Z}P$, we write $(u_g)_{g \in |P|} \in \mathbb{Z}^{|P|}$ for the family such that

$$u = \sum_{g \in |P|} u_g g.$$

Moreover, given $u, v \in \mathbb{Z}P$, we write $u \leq v$ when $u_g \leq v_g$ for every $g \in P$, and we say that u is *positive* when $0 \leq u$.

We call the function $\delta_P: |P^*| \rightarrow \mathbb{Z}P$ the *Henry's measure* on the polygraph P . By the definition of δ_P in Proposition 2.1.2.2 and Proposition 2.1.1.2, δ_P admits the following inductive definition:

- $\delta_P(g) = g$ for $g \in P$,
- $\delta_P(\text{id}_u^{k+1}) = \delta_P(u)$ for $k \in \mathbb{N}_{n-1}$ and $u \in P_k^*$,
- $\delta_P(u *_i v) = \delta_P(u) + \delta_P(v) - \delta_P(\partial_i^+(u))$ for $i, k \in \mathbb{N}_n$ with $i < k$ and i -composable $u, v \in P_k^*$.

Moreover, Henry's measure is natural in P :

Proposition 2.1.2.3. *Given a morphism $F: P \rightarrow Q$ in \mathbf{Pol}_n , we have*

$$\mathbb{Z}F \circ \delta_P = \delta_Q \circ |F^*|.$$

Proof. By functoriality, it is enough to check this equality for $g \in P$:

$$\mathbb{Z}F \circ \delta_P(g) = \mathbb{Z}F(g) = F(g) = \delta_Q(F(g)). \quad \square$$

However, Henry's measure is not positive in general, *i.e.*, we do not have $\delta_P(u) \geq 0$ for all $u \in P^*$.

Example 2.1.2.4. Consider the 2-polygraph P with

$$P_0 = \{x, y, z\}, \quad P_1 = \{f_1, f_2, f_3: x \rightarrow y, g: y \rightarrow z\}, \quad \text{and} \quad P_2 = \{\alpha_1: f_1 \Rightarrow f_2, \alpha_2: f_2 \Rightarrow f_3\}$$

as in

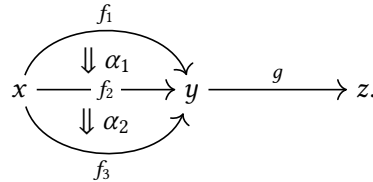

Given the 2-cell $u = (\alpha_1 *_1 \alpha_2) *_0 \text{id}_g^2$, we compute $\delta_P(u)$:

$$\begin{aligned} \delta_P(u) &= \delta_P(\alpha_1 *_1 \alpha_2) + \delta_P(\text{id}_g^2) - \delta_P(\partial_0^+(\alpha_1 *_1 \alpha_2)) \\ &= \delta_P(\alpha_1) + \delta_P(\alpha_2) - \delta_P(\partial_1^+(\alpha_1)) + \delta_P(g) - \delta_P(y) \\ &= \alpha_1 + \alpha_2 - f_2 + g - y. \end{aligned}$$

2.1.2.5 – Makkai's measure. As pointed out in [Hen18], one obtains the function defined by Makkai in [Mak05] from Henry's measure with a simple change of basis. Let $n \in \mathbb{N} \cup \{\omega\}$ and P be an n -polygraph. Given $k \in \mathbb{N}_n$ and $g \in P_k$, we define $m_g \in \mathbb{Z}P$ as

$$m_g = \begin{cases} g & \text{if } k = 0, \\ g - \delta_P(\partial_{k-1}^-(g)) - \delta_P(\partial_{k-1}^+(g)) & \text{if } k > 0. \end{cases}$$

We then write $\theta_P: \mathbb{Z}P \rightarrow \mathbb{Z}P$ for the group morphism which maps $g \in P$ to m_g .

Proposition 2.1.2.6. θ_P is an isomorphism which is natural in P .

Proof. The decomposition of the elements $(m_g)_{g \in P}$ in the basis $(g)_{g \in P}$ of the \mathbb{Z} -module $\mathbb{Z}P$ is triangular with respect to the filtration

$$\mathbb{Z}^{(|P_{\leq 0}|)} \subseteq \mathbb{Z}^{(|P_{\leq 1}|)} \subseteq \dots \subseteq \mathbb{Z}^{(|P_{\leq n}|)}$$

with 1's on the diagonal, so that $(m_g)_{g \in P}$ is a basis of $\mathbb{Z}P$. Thus, θ_P is an isomorphism. Moreover, given a morphism $F: P \rightarrow Q$ in \mathbf{Pol}_n , for $k \in \mathbb{N}_{n-1}$ and $g \in P_{k+1}$, we have

$$\begin{aligned} \mathbb{Z}F(\theta_P(g)) &= \mathbb{Z}F(g - \delta_P(\partial_k^-(g)) - \delta_P(\partial_k^+(g))) \\ &= \mathbb{Z}F(g) - \mathbb{Z}F(\delta_P(\partial_k^-(g))) - \mathbb{Z}F(\delta_P(\partial_k^+(g))) \\ &= F(g) - \delta_Q(F^*(\partial_k^-(g))) - \delta_Q(F^*(\partial_k^+(g))) && \text{(by Proposition 2.1.2.3)} \\ &= F(g) - \delta_Q(\partial_k^-(F(g))) - \delta_Q(\partial_k^+(F(g))) \\ &= \theta_Q(F(g)) = \theta_Q(\mathbb{Z}F(g)) \end{aligned}$$

so that $\mathbb{Z}F \circ \theta_P = \theta_Q \circ \mathbb{Z}F$. □

We define the *Makkai's measure* on the polygraph P as the function $\delta_P^M: |P^*| \rightarrow \mathbb{Z}P$ such that

$$\delta_P^M = \theta_P^{-1} \circ \delta_P.$$

Remark 2.1.2.7. By transporting the n -globular group structure of $\mathbb{Z}P$ through θ_P , we can equip the group $\mathbb{Z}P$ with another n -globular group structure that makes in fact δ_P^M an n -category functor

$$\delta_P^M: P^* \rightarrow \mathbb{Z}P.$$

Like Henry's measure, Makkai's measure is natural:

Proposition 2.1.2.8. Given a morphism $F: P \rightarrow Q$ in \mathbf{Pol}_n , we have

$$\mathbb{Z}F \circ \delta_P^M = \delta_Q^M \circ F^*.$$

Proof. This is a consequence of Proposition 2.1.2.3 and Proposition 2.1.2.6. □

Moreover, like δ_P , the function δ_P^M admits an inductive definition:

Proposition 2.1.2.9. The following hold:

- (i) $\delta_P^M(x) = x$ for all $x \in P_0$,
- (ii) $\delta_P^M(g) = g + \delta_P^M(\partial_k^-(g)) + \delta_P^M(\partial_k^+(g))$ for $k \in \mathbb{N}_{n-1}$ and $g \in P_{k+1}$,
- (iii) $\delta_P^M(\text{id}_u^{k+1}) = \delta_P^M(u)$ for $k \in \mathbb{N}_{n-1}$ and $u \in P_k^*$,
- (iv) $\delta_P^M(u *_i v) = \delta_P^M(u) + \delta_P^M(v) - \delta_P^M(\partial_i^+(u))$ for $i, k \in \mathbb{N}_n$ with $i < k$ and i -composable $u, v \in P_k^*$.

Proof. For $x \in P_0$, we have $\delta_P^M(x) = \delta_P(x) = x$. For $k \in \mathbb{N}_{n-1}$ and $g \in P_{k+1}$, we have

$$\begin{aligned} \delta_P^M(g) &= \theta_P^{-1} \circ \delta_P(g) \\ &= \theta_P^{-1}(g) \\ &= \theta_P^{-1}((g - \partial_k^-(g) - \partial_k^+(g)) + \partial_k^-(g) + \partial_k^+(g)) \\ &= g + \theta_P^{-1}(\partial_k^-(g)) + \theta_P^{-1}(\partial_k^+(g)) \\ &= g + \theta_P^{-1} \circ \delta_P(\partial_k^-(g)) + \theta_P^{-1} \circ \delta_P(\partial_k^+(g)) \\ &= g + \delta_P^M(\partial_k^-(g)) + \delta_P^M(\partial_k^+(g)). \end{aligned}$$

Given $k \in \mathbb{N}_{n-1}$ and $\tilde{u} \in P_k^*$, we have

$$\begin{aligned}\delta_P^M(\text{id}_{\tilde{u}}^{k+1}) &= \theta_P^{-1} \circ \delta_P(\text{id}_{i+1}\tilde{u}) \\ &= \theta_P^{-1} \circ \delta_P(\tilde{u}) \\ &= \delta_P^M(\tilde{u}).\end{aligned}$$

Finally, given $i, k \in \mathbb{N}_n$ with $i < k$ and i -composable $u_1, u_2 \in P_k^*$, we have

$$\begin{aligned}\delta_P^M(u_1 *_i u_2) &= \theta_P^{-1} \circ \delta_P(u_1 *_i u_2) \\ &= \theta_P^{-1}(u_1 + u_2 - \partial_i^+(u_1)) \\ &= \theta_P^{-1}(u_1) + \theta_P^{-1}(u_2) - \theta_P^{-1}(\partial_i^+(u_1)) \\ &= \theta_P^{-1} \circ \delta_P(u_1) + \theta_P^{-1} \circ \delta_P(u_2) - \theta_P^{-1} \circ \delta_P(\partial_i^+(u_1)) \\ &= \delta_P^M(u_1) + \delta_P^M(u_2) - \delta_P^M(\partial_i^+(u_1)).\end{aligned}$$

Thus, the properties of the statement hold. \square

However, contrary to δ_P , the function δ_P^M is positive and, in this regard, admits several convenient properties:

Proposition 2.1.2.10. *For all $k \in \mathbb{N}_n$ and $u \in P_k^*$, we have*

- (i) $\delta_P^M(u)$ is positive,
- (ii) for all $i \in \mathbb{N}_{k-1}$ and $\epsilon \in \{-, +\}$, $\delta_P^M(\partial_i^\epsilon(u)) \leq \delta_P^M(u)$,
- (iii) if $u = u_1 *_i u_2$ for some $i \in \mathbb{N}_{k-1}$ and i -composable $u_1, u_2 \in P_k^*$, then $\delta_P^M(u_1) \leq \delta_P^M(u)$ and $\delta_P^M(u_2) \leq \delta_P^M(u)$,
- (iv) if $\delta_P^M(u)_g > 0$ for some $g \in P$, then $\delta_P^M(g) \leq \delta_P^M(u)$.

Proof. We show the proposition by induction on $k \in \mathbb{N}_n$. The proposition holds for $k = 0$. So suppose that it holds up to dimension k for some $k \in \mathbb{N}_{n-1}$. We show that it holds for dimension $k + 1$. Let $u \in P_{k+1}^*$.

Proof of (i): We show this property by induction on an expression defining u from the generators of P (c.f. Remark 1.4.1.17). If $u = g$ for some $g \in P_{k+1}$, then $\delta_P^M(u) = g + \delta_P^M(\partial_k^-(g)) + \delta_P^M(\partial_k^+(g))$, which is positive by induction hypothesis. If $u = \text{id}_{\tilde{u}}$ for some $\tilde{u} \in P_k^*$, then $\delta_P^M(u) = \delta_P^M(\tilde{u})$, which is positive by induction hypothesis. Otherwise, if $u = u_1 *_i u_2$ for some $i \in \mathbb{N}_k$ and i -composable $u_1, u_2 \in P_{k+1}^*$, then $\delta_P^M(u) = \delta_P^M(u_1) + \delta_P^M(u_2) - \delta_P^M(\partial_i^+(u_1))$, so that, by induction hypothesis using (i) and (ii), we have $\delta_P^M(u) \geq 0$. So (i) holds.

Proof of (ii): It is sufficient to show that $\delta_P^M(\partial_k^\epsilon(u))$ is positive for $\epsilon \in \{-, +\}$, and we show this using again an induction on an expression defining u . By symmetry, we only handle the case $\epsilon = -$. If $u = g$ for some $g \in P_{k+1}$, then $\delta_P^M(\partial_k^-(u)) \leq \delta_P^M(u)$ by definition of δ_P^M and (i). If $u = \text{id}_{\tilde{u}}$ for some $\tilde{u} \in P_k^*$, then $\delta_P^M(\partial_k^-(u)) = \delta_P^M(u)$. Otherwise, if $u = u_1 *_i u_2$ for some $i \in \mathbb{N}_k$ and i -composable $u_1, u_2 \in P_{k+1}^*$, then

$$\begin{aligned}\delta_P^M(\partial_k^-(u)) &= \delta_P^M(\partial_k^-(u_1)) \\ &\leq \delta_P^M(u_1) && \text{(by induction on } u_1) \\ &\leq \delta_P^M(u_1) + \delta_P^M(u_2) - \delta_P^M(\partial_k^-(u_2)) && \text{(by induction on } u_2) \\ &= \delta_P^M(u).\end{aligned}$$

Thus, $\delta_p^M(\partial_k^\epsilon(u)) \leq \delta_p^M(u)$ for all $\epsilon \in \{-, +\}$ and $u \in P_{k+1}^*$.

Proof of (iii): If $u = u_1 *_i u_2$ for some $i \in \mathbb{N}_k$ and i -composable $u_1, u_2 \in P_{k+1}^*$, then, by definition of δ_p^M , we have $\delta_p^M(u) = \delta_p^M(u_1) + \delta_p^M(u_2) - \delta_p^M(\partial_i^+(u_1))$. By (ii), we have $\delta_p^M(u_2) - \delta_p^M(\partial_i^+(u_1)) \geq 0$, so that $\delta_p^M(u_1) \leq \delta_p^M(u)$. Similarly, $\delta_p^M(u_2) \leq \delta_p^M(u)$.

Proof of (iv): We show this by an induction on an expression defining u . If $u = g'$ for some $g' \in P_k$, then, we have $\delta_p^M(g) = \delta_p^M(g')$, so that $g = g'$ and $\delta_p^M(u) = \delta_p^M(g)$. If $u = \text{id}_{\tilde{u}}$ for some $\tilde{u} \in P_k^*$, then $\delta_p^M(\tilde{u}) = \delta_p^M(u)$, so that, by induction hypothesis, $\delta_p^M(g) \leq \delta_p^M(\tilde{u}) = \delta_p^M(u)$. Otherwise, if $u = u_1 *_i u_2$ for some $i \in \mathbb{N}_k$ and i -composable $u_1, u_2 \in P_k^*$, then, by the definition of δ_p^M , there is $j \in \{1, 2\}$, such that $\delta_p^M(u_j)_g > 0$. By symmetry, we can suppose $j = 1$. So, we have $\delta_p^M(g) \leq \delta_p^M(u_1)$, and thus $\delta_p^M(g) \leq \delta_p^M(u)$ by (iii). \square

Example 2.1.2.11. Recalling the polygraph P of Example 2.1.2.4, we do an example of calculation of δ_p^M and compute δ_p^M for $u = (\alpha_1 *_1 \alpha_2) *_0 \text{id}_g^2$:

$$\begin{aligned} \delta_p^M(u) &= \delta_p^M(\alpha_1 *_1 \alpha_2) + \delta_p^M(\text{id}_g^2) - \delta_p^M(\partial_0^+(\alpha_1 *_1 \alpha_2)) \\ &= \delta_p^M(\alpha_1) + \delta_p^M(\alpha_2) - \delta_p^M(\partial_1^+(\alpha_1)) + \delta_p^M(g) - \delta_p^M(y) \\ &= \alpha_1 + f_1 + f_2 + 2x + 2y + \alpha_2 + f_2 + f_3 + 2x + 2y - f_2 - x - y + g + y + z - y \\ &= \alpha_1 + \alpha_2 + f_1 + f_2 + f_3 + g + 3x + 3y + z. \end{aligned}$$

2.1.3 Elementary properties of free categories

We can now show elementary properties of free n -categories on polygraphs using the above defined Makkai's measure, as was done in [Mak05]. Let $n \in \mathbb{N} \cup \{\omega\}$ and P be an n -polygraph. First, we prove that the generators of P are injectively embedded in the associated free n -category P^* :

Proposition 2.1.3.1. *For $k \in \mathbb{N}_n$, $g_1, g_2 \in P_k$, if $g_1 \neq g_2$ in P_k , then $g_1 \neq g_2$ in P_k^* .*

Proof. Let $k \in \mathbb{N}_n$ and $g_1, g_2 \in P_k$ be such that $g_1 = g_2$ in P_k^* . So $\delta_p^M(g_1) = \delta_p^M(g_2)$. But, for $i \in \{1, 2\}$, g_i is the only $g \in P_i$ such that $\delta_p^M(g_i)_g > 0$ by definition of δ_p^M . Thus, $g_1 = g_2$ in P_k , which proves the statement. \square

Moreover, we can characterize the identities using δ_p^M :

Proposition 2.1.3.2. *Let $k \in \mathbb{N}_{n-1}$ and $u \in P_{k+1}^*$. The following are equivalent:*

- (i) *there exists $\tilde{u} \in P_k^*$ such that $u = \text{id}_{\tilde{u}}^{k+1}$,*
- (ii) *there exists $\epsilon \in \{-, +\}$ such that $\delta_p^M(u) = \delta_p^M(\partial_k^\epsilon(u))$,*
- (iii) *for all $g \in P_{k+1}$, $\delta_p^M(u)_g = 0$.*

Proof. The facts that (i) implies (ii) and that (ii) implies (iii) are trivial. So suppose that (iii) holds. We show that (i) by induction on an expression defining u :

- if $u = g$ for some $g \in P_{k+1}$, then $\delta_p^M(u)_g > 0$, contradicting the hypothesis,
- if $u = \text{id}_{\tilde{u}}^{k+1}$ for some $\tilde{u} \in P_k^*$, then the conclusion of the statement holds,

- if $u = u_1 *_i u_2$ for some $i \leq k$ and i -composable $u_1, u_2 \in P_{k+1}^*$, then, since $\delta_p^M(u_j) \leq \delta_p^M(u)$ for $j \in \{1, 2\}$ by Proposition 2.1.2.10(iii), we can use the induction hypothesis on u_1 and u_2 . So there exists $\tilde{u}_1, \tilde{u}_2 \in P_k^*$ such that $u_j = \text{id}_{\tilde{u}_j}^{k+1}$ for $j \in \{1, 2\}$. Thus, if $i = k$, then $u = \text{id}_{\tilde{u}_1}^{k+1}$ and if otherwise $i < k$, then $u = \text{id}_{\tilde{u}_1 *_i \tilde{u}_2}^{k+1}$. \square

The embeddings of the generators in the free categories can also be characterized using δ^M :

Proposition 2.1.3.3. *Let $k \in \mathbb{N}_n^*$ and $u \in P_k^*$. The following are equivalent:*

- (i) *there exists $g \in P_k$ such that $u = g$,*
- (ii) *there exists $g \in P_k$ such that $\delta_p^M(u) = \delta_p^M(g)$,*
- (iii) *there exists no $\tilde{u} \in P_{k-1}^*$ such that $u = \text{id}_{\tilde{u}}^k$, and if $u = u_1 *_i u_2$ for some $i < k$ and i -composable $u_1, u_2 \in P_k^*$, then there exists $j \in \{1, 2\}$ and $\tilde{u}_j \in P_i^*$ such that $u_j = \text{id}_{\tilde{u}_j}^k$.*

Proof. *Proof that (i) implies (ii):* This is clear.

Proof that (ii) implies (iii): Let $g \in P_k$ be such that $\delta_p^M(u) = \delta_p^M(g)$. First, by Proposition 2.1.3.2, u is not an identity. Moreover, if $u = u_1 *_i u_2$ for some $i < k$ and i -composable $u_1, u_2 \in P_k^*$, then

$$\delta_p^M(u) = \delta_p^M(u_1) + \delta_p^M(u_2) - \delta_p^M(\partial_i^-(u_2)).$$

Since $\delta_p^M(u)_g > 0$, we have that there exists $j \in \{1, 2\}$ such that $\delta_p^M(u_j)_g > 0$. By symmetry, suppose that $j = 1$. Then, by Proposition 2.1.2.10(iv), we have $\delta_p^M(g) \leq \delta_p^M(u_1)$. Moreover, by Proposition 2.1.2.10(ii), we have $\delta_p^M(u_2) - \delta_p^M(\partial_i^-(u_2)) \geq 0$, so that $\delta_p^M(u_1) \leq \delta_p^M(g)$. Hence,

$$\delta_p^M(u_1) = \delta_p^M(g) \quad \text{and} \quad \delta_p^M(u_2) - \delta_p^M(\partial_i^-(u_2)) = 0.$$

Thus, by Proposition 2.1.3.2, $u_2 = \text{id}_{\partial_i^-(u_2)}^k$, so (iii) holds.

Proof that (iii) implies (i): We show that (i) holds by induction on an expression defining u :

- if $u = g$ for some $g \in P_k$, then (i) holds;
- if $u = \text{id}_{\tilde{u}}^k$ for some $\tilde{u} \in P_{k-1}^*$, then this contradicts the hypothesis given by (iii);
- if $u = u_1 *_i u_2$ for some $i \in N_{k-1}$ and i -composable $u_1, u_2 \in P_k^*$, then, by hypothesis, there is $j \in \{1, 2\}$ such that $u_j = \text{id}_{\partial_i^-(u_j)}^k$. By symmetry, suppose that $j = 1$. Then, $u = u_2$ and we conclude by induction hypothesis. \square

Finally, we prove that identities and generators can be lifted through functors between free categories:

Proposition 2.1.3.4. *Let $F: P \rightarrow Q$ be a morphism of n -polygraphs, $k \in \mathbb{N}_n$ and $u \in P_k^*$. The following hold:*

- (i) *when $k > 0$, there exists a cell $u' \in P_{k-1}^*$ such that $u = \text{id}_{u'}^k$ if and only if there exists a cell $\tilde{u}' \in Q_{k-1}^*$ such that $F(u) = \text{id}_{\tilde{u}'}^k$,*
- (ii) *there exists a generator $g \in P_k$ such that $u = g$ if and only if there exists a generator $\tilde{g} \in Q_k$ such that $F(u) = \tilde{g}$.*

Proof. The left-to-right implications are clear, so we only prove the right-to-left ones.

Proof of (i): Suppose that there exists $\tilde{u}' \in Q_{k-1}^*$ such that $F(u) = \text{id}_{\tilde{u}'}^k$. By Proposition 2.1.3.2, we have that $\delta_Q^M(F(u))_g = 0$ for all $g \in Q_k$. By Proposition 2.1.2.8, we have $\delta_Q^M(F(u)) = \mathbb{Z}F(\delta_P^M(u))$, thus $\delta_P^M(u)_g = 0$ for all $g \in P_k$. Hence, by Proposition 2.1.3.2, there exists $u' \in P_{k-1}^*$ such that $u = \text{id}_{u'}^k$.

Proof of (ii): Suppose that there exists $\tilde{g} \in Q_k$ such that $F(u) = \tilde{g}$. We prove that there exists $g \in P_k$ such that $u = g$. When $k = 0$, this is clear. So suppose moreover that $k > 0$. It is sufficient to prove that the characterization (iii) of Proposition 2.1.3.3 is verified. By Proposition 2.1.3.3(iii), the cell $F(u)$ is not an identity, so that by (i), u is not an identity as well. Now if $u = u_1 *_i u_2$ for some $i \in \mathbb{N}_{k-1}$ and i -composable $u_1, u_2 \in P_k^*$, then $F(u) = F(u_1) *_i F(u_2)$, so that, by Proposition 2.1.3.3(iii), there is $j \in \{1, 2\}$ such that $F(u_j) = \text{id}_{F(\partial_i^-(u_j))}^k$. Using (i) $k - i$ times, we have that $u_j = \text{id}_{\partial_i^-(u_j)}^k$. Thus, by Proposition 2.1.3.3, there exists $g \in P_k$ such that $u = g$. \square

2.2 Free categories through categorical actions

Let $n \in \mathbb{N}$. In this section, we give a more precise description of the functor $-[-]: \text{Cat}_n^+ \rightarrow \text{Cat}_{n+1}$ introduced by Theorem 1.3.2.3, that maps an n -cellular extension to the associated free extension. Concretely, we express the functor $-[-]$ as the composite of functors

$$-[-]^A: \text{Cat}_n^+ \rightarrow \text{Cat}_n^A \quad \text{and} \quad -[-]^\approx: \text{Cat}_n^A \rightarrow \text{Cat}_{n+1}$$

where Cat_n^A is the category of n -categorical actions. The latter encode the structure of the “whiskered generators” of the free extensions $C[X]$ for $(C, X) \in \text{Cat}_n^+$, i.e., the $(n+1)$ -cells which can be written as

$$l_n \bullet_{n-1} (l_{n-1} \bullet_{n-2} \cdots \bullet_1 (l_1 \bullet_0 g \bullet_0 r_1) \bullet_1 \cdots \bullet_{n-2} r_{n-1}) \bullet_{n-1} r_n \quad (2.5)$$

for some suitably composable $g \in X$ and $l_i, r_i \in C_i$ for $i \in \mathbb{N}_n^*$. By considering adequately quotiented sequences of $(n+1)$ -cells of such form, one recovers the whole set $C[X]_{n+1}$.

By the exchange condition (E) satisfied by the canonical precategory structure on $C[X]$, a “whiskered generator” usually admits several decompositions as (2.5), and enumerating all of them can be expensive. Another description of all the possible decompositions can be obtained using *context classes*: the latter are structures which represent decompositions like (2.5) where g is replaced by a hole. In such structures, the different possible decompositions are then represented efficiently by quotienting with the equalities (E) dimensionwise.

We first introduce the definition of categorical actions (Section 2.2.1), and then of contexts and context classes, together with some of their properties (Section 2.2.2). We then give descriptions of the functor $-[-]^A$ using context classes (Section 2.2.3), and then of $-[-]^\approx$ by considering an adequate quotient on sequences of cells of categorical actions (Section 2.2.4). We then conclude the description of $-[-]$ as the composite of the two above functors and use it to give some properties of the cells of free extensions (Section 2.2.5). In the next section, this description will be used to show that the functor $-[-]$ is *computable*.

2.2.1 Categorical actions

Let $n \in \mathbb{N}$. An n -categorical action is the data of an n -cellular extension (C, C_{n+1}) together with, for $k \in \mathbb{N}_n^*$, composition operations

$$\bullet_{k,n+1}: C_k \times_{k-1} C_{n+1} \rightarrow C_{n+1} \quad \text{and} \quad \bullet_{n+1,k}: C_{n+1} \times_{k-1} C_k \rightarrow C_{n+1}$$

satisfying the axioms given below. We extend the convention used for precategories, meaning that, for $i, k, l \in \mathbb{N}_{n+1}$ with

$$i = \min(k, l) - 1 \quad \text{and} \quad \max(k, l) = n + 1,$$

given $(u, v) \in C_k \times_i C_l$, we write $u \bullet_i v$ for $u \bullet_{k,l} v$. The axioms satisfied by n -categorical actions are then the following:

(A-i) for $i, k, l \in \mathbb{N}_{n+1}$ satisfying

$$i = \min(k, l) - 1 \leq n - 1 \quad \text{and} \quad \max(k, l) = n + 1,$$

and $(u, v) \in C_k \times_i C_l$ and $\epsilon \in \{-, +\}$,

$$\partial_n^\epsilon(u \bullet_i v) = \begin{cases} u \bullet_i \partial_n^\epsilon(v) & \text{if } k < l, \\ \partial_n^\epsilon(u) \bullet_i v & \text{if } k > l, \end{cases}$$

(A-ii) for $i, k, l, m \in \mathbb{N}_{n+1}$ satisfying

$$i = \min(k, l) - 1 = \min(l, m) - 1 \leq n - 1 \quad \text{and} \quad \max(k, l, m) = n + 1,$$

and $(u, v, w) \in C_k \times_i C_l \times_i C_m$,

$$(u \bullet_i v) \bullet_i w = u \bullet_i (v \bullet_i w),$$

(A-iii) for $i, j \in \mathbb{N}_{n-1}$ with $i < j$, $u_1, u_2 \in C_{i+1}$, $v_1, v_2 \in C_{j+1}$ and $w \in C_{n+1}$ such that u_1, w, u_2 are i -composable and v_1, w, v_2 are j -composable,

$$u_1 \bullet_i (v_1 \bullet_j w \bullet_j v_2) \bullet_i u_2 = (u_1 \bullet_i v_1 \bullet_i u_2) \bullet_j (u_1 \bullet_i w \bullet_i u_2) \bullet_j (u_1 \bullet_i v_2 \bullet_i u_2),$$

(A-iv) for $i, k, l \in \mathbb{N}_{n+1}^*$ satisfying

$$i = \min(k, l) - 1 \leq n - 1 \quad \text{and} \quad \max(k, l) = n + 1,$$

and $(u, v) \in C_k \times_{i-1} C_l$,

$$(u \bullet_{i-1} \partial_i^-(v)) \bullet_i (\partial_i^+(u) \bullet_{i-1} v) = (\partial_i^-(u) \bullet_{i-1} v) \bullet_i (u \bullet_{i-1} \partial_i^+(v)).$$

Axioms (A-i), (A-ii) and (A-iii) above closely match Axioms (P-ii), (P-iv) and (P-v) of precategories (*c.f.* Remark 1.4.2.2). Axiom (A-iv) is analogous to the condition (E) satisfied by precategories derived from strict categories (*c.f.* Paragraph 1.4.3.1). An n -categorical action morphism between (C, C_{n+1}) and (D, D_{n+1}) is a morphism of n -cellular extension

$$(F, f): (C, C_{n+1}) \rightarrow (D, D_{n+1}) \in \mathbf{Cat}_n^+$$

which is moreover compatible with the $\bullet_{k,n+1}$ and $\bullet_{n+1,k}$ operations for $k \in \mathbb{N}_n^*$, *i.e.*,

– for $i \in \mathbb{N}_{n-1}$, $u \in C_{n+1}$, $v \in C_{i+1}$ such that u, v are i -composable,

$$f(u \bullet_i v) = f(u) \bullet_i F(v),$$

– for $i \in \mathbb{N}_{n-1}$, $u \in C_{i+1}$, $v \in C_{n+1}$ such that u, v are i -composable,

$$f(u \bullet_i v) = F(u) \bullet_i f(v).$$

We write \mathbf{Cat}_n^A for the category of n -categorical actions. There is a forgetful functor

$$\mathcal{U}: \mathbf{Cat}_n^A \rightarrow \mathbf{Cat}_n^+$$

which forgets the data of the $\bullet_{k,n+1}$ and $\bullet_{n+1,k}$ operations, for $k \in \mathbb{N}_n^*$. Since this functor is obviously derived from a morphism of essentially algebraic theories, by Theorem 1.1.2.7, it admits a left adjoint that we describe below, after introducing contexts and context classes.

2.2.2 Contexts and context classes

Here, we introduce *contexts* and *context classes*, that represent formal cells of strict categories with “holes” in them. Our definitions are similar to the one of context given by Métayer in [Mét08], but with a syntactical perspective that allows a computational implementation (c.f. Section 2.3.2). We moreover give some structure to these objects, like sources, targets, identities and compositions, and prove that these operations are compatible with n -functors.

2.2.2.1 – Definition. Let $n \in \mathbb{N} \cup \{\omega\}$ and $G \in \mathbf{Glob}_n$ be an n -globular set. Given $m \in \mathbb{N}_n$, an m -type is a pair (u, u') of parallel $(m-1)$ -globes of G (we extend the convention of Paragraph 1.2.2.1 so that the unique (-1) -globe $*$ is parallel with itself). Given $k \in \mathbb{N}_n$ with $k \geq m$ and $v \in G_k$, the m -type of v is the m -type $(\partial_{m-1}^-(v), \partial_{m-1}^+(v))$ so that every k -cell can be implicitly considered as an m -type, and we say that the m -types of this form are *instantiable*.

Let $C \in \mathbf{Cat}_n$. For every $m \in \mathbb{N}_n$ and m -type (u, u') , we define, by induction on m ,

- the notion of m -context of type (u, u') of C ,
- the notion of m -context class of type (u, u') of C ,
- for $k \in \mathbb{N}_n$ with $k \geq m$, the *evaluation* of an m -context E (resp. m -context class F) of type (u, u') at a cell $w \in C_k$ of type (u, u') which is a k -cell denoted $E[w]$ (resp. $F[w]$).

For $m \in \mathbb{N}_n$, an m -context class of type (u, u') of C will be an equivalence class of m -contexts of type (u, u') under a relation denoted \approx_m , so that we write $\llbracket E \rrbracket$ for the associated m -context class of an m -context E . This relation witnesses that two contexts are equivalent up to the equalities (E) considered in dimension m . Together with the above inductive definition, we prove the following:

Proposition 2.2.2.2. *Given $m, i, k \in \mathbb{N}_n$ with $m \leq i \leq k$, a k -cell v , an m -context E (resp. m -context class F) of type v and $\epsilon \in \{-, +\}$, we have*

$$\partial_i^\epsilon(E[v]) = E[\partial_i^\epsilon(v)] \quad (\text{resp. } \partial_i^\epsilon(F[v]) = F[\partial_i^\epsilon(v)]).$$

We now start the definition. There is a unique 0-context, denoted $[-]$, and the relation \approx_0 is the identity relation, so that a 0-context class is exactly a 0-context. Given $k \in \mathbb{N}_n$ and k -cell $v \in C_k$, the evaluation of the unique 0-context (class) $[-]$ at v is v , and Proposition 2.2.2.2 holds directly for $m = 0$.

Given $m \in \mathbb{N}_{n-1}$ and an $(m+1)$ -type (u, u') , an $(m+1)$ -context of type (u, u') is a triple $E = (l, F, r)$ where

- F is an m -context class of type $(\partial_{m-1}^-(u), \partial_{m-1}^+(u'))$,
- l and r are $(m+1)$ -cells of C such that $\partial_m^+(l) = F[u]$ and $\partial_m^-(r) = F[u']$.

Moreover, given $k \in \mathbb{N}_n$ with $k \geq m+1$ and $w \in C_k$ of type (u, u') , the evaluation $E[w]$ of E at w is the k -cell

$$E[w] = l \bullet_m F[w] \bullet_m r.$$

We define the relation \approx_{m+1} on $(m+1)$ -contexts of type (u, u') . When $m = 0$, for all 1-contexts E_1 and E_2 of type (u, u') , we put $E_1 \approx_1 E_2$ if and only if $E_1 = E_2$. When $m > 0$, we define \approx_{m+1} to be the reflexive symmetric transitive closure of \approx_{m+1}^1 , where \approx_{m+1}^1 is the relation such that, for all $(m+1)$ -contexts

$$E_1 = (l_1, F_1, r_1) \quad \text{and} \quad E_2 = (l_2, F_2, r_2)$$

of type (u, u') , we have $E_1 \approx_{m+1}^1 E_2$ if there exist m -contexts

$$E'_1 = (l'_1, F'_1, r'_1) \quad \text{and} \quad E'_2 = (l'_2, F'_2, r'_2)$$

of type $(\partial_{m-1}^-(u), \partial_{m-1}^+(u'))$ with $F_i = \llbracket E'_i \rrbracket$ for $i \in \{1, 2\}$, and $l, r, w \in C_{m+1}$ such that at least one of the two sets of conditions (\approx -L) and (\approx -R) is satisfied, where the set of conditions (\approx -L) is

$$\begin{array}{ll}
 (\approx\text{-L}) & \begin{array}{ll}
 l_1 = l \bullet_m (w \bullet_{m-1} F'_1[u] \bullet_{m-1} r'_1) & r_1 = r \\
 l_2 = l & r_2 = (w \bullet_{m-1} F'_2[u'] \bullet_{m-1} r'_2) \bullet_m r \\
 l'_1 = \partial_m^+(w) & r'_1 = r'_2 \\
 l'_2 = \partial_m^-(w) & F'_1 = F'_2
 \end{array}
 \end{array}$$

and the set of conditions (\approx -R) is

$$\begin{array}{ll}
 (\approx\text{-R}) & \begin{array}{ll}
 l_1 = l \bullet_m (l'_1 \bullet_{m-1} F'_1[u] \bullet_{m-1} w) & r_1 = r \\
 l_2 = l & r_2 = (l'_2 \bullet_{m-1} F'_2[u'] \bullet_{m-1} w) \bullet_m r \\
 l'_1 = l'_2 & r'_1 = \partial_m^+(w) \\
 r'_2 = \partial_m^-(w) & F'_1 = F'_2.
 \end{array}
 \end{array}$$

An $(m+1)$ -context class of type (u, u') is an equivalence class of $(m+1)$ -contexts of type (u, u') under \approx_{m+1} . Note that if $E_1 \approx_{m+1} E_2$ and w is a k -cell of type (u, u') , then $E_1[w] = E_2[w]$, so that we can define the evaluation $F[w]$ of an $(m+1)$ -context class F by a k -cell w , both of type (u, u') , as $E[w]$, where E is an $(m+1)$ -context of type (u, u') such that $F = \llbracket E \rrbracket$.

Finally, we check that Proposition 2.2.2.2 is satisfied: given $i, k \in \mathbb{N}_n$ with $m+1 \leq i \leq k$, an $(m+1)$ -context $E = (l, F, r)$ and a k -cell v , both of $(m+1)$ -type (u, u') , and $\epsilon \in \{-, +\}$, we have

$$\begin{aligned}
 \partial_i^\epsilon(E[v]) &= \partial_i^\epsilon(l \bullet_m F[v] \bullet_m r) \\
 &= l \bullet_m \partial_i^\epsilon(F[v]) \bullet_m r && \text{(by Axiom (P-ii))} \\
 &= l \bullet_m F[\partial_i^\epsilon(v)] \bullet_m r && \text{(by the induction hypothesis)} \\
 &= E[\partial_i^\epsilon(v)]
 \end{aligned}$$

and the property also holds for $(m+1)$ -context classes too, since we have

$$\partial_i^\epsilon(\llbracket E \rrbracket[v]) = \partial_i^\epsilon(E[v]) = E[\partial_i^\epsilon(v)] = \llbracket E \rrbracket[\partial_i^\epsilon(v)]$$

and this ends the definition of contexts and context classes of C .

Example 2.2.2.3. Let P be the 2-polygraph such that

$$\begin{aligned}
 P_0 &= \{w, x, y, z\} \\
 P_1 &= \{a: w \rightarrow z, b, b': w \rightarrow x, c, c': x \rightarrow y, d, d': y \rightarrow z, e: w \rightarrow z\} \\
 P_2 &= \{\alpha: a \Rightarrow b *_0 c *_0 d, \beta: b \Rightarrow b', \delta: d \Rightarrow d', \epsilon: b' *_0 c' *_0 d' \Rightarrow e\}.
 \end{aligned}$$

There are several 1-contexts of type (x, y) , like the following ones:

- $(\text{id}_x^1, [-], \text{id}_y^1)$,
- $(b, [-], \text{id}_y^1)$,
- $(\text{id}_x^1, [-], d)$,

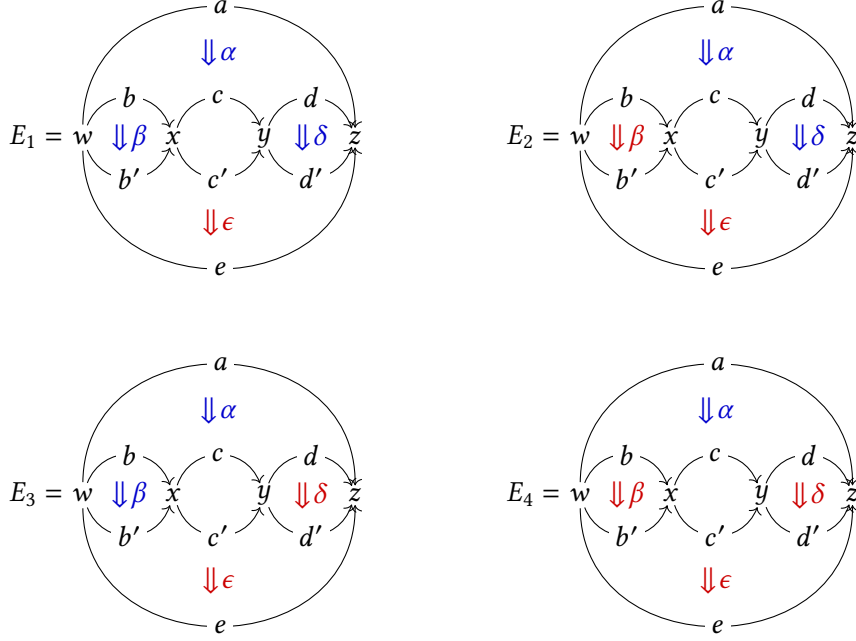
Figure 2.1 – The contexts E_1, E_2, E_3 and E_4

- $E_{f,h} = (f, [-], g)$ for $f \in \{b, b'\}$ and $h \in \{d, d'\}$.

By the definition of \approx_1 , a 1-context class is exactly a 1-context. Note that, for $f \in \{b, b'\}$ and $h \in \{c, c'\}$, the evaluation of $E_{f,h}$ at $g \in \{c, c'\}$ is $f *_0 g *_0 h$. There are several 2-contexts of type (c, c') , as the following ones:

- $E_1 = (\alpha *_1 (\beta *_0 \text{id}_c^2 *_0 \delta), E_{b',d'}, \epsilon)$,
- $E_2 = (\alpha *_1 (\text{id}_{b*_0c}^2 *_0 \delta), E_{b,d'}, (\beta *_0 \text{id}_{c'*_0d'}^2) *_1 \epsilon)$,
- $E_3 = (\alpha *_1 (\beta *_0 \text{id}_{c*_0d}^2), E_{b',d}, (\text{id}_{b'*_0c'}^2 *_0 \delta) *_1 \epsilon)$,
- $E_4 = (\alpha, E_{b,d}, (\beta *_0 \text{id}_{c'}^2 *_0 \delta) *_1 \epsilon)$

which can be represented as on Figure 2.1. Then, putting

$$l = \alpha *_1 (\text{id}_{b*_0c}^2 *_0 \delta), \quad w = \beta \quad \text{and} \quad r = \epsilon$$

and using $(\approx\text{-L})$, we have $E_1 \approx_2^1 E_2$. Similarly, putting

$$l = \alpha *_1 (\beta *_0 \text{id}_{c*_0d}^2), \quad w = \delta \quad \text{and} \quad r = \epsilon$$

and using $(\approx\text{-R})$, we have $E_1 \approx_m^1 E_3$. Finally, putting

$$l = \alpha, \quad w = \delta \quad \text{and} \quad r = (\beta *_0 \text{id}_{c'*_0d'}^2) *_1 \epsilon$$

and using $(\approx\text{-R})$, we have $E_2 \approx_m^1 E_4$. Thus, we have

$$\llbracket E_1 \rrbracket = \llbracket E_2 \rrbracket = \llbracket E_3 \rrbracket = \llbracket E_4 \rrbracket.$$

In fact, we can prove that the set of 2-contexts equivalent to E_1 under \approx_2 is $\{E_1, E_2, E_3, E_4\}$.

Remark 2.2.2.4. Given $m \in \mathbb{N}_n$, the relation \approx_m^{-1} on the m -contexts, which is defined by $E_1 \approx_m^{-1} E_2$ when $E_2 \approx_m^1 E_1$ for all m -contexts E_1, E_2 of the same m -type, admits a definition by axioms $(\approx\text{-L})'$ and $(\approx\text{-R})'$ which are symmetrical to $(\approx\text{-L})$ and $(\approx\text{-R})$. Moreover, \approx_m can be equivalently described as the reflexive transitive closure of $\approx_m^1 \cup \approx_m^{-1}$, so that, in the proofs, by symmetry of the definitions of \approx_m^1 and \approx_m^{-1} , we can often reduce a case analysis of $E_1 \approx_m E_2$ to $E_1 \approx_m^1 E_2$.

Remark 2.2.2.5. Given $m, k \in \mathbb{N}_{n+1}$ with $m \leq n$ and $m \leq k \leq n+1$, the notion of m -context, m -context class and their respective evaluations at a k -cell can be defined similarly for an n -categorical action C . Note that the notion of $(n+1)$ -context here makes little sense since there is no composition operation \bullet_n .

2.2.2.6 – Source and target of contexts. Let $n \in \mathbb{N} \cup \{\omega\}$ and $C \in \text{Cat}_n$. Given $m \in \mathbb{N}_n^*$, an m -type (u, u') and an m -context $E = (l, F, r)$ of type (u, u') of C , the *source* and the *target* of E are respectively the $(m-1)$ -cells

$$\partial_{m-1}^-(E) = \partial_{m-1}^-(l) \quad \text{and} \quad \partial_{m-1}^+(E) = \partial_{m-1}^+(r).$$

When $m > 1$, we moreover have

$$\partial_{m-2}^\epsilon \circ \partial_{m-1}^-(E) = \partial_{m-2}^\epsilon \circ \partial_{m-1}^+(E)$$

for $\epsilon \in \{-, +\}$. Indeed, given an $(m-1)$ -context $E' = (l', F', r')$ such that $F = \llbracket E' \rrbracket$, we have

$$\partial^+(l) = l' \bullet_{m-2} F'[u] \bullet_{m-2} r' \quad \text{and} \quad \partial^-(r) = l' \bullet_{m-2} F'[u'] \bullet_{m-2} r'$$

so that

$$\begin{aligned} \partial_{m-2}^- \circ \partial_{m-1}^-(E) &= \partial_{m-2}^- \circ \partial_{m-1}^-(l) \\ &= \partial_{m-2}^- \circ \partial_{m-1}^+(l) \\ &= \partial_{m-2}^-(l') \\ &= \partial_{m-2}^- \circ \partial_{m-1}^-(r) \\ &= \partial_{m-2}^- \circ \partial_{m-1}^+(r) \\ &= \partial_{m-2}^- \circ \partial_{m-1}^+(E) \end{aligned}$$

and similarly, $\partial_{m-2}^+ \circ \partial_{m-1}^-(E) = \partial_{m-2}^+ \circ \partial_{m-1}^+(E)$. The operations ∂^-, ∂^+ on m -contexts extend to m -context classes since they are compatible with the \approx_m relation. Given $i \in \mathbb{N}_{m-1}$ and $\epsilon \in \{-, +\}$ and an m -context E (resp. an m -context class F), we write $\partial_i^\epsilon(E)$ for $\partial_i^\epsilon \circ \partial_{m-1}^\epsilon(E)$ (resp. $\partial_i^\epsilon \circ \partial_{m-1}^\epsilon(F)$). Thus, for $i \in \mathbb{N}_{n-1}$, we can extend the notion of i -composable sequences of globes of globular sets to sequences X_1, \dots, X_l for some $l \in \mathbb{N}^*$ where X_s is either an m -context, an m -context class, or a cell of C for $s \in \mathbb{N}_l^*$, and say that X_1, \dots, X_l is i -composable when $\partial_i^+(X_s) = \partial_i^-(X_{s+1})$ for $s \in \mathbb{N}_{l-1}^*$.

It is immediate that the source and target operations are compatible with the evaluation of contexts (resp. context classes):

Proposition 2.2.2.7. *Given $i, m, k \in \mathbb{N}_n$ with $i < m \leq k$, $\epsilon \in \{-, +\}$, $u \in C_k$ and an m -context E of type u , we have*

$$\partial_i^\epsilon(E[u]) = \partial_i^\epsilon(E) \quad \text{and} \quad \partial_i^\epsilon(\llbracket E \rrbracket[u]) = \partial_i^\epsilon(\llbracket E \rrbracket).$$

2.2.2.8 – Identity contexts. Let $n \in \mathbb{N} \cup \{\omega\}$ and $C \in \mathbf{Cat}_n$. Given $m \in \mathbb{N}_n$ and an m -type (u, u') of C , we define an m -context $I^{(u, u')}$ and an m -context class $\bar{I}^{(u, u')}$, called respectively *identity context* and *identity context class* on (u, u') , by induction on m . When $m = 0$, we put

$$I^{(*, *)} = \bar{I}^{(*, *)} = [-]$$

and, when $m > 0$, we put

$$I^{(u, u')} = (\text{id}_u^m, \bar{I}^{(\partial^-(u), \partial^+(u'))}, \text{id}_{u'}^m) \quad \text{and} \quad \bar{I}^{(u, u')} = \llbracket I^{(u, u')} \rrbracket.$$

If C is part of an n -cellular extension (C, X) , given $g \in X$, we write I^g and \bar{I}^g for

$$I^{(\partial_{n-1}^-(g), \partial_{n-1}^+(g))} \quad \text{and} \quad \bar{I}^{(\partial_{n-1}^-(g), \partial_{n-1}^+(g))}$$

respectively. The identity contexts and identity context classes have trivial evaluation:

Proposition 2.2.2.9. For $m, k \in \mathbb{N}_n$ with $m \leq k$, an m -type (u, u') and $v \in C_k$ of type (u, u') , we have

$$I^{(u, u')} [v] = v \quad \text{and} \quad \bar{I}^{(u, u')} [v] = v$$

Proof. This is shown by a simple induction on m . □

2.2.2.10 – Composition operations. Let $n \in \mathbb{N} \cup \{\omega\}$ and $C \in \mathbf{Cat}_n$. Given $i, m \in \mathbb{N}_n$ with $i < m$, an m -context $E = (l, F, r)$ of some m -type (u, u') of C , and $v \in C_{i+1}$, if (v, E) is i -composable, we define an m -context $v \bullet_i E$ by induction on $m - i$ with

$$v \bullet_i E = \begin{cases} (v \bullet_i l, F, r) & \text{if } i + 1 = m, \\ (v \bullet_i l, v \bullet_i F, v \bullet_i r) & \text{if } i + 1 < m, \end{cases}$$

and, since it can be verified that the \bullet_i operation is compatible with \approx_m , we extend the operation on m -context classes and put $v \bullet_i \llbracket E \rrbracket = \llbracket v \bullet_i E \rrbracket$. Similarly, if (E, v) is i -composable, we define an m -context $E \bullet_i v$ using an induction on $m - i$ by

$$E \bullet_i v = \begin{cases} (l, F, r \bullet_i v) & \text{if } i + 1 = m, \\ (l \bullet_i v, F \bullet_i v, r \bullet_i v) & \text{if } i + 1 < m, \end{cases}$$

and we put $\llbracket E \rrbracket \bullet_i v = \llbracket E \bullet_i v \rrbracket$. These composition operations satisfy properties similar to the axioms of $(n+1)$ -precategories:

Proposition 2.2.2.11. Given $m \in \mathbb{N}_n$, an m -type (u, u') and an m -context E of type (u, u') of C , we have

(i) for all $i \in \mathbb{N}_{m-1}$ and $u_1 = \partial_i^-(E)$, $u_2 = \partial_i^+(E)$,

$$\text{id}_{u_1}^{i+1} \bullet_i E = E = E \bullet_i \text{id}_{u_2}^{i+1},$$

(ii) for all $i \in \mathbb{N}_{m-1}$ and $u_1, u_2 \in C_{i+1}$, if u_1, u_2, E are i -composable or u_1, E, u_2 are i -composable or E, u_1, u_2 are i -composable, then we respectively have

$$(u_1 \bullet_i u_2) \bullet_i E = u_1 \bullet_i (u_2 \bullet_i E)$$

or

$$(u_1 \bullet_i E) \bullet_i u_2 = u_1 \bullet_i (E \bullet_i u_2)$$

or

$$(E \bullet_i u_1) \bullet_i u_2 = E \bullet_i (u_1 \bullet_i u_2),$$

(iii) for all $i, j \in \mathbb{N}_{m-1}$ such that $i < j$, and $u_1, u_2 \in C_{i+1}$ and $v_1, v_2 \in C_{j+1}$ such that u_1, E, u_2 are i -composable and v_1, E, v_2 are j -composable, we have

$$u_1 \bullet_i (v_1 \bullet_j E \bullet_j v_2) \bullet_i u_2 = (u_1 \bullet_i v_1 \bullet_i u_2) \bullet_j (u_1 \bullet_i E \bullet_i u_2) \bullet_j (u_1 \bullet_i v_2 \bullet_i u_2),$$

and similar properties hold when replacing E by $\llbracket E \rrbracket$ in the equations.

Proof. (i), (ii) are proved by a simple induction on E and F , so we move directly to the proof of (iii). Let $(l, F, r) = E$, $i, j \in \mathbb{N}_{m-1}$ with $i < j$, and $u_1, u_2 \in C_{i+1}$ and $v_1, v_2 \in C_{j+1}$ such that u_1, E, u_2 are i -composable and v_1, E, v_2 are j -composable. We show that (iii) holds by induction on $m - j$. When $m = j + 1$, we have

$$\begin{aligned} u_1 \bullet_i (v_1 \bullet_j E \bullet_j v_2) \bullet_i u_2 &= (u_1 \bullet_i (v_1 \bullet_j l) \bullet_i u_2, F, u_1 \bullet_i (r \bullet_j v_2) \bullet_i u_2) \\ &= ((u_1 \bullet_i v_1 \bullet_i u_2) \bullet_j (u_1 \bullet_i l \bullet_i u_2), F, (u_1 \bullet_i r \bullet_i u_2)(u_1 \bullet_i v_2 \bullet_i u_2)) \\ &= (u_1 \bullet_i v_1 \bullet_i u_2) \bullet_j (u_1 \bullet_i E \bullet_i u_2) \bullet_j (u_1 \bullet_i v_2 \bullet_i u_2) \end{aligned}$$

and moreover,

$$\begin{aligned} u_1 \bullet_i (v_1 \bullet_j \llbracket E \rrbracket \bullet_j v_2) \bullet_i u_2 &= \llbracket u_1 \bullet_i (v_1 \bullet_j E \bullet_j v_2) \bullet_i u_2 \rrbracket \\ &= \llbracket (u_1 \bullet_i v_1 \bullet_i u_2) \bullet_j (u_1 \bullet_i E \bullet_i u_2) \bullet_j (u_1 \bullet_i v_2 \bullet_i u_2) \rrbracket \\ &= (u_1 \bullet_i v_1 \bullet_i u_2) \bullet_j (u_1 \bullet_i \llbracket E \rrbracket \bullet_i u_2) \bullet_j (u_1 \bullet_i v_2 \bullet_i u_2) \end{aligned}$$

so that the wanted equations hold. When $m > j + 1$, by doing a similar computation and using the induction hypothesis on F , we conclude that the wanted equations hold too. Thus, (iii) holds. \square

Moreover, by the axioms defining the relations \approx_m , the compositions of cells of C with context classes satisfy an equality similar to the condition (E) that characterizes n -categories among n -precategories:

Proposition 2.2.2.12. *Given $i, m \in \mathbb{N}_n$ with $0 < i < m$, an m -type (u, u') , an m -context E of type (u, u') , and $u_1, u_2 \in C_{i+1}$ such that u_1, E are $(i-1)$ -composable and E, u_2 are $(i-1)$ -composable, we have*

$$(u_1 \bullet_{i-1} \partial_i^-(\llbracket E \rrbracket)) \bullet_i (\partial_i^+(u_1) \bullet_{i-1} \llbracket E \rrbracket) = (\partial_i^-(u_1) \bullet_{i-1} \llbracket E \rrbracket) \bullet_i (u_1 \bullet_{i-1} \partial_i^+(\llbracket E \rrbracket))$$

and

$$(\llbracket E \rrbracket \bullet_{i-1} \partial_i^-(u_2)) \bullet_i (\partial_i^+(\llbracket E \rrbracket) \bullet_{i-1} u_2) = (\partial_i^-(\llbracket E \rrbracket) \bullet_{i-1} u_2) \bullet_i (\llbracket E \rrbracket \bullet_{i-1} \partial_i^+(u_2)).$$

Moreover, if $i + 1 < m$, we have

$$(u_1 \bullet_{i-1} \partial_i^-(E)) \bullet_i (\partial_i^+(u_1) \bullet_{i-1} E) = (\partial_i^-(u_1) \bullet_{i-1} E) \bullet_i (u_1 \bullet_{i-1} \partial_i^+(E))$$

and

$$(E \bullet_{i-1} \partial_i^-(u_2)) \bullet_i (\partial_i^+(E) \bullet_{i-1} u_2) = (\partial_i^-(E) \bullet_{i-1} u_2) \bullet_i (E \bullet_{i-1} \partial_i^+(u_2)).$$

Proof. Let $(l, F, r) = E$. We show this property by induction on $m - i$. If $m = i + 1$, then

$$\begin{aligned} &(u_1 \bullet_{i-1} \partial_i^-(E)) \bullet_i (\partial_i^+(u_1) \bullet_{i-1} E) \\ &= (u_1 \bullet_{i-1} \partial_i^-(l)) \bullet_i (\partial_i^+(u_1) \bullet_{i-1} E) \\ &= ([u_1 \bullet_{i-1} \partial_i^-(l)] \bullet_i [\partial_i^+(u_1) \bullet_{i-1} l], \partial_i^+(u_1) \bullet_{i-1} F, \partial_i^+(u_1) \bullet_{i-1} r) \\ &= ([\partial_i^-(u_1) \bullet_{i-1} l] \bullet_i [u_1 \bullet_{i-1} \partial_i^+(l)], \partial_i^+(u_1) \bullet_{i-1} F, \partial_i^+(u_1) \bullet_{i-1} r) && \text{(by (E))} \\ &\approx_m ([\partial_i^-(u_1) \bullet_{i-1} l], \partial_i^-(u_1) \bullet_{i-1} F, [u_1 \bullet_{i-1} \partial_i^-(r)] \bullet_i [\partial_i^+(u_1) \bullet_{i-1} r]) \\ &= ([\partial_i^-(u_1) \bullet_{i-1} l], \partial_i^-(u_1) \bullet_{i-1} F, [\partial_i^-(u_1) \bullet_{i-1} r] \bullet_i [u_1 \bullet_{i-1} \partial_i^+(r)]) && \text{(by (E))} \\ &= (\partial_i^-(u_1) \bullet_{i-1} E) \bullet_i (u_1 \bullet_i \partial_i^+(r)) \\ &= (\partial_i^-(u_1) \bullet_{i-1} E) \bullet_i (u_1 \bullet_i \partial_i^+(E)) \end{aligned}$$

so that

$$\begin{aligned}
& (u_1 \bullet_{i-1} \partial_i^- (\llbracket E \rrbracket)) \bullet_i (\partial_i^+ (u_1) \bullet_{i-1} \llbracket E \rrbracket) \\
&= \llbracket (u_1 \bullet_{i-1} \partial_i^- (E)) \bullet_i (\partial_i^+ (u_1) \bullet_{i-1} E) \rrbracket \\
&= \llbracket (\partial_i^- (u_1) \bullet_{i-1} E) \bullet_i (u_1 \bullet_i \partial_i^+ (E)) \rrbracket \\
&= (\partial_i^- (u_1) \bullet_{i-1} \llbracket E \rrbracket) \bullet_i (u_1 \bullet_i \partial_i^+ (\llbracket E \rrbracket))
\end{aligned}$$

and similarly,

$$(\llbracket E \rrbracket \bullet_{i-1} \partial_i^- (u_2)) \bullet_i (\partial_i^+ (\llbracket E \rrbracket) \bullet_{i-1} u_2) = (\partial_i^- (\llbracket E \rrbracket) \bullet_{i-1} u_2) \bullet_i (\llbracket E \rrbracket \bullet_{i-1} \partial_i^+ (u_2)).$$

Otherwise, if $m > i + 1$, then

$$\begin{aligned}
& (u_1 \bullet_{i-1} \partial_i^- (E)) \bullet_i (\partial_i^+ (u_1) \bullet_{i-1} l) \\
&= (u_1 \bullet_{i-1} \partial_i^- (l)) \bullet_i (\partial_i^+ (u_1) \bullet_{i-1} l) \\
&= (\partial_i^- (u_1) \bullet_{i-1} l) \bullet_i (u_1 \bullet_{i-1} \partial_i^+ (l)) \\
&= (\partial_i^- (u_1) \bullet_{i-1} l) \bullet_i (u_1 \bullet_{i-1} \partial_i^+ (E))
\end{aligned}$$

and similarly,

$$(u_1 \bullet_{i-1} \partial_i^- (E)) \bullet_i (\partial_i^+ (u_1) \bullet_{i-1} r) = (\partial_i^- (u_1) \bullet_{i-1} r) \bullet_i (u_1 \bullet_{i-1} \partial_i^+ (E))$$

and, by induction hypothesis,

$$\begin{aligned}
& (u_1 \bullet_{i-1} \partial_i^- (E)) \bullet_i (\partial_i^+ (u_1) \bullet_{i-1} F) \\
&= (u_1 \bullet_{i-1} \partial_i^- (F)) \bullet_i (\partial_i^+ (u_1) \bullet_{i-1} F) \\
&= (\partial_i^- (u_1) \bullet_{i-1} F) \bullet_i (u_1 \bullet_{i-1} \partial_i^+ (F)) \\
&= (\partial_i^- (u_1) \bullet_{i-1} F) \bullet_i (u_1 \bullet_{i-1} \partial_i^+ (E))
\end{aligned}$$

so that

$$(u_1 \bullet_{i-1} \partial_i^- (E)) \bullet_i (\partial_i^+ (u_1) \bullet_{i-1} E) = (\partial_i^- (u_1) \bullet_{i-1} E) \bullet_i (u_1 \bullet_{i-1} \partial_i^+ (E))$$

which implies

$$(u_1 \bullet_{i-1} \partial_i^- (\llbracket E \rrbracket)) \bullet_i (\partial_i^+ (u_1) \bullet_{i-1} \llbracket E \rrbracket) = (\partial_i^- (u_1) \bullet_{i-1} \llbracket E \rrbracket) \bullet_i (u_1 \bullet_{i-1} \partial_i^+ (\llbracket E \rrbracket)).$$

Similarly, we have

$$(\partial_i^- (E) \bullet_{i-1} u_2) \bullet_i (E \bullet_{i-1} \partial_i^+ (u_2)) = (E \bullet_{i-1} \partial_i^- (u_2)) \bullet_i (\partial_i^+ (E) \bullet_{i-1} u_2)$$

and

$$(\llbracket E \rrbracket \bullet_{i-1} \partial_i^- (u_2)) \bullet_i (\partial_i^+ (\llbracket E \rrbracket) \bullet_{i-1} u_2) = (\partial_i^- (\llbracket E \rrbracket) \bullet_{i-1} u_2) \bullet_i (\llbracket E \rrbracket \bullet_{i-1} \partial_i^+ (u_2)).$$

Hence, the proposition holds. \square

Finally, we prove that the composition operations on contexts and context classes are compatible with evaluation:

Proposition 2.2.2.13. *Given $i, m, k \in \mathbb{N}_n$ with $i < m \leq k$, $u \in C_{i+1}$, $v \in C_k$ and an m -context E of type v of C , if u, E are i -composable, then*

$$(u \bullet_i E)[v] = u \bullet_i (E[v])$$

and otherwise, if E, u are i -composable, then

$$(E \bullet_i u)[v] = (E[v]) \bullet_i u$$

and similar equalities hold for context classes.

Proof. By symmetry, we only prove the first equality, and we do so using an induction on $m - i$. Let $(l, F, r) = E$. When $i + 1 = m$, we have

$$(u \bullet_i E)[v] = u \bullet_i l \bullet_i E[v] \bullet_i r = u \bullet_i E[v]$$

and

$$(u \bullet_i \llbracket E \rrbracket)[v] = \llbracket u \bullet_i E \rrbracket[v] = (u \bullet_i E)[v] = u \bullet_i (E[v]) = u \bullet_i (\llbracket E \rrbracket[v]).$$

Otherwise, when $i + 1 < m$, we have

$$\begin{aligned} (u \bullet_i E)[v] &= (u \bullet_i l) \bullet_{m-1} (u \bullet_i F)[v] \bullet_{m-1} (u \bullet_i r) \\ &= (u \bullet_i l) \bullet_{m-1} (u \bullet_i (F[v])) \bullet_{m-1} (u \bullet_i r) && \text{(by induction hypothesis)} \\ &= u \bullet_i (E[v]) \end{aligned}$$

and, like above, we have $(u \bullet_i \llbracket E \rrbracket)[v] = u \bullet_i (\llbracket E \rrbracket[v])$. \square

2.2.2.14 – Contexts and functoriality. Let $n \in \mathbb{N} \cup \{\omega\}$, $C, D \in \text{Cat}_n$ and $H: C \rightarrow D$ be an n -functor. We extend H to m -contexts and m -context classes, by induction on m . More precisely, given $m \in \mathbb{N}_n$, an m -type (u, u') of C and an m -context E of type (u, u') of C , we define an m -context $H(E)$ and an m -context class $H(\llbracket E \rrbracket)$ of type $(H(u), H(u'))$ of D by induction on m as follows. If $m = 0$, we put

$$H([-]) = [-]$$

and otherwise, if $m > 0$, given $(l, F, r) = E$, we put

$$H(E) = (H(l), H(F), H(r)) \quad \text{and} \quad H(\llbracket E \rrbracket) = \llbracket H(E) \rrbracket$$

where $H(\llbracket E \rrbracket)$ is well-defined since, given two m -contexts E_1, E_2 such that $E_1 \approx_m E_2$, we can check that $H(E_1) \approx_m H(E_2)$. We verify that H is compatible with the different operations on contexts and context classes defined above:

Proposition 2.2.2.15. *Given $m, k \in \mathbb{N}_n$ with $m \leq k$, $u \in C_k$ and an m -context E of type u of C , we have*

$$H(E[u]) = H(E)[H(u)] \quad \text{and} \quad H(\llbracket E \rrbracket[u]) = H(\llbracket E \rrbracket)[H(u)]$$

Proof. We prove this property by induction on m . When $m = 0$, the property holds, so assume that $m > 0$. Let $(l, F, r) = E$. We have

$$\begin{aligned} H(E[u]) &= H(l) \bullet_{m-1} H(F[u]) \bullet_{m-1} H(r) \\ &= H(l) \bullet_{m-1} H(F)[H(u)] \bullet_{m-1} H(r) && \text{(by induction hypothesis)} \\ &= H(E)[H(u)] \end{aligned}$$

and we moreover deduce that

$$H(\llbracket E \rrbracket[u]) = H(E[u]) = H(E)[H(u)] = \llbracket H(E) \rrbracket[H(u)] = H(\llbracket E \rrbracket)[H(u)]$$

which concludes the induction. \square

Proposition 2.2.2.16. *Given $m \in \mathbb{N}_n$ and an m -type (u, u') of C , we have*

$$H(I^{(u, u')}) = I^{(H(u), H(u'))} \quad \text{and} \quad H(\bar{I}^{(u, u')}) = \bar{I}^{(H(u), H(u'))}$$

Proof. By a simple induction on m . □

Proposition 2.2.2.17. *Given $i, m \in \mathbb{N}_n$ with $i < m$, $u \in C_{i+1}$ and an m -context E of C , if u, E (resp. E, u) are i -composable, then*

$$H(u \bullet_i E) = H(u) \bullet_i H(E) \quad (\text{resp. } H(E \bullet_i u) = H(E) \bullet_i H(u))$$

and

$$H(u \bullet_i \llbracket E \rrbracket) = H(u) \bullet_i H(\llbracket E \rrbracket) \quad (\text{resp. } H(\llbracket E \rrbracket \bullet_i u) = H(\llbracket E \rrbracket) \bullet_i u).$$

Proof. Let $(l, F, r) = E$. We prove this property by induction on $m - i$. If $m = i + 1$, we compute that

$$\begin{aligned} H(u \bullet_i E) &= H((u \bullet_i l, F, r)) \\ &= (H(u \bullet_i l), H(F), H(r)) \\ &= (H(u) \bullet_i H(l), H(F), H(r)) \\ &= H(u) \bullet_i (H(l), H(F), H(r)) \\ &= H(u) \bullet_i H(E) \end{aligned}$$

and

$$\begin{aligned} H(u \bullet_i \llbracket E \rrbracket) &= H(\llbracket u \bullet_i E \rrbracket) \\ &= \llbracket H(u \bullet_i E) \rrbracket \\ &= \llbracket H(u) \bullet_i H(E) \rrbracket \\ &= H(u) \bullet_i \llbracket H(E) \rrbracket \\ &= H(u) \bullet_i H(\llbracket E \rrbracket). \end{aligned}$$

When $m > i + 1$, an analogous computation using the induction hypothesis shows the same equalities. The case of composition on the right is similar. □

2.2.3 Free action on a cellular extension

In this section, we use the formalism of contexts and contexts classes to define a left adjoint to the functor $\mathcal{U}: \text{Cat}_n^A \rightarrow \text{Cat}_n^+$. In the process, we give sufficient conditions for a monomorphism to be preserved by the free action functor $-[-]^A: \text{Cat}_n^+ \rightarrow \text{Cat}_n^A$ introduced above. Indeed, the image of a monomorphism (H, f) by $-[-]^A$ does not have to be a monomorphism since H is not necessarily injective on contexts and contexts classes, because of the quotients with the relations \approx_m . As shown below, it is sufficient to require moreover that H is a *Conduché functor*: those are the morphisms of Cat_n that uniquely “lift compositions of cells”. Consequently, they are better behaved regarding the relations \approx_m on contexts. We refer the reader to [Gue20] for a more extensive presentation of Conduché functors for strict n -categories. The resulting monomorphism preservation result of $-[-]^A$ will be useful when showing that the word problem on general polygraphs reduces to the one on finite polygraphs (*c.f.* Section 2.4.3).

2.2.3.1 – $(n+1)$ -categorical action structure. Let $n \in \mathbb{N}$. Given an n -cellular extension (C, X) , we define an n -categorical action $C[X]^A = (C, X^A)$ as follows: X^A is the set of pairs (g, F) with $g \in X$ and F an n -context class of type g . The n -source and n -target of such a pair (g, F) are defined respectively as the n -cells

$$\partial_n^-((g, F)) = F[d_n^-(g)] \quad \text{and} \quad \partial_n^+((g, F)) = F[d_n^+(g)].$$

so that (C, X^A) has a structure of n -cellular extension by Proposition 2.2.2.7. We extend the operations \bullet_i defined for n -context classes to such pairs by putting

$$u \bullet_i (g, F) = (g, u \bullet_i F) \quad \text{and} \quad (g, F) \bullet_i v = (g, F \bullet_i v)$$

for $i \in \mathbb{N}_{n-1}$ and $u, v \in C_{i+1}$ such that $u, (g, F)$ and $(g, F), v$ are i -composable. We then have:

Proposition 2.2.3.2. *The operations \bullet_i defined above equip $C[X]^A$ with the structure of an n -categorical action.*

Proof. This is a consequence of Proposition 2.2.2.11 and Proposition 2.2.2.12. \square

Remember that, by Remark 2.2.2.5, there are analogous notions of contexts, context classes and evaluations for categorical actions. We observe that:

Lemma 2.2.3.3. *Given $m \in \mathbb{N}_n, g \in X$ and an m -context class F of type g of C , we have*

$$F[(g, \bar{I}^g)] = (g, F_{\uparrow n})$$

where, for $k \in \mathbb{N}_n$ with $k \geq m$, $F_{\uparrow k}$ is the k -context class of type g defined inductively by

$$F_{\uparrow k} = \begin{cases} F & \text{if } k = m, \\ \llbracket (\text{id}_{F_{\uparrow k-1}[\partial_{k-1}^- (g)]}^k, F_{\uparrow k-1}, \text{id}_{F_{\uparrow k-1}[\partial_{k-1}^+ (g)]}^k) \rrbracket & \text{if } k > m. \end{cases}$$

In particular, if $m = n$, we have $F[(g, \bar{I}^g)] = (g, F)$.

Proof. By a simple induction on m . \square

With the above lemma, we can deduce the freeness of $C[X]^A$:

Proposition 2.2.3.4. *$C[X]^A$ is the free categorical action relatively to the forgetful functor \mathcal{U} .*

Proof. Given an n -categorical action (D, D') and a morphism

$$(H, h): (C, X) \rightarrow \mathcal{U}(D, D') \in \mathbf{Cat}_n^+$$

we define a function $h': X^A \rightarrow D'$ by putting $h'((g, F)) = H(F)[h(g)]$. By Propositions 2.2.2.2, 2.2.2.13 and 2.2.2.17, we obtain a morphism

$$(H, h'): (C, X^A) \rightarrow (D, D') \in \mathbf{Cat}_n^A.$$

Note that h can be recovered from h' since, for $g \in X$, we have

$$h(g) = \bar{I}^g[g] = h'((g, \bar{I}^g)).$$

Thus, the above construction defines a function

$$\Psi_{(D, D')} : \mathbf{Cat}_n^+((C, X), \mathcal{U}(D, D')) \rightarrow \mathbf{Cat}_n^A((C, X^A), (D, D'))$$

which is injective. It is moreover surjective since, by Proposition 2.2.2.16 and Lemma 2.2.3.3, any morphism

$$(\bar{H}, \bar{h}): (C, X^A) \rightarrow (D, D') \in \mathbf{Cat}_n^A$$

is uniquely determined by \bar{H} and the images of (g, \bar{I}^g) by \bar{h} . Finally, we observe that the function $\Psi_{(D, D')}$ is natural in (D, D') , so that $C[X]^A$ is indeed the free n -categorical action on (C, X) relatively to the forgetful functor \mathcal{U} . \square

The construction $(C, X) \mapsto C[X]^A$ of the above proof uniquely extends to a functor

$$-[-]^A: \mathbf{Cat}_n^+ \rightarrow \mathbf{Cat}_n^A$$

which is left adjoint to \mathcal{U} . Given $(H, h): (C, X) \rightarrow (D, Y)$ in \mathbf{Cat}_n^+ , the n -categorical action morphism

$$H[h]^A: C[X]^A \rightarrow D[Y]^A \in \mathbf{Cat}_n^A$$

is defined by

$$H[h]_i^A = H_i \quad \text{and} \quad H[h]_{n+1}^A((g, F)) = (h(g), H(F))$$

for $i \in \mathbb{N}_n$ and $(g, F) \in X^A$.

2.2.3.5 – Conduché functors. We now introduce Conduché functors, following the definition given in [Gue20]. Let $n \in \mathbb{N} \cup \{\omega\}$, $C, D \in \mathbf{Cat}_n$ and $F: C \rightarrow D$ be an n -functor. We say that F is n -Conduché when it satisfies that, for all $i, k \in \mathbb{N}_n$ with $i < k$, $u \in C_k$, i -composable $v_1, v_2 \in D_k$ such that $F(u) = v_1 *_i v_2$, there exist unique i -composable $u_1, u_2 \in C_k$ such that

$$F(u_1) = v_1 \quad \text{and} \quad F(u_2) = v_2 \quad \text{and} \quad u_1 *_i u_2 = u.$$

The Conduché property implies a unique lifting of identities:

Proposition 2.2.3.6. *If $F: C \rightarrow D$ is n -Conduché, then given $i, k \in \mathbb{N}_n$ with $i < k$, $u \in C_k$, and $v \in D_i$ such that $F(u) = \text{id}_v^k$, there exists a unique $u' \in C_i$ such that*

$$F(u') = v \quad \text{and} \quad u = \text{id}_{u'}^k,$$

Proof. We have $F(u) = \text{id}_v^k = \text{id}_v^k *_i \text{id}_v^k$ and u can be factorized as $\text{id}_{\partial_i^-(u)}^k *_i u$ and $u *_i \text{id}_{\partial_i^+(u)}^k$. Moreover,

$$F(\text{id}_{\partial_i^-(u)}^k) = \text{id}_{F(\partial_i^-(u))}^k = \text{id}_{\partial_i^-(F(u))}^k = \text{id}_v^k$$

and similarly,

$$F(\text{id}_{\partial_i^+(u)}^k) = \text{id}_v^k$$

so that, since F is n -Conduché, $u = \text{id}_{\partial_i^-(u)}^k$. Finally, if $u = \text{id}_{u'}^k$ for some $u' \in C_i$, then $u' = \partial_i^-(u)$, which shows unicity. \square

We can moreover characterize F as an n -Conduché using the precategorical structure of C and D :

Proposition 2.2.3.7. *The n -functor F is n -Conduché if and only if for all $i, k_1, k_2, k \in \mathbb{N}_n$ with*

$$i = \min(k_1, k_2) - 1 \quad \text{and} \quad k = \max(k_1, k_2),$$

and cells $u \in C_k$, $v_1 \in D_{k_1}$, $v_2 \in D_{k_2}$ such that v_1, v_2 are i -composable and $F(u) = v_1 \bullet_i v_2$, there exist unique $u_1 \in C_{k_1}$ and $u_2 \in C_{k_2}$ such that u_1, u_2 are i -composable and

$$F(u_1) = v_1, \quad F(u_2) = v_2 \quad \text{and} \quad u_1 \bullet_i u_2 = u.$$

Proof. Suppose that F is n -Conduché and let $i, k_1, k_2, k \in \mathbb{N}_n$ satisfying

$$i = \min(k_1, k_2) - 1 \quad \text{and} \quad k = \max(k_1, k_2),$$

and cells $u \in C_k$, $v_1 \in D_{k_1}$, $v_2 \in D_{k_2}$ such that v_1, v_2 are i -composable and $F(u) = v_1 \bullet_i v_2$. Then, $v_1 \bullet_i v_2 = \text{id}_{v_1}^k *_i \text{id}_{v_2}^k$, so, since F is n -Conduché and by Proposition 2.2.3.6, there exist unique $u_1 \in C_{k_1}$ and $u_2 \in C_{k_2}$ such that u_1, u_2 are i -composable and

$$F(u_1) = v_1, \quad F(u_2) = v_2 \quad \text{and} \quad u = \text{id}_{u_1}^k *_i \text{id}_{u_2}^k$$

where the latter equality is equivalent to $u = u_1 \bullet_i u_2$.

Conversely, suppose that F satisfies the unique lifting property of the statement. Let $i, k \in \mathbb{N}_n$ with $i < k$, $u \in C_k$ and $v_1, v_2 \in D_k$ such that v_1, v_2 are i -composable and $F(u) = v_1 *_i v_2$. We show by induction on $k - i$ that there are unique i -composable $u_1, u_2 \in C_k$ such that

$$F(u_1) = v_1, \quad F(u_2) = v_2 \quad \text{and} \quad u_1 *_i u_2 = u.$$

If $i = k - 1$, then $v_1 *_i v_2 = v_1 \bullet_i v_2$, so there exist unique $u_1, u_2 \in C_k$ such that u_1, u_2 are i -composable and $F(u_1) = v_1$, $F(u_2) = v_2$ and $u = u_1 \bullet_i u_2$, and the last equality is equivalent to $u = u_1 *_i u_2$. Otherwise, if $i < k - 1$, then

$$v_1 *_i v_2 = (v_1 \bullet_i \partial_{i+1}^-(v_2)) *_i (\partial_{i+1}^+(v_1) \bullet_i v_2)$$

so there exist unique i -composable $w_1, w_2 \in C_k$ such that

$$F(w_1) = (v_1 \bullet_i \partial_{i+1}^-(v_2)), \quad F(w_2) = (\partial_{i+1}^+(v_1) \bullet_i v_2) \quad \text{and} \quad w_1 *_i w_2 = u.$$

By the hypothesis on F , there exist unique i -composable cells $u_1 \in C_k$ and $u'_2 \in C_{i+1}$ such that

$$F(u_1) = v_1, \quad F(u'_2) = \partial_{i+1}^-(v_2) \quad \text{and} \quad u_1 \bullet_i u'_2 = w_1$$

and similarly, there exist unique i -composable $u'_1 \in C_{i+1}$ and $u_2 \in C_k$ such that

$$F(u'_1) = \partial_{i+1}^+(v_1), \quad F(u_2) = v_2 \quad \text{and} \quad u'_1 \bullet_i u_2 = w_2.$$

Moreover, we have

$$\begin{aligned} F(\partial_{i+1}^+(u_1)) &= \partial_{i+1}^+(v_1) = F(u'_1) \\ F(u'_2) &= \partial_{i+1}^-(v_2) = F(\partial_{i+1}^-(u_2)) \end{aligned}$$

and

$$\partial_{i+1}^+(u_1) \bullet_i u'_2 = \partial_{i+1}^+(w_1) = \partial_{i+1}^-(w_2) = u'_1 \bullet_i \partial_{i+1}^-(u_2)$$

so that, by the hypothesis on F , $\partial_{i+1}^+(u_1) = u'_1$ and $u'_2 = \partial_{i+1}^-(u_2)$. Thus,

$$u = (u_1 \bullet_i \partial_{i+1}^-(u_2)) *_i (\partial_{i+1}^+(u_1) \bullet_i u_2) = u_1 *_i u_2$$

For unicity, if there exist i -composable $\tilde{u}_1, \tilde{u}_2 \in C_k$ such that

$$F(\tilde{u}_1) = v_1, \quad F(\tilde{u}_2) = v_2 \quad \text{and} \quad u = \tilde{u}_1 *_i \tilde{u}_2$$

then

$$F(\tilde{u}_1 \bullet_i \partial_{i+1}^-(\tilde{u}_2)) = v_1 \bullet_i \partial_{i+1}^-(v_2) = F(w_1)$$

and

$$F(\partial_{i+1}^+(\tilde{u}_1) \bullet_i \tilde{u}_2) = \partial_{i+1}^+(v_1) \bullet_i v_2 = F(w_2)$$

so that, by the hypothesis on F ,

$$w_1 = \tilde{u}_1 \bullet_i \partial_{i+1}^-(\tilde{u}_2) \quad \text{and} \quad w_2 = \partial_{i+1}^+(\tilde{u}_1) \bullet_i \tilde{u}_2$$

and, using the hypothesis on F again, we deduce that $\tilde{u}_1 = u_1$ and $\tilde{u}_2 = u_2$, which concludes the induction. Hence, F is n -Conduché. \square

2.2.3.8 – Conduché categorical action morphisms. Let $n \in \mathbb{N}$. Anticipating the associated monomorphism preservation result for the left adjoint $\text{Cat}_n^A \rightarrow \text{Cat}_{n+1}$, we need to introduce a notion of Conduché morphism between n -categorical actions, so that the Conduché property will also be preserved by $-[-]^A$. Following Proposition 2.2.3.7, given two n -categorical actions $(C, C_{n+1}), (D, D_{n+1}) \in \text{Cat}_n^A$ and a morphism $(F, f): (C, C_{n+1}) \rightarrow (D, D_{n+1}) \in \text{Cat}_n^A$, we say that the morphism (F, f) is n -Conduché when F is n -Conduché and

- (i) for all $u \in C_{n+1}$, if $f(u) = \tilde{u}' \bullet_i \tilde{v}$ for some $i \in \mathbb{N}_{n-1}$, $\tilde{u} \in D_{n+1}$ and $\tilde{v} \in D_{i+1}$, then there exist unique i -composable $u' \in C_{n+1}$ and $v \in C_{i+1}$ such that

$$f(u') = \tilde{u}', \quad F(v) = \tilde{v} \quad \text{and} \quad u = u' \bullet_i v,$$

- (ii) for all $v \in C_{n+1}$, if $f(v) = \tilde{u} \bullet_i \tilde{v}'$ for some $i \in \mathbb{N}_{n-1}$, $\tilde{u} \in D_{i+1}$ and $\tilde{v}' \in D_{n+1}$, then there exist unique i -composable $u \in C_{i+1}$ and $v' \in C_{n+1}$ such that

$$F(u) = \tilde{u}, \quad f(v') = \tilde{v}' \quad \text{and} \quad v = u \bullet_i v'.$$

2.2.3.9 – Conduché functors and contexts. Let $n \in \mathbb{N} \cup \{\omega\}$. We now show that Conduché functors have several good properties regarding contexts and context classes. First, they lift the relations \approx_m that define the m -context classes:

Proposition 2.2.3.10. *Let $H: C \rightarrow D$ be a morphism in Cat_n such that H is an n -Conduché functor. Then, given $m \in \mathbb{N}_n$ and an m -context E_1 of C of type (u, u') and an m -context \tilde{E}_2 of D of type $(H(u), H(u'))$ such that $H(E_1) \approx_m \tilde{E}_2$, there exists an m -context E_2 of C of type (u, u') such that*

$$H(E_2) = \tilde{E}_2 \quad \text{and} \quad E_1 \approx_m E_2.$$

Proof. We prove this property using an induction on m . The property holds for $m \leq 1$, so suppose that $m \geq 2$. Let

$$(l_1, F_1, r_1) = E_1 \quad \text{and} \quad (\tilde{l}_2, \tilde{F}_2, \tilde{r}_2) = \tilde{E}_2.$$

By Remark 2.2.2.4, it is sufficient to prove the case where $H(E_1) \approx_m^1 \tilde{E}_2$. By the symmetry in the definition of \approx_m^1 , we can suppose that $(\approx\text{-L})$ is verified, so that there exist $\tilde{l}'_i, \tilde{r}'_i \in D_{m-1}$ for $i \in \{1, 2\}$ and an $(m-2)$ -context class \tilde{F}' and $\tilde{l}, \tilde{w}, \tilde{r} \in D_m$ such that

$$H(F_1) = \llbracket (\tilde{l}'_1, \tilde{F}', \tilde{r}'_1) \rrbracket \quad \text{and} \quad \tilde{F}_2 = \llbracket (\tilde{l}'_2, \tilde{F}', \tilde{r}'_2) \rrbracket$$

satisfying

$$\begin{aligned} H(l_1) &= \tilde{l} \bullet_{m-1} (\tilde{w} \bullet_{m-2} \tilde{F}'[H(u)] \bullet_{m-2} \tilde{r}'_1) & H(r_1) &= \tilde{r} \\ \tilde{l}_2 &= \tilde{l} & \tilde{r}_2 &= (\tilde{w} \bullet_{m-2} \tilde{F}'[H(u')] \bullet_{m-2} \tilde{r}'_2) \bullet_{m-1} \tilde{r} \\ \tilde{l}'_1 &= \partial_m^+(\tilde{w}) & \tilde{r}'_1 &= \tilde{r}'_2 \\ \tilde{l}'_2 &= \partial_m^-(\tilde{w}). \end{aligned}$$

By induction hypothesis, there is an $(m-1)$ -context (l'_1, F'_1, r'_1) of C such that

$$H(l'_1) = \tilde{l}'_1, \quad H(F'_1) = \tilde{F}', \quad H(r'_1) = \tilde{r}'_1 \quad \text{and} \quad F_1 = \llbracket (l'_1, F'_1, r'_1) \rrbracket.$$

Considering $H(l_1)$, since H is n -Conduché, there are unique $l, w \in C_m$ and $t, t' \in C_{m-1}$ such that

$$H(l) = \tilde{l}, \quad H(w) = \tilde{w}, \quad H(t) = \tilde{F}'[H(u)], \quad H(t') = \tilde{r}'_1 \quad \text{and} \quad l_1 = l \bullet_{m-1} (w \bullet_{m-2} t \bullet_{m-2} t').$$

By Proposition 2.2.2.15, we moreover have $H(t) = H(F'_1[u])$. We compute that

$$\partial_{m-1}^+(w) \bullet_{m-2} t \bullet_{m-2} t' = \partial_{m-1}^+(l_1) = l'_1 \bullet_{m-2} F'_1[u] \bullet_{m-2} r'_1$$

and

$$H(\partial_{m-1}^+(w)) = \partial_{m-1}^+(\tilde{w}) = \tilde{l}'_1$$

so that, since F is n -Conduché,

$$\partial_{m-1}^+(w) = l'_1, \quad t = F'_1[u] \quad \text{and} \quad t' = r'_1.$$

By putting

$$r = r_1, \quad l_2 = l, \quad l'_2 = \partial_m^-(w), \quad r'_2 = r'_1 \quad \text{and} \quad r_2 = (w \bullet_{m-1} F'[u'] \bullet_{m-1} r'_2) \bullet_m r$$

we have

$$H(r) = \tilde{r}, \quad H(l_2) = \tilde{l}_2, \quad H(l'_2) = \tilde{l}'_2, \quad H(r'_2) = \tilde{r}'_2 \quad \text{and} \quad H(r_2) = \tilde{r}_2.$$

Hence, by defining $F_2 = (l'_2, F', r'_2)$ and $E_2 = (l_2, F_2, r_2)$, considering $(\approx\text{-L})$, we have $H(E_2) = \tilde{E}_2$ and $E_1 \approx_m E_2$. \square

Moreover, the unique lifting property of Conduché functors can be extended to context and context class evaluations, as in:

Proposition 2.2.3.11. *Let $H: C \rightarrow D$ be a morphism in Cat_n such that H is an n -Conduché functor. Given $m, k \in \mathbb{N}_n$ with $m \leq k$, $u \in C_k$, $\tilde{v} \in D_k$ and an m -context \tilde{E} of type \tilde{v} of D ,*

(i) *if $H(u) = \tilde{E}[\tilde{v}]$, then there exist unique $v \in C_k$ and m -context E of type v of C such that*

$$H(v) = \tilde{v}, \quad H(E) = \tilde{E} \quad \text{and} \quad u = E[v],$$

(ii) *if $H(u) = \llbracket \tilde{E} \rrbracket[\tilde{v}]$, then there exist unique $v \in C_k$ and m -context class F of type v of C such that*

$$H(v) = \tilde{v}, \quad H(F) = \llbracket \tilde{E} \rrbracket \quad \text{and} \quad u = F[v].$$

Proof. We show this property by induction on m . If $m = 0$, the property holds. So suppose that $m > 0$. Let $(\tilde{l}, \tilde{F}', \tilde{r}) = \tilde{E}$. Assume first that $H(u) = \tilde{E}[\tilde{v}]$. Thus, $H(u) = \tilde{l} \bullet_{m-1} \tilde{F}'[\tilde{v}] \bullet_{m-1} \tilde{r}$, so that, since H is n -Conduché, there exist unique $l, r \in C_m$ and $w \in C_k$ such that

$$H(l) = \tilde{l}, \quad H(w) = \tilde{F}'[\tilde{v}], \quad H(r) = \tilde{r} \quad \text{and} \quad u = l \bullet_{m-1} w \bullet_{m-1} r.$$

By induction hypothesis, there are unique $v \in C_k$ and m -context class F' such that

$$H(v) = \tilde{v}, \quad H(F') = \tilde{F}' \quad \text{and} \quad w = F'[v]$$

thus, by putting $E = (l, F', r)$, we have $H(E) = \tilde{E}$ and $u = E[v]$, and the unicity of E and v follows from the unicity properties above, showing (i).

Now suppose that $H(u) = \llbracket \tilde{E} \rrbracket[\tilde{v}]$. In particular, we have $H(u) = \tilde{E}[\tilde{v}]$, and, by the first part, there exist $v \in C_k$ and an m -context E such that

$$H(v) = \tilde{v}, \quad H(E) = \tilde{E} \quad \text{and} \quad u = E[v]$$

and we moreover have $H(\llbracket E \rrbracket) = \llbracket \tilde{E} \rrbracket$ and $u = \llbracket E \rrbracket[v]$, which concludes existence. For unicity, suppose that there is $v' \in C_k$ and an m -context class F of type v' such that

$$H(v') = \tilde{v}, \quad H(F) = \llbracket \tilde{E} \rrbracket \quad \text{and} \quad u = F[v'].$$

Let E' be an m -context such that $F = \llbracket E' \rrbracket$. So $\tilde{E} \approx_m H(E')$, and, by Proposition 2.2.3.10, there exist an m -context \bar{E} such that

$$E \approx_m \bar{E} \quad \text{and} \quad H(\bar{E}) = H(E')$$

so we moreover have $u = \bar{E}[v]$. Since $u = E'[v']$, by the unicity property of the first part, we have $v = v'$ and $\bar{E} = E'$, which implies $\llbracket E \rrbracket = F$. Hence, (ii) holds. \square

In order for monomorphisms to be preserved by the functor $-[-]^A$, one needs the injectiveness on cells of such morphisms to extend to contexts and context classes. This is the case for Conduché monomorphisms:

Proposition 2.2.3.12. *Let $H: C \rightarrow D$ be a monomorphism in Cat_n which is moreover n -Conduché. Given $m \in \mathbb{N}_n$ and an m -type (u, u') , H induces an injective function between m -contexts (resp. m -context classes) of type (u, u') of C and m -contexts (resp. m -context classes) of type $(H(u), H(u'))$ of D .*

Proof. We prove this property by induction on m . When $m = 0$, the property holds. So suppose that $m > 0$. Let $E_1 = (l_1, F'_1, r_1)$ and $E_2 = (l_2, F'_2, r_2)$ be two m -contexts of type (u, u') such that $H(E_1) = H(E_2)$, i.e.,

$$H(l_1) = H(l_2), \quad H(F'_1) = H(F'_2) \quad \text{and} \quad H(r_1) = H(r_2).$$

Thus, since H is a monomorphism, $l_1 = l_2$ and $r_1 = r_2$, and, by induction hypothesis, $F'_1 = F'_2$.

Now let F_1 and F_2 be two m -context classes of type (u, u') of C such that $H(F_1) = H(F_2)$. Let E_1, E_2 be m -contexts of type (u, u') such that $F_1 = \llbracket E_1 \rrbracket$ and $F_2 = \llbracket E_2 \rrbracket$. Thus, we have that $H(E_1) \approx_m H(E_2)$ and, by Proposition 2.2.3.10, there exists an m -context \bar{E}_1 such that

$$H(\bar{E}_1) = H(E_2) \quad \text{and} \quad E_1 \approx_m \bar{E}_1$$

By the first part, $\bar{E}_1 = E_2$, so that $E_1 \approx_m E_2$, which implies $F_1 = F_2$. \square

Finally, since we aim at showing that monomorphic Conduché functors are preserved by $-[-]^A$, we prove that Conduché morphisms have a property of lifting of factorization of contexts and context classes analogous to the one on cells:

Proposition 2.2.3.13. *Let $H: C \rightarrow D$ be a morphism in Cat_n which is n -Conduché, $m \in \mathbb{N}_n$, (u, u') be an m -type of C , and E be an m -context of type (u, u') . Suppose that either H is a monomorphism or (u, u') is an instantiable type. We then have:*

- (i) *if $H(E) = \tilde{v} \bullet_i \tilde{E}'$ for some $i \in \mathbb{N}_{m-1}$, $\tilde{v} \in D_{i+1}$ and m -context \tilde{E}' of type $(H(u), H(u'))$, then there exist unique $v \in C_{i+1}$ and m -context E' of type (u, u') such that*

$$H(v) = \tilde{v}, \quad H(E') = \tilde{E}' \quad \text{and} \quad E = v \bullet_i E',$$

- (ii) *if $H(\llbracket E \rrbracket) = \tilde{v} \bullet_i \tilde{F}$ for some $i \in \mathbb{N}_{m-1}$, $\tilde{v} \in D_{i+1}$ and m -context class \tilde{F} of type $(H(u), H(u'))$, then there exist unique $v \in C_{i+1}$ and m -context F of type (u, u') such that*

$$H(v) = \tilde{v}, \quad H(F) = \tilde{F} \quad \text{and} \quad \llbracket E \rrbracket = v \bullet_i F.$$

and similarly for compositions on the right of contexts and context classes by cells.

Proof. We show the property by induction on m . The property holds for $m \leq 1$ so assume that $m > 1$. Let $E = (l, F, r)$ be an m -context of type (u, u') such that $H(E) = \tilde{v} \bullet_i \tilde{E}'$ for some $i \in \mathbb{N}_{m-1}$, $\tilde{v} \in D_{i+1}$ and m -context $\tilde{E}' = (\tilde{l}', \tilde{F}', \tilde{r}')$. If $i + 1 = m$, we then have

$$H(l) = \tilde{v} \bullet_{m-1} \tilde{l}', \quad H(F) = \tilde{F}' \quad \text{and} \quad H(r) = \tilde{r}'$$

thus, since H is n -Conduché, there are unique $v \in C_{i+1}$ and $l' \in C_m$ such that

$$H(v) = \tilde{v}, \quad H(l) = \tilde{l}' \quad \text{and} \quad l = v \bullet_i l'$$

so that $E = v \bullet_i E'$ with $E' = (l', F, r)$, and one easily check that the unicity property is verified. Otherwise, if $i + 1 < m$, we then have

$$H(l) = \tilde{v} \bullet_i \tilde{l}', \quad H(F) = \tilde{v} \bullet_i \tilde{F}', \quad \text{and} \quad H(r) = \tilde{v} \bullet_i \tilde{r}'.$$

By induction hypothesis and since H is n -Conduché, there are unique $v_1, v_2, v_3 \in C_{i+1}$, $l', r' \in C_m$ and $(m-1)$ -context class F' such that

$$\begin{array}{lll} \tilde{v} = H(v_1) & \tilde{v} = H(v_2) & \tilde{v} = H(v_3) \\ \tilde{l}' = H(l') & \tilde{F}' = H(F') & \tilde{r}' = H(r') \\ l = v_1 \bullet_i l' & F = v_2 \bullet_i F' & r = v_3 \bullet_i r'. \end{array}$$

Moreover,

$$v_1 \bullet_i \partial_{m-1}^+(l') = \partial_{m-1}^+(l) = F[u] = v_2 \bullet_i F'[u]$$

and

$$H(\partial_{m-1}^+(l')) = \partial_{m-1}^+(\tilde{l}') = \tilde{F}'[H(u)] = H(F'[u])$$

so that, since H is n -Conduché,

$$v_1 = v_2 \quad \text{and} \quad \partial_{m-1}^+(l') = F'[u]$$

Similarly,

$$v_2 = v_3 \quad \text{and} \quad F'[u'] = \partial_{m-1}^-(r')$$

so that $E = v_1 \bullet_i E'$ where $E' = (l', F', r')$, and the unicity of such a factorization is easily deduced from the unicity of v_1, l', r' and F' . Thus (i) holds.

Now, suppose that $H(\llbracket E \rrbracket) = \tilde{v} \bullet_i \tilde{F}$ for some $i \in \mathbb{N}_{m-1}$, $\tilde{v} \in D_{i+1}$ and $(m-1)$ -context class \tilde{F} . Let \tilde{E}' be an m -context such that $\tilde{F} = \llbracket \tilde{E}' \rrbracket$. Then, $H(E) \approx_m v \bullet_i \tilde{E}'$, so that, by Proposition 2.2.3.10, there exists an m -context \bar{E} of type (u, u') such that

$$H(\bar{E}) = \tilde{v} \bullet_i \tilde{E}' \quad \text{and} \quad E \approx_m \bar{E}.$$

Then, by the first part, there exist $v \in C_{i+1}$ and an m -context E' of type (u, u') such that

$$H(v) = \tilde{v}, \quad H(E') = \tilde{E}' \quad \text{and} \quad \bar{E} = v \bullet_i E'.$$

Thus, by putting $F = \llbracket E' \rrbracket$, we have $\llbracket E \rrbracket = v \bullet_i F$. Suppose now that

$$H(\bar{v}) = \tilde{v}, \quad H(\bar{F}) = F \quad \text{and} \quad \llbracket E \rrbracket = \bar{v} \bullet_i \bar{F}$$

for some $\bar{v} \in C_{i+1}$ and m -context class \bar{F} of type (u, u') . If H is a monomorphism, then, by Proposition 2.2.3.12, we have $\bar{v} = v$ and $\bar{F} = F$. Otherwise, if $(u, u') = (\partial_{m-1}^-(w), \partial_{m-1}^+(w))$ for some $w \in C_m$, then, by Proposition 2.2.2.13 and Proposition 2.2.2.15, we have

$$\bar{v} \bullet_i \bar{F}[w] = E[w] = v \bullet_i F[w] \quad \text{and} \quad H(\bar{F}[w]) = \tilde{F}[H(w)] = H(F[w])$$

so that, since H is n -Conduché, we have $\bar{v} = v$ and $\bar{F}[w] = F[w]$. Moreover, since

$$H(\bar{F}) = \tilde{F} = H(F)$$

we have $\bar{F} = F$ by Proposition 2.2.3.11. Hence, (ii) holds. \square

2.2.3.14 – Monomorphism preservation. Let $n \in \mathbb{N}$. From the above properties on contexts and context classes, we finally deduce a preservation property of monomorphisms of cellular extension by the free action functor:

Proposition 2.2.3.15. *Let $(H, h): (C, X) \rightarrow (D, Y)$ be a monomorphism in Cat_n^+ , such that H is n -Conduché. The n -categorical action morphism $H[h]^A$ is a monomorphism and an n -Conduché morphism of Cat_n^A .*

Proof. Since (H, h) is a monomorphism, both

$$H: C \rightarrow D \in \text{Cat}_n \quad \text{and} \quad h: X \rightarrow Y \in \text{Set}$$

are monomorphisms. Since $H[h]_{n+1}^A((g, F)) = (h(g), H(F))$ for $(g, F) \in X^A$, we have that $H[h]^A$ is a monomorphism by Proposition 2.2.3.12. And it is n -Conduché as a consequence of Proposition 2.2.3.13. \square

2.2.4 Free $(n+1)$ -categories on n -categorical actions

There is a forgetful functor

$$\mathcal{U}' : \text{Cat}_{n+1} \rightarrow \text{Cat}_n^A$$

which maps an $(n+1)$ -category C to an n -categorical action $(C_{\leq n}, C_{n+1})$ by forgetting the \bullet_n operation (where we consider the $(n+1)$ -precategory structure of C). Since \mathcal{U}' is obviously derived from an essentially algebraic theory morphism, this functor has a left adjoint $-[-]^\approx : \text{Cat}_n^A \rightarrow \text{Cat}_{n+1}$ by Theorem 1.1.2.7. In this section, given $(C, A) \in \text{Cat}_n^A$, we show that the $(n+1)$ -cells of $C[A]^\approx$ can be described as sequences of composable elements of A that are adequately quotiented. Moreover, we prove preservation properties of monomorphisms and Conduché functors for $-[-]^\approx$ that are analogous to the ones proved in the previous section for $-[-]^A$.

2.2.4.1 – Sequences. Let $n \in \mathbb{N}$ and $(C, A) \in \text{Cat}_n^A$. We define the set A^\star of n -composable sequences (or simply, n -sequences) of (C, A) as the set of terms of the form

$$(u_1, \dots, u_k)^s$$

for some $k \in \mathbb{N}$ and $u_1, \dots, u_k \in A$ such that u_1, \dots, u_k are n -composable. When $k = 0$, by convention, there is an empty sequence $()_u^s$ for each $u \in C_n$. Given $v = (v_1, \dots, v_k)^s \in A^\star$, we say that k is the *length* of v and we write $|v|$ for k . Moreover, we define a source $\partial_n^-(v)$ and a target $\partial_n^+(v)$ for v by putting

$$\partial_n^-(v) = \partial_n^-(v_1) \quad \text{and} \quad \partial_n^+(v) = \partial_n^+(v_k)$$

where, by convention, if $v = ()_u^s$ for some $u \in C_n$, then $\partial_n^-(v) = \partial_n^+(v) = u$. Thus, we obtain an n -cellular extension whose set of $(n+1)$ -globes is A^\star and whose underlying n -category is C . We now define composition operations for the n -sequences. Given $i \in \mathbb{N}_{n-1}$, a cell $u \in C_{i+1}$ and an n -sequence $v = (v_1, \dots, v_l)^s \in A^\star$ such that u, v are i -composable, we put

$$u \bullet_i v = (u \bullet_i v_1, \dots, u \bullet_i v_l)^s$$

where, by convention, if $v = ()_{\tilde{v}}^s$ for some $\tilde{v} \in C_n$, then $u \bullet_i v = ()_{u \bullet_i \tilde{v}}^s$. Given n -composable n -sequences $u = (u_1, \dots, u_k)^s$ and $v = (v_1, \dots, v_l)^s$ in A^\star , we put

$$u \bullet_n v = (u_1, \dots, u_k, v_1, \dots, v_l)^s.$$

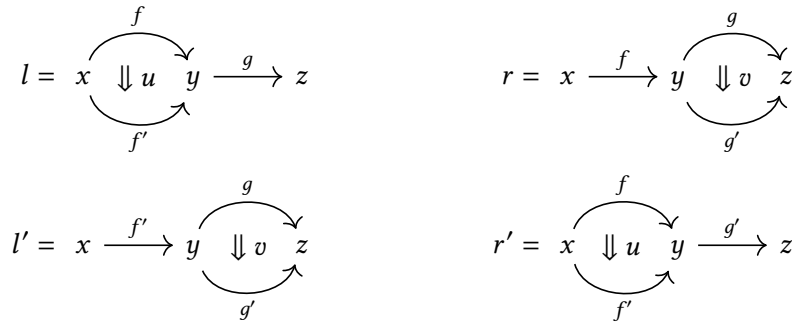

Figure 2.2 – A configuration of 2-cells l, l', r, r', u, v such that $\mathcal{X}(l, l', r, r', u, v)$

In order to obtain a strict $(n+1)$ -category from C and A^\star , we need to quotient A^\star so that the exchange condition (E) on precategories holds (c.f. Theorem 1.4.3.8). For this purpose, we define a relation

$$\mathcal{X} \subseteq A^6$$

such that, given $l, l', r, r', u, v \in A$, $\mathcal{X}(l, l', r, r', u, v)$ holds when u, v are $(n-1)$ -composable and the following equalities hold in A

$$\begin{aligned} l &= u \bullet_{n-1} \partial_n^-(v) & r &= \partial_n^-(u) \bullet_{n-1} v \\ l' &= \partial_n^+(u) \bullet_{n-1} v & r' &= u \bullet_{n-1} \partial_n^+(v). \end{aligned}$$

In Figure 2.2, we illustrate this condition in the case of a 1-categorical action. Given $l, l', r, r' \in A$, we write $\mathcal{X}(l, l', r, r')$ when there exist $u, v \in A$ such that we have $\mathcal{X}(l, l', r, r', u, v)$. We define an equivalence relation \approx on A^\star as the reflexive symmetric transitive closure of \approx^1 , where, for $l = (l_1, \dots, l_k)^s$ and $r = (r_1, \dots, r_k)^s$ in A^\star , $l \approx^1 r$ when there is $i \in \mathbb{N}_{k-1}^*$ such that

$$\mathcal{X}(l_i, l_{i+1}, r_i, r_{i+1}) \quad \text{and} \quad l_j = r_j \text{ for } j \in \mathbb{N}_k^* \setminus \{i, i+1\}.$$

We write A^\approx for the quotient set A^\star / \approx of n -sequence classes and write

$$\llbracket - \rrbracket : A^\star \rightarrow A^\approx$$

for the associated projection. We remark that, if $u, v \in A^\star$ are such that $u \approx v$, then $|u| = |v|$. Thus, the length given for the members of A^\star induces a *length* for the members of A^\approx .

Remark 2.2.4.2. The relation \approx^{-1} on A^\star , which is defined by $u \approx^{-1} v$ when $v \approx^1 u$ for all $u, v \in A^\star$, admits a definition which is symmetrical to the one of \approx^1 . Moreover, \approx can be equivalently described as the reflexive transitive closure of $\approx^1 \cup \approx^{-1}$, so that, in the proofs, by symmetry of the definitions of \approx^1 and \approx^{-1} , we can often reduce a case analysis of $u \approx v$ to $u \approx^1 v$.

Note that the operations ∂_n^ϵ for $\epsilon \in \{-, +\}$ on A^\star are compatible with the relation \approx , so that they are well-defined on A^\approx as well. Thus, we obtain an n -cellular extension $C[A]^\approx$ by extending the strict n -category C with A^\approx . The operations \bullet_i for $i \in \mathbb{N}_{n-1}$ and \bullet_n defined for A^\star are compatible with the relation \approx , so that they are well-defined on $C[A]_{n+1}^\approx = A^\approx$ as well. We add an identity operation by putting $\text{id}_u^{n+1} = \llbracket (\cdot)_u^s \rrbracket$ for $u \in C_n$. We then have:

Proposition 2.2.4.3. *The operations id^{n+1} and \bullet_i for $i \in \mathbb{N}_n$ defined above equip $C[A]^\approx$ with a structure of an $(n+1)$ -precategory.*

Proof. The axioms of $(n+1)$ -precategories are then easily verified from the definition of A^\star and since $C[A]_{\leq n}^{\approx} = C$ is an n -precategory. \square

More importantly, we have

Proposition 2.2.4.4. $C[A]_{\approx}^{\approx}$ has a structure of $(n+1)$ -category.

Proof. We prove the criterion (E) that characterizes $(n+1)$ -categories among $(n+1)$ -precategories by Theorem 1.4.3.8. This criterion is already satisfied by C , so that it is enough to verify it on $(n+1)$ -cells. Given $u \in C[A]_{n+1}^{\approx}$ (resp. $v \in C[A]_{n+1}^{\approx}$), we write $P^L(u)$ (resp. $P^R(v)$) when we have

$$(u \bullet_{i-1} \partial_i^-(v)) \bullet_i (\partial_i^+(u) \bullet_{i-1} v) = (\partial_i^-(u) \bullet_{i-1} v) \bullet_i (u \bullet_{i-1} \partial_i^+(v)) \quad (2.6)$$

for all $i \in \mathbb{N}_n^*$ and $v \in C[A]_{i+1}^{\approx}$ (resp. $u \in C[A]_{i+1}^{\approx}$) such that u, v are i -composable. Note that (E) is satisfied if and only if $P^L(u)$ and $P^R(u)$ for all $u \in C[A]_{n+1}^{\approx}$. By symmetry, we only prove that $P^L(u)$ for all $u \in C[A]_{n+1}^{\approx}$. We first show that, given $u \in C_n$,

$$P^L(\text{id}_u^{n+1}) \text{ holds.} \quad (2.7)$$

Indeed, for all $i \in \mathbb{N}_{n-1}^*$ and $v \in C_{i+1}$ such that u, v are $(i-1)$ -composable, we have

$$\begin{aligned} & (\text{id}_u^{n+1} \bullet_{i-1} \partial_i^-(v)) \bullet_i (\partial_i^+(\text{id}_u^{n+1}) \bullet_{i-1} v) \\ &= \text{id}^{n+1}(u \bullet_{i-1} \partial_i^-(v)) \bullet_i (\partial_i^+(u) \bullet_{i-1} v) \\ &= \text{id}^{n+1}((u \bullet_{i-1} \partial_i^-(v)) \bullet_i (\partial_i^+(u) \bullet_{i-1} v)) \\ &= \text{id}^{n+1}((\partial_i^-(u) \bullet_{i-1} v) \bullet_i (u \bullet_{i-1} \partial_i^+(v))) && \text{(by (E) in } C) \\ &= (\partial_i^-(u) \bullet_{i-1} v) \bullet_i \text{id}^{n+1}(u \bullet_{i-1} \partial_i^+(v)) \\ &= (\partial_i^-(u) \bullet_{i-1} v) \bullet_i (\text{id}^{n+1}(u) \bullet_{i-1} \partial_i^+(v)) \end{aligned}$$

and, for all $v \in C_{n+1}$ such that u, v are $(n-1)$ -composable, we have

$$\begin{aligned} & (\text{id}_u^{n+1} \bullet_{n-1} \partial_n^-(v)) \bullet_n (\partial_n^+(\text{id}_u^{n+1}) \bullet_{n-1} v) \\ &= \text{id}_{n+1}(u \bullet_{n-1} \partial_n^-(v)) \bullet_n (\partial_n^+(\text{id}_u^{n+1}) \bullet_{n-1} v) \\ &= u \bullet_{n-1} (v) \\ &= (\partial_n^-(\text{id}_u^{n+1}) \bullet_{n-1} (v)) \bullet_n \text{id}^{n+1}(u \bullet_{n-1} \partial_n^+(v)) \\ &= (\partial_n^-(\text{id}_u^{n+1}) \bullet_{n-1} (v)) \bullet_n (\text{id}_u^{n+1} \bullet_{n-1} \partial_n^+(v)) \end{aligned}$$

thus (2.7) holds. Now, we show that, given n -composable $u_1, u_2 \in C[A]_{n+1}^{\approx}$,

$$P^L(u_1) \text{ and } P^L(u_2) \text{ implies } P^L(u_1 \bullet_n u_2). \quad (2.8)$$

Indeed, if $P^L(u_1)$ and $P^L(u_2)$ hold, then, for $i \in \mathbb{N}_{n-1}^*$ and $v \in C_{i+1}$ such that u_1, v is $(i-1)$ -composable, we have

$$\begin{aligned} & [(u_1 \bullet_n u_2) \bullet_{i-1} \partial_i^-(v)] \bullet_i (\partial_i^+(u_1 \bullet_n u_2) \bullet_{i-1} v) \\ &= [(u_1 \bullet_{i-1} \partial_i^-(v)) \bullet_n (u_2 \bullet_{i-1} \partial_i^-(v))] \bullet_i (\partial_i^+(u_1 \bullet_n u_2) \bullet_{i-1} v) \\ &= [(u_1 \bullet_{i-1} \partial_i^-(v)) \bullet_i (\partial_i^+(u_1 \bullet_n u_2) \bullet_{i-1} v)] \bullet_n [(u_2 \bullet_{i-1} \partial_i^-(v)) \bullet_i (\partial_i^+(u_1 \bullet_n u_2) \bullet_{i-1} v)] \\ &= [(u_1 \bullet_{i-1} \partial_i^-(v)) \bullet_i (\partial_i^+(u_1) \bullet_{i-1} v)] \bullet_n [(u_2 \bullet_{i-1} \partial_i^-(v)) \bullet_i (\partial_i^+(u_2) \bullet_{i-1} v)] \\ &= [(\partial_i^-(u_1 \bullet_n u_2) \bullet_{i-1} v) \bullet_i (u_1 \bullet_{i-1} \partial_i^+(v))] \bullet_n [(\partial_i^-(u_1 \bullet_n u_2) \bullet_{i-1} v) \bullet_i (u_2 \bullet_{i-1} \partial_i^+(v))] \\ & && \text{(by } P^L(u_1) \text{ and } P^L(u_2)) \\ &= (\partial_i^-(u_1 \bullet_n u_2) \bullet_{i-1} v) \bullet_i [(u_1 \bullet_{i-1} \partial_i^+(v)) \bullet_n (u_2 \bullet_{i-1} \partial_i^+(v))] \end{aligned}$$

$$= (\partial_i^-(u_1 \bullet_n u_2) \bullet_{i-1} v) \bullet_i [(u_1 \bullet_n u_2) \bullet_{i-1} \partial_i^+(v)]$$

and, for $v \in C[A]_{n+1}^\approx$ such that u_1 and v are $(n-1)$ -composable, we have

$$\begin{aligned} & [(u_1 \bullet_n u_2) \bullet_{n-1} \partial_n^-(v)] \bullet_n (\partial_n^+(u_1 \bullet_n u_2) \bullet_{n-1} v) \\ &= [(u_1 \bullet_{n-1} \partial_n^-(v)) \bullet_n (u_2 \bullet_{n-1} \partial_n^-(v))] \bullet_n (\partial_n^+(u_1 \bullet_n u_2) \bullet_{n-1} v) \\ &= [(u_1 \bullet_{n-1} \partial_n^-(v)) \bullet_n (u_2 \bullet_{n-1} \partial_n^-(v))] \bullet_n (\partial_n^+(u_2) \bullet_{n-1} v) \\ &= (u_1 \bullet_{n-1} \partial_n^-(v)) \bullet_n [(u_2 \bullet_{n-1} \partial_n^-(v)) \bullet_n (\partial_n^+(u_2) \bullet_{n-1} v)] \\ &= (u_1 \bullet_{n-1} \partial_n^-(v)) \bullet_n [(\partial_n^-(u_2) \bullet_{n-1} v) \bullet_n (u_2 \bullet_{n-1} \partial_n^+(v))] && \text{(by } P^L(u_2)) \\ &= [(u_1 \bullet_{n-1} \partial_n^-(v)) \bullet_n (\partial_n^+(u_1) \bullet_{n-1} v)] \bullet_n (u_2 \bullet_{n-1} \partial_n^+(v)) \\ &= [(\partial_n^-(u_1) \bullet_{n-1} v) \bullet_n (u_1 \bullet_{n-1} \partial_n^+(v))] \bullet_n (u_2 \bullet_{n-1} \partial_n^+(v)) && \text{(by } P^L(u_1)) \\ &= (\partial_n^-(u_1 \bullet_n u_2) \bullet_{n-1} v) \bullet_n [(u_1 \bullet_{n-1} \partial_n^+(v)) \bullet_n (u_2 \bullet_{n-1} \partial_n^+(v))] \\ &= (\partial_n^-(u_1 \bullet_n u_2) \bullet_{n-1} v) \bullet_n [(u_1 \bullet_n u_2) \bullet_{n-1} \partial_n^+(v)] \end{aligned}$$

thus, (2.8) holds.

Hence, it is enough to show $P^L(u)$ for $u = \llbracket (u')^s \rrbracket$ with $u' \in A$. Given $i \in \mathbb{N}_{n-1}^*$ and $v \in C_{i+1}$ such that u, v are $(i-1)$ -composable, the equality (2.6) holds since we have

$$(u' \bullet_{i-1} \partial_i^-(v)) \bullet_i (\partial_i^+(u') \bullet_{i-1} v) = (\partial_i^-(u') \bullet_{i-1} v) \bullet_i (u' \bullet_i \partial_{i+1}^+(v))$$

by Axiom (A-iv). We show that (2.6) holds for $v = \llbracket (v_1, \dots, v_k)^s \rrbracket \in C[A]_{n+1}^\approx$ such that u, v are $(n-1)$ -composable, using an induction on $k \in \mathbb{N}$. The case $k = 0$ corresponds to $v = \text{id}_v^{n+1}$ for some cell $\tilde{v} \in C_n$, and, by a similar argument than the one used to show (2.7), we have that (2.6) holds. When $k > 0$, given $v' = \llbracket (v_2, \dots, v_k)^s \rrbracket$, we have

$$\begin{aligned} & (u \bullet_{n-1} \partial_n^-(v)) \bullet_n (\partial_n^+(u) \bullet_{n-1} v) \\ &= (\llbracket (u')^s \rrbracket \bullet_{n-1} \partial_n^-(v_1)) \bullet_n (\partial_n^+(u') \bullet_{n-1} \llbracket (v_1)^s \rrbracket) \bullet_n (\partial_n^+(u) \bullet_{n-1} v') && \text{(since } v = \llbracket (v_1)^s \rrbracket \bullet_n v') \\ &= \llbracket (u' \bullet_{n-1} \partial_n^-(v_1), \partial_n^+(u') \bullet_{n-1} v_1)^s \rrbracket \bullet_n (\partial_n^+(u) \bullet_{n-1} v') \\ &= \llbracket (\partial_n^-(u') \bullet_{n-1} v_1, u' \bullet_{n-1} \partial_n^+(v_1))^s \rrbracket \bullet_n (\partial_n^+(u) \bullet_{n-1} v') && \text{(by the definition of } \approx) \\ &= (\partial_n^-(u) \bullet_{n-1} \llbracket (v_1)^s \rrbracket) \bullet_n (u \bullet_{n-1} \partial_n^+(v_1)) \bullet_n (\partial_n^+(u) \bullet_{n-1} v') \\ &= (\partial_n^-(u) \bullet_{n-1} \llbracket (v_1)^s \rrbracket) \bullet_n (u \bullet_{n-1} \partial_n^-(v')) \bullet_n (\partial_n^+(u) \bullet_{n-1} v') \\ &= (\partial_n^-(u) \bullet_{n-1} \llbracket (v_1)^s \rrbracket) \bullet_n (\partial_n^-(u) \bullet_{n-1} v') \bullet_n (u \bullet_{n-1} \partial_n^+(v')) && \text{(by induction hypothesis)} \\ &= (\partial_n^-(u) \bullet_{n-1} v) \bullet_n (u \bullet_{n-1} \partial_n^+(v)) && \text{(since } v = \llbracket (v_1)^s \rrbracket \bullet_n v') \end{aligned}$$

thus (2.6) holds, which concludes the proof of $P^L(u)$. Hence, $C[A]^\approx$ is an $(n+1)$ -precategory satisfying (E), so it is an $(n+1)$ -category by Theorem 1.4.3.8. \square

Finally, we show that this construction is universal:

Proposition 2.2.4.5. *$C[A]^\approx$ is the free $(n+1)$ -category on the action (C, A) relatively to the forgetful functor \mathcal{U}' .*

Proof. Let D be an $(n+1)$ -category and $(F, f): (C, A) \rightarrow (D_{\leq n}, D_{n+1})$ be a morphism of n -categorical action. We define an $(n+1)$ -functor $G: C[A]^\approx \rightarrow D$ such that $G_{\leq n} = F$. We first define G on A^* by putting

$$G((u)_u^s) = \text{id}_{F(u)}^{n+1} \qquad G((v_1, \dots, v_k)^s) = f(v_1) \bullet_n \cdots \bullet_n f(v_k)$$

for $u \in C_n$ and n -composable v_1, \dots, v_k for some $k \in \mathbb{N}^*$. Now, given $u, u' \in A$ that are $(n-1)$ -composable, we have

$$\begin{aligned} & [f(u) \bullet_{n-1} F(\partial_n^-(u'))] \bullet_n [F(\partial_n^+(u)) \bullet_{n-1} f(u')] \\ &= [F(\partial_n^-(u)) \bullet_{n-1} f(u')] \bullet_n [f(u) \bullet_{n-1} F(\partial_n^+(u'))] \end{aligned}$$

by (E) on D . Thus, given $u = (u_1, \dots, u_k)^s$ and $v = (v_1, \dots, v_l)^s$ in A^\star such that $u \approx v$, we have $G(u) = G(v)$, so that G is well-defined on $C[A]_{n+1}^\approx = A^\star / \approx$, and it is easily shown to be an $(n+1)$ -functor. The operation $(F, f) \mapsto G$ defined above induces a function

$$\theta_D : \mathbf{Cat}_n^A((C, A), (D_{\leq n}, D_{n+1})) \rightarrow \mathbf{Cat}_{n+1}(C[A]^\approx, D)$$

which is natural in D . Note that θ_D is injective, since $f(u) = G(\llbracket (u)^s \rrbracket)$ for every $u \in A$. It is moreover surjective since a $(n+1)$ -functor $H : C[A]^\approx \rightarrow D$ is uniquely determined by $H_{\leq n}$ and $(H(\llbracket (u)^s \rrbracket))_{u \in A}$. So $C[A]^\approx$ is the free $(n+1)$ -category on the n -categorical action (C, A) . \square

In the following, for all n -categorical action (C, A) , we write $C[A]^\approx$ for $C[A]^\approx$ as above. The construction $(C, A) \mapsto C[A]^\approx$ uniquely extends to a functor

$$-[-]^\approx : \mathbf{Cat}_n^A \rightarrow \mathbf{Cat}_{n+1}$$

which is left adjoint to \mathcal{U}' . Given $(H, h) : (C, A) \rightarrow (D, B)$ in \mathbf{Cat}_n^+ , the $(n+1)$ -functor

$$H[h]^\approx : C[A]^\approx \rightarrow D[B]^\approx \in \mathbf{Cat}_{n+1}$$

is defined by

$$H[h]_i^\approx = H_i \quad \text{and} \quad H[h]_{n+1}^\approx(\llbracket (u_1, \dots, u_k)^s \rrbracket) = \llbracket (h(u_1), \dots, h(u_k))^s \rrbracket$$

for $i \in \mathbb{N}_n$ and $(u_1, \dots, u_k)^s \in A^\star$.

2.2.4.6 – Monomorphism preservation. In this section, we complete the monomorphism preservation result for $-[-]^A$ given in Proposition 2.2.3.15 with a similar one for $-[-]^\approx$. Like for $-[-]^A$, the functor $-[-]^\approx$ does not have to preserve monomorphisms in general because of the quotient with \approx of the $(n+1)$ -cells. However, as we will prove, it preserves monomorphisms that are moreover Conduché. Indeed, the latter are well-behaved regarding the relation \approx since they can “lift” it.

Let $n \in \mathbb{N}$ and $(F, f) : (C, A) \rightarrow (D, B)$ be a morphism in \mathbf{Cat}_n^A . We write

$$f^\star : A^\star \rightarrow B^\star$$

for the function which maps $(u_1, \dots, u_k)^s \in A^\star$ to $(f(u_1), \dots, f(u_k))^s \in B^\star$. Moreover, we write

$$f^\approx : A^\approx \rightarrow B^\approx$$

for $F[f]_{n+1}^\approx$. We first prove a lifting property for \approx :

Proposition 2.2.4.7. *If (F, f) is a monomorphism and n -Conduché, we then have*

- (i) *for all $l, l' \in A$ and $\tilde{r}, \tilde{r}' \in B$ such that $X(f(l), f(l'), \tilde{r}, \tilde{r}')$, there exist unique $r, r' \in A$ such that $f(r) = \tilde{r}$, $f(r') = \tilde{r}'$ and $X(l, l', r, r')$,*
- (ii) *for all $t \in A^\star$ and $\tilde{t}' \in B^\star$ such that $f^\star(t) \approx \tilde{t}'$, there is a unique $t' \in A^\star$ such that $f^\star(t') = \tilde{t}'$ and $t \approx t'$.*

Proof. Let $l, l' \in A$ and $\tilde{r}, \tilde{r}' \in B$ such that $\mathcal{X}(f(l), f(l'), \tilde{r}, \tilde{r}')$. So there exist $\tilde{u}, \tilde{v} \in B$ satisfying

$$\begin{aligned} f(l) &= \tilde{u} \bullet_{n-1} \partial_n^-(\tilde{v}) & \tilde{r} &= \partial_n^-(\tilde{u}) \bullet_{n-1} \tilde{v} \\ f(l') &= \partial_n^+(\tilde{u}) \bullet_{n-1} \tilde{v} & \tilde{r}' &= \tilde{u} \bullet_{n-1} \partial_n^+(\tilde{v}). \end{aligned}$$

Since (F, f) is n -Conduché and a monomorphism, there exist $u, v \in A$ such that

$$\begin{aligned} \tilde{u} &= f(u) & l &= u \bullet_{n-1} \partial_n^-(v) \\ \tilde{v} &= f(v) & l' &= \partial_n^+(u) \bullet_{n-1} v. \end{aligned}$$

By putting $r = \partial_n^-(u) \bullet_{n-1} v$ and $r' = u \bullet_{n-1} \partial_n^+(v)$, we have $f(r) = \tilde{r}$ and $f(r') = \tilde{r}'$ and $\mathcal{X}(l, l', r, r')$. The unicity of r, r' comes from the fact that f is a monomorphism. Thus (i) holds.

Now let $t \in A^*$ and $\tilde{t}' \in B^*$ such that $f^*(t) \approx \tilde{t}'$. By Remark 2.2.4.2, it is enough handle the case where $f^*(t) \approx^1 \tilde{t}'$. So suppose that $f^*(t) \approx^1 \tilde{t}'$. By (i), there is $t' \in A^*$ such that $f^*(t') = \tilde{t}'$ and $t \approx t'$. The unicity of t' comes from the fact that f^* is a monomorphism. Thus (ii) holds. \square

We then deduce a monomorphism preservation result for $-[-]^\approx$:

Proposition 2.2.4.8. *If (F, f) is a monomorphism and n -Conduché, then the $(n+1)$ -functor $F[f]^\approx$ is a monomorphism.*

Proof. Let $u, u' \in A^\approx$ such that $f^\approx(u) = f^\approx(u')$, and $t, t' \in A^*$ such that $\llbracket t \rrbracket = u$ and $\llbracket t' \rrbracket = u'$. Note that $f^*(t) \approx f^*(t')$. By Proposition 2.2.4.7(ii), there exists $\bar{t} \in A^*$ such that

$$f^*(\bar{t}) = f^*(t') \quad \text{and} \quad t \approx \bar{t}.$$

Since f is injective, f^* is too. Thus, we have $\bar{t} = t'$, so that $u = u'$. \square

Moreover, Conduché functors are also preserved:

Proposition 2.2.4.9. *If (F, f) is a monomorphism and n -Conduché, then the $(n+1)$ -functor $F[f]^\approx$ is $(n+1)$ -Conduché.*

Proof. We use the characterization of $(n+1)$ -Conduché functor given by Proposition 2.2.3.7. First, let $u \in A^\approx$ such that $f^\approx(u) = \tilde{v} \bullet_i \tilde{u}'$ for some $i \in \mathbb{N}_{n-1}$, $\tilde{v} \in D_{i+1}$ and $\tilde{u}' \in B^\approx$. Given $t \in A^*$ and $\tilde{t}' \in B^*$ such that $\llbracket t \rrbracket = u$ and $\llbracket \tilde{t}' \rrbracket = \tilde{u}'$, we have

$$f^*(t) \approx \tilde{v} \bullet_i \tilde{t}'$$

so that, by Proposition 2.2.4.7(ii), there exists $\bar{t} \in A^*$ such that

$$f^*(\bar{t}) = \tilde{v} \bullet_i \tilde{t}' \quad \text{and} \quad t \approx \bar{t}.$$

Since (F, f) is monomorphic and n -Conduché, there exist $v \in C_{i+1}$ and $t' \in B^*$ such that

$$F(v) = \tilde{v}, \quad f^*(t') = \tilde{t}' \quad \text{and} \quad \bar{t} = v \bullet_i t'.$$

Hence, putting $u' = \llbracket t' \rrbracket$, we have $f^\approx(u') = \tilde{u}'$ and $u = v \bullet_i u'$. The unicity of v and u' is a consequence of Proposition 2.2.4.8.

Now, let $u \in A^\approx$ such that $f^\approx(u) = \tilde{u}_1 \bullet_n \tilde{u}_2$ for some $\tilde{u}_1, \tilde{u}_2 \in B^\approx$. Given $t \in A^*$ and $\tilde{t}_1, \tilde{t}_2 \in B^*$ such that $\llbracket t \rrbracket = u$, $\llbracket \tilde{t}_1 \rrbracket = \tilde{u}_1$ and $\llbracket \tilde{t}_2 \rrbracket = \tilde{u}_2$, we have

$$f^*(t) \approx \tilde{t}_1 \bullet_n \tilde{t}_2$$

so that, by Proposition 2.2.4.7(ii), there exists $\bar{t} \in A^*$ such that $f^*(\bar{t}) = \tilde{t}_1 \bullet_n \tilde{t}_2$. Since \bullet_n is defined as concatenation of lists on A^* , there are $t_1, t_2 \in A^*$ such that

$$f^*(t_1) = \tilde{t}_1, \quad f^*(t_2) = \tilde{t}_2 \quad \text{and} \quad \bar{t} = t_1 \bullet t_2.$$

By putting $u_1 = \llbracket t_1 \rrbracket$ and $u_2 = \llbracket t_2 \rrbracket$, we have $f^\approx(u_1) = \tilde{u}_1$, $f^\approx(u_2) = \tilde{u}_2$ and $u = u_1 \bullet_n u_2$. The unicity of u_1, u_2 is a consequence of Proposition 2.2.4.8. We conclude using Proposition 2.2.3.7. \square

2.2.5 Another description of free categories on cellular extensions

Let $n \in \mathbb{N}$. We can sum up the content of the previous sections to give another description of the functor

$$-[-]: \text{Cat}_n^+ \rightarrow \text{Cat}_{n+1}.$$

Indeed, since its right adjoint $\mathcal{V}_n: \text{Cat}_{n+1} \rightarrow \text{Cat}_n^+$ is the composite of the right adjoints

$$\mathcal{U}': \text{Cat}_{n+1} \rightarrow \text{Cat}_n^A \quad \text{and} \quad \mathcal{U}: \text{Cat}_n^A \rightarrow \text{Cat}_n$$

we have, by Propositions 2.2.3.4, 2.2.4.5, 1.2.3.14 and 1.2.3.15, that there exists a canonical natural isomorphism

$$\Phi: -[-] \Rightarrow (-[-]^\approx) \circ (-[-]^A) \tag{2.9}$$

and, writing η and η' for the units associated to the respective adjunctions

$$-[-] \dashv \mathcal{V}_n \quad \text{and} \quad (-[-]^\approx) \circ (-[-]^A) \dashv \mathcal{U} \circ \mathcal{U}'$$

we moreover have $\eta' = \Phi \circ \eta$.

2.2.5.1 – Some properties of free extensions. This description allows us to prove several properties of the functor $-[-]$. First, we show that $(n+1)$ -generators of an n -cellular extension are injectively embedded in the associated free $(n+1)$ -category:

Proposition 2.2.5.2. *Given an n -cellular extension (C, X) , $\eta_{(C,X)}$ is a monomorphism.*

Proof. Since $\eta' = \Phi \circ \eta$, it is enough to prove that η' is a monomorphism. By definition of the functors $-[-]^A$ and $-[-]^\approx$, $\eta'_{(C,X)}: (C, X) \rightarrow C[X^A]^\approx$ is the identity on the i -cells for $i \in \mathbb{N}_n$. Moreover, given $g \in X$, $\eta'_{(C,X)}$ maps g to

$$\eta'_{(C,X)}(g) = \llbracket ((g, \bar{I}^g))^s \rrbracket.$$

By the definition of \approx , the restriction of \approx to sequences of length 1 is the identity relation. So, given generators $g, g' \in X$ such that $\eta'_{(C,X)}(g) = \eta'_{(C,X)}(g')$, we have $((g, \bar{I}^g))^s = ((g', \bar{I}^{g'}))^s$, and in particular $g = g'$. Thus, $\eta'_{(C,X)}$ is a monomorphism and so is $\eta_{(C,X)}$. \square

Given an n -cellular extension (C, X) , the above proposition justifies that, given $g \in X$, we directly write g for $\eta_{(C,X)}$. Our description of $-[-]$ also induces a decomposition property for the $(n+1)$ -cells of free extensions:

Proposition 2.2.5.3. *Given an n -cellular extension (C, X) and $u \in C[X]_{n+1}$, u can be written*

$$F_1[g_1] *_{n-1} \cdots *_{n-1} F_k[g_k]$$

where $k \in \mathbb{N}$, $g_i \in X$ and F_i is an n -context class of type g_i for $i \in \mathbb{N}_k^*$. Moreover, k is unique for u .

Proof. By the isomorphism (2.9), it is sufficient to prove this property in $(X^A)^\approx$. First note that, given $g \in X$ and an n -context class F of type g , by Lemma 2.2.3.3, we have the following equalities in $(X^A)^\approx$:

$$\llbracket ((g, F))^s \rrbracket = F[\llbracket ((g, \bar{I}^g))^s \rrbracket] = F[\eta'_{(C,X)}(g)].$$

By definition of $(X^A)^\approx$, $u \in (X^A)^\approx$ is of the form

$$u = \llbracket (u_1, \dots, u_k)^s \rrbracket$$

for some $u_i \in X^A$ for $i \in \mathbb{N}_k^*$. Moreover, each u_i is of the form

$$u_i = (g_i, F_i)$$

for some $g_i \in X$ and n -context class F_i of type g_i . Thus, we have

$$\begin{aligned} u &= \llbracket (u_1)^s \rrbracket *_n \cdots *_n \llbracket (u_k)^s \rrbracket \\ &= F_1[\eta'_{(C,X)}(g_1)] *_n \cdots *_n F_k[\eta'_{(C,X)}(g_k)] \end{aligned}$$

which is the wanted form. Moreover, since the length of an n -sequence is preserved by \approx , k is unique for u . \square

Finally, we can combine the monomorphism preservation results given for the functors $-[-]^A$ and $-[-]^\approx$ to deduce a monomorphism preservation property for $-[-]$:

Proposition 2.2.5.4. *Given a morphism $(F, f): (C, X) \rightarrow (D, Y) \in \mathbf{Cat}_n^+$ such that (F, f) is a monomorphism and F is n -Conduché, we have that $F[f]$ is a monomorphism and $(n+1)$ -Conduché.*

Proof. This is a consequence of Propositions 2.2.4.8, 2.2.4.9 and 2.2.3.15. \square

2.2.5.5 – Monomorphisms of polygraphs. We conclude this section with a criterion for monomorphisms of polygraphs which will be useful to prove that the word problem instance on a polygraph reduces to a word problem instance on a finite subpolygraph. First, we adapt Proposition 2.2.5.4 to polygraphs:

Proposition 2.2.5.6. *Given $n \in \mathbb{N} \cup \{\omega\}$ and a morphism $F: P \rightarrow Q \in \mathbf{Pol}_n$ such that $F_i: P_i \rightarrow Q_i$ is injective for $i \in \mathbb{N}_n$, then $F^*: P^* \rightarrow Q^*$ is a monomorphism and n -Conduché.*

Proof. By a simple induction on $n \in \mathbb{N}$, using Proposition 2.2.5.4. The property moreover holds for $n = \omega$ since, given an ω -functor $G: C \rightarrow D$, G is a monomorphism (resp. ω -Conduché) if and only if $G_{\leq k}$ is a monomorphism (resp. k -Conduché) for $k \in \mathbb{N}$. \square

We can now deduce the following criterion for monomorphisms of polygraphs, which already appears in the work of Makkai:

Proposition 2.2.5.7 ([Mak05, Lemma 5.(9)(ii)]). *Given $n \in \mathbb{N} \cup \{\omega\}$ and a morphism $F: P \rightarrow Q$ in \mathbf{Pol}_n , the following are equivalent:*

- (i) F is a monomorphism in \mathbf{Pol}_n ,
- (ii) for $i \in \mathbb{N}_n$, $F_i: P_i \rightarrow Q_i$ is a monomorphism in \mathbf{Set} ,
- (iii) F^* is a monomorphism in \mathbf{Cat}_n ,
- (iv) for $i \in \mathbb{N}_n$, $F_i^*: P_i^* \rightarrow Q_i^*$ is a monomorphism of \mathbf{Set} .

Proof. We prove this property using an induction on $n \in \mathbb{N}$. We can observe that the property holds for $n = 0$. So suppose that the property holds for some $n \in \mathbb{N}$. We show that it holds for $n + 1$. So let $(F, f): (P, X) \rightarrow (Q, Y)$ be a morphism of \mathbf{Pol}_{n+1} with $F: P \rightarrow Q \in \mathbf{Pol}_n$ and $f: X \rightarrow Y \in \mathbf{Set}$.

Proof that (i) implies (ii): Since $(-)^{\mathbf{Pol}_{\leq n}}$ is a right adjoint, F is a monomorphism, so that, by induction hypothesis, F_n^* is injective. Let $g_1, g_2 \in X$ such that $f(g_1) = f(g_2)$. Then, for $\epsilon \in \{-, +\}$,

$$F^*(d_n^\epsilon(g_1)) = F^*(d_n^\epsilon(g_2)).$$

Since F_n^* is injective, we have $d_n^\epsilon(g_1) = d_n^\epsilon(g_2)$. Let $Y = \{*\}$ and (P, Y) be the $(n+1)$ -polygraph such that

$$d_n^-(*) = d_n^-(g_1) \quad \text{and} \quad d_n^+(*) = d_n^+(g_1).$$

Denoting $f^i: Y \rightarrow X$ for the functions such that $f^i(*) = g_i$ for $i \in \{1, 2\}$, f^1 and f^2 induces morphisms of polygraphs $(\text{id}_P, f^1), (\text{id}_P, f^2): (P, Y) \rightarrow (P, X)$ and we have

$$(F, f) \circ (\text{id}_P, f^1) = (F, f) \circ (\text{id}_P, f^2).$$

Since (F, f) is a monomorphism, it implies $f^1 = f^2$, i.e., $g_1 = g_2$. Thus, f is an injective function.

Proof that (ii) implies (i): This is trivial.

Proof that (iii) implies (iv): For $i \in \mathbb{N}_{n+1}$, the functor $(-)_i: \mathbf{Cat}_{n+1} \rightarrow \mathbf{Set}$ is derived from a morphism of essentially algebraic theories. Thus, by Theorem 1.1.2.7, it is a right adjoint, and as such, it preserves monomorphisms. Hence, if $F^*[f]$ is a monomorphism, then $F^*[f]_i$ is a monomorphism for $i \in \mathbb{N}_{n+1}$.

Proof that (iv) implies (iii): A morphism $G: C \rightarrow D \in \mathbf{Cat}_{n+1}$ is completely determined by the $G_i: C_i \rightarrow D_i$ for $i \in \mathbb{N}_{n+1}$. Thus, if $F^*[f]_i$ is a monomorphism for $i \in \mathbb{N}_{n+1}$, then $F^*[f]$ is a monomorphism.

Proof that (ii) implies (iv): This is a consequence of Proposition 2.2.5.6.

Proof that (iv) implies (ii): By the induction hypothesis, $F_i: P_i \rightarrow Q_i$ is a monomorphism of set for $i \in \mathbb{N}_n$. Moreover, we have the commutative diagram

$$\begin{array}{ccc} X & \xrightarrow{f} & Y \\ \eta_{(P^*, X)} \downarrow & & \downarrow \eta_{(Q^*, Y)} \\ P^*[X]_{n+1} & \xrightarrow{F^*[f]_{n+1}} & Q^*[Y]_{n+1} \end{array}$$

where $\eta_{(P^*, X)}$ is injective by Proposition 2.2.5.2, and $F^*[f]_{n+1}$ is injective. Thus, f is injective.

For the extension to $n = \omega$, note that the functors $(-)^{\text{Pol}}_{\leq k, \omega}: \mathbf{Pol}_\omega \rightarrow \mathbf{Pol}_k$ for $k \in \mathbb{N}$ preserves monomorphisms (since they are right adjoints by Proposition 1.3.3.12) and jointly reflect them (since \mathbf{Pol}_ω is a limit cone on the categories \mathbf{Pol}_k). Thus, F is a monomorphism in \mathbf{Pol}_ω if and only if $F_{\leq k}$ is a monomorphism in \mathbf{Pol}_k for $k \in \mathbb{N}$. We then conclude using the same remark as the one in the proof of Proposition 2.2.5.6. \square

2.3 Computable free extensions

In order to consider decidability problems on strict categories, like the word problem, we must first clarify the notion of computability on these structures and, in particular, how to represent them computationally. In classical computable model theory [Har98; AK00], computable models are structures whose sets are subsets of \mathbb{N} and whose operations are recursive functions between those subsets. However, this approach would be inadequate for our purposes since the constructions we introduced for strict categories, like the functor $-[-]: \mathbf{Cat}_n^+ \rightarrow \mathbf{Cat}_{n+1}$, do not produce strict $(n+1)$ -categories whose sets of cells are subsets of \mathbb{N} . Instead, we use *encodings* to witness that these sets can be represented as subsets of \mathbb{N} and the structural operations (sources, targets, identities, compositions) as recursive functions between these subsets.

After recalling the definition of recursive functions, we introduce the setting of computability with encodings that will then allow to define computational descriptions of strict n -categories

(Section 2.3.1). Using this formalism, we give sufficient conditions for the free extension on a cellular extension to be computable (Section 2.3.2). The constructive content of the proofs will ultimately lead to a concrete computational implementation, as we will see in Section 2.4. We then consider the special case of polygraphs and give a more efficient procedure to compute the free strict category on a polygraph (Section 2.3.3).

2.3.1 Computability with encodings

In this section, we introduce the formalism of computability with encodings, after recalling some elementary definitions and facts about recursive functions. The latter are essentially the functions $\mathbb{N} \rightarrow \mathbb{N}$ whose values can be computed by a program or an algorithm. We then introduce computational descriptions for the higher categorical objects that we will manipulate (n -globular sets, n -categories, n -precategories and n -cellular extensions, *etc.*). These descriptions will consist in encodings and recursive functions that represent the structural operations of these objects by the mean of the encodings. Using such descriptions, higher categorical objects can then be inputs and outputs of programs.

2.3.1.1 – Recursive functions. We recall the definition and several elementary properties of recursive functions. We refer the reader to existing monographs (like [Rog87]) for a more complete presentation.

Given two sets X, Y , we write $\mathbf{Part}(X, Y)$ for the set of partial functions between X and Y . A function $f \in \mathbf{Part}(X, Y)$ is *total* when it is defined on all X . There are several operations which can be defined between the partial functions in the sets $\mathbf{Part}(\mathbb{N}^k, \mathbb{N})$.

For $k \in \mathbb{N}$ and $(l_i)_{i \in \mathbb{N}_k^*} \in \mathbb{N}^k$, there is a composition operation

$$\circ_{k, (l_i)_i} : \mathbf{Part}(\mathbb{N}^k, \mathbb{N}) \times \prod_{i \in \mathbb{N}_k^*} \mathbf{Part}(\mathbb{N}^{l_i}, \mathbb{N}) \rightarrow \mathbf{Part}(\mathbb{N}^{l_1 + \dots + l_k}, \mathbb{N})$$

so that, given partial functions $g \in \mathbf{Part}(\mathbb{N}^k, \mathbb{N})$ and $f_i \in \mathbf{Part}(\mathbb{N}^{l_i}, \mathbb{N})$ for $i \in \mathbb{N}_k^*$, the partial function $h = \circ_{k, (l_i)_i}(g, (f_i)_i)$ is such that, for $\bar{x}_1 \in \mathbb{N}^{l_1}, \dots, \bar{x}_k \in \mathbb{N}^{l_k}$, $h(\bar{x}_1, \dots, \bar{x}_k)$ is defined if and only if $f_i(\bar{x}_i)$ is defined for $i \in \mathbb{N}_k^*$ and $g(f_1(\bar{x}_1), \dots, f_k(\bar{x}_k))$ is defined, and in this case,

$$h(\bar{x}_1, \dots, \bar{x}_k) = g(f_1(\bar{x}_1), \dots, f_k(\bar{x}_k)).$$

For $k \in \mathbb{N}$, there is a recursion operation

$$\rho_k : \mathbf{Part}(\mathbb{N}^k, \mathbb{N}) \times \mathbf{Part}(\mathbb{N}^{k+2}, \mathbb{N}) \rightarrow \mathbf{Part}(\mathbb{N}^{k+1}, \mathbb{N})$$

so that, given $f \in \mathbf{Part}(\mathbb{N}^k, \mathbb{N})$ and $g \in \mathbf{Part}(\mathbb{N}^{k+2}, \mathbb{N})$, the partial function $h = \rho_k(f, g)$ is such that, for all $x_1, \dots, x_k \in \mathbb{N}$,

- $h(x_1, \dots, x_k, 0)$ is defined if and only if $f(x_1, \dots, x_k)$ is defined, and, in this case,

$$h(x_1, \dots, x_k, 0) = f(x_1, \dots, x_k),$$

- for $n \in \mathbb{N}$, $h(x_1, \dots, x_k, n+1)$ is defined if and only if both

$$h(x_1, \dots, x_k, n) \quad \text{and} \quad g(x_1, \dots, x_k, n, h(x_1, \dots, x_k, n))$$

are defined and, in this case,

$$h(x_1, \dots, x_k, n+1) = g(x_1, \dots, x_k, n, h(x_1, \dots, x_k, n)).$$

For $k \in \mathbb{N}$, there is a minimization operation

$$\mu_k : \mathbf{Part}(\mathbb{N}^{k+1}, \mathbb{N}) \rightarrow \mathbf{Part}(\mathbb{N}^k, \mathbb{N})$$

such that, given $f \in \mathbf{Part}(\mathbb{N}^{k+1}, \mathbb{N})$, the partial function $g = \mu_k(f)$ is so that, for all $x_1, \dots, x_k \in \mathbb{N}$,

- if there exists a smallest number $n \in \mathbb{N}$ such that $f(x_1, \dots, x_k, n)$ is non-zero or undefined, then

$$g(x_1, \dots, x_k) = f(x_1, \dots, x_k, n)$$

(if $f(x_1, \dots, x_k, n)$ is undefined, then $g(x_1, \dots, x_k)$ is undefined),

- otherwise, $g(x_1, \dots, x_k)$ is undefined.

We define subsets $\text{Rec}_k \subseteq \mathbf{Part}(\mathbb{N}^k, \mathbb{N})$ for $k \in \mathbb{N}$ as the smallest family of subsets of $\mathbf{Part}(\mathbb{N}^k, \mathbb{N})$ such that

- for all $k \in \mathbb{N}$ and $c \in \mathbb{N}$, the total function $(x_1, \dots, x_k) \mapsto c$ is in Rec_k ,
- for all $k \in \mathbb{N}^*$ and $i \in \mathbb{N}_k^*$, the total function $(x_1, \dots, x_k) \mapsto x_i$ is in Rec_k ,
- the total function $x \mapsto x + 1$ is in Rec_1 ,
- given $k \in \mathbb{N}$ and $(l_i)_{i \in \mathbb{N}_k^*} \in \mathbb{N}^k$, $g \in \text{Rec}_k$, $f_i \in \text{Rec}_{l_i}$ for $i \in \mathbb{N}_k^*$, the partial function $\circ_{k, (l_i)_i}(g, (f_i)_i)$ is in $\text{Rec}_{l_1 + \dots + l_k}$,
- given $k \in \mathbb{N}$, $f \in \text{Rec}_k$, $g \in \text{Rec}_{k+2}$, the partial function $\rho_k(f, g)$ is in Rec_{k+1} ,
- given $k \in \mathbb{N}$ and $f \in \text{Rec}_{k+1}$, the partial function $\mu_k(f)$ is in Rec_k .

Given $k \in \mathbb{N}$, a partial function $f : \mathbb{N}^k \rightarrow \mathbb{N}$ is said to be *recursive* when $f \in \text{Rec}_k$. It is well-known [Tur37] that f is recursive when one of the following equivalent conditions hold:

- there exists a Turing machine \mathcal{M} such that f is defined on $(x_1, \dots, x_k) \in \mathbb{N}_k$ if and only if \mathcal{M} halts on input (x_1, \dots, x_k) and, in this case, $f(x_1, \dots, x_k)$ is the output of \mathcal{M} on this input;
- there exists a lambda-term t such that $f(x_1, \dots, x_k)$ is defined if and only if there exists $x \in \mathbb{N}$ such that $t [x_1] \dots [x_k]$ is beta-equivalent to $[x]$ and, in this case, $f(x_1, \dots, x_k) = x$ (where, for $i \in \mathbb{N}$, $[i]$ denotes Church-encoding of i).

So, intuitively, recursive functions are the partial functions that can be computed by a program. In particular, functions like addition, multiplication, division are recursive. For every $k \in \mathbb{N}$, there exists a recursive function

$$v_k : \mathbb{N}^{k+1} \rightarrow \mathbb{N}$$

which is universal for recursive functions with k arguments, *i.e.*, for every function $f \in \text{Rec}_k$, there exists $c \in \mathbb{N}$, such that, for all $\bar{x} \in \mathbb{N}^k$, $v_k(c, \bar{x})$ is defined if and only if $f(\bar{x})$ is defined, and, in this case, $v_k(c, \bar{x}) = f(\bar{x})$. We say that such c is a *code* for f . Moreover, the recursive function v_k can be chosen such that there are recursive functions

$$\bar{o}_{k, (l_i)_i} : \mathbb{N}^{k+1} \rightarrow \mathbb{N} \quad \text{and} \quad \bar{\rho}_k : \mathbb{N}^2 \rightarrow \mathbb{N} \quad \text{and} \quad \bar{\mu}_k : \mathbb{N} \rightarrow \mathbb{N}$$

for $k \in \mathbb{N}$ and $(l_i)_i \in \mathbb{N}^k$ satisfying

- for $f \in \text{Rec}_k$, $f^\# \in \mathbb{N}$, $g_i \in \text{Rec}_{l_i}$ and $g_i^\# \in \mathbb{N}$ for $i \in \mathbb{N}_k^*$, if $f^\#$ is a code for f and $g_i^\#$ is a code for g_i , then $\bar{\circ}_{k,(l_i)}(f^\#, (g_i^\#)_i)$ is a code for $\circ_{k,(l_i)}(f, (g_i)_i)$,
- for $f \in \text{Rec}_k$, $f^\# \in \mathbb{N}$, $g \in \text{Rec}_{k+2}$, $g^\# \in \mathbb{N}$ if $f^\#$ is a code for f and $g^\#$ is a code for g , then $\bar{\rho}_k(f^\#, g^\#)$ is a code for $\rho_k(f, g)$,
- for $f \in \text{Rec}_{k+1}$ and $f^\# \in \mathbb{N}$, if $f^\#$ is a code for f , then $\bar{\mu}(f^\#)$ is a code for $\mu(f)$.

In the following, we suppose fixed a sequence of such universal function v_k for $k \in \mathbb{N}$. Finally, we recall that a subset $S \subseteq \mathbb{N}^k$ is said *recursive* or *decidable* when the characteristic function

$$\mathbf{1}_S: \mathbb{N}^k \rightarrow \{0, 1\} \subset \mathbb{N}$$

is recursive.

2.3.1.2 – Bijections on integers. In order to represent tuples of elements of \mathbb{N} as one element of \mathbb{N} so that these tuples can be manipulated by recursive functions, one needs bijections $\mathbb{N}^k \rightarrow \mathbb{N}$ for $k \in \mathbb{N}$ that have good properties regarding computability. We define such bijections below.

Let $\theta_2: \mathbb{N} \times \mathbb{N} \rightarrow \mathbb{N}$ be the function such that, for $(c_1, c_2) \in \mathbb{N}^2$,

$$\theta_2(c_1, c_2) = c_1 + \frac{(c_1 + c_2)(c_1 + c_2 + 1)}{2}.$$

We have that:

Proposition 2.3.1.3. θ_2 is bijective and both θ_2 and θ_2^{-1} are recursive.

Proof. We define a function $\bar{\theta}_2: \mathbb{N} \rightarrow \mathbb{N}^2$ as follows: for every $c \in \mathbb{N}$, we put $\bar{\theta}_2(c) = (c_1, c_2)$ where $c_1, c_2 \in \mathbb{N}$ are unique such that

- (i) there is a unique $k \in \mathbb{N}$ which is the smallest integer such that $c < \frac{k(k+1)}{2}$,
- (ii) $c_1 = c - \frac{(k-1)k}{2}$,
- (iii) $c_2 = \frac{k(k+1)}{2} - c - 1$.

The function $\bar{\theta}_2$ is injective since, for c, c_1, c_2, k as above, we have

$$k = c_1 + c_2 + 1 \quad \text{and} \quad c = c_1 + \frac{(k-1)k}{2}.$$

Moreover, for $(c_1, c_2) \in \mathbb{N}^2$ and $k = c_1 + c_2 + 1$, we have

$$\frac{(k-1)k}{2} \leq \theta_2(c_1, c_2) < c_1 + c_2 + 1 + \frac{(k-1)k}{2} = \frac{k(k+1)}{2}$$

so that $\bar{\theta}_2(\theta_2(c_1, c_2)) = (c_1, c_2)$. Thus, θ_2 is a section of $\bar{\theta}_2$, so $\bar{\theta}_2$ is bijective and $\bar{\theta}_2^{-1} = \theta_2$. Moreover, by their respective definitions, both θ_2 and θ_2^{-1} are recursive. \square

The following property will be useful for showing that an algorithm that takes tuples as inputs and involving recursion (*i.e.*, the algorithm calls itself) is terminating:

Proposition 2.3.1.4. For all $c_1, c_2 \in \mathbb{N}$, $\max(c_1, c_2) \leq \theta_2(c_1, c_2)$.

Proof. For all $c_1, c_2 \in \mathbb{N}$, it is clear that $c_1 \leq \theta_2(c_1, c_2)$ by definition of θ_2 . Moreover, if $c_2 \in \mathbb{N}^*$, then we have $c_1 + c_2 + 1 \geq 2$ so that $2c_1 + c_2 \leq \theta_2(c_1, c_2)$, and the conclusion follows. \square

We define functions $\theta_n: \mathbb{N}^n \rightarrow \mathbb{N}$ for $n \geq 2$. The function θ_2 was defined above and we put

$$\theta_{n+1} = \theta_2 \circ (1_{\mathbb{N}} \times \theta_n)$$

for $n \geq 2$. We easily verify by induction that

Proposition 2.3.1.5. *For every $n \in \mathbb{N}$ with $n \geq 2$, θ_n is bijective and both θ_n and θ_n^{-1} are recursive. Moreover, for all $(c_1, \dots, c_n) \in \mathbb{N}^n$, we have $\max(c_1, \dots, c_n) \leq \theta_n(c_1, \dots, c_n)$.*

2.3.1.6 – Encodings. Given a set X , an *encoding for X* is the data of a relation $\mathcal{E}_X \subseteq \mathbb{N} \times X$ such that

- (i) for all $x \in X$, there exists $x^\# \in \mathbb{N}$ such that $x^\# \mathcal{E}_X x$,
- (ii) for all $x, x' \in X$ and $c \in \mathbb{N}$ such that $c \mathcal{E}_X x$ and $c \mathcal{E}_X x'$, we have $x = x'$.

The $x^\# \in \mathbb{N}$ such that $x^\# \mathcal{E}_X x$ for some $x \in X$ are called *codes* of x and the set

$$\{c \in \mathbb{N} \mid \text{there exists } x \in X \text{ such that } c \mathcal{E}_X x\}$$

is called the *support* of \mathcal{E}_X . The encoding X is said

- *injective* when, for all $x \in X$, there is a unique $c \in \mathbb{N}$ such that $c \mathcal{E}_X x$,
- *decidable* when the set

$$\{c \in \mathbb{N} \mid \exists x \in X, \quad c \mathcal{E}_X x\}$$

is decidable,

- *equality-decidable* when the set

$$\{(c, c') \in \mathbb{N} \times \mathbb{N} \mid \exists x \in X, \quad c \mathcal{E}_X x \quad \text{and} \quad c' \mathcal{E}_X x\} \quad (2.10)$$

is decidable.

We note that:

Proposition 2.3.1.7. *Given a set X and an encoding \mathcal{E}_X of X , we have:*

- (i) *if \mathcal{E}_X is equality-decidable, then it is decidable,*
- (ii) *if \mathcal{E}_X is injective and decidable, then it is equality-decidable.*

Proof. For (i), given $c \in \mathbb{N}$, deciding whether “there exists $x \in X$ such that $c \mathcal{E}_X x$ ” is equivalent to deciding whether “ (c, c) belongs to the set (2.10)”. For (ii), given $c_1, c_2 \in \mathbb{N}$, deciding whether “ (c_1, c_2) belongs to the set (2.10)” is equivalent to, since \mathcal{E}_X is injective, deciding whether “ $c_1 = c_2$ and there exists $x \in X$ such that $c_1 \mathcal{E}_X x$ ”. \square

Example 2.3.1.8. The set \mathbb{N} admits a trivial encoding $\mathcal{E}_{\mathbb{N}}$ which is the identity relation. This encoding is injective, decidable and equality-decidable.

Given two sets X and Y equipped with respective encodings \mathcal{E}_X and \mathcal{E}_Y , and a partial function

$$f: X \rightarrow Y$$

we say that f is *computable* when there exists a recursive function $\bar{f}: \mathbb{N} \rightarrow \mathbb{N}$ such that, for all $x \in X$ and $x^\# \in \mathbb{N}$ with $x^\# \mathcal{E}_X x$, we have that if $f(x)$ is defined, then $\bar{f}(x^\#)$ is defined, and, in this case,

$$\bar{f}(x^\#) \mathcal{E}_Y f(x).$$

Such a function \bar{f} is called a *recursive model* of f . Moreover, a *code for f* is a code of such a function \bar{f} . We easily verify that the sets equipped with encodings and the computable functions between them form a category.

2.3.1.9 – Datatypes. As we will see in Section 2.3.2, the formalism of encodings allows stating in a precise sense how different constructions on higher categories are computable. However, it is a rather low-level perspective which would likely differ from the one taken by an actual implementation of these constructions. Indeed, in common programming languages, a set is usually not encoded as a subset of \mathbb{N} but as a subset of the inhabitants of some *datatype*. The two approaches are essentially equivalent since a datatype `t` induces an encoding for the set of inhabitants of `t` (in a way we will not explain, since it is technical and depends on how the considered programming language is compiled). We shall mention this more concrete perspective on computability in parallel to the one with encodings by providing hints on how to encode the different encountered sets with datatypes of OCAML. In the following, given a set S , we say that S is *encoded* by a datatype `t` when S is equipped with an inclusion from S to the inhabitants of `t`. In this case, the restriction of the encoding on `t` induces an encoding on S .

Remark 2.3.1.10. In the current implementation of OCAML, the `int` datatype can only encode natural numbers up to $2^{62} - 1$. For simplicity, we shall assume in the following that `int` can represent all the natural numbers, so that \mathbb{N} is encoded by `int`. This approximation should have no practical consequences since the code for the word problem introduced in the next section is not expected to be used on examples that require integers beyond $2^{62} - 1$.

Example 2.3.1.11. Under the assumption of Remark 2.3.1.10, the set of finite increasing sequences on \mathbb{N} is naturally encoded by the datatype `int list`.

2.3.1.12 – Standard derivations of encodings. In order not to spend too much time defining encodings, we define several derivations of encodings for several “data structures” that we consider as standard. These derived encodings will equip implicitly the sets associated with the “data structures”: subset of a set, product of sets, coproduct of sets, set of finite sequences over a set, set of finite subsets of a set, dependent sum and functions with finite domains.

Let X be a set and X' be a subset of X and \mathcal{E}_X be an encoding of X . We derive an encoding $\mathcal{E}_{X'}$ of X' by putting $c \mathcal{E}_{X'} s$ when $c \mathcal{E}_X s$ for $c \in \mathbb{N}$ and $s \in X'$. We easily verify that:

Proposition 2.3.1.13. *The following holds:*

- (i) *if \mathcal{E}_X is injective, then $\mathcal{E}_{X'}$ is injective,*
- (ii) *if $\mathcal{E}_{X'}$ is decidable and \mathcal{E}_X is equality-decidable, then $\mathcal{E}_{X'}$ is equality-decidable.*

Remark 2.3.1.14. If X is encoded by the datatype `t`, then X' is naturally encoded by `t` as well.

Let X_1 and X_2 be two sets together with encodings \mathcal{E}_{X_1} and \mathcal{E}_{X_2} . We derive an encoding $\mathcal{E}_{X_1 \times X_2}$ of $X_1 \times X_2$ from \mathcal{E}_{X_1} and \mathcal{E}_{X_2} : for all $c \in \mathbb{N}$ and $(x, y) \in X_1 \times X_2$, we put

$$c \mathcal{E}_{X_1 \times X_2} (x, y)$$

when, for $c_1, c_2 \in \mathbb{N}$ such that $(c_1, c_2) = \theta_2^{-1}(c)$, we have $c_1 \mathcal{E}_{X_1} x$ and $c_2 \mathcal{E}_{X_2} y$. We easily verify the following property:

Proposition 2.3.1.15. *If the encodings \mathcal{E}_{X_1} and \mathcal{E}_{X_2} are decidable (resp. equality-decidable, injective), then $\mathcal{E}_{X_1 \times X_2}$ is decidable (resp. equality-decidable, injective).*

Note that, given sets X_1, \dots, X_n for $n \geq 3$ with encodings \mathcal{E}_{X_i} for $i \in \mathbb{N}_n^*$, we can derive similarly an encoding $\mathcal{E}_{X_1 \times \dots \times X_n}$ for the product set $X_1 \times \dots \times X_n$, and this encoding satisfies a property similar to Proposition 2.3.1.15.

Remark 2.3.1.16. If X_1, \dots, X_n are encoded by datatypes $\mathbf{t}_1, \dots, \mathbf{t}_n$, then $X_1 \times \dots \times X_n$ is naturally encoded by the datatype `type t = Tuple of t1 * ... * tn`.

We also derive an encoding $\mathcal{E}_{X_1 \sqcup X_2}$ of $X_1 \sqcup X_2$ from \mathcal{E}_{X_1} and \mathcal{E}_{X_2} : for $c \in \mathbb{N}$, given $x \in X_1$, we put

$$c \mathcal{E}_{X_1 \sqcup X_2} \iota_{X_1}(x)$$

when $c = \theta_2(1, x^\#)$ for some $x^\# \in \mathbb{N}$ such that $x^\# \mathcal{E}_{X_1} x$; given $y \in X_2$, we put

$$c \mathcal{E}_{X_1 \sqcup X_2} \iota_{X_2}(y)$$

when $c = \theta_2(2, y^\#)$ for some $y^\# \in \mathbb{N}$ such that $y^\# \mathcal{E}_{X_2} y$. We easily verify that

Proposition 2.3.1.17. *If the encodings \mathcal{E}_{X_1} and \mathcal{E}_{X_2} are decidable (resp. equality-decidable, injective), then $\mathcal{E}_{X_1 \sqcup X_2}$ is decidable (resp. equality-decidable, injective).*

Note that this definition adapts naturally to derive an encoding $\mathcal{E}_{X_1 \sqcup \dots \sqcup X_n}$ of a coproduct of sets $X_1 \sqcup \dots \sqcup X_n$, and this encoding satisfies a property similar to Proposition 2.3.1.17.

Remark 2.3.1.18. If X_1, \dots, X_n are encoded by datatypes $\mathbf{t}_1, \dots, \mathbf{t}_n$, then $X_1 \sqcup \dots \sqcup X_n$ is naturally encoded by the datatype `type t = Inj1 of t1 | ... | Injn of tn`.

We derive an encoding $\mathcal{E}_{X^{<\omega}}$ of the set $X^{<\omega}$ of finite sequences of elements of X : for $c \in \mathbb{N}$, given $k \in \mathbb{N}$ and $(x_1, \dots, x_k) \in X^{<\omega}$, we put

$$c \mathcal{E}_{X^{<\omega}}(x_1, \dots, x_k)$$

when $c = \theta_2(k, \bar{c})$ with $\bar{c} = \theta_k(c_1, \dots, c_k)$ for some $\bar{c}, c_1, \dots, c_k \in \mathbb{N}$ such that $c_i \mathcal{E}_X x_i$ for $i \in \mathbb{N}_k^*$ (by convention, $\theta_2(0, 0)$ is the code of the empty sequence). We easily verify that $\mathcal{E}_{X^{<\omega}}$ is indeed an encoding and that:

Proposition 2.3.1.19. *If the encoding \mathcal{E}_X is injective (resp. decidable, equality-decidable), then the encoding $\mathcal{E}_{X^{<\omega}}$ is injective (resp. decidable, equality-decidable).*

Remark 2.3.1.20. If X is encoded by the datatype \mathbf{t} , then $X^{<\omega}$ is naturally encoded by the datatype `t list`.

We derive an encoding $\mathcal{E}_{\mathcal{P}_f(X)}$ of the set $\mathcal{P}_f(X)$ of finite subsets of X : for $c \in \mathbb{N}$, given $k \in \mathbb{N}$ and $x_1, \dots, x_k \in X$ with $x_i \neq x_j$ for $i \neq j$, we put

$$c \mathcal{E}_{\mathcal{P}_f(X)} \{x_1, \dots, x_k\}$$

when $c = \theta_2(k, \bar{c})$ with $\bar{c} = \theta_k(c_1, \dots, c_k)$ for some $\bar{c}, c_1, \dots, c_k \in \mathbb{N}$ satisfying

$$c_1 < \dots < c_k$$

and such that there exists a permutation σ of \mathbb{N}_k^* with $c_i \mathcal{E}_X x_{\sigma(i)}$ (by convention, $\theta_2(0, 0)$ is the code for the empty set). The codes of the elements are required to be sorted in order to preserve the injectiveness. We verify:

Proposition 2.3.1.21. *If the encoding \mathcal{E}_X is injective (resp. equality-decidable), then $\mathcal{E}_{\mathcal{P}_f(X)}$ is injective (resp. equality-decidable).*

Proof. The preservation of injectiveness is trivial. So suppose that \mathcal{E}_X is equality-decidable. Let $c^1, c^2 \in \mathbb{N}$. We exhibit a procedure to decide whether there exists $S \in \mathcal{P}_f(X)$ such that

$$c^1 \mathcal{E}_{\mathcal{P}_f(X)} S \quad \text{and} \quad c^2 \mathcal{E}_{\mathcal{P}_f(X)} S$$

First, we verify that, for $i \in \{1, 2\}$, $c^i \mathcal{E}_{\mathcal{P}_f(X)} S^i$ for some $S^i \in \mathcal{P}_f(X)$. We compute

$$(k^i, \bar{c}^i) = \theta_2^{-1}(c^i)$$

If $k^i = 0$, then c^i is a code if and only if $\bar{c}^i = 0$ and, in this case, it is the code for the empty subset. Otherwise, if $k^i > 0$, we compute

$$(c_1^i, \dots, c_k^i) = \theta_k^{-1}(\bar{c}^i)$$

If the c_1^i, \dots, c_k^i are not sorted, then c^i is not the code of a finite subset. So suppose that c_1^i, \dots, c_k^i are sorted. Then, c^i is the code of an element of $\mathcal{P}_f(X)$ if and only if each c_j^i is the code of an element of X for $j \in \mathbb{N}_k^*$ and, for $j_1, j_2 \in \mathbb{N}_k^*$ with $j_1 \neq j_2$, $c_{j_1}^i$ and $c_{j_2}^i$ encodes different elements of X . These two conditions can be verified computationally since \mathcal{E}_X is supposed equality-decidable. So suppose that, for $i \in \{1, 2\}$, $c^i \mathcal{E}_{\mathcal{P}_f(X)} S^i$ for some $S^i \in \mathcal{P}_f(X)$. Then, $S^1 = S^2$ if and only if $k_1 = k_2$ and there exists a bijection $\sigma: \mathbb{N}_{k_1}^* \rightarrow \mathbb{N}_{k_2}^*$ such that c_j^1 and $c_{\sigma(j)}^2$ encode the same element of X for $j \in \mathbb{N}_{k_1}^*$. Once again, since \mathcal{E}_X is equality-decidable, this condition can be verified computationally. Thus, $\mathcal{E}_{\mathcal{P}_f(X)}$ is equality-decidable. \square

Remark 2.3.1.22. Our choice for the encoding of finite subsets does not preserve decidability in general. Indeed, to decide if $c \in \mathbb{N}$ is the code of a finite subset of X , where $c = \theta_2(k, \bar{c})$ with $k \in \mathbb{N}^*$ and $\bar{c} = \theta_k(c_1, \dots, c_k)$, we need to verify that the c_j encode different elements of X , and we can not do so computationally if we only know that \mathcal{E}_X is decidable. In fact, it can be easily shown that if $\mathcal{E}_{\mathcal{P}_f(X)}$ is decidable, then \mathcal{E}_X is equality-decidable. However, other choices for $\mathcal{E}_{\mathcal{P}_f(X)}$ were possible and, among them, ones that preserve decidability. But the one we proposed preserves injectivity and that is our main concern for what is following.

Remark 2.3.1.23. If X is encoded by the datatype `t` such that the set of inhabitants of `t` is equipped with a total order, then $\mathcal{P}_f(X)$ is naturally encoded by the datatype `t list`. In practice, we can suppose all the datatypes we will consider to be equipped with total orders since OCAML can automatically derive particular ones for us.

Given moreover a finite set S and an encoding \mathcal{E}_S , we derive an encoding $\mathcal{E}_{\mathcal{F}(S, X)}$ of the set $\mathcal{F}(S, X)$ of functions $S \rightarrow X$: for $c \in \mathbb{N}$ and $f: S \rightarrow X$, we put

$$c \mathcal{E}_{\mathcal{F}(S, X)} f$$

when $c \mathcal{E}_{\mathcal{P}_f(S \times X)} \{(s, f(s)) \mid s \in S\}$, i.e., c is the code of the graph of f , encoded as a finite subset of $S \times X$. From Proposition 2.3.1.15 and Proposition 2.3.1.21, we deduce that:

Proposition 2.3.1.24. *If both \mathcal{E}_S and \mathcal{E}_X are injective (resp. equality-decidable), then $\mathcal{E}_{\mathcal{F}(S, X)}$ is injective (resp. equality-decidable).*

Remark 2.3.1.25. If S and X are encoded by datatypes `s` and `t` respectively, then $\mathcal{F}(S, X)$ is naturally encoded by the datatype `(s * t) list`.

Finally, given a function $\mathcal{S}: X \rightarrow \mathbf{Set}$ (i.e., for $x \in X$, $\mathcal{S}(x)$ is a set), and, for each x in X , an encoding $\mathcal{E}_{\mathcal{S}(x)}$ of $\mathcal{S}(x)$, we derive an encoding $\mathcal{E}_{\sum_x \mathcal{S}(x)}$ of the dependent sum

$$\sum_{x \in X} \mathcal{S}(x)$$

as follows: for all $c \in \mathbb{N}$, $x \in X$ and $y \in \mathcal{S}(x)$, we put

$$c \mathcal{E}_{\sum_x \mathcal{S}(x)}(x, y)$$

when $c = \theta_2(x^\#, y^\#)$ for some $x^\#, y^\# \in \mathbb{N}$ such that $x^\# \mathcal{E}_X x$ and $y^\# \mathcal{E}_{\mathcal{S}(x)} y$. We easily verify that:

Proposition 2.3.1.26. *If \mathcal{E}_X is injective and $\mathcal{E}_{\mathcal{S}(x)}$ is injective for $x \in X$, then $\mathcal{E}_{\sum_x \mathcal{S}(x)}$ is injective.*

Remark 2.3.1.27. If X is encoded by the datatype \mathfrak{t} , and, for $x \in X$, $\mathcal{S}(x)$ is encoded by the datatype \mathfrak{u} , then $\sum_{x \in X} \mathcal{S}(x)$ is naturally encoded by the datatype $\mathfrak{t} * \mathfrak{u}$.

2.3.1.28 – Encodings for quotient sets. Under specific conditions, we can also derive encodings for quotient sets, and they will play an important role in the algorithm that solves the word problem. Given a set S and a relation \mathcal{R} on S , \mathcal{R} is *right-finite* when, for all $s \in S$, the set $\{s' \in S \mid s \mathcal{R} s'\}$ is finite; given an encoding \mathcal{E}_S of S , \mathcal{R} is *effectively right-finite* when there is a computable function $R: S \rightarrow \mathcal{P}_f(S)$ such that, for all $s, s' \in S$, $s \mathcal{R} s'$ if and only if $s' \in R(s)$. Dually, there are notions of *left-finite* and *effectively left-finite* relations. The relation \mathcal{R} is *decidable* when the characteristic function

$$\mathbf{1}_{\mathcal{R}}: S \times S \rightarrow \{0, 1\} \subset \mathbb{N}$$

is computable (where $S \times S$ is equipped with the encoding for product set given above and \mathbb{N} equipped with the trivial encoding on \mathbb{N}).

Let X be a set and \sim be an equivalence relation on X . Given $x \in X$, we write $\llbracket x \rrbracket \subseteq X$ for the equivalence class of x with regards to \sim . Let X/\sim be the set $\{\llbracket x \rrbracket \mid x \in X\}$, i.e., the quotient of X by \sim . We say that \sim has *finite classes* when $\llbracket x \rrbracket$ is finite for all $x \in X$. Equivalently, \sim has finite classes if and only if \sim is right-finite (resp. left-finite). Given an encoding \mathcal{E}_X of X , if \sim has finite classes, we can derive an encoding $\mathcal{E}_{X/\sim}$ of X/\sim by putting, for all $c \in \mathbb{N}$ and $x \in X$,

$$c \mathcal{E}_{X/\sim} \llbracket x \rrbracket \quad \text{when} \quad c \mathcal{E}_{\mathcal{P}_f(X)} \llbracket x \rrbracket.$$

We then have:

Proposition 2.3.1.29. *Suppose that \sim has finite classes. Then, the following hold:*

- (i) *the function which maps an element $s \in X/\sim$ to the finite set of $x \in X$ such that $\llbracket x \rrbracket = s$ is computable,*
- (ii) *if \mathcal{E}_X is injective, then $\mathcal{E}_{X/\sim}$ is injective,*
- (iii) *if \mathcal{E}_X is equality-decidable and the relation \sim is effectively right-finite, then $\mathcal{E}_{X/\sim}$ equality-decidable (and so, decidable) and the function $\llbracket - \rrbracket: X \rightarrow X/\sim$ is computable.*

Proof. *Proof of (i):* Since the code of $s \in X/\sim$ is a code for the equivalence class of X defined by s , the identity function $\mathbb{N} \rightarrow \mathbb{N}$ is a recursive model of the function which maps $s \in X/\sim$ to the equivalence class defined by s .

Proof of (ii): This is a consequence of the fact that $\mathcal{E}_{\mathcal{P}_f(X)}$ is injective when \mathcal{E}_X is by Proposition 2.3.1.21.

Proof of (iii): Suppose that \mathcal{E}_X is equality-decidable and \sim is effectively right-finite. Then, by Proposition 2.3.1.21, $\mathcal{E}_{\mathcal{P}_f(X)}$ is equality-decidable. Since \sim is effectively right-finite, the function $R: X \rightarrow \mathcal{P}_f(X)$ which maps $x \in X$ to its equivalence class is computable, relatively to the encodings \mathcal{E}_X and $\mathcal{E}_{\mathcal{P}_f(X)}$. So, let $c^1, c^2 \in \mathbb{N}$. We give a procedure to decide if there is $x \in X$

such that $c^1 \mathcal{E}_{X/\sim} \llbracket x \rrbracket$ and $c^2 \mathcal{E}_{X/\sim} \llbracket x \rrbracket$. Let $(k, \bar{c}^1) = \theta_2^{-1}(c^1)$. If $k = 0$, then c^1 is not a code for an element of X/\sim . So suppose that $k > 0$. We compute $(c_1^1, \dots, c_k^1) = \theta_k^{-1}(\bar{c}^1)$. Since \mathcal{E}_X is equality-decidable, we verify that c_1^1 is the code for an element $x \in X$. If it is not the case, then c^1 is not a code for an element of X/\sim . Otherwise, since R is computable, we compute the equivalence class $X' = R(x)$ of x . Then, by our definition of $\mathcal{E}_{X/\sim}$, c^1 and c^2 encode the same element of X/\sim if and only if $c^1 \mathcal{E}_{\mathcal{P}_f(X)} X'$ and $c^2 \mathcal{E}_{\mathcal{P}_f(X)} X'$, which can be decided since $\mathcal{E}_{\mathcal{P}_f(X)}$ is equality-decidable by Proposition 2.3.1.21. Moreover, the function $\llbracket - \rrbracket : X \rightarrow X/\sim$ is computable since, for $x \in X$, a code of $\llbracket x \rrbracket$ is given by a code of $R(x)$, which can be computed since R is computable. \square

Remark 2.3.1.30. If X is encoded by a datatype `t` and \sim has finite classes, then, by Remark 2.3.1.23, the set X/\sim is naturally encoded by the datatype `t list`.

We often do not have a direct description of the equivalence relation \sim , and instead have a relation \sim^1 such that \sim is the reflexive transitive closure of \sim^1 . In such a situation, we will use the following property:

Proposition 2.3.1.31. *Given a set S with an encoding \mathcal{E}_S , a relation \sim^1 on S and an equivalence relation \sim on S , such that \mathcal{E}_S is equality-decidable, \sim^1 is effectively right-finite and \sim has finite classes on S and is the reflexive transitive closure of \sim^1 , we have that \sim is effectively right-finite, $\mathcal{E}_{S/\sim}$ is equality-decidable and the function $\llbracket - \rrbracket : S \rightarrow S/\sim$ is computable.*

Proof. Let $R : S \rightarrow \mathcal{P}_f(S)$ be the computable function such that, for all $s, s' \in S$, $s \sim^1 s'$ if and only if $s' \in R(s)$. Using R , we can compute the equivalence class of $s \in S$ by the following procedure, which is essentially a *breadth-first search* algorithm:

```

function COMPUTECLASS( $s$ )
   $N \leftarrow \{s\}$ 
   $D \leftarrow \emptyset$ 
  while  $N \neq \emptyset$  do
    choose  $s' \in N$ 
     $N \leftarrow N \setminus \{s'\}$ 
    if  $s' \notin D$  then
       $D \leftarrow D \cup \{s'\}$ 
       $N \leftarrow N \cup R(s')$ 
    end if
  end while
  return  $D$ 
end function

```

Note that this procedure terminates on any $s \in S$ since D contains elements s' such that $s \sim s'$ and \sim has finite classes, and, at each loop turn, either one element is removed from N or one element is added to D , so that it gives a function $\text{COMPUTECLASS} : S \rightarrow \mathcal{P}_f(S)$. Moreover, this function is computable since \mathcal{E}_S is equality-decidable. So \sim is effectively right-finite and Proposition 2.3.1.29(iii) applies. \square

2.3.1.32 – Encodings for recursive functions. For $k \in \mathbb{N}$, by our choice of the universal functions v_k , there are encodings $\mathcal{E}_{\text{Rec}_k}$ of Rec_k defined as follows: for all $f \in \text{Rec}_k$ and $f^\# \in \mathbb{N}$, $f^\# \mathcal{E} f$ if and only if

$$v_k(f^\#, -) = f(-).$$

By standard undecidability theorems on recursive functions, like Rice's theorem, these encodings are neither injective, nor equality-decidable. Decidability depends on the choice for v_k . However,

the restrictions of the functions $\circ_{k,(l_i)_i}$, ρ_k and μ_k for $k \in \mathbb{N}$ and $(l_i)_i \in \mathbb{N}^k$ to recursive functions are computable: recursive models are given by the function $\bar{\circ}_{k,(l_i)_i}$, $\bar{\rho}_k$ and $\bar{\mu}_k$. This enables to write algorithms that take as inputs computable functions and outputs computable functions.

Remark 2.3.1.33. In particular, and this will be important in the following, any constructive proof of a property that concludes that some function f is computable under some hypothesis leads to an algorithm which computes a code for f from a code for this hypothesis.

2.3.1.34 – Computational categorical descriptions. In this paragraph, we introduce computational descriptions, or *codes*, for several higher categorical structures: n -globular set, n -categories, n -precategories and n -cellular extensions. Such descriptions are the data of codes of recursive functions that are recursive models for the different structural operations that appear in the definition of each structure. These descriptions will enable such higher categorical structures to be inputs and outputs of computable functions.

Let $n \in \mathbb{N}$. Given an n -globular set G , an *encoding* \mathcal{E}_G of G is the data of encodings \mathcal{E}_i of the sets G_i for $i \in \mathbb{N}_n$; it is *injective* (resp. *decidable*, *equality-decidable*) when \mathcal{E}_i is injective (resp. decidable, equality-decidable) for $i \in \mathbb{N}_n$. Given such an encoding \mathcal{E}_G , the n -globular set G is *computable* when the functions $\partial_i^-, \partial_i^+ : G_{i+1} \rightarrow G_i$ are computable for $i \in \mathbb{N}_{n-1}$. A *recursive model* of G is the data of recursive models $\bar{\partial}_i^-, \bar{\partial}_i^+ : \mathbb{N} \rightarrow \mathbb{N}$ of ∂_i^- and ∂_i^+ respectively for $i \in \mathbb{N}_{n-1}$. A *code* for G is the data of $\partial_i^{-,\#}, \partial_i^{+,\#} \in \mathbb{N}$ for $i \in \mathbb{N}_{n-1}$ such that $\bar{\partial}_i^{-,\#}$ and $\bar{\partial}_i^{+,\#}$ are codes for ∂_i^- and ∂_i^+ respectively.

Given a strict n -category C and an encoding \mathcal{E}_C of C (seen as an n -globular set), C is *computable* when the underlying n -globular set of C is computable and

- for $k \in \mathbb{N}_{n-1}$, the function $\text{id}^{k+1} : C_k \rightarrow C_{k+1}$ is encodable,
- for $i, k \in \mathbb{N}_n$ with $i < k$, the functions $*_{i,k} : C_k \times_i C_k \rightarrow C_k$ (seen as a partial function of type $C_k \times C_k \rightarrow C_k$) is computable.

A *recursive model* of C is the data of a recursive model of the underlying n -globular set of C together with

- for $k \in \mathbb{N}_{n-1}$, a recursive model $\bar{\text{id}}^{k+1} : \mathbb{N} \rightarrow \mathbb{N}$ of id^{k+1} ,
- for $i, k \in \mathbb{N}$ with $i < k$, a recursive model $\bar{*}_{i,k} : \mathbb{N} \rightarrow \mathbb{N}$ of $*_{i,k}$.

A *code* of C is the data of a code of the underlying n -globular set of C , together with codes $\text{id}^{k+1,\#}$ of id^{k+1} for $k \in \mathbb{N}_{n-1}$, and codes $*_{i,k}^\#$ of $*_{i,k}$ for $i, k \in \mathbb{N}_n$ with $i < k$. Using θ_m for the correct value of $m \in \mathbb{N}$, a code of C can be represented as one element of \mathbb{N} .

Remark 2.3.1.35. If $C_0 \sqcup \dots \sqcup C_n$ is encoded by a datatype `cell`, then a recursive model of C can be represented by OCAML functions

- `csrc, ctgt : int -> cell -> cell`,
- `identity : int -> cell -> cell`,
- `comp : int -> int -> cell -> cell -> cell`.

Given an n -precategory C and an encoding \mathcal{E}_C of C (seen as an n -globular set), C is *computable* when the underlying n -globular set of C is computable and

- for $k \in \mathbb{N}_{n-1}$, the function $\text{id}^{k+1} : C_k \rightarrow C_{k+1}$ is computable,

- for $i, k, l \in \mathbb{N}_n$ with $i = \min(k, l) - 1$, the function $\bullet_{k,l}: C_k \times_i C_l \rightarrow C_{\max(k,l)}$ (seen as a partial function of type $C_k \times C_l \rightarrow C_{\max(k,l)}$) is computable.

We define the notions of *recursive model* and *code* of C as expected.

Remark 2.3.1.36. If $C_0 \sqcup \dots \sqcup C_n$ is encoded by a datatype `cell`, then a recursive model of C can be represented by means of OCAML functions in a way analogous to Remark 2.3.1.35.

We verify that the definition of “computable” is coherent between n -categories and n -precategories:

Proposition 2.3.1.37. *Given an n -category C and an encoding \mathcal{E}_C of C , the n -category C is computable if and only if the n -precategory C is computable.*

Proof. By Remark 2.3.1.33, the constructive content of the proof of Proposition 1.4.3.2 induces an algorithm which computes a code of the n -precategory C from a code of the n -category C . Conversely, the proof of Proposition 1.4.3.4 induces an algorithm which computes a code of the n -category C from a code of the n -precategory C . Thus, the proposition holds. \square

Given an n -cellular extension $(C, X) \in \mathbf{Cat}_n^+$, an *encoding* $\mathcal{E}_{(C,X)}$ of (C, X) is the data of an encoding $\mathcal{E}_C = (\mathcal{E}_i)_{i \in \mathbb{N}_n}$ of C (seen as an n -globular set) together with an encoding \mathcal{E}_X of X . It is *injective* (resp. *decidable*, *equality-decidable*) when both \mathcal{E}_C and \mathcal{E}_X are. Given such an encoding $\mathcal{E}_{(C,X)}$, the n -cellular extension (C, X) is *computable* when the n -category C is computable and the functions $d_n^-, d_n^+ : X \rightarrow C_n$ are computable. A *recursive model* of (C, X) is the data of a recursive model of the n -category C together with recursive models \bar{d}_n^-, \bar{d}_n^+ of the functions d_n^- and d_n^+ respectively. A *code* of (C, X) is the data of a code of the n -category C together with codes $d_n^{-,\#}, d_n^{+,\#}$ of d_n^- and d_n^+ respectively.

Finally, given an n -categorical action (C, A) and an encoding $\mathcal{E}_{(C,A)}$ of (C, A) (seen as an n -cellular extension), (C, A) is *computable* when the underlying n -cellular extension of (C, A) is computable and, for $i \in \mathbb{N}_{n-1}$, the functions

$$\bullet_{i+1,n+1} : C_{i+1} \times_i A \rightarrow A \quad \text{and} \quad \bullet_{n+1,i+1} : A \times_i C_{i+1} \rightarrow A$$

are computable (as partial functions on domains $C_{i+1} \times A$ and $A \times C_{i+1}$ respectively). The notions of *recursive model* and of *code* of (C, A) are defined as expected.

2.3.2 Computable free cellular extensions

In this section, we give conditions for which we can compute codes for free $(n+1)$ -categories from codes of n -cellular extensions. Using the decomposition of the functor $-[-] : \mathbf{Cat}_n^+ \rightarrow \mathbf{Cat}_{n+1}^+$ given in Section 2.2, this amounts to give conditions for which we can compute codes for the images of the functors

$$-[-]^A : \mathbf{Cat}_n^+ \rightarrow \mathbf{Cat}_n^A \quad \text{and} \quad -[-]^\approx : \mathbf{Cat}_n^A \rightarrow \mathbf{Cat}_{n+1}^A$$

The main obstacle for computability of the images of these functors are respectively the quotients of m -contexts by the equivalence relations \approx_m , and the quotient of sequences using the equivalence relations \approx . Indeed, in each case, we must ensure that we can compute the equivalence classes associated with each equivalence relations. Our plan is to use Proposition 2.3.1.31 on \approx_m^1 and \approx^1 , so that we need to find conditions for which \approx_m^1 and \approx^1 have finite classes and are effectively right-finite. The conditions we propose are some finite factorization properties on cells of n -cellular extension and n -categorical actions, so that there are a finite number of possible instances of the axioms defining \approx_m^1 and \approx^1 for each equivalence classes.

2.3.2.1 – Finitely factorizable precategories. Let $n \in \mathbb{N}$. Given an n -precategory C , C is *finitely factorizable* when we have that

- for all $i \in \mathbb{N}_{n-2}$ and $u \in C_{i+2}$, there is a finite number of pairs

$$(u_1, u_2) \in C_{i+2} \times_i C_{i+1} \sqcup C_{i+1} \times_i C_{i+2} \quad (2.11)$$

such that $u = u_1 \bullet_i u_2$,

- for all $i \in \mathbb{N}_{n-1}$ and $u \in C_{i+1}$, there is a finite number of pairs

$$(u_1, u_2) \in C_{i+1} \times_i C_{i+1} \quad (2.12)$$

such that $u = u_1 \bullet_i u_2$.

When C is equipped with an encoding \mathcal{E}_C , we say that C is *effectively factorizable* when it is finitely factorizable and moreover

- for $i \in \mathbb{N}_{n-2}$, there is a computable function

$$C_{i+2} \rightarrow \mathcal{P}_f(C_{i+2} \times C_{i+1} \sqcup C_{i+1} \times C_{i+2})$$

which takes as input $u \in C_{i+2}$ and outputs the finite set of pairs (u_1, u_2) as in (2.11) such that $u = u_1 \bullet_i u_2$,

- for $i \in \mathbb{N}_{n-1}$, there is a computable function

$$C_{i+1} \rightarrow \mathcal{P}_f(C_{i+1} \times C_{i+1})$$

which takes as input $u \in C_{i+1}$ and outputs the finite set of pairs (u_1, u_2) as in (2.12) such that $u = u_1 \bullet_i u_2$.

Remark 2.3.2.2. If $C_0 \sqcup \dots \sqcup C_n$ is encoded by a datatype `cell`, then the above computable functions can be represented by OCAML functions

- `cfact_het_l : int -> cell -> (cell * cell) list`,
- `cfact_het_r : int -> cell -> (cell * cell) list`,
- `cfact_hom : int -> cell -> (cell * cell) list`,

where, for $i \in \mathbb{N}_{n-2}$, we identify finite subsets of $C_{i+2} \times C_{i+1} \sqcup C_{i+1} \times C_{i+2}$ with pairs of finite subsets of $C_{i+2} \times C_{i+1}$ and $C_{i+1} \times C_{i+2}$.

Since strict categories are canonically precategories by Theorem 1.4.3.8, the notions of finite factorizability and effective factorizability for precategories directly translate to strict categories. We then verify that the finite factorizability property on cells induces a finite factorizability property with regard to contexts and context classes:

Proposition 2.3.2.3. *Given a finitely factorizable $C \in \mathbf{Cat}_n$ and $m \in \mathbb{N}_n^*$, for all $u, v \in C_m$, there is a finite number of m -contexts E (resp. m -context class F) of type $(\partial_{m-1}^-(u), \partial_{m-1}^+(u))$ such that $E[u] = v$ (resp. $F[u] = v$).*

Proof. We prove this property by an induction on m . If $m = 0$, then the property is trivial. So suppose that $m \geq 1$. Let $u, v \in C_m$ and consider the set S of m -contexts E of type $(\partial_{m-1}^-(u), \partial_{m-1}^+(u))$ such that $E[u] = v$. By definition, the elements of S are the triples (l, F', r) where $l, r \in C_m$ and F' is an $(m-1)$ -context class of type $(\partial_{m-2}^-(u), \partial_{m-2}^+(u))$ such that

$$\partial_{m-1}^+(l) = F'[\partial_{m-1}^-(u)], \quad F'[\partial_{m-1}^+(u)] = r \quad \text{and} \quad l \bullet_{m-1} F'[u] \bullet_{m-1} r = v.$$

By the finite factorization property, the number of triples $(l, F'[u], r)$ obtained by iterating on the elements (l, F', r) of S is finite. In particular, by Proposition 2.2.2.2, the number of $(m-1)$ -cells

$$F'[\partial_{m-1}^-(u)] = \partial_{m-1}^-(F'[u])$$

for $(l, F', r) \in S$ is finite. Thus, by induction hypothesis, there is a finite number of possible $(m-1)$ -context classes F' in the triples (l, F', r) of S . Hence, S is finite. Since m -context classes are quotient of m -contexts, we deduce moreover that there is a finite number of m -context classes F such that $F[u] = v$. \square

2.3.2.4 – Finitely factorizable actions. Let $n \in \mathbb{N}$. An n -categorical action (C, A) is *finitely factorizable* when the underlying strict n -category C is finitely factorizable and, in the case where $n > 0$, for every $u \in A$, there is a finite number of pairs

$$(u_1, u_2) \in A \times_{n-1} C_n \sqcup C_n \times_{n-1} A \tag{2.13}$$

such that $u = u_1 \bullet_{n-1} u_2$. When (C, A) is equipped with an encoding $\mathcal{E}_{(C,A)}$, we say that (C, A) is *effectively factorizable* when it is finitely factorizable, and moreover C is effectively factorizable, and there exists a computable function

$$A \rightarrow \mathcal{P}_f(A \times_{n-1} C_n \sqcup C_n \times_{n-1} A)$$

which, on input $u \in A$, outputs the finite set of pairs (u_1, u_2) as in (2.13) such that $u = u_1 \bullet_{n-1} u_2$.

Remark 2.3.2.5. If $C_0 \sqcup \dots \sqcup C_n$ and A are encoded by datatypes `cell` and `cell_top` respectively, then the computable functions which witness that (C, A) is effectively factorizable can be represented by means of OCAML functions in a way analogous to Remark 2.3.2.2.

2.3.2.6 – Contexts and computability. Let $n \in \mathbb{N}$ and C be an n -category equipped with an encoding \mathcal{E}_C which is injective and decidable and such that C is computable and effectively factorizable. We prove below several computational properties on the contexts of C . First, the contexts and contexts classes of C on instantiable types admit encodings derived from \mathcal{E}_C for which several elementary operations on contexts and contexts classes are derivable:

Proposition 2.3.2.7. *For $m \in \mathbb{N}_n$, $u \in C_m$ and $u' = (\partial_{m-1}^-(u), \partial_{m-1}^+(u))$, the following holds:*

- (i) *there are canonical injective encodings of the m -contexts and m -context classes of type u' ,*
- (ii) *the equivalence classes of m -contexts of type u' under \approx_m are finite, and the function mapping an m -context class F of type u' to the finite set of m -context E of type u' such that $\llbracket E \rrbracket = F$ is computable,*
- (iii) *for $i \in \mathbb{N}_{m-1}$ and $\epsilon \in \{-, +\}$, the function which takes as input an m -context E (resp. an m -context class F) of type u' and outputs $\partial_i^\epsilon(E)$ (resp. $\partial_i^\epsilon(F)$) is computable,*
- (iv) *for $k \in \{m, \dots, n\}$, the function which takes as input an m -context E (resp. m -context class F) of type u' and a cell $v \in C_k$ of m -type u' and outputs the cell $E[v]$ (resp. $F[v]$) of C_k is computable.*

Proof. We show this property by induction on m . There is a unique 0-context (resp. 0-context class) of type u' which can be encoded by $0 \in \mathbb{N}$. Thus, the case $m = 0$ holds. So suppose $m \geq 1$.

Proof of (i): We define an encoding for m -contexts (l, F, r) of type u' using the standard derivation of encodings for triples based on the encodings of C_m and of $(m-1)$ -context classes obtained by induction hypothesis, so that we get an encoding which is injective. By Proposition 2.3.2.3, the restriction of the equivalence relation \approx_m to m -contexts of type u' has finite classes, so that we obtain an encoding of m -context classes of type u' using the standard derivation of encodings for quotient sets based on the encoding of $(m-1)$ -contexts of type u' , and this encoding is injective by Proposition 2.3.1.29(ii).

Proof of (ii): Note that, given two m -contexts E_1, E_2 of type u' such that $E_1 \approx_m E_2$, we have that $E_1[u] = E_2[u]$. Thus, by Proposition 2.3.2.3, the equivalence classes of m -contexts of type u' under \approx_m are finite. By our choice of encodings in (i), the identity function is a recursive model of the function which maps an $(m-1)$ -context class F of type u' to the finite list of codes of $(m-1)$ -contexts E of type u' such that $\llbracket E \rrbracket = F$, so that the latter function is computable.

Proof of (iii): Let $i \in \mathbb{N}_{m-1}$. For all m -context $E = (l, F', r)$, $\partial_i^-(E)$ is defined as $\partial_i^-(l)$. Since the operations ∂_i^- on m -cells of C is computable by hypothesis on C and \mathcal{E}_C , the function which maps an m -context E of type u' to $\partial_i^-(E)$ is computable. For all m -context class F , $\partial_i^-(F)$ is defined as $\partial_i^-(E)$ where E is an m -context such that $\llbracket E \rrbracket = F$. Since, by (ii), we have a computable function which maps an m -context class F of type u' to the (non-empty) set of m -context E such that $F = \llbracket E \rrbracket$, the function which maps an m -context F of type u' to $\partial_i^-(F)$ is computable. And similarly for the target operations.

Proof of (iv): Let $k \in \{m, \dots, n\}$. Recall that, for an m -context $E = (l, F, r)$ of type u' and $v \in C_{k+1}$ of m -type u' , $E[v]$ is defined by

$$E[v] = l \bullet_{m-1} F[v] \bullet_{m-1} r$$

so that, by the induction hypothesis, and since C is supposed computable, the function which takes as inputs E and v as above, and outputs the cell $E[v]$, is computable. For context classes, recall that, for an m -context class F of type u' and $v \in C_{k+1}$ of m -type u' , $F[v]$ is defined by

$$F[v] = E[v]$$

where E is some m -context such that $\llbracket E \rrbracket = F$. Hence, by (ii), the function which takes as inputs F and v as above, and outputs the cell $F[v]$, is computable. \square

Remark 2.3.2.8. Note that the proof of Proposition 2.3.2.7 only used the fact that C was finitely factorizable and not *effectively* factorizable.

Remark 2.3.2.9. If $C_0 \sqcup \dots \sqcup C_n$ is encoded by a datatype `cell`, then, by the proof of Proposition 2.3.2.7(i), m -contexts and m -contexts classes on some type $u' \in C_n$ are naturally encoded by the datatypes

```
type ctxt =
| CtxtZ                               (* constructor for the 0-context *)
| CtxtS of cell * ctxtcl * cell       (* constructor for the (m+1)-contexts *)
and ctxtcl = ctxt list
```

as a consequence of Remarks 2.3.1.16 and 2.3.1.30.

We now aim at showing that the function which maps an m -context E of instantiable type to its m -context class $\llbracket E \rrbracket$ is computable. By Proposition 2.3.1.31, it is sufficient to show that the restriction of the relations \approx_m^1 and \approx_m^{-1} to m -contexts of instantiable types is effectively right-finite, and, by Remark 2.2.2.4, it is enough to it for \approx_m^1 . So we prove:

Proposition 2.3.2.10. *For every $m \in \mathbb{N}_n$, $u \in C_m$ and $u' = (\partial_{m-1}^-(u), \partial_{m-1}^+(u))$, the function which maps an m -context E of type u' and outputs the finite set of m -contexts E' of type u' such that $E \approx_m^1 E'$ is computable.*

Proof. We show this property by induction on m . If $m = 0$ or $m = 1$, the property holds. Now suppose that $m \geq 2$. Remember that, for all m -contexts $E_1 = (l_1, F_1, r_1)$ and $E_2 = (l_2, F_2, r_2)$ of type u' , we have $E_1 \approx_m^1 E_2$ if there exists $(m-1)$ -contexts $E'_i = (l'_i, F'_i, r'_i)$ of type u' with $\llbracket E'_i \rrbracket = F_i$ for $i \in \{1, 2\}$ and $l, r, w \in C_m$ such that one of the sets of conditions (\approx -L) and (\approx -R) are satisfied. By symmetry, it is enough to show that we can compute the m -contexts E_2 such that $E_1 \approx_m^1 E_2$ by (\approx -L). We recall the set of conditions (\approx -L) below:

$$\begin{array}{ll} l_1 = l \bullet_m (w \bullet_{m-1} F'_1[u] \bullet_{m-1} r'_1) & r_1 = r \\ l_2 = l & r_2 = (w \bullet_{m-1} F'_2[u'] \bullet_{m-1} r'_2) \bullet_m r \\ l'_1 = \partial_m^+(w) & r'_1 = r'_2 \\ l'_2 = \partial_m^-(w) & F'_1 = F'_2. \end{array}$$

By Proposition 2.3.2.7(ii), there is a finite number of $(m-1)$ -contexts E'_1 such that $\llbracket E'_1 \rrbracket = F_1$, and we can compute them. So let $E'_1 = (l'_1, F'_1, r'_1)$ be such that $\llbracket E'_1 \rrbracket = F_1$. Since C is effectively factorizable, there is a finite number of pairs $(l, w) \in C_m^2$ such that

$$l_1 = l \bullet_{m-1} (w \bullet_{m-2} F'_1[\partial_{m-1}^-(u)] \bullet_{m-2} r'_1)$$

with $\partial_{m-1}^+(w) = l'_1$, and we can compute them. So let (l, w) be such a pair. We define an m -context $E_2 = (l_2, F_2, r_2)$ by putting $F_2 = \llbracket E'_2 \rrbracket$ with $E'_2 = (l'_2, F'_2, r'_2)$ and

$$\begin{array}{lll} l'_2 = \partial_{m-1}^-(w) & F'_2 = F'_1 & r'_2 = r'_1 \\ l_2 = l & & r_2 = (w \bullet_{m-2} F'_2[\partial_{m-1}^+(u)] \bullet_{m-2} r'_2) \bullet_{m-1} r_1. \end{array}$$

The m -context E_2 satisfies the set of conditions (\approx -L) and we can compute it since C is computable. So, by iterating on all E'_1, l, w as above, we compute all the m -contexts E_2 such that $E_1 \approx_m^1 E_2$ by the set of conditions (\approx -L). \square

We can then deduce:

Proposition 2.3.2.11. *For every $m \in \mathbb{N}_n$, $u \in C_m$ and $u' = (\partial_{m-1}^-(u), \partial_{m-1}^+(u))$, the restriction of \approx_m to m -contexts of instantiable types is effectively right-finite, and the function which maps an m -context E of type u' to $\llbracket E \rrbracket$ is computable.*

Proof. Note that \mathcal{E}_C is equality-decidable by Proposition 2.3.1.7(ii). The property is then a consequence of Propositions 2.3.2.10 and 2.3.1.31 and Remark 2.2.2.4 since \approx_m is the reflexive transitive closure of $\approx_m^1 \cup \approx_m^{-1}$. \square

Remark 2.3.2.12. Using the datatypes from Remark 2.3.2.9, the proof of Proposition 2.3.2.11 translates into an OCAML function `ctxt_to_ctxtcl : ctxt -> ctxtcl`.

From the above property, we deduce that the encodings of contexts and context classes of C are decidable:

Proposition 2.3.2.13. *Given $m \in \mathbb{N}_n$, $u \in C_m$ and $u' = (\partial_{m-1}^-(u), \partial_{m-1}^+(u))$, the encoding of the m -contexts (resp. m -context classes) of type u' given by Proposition 2.3.2.7(i) is decidable.*

Proof. We prove this property by induction on m . If $m = 0$, then the property holds. So suppose that $m \geq 1$. Recall that the m -contexts of type u' are the triples $E = (l, F, r)$ where $l, r \in C_m$ and F is an $(m-1)$ -context of type $(\partial_{m-2}^-(u), \partial_{m-2}^+(u))$ such that

$$\partial_{m-1}^+(l) = F[\partial_{m-1}^-(u)] \quad \text{and} \quad F[\partial_{m-1}^+(u)] = \partial_{m-1}^-(r).$$

Since \mathcal{E}_C is injective and decidable, and C is computable, the subset of codes of such triples is decidable by induction hypothesis and Proposition 2.3.2.7(iv). By Proposition 2.3.1.7(ii), the encoding of m -contexts of type u' is moreover equality-decidable, since injective and decidable. Hence, the encoding of m -context classes of type u' is decidable since equality-decidable by Propositions 2.3.2.11 and 2.3.1.29. \square

Remark 2.3.2.14. Using the datatypes from Remark 2.3.2.9, the proof of Proposition 2.3.2.13 translates into OCAML functions

```
check_ctxt : ctxt -> bool
check_ctxtcl : ctxtcl -> bool
```

which witness that the encodings for contexts and context classes are decidable.

We now prove that the composition operations for contexts and context classes are computable:

Proposition 2.3.2.15. *Given $m \in \mathbb{N}_n^*$, $i \in \mathbb{N}_{m-1}$, $u \in C_m$ and $u' = (\partial_{m-1}^-(u), \partial_{m-1}^+(u))$, the function which takes as inputs an $(i+1)$ -cell $v \in C_{i+1}$ and an m -context E (resp. m -context class F) of type u' such that v, E (resp. v, F) are i -composable, and outputs $v \bullet_i E$ (resp. $v \bullet_i F$), is computable, and similarly for the right composition of m -contexts (resp. m -context classes).*

Proof. We prove this by induction on m . The property holds when $m = 1$. So suppose that $m \geq 2$. Given $v \in C_{i+1}$ and an m -context $E = (l, F, r)$ of type u' such that v, E are i -composable, recall that $v \bullet_i E$ is defined by

$$v \bullet_i E = \begin{cases} (v \bullet_i l, F, r) & \text{if } i = m - 1, \\ (v \bullet_i l, v \bullet_i F, v \bullet_i r) & \text{if } i < m - 1. \end{cases}$$

Thus, by the induction hypothesis and since C is computable, we can compute $v \bullet_i E$. Now, given an m -context F of type u' and $v \in C_{i+1}$ such that v, F are i -composable, recall that $v \bullet_i F$ is defined by $\llbracket v \bullet_i E \rrbracket$ where E is an m -context such that $\llbracket E \rrbracket = F$. Given the code of an m -context class F of type u' , using Proposition 2.3.2.7(ii) we can compute the code of some E of type u' such that $\llbracket E \rrbracket = F$. Then, using the first part, we can compute the code of $v \bullet_i E$. Finally, using Proposition 2.3.2.11, we can compute $\llbracket v \bullet_i E \rrbracket = v \bullet_i F$. \square

Finally, we show that contexts and context classes have some effective factorization property:

Proposition 2.3.2.16. *Given $u \in C_n$ and $u' = (\partial_{n-1}^-(u), \partial_{n-1}^+(u))$,*

- (i) *the function which takes as input an n -context E of type u' , and outputs the finite set of pairs (v, \tilde{E}) where $v \in C_n$ and \tilde{E} is an n -context of type u' such that v, \tilde{E} are $(n-1)$ -composable and $E = v \bullet_{n-1} \tilde{E}$, is computable,*

- (ii) the function which takes as input an n -context class F of type u' , and outputs the finite set of pairs (v, \tilde{F}) where $v \in C_n$ and \tilde{F} is an n -context class of type u' such that v, \tilde{F} are $(n-1)$ -composable and $F = v \bullet_{n-1} \tilde{F}$, is computable,

and similarly for right composition of n -contexts and n -context classes.

Proof. Given an n -context $E = (l, F', r)$ and a pair (v, \tilde{E}) such that $E = v \bullet_{n-1} \tilde{E}$, we have that $\tilde{E} = (\tilde{l}, F', r)$ for some $\tilde{l} \in C_n$ such that $v \bullet_{n-1} \tilde{l} = l$. Since C is effectively factorizable, we can compute the possible cells \tilde{l} . Thus, (i) holds.

Now let F be an n -context class and (v, \tilde{F}) be a pair such that $F = v \bullet_{n-1} \tilde{F}$. There exists an n -context \tilde{E} such that $\llbracket \tilde{E} \rrbracket = \tilde{F}$. So, $\llbracket v \bullet_{n-1} \tilde{E} \rrbracket = F$. We deduce the following procedure for (ii). By Proposition 2.3.2.7(ii), we can compute the finite set of n -contexts E such that $\llbracket E \rrbracket = F$. Moreover, by (i), we can compute the pairs (v', \tilde{E}) such that $E = v' \bullet_{n-1} \tilde{E}$. By Proposition 2.3.2.11, we can compute the value of $\llbracket \tilde{E} \rrbracket$ for such a pair, and the computed pairs $(v', \llbracket \tilde{E} \rrbracket)$ are then all the pairs (v, \tilde{F}) such that $F = v \bullet_{n-1} \tilde{F}$. Thus, (ii) holds. \square

2.3.2.17 – Computability of free actions. By the preceding properties and the description of the functor $-[-]^A$ given in Section 2.2.3, we can conclude a computability preservation property of free categorical actions on a cellular extension. Let $n \in \mathbb{N}$ and (C, X) be an n -cellular extension equipped with an encoding $\mathcal{E}_{(C, X)}$ which is injective and decidable and such that (C, X) is computable and C effectively factorizable. First, we have:

Proposition 2.3.2.18. *There exists an injective and decidable encoding \mathcal{E}_{X^A} such that the n -categorical action $C[X]^A$ is computable.*

Proof. Recall that X^A is the set of pairs (g, F) where $g \in X$ and F is an n -context class of type $(\partial_{n-1}^-(g), \partial_{n-1}^+(g))$, the latter being instantiable since $\partial_{n-1}^\epsilon(g) = \partial_{n-1}^\epsilon(d_n^-(g))$ for $\epsilon \in \{-, +\}$. By Proposition 2.3.2.7(i) and Proposition 2.3.1.26, since \mathcal{E}_X is injective, the set X^A admits an injective encoding \mathcal{E}_{X^A} obtained using the standard derivation of encodings for dependent sums, and this encoding is moreover decidable since \mathcal{E}_X is decidable and since the procedure given by Proposition 2.3.2.13 can be effectively parametrized by $(\partial_{n-1}^-(g), \partial_{n-1}^+(g))$ for $g \in X$. By Proposition 2.3.2.7(iii) and Proposition 2.3.2.15, the operations $\partial_n^-, \partial_n^+, \bullet_{i, n+1}$ and $\bullet_{n+1, i}$ for $i \in \mathbb{N}_n^*$ on X^A are computable too. Thus, the encodings \mathcal{E}_C and \mathcal{E}_{X^A} induce an encoding $\mathcal{E}_{C[X]^A}$ of the n -categorical action $C[X]^A$ which is injective and decidable, and such that $C[X]^A$ is computable. \square

Remark 2.3.2.19. If $C_0 \sqcup \dots \sqcup C_n$ and X are encoded by datatypes `cell` and `gen`, then, by Remark 2.3.1.27 and using the datatype for context classes from Remark 2.3.2.9, the set X^A is naturally encoded by the datatype

```
type act_cell = gen * ctxtcl
```

We verify that the embedding of generators is computable for the above encoding:

Proposition 2.3.2.20. *Under the encoding \mathcal{E}_{X^A} of Proposition 2.3.2.18, the embedding $X \rightarrow X^A$ is computable.*

Proof. Given $g \in X$, since C is computable, $\text{id}_{\partial_i^-(g)}^{i+1}$ and $\text{id}_{\partial_i^+(g)}^{i+1}$ can be computed for $i \in \mathbb{N}_{n-1}$, so that we can compute the code of the n -context class \bar{I}^g using Proposition 2.3.2.11 and the code of the pair $(g, \bar{I}^g) \in X^A$. Hence, the embedding $X \rightarrow X^A$ is computable. \square

Finally, we check the effective factorizability of the free action:

Proposition 2.3.2.21. *$C[X]^A$ is effectively factorizable.*

Proof. Since C is effectively factorizable, this is a consequence of Proposition 2.3.2.16(ii). \square

2.3.2.22 – Source-finite actions. In order to obtain a computability result analogous to Proposition 2.3.2.18 for free categories on a computable categorical actions, effective factorizability is not enough. Indeed, the problem is that the relation \approx has not necessarily finite classes, even for a categorical action which is finitely factorizable. A sufficient additional condition, called source-finiteness, is introduced below.

Let $n \in \mathbb{N}$. Given a set X , there is an n -categorical action $\uparrow_A^n(X)$ uniquely defined by

$$(\uparrow_A^n(X))_{n+1} = X \quad \text{and} \quad (\uparrow_A^n(X))_i = \{*\} \text{ for } i \in \mathbb{N}_n.$$

Note that the operations are trivial on the elements of $(\uparrow_A^n(X))_{n+1}$, i.e.,

$$* \bullet_i g \bullet_i * = g$$

for $i \in \mathbb{N}_{n-1}$ and $g \in X$.

Remark 2.3.2.23. The operation $X \mapsto \uparrow_A^n(X)$ extends to a functor $\mathbf{Set} \rightarrow \mathbf{Cat}_n^A$ which is right adjoint to the functor $\mathbf{Cat}_n^A \rightarrow \mathbf{Set}$ which maps an n -categorical action (C, A) to A/\sim where \sim is the smallest equivalence relation on A such that $u \sim l \bullet_i u \bullet_i r$ for all $i \in \mathbb{N}_{n-1}$, $l, r \in C_{i+1}$ and $u \in A$ such that l, u, r are i -composable.

Given an n -categorical action (C, A) and a set X , a *labelling of (C, A) over X* is an n -categorical action morphism $(\bar{*}, h): (C, A) \rightarrow \uparrow_A^n(X)$. Suppose that (C, A) is equipped with such a labelling. We then say that (C, A) is *source-finite over X* when, for every $v \in C_n$ and $g \in X$, there is a finite number of $u \in A$ such that $\partial_n^-(u) = v$ and $h(u) = g$.

Remark 2.3.2.24. In the following, the n -categorical actions (C, A) we will consider do not generally satisfy that $\{u \in A \mid \partial_n^-(u) = v\}$ is finite for every $v \in C_n$. Instead, the weaker source-finiteness property relatively to a labelling will be sufficient for our purposes. Notably, as we will see in Paragraph 2.3.2.33, the free n -categorical action $C[X]^A$ on an n -cellular extension (C, X) where C is finitely factorizable is canonically source-finite.

Writing $\mathbb{N}X$ for the free commutative monoid on X , there is a function

$$m_X^{(C,A),h}: A^* \rightarrow \mathbb{N}X$$

often simply denoted m_X such that

$$m_X((t_1, \dots, t_k)^s) = h(t_1) + \dots + h(t_k)$$

for $t = (t_1, \dots, t_k)^s \in A^*$. The function m_X is compatible with the relation \approx , so that it induces a function $A^\approx \rightarrow \mathbb{N}X$, still denoted m_X . This latter satisfies that $m_X(u \bullet_n v) = m_X(u) + m_X(v)$ for n -composable $u, v \in A^\approx$. Note that we can identify $\mathbb{N}X$ canonically to the subset of functions $f: X \rightarrow \mathbb{N}$ such that $\{g \in X \mid f(g) \neq 0\}$ is finite, so that we consider $m_X(u)$ as a function of type $X \rightarrow \mathbb{N}$ and write $m_X(u)_g$ for the value of $m_X(u)$ at g . The source-finiteness property implies several finiteness properties on the free category on a categorical action:

Proposition 2.3.2.25. *Let X be a set and (C, A) be an n -categorical action which is labeled over X through $(\bar{*}, h): (C, A) \rightarrow \uparrow_A^n(X)$ and source-finite over X . The following hold:*

- (i) *for all $k \in \mathbb{N}$, $g_1, \dots, g_k \in X$ and $u \in C_n$, there is a finite number of $t = (t_1, \dots, t_k)^s \in A^*$ such that $\partial_n^-(t) = u$ and $h(t_i) = g_i$ for $i \in \mathbb{N}_k^*$,*
- (ii) *the relation \approx on A has finite classes,*

(iii) if (C, A) is finitely factorizable, then $C[A]^\approx$ is finitely factorizable.

Proof. Proof of (i): We do an induction on the length k . There is only one t of length 0 such that $\partial_n^-(t) = u$. Now, suppose that the property holds for some $k \in \mathbb{N}$. We prove that it holds for $k + 1$. Let $g_1, \dots, g_{k+1} \in X$, $u \in C_n$ and $t = (t_1, \dots, t_{k+1})^s \in A^\star$ be such that $\partial_n^-(t) = u$ and $h(t_i) = g_i$ for $i \in \mathbb{N}_{k+1}^*$. Since $\partial_n^-(t_1) = u$ and $h(t_1) = g_1$ and (C, A) is source-finite, there is a finite number of possible t_1 . For each of these, by putting $t' = (t_2, \dots, t_{k+1})^s$, we have $\partial_n^-(t') = \partial_n^+(t_1)$, thus, by induction hypothesis, there is a finite number of possible t' , which concludes (i).

Proof of (ii): Let $u \in A^\approx$, and $k \in \mathbb{N}$ and $t = (t_1, \dots, t_k)^s \in A^\star$ be such that $\llbracket t \rrbracket = u$. We have that $m_X(u) = h(t_1) + \dots + h(t_k)$, so there is a finite number of possible tuples $(h(t_1), \dots, h(t_k))$ relatively to u . Hence, by (i), there is a finite number of possible t .

Proof of (iii): Let $u \in A^\approx$. Consider $v \in C_n$ and $w \in A^\approx$ such that $u = v \bullet_{n-1} w$. Let $k \in \mathbb{N}$ and $t_1, \dots, t_k \in A$ such that $w = \llbracket (t_1, \dots, t_k)^s \rrbracket$. Then,

$$u = \llbracket (v \bullet_{n-1} t_1, \dots, v \bullet_{n-1} t_k)^s \rrbracket.$$

By (ii), there is a finite number of possible values for $(v \bullet_{n-1} t_1, \dots, v \bullet_{n-1} t_k)^s \in A^\star$, and, since (C, A) is finitely factorizable, there is a finite number of possible pairs $(v, (t_1, \dots, t_k))$. Hence, there is a finite number of pairs $(v, w) \in C_n \times A^\approx$ such that $u = v \bullet_{n-1} w$, and, similarly, there are a finite number of pairs $(v, w) \in A^\approx \times C_n$ such that $u = v \bullet_{n-1} w$. Now consider $v, w \in A^\approx$ such that $u = v \bullet_n w$. Let $k, l \in \mathbb{N}$ and s_1, \dots, s_k and t_1, \dots, t_l in A be such that $v = \llbracket (s_1, \dots, s_k)^s \rrbracket$ and $w = \llbracket (t_1, \dots, t_l)^s \rrbracket$. Then,

$$u = \llbracket (s_1, \dots, s_k, t_1, \dots, t_l)^s \rrbracket.$$

Using (ii), we conclude similarly that there is a finite number of pairs $(v, w) \in A^\approx \times A^\approx$ such that $u = v \bullet_n w$. Hence, $C[A]^\approx$ is finitely factorizable. \square

2.3.2.26 – Computability of free categories on actions. With source-finiteness, we can deduce computability properties for free categories on categorical actions. Let $n \in \mathbb{N}$, X be a set and (C, A) be an n -categorical action labeled over X through $(\ast, h): (C, A) \rightarrow \hat{\uparrow}_A^n(X)$ and source-finite over X , and $\mathcal{E}_{(C,A)}$ be an injective and decidable encoding of (C, A) such that (C, A) is computable and effectively factorizable. We introduce first an encoding for A^\star with the following property:

Proposition 2.3.2.27. *The following hold:*

- (i) there is an injective and decidable encoding \mathcal{E}_{A^\star} of A^\star ,
- (ii) the function which maps $u \in A$ to $(u)^s \in A^\star$ is computable,
- (iii) the function which maps $u \in C_n$ to $(\)_u^s \in A^\star$ is computable,
- (iv) for $i \in \mathbb{N}_{n-1}$, the function which maps

$$(u, v) \in A^\star \times_i C_{i+1} \sqcup C_{i+1} \times_i A^\star$$

to $u \bullet_i v$ is computable,

- (v) the function which maps

$$(u, v) \in A^\star \times_n A^\star$$

to $u \bullet_n v$ is computable.

Proof. The set A^\star is canonically isomorphic to $C_n \sqcup A'$ where C_n is in bijection with the identities of A^\star , and A' is the subset of $A^{<\omega}$ consisting of non-empty sequences of n -composable elements of A . Thus, we derive an encoding \mathcal{E}_{A^\star} of A^\star using the standard derivations of encodings for finite sequences, subsets and disjoint union, and \mathcal{E}_{A^\star} is injective since \mathcal{E}_{C_n} and \mathcal{E}_A are. Moreover, since (C, A) is computable and $\mathcal{E}_{(C,A)}$ is injective and decidable, A' is a decidable subset of $A^{<\omega}$, so that \mathcal{E}_{A^\star} is moreover decidable. Thus, (i) holds. By the definition of \mathcal{E}_{A^\star} , (ii) holds. Moreover, by the definitions of $\text{id}_{(-)}^{n+1}$ and the compositions \bullet_i and \bullet_n on A^\star given in Section 2.2.4, (iii), (iv) and (v) hold. \square

Remark 2.3.2.28. If $C_0 \sqcup \dots \sqcup C_n$ and A are encoded by datatypes `cell` and `top_cell` respectively, then, by the proof of Proposition 2.3.2.27(i) the set A^\star is naturally encoded by the datatype

```
type seq =
| SeqZ of cell          (* constructor for zero-length sequences *)
| SeqP of top_cell list (* constructor for positive-length sequences *)
```

and the computable function which witnesses that the encoding A^\star is decidable can be represented by an OCAML function `check_seq : seq -> bool`.

We now show that A^\approx admits an injective and decidable encoding, using the method given by Proposition 2.3.1.31. For this purpose, we first prove:

Proposition 2.3.2.29. *The relation \approx^1 on A^\star is effectively right-finite.*

Proof. By the definition of \approx^1 , it is enough to show that the function which takes an input an n -composable pair $(l, l') \in A^2$ and outputs the finite set of pairs $(r, r') \in A^2$ such that $\mathcal{X}(l, l', r, r')$, is computable. The latter set is indeed finite by Proposition 2.3.2.25(ii) since $(l, l')^s \approx (r, r')^s$. So let $(l, l') \in A$ be a pair of n -composable elements. Since $(C, A) \in \mathbf{Cat}_n^A$ is computable and effectively factorizable, and $\mathcal{E}_{(C,A)}$ is injective, we can compute all the pairs $(u, v) \in A^2$ such that u, v are $(n-1)$ -composable and satisfy

$$l = u \bullet_{n-1} \partial_n^-(v) \quad \text{and} \quad l' = \partial_n^+(u) \bullet_{n-1} v$$

and, for each such pair, we can compute the pair (r, r') where

$$r = \partial_n^-(u) \bullet_{n-1} v \quad \text{and} \quad r' = u \bullet_{n-1} \partial_{n-1}^+(v).$$

Hence, we can compute all the pairs (r, r') such that $\mathcal{X}(l, l', r, r')$ which concludes the proof. \square

We can now deduce the computability of $C[A]^\approx$:

Proposition 2.3.2.30. *The following hold:*

- (i) *there is an injective and decidable encoding \mathcal{E}_{A^\approx} of A^\approx ,*
- (ii) *the function $\llbracket - \rrbracket : A^\star \rightarrow A^\approx$ is computable,*
- (iii) *the function which maps $u \in A$ to $\llbracket (u)^s \rrbracket \in A^\approx$ is computable,*
- (iv) *the function which maps $u \in C_n$ to $\text{id}_u^{n+1} \in A^\approx$ is computable,*
- (v) *for $i \in \mathbb{N}_{n-1}$, the function which maps*

$$(u, v) \in A^\approx \times_i C_{i+1} \sqcup C_{i+1} \times_i A^\approx$$

to $u \bullet_i v$ is computable,

(vi) the function which maps

$$(u, v) \in A^\approx \times_n A^\approx$$

to $u \bullet_n v$ is computable.

Proof. Since the relation \approx has finite classes by Proposition 2.3.2.25(ii), we can define the encoding \mathcal{E}_{A^\approx} of $A^\approx = A^\star / \approx$ using the standard derivation of encodings for quotient sets. By Proposition 2.3.2.29, \approx^1 is effectively right-finite and, by Remark 2.2.4.2, so is \approx^{-1} . Thus, by Propositions 2.3.2.27 and 2.3.1.31, \mathcal{E}_{A^\approx} is injective and decidable, and the function $\llbracket - \rrbracket : A^\star \rightarrow A^\approx$ is computable, thus (i) and (ii) holds, and (iii) holds by Proposition 2.3.2.27(ii). By (ii) and Proposition 2.3.2.30(ii), (iv) holds. Given $i \in \mathbb{N}_{n-1}$ and $(u, v) \in A^\approx \times_i C_{i+1}$, by Proposition 2.3.1.29(i), we can compute some $u' \in A^\star$ such that $\llbracket u' \rrbracket = u$. Then, by (ii) and Proposition 2.3.2.27(iv), we can compute the cell $\llbracket u' \bullet_i v \rrbracket = u \bullet_i v$, thus (v) holds and, by a similar argument, (vi) holds. \square

Remark 2.3.2.31. By the proof of Proposition 2.3.2.30(i), using the datatype for n -sequences from Remark 2.3.2.28, the set A^\approx is naturally encoded by the datatype `type seqcl = seq list` as a consequence of Remark 2.3.1.30, and the computable function which witnesses that the encoding of A^\approx is decidable can be represented by an OCAML function `check_seqcl : seqcl -> bool`. Moreover, an OCAML function `seq_to_seqcl : seq -> seqcl` can be derived from the proof of Proposition 2.3.2.30(ii).

By Proposition 2.3.2.30, \mathcal{E}_C can be extended by \mathcal{E}_{A^\approx} to an injective and decidable encoding $\mathcal{E}_{C[A]^\approx}$ of the free $(n+1)$ -category $C[A]^\approx$ on (C, A) . For this encoding, we have:

Proposition 2.3.2.32. *The $(n+1)$ -category $C[A]^\approx$ is effectively factorizable.*

Proof. Given $u \in A^\approx$, by Proposition 2.3.1.29(i), we can compute the finite set of all

$$t = (t_1, \dots, t_k)^s \in A^\star$$

such that $\llbracket t \rrbracket = u$. Using that (C, A) is effectively factorizable, we can compute the set of pairs $(v, t') \in C_n \times A^\star$ with $t' = (t'_1, \dots, t'_k)^s$ such that $v \bullet_{n-1} t' = t$. So, by Proposition 2.3.2.30(ii), we can compute the finite set of the pairs $(v, w) \in C_n \times_{n-1} A^\approx$ such that $u = v \bullet_n w$.

Moreover, for each t as above, we can compute the set of all n -composable pairs $t_1, t_2 \in A^\star$ such that $t_1 \bullet_n t_2 = t$. Thus, by Proposition 2.3.2.30(ii), we can compute the finite set of n -composable pairs $(u_1, u_2) \in A^\approx \times A^\approx$ such that $u = u_1 \bullet_n u_2$. Hence, $C[A]^\approx$ is effectively factorizable. \square

2.3.2.33 – Computability of free extensions. We now combine the properties of previous paragraphs to deduce a computability property for free extensions.

Let $n \in \mathbb{N}$. Given $(C, X) \in \text{Cat}_n^+$, there is a canonical labelling of $C[X]^A$ over X which maps (g, F) to g for $(g, F) \in X^A$. For this labelling, we have:

Proposition 2.3.2.34. *Given $(C, X) \in \text{Cat}_n^+$ where C is finitely factorizable, the n -categorical action $C[X]^A$ is source-finite over X .*

Proof. Given $v \in C_n$ and $g \in X$, an element $u \in X^A$ above g such that $\partial_n^-(u) = v$ is the data of an n -context class F of type $(\partial_{n-1}^-(g), \partial_{n-1}^+(g))$ such that $F[\partial_n^-(g)] = v$. By Proposition 2.3.2.3, there is a finite number of those. \square

We then obtain the following computability result for free extensions:

Proposition 2.3.2.35. *Let $n \in \mathbb{N}$, $(C, X) \in \text{Cat}_n^+$ and $\mathcal{E}_{(C,X)}$ be an injective and decidable encoding of (C, X) such that (C, X) is computable and C effectively factorizable. Then, there is an injective and decidable encoding $\mathcal{E}_{C[X]}$ of the $(n+1)$ -category $C[X]$ that extends \mathcal{E}_C such that $C[X]$ is computable and effectively factorizable. Moreover, the canonical embedding $X \rightarrow C[X]_{n+1}$ is computable.*

Proof. The encoding $\mathcal{E}_{C[X]_{n+1}}$ of $C[X]_{n+1}$ is constructed using Propositions 2.3.2.18, 2.3.2.21, 2.3.2.30 and 2.3.2.34, so that, by extending \mathcal{E}_C with $\mathcal{E}_{C[X]_{n+1}}$, we obtain an encoding of $C[X]$ which makes $C[X]$ computable and moreover computationally factorizable by Proposition 2.3.2.32. Moreover, the embedding $X \rightarrow C[X]_{n+1}$ is computable by Proposition 2.3.2.20 and Proposition 2.3.2.30(iii). \square

Remark 2.3.2.36. By inspecting the constructive content of the proof of Proposition 2.3.2.35 and of the propositions it uses, we have in fact proved a stronger statement: for $n \in \mathbb{N}$, there is a computable function which takes as inputs

- a code for a computable n -cellular extension (C, X) that is equipped with an injective and decidable encoding $\mathcal{E}_{(C,X)}$,
- codes of the computable functions that witness that C is effectively factorizable,

and which outputs

- a code for the $(n+1)$ -category $C[X]$, which is equipped with the injective and decidable encoding $\mathcal{E}_{C[X]}$ given by Proposition 2.3.2.35 that extends \mathcal{E}_C ,
- a code for the embedding $X \rightarrow C[X]_{n+1}$.

Thus, we can consider that Proposition 2.3.2.35 is “effectively parametrized” by (C, X) and the computable functions that witness that C is effectively factorizable.

2.3.3 The case of polygraphs

We now consider the special case of polygraphs and show that, when provided with an adequate computational description of those, the associated free strict categories are computable. Moreover, we introduce in this case an alternative procedure to compute the context class associated to a context than the one provided by Proposition 2.3.2.7(ii), enabling faster recursive models for those free categories.

2.3.3.1 – Computable polygraphs. For $n \in \mathbb{N}$ and an n -polygraph P equipped with injective and decidable encodings \mathcal{E}_{P_i} of P_i for $i \in \mathbb{N}_n$, we define by induction on n the property that P is a *computable* polygraph, together with a decidable and injective encoding \mathcal{E}_{P^*} of the free n -category P^* , such that P^* is computable and effectively factorizable for this encoding. A 0-polygraph P is always computable and we take $\mathcal{E}_{P^*} = \mathcal{E}_{P_0}$. Given $n \in \mathbb{N}$, an $(n+1)$ -polygraph $P' = (P, X)$ is computable when P is and when the functions $d_n^-, d_n^+ : X \rightarrow P_n^*$ are computable, relatively to the encoding $\mathcal{E}_{P_n^*}$ of P_n^* coming with the encoding \mathcal{E}_{P^*} given by the induction. Moreover, we take for $\mathcal{E}_{(P')^*}$ the encoding given by Proposition 2.3.2.35. For these encodings, we have the following computability property for free strict categories on computable polygraphs:

Proposition 2.3.3.2. *Given $n \in \mathbb{N}$ and an n -polygraph P equipped with injective and decidable encodings \mathcal{E}_{P_i} of P_i for $i \in \mathbb{N}_n$ such that P is computable, the n -category P^* is computable and the embeddings $P_i \rightarrow P_i^*$ are computable for $i \in \mathbb{N}_n$.*

Proof. By induction on n , using Proposition 2.3.2.35. \square

2.3.3.3 – More efficient computation of the equivalences classes. Let $n \in \mathbb{N}$ with $n \geq 2$ and C be an n -category equipped with an injective and decidable encoding $\mathcal{E}_{(C,X)}$, such that C is computable and effectively factorizable for this encoding. Recall that we defined in the proof of Proposition 2.3.2.11 an algorithm which, given an m -context E of C for some $m \in \mathbb{N}_n$ as input, and output $\llbracket E \rrbracket$. This algorithm is derived by Proposition 2.3.1.31 using the definition of \approx_m^1 , but other algorithms are possible. For concrete applications like the word problem below, it is important that the algorithm that executes this operation is fast, since it is part of the implementations of the composition operations \bullet ; (c.f. Proposition 2.3.2.18). One way to obtain a faster algorithm is to use a more suitable relation $\hat{\approx}_m^1$ that generates \approx_m as a reflexive transitive closure, so that the algorithm derived by Proposition 2.3.1.31 is more efficient (when C allows it). We give such an alternative generating relation in the case where $C = P^*$ for some computable n -polygraph P by refining a bit the axioms used to define \approx_m^1 .

So let P be an n -polygraph and $m \in \mathbb{N}_n$. We define a relation $\hat{\approx}_m$ between m -contexts of the same type of P^* . Given an m -type (u, u') and two m -contexts of type (u, u')

$$E_1 = (l_1, F_1, r_1) \quad \text{and} \quad E_2 = (l_2, F_2, r_2)$$

we write $E_1 \hat{\approx}_m E_2$ when there exists $(m-1)$ -contexts (l'_i, F'_i, r'_i) such that $\llbracket (l'_i, F'_i, r'_i) \rrbracket = F_i$ for $i \in \{1, 2\}$, and $l, w, r \in P_m^*$ with $|w| = 1$ (recall the notion of length defined in Paragraph 2.2.4.1) and such that either the set of conditions (\approx -L) or (\approx -R) (the ones defining \approx_m^1) is satisfied. Note that the only difference between the definitions of $\hat{\approx}_m^1$ and \approx_m^1 is that we require w to be of length 1. We verify that:

Proposition 2.3.3.4. *The reflexive symmetric transitive closure of $\hat{\approx}_m^1$ is \approx_m .*

Proof. Let $\hat{\approx}_m$ be the reflexive symmetric transitive closure of $\hat{\approx}_m^1$. Since we have $\hat{\approx}_m^1 \subseteq \approx_m^1$, it is enough to show that $\approx_m^1 \subseteq \hat{\approx}_m$. Let (u, u') be an m -type and

$$E_1 = (l_1, F_1, r_1) \quad \text{and} \quad E_2 = (l_2, F_2, r_2)$$

be two m -contexts of type (u, u') of P^* such that $E_1 \approx_m^1 E_2$. By definition of \approx_m^1 , there exist $(m-1)$ -contexts (l'_i, F'_i, r'_i) such that $\llbracket (l'_i, F'_i, r'_i) \rrbracket = F_i$ for $i \in \{1, 2\}$, and $l, w, r \in P_m^*$ such that either (\approx -L) or (\approx -R) is satisfied. By symmetry, suppose that (\approx -L) is satisfied. We prove that $E_1 \hat{\approx}_m E_2$ by induction on the length $|w|$ of w . If $|w| = 0$, then $w = \text{id}_{\tilde{w}}$ for some $\tilde{w} \in P_{m-1}^*$, so that $E_1 = E_2$, thus $E_1 \hat{\approx}_m E_2$. If $|w| = 1$, then $E_1 \hat{\approx}_m^1 E_2$ by definition of $\hat{\approx}_m^1$. Otherwise, suppose that $|w| = k + 1$ for some $k \in \mathbb{N}^*$. Then, by the definition of the functor $-[-]^\approx$, we have that $w = w' \bullet_n w''$ for some $w', w'' \in P_m^*$ such that $|w'| = 1$ and $|w''| = k$. Note that

$$(w' \bullet_{m-1} w'') \bullet_{m-2} F'_1[u] \bullet_{m-2} r'_1 = (w' \bullet_{m-2} F'_1[u] \bullet_{m-2} r'_1) \bullet_{m-1} (w'' \bullet_{m-2} F'_1[u] \bullet_{m-2} r'_1)$$

so that, by induction hypothesis, we have $E_1 \hat{\approx}_m E_3$ where $E_3 = (l_3, F_3, r_3)$ is an m -context of type (u, u') with $F_3 = \llbracket (l'_3, F'_3, r'_3) \rrbracket$ for some $(m-1)$ -context (l'_3, F'_3, r'_3) defined by $F'_3 = F'_1$ and

$$\begin{aligned} l'_3 &= \partial_{m-1}^-(w'') & r'_3 &= r'_1 \\ l_3 &= l \bullet_{m-1} (w' \bullet_{m-2} F'_1[u] \bullet_{m-2}) & r_3 &= (w'' \bullet_{m-2} F'_1[u'] \bullet_{m-2} r'_1) \bullet_{m-1} r. \end{aligned}$$

Thus, we also have $E_3 \hat{\approx}_m^1 E_2$, so that $E_1 \hat{\approx}_m E_2$. Hence, $\hat{\approx}_m = \approx_m$. \square

Remark 2.3.3.5. We can do a remark similar to Remark 2.2.2.4. Given $m \in \mathbb{N}_n$, the relation $\hat{\approx}_m^{-1}$ on the m -context, which is defined by $E_1 \hat{\approx}_m^{-1} E_2$ if and only if $E_2 \hat{\approx}_m^1 E_1$ for all m -contexts E_1, E_2 of the same m -type, admits a definition by axioms (\approx -L)' and (\approx -R)' which are symmetrical to (\approx -L) and (\approx -R). Moreover, $\hat{\approx}_m$ can be equivalently described as the reflexive transitive closure of $\hat{\approx}_m^1 \cup \hat{\approx}_m^{-1}$, so that, in the proofs, by symmetry of the definitions of $\hat{\approx}_m^1$ and $\hat{\approx}_m^{-1}$, we can often reduce a case analysis of $E_1 \hat{\approx}_m E_2$ to $E_1 \hat{\approx}_m^1 E_2$.

Now, suppose that P is equipped with injective and decidable encodings \mathcal{E}_{P_i} of P_i for $i \in \mathbb{N}_n$ and that P is computable for these encodings, so that, by the definition of “computable” for polygraphs, we derive an injective and decidable encoding \mathcal{E}_{P^*} of P^* for which P^* is computable and effectively factorizable. For this encoding, we have:

Proposition 2.3.3.6. *Given $m \in \mathbb{N}_n$ with $m \geq 2$, the function which takes as input an m -cell $u \in P_m^*$, and outputs the finite set of $(m-1)$ -composable pairs $(v, w) \in (P_m^*)^2$ such that $u = v \bullet_{m-1} w$ and $|w| = 1$, is computable.*

Proof. Let $u \in P_m^*$. Consider $v, w \in P_m^*$ such that $u = v \bullet_{m-1} w$. Then, by putting $C = P_{m-1}^*$ and $A = (P_m)^A$, we have $v = \llbracket s \rrbracket$ and $w = \llbracket t \rrbracket$ for some $k, l \in \mathbb{N}$ and

$$s = (s_1, \dots, s_k)^s \quad \text{and} \quad t = (t_1, \dots, t_l)^s$$

in A^* . Since $|w| = 1$, we have $l = 1$. Moreover, we deduce that $u = \llbracket (s_1, \dots, s_k, t_1)^s \rrbracket$. By Proposition 2.3.1.29(i), we can compute the set of possible representants $(s_1, \dots, s_k, t_1)^s \in A^*$ of u . For each possible value, by Proposition 2.3.2.30(ii), we can compute the codes of $v = \llbracket (s_1, \dots, s_k)^s \rrbracket$ and $w = \llbracket (t_1)^s \rrbracket$, which concludes the proof. \square

Hence, we get another proof of Proposition 2.3.2.11:

Proposition 2.3.3.7. *For every $m \in \mathbb{N}_n$, $u \in C_m$ and $u' = (\partial_{m-1}^-(u), \partial_{m-1}^+(u))$, the restriction of \approx_m to m -contexts of instantiable types is effectively right-finite, and the function which maps an m -context E of type u' to $\llbracket E \rrbracket$ is computable.*

Proof. By Proposition 2.3.1.31, it is sufficient to prove that the restriction of $\hat{\approx}_m^1 \cup \hat{\approx}_m^1$ to m -contexts of instantiable type is effectively right-finite. By Remark 2.3.3.5, it is enough to show that the restriction of $\hat{\approx}^1$ is effectively right-finite. Using Proposition 2.3.3.6, the proof of the latter property is similar to the one of Proposition 2.3.2.10. \square

However, the instance of the algorithm of Proposition 2.3.1.31 using the effectively right-finite $\hat{\approx}_m^1$ will be more efficient than the one using \approx_m^1 . Indeed, given $m \in \mathbb{N}_n$ and an m -context E , we have

$$\{E' \mid E' \text{ } m\text{-context such that } E \hat{\approx}_m^1 E'\} \subseteq \{E' \mid E' \text{ } m\text{-context such that } E \approx_m^1 E'\}$$

by definition of \approx_m^1 and $\hat{\approx}_m^1$. Thus, intuitively, we iterate on less m -context E' per m -context E in the algorithm of Proposition 2.3.1.31 when using $\hat{\approx}_m^1$ than when using \approx_m^1 .

2.4 Word problem on polygraphs

We now use the computability results of the previous sections to give a solution to the word problem on polygraphs of strict categories. Our solution is strongly inspired from the one given by Makkai in [Mak05]. However, whereas Makkai deemed his procedure “infeasible” in practice, the one we propose admits a relatively fast implementation, that solves rapidly most instances of the word problem.

We first give a precise statement to this problem after introducing terms on polygraphs (Section 2.4.1). Then, we give a solution to the word problem on the special case of finite polygraphs (Section 2.4.2). By Proposition 2.3.3.2, we can already compute recursive models with injective encodings for the free strict categories on computable polygraphs and, in particular, finite polygraphs, so that the word problem is already essentially solved since one can compare two terms by comparing the codes of their evaluations in the recursive models. But one hardly writes down

a code for a computable polygraph, because of its intrinsically inductive definition. Thus, most of our concerns will be to define a user-friendly way to use polygraphs as inputs of programs. Next, we show how to extend our method to more general polygraphs (possibly infinite, possibly not computable). Finally, we illustrate the discussion of this section by providing an implementation in OCAML (Section 2.4.4).

2.4.1 Terms and word problem

Here, we define the terms on polygraphs and give a precise statement to the word problem on polygraphs.

2.4.1.1 – Terms on polygraphs. Let $n \in \mathbb{N} \cup \{\omega\}$. Given an n -polygraph P , for $k \in \mathbb{N}_n$, we define the sets of k -terms \mathcal{T}_k^P of P inductively as follows:

- given $k \in \mathbb{N}_n$ and $g \in P_k$, there is a k -term $\overline{\text{gen}}_k(g) \in \mathcal{T}_k^P$,
- given $k \in \mathbb{N}_{n-1}$ and a k -term $t \in \mathcal{T}_k^P$, there is a $(k+1)$ -term $\overline{\text{id}}_k^{k+1}(t) \in \mathcal{T}_{k+1}^P$,
- given $i, k \in \mathbb{N}_n$ with $i < k$ and k -terms $t_1, t_2 \in \mathcal{T}_k^P$, there is a k -term $t_1 \overline{*}_{i,k} t_2 \in \mathcal{T}_k^P$.

We write $\mathcal{T}^P = \sqcup_{k \in \mathbb{N}_n} \mathcal{T}_k^P$ for the set of all terms of P . Given a morphism $F: P \rightarrow Q \in \mathbf{Pol}_n$, there is a function

$$\mathcal{T}^F: \mathcal{T}^P \rightarrow \mathcal{T}^Q$$

defined on $t \in \mathcal{T}^P$ by induction on t :

- for $k \in \mathbb{N}_n$ and $g \in P_k$, $\mathcal{T}^F(\overline{\text{gen}}_k(g)) = \overline{\text{gen}}_k(F(g))$,
- for $k \in \mathbb{N}_{n-1}$ and a k -term t , $\mathcal{T}^F(\overline{\text{id}}_k^{k+1}(t)) = \overline{\text{id}}_k^{k+1}(\mathcal{T}^F(t))$,
- for $i, k \in \mathbb{N}_n$ with $i < k$ and k -terms t_1, t_2 , $\mathcal{T}^F(t_1 \overline{*}_{i,k} t_2) = \mathcal{T}^F(t_1) \overline{*}_{i,k} \mathcal{T}^F(t_2)$.

We now define subsets \mathcal{W}_k^P of \mathcal{T}_k^P consisting of the k -terms that are *well-typed*, together with an *evaluation function*

$$\llbracket - \rrbracket_k^P: \mathcal{W}_k^P \rightarrow P_k^*$$

by induction on $k \in \mathbb{N}_n$. All 0-terms are well-typed and are of the form $\overline{\text{gen}}_0(g)$ for some $g \in P_0$ and we put $\llbracket \overline{\text{gen}}_0(g) \rrbracket_k^P = g$. For $k \in \mathbb{N}_n^*$, a k -term is *well-typed* when there exist $u, v \in P_{k-1}^*$ such that there is a derivation $\vdash_k^P t: u \rightarrow v$, with \vdash_k^P defined below:

- given $g \in P_k$, we have $\vdash_k^P \overline{\text{gen}}_k(g): d_{k-1}^-(g) \rightarrow d_{k-1}^+(g)$,
- given a well-typed $(k-1)$ -term t , we have $\vdash_k^P \overline{\text{id}}_k^{k+1}(t): \llbracket t \rrbracket_{k-1}^P \rightarrow \llbracket t \rrbracket_{k-1}^P$,
- given $i \in \mathbb{N}_{k-2}$ and k -terms t_1, t_2 such that $\vdash_k^P t_1: u_1 \rightarrow u_1'$ and $\vdash_k^P t_2: u_2 \rightarrow u_2'$ for some $u_1, u_1', u_2, u_2' \in P_{k-1}^*$ with $\partial_i^+(u_1) = \partial_i^-(u_2)$, we have $\vdash_k^P t_1 \overline{*}_{i,k} t_2: u_1 * u_2 \rightarrow u_1' * u_2'$,
- given k -terms t_1, t_2 such that $\vdash_k^P t_1: u_1 \rightarrow u_2$ and $\vdash_k^P t_2: u_2 \rightarrow u_3$ for some $u_1, u_2, u_3 \in P_{k-1}^*$, we have $\vdash_k^P t_1 \overline{*}_{k-1,k} t_2: u_1 \rightarrow u_3$.

We then easily verify the following property by induction on t :

Proposition 2.4.1.2. *Given $t \in \mathcal{W}_k^P$, the following hold:*

- (i) *there are unique $u, u' \in P_{k-1}^*$ such that $\vdash_k^P t: u \rightarrow u'$ is derivable,*

(ii) the derivation $\vdash_k^P t: u \rightarrow u'$ is unique,

(iii) $\partial_{k-2}^\epsilon(u) = \partial_{k-2}^\epsilon(u')$ for $\epsilon \in \{-, +\}$.

Given a well-typed k -term t with associated derivation $\vdash_k^P t: u \rightarrow u'$, we define a cell $\llbracket t \rrbracket_k^P \in P_k^*$ such that $\partial_{k-1}^-(\llbracket t \rrbracket_k^P) = u$ and $\partial_{k-1}^+(\llbracket t \rrbracket_k^P) = u'$ by induction on the derivation of t :

- if $t = \overline{\text{gen}}_k(g)$ for some $g \in P_k$, then $\llbracket t \rrbracket_k^P = g$,
- if $t = \overline{\text{id}}_{k-1}^k(\tilde{t})$ for some $\tilde{t} \in \mathcal{T}_{k-1}^P$, then $\llbracket t \rrbracket_k^P = \text{id}_{\llbracket \tilde{t} \rrbracket_{k-1}^P}^k$,
- if $t = t_1 \bar{*}_{i,k} t_2$ for some $i \in \mathbb{N}_{k-1}$ and $t_1, t_2 \in \mathcal{T}_k^P$, then $\llbracket t \rrbracket_k^P = \llbracket t_1 \rrbracket_k^P *_i \llbracket t_2 \rrbracket_k^P$.

Note that the well-typedness of t ensures that $\llbracket - \rrbracket_k^P$ is well-defined, which concludes the inductive definition of \mathcal{W}_k^P and $\llbracket - \rrbracket_k^P$. We write \mathcal{W}^P for $\bigsqcup_{k \in \mathbb{N}_n} \mathcal{W}_k^P$. The above evaluation functions of well-typed k -terms define a function

$$\llbracket - \rrbracket^P: \mathcal{W}^P \rightarrow P^*.$$

Given a morphism $F: P \rightarrow Q$ in \mathbf{Pol}_n , the function \mathcal{T}^F restricts to a function $\mathcal{W}^F: \mathcal{W}^P \rightarrow \mathcal{W}^Q$. We then have the following naturality property:

Proposition 2.4.1.3. *Given a morphism $F: P \rightarrow Q$ in \mathbf{Pol}_n ,*

$$\llbracket - \rrbracket^Q \circ \mathcal{W}^F = F^* \circ \llbracket - \rrbracket^P.$$

Proof. Given $t \in \mathcal{W}^P$, we prove by induction on t that $\llbracket \mathcal{W}^F(t) \rrbracket^Q = F^*(\llbracket t \rrbracket^P)$:

- if $t = \overline{\text{gen}}_k(g)$ for some $k \in \mathbb{N}_n$ and $g \in P_k$,

$$\llbracket \mathcal{W}^F(t) \rrbracket^Q = F(g) = F^* \circ \llbracket t \rrbracket^P,$$

- if $t = \overline{\text{id}}_k^{k+1}(\tilde{t})$ for some $k \in \mathbb{N}_{n-1}$ and $\tilde{t} \in \mathcal{T}_k^P$, then,

$$\begin{aligned} \llbracket \mathcal{W}^F(t) \rrbracket^Q &= \llbracket \overline{\text{id}}_k^{k+1}(\mathcal{W}^F(\tilde{t})) \rrbracket^Q \\ &= \text{id}_k^{k+1}(\llbracket \mathcal{W}^F(\tilde{t}) \rrbracket^Q) \\ &= \text{id}_k^{k+1}(F^*(\llbracket \tilde{t} \rrbracket^Q)) && \text{(by induction hypothesis)} \\ &= F^*(\text{id}_k^{k+1}(\llbracket \tilde{t} \rrbracket^Q)) \\ &= F^*(\llbracket t \rrbracket^Q), \end{aligned}$$

- if $t = t_1 \bar{*}_{i,k} t_2$ for some $i, k \in \mathbb{N}_n$ with $i < k$ and $t_1, t_2 \in \mathcal{W}_k^P$, then,

$$\begin{aligned} \llbracket \mathcal{W}^F(t) \rrbracket^Q &= \llbracket \mathcal{W}^F(t_1) \bar{*}_{i,k} \mathcal{W}^F(t_2) \rrbracket^Q \\ &= \llbracket \mathcal{W}^F(t_1) \rrbracket^Q *_i \llbracket \mathcal{W}^F(t_2) \rrbracket^Q \\ &= F^*(\llbracket t_1 \rrbracket^P) *_i F^*(\llbracket t_2 \rrbracket^P) && \text{(by induction hypothesis)} \\ &= F^*(\llbracket t_1 \rrbracket^P *_i \llbracket t_2 \rrbracket^P) \\ &= F^*(\llbracket t \rrbracket^P). \end{aligned} \quad \square$$

2.4.1.4 – Word problem statement. For $n \in \mathbb{N} \cup \{\omega\}$ an n -polygraph P , the *word problem on P* consists, given $k \in \mathbb{N}_n$ and $t_1, t_2 \in \mathcal{W}_k^P$, in deciding whether $\llbracket t_1 \rrbracket^P = \llbracket t_2 \rrbracket^P$. By “deciding”, we mean exhibiting a procedure parametrized by P, n, k, t_1 and t_2 that terminates in a finite number of steps and such that this procedure returns “yes” if and only if $\llbracket t_1 \rrbracket^P = \llbracket t_2 \rrbracket^P$ and returns “no” otherwise. It is desirable that most of the steps of this procedure be implementable on a computer.

2.4.2 Solution to the word problem on finite polygraphs

In this section, we show how to derive an algorithm for the word problem on finite polygraphs from the results of Section 2.3. This algorithm takes as inputs a polygraph P and two well-typed terms $t_1, t_2 \in \mathcal{W}^P$ and decides whether $\llbracket t_1 \rrbracket^P = \llbracket t_2 \rrbracket^P$. Before deriving the algorithm, we must describe the computational representation of polygraphs and terms that we use. We first define *set-encoded polygraphs* that are polygraphs equipped with a choice of encodings of their sets of generators. Then, we show that well-typed terms of set-encoded polygraphs admit a canonical computational representation, by deriving an encoding for the set of well-typed terms. We then show how to represent polygraphs computationally. Finally, we give the algorithm that solves the word problem based on these computational representations.

2.4.2.1 – Set-encoded polygraphs. Given $n \in \mathbb{N}$, a *set-encoded n -polygraph* is a finite n -polygraph P equipped with encodings \mathcal{E}_{P_k} of P_k for $k \in \mathbb{N}_n$ that are injective and decidable. Given two set-encoded n -polygraphs P and Q , a *morphism of set-encoded n -polygraphs* between P and Q is a morphism $F: P \rightarrow Q \in \mathbf{Pol}_n$ such that, for every $k \in \mathbb{N}_n$ and $g \in P_k$, there is $m \in \mathbb{N}$ satisfying $m \mathcal{E}_{P_k} g$ and $m \mathcal{E}_{Q_k} F(g)$. We write \mathbf{sePol}_n for the category of set-encoded n -polygraphs.

Given $n \in \mathbb{N}$ and a set-encoded n -polygraph P , we define an encoding $\mathcal{E}_{\mathcal{T}^P}$ of \mathcal{T}^P . We first define a function $e^P: \mathcal{T}^P \rightarrow \mathbb{N}$ inductively on its argument $t \in \mathcal{T}^P$:

- if $t = \overline{\text{gen}}_k(g)$ for some $k \in \mathbb{N}_n$ and $g \in P_k$, then

$$e^P(t) = \theta_2(0, 1 + \theta_2(k, g^\#))$$

where $g^\# \in \mathbb{N}$ is unique such that $g^\# \mathcal{E}_{P_k} g$,

- if $t = \overline{\text{id}}_k^{k+1}(\tilde{t})$ for some $k \in \mathbb{N}_{n-1}$ and $\tilde{t} \in \mathcal{T}_k^P$, then

$$e^P(t) = \theta_2(1, 1 + \theta_2(k, e^P(\tilde{t}))),$$

- if $t = t_1 \overline{\text{r}}_{i,k} t_2$ for some $k, i \in \mathbb{N}_n$ with $i < k$ and $t_1, t_2 \in \mathcal{T}_k^P$, then

$$e^P(t) = \theta_2(2, 1 + \theta_4(k, i, e^P(t_1), e^P(t_2))).$$

We then put $c \mathcal{E}_{\mathcal{T}^P} t$ for $c \in \mathbb{N}$ and $t \in \mathcal{T}^P$ when $c = e^P(t)$. We then have:

Proposition 2.4.2.2. *Given $n \in \mathbb{N}$ and a set-encoded n -polygraph P , $\mathcal{E}_{\mathcal{T}^P}$ is an injective and decidable encoding of \mathcal{T}^P .*

Proof. Given $c \in \mathbb{N}$ and $t_1, t_2 \in \mathcal{T}^P$ such that $c \mathcal{E}_{\mathcal{T}^P} t_1$ and $c \mathcal{E}_{\mathcal{T}^P} t_2$, we verify that $t_1 = t_2$, by induction on c . Let $(c_1, c_2) \in \mathbb{N}^2$ such that $c = \theta_2(c_1, c_2)$. Then, by the definition of e^P , we have $c_1 \in \{0, 1, 2\}$. Suppose that $c_1 = 0$. Thus, by the definition of e^P , we have $c_2 > 0$. So let $(k, g^\#) = \theta_2^{-1}(c_2 - 1)$. We then have $t_1 = t_2 = \overline{\text{gen}}_k(g)$ where $g \in P_k$ is such that $g^\# \mathcal{E}_{P_k} g$. Now suppose that $c_1 = 1$. Again, by the definition of e^P , we have $c_2 > 0$ and we write (k, \tilde{c}) for $\theta_2^{-1}(c_2 - 1)$. By the definition of e^P , for $i \in \{1, 2\}$, the term t_i is of the form $\overline{\text{id}}_k^{k+1}(\tilde{t}_i)$ for some $\tilde{t}_i \in \mathcal{T}^P$ such that $\tilde{c} \mathcal{E}_{\mathcal{T}^P} \tilde{t}_i$. By Proposition 2.3.1.5, we have $\tilde{c} < c$ so that, by induction hypothesis, $\tilde{t}_1 = \tilde{t}_2$ and thus $t_1 = t_2$. The case $c = 2$ is similar. Thus, $\mathcal{E}_{\mathcal{T}^P}$ is an encoding which is injective by definition. Moreover, by doing a case analysis similar to the one above and using the decidability of the encodings \mathcal{E}_{P_k} , we get a decidability procedure for the support of $\mathcal{E}_{\mathcal{T}^P}$, which terminates by Proposition 2.3.1.5. \square

Remark 2.4.2.3. Given $n \in \mathbb{N}$ and an n -polygraph P , if $P_0 \sqcup \dots \sqcup P_n$ is encoded by the datatype `gen`, then the set \mathcal{T}^P is naturally encoded by the datatype

```
type term =
| TermGen of int * gen
| TermId of int * term
| TermComp of (int * int * term * term)
```

We verify that the functions on terms derived from morphisms of set-encoded polygraphs are compatible with the encodings on terms:

Proposition 2.4.2.4. *Given $n \in \mathbb{N}$, two set-encoded n -polygraphs P and Q and a morphism of set-encoded n -polygraphs $F: P \rightarrow Q$, for all $c \in \mathbb{N}$ and $t \in \mathcal{T}^P$, we have $c \mathcal{E}_{\mathcal{T}^Q} t$ if and only if $c \mathcal{E}_{\mathcal{T}^Q} \mathcal{T}^F(t)$.*

Proof. This is proved by induction on t . The only non-trivial case is when $t = \overline{\text{gen}}_k(g)$ for some $k \in \mathbb{N}_n$ and $g \in P_k$. By the definition of set-encoded n -polygraph morphism, we have that, for all $c' \in \mathbb{N}$, $c' \mathcal{E}_{P_k} g$ if and only if $c' \mathcal{E}_{Q_k} F(g)$. Hence, $c \mathcal{E}_{\mathcal{T}^P} \overline{\text{gen}}_k(g)$ if and only if $c \mathcal{E}_{\mathcal{T}^Q} \overline{\text{gen}}_k(F(g))$. \square

Since \mathcal{W}^P is a subset of \mathcal{T}^P , we derive an injective encoding $\mathcal{E}_{\mathcal{W}^P}$ for \mathcal{W}^P (but we do not know that it is decidable at the moment). We then have:

Proposition 2.4.2.5. *Given $n \in \mathbb{N}$ and a set-encoded n -polygraph P , if P is computable, then*

- (i) *the function $\llbracket - \rrbracket^P$ is computable,*
- (ii) *the encoding $\mathcal{E}_{\mathcal{W}^P}$ is decidable.*

Proof. Proof of (i): Remember that the encoding of P^* is the one given by Proposition 2.3.3.2. The latter properties also states that P^* is computable for these encodings and so are the embeddings $P_k \rightarrow P_k^*$ for $k \in \mathbb{N}_n$. Thus, the operations $*_{i,k}$ and id^k are computable for $i, k \in \mathbb{N}_n$ with $i < k$, so that the inductive definition of $\llbracket - \rrbracket^P$ witnesses the fact that $\llbracket - \rrbracket^P$ is computable.

Proof of (ii): Using (i), we give a procedure that decides, given $c \in \mathbb{N}$, whether $c \mathcal{E}_{\mathcal{W}^P} t$ for some $t \in \mathcal{W}^P$. By Proposition 2.4.2.2, we can first decide whether $c \mathcal{E}_{\mathcal{T}^P} t$ for some $t \in \mathcal{T}^P$. Then, we verify by induction on t that $t \in \mathcal{W}^P$ using the following inductive verification procedure:

- if $t = \overline{\text{gen}}_k(g)$ for some $k \in \mathbb{N}_n$ and $g \in P_k$, then $t \in \mathcal{W}^P$,
- if $t = \overline{\text{id}}_k^{k+1}(\tilde{t})$ for some $k \in \mathbb{N}_{n-1}$ and $\tilde{t} \in \mathcal{T}_k^P$, then $t \in \mathcal{W}^P$ if and only if $\tilde{t} \in \mathcal{W}^P$,
- if $t = t_1 *_{i,k} t_2$ for some $i, k \in \mathbb{N}_n$ with $i < k$, then $t \in \mathcal{W}^P$ if and only if $t_1, t_2 \in \mathcal{W}^P$ and $\partial_i^+(\llbracket t_1 \rrbracket^P) = \partial_i^-(\llbracket t_2 \rrbracket^P)$.

Note that the last condition “ $\partial_i^+(\llbracket t_1 \rrbracket^P) = \partial_i^-(\llbracket t_2 \rrbracket^P)$ ” can be computationally verified since $\llbracket - \rrbracket^P$ is computable by (i), and P^* is computable by Proposition 2.3.3.2 (thus so are the functions $\partial_i^-, \partial_i^+$), and $\mathcal{E}_{P_k^*}$ is injective. \square

Remark 2.4.2.6. In the same spirit as Remark 2.3.2.36, we in fact proved the stronger statement that Proposition 2.4.2.5 is “effectively parametrized” by P , *i.e.*, there is a computable function which takes as inputs

- the codes of the computable functions that decide the support of \mathcal{E}_{P_k} for $k \in \mathbb{N}_n$,

- the codes of the computable functions that witness that P is computable,

and which outputs

- a code for the computable function $\llbracket - \rrbracket^P$,
- a code for the function that decides the support of \mathcal{W}^P .

2.4.2.7 – Term definitions for polygraphs. In order to define algorithms parametrized by finite polygraphs, we need to define an encodable structure that represents such polygraphs. The difficulty here lies in the fact that the definition of $(n+1)$ -polygraphs depends on the free n -category construction to define the source and target of the $(n+1)$ -generators. An encoding for such free n -category can be defined inductively using Proposition 2.3.2.35, but this encoding would be terrible for practical purposes, since it would require a user to manipulate by hand the complicated internal encodings of Proposition 2.3.2.35. Instead, we define a more natural structure that uses well-typed terms to define the source and target of $(n+1)$ -generators.

For $n \in \mathbb{N}$, we define the notion of n -term definition together with the *set-encoded n -polygraph associated to an n -term definition*. A 0-term definition is a finite subset $D_0 \subset \mathbb{N}$ and the 0-polygraph associated to D_0 is \bar{D} with $\bar{D}_0 = D_0$ and \mathcal{E}_{D_0} induced by $\mathcal{E}_{\mathbb{N}}$. For $n \in \mathbb{N}$, an $(n+1)$ -term definition is a dependent pair

$$D = ((D', S), (d_n^{t-}, d_n^{t+}))$$

where D' is an n -term definition, S is a finite subset of \mathbb{N} , and d_n^{t-}, d_n^{t+} are functions $S \rightarrow \mathcal{W}_n^{\bar{D}'}$ such that

$$\partial_{n-1}^\epsilon(\llbracket d_n^{t-}(g) \rrbracket^{\bar{D}'}) = \partial_{n-1}^\epsilon(\llbracket d_n^{t+}(g) \rrbracket^{\bar{D}'})$$

for $\epsilon \in \{-, +\}$ and $g \in S$. The set-encoded $(n+1)$ -polygraph \bar{D} associated to D is defined by

$$\bar{D}_{\leq n} = \bar{D}', \quad \bar{D}_{n+1} = S \quad \text{and} \quad d_n^\epsilon(g) = \llbracket d_n^{t^\epsilon}(g) \rrbracket^{\bar{D}'}$$

for $\epsilon \in \{-, +\}$ and $g \in \bar{D}_{n+1}$. Finally, $\mathcal{E}_{D_{n+1}}$ is the encoding induced by $\mathcal{E}_{\mathbb{N}}$. For $n \in \mathbb{N}$, we write D_n for the set of n -term definitions. By induction on n , we define an injective encoding on D_n . We define the encoding \mathcal{E}_{D_0} for D_0 from the encoding $\mathcal{E}_{\mathbb{N}}$ using the standard derivation of encodings for finite subsets. Given $n \in \mathbb{N}$, we define the encoding $\mathcal{E}_{D_{n+1}}$ for D_{n+1} using the standard derivation of encodings for dependent pairs where

- the encoding for the pairs (D', S) is defined with the standard derivation of encodings for pairs using \mathcal{E}_{D_n} and $\mathcal{E}_{\mathcal{P}_f(\mathbb{N})}$,
- given a pair (D', S) , the encoding for the pairs (d_n^{t-}, d_n^{t+}) is defined with the standard derivations of encodings for pairs and functions with finite domains, using, for domain and codomain of d_n^{t-} and d_n^{t+} , the encodings \mathcal{E}_S (induced by $\mathcal{E}_{\mathbb{N}}$) and $\mathcal{E}_{\mathcal{W}^{D'}}$ respectively.

Remark 2.4.2.8. By Remarks 2.3.1.23 and 2.3.1.27, using the datatype for terms from Remark 2.4.2.3 with `gen = int`, the set $\sqcup_{n \in \mathbb{N}} D_n$ is naturally encoded by the datatype

```
type term_def =
| TermDefZ of int list
| TermDefS of term_def * int list * (int * term) list * (int * term) list
```

Up to isomorphism, term definitions encode all finite set-encoded polygraphs:

Proposition 2.4.2.9. *Given $n \in \mathbb{N}$ and a finite set-encoded n -polygraph P , there exists an n -term definition $D \in \mathcal{D}_n$ and an isomorphism $P \rightarrow \bar{D}$ in \mathbf{sePol}_n . Moreover, \bar{D} and the isomorphism does not depend on D .*

Proof. We prove this property by induction on n . If $n = 0$, then there is a unique $D \in \mathcal{D}_0$ such that P is isomorphic to \bar{D} in \mathbf{sePol}_n , which is such that D_0 is the support of \mathcal{E}_{P_0} . So suppose that the property holds for some $n \in \mathbb{N}$. We show that it holds for $n+1$. Let P be a finite set-encoded $(n+1)$ -polygraph. By induction, there is $D' \in \mathcal{D}_n$ and an isomorphism $F: P_{\leq n} \rightarrow \bar{D}'$ in \mathbf{sePol}_n . We now define the $(n+1)$ -term $D = ((D', S), (d_n^{\pm}, d_n^{\pm})) \in \mathcal{D}_{n+1}$ and $f: P_{n+1} \rightarrow S$ such that $(F, f): P \rightarrow \bar{D}$ is an isomorphism in \mathbf{sePol}_{n+1} . By the constraints imposed on the morphisms of \mathbf{sePol}_{n+1} and since \mathcal{E}_S is the canonical encoding of the subset $S \subset \mathbb{N}$, we necessarily have that S is the support of $\mathcal{E}_{P_{n+1}}$ and f maps $g \in P_{n+1}$ to the unique $g^\# \in S$ such that $g^\# \mathcal{E}_{P_{n+1}} g$. For such S and f , we define $d_n^{\pm, \epsilon}$ for $\epsilon \in \{-, +\}$ by choosing n -terms $t_g^-, t_g^+ \in \mathcal{W}^{P_{\leq n}}$ such that $\llbracket t_g^\epsilon \rrbracket^{P_{\leq n}} = d_n^\epsilon(g)$ for $g \in P_{n+1}$ (that exist by Proposition 1.4.1.16), and we put $d_n^{\pm, \epsilon}(f(g)) = \mathcal{W}^F(t_g^\epsilon)$. Thus, for $g \in P_{n+1}$, we have

$$\begin{aligned} d_n^\epsilon(f(g)) &= \llbracket \mathcal{W}^F(t_g^\epsilon) \rrbracket^{\bar{D}'} \\ &= F^*(\llbracket t_g^\epsilon \rrbracket^{P_{\leq n}}) && \text{(by Proposition 2.4.1.3)} \\ &= F^*(d_n^\epsilon(g)) \end{aligned}$$

so that (F, f) is a morphism of \mathbf{sePol}_{n+1} which is moreover an isomorphism. By induction hypothesis, \bar{D}' and the isomorphism F does not depend on D' , and S and the bijection $f: P_{n+1} \rightarrow S$ are uniquely defined from P_{n+1} and $\mathcal{E}_{P_{n+1}}$. Moreover, the functions $d_n^{\pm}, d_n^{\pm, \epsilon}: \bar{D}_{n+1} \rightarrow \bar{D}_n^*$ are uniquely defined from P, F and f since

$$d_n^\epsilon(f(g)) = F^*(d_n^\epsilon(g))$$

so that neither \bar{D} nor $(F, f): P_{n+1} \rightarrow \bar{D}$ depends on D . \square

Moreover, the polygraphs associated to term definitions have the required computability properties to solve the word problem:

Proposition 2.4.2.10. *Given $n \in \mathbb{N}$ and $D \in \mathcal{D}_n$,*

- (i) \bar{D} is computable,
- (ii) the function $\llbracket - \rrbracket^{\bar{D}}: \mathcal{W}^{\bar{D}} \rightarrow \bar{D}^*$ is computable,
- (iii) the encoding $\mathcal{E}_{\mathcal{W}^D}$ is decidable.

Proof. We prove the property by induction on n . When $n = 0$, the property holds. So suppose that the property holds for some $n \in \mathbb{N}$. We show that it holds for $n + 1$.

Proof of (i): Let $D = (D', S, d_n^{\pm}, d_n^{\pm})$ be an $(n+1)$ -term definition. By induction hypothesis, the n -polygraph \bar{D}' is computable. Moreover, note that the functions $d_n^{\pm}, d_n^{\pm, \epsilon}$ are computable: for $\epsilon \in \{-, +\}$, the value of $d_n^{\pm, \epsilon}$ at some $g \in S$ can be computed by searching for the unique pair (g, t) with $t \in \mathcal{W}^{\bar{D}'}$ in the graph of $d_n^{\pm, \epsilon}$ (which is part of the code of D). By the induction hypothesis, $\llbracket - \rrbracket^{\bar{D}'}: \mathcal{W}^{\bar{D}'} \rightarrow (\bar{D}')^*$ is computable, so that $d_n^\epsilon = \llbracket - \rrbracket^{\bar{D}'} \circ d_n^{\pm, \epsilon}: \bar{D}_{n+1} \rightarrow \bar{D}_n^*$ is computable for $\epsilon \in \{-, +\}$.

Proof of (ii) and (iii): This is a consequence of (i) and Proposition 2.4.2.5. \square

Remark 2.4.2.11. In the same spirit as Remark 2.4.2.6, we have in fact proved the stronger statement that Proposition 2.4.2.10 is “effectively parametrized” by D , i.e., there is a computable function which takes D as input and outputs:

- codes for functions that witness that \bar{D} is a computable n -polygraph,
- a code for $\llbracket - \rrbracket^{\bar{D}} : \mathcal{W}^{\bar{D}} \rightarrow \bar{D}^*$,
- a code for the computable function that decides the support of $\mathcal{E}_{\mathcal{W}^{\bar{D}}}$.

Finally, we prove that the codes for term definitions of polygraphs are decidable:

Proposition 2.4.2.12. *For all $n \in \mathbb{N}$, the encoding \mathcal{E}_{D_n} is decidable.*

Proof. We show this property by induction on n . When $n = 0$, $\mathcal{E}_{D_0} = \mathcal{E}_{\mathcal{P}_f(\mathbb{N})}$ is decidable. Suppose now that the property holds for $n \in \mathbb{N}$. We show that it holds for $n + 1$. So let $c \in \mathbb{N}$. We give a procedure to decide whether $c \in \mathcal{E}_{D_{n+1}}$ for some $D \in D_{n+1}$. First, we can decide whether $c \in \mathcal{E}_{\mathbb{N}^4} (c_d, c_s, c_-, c_+)$ for some $c_d, c_s, c_-, c_+ \in \mathbb{N}$. Then, by induction hypothesis, we can decide whether there exists $D \in D_n$ such that $c_d \in \mathcal{E}_{D_n} D$. By Proposition 2.3.1.21, we can decide whether there exists $S \in \mathcal{P}_f(\mathbb{N})$ such that $c_s \in \mathcal{E}_{\mathcal{P}_f(\mathbb{N})} S$. By Remark 2.4.2.11, using c_d , we can compute codes for computable functions that witness that \bar{D} is a computable n -polygraph, a code for $\llbracket - \rrbracket^{\bar{D}}$ and a code for a computable function that decides the support of $\mathcal{E}_{\mathcal{W}^{\bar{D}}}$. Moreover, using Remark 2.3.2.36, we can compute a code for the n -category \bar{D}^* . Thus, we can decide whether c_- and c_+ are codes for functions with finite domains $d_n^{t-}, d_n^{t+} : S \rightarrow \mathcal{W}_n^{\bar{D}}$. Moreover, since \bar{D}^* and $\llbracket - \rrbracket^{\bar{D}}$ are computable, and $\mathcal{E}_{\bar{D}_{n-1}^*}$ is injective, we can verify computationally that

$$\partial_{n-1}^\epsilon(\llbracket d_n^{t-}(s) \rrbracket^{\bar{D}}) = \partial_{n-1}^\epsilon(\llbracket d_n^{t+}(s) \rrbracket^{\bar{D}})$$

for every $s \in S$ and $\epsilon \in \{-, +\}$. If the above equality holds, we have that $D' = ((D, S), (d_n^{t-}, d_n^{t+}))$ is a member of D_{n+1} and $c \in \mathcal{E}_{D_{n+1}} D'$. Thus, the encoding $\mathcal{E}_{D_{n+1}}$ is decidable. \square

2.4.2.13 – Solution to the word problem on finite polygraphs. Given $n \in \mathbb{N}$, an n -word problem instance is a dependent pairs $(D, (t_1, t_2))$ where $D \in D_n$ and $t_1, t_2 \in \mathcal{W}^{\bar{D}}$. We write W_n for the set of n -word problem instances, and we define an injective encoding \mathcal{E}_{W_n} using the standard derivation of encodings for dependent pairs, using \mathcal{E}_{D_n} and $\mathcal{E}_{\mathcal{W}^{\bar{D}}}$ for $D \in D_n$. There is an algorithm which decides the word problem for word problem instances:

Proposition 2.4.2.14. *The function which takes as input an n -word problem instance $(D, (t_1, t_2))$ and outputs 0 if $\llbracket t_1 \rrbracket^{\bar{D}} \neq \llbracket t_2 \rrbracket^{\bar{D}}$, and 1 if $\llbracket t_1 \rrbracket^{\bar{D}} = \llbracket t_2 \rrbracket^{\bar{D}}$, is computable.*

Proof. By Proposition 2.4.2.10(ii) and Remark 2.4.2.11, we can compute a code of the evaluation function $\llbracket - \rrbracket^{\bar{D}} : \mathcal{W}^{\bar{D}} \rightarrow \bar{D}^*$ from a code of D . Since the encoding of \bar{D}^* is injective, given $t_1, t_2 \in \mathcal{W}^{\bar{D}}$, we can compute $\llbracket t_1 \rrbracket^{\bar{D}}$ and $\llbracket t_2 \rrbracket^{\bar{D}}$ and compare the resulting codes. Thus, the property holds. \square

Moreover, we can decide the correct inputs for the computable function of Proposition 2.4.2.14:

Proposition 2.4.2.15. *For $n \in \mathbb{N}$, the encodings \mathcal{E}_{W_n} are decidable.*

Proof. Let $n \in \mathbb{N}$ and $c \in \mathbb{N}$. We can decide whether $c \in \mathcal{E}_{\mathbb{N}^3} (c_d, c_1, c_2)$ for some $c_d, c_1, c_2 \in \mathbb{N}$. By Proposition 2.4.2.12, we can decide whether there exists $D \in D_n$ such that $c_d \in \mathcal{E}_{D_n} D$. By Remark 2.4.2.11, we can compute the code of a computable function that decides the support of $\mathcal{E}_{\mathcal{W}^{\bar{D}}}$ from c_d . Thus, we can decide whether there exist $t_1, t_2 \in \mathcal{W}^{\bar{D}}$ such that $c_k \in \mathcal{E}_{\mathcal{W}^{\bar{D}}} t_k$ for $k \in \{1, 2\}$. Hence, \mathcal{E}_{W_n} is decidable. \square

Thus, given $n \in \mathbb{N}$, the following method can be used to decide whether two well-typed terms t_1, t_2 of a finite n -polygraph P are such that $\llbracket t_1 \rrbracket^P = \llbracket t_2 \rrbracket^P$:

- (1) pick injective and decidable encodings \mathcal{E}_{P_k} of P_k for $k \in \mathbb{N}_n$, making P set-encoded,
- (2) using the constructive proof of Proposition 2.4.2.9, build $D \in D_n$ so that there is an isomorphism $F: P \rightarrow \bar{D} \in \mathbf{sePol}_n$,
- (3) decide the n -word problem instance $(D, \mathcal{W}^F(t_1), \mathcal{W}^F(t_2))$ using the algorithm derived from Proposition 2.4.2.14.

Remark 2.4.2.16. For step (3), the codes of $\mathcal{W}^F(t_1)$ and $\mathcal{W}^F(t_2)$ that must be transmitted to the algorithm are exactly the codes of t_1 and t_2 under the encoding $\mathcal{E}_{\mathcal{T}^P}$ by Proposition 2.4.2.4.

2.4.3 Solution to the word problem on general polygraphs

We now consider the word problem on general polygraphs (*i.e.*, not necessarily finite) and give a solution that reduces to the case of finite polygraphs: given two well-typed terms t_1, t_2 of a polygraph P , we decide the word problem (t_1, t_2) on a finite subpolygraph of P that contains t_1 and t_2 . In order to prove the correctness of the method, we need to justify that the word problem behaves similarly on this subpolygraph. We first define the support function of a polygraph P , that maps a cell u of the associated free category P^* to the finite subset of generators of P that are “present” in u . This function will help us find a finite subpolygraph of P whose free category contains u . Then, we justify that the above method is correct.

2.4.3.1 – The support function. Given $n \in \mathbb{N} \cup \{\omega\}$ and an n -polygraph P , we define the *support function*

$$\text{supp}^P: P^* \rightarrow \mathcal{P}_f(\sqcup_{i \in \mathbb{N}_n} P_i)$$

or simply, supp , such that, for $g \in P$, we have $g \in \text{supp}(u)$ if and only if $\delta_p^M(u)_g > 0$ (by convention, we put $\text{supp}(*) = \emptyset$ for the unique (-1) -cell $* \in P_{-1}^*$). The following property gives an inductive definition of supp :

Proposition 2.4.3.2. *Given $n \in \mathbb{N} \cup \{\omega\}$ and an n -polygraph P , the following hold:*

- (i) $\text{supp}(g) = \{g\} \cup \text{supp}(\partial_n^-(g)) \cup \text{supp}(\partial_n^+(g))$ for $g \in P$,
- (ii) $\text{supp}(\text{id}_u^{k+1}) = \text{supp}(u)$ for $k \in \mathbb{N}_{n-1}$ and $u \in P_k^*$,
- (iii) $\text{supp}(u_1 *_i u_2) = \text{supp}(u_1) \cup \text{supp}(u_2)$ for $i, k \in \mathbb{N}_n$ with $i < k$ and i -composable $u_1, u_2 \in P_k^*$.

Proof. Proof of (i): This holds since $\delta_p^M(g) = g + \delta_p^M(\partial_{k-1}^-(g)) + \delta_p^M(\partial_{k-1}^+(g))$ for $k \in \mathbb{N}_n$ and $g \in P_k$.

Proof of (ii): This holds since $\delta_p^M(\text{id}_u^{k+1}) = \delta_p^M(u)$ for $k \in \mathbb{N}_{n-1}$ and $u \in P_k^*$.

Proof of (iii): Given $i, k \in \mathbb{N}_n$ and i -composable $u_1, u_2 \in P_k^*$, we have

$$\delta_p^M(u_1 *_i u_2) \leq \delta_p^M(u_1) + \delta_p^M(u_2)$$

thus $\text{supp}(u_1 *_i u_2) \subseteq \text{supp}(u_1) \cup \text{supp}(u_2)$. Moreover, by Proposition 2.1.2.10(iii), we have

$$\delta_p^M(u_j) \leq \delta_p^M(u_1 *_i u_2)$$

for $j \in \{1, 2\}$, thus $\text{supp}(u_1) \cup \text{supp}(u_2) \subseteq \text{supp}(u_1 *_i u_2)$. \square

Given $n \in \mathbb{N} \cup \{\omega\}$, we write

$$|-|: \mathbf{Pol}_n \rightarrow \mathbf{Set}$$

for the canonical functor mapping $P \in \mathbf{Pol}_n$ to $|P| = \sqcup_{k \in \mathbb{N}_n} P_k$. The function supp^P is then natural in P :

Proposition 2.4.3.3. *Given $n \in \mathbb{N} \cup \{\omega\}$ and a morphism $F: \mathbf{P} \rightarrow \mathbf{Q} \in \mathbf{Pol}_n$, for $k \in \mathbb{N}_n$ and $u \in \mathbf{P}_k^*$, we have*

$$\text{supp}^{\mathbf{Q}}(F(u)) = |F|(\text{supp}^{\mathbf{P}}(u)).$$

Proof. We prove this property by induction k and on an expression defining u (c.f. Proposition 1.4.1.16):

- if $u = g$ for some $g \in \mathbf{P}_k$, then

$$\begin{aligned} \text{supp}^{\mathbf{Q}}(F(g)) &= \{F(g)\} \cup \text{supp}^{\mathbf{Q}}(\partial_{k-1}^-(F(g))) \cup \text{supp}^{\mathbf{Q}}(\partial_{k-1}^+(F(g))) \\ &\quad \text{(by Proposition 2.4.3.2)} \\ &= |F|(\{g\}) \cup \text{supp}^{\mathbf{Q}}(F(\partial_{k-1}^-(g))) \cup \text{supp}^{\mathbf{Q}}(F(\partial_{k-1}^+(g))) \\ &= |F|(\{g\}) \cup |F|(\text{supp}^{\mathbf{P}}(\partial_{k-1}^-(g))) \cup |F|(\text{supp}^{\mathbf{P}}(\partial_{k-1}^+(g))) \\ &\quad \text{(by induction on } k) \\ &= |F|(\{g\} \cup \text{supp}^{\mathbf{P}}(\partial_{k-1}^-(g)) \cup \text{supp}^{\mathbf{P}}(\partial_{k-1}^+(g))) \\ &= |F|(\text{supp}^{\mathbf{P}}(g)) \quad \text{(by Proposition 2.4.3.2),} \end{aligned}$$

- if $u = \text{id}_u^k$ for some $\tilde{u} \in \mathbf{P}_{k-1}^*$, then,

$$\begin{aligned} \text{supp}^{\mathbf{Q}}(F(\text{id}_u^k)) &= \text{supp}^{\mathbf{Q}}(\text{id}_{F(\tilde{u})}^k) \\ &= \text{supp}^{\mathbf{Q}}(F(\tilde{u})) \quad \text{(by Proposition 2.4.3.2)} \\ &= |F|(\text{supp}^{\mathbf{P}}(\tilde{u})) \quad \text{(by induction on } k) \\ &= |F|(\text{supp}^{\mathbf{P}}(\text{id}_{\tilde{u}}^k)) \quad \text{(by Proposition 2.4.3.2),} \end{aligned}$$

- if $u = u_1 *_i u_2$ for some $i \in \mathbb{N}_{k-1}$ and $u_1, u_2 \in \mathbf{P}_k^*$, then

$$\begin{aligned} \text{supp}^{\mathbf{Q}}(F(u_1 *_i u_2)) &= \text{supp}^{\mathbf{Q}}(F(u_1) *_i F(u_2)) \\ &= \text{supp}^{\mathbf{Q}}(F(u_1)) \cup \text{supp}^{\mathbf{Q}}(F(u_2)) \quad \text{(by Proposition 2.4.3.2)} \\ &= |F|(\text{supp}^{\mathbf{P}}(u_1)) \cup |F|(\text{supp}^{\mathbf{P}}(u_2)) \quad \text{(by induction on } u) \\ &= |F|(\text{supp}^{\mathbf{P}}(u_1) \cup \text{supp}^{\mathbf{P}}(u_2)) \\ &= |F|(\text{supp}^{\mathbf{P}}(u_1 *_i u_2)) \quad \text{(by Proposition 2.4.3.2). } \square \end{aligned}$$

Moreover, the supp function can be used to characterize the image of a free functor F^* in the case where F is a monomorphism:

Proposition 2.4.3.4. *Given $n \in \mathbb{N} \cup \{\omega\}$, a monomorphism $F: \mathbf{P} \rightarrow \mathbf{Q} \in \mathbf{Pol}_n$, $k \in \mathbb{N}_n$ and $\tilde{u} \in \mathbf{Q}_k^*$, there exists $u \in \mathbf{P}_k^*$ such that $F(u) = \tilde{u}$ if and only if $\text{supp}^{\mathbf{Q}}(\tilde{u}) \subseteq |F|(|\mathbf{P}|)$.*

Proof. If there exists $u \in \mathbf{P}_k^*$ such that $F(u) = \tilde{u}$, then, by Proposition 2.4.3.3,

$$\text{supp}^{\mathbf{Q}}(\tilde{u}) = |F|(\text{supp}^{\mathbf{P}}(u)) \subseteq |F|(|\mathbf{P}|)$$

which proves one implication. We prove the converse one by induction on an expression defining \tilde{u} . So suppose that $\text{supp}^{\mathbf{Q}}(\tilde{u}) \subseteq |F|(|\mathbf{P}|)$. Then,

- if $\tilde{u} = \tilde{g}$ for some $\tilde{g} \in \mathbf{Q}_k$, since $\tilde{g} \in \text{supp}^{\mathbf{Q}}(\tilde{u})$, there exists $g \in \mathbf{P}_k$ such that $F(g) = \tilde{g}$;

- if $\tilde{u} = \text{id}_{\tilde{u}}^k$ for some $\tilde{u}' \in \mathbb{Q}_{k-1}^*$, since $\text{supp}^{\mathbb{Q}}(\text{id}_{\tilde{u}}^k) = \text{supp}^{\mathbb{Q}}(\tilde{u}')$, by induction hypothesis, there exists $u' \in \mathbb{P}_{k-1}^*$ such that $F(u') = \tilde{u}'$, thus $F(\text{id}_{\tilde{u}}^k) = \tilde{u}$;
- if $\tilde{u} = \tilde{u}_1 *_i \tilde{u}_2$ for some $i \in \mathbb{N}_{k-1}$ and i -composable $u_1, u_2 \in \mathbb{P}_k^*$, since

$$\text{supp}^{\mathbb{Q}}(\tilde{u}_1) \cup \text{supp}^{\mathbb{Q}}(\tilde{u}_2) = \text{supp}^{\mathbb{Q}}(\tilde{u}_1 *_i \tilde{u}_2),$$

by induction hypothesis, there exist $u_1, u_2 \in \mathbb{P}_k^*$ such that $F(u_j) = \tilde{u}_j$ for $j \in \{1, 2\}$. Moreover, since F^* is a monomorphism by Proposition 2.2.5.7 and $\partial_i^+(\tilde{u}_1) = \partial_i^-(\tilde{u}_2)$, we have $\partial_i^+(u_1) = \partial_i^-(u_2)$. Thus, $F(u_1 *_i u_2) = \tilde{u}$. \square

2.4.3.5 – Stability. As explained earlier, in order to solve the word problem for a general polygraph \mathbb{P} , given a cell $u \in \mathbb{P}^*$, we need to define a finite “subpolygraph” of \mathbb{P} that contains u . The restriction of \mathbb{P} to the generators of $\text{supp}(u)$ is a good candidate, but is it a polygraph? More generally, given $S \subseteq |\mathbb{P}|$, this raise the question of knowing whether the restriction of \mathbb{P} to S is still a polygraph. Below, we define a property of stability on subsets of $|\mathbb{P}|$ and show that it is a sufficient condition for the restriction of \mathbb{P} to such subsets to be a polygraph.

Given $n \in \mathbb{N} \cup \{\omega\}$ and an n -polygraph \mathbb{P} , a subset $S \subseteq |\mathbb{P}|$ is *stable* when, for every $k \in \mathbb{N}_n^*$ and $g \in S \cap \mathbb{P}_k$, we have

$$\text{supp}(\partial_{k-1}^-(g)) \cup \text{supp}(\partial_{k-1}^+(g)) \subseteq S.$$

As one can expect, supports of cells are stable:

Proposition 2.4.3.6. *Given $n \in \mathbb{N} \cup \{\omega\}$, an n -polygraph \mathbb{P} , $k \in \mathbb{N}_n$ and $u \in \mathbb{P}_k^*$, $\text{supp}(u)$ is stable.*

Proof. This is proved by induction on k and on an expression defining u . If $k = 0$, then the property holds. So suppose that $k \geq 1$. If $u = g$ for some $g \in \mathbb{P}_k$, then, by definition,

$$\text{supp}(u) = \{g\} \cup \text{supp}(\partial_{k-1}^-(g)) \cup \text{supp}(\partial_{k-1}^+(g)).$$

By induction hypothesis, $\text{supp}(\partial_{k-1}^-(g))$ and $\text{supp}(\partial_{k-1}^+(g))$ are stable. Moreover, we have

$$\text{supp}(\partial_{k-1}^-(g)) \cup \text{supp}(\partial_{k-1}^+(g)) \subseteq \text{supp}(u)$$

so that $\text{supp}(u)$ is stable. Otherwise, the cases where $u = \text{id}_{\tilde{u}}^k$ for some $\tilde{u} \in \mathbb{P}_{k-1}^*$ or $u = u_1 *_i u_2$ for some $i \in \mathbb{N}_{k-1}$ and i -composable $u_1, u_2 \in \mathbb{P}_k^*$ are simple and left to the reader. \square

Moreover, polygraphs can be restricted to stable subsets:

Proposition 2.4.3.7. *Given $n \in \mathbb{N} \cup \{\omega\}$, an n -polygraph \mathbb{P} and a stable subset $S \subseteq |\mathbb{P}|$, there are unique n -polygraph \mathbb{Q} and morphism $F: \mathbb{Q} \rightarrow \mathbb{P}$ such that $\mathbb{Q}_k = S \cap \mathbb{P}_k$ for $k \in \mathbb{N}_n$ and such that $F_k: \mathbb{Q}_k \rightarrow \mathbb{P}_k$ is the embedding of $S \cap \mathbb{P}_k$ in \mathbb{P}_k .*

Proof. We show this property by induction on n . When $n = 0$, this property holds. So suppose that it holds for some $n \in \mathbb{N}$. We show that it holds for $n+1$. So let $\mathbb{P} = (\mathbb{P}', \mathbb{P}_{n+1})$ be an $(n+1)$ -polygraph and S be a stable subset $S \subseteq |\mathbb{P}|$. By induction hypothesis, there are unique n -polygraph \mathbb{Q}' and morphism $F': \mathbb{Q}' \rightarrow \mathbb{P}'$ such that $\mathbb{Q}'_k = S \cap \mathbb{P}_k$ for $k \in \mathbb{N}_n$ and such that F'_k is the embedding of $S \cap \mathbb{P}_k$ in \mathbb{P}_k . Let $\mathbb{Q}_{n+1} = S \cap \mathbb{P}_{n+1}$ and $f: \mathbb{Q}_{n+1} \rightarrow \mathbb{P}_{n+1}$ be the embedding of $S \cap \mathbb{P}_{n+1}$ into \mathbb{P}_{n+1} . We now show that there exist unique $d_n^-, d_n^+: \mathbb{Q}_{n+1} \rightarrow \mathbb{Q}_n^*$ that equip $\mathbb{Q} = (\mathbb{Q}', \mathbb{Q}_{n+1})$ with a structure of $(n+1)$ -polygraph and such that (F, f) is a morphism of polygraphs $\mathbb{P} \rightarrow \mathbb{Q}$. We start with existence. Given $g \in \mathbb{Q}_{n+1}$ and $\epsilon \in \{-, +\}$, since $g \in S_{n+1}$ and S is stable, we have

$$\text{supp}^{\mathbb{P}'}(d_n^\epsilon(f(g))) \subseteq S \cap |\mathbb{P}'| = |F'|(\mathbb{Q}').$$

Then, by Proposition 2.4.3.4, for $\epsilon \in \{-, +\}$, there exists $d_n^\epsilon(g) \in (Q')_n^*$ such that

$$(F')^*(d_n^\epsilon(g)) = d_n^\epsilon(f(g)).$$

Moreover, for $\delta \in \{-, +\}$, we have

$$\begin{aligned} (F')^*(\partial_{n-1}^\delta(d_n^-(g))) &= \partial_{n-1}^\delta((F')^*(d_n^-(g))) \\ &= \partial_{n-1}^\delta(d_n^-(f(g))) \\ &= \partial_{n-1}^\delta(d_n^+(f(g))) \\ &= \partial_{n-1}^\delta((F')^*(d_n^+(g))) \\ &= (F')^*(\partial_{n-1}^\delta(d_n^+(g))) \end{aligned}$$

so that, since $(F')^*$ is a monomorphism by Proposition 2.2.5.7, we have

$$\partial_{n-1}^\delta(d_n^-(g)) = \partial_{n-1}^\delta(d_n^+(g)).$$

Thus, $d_n^-, d_n^+ : Q_{n+1} \rightarrow (Q')_n^*$ as above equip (Q', Q_{n+1}) with a structure of $(n+1)$ -polygraph. For unicity, note that, since $(F')_n^* : (Q')_n^* \rightarrow (P')_n^*$ is a monomorphism by Proposition 2.2.5.7, the functions $d_n^-, d_n^+ : Q_{n+1} \rightarrow (Q')_n^*$ are uniquely defined by $(F')^*(d_n^\epsilon(g)) = d_n^\epsilon(f(g))$ for $\epsilon \in \{-, +\}$ and $g \in Q_{n+1}$.

The case $n = \omega$ follows from the finite cases since \mathbf{Pol}_ω is a limit cone on the \mathbf{Pol}_k for $k \in \mathbb{N}$ by definition. \square

Up to isomorphism, the subobjects of a polygraph P obtained using Proposition 2.4.3.7 are exactly the subobjects of P , as a consequence of the following property:

Proposition 2.4.3.8. *Given $n \in \mathbb{N} \cup \{\omega\}$ and a morphism $F : P \rightarrow Q$ in \mathbf{Pol}_n , the set $|F|(|P|)$ is stable.*

Proof. Let $k \in \mathbb{N}_n^*$ and $\tilde{g} \in |F|(|P|) \cap Q_k$. Write $g \in P_k$ for a k -generator such that $F(g) = \tilde{g}$. For $\epsilon \in \{-, +\}$, we have

$$\begin{aligned} \text{supp}(d_{k-1}^\epsilon(\tilde{g})) &= \text{supp}(F^*(d_{k-1}^\epsilon(g))) \\ &= |F|(\text{supp}(d_{k-1}^\epsilon(g))) \quad (\text{by Proposition 2.4.3.3}) \end{aligned}$$

thus $\text{supp}(d_{k-1}^\epsilon(\tilde{g})) \subseteq |F|(|P|)$. \square

Finally, we conclude that we can use the supp functions to find finite subpolygraphs whose free categories contain a particular cell:

Proposition 2.4.3.9. *Given $n \in \mathbb{N} \cup \{\omega\}$, an n -polygraph P and $\tilde{u} \in P^*$, there exist a finite n -polygraph Q , a monomorphism $F : Q \rightarrow P$ and $u \in Q^*$ such that $F^*(u) = \tilde{u}$ and $|F|(|Q|) = \text{supp}(u)$.*

Proof. By Proposition 2.4.3.6, $S = \text{supp}^P(\tilde{u})$ is stable. By Proposition 2.4.3.7, there exist an n -polygraph Q and a monomorphism $F : Q \rightarrow P$ such that $Q_k = S \cap P_k$ and F_k is the embedding of $S \cap P_k$ in P_k for $k \in \mathbb{N}_n$. Thus, $|F|(|Q|) = \text{supp}^P(\tilde{u})$, and, by Proposition 2.4.3.4, there exists $u \in Q^*$ such that $F(u) = \tilde{u}$. \square

2.4.3.10 – Support of terms. As suggested by Proposition 2.4.3.2, the support function can be directly defined on terms of a polygraph, without evaluation. Given $n \in \mathbb{N} \cup \{\omega\}$, an n -polygraph \mathcal{P} and $t \in \mathcal{T}^{\mathcal{P}}$, we define $\text{supp}(t) \subseteq |\mathcal{P}|$ by induction on t :

- if $t = \overline{\text{gen}}_k(g)$ for some $k \in \mathbb{N}_n$ and $g \in \mathcal{P}_k$, then,

$$\text{supp}(g) = \{g\} \cup \text{supp}(d_{k-1}^-(g)) \cup \text{supp}(d_{k-1}^+(g)),$$

- if $t = \overline{\text{id}}_k^{k+1}(\tilde{t})$ for some $k \in \mathbb{N}_{n-1}$ and $\tilde{t} \in \mathcal{T}_k^{\mathcal{P}}$, then,

$$\text{supp}(t) = \text{supp}(\tilde{t}),$$

- if $t = t_1 \overline{*}_{i,k} t_2$ for some $i, k \in \mathbb{N}_n$ with $i < k$ and $t_1, t_2 \in \mathcal{T}_k^{\mathcal{P}}$, then,

$$\text{supp}(t) = \text{supp}(t_1) \cup \text{supp}(t_2).$$

By a simple induction on $t \in \mathcal{W}^{\mathcal{P}}$, we have:

Proposition 2.4.3.11. *Given $t \in \mathcal{W}^{\mathcal{P}}$, $\text{supp}(t) = \text{supp}(\llbracket t \rrbracket^{\mathcal{P}})$.*

Thus, we can compute the support of a cell $u \in \mathcal{P}^*$ directly from a well-typed term $t \in \mathcal{W}^{\mathcal{P}}$ such that $\llbracket t \rrbracket^{\mathcal{P}} = u$.

2.4.3.12 – Monomorphisms and terms. Finally, before concluding the correctness of the method exposed earlier for solving the word problem on general polygraphs by reducing it on finite polygraphs, we need to justify that the word problem behaves in the same manner (with regard to well-typed terms and their evaluation) on a polygraph \mathcal{Q} and on its subpolygraphs. First, we prove that the subpolygraphs \mathcal{P} of \mathcal{Q} do not miss any well-typed term of \mathcal{Q} that evaluates to $u \in \mathcal{P}^*$:

Proposition 2.4.3.13. *Given $n \in \mathbb{N} \cup \{\omega\}$ and a monomorphism $F: \mathcal{P} \rightarrow \mathcal{Q} \in \text{Pol}_n$, for $k \in \mathbb{N}_n$ and $u \in \mathcal{P}_k^*$, the function \mathcal{W}^F induces a bijection between the subset of well-typed k -terms $t \in \mathcal{W}_k^{\mathcal{P}}$ such that $\llbracket t \rrbracket^{\mathcal{P}} = u$, and the subset of well-typed k -terms $\tilde{t} \in \mathcal{W}_k^{\mathcal{Q}}$ such that $\llbracket \tilde{t} \rrbracket^{\mathcal{Q}} = F^*(u)$.*

Proof. By Proposition 2.2.5.7, $F_k: \mathcal{P}_k \rightarrow \mathcal{Q}_k$ is injective for $k \in \mathbb{N}_n$, so \mathcal{W}^F is injective, so that we only have to prove the surjectivity part of the statement. Given $k \in \mathbb{N}_n$, $u \in \mathcal{P}_k^*$ and $\tilde{t} \in \mathcal{W}_k^{\mathcal{Q}}$ such that $\llbracket \tilde{t} \rrbracket^{\mathcal{Q}} = F^*(u)$, we prove by induction on \tilde{t} that there is $t \in \mathcal{W}^{\mathcal{P}}$ such that $\mathcal{W}^F(t) = \tilde{t}$:

- if $\tilde{t} = \overline{\text{gen}}_k(\tilde{g})$ for some $\tilde{g} \in \mathcal{Q}_k$, then, $\llbracket \tilde{t} \rrbracket^{\mathcal{Q}} = \tilde{g} = F^*(u)$, so that, by Proposition 2.1.3.4(ii), there exists $g \in \mathcal{P}_k$ such that $u = g$. Thus, $\mathcal{W}^F(\overline{\text{gen}}_k(g)) = \tilde{t}$;
- if $\tilde{t} = \overline{\text{id}}_{k-1}^k(\tilde{t}')$ for some $\tilde{t}' \in \mathcal{W}_{k-1}^{\mathcal{Q}}$, then $F^*(u) = \text{id}_{\llbracket \tilde{t}' \rrbracket^{\mathcal{Q}}}^k$. By Proposition 2.1.3.4(i), there exists $u' \in \mathcal{P}_{k-1}^*$ such that $u = \text{id}_{u'}^k$, so that $F^*(u') = \llbracket \tilde{t}' \rrbracket^{\mathcal{Q}}$. By induction hypothesis, there exists $t' \in \mathcal{W}^{\mathcal{P}}$ such that $\mathcal{W}^F(t') = \tilde{t}'$, so that $\mathcal{W}^F(\overline{\text{id}}_{k-1}^k(t')) = \tilde{t}$;
- if $\tilde{t} = \tilde{t}_1 \overline{*}_{i,k} \tilde{t}_2$ for some $i \in \mathbb{N}_{k-1}$ and $\tilde{t}_1, \tilde{t}_2 \in \mathcal{W}_k^{\mathcal{Q}}$, then $F^*(u) = \llbracket \tilde{t}_1 \rrbracket^{\mathcal{Q}} *_i \llbracket \tilde{t}_2 \rrbracket^{\mathcal{Q}}$. Since F^* is n -Conduché by Proposition 2.2.5.6, there exist i -composable $u_1, u_2 \in \mathcal{P}_k^*$ such that $u = u_1 *_i u_2$ and $F^*(u_j) = \llbracket \tilde{t}_j \rrbracket^{\mathcal{Q}}$ for $j \in \{1, 2\}$. Then, by induction hypothesis, for $j \in \{1, 2\}$, there exists $t_j \in \mathcal{W}_k^{\mathcal{P}}$ such that $\mathcal{W}^F(t_j) = \tilde{t}_j$, and, by Proposition 2.4.1.3, we have moreover

$$F^*(\llbracket t_j \rrbracket^{\mathcal{P}}) = \llbracket \mathcal{W}^F(t_j) \rrbracket^{\mathcal{Q}} = \llbracket \tilde{t}_j \rrbracket^{\mathcal{Q}} = F^*(u_j)$$

so that $\llbracket t_j \rrbracket^{\mathcal{P}} = u_j$ by Proposition 2.2.5.6. Since $\partial_i^+(u_1) = \partial_i^-(u_2)$, we have $t = t_1 \overline{*}_{i,k} t_2 \in \mathcal{W}^{\mathcal{P}}$ and moreover $\mathcal{W}^F(t) = \tilde{t}$. □

Moreover, we verify that the evaluation of well-typed terms is the same for Q as for its subpolygraphs:

Proposition 2.4.3.14. *Given $n \in \mathbb{N} \cup \{\omega\}$ and a monomorphism $F: P \rightarrow Q \in \mathbf{Pol}_n$, for $k \in \mathbb{N}_n$ and $t_1, t_2 \in \mathcal{W}_k^P$, we have $\llbracket t_1 \rrbracket^P = \llbracket t_2 \rrbracket^P$ if and only if $\llbracket \mathcal{W}^F(t_1) \rrbracket^Q = \llbracket \mathcal{W}^F(t_2) \rrbracket^Q$.*

Proof. This is a consequence of the facts that, by Proposition 2.4.1.3, we have

$$\llbracket - \rrbracket^Q \circ \mathcal{W}^F = F^* \circ \llbracket - \rrbracket^P$$

and, by Proposition 2.2.5.7, F^* is a monomorphism. \square

2.4.3.15 – Solution to the word problem on general polygraphs. Given $n \in \mathbb{N} \cup \{\omega\}$, an n -polygraph P , $k \in \mathbb{N}_n$ and $t_1, t_2 \in \mathcal{W}_k^P$, we combine the properties of the section to describe a method to decide whether $\llbracket t_1 \rrbracket^P = \llbracket t_2 \rrbracket^P$.

First, let $Q = P_{\leq k}$. By the definition of \mathcal{W}^Q , we have $t_1, t_2 \in \mathcal{W}^Q$ and, by the definition of $\llbracket - \rrbracket^P$,

$$\llbracket t_1 \rrbracket^P = \llbracket t_2 \rrbracket^P \quad \text{if and only if} \quad \llbracket t_1 \rrbracket^Q = \llbracket t_2 \rrbracket^Q.$$

Thus, it is sufficient to decide whether $\llbracket t_1 \rrbracket^Q = \llbracket t_2 \rrbracket^Q$. If $\llbracket t_1 \rrbracket^Q = \llbracket t_2 \rrbracket^Q$, then, by Proposition 2.4.3.11, we have $\text{supp}(t_1) = \text{supp}(t_2)$. We can easily calculate both $\text{supp}(t_1)$ and $\text{supp}(t_2)$ using the inductive definition of supp on terms and verify that $\text{supp}(t_1) = \text{supp}(t_2)$ by Proposition 2.4.3.11 (otherwise, we conclude that $\llbracket t_1 \rrbracket^P \neq \llbracket t_2 \rrbracket^P$). Thus, suppose that $\text{supp}(t_1) = \text{supp}(t_2)$.

Using the constructive content of the proof of Proposition 2.4.3.9, the subpolygraph R of Q induced by the stable subset $\text{supp}(t_1)$ satisfies that, by Proposition 2.4.3.4, there exist $u_1, u_2 \in R_k^*$ such that $F(u_i) = \llbracket t_i \rrbracket^Q$ for $i \in \{1, 2\}$. By Proposition 2.4.3.13 and by considering the canonical embedding $F: R \hookrightarrow Q$, we have that $t_1, t_2 \in \mathcal{W}_k^R$ and, by Proposition 2.4.3.14, we have

$$\llbracket t_1 \rrbracket^Q = \llbracket t_2 \rrbracket^Q \quad \text{if and only if} \quad \llbracket t_1 \rrbracket^R = \llbracket t_2 \rrbracket^R.$$

Since R is a finite k -polygraph, we can use the computational method for finite polygraphs from Paragraph 2.4.2.13 to decide whether $\llbracket t_1 \rrbracket^R = \llbracket t_2 \rrbracket^R$, which is equivalent to $\llbracket t_1 \rrbracket^P = \llbracket t_2 \rrbracket^P$ as we have shown.

2.4.4 An implementation in OCAML

In this section, we present the `cateq` program, which implements the solution to the word problem for finite polygraphs given in Section 2.4.2 in OCAML. One uses `cateq` by first describing a polygraph P , and then by querying the solution to several word problem instances on P . We first describe the implementation of `cateq` and then illustrate how to use it on some examples.

2.4.4.1 – Implementation. The implementation of `cateq` is obtained from the constructive content of the proofs of this section and the already introduced datatypes, together with additional performance enhancements that we shall describe below. Our presentation differs from the actual implementation, but it should nevertheless convey the main ideas.

In order to represent the terms of the polygraph we are considering, we use the datatype introduced by Remark 2.4.2.3 that we recall below:

```

(* The type of generators *)
type gen = int

(* The datatype of terms *)
type term =
| TermGen of int * gen
| TermId of int * term
| TermComp of int * int * term * term

```

A polygraph P is then described to the program using a term definition (c.f. Paragraph 2.4.2.7) which is introduced generator by generator. Concretely, the user creates a new k -generator by specifying a source $(k-1)$ -term and a target $(k-1)$ -term. A dictionary mapping generators to these informations is maintained globally, and the following functions are available to retrieve them:

```

val g_dim : gen -> int (* The dimension of a generator *)
val g_src : gen -> term (* The source of a generator *)
val g_tgt : gen -> term (* The target of a generator *)

```

By the description of the functor $-[-]^n : \text{Cat}_n^+ \rightarrow \text{Cat}_{n+1}$ we gave in Section 2.2.5, the cells of P^* are classes of sequences of classes of contexts (as defined in Paragraphs 2.2.2.1 and 2.2.4.1). We encode these objects using datatypes adapted from the ones of Remarks 2.3.2.9, 2.3.2.19, 2.3.2.28 and 2.3.2.31. The datatypes for contexts and sequences are defined as follows:

```

(* The datatype of contexts of generator type *)
type ctxt =
| CtxtZ of gen (* a 0-context of the type of a generator *)
| CtxtS of seqcl * ctxtcl * seqcl (* an (m+1)-context *)

(* The datatype of m-sequences *)
type seq =
| SeqZ of seqcl (* a zero-length m-sequence *)
| SeqP of ctxtcl list (* a positive-length m-sequence *)

```

The associated context classes (quotients of contexts under the relations \approx_m) and sequences classes (quotients of sequences under the relation \approx) are then represented by simple integer identifiers:

```

type seqcl = SeqCl of int
type ctxtcl = CtxtCl of int

```

Note that, contrary to the datatypes of Remarks 2.3.2.9 and 2.3.2.31, we did not define `ctxtcl` and `seqcl` as lists of `ctxt` and `seq` respectively. The above definition allows for quicker comparison of two classes: one just compares the two identifiers. In order to retrieve the sets of representatives of context classes, a dictionary between the known context class identifiers and their context representatives is maintained and can be queried with

```

val find_ctxtcl_reps : ctxtcl -> ctxt list option

```

Conversely, a dictionary between m -contexts and the known m -context class identifiers is maintained and can be queried with

```

val find_ctxt_cl : ctxt -> ctxtcl option

```

Moreover, a map between a context class identifier and a set of representatives can be added to the global dictionary with

```
val set_ctxt_cl : ctxt list -> ctxtcl -> unit
```

There are similar functions for sequences and sequence class identifiers:

```
val find_seqcl_reps : seqcl -> seq list option
val find_seq_cl : seq -> seqcl option
val set_seq_cl : seq list -> seqcl -> unit
```

We now present the implementation of the function which computes the set of representatives of the class of a particular m -context under the relation \approx_m , and then returns the associated context class identifier. First, we introduce the structures that allows to manipulate sets of contexts. In OCAML, this is done with:

```
(* Module which equips 'ctxt' with a total order *)
module Context =
  struct
    type t = ctxt
    let compare = compare (* comparison function for 'ctxt' generated by OCaml *)
  end

(* Module that defines the types and operations on sets of 'ctxt' *)
module ContextSet = Set.Make (Context)

(* The actual type of sets of 'ctxt' *)
type ctxt_set = ContextSet.t
```

Then, the context class identifier associated to a context is computed with the function

```
val get_ctxtcl : ctxt -> ctxtcl
let get_ctxtcl ctxt =
  match find_ctxt_cl ctxt with
  | Some cl -> cl
  | None -> let cl = get_ctxtcl' ctxt in cl
```

It first checks with `find_ctxt_cl` whether the class identifier has already been computed, and returns the saved value if it is the case (this is a classical dynamic programming technique, which is nevertheless critical for efficiency here). Otherwise, it calls `get_ctxtcl'` to do the actual computation:

```
val get_ctxtcl' : ctxt -> ctxtcl
let get_ctxtcl' ctxt =
  match ctxt with
  (* the case of 0-contexts, which is trivial *)
  | CtxtZ g ->
    (* 0-context classes have only one representative *)
    let reps = [ctxt] in
    (* we obtain a fresh identifier for this class *)
    let cl = fresh_ctxtclid () in
    (* we associate 'cl' with the singleton set of representatives *)
    set_ctxt_cl reps cl;
    (* we return the class identifier *)
    cl
  (* the case of (m{+}1)-contexts *)
  | CtxtS _ ->
    (* BFS that computes the other context of the class *)
    let rec aux already_done_set = function
      (* if there is no other context to handle, we return *)
```

```

| [] -> already_done_set
(* otherwise, we handle the top context *)
| curr :: nexts ->
  if ContextSet.mem curr already_done_set then
    (* if 'curr' already handled, we continue *)
    aux already_done_set nexts
  else
    (* otherwise, we compute the neighbors of 'curr' and add them
       to the list of contexts to explore *)
    let ngbrs = ContextSet.elements (ctxt_rel_ngbrs curr) in
    aux (ContextSet.add curr already_done_set) (List.append ngbrs nexts)
in
(* the above BFS returns the set of representatives for the class of 'ctxt' *)
let reps = ContextSet.elements (aux (ContextSet.empty) [ctxt]) in
(* we then get a fresh identifier, set the class and return *)
let cl = fresh_ctxtclid () in
set_ctxt_cl reps cl;
cl

```

The code of the case `CtxtS` in `get_ctxtclid'` is exactly the breadth-first search algorithm given in the proof of Proposition 2.3.1.31, where

```
val ctxt_rel_ngbrs : ctxt -> ctxt_set
```

is the function which witnesses that the relations $\approx_m^1 \cup \approx_m^{-1}$ are effectively right finite for $m \in \mathbb{N}$, and which is derived from the proof of Proposition 2.3.2.10. We skip the code of this function since it is quite technical.

The computation of the set of representatives of a class of a particular m -sequence is done similarly. First, we introduce the structures that allow manipulating sets of sequences:

```

module Sequence =
  struct
    type t = seq
    let compare = compare
  end

module SequenceSet = Set.Make (Sequence)

type seq_set = SequenceSet.t

```

Then, the retrieval of an m -sequence class identifier associated with a particular m -sequence is done with the two functions:

```

val get_seqcl : seq -> seqcl
val get_seqcl' : seq -> seqcl

let get_seqcl seq =
  match find_seq_cl seq with
  | Some cl -> cl
  | None -> let cl = get_seqcl' seq in cl

let get_seqcl' seq =
  match seq with
  | SeqZ _ ->
    let reps = [seq] in
    let cl = fresh_cid () in
    set_seq_cl reps cl;
    cl

```

```

| SeqP _ ->
  let rec aux already_done_set = function
    | [] -> already_done_set
    | curr :: nexts ->
      if SequenceSet.mem curr already_done_set then
        aux already_done_set nexts
      else
        let ngbrs = SequenceSet.elements (seq_rel_ngbrs curr) in
          aux (SequenceSet.add curr already_done_set) (List.append ngbrs nexts)
  in
  let reps = SequenceSet.elements (aux (ContextSet.empty) [seq]) in
  let cl = fresh_cid () in
  set_seq_cl reps cl;
  cl

```

Like for `CtxtS`, the code of the case of `SeqP` in `get_seqcl'` is the procedure given in the proof of Proposition 2.3.1.31, where

```
val seq_rel_ngbrs : seq -> seq_set
```

is the function which witnesses that the relation $\approx^1 \cup \approx^{-1}$ is effectively right finite, and which is derived from the proof of Proposition 2.3.2.29. We also skip the code of this function since it is quite technical.

We then implement the source ∂^- , target ∂^+ , identity `id` and composition `*` operations for P^* , by unfolding the constructive proofs of Proposition 2.4.2.10(i) and Proposition 2.3.3.2, that jointly implies that the strict category P^* is computable. As a result, we obtain functions

```

val csrc : int -> seqcl -> seqcl
val ctgt : int -> seqcl -> seqcl
val identity : int -> seqcl -> seqcl
val comp : int -> int -> seqcl -> seqcl -> seqcl

```

which describe a recursive model of P^* (c.f. Remark 2.3.1.35). Moreover, unfolding the proof of Proposition 2.3.3.2 again, we obtain an implementation of the embedding function $P \rightarrow P^*$:

```
val gen_embed : gen -> seqcl
```

We then code the evaluation function $\llbracket - \rrbracket^P : \mathcal{W}^P \rightarrow P^*$, following the constructive proof of Proposition 2.4.2.10(ii):

```

val eval_wtterm : term -> seqcl
let rec eval_wtterm term =
  match term with
  | TermGen k gen -> gen_embed gen
  | TermId k term' ->
    let seqcl = eval_wtterm term' in
    identity k seqcl
  | TermComp (k,i,term_l,term_r) ->
    let seqcl_l = eval_wtterm term_l in
    let seqcl_r = eval_wtterm term_r in
    comp i k seqcl_l seqcl_r

```

The function which solves the word problem, given by Proposition 2.4.2.14, is then simply implemented as follows:

```
val solve_word_problem : term -> term -> bool
let solve_word_problem term_l term_r =
  eval_wtterm term_l = eval_wtterm term_r
```

Concretely, `solve_word_problem` computes the `seqcl` identifiers of the evaluations of `term_l` and `term_r` and compares them.

2.4.4.2 – Examples. We now show how to use `cateq` on several examples starting with a simple one. Consider the 1-polygraph P with $P_0 = \{x\}$ and $P_1 = \{f, g: x \rightarrow x\}$. Let's see how to query `cateq` whether the cells $f *_0 g$ and $g *_0 f$ are equal. We first populate the current polygraph with the following commands:

```
# x := gen *
# f,g := gen x -> x
```

A command of the form `[name] := gen *` creates a 0-generator which is called `[name]`. The syntax `[name] := gen [src] -> [tgt]` creates an $(k+1)$ -generator called `[name]` of source and target the k -cells `[src]` and `[tgt]` respectively. Several generators with the same source and target can be defined by separating their names with commas, like was done for `f` and `g`. We then formulate our query with the command

```
# f *_0 g = g *_0 f
```

and `cateq` replies

```
false
```

The cells are composed in the query using the composition operation `*0` for 0-composable cells. For composing cells in dimension 1, 2, *etc.* one then uses the operations `*1`, `*2`, *etc.* For identities, one uses the syntax `id1`, `id2`, *etc.* For example, we can query

```
# f *_0 id1 x = f
```

and `cateq` answers `true`.

Now consider the 2-polygraph P with $P_0 = \{x\}$, $P_1 = \emptyset$ and $P_2 = \{\alpha, \beta, \gamma, \delta: id_x^1 \Rightarrow id_x^1\}$. We define it in `cateq` with the commands

```
# x := gen *
# alpha,beta,gamma,delta := gen id1 x -> id1 x
```

We then verify with `cateq` that $\alpha *_0 \beta *_0 \gamma *_0 \delta$ can be expressed with two other expressions:

```
# alpha *_0 beta *_0 gamma *_0 delta = (alpha *_1 beta) *_0 (delta *_0 gamma)
# alpha *_0 beta *_0 gamma *_0 delta = beta *_1 alpha *_1 gamma *_1 delta
```

And `cateq` answers `true` to both queries. We see that `alpha *_0 beta *_0 gamma *_0 delta` is quite long to write. To solve this problem, we introduce a variable using the syntax `[name] := [expr]`:

```
# X := alpha *_0 beta *_0 gamma *_0 delta
```

We can then make other queries using `X`:

```
# X = gamma *1 (alpha *0 beta) *1 delta
# X = alpha *1 beta *1 gamma *1 gamma
# alpha *0 X = X *1 alpha
```

to which `cateq` answers `true`, `false` and `true` respectively.

Remark 2.4.4.3. The representatives of the 2-sequence class of \bar{x} are in correspondence with the total orders on $\{\alpha, \beta, \gamma, \delta\}$. Thus, there are $4!$ representative 2-sequences of \bar{x} that `cateq` has to compute in order to decide a word problem instance involving \bar{x} . More generally, in order to decide an equality involving the cell $\alpha_1 *0 \cdots *0 \alpha_k$ for some distinct 2-generators $\alpha_1, \dots, \alpha_k: \text{id}_x^1 \Rightarrow \text{id}_x^1 \in P_2$ of a polygraph P , `cateq` has to consider all the representative $k!$ 2-sequences of this expression for computing the associated 2-sequence class. Thus, the worst-case complexity of `cateq` is pretty bad: at least factorial in the size of the queried expressions. But `cateq` handles well queries on expressions that do not have too many “bubble” generators like α, β, γ or δ , so that it is still efficient on a large class of word problem instances.

In Chapter 3, we will use `cateq` to justify the correctness of an important counter-example for two pasting diagram formalisms, motivating the rest of that chapter (*c.f.* Paragraph 3.1.2.13). Moreover, the results the latter will enable writing an extension to `cateq` which enables a simpler definition of word problem instances (*c.f.* Paragraph 3.4.1.32).

2.5 Non-existence of some measure on polygraphs

Recall the definition of Makkai’s measure given in Paragraph 2.1.2.5. As we have shown there, Makkai’s measure has good properties: it is natural, it is positive, and it admits an inductive definition. But, it was remarked by Makkai [Mak05] that his measure has one defect: it double-counts some generators. To some extent, such double-counting is sensible in particular situations. For example, consider a polygraph P with a generator $f: x \rightarrow x \in P_1$. Then, $\delta_P^M(f) = 2x + f$, so x is counted twice, but it seems logical since x “appears twice” in f as is illustrated in its graphical representation:

$$x \xrightarrow{f} x.$$

However, in other situations, double-counting does not seem adequate. For example, consider the polygraph Q with two 0-generators y, z , two 1-generators $g, h: y \rightarrow z$ and one 2-generator $\alpha: g \Rightarrow h$. Then,

$$\delta_Q^M(\alpha) = 2x + 2y + g + h + \alpha$$

so that y and z get counted twice by δ_Q^M , which does not seem natural since y and z “appear once” in the graphical representation of α :

$$\begin{array}{ccc} & g & \\ y & \curvearrowright & z \\ & \Downarrow \alpha & \\ & \curvearrowleft & \\ & h & \end{array}$$

We call *polyplex* a cell $u \in P^*$ for some polygraph P such that the generators of P “appear exactly once” in u . Intuitively, polyplexes are cells which are “as separated as possible”, *i.e.*, without non-necessary identifications between the sources and targets of the generators involved in these cells. On the one hand, f is not a polyplex, since one can conceive a polygraph P' with a 1-generator $f': x'_1 \rightarrow x'_2$ with $x'_1 \neq x'_2$, so that f is a *specialization* of f' . On the other hand, α is a polyplex, since all the identifications between the sources and targets of the generators seem necessary. Polyplexes were first studied by Makkai [Mak05] through the related notion of *computepe*, and

then by Burroni [Bur12] (who introduced the name *polyplex*) and Henry [Hen18]. It was asked by Makkai [Mak05] whether there exists another measure π on polygraphs with good properties like the ones satisfied by Makkai's measure and such that generators in polyplexes get counted only once, *i.e.*, given a polyplex u of a polygraph P ,

$$\pi_P(u) = \sum_{g \in P} g.$$

Of course, there exist several measures that satisfy the latter property. Among them, we can even find measures with several additional properties, like being positive. The really interesting question that is left unanswered is whether there exists a measure π as above that would moreover be natural in P . The existence of such a measure would be useful, since it could help characterize polyplexes in particular.

In this section, we give a negative answer to this question. First, we introduce the definitions of *plexes* and *polyplexes* (where plexes are, intuitively, polyplexes of length one), together with some of their properties (Section 2.5.1). In the process, we answer another open question raised by Makkai [Mak05] and show that a cell $u \in P^*$ of the free strict category on a polygraph P can be the specialization of several non-isomorphic polyplexes, and we do so by providing an example. Then, by adapting the latter, we show that there is no natural measure on polygraphs that counts exactly once the generators of polyplexes (Section 2.5.2).

2.5.1 Plexes and polyplexes

In [Mak05], Makkai defined the notion of plexes (calling them *computopes*) using the formalism of concrete categories. We recall this formalism, and show that it can be used to derive both the notion of plexes and polyplexes.

2.5.1.1 – Concrete categories. A *concrete category* a category C endowed with a functor

$$|-|^C : C \rightarrow \mathbf{Set}.$$

In the setting of [Mak05], the above *concretization functor* should be understood as a candidate set representation of C in order to express C as a presheaf category, in the way suggested by the following canonical example:

Example 2.5.1.2. Let C be a small category. \hat{C} has a canonical structure of concrete category, where $|-|^{\hat{C}}$ is defined on presheaves $P \in \hat{C}$ by

$$|P|^{\hat{C}} = \bigsqcup_{c \in C_0} P(c)$$

and extended naturally to morphisms between presheaves.

An *equivalence of concrete categories* between concrete categories $(C, |-|^C)$ and $(\mathcal{D}, |-|^{\mathcal{D}})$ is the data of an equivalence of categories $\mathcal{E} : C \rightarrow \mathcal{D}$ and a natural isomorphism

$$\Phi : |-|^{\mathcal{D}} \circ \mathcal{E} \Rightarrow |-|^C.$$

If such an equivalence exists, $(C, |-|^C)$ and $(\mathcal{D}, |-|^{\mathcal{D}})$ are said *concretely equivalent*. One might then consider the following natural question:

When is some concrete category $(C, |-|^C)$ concretely equivalent
to a presheaf category $(\hat{C}, |-|^{\hat{C}})$ for some small category C ?

When it is the case, we say that $(C, |-|^C)$ is a *concrete presheaf category*. In [Mak05], Makkai gave a criterion, that we shall introduce in the coming paragraphs, to answer the above question. He then used this criterion to show that \mathbf{Pol}_ω is not a concrete presheaf category, when \mathbf{Pol}_ω is equipped with the concretization functor given by the below example:

Example 2.5.1.3. The functor $|-|: \mathbf{Pol}_\omega \rightarrow \mathbf{Set}$ (already defined in Paragraph 2.4.3.1) which maps $P \in \mathbf{Pol}_\omega$ to

$$|P| = \bigsqcup_{k \in \mathbb{N}} P_k$$

equips \mathbf{Pol}_ω with a structure of concrete category.

Later, we will study the properties of \mathbf{Pol}_ω equipped with the above concretization functor. Another concretization functor on \mathbf{Pol}_ω that will be of interest for us is given by the below example:

Example 2.5.1.4. There is a functor $|(-)^*|: \mathbf{Pol}_\omega \rightarrow \mathbf{Set}$ which maps $P \in \mathbf{Pol}_\omega$ to

$$|P^*| = \bigsqcup_{k \in \mathbb{N}} P_k^*$$

and which is extended naturally to morphisms of \mathbf{Pol}_ω . This functor also equips \mathbf{Pol}_ω with a structure of concrete category.

In order to distinguish with the preceding concrete category structures on \mathbf{Pol}_ω , we use the convention that we write \mathbf{Pol}_ω when considering the concrete category structure on \mathbf{Pol}_ω given by $|-|$ and \mathbf{Pol}_ω^* when considering the concrete category structure on \mathbf{Pol}_ω given by $|(-)^*|$.

2.5.1.5 – Category of elements. Before presenting the criterion of Makkai, we shall first introduce the category of elements associated with a concrete category. Given a concrete category $(C, |-|^C)$, the *category of elements* $\text{Elt}(C)$ of C is the category

- whose objects are the pairs (X, x) where $X \in C_0$ and $x \in |X|^C$,
- and whose morphisms from (X, x) to (Y, y) are the morphisms $f: X \rightarrow Y \in C$ such that $|f|^C(x) = y$. Given such a morphism $f: (X, x) \rightarrow (Y, y)$, we say that y is a *specialization* of x .

An object $(X, x) \in \text{Elt}(C)$ is *principal* when, for all morphism $f: (Y, y) \rightarrow (X, x) \in \text{Elt}(C)$ such that f is a monomorphism in C , we have that f is an isomorphism; it is *primitive* when it is principal and, for all $f: (Y, y) \rightarrow (X, x) \in \text{Elt}(C)$ where (Y, y) is principal, f is an isomorphism.

Example 2.5.1.6. Let C be a small category and consider the canonical concrete category structure on \hat{C} given by Example 2.5.1.2. The category $\text{Elt}(\hat{C})$ has

- as objects the pairs $(P, \iota_c(x))$ where $P \in \hat{C}$ and $x \in P(c)$,
- and as morphisms from $(P, \iota_c(x))$ to $(Q, \iota_d(y))$ the natural transformations $\alpha: P \Rightarrow Q$ such that $c = d$ and $\alpha_c(x) = y$.

Given $(P, \iota_c(x)) \in \text{Elt}(\hat{C})$, we have that:

- $(P, \iota_c(x))$ is principal when P is the smallest subpresheaf P' of P such that $x \in P'(c)$. In particular, for all $c \in C$, $(C(-, c), \iota_c(\text{id}_c)) \in \text{Elt}(\hat{C})$ is principal;
- $(P, \iota_c(x))$ is primitive when the natural transformation $\theta: C(-, c) \rightarrow P$ which maps id_c to x is an isomorphism.

2.5.1.7 – Characterization of concrete presheaves. The criterion given by Makkai for characterizing the concrete categories that are concretely equivalent to presheaf categories is the following:

Theorem 2.5.1.8 ([Mak05, Theorem 4]). *Let $(C, |-|^C)$ be a concrete category. C is concretely equivalent to a presheaf category if and only if the following conditions are all satisfied:*

- (i) $|-|^C$ reflects isomorphisms,
- (ii) C is cocomplete and $|-|^C$ preserves all small colimits,
- (iii) the collection of isomorphism classes of primitive elements of $\text{Elt}(C)$ is small,
- (iv) for every element $(X, x) \in \text{Elt}(C)$, there is a morphism $(U, u) \rightarrow (X, x)$ for some primitive element (U, u) ,
- (v) given two morphisms $f, g: (U, u) \rightarrow (X, x) \in \text{Elt}(C)$ where (U, u) is primitive, we have $f = g$,
- (vi) given two morphisms $f: (U, u) \rightarrow (X, x)$ and $g: (V, v) \rightarrow (X, x)$ of $\text{Elt}(C)$ where both (U, u) and (V, v) are primitive, there is an isomorphism $\theta: (U, u) \rightarrow (V, v)$ such that $g \circ \theta = f$.

Makkai showed that \mathbf{Pol}_ω was not concretely equivalent to a presheaf category by proving that (v) was not satisfied in \mathbf{Pol}_ω , using the standard Eckmann-Hilton argument in strict categories [Sim11]. However, he did not know whether (vi) was true in \mathbf{Pol}_ω . In the following, we will show that \mathbf{Pol}_ω does not satisfy (vi).

2.5.1.9 – Plexes. Consider the category $\text{Elt}(\mathbf{Pol}_\omega)$. An object of $\text{Elt}(\mathbf{Pol}_\omega)$ is a pair (P, g) where P is an ω -polygraph and g is a generator of P . By Proposition 2.4.3.9, such an object is principal when P is the smallest subpolygraph of P that contains g or, equivalently, $\text{supp}(g) = P$. In this case, P is finite and g is uniquely determined as the generator of maximal dimension of P . We denote by g_P this generator. So “being principal” reduces, in the case of $\text{Elt}(\mathbf{Pol}_\omega)$, to a property on polygraphs: we say that an ω -polygraph Q is *principal* when Q is finite and Q has a unique maximal generator, denoted g_Q , such that Q is the smallest subpolygraph of Q that contains g_Q . We then have directly:

Proposition 2.5.1.10. *Given $(P, g) \in \text{Elt}(\mathbf{Pol}_\omega)$, the following are equivalent:*

- (i) (P, g) is principal,
- (ii) P is principal and $g = g_P$,
- (iii) $\text{supp}(g) = P$.

Following the terminology of [Hen17], a *plex* is an ω -polygraph P such that P is principal and which satisfies that $(P, g_P) \in \text{Elt}(\mathbf{Pol}_\omega)$ is primitive. As far as we know, there is no easy characterization of plexes as there is for principal polygraphs. Intuitively, a plex is a principal ω -polygraph which is “as separated as possible”.

Example 2.5.1.11. Let P be an ω -polygraph such that

$$P_0 = \{x, y\} \quad P_1 = \{f: x \rightarrow x, g: x \rightarrow y\} \quad P_2 = \{\alpha: f \Rightarrow f\}$$

and $P_k = \emptyset$ for $k \geq 3$. P can be pictured by

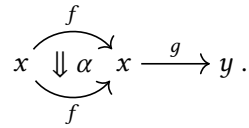

The ω -polygraph P is not principal since it is not the smallest subpolygraph which contains α . However, α is the specialization of the generator $\alpha' \in P'$, where P' is the ω -polygraph such that

$$P'_0 = \{x'\}, \quad P'_1 = \{f' : x' \rightarrow x'\}, \quad P'_2 = \{\alpha' : f' \Rightarrow g'\},$$

and $P'_k = \emptyset$ for $k \geq 3$, and which can be pictured by

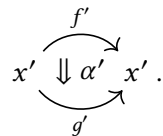

P' is principal but it is not a plex since α' is the specialization of $\alpha'' \in P''$, where P'' is the ω -polygraph such that

$$P''_0 = \{x'', y''\} \quad P''_1 = \{f'', g'' : x'' \rightarrow y''\} \quad P''_2 = \{\alpha'' : f'' \Rightarrow g''\}$$

and $P''_k = \emptyset$ for $k \geq 3$, so that the cell α'' can be pictured as

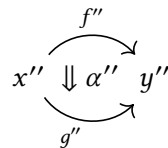

and it can be verified that P'' is a plex.

2.5.1.12 – Polyplexes. Consider now the category $\text{Elt}(\mathbf{Pol}_\omega^*)$ (where, by the convention we introduced, \mathbf{Pol}_ω^* denotes \mathbf{Pol}_ω equipped with the concretization functor of Example 2.5.1.4). An object of $\text{Elt}(\mathbf{Pol}_\omega^*)$ is a pair (P, u) where P is an ω -polygraph and u is a cell of P^* . Such an element is principal when P is the smallest subpolygraph Q such that $u \in Q^*$. By Proposition 2.4.3.9, we have directly:

Proposition 2.5.1.13. *Given $(P, u) \in \text{Elt}(\mathbf{Pol}_\omega^*)$, (P, u) is principal if and only if $P = \text{supp}(u)$.*

Following again the terminology of [Hen17], a *polyplex* is an element (P, u) such that (P, u) is both principal and primitive. Like for plexes, there is no simple characterization of polyplexes we are aware of. Intuitively, they are the elements $(P, u) \in \text{Elt}(\mathbf{Pol}_\omega^*)$ with $P = \text{supp}(u)$ such that the generators defining u are “as separated as possible”.

Example 2.5.1.14. Let P be the ω -polygraph such that

$$P_0 = \{x\}, \quad P_1 = \{f : x \rightarrow x\}, \quad P_2 = \{\alpha : f \Rightarrow f\},$$

and $P_k = \emptyset$ for $k \geq 3$, and $u = \alpha *_1 \alpha$, which can be pictured by

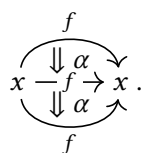

The element (P, u) is principal, but it is not a polyplex, since u is the specialization of $u' \in P'^*$, where P' is the ω -polygraph such that

$$P'_0 = \{x', y'\} \quad P'_1 = \{f', g', h': x' \rightarrow y'\} \quad P'_2 = \{\alpha': f' \Rightarrow g', \beta': g' \Rightarrow h'\}$$

and $P'_k = \emptyset$ for $k \geq 3$, and $u' = \alpha' *_1 \beta'$, which can be pictured by

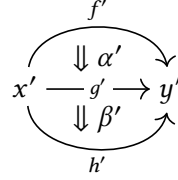

and it can be verified that (P, u) is a polyplex.

We write $\mathcal{U}: \text{Elt}(\mathbf{Pol}_\omega) \rightarrow \text{Elt}(\mathbf{Pol}_\omega^*)$ for the canonical embedding. We then have:

Proposition 2.5.1.15. *Let $(P, g) \in \text{Elt}(\mathbf{Pol}_\omega)$. Then*

- (i) (P, g) is principal if and only if $\mathcal{U}(P, g)$ is principal,
- (ii) (P, g) is a plex if and only if $\mathcal{U}(P, g)$ is a polyplex.

Proof. By Propositions 2.5.1.10 and 2.5.1.13, (i) holds. Suppose now that both (P, g) and $\mathcal{U}(P, g)$ are principal. By Proposition 2.1.3.4(ii), \mathcal{U} is fully faithful, so that it reflects isomorphisms. Thus, if $\mathcal{U}(P, g)$ is a polyplex, then (P, g) is a plex. For the converse, note that if $f: (Q, v) \rightarrow \mathcal{U}(P, g)$ is a morphism of $\text{Elt}(\mathbf{Pol}_\omega^*)$, then, by Proposition 2.1.3.4(ii), $v \in Q$, so that

$$(Q, v) = \mathcal{U}(Q, v) \quad \text{and} \quad f = \mathcal{U}(f).$$

Hence, if (P, g) is a plex, then $\mathcal{U}(P, g)$ is a polyplex. \square

Conversely, there is a functor

$$\mathcal{V}: \text{Elt}(\mathbf{Pol}_\omega^*) \rightarrow \text{Elt}(\mathbf{Pol}_\omega)$$

which is described as follows. Given an ω -polygraph P and $u \in P_k^*$ for some $k \in \mathbb{N}$, the image of the element $(P, u) \in \text{Elt}(\mathbf{Pol}_\omega^*)$ by \mathcal{V} is the element (P^{u+}, g_u) , where P^{u+} is the ω -polygraph obtained from P by adding a k -generator $h_u: \partial_{k-1}^-(u) \rightarrow \partial_{k-1}^+(u)$ and an $(k+1)$ -generator $g_u: u \rightarrow h_u$. Given a morphism $F: (P, u) \rightarrow (Q, v)$ of $\text{Elt}(\mathbf{Pol}_\omega^*)$, $\mathcal{V}(F)$ is the morphism of ω -polygraphs which maps $g \in P$ to $F(g)$, h_u to h_v , and g_u to g_v .

Proposition 2.5.1.16. *Given $(P, u) \in \text{Elt}(\mathbf{Pol}_\omega^*)$, we have that:*

- (i) (P, u) is principal if and only if $\mathcal{V}(P, u)$ is principal,
- (ii) (P, u) is a polyplex if and only if $\mathcal{V}(P, u)$ is a plex.

Proof. We have $\text{supp}^{P^{u+}}(g_u) = \text{supp}^P(u) \cup \{h_u, g_u\}$, so that, by Propositions 2.5.1.10 and 2.5.1.13, the property (i) holds. Suppose now that both (P, u) and (P^{u+}, g_u) are principal. If (P^{u+}, g_u) is a plex, then, given a morphism $F: (Q, v) \rightarrow (P, u)$ of $\text{Elt}(\mathbf{Pol}_\omega^*)$ with (Q, v) principal, we have that $\mathcal{V}(F)$ is an isomorphism by (i), which maps h_v to h_u and g_v to g_u , so that F is an isomorphism. Conversely, suppose that (P, u) is a polyplex and let $F: (Q, g) \rightarrow (P^{u+}, g_u)$ be a morphism of $\text{Elt}(\mathbf{Pol}_\omega)$ with (Q, g) principal. Then, we have $F^*(d^+(g)) = h_u$, so that, by

Proposition 2.1.3.4, $d^+(g) = h$ for some $h \in Q$. Let $v = d^-(g)$ and \tilde{Q} be the smallest subpolygraph of Q that contains v (given by Proposition 2.4.3.9). We then have:

$$\begin{aligned} |F|(|\tilde{Q}|) &= |F|(\text{supp}(v)) && \text{(since } |\tilde{Q}| = \text{supp}(v)\text{)} \\ &= \text{supp}(F^*(v)) && \text{(by Proposition 2.4.3.3)} \\ &= \text{supp}(u) \\ &= |P| && \text{(since } (P, u) \text{ is principal).} \end{aligned}$$

Thus, the generators of \tilde{Q} are mapped to the generators of P . Hence, $h \notin \tilde{Q}$. Moreover, since Q is principal, $Q = \tilde{Q} \cup \{h, g\}$, so that there are an isomorphism $\Theta: (\tilde{Q}^{v+}, g_v) \rightarrow (Q, g)$ and a morphism $F': (\tilde{Q}, v) \rightarrow (P, u)$ of $\text{Elt}(\mathbf{Pol}_\omega^*)$ such that $F \circ \Theta = \mathcal{V}(F')$. By (i), (\tilde{Q}, v) is principal and, since (P, u) is a polyplex, F' is an isomorphism and so is F . Hence, (ii) holds. \square

We now answer the question raised by Makkai and prove that \mathbf{Pol}_ω does not satisfy the point (vi) of the characterization of concrete presheaf categories (Theorem 2.5.1.8), giving another proof that \mathbf{Pol}_ω is not a concrete presheaf category. First, we give a counter-example to (vi) for \mathbf{Pol}_ω^* , proving by the way that it is also not concretely equivalent to a presheaf category:

Proposition 2.5.1.17. *There exist $(Q, v) \in \text{Elt}(\mathbf{Pol}_\omega^*)$ and morphisms*

$$F: (P, u) \rightarrow (Q, v) \quad \text{and} \quad F': (P', u') \rightarrow (Q, v)$$

of $\text{Elt}(\mathbf{Pol}_\omega^)$ where (P, u) and (P', u') are polyplexes such that P and P' are not isomorphic in \mathbf{Pol}_ω .*

Proof. Consider the ω -polygraph Q with

$$Q_0 = \{x\} \quad Q_1 = \emptyset \quad Q_2 = \{\alpha: \text{id}_x^1 \rightrightarrows \text{id}_x^1\} \quad Q_3 = \{A: \text{id}_x^2 \rightrightarrows \alpha, B: \alpha \rightrightarrows \text{id}_x^2\}$$

and $Q_k = \emptyset$ for $k \geq 4$ together with the 3-cell $v = (A *_0 \alpha) *_2 (B *_0 \alpha): \alpha \rightrightarrows \alpha$, which can be represented by

$$\begin{array}{c} \text{id}_x^1 \\ \curvearrowright \\ x \Downarrow \alpha x \\ \curvearrowleft \\ \text{id}_x^1 \end{array} \xrightarrow{\equiv} \begin{array}{c} \text{id}_x^1 \quad \text{id}_x^1 \\ \curvearrowright \quad \curvearrowright \\ x \Downarrow \alpha x \quad x \Downarrow \alpha x \\ \curvearrowleft \quad \curvearrowleft \\ \text{id}_x^1 \quad \text{id}_x^1 \end{array} \xrightarrow{\equiv} \begin{array}{c} \text{id}_x^1 \\ \curvearrowright \\ x \Downarrow \alpha x \\ \curvearrowleft \\ \text{id}_x^1 \end{array}.$$

The element (Q, v) is a specialization of the element (P, u) where

$$P_0 = \{y\} \quad P_1 = \emptyset \quad P_2 = \{\beta, \gamma: \text{id}_y^1 \rightrightarrows \text{id}_y^1\} \quad P_3 = \{C: \text{id}_y^2 \rightrightarrows \beta, D: \beta \rightrightarrows \text{id}_y^2\}$$

and $u = (C *_0 \gamma) *_2 (D *_0 \gamma)$, which can be represented by

$$\begin{array}{c} \text{id}_y^1 \\ \curvearrowright \\ y \Downarrow \gamma y \\ \curvearrowleft \\ \text{id}_y^1 \end{array} \xrightarrow{\equiv} \begin{array}{c} \text{id}_y^1 \quad \text{id}_y^1 \\ \curvearrowright \quad \curvearrowright \\ y \Downarrow \beta y \quad y \Downarrow \gamma y \\ \curvearrowleft \quad \curvearrowleft \\ \text{id}_y^1 \quad \text{id}_y^1 \end{array} \xrightarrow{\equiv} \begin{array}{c} \text{id}_y^1 \\ \curvearrowright \\ y \Downarrow \gamma y \\ \curvearrowleft \\ \text{id}_y^1 \end{array}.$$

Moreover, (Q, v) is the specialization of the element (P', u') where

$$P'_0 = \{y'\} \quad P'_1 = \emptyset \quad P'_2 = \{\beta', \gamma': \text{id}_{y'}^1 \rightrightarrows \text{id}_{y'}^1\} \quad P'_3 = \{C': \text{id}_{y'}^2 \rightrightarrows \beta', D': \gamma' \rightrightarrows \text{id}_{y'}^2\}$$

and $u' = (C' *_0 \gamma') *_2 (\beta' *_0 D')$, which can be represented by

$$\begin{array}{c} \text{id}_{y'}^1 \\ \curvearrowright \\ y' \Downarrow \gamma' y' \\ \curvearrowleft \\ \text{id}_{y'}^1 \end{array} \xrightarrow{C' *_0 \gamma'} \begin{array}{c} \text{id}_{y'}^1 \quad \text{id}_{y'}^1 \\ \curvearrowright \quad \curvearrowright \\ y' \Downarrow \beta' y' \quad y' \Downarrow \gamma' y' \\ \curvearrowleft \quad \curvearrowleft \\ \text{id}_{y'}^1 \quad \text{id}_{y'}^1 \end{array} \xrightarrow{\beta' *_0 D'} \begin{array}{c} \text{id}_{y'}^1 \\ \curvearrowright \\ y' \Downarrow \beta' y' \\ \curvearrowleft \\ \text{id}_{y'}^1 \end{array}.$$

We verify that (P, u) is a polyplex. By Proposition 2.5.1.13, it is principal. Now let

$$G: (R, w) \rightarrow (P, u) \in \text{Elt}(\mathbf{Pol}_\omega^*)$$

where (R, w) is principal. Then, by Proposition 2.1.2.8, $\mathbb{Z}G(\delta_R^M(w)) = \delta_P^M(u)$ and we compute that

$$\mathbb{Z}G(\delta_R^M(w)) = \delta_P^M(u) = 5\gamma + \beta + C + D.$$

Thus, R has exactly two 3-generators \tilde{C} and \tilde{D} and exactly two 2-generators $\tilde{\beta}$ and $\tilde{\gamma}$ that are mapped to respectively to C, D, β and γ by G . By Proposition 2.1.3.4, we can deduce the sources and targets of $\tilde{\beta}$ and $\tilde{\gamma}$ from the ones of β and γ :

$$\tilde{\beta}: \text{id}^1(\tilde{y}_1) \Rightarrow \text{id}^1(\tilde{y}_1) \quad \text{and} \quad \tilde{\gamma}: \text{id}^1(\tilde{y}_2) \Rightarrow \text{id}^1(\tilde{y}_2)$$

for some $\tilde{y}_1, \tilde{y}_2 \in R_0$. We can moreover deduce the sources and targets of \tilde{C} and \tilde{D} :

$$\tilde{C}: \text{id}^2(\tilde{y}_1) \Rightarrow \tilde{\beta} \quad \text{and} \quad \tilde{D}: \tilde{\beta} \Rightarrow \text{id}^2(\tilde{y}_1).$$

By computing $\delta_R^M(\tilde{C})$ and $\delta_R^M(\tilde{D})$ and using Proposition 2.1.2.10(iv), we have

$$3\tilde{y}_1 \leq \delta_R^M(\tilde{C}) \leq \delta_R^M(w) \quad \text{and} \quad 3\tilde{y}_2 \leq \delta_R^M(\tilde{D}) \leq \delta_R^M(w)$$

so that, if $\tilde{y}_1 \neq \tilde{y}_2$, then $6y \leq \delta_P^M(u)$, contradicting $\delta_P^M(u)_y = 5$. Thus $\tilde{y}_1 = \tilde{y}_2$, and, since (R, w) is principal, $R_0 = \{\tilde{y}_1\}$. Hence, G is an isomorphism. We conclude that (P, u) is a polyplex. Using similar techniques, we can prove that (P', u') is a polyplex.

We now verify that P and P' are not isomorphic. Suppose by contradiction that there is an isomorphism $\Theta: P \rightarrow P' \in \mathbf{Pol}_\omega$. Then, either $\Theta(C) = C'$ or $\Theta(C) = D'$. Since

$$d_2^-(\Theta(C)) = \Theta^*(d_2^-(C)) = \text{id}_{y'}^2 \neq \gamma' = d_2^-(D')$$

we necessarily have $\Theta(C) = C'$, and thus, $\Theta(D) = D'$. But then,

$$\beta' = d_2^+(C') = \Theta^*(d_2^+(C)) = \Theta^*(d_2^-(D)) = d_2^-(D') = \gamma'$$

contradicting $\beta' \neq \gamma'$. So P and P' are not isomorphic. \square

Finally, we answer the question of Makkai and conclude that \mathbf{Pol}_ω does not verify the condition (vi) of Theorem 2.5.1.8:

Proposition 2.5.1.18. *There exist $(\bar{Q}, g) \in \text{Elt}(\mathbf{Pol}_\omega)$ and morphisms*

$$F: (\bar{P}, g_{\bar{P}}) \rightarrow (\bar{Q}, g) \quad \text{and} \quad F': (\bar{P}', g_{\bar{P}'}) \rightarrow (\bar{Q}, g)$$

of $\text{Elt}(\mathbf{Pol}_\omega)$ where $(\bar{P}, g_{\bar{P}})$ and $(\bar{P}', g_{\bar{P}'})$ are plexes such that \bar{P} and \bar{P}' are not isomorphic in \mathbf{Pol}_ω .

Proof. By Proposition 2.5.1.17, there are polyplexes (P, u) and (P', u') and morphisms

$$F: (P, u) \rightarrow (Q, v) \quad \text{and} \quad F': (P', u') \rightarrow (Q, v)$$

for some $(Q, v) \in \text{Elt}(\mathbf{Pol}_\omega^*)$ such that P and P' are not isomorphic. By applying \mathcal{V} , we obtain morphisms

$$\mathcal{V}(F): (P^{u+}, g_u) \rightarrow (Q^{v+}, g_v) \quad \text{and} \quad \mathcal{V}(F'): (P'^{u'+}, g_{u'}) \rightarrow (Q^{v+}, g_v)$$

of $\text{Elt}(\mathbf{Pol}_\omega)$, where (P^{u+}, g_u) and $(P'^{u'+}, g_{u'})$ are plexes by Proposition 2.5.1.16. We now show that P^{u+} and $P'^{u'+}$ are not isomorphic. So suppose by contradiction that there exists an isomorphism $\Theta: P^{u+} \rightarrow P'^{u'+}$. Since u and u' are of the same dimension, g_u and $g_{u'}$ are the unique maximal generators of P^{u+} and $P'^{u'+}$ respectively, so Θ maps g_u on $g_{u'}$. Thus, Θ maps $h_u = d^+(g_u)$ to $h_{u'} = d^+(g_{u'})$. So Θ induces an isomorphism between P and P' seen as subpolygraphs of P^{u+} and $P'^{u'+}$ respectively, which is a contradiction. \square

2.5.2 Inexistence of the measure

In this section, we prove that there is no measure on polygraphs which is natural and which does not double-counts generators of polyplexes. More precisely, we show that there exists no family of functions $\pi = (\pi_P: |P^*| \rightarrow \mathbb{Z})_{P \in \mathbf{Pol}_\omega}$ such that

(PP-i) for all morphism $F: P \rightarrow Q$ in \mathbf{Pol}_ω , $\mathbb{Z}F \circ \pi_P = \pi_Q \circ |F^*|$,

(PP-ii) for every polyplex $(P, u) \in \text{Elt}(\mathbf{Pol}_\omega^*)$, $\pi(u)_g = 1$ for all $g \in P$.

2.5.2.1 – Unicity. We first prove that the properties (PP-i) and (PP-ii) completely determine the family π , if it exists. This comes from the fact that every cell of the free ω -category on an ω -polygraph can be “lifted” by a polyplex.

Let P be an ω -polygraph. Given $g \in P$, a *plex lifting* of g is a morphism

$$F: (Q, g_Q) \rightarrow (P, g)$$

in $\text{Elt}(\mathbf{Pol}_\omega)$ where (Q, g_Q) is a plex. Given $u \in P^*$, a *polyplex lifting* of u is a morphism

$$F: (Q, v) \rightarrow (P, u)$$

in $\text{Elt}(\mathbf{Pol}_\omega^*)$ where (Q, v) is a polyplex. In this situation, we say that (Q, v) *lifts* u . In [Mak05], it is shown that “there is enough plexes”, *i.e.*,

Proposition 2.5.2.2 ([Mak05, Theorem 3]). *Given an ω -polygraph P and $g \in P$, there exists a plex lifting of g .*

We deduce the same property for polyplexes:

Proposition 2.5.2.3. *Given an ω -polygraph P and $u \in P^*$, there exists a polyplex lifting of u .*

Proof. By Proposition 2.5.2.2, there exist a plex (Q, g) and a morphism $F: (Q, g) \rightarrow (P^{u+}, g_u)$ in $\text{Elt}(\mathbf{Pol}_\omega)$. We have $F^*(d^+(g)) = h_u$, so $d^+(g) = h$ for some $h \in Q$. Let $v = d^-(g)$ and \tilde{Q} be the smallest subpolygraph of Q that contains v . Since $F^*(v) = u$, F maps the generators of \tilde{Q} to generators of P . Since (Q, g) is principal, we have $Q = \tilde{Q} \cup \{h, g\}$. So there exists an isomorphism $\Theta: \tilde{Q}^{v+} \rightarrow Q$ and $F': \tilde{Q} \rightarrow P$ such that $F \circ \Theta = \mathcal{V}(F')$. By Proposition 2.5.1.16(ii), the element (\tilde{Q}, v) is a polyplex and $F': (\tilde{Q}, v) \rightarrow (P, u)$ is a morphism of $\text{Elt}(\mathbf{Pol}_\omega^*)$. \square

We then have the following unicity result:

Proposition 2.5.2.4. *There is at most one family of functions $\pi = (\pi_P : |P^*| \rightarrow \mathbb{Z}P)_{P \in \text{Pol}_\omega}$ which satisfies (PP-i) and (PP-ii).*

Proof. Let P be an ω -polygraph and $u \in P^*$. Then, by Proposition 2.5.2.3, there exists a morphism $F : (Q, v) \rightarrow (P, u)$ where (Q, v) is a polyplex. Since π is natural and satisfies (PP-ii), we have

$$\pi_P(u) = \mathbb{Z}F(\pi_Q(v)) = \mathbb{Z}F\left(\sum_{g \in Q} g\right)$$

so $(\pi_P)_{P \in \text{Pol}_\omega}$ is uniquely determined. \square

2.5.2.5 – Designing a counter-example. So a family π that satisfies (PP-i) and (PP-ii) is unique, but does it exist at all? By looking at the proof of Proposition 2.5.2.3, it would require some sort of compatibility between the polyplex liftings of a cell $u \in P^*$ of an ω -polygraph P . Proposition 2.5.1.17 is already a bad sign for the existence of π but does not necessarily prevent the existence of π : it could be the case that, for all $P, u \in P^*$, and polyplexes liftings $(F^i : (Q^i, v^i) \rightarrow (P, u))$ of u for $i \in \{1, 2\}$, we have

$$\mathbb{Z}F^1\left(\sum_{g \in Q^1} g\right) = \mathbb{Z}F^2\left(\sum_{g \in Q^2} g\right)$$

even though Q^1 and Q^2 are not necessarily isomorphic. We show below that it is not the case by exhibiting a counter-example, which refines the one of the proof of Proposition 2.5.1.17.

The idea to build such a counter-example is the following. Given an ω -polygraph P with 3-generators A and B of the form

$$x \begin{array}{c} \xrightarrow{f} \\ \Downarrow \alpha \\ \xrightarrow{f} \end{array} x \stackrel{A}{\cong} x \begin{array}{c} \xrightarrow{f} \\ \Downarrow \alpha \\ \xrightarrow{f} \end{array} x \stackrel{B}{\cong} x \begin{array}{c} \xrightarrow{f} \\ \Downarrow \alpha \\ \xrightarrow{f} \end{array} x$$

a polyplex lifting of $A *_2 B$ is given by the polyplex $(P', A' *_2 B')$, where A' and B' are of the form

$$x' \begin{array}{c} \xrightarrow{f'} \\ \Downarrow \alpha' \\ \xrightarrow{g'} \end{array} y' \stackrel{A'}{\cong} x' \begin{array}{c} \xrightarrow{f'} \\ \Downarrow \beta' \\ \xrightarrow{g'} \end{array} y' \stackrel{B'}{\cong} x' \begin{array}{c} \xrightarrow{f'} \\ \Downarrow \gamma' \\ \xrightarrow{g'} \end{array} y'$$

so that f has two pre-images in P' and, if the family π exists, $\pi(A *_2 B)_f = 2$. Now, if P has a 2-generator C of the form

$$x \begin{array}{c} \xrightarrow{f} \\ \Downarrow \alpha \\ \xrightarrow{f} \end{array} x \stackrel{C}{\cong} x \begin{array}{c} \xrightarrow{f} \\ \Downarrow \text{id}_f \\ \xrightarrow{f} \end{array} x$$

then, a polyplex lifting of $A *_2 C$ is given by $(P'', A'' *_2 C'')$ where A'' and C'' are of the form

$$x'' \begin{array}{c} \xrightarrow{f''} \\ \Downarrow \alpha'' \\ \xrightarrow{f''} \end{array} y'' \stackrel{A''}{\cong} x'' \begin{array}{c} \xrightarrow{f''} \\ \Downarrow \beta'' \\ \xrightarrow{f''} \end{array} y'' \stackrel{C''}{\cong} x'' \begin{array}{c} \xrightarrow{f''} \\ \Downarrow \text{id}_{f''} \\ \xrightarrow{f''} \end{array} y''$$

so that f has only one pre-image in P'' and $\pi(A *_2 C)_f = 1$. So, we can control the number of preimages of f in a polyplex lifting of $A *_2 X$ by choosing the right 3-generator $X \in P_3$. From this remark, we build an ω -polygraph P with 3-cells $H, H', K, K' \in P_3^*$ satisfying

$$(H *_2 K) *_0 (H' *_2 K') = (H *_2 K') *_0 (H' *_2 K)$$

and such that there are less preimages for some 1-generator $f \in P$ in the polyplex lifting associated to the left hand-side than in the one associated to the right hand-side. Thus, this incoherence will contradict the existence of π .

Consider the ω -polygraph P where

$$\begin{aligned} P_0 &= \{x\} & P_1 &= \{f: x \rightarrow x\} \\ P_2 &= \{\lambda: \text{id}_x \Rightarrow f, \rho: f \Rightarrow \text{id}_x, \alpha: f \Rightarrow f\} \\ P_3 &= \{A: \alpha \Rightarrow \alpha, A': \text{id}_f \Rightarrow \alpha, B: \alpha \Rightarrow \alpha, B': \alpha \Rightarrow \text{id}_f\} \end{aligned}$$

together with the 3-cell

$$u = (H *_2 K) *_0 (H' *_2 K') = (H *_0 H') *_2 (K *_0 K')$$

where

$$\begin{aligned} H &= \lambda *_1 A *_1 \rho & H' &= \lambda *_1 A' *_1 \rho \\ K &= \lambda *_1 B *_1 \rho & K' &= \lambda *_1 B' *_1 \rho \end{aligned}$$

so that u can be represented by

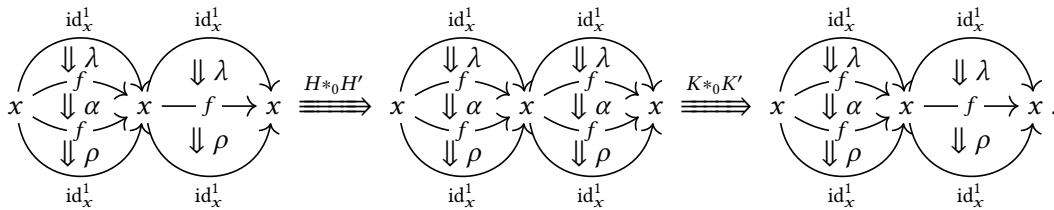

In the following, we describe two polyplexes that lift u . First, we prove some technical lemmas relating Makkai's measure and decomposition of cells with contexts:

Lemma 2.5.2.6. *Let Q be an ω -polygraph, $k \in \mathbb{N}$ and $g \in Q_k$. Given $m \in \mathbb{N}_{k-1}$ and an m -context E of type g , we have*

$$\delta_Q^M(\partial_{k-1}^+(E[g])) = \delta_Q^M(\partial_{k-1}^-(E[g])) + \delta_Q^M(d_{k-1}^+(g)) - \delta_Q^M(d_{k-1}^-(g))$$

and, given an m -context class F of type g , we have

$$\delta_Q^M(\partial_{k-1}^+(F[g])) = \delta_Q^M(\partial_{k-1}^-(F[g])) + \delta_Q^M(d_{k-1}^+(g)) - \delta_Q^M(d_{k-1}^-(g)).$$

Proof. We prove this by induction on m . If $m = 0$, then the property holds. So suppose that $m > 0$ and let $(l, F', r) = E$. We have, using Proposition 2.1.2.9,

$$\begin{aligned}
\delta_Q^M(\partial_{k-1}^+(E[g])) &= \delta_Q^M(l \bullet_{m-1} \partial_{k-1}^+(F'[g]) \bullet_{m-1} r) \\
&= \delta_Q^M(\text{id}_l^{k-1} *_{m-1} \partial_{k-1}^+(F'[g]) *_{m-1} \text{id}_r^{k-1}) \\
&= \delta_Q^M(l) + \delta_Q^M(\partial_{k-1}^+(F'[g])) + \delta_Q^M(r) - \delta_Q^M(\partial_{m-1}^+(l)) - \delta_Q^M(\partial_{m-1}^+(r)) \\
&= \delta_Q^M(l) + \delta_Q^M(\partial_{k-1}^-(F'[g])) + \delta_Q^M(r) - \delta_Q^M(\partial_{m-1}^+(l)) - \delta_Q^M(\partial_{m-1}^-(r)) \\
&\quad + \delta_Q^M(d_{k-1}^+(g)) - \delta_Q^M(d_{k-1}^-(g)) \quad (\text{by induction hypothesis}) \\
&= \delta_Q^M(\text{id}_l^{k-1} *_{m-1} \partial_{k-1}^-(F'[g]) *_{m-1} \text{id}_r^{k-1}) \\
&\quad + \delta_Q^M(d_{k-1}^+(g)) - \delta_Q^M(d_{k-1}^-(g)) \\
&= \delta_Q^M(l \bullet_{m-1} \partial_{k-1}^-(F'[g]) \bullet_{m-1} r) + \delta_Q^M(d_{k-1}^+(g)) - \delta_Q^M(d_{k-1}^-(g)) \\
&= \delta_Q^M(\partial_{k-1}^-(E[g])) + \delta_Q^M(d_{k-1}^+(g)) - \delta_Q^M(d_{k-1}^-(g)).
\end{aligned}$$

Moreover, given the fact that $F = \llbracket E' \rrbracket$ for some m -context E' , a similar equality holds for F . \square

Lemma 2.5.2.7. *Given an ω -polygraph Q , $k \in \mathbb{N}$ and $u \in Q_k^*$, if*

$$u = F_1[g_1] *_{k-1} \cdots *_{k-1} F_l[g_l]$$

for some $l \in \mathbb{N}$ and $g_i \in Q_k$ and $(k-1)$ -context classes F_i for $i \in \mathbb{N}_l^$, then*

$$\sum_{g \in Q_k} \delta_Q^M(u)_g = g_1 + \cdots + g_l.$$

Proof. Given $g \in Q_k$, $m \in \mathbb{N}_{k-1}$ and an m -context E of type g , a simple induction on m shows that

$$\sum_{g' \in Q_k} \delta_Q^M(E[g])_{g'} = \sum_{g' \in Q_k} \delta_Q^M(\llbracket E \rrbracket[g])_{g'} = g.$$

Moreover, given $(k-1)$ -composable $u_1, u_2 \in Q_k^*$, by Proposition 2.1.2.9, we have

$$\delta_Q^M(u_1 *_{k-1} u_2) = \delta_Q^M(u_1) + \delta_Q^M(u_2) - \delta_Q^M(\partial_{k-1}^+(u_1))$$

so that, for all $g' \in Q_k$,

$$\delta_Q^M(u_1 *_{k-1} u_2)_{g'} = \delta_Q^M(u_1)_{g'} + \delta_Q^M(u_2)_{g'}.$$

Thus, the statement holds. \square

2.5.2.8 – The first polyplex. We now introduce a first polyplex of which the element (P, u) is the specialization. Consider the ω -polygraph P^1 where

$$\begin{aligned}
P_0^1 &= \{x_1\} & P_1^1 &= \{f_1, g_1, h_1 : x_1 \rightarrow x_1\} \\
P_2^1 &= \{ & \lambda_1 : \text{id}_{x_1}^1 &\Rightarrow f_1, & \lambda'_1 : \text{id}_{x_1}^1 &\Rightarrow h_1, \\
& & \rho_1 : g_1 &\Rightarrow \text{id}_{x_1}^1, & \rho'_1 : h_1 &\Rightarrow \text{id}_{x_1}^1, \\
& & \alpha_1, \alpha'_1, \alpha''_1 : f_1 &\Rightarrow g_1, & \beta_1 : h_1 &\Rightarrow h_1 & \} \\
P_3^1 &= \{A_1 : \alpha_1 &\Rightarrow \alpha'_1, & A'_1 : \text{id}_{h_1} &\Rightarrow \beta_1, & B_1 : \alpha'_1 &\Rightarrow \alpha''_1, & B'_1 : \beta_1 &\Rightarrow \text{id}_{h_1}\}
\end{aligned}$$

and the 3-cell

$$u_1 = (H_1 *_2 K_1) *_0 (H'_1 *_2 K'_1) = (H_1 *_0 H'_1) *_2 (K_1 *_0 K'_1) \in (P^1)_3^*$$

where

$$\begin{aligned} H_1 &= \lambda_1 *_{\mathbf{1}} A_1 *_{\mathbf{1}} \rho_1 & H'_1 &= \lambda'_1 *_{\mathbf{1}} A'_1 *_{\mathbf{1}} \rho'_1 \\ K_1 &= \lambda_1 *_{\mathbf{1}} B_1 *_{\mathbf{1}} \rho_1 & K'_1 &= \lambda'_1 *_{\mathbf{1}} B'_1 *_{\mathbf{1}} \rho_1 \end{aligned}$$

which can be represented by

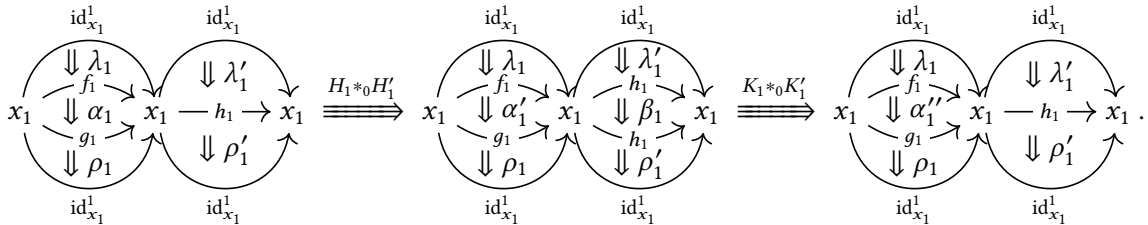

Given the morphism $F^1 : P^1 \rightarrow P \in \mathbf{Pol}_\omega$ defined by the mappings

$$\begin{array}{ll} x_1 \mapsto x & f_1, g_1, h_1 \mapsto f \\ \lambda_1, \lambda'_1 \mapsto \lambda & \rho_1, \rho'_1 \mapsto \rho \\ \alpha_1, \alpha'_1, \alpha''_1 \mapsto \alpha & \beta_1 \mapsto \alpha \\ A_1 \mapsto A & A'_1 \mapsto A' \\ B_1 \mapsto B & B'_1 \mapsto B' \end{array}$$

we have that $(F^1)^*(u_1) = u$. We moreover verify that:

Proposition 2.5.2.9. (P^1, u_1) is a polyplex.

Proof. We compute

$$\delta_{P^1}^M(u_1) = 23x_1 + 3f_1 + 3g_1 + 4h_1 + \lambda_1 + \lambda'_1 + \rho_1 + \rho'_1 + \alpha_1 + \alpha'_1 + \alpha''_1 + \beta_1 + A_1 + A'_1 + B_1 + B'_1 \quad (2.14)$$

so that (P^1, u_1) is principal by Proposition 2.5.1.13. Let $G : (Q, v) \rightarrow (P^1, u_1)$ be a morphism in $\mathbf{Elt}(\mathbf{Pol}_\omega^*)$ where (Q, v) is principal. Since $\mathbb{Z}G(\delta_Q^M(v)) = \delta_{P^1}^M(u_1)$ (by Proposition 2.1.2.8), Q_3 has exactly four generators,

$$\bar{A}, \bar{A}', \bar{B}, \bar{B}'$$

respectively mapped to A_1, A'_1, B_1, B'_1 by G , and Q_2 has exactly eight generators

$$\bar{\lambda}, \bar{\lambda}', \bar{\rho}, \bar{\rho}', \bar{\alpha}, \bar{\alpha}', \bar{\alpha}'', \bar{\beta}$$

respectively mapped to $\lambda_1, \lambda'_1, \rho_1, \rho'_1, \alpha_1, \alpha'_1, \alpha''_1, \beta_1$ by G . Since G is an ω -polygraph morphism, by Proposition 2.1.3.4, we deduce that

$$\bar{A} : \bar{\alpha} \Rightarrow \bar{\alpha}' \quad \bar{B} : \bar{\alpha}' \Rightarrow \bar{\alpha}'' \quad (2.15)$$

$$\bar{A}' : \text{id}_h^2 \Rightarrow \bar{\beta} \quad \bar{B}' : \bar{\beta} \Rightarrow \text{id}_h^2 \quad (2.16)$$

for some preimage $\bar{h} \in Q_1$ of h_1 . From (2.15) and (2.16), we deduce that

$$\bar{\alpha}, \bar{\alpha}', \bar{\alpha}'' : \bar{f} \Rightarrow \bar{g}$$

for some preimages \bar{f}, \bar{g} of f and g respectively, and that $\bar{\beta} : \bar{h} \Rightarrow \bar{h}$. We have

$$G^*(\partial_2^-(v)) = \partial_2^-(u_1) = (\lambda_1 *_{\mathbf{1}} \alpha_1 *_{\mathbf{1}} \rho_1) *_{\mathbf{0}} (\lambda'_1 *_{\mathbf{1}} \rho'_1)$$

and we compute

$$\mathbb{Z}G(\delta_Q^M(\partial_2^-(v))) = \delta_{p_1}^M(\partial_2^-(u_1)) = 9x_1 + f_1 + g_1 + h_1 + \lambda_1 + \lambda'_1 + \rho_1 + \rho'_1 + \alpha_1. \quad (2.17)$$

By Proposition 2.1.2.10(iv), we deduce that

$$\bar{\lambda}: \text{id}_{\bar{x}}^2 \Rightarrow \bar{f}, \quad \bar{\rho}: \bar{g} \Rightarrow \text{id}_{\bar{x}}^2, \quad \bar{\lambda}': \text{id}_{\bar{x}'}^2 \Rightarrow \bar{h}', \quad \bar{\rho}': \bar{h}' \Rightarrow \text{id}_{\bar{x}'}^2,$$

for some preimages $\bar{h}', \bar{x}, \bar{x}' \in Q$ of the generators h, x, x respectively.

We now verify that $\bar{h} = \bar{h}'$. By Proposition 2.2.5.3 and Lemma 2.5.2.7, the cell v can be written

$$v = F_1[C_1] *_2 F_2[C_2] *_2 F_3[C_3] *_2 F_4[C_4]$$

for some 2-context classes F_1, F_2, F_3, F_4 and $\{C_1, C_2, C_3, C_4\} = \{\bar{A}, \bar{A}', \bar{B}, \bar{B}'\}$. By Lemma 2.5.2.6, we have

$$\delta_Q^M(\partial_2^-(F_i[C_i])) = \delta_Q^M(\partial_2^-(v)) + \sum_{1 \leq j < i} [\delta_Q^M(d_2^+(C_j)) - \delta_Q^M(d_2^-(C_j))] \quad (2.18)$$

for $i \in \{1, 2, 3, 4\}$. Let $p, q \in \{1, 2, 3, 4\}$ be such that $C_p = \bar{A}'$ and $C_q = \bar{B}'$. Since

$$\delta_Q^M(d_2^-(\bar{B}'))_{\bar{\beta}} = 1$$

we have $\delta_Q^M(\partial_2^-(F_q[C_q]))_{\bar{\beta}} \geq 1$. Moreover, by (2.15) and (2.17),

$$\delta_Q^M(\partial_2^-(v))_{\bar{\beta}} = \delta_Q^M(d_2^+(\bar{A}))_{\bar{\beta}} = \delta_Q^M(d_2^+(\bar{B}))_{\bar{\beta}} = 0$$

so that, by (2.18), we have $p < q$. Then, since

$$1 = \delta_Q^M(d_2^-(\bar{A}'))_{\bar{h}} \leq \delta_Q^M(\partial_2^-(F_p[C_p]))_{\bar{h}} \quad \text{and} \quad \delta_Q^M(d_2^+(\bar{A}))_{\bar{h}} = \delta_Q^M(d_2^+(\bar{B}))_{\bar{h}} = 0$$

we have $1 \leq \delta_Q^M(\partial_2^-(v))_{\bar{h}}$ by (2.18) again. Moreover,

$$1 \leq \delta_Q^M(\bar{\lambda}')_{\bar{h}'} \leq \delta_Q^M(\partial_2^-(v))_{\bar{h}'}$$

thus $1 \leq \delta_Q^M(\partial_2^-(v))_{\bar{h}'}$. Since both \bar{h} and \bar{h}' are preimages of h and

$$(\mathbb{Z}G(\delta_Q^M(\partial_2^-(v))))_h = \delta_{p_1}^M(\partial_2^-(u_1))_h = 1$$

we have $\bar{h} = \bar{h}'$.

We now prove that $\bar{f}, \bar{g}, \bar{h}$ are the only 1-generators of Q . Suppose by contradiction that there is another preimage $\bar{f}' \in Q_1$ of f_1 . Then, since (Q, v) is principal, we have $\delta_Q^M(v)_{\bar{f}'} \geq 1$ so there exists $r \in \{1, 2, 3, 4\}$ such that $\delta_Q^M(F_r[C_r])_{\bar{f}'} \geq 1$. By definition of $\bar{A}, \bar{A}', \bar{B}, \bar{B}'$, we have $\delta_Q^M(C_i)_{\bar{f}'} = 0$ for $i \in \{1, 2, 3, 4\}$. We deduce that $\delta_Q^M(\partial_2^-(F_r[C_r]))_{\bar{f}'} \geq 1$, and, by (2.18), that $\delta_Q^M(\partial_2^-(v))_{\bar{f}'} \geq 1$. But

$$\delta_Q^M(\partial_2^-(v))_{\bar{f}} = 1, \quad \mathbb{Z}G(\delta_Q^M(\partial_2^-(v))) = \delta_{p_1}^M(\partial_2^-(u)) \quad \text{and} \quad \delta_{p_1}^M(\partial_2^-(u))_{\bar{f}_1} = 1$$

so $\bar{f} = \bar{f}'$, contradicting $\bar{f} \neq \bar{f}'$. Thus, \bar{f} is the unique preimage of f . The same argument gives that \bar{g} and \bar{h} are the unique preimages of g and h respectively.

Finally, we have $\bar{x} = \bar{x}'$ since, otherwise, it would not be possible to compose the 1-, 2- and 3-generators of Q together, and, since (Q, v) is principal, there are no other 0-cells. So G is an isomorphism. Hence, (Q, v) is a polyplex. \square

2.5.2.10 – The second polyplex. We now introduce another polyplex of which can be specialized to (P, u) . Consider the ω -polygraph P^2 where

$$\begin{aligned} P_0^2 &= \{x_2\} & P_1^2 &= \{f_2, g_2\} \\ P_2^2 &= \{ \lambda_2: \text{id}_{x_2} \Rightarrow f_2, & \lambda'_2: \text{id}_{x_2} \Rightarrow g_2, \\ & \rho_2: f_2 \Rightarrow \text{id}_{x_2}, & \rho'_2: g_2 \Rightarrow \text{id}_{x_2}, \\ & \alpha_2, \alpha'_2: f_2 \Rightarrow f_2, & \beta_2, \beta'_2: g_2 \Rightarrow g_2 \} \\ P_3^2 &= \{A_2: \alpha_2 \Rightarrow \alpha'_2, A'_2: \text{id}_{g_2}^2 \Rightarrow \beta_2, B_2: \beta_2 \Rightarrow \beta'_2, B'_2: \alpha'_2 \Rightarrow \text{id}_{f_2}^2\} \end{aligned}$$

and the 3-cell

$$u_2 = (H_2 *_2 K'_2) *_0 (H'_2 *_2 K_2) = (H_2 *_0 H'_2) *_2 (K'_2 *_0 K_2) \in (P^2)_3^*$$

where

$$\begin{aligned} H_2 &= \lambda_2 *_1 A_2 *_1 \rho_2 & H'_2 &= \lambda'_2 *_1 A'_2 *_1 \rho'_2 \\ K'_2 &= \lambda_2 *_1 B'_2 *_1 \rho_2 & K_2 &= \lambda'_2 *_1 B_2 *_1 \rho'_2 \end{aligned}$$

which can be represented by

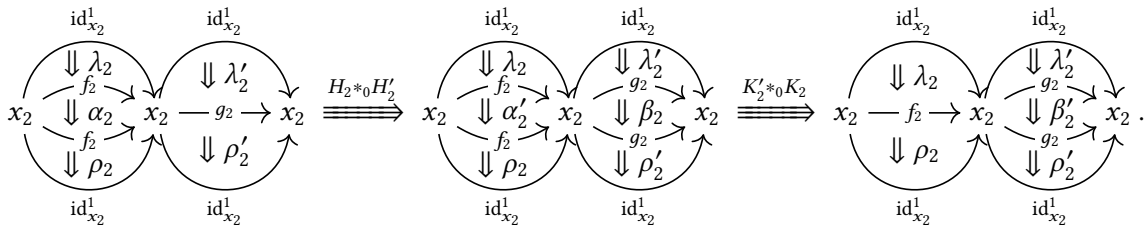

Given the morphism $F^2: P^2 \rightarrow P \in \mathbf{Pol}_\omega$ defined by the mappings

$$\begin{aligned} x_2 &\mapsto x & f_2, g_2 &\mapsto f \\ \lambda_2, \lambda'_2 &\mapsto \lambda & \rho_2, \rho'_2 &\mapsto \rho \\ \alpha_2, \alpha'_2 &\mapsto \alpha & \beta_2, \beta'_2 &\mapsto \alpha \\ A_2 &\mapsto A & A'_2 &\mapsto A' \\ B_2 &\mapsto B & B'_2 &\mapsto B' \end{aligned}$$

we have

$$\begin{aligned} (F^2)^*(u_2) &= (H *_0 H') *_2 (K' *_0 K) \\ &= (H *_0 H') *_2 [(K' *_0 \text{id}_{\partial_1^-(K)}^3) *_1 (\text{id}_{\partial_1^+(K')}^3 *_0 K)] && \text{(by Axioms (S-iii) and (S-vi))} \\ &= (H *_0 H') *_2 (K' *_1 K) && \text{(by Axiom (S-iii))} \\ &= (H *_0 H') *_2 [(\text{id}_{\partial_1^-(K)}^3 *_0 K') *_1 (K *_0 \text{id}_{\partial_1^+(K')}^3)] && \text{(by Axiom (S-iii))} \\ &= (H *_0 H') *_2 (K *_0 K') && \text{(by Axioms (S-iii) and (S-vi))} \\ &= (H *_2 K) *_0 (H' *_2 K') \\ &= u \end{aligned}$$

We then verify that:

Proposition 2.5.2.11. (P^2, u_2) is a polyplex.

Proof. We compute

$$\delta_{\mathbb{P}^2}^{\mathbb{M}}(u_2) = 23x_2 + 5f_2 + 5g_2 + \lambda_2 + \lambda'_2 + \rho_2 + \rho'_2 + \alpha_2 + \alpha'_2 + \beta_2 + \beta'_2 + A_2 + A'_2 + B_2 + B'_2$$

so that (\mathbb{P}^2, u_2) is principal by Proposition 2.5.1.13. Let $G: (\mathbb{Q}, v) \rightarrow (\mathbb{P}^2, u_2)$ be a morphism of $\text{Elt}(\text{Pol}_\omega^*)$ where (\mathbb{Q}, v) is principal. Since $\mathbb{Z}G(\delta_{\mathbb{Q}}^{\mathbb{M}}(v)) = \delta_{\mathbb{P}^2}^{\mathbb{M}}(u_2)$ (by Proposition 2.1.2.8), we deduce that \mathbb{Q} has exactly four 3-generators

$$\bar{A}, \bar{A}', \bar{B}, \bar{B}'$$

mapped to A_2, A'_2, B_2, B'_2 respectively by G , and eight 2-generators

$$\bar{\lambda}, \bar{\lambda}', \bar{\rho}, \bar{\rho}', \bar{\alpha}, \bar{\alpha}', \bar{\beta}, \bar{\beta}'$$

mapped to $\lambda_2, \lambda'_2, \rho_2, \rho'_2, \alpha_2, \alpha'_2, \beta_2, \beta'_2$ respectively by G . Since G is an ω -polygraph morphism, by Proposition 2.1.3.4, we deduce that

$$\bar{A}: \bar{\alpha} \Rightarrow \bar{\alpha}' \qquad \bar{B}: \bar{\beta} \Rightarrow \bar{\beta}' \qquad (2.19)$$

$$\bar{A}': \text{id}_{\bar{g}} \Rightarrow \bar{\beta} \qquad \bar{B}': \bar{\alpha}' \Rightarrow \text{id}_{\bar{f}} \qquad (2.20)$$

for some preimages $\bar{f}, \bar{g} \in \mathbb{Q}_1$ of f and g respectively. By (2.19) and (2.20), we have

$$\bar{\alpha}, \bar{\alpha}': \bar{f} \Rightarrow \bar{f} \quad \text{and} \quad \bar{\beta}, \bar{\beta}': \bar{g} \Rightarrow \bar{g}.$$

Moreover,

$$G^*(\partial_2^-(v)) = \partial_2^-(u_2) = (\lambda_2 * \rho_2) * (\lambda'_2 * \rho'_2)$$

so that

$$\mathbb{Z}G(\delta_{\mathbb{Q}}^{\mathbb{M}}(\partial_2^-(v))) = \delta_{\mathbb{P}^2}^{\mathbb{M}}(\partial_2^-(u_2)) = 9x_2 + 2f_2 + g_2 + \lambda_2 + \lambda'_2 + \rho_2 + \rho'_2 + \alpha_2.$$

By Proposition 2.1.2.10(iv), $2\bar{f} \leq \delta_{\mathbb{Q}}^{\mathbb{M}}(\bar{\alpha}) \leq \delta_{\mathbb{Q}}^{\mathbb{M}}(\partial_2^-(v))$ thus

$$\bar{\lambda}: \text{id}_{\bar{x}} \Rightarrow \bar{f} \quad \text{and} \quad \bar{\rho}: \bar{f} \Rightarrow \text{id}_{\bar{x}}$$

for some $\bar{x} \in \mathbb{Q}_0$. Similarly, by considering $\partial_2^+(v)$ and $\delta_{\mathbb{P}^2}^{\mathbb{M}}(\partial_2^+(u_2))$, we have

$$\bar{\lambda}': \text{id}_{\bar{x}'} \Rightarrow \bar{g} \quad \text{and} \quad \bar{\rho}': \bar{g} \Rightarrow \text{id}_{\bar{x}'}$$

for some $\bar{x} \in \mathbb{Q}_0$. By the same arguments as for (\mathbb{P}^1, u_1) , we have that \bar{f}, \bar{g} are the only 1-generators of \mathbb{Q} , $\bar{x} = \bar{x}'$ and \bar{x} is the only 0-generator of \mathbb{Q} . Thus, G is an isomorphism. Hence, (\mathbb{P}^2, u_2) is a polyplex. \square

2.5.2.12 – Inexistence of a polyplex-compatible measure. Now that we have built the polyplex liftings

$$(\mathbb{P}^1, u_1) \quad \text{and} \quad (\mathbb{P}^2, u_2)$$

of (\mathbb{P}, u) , we can conclude the inexistence of a natural measure π on polygraphs that does not double-counts, since π would not be consistently defined on u :

Proposition 2.5.2.13. *A family of functions $\pi = (\pi_{\mathbb{P}^*}: |\mathbb{P}^*| \rightarrow \mathbb{Z}\mathbb{P})_{\mathbb{P} \in \text{Pol}_\omega}$ can not satisfy both (PP-i) and (PP-ii).*

Proof. By contradiction, suppose that there exists a family π satisfying both (PP-i) and (PP-ii). We compute $\pi_{\mathbb{P}}(u)$ in two different ways. First, note that there are exactly three preimages f_1, g_1, h_1 of f by F^1 , whereas there are two preimages f_2, g_2 of f by F^2 . Then, on the one hand, we have $\pi_{\mathbb{P}}(u) = \mathbb{Z}F^1(\pi_{\mathbb{P}^1}(u_1))$, thus $\pi_{\mathbb{P}}(u)_f = 3$. On the other hand, we have $\pi_{\mathbb{P}}(u) = \mathbb{Z}F^2(\pi_{\mathbb{P}^2}(u_2))$, so that $\pi_{\mathbb{P}}(u)_f = 2$, which is a contradiction. \square

Pasting diagrams

Introduction

Originally, the motivation behind pasting diagrams was to give a simpler description of cells of free strict categories on polygraphs, and thus, of strict categories in general: the standard description of the cells as classes of well-typed expressions given by Proposition 1.4.1.16, or even the one as classes of sequences of context classes given in Section 2.2, are quite heavy and difficult to use without computer assistance. Those descriptions seem necessary to handle the full complexity that general polygraphs can induce, but appear excessive for most simple instances. Indeed, it has now become common practice in the literature about strict categories (and, in particular, this manuscript) to represent cells of strict categories simply by diagrams of generators, named *pasting diagrams*. For example, one can consider the pasting diagram

$$\begin{array}{c}
 \begin{array}{ccccccc}
 u & \xrightarrow{a} & v & \xrightarrow{c} & w & \xrightarrow{f} & x & \xrightarrow{h} & y \\
 & & \begin{array}{c} \text{b} \\ \Downarrow \alpha \\ \text{c} \\ \Downarrow \beta \\ \text{d} \end{array} & & \begin{array}{c} \text{e} \\ \Downarrow \gamma \\ \text{f} \\ \Downarrow \delta \\ \text{g} \end{array} & & & & \\
 & & \begin{array}{c} \text{b} \\ \Downarrow \alpha \\ \text{c} \\ \Downarrow \beta \\ \text{d} \end{array} & & \begin{array}{c} \text{e} \\ \Downarrow \gamma \\ \text{f} \\ \Downarrow \delta \\ \text{g} \end{array} & & & &
 \end{array}
 \end{array} \tag{3.1}$$

in any 2-category C that has 0-cells u, v, w, x, y , 1-cells a, b, c, d, e, f, g, h and 2-cells $\alpha, \beta, \gamma, \delta$ whose sources and targets satisfy the equalities suggested by the diagram:

$$\partial_0^+(a) = v = \partial_0^-(b) \quad \partial_1^+(\alpha) = c = \partial_1^-(\beta) \quad \partial_1^+(\beta) = d \quad \text{etc.}$$

From this diagram, one easily finds expressions that compose “all the cells together” like

$$\text{id}_a^2 *_0 (\alpha *_1 \beta) *_0 ((\gamma *_0 \text{id}_h^2) *_1 (\delta *_0 \text{id}_h^2))$$

or

$$(\text{id}_a^2 *_0 \alpha *_0 \text{id}_e^2 *_0 \text{id}_h^2) *_1 (\text{id}_a^2 *_0 \text{id}_c^2 *_0 \gamma *_0 \text{id}_h^2) *_1 (\text{id}_a^2 *_0 \beta *_0 \delta *_0 \text{id}_h^2).$$

A remarkable property of (3.1), and of pasting diagrams in general, is that all such expressions are equivalent modulo the axioms of strict categories (c.f. Paragraph 1.4.1.1), so that the 2-cell obtained by composing “all the cells of the diagram together” is well-defined. Moreover, there are

subdiagrams of (3.1) that are also pasting diagrams, and they can moreover be composed together by simply taking their set union. For example,

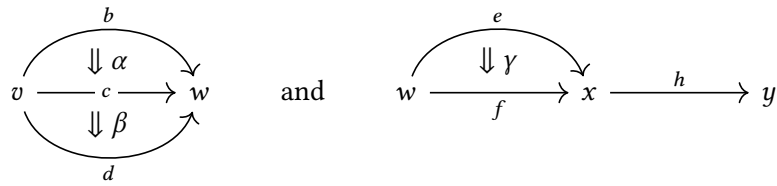

are subdiagrams of (3.1) that are pasting diagrams and that can be composed in dimension 0 along w to produce the subdiagram of (3.1)

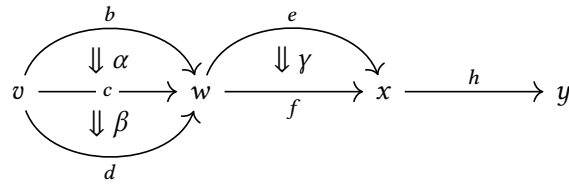

which is also a pasting diagram. However, not all subdiagrams of (3.1) are pasting diagrams. For example, the subdiagram

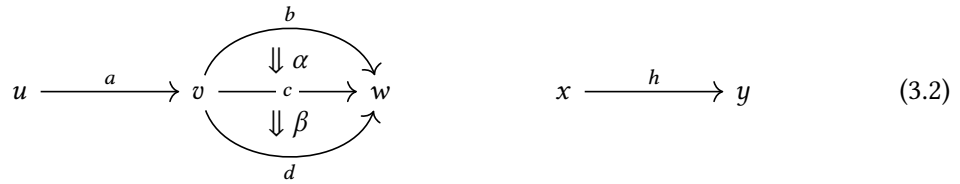

is not a pasting diagram, since it is not possible to find an expression which composes the generators on the left-hand side with the ones on the right-hand side.

As suggested by the above example, a pasting diagram induces an ω -category of the subdiagrams that are pasting diagrams. In fact, this ω -category is the free ω -category on the canonical ω -polygraph associated with the diagram. For instance, the ω -category of sub-pasting diagrams of (3.1) is the free ω -category on the ω -polygraph P where

$$\begin{aligned}
 P_0 &= \{u, v, w, x, y\} \\
 P_1 &= \{a: u \rightarrow v, \quad b, c, d: v \rightarrow w, \quad e, f, g: w \rightarrow x, \quad h: x \rightarrow y\} \\
 P_2 &= \{\alpha: b \Rightarrow c, \quad \beta: c \Rightarrow d, \quad \gamma: e \Rightarrow f, \quad \delta: f \Rightarrow g\}
 \end{aligned}$$

and $P_k = \emptyset$ for $k \geq 3$. Then, every cell $u \in P^*$ can be faithfully represented by the sub-pasting diagram of (3.1) associated with the subset $\text{supp}(u) \subseteq |P|$. Thus, the cells of the free ω -category on an ω -polygraph Q associated with a pasting diagram admit a simple description as particular subsets of $|Q|$, which contrasts with the complex descriptions as classes of well-typed expressions or sequences of context classes.

In order for this description to be complete, one needs to be able to characterize the pasting diagrams among general diagrams. A first issue which can prevent a diagram to be a pasting diagram is that the cells of the diagrams can be composed in several non-equivalent ways. For example, the diagram

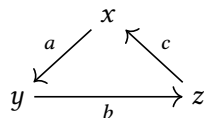

is not a pasting diagram, since the loop there allows for several non-equivalent expressions which compose all the generators of the diagram, like

$$a *_0 b *_0 c, \quad b *_0 c *_0 a, \quad a *_0 b *_0 c *_0 a *_0 b *_0 c, \quad \text{etc.}$$

Another possible issue is that it might not be possible to compose the generators of the diagram at all. Such problem is exhibited by non-connected diagrams, like (3.2). Another example is given by the diagram

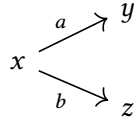

where the “fork” prevents the existence of an expression which composes all the generators of the diagram together. In dimension one, the absence of loops and forks, together with connectedness and finiteness, completely characterize pasting diagrams: they are the diagrams of the form

$$x_0 \xrightarrow{a_1} x_1 \xrightarrow{a_2} x_2 \xrightarrow{a_3} \cdots \xrightarrow{a_n} x_n.$$

However, in higher dimensions, more subtle problems arise, making generalizations of the conditions for dimension one insufficient, and one hardly finds sets of conditions that correctly filter out all non-pasting diagrams.

The different pasting diagram formalisms that were introduced until now gave several proposals for such sets of conditions. The three main formalisms are Johnson’s *pasting schemes* [Joh89], Street’s *parity complexes* [Str91; Str94] and Steiner’s *augmented directed complexes* [Ste04]. Even though the ideas underlying the definitions of those formalisms are quite similar, they differ on many points and comparing them precisely is uneasy. In particular, each of the three formalisms has a specific notion of cell which represents a sub-pasting diagram. The most natural definition of cell is the one adopted by pasting schemes, where cells are simply sets of generators, and, for example, the pasting diagram (3.1) corresponds to the cell

$$\{u, v, w, x, y, a, b, c, d, e, f, g, h, \alpha, \beta, \gamma, \delta\}.$$

In the formalism of parity complexes, the cells are constituted of several sets that keep the generators organized by dimension and by status of source or target. For example, the pasting diagram (3.1) is represented by the cell consisting of five sets

$$\begin{aligned} X_2 &= \{\alpha, \beta, \gamma, \delta\}, \\ X_{1,-} &= \{a, b, e, h\}, & X_{1,+} &= \{a, d, g, h\}, \\ X_{0,-} &= \{u\}, & X_{0,+} &= \{y\} \end{aligned}$$

where $X_{i,-}$ represents the i -source, $X_{i,+}$ the i -target, and X_2 the 2-dimensional part of the diagram. Finally, in the formalism of augmented directed complexes, the definition of cell is similar to the one of parity complexes, but the elements that appear in diagrams are seen there as generators of free abelian groups, so that a cell consists of elements of free groups instead of sets. For example, the pasting diagram (3.1) is represented there as the cell

$$\begin{aligned} X_2 &= \alpha + \beta + \gamma + \delta, \\ X_{1,-} &= a + b + e + h, & X_{1,+} &= a + d + g + h, \\ X_{0,-} &= u, & X_{0,+} &= y. \end{aligned}$$

The latter definition of cell, even though it is less natural at first, has the advantage of allowing the use of tools from group theory and linear algebra in the proofs.

To the best of our knowledge, no formal account of the differences between the above three formalisms was ever made. In particular, it was not known whether one of these formalisms is more expressive than another. In this chapter, we carry out the task of formally relating them. It turns out that the three notions are incomparable in terms of expressive power (each of the three allows a pasting diagram which is not allowed by others). In the process, it appeared that the formalisms of parity complexes and pasting schemes are flawed, in the sense that the sets of conditions provided by the two formalisms are inadequate to filter out all non-pasting diagrams, refuting the related freeness properties of these structures claimed in the respective articles [Str91; Joh89]. We illustrate this problem by giving an example of a diagram which is not a pasting diagram but still accepted by both formalisms.

This motivated the introduction of a new formalism, called *torsion-free complexes*, whose axiomatic corrects and generalizes the one of parity complexes, and which are able to encompass augmented directed complexes and fixed versions of parity complexes and pasting schemes. Moreover, the good properties of their axiomatic allows for an efficient computational implementation of torsion-free complexes, so that they can be used as part of a library for manipulating strict categories.

We shall mention several recent works related to pasting diagrams and their formalisms. In [Buc15], Buckley gave a mechanized Coq proof of several results of [Str91] but stops before handling the freeness property of parity complexes, so that the deficiency we point out in this chapter was missed. In [Cam16], Campbell isolates a common structure behind parity complexes and pasting schemes, called *parity structure*, and introduces another formalism with stronger axioms than the ones of parity complexes and pasting schemes, taking an opposite path from this chapter where we introduce a more general formalism. In [Ngu17], Nguyen studies *pre-polytopes with labeled structures* and shows that they induce a parity structure that satisfies a variant of Campbell's axioms that are enough to obtain another formalism for pasting diagrams.

Outline. This chapter is organized as follows. We first recall the definitions and the axioms of each of the existing formalisms: parity complexes (Section 3.1.2), pasting schemes (Section 3.1.3) and augmented directed complexes (Section 3.1.4). Then, by reusing the definitions used in parity complexes, we introduce the formalism of *torsion-free complexes* (Section 3.1.5). We provide general axioms for them (Paragraph 3.1.5.1) and also stronger ones that are more amenable to computations (Paragraph 3.1.5.5). We relate each of the four formalisms to the unifying notion of ω -hypergraph (Section 3.1.1), so that each formalism can be described as a class of ω -hypergraphs (the ones that satisfy the axioms of the formalism) together with a notion of cell (which represents a pasting diagram) and operations on these cells. We also discuss the counter-example to the freeness property of parity complexes and pasting schemes (Paragraph 3.1.2.13).

Then, we prove that torsion-free complexes satisfy the properties expected from a pasting diagram formalism. We first show that cells of a torsion-free complex have a structure of an ω -category by adapting the results of Street [Str91] (Section 3.2, *c.f.* Theorem 3.2.3.3), and then prove that this ω -category is the free ω -category on a canonical ω -polygraph associated with this torsion-free complex (Section 3.3, *c.f.* Corollary 3.3.3.5).

Next, we give other possible definitions of cells for torsion-free complexes (Section 3.4). Indeed, whereas we reused the definition of cells of parity complexes for torsion-free complexes, we show that the ω -category of cells can be equivalently obtained using other definitions for cells: *maximal-well-formed sets* (Theorem 3.4.1.24) and *closed-well-formed sets* (Theorem 3.4.1.27). The latter are similar to the cells of pasting schemes, and allow a more user-friendly approach of torsion-free complexes. We illustrate this by providing an extension of *cateq* which enables

to specify cells of free categories on polygraphs using closed-well-formed sets of torsion-free complexes (Paragraph 3.4.1.32), after characterizing when a polygraph can be represented by a torsion-free complex (Theorem 3.4.1.29).

Finally, we relate the torsion-free complexes to the three other formalisms (Section 3.4). We show that the parity complexes, pasting schemes (after fixing their common deficiency), and augmented directed complexes are special cases of torsion-free complexes (Theorem 3.4.2.3, Theorem 3.4.3.9 and Theorem 3.4.4.22). Those are the only embeddings that exist between the four formalisms and we provide counter-examples to the others (Section 3.4.5).

3.1 The formalisms of pasting diagrams

In this section, we introduce the definitions of the formalisms of pasting diagrams that we will consider in this chapter. We present them through the common perspective of ω -hypergraphs, that are structures which encode the information in diagrams of generators like (3.1). Then, the definition of each formalism roughly follows the same pattern. First, a definition for cells that represent pasting diagrams is introduced, together with an identity and composition operations that aim at equipping those cells with a structure of ω -category. Then, a class of ω -hypergraphs that are correctly handled by the considered formalism is defined by the mean of axioms or conditions.

We first introduce ω -hypergraphs (Section 3.1.1) and then recall the definitions of the three main existing formalisms for pasting diagrams: *parity complexes* (Section 3.1.2), *pasting schemes* (Section 3.1.3) and *augmented directed complexes* (Section 3.1.4). Then, we introduce the new formalism of *torsion-free complexes* that share the definitions of parity complexes but have different axioms on ω -hypergraphs (Section 3.1.5).

3.1.1 Hypergraphs

In this section, we introduce the structure of ω -hypergraph that we will use as a common basis in order to define the pasting diagram formalisms. This notion is essentially the same as the one of *parity structure* introduced by Campbell in [Cam16] when defining a new formalism whose instances are both parity complexes and pasting schemes. It is also similar to the notion of *oriented graded poset* that, in a related context, Hadzihasanovic used to define presentations of polygraphs [Had18].

3.1.1.1 – Definition. A *graded set* is a set P together with a partition

$$P = \bigsqcup_{n \in \mathbb{N}} P_n$$

the elements of P_n being of *dimension* n . An ω -hypergraph is a graded set P , the elements of dimension n being called *n-generators*, together with, for $n \in \mathbb{N}$ and for each generator $u \in P_{n+1}$, two finite subsets $u^-, u^+ \subseteq P_n$ called the *source* and *target* of u . Given a subset $U \subseteq P$ and $\epsilon \in \{-, +\}$, we write U^ϵ for

$$U^\epsilon = \bigcup_{u \in U} u^\epsilon.$$

Simple ω -hypergraphs can be represented graphically using *diagrams*, where 0-generators are represented by their names, and higher generators by arrows $\rightarrow, \Rightarrow, \Rrightarrow$, etc. that represent respectively 1-generators, 2-generators, 3-generators etc.

Example 3.1.1.2. The diagram



represents the ω -hypergraph P with

$$P_0 = \{x, y, y', z\}, \quad P_1 = \{a, b, c, d\}, \quad P_2 = \{\alpha\},$$

and $P_n = \emptyset$ for $n \geq 3$, sources and targets being

$$a^- = \{x\}, \quad a^+ = \{y\}, \quad \alpha^- = \{a, c\}, \quad \alpha^+ = \{b, d\},$$

and so on.

3.1.1.3 – Fork-freeness. Given an ω -hypergraph P and $n \in \mathbb{N}$, a subset $U \subseteq P_n$ is *fork-free* (also called *well-formed* in [Str91]) when:

- either $n = 0$ and $|U| = 1$,
- or $n > 0$ and for all $u, v \in U$ and $\epsilon \in \{-, +\}$, we have $u^\epsilon \cap v^\epsilon = \emptyset$.

For example, the subset $\{a, b\}$ of (3.3) is not fork-free since $a^- \cap b^- = \{x\}$, but $\{a, c\}$ is.

Remark 3.1.1.4. Note that the definition of fork-freeness depends on the intended dimension n . This subtlety is important in the case of the empty set: \emptyset is not well-formed as a subset of P_0 but it is as a subset of P_n when $n > 0$.

3.1.1.5 – The relation \triangleleft . Given an ω -hypergraph P , $n \in \mathbb{N}^*$ and $U \subseteq P_n$, for $u, v \in U$, we write $u \triangleleft_U^1 v$ when $u^+ \cap v^- \neq \emptyset$ and we define the relation \triangleleft_U on U as the transitive closure of \triangleleft_U^1 . Given subsets $V, W \subseteq U$, we write $V \triangleleft_U W$ when there exist $u \in V$ and $v \in W$ such that $u \triangleleft_U v$. We define the relation \triangleleft on P by putting $u \triangleleft v$ when there exists $n \in \mathbb{N}^*$ such that $u, v \in P_n$ and $u \triangleleft_{P_n} v$. The ω -hypergraph P is then said *acyclic* when \triangleleft is irreflexive.

Example 3.1.1.6. The ω -hypergraph represented by



is not acyclic since $a \triangleleft b \triangleleft a$. On the contrary, the ω -hypergraph represented by (3.1) is acyclic.

Given a subset $V \subseteq U$, we say that V is a *segment* for \triangleleft_U when for all $u_1, u_2, u_3 \in U$ such that

$$u_1, u_3 \in V \quad \text{and} \quad u_1 \triangleleft_U u_2 \triangleleft_U u_3,$$

it holds that $u_2 \in V$. For $V \subseteq U$, we say that V is *initial* (resp. *terminal*) in U when, for all $u \in U$, if there exists $v \in V$ such that $u \triangleleft_U v$ (resp. $v \triangleleft_U u$), then $u \in V$.

Remark 3.1.1.7. In [Str91], \triangleleft is defined as a transitive and reflexive relation whereas in [Joh89], it is only defined as a transitive relation. Here, we prefer the transitive (and not reflexive) definition, since it carries more information than the transitive and reflexive definition.

3.1.1.8 – Other source and target operations. Given an ω -hypergraph P , for $n \geq 2$, $u \in P_n$ and $\epsilon, \eta \in \{-, +\}$, we write $u^{\epsilon\eta}$ for $(u^\epsilon)^\eta$. We extend the notation to subsets $U \subseteq P_n$ and write $U^{\epsilon\eta}$ for $(U^\epsilon)^\eta$. Moreover, we write u^\mp and u^\pm for

$$u^\mp = u^- \setminus u^+ \quad \text{and} \quad u^\pm = u^+ \setminus u^-.$$

We also extend the notation to subsets $U \subseteq P_n$ and write U^\mp and U^\pm for

$$U^\mp = U^- \setminus U^+ \quad \text{and} \quad U^\pm = U^+ \setminus U^-.$$

Example 3.1.1.9. Consider the ω -hypergraph represented by the diagram

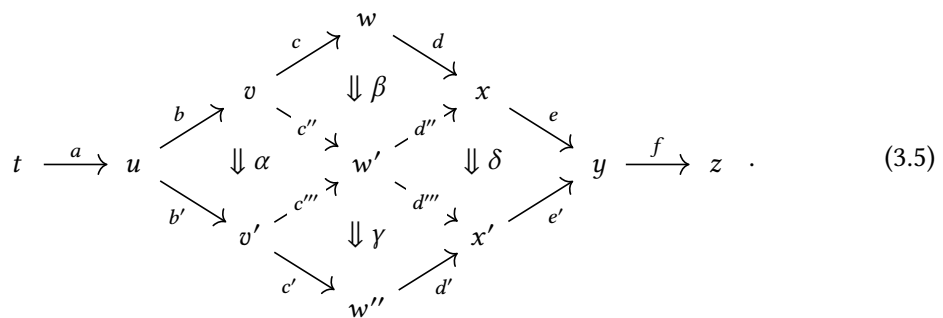

For this ω -hypergraph, we have

$$\alpha^{--} = \{u, v\}, \quad \alpha^{+-} = \{u, v'\}, \quad \alpha^{-\mp} = \{u\}, \quad \alpha^{+\pm} = \{w'\}$$

and, writing U for the set $\{a, b, c, d, e, f\}$,

$$\begin{aligned} U^- &= \{t, u, v, w, x, y\}, & U^+ &= \{u, v, w, x, y, z\}, \\ U^\mp &= \{t\}, & U^\pm &= \{z\} \end{aligned}$$

and, writing V for the set $\{\alpha, \beta, \gamma, \delta\}$,

$$\begin{aligned} V^- &= \{b, c, c'', c''', d, d'', d''', e\}, & V^+ &= \{b', c', c'', c''', d', d'', d''', e'\}, \\ V^\mp &= \{b, c, d, e\}, & V^\pm &= \{b', c', d', e'\}. \end{aligned}$$

From the above examples, one can intuitively describe the operations $(-)^-$ and $(-)^+$ as computing the “inner” sources and targets of a set of generators, whereas the operations $(-)^{\mp}$ and $(-)^{\pm}$ compute the source and target “borders” of a set of generators.

3.1.2 Parity complexes

In this subsection, we recall the formalism of parity complexes developed by Street in [Str91]. Most of the content will be reused when defining torsion-free complexes. The idea behind the formalism is to represent an $(n+1)$ -cell as a pair of source and target n -cells together with a subset of P_{n+1} which “moves” the source n -cell to the target n -cell. Under the axioms of parity complexes, these cells will have a structure of ω -category.

3.1.2.1 – Pre-cells. Let P be an ω -hypergraph. For $n \in \mathbb{N}$, an n -pre-cell of P is a tuple

$$X = (X_{0,-}, X_{0,+}, \dots, X_{n-1,-}, X_{n-1,+}, X_n)$$

of finite subsets of P , such that $X_{i,\epsilon} \subseteq P_i$ for $i \in \mathbb{N}_{n-1}$ and $\epsilon \in \{-, +\}$, and $X_n \subseteq P_n$. By convention, we often denote X_n by $X_{n,-}$ or $X_{n,+}$. We write $\text{PCell}(P)$ for the graded set of pre-cells of P .

Given $n \in \mathbb{N}$, $\epsilon \in \{-, +\}$ and an $(n+1)$ -pre-cell X of P , we define the n -pre-cell $\partial_n^\epsilon(X)$ as

$$\partial_n^\epsilon(X) = (X_{0,-}, X_{0,+}, \dots, X_{n-1,-}, X_{n-1,+}, X_{n,\epsilon}).$$

The globular conditions $\partial_n^\epsilon \circ \partial_{n+1}^- = \partial_n^\epsilon \circ \partial_{n+1}^+$ are then trivially satisfied, so that the functions ∂^-, ∂^+ equip $\text{PCell}(P)$ with a structure of an ω -globular set.

3.1.2.2 – Movement and orthogonality. Let P be an ω -hypergraph. Given $n \in \mathbb{N}$ and finite sets

$$M \subseteq P_{n+1}, \quad U \subseteq P_n \quad \text{and} \quad V \subseteq P_n,$$

we say that M moves U to V when

$$U = (V \cup M^-) \setminus M^+ \quad \text{and} \quad V = (U \cup M^+) \setminus M^-.$$

Intuitively, the first equation means that U is the subset obtained from V by replacing the target of M by its source, and the second equation has a dual meaning.

Example 3.1.2.3. In the ω -hypergraph (3.5), the set $\{\alpha, \beta, \gamma, \delta\}$ moves the set $\{a, b, c, d, e, f\}$ to the set $\{a, b', c', d', e', f\}$.

3.1.2.4 – Cells. Let P be an ω -hypergraph. Given $n \in \mathbb{N}$, an n -cell of P is an n -pre-cell of P , such that

- (i) $X_{i+1,\epsilon}$ moves $X_{i,-}$ to $X_{i,+}$ for $i \in \mathbb{N}_{n-1}$ and $\epsilon \in \{-, +\}$,
- (ii) $X_{i,\epsilon}$ is fork-free for $i \in \mathbb{N}_n$ and $\epsilon \in \{-, +\}$.

We denote by $\text{Cell}(P)$ the graded set of cells of P , which inherits the structure of globular set from $\text{PCell}(P)$. An n -cell X can be represented as on Figure 3.1 where each arrow

$$U \xrightarrow{M} V$$

means that M moves U to V .

Example 3.1.2.5. The ω -hypergraph represented by (3.5) has, among others,

- a 0-cell ($\{t\}$),
- a 1-cell ($\{t\}, \{w'\}, \{a, b, c''\}, \{a, b, c'''\}, \{\alpha\}$),
- a 2-cell ($\{t\}, \{z\}, \{a, b, c, d, e, f\}, \{a, b', c', d', e', f\}, \{\alpha, \beta, \gamma, \delta\}$), etc.

Remark 3.1.2.6. In [Str91], cells are defined as pairs (M, N) with $M, N \subseteq P$ satisfying conditions similar to the fork-freeness and movement conditions. This definition is equivalent to the above one: given an n -cell (in the sense of Street) (M, N) , one obtains an n -cell X (in our sense), by setting $X_n = M_n$ and, for $i \in \mathbb{N}_{n-1}$, $X_{i,-} = M_i$ and $X_{i,+} = N_i$, and an inverse translation is defined easily.

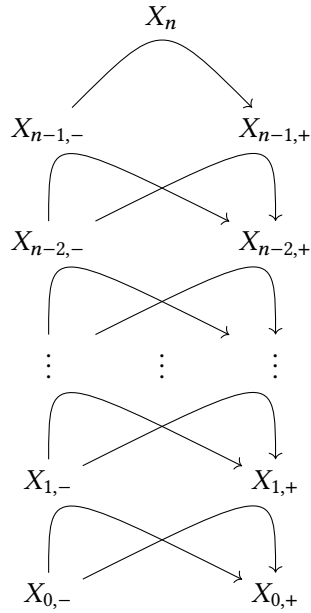

Figure 3.1 – Movements in a cell

3.1.2.7 – Identity and composition of operations. Let P be an ω -hypergraph. Given $n \in \mathbb{N}$ and an n -cell X , the *identity of X* is the $(n+1)$ -cell

$$\text{id}^{n+1}(X) = (X_{0,-}, X_{0,+}, \dots, X_{n-1,-}, X_{n-1,+}, X_n, X_n, \emptyset).$$

Given $i, n \in \mathbb{N}$ with $i < n$, and i -composable n -cells $X, Y \in \text{Cell}(P)_n$, the i -composition $X *_i Y$ of X and Y is defined as the n -pre-cell Z such that, for $j \in \mathbb{N}_n$ and $\epsilon \in \{-, +\}$,

$$Z_{j,\epsilon} = \begin{cases} X_{j,\epsilon} & \text{if } j < i, \\ X_{i,-} & \text{if } j = i \text{ and } \epsilon = -, \\ Y_{i,+} & \text{if } j = i \text{ and } \epsilon = +, \\ X_{j,\epsilon} \cup Y_{j,\epsilon} & \text{if } j > i. \end{cases}$$

It will be shown in Section 3.2 that, under suitable assumptions, the composite of two n -cells is actually an n -cell.

3.1.2.8 – Atoms and relevance. Let P be an ω -hypergraph. Given $n \in \mathbb{N}$ and $u \in P_n$, we define sets $\langle u \rangle_{i,\epsilon} \subseteq P_i$ for $i \in \mathbb{N}_n$ and $\epsilon \in \{-, +\}$ with a downward induction by

$$\langle u \rangle_{n,-} = \langle u \rangle_{n,+} = \{u\}$$

and

$$\langle u \rangle_{j,-} = \langle u \rangle_{j+1,-}^{\mp} \quad \langle u \rangle_{j,+} = \langle u \rangle_{j+1,+}^{\pm}$$

for $j \in \mathbb{N}_{n-1}$. We often write $\langle u \rangle_n$ for both $\langle u \rangle_{n,-}$ and $\langle u \rangle_{n,+}$. The *atom associated to u* is then the n -pre-cell of P

$$\langle u \rangle = (\langle u \rangle_{0,-}, \langle u \rangle_{0,+}, \dots, \langle u \rangle_{n-1,-}, \langle u \rangle_{n-1,+}, \langle u \rangle_n).$$

A generator u is said *relevant* when the atom $\langle u \rangle$ is a cell. When P is a parity complex, the relevant generators of P will have the role of generating cells in the ω -category $\text{Cell}(P)$.

Example 3.1.2.9. The atom associated to α in (3.3) is $\langle \alpha \rangle$ with

$$\begin{aligned} \langle \alpha \rangle_{0,-} &= \{u\}, & \langle \alpha \rangle_{1,-} &= \{a, c\}, & \langle \alpha \rangle_2 &= \{\alpha\}, \\ \langle \alpha \rangle_{0,+} &= \{z\}, & \langle \alpha \rangle_{1,+} &= \{b, d\}, & & \end{aligned}$$

and, since it is a cell, α is relevant.

3.1.2.10 – Tightness. Some defects were found in the first definition of parity complexes given in [Str91], so that Street fixed his definition in [Str94]. His correction involves the notion of tightness defined as follows. Given $n \in \mathbb{N}$, a subset $U \subseteq P_n$ is said to be *tight* when, for all $u, v \in P_n$ such that $u \triangleleft v$ and $v \in U$, we have $u^- \cap U^\pm = \emptyset$.

Example 3.1.2.11. In (3.5), $U = \{\beta, \gamma\}$ is not tight since $\alpha \triangleleft \gamma$ and $c'' \in \alpha^- \cap U^\pm$. However, the set $U' = \{\alpha, \beta, \gamma, \delta\}$ is tight.

3.1.2.12 – Parity complexes. We can now state the definition of a parity complex, reformulating the one given in [Str91] by taking into account the corrections introduced in [Str94]. A *parity complex* is an ω -hypergraph P satisfying the axioms (C0) to (C5) below:

- (C0) for $n \in \mathbb{N}^*$ and $u \in P_n$, $u^- \neq \emptyset$ and $u^+ \neq \emptyset$;
- (C1) for $n \in \mathbb{N}$ with $n \geq 2$ and $u \in P_n$, $u^{--} \cup u^{++} = u^{-+} \cup u^{+-}$;
- (C2) for $n \in \mathbb{N}^*$ and $u \in P_n$, u^- and u^+ are fork-free;
- (C3) P is acyclic;
- (C4) for $n \in \mathbb{N}^*$, $u, v \in P_n$, $w \in P_{n+1}$, if $u \triangleleft v$, $u \in w^\epsilon$ and $v \in w^\eta$ for some $\epsilon, \eta \in \{-, +\}$, then $\epsilon = \eta$;
- (C5) for $i, n \in \mathbb{N}$ with $i < n$ and $u \in P_n$, $\langle u \rangle_{i,-}$ is tight.

Axiom (C0) ensures that each generator has defined source and target. Axiom (C1) enforces basic globular properties on generators. For example, it forbids the ω -hypergraph

$$\begin{array}{ccccc} & & a & & \\ & & \curvearrowright & & \\ w & & & & z \\ & & \Downarrow \alpha & & \\ & x & & y & \\ & & \curvearrowleft & & \\ & & b & & \end{array} \quad (3.6)$$

since $\alpha^{--} \cup \alpha^{++} = \{w, y\}$ and $\alpha^{+-} \cup \alpha^{-+} = \{x, z\}$. Axiom (C2) forbids generators with parallel elements in their sources or targets. For example, the ω -hypergraph

$$\begin{array}{ccc} x & \xrightarrow{a} & z \\ y & & \end{array} \quad (3.7)$$

does not satisfy Axiom (C2) since $a^- = \{x, y\}$ is not fork-free. Axiom (C3) forbids ω -hypergraphs with some loops like (3.4). Axiom (C4) can be informally described as forbidding “bridges”. For instance, the ω -hypergraph

$$\begin{array}{ccccc} & & y & & \\ & & \swarrow & & \\ & & a & & \\ x & & & & z \\ & & \Downarrow \alpha & & \\ & & a' & & \\ & & \searrow & & \\ & & y' & & \end{array} \quad (3.8)$$

does not satisfy Axiom (C4). Indeed, $a \triangleleft c \triangleleft b'$ and $a \in \alpha^-$ and $b' \in \alpha^+$. Axiom (C5) prevents more subtle problems, like the one exposed by (3.13) discussed in Paragraph 3.1.5.3 (even though (3.13) does not satisfy Axiom (C3) in the first place). It entails that the sources and targets of each generator are segments (as defined in Paragraph 3.1.1.5), which is a condition that we will motivate in Paragraph 3.1.5.3 when discussing Axiom (T3) of torsion-free complexes.

3.1.2.13 – A counter-example to the freeness property. Given a parity complex P , the main result claimed in [Str91] is that the globular set $\text{Cell}(P)$ together with the source, target, identity and composition operations, has the structure of an ω -category, which is freely generated by the atoms $\langle u \rangle$ for $u \in P$ ([Str91, Theorem 4.2]). More precisely, this result states that there is an ω -polygraph Q and an ω -functor $F: Q^* \rightarrow \text{Cell}(P)$ such that

- $Q_k = P_k$ for $k \in \mathbb{N}$,
- $F(u) = \langle u \rangle$ for $u \in Q$,
- F is an isomorphism.

Intuitively, this property says that parity complexes are adequate structures for representing pasting diagrams, since then a cell X of $\text{Cell}(P)$ corresponds to a unique class of expressions that compose together the generators which appear in X by Proposition 1.4.1.16. However, this property does not hold as we illustrate with a counter-example.

Consider the ω -hypergraph P defined by the diagram given by

$$\begin{array}{ccc}
 & a & d \\
 \begin{array}{c} \alpha \Downarrow \Downarrow \alpha' \\ \beta \Downarrow \Downarrow \beta' \end{array} & \begin{array}{c} \gamma \Downarrow \Downarrow \gamma' \\ \delta \Downarrow \Downarrow \delta' \end{array} & \\
 x \xrightarrow{b} y & \xrightarrow{e} z & \\
 \begin{array}{c} \curvearrowright \\ c \end{array} & \begin{array}{c} \curvearrowright \\ f \end{array} &
 \end{array} \tag{3.9}$$

together with two 3-generators

$$\begin{array}{ccc}
 \begin{array}{c} a \\ \Downarrow \alpha \\ x \xrightarrow{b} y \xrightarrow{e} z \\ \Downarrow \delta \\ \curvearrowright \\ f \end{array} & \stackrel{A}{\cong} & \begin{array}{c} a \\ \Downarrow \alpha' \\ x \xrightarrow{b} y \xrightarrow{e} z \\ \Downarrow \delta' \\ \curvearrowright \\ f \end{array} , \\
 \begin{array}{c} d \\ \Downarrow \gamma \\ x \xrightarrow{b} y \xrightarrow{e} z \\ \Downarrow \beta \\ \curvearrowright \\ c \end{array} & \stackrel{B}{\cong} & \begin{array}{c} d \\ \Downarrow \gamma' \\ x \xrightarrow{b} y \xrightarrow{e} z \\ \Downarrow \beta' \\ \curvearrowright \\ c \end{array} .
 \end{array}$$

By carefully checking Axioms (C0) to (C5), it can be shown that P is a parity complex. The diagram (3.9) moreover defines a polygraph Q , whose induced ω -category Q^* is supposed to be isomorphic to $\text{Cell}(P)$, as a consequence of [Str91, Theorem 4.2], but it is not the case here. Indeed, we can find two expressions that compose together the 3-generators A and B in Q^* , inducing two 3-cells H_1 and H_2 with

$$H_1 = ((a \bullet_0 \gamma) \bullet_1 A \bullet_1 (\beta \bullet_0 f)) \bullet_2 ((\alpha' \bullet_0 d) \bullet_1 B \bullet_1 (c \bullet_0 \delta'))$$

and

$$H_2 = ((\alpha \bullet_0 d) \bullet_1 B \bullet_1 (c \bullet_0 \delta)) \bullet_2 ((a \bullet_0 \gamma') \bullet_1 A \bullet_1 (\beta' \bullet_0 f))$$

that share the same source and target

$$\begin{array}{c} \partial_2^-(H_1) = \partial_2^-(H_2) = x \begin{array}{ccc} \begin{array}{c} \xrightarrow{a} \\ \Downarrow \alpha \\ \xrightarrow{b} \\ \Downarrow \beta \\ \xrightarrow{c} \end{array} & y & \begin{array}{c} \xrightarrow{d} \\ \Downarrow \gamma \\ \xrightarrow{e} \\ \Downarrow \delta \\ \xrightarrow{f} \end{array} \\ \end{array} \\ \\ \partial_2^+(H_1) = \partial_2^+(H_2) = x \begin{array}{ccc} \begin{array}{c} \xrightarrow{a} \\ \Downarrow \alpha' \\ \xrightarrow{b} \\ \Downarrow \beta' \\ \xrightarrow{c} \end{array} & y & \begin{array}{c} \xrightarrow{d} \\ \Downarrow \gamma' \\ \xrightarrow{e} \\ \Downarrow \delta' \\ \xrightarrow{f} \end{array} \\ \end{array} . \end{array}$$

Note that we used a precategory syntax for H_1 and H_2 in order to avoid putting too many id^3 so that we get more readable expressions. The canonical morphism $F: \mathcal{Q}^* \rightarrow \text{Cell}(P)$ maps H_1 and H_2 to the same 3-cell X defined by:

$$\begin{aligned} X_3 &= \{A, B\}, \\ X_{2,-} &= \{\alpha, \beta, \gamma, \delta\}, & X_{2,+} &= \{\alpha', \beta', \gamma', \delta'\}, \\ X_{1,-} &= \{a, d\}, & X_{1,+} &= \{c, f\}, \\ X_{0,-} &= \{x\}, & X_{0,+} &= \{z\}. \end{aligned}$$

However, H_1 and H_2 are different cells in \mathcal{Q}^* . Let's verify this fact with `cateq` (c.f. Section 2.4.4). First, we define the polygraph \mathcal{Q} and the cells H_1 and H_2 in `cateq`:

```
# x,y,z := gen *
# a,b,c := gen x -> y
# d,e,f := gen y -> z
# alpha,alpha' := gen a -> b
# beta,beta' := gen b -> c
# gamma,gamma' := gen d -> e
# delta,delta' := gen e -> f
# A := gen alpha *0 delta -> alpha' *0 delta'
# B := gen beta *0 gamma -> beta' *0 gamma'
# H1 := ((id3 a *0 id3 gamma) *1 A *1 (id3 beta *0 id3 f))
#       *2 ((id3 alpha' *0 id3 d) *1 B *1 (id3 c *0 id3 delta'))
# H2 := ((id3 alpha *0 id3 d) *1 B *1 (id3 c *0 id3 delta))
#       *2 ((id3 a *0 id3 gamma') *1 A *1 (id3 beta' *0 id3 f))
```

We then query whether H_1 is equal to H_2 with the command

```
# H1 = H2
```

to which `cateq` answers `false`, so that $H_1 \neq H_2$ by Proposition 2.4.2.14 (before `cateq` was implemented, a proof in Agda that $H_1 \neq H_2$ was given in [FM19]).

Hence, the distinct cells H_1 and H_2 of \mathcal{Q}^* are sent to the same cell of $\text{Cell}(P)$ by F as one could have expected, since the information that makes H_1 and H_2 different is the order in which A

and B are composed, which can not be expressed by a cell of a parity complex. This refutes [Str91, Theorem 4.2] which asserts that F is an isomorphism. Thus, parity complexes do not necessarily induce free ω -categories in general.

3.1.3 Pasting schemes

Johnson's loop-free pasting schemes [Joh89] is another proposed formalism for pasting diagrams. Like parity complexes, they are based on ω -hypergraphs, but the cells will now be represented as single subsets of generators instead of tuples like for parity complexes (which is arguably a more natural representation of pasting diagrams compared to the cells of parity complexes). As a consequence, one will rely on set relations, namely B and E , on the ω -hypergraph to define the globular operations on the cells. Concretely, B and E encode which generators to remove to obtain respectively the target and the source of a cell. We introduce the formalism in detail below.

3.1.3.1 – Conventions for relations. First, we set some elementary definitions and notations for relations. A *relation between two sets X and Y* is a subset $L \subseteq X \times Y$. For $(x, y) \in X \times Y$, we write $x L y$ when $(x, y) \in L$. The *identity relation on a set X* is the relation $L \subseteq X \times X$ such that $x L y$ iff $x = y$. Given a binary relation L between X and Y , and $x \in X$, we write $L(x)$ for the set

$$L(x) = \{y \in Y \mid x L y\}.$$

More generally, given a subset $X' \subseteq X$, we denote by $L(X')$ the set

$$\{y \in Y \mid \exists x \in X', x L y\}.$$

The relation L is said *finitary* when, for all $x \in X$, $L(x)$ is a finite set. If L is a relation on a graded set $P = \sqcup_{n \in \mathbb{N}} P_n$, given $k, l \in \mathbb{N}$, we write L_k^l for the relation between P_l and P_k defined as $L \cap (P_l \times P_k)$. Similarly, we write L^l for the relation between P_l and P defined as $L \cap (P_l \times P)$.

Given relations L between X and Y and L' between Y and Z , we write LL' for the relation between X and Z which is the composite relation defined as

$$LL' = \{(x, z) \in X \times Z \mid \exists y \in Y, x L y \text{ and } y L' z\}.$$

3.1.3.2 – Pre-pasting schemes. A *pre-pasting scheme* (P, B, E) is given by a graded set P and two relations B, E (for “beginning” and “end”) on P such that

- (i) B and E are finitary,
- (ii) for $k, l \in \mathbb{N}$ with $l < k$, $B_k^l = E_k^l = \emptyset$,
- (iii) B_k^k (resp. E_k^k) is the identity relation on P_k ,
- (iv) for $k, l \in \mathbb{N}$ with $k < l$, $L \in \{B, E\}$, $u \in P_{l+1}$ and $v \in P_k$, $u L_k^{l+1} v$ if and only if

$$u L_l^{l+1} B_k^l v \quad \text{and} \quad u L_l^{l+1} E_k^l v.$$

Example 3.1.3.3. The diagram (3.3) can be encoded as a pre-pasting scheme

$$\begin{array}{ll} B_1^2(\alpha) = \{a, c\}, & E_1^2(\alpha) = \{b, d\}, \\ B_0^2(\alpha) = \{y\}, & E_0^2(\alpha) = \{y'\}, \\ B_0^1(a) = \{x\}, & E_0^1(a) = \{y\} \dots \end{array}$$

Note that the relations B and E of a pre-pasting scheme P are completely determined by the data of $B_k^{k+1}(u)$ and $E_k^{k+1}(u)$ for $k \in \mathbb{N}$ and $u \in P_k$. As a consequence, the data of a pre-pasting scheme structure on P is equivalent to the data of an ω -hypergraph structure on P : the correspondence is given by

$$u^- = B_k^{k+1}(u) \quad \text{and} \quad u^+ = E_k^{k+1}(u)$$

for $k \in \mathbb{N}^*$ and $u \in P_{k+1}$. In particular, the relation \triangleleft on a pasting scheme is defined as the one on the associated ω -hypergraph.

3.1.3.4 – Direct loops. Given an ω -hypergraph P , P has a direct loop when

- (i) either there exist $n \in \mathbb{N}^*$ and $u, v \in P_n$ such that $u \triangleleft v$ and $E(v) \cap B(u) \neq \emptyset$,
- (ii) or there exists $w \in P$ such that $E(w) \cap B(w) \neq \{w\}$.

Example 3.1.3.5. The ω -hypergraph



has a direct loop by the first criterion, because $\alpha \triangleleft \beta$ and $y \in B(\alpha) \cap E(\beta)$. Examples of direct loops by the second condition are given by the ω -hypergraphs

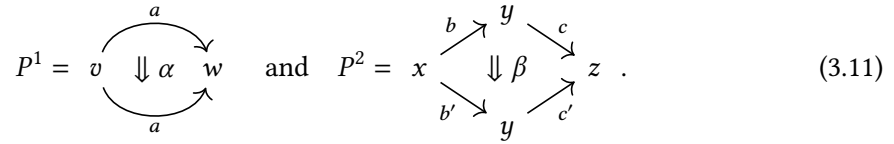

Indeed, in P^1 , we have $a \in B(\alpha) \cap E(\alpha)$, and, in P^2 , we have $y \in B(\beta) \cap E(\beta)$.

3.1.3.6 – Finite graded subsets. Let P be a pre-pasting scheme. We define the relation $R \subseteq P \times P$ as the smallest reflexive transitive relation on P such that, for all $k \in \mathbb{N}$ and $x \in P_{k+1}$, we have

$$B(x) \cup E(x) \subseteq R(x).$$

Example 3.1.3.7. In the case of the ω -hypergraph (3.10), we have

$$R(\alpha) = \{x, y, z, a_1, a_2, b, \alpha\} \quad \text{and} \quad R(\beta) = \{x, y, z, b, c_1, c_2, \beta\}.$$

A *finite graded subset of dimension n* of P (abbreviated *n -fgs*) is an $(n+1)$ -tuple $X = (X_0, \dots, X_n)$ such that $X_k \subseteq P_k$ and X_k is finite for $k \in \mathbb{N}_n$. We often identify the n -fgs X with the set $\cup_{k \in \mathbb{N}_n} X_k$, but one should keep in mind that the n -fgs X and the $(n+1)$ -fgs $(X_0, \dots, X_n, \emptyset)$ are two different objects. We say that X is *closed* when $R(X) = X$. Given $n \in \mathbb{N}$ and an $(n+1)$ -fgs X of P , we define the *source* and the *target* of X as the n -fgs's $\partial_n^-(X)$ and $\partial_n^+(X)$ of P such that

$$\partial_n^-(X) = X \setminus E^n(X) \quad \text{and} \quad \partial_n^+(X) = X \setminus B^n(X).$$

Example 3.1.3.8. Considering the ω -hypergraph (3.10), we have

$$\partial_n^-(R(\alpha)) = R(\alpha) \setminus \{b, \alpha\} = \{x, y, z, a_1, a_2\} \quad \text{and} \quad \partial_n^+(R(\alpha)) = R(\alpha) \setminus \{y, a_1, a_2\} = \{x, z, b\}.$$

Remark 3.1.3.9. The fgs's of the form $R(u)$ for $u \in P$ are the analogue of the atoms defined for parity complexes.

3.1.3.10 – Well-formed sets. Given a pre-pasting scheme P , we define by induction on n the notion of *well-formed n -fgs* (abbreviated *n -wfs*): given $n \in \mathbb{N}$, an n -fgs X of P is *well-formed* when

- (i) X is closed,
- (ii) X_n is fork-free,
- (iii) when $n > 0$, $\partial_n^-(X)$ and $\partial_n^+(X)$ are well-formed $(n-1)$ -fgs.

We denote by $\text{WF}(P)$ the graded set of n -wfs's of P for $n \in \mathbb{N}$. By [Joh89, Theorem 3], for $n \in \mathbb{N}$, the operations ∂_n^- and ∂_n^+ on $(n+1)$ -fgs's restrict to functions

$$\partial_n^-: \text{WF}(P)_{n+1} \rightarrow \text{WF}(P)_n \quad \text{and} \quad \partial_n^+: \text{WF}(P)_{n+1} \rightarrow \text{WF}(P)_n$$

and they equip $\text{WF}(P)$ with a structure of ω -globular set. In the following, the wfs's will be the “cells” of the pasting diagram formalism of pasting schemes.

Example 3.1.3.11. The pre-pasting scheme

$$\begin{array}{ccccc}
 & & y_1 & & \\
 & a_1 \nearrow & \Downarrow \alpha & \searrow a_2 & \\
 x & \xrightarrow{b} & & \xrightarrow{c} & z \\
 & c_1 \searrow & \Downarrow \beta & \nearrow c_2 & \\
 & & y_2 & &
 \end{array} \tag{3.12}$$

has, among others,

- the 0-wfs $\{x\}$ and $\{z\}$,
- the 1-wfs $\{x, y_1, z, a_1, a_2\}$ and $\{x, y_2, z, c_1, c_2\}$,
- the 2-wfs $\{x, y_1, y_2, z, a_1, a_2, b, c_1, c_2, \alpha, \beta\}$.

3.1.3.12 – Identity and composition operations. We can introduce identity and composition operations like we did for the cells of parity complexes. Let P be a pre-pasting scheme. Given $n \in \mathbb{N}$ and an n -wfs $X = (X_0, \dots, X_n)$ of P , the *identity of X* is the $(n+1)$ -wfs $\text{id}^{n+1}(X)$ defined by

$$\text{id}^{n+1}(X) = (X_0, \dots, X_n, \emptyset).$$

Given $i, n \in \mathbb{N}$ with $i < n$ and X, Y two n -wfs such that $\partial_i^+(X) = \partial_i^-(Y)$, the *i -composition of X and Y* is the n -fgs $X *_i Y$ such that

$$X *_i Y = X \cup Y.$$

Under the conditions of a pre-pasting scheme, it is not necessarily the case that the composite of two n -wfs's is an n -wfs, but it will under the axioms of a pasting scheme introduced below.

3.1.3.13 – Loop-free pasting schemes. We now state the full definition of loop-free pasting schemes, reformulating the one of [Joh89]. A *pasting scheme* is a pre-pasting scheme P satisfying the following two axioms:

- (S0) for $k \in \mathbb{N}$ and $u \in P_{k+1}$, $B_k^{k+1}(u) \neq \emptyset$ and $E_k^{k+1}(u) \neq \emptyset$;
- (S1) for $k, l \in \mathbb{N}$ with $k \leq l$, $L \in \{B, E\}$, $u \in P_{l+1}$ and $v \in P_k$,
 - if $u E_l^{l+1} L_k^l v$ then $u E_k^{k+1} v$ or $u B_k^{k+1} L_k^l v$,

- if $u B_l^{l+1} L_k^l v$ then $u B_k^{l+1} v$ or $u E_l^{l+1} L_k^l v$.

The pasting scheme P is a *loop-free pasting scheme* when it moreover satisfies the following axioms:

- (S2) P has no direct loops;
- (S3) for $u \in P$, $R(u) \in \text{WF}(P)$;
- (S4) for $k, n \in \mathbb{N}$ with $k < n$, $X \in \text{WF}(P)_k$ and $u \in P_n$,
 - if $\partial_k^-(R(u)) \subseteq X$, then $\langle u \rangle_{k,-}$ is a segment for \triangleleft_{X_k} ,
 - if $\partial_k^+(R(u)) \subseteq X$, then $\langle u \rangle_{k,+}$ is a segment for \triangleleft_{X_k} ;
- (S5) for $n \in \mathbb{N}$, $X \in \text{WF}(P)_n$ and $u \in P_{n+1}$ with $\partial_n^-(R(u)) \subseteq X$, the following hold:
 - (a) $X \cap E(u) = \emptyset$,
 - (b) for $y \in X$, if $B(u) \cap R(y) \neq \emptyset$, then $y \in B(u)$.

Axiom (S1) enforces basic globular properties on generators and forbids, for example, the ω -hypergraph (3.6). Axiom (S2) forbids ω -hypergraphs with loops like (3.4), (3.10) and (3.11). Axiom (S3) enforces fork-freeness on the iterated sources and targets of a generator (for example, it forbids the ω -hypergraph (3.7)). Axiom (S4) relates to Axiom (C5) of parity complexes and prevent situations in the spirit of (3.13) discussed in Paragraph 3.1.5.3 (even though (3.13) does not satisfy Axiom (S2) in the first place). We motivate this axiom in Paragraph 3.1.5.3 when we discuss a similar axiom for torsion-free complexes. Axiom (S5) can be deduced from the other axioms (*c.f.* [Joh87, Theorem 3.7]) but it simplifies the proofs of [Joh89]. An example of a sensible pre-pasting scheme that satisfy Axioms (S0) to (S3), but neither Axiom (S4) nor Axiom (S5), exists in dimension four (see [Pow91, Example 3.11]).

3.1.3.14 – A counter-example to the freeness property. The main result claimed in [Joh89] is similar to the one of [Str91]: given a loop-free pasting scheme P , the globular set $\text{WF}(P)$ together with the source, target, identity and composition operations has the structure of an ω -category, which is freely generated by the wfs's $R(u)$ for $u \in P$ ([Joh89, Theorem 13]), *i.e.*, there exist an ω -polygraph Q and an ω -functor $F: Q^* \rightarrow \text{WF}(P)$ such that

- $Q_k = P_k$ for $k \in \mathbb{N}$,
- $F(u) = R(u)$ for $u \in Q$,
- F is an isomorphism.

But the same flaw as for parity complexes is present here too, which makes the freeness result wrong. In fact, the counter-example to the freeness property of parity complexes, introduced in Paragraph 3.1.2.13, is also a counter-example to the freeness property of pasting schemes: the ω -hypergraph P is a loop-free pasting scheme and the canonical morphism $F: Q^* \rightarrow \text{WF}(P)$ sends H_1 and H_2 to the same 3-wfs X where

$$X = \{x, y, z, \alpha, \beta, \gamma, \delta, \alpha', \beta', \gamma', \delta', A, B\}$$

refuting the freeness property [Joh89, Theorem 13].

3.1.4 Augmented directed complexes

Augmented directed complexes, designed by Steiner in [Ste04], are not directly based on ω -hypergraphs, but on chain complexes. Under the conditions required by Steiner, it happens that the data of a chain complex is equivalent to the data of an ω -hypergraph. The definition of cells for this formalism strongly resembles the one of parity complexes. The only difference is that the cells are tuples of group elements instead of subsets of an ω -hypergraph. We recall the formalism in detail below.

3.1.4.1 – Augmented directed complex. A *pre-augmented directed complex* (K, d, e) (abbreviated *pre-adc*) is the data of

- for $n \in \mathbb{N}$, an abelian group K_n together with a distinguished submonoid $K_n^* \subseteq K_n$,
- for $n \in \mathbb{N}$, group morphisms called *boundary operators*

$$d_n: K_{n+1} \rightarrow K_n,$$

- an *augmentation*, that is, a group morphism

$$e: K_0 \rightarrow \mathbb{Z}.$$

An *augmented directed complex*, abbreviated *adc*, is a pre-adc (K, d, e) such that

$$e \circ d_0 = 0 \quad \text{and} \quad d_n \circ d_{n+1} = 0 \quad \text{for } n \in \mathbb{N}.$$

3.1.4.2 – Bases for pre-adc's. Given a pre-adc (K, d, e) , a *basis* of (K, d, e) is the data of a graded set $P \subseteq \bigsqcup_{n \in \mathbb{N}} K_n$ such that each K_n^* is the free commutative monoid on P_n and each K_n is the free abelian group on K_n^* . Given a basis P of (K, d, e) , every element $u \in K_n$ can be uniquely written as

$$u = \sum_{g \in P_n} u_g g,$$

with $u_g \in \mathbb{Z}$ such that $u_g \neq 0$ for a finite number of $g \in P_n$. This representation induces a partial order \leq where, for $n \in \mathbb{N}$ and $u, v \in K_n$, $u \leq v$ when $u_g \leq v_g$ for all $g \in P_n$. Given $n \in \mathbb{N}$ and $u, v \in K_n$ we can define a *greatest lower bound* $u \wedge v$ of u and v by

$$u \wedge v = \sum_{g \in P_n} \min(u_g, v_g) g.$$

Given $n \in \mathbb{N}$ and $u \in K_{n+1}$, we write $u^\mp, u^\pm \in K_n^*$ for the unique elements satisfying

$$d_n(u) = u^\pm - u^\mp \quad \text{and} \quad u^\mp \wedge u^\pm = 0.$$

Moreover, we write u^-, u^+ for

$$u^- = \sum_{g \in P_{n+1}} u_g g^\mp \quad \text{and} \quad u^+ = \sum_{g \in P_{n+1}} u_g g^\pm.$$

Remark 3.1.4.3. The elements u^\mp and u^\pm are respectively denoted by $\partial^-(u)$ and $\partial^+(u)$ in [Ste04]. We adopt the former notation for consistency with those of Section 3.1.2.

3.1.4.4 – From ω -hypergraphs to pre-*adc*'s with basis. Given an ω -hypergraph P , we define the *pre- adc* (K, d, e) associated to P as follows. For $n \in \mathbb{N}$, K_n^* is defined as the free commutative monoid on P_n and K_n as the free abelian group on K_n^* . The augmentation $e: K_0 \rightarrow \mathbb{Z}$ is defined as the unique morphism such that $e(x) = 1$ for $x \in P_0$. Given $n \in \mathbb{N}$ and a finite subset $U \subseteq P_n$, we write $\Sigma_n(U)$ for $\sum_{u \in U} u \in K_n$. Then, $d_n: K_{n+1} \rightarrow K_n$ is defined as the unique morphism such that

$$d_n(u) = \Sigma_n(u^+) - \Sigma_n(u^-)$$

for $u \in P_{n+1}$. Then, K canonically admits P as a basis. We say that P is an *adc* when K is an *adc*.

Example 3.1.4.5. We explicitly describe the pre-*adc* associated to the ω -hypergraph (3.12) as follows. Writing S^* for the free commutative monoid on a set S , we put

$$K_0^* = \{x, y_1, y_2, z\}^*, \quad K_1^* = \{a_1, a_2, b, c_1, c_2\}^*, \quad K_2^* = \{\alpha, \beta\}^*$$

and $K_n^* = \{0\}$ for $n \geq 3$. K_0, K_1, K_2 and K_n for $n \geq 3$ are then the induced free abelian groups on these monoids. The operations e and d are defined by universal property to be the unique morphisms such that

$$e(x) = e(y_1) = e(y_2) = e(z) = 1$$

and

$$\begin{aligned} d_0(a_1) &= y_1 - x, & d_0(a_2) &= z - y_1, & d_0(b) &= z - x, \\ d_0(c_1) &= y_2 - x, & d_0(c_2) &= z - y_2, \\ d_1(\alpha) &= b - (a_1 + a_2), & d_1(\beta) &= (c_1 + c_2) - b. \end{aligned}$$

We can now give some examples for the operations $(-)^{\mp}$ and $(-)^{\pm}$ operations defined above:

$$\begin{aligned} (a_1 + a_2)^{\mp} &= x, & (a_1 + a_2)^{\pm} &= z, \\ (\alpha + \beta)^{\mp} &= a_1 + a_2, & (\alpha + \beta)^{\pm} &= c_1 + c_2. \end{aligned}$$

We moreover illustrate the operations $(-)^{-}$ and $(-)^{+}$:

$$\begin{aligned} (a_1 + a_2)^{-} &= x + y_1 & (a_1 + a_2)^{+} &= y_1 + z \\ (\alpha + \beta)^{-} &= a_1 + a_2 + b & (\alpha + \beta)^{+} &= b + c_1 + c_2. \end{aligned}$$

Thus, the operations $(-)^{\mp}$ and $(-)^{\pm}$ compute the source and target “borders” of an element of K_n , whereas the operations $(-)^{-}$ and $(-)^{+}$ compute the sum of the “inner” sources and targets of an element of K_n . They are the analogues of the operations defined for ω -hypergraph in Paragraph 3.1.1.8.

3.1.4.6 – Cells. Let K be a pre-*adc*. Given $n \in \mathbb{N}$, an *n-pre-cell* of K is given by an $(2n+1)$ -tuple

$$X = (X_{0,-}, X_{0,+}, \dots, X_{n-1,-}, X_{n-1,+}, X_n)$$

with $X_n \in K_n^*$ and $X_{i,-}, X_{i,+} \in K_i^*$ for $i \in \mathbb{N}_{n-1}$. For the sake of conciseness, we often refer to X_n by $X_{n,-}$ or $X_{n,+}$. We write $\text{PCell}^*(K)$ for the graded set of pre-cells of K . When $n > 0$, given $\epsilon \in \{-, +\}$, we define the *n-pre-cell* $\partial_n^\epsilon(X)$ as

$$\partial_n^\epsilon(X) = (X_{0,-}, X_{0,+}, \dots, X_{n-1,-}, X_{n-1,+}, X_{n,\epsilon}).$$

The globular conditions $\partial_n^\epsilon \circ \partial_{n+1}^- = \partial_n^\epsilon \circ \partial_{n+1}^+$ are then trivially satisfied and the functions ∂^-, ∂^+ equip $\text{PCell}^*(K)$ with a structure of ω -globular set.

Given $n \in \mathbb{N}$, an *n-cell* of K is an *n-pre-cell* X of K such that

$$(i) \text{ for } i \in \mathbb{N}_{n-1}, d_i(X_{i+1,-}) = d_i(X_{i+1,+}) = X_{i,+} - X_{i,-},$$

$$(ii) e(X_{0,-}) = e(X_{0,+}) = 1.$$

We denote by $\text{Cell}^*(K)$ the graded set of cells of K , which inherits the ω -globular structure from $\text{PCell}^*(K)$.

Remark 3.1.4.7. The condition (i) is analogous to the moving condition (i) of parity complex cells, and the condition (ii) is related to the fork-freeness condition (ii) of parity complex cells instantiated in dimension 0.

3.1.4.8 – Identity and composition operations. Let K be a pre- adc . We define the identity and composition operations that will equip $\text{Cell}^*(K)$ with a structure of ω -category. Given $n \in \mathbb{N}$ and an n -pre-cell X of K , we define the *identity of X* as the $(n+1)$ -pre-cell $\text{id}^{n+1}(X)$ of K such that

$$\text{id}^{n+1}(X) = (X_{0,-}, X_{0,+}, \dots, X_{n-1,-}, X_{n-1,+}, X_n, X_n, 0).$$

Given $i, n \in \mathbb{N}$ with $i < n$ and i -composable n -cells X, Y , we define the i -composition $X *_i Y$ of X and Y as the n -pre-cell Z such that, for $j \in \mathbb{N}_n$ and $\epsilon \in \{-, +\}$,

$$Z_{j,\epsilon} = \begin{cases} X_{j,\epsilon} + Y_{j,\epsilon} & \text{when } j > i, \\ X_{i,-} & \text{when } j = i \text{ and } \epsilon = -, \\ Y_{i,+} & \text{when } j = i \text{ and } \epsilon = +, \\ X_{j,\epsilon} \text{ (or equivalently } Y_{j,\epsilon}) & \text{when } j < i. \end{cases}$$

We then easily verify that $Z \in \text{Cell}^*(K)$.

3.1.4.9 – Atoms. Let K be a pre- adc equipped with a basis P . We define here the analogue for adc 's of the notion of atoms for parity complexes, that will have the role of generating cells in $\text{Cell}^*(K)$. Given $n \in \mathbb{N}$ and $u \in P_n$, we define $[u]_{i,\epsilon} \subseteq P_i$ for $i \in \mathbb{N}_n$ and $\epsilon \in \{-, +\}$ using a downward induction by

$$[u]_{n,-} = [u]_{n,+} = u$$

and

$$[u]_{j,-} = [u]_{j+1,-}^{\mp} \quad [u]_{j,+} = [u]_{j+1,+}^{\pm}$$

for $j \in \mathbb{N}_{n-1}$. For simplicity, we sometimes write $[u]_{n,-}$ or $[u]_{n,+}$ for $[u]_n$. The *atom associated to u* is then the n -pre-cell of K

$$[u] = ([u]_{0,-}, [u]_{0,+}, \dots, [u]_{n-1,-}, [u]_{n-1,+}, [u]_n).$$

Example 3.1.4.10. In the pre- adc associated to the ω -hypergraph (3.12), the atom $[\alpha]$ associated to α is defined by

$$\begin{aligned} [\alpha]_2 &= \alpha, \\ [\alpha]_{1,-} &= a_1 + a_2, & [\alpha]_{1,+} &= b, \\ [\alpha]_{0,-} &= x, & [\alpha]_{0,+} &= z. \end{aligned}$$

3.1.4.11 – Unital loop-free basis. Let K be a pre-adc equipped with a basis B . Given $i \in \mathbb{N}$, we define a relation $<_i$ on B as the smallest transitive relation such that, for $k, l \in \mathbb{N}$ with $i < \min(k, l)$, and $u \in B_k, v \in B_l$ with $[u]_{i,+} \wedge [v]_{i,-} \neq 0$, we have $u <_i v$. The basis B is then said

- *unital* when for all $u \in B$, $e([u]_{0,-}) = e([u]_{0,+}) = 1$,
- *loop-free* when, for all $i \in \mathbb{N}$, $<_i$ is irreflexive.

Example 3.1.4.12. Consider the pre-adc K with basis B derived from the hypergraph (3.4). The basis B is then unital but not loop-free since $a <_0 b <_0 a$. Now, consider the pre-adc with basis B derived from the hypergraph (3.7). The basis B is then not unital since $e([a]_{0,-}) = e(x + y) = 2$, but it is loop-free. Now consider the pre-adc K with basis B derived from the hypergraph (3.5). We have, among others, the relations

$$\begin{aligned} a <_0 b <_0 c <_0 d <_0 e <_0 f, \\ a <_0 \alpha <_0 \delta <_0 f, \\ \beta <_1 \alpha <_1 \gamma \quad \text{and} \quad \beta <_1 \delta <_1 \gamma. \end{aligned}$$

It can be verified that B is unital and loop-free.

3.1.4.13 – The freeness property. In [Ste04], the author shows that, given an adc K with a loop-free unital basis B , the globular set $\text{Cell}^*(K)$, together with identity and composition operations, has a structure of an ω -category which is freely generated by the atoms $[u]$ for $u \in B$, *i.e.*, there exist an ω -polygraph Q and an ω -functor $F: Q^* \rightarrow \text{Cell}^*(K)$ such that

- $Q_k = B_k$ for $k \in \mathbb{N}$,
- $F(u) = [u]$ for $u \in Q$,
- F is an isomorphism.

Contrary to parity complexes and pasting schemes, the pre-adc with basis associated to the ω -hypergraph (3.9) is not a loop-free adc. Indeed, it is an adc with unital basis, but the basis is not loop-free since $A <_1 B <_1 A$. Thus, augmented directed complexes are, to the best of our knowledge, the only formalism of pasting diagrams among the three that we have already introduced for which the freeness property holds.

3.1.5 Torsion-free complexes

In this section, we introduce *torsion-free complexes*. They are a new formalism for pasting diagrams based on parity complexes. More precisely, torsion-free complexes rely on the same notion of cell than parity complexes, but satisfy different axioms, namely the axioms (T0) to (T4) introduced in Paragraph 3.1.5.1. Whereas the axioms (T0) to (T2) were already present in [Str91], Axiom (T3) generalizes Axiom (C4) and Axiom (C5) of parity complexes, and can be thought as an equivalent of Axiom (S4) of pasting schemes. Axiom (T4) prevents diagrams with “torsion” as exhibited by the counter-example to the freeness property provided for parity complexes and pasting schemes (*c.f.* Paragraph 3.1.2.13). Under these new axioms, the category of cells (as defined in Section 3.1.2) is freely generated by the atoms, as proved in Section 3.3. The proofs will be the object of the following sections.

3.1.5.1 – Definitions. Here, we give the axiomatics of torsion-free complexes, after giving a concise reformulation of Axiom (S4), and introducing the notion of *torsion*, the consideration of which solves the issue of parity complexes and pasting schemes illustrated by the example given in Paragraph 3.1.2.13.

Let P be an ω -hypergraph. Given $k \in \mathbb{N}$ and $u \in P_k$, we say that u *satisfies the segment condition* when, for all $n \in \mathbb{N}_{k-1}$ and every n -cell X such that $\langle u \rangle_{n,-} \subseteq X_n$, it holds that both $\langle u \rangle_{n,-}$ and $\langle u \rangle_{n,+}$ are segments for \triangleleft_{X_n} .

Given $n, k, l \in \mathbb{N}$ with $0 < n < \min(k, l)$, $u \in P_k$, $v \in P_l$ and an n -cell X , u and v are said to be *in torsion with respect to X* when

$$\langle u \rangle_{n,+} \subseteq X_n, \quad \langle v \rangle_{n,-} \subseteq X_n, \quad \langle u \rangle_{n,+} \cap \langle v \rangle_{n,-} = \emptyset \quad \text{and} \quad \langle u \rangle_{n,+} \triangleleft_{X_n} \langle v \rangle_{n,-} \triangleleft_{X_n} \langle u \rangle_{n,+}.$$

We will give some intuition on these definitions in the following paragraphs after we gave the definition of torsion-free complexes. The ω -hypergraph P is then a *torsion-free complex* when it satisfies the following axioms:

- (T0) (non-emptiness) for all $u \in P$, $u^- \neq \emptyset$ and $u^+ \neq \emptyset$;
- (T1) (acyclicity) P is acyclic;
- (T2) (relevance) for all $u \in P$, u is relevant;
- (T3) (segment condition) for $u \in P$, u satisfies the segment condition;
- (T4) (torsion-freeness) for all $n, k, l \in \mathbb{N}^*$ with $n < \min(k, l)$, $u \in P_k$, $v \in P_l$ and every n -cell X , u and v are not in torsion with respect to X .

We shall now give some intuition about these axioms.

3.1.5.2 – Axioms (T1) and (T2). Axiom (T1) enforces the same notion of acyclicity than for parity complexes, forbidding loops like

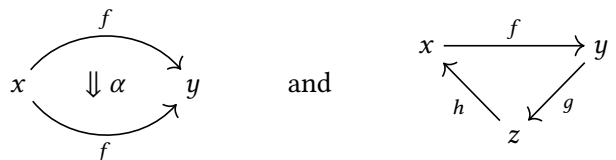

Axiom (T2) requires that the generators of the ω -hypergraph induce cells, forbidding ω -hypergraphs like (3.6) and (3.7). It can be shown that Axiom (T2) entails Axioms (C1) and (C2) of parity complexes.

3.1.5.3 – The segment Axiom (T3). Recall that our goal is to find conditions on ω -hypergraphs P so that the ω -category of cells $\text{Cell}(P)$ is freely generated by the atoms. In particular, every cell should be decomposable as a composite of context classes applied to atoms (*c.f.* Proposition 2.2.5.3). But there are cells of ω -hypergraphs satisfying Axioms (T0) to (T2) that can not be decomposed this way. The problem comes from an incompatibility between two concurrent phenomena:

- (i) on the one side, the decomposition property that we want requires that some orders of compositions be allowed;
- (ii) on the other side, the relation \triangleleft imposes restrictions on the orders in which the generators can be composed.

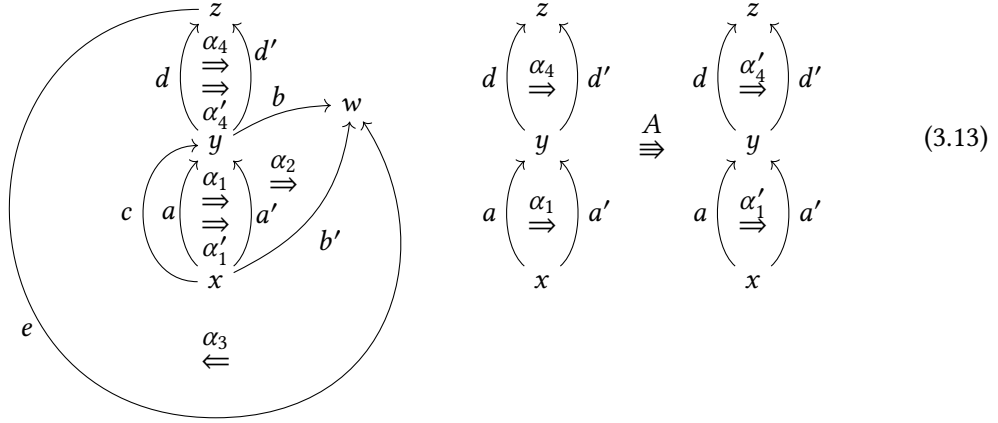
Figure 3.2 – A problematic ω -hypergraph

We illustrate this incompatibility in an example. Consider the ω -hypergraph P represented on Figure 3.2 where, more precisely,

$$\begin{aligned} A^- &= \{\alpha_1, \alpha_4\}, & A^+ &= \{\alpha'_1, \alpha'_4\}, \\ \alpha_1^- &= \alpha_1'^- = \{a\}, & \alpha_1^+ &= \alpha_1'^+ = \{a'\}, \\ \alpha_4^- &= \alpha_4'^- = \{d\}, & \alpha_4^+ &= \alpha_4'^+ = \{d'\}, \quad \text{etc.} \end{aligned}$$

One can verify that P satisfies Axioms (T0), (T1) and (T2). In this ω -hypergraph, there is a 2-cell X given by

$$\begin{aligned} X_2 &= \{\alpha_1, \alpha_2, \alpha_3, \alpha_4\}, \\ X_{1,-} &= \{a, b\}, & X_{1,+} &= \{c, d', e\}, \\ X_{0,-} &= \{x\}, & X_{0,+} &= \{z\}, \end{aligned}$$

and a 3-cell Y given by

$$\begin{aligned} Y_3 &= \{A\}, \\ Y_{2,-} &= \{\alpha_1, \alpha_2, \alpha_3, \alpha_4\}, & Y_{2,+} &= \{\alpha_1, \alpha'_2, \alpha'_3, \alpha_4\}, \\ Y_{1,-} &= \{a, b\}, & Y_{1,+} &= \{c, d', e\}, \\ Y_{0,-} &= \{x\}, & Y_{0,+} &= \{z\} \end{aligned}$$

so that $X = \partial_2^-(Y)$. Suppose by contradiction that $\text{Cell}(P)$ is an ω -category which is freely generated by the atoms. Then, by the decomposition property of cells of free extensions (Proposition 2.2.5.3), and by the value of Y_3 , Y can be written

$$Y = F_1[\langle A \rangle] *_2 \cdots *_2 F_k[\langle A \rangle]$$

for some 2-context classes F_1, \dots, F_k of type $\langle A \rangle$ (it can moreover be shown that $k = 1$ but it is not important at the moment). Since $X = \partial_2^-(Y)$, it implies that X can be written

$$X = \phi *_1 X' *_1 \psi \tag{3.14}$$

where $X' = \text{id}_f^2 *_0 \partial_2^-(\langle A \rangle) *_0 \text{id}_g^2$ for some 2-cells ϕ, ψ and 1-cells f, g in $\text{Cell}(P)$, illustrating (i). Since $\text{Cell}(P)_{\leq 2} \simeq \text{Cell}(P \setminus \{A\})_{\leq 2}$ and $P \setminus \{A\}$ is a torsion-free complex, using Lemma 3.2.3.1 introduced later, the existence of the composite (3.14) implies that

$$\text{the sets } \phi_2, X'_2 \text{ and } \psi_2 \text{ form a partition of } X_2 = \{\alpha_1, \alpha_2, \alpha_3, \alpha_4\}, \tag{3.15}$$

and, using Lemma 3.3.3.3 introduced later, that

$$\text{for } (\beta, \gamma) \in (\phi_2 \times (X'_2 \cup \psi_2)) \cup ((\psi_2 \cup X'_2) \times \psi_2), \text{ we have } \neg(\gamma \triangleleft_{X_2} \beta), \quad (3.16)$$

or, more simply put, the partition ϕ_2, X'_2, ψ_2 respects the relation \triangleleft_{X_2} , illustrating (ii). We show that (3.15) and (3.16) entails a contradiction. Consider $\alpha_2 \in X_2$. Since we have

$$X'_2 = A^- = \{\alpha_1, \alpha_4\},$$

by (3.15), either $\alpha_2 \in \phi_2$ or $\alpha_2 \in \psi_2$. By (3.16), since $\alpha_1 \triangleleft_{X_2}^1 \alpha_2$, we have $\alpha_2 \in \psi_2$. Now consider $\alpha_3 \in X_2$. By (3.15), either $\alpha_3 \in \phi_2$ or $\alpha_3 \in \psi_2$. By (3.16), since $\alpha_3 \triangleleft_{X_2}^1 \alpha_4$, we have $\alpha_3 \in \phi_2$. But then,

$$\alpha_3 \in \phi_2, \quad \alpha_2 \in \psi_2 \quad \text{and} \quad \alpha_2 \triangleleft_{X_2}^1 \alpha_3,$$

contradicting (3.16). Hence, $\text{Cell}(P)$ is not an ω -category freely generated by the atoms.

Axiom (T3) prevents this kind of problems and, in particular, forbids the ω -hypergraph P . Indeed, we have

$$\langle A \rangle_{2,-} = \{\alpha_1, \alpha_4\} \subseteq X_2, \quad \alpha_1 \triangleleft_{X_2} \alpha_2 \triangleleft_{X_2} \alpha_3 \triangleleft_{X_2} \alpha_4 \quad \text{and} \quad \alpha_2, \alpha_3 \notin \langle A \rangle_{2,-}$$

so that $\langle A \rangle_{2,-}$ is not a segment for \triangleleft_{X_2} , and A does not satisfy the segment condition.

3.1.5.4 – The torsion-freeness Axiom (T4). The notion of torsion captures the essence of the counter-example to the freeness property of parity complexes and pasting schemes presented in Paragraph 3.1.2.13. Indeed, considering the ω -hypergraph P represented by (3.9), there is a 2-cell X defined by

$$\begin{aligned} X_2 &= \{\alpha', \beta, \gamma, \delta'\}, \\ X_{1,-} &= \{a, d\}, & X_{1,+} &= \{c, f\}, \\ X_{0,-} &= \{x\}, & X_{0,+} &= \{z\}, \end{aligned}$$

which is induced by the pasting diagram

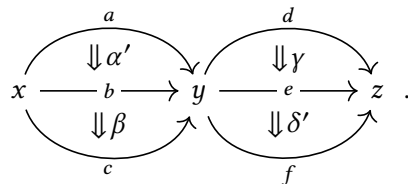

Then, one can verify that A and B are in torsion with respect to X , so that P does not satisfy Axiom (T4) (on the other hand, it satisfies Axioms (T0) to (T3)).

Intuitively, the situations with torsion are the minimal cases where the freeness property fails for a parity complex P (and similarly for a pasting scheme P). When $u, v \in P$ are in torsion with respect to a cell X of P , there are two possible order to compose u and v : first u then v , or first v then u . And both composites produce equal cells in $\text{Cell}(P)$. However, this equality can not be deduced from an exchange law, since the torsion says basically that u and v cross each other, preventing to obtain the left-hand side of Axiom (S-vi) of ω -categories (c.f. Paragraph 1.4.1.1).

3.1.5.5 – More computable axioms. Axioms (T3) and (T4) happen to be hard to check in practice. Indeed, both involve a quantification on all the cells of an ω -hypergraph, and enumerating them can be tough since their number is exponential in the number of elements of the ω -hypergraph in the worst case. Here, we give stronger axioms that are simpler to verify, in the sense that they can be checked using an algorithm with polynomial complexity.

Given an ω -hypergraph P , for $n \in \mathbb{N}$, $u, v \in P_n$, we write $u \rightsquigarrow v$ when there exists $w \in P_{n+1}$ such that $u \in w^-$ and $v \in w^+$ and we write \rightsquigarrow^* for the reflexive transitive closure of \rightsquigarrow . For $U, V \subseteq P_n$, we write $U \rightsquigarrow^* V$ when there exist $u \in U$ and $v \in V$ such that $u \rightsquigarrow^* v$. Consider the following axiom on an ω -hypergraph P :

(T3') for $k, n \in \mathbb{N}^*$ with $k < n$ and $u \in P_n$, we do not have $\langle u \rangle_{k,+} \rightsquigarrow^* \langle u \rangle_{k,-}$.

Then, Axiom (T3) can be replaced by Axiom (T3') in the axioms of torsion-free complexes:

Lemma 3.1.5.6. *Let P be an ω -hypergraph satisfying Axioms (T0), (T1) and (T2). If P satisfies Axiom (T3'), then it satisfies Axiom (T3).*

Proof. Suppose that P satisfies Axiom (T3'). Let $n, k \in \mathbb{N}$ with $n < k$, X be an n -cell and $u \in P_k$ such that $\langle u \rangle_{n,-} \subseteq X_n$. If $n = 0$, there is nothing to prove, so we can assume $n > 0$. By contradiction, suppose that $\langle u \rangle_{n,-}$ is not a segment for \triangleleft_{X_n} . So there are $r \in \mathbb{N}$ with $r > 2$ and $u_1, \dots, u_r \in X_n$ such that

$$u_1, u_r \in \langle u \rangle_{n,-}, \quad u_2, \dots, u_{r-1} \notin \langle u \rangle_{n,-} \quad \text{and} \quad u_i \triangleleft_{X_n}^1 u_{i+1}$$

for $i \in \mathbb{N}_{r-1}^*$. In particular, there are $v_1, \dots, v_{r-1} \in P_{n-1}$ such that $v_i \in u_i^+ \cap u_{i+1}^-$ for $i \in \mathbb{N}_{r-1}^*$. Given $w \in X_n$ such that $v_1 \in w^-$, since X_n is fork-free, we have $w = u_2 \notin \langle u \rangle_{n,-}$. Thus, since u is relevant by Axiom (T2), $v_1 \in \langle u \rangle_{n,-}^\pm = \langle u \rangle_{n-1,+}$. Similarly, $v_{r-1} \in \langle u \rangle_{n-1,-}$. So $\langle u \rangle_{n-1,+} \rightsquigarrow^* \langle u \rangle_{n-1,-}$, contradicting Axiom (T3'). Hence, P satisfies Axiom (T3). \square

Now, consider the following axiom on an ω -hypergraph P :

(T4') for $n, k, l \in \mathbb{N}^*$ with $n < \min(k, l)$, $u \in P_k$ and $v \in P_l$, if $\langle u \rangle_{n,+} \cap \langle v \rangle_{n,-} = \emptyset$, then at most one of the following holds:

- $\langle u \rangle_{n-1,+} \rightsquigarrow^* \langle v \rangle_{n-1,-}$,
- $\langle v \rangle_{n-1,+} \rightsquigarrow^* \langle u \rangle_{n-1,-}$.

Then, Axiom (T4) can be replaced by Axiom (T4') in the axioms of torsion-free complexes:

Lemma 3.1.5.7. *Let P be an ω -hypergraph satisfying Axioms (T0), (T1) and (T2). If P satisfies Axiom (T4'), then it satisfies Axiom (T4).*

Proof. Suppose that P satisfies Axiom (T4'). By contradiction, assume that P does not satisfy Axiom (T4). So there are $n, k, l \in \mathbb{N}^*$ with $n < \min(k, l)$, $u \in P_k$, $v \in P_l$ and an n -cell X such that u and v are in torsion with respect to X . That is,

$$\langle u \rangle_{n,+} \subseteq X_n, \quad \langle v \rangle_{n,-} \subseteq X_n, \quad \langle u \rangle_{n,+} \cap \langle v \rangle_{n,-} = \emptyset \quad \text{and} \quad \langle u \rangle_{n,+} \triangleleft_{X_n} \langle v \rangle_{n,-} \triangleleft_{X_n} \langle u \rangle_{n,+}.$$

By the last condition, there are $r \in \mathbb{N}$ with $r > 1$, and $w_1, \dots, w_r \in X_n$ such that

$$w_1 \in \langle u \rangle_{n,+}, \quad w_r \in \langle v \rangle_{n,-}, \quad w_2, \dots, w_{r-1} \notin \langle u \rangle_{n,+} \cup \langle v \rangle_{n,-}, \quad \text{and} \quad w_i \triangleleft_{X_n}^1 w_{i+1}$$

for $i \in \mathbb{N}_{r-1}^*$. Thus, there are $\bar{w}_1, \dots, \bar{w}_{r-1} \in P_{n-1}$ such that $\bar{w}_i \in w_i^+ \cap w_{i+1}^-$ for $i \in \mathbb{N}_{r-1}^*$. Given $w \in X_n$ with $\bar{w}_1 \in w^-$, we have $w = w_2 \notin \langle u \rangle_{n,+}$ since X_n is fork-free. Thus,

$$\bar{w}_1 \in \langle u \rangle_{n,+}^\pm = \langle u \rangle_{n-1,+}.$$

Similarly, $\bar{w}_{r-1} \in \langle v \rangle_{n-1,-}$, so $\langle u \rangle_{n-1,+} \rightsquigarrow^* \langle v \rangle_{n-1,-}$. Likewise, we have $\langle v \rangle_{n-1,+} \rightsquigarrow^* \langle u \rangle_{n-1,-}$, which contradicts Axiom (T4'). Hence, P satisfies Axiom (T4). \square

3.2 The category of cells

In this section, we show that, given a torsion-free complex P , the ω -globular set $\text{Cell}(P)$ has a structure of an ω -category. Indeed, even though we defined identity and composition operations in Paragraph 3.1.2.7, we do not know for now that the composition of two cells is a cell. In order to show this, we adapt the proofs of [Str91] and take the opportunity to simplify them. In particular, we give a detailed proof of the “gluing theorem” (Theorem 3.2.2.3, adapted from [Str91, Lemma 3.2]), which enables to build an $(n+1)$ -cell from an n -cell by gluing a set of $(n+1)$ -generators.

3.2.1 Movement properties

Before being able to show the gluing theorem, we need some technical results about movement (notion which appears in the definition of cells). We state and prove here several such properties, some of which coming from [Str91].

In the following, we suppose given an ω -hypergraph P . We first state a criterion for movement:

Lemma 3.2.1.1 ([Str91, Proposition 2.1]). *For $n \in \mathbb{N}$, finite subsets $U \subseteq P_n$ and $S \subseteq P_{n+1}$, there exists $V \subseteq P_n$ such that S moves U to V if and only if $S^\mp \subseteq U$ and $U \cap S^+ = \emptyset$.*

Proof. If S moves U to V , then, by definition,

$$S^\mp \subseteq (V \cup S^-) \setminus S^+ = U$$

and

$$U \cap S^+ = ((V \cup S^-) \setminus S^+) \cap S^+ = \emptyset.$$

Conversely, if $S^\mp \subseteq U$ and $U \cap S^+ = \emptyset$, let $V = (U \cup S^+) \setminus S^-$. Then

$$\begin{aligned} (V \cup S^-) \setminus S^+ &= (U \cup S^+ \cup S^-) \setminus S^+ \\ &= (U \setminus S^+) \cup (S^- \setminus S^+) \\ &= U \cup S^\mp && \text{(since } U \cap S^+ = \emptyset\text{)} \\ &= U && \text{(since } S^\mp \subseteq U\text{)} \end{aligned}$$

and S moves U to V . □

The next property states that it is possible to modify a movement by adding or removing “independent” elements.

Lemma 3.2.1.2 ([Str91, Proposition 2.2]). *Let $n \in \mathbb{N}$, $U, V \subseteq P_n$ and $S \subseteq P_{n+1}$ be finite subsets such that S moves U to V . Then, given $X, Y \subseteq P_n$ such that*

$$X \subseteq U, \quad X \cap S^\mp = \emptyset \quad \text{and} \quad Y \cap (S^- \cup S^+) = \emptyset,$$

we have that S moves $(U \cup Y) \setminus X$ to $(V \cup Y) \setminus X$.

Proof. By Lemma 3.2.1.1, we have $S^\mp \subseteq U$ and $U \cap S^+ = \emptyset$. Using the hypothesis, we can refine both equalities to

$$S^\mp \subseteq (U \cup Y) \setminus X \quad \text{and} \quad ((U \cup Y) \setminus X) \cap S^+ = \emptyset.$$

Using Lemma 3.2.1.1 again, S moves $(U \cup Y) \setminus X$ to W where

$$\begin{aligned}
W &= (((U \cup Y) \setminus X) \cup S^+) \setminus S^- \\
&= ((U \cup S^+ \cup Y) \setminus X) \setminus S^- && \text{(since } X \cap S^+ \subseteq U \cap S^+ = \emptyset) \\
&= (((U \cup S^+) \setminus S^-) \cup Y) \setminus X && \text{(since } Y \cap S^- = \emptyset) \\
&= (V \cup Y) \setminus X. && \square
\end{aligned}$$

The following property gives sufficient conditions for composing movements.

Lemma 3.2.1.3 ([Str91, Proposition 2.3]). *Let $n \in \mathbb{N}$, and $U, V, W \subseteq P_n$, $S, T \subseteq P_{n+1}$ be finite subsets such that S moves U to V and T moves V to W , if $S^- \cap T^+ = \emptyset$ then $S \cup T$ moves U to W .*

Proof. We compute $(U \cup (S \cup T)^+) \setminus (S \cup T)^-$:

$$\begin{aligned}
(U \cup S^+ \cup T^+) \setminus (S^- \cup T^-) &= (((U \cup S^+) \setminus S^-) \cup T^+) \setminus T^- \\
&= (V \cup T^+) \setminus T^- \\
&= W.
\end{aligned}$$

Similarly, $(W \cup (S \cup T)^-) \setminus (S \cup T)^+ = U$ and $S \cup T$ moves U to W . \square

Conversely, the next property enables to decompose movements, under a condition of orthogonality: given $n \in \mathbb{N}$ and finite sets $S, T \subseteq P_n$, we say that S and T are *orthogonal*, written $S \perp T$, when $(S^- \cap T^-) \cup (S^+ \cap T^+) = \emptyset$. We then have:

Lemma 3.2.1.4 ([Str91, Proposition 2.4]). *Given $n \in \mathbb{N}$, finite subsets $U, W \subseteq P_n$, $S, T \subseteq P_{n+1}$ such that $S \cup T$ moves U to W and $S^\mp \subseteq U$, if $S \perp T$ then there exists V such that S moves U to V and T moves V to W .*

Proof. Let $R = S \cup T$. By Lemma 3.2.1.1, $R^\mp \subseteq U$ and $U \cap S^+ \subseteq U \cap R^+ = \emptyset$. By Lemma 3.2.1.1 again, S moves U to $V = (U \cup S^+) \setminus S^-$. Moreover,

$$\begin{aligned}
S^- \cap T^+ &= S^\mp \cap T^+ && \text{(since } S^+ \cap T^+ = \emptyset, \text{ by } S \perp T) \\
&\subseteq U \cap T^+ && \text{(since } S^\mp \subseteq U, \text{ by hypothesis)} \\
&\subseteq U \cap (S \cup T)^+ \\
&= \emptyset && \text{(by Lemma 3.2.1.1).}
\end{aligned}$$

so that

$$\begin{aligned}
&R^\mp \subseteq U \\
\Leftrightarrow &((S^- \cup T^-) \setminus T^+) \setminus S^+ \subseteq U \\
\Leftrightarrow &((T^- \setminus T^+) \cup S^-) \setminus S^+ \subseteq U && \text{(since } S^- \cap T^+ = \emptyset) \\
\Leftrightarrow &T^\mp \cup S^- \subseteq U \cup S^+ \\
\Leftrightarrow &T^\mp \subseteq (U \cup S^+) \setminus S^- && \text{(since } T^\mp \cap S^- = \emptyset, \text{ by } S \perp T).
\end{aligned}$$

Hence, $T^\mp \subseteq (U \cup S^+) \setminus S^- = V$ and

$$V \cap T^+ \subseteq (U \cup S^+) \cap T^+ \subseteq (U \cap R^+) \cup (S^+ \cap T^+) = \emptyset.$$

By Lemma 3.2.1.1, T moves V to $(V \cup T^+) \setminus T^-$. Moreover,

$$\begin{aligned} S^- \cap T^+ &= S^\mp \cap T^+ && \text{(since } S \perp T) \\ &\subseteq U \cap R^+ && \text{(since } S^\mp \subseteq U \text{ by hypothesis)} \\ &= \emptyset. \end{aligned}$$

Therefore,

$$\begin{aligned} (V \cup T^+) \setminus T^- &= (((U \cup S^+) \setminus S^-) \cup T^+) \setminus T^- \\ &= (U \cup S^+ \cup T^+) \setminus (S^- \cup T^-) && \text{(since } S^- \cap T^+ = \emptyset) \\ &= W. \end{aligned}$$

Hence, T moves V to W . □

The next three properties (not in [Str91]) describe which elements are touched or left untouched by movement.

Lemma 3.2.1.5. *Given $n \in \mathbb{N}$, finite subsets $U, V \subseteq P_n$ and $S \subseteq P_{n+1}$, if S moves U to V , then*

$$S^\mp = U \setminus V \quad \text{and} \quad S^\pm = V \setminus U.$$

In particular, if T moves U to V , then $S^\mp = T^\mp$ and $S^\pm = T^\pm$.

Proof. By the definition of movement, we have

$$V = (U \cup S^+) \setminus S^- \quad \text{and} \quad U = (V \cup S^-) \setminus S^+$$

and therefore

$$\begin{aligned} U \cap V &= U \cap ((U \setminus S^-) \cup S^\pm) \\ &= U \setminus S^\mp && \text{(since } U \cap S^+ = \emptyset). \end{aligned}$$

Similarly, $U \cap V = V \setminus S^\pm$. Hence, $S^\mp = U \setminus V$ and $S^\pm = V \setminus U$. □

Lemma 3.2.1.6. *Given $n \in \mathbb{N}$, finite subsets $U, V \subseteq P_n$ and $S \subseteq P_{n+1}$, if S moves U to V , then*

$$U \setminus S^- = U \setminus S^\mp = U \cap V = V \setminus S^\pm = V \setminus S^+.$$

Proof.

$$\begin{aligned} U \setminus S^- &= U \setminus S^\mp && \text{(since } U \cap S^+ = \emptyset, \text{ by definition of movement)} \\ &= U \cap V && \text{(by Lemma 3.2.1.5)} \\ &= V \setminus S^\pm \\ &= V \setminus S^+ && \text{(since } V \cap S^- = \emptyset, \text{ by definition of movement)} \end{aligned}$$

Lemma 3.2.1.7. *For $n \in \mathbb{N}$, finite subsets $U, V \subseteq P_n$ and $S \subseteq P_{n+1}$, if S moves U to V , then*

$$U = (U \cap V) \sqcup S^\mp \quad \text{and} \quad V = (U \cap V) \sqcup S^\pm.$$

Proof. We have

$$\begin{aligned} U &= (V \cup S^-) \setminus S^+ \\ &= (V \setminus S^+) \cup (S^- \setminus S^+) \\ &= (U \cap V) \cup S^\mp \end{aligned} \quad (\text{by Lemma 3.2.1.6})$$

and

$$\begin{aligned} (U \cap V) \cap S^\mp &\subseteq V \cap S^- \\ &= ((U \cup S^-) \setminus S^-) \cap S^- \\ &= \emptyset. \end{aligned}$$

Hence, $U = (U \cap V) \sqcup S^\mp$. Similarly $V = (U \cap V) \sqcup S^\pm$. \square

Finally, the last lemma enables to decompose a moving set starting from a subset which is a segment:

Lemma 3.2.1.8. *For $n \in \mathbb{N}$, finite subsets $U, V \subseteq P_n$, $S \subseteq P_{n+1}$ and $T \subseteq S$ such that S is fork-free and moves U to V , and T is a segment in S for \triangleleft_S , there exist $L, R \subseteq S$ and $A, B \subseteq P_n$ such that*

- L, T, R is a partition of S ,
- L is initial in S for \triangleleft_S and R is final in S for \triangleleft_S ,
- L moves U to A , T moves A to B and R moves B to V .

Proof. Let

$$L = \{x \in S \mid x \triangleleft_S T\} \quad \text{and} \quad R = S \setminus (L \cup T).$$

Thus, L, T, R is a partition of S , and since S is fork-free, we have

$$L \perp T \quad L \perp R \quad T \perp R.$$

Since T is a segment for \triangleleft_S , we have that $L^- \cap T^+ = \emptyset$, and, by definition of L and R , $L^- \cap R^+ = \emptyset$ so that L is initial in S . In particular, $L^\mp \subseteq U$. Thus, by Lemma 3.2.1.3, writing A for $(U \cup L^+) \setminus L^-$, we have that L moves U to A . Furthermore, since $L \cap R = \emptyset$, we have $T^- \cap R^+ = \emptyset$ so that R is terminal in S . In particular, $R^\pm \subseteq V$. Thus, by the dual of Lemma 3.2.1.3, writing B for $(V \cup R^-) \setminus R^+$, we have that R moves B to V . \square

3.2.2 Gluing sets on cells

In this section, we state and prove a property similar to [Str91, Lemma 3.2] which enables to build $(n+1)$ -cells from n -cells by gluing sets of generators. We adapt the proof given by Street to the new set of axioms and simplify it (notably, we remove the need for the notion of receptivity).

3.2.2.1 – Gluings and activations. Let P be an ω -hypergraph. Given $n \in \mathbb{N}$, an n -pre-cell X of P and a finite set $G \subseteq P_{n+1}$, we say that G is *glueable on X* if $G^\mp \subseteq X_n$. If so, we call *gluing of G on X* the $(n+1)$ -pre-cell Y of P defined by

$$Y_{n+1} = G, \quad Y_{n,-} = X_n, \quad Y_{n,+} = (X_n \cup G^+) \setminus G^- \quad \text{and} \quad Y_{i,\epsilon} = X_{i,\epsilon}$$

for $i \in \mathbb{N}_n$ and $\epsilon \in \{-, +\}$. We denote Y by $\text{Glue}(X, G)$. Moreover, we call *activation of G on X* the n -pre-cell $\text{Act}(X, G)$ defined by

$$\text{Act}(X, G) = \partial_n^+(\text{Glue}(X, G))$$

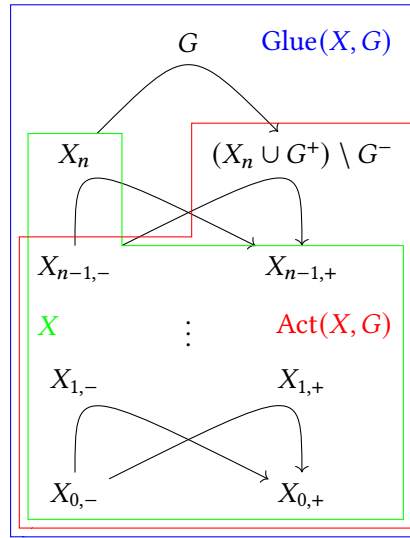

Figure 3.3 – Cells involved and their movements in Theorem 3.2.2.3

We say that G is *dually glueable on X* when $G^\pm \subseteq X_n$ and we define the dual gluing $\overline{\text{Glue}}(X, G)$ and the dual activation $\overline{\text{Act}}(X, G)$ in a similar fashion. For example, consider the ω -hypergraph (3.13) from Paragraph 3.1.5.3 and recall there the definitions of X and Y . Then $\{A\}$ is glueable on X and $\text{Glue}(X, \{A\}) = Y$, and $\text{Act}(X, \{A\})$ is the 2-pre-cell \bar{X} with

$$\begin{aligned} \bar{X}_2 &= \{\alpha_1, \alpha'_2, \alpha'_3, \alpha_4\}, \\ \bar{X}_{1,-} &= \{a, b\}, & \bar{X}_{1,+} &= \{c, d', e\}, \\ \bar{X}_{0,-} &= \{x\}, & \bar{X}_{0,+} &= \{z\}. \end{aligned}$$

Conversely, $\{A\}$ is dually glueable on \bar{X} , and we have $\overline{\text{Glue}}(\bar{X}, \{A\}) = Y$, and $\overline{\text{Act}}(\bar{X}, \{A\}) = X$.

3.2.2.2 – The gluing theorem. We now prove the “gluing theorem”. It is an adaptation of [Str91, Lemma 3.2] which enables to build new cells using the gluing and activation operations. The theorem moreover gives additional results concerning intersections with the source and the target sets of gluing sets, that will have as consequence that the composition in the category of cell $\text{Cell}(P)$ respects the relation \triangleleft (see Proposition 3.3.1.10).

Theorem 3.2.2.3. *Let P be an ω -hypergraph which satisfies Axioms (T0), (T1), (T2) and (T3). Given $n \in \mathbb{N}$, an n -cell X of P and a finite fork-free set $G \subseteq P_{n+1}$ such that G is glueable on X , we have that*

- (a) $\text{Act}(X, G)$ is a cell and $G^+ \cap X_n = \emptyset$,
- (b) $\text{Glue}(X, G)$ is a cell,
- (c) given a finite, fork-free subset $G' \subseteq P_{n+1}$ which is dually glueable on X , $G'^- \cap G^+ = \emptyset$.

and dual properties hold when G is dually glueable on X .

Proof. See Figure 3.3 for a representation of the cells in the statement of the theorem. In the following, write S for

$$S = \text{Act}(X, G)_n = (X_n \cup G^+) \setminus G^-.$$

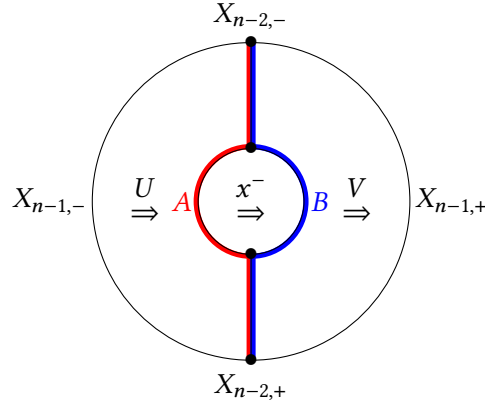
Figure 3.4 – The decomposition of X_n

We prove the different subproperties (and their duals) of the theorem by induction on n .

Proof of (a): We prove (a) in two steps: first, in the case where $|G| = 1$, then, in the general case.

Step 1: (a) holds when $|G| = 1$. Let $x \in P_{n+1}$ be such that $\{x\} = G$. If $n = 0$, then there exists $y \in P_0$ such that $X_0 = \{y\}$. By Axioms (T1) and (T2), there exists $z \in P_0$ with $y \neq z$ such that $x^- = \{y\}$ and $x^+ = \{z\}$. So $\text{Act}(X, G) = \{z\}$ is a cell. So suppose that $n > 0$. Then, we have $S = (X_n \cup x^+) \setminus x^-$ and, in order to prove that $\text{Act}(X, G)$ is a cell, we are required to show that

- S moves $X_{n-1,-}$ to $X_{n-1,+}$;
- S is fork-free.

Using Axiom (T3), we get that x^- is a segment in X_n for \triangleleft_{X_n} . By Lemma 3.2.1.8, we can decompose the set X_n as a partition

$$X_n = U \cup x^- \cup V$$

with U initial and V final in X_n and, writing $A, B \subseteq P_{n-1}$ for

$$A = (X_{n-1,-} \cup U^+) \setminus U^- \quad \text{and} \quad B = (X_{n-1,+} \cup V^-) \setminus V^+$$

we have that

$$U \text{ moves } X_{n-1,-} \text{ to } A, \quad x^- \text{ moves } A \text{ to } B, \quad V \text{ moves } B \text{ to } X_{n-1,+}$$

as pictured on Figure 3.4. In the following, for $Z \subseteq P_{n-1}$, we write $D(Z)$ for the $(n-1)$ -pre-cell of P defined by

$$\begin{aligned} D(Z)_{n-1} &= Z, \\ D(Z)_{i,\epsilon} &= X_{i,\epsilon} \quad \text{for } i \in \mathbb{N}_{n-2} \text{ and } \epsilon \in \{-, +\}. \end{aligned}$$

Since

$$D(A) = \text{Act}(D(X_{n-1,-}), U), \quad D(B) = \text{Act}(D(A), x^-),$$

and $D(X_{n-1,-}) = \partial_{n-1}^-(X)$ is an $(n-1)$ -cell and both U and x^- are fork-free, by using two times the induction hypothesis of Theorem 3.2.2.3, first on $D(X_{n-1,-})$, then on $D(A)$, we get that

$$D(A) \text{ and } D(B) \text{ are cells.} \tag{3.17}$$

By Axiom (T2), we have that

$$x^+ \text{ is fork-free.} \quad (3.18)$$

Since x^- moves A to B , by Lemma 3.2.1.1, we get

$$A \cap x^{-+} = \emptyset. \quad (3.19)$$

By Axiom (T2), it holds that $x^{+\mp} = x^{-\mp} \subseteq A$. By (3.17) and (3.18), using the induction hypothesis of Theorem 3.2.2.3 on $D(A)$, we get

$$A \cap x^{++} = \emptyset. \quad (3.20)$$

By Lemma 3.2.1.1, there exists B' such that x^+ moves A to B' , and

$$\begin{aligned} B' &= (A \cup x^{++}) \setminus x^{+-} \\ &= (A \setminus x^{+-}) \cup (x^{++} \setminus x^{+-}) \\ &= (A \setminus x^{+\mp}) \cup x^{+\pm} && \text{(by (3.20))} \\ &= (A \setminus x^{-\mp}) \cup x^{-\pm} && \text{(since } x^{+\mp} = x^{-\mp}, \text{ by Axiom (T2))} \\ &= (A \setminus x^{--}) \cup (x^{-+} \setminus x^{--}) && \text{(by (3.19))} \\ &= (A \cup x^{-+}) \setminus x^{--} \\ &= B && \text{(since } x^- \text{ moves } A \text{ to } B). \end{aligned}$$

Hence,

$$x^+ \text{ moves } A \text{ to } B. \quad (3.21)$$

Since $x^{+\mp} \subseteq D(A)_{n-1}$ and $U^\pm \subseteq D(A)_{n-1}$, using the induction hypothesis of Theorem 3.2.2.3, by (c) we get

$$U^- \cap x^{++} = \emptyset. \quad (3.22)$$

Similarly, with $D(B)$, we get

$$x^{+-} \cap V^+ = \emptyset. \quad (3.23)$$

By definition, U moves $X_{n-1,-}$ to A , and x^+ moves A to B by (3.21). Moreover, by (3.22), $U^- \cap x^{++} = \emptyset$. Using Lemma 3.2.1.3, we deduce that

$$U \cup x^+ \text{ moves } X_{n-1,-} \text{ to } B. \quad (3.24)$$

Since U and V are disjoint and respectively initial and terminal in X_n , we have that $U^- \cap V^+ = \emptyset$. Also, by (3.23), we have $(x^{+-} \cap V^+) = \emptyset$, therefore

$$\begin{aligned} (U \cup x^+)^- \cap V^+ &\subseteq (U^- \cap V^+) \cup (x^{+-} \cap V^+) \\ &= \emptyset. \end{aligned}$$

Using (3.24) and Lemma 3.2.1.3, knowing that $S = U \cup x^+ \cup V$, we deduce that

$$S \text{ moves } X_{n-1,-} \text{ to } X_{n-1,+}. \quad (3.25)$$

The set $U \cup V$ is fork-free as a subset of the fork-free X_n , and x^+ is fork-free since x is relevant by Axiom (T2). Moreover,

$$\begin{aligned} U^- \cap x^{+-} &= U^- \cap x^{+\mp} && \text{(by (3.22))} \\ &\subseteq U^- \cap A && \text{(by (3.21) and Lemma 3.2.1.1)} \\ &= \emptyset && \text{(since } U \text{ moves } X_{n-1,-} \text{ to } A), \\ U^+ \cap x^{++} &= U^\pm \cap x^{++} && \text{(by (3.22))} \\ &\subseteq A \cap x^{++} && \text{(by Lemma 3.2.1.1 since } U \text{ moves } X_{n-1,-} \text{ to } A) \\ &= \emptyset && \text{(by (3.21) and Lemma 3.2.1.1).} \end{aligned}$$

So $U \perp x^+$. Similarly, $x^+ \perp V$. Hence, since $S = U \cup x^+ \cup V$,

$$S \text{ is fork-free.} \quad (3.26)$$

Then, by (3.25) and (3.26),

$$\text{Act}(X, G) \text{ is a cell.}$$

Finally, we prove the second part of (a). By Axiom (T1), $x^- \cap x^+ = \emptyset$. Since $U \perp x^+$ and $x^+ \perp V$ (by (3.26)), using Axiom (T0), we deduce that

$$U \cap x^+ = x^+ \cap V = \emptyset$$

so that

$$X_n \cap x^+ = (U \cup x^- \cup V) \cap x^+ = \emptyset$$

which concludes the proof of the Step 1.

Step 2: (a) holds. We prove this by induction on $|G|$. If $|G| = 0$, then the result is trivial. Moreover, the case $|G| = 1$ was proved in Step 1. So suppose that $|G| \geq 2$. Since the relation \triangleleft is acyclic by Axiom (T1), we can consider a minimal $x \in G$ for \triangleleft_G . Let

$$\tilde{G} = G \setminus \{x\}, \quad U = (X_n \cup x^+) \setminus x^-, \quad V = (U \cup \tilde{G}^+) \setminus \tilde{G}^-$$

and recall that we defined S as $(X_n \cup G^+) \setminus G^-$. In order to show that $\text{Act}(X, G)$ is a cell, we are required to prove that:

- S moves $X_{n-1,-}$ to $X_{n-1,+}$;
- S is fork-free.

For this purpose, we will first move X_n with $\{x\}$ to U and use Step 1, then move U by \tilde{G} to V and use the induction of Step 2. Finally, we will prove that $V = S$. So, using Step 1 with X and $\{x\}$, we get that

- $\text{Act}(X, \{x\})$ is a cell;
- in particular, U is fork-free and, when $n > 0$, U moves $X_{n-1,-}$ to $X_{n-1,+}$;
- $X_n \cap x^+ = \emptyset$.

By Lemma 3.2.1.1, we deduce that $\{x\}$ moves X_n to U . Moreover,

$$\begin{aligned} \tilde{G}^\mp &= \tilde{G}^- \setminus \tilde{G}^+ \\ &= (G^- \setminus x^-) \setminus (G^+ \setminus x^+) && \text{(since fork-freeness implies that } G^\epsilon = \sqcup_{u \in G} u^\epsilon) \\ &\subseteq ((G^- \setminus x^-) \setminus G^+) \cup x^+ \\ &= ((G^- \setminus G^+) \setminus x^-) \cup x^+ \\ &\subseteq (X_n \setminus x^-) \cup x^+ && \text{(since } G^\mp \subseteq X_n \text{ by Lemma 3.2.1.1)} \\ &\subseteq (X_n \cup x^+) \setminus x^- && \text{(since } x^- \cap x^+ = \emptyset \text{ by Axiom (T1))} \\ &= U. \end{aligned}$$

Also, \tilde{G} is fork-free as a subset of the fork-free set G . Using the induction hypothesis of Step 2 for \tilde{G} , we get that

- $\text{Act}(\text{Act}(X, \{x\}), \tilde{G})$ is a cell;

- In particular, $V = (U \cup \tilde{G}^+) \setminus \tilde{G}^-$ is fork-free, and, when $n > 0$, V moves $X_{n-1,-}$ to $X_{n-1,+}$;
- $U \cap \tilde{G}^+ = \emptyset$.

By Lemma 3.2.1.1, we deduce that \tilde{G} moves U to V . Also, note that $x^- \cap \tilde{G}^+ = \emptyset$ since x was taken minimal in G . Using Lemma 3.2.1.3, we deduce that $G = \{x\} \cup \tilde{G}$ moves X_n to V . But $S = (X_n \cup G^+) \setminus G^-$ so that $S = V$.

The second part of (a) is left to show, that is, $X_n \cap G^+ = \emptyset$. We compute that

$$\begin{aligned}
X_n \cap G^+ &= (U \cup x^- \setminus x^+) \cap G^+ && \text{(by Lemma 3.2.1.1, since } \{x\} \text{ moves } X_n \text{ to } U) \\
&= ((U \cup x^-) \cap G^+) \setminus x^+ \\
&= (U \cap G^+) \setminus x^+ && \text{(since } x^- \cap G = x^- \cap (x^+ \cup \tilde{G}) = \emptyset) \\
&= (U \cap \tilde{G}^+) \\
&= \emptyset
\end{aligned}$$

which concludes the proofs of Step 2 and (a).

Proof of (b): By (a), $\text{Act}(X, G)$ is a cell. To conclude, we need to show that G moves X_n to S . By definition of S , we have that $S = (X_n \cup G^+) \setminus G^-$. Moreover,

$$\begin{aligned}
(S \cup G^-) \setminus G^+ &= (((X_n \cup G^+) \setminus G^-) \cup G^-) \setminus G^+ \\
&= (X_n \cup G^+ \cup G^-) \setminus G^+ \\
&= (X_n \setminus G^+) \cup G^\mp \\
&= X_n \cup G^\mp && \text{(since } X_n \cap G^+ = \emptyset \text{ by (a))} \\
&= X_n && \text{(since } G \text{ is glueable on } X).
\end{aligned}$$

Hence, $\text{Glue}(X, G)$ is a cell.

Proof of (c): By contradiction, suppose that $G'^- \cap G^+ \neq \emptyset$. Then, there are $x \in G'$, $y \in G$ and $z \in x^- \cap y^+$. Consider

$$\begin{aligned}
U &= \{x' \in G' \mid x \triangleleft_{G'} x'\} \cup \{x\}, \\
V &= \{y' \in G \mid y' \triangleleft_G y\} \cup \{y\}.
\end{aligned}$$

By the acyclicity Axiom (T1), we have

$$U^+ \cap V^- = \emptyset.$$

Since U is a terminal set for $\triangleleft_{G'}$, we have in particular $U^+ \cap G'^- \subseteq U^-$. So,

$$U^+ = (U^+ \setminus G'^-) \cup (U^+ \cap G'^-) \subseteq G'^\pm \cup U^-.$$

Hence, $U^\pm \subseteq G'^\pm \subseteq X_n$ (since G' is dually glueable on X). Similarly, $V^\mp \subseteq X_n$. Using the dual version of (a), the n -pre-cell $Y = \overline{\text{Act}}(X, U)$ is an n -cell such that $Y_n = (X_n \cup U^-) \setminus U^+$ (see Figure 3.5) and we have

$$\begin{aligned}
V^\mp &= V^\mp \setminus U^+ && \text{(since } V^- \cap U^+ = \emptyset) \\
&\subseteq X_n \setminus U^+ && \text{(since } V^\mp \subseteq X_n) \\
&\subseteq (X_n \cup U^-) \setminus U^+ \\
&= Y_n.
\end{aligned}$$

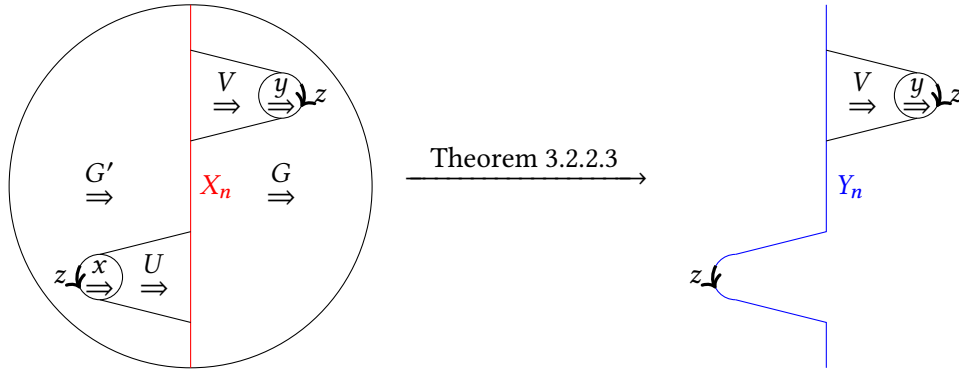
Figure 3.5 – V , U and Y_n

Using Theorem 3.2.2.3(a) with Y and V , we get

$$Y_n \cap V^+ = \emptyset.$$

But, since $z \in U^\mp \subseteq Y_n$ (by Axiom (T1)) and $U^\mp \subseteq Y_n$, $z \in Y_n \cap V^+$, which is a contradiction. Hence,

$$G'^- \cap G^+ = \emptyset$$

which ends the proof of (c). \square

3.2.3 Cell(P) is an ω -category

Here, we prove that $\text{Cell}(P)$ has a structure of an ω -category. For this purpose, we first prove that the composite of two cells is a cell using Theorem 3.2.2.3 shown above. Then, we quickly verify that the axioms of ω -categories are satisfied by $\text{Cell}(P)$ (which is almost immediate by the definitions of the operations of $\text{Cell}(P)$).

We first show that the $(n-1)$ -composition of two n -cells is a cell, together with several intersection results, that we will need for the general case and later for the proof of the freeness property.

Lemma 3.2.3.1. *Let P be an ω -hypergraph satisfying Axioms (T0), (T1), (T2) and (T3). Given $n \in \mathbb{N}^*$ and two n -cells X, Y of P that are $(n-1)$ -composable, the following hold:*

- (a) $X_n^- \cap Y_n^+ = \emptyset$,
- (b) $X_n \cap Y_n = \emptyset$,
- (c) $X *_{n-1} Y$ is an n -cell of P .

Proof. Using Theorem 3.2.2.3(c) with $\partial_{n-1}^+(X)$, X_n and Y_n , we get

$$X_n^- \cap Y_n^+ = \emptyset.$$

Moreover,

$$\begin{aligned} X_n^+ \cap Y_n^+ &= X_n^\pm \cap Y_n^+ && \text{(since } X_n^- \cap Y_n^+ = \emptyset\text{)} \\ &\subseteq X_{n-1,+} \cap Y_n^+ \\ &= Y_{n-1,-} \cap Y_n^+ \\ &= \emptyset && \text{(by Theorem 3.2.2.3(a)).} \end{aligned}$$

By Axiom (T0), it implies that $X_n \cap Y_n = \emptyset$. Similarly,

$$X_n^- \cap Y_n^- = \emptyset$$

So $X_n \cup Y_n$ is fork-free. For $X *_{n-1} Y$ to be a cell, $X_n \cup Y_n$ must move $X_{n-1,-}$ to $Y_{n-1,+}$. But, since X and Y are cells and are $(n-1)$ -composable, we know that X_n moves $X_{n-1,-}$ to $X_{n-1,+}$, Y_n moves $Y_{n-1,-}$ to $Y_{n-1,+}$ and $X_{n-1,+} = Y_{n-1,-}$. Since $X_n^- \cap Y_n^+$, using Lemma 3.2.1.3, we get that $X_n \cup Y_n$ moves $X_{n-1,-}$ to $Y_{n-1,+}$. Hence, $X *_{n-1} Y$ is a cell. \square

We now prove the general case of composition of two cells, together with an intersection result, that will also be useful later in the proof of the freeness property.

Lemma 3.2.3.2. *Let P be an ω -hypergraph satisfying Axioms (T0), (T1), (T2) and (T3). Let $i, n \in \mathbb{N}$ with $i < n$ and X, Y be two n -cells of P that are i -composable. Then,*

$$(i) \text{ for } j \in \mathbb{N} \text{ with } i < j \leq n, (X_{j,-}^- \cup X_{j,+}^-) \cap (Y_{j,-}^+ \cup Y_{j,+}^+) = \emptyset,$$

(ii) $X *_i Y$ is a cell.

Proof. By induction on $n - i$. If $n - i = 1$, the properties follow from Lemma 3.2.3.1. So suppose that $n - i > 1$. For $\epsilon, \eta \in \{-, +\}$, by induction hypothesis with $\partial_{n-1}^\epsilon(X)$ and $\partial_{n-1}^\eta(Y)$, we get

$$X_{n-1,\epsilon}^- \cap Y_{n-1,\eta}^+ = \emptyset.$$

Therefore,

$$(X_{n-1,-}^- \cup X_{n-1,+}^-) \cap (Y_{n-1,-}^+ \cup Y_{n-1,+}^+) = \emptyset.$$

We moreover obtain

$$(X_{j,-}^- \cup X_{j,+}^-) \cap (Y_{j,-}^+ \cup Y_{j,+}^+) = \emptyset \quad \text{for } j \in \mathbb{N} \text{ with } i < j < n - 1.$$

Let $Z = \partial_{n-1}^+(X) *_i \partial_{n-1}^-(Y)$. By induction, Z is a $(n-1)$ -cell and

$$Z_{n-1} = X_{n-1,+} \cup Y_{n-1,-}.$$

Using Theorem 3.2.2.3(c), we get

$$X_n^- \cap Y_n^+ = \emptyset$$

which concludes the proof of (i).

For (ii), we already know that $\partial_{n-1}^-(X) *_i \partial_{n-1}^-(Y)$ and $\partial_{n-1}^+(X) *_i \partial_{n-1}^+(Y)$ are cells by induction. So, in order to prove that $X *_i Y$ is a cell, we just need to show that $X_n \cup Y_n$ is fork-free and moves $X_{n-1,-} \cup Y_{n-1,-}$ to $X_{n-1,+} \cup Y_{n-1,+}$. But

$$\begin{aligned} X_n^+ \cap Y_n^+ &= X_n^\pm \cap Y_n^+ && \text{(by (i))} \\ &\subseteq Z_{n-1} \cap Y_n^+ \\ &= \emptyset && \text{(by Theorem 3.2.2.3(a)).} \end{aligned}$$

Similarly,

$$X_n^- \cap Y_n^- = \emptyset$$

so $X_n \cup Y_n$ is fork-free. Using the dual of Theorem 3.2.2.3(a) with Z and X_n , we get

$$X_n^- \cap (X_{n-1,+} \cup Y_{n-1,-}) = X_n^- \cap Y_{n-1,-} = \emptyset.$$

Similarly, if $Z' = \partial_{n-1}^-(X) *_i \partial_{n-1}^-(Y)$ then $Z'_{n-1} = X_{n-1,-} \cup Y_{n-1,-}$. Using Theorem 3.2.2.3(a) with Z' and X_n , we have

$$X_n^+ \cap (X_{n-1,-} \cup Y_{n-1,-}) = X_n^+ \cap Y_{n-1,-} = \emptyset.$$

Since X_n moves $X_{n-1,-}$ to $X_{n-1,+}$, using Lemma 3.2.1.2, we deduce that

$$X_n \text{ moves } X_{n-1,-} \cup Y_{n-1,-} \text{ to } X_{n-1,+} \cup Y_{n-1,-}.$$

Similarly,

$$Y_n \text{ moves } X_{n-1,+} \cup Y_{n-1,-} \text{ to } X_{n-1,+} \cup Y_{n-1,+}.$$

Since $X_n^- \cap Y_n^+ = \emptyset$, by Lemma 3.2.1.3, we have

$$X_n \cup Y_n \text{ moves } X_{n-1,-} \cup Y_{n-1,-} \text{ to } X_{n-1,+} \cup Y_{n-1,+}.$$

Hence, $X *_i Y$ is a cell. □

We can finally conclude that $\text{Cell}(P)$ has a structure of ω -category given by the identity and composition operations on cells:

Theorem 3.2.3.3. *(Cell(P), ∂^- , ∂^+ , id, *) is an ω -category.*

Proof. We already know that $\text{Cell}(P)$ is a ω -globular set. By Lemma 3.2.3.2, the composition operation $*$ is well-defined on composable cells. Moreover, all the axioms of ω -categories (given in Section 1.4.1), follow readily from the definitions of ∂^- , ∂^+ , id and $*$. For example, consider the exchange law Axiom (S-v). Given $i, j, n \in \mathbb{N}$ with $i < j \leq n$ and $X, X', Y, Y' \in \text{Cell}(P)_n$ such that X, Y are i -composable, X, X' are j -composable and Y, Y' are j -composable, let

$$Z = (X *_j Y) *_i (X' *_j Y') \quad \text{and} \quad Z' = (X *_i X') *_j (Y *_i Y').$$

For $k \leq n$ and $\epsilon \in \{-, +\}$, we have

$$Z_{k,\epsilon} = Z'_{k,\epsilon} = \begin{cases} X_{k,\epsilon} \cup X'_{k,\epsilon} \cup Y_{k,\epsilon} \cup Y'_{k,\epsilon} & \text{when } k > j, \\ X_{j,-} \cup Y_{j,-} & \text{when } k = j \text{ and } \epsilon = -, \\ X'_{j,+} \cup Y'_{j,+} & \text{when } k = j \text{ and } \epsilon = +, \\ X_{k,\epsilon} \cup Y_{k,\epsilon} & \text{when } i < k < j, \\ X_{i,-} & \text{when } k = i \text{ and } \epsilon = -, \\ Y_{i,+} & \text{when } k = i \text{ and } \epsilon = +, \\ X_{k,\epsilon} & \text{when } k < i, \end{cases}$$

so $Z = Z'$. Thus, $\text{Cell}(P)$ satisfies Axiom (S-v), and the other axioms are shown as easily. Hence, the identity and composition operations equip $\text{Cell}(P)$ with a structure of ω -category. □

Remark 3.2.3.4. For the proof of Theorem 3.2.3.3, we did not use Axiom (T4), so that the same property holds for an ω -hypergraph which only satisfies Axioms (T0), (T1), (T2), (T3).

3.3 The freeness property

In this section, we prove that, given a torsion-free complex P , $\text{Cell}(P)$ is freely generated by the atoms, under the form of Corollary 3.3.3.5. More precisely, for $n \in \mathbb{N}$, we prove that $\text{Cell}(P)_{\leq n+1}$ is the free $(n+1)$ -category on the canonical n -cellular extension $(\text{Cell}(P)_{\leq n}, P_{n+1})$. For this purpose, we will use the characterization of the functor $-[-]: \text{Cat}_n^+ \rightarrow \text{Cat}_{n+1}$ given in Section 2.2. Concretely, we will prove that every $(n+1)$ -cell of $\text{Cell}(P)$ can be written as a composite

$$F_1[x_1] \bullet_n \cdots \bullet_n F_p[x_p]$$

and that this composition is essentially unique, relatively to the relation \approx defined in Section 2.2. We first prove that cells of $\text{Cell}(P)$ admit such decompositions. Then, we prove the unicity of the decomposition, first handling the case $p = 1$ and the general case afterwards.

In this section, we write P for a torsion-free complex.

3.3.1 Cell decompositions

Here, we prove that the n -cells of $\text{Cell}(P)$ can be written as composites of applied $(n-1)$ -context classes. Actually, we prove the stronger statement that such a composite exists for any total ordering, called *linear extensions*, of the top-level n -generators that respects the relation \triangleleft .

3.3.1.1 – Linear extensions. Given a finite poset $(S, <)$, a *linear extension* of $(S, <)$ is the data of a bijection $\sigma: \mathbb{N}_{|S|}^* \rightarrow S$ such that, for $i, j \in \mathbb{N}_{|S|}^*$, if $\sigma(i) < \sigma(j)$, then $i < j$. Given two linear extensions $\sigma, \sigma': \mathbb{N}_{|S|} \rightarrow S$, a *morphism of linear extensions* of $(S, <)$ between σ and σ' is a function $\rho: \mathbb{N}_{|S|}^* \rightarrow \mathbb{N}_{|S|}^*$ such that the triangle

$$\begin{array}{ccc} \mathbb{N}_{|S|}^* & \xrightarrow{\rho} & \mathbb{N}_{|S|}^* \\ & \searrow \sigma & \swarrow \sigma' \\ & S & \end{array}$$

is commutative (in particular, ρ is a bijection). We write $\text{LinExt}(S)$ for the category of linear extensions of S . Given $n \in \mathbb{N}$ and a bijection $\rho: \mathbb{N}_n^* \rightarrow \mathbb{N}_n^*$, we write $\text{Inv}(\rho) \in \mathbb{N}$ for the number of *inversions* of ρ , i.e.,

$$\text{Inv}(\rho) = |\{(i, j) \in \mathbb{N}_n^* \times \mathbb{N}_n^* \mid i < j \text{ and } \rho(i) > \rho(j)\}|$$

Moreover, given $i, j \in \mathbb{N}_n^*$ such that $i \neq j$, we write $\tau_{i,j}$ for the bijection $\mathbb{N}_n^* \rightarrow \mathbb{N}_n^*$ which is the transposition of i and j . We show that the morphisms of linear extensions are generated by the transpositions:

Lemma 3.3.1.2. *Given a poset $(S, <)$ and $\sigma, \sigma' \in \text{LinExt}(S)$ and $\rho: \sigma \rightarrow \sigma' \in \text{LinExt}(S)_1$, there exist $p \in \mathbb{N}$ and $\sigma_0, \dots, \sigma_p \in \text{LinExt}(S)$ with $\sigma = \sigma_0$ and $\sigma_p = \sigma'$, and $\rho_i: \sigma_{i-1} \rightarrow \sigma_i \in \text{LinExt}(S)$ for $i \in \mathbb{N}_p^*$ such that*

$$\rho = \rho_1 *_{\sigma} \cdots *_{\sigma} \rho_p \quad \text{and} \quad \rho_i \text{ is a transposition for } i \in \mathbb{N}_p^*.$$

Proof. We prove the result by induction on the number $\text{Inv}(\rho)$ of inversions of the bijection ρ . If $\text{Inv}(\rho) = 0$, then

$$\rho = 1_{\mathbb{N}_{|S|}^*} = \text{id}_{\sigma}^1.$$

So suppose that $\text{Inv}(\rho) > 0$. Thus, there exists $k \in \mathbb{N}_{|S|-1}^*$ such that $\rho(k) > \rho(k+1)$. The bijection $\bar{\sigma} = \sigma \circ \tau_{k,k+1}$ is then a linear extension of $(S, <)$ as in

$$\begin{array}{ccccc} \mathbb{N}_{|S|}^* & \xrightarrow{\tau_{k,k+1}} & \mathbb{N}_{|S|}^* & \xrightarrow{\rho \circ \tau_{k,k+1}} & \mathbb{N}_{|S|}^* \\ & \searrow \sigma & \downarrow \bar{\sigma} & \swarrow \sigma' & \\ & & S & & \end{array} .$$

Indeed, for $i, j \in \mathbb{N}_{|S|}^*$ such that $i \neq j$ and $\bar{\sigma}(i) < \bar{\sigma}(j)$,

- if $\{i, j\} \cap \{k, k+1\} = \emptyset$, then $\sigma(i) < \sigma(j)$ and $i < j$;
- if $i = k$ and $j \neq k+1$, then $\sigma(i+1) < \sigma(j)$ and $i+1 < j$, so $i < j$;
- if $i = k$ and $j = k+1$, then $i < j$;
- if $i = k+1$ and $j \neq k$, then $\sigma(i-1) < \sigma(j)$, so $i-1 < j$, and, since $j \neq i$, $i < j$;
- if $i = k+1$ and $j = k$, then $\sigma(k) < \sigma(k+1)$, so $\sigma'(\rho(k)) < \sigma'(\rho(k+1))$ and $\rho(k) < \rho(k+1)$, contradicting the hypothesis;
- if $i \notin \{k, k+1\}$ and $j \in \{k, k+1\}$, then $i < j$ like when $i \in \{k, k+1\}$ and $j \notin \{k, k+1\}$.

Moreover, the number of inversions of $\rho \circ \tau_{k,k+1}$ is $\text{Inv}(\rho) - 1$. By induction hypothesis, $\rho \circ \tau_{k,k+1}$ can be written as

$$\rho \circ \tau_{k,k+1} = \rho_2 * 0 \cdots * 0 \rho_p$$

for some $p \in \mathbb{N}$ and transpositions $\rho_i: \sigma_{i-1} \rightarrow \sigma_i \in \text{LinExt}(S)_1$ for $i \in \mathbb{N}_{p-1}^*$, so that

$$\rho = \tau_{k,k+1} * 0 \rho_2 * 0 \cdots * 0 \rho_p$$

is of the wanted form. □

3.3.1.3 – Decomposition theorem. In this paragraph, we show that cells can be decomposed as composites of applied context classes that respect the relation \triangleleft . First, we state a simple criterion for the equality of two cells in $\text{Cell}(P)$:

Lemma 3.3.1.4. *Given $k, n \in \mathbb{N}$ with $k < n$, $\epsilon \in \{-, +\}$ and $X, Y \in \text{Cell}(P)_n$ such that*

$$\partial_k^\epsilon(X) = \partial_k^\epsilon(Y) \quad \text{and} \quad X_{i,\epsilon} = Y_{i,\epsilon}$$

for $i \in \{k+1, \dots, n\}$, we have $X = Y$.

Proof. It is enough to prove the case $\epsilon = -$. Moreover, by induction on $n - k$, it is sufficient to prove the case $k = n - 1$. But, since X and Y are n -cells, we have

$$X_{k,+} = (X_{k,-} \cup X_n^+) \setminus X_n^- = (Y_{k,-} \cup Y_n^+) \setminus Y_n^- = Y_{n-1,+}$$

so that $X = Y$. □

Next, we show that we can write a cell as a composition by extracting a minimal element for \triangleleft :

Lemma 3.3.1.5. *Let $n \in \mathbb{N}^*$ and X be an n -cell and g be a minimal element of X_n for \triangleleft_{X_n} . Then, there exist n -cells Y and Z that are $(n-1)$ -composable such that*

$$Y_n = \{g\} \quad Z_n = X_n \setminus \{g\} \quad X = Y *_{n-1} Z.$$

Proof. Since g is minimal for \triangleleft_{X_n} , we have $\{g\}^\mp \subseteq X_{n-1,-}$. Moreover, since X is an n -cell, X_n is fork-free so that $\{g\} \perp (X_n \setminus \{g\})$. Thus, by Lemma 3.2.1.4, writing V for $(X_{n-1,-} \cup g^+) \setminus g^-$, we have that

$$\{g\} \text{ moves } X_{n-1,-} \text{ to } V \text{ and } X_n \setminus \{g\} \text{ moves } V \text{ to } X_{n-1,+}.$$

By Theorem 3.2.2.3, the cell $Y = \text{Glue}(\partial_{n-1}^-(X), \{g\})$ is an n -cell which satisfies that

$$Y_n = \{g\}, \quad \partial_{n-1}^-(Y) = \partial_{n-1}^-(X) \quad \text{and} \quad Y_{n-1,+} = V.$$

By Theorem 3.2.2.3 again, $Z = \text{Glue}(\partial_{n-1}^+(Y), X_n \setminus \{g\})$ is an n -cell such that

$$Z_n = X_n \setminus \{g\}, \quad \partial_{n-1}^-(Z) = \partial_{n-1}^+(Y) \quad \text{and} \quad Z_{n-1,+} = X_{n-1,+},$$

so that $\partial_{n-1}^+(Z) = \partial_{n-1}^+(X)$. Then, by the definition of $*_{n-1}$, we have $X = Y *_{n-1} Z$. \square

The previous lemma implies that we can write a cell as a composite of cells with a single top-level generator, that are moreover ordered by a given linear extension:

Lemma 3.3.1.6. *Let $n \in \mathbb{N}^*$ and X be an n -cell of P , $p = |X_n|$ and $\sigma: \mathbb{N}_p^* \rightarrow (X_n, \triangleleft_{X_n})$ be a linear extension. There exist n -cells X^1, \dots, X^p that are $(n-1)$ -composable and such that*

$$X_n^i = \{\sigma(i)\} \quad \text{for } i \in \mathbb{N}_p^* \quad \text{and} \quad X = X^1 *_{n-1} \cdots *_{n-1} X^p.$$

Proof. We prove this property by induction on p . When $p = 0$ or $p = 1$, then the property is trivial. So suppose that $p > 1$. Note that $\sigma(1)$ is minimal in X_n for \triangleleft_{X_n} . By Lemma 3.3.1.5, we can write $X = X^1 *_{n-1} X'$ where X^1 and X' are $(n-1)$ -composable n -cells such that $X_n^1 = \{\sigma(1)\}$ and $X'_n = X_n \setminus \{\sigma(1)\}$. By induction hypothesis, we have that $X' = X^2 *_{n-1} \cdots *_{n-1} X^p$ for some $(n-1)$ -composable n -cells X^2, \dots, X^p such that $X_n^i = \{\sigma(i)\}$ for $i \in \{2, \dots, p\}$, which concludes the proof. \square

Next, we give a sufficient criterion for a cell to be written as an applied context class:

Lemma 3.3.1.7. *Let $k, n \in \mathbb{N}$ with $k < n$, $g \in P_n$ and X be an n -cell such that*

$$X_{i,\epsilon} = \langle g \rangle_{i,\epsilon} \quad \text{for } i \in \{k+1, \dots, n\} \text{ and } \epsilon \in \{-, +\}.$$

There exists a k -context class F of type $\langle g \rangle$ such that $X = F[\langle g \rangle]$.

Proof. We show this property by induction on k . When $k = 0$, we have that $X_{i,\epsilon} = \langle g \rangle_{i,\epsilon}$ for $i \in \mathbb{N}_n^*$ and $\epsilon \in \{-, +\}$. Moreover, since X is an n -cell, we have that $\langle g \rangle_{1,-}$ moves $X_{0,-}$ to $X_{0,+}$, so that

$$\langle g \rangle_{1,-}^\mp = \langle g \rangle_{0,-} \subseteq X_{0,-}$$

Since $X_{0,-}$ is fork-free, we have $|X_{0,-}| = 1$. Thus, $X_{0,-} = \langle g \rangle_{0,-}$ and, similarly, $X_{0,+} = \langle g \rangle_{0,+}$. Hence, we have $X = \langle g \rangle$ and the property of the statement is verified with the unique 0-context class.

So suppose that $k > 0$. We have that $X_{k+1,\epsilon} = \langle g \rangle_{k+1,\epsilon}$ moves $X_{k,-}$ to $X_{k,+}$, so $\langle g \rangle_{k,-} \subseteq X_{k,-}$. By Axiom (T3), $\langle g \rangle_{k,-}$ is a segment for $\triangleleft_{X_{k,-}}$ and, by Lemma 3.2.1.8, there exist $U, V \subseteq X_{k,-}$ and $A, B \subseteq P_{k-1}$ such that

- $U, \langle g \rangle_{k,-}, V$ is a partition of $X_{k,-}$,
- U moves $X_{k-1,-}$ to A , $\langle g \rangle_{k,-}$ moves A to B and V moves B to $X_{k-1,+}$.

Writing

$$L = \text{Glue}(\partial_{k-1}^-(X), U) \quad X^k = \text{Glue}(\partial_{k-1}^+(L), \langle g \rangle_{k,-}) \quad R = \text{Glue}(\partial_{k-1}^+(X^k), V)$$

by Theorem 3.2.2.3, we have that L, X^k, R are k -cells that are $(k-1)$ -composable and such that

$$\partial_k^-(X) = L \bullet_{k-1} X^k \bullet_{k-1} R$$

By induction on $i \in \{k+1, n\}$, we define i -cells X^i such that $\partial_{i-1}^-(X^i) = X^{i-1}$ and $X_i^i = \langle g \rangle_{i,-}$ by putting

$$X^i = \text{Glue}(X^{i-1}, \langle g \rangle_{i,-})$$

which is indeed a cell by Theorem 3.2.2.3. Then, X^n is an n -cell such that

$$\partial_k^-(X^n) = X^k \quad \text{and} \quad X_{i,\epsilon}^n = \langle g \rangle_{i,\epsilon} \quad \text{for } i \in \{k, \dots, n\}.$$

Moreover, since $\partial_k^-(X^n) = X^k$,

$$L, X^n, R \text{ are } (k-1)\text{-composable} \quad \text{and} \quad \partial_k^-(L \bullet_{k-1} X^n \bullet_{k-1} R) = \partial_k^-(X).$$

Furthermore, we have that

$$X_{i,-} = \langle g \rangle_{i,-} = X_{i,-}^n = (L \bullet_{k-1} X^n \bullet_{k-1} R)_{i,-}$$

for $i \in \{k+1, n\}$ so that, by Lemma 3.3.1.4, we have that

$$X = L \bullet_{k-1} X^n \bullet_{k-1} R.$$

By induction hypothesis, there exists a $(k-1)$ -context class F' such that $X^n = F'[\langle g \rangle]$. Writing F for the k -context class $\llbracket (L, F', R) \rrbracket$, we have that $X = F[\langle g \rangle]$ as wanted. \square

We can now prove the decomposition theorem, which states that every cell of $\text{Cell}(P)$ can be written as a composite of applied context classes that respects a given linear extension:

Theorem 3.3.1.8. *Given $n \in \mathbb{N}^*$, an n -cell X , $p = |X_n|$ and a linear extension $\sigma: \mathbb{N}_p^* \rightarrow (X_n, \triangleleft_{X_n})$, there exist $(n-1)$ -context classes F_1, \dots, F_p of $\text{Cell}(P)$ respectively of type $\langle \sigma(1) \rangle, \dots, \langle \sigma(p) \rangle$ such that*

$$X = F_1[\langle \sigma(1) \rangle] \bullet_{n-1} \cdots \bullet_{n-1} F_p[\langle \sigma(p) \rangle].$$

Remark 3.3.1.9. By Axiom (T1), given $n \in \mathbb{N}^*$ and a finite subset $S \subseteq P_n$, there always exists a linear extension $\sigma: \mathbb{N}_{|P|}^* \rightarrow (S, \triangleleft_S)$, so that an n -cell X of P has at least one decomposition of the form given by Theorem 3.3.1.8.

Proof. By Lemma 3.3.1.6, X can be written

$$X = X^1 \bullet_{n-1} \cdots \bullet_{n-1} X^p$$

for some n -cells X^1, \dots, X^p such that $X_n^i = \{\sigma(i)\}$ for $i \in \mathbb{N}_p^*$. We conclude with Lemma 3.3.1.7. \square

We verify with the following property that Theorem 3.3.1.8 does not miss other possible decompositions:

Proposition 3.3.1.10. *Given $n \in \mathbb{N}^*$ and $X \in \text{Cell}(P)_n$ such that*

$$X = F_1[\langle x_1 \rangle] \bullet_{n-1} \cdots \bullet_{n-1} F_k[\langle x_k \rangle]$$

for some $k \in \mathbb{N}$, $x_1, \dots, x_k \in P_n$ and $(n-1)$ -context classes F_1, \dots, F_k of $\text{Cell}(P)$, we have

- (i) $X_n = \{x_1, \dots, x_k\}$,
- (ii) for $i, j \in \mathbb{N}_k^*$ with $i \neq j$, we have $x_i \neq x_j$,
- (iii) the function $p \mapsto x_p$ of type $\mathbb{N}_k^* \rightarrow X_n$ is a linear extension of $(X_n, \triangleleft_{X_n})$.

In particular, if X satisfies moreover that

$$X = F'_1[\langle y_1 \rangle] \bullet_{n-1} \cdots \bullet_{n-1} F'_l[\langle y_l \rangle]$$

for some $l \in \mathbb{N}$, $y_1, \dots, y_l \in P_n$ and $(n-1)$ -context classes F'_1, \dots, F'_l , then $k = l$ and

$$\{x_1, \dots, x_k\} = \{y_1, \dots, y_l\}.$$

Proof. Given $m < n$, $x \in P_n$ and an m -context class F of type $\langle x \rangle$, by a simple induction on m , one can prove that $(F[\langle x \rangle])_n = \{x\}$. Thus, by definition of \bullet_{n-1} , we have $X_n = \{x_1, \dots, x_k\}$, so (i) holds. Let $i, j \in \mathbb{N}_k^*$ with $i < j$, and Y, Z be the n -cells defined by

$$Y = F_1[\langle x_1 \rangle] \bullet_{n-1} \cdots \bullet_{n-1} F_i[\langle x_i \rangle] \quad \text{and} \quad Z = F_{i+1}[\langle x_{i+1} \rangle] \bullet_{n-1} \cdots \bullet_{n-1} F_k[\langle x_k \rangle].$$

Then $x_i \in Y_n$, $x_j \in Z_n$ and Y, Z are $(n-1)$ -composable. By Lemma 3.2.3.1, we have $Y_n \cap Z_n = \emptyset$. Hence, $x_i \neq x_j$, thus (ii) holds. Moreover, by Lemma 3.2.3.1 again, we have $(Y_n)^- \cap (Z_n)^+ = \emptyset$, so that $\neg(x_j \triangleleft_{X_n}^1 x_i)$. Thus, by contrapositive, given $i, j \in \mathbb{N}_k^*$ such that $x_i \triangleleft_{X_n}^1 x_j$, we have $i \leq j$, and in fact $i < j$ by Axiom (T1). Since \triangleleft_{X_n} is the transitive closure of $\triangleleft_{X_n}^1$, given $i, j \in \mathbb{N}_k^*$, we have that $x_i \triangleleft_{X_n} x_j$ implies $i < j$, so the function $p \mapsto x_p$ is a linear extension of $(X_n, \triangleleft_{X_n})$, which concludes the proof of (iii). \square

3.3.2 Freeness of decompositions of length one

In this section, we show the unicity of decomposition of cells of $\text{Cell}(P)$ as an applied context class, that is, given $k, n \in \mathbb{N}$ with $k < n$, $g \in P_n$ and k -context classes F_1, F_2 of type $\langle g \rangle$ of $\text{Cell}(P)$, then $F_1[\langle g \rangle] = F_2[\langle g \rangle]$ implies that $F_1 = F_2$. In order to show this, we first prove two technical lemmas on the manipulation of contexts by mutual induction. The first states that, as long as we respect the relation \triangleleft , we can modify the whiskers of the contexts:

Lemma 3.3.2.1. *Let $k, n \in \mathbb{N}^*$ with $k < n$, $\epsilon \in \{-, +\}$, $g \in P_n$ and $E = (L, F, R)$ be a k -context of type $\langle g \rangle$ of $\text{Cell}(P)$. Consider the following subsets of P_k :*

$$\begin{aligned} S &= L_k \cup R_k, & S' &= S \cup \langle g \rangle_{k,\epsilon}, \\ U &= \{y \in S \mid y \triangleleft_{S'} \langle g \rangle_{k,\epsilon}\}, & V &= \{y \in S \mid \langle g \rangle_{k,\epsilon} \triangleleft_{S'} y\}. \end{aligned}$$

Then, for every partition $U' \cup V'$ of S such that $U \subseteq U'$, $V \subseteq V'$, U' is initial in S and V' is final in S , there exists a k -context $E' = (L', F', R')$ of type X such that

$$L'_k = U', \quad R'_k = V', \quad E \approx_k E'.$$

For $k = 2$, Lemma 3.3.2.1 states that, given $g \in P_n$ for some $n > 2$ and a 2-context $E = (L, F, R)$ of type $\langle g \rangle$ Figure 3.6, E is equivalent through \approx_2 to a 2-context $E' = (L', F', R')$ as on the right of Figure 3.6. The second lemma gives sufficient conditions under which two composable context classes can be decomposed in a way that allows them to be exchanged by the relations \approx_k or \approx defined in Section 2.2:

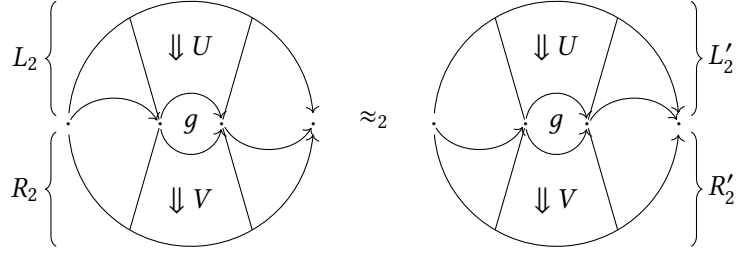

Figure 3.6 – Illustration of Lemma 3.3.2.1

Lemma 3.3.2.2. Let $k, n_1, n_2 \in \mathbb{N}^*$ with $k < \min(n_1, n_2)$, $g_1 \in P_{n_1}$, $g_2 \in P_{n_2}$, and F_1, F_2 be k -context classes of $\text{Cell}(P)$, of type $\langle g_1 \rangle$ and $\langle g_2 \rangle$ respectively, such that

$$F_1[\partial_k^+(\langle g_1 \rangle)] = F_2[\partial_k^-(\langle g_2 \rangle)] \quad \text{and} \quad \langle g_1 \rangle_{k,+} \cap \langle g_2 \rangle_{k,-} = \emptyset.$$

There exist k -context classes \bar{F}_1, \bar{F}_2 of type $\langle g_1 \rangle$ and $\langle g_2 \rangle$ respectively, such that

- either \bar{F}_1, \bar{F}_2 are $(k-1)$ -composable and

$$F_1 = \bar{F}_1 \bullet_{k-1} \bar{F}_2[\partial_k^-(\langle g_2 \rangle)] \quad F_2 = \bar{F}_1[\partial_k^+(\langle g_1 \rangle)] \bullet_{k-1} \bar{F}_2,$$

- or \bar{F}_2, \bar{F}_1 are $(k-1)$ -composable and

$$F_1 = \bar{F}_2[\partial_k^-(\langle g_2 \rangle)] \bullet_{k-1} \bar{F}_1 \quad F_2 = \bar{F}_2 \bullet_{k-1} \bar{F}_1[\partial_k^+(\langle g_1 \rangle)].$$

Proof. We prove the two lemmas by induction on k .

Proof of Lemma 3.3.2.1. Let $p = |L_k|$. Since U' is initial in S , $U' \cap L_k$ is initial for \triangleleft_{L_k} , so there exists a linear extension

$$\sigma: \mathbb{N}_p^* \rightarrow (L_k, \triangleleft_{L_k})$$

such that $\{i \in \mathbb{N}_p^* \mid \sigma(i) \in U'\} = \{1, \dots, i_0\}$ for some $i_0 \in \mathbb{N}_p$. Writting x_i for $\sigma(i)$ for $i \in \mathbb{N}_p^*$, by Theorem 3.3.1.8, L can be decomposed as

$$L = F_1[\langle x_1 \rangle] \bullet_{k-1} \cdots \bullet_{k-1} F_p[\langle x_p \rangle]$$

for some $(k-1)$ -context classes F_1, \dots, F_p . For $i \in \{i_0 + 1, \dots, p\}$, we aim at transferring $F_i[x_i]$ from L to R using the relation \approx_k on k -contexts. If $k = 1$, then $\langle x_1 \rangle, \dots, \langle x_p \rangle, \partial_1^\epsilon(\langle g \rangle)$ are 0-composable, so that

$$x_1 \triangleleft_{S'} \cdots \triangleleft_{S'} x_p \triangleleft_{S'} \langle g \rangle_{1,\epsilon}$$

which implies that $x_1, \dots, x_p \in U'$ and $i_0 = p$. Thus, we can suppose that $k > 1$. Assume moreover that $i_0 < p$. To transfer the $F_i[x_i]$'s, our plan is to use Lemma 3.3.2.2. We only need to show how to do this for $i = p$, and then iterate this procedure for $i \in \{i_0 + 1, \dots, p-1\}$.

Note that $F_p[\partial_{k-1}^+(\langle x_p \rangle)] = F[\partial_{k-1}^-(\langle g \rangle)]$. Moreover, since $x_p \notin U'$, we have $x_p \notin U$, so that

$$\langle x_p \rangle_{k-1,+} \cap \langle g \rangle_{k-1,-} = \emptyset.$$

Thus, using Lemma 3.3.2.2 inductively, we get $(k-1)$ -context classes \bar{F}_p and \bar{F} of type $\langle x_p \rangle$ and $\langle g \rangle$ such that

– either \bar{F}_p, \bar{F} are $(k-2)$ -composable and

$$F_p = \bar{F}_p \bullet_{k-2} \bar{F}[\partial_{k-1}^-(\langle g \rangle)] \qquad F = \bar{F}_p[\partial_{k-1}^+(\langle x_p \rangle)] \bullet_{k-2} \bar{F}$$

– or \bar{F}, \bar{F}_p are $(k-2)$ -composable and

$$F_p = \bar{F}[\partial_{k-1}^-(\langle g \rangle)] \bullet_{k-2} \bar{F}_p \qquad F = \bar{F} \bullet_{k-2} \bar{F}_p[\partial_{k-1}^+(\langle x_p \rangle)]$$

By symmetry, we can suppose that we are in the first situation. Then, by axiom (\approx -L) of \approx_k , we get that $E \approx_k \tilde{E}$ where $\tilde{E} = (\tilde{L}, \tilde{F}, \tilde{R})$ is such that

$$\begin{aligned} \tilde{L} &= F_1[\langle x_1 \rangle] \bullet_{k-1} \cdots \bullet_{k-1} F_{p-1}[\langle x_{p-1} \rangle] \\ \tilde{F} &= \bar{F}_p[\partial_{k-1}^-(\langle x_p \rangle)] \bullet_{k-2} \bar{F} \\ \tilde{R} &= (\bar{F}_p[\langle x_p \rangle] \bullet_{k-2} \bar{F}[\partial_{k-1}^+(\langle g \rangle)]) \bullet_{k-1} R \end{aligned}$$

By iterating the above procedure for $i \in \{i_0 + 1, \dots, p-1\}$, we obtain a k -context $E' = (L', F', R')$ of type $\langle g \rangle$ such that

$$E \approx_k E' \qquad L'_k = L_k \cap U' \qquad R'_k = R_k \cup (L_k \setminus U')$$

Using a similar method to transfer elements from R' to L' , we get a k -context $E'' = (L'', F'', R'')$ of type $\langle g \rangle$ such that

$$E' \approx_k E'' \qquad L''_k = L'_k \cup (R'_k \setminus V') \qquad R''_k = R'_k \cap V'$$

Then, we have $E \approx_k E''$ and we compute that

$$\begin{aligned} L''_k &= L'_k \cup (R'_k \setminus V') \\ &= (L_k \cap U') \cup (R_k \setminus V') \cup (L_k \setminus (U' \cup V')) \\ &= (L_k \cap U') \cup (R_k \cap U') && \text{(since } L_k \cup R_k = U' \cup V') \\ &= U' \end{aligned}$$

and, similarly, $R''_k = V'$. Thus, E'' satisfies the wanted properties.

Proof of Lemma 3.3.2.2. Let $E_k = (L^k, F^k, R^k)$ be such that $\llbracket E_k \rrbracket = F_k$ for $k \in \{1, 2\}$. Consider

$$\begin{aligned} M &= F_1[\partial_k^+(\langle g_1 \rangle)] && \text{(or, equivalently, } F_2[\partial_k^-(\langle g_2 \rangle)]), \\ S_i &= L_k^i \cup R_k^i && \text{for } i \in \{1, 2\}, \\ S' &= M_k, \\ U_1 &= \{x \in S_1 \mid x \triangleleft_{S'} \langle g_1 \rangle_{k,+}\} && V_1 = \{x \in S_1 \mid \langle g_1 \rangle_{k,+} \triangleleft_{S'} x\} \\ U_2 &= \{x \in S_2 \mid x \triangleleft_{S'} \langle g_2 \rangle_{k,-}\} && V_2 = \{x \in S_2 \mid \langle g_2 \rangle_{k,-} \triangleleft_{S'} x\} \end{aligned}$$

Since, by Axiom (T4), g_1 and g_2 are not in torsion with respect to $F_1[\partial_k^+(\langle g_1 \rangle)]$, we have

$$\text{either } \neg(\langle g_1 \rangle_{k,+} \triangleleft_{S'} \langle g_2 \rangle_{k,-}) \quad \text{or} \quad \neg(\langle g_2 \rangle_{k,-} \triangleleft_{S'} \langle g_1 \rangle_{k,+}).$$

By symmetry, we can suppose that $\neg(\langle g_2 \rangle_{k,-} \triangleleft_{S'} \langle g_1 \rangle_{k,+})$. Since we can use Lemma 3.3.2.1 (which is proved for the current value of k) to change E_1 and E_2 , we can suppose that

$$\begin{aligned} L_k^1 &= U_1, && R_k^1 = S_1 \setminus U_1, \\ L_k^2 &= S_2 \setminus V_2, && R_k^2 = V_2. \end{aligned}$$

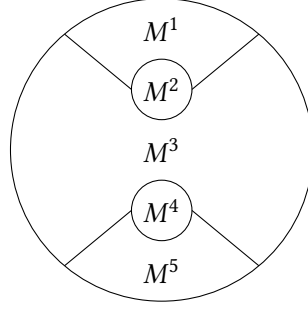
Figure 3.7 – The decomposition of M

Then,

$$(U_1 \cup \langle g_1 \rangle_{k,+}) \cap (\langle g_2 \rangle_{k,-} \cup V_2) = \emptyset$$

since, otherwise, it would contradict the condition $\neg(\langle g_2 \rangle_{k,-} \triangleleft_{S'} \langle g_1 \rangle_{k,+})$. Consider the following sets:

$$\begin{aligned} Q_1 &= U_1, & Q_2 &= \langle g_1 \rangle_{k,+}, \\ Q_3 &= S' \setminus (U_1 \cup \langle g_1 \rangle_{k,+} \cup \langle g_2 \rangle_{k,-} \cup V_2), \\ Q_4 &= \langle g_2 \rangle_{k,-}, & Q_5 &= V_2. \end{aligned}$$

Then Q_1, Q_2, Q_3, Q_4, Q_5 form a partition of S' . Moreover, this partition is compatible with $\triangleleft_{S'}$. Indeed, given $x, y \in S'$ such that $x \triangleleft_{S'} y$,

- if $x \in Q_2$, then we can not have $y \in Q_1$ since, by Axiom (T3), $\langle g_1 \rangle_{k,+}$ is a segment for $\triangleleft_{S'}$,
- if $x \in Q_3$, then we can not have $y \in Q_1 \cup Q_2$ (otherwise, we would have $x \in U_1 \cup \langle g_1 \rangle_{k,+}$),
- if $x \in Q_4$, then either $y \in Q_4$ or $y \in Q_5$ by definition of Q_5 ,
- if $x \in Q_5$, then $y \in Q_5$ since, by Axiom (T3), $\langle g_2 \rangle_{k,-}$ is a segment for $\triangleleft_{S'}$.

Thus, there exists a linear extension for $(S', \triangleleft_{S'})$

$$\sigma: \mathbb{N}_{S'} \rightarrow S'$$

such that, for $i, j \in \mathbb{N}_{|S'|}$ and $r, s \in \mathbb{N}_5^*$, if $\sigma(i) \in Q_r$ and $\sigma(j) \in Q_s$ with $r < s$, then $i < j$. Since $S' = M_k$, using Theorem 3.3.1.8, M can be written

$$M = \prod_{i=1}^{|S'|} F_i[\langle \sigma(i) \rangle]$$

for some $(k-1)$ -context classes $F_1, \dots, F_{|S'|}$. By gathering the terms corresponding to Q_1, \dots, Q_5 respectively, we obtain five k -cells $M^1, M^2, M^3, M^4, M^5 \in \text{Cell}(P)_k$ where

$$M^j = \prod_{i \in \sigma^{-1}(Q_j)} F_i[\langle \sigma(i) \rangle]$$

as in Figure 3.7 and such that

$$M = M^1 \bullet_{k-1} M^2 \bullet_{k-1} M^3 \bullet_{k-1} M^4 \bullet_{k-1} M^5.$$

Since

$$\partial_{k-1}^-(L^1) = \partial_{k-1}^-(M) = \partial_{k-1}^-(M^1) \quad \text{and} \quad L_k^1 = U_1 = M_k^1,$$

by Lemma 3.3.1.4, we have $L^1 = M^1$. Moreover, since

$$\partial_{k-1}^-(F'_1[\langle g_1 \rangle]) = \partial_{k-1}^+(L^1) = \partial_{k-1}^+(M^1) = \partial_{k-1}^-(M^2) \quad \text{and} \quad (F'_1[\partial_k^+(\langle g_1 \rangle)])_k = \langle g_1 \rangle_{k,+} = M_k^2,$$

by Lemma 3.3.1.4, it implies that

$$F'_1[\partial_k^+(\langle g_1 \rangle)] = M^2$$

Similarly, we can show that

$$F'_2[\partial_k^-(\langle g_2 \rangle)] = M^4 \quad \text{and} \quad R^2 = M^5.$$

Moreover, since

$$\partial_{k-1}^-(L^2) = \partial_{k-1}^-(M) = \partial_{k-1}^-(M^1 \bullet_{k-1} M^2 \bullet_{k-1} M^3),$$

and

$$\begin{aligned} L_k^2 &= S_2 \setminus V_2 \\ &= S' \setminus (\langle g_2 \rangle_{k,-} \cup V_2) \\ &= Q_1 \cup Q_2 \cup Q_3, \end{aligned}$$

by Lemma 3.3.1.4, we have

$$L^2 = M^1 \bullet_{k-1} M^2 \bullet_{k-1} M^3.$$

Similarly, we have

$$R^1 = M^3 \bullet_{k-1} M^4 \bullet_{k-1} M^5.$$

Hence, writing

$$\bar{F}_1 = \llbracket (L^1, F'_1, \text{id}_{F'_1[\partial_{k-1}^+(\langle g_1 \rangle)]}^k) \rrbracket \quad \text{and} \quad \bar{F}_2 = \llbracket (M^3, F'_2, R^2) \rrbracket$$

we have

$$F_1 = \bar{F}_1 \bullet_{k-1} \bar{F}_2[\partial_k^-(\langle g_2 \rangle)] \quad \text{and} \quad F_2 = \bar{F}_1[\partial_k^+(\langle g_1 \rangle)] \bullet_{k-1} \bar{F}_2$$

as wanted. □

From these two lemmas, we deduce that applied context classes are completely determined by their sources (or targets):

Theorem 3.3.2.3. *Given $k, n \in \mathbb{N}$ with $k < n$, $g \in P_n$ and k -context classes F_1, F_2 of type $\langle g \rangle$ such that*

$$\partial_k^-(F_1[\langle g \rangle]) = \partial_k^-(F_2[\langle g \rangle]) \quad \text{or} \quad \partial_k^+(F_1[\langle g \rangle]) = \partial_k^+(F_2[\langle g \rangle]),$$

we have $F_1 = F_2$.

Proof. By symmetry, it is enough to prove the case where $\partial_k^-(F_1[\langle g \rangle]) = \partial_k^-(F_2[\langle g \rangle])$. We prove this property by an induction on k . If $k = 0$, the result is trivial. So suppose that $k > 0$. Let

$$E_1 = (L^1, F'_1, R^1) \quad \text{and} \quad E_2 = (L^2, F'_2, R^2)$$

be k -contexts such that $F_i = \llbracket E_i \rrbracket$ for $i \in \{1, 2\}$. Thus,

$$L^1 \bullet_{k-1} F'_1[\partial_k^-(\langle g \rangle)] \bullet_{k-1} R^1 = L^2 \bullet_{k-1} F'_2[\partial_k^-(\langle g \rangle)] \bullet_{k-1} R^2$$

In particular, $L_k^1 \cup \langle g \rangle_{k,-} \cup R_k^1 = L_k^2 \cup \langle g \rangle_{k,-} \cup R^2$ and, by Lemma 3.2.3.1, both sides are partitions, so that we have $L_k^1 \cup R_k^1 = L_k^2 \cup R_k^2$. Consider the following subsets of P_k :

$$\begin{aligned} S &= L_k^1 \cup R_k^1, & S' &= S \cup \langle g \rangle_{k,-}, \\ U &= \{x \in S \mid x \triangleleft_{S'} \langle g \rangle_{k,-}\}, & V &= S \setminus U. \end{aligned}$$

By Lemma 3.3.2.1, we can suppose that

$$L_k^1 = L_k^2 = U \quad \text{and} \quad R_k^1 = R_k^2 = V.$$

For $i \in \{1, 2\}$, we have

$$\partial_{k-1}^-(L^i) = \partial_{k-1}^-(F_i[\langle g \rangle]) = \partial_{k-1}^- \circ \partial_k^-(F_i[\langle g \rangle])$$

so that $\partial_{k-1}^-(L^1) = \partial_{k-1}^-(L^2)$. Thus, by Lemma 3.3.1.4, we have

$$L^1 = L^2$$

and, by a similar argument, $R^1 = R^2$. Moreover, for $i \in \{1, 2\}$, $\partial_{k-1}^+(L^i) = \partial_{k-1}^+(F'_i[\langle g \rangle])$, so

$$\partial_{k-1}^+(F'_1[\langle g \rangle]) = \partial_{k-1}^+(F'_2[\langle g \rangle]).$$

By induction hypothesis, we have $F'_1 = F'_2$. Hence, $F_1 = F_2$. \square

In particular, we can conclude a unique decomposition of cells as applied context classes:

Corollary 3.3.2.4. *Given $k, n \in \mathbb{N}$ with $k < n$, $g \in P_n$ and k -context classes F_1, F_2 , both of type $\langle g \rangle$ such that $F_1[\langle g \rangle] = F_2[\langle g \rangle]$, we have $F_1 = F_2$.*

Proof. In particular, we have $\partial_k^-(F_1[\langle g \rangle]) = \partial_k^-(F_2[\langle g \rangle])$ so Theorem 3.3.2.3 applies. \square

3.3.3 Freeness of general decompositions

We now consider the general case and prove the unicity, up to the relation \approx of formal sequences of applied context classes, of the decompositions of cells as composites of several applied context classes of $\text{Cell}(P)$. By the characterization of $-[-]^n$ given in Section 2.2, it will entail that $\text{Cell}(P)_{\leq n+1}$ is the free $(n+1)$ -category on the canonical n -cellular extension $(\text{Cell}(P)_{\leq n}, P_{n+1})$ introduced below and, more generally, that $\text{Cell}(P)$ is freely generated by the atoms $\langle x \rangle$ for $x \in P$.

3.3.3.1 – The canonical cellular extension. Given $n \in \mathbb{N}$, there is an n -cellular extension

$$\text{Cell}(P)_{\leq n} \xleftarrow[\partial_n^+ \circ \langle - \rangle]{\partial_n^- \circ \langle - \rangle} P_{n+1}$$

where, for $x \in P_{n+1}$ and $\epsilon \in \{-, +\}$, $\partial_n^\epsilon \circ \langle - \rangle(x) = \partial_n^\epsilon(\langle x \rangle)$, which is an n -cell by Axiom (T2). We write $\text{Cell}(P)^{n+}$ for the $(n+1)$ -category

$$\text{Cell}(P)^{n+} = \text{Cell}(P)_{\leq n} [P_{n+1}]$$

i.e., the image of $(\text{Cell}(P)_{\leq n}, P_{n+1}) \in \text{Cat}_n^+$ by the functor $-[-]^n: \text{Cat}_n^+ \rightarrow \text{Cat}_{n+1}$. Remember from Section 2.2 that the $(n+1)$ -cells of $\text{Cell}(P)^{n+}$ are the quotients under \approx of n -sequences

$$((g_1, F_1), \dots, (g_k, F_k))^s$$

where $g_i \in P_{n+1}$ and F_i is an n -context class of type $\partial_n^-(\langle g \rangle)$ for $i \in \mathbb{N}_k^*$. For conciseness, given $g \in P_{n+1}$ and an n -context class of type $\partial_n^-(\langle g \rangle)$, we write $F[g]$ for

$$F[g] = \llbracket ((g, F))^s \rrbracket \in (\text{Cell}(P)^{n+1})_{n+1}.$$

There is a morphism of n -cellular extension

$$(\text{Cell}(P)_{\leq n}, P_{n+1}) \xrightarrow{(\text{id}_{\text{Cell}(P)_{\leq n}}, \langle - \rangle)} (\text{Cell}(P)_{\leq n}, \text{Cell}(P)_{n+1})$$

which maps $x \in P_{n+1}$ to $\langle - \rangle(x) = \langle x \rangle$. By the universal property of $\text{Cell}(P)^{n+1}$ discussed in Section 1.3.2, it induces a unique $(n+1)$ -functor

$$\text{eval}^n : \text{Cell}(P)^{n+1} \rightarrow \text{Cell}(P)_{\leq n+1}$$

often written eval for conciseness, such that

$$\text{eval}_{\leq n}^n = \text{id}_{\text{Cell}(P)_{\leq n}} \quad \text{and} \quad \text{eval}(F[g]) = F[\langle g \rangle]$$

for all $g \in P_{n+1}$ and n -context class F of type $\partial_n^-(\langle g \rangle)$.

3.3.3.2 – Freeness of $\text{Cell}(P)$. We now show the freeness of $\text{Cell}(P)$ by proving the unicity of decomposition of cells as sequences of applied context classes up to the relation \approx . First, we show an analogous of Theorem 3.3.1.8, *i.e.*, that the decompositions in $\text{Cell}(P)^{n+1}$ can also be reordered by linear extensions:

Lemma 3.3.3.3. *Let $n \in \mathbb{N}$ and X be an $(n+1)$ -cell of $\text{Cell}(P)^{n+1}$ such that*

$$X = F_1[x_1] \bullet_n \cdots \bullet_n F_p[x_p]$$

for some $p \in \mathbb{N}$, $x_1, \dots, x_p \in P_{n+1}$ and n -context classes F_1, \dots, F_p of $\text{Cell}(P)$. Then, we have that the function $q \mapsto x_q$ of type $\mathbb{N}_q^* \rightarrow X_{n+1}$ is a linear extension of $(X_{n+1}, \triangleleft_{X_{n+1}})$. Moreover, if σ is a linear extension of $(X_{n+1}, \triangleleft_{X_{n+1}})$, then there exist n -context classes $\bar{F}_1, \dots, \bar{F}_p$ of respective types $\langle \sigma(1) \rangle, \dots, \langle \sigma(p) \rangle$ such that

$$X = \bar{F}_1[\sigma(1)] \bullet_n \cdots \bullet_n \bar{F}_p[\sigma(p)].$$

Proof. Write $\rho: \mathbb{N}_p \rightarrow X_{n+1}$ for the function such that

$$\rho(i) = x_i$$

for $i \in \mathbb{N}_p^*$. By the functoriality of eval , we have

$$\text{eval}(X) = F_1[\langle x_1 \rangle] \bullet_n \cdots \bullet_n F_p[\langle x_p \rangle]$$

so that ρ is a linear extension by Proposition 3.3.1.10. We are left to prove the second part of the statement. We have a morphism of linear extensions

$$f = \sigma^{-1} \circ \rho$$

between σ and ρ . By Lemma 3.3.1.2, we can suppose that $f = \tau_{i,i+1}$ for some $i \in \mathbb{N}_{p-1}^*$. To conclude, we only need to show that x_i and x_{i+1} can be swapped in the decomposition of X as $F_1[x_1] \bullet_n \cdots \bullet_n F_p[x_p]$. By contradiction, suppose that $\langle x_i \rangle_{n,+} \cap \langle x_{i+1} \rangle_{n,-} \neq \emptyset$. In particular, we have $\rho(i) \triangleleft_{X_{n+1}} \rho(i+1)$. Since $\rho = \sigma \circ \tau_{i,i+1}$, it implies $\sigma(i+1) \triangleleft_{X_{n+1}} \sigma(i)$. Thus, since σ is a

linear extension, we deduce that $i + 1 < i$, which is a contradiction. So $\langle x_i \rangle_{n,+} \cap \langle x_{i+1} \rangle_{n,-} = \emptyset$. By Lemma 3.3.2.2, there exist n -context classes \bar{F}_i and \bar{F}_{i+1} such that, in $\text{Cell}(P)_{\leq n} [P_{n+1}]^{\approx}$,

$$((x_i, F_i), (x_{i+1}, F_{i+1}))^s \approx ((x_{i+1}, \bar{F}_i), (x_i, \bar{F}_{i+1}))^s$$

so that

$$\begin{aligned} & ((x_1, F_1), \dots, (x_p, F_p))^s \\ \approx & ((x_1, F_1), \dots, (x_{i-1}, F_{i-1}), (x_{i+1}, \bar{F}_i), (x_i, \bar{F}_{i+1}), (x_{i+2}, F_{i+2}), \dots, (x_p, F_p))^s \end{aligned}$$

i.e., in $\text{Cell}(P)^{n+}$,

$$X = F_1[x_1] \bullet_n \cdots \bullet_n F_{i-1}[x_{i-1}] \bullet_n \bar{F}_i[x_{i+1}] \bullet_n \bar{F}_{i+1}[x_i] \bullet_n F_{i+2}[x_{i+2}] \bullet_n \cdots \bullet_n F_p[x_p]$$

which concludes the proof. \square

We can now deduce that $\text{Cell}(P)_{\leq n+1}$ is canonically a free extension on $\text{Cell}(P)_{\leq n}$:

Theorem 3.3.3.4. *For $n \in \mathbb{N}$, $\text{eval}^n : \text{Cell}(P)^{n+} \rightarrow \text{Cell}(P)_{\leq n+1}$ is an isomorphism.*

Proof. Since $\text{eval}_{\leq n} = \text{id}_{\text{Cell}(P)_{\leq n}}$, it is enough to prove that eval induces a bijection on the $(n+1)$ -cells. By Theorem 3.3.1.8, it is surjective, so we are left to prove injectivity. Let X^1 and X^2 be $(n+1)$ -cells of $\text{Cell}(P)^{n+}$, such that $\text{eval}(X^1) = \text{eval}(X^2)$ and

$$X^i = F_1^i[x_1^i] \bullet_n \cdots \bullet_n F_{p_i}^i[x_{p_i}^i]$$

for some $p_i \in \mathbb{N}$, $x_1^i, \dots, x_{p_i}^i \in P_{n+1}$ and n -context classes $F_1^i, \dots, F_{p_i}^i$ for $i \in \{1, 2\}$. By functoriality of eval , we have

$$\text{eval}(X^i) = F_1^i[\langle x_1^i \rangle] \bullet_n \cdots \bullet_n F_{p_i}^i[\langle x_{p_i}^i \rangle]$$

for $i \in \{1, 2\}$, so that, by Proposition 3.3.1.10, we have $p_1 = p_2$, and we write p for the common value. Moreover,

$$\{x_1^1, \dots, x_p^1\} = \{x_1^2, \dots, x_p^2\}.$$

By Lemma 3.3.3.3, we can suppose that $x_j^1 = x_j^2$ for $j \in \mathbb{N}_p^*$, and we write x_j for the common value. Since $\partial_n^-(X^i) = \partial_n^-(F_1^i[x_1])$ for $i \in \{1, 2\}$, we have

$$\partial_n^-(F_1^1[x_1]) = \partial_n^-(F_1^2[x_1])$$

so that, by Theorem 3.3.2.3, $F_1^1 = F_1^2$. In particular, $\partial_n^+(F_1^1[x_1]) = \partial_n^+(F_1^2[x_1])$, so that

$$\partial_n^-(F_2^1[x_2] \bullet_n \cdots \bullet_n F_p^1[x_p]) = \partial_n^-(F_2^2[x_2] \bullet_n \cdots \bullet_n F_p^2[x_p])$$

Thus, we can iterate the above procedure to show that $F_j^1 = F_j^2$ for $j \in \{1, \dots, p\}$, so that $X^1 = X^2$. Hence, the $(n+1)$ -functor eval is an isomorphism. \square

By an inductive argument, we conclude that $\text{Cell}(P)$ is freely generated by the atoms:

Corollary 3.3.3.5. *There are unique polygraph $Q \in \mathbf{Pol}_\omega$ and ω -functor $F : Q^* \rightarrow \text{Cell}(P) \in \mathbf{Cat}_\omega$ such that $Q_n = P_n$ for $n \in \mathbb{N}$ and $F(g) = \langle g \rangle$ for $g \in P$. Moreover, F is an isomorphism.*

Proof. We show by induction on $n \in \mathbb{N}$ that there are unique n -polygraph Q^n and morphism

$$F^n: (Q^n)^* \rightarrow \text{Cell}(P)_{\leq n}$$

such that $Q_k^n = P_k$ for $k \in \mathbb{N}$ and $F^n(g) = \langle g \rangle$ for $g \in Q^n$, and that F^n is moreover an isomorphism. This is clear for $n = 0$. So suppose that $n > 0$. If Q^n and F^n as above exist, then, by the unicity property of the induction hypothesis, we have $Q_{\leq n-1}^n = Q^{n-1}$ and $F_{\leq n-1}^n = F^{n-1}$. The n -functor F^n is then uniquely defined by the universal property of $(Q^n)^* = (Q^{n-1})^*[Q^n]$ given by Theorem 1.3.2.3 knowing that $F^n(g) = \langle g \rangle$ for $g \in Q^n$. Moreover, the n -polygraph structure on Q^n is unique since

$$d_{n-1}^\epsilon(g) = (F^{n-1})^{-1} \circ \partial_{n-1}^\epsilon(\langle g \rangle) \quad (3.27)$$

for $g \in Q_n^n$ and $\epsilon \in \{-, +\}$. Finally, F^n is an isomorphism since, by Theorem 3.3.3.4, $(\text{eval}^{n-1})^{-1} \circ F^n$ is the image by $-[-]^{n-1}$ of the isomorphism

$$(F^{n-1}, 1_{P_n}): ((Q^{n-1})^*, Q_n^n) \rightarrow (\text{Cell}(P)_{\leq n-1}, P_n) \in \text{Cat}_{n-1}^+$$

so that the unicity of Q^n and F^n , and the fact that F^n is an isomorphism are proved. For existence, one defines the n -polygraph structure on Q^n from the one on Q^{n-1} and with (3.27), and the n -functor F^n is then defined by extending F^{n-1} , using the universal property of $(Q^n)^*$.

Thus, by the definition of Pol_ω and Proposition 1.2.3.12, we obtain unique ω -polygraph Q and ω -functor $F: Q^* \rightarrow \text{Cell}(P)$, such that $Q_n = P_n$ for $n \in \mathbb{N}$ and $F(g) = \langle g \rangle$, and F is moreover an isomorphism. \square

3.4 Relating formalisms

This section aims at relating all the introduced formalisms together. In particular, we show that the formalism of torsion-free complexes is a Rosetta stone that can express the other ones (after correcting the defect of parity complexes and pasting schemes). Embedding parity complexes into torsion-free complexes is almost direct, since they share the same definition of cells and several axioms. However, additional developments are needed for translating pasting schemes and augmented directed complexes into torsion-free complexes. Indeed, in the first case, one needs to show that a definition of cells analogous to the ones of pasting schemes can be used for torsion-free complexes before being able to relate the axioms of the two formalisms. In the second case, one needs to link the abelian group setting of augmented directed complexes to the set setting of torsion-free complexes.

We first introduce two other set-based definitions of cells for torsion-free complexes: *closed-well-formed fgs's* and *maximal-well-formed fgs's* (Section 3.4.1). The former is similar to the well-formed fgs of pasting schemes, while the latter is a convenient intermediate between the cells of torsion-free complexes and closed-well-formed fgs's. The ω -categories of cells induced by these two other definitions is then isomorphic to the one obtained with the initial definition (Theorems 3.4.1.24 and 3.4.1.27). Using the more natural definition of cells as *closed-well-formed fgs's*, we give a characterization of polygraphs that can be represented by torsion-free complex (Theorem 3.4.1.29) and illustrate the use of torsion-free complexes with an extension of cat_{eq} that enables to specify cells more easily (Paragraph 3.4.1.32). Next, we show the embeddings of parity complexes (Section 3.4.2) and pasting schemes (Section 3.4.3) into torsion-free complexes. Then, we develop the relation between the set-based and group-based definitions of cells before showing the embedding augmented directed complexes into torsion-free complexes (Section 3.4.4). Finally, we illustrate that those are the only embeddings between the formalisms by providing counter-examples to the other ones (Section 3.4.5).

3.4.1 Closed and maximal cells

In this section, we introduce two other set-based definitions of cells for torsion-free complexes, namely closed-well-formed fgs's and maximal-well-formed fgs's, together with identity and compositions operations for them. We moreover provide translation functions between the different definitions of cells, and show that the ω -categories of cells with the new definitions are isomorphic to the one with the original definition of cells (Theorems 3.4.1.24 and 3.4.1.27). Using this different representation, we characterize the polygraphs that can be represented by torsion-free complexes (Theorem 3.4.1.29). Finally, we illustrate the use of torsion-free complexes by introducing an extension of cateq based on closed-well-formed fgs's (Paragraph 3.4.1.32).

3.4.1.1 – Definitions. Let P be an ω -hypergraph. Recall the definitions of fgs and closed fgs from Paragraph 3.1.3.6. We write

$$\text{Closed}(P)$$

for the graded set of closed fgs's of P . Given an n -fgs X of P , $x \in X$ is said to be *maximal in X* when for all $y \in P$ such that $x R y$ and $x \neq y$, it holds that $y \notin X$. We write $\max(X)$ for the n -fgs of P made of the maximal elements of X . The n -fgs X is then said to be *maximal* when $\max(X) = X$. We write

$$\text{Max}(P)$$

for the gradet set of maximal fgs. Given $n \in \mathbb{N}$ and X an n -pre-cell of P , we write $\cup X$ for the n -fgs of P given by

$$\cup X = \bigcup_{i \in \mathbb{N}_n} (X_{i,-} \cup X_{i,+}).$$

3.4.1.2 – Maximality lemma. Let P be an ω -hypergraph. In order to relate the cells of $\text{Cell}(P)$ with the fgs's of $\text{Max}(P)$, we give here a simple criterion to characterize the maximal elements in a cell of $\text{Cell}(P)$:

Lemma 3.4.1.3 (Maximality lemma). *Suppose that P satisfies Axioms (T0), (T1), (T2) and (T3). Let $k, n \in \mathbb{N}$ with $k < n$ and $X \in \text{Cell}(P)_n$. For $x \in X_{k,-}$ (resp. $x \in X_{k,+}$) with x not maximal in $\cup X$, we have $x \in X_{k+1,-}^{\mp}$ (resp. $x \in X_{k+1,+}^{\pm}$).*

Proof. We prove this property by induction on $l = n - k$. By symmetry, we only prove the case where $x \in X_{k,-}$. Since x is not maximal, by definition of R , there exist

$$p \in \mathbb{N}^*, \quad \eta \in \{-, +\}, \quad x_0, x_1, \dots, x_p \in P \quad \text{and} \quad \epsilon_1, \dots, \epsilon_p \in \{-, +\}$$

such that

$$x_0 = x, \quad x_p \in X_{k+p,\eta} \quad \text{and} \quad x_i \in x_{i+1}^{\epsilon_{i+1}} \quad \text{for } i \in \mathbb{N}_{p-1}.$$

Suppose that $p = 1$. By Lemma 3.2.1.1, we have

$$X_{k,-} \cap X_{k+1,\eta}^+ = \emptyset.$$

Since $x \in x_1^{\epsilon_1}$ and $x_1 \in X_{k+1,\eta}$, we have

$$\epsilon_1 = - \quad \text{and} \quad x \in X_{k+1,\eta}^{\mp}.$$

so that, by Lemma 3.2.1.5, $x \in X_{k+1,-}^{\mp}$.

Otherwise, suppose that $p > 1$. Let $y \in X_{k+p,\eta}$ be the smallest of $X_{k+p,\eta}$ for $\triangleleft_{X_{k+p,\eta}}$ such that $y R x_{p-1}$. If $x_{p-1} \in y^-$, then, by minimality of y , there is no $\bar{y} \in X_{k+p,\eta}$ such that $x_{p-1} \in \bar{y}^+$. Therefore,

$$x_{p-1} \in X_{k+p,\eta}^{\mp} \subseteq X_{k+p-1,-}.$$

Hence, x is not minimal in $\partial_{k+p-1}^-(X)$ and we conclude by induction. We now consider the case $x_{p-1} \in y^+$. Let

$$G = \{z \in X_{k+p,\eta} \mid z \triangleleft_{X_{k+p,\eta}} y\} \cup \{y\} \quad \text{and} \quad Y = \text{Act}(\partial_{k+p-1}^-(X), G).$$

We have $x \in Y_{k,-}$ and $x_{p-1} \in Y_{k+p-1}$. Moreover, by Theorem 3.2.2.3, Y is a cell. By induction hypothesis, we have $x \in Y_{k+1,-}^\mp$. Since $X_{k+1,-}$ and $Y_{k+1,-}$ both move $X_{k,-}$ to $X_{k,+}$, by Lemma 3.2.1.5, we have $x \in X_{k+1,-}^\mp$ which concludes the proof. \square

The above criterion gives a simple description of the set of maximal elements of a cell of $\text{Cell}(P)$.

Lemma 3.4.1.4. *Suppose that P satisfies Axioms (T0), (T1), (T2) and (T3). Let $k, n \in \mathbb{N}$ with $k < n$, an n -cell $X \in \text{Cell}(P)_n$ and $\epsilon \in \{-, +\}$. Then,*

$$\max(\cup X) \cap P_k = X_{k,-} \cap X_{k,+}.$$

Proof. By Lemma 3.4.1.3,

$$\max(\cup X) \cap P_k = (X_{k,-} \setminus X_{k+1,-}^\mp) \cup (X_{k,+} \setminus X_{k+1,+}^\pm).$$

By Lemma 3.2.1.6, it can be simplified to

$$\max(\cup X) \cap P_k = X_{k,-} \cap X_{k,+}. \quad \square$$

3.4.1.5 – The translation functions. We now provide *translation functions* between the graded sets $\text{Cell}(P)$, $\text{Max}(P)$ and $\text{Closed}(P)$ and introduce several properties on them. The functions we introduce are the ones represented on the diagram

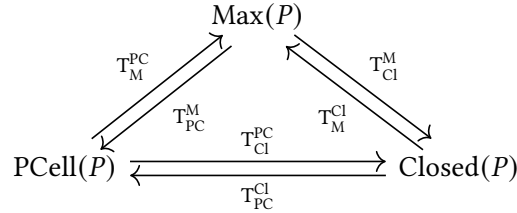

and are defined as follows:

- $T_M^{PC} : \text{PCell}(P) \rightarrow \text{Max}(P)$ is defined by

$$T_M^{PC}(X) = \max(\cup X) \text{ for } X \text{ an } n\text{-pre-cell of } P,$$

- $T_{PC}^M : \text{Max}(P) \rightarrow \text{PCell}(P)$ is such that, for X an n -fgs of P , $T_{PC}^M(X)$ is the n -pre-cell Y of P defined by

$$Y_n = X_n$$

and

$$Y_{i,-} = X_i \cup Y_{i+1,-}^\mp \quad Y_{i,+} = X_i \cup Y_{i+1,+}^\pm$$

for $i \in \mathbb{N}_{n-1}$,

- $T_{Cl}^M : \text{Max}(P) \rightarrow \text{Closed}(P)$ is defined by

$$T_{Cl}^M(X) = R(X) \text{ for } X \text{ a maximal } n\text{-fgs of } P,$$

- $T_M^{\text{Cl}}: \text{Closed}(P) \rightarrow \text{Max}(P)$ is defined by

$$T_M^{\text{Cl}}(X) = \max(X) \text{ for } X \text{ a closed } n\text{-fgs,}$$

- $T_{\text{Cl}}^{\text{PC}}: \text{PCell}(P) \rightarrow \text{Closed}(P)$ is defined by

$$T_{\text{Cl}}^{\text{PC}}(X) = R(\cup X) \text{ for } X \text{ an } n\text{-pre-cell of } P,$$

- $T_{\text{PC}}^{\text{Cl}}: \text{Closed}(P) \rightarrow \text{PCell}(P)$ is defined by

$$T_{\text{PC}}^{\text{Cl}} = T_{\text{PC}}^{\text{M}} \circ T_M^{\text{Cl}}.$$

These operations can be related to each other, as state the following lemmas.

Proposition 3.4.1.6. *We have $T_{\text{Cl}}^{\text{M}} \circ T_M^{\text{Cl}} = 1_{\text{Closed}(P)}$ and $T_M^{\text{Cl}} \circ T_{\text{Cl}}^{\text{M}} = 1_{\text{Max}(P)}$.*

Proof. Let X be a closed n -fgs of P and $x \in X$. We have $T_M^{\text{Cl}}(X) \subseteq X$ so

$$T_{\text{Cl}}^{\text{M}} \circ T_M^{\text{Cl}}(X) \subseteq X.$$

Moreover, for $x \in X$, since X is finite, there is $y \in \max(X)$ with $y R x$. It implies that $y \in T_M^{\text{Cl}}(X)$ and $x \in T_{\text{Cl}}^{\text{M}} \circ T_M^{\text{Cl}}(X)$. Therefore,

$$X \subseteq T_{\text{Cl}}^{\text{M}} \circ T_M^{\text{Cl}}(X),$$

which shows that

$$T_{\text{Cl}}^{\text{M}} \circ T_M^{\text{Cl}} = 1_{\text{Closed}(P)}.$$

For the other equality, note that, for all n -fgs X of P , $R(X)$ has the same maximal elements as X . It implies that

$$T_M^{\text{Cl}} \circ T_{\text{Cl}}^{\text{M}} = 1_{\text{Max}(P)}. \quad \square$$

Lemma 3.4.1.7. *Suppose that P satisfies Axioms (T0), (T1), (T2) and (T3). Let $n \in \mathbb{N}$, $X \in \text{Cell}(P)_n$ and $Y = T_M^{\text{PC}}(X)$. Then,*

$$Y_n = X_n \quad \text{and} \quad Y_i = X_{i,-} \cap X_{i,+} \text{ for } i \in \mathbb{N}_{n-1}.$$

Proof. This is a direct consequence of Lemma 3.4.1.4. □

Proposition 3.4.1.8. *Suppose that P satisfies Axioms (T0), (T1), (T2) and (T3). Then, given a cell $X \in \text{Cell}(P)$, we have $T_{\text{PC}}^{\text{M}} \circ T_M^{\text{PC}}(X) = X$.*

Proof. Let $n \in \mathbb{N}$, $X \in \text{Cell}(P)_n$, $Y = T_M^{\text{PC}}(X)$ and $Z = T_{\text{PC}}^{\text{M}}(Y)$. For $i \in \mathbb{N}_n$ and $\epsilon \in \{-, +\}$, we show that $X_{i,\epsilon} = Z_{i,\epsilon}$ by a decreasing induction on i . By Lemma 3.4.1.7, we have

$$Z_n = Y_n = X_n$$

and, for $i \in \mathbb{N}_{n-1}$, we have

$$\begin{aligned} Z_{i,-} &= Y_i \cup Z_{i+1,-}^{\mp} \\ &= (X_{i,-} \cap X_{i,+}) \cup X_{i+1,-}^{\mp} \\ &= X_{i,-} \end{aligned} \quad \text{(by Lemma 3.2.1.7).}$$

Similarly,

$$Z_{i,+} = X_{i,+},$$

so $X = Z$. Hence, $T_{\text{PC}}^{\text{M}} \circ T_M^{\text{PC}}(X) = X$. □

Proposition 3.4.1.9. *We have $T_{\text{Cl}}^{\text{M}} \circ T_{\text{M}}^{\text{PC}} = T_{\text{Cl}}^{\text{PC}}$.*

Proof. Let $n \in \mathbb{N}$ and $X \in \text{PCell}(P)_n$. Then,

$$\begin{aligned} T_{\text{Cl}}^{\text{M}} \circ T_{\text{M}}^{\text{PC}}(X) &= R(\max(\cup X)) \\ &= R(\cup X) \\ &= T_{\text{Cl}}^{\text{PC}}(X). \end{aligned}$$

Hence, $T_{\text{Cl}}^{\text{M}} \circ T_{\text{M}}^{\text{PC}} = T_{\text{Cl}}^{\text{PC}}$. □

3.4.1.10 – Sources and targets. Here, we define source and target operations for the graded sets $\text{Closed}(P)$ and $\text{Max}(P)$. Later, we will show that they respectively equip the subsets of well-formed closed fgs and well-formed maximal fgs with a structure of ω -globular set. For now, we prove that these operations are compatible with the translation operations.

Given $n \in \mathbb{N}^*$ and a closed n -fgs X , we define the *source* $\bar{\partial}_{n-1}^-(X)$ (resp. *target* $\bar{\partial}_{n-1}^+(X)$) of X as the closed $(n-1)$ -fgs Y defined by

$$Y = R(X \setminus (X_n \cup R(X_n^+))) \quad (\text{resp. } R(X \setminus (X_n \cup R(X_n^-))).$$

Respectively, given $n \in \mathbb{N}^*$ and a maximal n -fgs X , we define the *source* $\tilde{\partial}_{n-1}^-(X)$ (resp. *target* $\tilde{\partial}_{n-1}^+(X)$) of X as the maximal $(n-1)$ -fgs Y such that

$$Y_{n-1} = X_{n-1} \cup X_n^{\mp} \quad (\text{resp. } Y_{n-1} = X_{n-1} \cup X_n^{\pm}) \quad \text{and} \quad Y_i = X_i \quad \text{for } i \in \mathbb{N}_{n-2}.$$

When P satisfies enough axioms of torsion-free complexes, we can prove several compatibility results between these source and target operations and the translation functions, in the form of the following propositions.

Proposition 3.4.1.11. *If P satisfies Axioms (T0), (T1), (T2) and (T3), then, for $n \in \mathbb{N}^*$, $\epsilon \in \{-, +\}$ and $X \in \text{Cell}(P)_n$, we have*

$$T_{\text{M}}^{\text{PC}}(\partial_{n-1}^{\epsilon}(X)) = \tilde{\partial}_{n-1}^{\epsilon}(T_{\text{M}}^{\text{PC}}(X)).$$

Proof. Let $Y = T_{\text{M}}^{\text{PC}}(\partial_{n-1}^{\epsilon}(X))$, $X' = T_{\text{M}}^{\text{PC}}(X)$ and $Z = \tilde{\partial}_{n-1}^{\epsilon}(X')$. By Lemma 3.4.1.7, we have

$$Y_{n-1} = X_{n-1, \epsilon} \quad \text{and} \quad Y_i = X_{i, -} \cap X_{i, +} \quad \text{for } i \in \mathbb{N}_{n-1}.$$

Moreover,

$$X'_n = X_n \quad \text{and} \quad X'_i = X_{i, -} \cap X_{i, +} \quad \text{for } i \in \mathbb{N}_{n-1}.$$

If $\epsilon = -$, then, by Lemma 3.2.1.7,

$$Z_{n-1} = (X_{n-1, -} \cap X_{n-1, +}) \cup X_n^{\mp} = X_{n-1, -}$$

and $Z_i = X'_i = X_{i, -} \cap X_{i, +}$ for $i \in \mathbb{N}_{n-1}$, so $Y = Z$. Similarly, if $\epsilon = +$, we have $Y = Z$. □

Proposition 3.4.1.12. *For $n \in \mathbb{N}^*$, $\epsilon \in \{-, +\}$ and $X \in \text{Max}(P)_n$, we have*

$$T_{\text{Cl}}^{\text{M}}(\tilde{\partial}_{n-1}^{\epsilon}(X)) = \bar{\partial}_{n-1}^{\epsilon}(T_{\text{Cl}}^{\text{M}}(X)).$$

Proof. By symmetry, it is sufficient to handle the case $\epsilon = -$. Let

$$Y = T_{\text{Cl}}^{\text{M}}(\tilde{\partial}_{n-1}^-(X)) \quad \text{and} \quad Z = \bar{\partial}_{n-1}^-(T_{\text{Cl}}^{\text{M}}(X))$$

By unfolding the definitions, we have

$$Y = R((X \setminus X_n) \cup X_n^\mp) \quad \text{and} \quad Z = R(R(X) \setminus (X_n \cup R(X_n^+))).$$

In order to show that $Y \subseteq Z$, we only need to prove that $Y' \subseteq Z$ where

$$Y' = (X \setminus X_n) \cup X_n^\mp.$$

First, we have that $Y' \subseteq R(X)$. Moreover,

$$\begin{aligned} Y' \cap (X_n \cup R(X_n^+)) &= ((X \setminus X_n) \cup X_n^\mp) \cap (X_n \cup R(X_n^+)) \\ &= ((X \setminus X_n) \cup X_n^\mp) \cap R(X_n^+) \\ &= (X \setminus X_n) \cap R(X_n^+) \\ &= X \cap R(X_n^+) \\ &= \emptyset \end{aligned} \quad (\text{since } X \text{ is maximal}).$$

So $Y' \subseteq Z$, which implies that $Y \subseteq Z$.

Similarly, in order to show that $Z \subseteq Y$, we only need to prove that $Z' \subseteq Y$ where

$$Z' = R(X) \setminus (X_n \cup R(X_n^+)).$$

But

$$Z' \subseteq Y \Leftrightarrow R(X) \subseteq Y \cup X_n \cup R(X_n^+)$$

and

$$\begin{aligned} Y \cup X_n \cup R(X_n^+) &= R((X \setminus X_n) \cup X_n^\mp) \cup X_n \cup R(X_n^+) \\ &= R((X \setminus X_n) \cup X_n^\mp \cup X_n^+) \cup X_n \\ &= R((X \setminus X_n) \cup X_n^- \cup X_n^+) \cup X_n \\ &= R((X \setminus X_n) \cup X_n^- \cup X_n^+ \cup X_n) \\ &= R(X). \end{aligned}$$

So $Z' \subseteq Y$, which implies that $Z \subseteq Y$. Hence, $Y = Z$, which concludes the proof. \square

Proposition 3.4.1.13. *If P satisfies Axioms (T0), (T1), (T2) and (T3), then, for $n \in \mathbb{N}^*$, $\epsilon \in \{-, +\}$ and $X \in \text{Cell}(P)_n$,*

$$\mathbb{T}_{\text{Cl}}^{\text{PC}}(\partial_{n-1}^\epsilon(X)) = \tilde{\partial}_{n-1}^\epsilon(\mathbb{T}_{\text{Cl}}^{\text{PC}}(X)).$$

Proof. We have

$$\begin{aligned} \mathbb{T}_{\text{Cl}}^{\text{PC}}(\partial_{n-1}^\epsilon(X)) &= \mathbb{T}_{\text{Cl}}^{\text{M}} \circ \mathbb{T}_{\text{M}}^{\text{PC}}(\partial_{n-1}^\epsilon(X)) && \text{(by Proposition 3.4.1.9)} \\ &= \mathbb{T}_{\text{Cl}}^{\text{M}}(\tilde{\partial}_{n-1}^\epsilon(\mathbb{T}_{\text{M}}^{\text{PC}}(X))) && \text{(by Proposition 3.4.1.11)} \\ &= \tilde{\partial}_{n-1}^\epsilon(\mathbb{T}_{\text{Cl}}^{\text{M}} \circ \mathbb{T}_{\text{M}}^{\text{PC}}(X)) && \text{(by Proposition 3.4.1.12)} \\ &= \tilde{\partial}_{n-1}^\epsilon(\mathbb{T}_{\text{Cl}}^{\text{PC}}(X)) \end{aligned}$$

which concludes the proof. \square

3.4.1.14 – Identities and compositions. Here, we define identity and composition operations for the graded sets $\text{Max}(P)$ and $\text{Closed}(P)$, and prove some compatibility results with the translations functions.

Given $n \in \mathbb{N}$ and a closed (resp. maximal) n -fgs X , we define the *identity of X* as the closed (resp. maximal) $(n+1)$ -fgs $\text{id}^{n+1}(X)$ defined by

$$\text{id}^{n+1}(X) = (X_0, \dots, X_n, \emptyset).$$

Given $i, n \in \mathbb{N}$ with $i < n$ and two maximal n -fgs X, Y , we define the *maximal i -composition of X and Y* as the maximal n -fgs $X *_i^M Y$ defined by

$$X *_i^M Y = \max(\text{R}(X) \cup \text{R}(Y)).$$

Respectively, given $i, n \in \mathbb{N}$ with $i < n$ and two closed n -fgs X, Y , we define the *closed i -composition of X and Y* as the closed n -fgs $X *_i^{\text{Cl}} Y$ defined by

$$X *_i^{\text{Cl}} Y = X \cup Y.$$

For simplicity, we sometimes write $*^{\text{Cl}}$ (resp. $*^M$) for $*_i^{\text{Cl}}$ (resp. $*_i^M$). We now prove several compatibility results of the identity and composition operations with the translation functions.

Proposition 3.4.1.15. For $n \in \mathbb{N}$ and an n -cell $X \in \text{Cell}(P)$,

$$\text{T}_{\text{Cl}}^{\text{PC}}(\text{id}^{n+1}(X)) = \text{id}^{n+1}(\text{T}_{\text{Cl}}^{\text{PC}}(X)).$$

Proof. It readily follows from the definitions. □

Proposition 3.4.1.16. For $n \in \mathbb{N}$ and an n -cell $X \in \text{Cell}(P)$,

$$\text{T}_M^{\text{PC}}(\text{id}^{n+1}(X)) = \text{id}^{n+1}(\text{T}_M^{\text{PC}}(X)).$$

Proof. It readily follows from the definitions. □

Proposition 3.4.1.17. For $i, n \in \mathbb{N}$ with $i < n$, and i -composable n -cells X and Y in $\text{Cell}(P)$,

$$\text{T}_{\text{Cl}}^{\text{PC}}(X *_i Y) = \text{T}_{\text{Cl}}^{\text{PC}}(X) *_i^{\text{Cl}} \text{T}_{\text{Cl}}^{\text{PC}}(Y).$$

Proof. Let $Z = X *_i Y$. We have

$$\text{T}_{\text{Cl}}^{\text{PC}}(X *_i Y) = \text{R}(\cup Z)$$

and

$$\text{T}_{\text{Cl}}^{\text{PC}}(X) *_i^{\text{Cl}} \text{T}_{\text{Cl}}^{\text{PC}}(Y) = \text{R}(\cup X) \cup \text{R}(\cup Y) = \text{R}((\cup X) \cup (\cup Y)).$$

By definition of composition, $\cup Z \subseteq (\cup X) \cup (\cup Y)$, so

$$\text{T}_{\text{Cl}}^{\text{PC}}(X *_i Y) \subseteq \text{T}_{\text{Cl}}^{\text{PC}}(X) *_i^{\text{Cl}} \text{T}_{\text{Cl}}^{\text{PC}}(Y).$$

For the other inclusion, note that $X_{j,\epsilon} \subseteq Z_{j,\epsilon}$ for $j \in \mathbb{N}_n$ and $\epsilon \in \{-, +\}$ with $(j, \epsilon) \neq (i, +)$, and

$$\begin{aligned} X_{i,+} &= (X_{i,-} \cup X_{i+1,-}^+) \setminus X_{i+1,-}^- \\ &\subseteq Z_{i,-} \cup Z_{i+1,-}^+ \\ &\subseteq \text{R}(\cup Z) \end{aligned}$$

so $\cup X \subseteq R(\cup Z)$. Similarly, $\cup Y \subseteq R(\cup Z)$, thus

$$(\cup X) \cup (\cup Y) \subseteq R(\cup Z),$$

which implies that

$$T_{Cl}^{PC}(X) *_i^{Cl} T_{Cl}^{PC}(Y) \subseteq T_{Cl}^{PC}(X *_i Y).$$

Hence,

$$T_{Cl}^{PC}(X) *_i^{Cl} T_{Cl}^{PC}(Y) = T_{Cl}^{PC}(X *_i Y). \quad \square$$

Proposition 3.4.1.18. For $i, n \in \mathbb{N}$ with $i < n$, and $X, Y \in \text{Closed}(P)_n$,

$$T_M^{Cl}(X *_i^{Cl} Y) = T_M^{Cl}(X) *_i^M T_M^{Cl}(Y).$$

Proof. We have

$$\begin{aligned} T_M^{Cl}(X) *_i^M T_M^{Cl}(Y) &= \max(R(T_M^{Cl}(X)) \cup R(T_M^{Cl}(Y))) \\ &= \max(X \cup Y) && \text{(by Proposition 3.4.1.6)} \\ &= T_M^{Cl}(X *_i^{Cl} Y) \end{aligned}$$

which concludes the proof. \square

Proposition 3.4.1.19. For $i, n \in \mathbb{N}$ with $i < n$, and i -composable n -cells X and Y of P ,

$$T_M^{PC}(X *_i Y) = T_M^{PC}(X) *_i^M T_M^{PC}(Y).$$

Proof. We have

$$\begin{aligned} T_M^{PC}(X *_i Y) &= T_M^{Cl} \circ T_{Cl}^{PC}(X *_i Y) && \text{(by Propositions 3.4.1.6 and 3.4.1.9)} \\ &= T_M^{Cl}(T_{Cl}^{PC}(X) *_i^{Cl} T_{Cl}^{PC}(Y)) && \text{(by Proposition 3.4.1.13)} \\ &= T_M^{Cl} \circ T_{Cl}^{PC}(X) *_i^M T_M^{Cl} \circ T_{Cl}^{PC}(Y) && \text{(by Proposition 3.4.1.18)} \\ &= T_M^{PC}(X) *_i^M T_M^{PC}(Y) && \text{(by Propositions 3.4.1.6 and 3.4.1.9)} \end{aligned}$$

which concludes the proof. \square

3.4.1.20 – Well-formed cells. We defined above source, target, identity and composition operations for both $\text{Closed}(P)$ and $\text{Max}(P)$. However, these operations are not expected to equip the graded sets $\text{Closed}(P)$ and $\text{Max}(P)$ with a structure of ω -category (in fact, not even a structure of ω -globular set). In order to obtain an ω -category, we need to restrict to subsets of “well-formed” elements of $\text{Closed}(P)$ and $\text{Max}(P)$. Then, we can show that the two induced ω -category of cells are isomorphic to $\text{Cell}(P)$.

Let P be an ω -hypergraph. Given $n \in \mathbb{N}$ and $X \in \text{Closed}(P)_n$, we say that X is *closed-well-formed* when

- X_n is fork-free,
- $\bar{\partial}_{n-1}^-(X)$ and $\bar{\partial}_{n-1}^+(X)$ are closed-well-formed,
- if $n \geq 2$, $\bar{\partial}_{n-2}^- \circ \bar{\partial}_{n-1}^-(X) = \bar{\partial}_{n-2}^- \circ \bar{\partial}_{n-1}^+(X)$ and $\bar{\partial}_{n-2}^+ \circ \bar{\partial}_{n-1}^-(X) = \bar{\partial}_{n-2}^+ \circ \bar{\partial}_{n-1}^+(X)$.

We write $\text{Closed}_{WF}(P)$ for the graded set of closed-well-formed fgs of P . Respectively, given $n \in \mathbb{N}$ and $X \in \text{Max}(P)_n$, we say that X is *maximal-well-formed* when

- X_n is fork-free,
- $\tilde{\partial}_{n-1}^-(X)$ and $\tilde{\partial}_{n-1}^+(X)$ are maximal-well-formed,
- if $n \geq 2$, $\tilde{\partial}_{n-2}^- \circ \tilde{\partial}_{n-1}^-(X) = \tilde{\partial}_{n-2}^- \circ \tilde{\partial}_{n-1}^+(X)$ and $\tilde{\partial}_{n-2}^+ \circ \tilde{\partial}_{n-1}^-(X) = \tilde{\partial}_{n-2}^+ \circ \tilde{\partial}_{n-1}^+(X)$.

We write $\text{Max}_{\text{WF}}(P)$ for the graded set of maximal-well-formed fgs of P . We now aim at proving that both $\text{Closed}_{\text{WF}}(P)$ and $\text{Max}_{\text{WF}}(P)$ are ω -categories isomorphic to $\text{Cell}(P)$ when P satisfies enough axioms of torsion-free complexes. We first show this property for $\text{Max}_{\text{WF}}(P)$ after introducing several technical results.

Lemma 3.4.1.21. *If P satisfies Axioms (T0), (T1), (T2) and (T3), then, for $n \in \mathbb{N}$ and $X \in \text{Cell}(P)_n$, we have $\text{T}_M^{\text{PC}}(X) \in \text{Max}_{\text{WF}}(P)_n$.*

Proof. We proceed by induction on n . If $n = 0$, the result is trivial. So suppose that $n > 0$ and let $Y = \text{T}_M^{\text{PC}}(X)$. Since $Y_n = X_n$, Y_n is fork-free. Moreover, by Proposition 3.4.1.11, we have

$$\tilde{\partial}_{n-1}^\epsilon(Y) = \text{T}_M^{\text{PC}}(\partial_{n-1}^\epsilon(X)) \quad \text{for } \epsilon \in \{-, +\}.$$

By the induction hypothesis, $\tilde{\partial}_{n-1}^\epsilon(Y)$ is maximal-well-formed. And, when $n \geq 2$, for $\eta \in \{-, +\}$, we have

$$\begin{aligned} \tilde{\partial}_{n-2}^\eta \circ \tilde{\partial}_{n-1}^\eta(Y) &= \text{T}_M^{\text{PC}}(\partial_{n-2}^\eta \circ \partial_{n-1}^\eta(X)) && \text{(by Proposition 3.4.1.11)} \\ &= \text{T}_M^{\text{PC}}(\partial_{n-2}^\eta \circ \partial_{n-1}^+(X)) \\ &= \tilde{\partial}_{n-2}^\eta \circ \tilde{\partial}_{n-1}^+(Y). \end{aligned}$$

Hence, Y is maximal-well-formed. □

Lemma 3.4.1.22. *If P satisfies Axioms (T0), (T1), (T2) and (T3), then, for $n \in \mathbb{N}$ and $X \in \text{Max}_{\text{WF}}(P)_n$, there exists an n -cell $Y \in \text{Cell}(P)_n$ such that $\text{T}_M^{\text{PC}}(Y) = X$.*

Proof. We proceed by induction on n . If $n = 0$, the result is trivial. So suppose that $n > 0$. By induction, let $S, T \in \text{Cell}(P)_{n-1}$ be such that $\text{T}_M^{\text{PC}}(S) = \tilde{\partial}_{n-1}^-(X)$ and $\text{T}_M^{\text{PC}}(T) = \tilde{\partial}_{n-1}^+(X)$. When $n \geq 2$, for $\epsilon \in \{-, +\}$, we have

$$\begin{aligned} \partial_{n-2}^\epsilon(S) &= \text{T}_{\text{PC}}^{\text{M}} \circ \text{T}_M^{\text{PC}}(\partial_{n-2}^\epsilon(S)) && \text{(by Proposition 3.4.1.8)} \\ &= \text{T}_{\text{PC}}^{\text{M}}(\tilde{\partial}_{n-2}^\epsilon(\text{T}_M^{\text{PC}}(S))) && \text{(by Proposition 3.4.1.11)} \\ &= \text{T}_{\text{PC}}^{\text{M}}(\tilde{\partial}_{n-2}^\epsilon \circ \tilde{\partial}_{n-1}^\eta(X)) \\ &= \text{T}_{\text{PC}}^{\text{M}}(\tilde{\partial}_{n-2}^\epsilon \circ \tilde{\partial}_{n-1}^+(X)) && \text{(because } X \text{ is maximal-well-formed)} \\ &= \text{T}_{\text{PC}}^{\text{M}}(\tilde{\partial}_{n-2}^\epsilon(\text{T}_M^{\text{PC}}(T))) \\ &= \text{T}_{\text{PC}}^{\text{M}} \circ \text{T}_M^{\text{PC}}(\partial_{n-2}^\epsilon(T)) \\ &= \partial_{n-2}^\epsilon(T). \end{aligned}$$

Moreover,

$$\begin{aligned} (S_{n-1} \cup X_n^+) \setminus X_n^- &= (X_{n-1} \cup X_n^\mp \cup X_n^+) \setminus X_n^- \\ &= X_{n-1} \cup X_n^\pm \\ &= T_{n-1}. \end{aligned}$$

Similarly, $(T_{n-1} \cup X_n^-) \setminus X_n^+ = S_{n-1}$ so X_n moves S_{n-1} to T_{n-1} . Hence, the n -pre-cell Y defined by

$$Y_n = X_n, \quad Y_{n-1,-} = S_{n-1}, \quad Y_{n-1,+} = T_{n-1} \quad \text{and} \quad Y_{i,\delta} = S_{i,\delta} \quad \text{for } i \in \mathbb{N}_{n-2} \text{ and } \delta \in \{-, +\}$$

is an n -cell. Let $Z = T_M^{\text{PC}}(Y)$. We have $Z_n = X_n$ and

$$\begin{aligned} \tilde{\partial}_{n-1}^-(Z) &= \tilde{\partial}_{n-1}^-(T_M^{\text{PC}}(Y)) \\ &= T_M^{\text{PC}}(\tilde{\partial}_{n-1}^-(Y)) && \text{(by Proposition 3.4.1.11)} \\ &= T_M^{\text{PC}}(S) \\ &= \tilde{\partial}_{n-1}^-(X). \end{aligned}$$

So, by definition of $\tilde{\partial}^-$, we have

$$Z_{n-1} \cup X_n^\mp = X_{n-1} \cup X_n^\mp \quad \text{and} \quad Z_i = X_i \quad \text{for } i \in \mathbb{N}_{n-2}.$$

Since X and Z are maximal, we have

$$X_{n-1} \cap X_n^\mp = Z_{n-1} \cap X_n^\mp = \emptyset.$$

Hence, $X_{n-1} = Z_{n-1}$ and $X = Z = T_M^{\text{PC}}(Y)$ which concludes the proof. \square

Lemma 3.4.1.23. *If P satisfies Axioms (T0), (T1), (T2) and (T3), then, T_M^{PC} induces a bijection between $\text{Cell}(P)$ and $\text{Max}_{\text{WF}}(P)$.*

Proof. By Lemma 3.4.1.22, $T_M^{\text{PC}}: \text{Cell}(P) \rightarrow \text{Max}_{\text{WF}}(P)$ is surjective and, by Proposition 3.4.1.8, it is injective, so it is bijective. \square

We can now deduce that maximal-well-formed fgs's are an adequate alternative definition of cells for torsion-free complexes:

Theorem 3.4.1.24. *If P satisfies Axioms (T0), (T1), (T2) and (T3), then, $\text{Max}_{\text{WF}}(P)$ is an ω -category and T_M^{PC} induces an isomorphism between $\text{Cell}(P)$ and $\text{Max}_{\text{WF}}(P)$.*

Proof. By definition of $\text{Max}_{\text{WF}}(P)$, the functions $\tilde{\partial}_k^-, \tilde{\partial}_k^+$ for $k \in \mathbb{N}$ equip $\text{Max}_{\text{WF}}(P)$ with a structure of ω -globular set. We first prove that the composition operation $*^M$ restricts to $\text{Max}_{\text{WF}}(P)$. Let $i, n \in \mathbb{N}$ with $i < n$, and $X, Y \in \text{Max}_{\text{WF}}(P)_n$ be such that $\tilde{\partial}_i^+(X) = \tilde{\partial}_i^-(Y)$. By Lemma 3.4.1.23, there exist $X', Y' \in \text{Cell}(P)_n$ such that $T_M^{\text{PC}}(X') = X$ and $T_M^{\text{PC}}(Y') = Y$. By Proposition 3.4.1.11, we have

$$T_M^{\text{PC}}(\partial_i^+(X')) = \tilde{\partial}_i^+(X) = \tilde{\partial}_i^-(Y) = T_M^{\text{PC}}(\partial_i^-(Y')),$$

and, by Lemma 3.4.1.23, $\partial_i^+(X') = \partial_i^-(Y')$ so X' and Y' are i -composable. By Lemma 3.4.1.23, we have $T_M^{\text{PC}}(X' *_i Y') \in \text{Max}_{\text{WF}}(P)$ and, by Proposition 3.4.1.19, $X *_i^M Y \in \text{Max}_{\text{WF}}(P)$.

By Propositions 3.4.1.11, 3.4.1.16 and 3.4.1.19, T_M^{PC} commutes with the source, target, identity and composition operations and is a bijection when restricted to $\text{Max}_{\text{WF}}(P)$, so that $\text{Max}_{\text{WF}}(P)$ is an ω -category since $\text{Cell}(P)$ is (by Theorem 3.2.3.3 and Remark 3.2.3.4), and T_M^{PC} induces an isomorphism of ω -categories. \square

We prove a similar property for closed-well-formed fgs's after showing some technical results.

Lemma 3.4.1.25. T_{Cl}^M induces a bijection between $\text{Max}_{\text{WF}}(P)$ and $\text{Closed}_{\text{WF}}(P)$.

Proof. We already know that T_{Cl}^M is a bijection by Proposition 3.4.1.6. For $n \in \mathbb{N}$, we show that T_{Cl}^M sends a maximal-well-formed n -fgs X to a closed-well-formed n -fgs by induction on n . If $n = 0$, the result is trivial. So suppose that $n > 0$. Let $Y = T_{\text{Cl}}^M(X)$. Then, $Y_n = X_n$ is fork-free and,

for $\epsilon \in \{-, +\}$, we have $\bar{\partial}_{n-1}^\epsilon(Y) = T_{\text{Cl}}^{\text{M}}(\tilde{\partial}_{n-1}^\epsilon(X))$ by Proposition 3.4.1.12, and it is closed-well-formed by induction. Moreover, when $n \geq 2$,

$$\begin{aligned} \bar{\partial}_{n-2}^\epsilon \circ \bar{\partial}_{n-1}^\epsilon(Y) &= T_{\text{Cl}}^{\text{M}}(\tilde{\partial}_{n-2}^\epsilon \circ \tilde{\partial}_{n-1}^\epsilon(X)) && \text{(by Proposition 3.4.1.12)} \\ &= T_{\text{Cl}}^{\text{M}}(\tilde{\partial}_{n-2}^\epsilon \circ \tilde{\partial}_{n-1}^{\pm}(X)) \\ &= \bar{\partial}_{n-2}^\epsilon \circ \bar{\partial}_{n-1}^{\pm}(Y) \end{aligned}$$

so Y is closed-well-formed. Similarly, T_{M}^{Cl} sends closed-well-formed fgs to maximal-well-formed fgs, which concludes the proof. \square

Lemma 3.4.1.26. *If P satisfies Axioms (T0), (T1), (T2) and (T3), then, $T_{\text{Cl}}^{\text{PC}}$ induces a bijection between $\text{Cell}(P)$ and $\text{Closed}_{\text{WF}}(P)$.*

Proof. The result is a consequence of Proposition 3.4.1.9 and Lemmas 3.4.1.23 and 3.4.1.25. \square

We can now conclude that closed-well-formed fgs's are an adequate alternative definition of cells for torsion-free complexes:

Theorem 3.4.1.27. *If P satisfies Axioms (T0), (T1), (T2) and (T3), then, $\text{Closed}_{\text{WF}}(P)$ is an ω -category and $T_{\text{Cl}}^{\text{PC}}$ induces an isomorphism between $\text{Cell}(P)$ and $\text{Closed}_{\text{WF}}(P)$.*

Proof. By a proof similar to the one of Theorem 3.4.1.24, using Propositions 3.4.1.13, 3.4.1.15 and 3.4.1.17 and Lemma 3.4.1.26. \square

3.4.1.28 – From polygraphs to torsion-free complexes. We saw earlier (Corollary 3.3.3.5) that torsion-free complexes induce free ω -categories on a canonical ω -polygraph. However, in practice, we are often interested in the inverse operation, *i.e.*, representing the cells of an ω -category freely generated on an ω -polygraph by the cells of a torsion-free complex. Here, we define the ω -hypergraph P^{H} associated to an ω -polygraph P and, in the case where P^{H} is a torsion-free complex, give conditions under which the ω -category $\text{Closed}_{\text{WF}}(P^{\text{H}})$ is isomorphic to the free ω -category P^* .

Recall the definition of the support function supp given in Paragraph 2.4.3.1. Given $P \in \mathbf{Pol}_\omega$, we define an ω -hypergraph P^{H} by putting $P_n^{\text{H}} = P_n$ for $n \in \mathbb{N}$ and, when $n > 0$,

$$g^- = \text{supp}^P(d_{n-1}^-(g)) \cap P_{n-1} \quad g^+ = \text{supp}^P(d_{n-1}^+(g)) \cap P_{n-1}$$

for $g \in P_n^{\text{H}}$. Under this definition, supp^P can be seen as a function $P^* \rightarrow \text{Closed}(P^{\text{H}})$. We then have the following criterion to know whether P^* can be faithfully represented by the closed-well-formed fgs's of P^{H} :

Theorem 3.4.1.29. *Let $P \in \mathbf{Pol}_\omega$ such that P^{H} is a torsion-free complex. Then, supp^P is the underlying function of an ω -functor $F: P^* \rightarrow \text{Closed}_{\text{WF}}(P^{\text{H}})$ if and only if, for $n \in \mathbb{N}^*$, $g \in P_n$ and $\epsilon \in \{-, +\}$, we have*

$$\text{supp}^P(d_{n-1}^\epsilon(g)) = R(g^\epsilon).$$

In this case, F is moreover an isomorphism.

Remark 3.4.1.30. If the condition of Theorem 3.4.1.29 is satisfied, then $T_{\text{PC}}^{\text{Cl}} \circ F: P^* \rightarrow \text{Cell}(P^{\text{H}})$ is the unique isomorphism given by Corollary 3.3.3.5 which maps $g \in P$ to $\langle g \rangle \in \text{Cell}(P^{\text{H}})$.

Proof. If supp^P induces an ω -functor $F: P^* \rightarrow \text{Closed}_{\text{WF}}(P^H)$, then we have

$$\begin{aligned} \text{supp}^P(d_{n-1}^\epsilon(g)) &= F(d_{n-1}^\epsilon(g)) \\ &= \bar{\partial}_{n-1}^\epsilon(F(g)) \\ &= \bar{\partial}_{n-1}^\epsilon(R(g)) \\ &= R(g^\epsilon) \end{aligned} \quad (\text{by definition of } \bar{\partial}_{n-1}^\epsilon)$$

which proves the necessity. For sufficiency, we prove by induction on $n \in \mathbb{N}$ that supp^P is the underlying function of an n -functor $F^n: (P^*)_{\leq n} \rightarrow \text{Closed}_{\text{WF}}(P^H)_{\leq n}$. This is clear for $n = 0$, and, when $n > 0$, we define F^n by extending F^{n-1} and so that $F^n(g) = R(g)$ using the universal property of $(P^*)_{\leq n} = (P^*)_{\leq n-1}[P_n]$. This is possible since the condition of the statement implies that

$$F^{n-1}(d_{n-1}^\epsilon(g)) = \bar{\partial}_{n-1}^\epsilon(R(g))$$

for $g \in P_n$ and $\epsilon \in \{-, +\}$. We then obtain an ω -functor $F: P^* \rightarrow \text{Closed}_{\text{WF}}(P^H)$ using Proposition 1.2.3.12, which satisfies that $F(g) = R(g)$ for $g \in P$. Then, by Theorem 3.4.1.27, $T_{\text{PC}}^{\text{Cl}} \circ F$ is an ω -functor $P^* \rightarrow \text{Cell}(P)$ which maps g to $\langle g \rangle$. It is then an isomorphism by Corollary 3.3.3.5, so that F is an isomorphism too. \square

Example 3.4.1.31. Let P be the ω -polygraph with

$$\begin{aligned} P_0 &= \{x, y, z\} & P_1 &= \{f: x \rightarrow y, g, g': y \rightarrow z\} & P_2 &= \{\alpha, \alpha': g \Rightarrow g'\} \\ P_3 &= \{A: \text{id}_f^2 *_0 \alpha \Rightarrow \text{id}_{g'}^2 \alpha'\} \end{aligned}$$

and $P_k = \emptyset$ for $k \in \mathbb{N}$ with $k \geq 4$ as in

$$\begin{array}{ccc} \begin{array}{c} x \xrightarrow{f} y \begin{array}{c} \xrightarrow{g} z \\ \alpha \Downarrow \Downarrow \alpha' \\ \xrightarrow{g'} z \end{array} \end{array} & \text{and} & \begin{array}{c} x \begin{array}{c} \xrightarrow{f *_0 g} z \\ \Downarrow \text{id}_f^2 *_0 \alpha \\ \xrightarrow{f *_0 g'} z \end{array} \end{array} \xrightarrow{A} \begin{array}{c} x \begin{array}{c} \xrightarrow{f *_0 g} z \\ \Downarrow \text{id}_f^2 *_0 \alpha' \\ \xrightarrow{f *_0 g'} z \end{array} \end{array} \end{array}$$

We can verify that P^H is a torsion-free complex. But, by Theorem 3.4.1.29, the function supp^P does not induce an ω -functor $P^* \rightarrow \text{Closed}_{\text{WF}}(P^H)$ since

$$\text{supp}^P(d_2^-(A)) = \{x, y, z, f, g, g', \alpha\} \neq \{y, z, g, g', \alpha\} = R(A^-).$$

However, by considering a modified version of P where

$$P_3 = \{A: \alpha \Rightarrow \alpha'\}$$

it can be verified that P^H is still a torsion-free complex and that, by Theorem 3.4.1.29, the function supp^P induces an ω -functor $P^* \rightarrow \text{Closed}_{\text{WF}}(P^H)$ which is an isomorphism.

3.4.1.32 – A pasting diagram extension for cateq. We illustrate the use of pasting diagrams by describing an extension of cateq that allows specifying cells using pasting diagrams or, more precisely, closed-well-formed fgs's of torsion-free complexes.

For example, consider the ω -hypergraph (3.1) on page 189. It can be verified that it is a torsion-free complex. The associated ω -polygraph is then described in cateq by the following commands:

```
# u,v,w,x,y := gen *
# a := gen u -> v
# b,c,d := gen v -> w
# e,f,g := gen w -> x
# h := gen x -> y
# alpha := gen b -> c
# beta := gen c -> d
# gamma := gen e -> f
# delta := gen f -> g
```

Then, as suggested back there, the cell composing “all the generators together” can be defined with the expressions

```
# X1 := id2 a *0 (alpha *1 beta)
      *0 ((gamma *0 id2 h) *1 (delta *0 id2 h))
```

and

```
# X2 := (id2 a *0 alpha *0 id2 e *0 id2 h)
      *1 (id2 a *0 id2 c *0 gamma *0 id2 h)
      *1 (id2 a *0 beta *0 delta *0 id2 h)
```

and one can verify that the answer of `cateq` on the query

```
# X1 = X2
```

is `true`. We can define this cell using pasting diagrams with the syntax `{[gen1], [gen2], ...}` as in

```
# X3 := {u,v,w,x,y,a,b,c,d,e,f,g,h,alpha,beta,gamma,delta}
```

and one verifies that `cateq` answers `true` on the query `X2 = X3`. In fact, `cateq` applies the closure operator R on a pasting diagram input, so that it is sufficient to specify the maximum elements. Thus, we can define

```
# X4 := {a,alpha,beta,gamma,delta,h}
```

and verify that `X3 = X4` evaluates to `true`. We are allowed to mix the pasting diagram syntax with the usual syntax and write a query like

```
# id2 a *0 {alpha,beta,gamma,delta} *0 id2 h = X4
```

which `cateq` evaluates to `true`.

Let’s now look at another example and see how to specify the cells H_1 and H_2 associated with the ω -hypergraph P of Paragraph 3.1.2.13 using pasting diagram syntax. We can already use this syntax to specify the generators, as in

```
# x,y,z := gen *
# a,b,c := gen x -> y
# d,e,f := gen y -> z
# alpha,alpha' := gen a -> b
```

```
# beta,beta' := gen b -> c
# gamma,gamma' := gen d -> e
# delta,delta' := gen e -> f
# A := gen {alpha,delta} -> {alpha',delta'}
# B := gen {beta,gamma} -> {beta',gamma'}
```

Then, H_1 and H_2 can be defined with

```
# H1 := {beta,A,gamma} *2 {alpha',B,delta'}
# H2 := {alpha,B,delta} *2 {gamma',A,beta'}
```

which is more economical than the expression used in Paragraph 3.1.2.13. Note that, even though P is not a torsion-free complex, the definition of H_1 is accepted. Indeed, `cateq` allows the use of the pasting diagram syntax for a local expression when the sub- ω -hypergraph induced by the expression is a torsion-free complex. For example, the two sets of generators $\{\beta, A, \gamma\}$ and $\{\alpha', B, \delta'\}$ induce two sub- ω -hypergraphs (by applying the R operation) of P that are torsion-free complexes, so that the definition of H_1 is accepted by `cateq`. However, `cateq` refuses the definition of H done by command

```
# H := {A,B}
```

since the sub- ω -hypergraph induced by $\{A, B\}$ (which is P) is not a torsion-free complex.

Remark 3.4.1.33. In fact, `cateq` checks that an ω -hypergraph is a torsion-free complex using the stronger Axioms (T3') and (T4'), since they are more efficiently computed. As a consequence, it might miss some torsion-free complexes that only satisfy Axioms (T3) and (T4) but not the stronger ones.

Remark 3.4.1.34. When provided with a command involving a pasting diagram syntax, `cateq` verifies that the condition given by Theorem 3.4.1.29 is satisfied with regard to the current polygraph, and otherwise refuses the command and alerts the user, so that the use of pasting diagram syntax in `cateq` is always safe.

3.4.2 Embedding parity complexes

In this section, we show that parity complexes are a particular case of torsion-free complexes, under two reasonable caveats. Firstly, since parity complexes do not require all the generators to be relevant, there are parity complexes that are not torsion-free complexes. But, by [Str91, Theorem 4.2], irrelevant generators of a parity complex P do not play any role in the generated ω -category $\text{Cell}(P)$, so that, by restraining P to the ω -hypergraph \bar{P} of relevant generators, we have $\text{Cell}(P) = \text{Cell}(\bar{P})$. Thus, it is reasonable to assume that all the parity complexes we are considering for embedding in torsion-free complexes have relevant generators, *i.e.*, satisfy Axiom (T2). Secondly, as discussed in Paragraph 3.1.5.4, general parity complexes are not freely generated by their atoms and, since the latter property is supposed to be the *raison d'être* of such structures, it is reasonable to only consider the parity complexes that satisfy this property. We believe that Axiom (T4) is the minimal additional condition to require for the ω -category of cells of a parity complex to be freely generated, so we will only consider parity complexes that moreover satisfy Axiom (T4).

Under the assumptions given above, we are only left to derive Axiom (T3) from the axioms of a parity complex. We show below that it is essentially a consequence of the tightness requirements stated by Axiom (C5). First, we recall from [Str94] the link between tightness and the segment property:

Proposition 3.4.2.1 ([Str94, Proposition 1.4]). *Let P be an ω -hypergraph. For $n \in \mathbb{N}^*$, subsets $U, V \subseteq P_n$ with U tight, V fork-free and $U \subseteq V$, we have that U is a segment for \triangleleft_V .*

Proof. Let $x, y, z \in V$ such that $x, z \in U$ and $x \triangleleft_V^1 y \triangleleft_V z$. Then, there is $w \in x^+ \cap y^-$. By definition of tightness, since $y \triangleleft_V z$, we have $y^- \cap U^+ = \emptyset$. So there is $\bar{y} \in U$ such that $w \in \bar{y}^-$. Since V is fork-free, $y = \bar{y}$. Hence, U is a segment for \triangleleft_V . \square

Then, we show how to derive the segment property from the axioms of parity complexes:

Lemma 3.4.2.2. *Let P be a parity complex which satisfies Axiom (T2). Given $n \in \mathbb{N}$ and $x \in P_n$, x satisfies the segment condition.*

Proof. Let $k, n \in \mathbb{N}$ with $k < n$, $x \in P_n$ and X be a k -cell. Suppose first that $\langle x \rangle_{k,-} \subseteq X_k$. By Axiom (C5), the set $\langle x \rangle_{k,-}$ is tight, so that, by Proposition 3.4.2.1, $\langle x \rangle_{k,-}$ is a segment for \triangleleft_{X_k} .

Now suppose that $\langle x \rangle_{k,+} \subseteq X_k$. By contradiction, assume that $\langle x \rangle_{k,+}$ is not a segment for \triangleleft_{X_k} . By definition of \triangleleft_{X_k} , there exist $p > 1$ and $u_0, \dots, u_p \in X_k$ such that

$$u_0, u_p \in \langle x \rangle_{k,+}, \quad u_1, \dots, u_{p-1} \notin \langle x \rangle_{k,+} \quad \text{and} \quad u_i \triangleleft_{X_k}^1 u_{i+1}.$$

By definition of $\triangleleft_{X_k}^1$, there exist z_0, \dots, z_{p-1} such that $z_i \in u_i^+ \cap u_{i+1}^-$. Note that $z_0 \in \langle x \rangle_{k,+}^\pm$. Indeed, if $z_0 \in v^-$ for some $v \in X_k$, then, since X_k is fork-free, $v = u_1$, so $v \notin \langle x \rangle_{k,+}$. Similarly, we have $z_{p-1} \in \langle x \rangle_{k,+}^\mp$. Since x is relevant by Axiom (T2), we have

$$\langle x \rangle_{k+1,+}^\pm = \langle x \rangle_{k,+} \subseteq X_k$$

By [Str91, Lemma 3.2] (which is the analogous for parity complexes of Theorem 3.2.2.3) and Axiom (T2), we have that

$$\langle x \rangle_{k,-} \cap X_n \subseteq \langle x \rangle_{k+1,+}^- \cap X_n = \emptyset$$

and the k -pre-cell $Y = \overline{\text{Act}}(X, \langle x \rangle_{k+1,+})$ is a k -cell. Moreover, by Lemma 3.2.1.6,

$$Y_k = (X_k \cup \langle x \rangle_{k+1,+}^-) \setminus \langle x \rangle_{k+1,+}^+ = (X_k \setminus \langle x \rangle_{k,+}) \cup \langle x \rangle_{k,-}.$$

Thus, $\langle x \rangle_{k,-} \subseteq Y_k$ and, as shown by the first part, $\langle x \rangle_{k,-}$ is a segment for \triangleleft_{Y_k} . Since

$$\langle x \rangle_{k,-}^\mp = \langle x \rangle_{k,+}^\mp \quad \text{and} \quad \langle x \rangle_{k,-}^\pm = \langle x \rangle_{k,+}^\pm,$$

there exist $\tilde{u}_0, \tilde{u}_p \in \langle x \rangle_{k,-}$ such that $z_0 \in \tilde{u}_0^+$ and $z_{p-1} \in \tilde{u}_p^-$. So

$$\tilde{u}_0 \triangleleft_{X_k}^1 u_1 \triangleleft_{X_k}^1 \cdots \triangleleft_{X_k}^1 u_{p-1} \triangleleft_{X_k}^1 \tilde{u}_p$$

with $u_1, \dots, u_{p-1} \notin \langle x \rangle_{k,-}$ (since $\langle x \rangle_{k+1,+}^- \cap X_n = \emptyset$), contradicting the fact that $\langle x \rangle_{k,-}$ is a segment for \triangleleft_{Y_k} . Thus, $\langle x \rangle_{k,+}$ is a segment for \triangleleft_{X_k} . Hence, x satisfies the segment condition. \square

We can conclude that parity complexes are embedded into torsion-free complexes:

Theorem 3.4.2.3. *Given a parity complex P which satisfies Axiom (T2) and Axiom (T4), P is a torsion-free complex.*

Proof. Axiom (T0) is a consequence of Axiom (C0). Axiom (T1) is a consequence of Axiom (C3). And Axiom (T3) is a consequence of Lemma 3.4.2.2. \square

Remark 3.4.2.4. Given P as in Theorem 3.4.2.3, the category $\text{Cell}(P)$ of cells of the parity complex P is, of course, exactly the category $\text{Cell}(P)$ of cells of the torsion-free complex P .

3.4.3 Embedding pasting schemes

In this section, we show that loop-free pasting schemes are a particular case of torsion-free complexes, under the caveat that we only consider loop-free pasting schemes that satisfy Axiom (T4) since, like for parity complexes, loop-free pasting schemes do not induce free ω -categories in general. We think that it is a reasonable requirement since we also believe that Axiom (T4) is the minimal additional condition to add to the axioms of loop-free pasting schemes for this property to hold.

In order to embed pasting schemes into torsion-free complexes, our main concerns will be to derive Axioms (T2) and (T3) from Axioms (S3) and (S4). For this purpose, we will need to relate the cells of torsion-free complexes with the wfs's (as defined in Paragraph 3.1.3.10), using closed-well-formed fgs's (as defined in Paragraph 3.4.1.1) as an intermediate. In fact, we will prove that the latter are exactly the wfs's. First, we prove a technical result about the relations B and E:

Lemma 3.4.3.1. *Let P be a pasting scheme, $k, n \in \mathbb{N}$ with $k < n$, $x \in P_n$ and $y \in P_k$. If $x B_{n-1}^n R_k^{n-1} y$ then*

$$y \in B_k^n(x) \quad \text{or} \quad x E_{n-1}^n R_k^{n-1} y.$$

Dually, if $x E_{n-1}^n R_k^{n-1} y$ then

$$y \in E_k^n(x) \quad \text{or} \quad x B_{n-1}^n R_k^{n-1} y.$$

Proof. We do an induction on $n - k$. If $k = n - 1$, the result is trivial. If $k = n - 2$, the result is a consequence of Axiom (S1). So suppose that $k < n - 2$. We will only prove the first part, since the second is dual. So assume that $y \notin B_k^n(x)$. By the definition of B, we have

$$\neg(x B_{n-1}^n B_k^{n-1} y) \quad \text{or} \quad \neg(x B_{n-1}^n E_k^{n-1} y).$$

By symmetry, we can suppose that $\neg(x B_{n-1}^n E_k^{n-1} y)$. Let $u \in P_{n-1}$ be minimal for \triangleleft such that

$$x B_{n-1}^n u R_k^{n-1} y.$$

Then, there are two possible cases: either $u B_{n-2}^{n-1} R_k^{n-2} y$ or $u E_{n-2}^{n-1} R_k^{n-2} y$.

In the first case, let $v \in P_{n-2}$ be such that $u B_{n-2}^{n-1} v R_k^{n-2} y$. By the minimality of u , we have

$$\neg(x B_{n-1}^n E_{n-2}^{n-1} v),$$

so $\neg(x B_{n-2}^n v)$ by definition of B. By Axiom (S1), we have $x E_{n-1}^n E_{n-2}^{n-1} v$. So $x E_{n-1}^n R_k^{n-1} y$.

In the second case, since we supposed $\neg(x B_{n-1}^n E_k^{n-1} y)$, we have $\neg(u E_k^{n-1} y)$. By induction hypothesis, we deduce $u B_{n-2}^{n-1} R_k^{n-2} y$ and we can conclude using the first case. \square

Then, we prove that the source and target of wfs's computed by the operations defined for pasting schemes in Paragraph 3.1.3.6 are the same as the ones computed with the operations defined for closed fgs's in Paragraph 3.4.1.10:

Lemma 3.4.3.2. *Let P be a loop-free pasting scheme. Given $n \in \mathbb{N}^*$, $\epsilon \in \{-, +\}$ and an n -wfs X of P , we have $\partial_{n-1}^\epsilon(X) = \bar{\partial}_{n-1}^\epsilon(X)$.*

Proof. We only prove the case $\epsilon = -$. Recall that

$$\partial_{n-1}^-(X) = X \setminus E(X) \quad \text{and} \quad \bar{\partial}_{n-1}^-(X) = R(X \setminus (X_n \cup R(X_n^+))).$$

We first prove $\bar{\partial}_{n-1}^-(X) \subseteq \partial_{n-1}^-(X)$, that is,

$$R(X \setminus (X_n \cup R(X_n^+))) \subseteq X \setminus E(X).$$

Since $X \setminus E(X)$ is closed (by [Joh89, Theorem 12]), it is equivalent to

$$X \setminus (X_n \cup R(X_n^+)) \subseteq X \setminus E(X)$$

which is itself equivalent to

$$E(X) \subseteq (X_n \cup R(X_n^+))$$

which holds. We now prove $\partial_{n-1}^-(X) \subseteq \bar{\partial}_{n-1}^-(X)$, that is,

$$X \setminus E(X) \subseteq R(X \setminus (X_n \cup R(X_n^+))) = \bar{\partial}_{n-1}^-(X).$$

Let $k \in \mathbb{N}_{n-1}$ and $x \in (X \setminus E(X))_k$. If $x \notin R(X_n^+)$ then $x \in \bar{\partial}_{n-1}^-(X)$. So suppose that $x \in R(X_n^+)$. Since $E(X)_{n-1} = X_n^+$, it implies that $k < n - 1$. By definition of $R(X_n^+)$, there exists $y \in X_n$ such that $y E_{n-1}^n R_k^{n-1} x$ and, by Axiom (S2), we can take y minimal for \triangleleft satisfying this property. By Lemma 3.4.3.1, it holds that $y B_{n-1}^n R_k^{n-1} x$. Let $z \in P_{n-1}$ be such that $y B_{n-1}^n z R_k^{n-1} x$. Then, there is no $\bar{y} \in X_n$ such that $\bar{y} E_{n-1}^n z$: otherwise, $\bar{y} E_{n-1}^n R_k^{n-1} x$ and $\bar{y} \triangleleft y$, contradicting the minimality of y . So $z \notin R(X_n^+)$ and $z R x$. It implies that $z \in X \setminus (X_n \cup R(X_n^+))$ and $x \in \bar{\partial}_{n-1}^-(X)$. \square

We can then prove the inclusion of wfs's into closed-well-formed fgs's:

Proposition 3.4.3.3. *Let P be a loop-free pasting scheme. Given $n \in \mathbb{N}$ and an n -wfs $X \in \text{WF}(P)_n$, we have $X \in \text{Closed}_{\text{WF}}(P)_n$.*

Proof. We prove this lemma by induction on n . If $n = 0$, the result is trivial. So suppose $n > 0$. Since X is well-formed, X_n is fork-free. Moreover, by Lemma 3.4.3.2, for $\epsilon \in \{-, +\}$, we have that $\bar{\partial}_{n-1}^\epsilon(X) = \partial_{n-1}^\epsilon(X)$ is a well-formed $(n-1)$ -fgs. By induction, $\bar{\partial}_{n-1}^\epsilon(X) \in \text{Closed}_{\text{WF}}(P)_{n-1}$. Moreover, when $n \geq 2$, since $\partial_{n-2}^\epsilon \circ \partial_{n-1}^-(X) = \partial_{n-2}^\epsilon \circ \partial_{n-1}^+(X)$, by Lemma 3.4.3.2,

$$\bar{\partial}_{n-2}^\epsilon \circ \bar{\partial}_{n-1}^-(X) = \bar{\partial}_{n-2}^\epsilon \circ \bar{\partial}_{n-1}^+(X).$$

Hence, $X \in \text{Closed}_{\text{WF}}(P)_n$. \square

Next, we prove an analogue of the gluing Theorem 3.2.2.3 for wfs's:

Lemma 3.4.3.4. *Let P be a loop-free pasting scheme, $n \in \mathbb{N}$, X be an n -wfs, $S \subseteq P_{n+1}$ be a finite subset with S fork-free and $S^\mp \subseteq X$, and $Y = X \cup R(S)$. Then, Y is an $(n+1)$ -wfs of P and $\partial_n^-(Y) = X$.*

Proof. We show this lemma by induction on $k = |S|$. If $k = 0$, the result is trivial. If $k = 1$, the result is a consequence of [Joh89, Proposition 8]. So suppose that $k > 1$. By Axiom (S2), take $x \in S$ minimal for \triangleleft . By minimality, we have

$$x^- \subseteq S^\mp \subseteq X.$$

Using [Joh89, Proposition 8], $X \cup R(x)$ is well-formed. By Axiom (S5), $X \cap E(x) = \emptyset$, so we have that $\bar{\partial}_n^-(X \cup R(x)) = X$. Let

$$\bar{X} = \partial_n^+(X \cup R(x)) \quad \text{and} \quad \bar{S} = S \setminus \{x\}.$$

We have

$$\begin{aligned} \bar{S}^\mp \subseteq \bar{X}_n &\Leftrightarrow \bar{S}^- \subseteq \bar{X}_n \cup \bar{S}^+ \\ &\Leftrightarrow S^- \subseteq \bar{X}_n \cup \bar{S}^+ \cup x^- \\ &\Leftrightarrow S^- \subseteq (X_n \setminus x^-) \cup x^+ \cup \bar{S}^+ \cup x^- \\ &\Leftrightarrow S^- \subseteq X_n \cup S^+ \\ &\Leftrightarrow S^\mp \subseteq X_n \end{aligned}$$

so $\bar{S}^\mp \subseteq \bar{X}$. By induction, $\bar{X} \cup R(\bar{S})$ is well-formed and $\partial_n^-(\bar{X} \cup R(\bar{S})) = \bar{X}$. Since $\text{WF}(P)$ has the structure of an ω -category by [Joh89, Theorem 12], we can compose $X \cup R(x)$ and $\bar{X} \cup R(\bar{S})$. So

$$X \cup R(S) = X \cup R(x) \cup \bar{X} \cup R(\bar{S})$$

is well-formed and $\partial_n^-(X \cup R(S)) = X$. \square

We can now prove the converse inclusion of closed-well-formed fgs's into wfs's:

Proposition 3.4.3.5. *Let P be a loop-free pasting scheme. Given $n \in \mathbb{N}$ and $X \in \text{Closed}_{\text{WF}}(P)_n$, we have $X \in \text{WF}(P)_n$.*

Proof. We prove this lemma by induction on n . If $n = 0$, the result is trivial. So suppose $n > 0$. Let $Y = \bar{\partial}_{n-1}^-(X)$. By definition of $\text{Closed}_{\text{WF}}(P)$, $Y \in \text{Closed}_{\text{WF}}(P)$ and, by induction, $Y \in \text{WF}(P)$. By definition of $\bar{\partial}^-$, we have $X_n^\mp \subseteq Y$. Moreover, by Lemma 3.4.3.4, $Y \cup R(X_n)$ is well-formed. But $Y = R(X \setminus (X_n \cup R(X_n^+)))$, so that $X = Y \cup R(X_n)$ is well-formed. \square

We now give a simple form for the sources and targets of atomic wfs's:

Lemma 3.4.3.6. *Let P be a loop-free pasting scheme. Given $i, n \in \mathbb{N}$ such that $i < n$, $\epsilon \in \{-, +\}$ and $x \in P_n$, we have*

$$\partial_i^\epsilon(R(x)) = R(\langle x \rangle_{i,\epsilon}).$$

Proof. By symmetry, we can suppose that $\epsilon = -$. We have

$$\begin{aligned} \partial_i^-(R(x)) &= \partial_i^-(T_{\text{Cl}}^M(\{x\})) \\ &= T_{\text{Cl}}^M(\bar{\partial}_i^-(\{x\})) && \text{(by Proposition 3.4.1.12 and Lemma 3.4.3.2)} \\ &= T_{\text{Cl}}^M(\langle x \rangle_{i,-}) \\ &= R(\langle x \rangle_{i,-}). \end{aligned}$$

Hence, $\partial_i^-(R(x)) = R(\langle x \rangle_{i,-})$. \square

Using the above lemma, we deduce the relevance of the generators:

Lemma 3.4.3.7. *Let P be a loop-free pasting scheme. Given $n \in \mathbb{N}$ and $x \in P_n$, x is relevant.*

Proof. By Axiom (S3), $R(x)$ is well-formed. So, for $i \in \mathbb{N}_{n-1}$ and $\epsilon \in \{-, +\}$, $\partial_i^\epsilon(R(x))$ is well-formed. Then, by Lemma 3.4.3.6, $\langle x \rangle_{i,-}$ and $\langle x \rangle_{i,+}$ are fork-free. We show that $\langle x \rangle_{i+1,-}^\pm = \langle x \rangle_{i,+}$ and $\langle x \rangle_{i+1,+}^\mp = \langle x \rangle_{i,-}$. We have

$$\langle x \rangle_{n,-}^\pm = \langle x \rangle^\pm = x^\pm = \langle x \rangle_{n-1,+}$$

and, similarly, $\langle x \rangle_{n,+}^\mp = \langle x \rangle_{n-1,-}$. For $i \in \mathbb{N}_{n-1}$, we have

$$\begin{aligned} \langle x \rangle_{i+1,-}^\pm &= (\partial_i^+(\langle x \rangle_{i+1,-}))_i && \text{(by definition of } \partial_i^+) \\ &= (\partial_i^+ \circ \partial_{i+1}^-(R(x)))_i && \text{(by Lemma 3.4.3.6)} \\ &= (\partial_i^+(R(x)))_i && \text{(by globularity)} \\ &= (R(\langle x \rangle_{i,+}))_i && \text{(by Lemma 3.4.3.6)} \\ &= \langle x \rangle_{i,+} \end{aligned}$$

and similarly, $\langle x \rangle_{i+1,+}^{\mp} = \langle x \rangle_{i,-}$. Moreover, we have

$$\begin{aligned} (\langle x \rangle_{i,-} \cup \langle x \rangle_{i+1,-}^+) \setminus \langle x \rangle_{i+1,-}^- &= ((\langle x \rangle_{i+1,-}^- \setminus \langle x \rangle_{i+1,-}^+) \cup \langle x \rangle_{i+1,-}^+) \setminus \langle x \rangle_{i+1,-}^- \\ &= \langle x \rangle_{i+1,-}^+ \setminus \langle x \rangle_{i+1,-}^- = \langle x \rangle_{i,+} \end{aligned}$$

and

$$\begin{aligned} (\langle x \rangle_{i,+} \cup \langle x \rangle_{i+1,-}^-) \setminus \langle x \rangle_{i+1,-}^+ &= ((\langle x \rangle_{i+1,-}^- \setminus \langle x \rangle_{i+1,-}^+) \cup \langle x \rangle_{i+1,-}^-) \setminus \langle x \rangle_{i+1,-}^+ \\ &= \langle x \rangle_{i+1,-}^- \setminus \langle x \rangle_{i+1,-}^+ = \langle x \rangle_{i,-} \end{aligned}$$

so $\langle x \rangle_{i+1,-}$ moves $\langle x \rangle_{i,-}$ to $\langle x \rangle_{i,+}$ and, similarly, so does $\langle x \rangle_{i+1,+}$. Hence, $\langle x \rangle$ is a cell. \square

We now prove that the cells (in the sense of Paragraph 3.1.2.4) of pasting schemes are sent to wfs's by $T_{\text{Cl}}^{\text{PC}}$, and that all the generators satisfy the segment condition:

Lemma 3.4.3.8. *Let P be a loop-free pasting scheme and $n \in \mathbb{N}$. The following hold:*

(i) *for $x \in P_n$, x satisfies the segment condition,*

(ii) *for $X \in \text{Cell}(P)_n$, $T_{\text{Cl}}^{\text{PC}}(X) \in \text{WF}(P)_n$.*

Proof. We prove this lemma by an induction on n . If $n = 0$, the result is trivial. So suppose that $n > 0$.

We first prove (i). Let $k \in \mathbb{N}_{n-1}$, $x \in P_n$, X be a k -cell such that $\langle x \rangle_{k,-} \subseteq X_k$, and $Y = T_{\text{Cl}}^{\text{PC}}(X)$. By induction, $Y \in \text{WF}(P)$. Moreover, by Lemma 3.4.3.6,

$$\partial_k^-(R(x)) = R(\langle x \rangle_{k,-}) \subseteq Y.$$

So, by Axiom (S4), $\langle x \rangle_{k,-}$ is a segment for $\triangleleft_{Y_k} = \triangleleft_{X_k}$. Hence, x satisfies the segment condition.

We now prove (ii). Let $X \in \text{Cell}(P)_n$. By Proposition 3.4.3.5, it is enough to show that $T_{\text{Cl}}^{\text{PC}}(X)$ is closed-well-formed. This latter property can be obtained from Theorem 3.4.1.27 which requires the full segment axiom. But we can consider the restriction of P to an ω -hypergraph \bar{P} where

$$\bar{P}_i = P_i \text{ for } i \leq n \quad \text{and} \quad \bar{P}_i = \emptyset \text{ for } i > n.$$

By (i), \bar{P} satisfies Axiom (T3). Then, using Theorem 3.4.1.27, $T_{\text{Cl}}^{\text{PC}}(X)$ is closed-well-formed and is still closed-well-formed in P . Hence, by Proposition 3.4.3.5, $T_{\text{Cl}}^{\text{PC}}(X) \in \text{WF}(P)$. \square

We can conclude the embedding of pasting schemes into torsion-free complexes:

Theorem 3.4.3.9. *Let P be a loop-free pasting scheme. Then, P satisfies Axioms (T0), (T1), (T2) and (T3). In particular, if P satisfies Axiom (T4), then P is a torsion-free complex.*

Proof. The different axioms of torsion-free complexes can be deduced as follows: Axiom (T0) is a consequence of Axiom (S0), Axiom (T1) is a consequence of Axiom (S2), Axiom (T2) is a consequence of Lemma 3.4.3.7 and Axiom (T3) is a consequence of Lemma 3.4.3.8. \square

Moreover, one translates the cells of the pasting scheme to the wfs's using the operation $T_{\text{Cl}}^{\text{PC}}$:

Theorem 3.4.3.10. *Let P be a loop-free pasting scheme. $T_{\text{Cl}}^{\text{PC}}$ is an isomorphism between the ω -categories $\text{Cell}(P)$ and $\text{WF}(P)$. Moreover, for all $x \in P$, $T_{\text{Cl}}^{\text{PC}}(\langle x \rangle) = R(x)$.*

Proof. By Propositions 3.4.3.3 and 3.4.3.5, we have

$$\text{Closed}_{\text{WF}}(P) = \text{WF}(P)$$

as graded sets and, by Lemma 3.4.3.2 and the definition of id , $*^{\text{Cl}}$ and $*$, the two have the same structure of ω -category. Thus, by Theorems 3.4.3.9 and 3.4.1.27, $T_{\text{Cl}}^{\text{PC}}: \text{Cell}(P) \rightarrow \text{WF}(P)$ is an isomorphism. Moreover, by Proposition 3.4.1.9, for $x \in P$, we have

$$T_{\text{Cl}}^{\text{PC}}(\langle x \rangle) = T_{\text{Cl}}^{\text{M}} \circ T_{\text{M}}^{\text{PC}}(\langle x \rangle) = T_{\text{Cl}}^{\text{M}}(\{x\}) = R(x). \quad \square$$

3.4.4 Embedding augmented directed complexes

In this section, we relate the set-based approach of torsion-free complexes to the group-based approach of augmented directed complexes with loop-free unital basis and show an embedding of the latter into torsion-free complexes. More precisely, given an adc with a loop-free unital basis, we prove that the basis induces an ω -hypergraph which is a torsion-free complex such that the ω -category of cells of the adc is isomorphic to the ω -category of cells of this torsion-free complex. For this purpose, we relate properties defined for ω -hypergraphs, like fork-freeness (Paragraph 3.1.1.3) and movement (Paragraph 3.1.2.2), to analogous properties in augmented directed complexes, and define translation functions between the cells of augmented directed complexes and the ones of the associated ω -hypergraphs.

3.4.4.1 – Adc's as ω -hypergraphs. Here, dually to the translation given in Paragraph 3.1.4.4, we associate a canonical ω -hypergraph to an adc with basis, and we will prove in the following paragraphs that it is a torsion-free complex when the adc is loop-free unital.

Let (K, d, e) be an adc with a basis P . Note that P is canonically a graded set and, in the following, given $n \in \mathbb{N}$ and $x \in P_n$, we write \bar{x} to refer to x as an element of the graded set P whereas x alone refers to x as an element of the monoid K_n^* . Given $n \in \mathbb{N}$,

- for $s \in K_n^*$, we write $S_n(s)$ for $\{\bar{x} \in P_n \mid x \leq s\}$,
- for a finite subset $S \subseteq P_n$, we write $\bar{\Sigma}_n(S)$ for $\sum_{x \in S} x$.

From these definitions, we readily have:

Lemma 3.4.4.2. *For all $n \in \mathbb{N}$, $S_n \circ \bar{\Sigma}_n = 1_{\mathcal{P}_f(P_n)}$.*

For $n \in \mathbb{N}^*$ and $\bar{x} \in P_{n+1}$, we define subsets $\bar{x}^-, \bar{x}^+ \subseteq P_n$ such that

$$\bar{x}^- = S_n(x^-) \quad \text{and} \quad \bar{x}^+ = S_n(x^+)$$

where x^-, x^+ are the elements of K_{n-1} defined in Paragraph 3.1.4.2. We thus obtain an ω -hypergraph $(P, (-)^-, (-)^+)$ that we call the ω -hypergraph associated to K . In the following, we prove that, when P is a unital loop-free basis of K , P is a torsion-free complex. We already have:

Lemma 3.4.4.3. *If P is a unital basis of K , given $n \in \mathbb{N}^*$ and $\bar{x} \in P_n$, we have $\bar{x}^- \neq \emptyset$ and $\bar{x}^+ \neq \emptyset$. That is, P satisfies Axiom (T0).*

Proof. By contradiction, if $\bar{x}^- = \emptyset$, it implies that $[x]_{n-1,-} = 0$. Hence, $[x]_{i,-} = 0$ for $i \in \mathbb{N}_{n-1}$. In particular, $e([x]_{0,-}) = 0$, contradicting the fact that the basis is unital. Hence, $\bar{x}^- \neq \emptyset$ and, similarly, $\bar{x}^+ \neq \emptyset$. \square

3.4.4.4 – Fork-freeness and radicality. We now define an analogue for adc's of the notion of fork-freeness defined for ω -hypergraphs, and relate the notions between the two settings.

Let (K, d, e) be an adc with a loop-free unital basis P . Given $n \in \mathbb{N}^*$, an element $s \in K_n^*$ is said *fork-free* when for all $x, y \in P_n$ such that $x + y \leq s$, it holds that

$$\bar{x}^\epsilon \cap \bar{y}^\epsilon = \emptyset \quad \text{for } \epsilon \in \{-, +\}.$$

Moreover, in dimension 0, $s \in K_0^*$ is said to be fork-free when $e(s) = 1$. We extend the notion of fork-freeness to cells: given $n \in \mathbb{N}$ and $X \in \text{Cell}^*(K)$, X is said *fork-free* when, for $i \in \mathbb{N}_n$ and $\epsilon \in \{-, +\}$, $X_{i,\epsilon}$ is fork-free.

Contrary to subsets of the ω -hypergraph P , an element of P can appear in an element of K_n^* with a multiplicity greater than one (since K_n^* is the free monoid on P_n). It is then useful to

distinguish the elements of K_n^* where generators appear with multiplicity at most one: given $n \in \mathbb{N}$ and $s \in K_n^*$, s is said *radical* when for all $z \in K_n^*$ such that $2z \leq s$, we have $z = 0$. We then readily have:

Lemma 3.4.4.5. *For all $n \in \mathbb{N}$ and $s \in K_n^*$ radical, $\bar{\Sigma}_n \circ S_n(s) = s$*

Moreover, fork-freeness implies radicality:

Lemma 3.4.4.6. *Given $n \in \mathbb{N}$ and $s \in K_n^*$, if s is fork-free, then s is radical.*

Proof. If $n = 0$, $s \in K_n^*$ can be written $s = \sum_{1 \leq i \leq k} x_i$ for some $k \in \mathbb{N}$ and $x_i \in P_0$ for $i \in \mathbb{N}_k^*$. So $e(s) = k$, and, by fork-freeness, $k = 1$. Hence, s is radical.

Otherwise, assume that $n > 0$. By contradiction, suppose that there is $\bar{x} \in P_n$ such that $2\bar{x} \leq s$. By Lemma 3.4.4.3, it means that $\bar{x}^- \cap \bar{x}^+ \neq \emptyset$, contradicting the fact that s is fork-free. Hence, s is radical. \square

Like for cells of torsion-free complexes, cells of adc 's with loop-free basis are fork-free:

Lemma 3.4.4.7. *Given $n \in \mathbb{N}$ and $X \in \text{Cell}^*(K)_n$, X is fork-free.*

Proof. We prove this lemma using an induction on n . If $n = 0$, since $e(X_0) = 1$, X is fork-free by definition.

Otherwise, suppose that $n > 0$. By induction, $\partial_{n-1}^-(X)$ and $\partial_{n-1}^+(X)$ are fork-free, so $X_{i,\epsilon}$ is fork-free for $i \in \mathbb{N}_{n-1}$ and $\epsilon \in \{-, +\}$. Let $\bar{x}, \bar{y} \in P_n$ be such that $\bar{x} + \bar{y} \leq X_n$. By contradiction, suppose that there is $\bar{z} \in P_{n-1}$ such that $\bar{z} \in \bar{x}^- \cap \bar{y}^+$. By [Ste04, Proposition 5.4], there are

$$k \geq 1, \quad \bar{x}_1, \dots, \bar{x}_k \in P_n \quad \text{and} \quad X^1, \dots, X^k \in \text{Cell}^*(K)$$

with $X_n^i = \bar{x}_i$ for $i \in \mathbb{N}_k^*$ and such that

$$X = X^1 *_{n-1} \cdots *_{n-1} X^k$$

so $X_n = x_1 + \cdots + x_k$. Hence, there are $1 \leq i_1, i_2 \leq k$ with $i_1 \neq i_2$ such that $x_{i_1} = \bar{x}$ and $x_{i_2} = \bar{y}$. By symmetry, we can suppose that $i_1 < i_2$. If there is some i such that $\bar{z} \in \bar{x}_i^+$, by [Ste04, Proposition 5.4], we have $i < i_1$. So, for $i_1 \leq i \leq i_2$, it holds that $\bar{z} \notin \bar{x}_i^+$. Let $Y = X^{i_1} *_{n-1} X^{i_1+1} *_{n-1} \cdots *_{n-1} X^{i_2}$. We have that $Y \in \text{Cell}^*(K)$ and

$$Y_{n-1,-} = \sum_{i_1 \leq i \leq i_2} [x_i]_{n-1,-} - \sum_{i_1 \leq i \leq i_2} [x_i]_{n-1,+} + Y_{n-1,+}$$

with

$$2z \leq \sum_{i_1 \leq i \leq i_2} [x_i]_{n-1,-} \quad \text{and} \quad -(z \leq \sum_{i_1 \leq i \leq i_2} [x_i]_{n-1,+}) \quad \text{and} \quad Y_{n-1,+} \geq 0$$

so $2z \leq Y_{n-1,-}$, contradicting the fact that $\partial_{n-1}^-(Y)$ is radical by Lemma 3.4.4.6. Thus $\bar{x}^- \cap \bar{y}^+ = \emptyset$ and, similarly, $\bar{x}^+ \cap \bar{y}^- = \emptyset$. Hence, X is fork-free. \square

We now give several compatibility results for the operations $\bar{\Sigma}_n$ with sets and the structure of ω -hypergraph on P :

Lemma 3.4.4.8. *Let $n \in \mathbb{N}$, $U, V \subseteq P_n$ be finite subsets and $x \in P_n$. The following hold:*

- (i) *if $U \cap V = \emptyset$, then $\bar{\Sigma}_n(U) \wedge \bar{\Sigma}_n(V) = 0$ and $\bar{\Sigma}_n(U \cup V) = \bar{\Sigma}_n(U) + \bar{\Sigma}_n(V)$,*
- (ii) *if $U \subseteq V$, then $\bar{\Sigma}_n(U) \leq \bar{\Sigma}_n(V)$ and $\bar{\Sigma}_n(V \setminus U) = \bar{\Sigma}_n(V) - \bar{\Sigma}_n(U)$,*

(iii) if $n > 0$, then $\bar{\Sigma}_{n-1}(\bar{x}^\epsilon) = x^\epsilon$,

(iv) Suppose that U is fork-free. Then $\bar{\Sigma}_n(U)$ is fork-free. Moreover, in the case where $n > 0$, we have $\bar{\Sigma}_{n-1}(U^\epsilon) = (\bar{\Sigma}_n(U))^\epsilon$.

Proof. (i) and (ii) are direct consequences of the definitions. For (iii), note that $\bar{x}^\epsilon = S_{n-1}(x^\epsilon)$. By Lemma 3.4.4.7, $[x]_{n-1,\epsilon}$ is fork-free and, by Lemma 3.4.4.6, it is radical. So, by Lemma 3.4.4.5, we have $\bar{\Sigma}_{n-1}(\bar{x}^\epsilon) = x^\epsilon$.

For (iv), suppose that $U \subseteq P_n$ is fork-free. If $n = 0$, the result is trivial. So suppose that $n > 0$. Given $x, y \in P_n$ with $x \leq \bar{\Sigma}_n(U)$ and $y \leq \bar{\Sigma}_n(U)$, $\bar{z} \in P_{n-1}$ and $\epsilon \in \{-, +\}$ such that $z \leq x^\epsilon$ and $z \leq y^\epsilon$, we have $\bar{z} \in \bar{x}^\epsilon$ and $\bar{z} \in \bar{y}^\epsilon$. Since U is fork-free, $x = y$. Also, $\bar{\Sigma}_n(U)$ is radical by definition of $\bar{\Sigma}_n$, so that $\neg(x + y \leq \bar{\Sigma}_n(U))$. Hence, $\bar{\Sigma}_n(U)$ is fork-free. For the second part, note that, for $x, y \in U$ with $x \neq y$, we have $\bar{x}^\epsilon \cap \bar{y}^\epsilon = \emptyset$. Hence,

$$\begin{aligned} \bar{\Sigma}_{n-1}(U^\epsilon) &= \bar{\Sigma}_{n-1}(\cup_{\bar{x} \in U} \bar{x}^\epsilon) \\ &= \sum_{\bar{x} \in U} \bar{\Sigma}_{n-1}(\bar{x}^\epsilon) && \text{(by (i))} \\ &= \sum_{\bar{x} \in U} x^\epsilon && \text{(by (iii))} \\ &= (\bar{\Sigma}_n(U))^\epsilon. \end{aligned} \quad \square$$

We give analogous compatibility results for the operations S_n with the group structure of K_n and the operations $(-)^-$ and $(-)^+$ defined on K_n :

Lemma 3.4.4.9. *Let $n \in \mathbb{N}$, $u, v \in K_n^*$ be such that u, v are radical and $z \in P_n$. The following hold:*

(i) if $u \wedge v = 0$, then $S_n(u) \cap S_n(v) = \emptyset$ and $S_n(u + v) = S_n(u) \cup S_n(v)$,

(ii) if $u \leq v$, then $S_n(u) \subseteq S_n(v)$ and $S_n(v - u) = (S_n(v)) \setminus (S_n(u))$,

(iii) if $n > 0$, then $S_{n-1}(z^\epsilon) = \bar{z}^\epsilon$,

(iv) Suppose that u is fork-free. Then, $S_n(u)$ is fork-free. Moreover, in the case where $n > 0$, we have $S_{n-1}(u^\epsilon) = (S_n(u))^\epsilon$.

Proof. (i), (ii) and (iii) are direct consequences of the definitions. For (iv), suppose that u is fork-free. If $n = 0$, the result is trivial, so suppose that $n > 0$. Given $\bar{x}, \bar{y} \in S_n(u)$, $\bar{z} \in P_{n-1}$ and $\epsilon \in \{-, +\}$ such that $\bar{z} \in \bar{x}^\epsilon \cap \bar{y}^\epsilon$, we have $z \leq x^\epsilon$ and $z \leq y^\epsilon$. By fork-freeness, $\neg(x + y \leq u)$. But $x \leq u$ and $y \leq u$, so that $x = y$. Thus, $S_n(u)$ is fork-free. For the second part, note that, for $x, y \in P_n$ with $x \neq y$, $x \leq u$ and $y \leq u$, we have $x^\epsilon \wedge y^\epsilon = 0$. Hence,

$$\begin{aligned} S_{n-1}(u^\epsilon) &= S_{n-1}\left(\sum_{x \in P_n, x \leq u} x^\epsilon\right) \\ &= \bigcup_{x \in P_n, x \leq u} S_{n-1}(x^\epsilon) && \text{(by (i))} \\ &= \bigcup_{x \in P_n, x \leq u} \bar{x}^\epsilon && \text{(by (iii))} \\ &= (S_n(u))^\epsilon. \end{aligned} \quad \square$$

3.4.4.10 – Movement properties. We now relate the movement properties of ω -hypergraphs (Paragraph 3.1.2.2) to properties of augmented directed complexes. Such results will be required for proving the correspondence between the cells of ω -hypergraphs and the cells of augmented directed complexes.

Let (K, d, e) be an adc with a loop-free unital basis P . We first prove a compatibility result of the functions $\bar{\Sigma}_n$ with the operations $(-)^{\mp}$ and $(-)^{\pm}$ on ω -hypergraphs and adc's:

Lemma 3.4.4.11. *Let $n \in \mathbb{N}^*$, $u \in K_n^*$ fork-free and $U = S_n(u)$. We have*

$$u^{\mp} = \bar{\Sigma}_{n-1}(U^{\mp}) \quad \text{and} \quad u^{\pm} = \bar{\Sigma}_{n-1}(U^{\pm}).$$

Proof. We have

$$\begin{aligned} d(u) &= u^{\pm} - u^{\mp} \\ &= u^+ - u^- \\ &= \bar{\Sigma}_{n-1}(U^+) - \bar{\Sigma}_{n-1}(U^-) && \text{(by Lemma 3.4.4.8)} \\ &= (\bar{\Sigma}_{n-1}(U^{\pm}) + \bar{\Sigma}_{n-1}(U^+ \cap U^-)) \\ &\quad - (\bar{\Sigma}_{n-1}(U^{\mp}) + \bar{\Sigma}_{n-1}(U^+ \cap U^-)) && \text{(by Lemma 3.4.4.8)} \\ &= \bar{\Sigma}_{n-1}(U^{\pm}) - \bar{\Sigma}_{n-1}(U^{\mp}). \end{aligned}$$

Since $U^{\pm} \cap U^{\mp} = \emptyset$, we have $\bar{\Sigma}_{n-1}(U^{\pm}) \wedge \bar{\Sigma}_{n-1}(U^{\mp}) = \emptyset$. By uniqueness of the decomposition,

$$u^{\mp} = \bar{\Sigma}_{n-1}(U^{\mp}) \quad \text{and} \quad u^{\pm} = \bar{\Sigma}_{n-1}(U^{\pm}). \quad \square$$

Now, we show a compatibility of the operations $\bar{\Sigma}_n$ with movement:

Lemma 3.4.4.12. *Let $n \in \mathbb{N}$, $S \subseteq P_{n+1}$ be a finite and fork-free set and $U, V \subseteq P_n$ be finite sets such that S moves U to V . Then, $d(\bar{\Sigma}_{n+1}(S)) = \bar{\Sigma}_n(V) - \bar{\Sigma}_n(U)$.*

Proof. By definition of movement, $V = (U \cup S^+) \setminus S^-$. Hence,

$$\begin{aligned} \bar{\Sigma}_n(V) &= \bar{\Sigma}_n((U \cup S^+) \setminus S^-) \\ &= \bar{\Sigma}_n(U \cup S^+) - \bar{\Sigma}_n(S^-) && \text{(by Lemma 3.4.4.8, since } S^- \subseteq U \cup S^+) \\ &= \bar{\Sigma}_n(U) + \bar{\Sigma}_n(S^+) - \bar{\Sigma}_n(S^-) && \text{(since } U \cap S^+ = \emptyset \text{ by Lemma 3.2.1.1)} \\ &= \bar{\Sigma}_n(U) + (\bar{\Sigma}_{n+1}(S))^+ - (\bar{\Sigma}_{n+1}(S))^- && \text{(by Lemma 3.4.4.8)} \\ &= \bar{\Sigma}_n(U) + d(\bar{\Sigma}_{n+1}(S)). \end{aligned} \quad \square$$

Conversely, we prove sufficient conditions for the operations S_n to induce movement:

Lemma 3.4.4.13. *Let $n \in \mathbb{N}$, $s \in K_{n+1}^*$ fork-free, $u, v \in K_n^*$ with u, v radical, such that*

$$d(s) = v - u, \quad u \wedge s^+ = 0 \quad \text{and} \quad s^- \wedge v = 0.$$

Then, $S_{n+1}(s)$ moves $S_n(u)$ to $S_n(v)$.

Proof. Let $S = S_{n+1}(s)$, $U = S_n(u)$ and $V = S_n(v)$. Since $d(s) = v - u$, we have

$$s^- \leq s^- + v = u + s^+$$

so

$$S^- = S_n(s^-) \subseteq S_n(u + s^+) = U \cup S^+.$$

Thus,

$$\begin{aligned}
\bar{\Sigma}_n((U \cup S^+) \setminus S^-) &= \bar{\Sigma}_n(U \cup S^+) - \bar{\Sigma}_n(S^-) \\
&= \bar{\Sigma}_n \circ S_n(u + s^+) - s^- && \text{(by Lemma 3.4.4.8)} \\
&= u + s^+ - s^- \\
&= u + d(s) \\
&= v \\
&= \bar{\Sigma}_n(V)
\end{aligned}$$

so, by Lemma 3.4.4.2, $V = (U \cup S^+) \setminus S^-$. Similarly, $U = (V \cup S^-) \setminus S^+$. Hence, S moves U to V . \square

Finally, we show empty intersection results for cells of $\text{Cell}^*(K)$, whose analogous for $\text{Cell}(P)$ hold:

Lemma 3.4.4.14. *Let $n \in \mathbb{N}^*$ and $X \in \text{Cell}^*(K)_n$. Then, for $i \in \mathbb{N}_{n-1}$ and $\epsilon \in \{-, +\}$, we have*

$$X_{i,-} \wedge X_{i+1,\epsilon}^+ = 0 \quad \text{and} \quad X_{i+1,\epsilon}^- \wedge X_{i,+} = 0.$$

Proof. By contradiction, suppose given $n \in \mathbb{N}^*$, $X \in \text{Cell}^*(K)_n$, $i \in \mathbb{N}_{n-1}$ and $\epsilon \in \{-, +\}$ that give a counter-example for this property. By applying ∂^- , ∂^+ sufficiently, we can suppose that $i = n - 1$. Also, by symmetry, we only need to handle the first case, that is, when there is $z \in P_{n-1}$ such that $z \leq X_{n-1,-} \wedge X_n^+$. So there is $x \in P_n$ such that $x \leq X_n$ and $z \leq x^+$. By the definition of a cell, we have $d(X_n) = X_{n-1,+} - X_{n-1,-}$, thus

$$\begin{aligned}
X_{n-1,+} + \sum_{u \in P_n, u \leq X_n} u^- &= X_{n-1,-} + \sum_{u \in P_n, u \leq X_n} u^+ \\
&\geq 2z
\end{aligned}$$

and, since $X_{n-1,+}$ is radical, there is $y \in P_n$ with $y \leq X_n$ such that $z \leq y^-$. By [Ste04, Proposition 5.1], there are $k \in \mathbb{N}^*$, $x_1, \dots, x_k \in P_n$ with $x_1 + \dots + x_k = X_n$, $i_1, i_2 \in \mathbb{N}_k^*$ with $i_1 < i_2$, $x_{i_1} = x$ and $x_{i_2} = y$, and $X^1, \dots, X^k \in \text{Cell}^*(K)$ with $X_n^i = x_i$ for $i \in \mathbb{N}_k^*$ such that $X = X^1 *_{n-1} \dots *_{n-1} X^k$. Let $Y = X^1 *_{n-1} \dots *_{n-1} X^{i_1}$. Since Y is a cell, we have

$$\begin{aligned}
Y_{n-1,+} + \sum_{1 \leq i \leq k} x_i^- &= Y_{n-1,-} + \sum_{1 \leq i \leq k} x_i^+ \\
&= X_{n-1,-} + \sum_{1 \leq i \leq k} x_i^+ \\
&\geq 2z.
\end{aligned}$$

Moreover, since X is fork-free and $z \leq x_{i_2}^-$, we have $\neg(z \leq x_i^-)$ for $i \in \mathbb{N}_{i_1}$. So $2z \leq Y_{n-1,+}$, contradicting the fact that $Y_{n-1,+}$ is radical by Lemmas 3.4.4.7 and 3.4.4.6. Hence, $X_{i,-} \wedge X_n^+ = 0$. \square

3.4.4.15 – The translation operations. We now introduce translation functions between the cells of augmented directed complexes and the cells of their associated ω -hypergraphs, and show that these translations are bijective.

Let (K, d, e) be an adc with a loop-free unital basis P . We extend the operations $\bar{\Sigma}_n$ and S_n to translation functions between the pre-cells of P and the pre-cells of K . Given $n \in \mathbb{N}$ and an n -pre-cell $X \in \text{PCell}(P)_n$, we define $\bar{\Sigma}(X) \in \text{Cell}^*(K)$ as the n -pre-cell Y such that

$$Y_{i,\epsilon} = \bar{\Sigma}_i(X_{i,\epsilon}) \text{ for } i \in \mathbb{N}_n \text{ and } \epsilon \in \{-, +\}.$$

Similarly, given an n -pre-cell $X \in \text{PCell}^*(K)$, we define $S(X) \in \text{PCell}(P)$ as the n -pre-cell Y such that

$$Y_{i,\epsilon} = S_i(X_{i,\epsilon}) \text{ for } i \in \mathbb{N}_n \text{ and } \epsilon \in \{-, +\}.$$

We then have:

Proposition 3.4.4.16. \bar{S} induces a bijection with inverse S from $\text{Cell}(P)$ to $\text{Cell}^*(K)$. Moreover, given $x \in P$, we have $S([x]) = \langle \bar{x} \rangle$.

Proof. Let $n \in \mathbb{N}$ and $X \in \text{Cell}(P)_n$. Then, by Lemma 3.4.4.8, given $i \in \mathbb{N}_n$ and $\epsilon \in \{-, +\}$, $\bar{S}_i(X_{i,\epsilon})$ is fork-free. Moreover, when $i < n$, by Lemma 3.4.4.12, we have

$$d(\bar{S}_{i+1}(X_{i+1,\epsilon})) = \bar{S}_i(X_{i,+}) - \bar{S}_i(X_{i,-})$$

so $\bar{S}(X) \in \text{Cell}^*(K)$. Conversely, let $n \in \mathbb{N}$ and $X \in \text{Cell}^*(K)_n$. By Lemma 3.4.4.9, given $i \in \mathbb{N}_n$ and $\epsilon \in \{-, +\}$, $S_i(X_{i,\epsilon})$ is fork-free. Moreover, when $i < n$, by Lemmas 3.4.4.13 and 3.4.4.14, we have

$$S_{i+1}(X_{i+1,\epsilon}) \text{ moves } S_i(X_{i,-}) \text{ to } S_i(X_{i,+})$$

so $S(X) \in \text{Cell}(P)$. By Lemma 3.4.4.2, for $X \in \text{Cell}(P)$,

$$S \circ \bar{S}(X) = X,$$

and, by Lemmas 3.4.4.7, 3.4.4.6 and 3.4.4.5, for $X \in \text{Cell}^*(K)$,

$$\bar{S} \circ S(X) = X.$$

Hence, \bar{S} and S induce bijections between $\text{Cell}(P)$ and $\text{Cell}^*(K)$ and are inverse of each other.

Now let $n \in \mathbb{N}$, $x \in P_n$ and $X = S([x])$. We have $X_n = S_n([x]_n) = \{x\}$. We show by a decreasing induction on i that $X_{i,\epsilon} = \langle x \rangle_{i,\epsilon}$ for $i \in \mathbb{N}_{n-1}$ and $\epsilon \in \{-, +\}$. We have $[x]_{i,-} = [x]_{i+1,-}^\mp$, so, by Lemmas 3.4.4.7 and 3.4.4.11,

$$X_{i,-} = S_i([x]_{i+1,-}^\mp) = X_{i+1,-}^\mp.$$

Thus, $X_{i,-} = \langle x \rangle_{i,-}$. Similarly, $X_{i,+} = \langle x \rangle_{i,+}$. Hence, $S([x]) = \langle \bar{x} \rangle$. \square

3.4.4.17 — Adc's are torsion-free complexes. We have now enough material to prove that the ω -hypergraphs associated to adc 's equipped with loop-free unital bases are torsion-free complexes. In fact, we will show that they moreover satisfy the stronger Axioms (T3') and (T4').

Let (K, d, e) be an adc with a loop-free unital basis P . We have already shown how to derive Axiom (T0) for P in Lemma 3.4.4.3, and we now derive the other ones in the following lemmas.

Lemma 3.4.4.18. P satisfies Axiom (T1).

Proof. Note that, for $n \in \mathbb{N}^*$ and $\bar{x}, \bar{y} \in P_n$, $\bar{x} \triangleleft_{P_n}^1 \bar{y}$ implies $\bar{x} <_{n-1} \bar{y}$. So, by transitivity, we have $\triangleleft_{P_n} \subseteq <_{n-1}$. Since the basis P is loop-free, $<_{n-1}$ is irreflexive and so is \triangleleft_{P_n} . Hence, \triangleleft is irreflexive. \square

Lemma 3.4.4.19. P satisfies Axiom (T2).

Proof. Given $\bar{x} \in P$, we have $S([x]) = \langle \bar{x} \rangle$ By Proposition 3.4.4.16. Moreover, by Proposition 3.4.4.16, we have $S([x]) \in \text{Cell}(P)$. Hence, \bar{x} is relevant. \square

Lemma 3.4.4.20. P satisfies Axiom (T3').

Proof. By contradiction, suppose that there are $n \in \mathbb{N}^*$, $i \in \mathbb{N}_{n-1}$ and $\bar{x} \in P_n$ with $\langle \bar{x} \rangle_{i,+} \curvearrowright^* \langle \bar{x} \rangle_{i,-}$. So there are $k \geq 1$, $\bar{y}_1, \dots, \bar{y}_k \in P_i$ such that

$$\bar{y}_1 \in \langle \bar{x} \rangle_{i,+}, \quad \bar{y}_k \in \langle \bar{x} \rangle_{i,-} \quad \text{and} \quad \bar{y}_j \curvearrowright \bar{y}_{j+1} \text{ for } 1 \leq j < k.$$

By definition of \curvearrowright , it gives $\bar{z}_1, \dots, \bar{z}_{k-1} \in P_{i+1}$ with $\bar{y}_j \in \bar{z}_j^-$ and $\bar{y}_{j+1} \in \bar{z}_j^+$ for $1 \leq j < k$. So we have

$$x <_i z_1 <_i \dots <_i z_{k-1} <_i x,$$

contradicting the loop-freeness of the basis P . Hence, P satisfies Axiom (T3'). \square

Lemma 3.4.4.21. *P satisfies Axiom (T4').*

Proof. By contradiction, suppose that there are $i \in \mathbb{N}^*$, $m, n \in \mathbb{N}$ with $m > i$ and $n > i$, $\bar{x} \in P_m$ and $\bar{y} \in P_n$ such that

$$\langle \bar{x} \rangle_{i,+} \cap \langle \bar{y} \rangle_{i,-} = \emptyset, \quad \langle \bar{x} \rangle_{i-1,+} \curvearrowright^* \langle \bar{y} \rangle_{i-1,-} \quad \text{and} \quad \langle \bar{y} \rangle_{i-1,+} \curvearrowright^* \langle \bar{x} \rangle_{i-1,-}.$$

By the same method as for Lemma 3.4.4.20, we get $r, s \in \mathbb{N}$, $u_1, \dots, u_r \in P_i$, $v_1, \dots, v_s \in P_i$ such that

$$x <_i u_1 <_i \dots <_i u_r <_i y <_i v_1 <_i \dots <_i v_s <_i x,$$

contradicting the loop-freeness of the basis P . Hence, P satisfies Axiom (T4'). \square

We can conclude that:

Theorem 3.4.4.22. *The ω -hypergraph P associated to K is a torsion-free complex.*

Proof. This follows from Lemmas 3.4.4.3, 3.4.4.18, 3.4.4.19, 3.4.4.20, 3.1.5.6, 3.4.4.21 and 3.1.5.7. \square

Finally, we show that $\bar{\Sigma}$ exhibits an isomorphism between the two ω -categories of cells:

Theorem 3.4.4.23. *$\bar{\Sigma}$ induces an isomorphism of ω -categories between $\text{Cell}(P)$ and $\text{Cell}^*(K)$. Moreover, for $\bar{x} \in P$, we have $\bar{\Sigma}(\langle \bar{x} \rangle) = [x]$.*

Proof. By definition, $\bar{\Sigma}$ commutes with the source, target and identity operations defined on the ω -categories $\text{Cell}(P)$ and $\text{Cell}^*(K)$. We show that it commutes with the composition operations. Given $i, n \in \mathbb{N}$ with $i < n$, i -composable cells $X, Y \in \text{Cell}(P)_n$, by Lemma 3.2.3.2, we have

$$X_{j,\epsilon} \cap Y_{j,\epsilon} = \emptyset \quad \text{for } j \in \mathbb{N} \text{ with } i < j \leq n \text{ and } \epsilon \in \{-, +\}.$$

Thus, by Lemma 3.4.4.8, it follows readily that $\bar{\Sigma}_n(X *_i Y) = \bar{\Sigma}_n(X) *_i \bar{\Sigma}_n(Y)$. Thus, $\bar{\Sigma}$ is a morphism of ω -categories. We conclude with Proposition 3.4.4.16. \square

3.4.5 Absence of other embeddings

We conclude our comparison of the pasting diagram formalisms by showing that there are no embeddings between the four formalisms except the ones already proved, that is, that parity complexes, pasting scheme and augmented directed complexes are particular cases of torsion-free complexes (under the caveats stated for parity complexes and pasting schemes). We show these inexistence results by simply exhibiting counter-examples to the other embeddings.

Since adc 's are not exactly ω -hypergraphs, we should make the following precisions. When we say that "there is no embedding of adc 's with loop-free unital bases into the formalism X", we mean that, in general, the ω -hypergraph obtained from an adc with loop-free unital basis (as described in Paragraph 3.4.4.1) is not an instance of X. Conversely, when we say that "there is no embedding of the formalism X into adc 's with loop-free unital bases", we mean that, in general, the pre- adc with basis obtained from an ω -hypergraph which is an instance of X (as described in Paragraph 3.1.4.4) is not an adc with loop-free unital basis.

3.4.5.1 – No embedding in parity complexes. We show that there are no embeddings into parity complexes of the other formalisms. Considering the axioms of parity complexes, Axiom (C4) is relatively strong, and it has no real equivalent in the other formalisms, so it can be used to build a counter-example to embeddings. The ω -hypergraph (3.8) is a pasting scheme satisfying Axiom (T4) (and thus is a torsion-free complex) and is an adc with loop-free unital basis. But it is not a parity complex as we have seen in Paragraph 3.1.2.12, because it does not satisfy Axiom (C4). So pasting schemes, augmented directed complexes and torsion-free complexes are not parity complexes in general.

3.4.5.2 – No embedding in pasting schemes. We now show that there are no embeddings into pasting schemes of the other formalisms. We use the relatively strong Axiom (S2) to build a counter-example to the embeddings. The following ω -hypergraph is a parity complex satisfying Axiom (T4) (and thus it is a torsion-free complex) and is an adc with loop-free unital basis but it is not a pasting scheme:

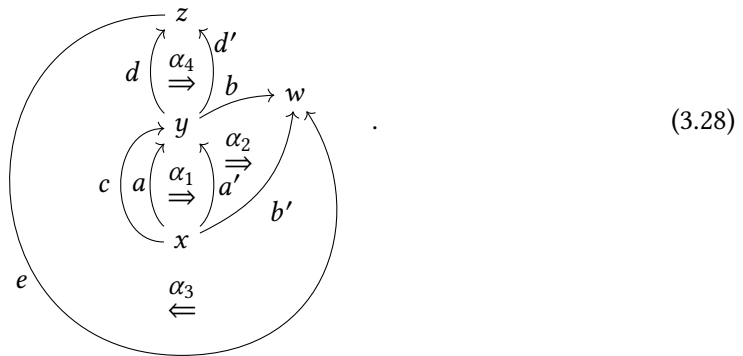

Indeed, Axiom (S2) is not satisfied because $\alpha_2 \triangleleft \alpha_3$ and $y \in B(\alpha_2) \cap E(\alpha_3) \neq \emptyset$. Note that (3.28) is essentially the ω -hypergraph (3.13) without the 3-generator A and the 2-generators α'_1 and α'_4 .

3.4.5.3 – No embedding in augmented directed complexes. Finally, we prove that there are no embeddings into augmented directed complexes with loop-free unital basis of the other formalisms. As shown in Section 3.4.4, such adc's satisfy Axiom (T4'), which is a stronger version of Axiom (T4). Thus, we can find a counter-example to embedding into adc's with loop-free unital basis by considering an adequate ω -hypergraph which satisfies Axiom (T4) but not Axiom (T4'). Consider the ω -hypergraph P from Figure 3.8 where the 3-generators $P_3\{A, B, C\}$ are such that

$$\begin{aligned} A^- &= \{\beta, \gamma\}, & A^+ &= \{\beta', \gamma'\}, \\ B^- &= \{\delta, \epsilon\}, & B^+ &= \{\delta', \epsilon'\}, \\ C^- &= \{\alpha, \gamma', \delta', \zeta\}, & C^+ &= \{\alpha', \gamma'', \zeta'\}. \end{aligned}$$

It can be shown that it is a parity complex and a pasting scheme. It moreover satisfies Axiom (T4) so that it is a torsion-free complex by Theorem 3.4.3.9. But its associated pre-adc is an adc with a basis which is not loop-free unital. Indeed, we have

$$e \leq [A]_{1,+} \wedge [B]_{1,-}, \quad h \leq [B]_{1,+} \wedge [C]_{1,-} \quad \text{and} \quad b \leq [C]_{1,-} \wedge [A]_{1,+},$$

so that

$$A <_1 B <_1 C <_1 A.$$

Hence, the basis of the associated augmented directed complex is not loop-free.

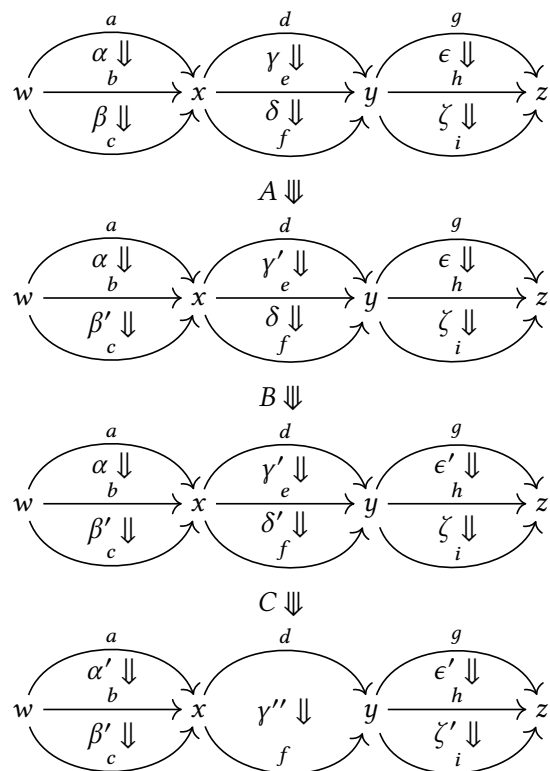
Figure 3.8 – The ω -hypergraph P

Coherence for Gray categories

Introduction

Algebraic structures, such as monoids, can be defined inside arbitrary categories. In order to generalize their definition to higher categories, the general principle is that one should look for a *coherent* version of the corresponding algebraic theory: this roughly means that we should add enough higher cells to our algebraic theory so that “all diagrams commute”. For instance, when generalizing the notion of monoid from monoidal categories to monoidal 2-categories, associativity and unitality are now witnessed by 2-cells, and one should add new axioms in order to ensure their coherence: in this case, those are MacLane’s unit (1.16) and pentagon (1.17) equations, thus resulting in the notion of pseudomonoid. The fact that these are indeed enough to make the structure coherent constitutes a reformulation of MacLane’s celebrated coherence theorem for monoidal categories [Mac63]. In this context, a natural question is: how can we systematically find those higher coherence cells?

Rewriting theory provides a satisfactory answer to this question. Namely, if we orient the axioms of the algebraic structures of interest in order to obtain a rewriting system which is suitably behaved (confluent and terminating), the confluence diagrams for critical branchings precisely provide us with such coherence cells. This was first observed by Squier for monoids, first formulated in homological language [Squ87] and then generalized as a homotopical condition [SOK94; Laf95]. These results were then extended to strict higher categories by Guiraud and Malbos [GM09; GM12; GM18] based on a notion of rewriting system adapted to this setting, which is provided by the polygraphs for strict categories (as introduced in Section 1.4.1). In particular, their work allow to recover the coherence laws for pseudomonoids in this way.

Our aim is to generalize those techniques in order to be able to define coherent algebraic structures in *weak* higher categories. We actually handle here the first non-trivial case, which is the one of dimension 3. Namely, it is well-known that tricategories are not equivalent to strict 3-categories: the “best” one can do is to show that they are equivalent to *Gray categories* [GPS95; Gur13], which is an intermediate structure between weak and strict 3-categories, roughly consisting in 3-categories in which the exchange law is not required to hold strictly. This means that classical rewriting techniques cannot be used out of the shelf in this context and one has to adapt those to Gray categories, which is the object of this chapter. It turns out that precategories offer a nice setting for rewriting, as could already be intuited from Chapters 2 and 3. Their 2-dimen-

sional instances, namely *sesquicategories*, were already advocated by Street in the context of rewriting [Str96]. Precategories have gained quite some interest recently, by being at the core of the graphical proof-assistant Globular [BKV16; BV17], which allows working with several kinds of semi-strict higher categories expressed as precategories. In particular, Gray categories are 3-precategories equipped with exchange 3-cells satisfying suitable axioms.

Outline. We first give additional results on precategories (Section 4.1), that justify their use as a computational framework for semi-strict higher categories. In particular, we show that the cells of free precategories admit a simple description as sequences of applied whiskers (that are analogous to contexts and context classes for strict categories), which allows a simple solution to the word problem on prepolygraphs. Then, we show how Gray categories can be presented by the mean of precategories after recalling the definition of Gray categories as categories enriched with strict 2-categories enriched with the Gray tensor product (Section 4.2). Next, we extend the theory of rewriting to prepolygraphs and, more specifically, presentations of Gray categories and show that the resulting theory has good properties similar to the ones of term rewriting systems (Section 4.3). In particular, a finite presentation of a Gray category always has a finite number of critical branchings, which contrasts with the case of strict categories [Laf03; GM09; Mim14], and the computational properties of precategories enable a mechanized computation of those critical branchings. Then, we derive a Squier-type coherence theorem (Theorem 4.3.4.8) and show that, given a presentation where the confluence diagrams of the critical branchings are “filled” by coherence cells, the presented Gray category is coherent. Finally, we apply our results to several algebraic structures (Section 4.4), which allows us to recover known coherence results and find new ones, such as for pseudomonoids (Section 4.4.1), pseudoadjunctions (Section 4.4.2), self-dualities (Section 4.4.4) and Frobenius pseudomonoids (Section 4.4.3).

4.1 Precategories for computations and presentations

In Chapter 2, we showed that strict categories could be seen as precategories satisfying additional equations. This fact allowed us to give a syntactical description of cells of free strict n -categories in the form of sequences of applied context classes, and which is moreover amenable to computation. This motivates using precategories as a more general computational framework for studying other semi-strict higher categories, as we will do in the following sections. In the present section, we give additional properties and constructions on precategories that will make them suitable for computations and for presenting other higher categories, like Gray categories.

We first give a syntactic description of free precategories by adapting the description of free strict categories given in Section 2.2. In particular, we define the notion of whisker (Section 4.1.1), which is the analogue of contexts and context classes for prepolygraphs and show that the cells of free precategories can be described as sequences of applied whiskers, which implies that free precategories admit a simple computational representation and the word problem on prepolygraphs has a trivial solution (Section 4.1.2). Then, we introduce several notions and constructions that will allow us to present precategories by the mean of prepolygraphs (Section 4.1.3).

4.1.1 Whiskers

Here, we define an analogue of contexts and context classes for precategories, called whiskers, and study their properties by closely following what we did in Section 2.2.2.

4.1.1.1 – Definition. Let $n \in \mathbb{N} \cup \{\omega\}$ and C be an n -precategory. Recall the notion of *type* from Section 2.2.2. For every $m \in \mathbb{N}_n$ and m -type (u, u') , we define by induction on m

- the notion of m -whisker of type (u, u') of C ,
- for $k \in \mathbb{N}_n$ with $k \geq m$, the evaluation of an m -whisker E of type (u, u') at a cell $v \in C_k$ of type (u, u') , which is a k -cell of C denoted $E[v]$.

Together with the above inductive definition, we prove the following:

Proposition 4.1.1.2. *Given $m, i, k \in \mathbb{N}_n$ with $m \leq i \leq k$, $v \in C_k$, an m -whisker E of type v and $\epsilon \in \{-, +\}$, we have*

$$\partial_i^\epsilon(E[v]) = E[\partial_i^\epsilon(v)].$$

There is a unique 0-whisker, denoted $[-]$ and, given $k \in \mathbb{N}_n$ and $v \in C_k$, the evaluation of the 0-whisker $[-]$ at v is v , so that Proposition 4.1.1.2 holds directly for $m = 0$. Given $m \in \mathbb{N}_{n-1}$ and an $(m+1)$ -type (u, u') , an $(m+1)$ -whisker of type (u, u') is a triple $E = (l, E', r)$ where

- E' is an m -whisker of type $(\partial_{m-1}^-(u), \partial_{m-1}^+(u'))$,
- l and r are $(m+1)$ -cells of C such that $\partial_m^+(l) = E'[u]$ and $\partial_m^-(r) = E'[u']$.

Given $k \in \mathbb{N}_n$ with $k \geq m + 1$ and $v \in C_k$ of type (u, u') , the evaluation $E[v]$ of E at v is the k -cell

$$E[v] = l \bullet_m E'[v] \bullet_m r.$$

Moreover, given $i \in \mathbb{N}_n$ with $m + 1 \leq i$ and $\epsilon \in \{-, +\}$, we have

$$\begin{aligned} \partial_i^\epsilon(E[v]) &= \partial_i^\epsilon(l \bullet_m E'[v] \bullet_m r) \\ &= l \bullet_m \partial_i^\epsilon(E'[v]) \bullet_m r \\ &= l \bullet_m E'[\partial_i^\epsilon(v)] \bullet_m r && \text{(by the induction hypothesis)} \\ &= E[\partial_i^\epsilon(v)] \end{aligned}$$

so that Proposition 4.1.1.2 holds, which ends the definition of whiskers.

Example 4.1.1.3. Let P be the 2-prepolygraph such that

$$\begin{aligned} P_0 &= \{w, x, y, z\} \\ P_1 &= \{a: w \rightarrow z, \quad b, b': w \rightarrow x, \quad c, c': x \rightarrow y, \quad d, d': y \rightarrow z, \quad e: w \rightarrow z\} \\ P_2 &= \{\alpha: a \Rightarrow b \bullet_0 c \bullet_0 d, \quad \beta: b \Rightarrow b', \quad \delta: d \Rightarrow d', \quad \epsilon: b' \bullet_0 c' \bullet_0 d' \Rightarrow e\} \end{aligned}$$

which can be represented by

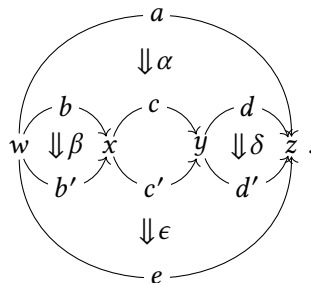

There are several 1-whiskers of type (x, y) , such as the following ones:

- $(\text{id}_x^1, [-], \text{id}_y^1)$,

- $(b, [-], \text{id}_y^1)$,
- $(\text{id}_x^1, [-], d)$,
- $E_{f,h} = (f, [-], g)$ for $f \in \{b, b'\}$ and $h \in \{d, d'\}$.

Note that, for $f \in \{b, b'\}$ and $h \in \{c, c'\}$, the evaluation of $E_{f,h}$ at $g \in \{c, c'\}$ is $f \bullet_0 g \bullet_0 h$. There are several 2-whiskers of type (c, c') , as the following ones:

- $E_1 = (\alpha \bullet_1 (\beta \bullet_0 c \bullet_0 d) \bullet_1 (b' \bullet_0 c \bullet_0 \delta), E_{b',d'}, \epsilon)$,
- $\bar{E}_1 = (\alpha \bullet_1 (b \bullet_0 c \bullet_0 \delta) \bullet_1 (\beta \bullet_0 c \bullet_0 d'), E_{b',d'}, \epsilon)$,
- $E_2 = (\alpha \bullet_1 (b \bullet_0 c \bullet_0 \delta), E_{b,d'}, (\beta \bullet_0 c' \bullet_0 d') \bullet_1 \epsilon)$,
- $E_3 = (\alpha \bullet_1 (\beta \bullet_0 c \bullet_0 d), E_{b',d}, (b' \bullet_0 c' \bullet_0 \delta) \bullet_1 \epsilon)$,
- $E_4 = (\alpha, E_{b,d}, (\beta \bullet_0 c' \bullet_0 d) \bullet_1 (b' \bullet_0 c' \bullet_0 \delta) \bullet_1 \epsilon)$,
- $\bar{E}_4 = (\alpha, E_{b,d}, (b \bullet_0 c' \bullet_0 \delta) \bullet_1 (\beta \bullet_0 c' \bullet_0 d') \bullet_1 \epsilon)$.

The reader is invited to compare the above whiskers with the contexts of Example 2.2.2.3.

4.1.1.4 – Source and target of whiskers. Let $n \in \mathbb{N} \cup \{\omega\}$ and C be an n -precategory. Given an integer $m \in \mathbb{N}_n^*$, an m -type (u, u') of C and an m -whisker $E = (l, F, r)$ of type (u, u') , the *source* and the *target* of E are respectively the $(m-1)$ -cells

$$\partial_{m-1}^-(E) = \partial_{m-1}^-(l) \quad \text{and} \quad \partial_{m-1}^+(E) = \partial_{m-1}^+(r).$$

When $m > 1$, we moreover have

$$\partial_{m-2}^\epsilon \circ \partial_{m-1}^-(E) = \partial_{m-2}^\epsilon \circ \partial_{m-1}^+(E)$$

for $\epsilon \in \{-, +\}$. Indeed, given $(l', E'', r') = E'$,

$$\partial_{m-1}^+(l) = l' \bullet_{m-2} E'' [u] \bullet_{m-2} r' \quad \text{and} \quad \partial_{m-1}^-(r) = l' \bullet_{m-2} E'' [u'] \bullet_{m-2} r'$$

so that

$$\begin{aligned} \partial_{m-2}^- \circ \partial_{m-1}^-(E) &= \partial_{m-2}^- \circ \partial_{m-1}^-(l) \\ &= \partial_{m-2}^- \circ \partial_{m-1}^+(l) \\ &= \partial_{m-2}^-(l') \\ &= \partial_{m-2}^- \circ \partial_{m-1}^-(r) \\ &= \partial_{m-2}^- \circ \partial_{m-1}^+(r) \\ &= \partial_{m-2}^- \circ \partial_{m-1}^+(E) \end{aligned}$$

and similarly, $\partial_{m-2}^+ \circ \partial_{m-1}^-(E) = \partial_{m-2}^+ \circ \partial_{m-1}^+(E)$. Given $i \in \mathbb{N}_{m-1}$, $\epsilon \in \{-, +\}$, we write $\partial_i^\epsilon(E)$ for $\partial_i^\epsilon \circ \partial_{m-1}^\epsilon(E)$. With these notations, for $i \in \mathbb{N}_{n-1}$, we can extend the notion of i -composable sequences of globes of globular sets to sequences X_1, \dots, X_l for some $l \in \mathbb{N}^*$ where X_s is either a whisker or a cell of C for $s \in \mathbb{N}_i^*$, and say that X_1, \dots, X_l is i -composable when

$$\partial_i^+(X_s) = \partial_i^-(X_{s+1}) \text{ for } s \in \mathbb{N}_{l-1}^*.$$

It is immediate that the source and target operations are compatible with the evaluation of whiskers:

Proposition 4.1.1.5. *Given $i, m, k \in \mathbb{N}_n$ with $i < m \leq k$, $\epsilon \in \{-, +\}$, a k -cell $u \in C$ and an m -whisker E of type u , we have*

$$\partial_i^\epsilon(E[u]) = \partial_i^\epsilon(E).$$

4.1.1.6 – Identity whiskers. Let $n \in \mathbb{N} \cup \{\omega\}$ and C be an n -precategory. Given $m \in \mathbb{N}_n$ and an m -type (u, u') of C , we define an m -whisker $I^{(u, u')}$, called the *identity whisker* on (u, u') , by induction on m . When $m = 0$, we put

$$I^{(*, *)} = [-]$$

and, when $m > 0$, we put

$$I^{(u, u')} = (\text{id}_u^m, I^{(\partial_{m-2}^-(u), \partial_{m-2}^+(u'))}, \text{id}_{u'}^m)$$

If C is part of an n -cellular extension $(C, X) \in \mathbf{PCat}_n^+$, given $g \in X$, we write I^g for

$$I^{(\partial_{n-1}^-(g), \partial_{n-1}^+(g))}.$$

The identity whiskers have then trivial evaluations:

Proposition 4.1.1.7. For $m, k \in \mathbb{N}_n$ with $m \leq k$, an m -type (u, u') and $v \in C_k$ of type (u, u') , we have

$$I^{(u, u')}[v] = v.$$

Proof. This is shown by a simple induction on m . □

4.1.1.8 – Composition operations. Let $n \in \mathbb{N} \cup \{\omega\}$ and C be an n -precategory. Let $i, m \in \mathbb{N}_n$ with $i < m$, (u, u') be an m -type and $E = (l, E', r)$ be an m -whisker of type (u, u') . Given a cell $v \in C_{i+1}$ such that (v, E) is i -composable, we define an m -whisker $v \bullet_i E$ using an induction on $m - i$ by

$$v \bullet_i E = \begin{cases} (v \bullet_i l, E', r) & \text{if } i + 1 = m, \\ (v \bullet_i l, v \bullet_i E', v \bullet_i r) & \text{if } i + 1 < m. \end{cases}$$

Similarly, when (E, v) is i -composable, we define an m -whisker $E \bullet_i v$ using an induction on $m - i$ by

$$E \bullet_i v = \begin{cases} (l, E', r \bullet_i v) & \text{if } i + 1 = m, \\ (l \bullet_i v, E' \bullet_i v, r \bullet_i v) & \text{if } i + 1 < m. \end{cases}$$

These composition operations satisfy properties similar to the axioms of $(n+1)$ -precategories:

Proposition 4.1.1.9. Given $m \in \mathbb{N}_n$, an m -type (u, u') of C and an m -whisker E of type (u, u') , we have

(i) for all $i \in \mathbb{N}_{m-1}$ and $u_1 = \partial_i^-(E)$, $u_2 = \partial_i^+(E)$,

$$\text{id}_{u_1}^{i+1} \bullet_i E = E = E \bullet_i \text{id}_{u_2}^{i+1},$$

(ii) for all $i \in \mathbb{N}_{m-1}$ and $u_1, u_2 \in C_{i+1}$, if u_1, u_2, E are i -composable or u_1, E, u_2 are i -composable or E, u_1, u_2 are i -composable, then we respectively have

$$(u_1 \bullet_i u_2) \bullet_i E = u_1 \bullet_i (u_2 \bullet_i E)$$

or

$$(u_1 \bullet_i E) \bullet_i u_2 = u_1 \bullet_i (E \bullet_i u_2)$$

or

$$(E \bullet_i u_1) \bullet_i u_2 = E \bullet_i (u_1 \bullet_i u_2),$$

(iii) for all $i, j \in \mathbb{N}_{m-1}$ such that $i < j$, and $u_1, u_2 \in C_{i+1}$ and $v_1, v_2 \in C_{j+1}$ such that u_1, E, u_2 are i -composable and v_1, E, v_2 are j -composable, we have

$$u_1 \bullet_i (v_1 \bullet_j E \bullet_j v_2) \bullet_i u_2 = (u_1 \bullet_i v_1 \bullet_i u_2) \bullet_j (u_1 \bullet_i E \bullet_i u_2) \bullet_j (u_1 \bullet_i v_2 \bullet_i u_2).$$

Proof. By a direct adaptation of the proof of Proposition 2.2.2.11. \square

Finally, we prove that the composition operations on whiskers are compatible with evaluation:

Proposition 4.1.1.10. *Given $i, m, k \in \mathbb{N}_n$ with $i < m \leq k$, $u \in C_{i+1}$, $v \in C_k$ and an m -whisker E of type v , if u, E are i -composable, then*

$$(u \bullet_i E)[v] = u \bullet_i (E[v])$$

and otherwise, if E, u are i -composable, then

$$(E \bullet_i u)[v] = (E[v]) \bullet_i u.$$

Proof. By a direct adaptation of the proof of Proposition 2.2.2.13. \square

4.1.1.11 – Whiskers and functoriality. Let $n \in \mathbb{N} \cup \{\omega\}$ and C, D be two n -precategories. Given an n -prefunctor $F: C \rightarrow D$, we extend F to m -whiskers. More precisely, given $m \in \mathbb{N}_n$, an m -type (u, u') of C and an m -whisker E of type (u, u') , we define an m -whisker $F(E)$ of type $(F(u), F(u'))$ by induction on m as follows. If $m = 0$, we put

$$F([-]) = [-]$$

Otherwise, if $m > 0$, given $(l, E', r) = E$, we put

$$F(E) = (F(l), F(E'), F(r)).$$

We then have compatibility results between F and the operations on whiskers, analogous to the ones shown for contexts and context classes:

Proposition 4.1.1.12. *Given $m, k \in \mathbb{N}_n$ with $m \leq k$, $u \in C_k$ and an m -whisker E of type u , we have*

$$F(E[u]) = F(E)[F(u)].$$

Proof. By a simple induction on m . \square

Proposition 4.1.1.13. *Given $m \in \mathbb{N}_n$ and an m -type (u, u') , we have $F(I^{(u, u')}) = I^{(F(u), F(u'))}$.*

Proof. By a simple induction on m . \square

Proposition 4.1.1.14. *Given $i, m \in \mathbb{N}_n$ with $i < m$, $u \in C_{i+1}$ and an m -whisker E , if u, E (resp. E, u) are i -composable, then*

$$F(u \bullet_i E) = F(u) \bullet_i F(E) \quad (\text{resp. } F(E \bullet_i u) = F(E) \bullet_i F(u)).$$

Proof. By a direct adaptation of the proof of Proposition 2.2.2.17. \square

4.1.2 Free precategories

Let $n \in \mathbb{N}$. Following what was done in Section 2.2.3 and Section 2.2.4, we give a concrete description of the functor

$$-[-]^n: \mathbf{PCat}_n^+ \rightarrow \mathbf{PCat}_{n+1}$$

based on whiskers. By adapting the content of Sections 2.3 and 2.4, this description allows a simple computational representation of cells of free precategories, providing a trivial solution to the word problem. The results of this section thus advocate the use of precategories for the computational treatment of semi-strict higher categories like Gray categories.

4.1.2.1 – Free extensions with whiskers. Let $(C, X) \in \mathbf{PCat}_n^+$ be an n -cellular extension. We write $C[X]$ for the $(n+1)$ -globular set such that $C[X]_{\leq n} = C$ and $C[X]_{n+1}$ is the set of sequences of the form

$$s = ((g_1, E_1), \dots, (g_k, E_k))$$

for some $k \in \mathbb{N}$, called the *length* of s , and where $g_i \in X$ and E_i is an n -whisker of type g_i for $i \in \mathbb{N}_k^*$ (when $k = 0$, by convention, there is an empty sequence $(\)_u$ for each $u \in C_n$). The source and target of s as above are defined by

$$\partial_n^-(s) = E_1[d_n^-(g_1)] \quad \text{and} \quad \partial_n^+(s) = E_k[d_n^+(g_k)]$$

so that $C[X]$ is an $(n+1)$ -globular set by Proposition 4.1.1.5.

We now equip $C[X]$ with a structure of $(n+1)$ -precategory that extends the one of C . Given an n -cell $u \in C_n$, we put

$$\text{id}_u^{n+1} = (\)_u.$$

Given $s = ((g_1, E_1), \dots, (g_k, E_k)) \in C[X]_{n+1}$ and $i \in \mathbb{N}_{n-1}$, for $u \in C_{i+1}$ such that u, s are i -composable, we put

$$u \bullet_i s = ((g_1, u \bullet_i E_1), \dots, (g_k, u \bullet_i E_k))$$

and, similarly, for $v \in C_{i+1}$ such that s, v are i -composable, we put

$$s \bullet_i v = ((g_1, E_1 \bullet_i v), \dots, (g_k, E_k \bullet_i v))$$

and, finally, for $s' = ((g'_1, E'_1), \dots, (g'_l, E'_l)) \in C[X]_{n+1}$ such that s, s' are n -composable, we put

$$s \bullet_n s' = ((g_1, E_1), \dots, (g_k, E_k), (g'_1, E'_1), \dots, (g'_l, E'_l)).$$

We check that:

Proposition 4.1.2.2. *The operations id^{n+1} and \bullet_i defined above equip $C[X]$ with a structure of an $(n+1)$ -precategory.*

Proof. The axioms of precategories are easily verified using Proposition 4.1.1.9 and the fact that C is an n -precategory. \square

In particular, we can use whiskers and whisker evaluations in $C[X]$. We then observe that:

Lemma 4.1.2.3. *Given $m \in \mathbb{N}_n$, $g \in X$ and an m -whisker E of type g , we have*

$$E[(g, I^g)] = (g, E_{\uparrow n})$$

where, for $k \in \mathbb{N}_n$ with $k \geq m$, $E_{\uparrow k}$ is the k -whisker of type g defined inductively by

$$E_{\uparrow k} = \begin{cases} E & \text{if } k = m, \\ (\text{id}_{E_{\uparrow k-1}[\partial_{k-1}^-(g)]}^k, E_{\uparrow k-1}, \text{id}_{E_{\uparrow k-1}[\partial_{k-1}^+(g)]}^k) & \text{if } k > m. \end{cases}$$

In particular, if $m = n$, we have $E[(g, I^g)] = (g, E)$.

Proof. By a simple induction on m . \square

With the above lemma, we can deduce the freeness of $C[X]$:

Theorem 4.1.2.4. *The $(n+1)$ -precategory $C[X]$ is the free $(n+1)$ -precategory relatively to the forgetful functor $\mathcal{V}_k: \mathbf{PCat}_{n+1} \rightarrow \mathbf{PCat}_n^+$.*

Proof. Let $D \in \mathbf{PCat}_{n+1}$ and $(F, f) : (C, X) \rightarrow (D_{\leq n}, D_{n+1}) \in \mathbf{PCat}_n^+$. We define a function

$$f' : C[X]_{n+1} \rightarrow D_{n+1}$$

by putting, for $u \in C_n$,

$$f'((\)_u) = \text{id}_{F(u)}^{n+1}$$

and, for $s = ((g_1, E_1), \dots, (g_k, E_k)) \in C[X]_{n+1}$,

$$f'(s) = F(E_1)[f(g_1)] \bullet_n \cdots \bullet_n F(E_k)[f(g_k)]$$

which is well-defined since, for $i \in \mathbb{N}_{k-1}^*$,

$$\begin{aligned} \partial_n^+(F(E_i)[f(g_i)]) &= F(E_i)[\partial_n^+(f(g_i))] && \text{(by Proposition 4.1.1.2)} \\ &= F(E_i)[F(d_n^+(g_i))] \\ &= F(E_i[d_n^+(g_i)]) && \text{(by Proposition 4.1.1.12)} \\ &= F(E_{i+1}[d_n^-(g_{i+1})]) \\ &= F(E_{i+1})[F(d_n^-(g_{i+1}))] && \text{(by Proposition 4.1.1.12)} \\ &= F(E_{i+1})[\partial_n^-(f(g_{i+1}))] \\ &= \partial_n^-(F(E_{i+1})[f(g_{i+1})]) && \text{(by Proposition 4.1.1.2)}. \end{aligned}$$

Moreover, a similar computation shows that, for $\epsilon \in \{-, +\}$,

$$\partial_n^\epsilon(f'(s)) = F(E_1[d_n^\epsilon(g_1)]) = F(\partial_n^\epsilon(s))$$

so that $(F, f') : C[X] \rightarrow D$ is a morphism of $(n+1)$ -globular set. We verify that it is an $(n+1)$ -pre-functor. By definition, (F, f') commutes with the identity operations. Let $i \in \mathbb{N}_{n-1}$, a cell $u \in C_{i+1}$ and $s = ((g_1, E_1), \dots, (g_k, E_k)) \in C[X]_{n+1}$. If u, s are i -composable, we compute that

$$\begin{aligned} f'(u \bullet_i s) &= F(u \bullet_i E_1)[f(g_1)] \bullet_n \cdots \bullet_n F(u \bullet_i E_k)[f(g_k)] \\ &= (F(u) \bullet_i F(E_1))[f(g_1)] \bullet_n \cdots \bullet_n (F(u) \bullet_i F(E_k))[f(g_k)] && \text{(by Proposition 4.1.1.14)} \\ &= (F(u) \bullet_i F(E_1)[f(g_1)]) \bullet_n \cdots \bullet_n (F(u) \bullet_i F(E_k)[f(g_k)]) && \text{(by Proposition 4.1.1.10)} \\ &= F(u) \bullet_i (F(E_1)[f(g_1)] \bullet_n \cdots \bullet_n F(E_k)[f(g_k)]) \\ &= F(u) \bullet_i f'(s) \end{aligned}$$

and, similarly, if s, u are i -composable, we have $f'(s \bullet_i u) = f'(s) \bullet_i F(u)$. Thus, (F, f') is an $(n+1)$ -prefunctor.

The operation $(F, f) \mapsto (F, f')$ defines a function

$$\Phi_D : \mathbf{PCat}_n^+((C, X), (D_{\leq k}, D_{n+1})) \rightarrow \mathbf{PCat}_{n+1}(C[X], D)$$

which is natural in D . It is injective since, by Propositions 4.1.1.7 and 4.1.1.13, we have

$$f'(((g, I^g))) = f(g)$$

for all $g \in X$, and it is surjective since, by Lemma 4.1.2.3 and Proposition 4.1.1.12, a morphism

$$(\bar{F}, \bar{f}) : C[X] \rightarrow D \in \mathbf{PCat}_{n+1}$$

is completely determined by \bar{F} and the images of $((g, I^g)) \in C[X]_{n+1}$ by \bar{f} for $g \in X$. Thus, $C[X]$ is the free $(n+1)$ -precategory on (C, X) . \square

The above theorem gives a unique normal form property for the cells of $C[X]$:

Corollary 4.1.2.5. *Given $u \in C[X]_{n+1}$, u can be uniquely written as*

$$u = u_1 \bullet_n \cdots \bullet_n u_k$$

for some $k \in \mathbb{N}$ and $u_1, \dots, u_k \in C[X]_{n+1}$ such that, for $i \in \mathbb{N}_k^*$,

$$u_i = l_{i,n} \bullet_{n-1} (l_{i,n-1} \bullet_{n-2} \cdots \bullet_1 (l_{i,1} \bullet_0 g_i \bullet_0 r_{i,1}) \bullet_1 \cdots \bullet_{n-2} r_{i,n-1}) \bullet_{n-1} r_{i,n} \quad (4.1)$$

for some $g_i \in X$ and $l_{i,j}, r_{i,j} \in C_j$ for $j \in \mathbb{N}_n^*$, and the decomposition (4.1) of each u_i is moreover unique.

Proof. By Theorem 4.1.2.4, u can be uniquely written as

$$u = E_1[g_1] \bullet_n \cdots \bullet_n E_k[g_k]$$

for some $k \in \mathbb{N}$, $(n+1)$ -generators $g_1, \dots, g_k \in X$ and whiskers E_1, \dots, E_k . Putting $u_i = E_i[g_i]$, one obtains the decomposition (4.1) of u_i by expanding the definition of $E_i[g_i]$. This decomposition of u_i is unique since E_i is unique relatively to u . \square

Anticipating the use of precategories for rewriting in Section 4.3, we call *rewriting step* an $(n+1)$ -cell of $C[X]$ of the form (4.1). In the case $n = 2$ that will mostly concern us in the following, a rewriting step of $C[X]$ is then a 3-cell S of the form

$$S = \lambda \bullet_1 (l \bullet_0 A \bullet_0 r) \bullet_1 \rho$$

for some $l, r \in C_1$, $\lambda, \rho \in C_2$ and $A \in X$.

Remark 4.1.2.6. By adapting the terminology of Section 2.3.1, if the n -cellular extension (C, X) is equipped with an injective and decidable encoding $\mathcal{E}_{(C,X)}$, one can define an injective and decidable encodings for the m -whiskers of C , by taking inspiration from Proposition 2.3.2.7(i). Then, using the standard derivation of encodings for finite sequences (c.f. Paragraph 2.3.1.12), one obtains an encoding of the $(n+1)$ -cells of $C[X]$, and thus, an encoding $\mathcal{E}_{C[X]}$ of the $(n+1)$ -precategory $C[X]$ that extends \mathcal{E}_C . Moreover, our description of $C[X]_{n+1}$ turns into a computable function which takes as input a code for the n -cellular extension (C, X) , and outputs a code for the $(n+1)$ -precategory $C[X]$ and a code for the function which maps $g \in X$ to $((g, I^g)) \in C[X]_{n+1}$.

4.1.2.7 – The word problem on prepolygraphs. One can consider an analogue of the word problem on strict polygraphs for prepolygraphs, that we shall explicitly describe. Let $n \in \mathbb{N} \cup \{\omega\}$ and P be an n -prepolygraph. For $k \in \mathbb{N}_n$, we define the sets of k -terms \mathcal{T}_k^P of P inductively as follows:

- for $k \in \mathbb{N}_n$ and $g \in P_k$, there is a k -term $\overline{\text{gen}}_k(g) \in \mathcal{T}_k^P$,
- for $k \in \mathbb{N}_{n-1}$ and a k -term $t \in \mathcal{T}_k^P$, there is a $(k+1)$ -term $\overline{\text{id}}_k^{k+1}(t) \in \mathcal{T}_{k+1}^P$,
- for $k, l, m \in \mathbb{N}_n^*$ with $m = \max(k, l)$, a k -term $t_1 \in \mathcal{T}_k^P$ and an l -term $t_2 \in \mathcal{T}_l^P$, there is an m -term $t_1 \bar{\bullet}_{k,l} t_2 \in \mathcal{T}_m^P$.

Following Section 2.4, one then defines the set $\mathcal{W}^P = \bigsqcup_{k \in \mathbb{N}_n} \mathcal{W}_k^P$ of *well-typed terms* and an *evaluation function*

$$\llbracket - \rrbracket^P : \mathcal{W}^P \rightarrow P^*$$

The word problem consists in, given $t_1, t_2 \in \mathcal{W}^P$, deciding whether $\llbracket t_1 \rrbracket^P = \llbracket t_2 \rrbracket^P$ or not.

Remember that the key step in our description of a solution to the word problem on polygraphs of strict categories was to show that one can compute the codes of the free $(n+1)$ -categories on n -cellular extensions (Remark 2.3.2.36). This is rather trivial for precategories, as stated by Remark 4.1.2.6. Thus, by adapting the formalism given in Section 2.4.2, we get an implementable solution to the word problem on prepolygraphs. More precisely, by directly adapting the notions of *set-encoded polygraph*, *term definition* of polygraphs, and of *word problem instance* to prepolygraphs, we get a decidable property analogous to Proposition 2.4.2.14:

Proposition 4.1.2.8. *The function which takes as input an n -word problem instance $(D, (t_1, t_2))$ (of prepolygraphs) and outputs 0 if $\llbracket t_1 \rrbracket \neq \llbracket t_2 \rrbracket$, and 1 if $\llbracket t_1 \rrbracket = \llbracket t_2 \rrbracket$, is computable.*

Proof. By adapting the content of Section 2.4.2 to prepolygraphs, using Remark 4.1.2.6. \square

4.1.3 Presentations of precategories

In this section, we introduce the tools that we will use to present precategories, like Gray categories, by the mean of prepolygraphs. First, we specify in which sense an $(n+1)$ -prepolygraph present an n -precategory. Basically, the $(n+1)$ -generators of such prepolygraph induce a relation on the n -cells of the free n -precategory that one can use to quotient those cells, and the quotienting operation can be simply defined as a left adjoint to $(-)^{\text{PCat}}_{\uparrow n+1, n}$. Then, since the techniques we develop in the next sections will target $(3, 2)$ -Gray categories, *i.e.*, a subset of 3-precategories where each 3-cell is invertible, we moreover recall the classical localization construction in the case of precategories. Such construction will allow us later to consider the free $(3, 2)$ -precategory associated to a 3-precategory presented by the mean of a 4-prepolygraph.

4.1.3.1 – Quotienting top-level cells. Given $n \in \mathbb{N}^*$ and an n -precategory C , a *congruence* for C is an equivalence relation \sim on C_n such that, for all $u, u' \in C_n$ satisfying $u \sim u'$,

- $\partial_{n-1}^\epsilon(u) = \partial_{n-1}^\epsilon(u')$ for $\epsilon \in \{-, +\}$,
- for $i \in \mathbb{N}_{n-1}$ and $v, w \in C_{i+1}$ such that v, u, w are i -composable, we have

$$v \bullet_i u \bullet_i w \sim v \bullet_i u' \bullet_i w.$$

Given such a congruence for C , there is an n -precategory C/\sim which is the n -precategory D such that $D_i = C_i$ for $i \in \mathbb{N}_{n-1}$ and $D_n = C_n/\sim$ and where the identities and compositions are induced by the ones on C . If $C = \bar{C}_{\leq n}$ for some $(n+1)$ -precategory \bar{C} , there is a canonical congruence $\sim^{\bar{C}}$ on C which is induced by the $(n+1)$ -cells \bar{C}_{n+1} , *i.e.*, $\sim^{\bar{C}}$ is the smallest congruence on C such that $\partial_n^-(u) \sim^{\bar{C}} \partial_n^+(u)$ for $u \in \bar{C}_{n+1}$. Writing $\bar{C}_{//n}$ for $\bar{C}_{\leq n}/\sim^{\bar{C}}$, there is a quotient functor

$$\llbracket - \rrbracket^C : C_{\leq n} \rightarrow \bar{C}_{//n}$$

often simply denoted $\llbracket - \rrbracket$, which is the identity on C_i for $i \in \mathbb{N}_{n-1}$, and which maps $u \in C_n$ to its class $\llbracket u \rrbracket$ under \sim^C . The operation $\bar{C} \mapsto \bar{C}_{//n}$ extends to a functor

$$(-)^{\text{PCat}}_{//n, n+1} : \text{PCat}_{n+1} \rightarrow \text{PCat}_n$$

often simply denoted $(-)^{\text{PCat}}_{//n}$, which satisfies that:

Proposition 4.1.3.2. $(-)^{\text{PCat}}_{//n, n+1}$ is a left adjoint to $(-)^{\text{PCat}}_{\uparrow n+1, n}$.

Proof. Let $C \in \mathbf{PCat}_{n+1}$ and $D \in \mathbf{PCat}_n$. Given an $(n+1)$ -prefunctor

$$F: C \rightarrow D_{\uparrow n+1} \in \mathbf{PCat}_{n+1},$$

we build an n -prefunctor $F': C//n \rightarrow D$ by putting

$$F'_{\leq n-1} = F_{\leq n-1} \quad \text{and} \quad F'(\llbracket u \rrbracket) = F(u) \quad \text{for } u \in C_n,$$

and this is well-defined since, for $v \in C_{n+1}$, we have

$$F(\partial_n^-(v)) = \partial_n^-(F(v)) = \partial_n^-(\text{id}_{F(\partial_n^-(v))}^{n+1}) = \partial_n^+(\text{id}_{F(\partial_n^-(v))}^{n+1}) = \partial_n^+(F(v)) = F(\partial_n^+(v))$$

so that F_n is compatible with \sim^C . Moreover, F' is easily shown to be compatible with the structure of n -precategory, so that it is indeed an n -prefunctor.

Conversely, given an n -prefunctor

$$G: C//n \rightarrow D \in \mathbf{PCat}_n,$$

we build an $(n+1)$ -prefunctor $G': C \rightarrow D_{\uparrow n+1}$ by putting

$$G'_{\leq n} = G \circ \llbracket - \rrbracket^C \quad \text{and} \quad G'(v) = \text{id}_{G(\llbracket \partial_n^-(v) \rrbracket)}^{n+1} \quad \text{for } v \in C_{n+1}.$$

We now show that this definition is compatible with the structures of $(n+1)$ -precategories of C and $D_{\uparrow n+1}$. Given $v \in C_{n+1}$ and $\epsilon \in \{-, +\}$, we have

$$G'(\partial_n^\epsilon(v)) = G(\llbracket \partial_n^\epsilon(v) \rrbracket) = G(\llbracket \partial_n^-(v) \rrbracket) = \partial_n^\epsilon(\text{id}_{G(\llbracket \partial_n^-(v) \rrbracket)}^{n+1}) = \partial_n^\epsilon(G'(v)),$$

and, given $u \in C_n$, we have

$$G'(\text{id}_u^{n+1}) = \text{id}_{G(\llbracket \partial_n^-(\text{id}_u^{n+1}) \rrbracket)}^{n+1} = \text{id}_{G(\llbracket u \rrbracket)}^{n+1}.$$

Moreover, given $i \in \mathbb{N}_n$, $v_1 \in C_{i+1}$ and $v_2 \in C_{n+1}$ such that v_1, v_2 are i -composable, if $i < n$, then

$$G'(v_1 \bullet_i v_2) = \text{id}_{G(\llbracket \partial_n^-(v_1 \bullet_i v_2) \rrbracket)}^{n+1} = v_1 \bullet_i \text{id}_{G(\llbracket \partial_n^-(v_2) \rrbracket)}^{n+1} = v_1 \bullet_i G'(v_2)$$

and, if $i = n$, then

$$\begin{aligned} G'(v_1 \bullet_n v_2) &= \text{id}_{G(\llbracket \partial_n^-(v_1 \bullet_n v_2) \rrbracket)}^{n+1} \\ &= \text{id}_{G(\llbracket \partial_n^-(v_1) \rrbracket)}^{n+1} \\ &= \text{id}_{G(\llbracket \partial_n^-(v_1) \rrbracket)}^{n+1} \bullet_n \text{id}_{G(\llbracket \partial_n^-(v_2) \rrbracket)}^{n+1} \\ &= \text{id}_{G(\llbracket \partial_n^-(v_1) \rrbracket)}^{n+1} \bullet_n \text{id}_{G(\llbracket \partial_n^+(v_2) \rrbracket)}^{n+1} && \text{(by definition of } \sim^C) \\ &= \text{id}_{G(\llbracket \partial_n^-(v_1) \rrbracket)}^{n+1} \bullet_n \text{id}_{G(\llbracket \partial_n^-(v_2) \rrbracket)}^{n+1} \\ &= G'(v_1) \bullet_n G'(v_2) \end{aligned}$$

and similarly for i -composable $v_1 \in C_{n+1}$ and $v_2 \in C_{i+1}$. Thus, G' is an $(n+1)$ -prefunctor.

The operations $F \mapsto F'$ and $G \mapsto G'$ are easily proved to be inverse of each other, so that we get a bijection

$$\Psi_{C,D}: \mathbf{PCat}_{n+1}(C, D_{\uparrow n+1}) \rightarrow \mathbf{PCat}_n(C//n, D)$$

which is natural in C and D . Thus, $(-)^{\mathbf{PCat}}_{//n, n+1}$ is a left adjoint to $(-)^{\mathbf{PCat}}_{\uparrow n+1, n}$. \square

4.1.3.3 – Presenting with prepolygraphs. Given $n \in \mathbb{N}$, the quotienting operation defined in the previous paragraph naturally defines a notion of presentation of n -categories by $(n+1)$ -prepolygraphs. Consider the functor $(-): \mathbf{Pol}_{n+1} \rightarrow \mathbf{PCat}_n$ defined as the composite

$$\mathbf{Pol}_{n+1} \xrightarrow{(-)^{*,n+1}} \mathbf{PCat}_{n+1} \xrightarrow{(-)_{//n}^{\mathbf{PCat}}} \mathbf{PCat}_n$$

which, to an $(n+1)$ -prepolygraph P , associates the n -precategory $\bar{P} = P^*/\sim^{P^*}$. By the definition of \sim^{P^*} and the description of $-[-]^n$ given in Section 4.1.2, we have that \sim^{P^*} is the smallest congruence on P^* such that $d_n^-(g) \sim^{P^*} d_n^+(g)$ for $g \in P_{n+1}$, so that we often simply write \sim^P for \sim^{P^*} . In the following, we say that an $(n+1)$ -prepolygraph P is a *presentation* of an n -precategory C when C is isomorphic to \bar{P} .

4.1.3.4 – (3, 2)-precategories. We now recall the classical localization construction in the case of precategories, that will allow us later to consider (3, 2)-precategories presented by 4-prepolygraphs.

Given a 3-precategory C , a 3-cell $F: \phi \Rightarrow \phi' \in C_3$ is *invertible* when there exists $G: \phi' \Rightarrow \phi$ such that $F \bullet_2 G = \text{id}_\phi$ and $G \bullet_2 F = \text{id}_{\phi'}$. In this case, G is unique and we write F^{-1} for G . A (3, 2)-precategory is a 3-precategory where every 3-cell is invertible. The (3, 2)-precategories form a full subcategory of \mathbf{PCat}_3 denoted $\mathbf{PCat}_{(3,2)}$. There is a forgetful functor

$$\mathcal{U}: \mathbf{PCat}_{(3,2)} \rightarrow \mathbf{PCat}_3$$

which admits a left adjoint $(-)^T$ also called *localization functor* described as follows. Given a 3-precategory C , for every $F: \phi \Rightarrow \phi' \in C_3$, we write F^+ for a formal element of source ϕ and target ϕ' , and F^- for a formal element of source ϕ' and target ϕ . A *zigzag* of C is a list

$$(F_1^{\epsilon_1}, \dots, F_k^{\epsilon_k}) \tag{4.2}$$

for some $k \in \mathbb{N}$, $F_1, \dots, F_k \in C_3$ and $\epsilon_1, \dots, \epsilon_k \in \{-, +\}$ such that

$$\partial_2^+(F_i^{\epsilon_i}) = \partial_2^-(F_{i+1}^{\epsilon_{i+1}}) \text{ for } i \in \mathbb{N}_{k-1}^*$$

where we use the convention that there is one empty list $()_\phi$ for each $\phi \in P_2^*$. The source and the target of a zigzag as in (4.2) are $\partial_2^-(F_1^{\epsilon_1})$ and $\partial_2^+(F_k^{\epsilon_k})$ respectively. Then, we define a 3-globular set C^T such that $(C^T)_{\leq 2} = C_{\leq 2}$ and C_3^T is the quotient of the zigzags defined above by the following equalities: for every zigzag $(F_1^{\epsilon_1}, \dots, F_k^{\epsilon_k})$,

- if $F_i = \text{id}_\psi^3$ for some $i \in \mathbb{N}_k^*$ and $\psi \in C_2$, then

$$(F_1^{\epsilon_1}, \dots, F_k^{\epsilon_k}) = (F_1^{\epsilon_1}, \dots, F_{i-1}^{\epsilon_{i-1}}, F_{i+1}^{\epsilon_{i+1}}, \dots, F_k^{\epsilon_k}),$$

- if $\epsilon_i = \epsilon_{i+1} = +$ for some $i \in \mathbb{N}_{k-1}^*$, then

$$(F_1^{\epsilon_1}, \dots, F_k^{\epsilon_k}) = (F_1^{\epsilon_1}, \dots, F_{i-1}^{\epsilon_{i-1}}, (F_i \bullet_2 F_{i+1})^+, F_{i+2}^{\epsilon_{i+2}}, \dots, F_k^{\epsilon_k}),$$

- if $\epsilon_i = \epsilon_{i+1} = -$ for some $i \in \mathbb{N}_{k-1}^*$, then

$$(F_1^{\epsilon_1}, \dots, F_k^{\epsilon_k}) = (F_1^{\epsilon_1}, \dots, F_{i-1}^{\epsilon_{i-1}}, (F_{i+1} \bullet_2 F_i)^-, F_{i+2}^{\epsilon_{i+2}}, \dots, F_k^{\epsilon_k}),$$

- if $\{\epsilon_i, \epsilon_{i+1}\} = \{-, +\}$ and $F_i = F_{i+1}$ for some $i \in \mathbb{N}_{k-1}^*$, then

$$(F_1^{\epsilon_1}, \dots, F_k^{\epsilon_k}) = (F_1^{\epsilon_1}, \dots, F_{i-1}^{\epsilon_{i-1}}, F_{i+2}^{\epsilon_{i+2}}, \dots, F_k^{\epsilon_k}).$$

We write $\llbracket - \rrbracket$ for the function which maps a zigzag to its class in C_3^\top . Since the definitions of source and target of zigzags are compatible with the above equalities, they induce source and target operations $\partial_2^-, \partial_2^+ : C_3^\top \rightarrow C_2^\top$. Given $\phi \in C_2$, we put

$$\text{id}_\phi^3 = \llbracket (\cdot)_\phi \rrbracket.$$

Moreover, given $i \in \{0, 1\}$, $u \in C_{i+1}$ and $F = \llbracket (F_1^{\epsilon_1}, \dots, F_k^{\epsilon_k}) \rrbracket \in C_3^\top$ with $\partial_i^+(u) = \partial_i^-(F)$, we put

$$u \bullet_i F = \llbracket ((u \bullet_i F_1)^{\epsilon_1}, \dots, (u \bullet_i F_k)^{\epsilon_k}) \rrbracket$$

and, given $G = \llbracket (G_1^{\delta_1}, \dots, G_l^{\delta_l}) \rrbracket \in (C^\top)_3$, we put

$$F \bullet_2 G = \llbracket (F_1^{\epsilon_1}, \dots, F_k^{\epsilon_k}, G_1^{\delta_1}, \dots, G_l^{\delta_l}) \rrbracket.$$

All these operations are well-defined since they are compatible with the above quotient equalities, and they equip C^\top with a structure of 3-precategory.

There is a canonical 3-prefunctor $\eta : C \rightarrow C^\top$ sending $F \in C_3$ to $\llbracket (F^+) \rrbracket \in C_3^\top$. Moreover, given a (3, 2)-precategory D and a 3-prefunctor $G : C \rightarrow D$, we can define $G' : C^\top \rightarrow D$ by putting $G'_{\leq 2} = G$ and

$$G'(\llbracket (F_1^{\epsilon_1}, \dots, F_k^{\epsilon_k}) \rrbracket) = G'(F_1^{\epsilon_1}) \bullet_2 \dots \bullet_2 G'(F_k^{\epsilon_k})$$

for $\llbracket (F_1^{\epsilon_1}, \dots, F_k^{\epsilon_k}) \rrbracket \in (C^\top)_3$, where we use the convention that

$$G'(F^\epsilon) = \begin{cases} G(F) & \text{if } \epsilon = +, \\ G(F)^{-1} & \text{if } \epsilon = -, \end{cases}$$

for $F \in C_3$ and $\epsilon \in \{-, +\}$. The definition of G' is compatible with the quotient equalities above so that G' is well-defined, and G' can be shown to uniquely factorize G through η . The operation $C \mapsto C^\top$ naturally extends to a functor $(-)^T : \mathbf{PCat}_3 \rightarrow \mathbf{PCat}_{(3,2)}$ and the above discussion shows that:

Proposition 4.1.3.5. $(-)^T$ is a left adjoint for \mathcal{U} .

In the following, given a 3-precategory C and $F \in C_3$, we simply write F for $\eta(F) \in C_3^\top$.

4.2 Gray categories

Strict 3-categories are categories enriched in (\mathbf{Cat}_2, \times) . Similarly, Gray categories are categories enriched in \mathbf{Cat}_2 together with the Gray tensor product. The latter can be described as an ‘‘asynchronous’’ variant of the cartesian product where two interleavings of the same morphisms are related by ‘‘exchange’’ cells. Typically, consider the 1-categories C and D below

$$C = x \xrightarrow{f} x' \qquad D = y \xrightarrow{g} y'$$

their cartesian and Gray tensor products are respectively

$$C \times D = \begin{array}{ccc} (x, y) & \xrightarrow{(f, y)} & (x', y) \\ (x, g) \downarrow & & \downarrow (x', g) \\ (x, y') & \xrightarrow{(f, y')} & (x', y') \end{array} = \begin{array}{ccc} (x, y) & \xrightarrow{(f, y)} & (x', y) \\ & \Downarrow \chi & \\ (x, y') & \xrightarrow{(f, y')} & (x', y') \end{array}$$

$$C \boxtimes D = \begin{array}{ccc} (x, y) & \xrightarrow{(f, y)} & (x', y) \\ (x, g) \downarrow & \Downarrow \chi & \downarrow (x', g) \\ (x, y') & \xrightarrow{(f, y')} & (x', y') \end{array}$$

where the exchange 2-cell χ can be invertible or not, depending on whether we consider the pseudo or lax variant of the Gray tensor product. We first recall those two variants of the Gray tensor product (Section 4.2.1). We then give a more explicit description of Gray categories in terms of generators and relations (Section 4.2.2). Then, we introduce an economical way to describe the structure of a Gray category with *Gray presentations* (Section 4.2.3), and show that the latter correctly present Gray categories (Section 4.2.4).

4.2.1 The Gray tensor products

We recall here the definitions of the lax and pseudo variants of the Gray tensor products, that are both tensor products on the category of strict 2-categories \mathbf{Cat}_2 . We refer the reader to [Gra06, Section I, 4] for details.

4.2.1.1 – The lax Gray tensor product. In the following, we consider the 2-precategorical syntax for strict 2-categories, as given by Theorem 1.4.3.8. By the condition (E), a strict 2-category is then simply a 2-precategory C such that, for all 0-composable $\phi, \psi \in C_2$,

$$(\phi \bullet_0 \partial_1^-(\psi)) \bullet_0 (\partial_1^+(\phi) \bullet_0 \psi) = (\partial_1^-(\phi) \bullet_0 \psi) \bullet_0 (\phi \bullet_0 \partial_1^+(\psi)).$$

Given two strict 2-categories $C, D \in \mathbf{Cat}_2$, we define another strict 2-category $C \boxtimes^{\text{lax}} D$ which is presented as follows:

- the 0-cells of $C \boxtimes^{\text{lax}} D$ are the pairs (x, y) where $x \in C_0$ and $y \in D_0$,
- the 1-cells of $C \boxtimes^{\text{lax}} D$ are generated by the 1-cells

$$(f, y): (x, y) \rightarrow (x', y) \quad \text{and} \quad (x, g): (x, y) \rightarrow (x, y'),$$

for $f: x \rightarrow x' \in C_1$ and $g: y \rightarrow y' \in C_2$,

- the 2-cells of $C \boxtimes^{\text{lax}} D$ are generated by the 2-cells

$$(\phi, y): (f, y) \rightarrow (f', y) \quad \text{and} \quad (x, \psi): (x, g) \rightarrow (x, g')$$

for $x, y \in C_0$, $\phi: f \Rightarrow f' \in C_2$ and $\psi: g \Rightarrow g' \in C_2$, and by the 2-cells

$$\begin{array}{ccc} (x, y) & \xrightarrow{(f, y)} & (x', y) \\ (x, g) \downarrow & \Downarrow (f, g) & \downarrow (x', g) \\ (x, y') & \xrightarrow{(f, y')} & (x', y') \end{array}$$

for $f: x \rightarrow x' \in C_1$ and $g: y \rightarrow y' \in C_1$,

under the conditions that

- (i) the 1-generators are compatible with 0-composition, meaning that

$$\begin{aligned} (\text{id}_x^1, y) &= (x, \text{id}_y^1) = \text{id}_{(x, y)}^1 \\ (f \bullet_0 f', y) &= (f, y) \bullet_0 (f', y) \\ (x, g \bullet_0 g') &= (x, g) \bullet_0 (x, g') \end{aligned}$$

for all $x \in C_0$, $y \in D_0$, 0-composable $f, f' \in C_1$ and 0-composable $g, g' \in D_1$,

(ii) the 2-generators are compatible with 0-composition, meaning that

$$\begin{aligned} (\text{id}_x^2, y) &= (x, \text{id}_y^2) = \text{id}_{(x,y)}^2 \\ (\phi_1 \bullet_0 \phi_2, y) &= (\phi_1, y) \bullet_0 (\phi_2, y) \\ (x, \psi_1 \bullet_0 \psi_2) &= (x, \psi_1) \bullet_0 (x, \psi_2) \end{aligned}$$

for all $x \in C_0, y \in D_0$, 0-composable $\phi, \phi' \in C_2$ and 0-composable $\psi, \psi' \in D_2$, i.e., graphically,

$$\begin{array}{c} \begin{array}{ccc} \begin{array}{c} \xrightarrow{(\text{id}_x^1, y)} \\ (x, y) \Downarrow (\text{id}_x^2, y) \\ \xleftarrow{(\text{id}_x^1, y)} \end{array} & = & \begin{array}{c} \xrightarrow{(x, \text{id}_y^1)} \\ (x, y) \Downarrow (x, \text{id}_y^2) \\ \xleftarrow{(x, \text{id}_y^1)} \end{array} \\ \begin{array}{ccc} \begin{array}{c} \xrightarrow{(f_1 \bullet_0 f_2, y)} \\ (x_0, y) \Downarrow (\phi_1 \bullet_0 \phi_2, y) \\ \xleftarrow{(f_1' \bullet_0 f_2', y)} \end{array} & = & \begin{array}{c} \xrightarrow{(f_1, y)} \\ (x_0, y) \Downarrow (\phi_1, y) \\ \xleftarrow{(f_1', y)} \end{array} \\ \begin{array}{ccc} \begin{array}{c} \xrightarrow{(x, g_1 \bullet_0 g_2)} \\ (x, y_0) \Downarrow (x, \psi_1 \bullet_0 \psi_2) \\ \xleftarrow{(x, g_1' \bullet_0 g_2')} \end{array} & = & \begin{array}{c} \xrightarrow{(x, g_1)} \\ (x, y_0) \Downarrow (x, \psi_1) \\ \xleftarrow{(x, g_1')} \end{array} \end{array} \end{array}$$

(iii) the 2-generators are compatible with 1-composition, meaning that

$$\begin{aligned} (\text{id}_f^2, y) &= \text{id}_{(f,y)}^2 \\ (\phi_1 \bullet_1 \phi_2, y) &= (\phi_1, y) \bullet_1 (\phi_2, y) \\ (x, \text{id}_g^2) &= \text{id}_{(x,g)}^2 \\ (x, \psi_1 \bullet_1 \psi_2) &= (x, \psi_1) \bullet_1 (x, \psi_2) \end{aligned}$$

for parallel $f_0, f_1, f_2 \in C_1$ and parallel $g_0, g_1, g_2 \in D_1$ and 2-cells

$$\phi_i: f_{i-1} \Rightarrow f_i: x \rightarrow x' \in C_2 \quad \text{and} \quad \psi_i: g_{i-1} \Rightarrow g_i: y \rightarrow y' \in D_2$$

for $i \in \{1, 2\}$, and 1-cells $f: x \rightarrow x' \in C_1$ and $g: y \rightarrow y' \in D_1$, i.e., graphically,

$$\begin{array}{c} \begin{array}{ccc} \begin{array}{c} \xrightarrow{(f, y)} \\ (x, y) \Downarrow (\text{id}_f^2, y) \\ \xleftarrow{(f, y)} \end{array} & = & \begin{array}{c} \xrightarrow{(f, y)} \\ (x, y) \Downarrow \text{id}_{(f,y)}^2 \\ \xleftarrow{(f, y)} \end{array} \\ \begin{array}{ccc} \begin{array}{c} \xrightarrow{(f_0, y)} \\ (x, y) \Downarrow (\phi_1 \bullet_1 \phi_2, y) \\ \xleftarrow{(f_2, y)} \end{array} & = & \begin{array}{c} \xrightarrow{(f_0, y)} \\ (x, y) \Downarrow (\phi_1, y) \\ \xrightarrow{(f_1, y)} \\ \Downarrow (\phi_2, y) \\ \xleftarrow{(f_2, y)} \end{array} \end{array} \end{array}$$

$$\begin{array}{ccc}
(x, y) \begin{array}{c} \xrightarrow{(x, g)} \\ \Downarrow (x, \text{id}_g^2) \\ \xrightarrow{(x, g)} \end{array} (x, y') = (x, y) \begin{array}{c} \xrightarrow{(x, g)} \\ \Downarrow \text{id}_{(x, g)}^2 \\ \xrightarrow{(x, g)} \end{array} (x, y') \\
(x, y) \begin{array}{c} \xrightarrow{(x, g_0)} \\ \Downarrow (x, \psi_1 \bullet_1 \psi_2) \\ \xrightarrow{(x, g_2)} \end{array} (x, y') = (x, y) \begin{array}{c} \xrightarrow{(x, g_0)} \\ \Downarrow (x, \psi_1) \\ \xrightarrow{(x, g_1)} \\ \Downarrow (x, \psi_2) \\ \xrightarrow{(x, g_2)} \end{array} (x', y) ,
\end{array}$$

(iv) the interchangers are compatible with 0-composition, meaning that

$$\begin{aligned}
(\text{id}_x^1, g) &= \text{id}_{(x, g)}^2 \\
(f_1 \bullet_0 f_2, g) &= ((f_1, y) \bullet_0 (f_2, g)) \bullet_1 ((f_1, g) \bullet_0 (f_2, y')) \\
(f, \text{id}_y^1) &= \text{id}_{(f, y)}^2 \\
(f, g_1 \bullet_0 g_2) &= ((f, g_1) \bullet_0 (x', g_2)) \bullet_1 ((x, g_1) \bullet_0 (f, g_2))
\end{aligned}$$

for all $f_i: x_{i-1} \rightarrow x_i$ and $g_i: y_{i-1} \rightarrow y_i$ for $i \in \{1, 2\}$ and $f: x \rightarrow x'$ and $g: y \rightarrow y'$, i.e., graphically,

$$\begin{array}{ccc}
(x, y) \xrightarrow{(\text{id}_x^1, y)} (x, y) & & (x, y) \\
(x, g) \downarrow & \Downarrow (\text{id}_x^1, g) & \downarrow (x, g) \\
(x, y') \xrightarrow{(\text{id}_x^1, y)} (x, y') & = & (x, g) \begin{array}{c} \left(\text{id}_{(x, g)}^2 \right) \\ \Downarrow \\ (x, y') \end{array}
\end{array}$$

$$\begin{array}{ccc}
(x_0, y) \xrightarrow{(f_1 \bullet_0 f_2, y)} (x_2, y) & & (x_0, y) \xrightarrow{(f_1, y)} (x_1, y) \xrightarrow{(f_2, y)} (x_2, y) \\
(x_0, g) \downarrow & \Downarrow (f_1 \bullet_0 f_2, g) & \downarrow (x_2, g) \\
(x_0, y') \xrightarrow{(f_1 \bullet_0 f_2, y')} (x_2, y') & = & (x_0, y') \xrightarrow{(f_1, y')} (x_1, y') \xrightarrow{(f_2, y')} (x_2, y') \\
& & \downarrow (x_1, g) \quad \downarrow (f_2, g) \quad \downarrow (x_2, g)
\end{array}$$

$$\begin{array}{ccc}
(x, y) \xrightarrow{(f, y)} (x', y) & & (x, y) \begin{array}{c} \xrightarrow{(f, y)} \\ \Downarrow \text{id}_{(f, y)}^2 \\ \xrightarrow{(f, y)} \end{array} (x', y) \\
(x, \text{id}_y^1) \downarrow & \Downarrow (f, \text{id}_y^1) & \downarrow (x', \text{id}_y^1) \\
(x, y) \xrightarrow{(f, y)} (x', y) & = & (x, y) \begin{array}{c} \xrightarrow{(f, y)} \\ \Downarrow \text{id}_{(f, y)}^2 \\ \xrightarrow{(f, y)} \end{array} (x', y)
\end{array}$$

$$\begin{array}{ccc}
(x, y_0) \xrightarrow{(f, y_0)} (x', y_0) & & (x, y_0) \xrightarrow{(f, y_0)} (x', y_0) \\
(x, g_1 \bullet_0 g_2) \downarrow & \Downarrow (f, g_1 \bullet_0 g_2) & \downarrow (x', g_1 \bullet_0 g_2) \\
(x, y_2) \xrightarrow{(f, y_2)} (x', y_2) & = & (x, y_1) \xrightarrow{(f, y_1)} (x', y_1) \\
& & \downarrow (x, g_2) \quad \downarrow (f, g_2) \quad \downarrow (x', g_2) \\
& & (x, y_2) \xrightarrow{(f, y_2)} (x', y_2)
\end{array}$$

(v) the interchangers commute with the 2-generators, meaning that

$$\begin{aligned}
((f, g) \bullet_1 ((x, g) \bullet_0 (\phi, y'))) &= (((\phi, y) \bullet_0 (x', g)) \bullet_1 (f', g)) \\
((f, g) \bullet_1 ((x, \psi) \bullet_0 (f, y'))) &= (((f, y) \bullet_0 (x', \psi)) \bullet_1 (f, g'))
\end{aligned}$$

for $\phi: f \Rightarrow f': x \rightarrow x'$ and $\psi: g \Rightarrow g': y \rightarrow y'$, i.e., graphically,

$$\begin{array}{ccc}
 \begin{array}{ccc}
 & \xrightarrow{(f,y)} & \\
 (x,y) & \Downarrow (f,g) & (x',y) \\
 \downarrow (x,g) & \xrightarrow{(f,y')} & \downarrow (x',g) \\
 (x,y') & \Downarrow (\phi,y') & (x',y') \\
 & \xrightarrow{(f',y')} &
 \end{array} & = &
 \begin{array}{ccc}
 & \xrightarrow{(f,y)} & \\
 (x,y) & \Downarrow (\phi,y) & (x',y) \\
 \downarrow (x,g) & \xrightarrow{(f',y)} & \downarrow (x',g) \\
 (x,y') & \Downarrow (f',g) & (x',y') \\
 & \xrightarrow{(f',y')} &
 \end{array} \\
 \\
 \begin{array}{ccc}
 (x,y) \xrightarrow{(f,y)} (x',y) \\
 \left(\begin{array}{ccc}
 (x,\psi) & \xleftarrow{(x,g)} & (x',g) \\
 \downarrow & & \downarrow \\
 (x,y') & \xrightarrow{(f,y')} & (x',y')
 \end{array} \right) & &
 \begin{array}{ccc}
 (x,y) \xrightarrow{(f,y)} (x',y) \\
 \left(\begin{array}{ccc}
 (f,g') & \xleftarrow{(x',g')} & (x',\psi) \\
 \downarrow & & \downarrow \\
 (x,y') & \xrightarrow{(f,y')} & (x',y')
 \end{array} \right)
 \end{array}
 \end{array}
 \end{array}$$

Remark 4.2.1.2. More formally, the construction of $C \boxtimes^{\text{lax}} D$ is done by considering the adequate quotient of the free 2-category P^* on a 2-polygraph P of strict categories, where

$$\begin{aligned}
 P_0 &= \{(x, y) \mid x \in C_0, y \in D_0\} \\
 P_1 &= \{(f, y): (x, y) \rightarrow (x', y) \mid f: x \rightarrow x' \in C_1, y \in D_0\} \\
 &\quad \cup \{(x, g): (x, y) \rightarrow (x, y') \mid x \in C_0, g: y \rightarrow y' \in D_1\} \\
 P_2 &= \{(\phi, y): (f, y) \Rightarrow (f', y) \mid \phi: f \Rightarrow f' \in C_2, y \in D_0\} \\
 &\quad \cup \{(x, \psi): (x, g) \Rightarrow (x, g') \mid x \in C_0, \psi: g \Rightarrow g' \in D_2\} \\
 &\quad \cup \{(f, g): (f, y) \bullet_0 (x', g) \Rightarrow (x, g) \bullet_0 (f, y') \mid f: x \rightarrow x' \in C_1, g: y \rightarrow y' \in D_1\}.
 \end{aligned}$$

The quotient is constructed as a coequalizer

$$E \begin{array}{c} \xrightarrow{l} \\ \xrightarrow{r} \end{array} P^* \dashrightarrow C \boxtimes^{\text{lax}} D$$

where E is a coproduct based on the above equations, and l, r are 2-functors that respectively correspond to the left-hand side and right-hand side of these equations. Such a coequalizer exists since Cat_2 is cocomplete by Proposition 1.4.1.4.

The construction $(C, D) \mapsto C \boxtimes^{\text{lax}} D$ naturally extends to a bifunctor

$$(-) \boxtimes^{\text{lax}} (-): \text{Cat}_2 \times \text{Cat}_2 \rightarrow \text{Cat}_2$$

that sends a pair of 2-functors

$$F: C \rightarrow C' \quad \text{and} \quad G: D \rightarrow D'$$

to the 2-functor $F \boxtimes^{\text{lax}} G$ uniquely defined by the following mappings of generators:

$$\begin{aligned}
 (\phi, y) &\mapsto (F(\phi), G(y)) \\
 (x, \psi) &\mapsto (F(x), G(\psi)) \\
 (f, g) &\mapsto (F(f), G(g))
 \end{aligned}$$

for all $x \in C_0, y \in D_0, \phi \in C_2, \psi \in D_2, f \in C_1$ and $g \in D_1$.

Writing $\mathbf{1}$ for the terminal strict 2-category whose only 0-cell is denoted $*$, for $C \in \mathbf{Cat}_2$, there are 2-functors

$$\lambda_C^{\text{lax}} : \mathbf{1} \boxtimes^{\text{lax}} C \rightarrow C \quad \text{and} \quad \rho_C^{\text{lax}} : C \boxtimes^{\text{lax}} \mathbf{1} \rightarrow C$$

uniquely defined by the mappings

$$\lambda_C^{\text{lax}}((*, \psi)) = \psi \quad \text{and} \quad \rho_C^{\text{lax}}((\psi, *)) = \psi$$

for $\psi \in C_2$, and both are isomorphisms natural in C .

For $C, D, E \in \mathbf{Cat}_2$, there is a 2-functor

$$\alpha_{C,D,E}^{\text{lax}} : (C \boxtimes^{\text{lax}} D) \boxtimes^{\text{lax}} E \rightarrow C \boxtimes^{\text{lax}} (D \boxtimes^{\text{lax}} E)$$

uniquely defined by the following mappings on generators

$$\begin{aligned} ((\phi, y), z) &\mapsto (\phi, (y, z)) & ((f, g), z) &\mapsto (f, (g, z)) \\ ((x, \chi), z) &\mapsto (x, (\chi, z)) & ((f, y), h) &\mapsto (x, (g, h)) \\ ((x, y), \psi) &\mapsto (x, (y, \psi)) & ((x, g), h) &\mapsto (x, (g, h)) \end{aligned}$$

for $x \in C_0, y \in D_0, z \in E_0, f \in C_1, g \in D_1, h \in E_1, \phi \in C_2, \chi \in D_2, \psi \in E_2$, and $\alpha_{C,D,E}^{\text{lax}}$ is moreover an isomorphism natural in C, D, E .

By checking coherence conditions (1.16) and (1.17) of monoidal categories (c.f. Paragraph 1.5.1.1), one can verify that:

Proposition 4.2.1.3. $(\mathbf{Cat}_2, \mathbf{1}, \boxtimes^{\text{lax}}, \lambda^{\text{lax}}, \rho^{\text{lax}}, \alpha^{\text{lax}})$ is a monoidal category.

The monoidal structure $(\mathbf{Cat}_2, \mathbf{1}, \boxtimes^{\text{lax}}, \lambda^{\text{lax}}, \rho^{\text{lax}}, \alpha^{\text{lax}})$ is called the *lax Gray tensor product*.

4.2.1.4 – The pseudo Gray tensor product. The other variant of Gray tensor is called the *pseudo Gray tensor product* and is the monoidal structure $(\mathbf{Cat}_2, \mathbf{1}, \boxtimes, \lambda, \rho, \alpha)$ such that, given two 2-categories $C, D \in \mathbf{Cat}_2$, $C \boxtimes D$ is defined the same way as $C \boxtimes^{\text{lax}} D$, except that we moreover require that, for $f: x \rightarrow x' \in C_1$ and $g: y \rightarrow y' \in D_1$, the 2-cell (f, g) of $C \boxtimes D$ be invertible for \bullet_1 . The natural isomorphisms λ, ρ, α are then uniquely defined by similar mappings than those defining $\lambda^{\text{lax}}, \rho^{\text{lax}}, \alpha^{\text{lax}}$. By checking the coherence conditions (1.16) and (1.17) of monoidal categories, one can verify that:

Proposition 4.2.1.5. $(\mathbf{Cat}_2, \mathbf{1}, \boxtimes, \lambda, \rho, \alpha)$ is a monoidal category.

Remark 4.2.1.6. More formally, given $C, D \in \mathbf{Cat}_2$, $C \boxtimes D$ is built by adapting the construction of Remark 4.2.1.2: the strict 2-category $C \boxtimes D$ is the quotient of the free 2-category Q^* where Q is the 2-polygraph of strict categories such that

$$\begin{aligned} Q_0 &= P_0 & Q_1 &= P_1 \\ Q_2 &= P_2 \cup \{(f, g)^{-1} : (x, g) \bullet_0 (f, y') \Rightarrow (f, y) \bullet_0 (x', g) \mid f: x \rightarrow x' \in C_1, g: y \rightarrow y' \in D_1\} \end{aligned}$$

Like for $C \boxtimes^{\text{lax}} D$, the strict 2-category $C \boxtimes D$ is then obtained by quotienting Q^* by the mean of a coequalizer derived from the equations (i) to (v) and moreover the ones of the following additional condition:

(vi) for $f: x \rightarrow x' \in C_1$ and $g: y \rightarrow y' \in D_1$,

$$(f, g) \bullet_1 (f, g)^{-1} = \text{id}^2((f, y) \bullet_0 (x', g)) \quad \text{and} \quad (f, g)^{-1} \bullet_1 (f, g) = \text{id}^2((x, g) \bullet_0 (f, y')).$$

4.2.2 Gray categories

To each of the two Gray tensor products that we defined in the previous section, there is an associated notion of 3-category, that is a category enriched in \mathbf{Cat}_2 equipped with one of the two tensor products (*c.f.* Paragraph 1.5.1.4 for the definition of enriched categories). We describe the two notions of 3-categories, namely *lax Gray categories* and *pseudo Gray categories*. We moreover introduce (3, 2)-Gray categories, which are lax Gray categories where every 3-cell is invertible, that we will study in the following sections.

4.2.2.1 – Lax Gray categories. A *lax Gray category* (as in [Gra06, Section I, 4.25]) is a category enriched in the category \mathbf{Cat}_2 of strict 2-categories equipped with the lax Gray tensor product. Alternatively, we give a more explicit definition using generators and relations: a *Gray category* is a 3-precategory C together with, for every pair of 0-composable 2-cells

$$\phi: f \Rightarrow f': x \rightarrow y \quad \text{and} \quad \psi: g \Rightarrow g': y \rightarrow z$$

of C , a 3-cell

$$X_{\phi, \psi}: (\phi \bullet_0 g) \bullet_1 (f' \bullet_0 \psi) \Rightarrow (f \bullet_0 \psi) \bullet_1 (\phi \bullet_0 g')$$

called *interchanger*, which can be represented using string diagrams by

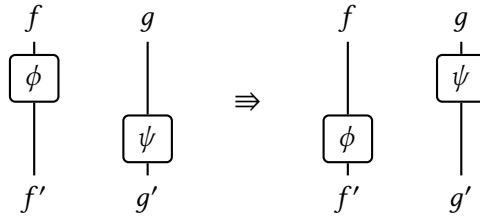

and satisfying the following sets of axioms

(G-i) (compatibility with compositions and identities) given 2-cells

$$\phi: f \Rightarrow f' \quad \phi': f' \Rightarrow f'' \quad \psi: g \Rightarrow g' \quad \psi': g' \Rightarrow g''$$

of C and 1-cells e, h of C such that e, ϕ, ψ, h are 0-composable, we have

$$\begin{aligned} X_{\text{id}_f^2, \psi} &= \text{id}_{f \bullet_0 \psi}^3 & X_{\phi \bullet_1 \phi', \psi} &= ((\phi \bullet_0 g) \bullet_1 X_{\phi', \psi}) \bullet_2 (X_{\phi, \psi} \bullet_1 (\phi' \bullet_0 g')) \\ X_{\phi, \text{id}_g^2} &= \text{id}_{\phi \bullet_0 g}^3 & X_{\phi, \psi \bullet_1 \psi'} &= (X_{\phi, \psi} \bullet_1 (f' \bullet_0 \psi')) \bullet_2 ((f \bullet_0 \psi) \bullet_1 X_{\phi, \psi'}) \end{aligned}$$

and

$$X_{e \bullet_0 \phi, \psi} = e \bullet_0 X_{\phi, \psi} \quad X_{\phi, \psi \bullet_0 h} = X_{\phi, \psi} \bullet_0 h.$$

Moreover, given $\phi, \psi \in C_2$ and $f \in C_1$ such that ϕ, f, ψ are 0-composable, we have

$$X_{\phi \bullet_0 f, \psi} = X_{\phi, f \bullet_0 \psi},$$

(G-ii) (exchange law for 3-cells) given 3-cells

$$A: \phi \Rightarrow \psi \in C_3 \quad B: \psi \Rightarrow \psi' \in C_3$$

of C such that A, B are 1-composable, we have

$$(A \bullet_1 \psi) \bullet_2 (\phi' \bullet_1 B) = (\phi \bullet_1 B) \bullet_2 (A \bullet_1 \psi'),$$

(G-iii) (compatibility between interchangers and 3-cells) given 3-cells

$$A: \phi \Rightarrow \phi': u \Rightarrow u' \quad \text{and} \quad B: \psi \Rightarrow \psi': v \Rightarrow v'$$

of C such that A, B are 0-composable, we have

$$\begin{aligned} ((A \bullet_0 v) \bullet_1 (u' \bullet_0 \psi)) \bullet_2 X_{\phi', \psi} &= X_{\phi, \psi} \bullet_2 ((u \bullet_0 \psi) \bullet_1 (A \bullet_0 v')) \\ ((\phi \bullet_0 v) \bullet_1 (u' \bullet_0 B)) \bullet_2 X_{\phi, \psi'} &= X_{\phi, \psi} \bullet_2 ((u \bullet_0 B) \bullet_1 (\phi \bullet_0 v')). \end{aligned}$$

A *morphism between two lax Gray categories* C and D is a 3-prefunctor $F: C \rightarrow D$ such that

$$F(X_{\phi, \psi}) = X_{F(\phi), F(\psi)}$$

for 0-composable $\phi, \psi \in C_2$.

4.2.2.2 – Pseudo Gray categories. We similarly have a notion of *pseudo Gray category* which is a category enriched in the category of 2-categories equipped with the pseudo Gray tensor product. In terms of generators and relations, a pseudo Gray category is a lax Gray category C where $X_{\phi, \psi}$ is invertible for 0-composable $\phi, \psi \in C_2$. A morphism between two pseudo Gray categories C, D is a morphism of lax Gray categories between C and D .

4.2.2.3 – (3, 2)-Gray category. A *(3, 2)-Gray category* is a lax Gray category whose underlying 3-precategory is a (3, 2)-precategory. Note that it is then also a pseudo Gray category. As one can expect, a localization of a lax Gray category gives a (3, 2)-Gray category:

Proposition 4.2.2.4. *If C is a lax Gray category, then C^\top is a (3, 2)-Gray category.*

Proof. Given 1-composable $F: \phi \Rightarrow \phi', G: \psi \Rightarrow \psi' \in C_3$, by the exchange law for 3-cells, we have, in C_3^\top ,

$$(F \bullet_1 \psi) \bullet_2 (\phi' \bullet_1 G) = (\phi \bullet_1 G) \bullet_2 (F \bullet_1 \psi').$$

By inverting $F \bullet_1 \psi$ and $F \bullet_1 \psi'$, we obtain

$$(\phi' \bullet_1 G) \bullet_2 (F^{-1} \bullet_1 \psi') = (F^{-1} \bullet_1 \psi) \bullet_2 (\phi \bullet_1 G).$$

Similarly,

$$(\phi \bullet_1 G^{-1}) \bullet_2 (F \bullet_1 \psi) = (F \bullet_1 \psi') \bullet_2 (\phi' \bullet_1 G^{-1})$$

and

$$(F^{-1} \bullet_1 \psi') \bullet_2 (\phi \bullet_1 G^{-1}) = (\phi' \bullet_1 G^{-1}) \bullet_2 (F^{-1} \bullet_1 \psi).$$

Now, given general 1-composable $F: \phi \Rightarrow \phi', G: \psi \Rightarrow \psi' \in C_3^\top$, we have that

$$F = F_1 \bullet_2 F_2^{-1} \bullet_2 \cdots \bullet_2 F_{2k-1} \bullet_2 F_{2k}^{-1}$$

and

$$G = G_1 \bullet_2 G_2^{-1} \bullet_2 \cdots \bullet_2 G_{2l-1} \bullet_2 G_{2l}^{-1}$$

for some $k, l \in \mathbb{N}^*$ and $F_i, G_j \in C_3$ for $i \in \mathbb{N}_{2k}^*$ and $j \in \mathbb{N}_{2l}^*$. By applying the formulas above $4kl$ times to exchange the F_i 's with the G_j 's, we get

$$(F \bullet_1 \psi) \bullet_2 (\phi' \bullet_1 G) = (\phi \bullet_1 G) \bullet_2 (F \bullet_1 \psi').$$

A similar argument gives the compatibility between interchangers and 3-cells of C^\top . Thus, C^\top is a (3, 2)-Gray category. \square

4.2.3 Gray presentations

Starting from a 3-prepolygraph P such as the one of Example 1.4.2.12 on page 69, we want to add 3-generators to P and relations on the 3-cells of P_3^* so that we obtain a presentation of a lax Gray category. This can of course be achieved naively by adding, for each pair of 0-composable 2-cells ϕ, ψ in P_2^* , a 3-generator corresponding to the interchanger “ $X_{\phi, \psi}$ ”, together with the relevant relations, but the resulting presentation has numerous generators. We detail below a more economical way of proceeding in order to present lax Gray categories. The proof that our notion of presentation of Gray category really induces a Gray category is given in the next section.

4.2.3.1 – High-level definition. We give here the high-level definition of Gray presentations and defer some technicalities to the next paragraph. A *Gray presentation* is a 4-prepolygraph P containing the following distinguished generators:

- (i) for 0-composable α, g, β with $\alpha, \beta \in P_2, g \in P_1^*$, a 3-generator $X_{\alpha, g, \beta} \in P_3$ called *interchange generator*, which is of type

$$X_{\alpha, g, \beta}: (\alpha \bullet_0 g \bullet_0 h) \bullet_1 (f' \bullet_0 g \bullet_0 \beta) \Rightarrow (f \bullet_0 g \bullet_0 \beta) \bullet_1 (\alpha \bullet_0 g \bullet_0 h')$$

which can be represented using string diagrams by

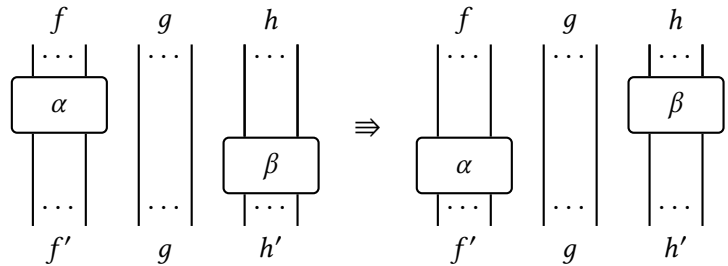

- (ii) for every pair of 3-generators $A, B \in P_3$ and $e, e', h, h' \in P_1^*$ and $\chi \in P_2^*$ as in

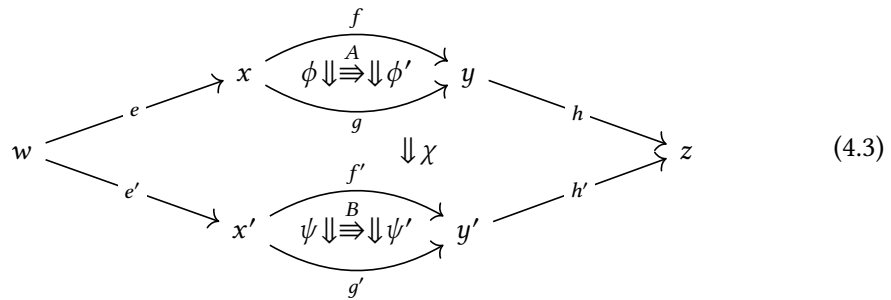

a 4-generator of type $\Gamma \Rightarrow \Delta$, called *independence generator*, where

$$\Gamma = ((e \bullet_0 A \bullet_0 h) \bullet_1 \chi \bullet_1 (e' \bullet_0 \psi \bullet_0 h')) \bullet_2 ((e \bullet_0 \phi' \bullet_0 h) \bullet_1 \chi \bullet_1 (e' \bullet_0 B \bullet_0 h'))$$

and

$$\Delta = ((e \bullet_0 \phi \bullet_0 h) \bullet_1 \chi \bullet_1 (e' \bullet_0 B \bullet_0 h')) \bullet_2 ((e \bullet_0 A \bullet_0 h) \bullet_1 \chi \bullet_1 (e' \bullet_0 \psi' \bullet_0 h')),$$

- whose vertices are the shuffles of the words $l_1 \dots l_k$ and $r_1 \dots r_{k'}$ on the alphabet

$$\Sigma_{\phi, \psi} = \{l_1, \dots, l_k, r_1, \dots, r_{k'}\},$$

- whose edges are of the form $X_{w, w'}: wl_i r_j w' \rightarrow wr_j l_i w'$ for some $i \in \mathbb{N}_k^*$, $j \in \mathbb{N}_{k'}^*$ and some words $w, w' \in \Sigma_{\phi, \psi}^*$ such that $wl_i r_j w' \in (\phi \sqcup \psi)_0$.

Given $i \in \mathbb{N}_k$, $j \in \mathbb{N}_{k'}$, $p \in \mathbb{N}_{k-i+1}$, $q \in \mathbb{N}_{k'-j+1}$ and a shuffle u of the words

$$l_i \dots l_{i+p-1} \quad \text{and} \quad r_j \dots r_{j+q-1},$$

we define $[u]_{\phi, \psi}^{i, j} \in P_2^*$ (or simply $[u]^{i, j}$) by induction on p and q :

$$[u]^{i, j} = \begin{cases} (\phi_i \bullet_0 \partial_1^+(\psi_j)) \bullet_1 [u']^{i+1, j} & \text{if } u = l_i u', \\ (\partial_1^+(\phi_i) \bullet_0 \psi_j) \bullet_1 [u']^{i, j+1} & \text{if } u = r_j u', \\ \partial_1^+(\phi_i) \bullet_0 \partial_1^+(\psi_j) & \text{if } u \text{ is the empty word,} \end{cases}$$

where, by convention, $\partial_1^+(\phi_0) = \partial_1^-(\phi_1)$ and $\partial_1^+(\psi_0) = \partial_1^-(\psi_1)$. Note that the indices of $[u]^{i, j}$ are uniquely determined if u has at least an l letter and an r letter. Intuitively, the letters l_i and r_j correspond to the 2-cells $\phi_i \bullet_0 (-)$ and $(-) \bullet_0 \psi_j$ where the 1-cells $(-)$ are most of the time uniquely determined by the context, so that $[u]^{1, 1}$ for $u \in (\phi \sqcup \psi)_0$ is an interleaving of the $\phi_i \bullet_0 (-)$ and $(-) \bullet_0 \psi_j$. Now, given $X_{u, v}: ul_i r_j v \rightarrow ur_j l_i v \in (\phi \sqcup \psi)_1$, we define the 3-cell

$$[X_{u, v}]_{\phi, \psi}: [ul_i r_j v]_{\phi, \psi}^{1, 1} \Rrightarrow [ur_j l_i v]_{\phi, \psi}^{1, 1} \in P_3^*$$

by

$$[X_{u, v}]_{\phi, \psi} = [u]_{\phi, \psi}^{1, 1} \bullet_1 (f_i \bullet_0 X_{\alpha_i, g_i \bullet_0 f'_j, \alpha'_j} \bullet_0 g'_j) \bullet_1 [v]_{\phi, \psi}^{i+1, j+1}.$$

We thus obtain a functor

$$[-]_{\phi, \psi}: (\phi \sqcup \psi)^* \rightarrow P^*(\partial_1^-(\phi) \bullet_0 \partial_1^-(\psi), \partial_1^+(\phi) \bullet_0 \partial_1^+(\psi))$$

where $(\phi \sqcup \psi)^*$ is the free 1-category on $\phi \sqcup \psi$ considered as a 1-polygraph, and where $[-]_{\phi, \psi}$ is defined by the mappings

$$\begin{aligned} u \in (\phi \sqcup \psi)_0 &\mapsto [u]_{\phi, \psi}^{1, 1} \in P_2^* \\ X_{u, v} \in (\phi \sqcup \psi)_1 &\mapsto [X_{u, v}]_{\phi, \psi} \in P_3^*. \end{aligned}$$

For example, for Q defined as above and $\phi = \psi = \tau \bullet_1 \tau$, $[l_1 l_2 r_1 r_2]_{\phi, \psi}$ and $[l_1 r_1 l_2 r_2]_{\phi, \psi}$ are respectively the 2-cells of Q_2^*

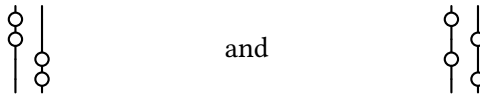

and $[X_{l_1, r_2}]_{\phi, \psi}$ and $[X_{l_1 r_1, \epsilon}]_{\phi, \psi}$ are respectively the 3-cells of Q_3^*

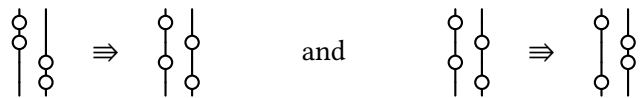

We write $X_{\phi, \psi}$ for the path

$$X_{u_1, v_1} \bullet_1 \dots \bullet_1 X_{u_{kk'}, v_{kk'}} \in (\phi \sqcup \psi)^*(l_1 \dots l_k r_1 \dots r_{k'}, r_1 \dots r_{k'} l_1 \dots l_k)$$

defined by induction by

$$u_1 = l_1 \dots l_{k-1} \quad \text{and} \quad v_1 = r_2 \dots r_{k'}$$

and where u_{i+1}, v_{i+1} are the unique words of $\Sigma_{\phi, \psi}^*$ such that

$$\partial_0^+(X_{u_i, v_i}) = u_{i+1} l_p r_q v_{i+1} \quad \text{with} \quad v_{i+1} = r_{q+1} \dots r_{k'} l_{p+1} \dots l_k$$

for some $p, q \in \mathbb{N}$. We can finally end the definition of Gray presentations by putting

$$X_{\phi, \psi} = [X_{\phi, \psi}]_{\phi, \psi}.$$

For example, for Q defined as above, $X_{\tau \bullet_1 \tau, \tau \bullet_1 \tau}$ is the composite of 3-cells of Q_3^* given by (4.5).

Example 4.2.3.3. We define the *Gray presentation of pseudomonoids* as the 4-prepolygraph obtained by extending the 3-prepolygraph for pseudomonoids P introduced in Example 1.4.2.12 on page 69. First, we add to P_3 the 3-generators

$$\begin{array}{ll} X_{\mu, \bar{n}, \mu}: \begin{array}{c} \Upsilon \\ \vdots \\ \Upsilon \end{array} \Rightarrow \begin{array}{c} \Upsilon \\ \vdots \\ \Upsilon \end{array} & X_{\mu, \bar{n}, \eta}: \begin{array}{c} \Upsilon \\ \vdots \\ \Upsilon \end{array} \circlearrowleft \Rightarrow \begin{array}{c} \Upsilon \\ \vdots \\ \Upsilon \end{array} \circlearrowright \\ X_{\eta, \bar{n}, \mu}: \begin{array}{c} \Upsilon \\ \vdots \\ \Upsilon \end{array} \circlearrowleft \Rightarrow \begin{array}{c} \Upsilon \\ \vdots \\ \Upsilon \end{array} \circlearrowright & X_{\eta, \bar{n}, \eta}: \begin{array}{c} \circlearrowleft \\ \vdots \\ \circlearrowright \end{array} \Rightarrow \begin{array}{c} \circlearrowleft \\ \vdots \\ \circlearrowright \end{array} \end{array}$$

for $n \in \mathbb{N}$. Second, we define P_4 as a minimal set of 4-generators such that, given a configuration of cells of $(P_{\leq 3})^*$ as in (4.3), there is a corresponding independence generator in P_4 , and given a configuration of cells of $(P_{\leq 3})^*$ as in the first or the second line of (4.4), there is a corresponding interchange naturality generator in P_4 .

4.2.4 Correctness of Gray presentations

Until the end of this section, we suppose given a Gray presentation P . The aim of this section is to prove that our definition of Gray presentation is correct, *i.e.*, that \bar{P} has a structure of a lax Gray category (Theorem 4.2.4.14). This will moreover implies that the localization of \bar{P} has a structure of $(3, 2)$ -Gray category (Corollary 4.2.4.15).

Recall the definition of *rewriting steps* given in Paragraph 4.1.2.1. We start by showing the exchange law for the 3-cells of \bar{P} that we first prove on rewriting steps:

Lemma 4.2.4.1. *Given rewriting steps $R_i: \phi_i \Rightarrow \phi'_i \in P_3^*$ for $i \in \{1, 2\}$, such that R_1, R_2 are 1-composable, we have, in \bar{P}_3 ,*

$$(R_1 \bullet_1 \phi_2) \bullet_2 (\phi'_1 \bullet_1 R_2) = (\phi_1 \bullet_1 R_2) \bullet_2 (R_1 \bullet_1 \phi'_2).$$

Proof. Let $l_i, r_i \in \bar{P}_1$, $\lambda_i, \rho_i \in \bar{P}_2$, $A_i \in P_3$ such that $R_i = \lambda_i \bullet_0 (l_i \bullet_0 A_i \bullet_0 r_i) \bullet_i \rho_i$ for $i \in \{1, 2\}$, and $\mu_i, \mu'_i \in \bar{P}_2$ such that $A_i: \mu_i \Rightarrow \mu'_i$ for $i \in \{1, 2\}$. In \bar{P}_3 , we have

$$\begin{aligned} & (R_1 \bullet_1 \phi_2) \bullet_2 (\phi'_1 \bullet_1 R_2) \\ &= \lambda_1 \\ & \bullet_1 [((l_1 \bullet_0 A_1 \bullet_0 r_1) \bullet_1 \rho_1 \bullet_1 \lambda_2 \bullet_1 (l_2 \bullet_0 \mu_2 \bullet_0 r_2)) \\ & \quad \bullet_2 ((l_1 \bullet_0 \mu'_1 \bullet_0 r_1) \bullet_1 \rho_1 \bullet_1 \lambda_2 \bullet_1 (l_2 \bullet_0 A_2 \bullet_0 r_2))] \\ & \bullet_1 \rho_2 \quad \text{(by precategories axioms)} \\ &= \lambda_1 \\ & \bullet_1 [((l_1 \bullet_0 \mu_1 \bullet_0 r_1) \bullet_1 \rho_1 \bullet_1 \lambda_2 \bullet_1 (l_2 \bullet_0 A_2 \bullet_0 r_2)) \\ & \quad \bullet_2 ((l_1 \bullet_0 A_1 \bullet_0 r_1) \bullet_1 \rho_1 \bullet_1 \lambda_2 \bullet_1 (l_2 \bullet_0 \mu'_2 \bullet_0 r_2))] \\ & \bullet_1 \rho_2 \quad \text{(by independence generator)} \\ &= (\phi_1 \bullet_1 R_2) \bullet_2 (R_1 \bullet_1 \phi'_2). \quad \square \end{aligned}$$

We can now conclude the exchange law for 3-cells:

Lemma 4.2.4.2. *Given $F_i: \phi_i \Rightarrow \phi'_i \in \bar{P}_3$ for $i \in \{1, 2\}$ such that F_1, F_2 are 1-composable, we have, in \bar{P}_3 ,*

$$(F_1 \bullet_1 \phi_2) \bullet_2 (\phi'_1 \bullet_1 F_2) = (\phi_1 \bullet_1 F_2) \bullet_2 (F_1 \bullet_1 \phi'_2).$$

Proof. For $i \in \{1, 2\}$, as an element of \bar{P}_3 , F_i can be written $F_i = R_{i,1} \bullet_2 \cdots \bullet_2 R_{i,k_i}$ where

$$R_{i,j} = \lambda_{i,j} \bullet_1 (l_{i,j} \bullet_0 A_{i,j} \bullet_0 r_{i,j}) \bullet_1 \rho_{i,j}$$

for some $k_i \in \mathbb{N}$ and $\lambda_{i,j}, \rho_{i,j} \in \bar{P}_2$, $l_{i,j}, r_{i,j} \in \bar{P}_1$, $A_{i,j} \in P_3$ for $j \in \mathbb{N}_{k_i}^*$. Note that

$$F_1 \bullet_1 \phi_2 = (R_{1,1} \bullet_1 \phi_2) \bullet_2 \cdots \bullet_2 (R_{1,k_1} \bullet_1 \phi_2)$$

and

$$\phi'_1 \bullet_1 F_2 = (\phi'_1 \bullet_1 R_{2,1}) \bullet_2 \cdots \bullet_2 (\phi'_1 \bullet_1 R_{2,k_2}).$$

Then, by using Lemma 4.2.4.1 $k_1 k_2$ times to reorder the R_{1,j_1} 's after the R_{2,j_2} 's for $i \in \{1, 2\}$ and $j_i \in \mathbb{N}_{k_i}^*$, we obtain that

$$(F_1 \bullet_1 \phi_2) \bullet_2 (\phi'_1 \bullet_1 F_2) = (\phi_1 \bullet_1 F_2) \bullet_2 (F_1 \bullet_1 \phi'_2). \quad \square$$

We now prove the various conditions on $X_{-, -}$. First, a technical lemma:

Proposition 4.2.4.3. *Given $f \in P_1^*$, $\phi, \psi \in P_2^*$ with f, ϕ, ψ 0-composable, there is a canonical isomorphism $(f \bullet_0 \phi) \sqcup \psi \simeq \phi \sqcup \psi$ and for all $p \in (\phi \sqcup \psi)_1^*$, we have*

$$[p]_{f \bullet_0 \phi, \psi} = f \bullet_0 [p]_{\phi, \psi}.$$

Similarly, given $\phi, \psi \in P_2^$ and $h \in P_1^*$ with ϕ, ψ, h 0-composable, we have a canonical isomorphism $\phi \sqcup (\psi \bullet_0 h) \simeq \phi \sqcup \psi$ and for all $p \in (\phi \sqcup (\psi \bullet_0 h))_1^*$, we have*

$$[p]_{\phi, \psi \bullet_0 h} = [p]_{\phi, \psi} \bullet_0 h.$$

Finally, given $\phi, \psi \in P_2^$ and $g \in P_1^*$ with ϕ, g, ψ 0-composable, we have a canonical isomorphism $(\phi \bullet_0 g) \sqcup \psi \simeq \phi \sqcup (g \bullet_0 \psi)$ and for all $p \in ((\phi \bullet_0 g) \sqcup \psi)_1^*$, we have*

$$[p]_{\phi \bullet_0 g, \psi} = [p]_{\phi, g \bullet_0 \psi}.$$

Proof. Let $f \in P_1^*$, $\phi, \psi \in P_2^*$ with f, ϕ, ψ 0-composable, $r, s \in \mathbb{N}$, $f_i, g_i \in P_1^*$ and $\alpha_i \in P_2$ for $i \in \mathbb{N}_r^*$, and $f'_j, g'_j \in P_1^*$ and $\alpha'_j \in P_2$ for $j \in \mathbb{N}_s^*$ such that

$$\phi = (f_1 \bullet_0 \alpha_1 \bullet_0 g_1) \bullet_1 \cdots \bullet_1 (f_r \bullet_0 \alpha_r \bullet_0 g_r) \quad \text{and} \quad \psi = (f'_1 \bullet_0 \alpha'_1 \bullet_0 g'_1) \bullet_1 \cdots \bullet_1 (f'_s \bullet_0 \alpha'_s \bullet_0 g'_s).$$

By contemplating the definitions of $(f \bullet_0 \phi) \sqcup \psi$ and $\phi \sqcup \psi$, we deduce a canonical isomorphism between them. Under this isomorphism, we easily verify that we have $[w]_{f \bullet_0 \phi, \psi} = f \bullet_0 [w]_{\phi, \psi}$ for $w \in ((f \bullet_0 \phi) \sqcup \psi)_0$. Now, given $u, r, j, v \in ((f \bullet_0 \phi) \sqcup \psi)_0$, we have

$$\begin{aligned} [X_{u,v}]_{f \bullet_0 \phi, \psi} &= [u]_{f \bullet_0 \phi, \psi} \bullet_1 (f \bullet_0 f_i \bullet_0 X_{\alpha_i, g_i \bullet_0 f_j, \alpha'_j} \bullet_0 g_j) \bullet_1 [v]_{f \bullet_0 \phi, \psi} \\ &= f \bullet_0 ([u]_{\phi, \psi} \bullet_1 (f_i \bullet_0 X_{\alpha_i, g_i \bullet_0 f_j, \alpha'_j} \bullet_0 g_j) \bullet_1 [v]_{\phi, \psi}) \\ &= f \bullet_0 [X_{u,v}]_{\phi, \psi}. \end{aligned}$$

By functoriality of $[-]_{f \bullet_0 \phi, \psi}$ and $[-]_{\phi, \psi}$, we deduce that, for all $p \in (f \bullet_0 \phi) \sqcup \psi^*$,

$$[p]_{f \bullet_0 \phi, \psi} = f \bullet_0 [p]_{\phi, \psi}.$$

The two other properties are shown similarly. □

We can now conclude the most simple properties of $X_{-, -}$:

Lemma 4.2.4.4. *Given $\phi: f \Rightarrow f' \in \bar{P}_2$ and $\psi: g \Rightarrow g' \in \bar{P}_2$, we have the following equalities in \bar{P}_3 :*

- (i) $X_{\text{id}_f^2, \psi} = \text{id}_{f \bullet_0 \psi}^3$ and $X_{\phi, \text{id}_g^2} = \text{id}_{\phi \bullet_0 g}^3$ when ϕ, ψ are 0-composable,
- (ii) $X_{l \bullet_0 \phi, \psi} = l \bullet_0 X_{\phi, \psi}$ for $l \in P_1^*$ such that l, ϕ, ψ are 0-composable,
- (iii) $X_{\phi \bullet_0 m, \psi} = X_{\phi, m \bullet_0 \psi}$ for $m \in P_1^*$ such that ϕ, m, ψ are 0-composable,
- (iv) $X_{\phi, \psi \bullet_0 r} = X_{\phi, \psi} \bullet_0 r$ for $r \in P_1^*$ such that ϕ, ψ, r are 0-composable.

Proof. The point (i) is clear, since both $X_{\text{id}_f^2, \psi}$ and X_{ϕ, id_g^2} are the identity paths on the unique 0-cells of $(\text{id}_f^2 \sqcup \psi)^*$ and $(\phi \sqcup \text{id}_g^2)^*$ respectively. (ii) is a consequence of Proposition 4.2.4.3, since $X_{f \bullet_0 \phi, \psi}$ is sent to $X_{\phi, \psi}$ by the canonical isomorphism $(f \bullet_0 \phi) \sqcup \psi \simeq \phi \sqcup \psi$. (iii) and (iv) follow similarly. \square

The last required properties on $X_{-, -}$ are more difficult to prove. In fact, we need a proper coherence theorem stating that, for 0-composable $\phi, \psi \in \bar{P}_2$, $X_{\phi, \psi} = [p]_{\phi, \psi}$ for all $p \in (\phi \sqcup \psi)_1^*$ parallel to $X_{\phi, \psi}$. We progressively introduce the necessary material to prove this fact below.

Given a word $w \in (\phi \sqcup \psi)_0$, there is a function

$$\text{l-index}_w: \mathbb{N}_{|\phi|}^* \rightarrow \mathbb{N}_{|\phi|+|\psi|}^*$$

defined such that, for $i \in \mathbb{N}_{|\phi|}^*$, if $w = w' l_i w''$, then $\text{l-index}_w(i) = |w'| + 1$. The function l-index characterizes the existence of paths in $(\phi \sqcup \psi)^*$:

Lemma 4.2.4.5. *Given 0-composable $\phi, \psi \in P_2^*$ and $w, w' \in (\phi \sqcup \psi)_0$, there is a path*

$$p: w \rightarrow w' \in (\phi \sqcup \psi)_1^*$$

if and only if $\text{l-index}_w(i) \leq \text{l-index}_{w'}(i)$ for $i \in \mathbb{N}_{|\phi|}^$.*

Proof. Given $X_{u, v}: u l_r r_s v \rightarrow u r_s l_r v \in (\phi \sqcup \psi)_1$, it is clear that $\text{l-index}_{u l_r r_s v}(i) \leq \text{l-index}_{u r_s l_r v}(i)$ for all $i \in \mathbb{N}_{|\phi|}^*$, so that, given a path $p: w \rightarrow w' \in (\phi \sqcup \psi)_1^*$, by induction on p , we have

$$\text{l-index}_w(i) \leq \text{l-index}_{w'}(i)$$

for $i \in \mathbb{N}_{|\phi|}^*$. Conversely, given $w, w' \in (\phi \sqcup \psi)_0$ such that $\text{l-index}_w \leq \text{l-index}_{w'}$, we show by induction on $N(w, w')$ defined by

$$N(w, w') = \sum_{1 \leq i \leq |\phi|} \text{l-index}_{w'}(i) - \text{l-index}_w(i)$$

that there is a path $p: w \rightarrow w' \in (\phi \sqcup \psi)_1^*$. If $N(w, w') = 0$, then $w = w'$ and $1_w: w \rightarrow w'$ is a suitable path. Otherwise, let i_{\max} be the largest $i \in \mathbb{N}_{|\phi|}$ such that $\text{l-index}_{w'}(i) > \text{l-index}_w(i)$. Then, either $i_{\max} = |\phi|$ or $\text{l-index}_w(i_{\max}) + 1 < \text{l-index}_w(i_{\max} + 1)$ since

$$\begin{aligned} \text{l-index}_w(i_{\max}) + 1 &\leq \text{l-index}_{w'}(i_{\max}) \\ &< \text{l-index}_{w'}(i_{\max} + 1) \\ &= \text{l-index}_w(i_{\max} + 1). \end{aligned}$$

So we can write $w = ul_{i_{\max}}r_jv$ for some words u, v and $j \in \mathbb{N}_{|\psi|}^*$. Thus, there exists a path generator $X_{u,v}: w \rightarrow \tilde{w} \in (\phi \sqcup \psi)_1$ where $\tilde{w} = ur_jl_{i_{\max}}v$. Then,

$$\text{l-index}_{\tilde{w}}(i) = \begin{cases} \text{l-index}_w(i) & \text{if } i \neq i_{\max}, \\ \text{l-index}_w(i_{\max}) + 1 & \text{if } i = i_{\max}, \end{cases}$$

so $\text{l-index } \tilde{w} \leq \text{l-index } w'$ and $N(\tilde{w}, w') < N(w, w')$. Thus, by induction, we get

$$p': \tilde{w} \rightarrow w' \in (\phi \sqcup \psi)_1^*$$

and we build a path $X_{u,v} \bullet_0 p': w \rightarrow w' \in (\phi \sqcup \psi)_1^*$ as wanted. \square

Given 0-composable $\phi, \psi \in \mathbf{P}_2^*$ and $w = w_1 \dots w_{|\phi|+|\psi|} \in (\phi \sqcup \psi)_0$, we define $\text{Inv}(w)$ as

$$\text{Inv}(w) = |\{(i, j) \in (\mathbb{N}_{|\phi|+|\psi|}^*)^2 \mid i < j \text{ and } w_i = r_{i'} \text{ and } w_j = l_{j'} \text{ for some } i' \in \mathbb{N}_{|\psi|}^* \text{ and } j' \in \mathbb{N}_{|\phi|}^*\}|.$$

The function Inv characterizes the length of the paths of $(\phi \sqcup \psi)^*$:

Lemma 4.2.4.6. *Given 0-composable $\phi, \psi \in \mathbf{P}_2^*$ and $p: w \rightarrow w' \in (\phi \sqcup \psi)_1^*$, we have*

$$|p| = \text{Inv}(w') - \text{Inv}(w).$$

In particular, given $w, w' \in (\phi \sqcup \psi)_0$, all the paths $p: w \rightarrow w' \in (\phi \sqcup \psi)_1^$ have the same length.*

Proof. We show this by induction on the length of p . If $p = \text{id}_w^1$, then the conclusion holds. Otherwise, $p = X_{u,u'} \bullet_0 r$ for some $u, u' \in \Sigma_{\phi, \psi}$ and $r: \tilde{w} \rightarrow w' \in (\phi \sqcup \psi)_1^*$. Then, by induction hypothesis, $|r| = \text{Inv}(w') - \text{Inv}(\tilde{w})$. Note that, by the definition of $X_{u,u'}$, $w = ul_i r_j u'$ and $\tilde{w} = ur_j l_i r$ for some $i \in \mathbb{N}_{|\phi|}^*$ and $j \in \mathbb{N}_{|\psi|}^*$. Hence,

$$|p| = |r| + 1 = \text{Inv}(w') - \text{Inv}(\tilde{w}) + \text{Inv}(\tilde{w}) - \text{Inv}(w) = \text{Inv}(w') - \text{Inv}(w). \quad \square$$

Given 0-composable $\phi, \psi \in \mathbf{P}_2^*$, we now prove the following coherence property for $(\phi \sqcup \psi)^*$:

Lemma 4.2.4.7. *Let \approx be a congruence on $(\phi \sqcup \psi)^*$. Suppose that, for all words $u_1, u_2, u_3 \in \Sigma_{\phi, \psi}$, and $i, i' \in \mathbb{N}_{|\phi|}^*$, $j, j' \in \mathbb{N}_{|\psi|}^*$ such that $u_1 l_i r_j u_2 l_{i'} r_{j'} u_3 \in (\phi \sqcup \psi)_0$, we have*

$$\begin{array}{ccc} & u_1 l_i r_j u_2 l_{i'} r_{j'} u_3 & \\ X_{u_1, u_2 l_{i'} r_{j'} u_3} \swarrow & & \searrow X_{u_1 l_i r_j u_2, u_3} \\ u_1 r_j l_i u_2 l_{i'} r_{j'} u_3 & \approx & u_1 l_i r_j u_2 r_{j'} l_{i'} u_3 \\ X_{u_1 r_j l_i u_2, u_3} \swarrow & & \searrow X_{u_1, u_2 r_{j'} l_{i'} u_3} \\ & u_1 r_j l_i u_2 r_{j'} l_{i'} u_3 & \end{array}$$

then, for all $p_1, p_2: v \rightarrow w \in (\phi \sqcup \psi)_1^$, we have $p_1 \approx p_2$.*

Proof. We prove this by induction on $|p_1|$. By Lemma 4.2.4.6, we have $|p_1| = |p_2|$. In particular, if $p_1 = \text{id}_v^1$, then $p_2 = \text{id}_v^1$. Otherwise, $p_i = q_i \bullet_0 r_i$ with $q_i: v \rightarrow v_i$ and $r_i: v_i \rightarrow w$ and $|q_i| = 1$ for $i \in \{1, 2\}$. If $q_1 = q_2$, then we conclude with the induction hypothesis on r_1 and r_2 . Otherwise, up to symmetry, we have $q_1 = X_{u_1, u_2 l_{i'} r_{j'} u_3}$ and $q_2 = X_{u_1 l_i r_j u_2, u_3}$ for some $u_1, u_2, u_3 \in \Sigma_{\phi, \psi}^*$, $i, i' \in \mathbb{N}_{|\phi|}^*$ and $j, j' \in \mathbb{N}_{|\psi|}^*$. Let

$$q'_1 = X_{u_1 r_j l_i u_2, u_3} \quad q'_2 = X_{u_1, u_2 r_{j'} l_{i'} u_3} \quad v' = u_1 r_j l_i u_2 r_{j'} l_{i'} u_3.$$

Since we have a path $v \xrightarrow{q_1} v_1 \xrightarrow{r_1} w$, by Lemma 4.2.4.5, we have $\text{l-index}_v(s) \leq \text{l-index}_w(s)$ for $s \in \mathbb{N}_{|\phi|}^*$. Moreover,

$$\text{l-index}_v(i) < \text{l-index}_{v_1}(i) \leq \text{l-index}_w(i) \quad \text{and} \quad \text{l-index}_v(i') < \text{l-index}_{v_2}(i') \leq \text{l-index}_w(i').$$

Also, for $s \in \mathbb{N}_{|\phi|}^*$,

$$\text{l-index}_{v'}(s) = \begin{cases} \text{l-index}_v(s) + 1 & \text{if } s \in \{i, i'\}, \\ \text{l-index}_v(s) & \text{otherwise.} \end{cases}$$

From the preceding properties, we deduce that $\text{l-index}_{v'}(s) \leq \text{l-index}_w(s)$ for $s \in \mathbb{N}_{|\phi|}^*$. Thus, by Lemma 4.2.4.5, there is a path $r': v' \rightarrow w \in (\phi \sqcup \psi)_1^*$ as in

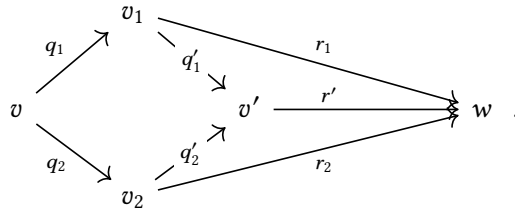

Since $|r_i| = |p_i| - 1$ for $i \in \{1, 2\}$, by induction hypothesis, we have $r_i \approx q'_i \bullet r'$ for $i \in \{1, 2\}$, which can be extended to $q_i \bullet r_i \approx q_i \bullet q'_i \bullet r'$, since \approx is a congruence. By hypothesis, we have $q_1 \bullet q'_1 \approx q_2 \bullet q'_2$, which can be extended to $q_1 \bullet q'_1 \bullet r' \approx q_2 \bullet q'_2 \bullet r'$. By transitivity of \approx , we get that $q_1 \bullet r_1 \approx q_2 \bullet r_2$, that is, $p_1 \approx p_2$. \square

We then apply this coherence property to $[-]_{-, -}$ and get that “all exchange methods are equivalent”, as in:

Proposition 4.2.4.8. *Given 0-composable $\phi, \psi \in \bar{\mathbb{P}}_2$, for all $p_1, p_2: u \rightarrow v \in (\phi \sqcup \psi)_1^*$, we have, in $\bar{\mathbb{P}}_3$,*

$$[p_1]_{\phi, \psi} = [p_2]_{\phi, \psi}.$$

Proof. By Lemma 4.2.4.2, for all words $u_1, u_2, u_3 \in \Sigma_{\phi, \psi}$, $i, i' \in \mathbb{N}_{|\phi|}^*$ and $j, j' \in \mathbb{N}_{|\psi|}^*$ such that

$$u_1 l_i r_j u_2 l_{i'} r_{j'} u_3 \in (\phi \sqcup \psi)_0,$$

we have

$$\begin{array}{ccc} & [u_1 l_i r_j u_2 l_{i'} r_{j'} u_3]_{\phi, \psi} & \\ [X_{u_1, u_2 l_{i'} r_{j'} u_3}]_{\phi, \psi} \swarrow & & \searrow [X_{u_1 l_i r_j u_2, u_3}]_{\phi, \psi} \\ [u_1 r_j l_i u_2 l_{i'} r_{j'} u_3]_{\phi, \psi} & = & [u_1 l_i r_j u_2 r_{j'} l_{i'} u_3]_{\phi, \psi} \\ [X_{u_1 r_j l_i u_2, u_3}]_{\phi, \psi} \swarrow & & \searrow [X_{u_1, u_2 r_{j'} l_{i'} u_3}]_{\phi, \psi} \\ & [u_1 r_j l_i u_2 r_{j'} l_{i'} u_3]_{\phi, \psi} & \end{array}$$

Moreover, the relation \approx defined on parallel $p_1, p_2 \in (\phi \sqcup \psi)_1^*$ by

$$p_1 \approx p_2 \quad \text{when} \quad [p_1]_{\phi, \psi} = [p_2]_{\phi, \psi}$$

is clearly a congruence. Hence, by Lemma 4.2.4.7, we have that $[p_1]_{\phi, \psi} = [p_2]_{\phi, \psi}$ for all parallel paths $p_1, p_2 \in (\phi \sqcup \psi)_1^*$. \square

The preceding property says in particular that $X_{\phi,\psi} = [p]_{\phi,\psi}$ for all 0-composable $\phi, \psi \in P_2^*$ and paths $p \in (\phi \sqcup \psi)_1^*$ parallel to $X_{\phi,\psi}$.

Let $\phi, \psi \in P_2^*$ be 0-composable 2-cells, and $\phi', \psi' \in P_2^*$ be 0-composable 2-cells such that ϕ, ϕ' and ψ, ψ' are 1-composable. To obtain the last required properties on $X_{-, -}$, we need to relate $\phi \sqcup \psi$ and $\phi' \sqcup \psi'$ to $(\phi \bullet_1 \phi') \sqcup (\psi \bullet_1 \psi')$. Given $w \in (\phi \sqcup \psi)_0$, there is a functor

$$w \cdot (-): (\phi' \sqcup \psi')^* \rightarrow ((\phi \bullet_1 \phi') \sqcup (\psi \bullet_1 \psi'))^*$$

which is uniquely defined by the mappings

$$\begin{aligned} u &\mapsto w \uparrow(u) \\ X_{u_1, u_2} &\mapsto X_{w \uparrow(u_1), \uparrow(u_2)} \end{aligned}$$

for $u \in (\phi' \sqcup \psi')_0$ and $X_{u_1, u_2} \in (\phi' \sqcup \psi')_1$ and where, for $v = v_1 \dots v_k \in \Sigma_{\phi', \psi'}^*$, the word

$$\uparrow(v) \in \Sigma_{\phi \bullet_1 \phi', \psi \bullet_1 \psi'}^*$$

is defined by

$$\uparrow(v)_r = \begin{cases} l_{|\phi|+i} & \text{if } v_r = l_i \text{ for some } i \in \mathbb{N}_{|\phi'|}^*, \\ r_{|\psi|+j} & \text{if } v_r = r_j \text{ for some } j \in \mathbb{N}_{|\psi'|}^*, \end{cases}$$

for $r \in \mathbb{N}_k^*$. Similarly, given $w \in (\phi' \sqcup \psi')_0$, there is a functor

$$(-) \cdot w: (\phi \sqcup \psi)^* \rightarrow ((\phi \bullet_1 \phi') \sqcup (\psi \bullet_1 \psi'))^*$$

which is uniquely defined by the mappings

$$\begin{aligned} u &\mapsto u \uparrow(w) \\ X_{u_1, u_2} &\mapsto X_{u_1, u_2 \uparrow(w)} \end{aligned}$$

for $u \in (\phi \sqcup \psi)_0$ and $X_{u_1, u_2} \in (\phi \sqcup \psi)_1$ and where $\uparrow(-)$ is defined as above. The functors $w \cdot (-)$ and $(-) \cdot w$ satisfy the following compatibility property:

Lemma 4.2.4.9. *Let $\phi, \psi \in P_2^*$ be 0-composable 2-cells, and $\phi', \psi' \in P_2^*$ be 0-composable 2-cells such that ϕ, ϕ' and ψ, ψ' are 1-composable. Given $w \in (\phi \sqcup \psi)_0$, we have the following equalities in P_3^* :*

$$(i) [w \cdot (u)]_{\phi \bullet_1 \phi', \psi \bullet_1 \psi'} = [w]_{\phi, \psi} \bullet_1 [u]_{\phi', \psi'} \text{ for } u \in (\phi' \sqcup \psi')_0,$$

$$(ii) [w \cdot (p)]_{\phi \bullet_1 \phi', \psi \bullet_1 \psi'} = [w]_{\phi, \psi} \bullet_1 [p]_{\phi', \psi'} \text{ for } p \in (\phi' \sqcup \psi')_1^*.$$

Similarly, given $w \in (\phi' \sqcup \psi')_0$, we have:

$$(i) [(u) \cdot w]_{\phi \bullet_1 \phi', \psi \bullet_1 \psi'} = [u]_{\phi, \psi} \bullet_1 [w]_{\phi', \psi'} \text{ for } u \in (\phi \sqcup \psi)_0,$$

$$(ii) [(p) \cdot w]_{\phi \bullet_1 \phi', \psi \bullet_1 \psi'} = [p]_{\phi, \psi} \bullet_1 [w]_{\phi', \psi'} \text{ for } p \in (\phi \sqcup \psi)_1^*.$$

Proof. We only prove the first part, since the second part is similar. We start by (i). We have

$$[w \cdot (u)]_{\phi \bullet_1 \phi', \psi \bullet_1 \psi'} = [w \uparrow(u)]_{\phi \bullet_1 \phi', \psi \bullet_1 \psi'}^{1,1}.$$

By a simple induction on w , we obtain

$$[w \uparrow(u)]_{\phi \bullet_1 \phi', \psi \bullet_1 \psi'}^{1,1} = [w]_{\phi \bullet_1 \phi', \psi \bullet_1 \psi'}^{1,1} \bullet_1 [\uparrow(u)]_{\phi \bullet_1 \phi', \psi \bullet_1 \psi'}^{|\phi|, |\psi|}$$

and, by other simple inductions on w and u , we get

$$[w]_{\phi \bullet_1 \phi', \psi \bullet_1 \psi'}^{1,1} = [w]_{\phi, \psi}^{1,1} = [w]_{\phi, \psi} \quad [\uparrow(u)]_{\phi \bullet_1 \phi', \psi \bullet_1 \psi'}^{|\phi|, |\psi|} = [u]_{\phi', \psi'}^{1,1} = [u]_{\phi, \psi}$$

so that (i) holds.

For (ii), by induction on p , it is sufficient to prove the equality for $p = X_{u_1, u_2} \in (\phi \sqcup \psi)_1$. Let $m = |\phi|$, $n = |\psi|$, and

$$(e_1 \bullet_0 \alpha_1 \bullet_0 f_1) \bullet_1 \cdots \bullet_1 (e_m \bullet_0 \alpha_m \bullet_0 f_m) \quad (g_1 \bullet_0 \beta_1 \bullet_0 h_1) \bullet_1 \cdots \bullet_1 (g_m \bullet_0 \beta_m \bullet_0 h_m)$$

be the unique decomposition as sequences of rewriting steps of ϕ and ψ respectively (c.f. Corollary 4.1.2.5), for some $e_i, f_i, g_j, h_j \in P_1^*$ and $\alpha_i, \beta_j \in P_2$ for $i \in \mathbb{N}_m^*$ and $j \in \mathbb{N}_n^*$. We then have

$$\begin{aligned} [w \cdot (X_{u_1, u_2})]_{\phi \bullet_1 \phi', \psi \bullet_1 \psi'} &= [X_{w \uparrow(u_1), \uparrow(u_2)}]_{\phi \bullet_1 \phi', \psi \bullet_1 \psi'} \\ &= [w \uparrow(u_1)]_{\phi \bullet_1 \phi', \psi \bullet_1 \psi'}^{1,1} \bullet_1 (e_i \bullet_0 X_{\alpha_i, f_i \bullet_0 g_j, \beta_j} \bullet_0 h_j) \bullet_1 [\uparrow(u_2)]_{\phi \bullet_1 \phi', \psi \bullet_1 \psi'}^{k_l, k_r} \end{aligned}$$

where i, j are such that $u_1 |_i r_j u_2 \in (\phi' \sqcup \psi')_0$ and

$$k_l = |\phi| + i + 1 \quad k_r = |\psi| + j + 1.$$

By simple inductions, we obtain

$$\begin{aligned} [w \uparrow(u_1)]_{\phi \bullet_1 \phi', \psi \bullet_1 \psi'}^{1,1} &= [w]_{\phi \bullet_1 \phi', \psi \bullet_1 \psi'}^{1,1} \bullet_1 [\uparrow(u_1)]_{\phi \bullet_1 \phi', \psi \bullet_1 \psi'}^{|\phi|, |\psi|} \\ &= [w]_{\phi, \psi}^{1,1} \bullet_1 [u_1]_{\phi', \psi'}^{1,1} \\ &= [w]_{\phi, \psi} \bullet_1 [u_1]_{\phi', \psi'}^{1,1} \end{aligned}$$

and

$$[\uparrow(u_2)]_{\phi \bullet_1 \phi', \psi \bullet_1 \psi'}^{k_l, k_r} = [u_2]_{\phi', \psi'}^{i+1, j+1}$$

so that

$$\begin{aligned} [w \cdot (X_{u_1, u_2})]_{\phi \bullet_1 \phi', \psi \bullet_1 \psi'} &= [w]_{\phi, \psi} \bullet_1 [u_1]_{\phi', \psi'}^{1,1} \bullet_1 (e_i \bullet_0 X_{\alpha_i, f_i \bullet_0 g_j, \beta_j} \bullet_0 h_j) \bullet_1 [u_2]_{\phi', \psi'}^{i+1, j+1} \\ &= [w]_{\phi, \psi} \bullet_1 [X_{u_1, u_2}]_{\phi', \psi'}. \end{aligned} \quad \square$$

We can now conclude the last required properties on $X_{-, -}$:

Lemma 4.2.4.10. *Given 1-composable $\phi, \phi' \in \bar{P}_2$, 1-composable $\psi, \psi' \in \bar{P}_2$ such that ϕ, ψ are 0-composable, we have the following equalities in \bar{P}_3 :*

$$X_{\phi \bullet_1 \phi', \psi} = ((\phi \bullet_0 \partial_1^-(\psi)) \bullet_1 X_{\phi', \psi}) \bullet_2 (X_{\phi, \psi} \bullet_1 (\phi' \bullet_0 \partial_1^+(\psi)))$$

and

$$X_{\phi, \psi \bullet_1 \psi'} = (X_{\phi, \psi} \bullet_1 (\partial_1^+(\phi) \bullet_0 \psi')) \bullet_2 ((\partial_1^-(\phi) \bullet_0 \psi) \bullet_1 X_{\phi, \psi'}).$$

Proof. We only prove the first equality, since the second one is similar. By definition of $X_{\phi \bullet_1 \phi', \psi}$, we have $X_{\phi \bullet_1 \phi', \psi} = [X_{\phi \bullet_1 \phi', \psi}]_{\phi \bullet_1 \phi', \psi}$. Moreover, by Proposition 4.2.4.8, we have

$$[X_{\phi \bullet_1 \phi', \psi}]_{\phi \bullet_1 \phi', \psi} = [p]_{\phi \bullet_1 \phi', \psi}$$

in \bar{P}_3 for all path $p \in ((\phi \bullet_1 \phi') \sqcup \psi)_1$ parallel to $X_{\phi \bullet_1 \phi', \psi}$. In particular,

$$[X_{\phi \bullet_1 \phi', \psi}]_{\phi \bullet_1 \phi', \psi} = [(w \cdot (X_{\phi', \psi})) \bullet_0 ((X_{\phi, \psi}) \cdot w')]_{\phi \bullet_1 \phi', \psi}$$

where

$$w = l_1 \dots l_{|\phi|} \quad w' = l_1 \dots l_{|\phi'|}$$

are the only 0-cells of $\phi' \sqcup \text{id}_{\partial_1^-(\phi)}$ and $\phi \sqcup \text{id}_{\partial_1^+(\psi)}$ respectively. Thus,

$$\begin{aligned} [X_{\phi \bullet_1 \phi', \psi}]_{\phi \bullet_1 \phi', \psi} &= [(w \cdot (X_{\phi', \psi})) \bullet_0 ((X_{\phi, \psi}) \cdot w')]_{\phi \bullet_1 \phi', \psi} \\ &= [(w \cdot (X_{\phi', \psi}))]_{\phi \bullet_1 \phi', \psi} \bullet_2 [(X_{\phi, \psi}) \cdot w']_{\phi \bullet_1 \phi', \psi} \\ &\quad \text{(by functoriality of } [-]_{\phi \bullet_1 \phi', \psi}) \\ &= ([w]_{\phi, \text{id}_{\partial_1^-(\psi)}} \bullet_1 [X_{\phi', \psi}]_{\phi', \psi}) \bullet_2 ([X_{\phi, \psi}]_{\phi, \psi} \bullet_1 [w']_{\phi', \text{id}_{\partial_1^+(\psi)}}) \\ &\quad \text{(by Lemma 4.2.4.9)} \\ &= ((\phi \bullet_0 \partial_1^-(\psi)) \bullet_1 X_{\phi', \psi}) \bullet_2 (X_{\phi, \psi} \bullet_1 (\phi' \bullet_0 \partial_1^+(\psi))) \\ &\quad \text{(by definition of } [-]_{-, -} \text{ and } X_{-, -}). \end{aligned}$$

Hence,

$$X_{\phi \bullet_1 \phi', \psi} = ((\phi \bullet_0 \partial_1^-(\psi)) \bullet_1 X_{\phi', \psi}) \bullet_2 (X_{\phi, \psi} \bullet_1 (\phi' \bullet_0 \partial_1^+(\psi))). \quad \square$$

We now prove the compatibility between 3-cells and interchangers. We start by proving the compatibility with 3-generators:

Lemma 4.2.4.11. *Given $A: \phi \Rightarrow \phi': f \Rightarrow f' \in \bar{P}_3$ and $\psi: g \Rightarrow g' \in \bar{P}_2$ such that A, ψ are 0-composable, we have, in \bar{P}_3 ,*

$$((A \bullet_0 g) \bullet_1 (f' \bullet_0 \psi)) \bullet_2 X_{\phi', \psi} = X_{\phi, \psi} \bullet_2 ((f \bullet_0 \psi) \bullet_1 (A \bullet_0 g')).$$

Similarly, given $\phi: f \Rightarrow f' \in \bar{P}_2$ and $B: \psi \Rightarrow \psi': g \Rightarrow g'$ such that ϕ, B are 0-composable, we have, in \bar{P} ,

$$X_{\phi, \psi} \bullet_2 ((g \bullet_0 B) \bullet_1 (\phi \bullet_0 f')) = ((\phi \bullet_0 g) \bullet_1 (f \bullet_0 B)) \bullet_2 X_{\phi, \psi'}.$$

Proof. We only prove the first part of the property, since the other one is symmetric, and we do so by an induction on $|\psi|$. If $|\psi| = 0$, ψ is an identity and the result follows. Otherwise, $\psi = w \bullet_1 \tilde{\psi}$ where $w = (l \bullet_0 \alpha \bullet_0 r)$ with $l, r \in \bar{P}_1$, $\alpha: h \Rightarrow h' \in \bar{P}_2$ and $\tilde{\psi} \in \bar{P}_2$ with $|\tilde{\psi}| = |\psi| - 1$. Let $\tilde{g} = \partial_1^+(w)$. By Lemma 4.2.4.10, we have

$$X_{\phi, \psi} = (X_{\phi, w} \bullet_1 (f' \bullet_0 \tilde{\psi})) \bullet_2 ((f \bullet_0 w) \bullet_1 X_{\phi, \tilde{\psi}}) \quad (4.6)$$

$$X_{\phi', \psi} = (X_{\phi', w} \bullet_1 (f' \bullet_0 \tilde{\psi})) \bullet_2 ((f \bullet_0 w) \bullet_1 X_{\phi', \tilde{\psi}}). \quad (4.7)$$

Also, by Lemma 4.2.4.4(iv), we have

$$X_{\phi, w} = X_{\phi, l \bullet_0 \alpha} \bullet_0 r \quad X_{\phi', w} = X_{\phi', l \bullet_0 \alpha} \bullet_0 r \quad (4.8)$$

so that

$$\begin{aligned} & ((A \bullet_0 g) \bullet_1 (f' \bullet_0 w)) \bullet_2 X_{\phi', w} \\ &= [((A \bullet_0 l \bullet_0 h) \bullet_1 (f' \bullet_0 l \bullet_0 \alpha)) \bullet_2 X_{\phi', l \bullet_0 \alpha}] \bullet_0 r \\ &= [X_{\phi, l \bullet_0 \alpha} \bullet_2 ((f \bullet_0 l \bullet_0 \alpha) \bullet_1 (A \bullet_0 l \bullet_0 h'))] \bullet_0 r \\ &\quad \text{(by interchange naturality generator)} \\ &= X_{\phi, w} \bullet_2 ((f \bullet_0 w) \bullet_1 (A \bullet_0 g')). \end{aligned} \quad (4.9)$$

Thus,

$$\begin{aligned}
& ((A \bullet_0 g) \bullet_1 (f' \bullet_0 \psi)) \bullet_2 X_{\phi', \psi} \\
&= ((A \bullet_0 g) \bullet_1 (f' \bullet_0 w) \bullet_1 (f' \bullet_0 \tilde{\psi})) \\
&\quad \bullet_2 (X_{\phi', w} \bullet_1 (f' \bullet_0 \tilde{\psi})) \bullet_2 ((f \bullet_0 w) \bullet_1 X_{\phi', \tilde{\psi}}) \quad (\text{by (4.7)}) \\
&= \left[(((A \bullet_0 g) \bullet_1 (f' \bullet_0 w)) \bullet_2 X_{\phi', w} \bullet_1 (f' \bullet_0 \tilde{\psi})) \right] \\
&\quad \bullet_2 ((f \bullet_0 w) \bullet_1 X_{\phi', \tilde{\psi}}) \\
&= \left[(X_{\phi, w} \bullet_2 ((f \bullet_0 w) \bullet_1 (A \bullet_0 \tilde{g}))) \bullet_1 (f' \bullet_0 \tilde{\psi}) \right] \\
&\quad \bullet_2 ((f \bullet_0 w) \bullet_1 X_{\phi', \tilde{\psi}}) \quad (\text{by (4.9)}) \\
&= (X_{\phi, w} \bullet_1 (f' \bullet_0 \tilde{\psi})) \\
&\quad \bullet_2 ((f \bullet_0 w) \bullet_1 (A \bullet_0 \tilde{g})) \bullet_1 (f' \bullet_0 \tilde{\psi}) \bullet_2 ((f \bullet_0 w) \bullet_1 X_{\phi', \tilde{\psi}}) \\
&= (X_{\phi, w} \bullet_1 (f' \bullet_0 \tilde{\psi})) \\
&\quad \bullet_2 \left[(f \bullet_0 w) \bullet_1 (((A \bullet_0 \tilde{g})) \bullet_1 (f' \bullet_0 \tilde{\psi})) \bullet_2 X_{\phi', \tilde{\psi}} \right] \\
&= (X_{\phi, w} \bullet_1 (f' \bullet_0 \tilde{\psi})) \\
&\quad \bullet_2 \left[(f \bullet_0 w) \bullet_1 (X_{\phi', \tilde{\psi}} \bullet_2 ((f \bullet_0 \tilde{\psi})) \bullet_1 (A \bullet_0 g')) \right] \quad (\text{by induction}) \\
&= (X_{\phi, w} \bullet_1 (f' \bullet_0 \tilde{\psi})) \bullet_2 ((f \bullet_0 w) \bullet_1 (X_{\phi', \tilde{\psi}})) \\
&\quad \bullet_2 ((f \bullet_0 w) \bullet_1 (f \bullet_0 \tilde{\psi})) \bullet_1 (A \bullet_0 g') \\
&= X_{\phi, \psi} \bullet_2 ((f \bullet_0 \psi) \bullet_1 (A \bullet_0 g')) \quad (\text{by (4.6)}). \quad \square
\end{aligned}$$

Next, we prove the compatibility between interchangers and rewriting steps:

Lemma 4.2.4.12. *Given a rewriting step $R: \phi \Rightarrow \phi': f \Rightarrow f' \in P_3^*$ with $R = \lambda \bullet_1 (l \bullet_0 A \bullet_0 r) \bullet_1 \rho$ for some $l, r \in P_1^*$, $\lambda, \rho \in P_2^*$, $A: \mu \Rightarrow \mu' \in P_3$, and $\psi: g \Rightarrow g' \in P_2^*$ such that R, ψ are 0-composable, we have, in \bar{P}_3 ,*

$$((R \bullet_0 g) \bullet_1 (f' \bullet_0 \psi)) \bullet_2 X_{\phi', \psi} = X_{\phi, \psi} \bullet_2 ((f \bullet_0 \psi) \bullet_1 (R \bullet_0 g')). \quad (4.10)$$

Similarly, given $\phi \in P_2^*$ and a rewriting step $S: \psi \Rightarrow \psi': g \Rightarrow g' \in P_3^*$ with $S = \lambda \bullet_1 (l \bullet_0 B \bullet_0 r) \bullet_1 \rho$ for some $\lambda, \rho \in P_2^*$, $l, r \in P_1^*$, $B: \nu \Rightarrow \nu' \in P_3$ such that ϕ, S are 0-composable, we have, in \bar{P}_3 ,

$$X_{\phi, \psi} \bullet_2 ((f \bullet_0 B) \bullet_1 (\phi \bullet_0 g')) = ((\phi \bullet_0 g) \bullet_1 (f' \bullet_0 B)) \bullet_2 X_{\phi, \psi'}.$$

Proof. By symmetry, we only prove the first part. Let

$$\begin{aligned}
\tilde{\mu} &= l \bullet_0 \mu \bullet_0 r & h &= \partial_1^-(\mu) & \tilde{h} &= \partial_1^-(\tilde{\mu}) \\
\tilde{\mu}' &= l \bullet_0 \mu' \bullet_0 r & h' &= \partial_1^+(\mu') & \tilde{h}' &= \partial_1^+(\tilde{\mu}).
\end{aligned}$$

We have

$$R \bullet_0 g = (\lambda \bullet_0 g) \bullet_1 (l \bullet_0 A \bullet_0 r \bullet_0 g) \bullet_1 (\rho \bullet_0 g)$$

and, by Lemma 4.2.4.10,

$$\begin{aligned}
X_{\phi, \psi} &= (((\lambda \bullet_1 \tilde{\mu}) \bullet_0 g) \bullet_1 X_{\rho, \psi}) \\
&\quad \bullet_2 (((\lambda \bullet_0 g) \bullet_1 X_{\tilde{\mu}, \psi} \bullet_1 (\rho \bullet_0 g'))) \\
&\quad \bullet_2 ((X_{\lambda, \psi} \bullet_1 ((\tilde{\mu} \bullet_1 \rho) \bullet_0 g'))) \quad (4.11)
\end{aligned}$$

and

$$\begin{aligned}
X_{\phi',\psi} &= (((\lambda \bullet_1 \tilde{\mu}') \bullet_0 g) \bullet_1 X_{\rho,\psi}) \\
&\bullet_2 (((\lambda \bullet_0 g) \bullet_1 X_{\tilde{\mu}',\psi} \bullet_1 (\rho \bullet_0 g'))) \\
&\bullet_2 ((X_{\lambda,\psi} \bullet_1 ((\tilde{\mu}' \bullet_1 \rho) \bullet_0 g))).
\end{aligned} \tag{4.12}$$

We start the calculation of the left-hand side of (4.10), using (4.12). We get

$$\begin{aligned}
&((R \bullet_0 g) \bullet_1 (f' \bullet_0 \psi)) \bullet_2 (((\lambda \bullet_1 \tilde{\mu}') \bullet_0 g) \bullet_1 X_{\rho,\psi}) \\
&= (\lambda \bullet_0 g) \\
&\bullet_1 \left[((l \bullet_0 A \bullet_0 r \bullet_0 g) \bullet_1 (\rho \bullet_0 g) \bullet_1 (f' \bullet_0 \psi)) \bullet_2 ((\mu' \bullet_0 g) \bullet_1 X_{\rho,\psi}) \right] \\
&= (\lambda \bullet_0 g) \\
&\bullet_1 \left[((\mu \bullet_0 g) \bullet_1 X_{\rho,\psi}) \bullet_2 ((l \bullet_0 A \bullet_0 r \bullet_0 g) \bullet_1 (\tilde{h}' \bullet_0 \psi) \bullet_1 (\rho \bullet_0 g')) \right] \quad (\text{by Lemma 4.2.4.2}) \\
&= ((\lambda \bullet_0 g) \bullet_1 (\tilde{\mu} \bullet_0 g) \bullet_1 X_{\rho,\psi}) \\
&\bullet_2 ((\lambda \bullet_0 g) \bullet_1 (l \bullet_0 A \bullet_0 r \bullet_0 g) \bullet_1 (\tilde{h}' \bullet_0 \psi) \bullet_1 (\rho \bullet_0 g')).
\end{aligned}$$

Also, we do a step of calculation for the right-hand side of (4.10), using (4.11). We get

$$\begin{aligned}
&(X_{\lambda,\psi} \bullet_1 ((\tilde{\mu} \bullet_1 \rho) \bullet_0 g')) \bullet_2 ((f \bullet_0 \psi) \bullet_1 (R \bullet_0 g')) \\
&= ((\lambda \bullet_0 g) \bullet_1 (\tilde{h} \bullet_0 \psi) \bullet_1 (l \bullet_0 A \bullet_0 r \bullet_0 g') \bullet_1 (\rho \bullet_0 g')) \\
&\bullet_2 (X_{\lambda,\psi} \bullet_1 (\tilde{\mu}' \bullet_0 g') \bullet_1 (\rho \bullet_0 g')).
\end{aligned}$$

Finally, we do the last step of calculation between the left-hand side and the right-hand side of (4.10). Note that

$$\begin{aligned}
&((l \bullet_0 A \bullet_0 r \bullet_0 g) \bullet_1 (\tilde{h}' \bullet_0 \psi)) \bullet_2 X_{\tilde{\mu}',\psi} \\
&= l \bullet_0 (((A \bullet_0 r \bullet_0 g) \bullet_1 (h' \bullet_0 r \bullet_0 \psi)) \bullet_2 X_{\mu',r \bullet_0 \psi}) \quad (\text{by Lemma 4.2.4.4(ii)}) \\
&= l \bullet_0 (((A \bullet_0 r \bullet_0 g) \bullet_1 (h' \bullet_0 r \bullet_0 \psi)) \bullet_2 X_{\mu',r \bullet_0 \psi}) \quad (\text{by Lemma 4.2.4.4(iii)}) \\
&= l \bullet_0 (X_{\mu,r \bullet_0 \psi} \bullet_2 ((h \bullet_0 r \bullet_0 \psi) \bullet_1 (A \bullet_0 r \bullet_0 g'))) \quad (\text{by Lemma 4.2.4.11}) \\
&= l \bullet_0 (X_{\mu \bullet_0 r,\psi} \bullet_2 ((h \bullet_0 r \bullet_0 \psi) \bullet_1 (A \bullet_0 r \bullet_0 g'))) \quad (\text{by Lemma 4.2.4.4(iii)}) \\
&= X_{\tilde{\mu},\psi} \bullet_2 ((\tilde{h} \bullet_0 \psi) \bullet_1 (l \bullet_0 A \bullet_0 r \bullet_0 g')) \quad (\text{by Lemma 4.2.4.4(ii)})
\end{aligned}$$

so that

$$\begin{aligned}
&((\lambda \bullet_0 g) \bullet_1 (l \bullet_0 A \bullet_0 r \bullet_0 g) \bullet_1 (\tilde{h}' \bullet_0 \psi) \bullet_1 (\rho \bullet_0 g')) \bullet_2 ((\lambda \bullet_0 g) \bullet_1 X_{\tilde{\mu}',\psi} \bullet_1 (\rho \bullet_0 g')) \\
&= (\lambda \bullet_0 g) \bullet_1 \left[((l \bullet_0 A \bullet_0 r \bullet_0 g) \bullet_1 (\tilde{h}' \bullet_0 \psi)) \bullet_2 X_{\tilde{\mu}',\psi} \right] \bullet_1 (\rho \bullet_0 g') \\
&= (\lambda \bullet_0 g) \bullet_1 \left[X_{\tilde{\mu},\psi} \bullet_2 ((\tilde{h} \bullet_0 \psi) \bullet_1 (l \bullet_0 A \bullet_0 r \bullet_0 g')) \right] \bullet_1 (\rho \bullet_0 g') \\
&= ((\lambda \bullet_0 g) \bullet_1 X_{\tilde{\mu},\psi} \bullet_1 (\rho \bullet_0 g')) \bullet_2 ((\lambda \bullet_0 g) \bullet_1 (\tilde{h} \bullet_0 \psi) \bullet_1 (l \bullet_0 A \bullet_0 r \bullet_0 g') \bullet_1 (\rho \bullet_0 g')).
\end{aligned}$$

By combining the previous equations, we obtain

$$\begin{aligned}
&((R \bullet_0 g) \bullet_1 (f' \bullet_0 \psi)) \bullet_2 X_{\phi',\psi} \\
&= ((\lambda \bullet_0 g) \bullet_1 (l \bullet_0 A \bullet_0 r \bullet_0 g) \bullet_1 (\rho \bullet_0 g) \bullet_1 (f' \bullet_0 \psi)) \\
&\bullet_2 (((\lambda \bullet_1 \tilde{\mu}') \bullet_0 g) \bullet_1 X_{\rho,\psi}) \\
&\bullet_2 (((\lambda \bullet_0 g) \bullet_1 X_{\tilde{\mu}',\psi} \bullet_1 (\rho \bullet_0 g')))
\end{aligned}$$

$$\begin{aligned}
& \bullet_2 ((X_{\lambda,\psi} \bullet_1 ((\tilde{\mu}' \bullet_1 \rho) \bullet_0 g')))) \\
= & (((\lambda \bullet_1 \tilde{\mu}) \bullet_0 g) \bullet_1 X_{\rho,\psi}) \\
& \bullet_2 (((\lambda \bullet_0 g) \bullet_1 X_{\tilde{\mu},\psi} \bullet_1 (\rho \bullet_0 g'))) \\
& \bullet_2 ((X_{\lambda,\psi} \bullet_1 ((\tilde{\mu} \bullet_1 \rho) \bullet_0 g'))) \\
& \bullet_2 ((f \bullet_0 \psi) \bullet_1 (\lambda \bullet_0 g) \bullet_1 (l \bullet_0 A \bullet_0 r \bullet_0 g) \bullet_1 (\rho \bullet_0 g)) \\
= & X_{\phi,\psi} \bullet_2 ((f \bullet_0 \psi) \bullet_1 (R \bullet_0 g'))
\end{aligned}$$

which is what we wanted. \square

We can deduce the complete compatibility between interchangers and 3-cells:

Lemma 4.2.4.13. *Given $F: \phi \Rightarrow \phi': f \Rightarrow f' \in \bar{P}_3$ and $\psi: g \Rightarrow g' \in \bar{P}_2$ such that F, ψ are 0-composable, we have*

$$((F \bullet_0 g) \bullet_1 (f' \bullet_0 \psi)) \bullet_2 X_{\phi',\psi} = X_{\phi,\psi} \bullet_2 ((f \bullet_0 \psi) \bullet_1 (F \bullet_0 g')).$$

Similarly, given $\phi: f \Rightarrow f' \in \bar{P}_2$ and $G: \psi \Rightarrow \psi': g \Rightarrow g' \in \bar{P}_3$ such that ϕ, G are 0-composable, we have

$$X_{\phi,\psi} \bullet_2 ((f \bullet_0 G) \bullet_1 (\phi \bullet_0 g')) = ((\phi \bullet_0 g) \bullet_1 (f' \bullet_0 G)) \bullet_2 X_{\phi,\psi'}.$$

Proof. Remember that each 3-cell \bar{P} can be written as a sequence of rewriting steps of P . By induction on the length of such a sequence defining F or G as in the statement, we conclude using Lemma 4.2.4.12. \square

We can conclude the correctness of our definition of Gray presentations:

Theorem 4.2.4.14. *Given a Gray presentation P , the presented precategory \bar{P} is canonically a lax Gray category.*

Proof. The axioms of lax Gray category follow from Lemmas 4.2.4.2, 4.2.4.4, 4.2.4.10 and 4.2.4.13. \square

Moreover, when applying a localization operation, we obtain a (3, 2)-Gray category:

Corollary 4.2.4.15. *Given a Gray presentation P , \bar{P}^\top is canonically a (3, 2)-Gray category.*

Proof. By Theorem 4.2.4.14 and Proposition 4.2.2.4. \square

4.3 Rewriting

In this section, we introduce rewriting techniques to show coherence results (“all diagrams commute”) for presented Gray categories. These techniques are obtained as generalizations of the ones from classical rewriting theory to the setting of free precategories, where we moreover have a relation \equiv on pairs of parallel rewriting paths which plays the role of a witness for confluence of the branchings. The coherence of the Gray presentations will then be implied by the confluence of the “critical branchings” from the rewriting systems associated to these presentations.

We first define the coherence property for Gray presentations (Section 4.3.1) and show how it can be obtained from a property of confluence on 3-precategories. Then, we adapt the elementary notions of rewriting to the setting of 3-prepolygraphs (Section 4.3.2) together with classical results: a criterion for termination based on reduction orders (Section 4.3.3), a critical pair lemma (Section 4.3.4) together with a finiteness property on the number of critical branchings (Section 4.3.5). From the critical pair lemma, we deduce a coherence theorem for Gray presentations (Theorem 4.3.4.8) that will be our main tool for the treatment of the examples of the next section.

4.3.1 Coherence in Gray categories

Recall that the aim of this chapter is to provide tools to study the *coherence* of presented Gray categories. Below, we define this notion and give a first criterion to obtain the coherence of (3, 2)-precategories obtained by the localization functor.

4.3.1.1 – Definition. A 3-precategory C is *coherent* when, for every pair of parallel 3-cells

$$F_1, F_2: \phi \Rightarrow \psi \in C_3$$

we have $F_1 = F_2$. A Gray presentation P is then *coherent* when the underlying (3, 2)-precategory of the (3, 2)-Gray category \bar{P}^\top is coherent (remember that \bar{P} is a lax Gray category by Theorem 4.2.4.14, which implies that \bar{P}^\top is a (3, 2)-Gray category by Proposition 4.2.2.4). Gray presentations P with no other 4-generators than the independence generators and the interchange naturality generators are usually not coherent. For example, in the Gray presentation P of pseudomonoids given in Example 4.2.3.3, we do not expect the following parallel 3-cells

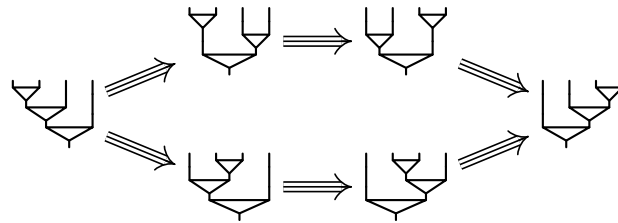

to be equal in \bar{P}^\top . For coherence, we need to add “tiles” in P_4 to fill the “holes” created by parallel 3-cells as the ones above. A trivial way to do this is to add a 4-generator $R: F_1 \Rightarrow F_2$ for every pair of parallel 3-cells F_1 and F_2 of P^* . However, this method gives quite big presentations, whereas we aim at small ones, so that the number of axioms to verify in concrete instances is as little as possible. We expose a better method in Section 4.3.4, in the form of Theorem 4.3.4.8: we will see that it is enough to add a tile of the form

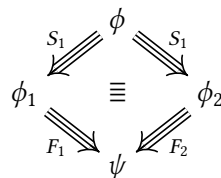

for every critical branching (S_1, S_2) of P for which we chose rewriting paths F_1, F_2 that make the branching (S_1, S_2) joinable (definitions are introduced below).

4.3.1.2 – Coherence from confluence. We now show how the coherence property can be obtained starting from 3-precategory whose 3-cells satisfy a property of confluence, motivating the adaptation of rewriting theory to 3-prepolygraphs in order to study the coherence of Gray presentations. In fact, we can already prove an analogue of the Church-Rosser property coming from rewriting theory in the context of confluent categories.

A 3-precategory C is *confluent* when, for 2-cells $\phi, \phi_1, \phi_2 \in C_2$ and 3-cells

$$F_1: \phi \Rightarrow \phi_1 \quad \text{and} \quad F_2: \phi \Rightarrow \phi_2$$

of C , there exist a 2-cell $\psi \in C_2$ and 3-cells

$$G_1: \phi_1 \Rightarrow \psi \in C_3 \quad \text{and} \quad G_2: \phi_2 \Rightarrow \psi \in C_3$$

of C such that $F_1 \bullet_2 G_1 = F_2 \bullet_2 G_2$. The 3-cells of a $(3, 2)$ -precategory associated to a confluent 3-precategory admits a simple form, as in:

Proposition 4.3.1.3. *Given a confluent 3-precategory C , all $F: \phi \Rightarrow \phi' \in C_3^\top$ can be written $F = G \bullet_2 H^{-1}$ for some $\psi \in C_2$, $G: \phi \Rightarrow \psi \in C_3$ and $H: \phi' \Rightarrow \psi \in C_3$.*

The above property says that confluent categories satisfy a ‘‘Church-Rosser property’’ ([BN99, Definition 2.1.3], for example), and is analogous to the classical result stating that confluent rewriting systems are Church-Rosser ([BN99, Theorem 2.1.5], for example).

Proof. By the definition of C^\top , all 3-cell $F: \phi \Rightarrow \phi' \in C_3^\top$ can be written

$$F = G_1^{-1} \bullet_2 H_1 \bullet_2 \cdots \bullet_2 G_k^{-1} \bullet_2 H_k$$

for some $k \in \mathbb{N}$ and 3-cells $G_i: \chi_i \Rightarrow \phi_{i-1}$ and $H_i: \chi_i \Rightarrow \phi_i$ of C for $i \in \mathbb{N}_k^*$ with $\phi_0 = \phi$ and $\phi_k = \phi'$, as in

$$\begin{array}{ccccccc} & & G_1 & \chi_1 & H_1 & G_2 & \cdots & H_{k-1} & G_k & \chi_k & H_k & \\ & & \Downarrow & \Downarrow & \Downarrow & \Downarrow & \cdots & \Downarrow & \Downarrow & \Downarrow & \Downarrow & \\ \phi_0 & & & & \phi_1 & & \cdots & & \phi_{k-1} & & & \phi_k \end{array} .$$

We prove the property by induction on k . If $k = 0$, then F is an identity and the result follows. Otherwise, since C is confluent, there exists $\psi_k \in C_2$, $G'_k: \phi_{k-1} \Rightarrow \psi_k \in C_3$ and $H'_k: \phi_k \Rightarrow \psi_k \in C_3$ with

$$\begin{array}{ccc} & G_k & \chi_k & H_k \\ & \Downarrow & \Downarrow & \Downarrow \\ \phi_{k-1} & & & \phi_k \\ & G'_k & \psi_k & H'_k \end{array} .$$

By induction, the morphism

$$G_1^{-1} \bullet_2 H_1 \bullet_2 \cdots \bullet_2 G_{k-2}^{-1} \bullet_2 H_{k-2} \bullet_2 G_{k-1}^{-1} \bullet_2 (H_{k-1} \bullet_2 G'_k)$$

can be written $G \bullet_2 H^{-1}$ for some 2-cell ψ and 3-cells $G: \phi_0 \Rightarrow \psi$ and $H: \psi_k \Rightarrow \psi$ of C . Since

$$G_k \bullet_2 G'_k = H_k \bullet_2 H'_k,$$

we have $G_k^{-1} \bullet_2 H_k = G'_k \bullet_2 H'_k{}^{-1}$. Hence,

$$F = G \bullet_2 H^{-1} \bullet_2 H'_k{}^{-1} = G \bullet_2 (H'_k \bullet_2 H)^{-1}$$

which is of the wanted form. □

Starting from a confluent 3-precategory, we have the following simple criterion to deduce the coherence of the associated $(3, 2)$ -precategory:

Proposition 4.3.1.4. *Let C be a confluent 3-precategory which moreover satisfies that, for every pair of parallel 3-cells $F_1, F_2: \phi \Rightarrow \phi'$ of C , we have $F_1 = F_2$ in the localization C^\top . Then, C^\top is coherent. In particular, if C is a confluent 3-precategory satisfying that, for all pair of parallel 3-cells $F_1, F_2: \phi \Rightarrow \phi'$ of C , there exists $G: \phi' \Rightarrow \phi'' \in C_3$ such that $F_1 \bullet_2 G = F_2 \bullet_2 G$ in C_3 , then C^\top is coherent.*

Proof. Let $F_1, F_2: \phi \Rightarrow \phi' \in C_3^\top$. By Proposition 4.3.1.3, for $i \in \{1, 2\}$, we have $F_i = G_i \bullet_2 H_i^{-1}$ for some 2-cell ψ_i and 3-cells $G_i: \phi \Rightarrow \psi_i$ and $H_i: \phi' \Rightarrow \psi_i$ of C , as in

$$\begin{array}{ccc}
 & \psi_1 & \\
 G_1 \nearrow & & \nwarrow H_1 \\
 \phi & & \phi' \\
 G_2 \searrow & & \swarrow H_2 \\
 & \psi_2 &
 \end{array}$$

By confluence, there are a 2-cell ψ and a 3-cell $K_i: \psi_i \Rightarrow \psi$ of C for $i \in \{1, 2\}$, such that, in C ,

$$G_1 \bullet_2 K_1 = G_2 \bullet_2 K_2.$$

By the hypothesis of the statement, we have $H_1 \bullet_2 K_1 = H_2 \bullet_2 K_2$ in C^\top so that

$$\begin{aligned}
 G_1 \bullet_2 H_1^{-1} &= G_1 \bullet_2 K_1 \bullet_2 (H_1 \bullet_2 K_1)^{-1} \\
 &= G_2 \bullet_2 K_2 \bullet_2 (H_2 \bullet_2 K_2)^{-1} \\
 &= G_2 \bullet_2 H_2^{-1}.
 \end{aligned}$$

Hence, $F_1 = F_2$. For the last part, given parallel 3-cells F_1, F_2 of C , note that if $F_1 \bullet_2 G = F_2 \bullet_2 G$ in C for some 3-cell G , then $\eta(F_1) = \eta(F_2)$ (where η is the canonical 3-prefunctor $C \rightarrow C^\top$). \square

4.3.2 Rewriting on 3-prepolygraphs

As we have seen in the previous section, coherence can be deduced from a confluence property on the 3-cells of 3-precategories. Since confluence of classical rewriting systems is usually shown using rewriting theory, it motivates an adaptation of rewriting theory to the context of 3-prepolygraphs for the purpose of studying the coherence of Gray presentations. Here, we translate the elementary terminology and properties of rewriting theory to this context.

4.3.2.1 – Paths. Given a 3-prepolygraph P , recall from Paragraph 4.1.2.1 that a *rewriting step* of P is a cell $S \in P_3^*$ of the form

$$S = \lambda \bullet_1 (l \bullet_0 A \bullet_0 r) \bullet_1 \rho$$

for some $l, r \in P_1^*$, $\lambda, \rho \in P_2^*$ and $A \in P_3$. For such S , we say that A is the *inner 3-generator* of S . A *rewriting path* of P is a 3-cell $F: \phi \Rightarrow \phi'$ in P_3^* . Remember that, by Corollary 4.1.2.5, such a rewriting path can be uniquely written as a composite of rewriting steps $S_1 \bullet_2 \cdots \bullet_2 S_k$. Given $\phi, \psi \in P_2^*$, we say that ϕ *rewrites to* ψ when there exists a rewriting path $F: \phi \Rightarrow \psi$. A *normal form* is a 2-cell $\phi \in P_2^*$ such that for all $\psi \in P_2^*$ and $F: \phi \Rightarrow \psi$, we have $F = \text{id}_\phi^3$. The 3-prepolygraph P is said *terminating* when there does not exist an infinite sequence of rewriting steps $F_i: \phi_i \Rightarrow \phi_{i+1}$ for $i \in \mathbb{N}$;

4.3.2.2 – Branchings. Given a 3-prepolygraph P , a *branching* is a pair of rewriting paths

$$F_1: \phi \Rightarrow \phi_1 \quad \text{and} \quad F_2: \phi \Rightarrow \phi_2$$

of P ; the *symmetric branching* of (F_1, F_2) is (F_2, F_1) . The branching (F_1, F_2) is *local* when both F_1 and F_2 are rewriting steps; it is *joinable* when there exist a 2-cell $\psi \in P_2^*$ and rewriting paths

$$G_1: \phi_1 \Rightarrow \psi \quad \text{and} \quad G_2: \phi_2 \Rightarrow \psi$$

of P ; given a congruence \equiv on P^* , if we moreover have that $F_1 \bullet_2 G_1 \equiv F_2 \bullet_2 G_2$, as in

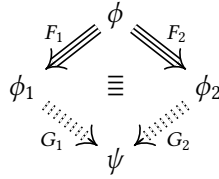

we say that the branching is *confluent for* \equiv .

4.3.2.3 – Rewriting systems. A *rewriting system* (P, \equiv) is the data of a 3-prepolygraph P together with a congruence \equiv on P^* . (P, \equiv) is *(locally) confluent* when every (local) branching is confluent for \equiv ; it is *convergent* when it is locally confluent and P is terminating.

Given a 4-prepolygraph P , the *rewriting system associated to* P is $(P_{\leq 3}, \sim^P)$ (recall the definition of \sim^P given in Section 4.1.3) where \sim^P intuitively witnesses that the “space” between two parallel 3-cells can be filled with elementary tiles that are the elements of P_4 . In the following, most of the concrete rewriting systems that we study are of this form.

4.3.2.4 – Newman’s lemma. Our definition of rewriting system contrasts with the classical definitions of abstract or term rewriting systems, in which all pairs of parallel paths are equal. Nevertheless, the analogues of several well-known properties of abstract rewriting systems can be proved in our context. In particular, the classical proof by well-founded induction of Newman’s lemma ([BN99, Lemma 2.7.2], for example), can be directly adapted in order to show that:

Theorem 4.3.2.5. *A convergent rewriting system is confluent.*

Proof. Let (P, \equiv) be a rewriting system which is convergent. Let $\Rightarrow^+ \subseteq P_2^* \times P_2^*$ be the partial order such that $\phi \Rightarrow^+ \psi$ if there exists a rewriting path $F: \phi \Rightarrow \psi \in P_3^*$ with $|F| > 0$. Since the underlying rewriting system is terminating, \Rightarrow^+ is well-founded. Thus, we can prove the theorem by induction on \Rightarrow^+ . So suppose given a branching $F_1: \phi \Rightarrow \phi_1 \in P_3^*$ and $F_2: \phi \Rightarrow \phi_2 \in P_3^*$. If $|F_1| = 0$ or $|F_2| = 0$, then the branching is confluent. Otherwise, for $i \in \{1, 2\}$, $F_i = S_i \bullet_2 F'_i$ for some rewriting step $S_i: \phi \Rightarrow \phi'_i$ and rewriting path $F'_i: \phi'_i \Rightarrow \phi_i$. Since the rewriting system is locally confluent, there are $\psi \in P_2^*$ and rewriting paths $G_i: \phi'_i \Rightarrow \psi$ for $i \in \{1, 2\}$ such that $S_1 \bullet_2 G_1 \equiv S_2 \bullet_2 G_2$. Since the rewriting system is terminating and \equiv is stable by composition, by composing the G_i ’s with a path $G: \psi \Rightarrow \psi'$ where ψ' is a normal form, we can suppose that ψ is a normal form. By induction on ϕ'_1 and ϕ'_2 , there are rewriting paths $H_i: \phi_i \Rightarrow \psi'$ and $F''_i: \psi \Rightarrow \psi'_i$ such that $F'_i \bullet_2 H_i \equiv G_i \bullet_2 F''_i$ for $i \in \{1, 2\}$. Since ψ is in normal form, $F''_i = \text{id}_{\psi}^3$ and we have $H_i: \phi_i \Rightarrow \psi$ for $i \in \{1, 2\}$ as in

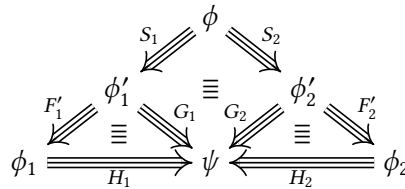

Moreover,

$$\begin{aligned}
 F_1 \bullet_2 H_1 &\equiv S_1 \bullet_2 (F'_1 \bullet_2 H_1) \\
 &\equiv S_1 \bullet_2 G_1 \\
 &\equiv S_2 \bullet_2 G_2 \\
 &\equiv S_2 \bullet_2 (F'_2 \bullet_2 H_2) \\
 &\equiv F_2 \bullet_2 H_2.
 \end{aligned}$$

□

Theorem 4.3.2.5 implies that, up to post-composition, all the parallel paths of a convergent rewriting system are equivalent. Later, this will allow us to apply Proposition 4.3.1.4 for showing the coherence of Gray presentations.

Lemma 4.3.2.6. *Given a convergent rewriting system (P, \equiv) and two rewriting paths*

$$F_1, F_2: \phi \Rightarrow \phi' \in P_3^*$$

of P as in

$$\begin{array}{ccc} & \phi & \\ F_1 \curvearrowright & & \curvearrowright F_2 \\ & \phi' & \end{array}$$

there exists $G: \phi' \Rightarrow \psi \in P_3^*$ such that $F_1 \bullet_2 G \equiv F_2 \bullet_2 G$, i.e.,

$$\begin{array}{ccccc} & & \phi & & \\ & F_1 \curvearrowright & & \curvearrowright F_2 & \\ \phi' & & \equiv & & \phi' \\ & G \curvearrowright & & \curvearrowright G & \\ & & \psi & & \end{array}$$

Proof. Given F_1, F_2 as above, since the rewriting system is terminating, there is a rewriting path $G: \phi' \Rightarrow \psi$ where ψ is a normal form. By Theorem 4.3.2.5, there exist $G_1: \psi \Rightarrow \psi'$ and $G_2: \psi \Rightarrow \psi'$ such that $F_1 \bullet_2 G \bullet_2 G_1 \equiv F_2 \bullet_2 G \bullet_2 G_2$. Since ψ is a normal form, we have

$$G_1 = G_2 = \text{id}_{\psi}^3.$$

Hence, $F_1 \bullet_2 G \equiv F_2 \bullet_2 G$. □

Note that, in Lemma 4.3.2.6, we do not necessarily have

$$\begin{array}{ccc} & \phi & \\ F_1 \curvearrowright & \equiv & \curvearrowright F_2 \\ & \phi' & \end{array}$$

which explains why the method we develop in this section for showing coherence will only apply to $(3, 2)$ -precategories, but not to general 3-precategories.

4.3.3 Termination

In this section, we give a termination criterion 3-prepolygraphs (and thus, rewriting systems) based on a generalization of the notion of reduction order from classical rewriting theory where we require a compatibility between the order and the composition operations of cells. We moreover consider the specific case of Gray presentations and show how to handle the interchange generators.

4.3.3.1 – Reduction orders. A *reduction order* for a 3-prepolygraph P is a well-founded partial order $<$ on P_2^* such that:

- if $\phi > \phi'$ for some $\phi, \phi' \in P_2^*$, then $\partial_1^\epsilon(\phi) = \partial_1^\epsilon(\phi')$ for $\epsilon \in \{-, +\}$,
- given $A: \phi \Rightarrow \phi' \in P_3$, we have $\phi > \phi'$,

- given $l, r \in P_1^*$ and $\phi, \phi' \in P_2^*$ such that l, ϕ, r are 0-composable and $\phi > \phi'$, we have

$$l \bullet_0 \phi \bullet_0 r > l \bullet_0 \phi' \bullet_0 r,$$

- given 1-composable $\lambda, \phi, \rho \in P_2^*$, and $\phi' \in P_2^*$ such that $\phi > \phi'$, we have

$$\lambda \bullet_1 \phi \bullet_1 \rho > \lambda \bullet_1 \phi' \bullet_1 \rho.$$

One has then the following criterion to show the termination of a 3-prepolygraph:

Proposition 4.3.3.2. *Given a 3-prepolygraph P , if there exists a reduction order for P , then P is terminating.*

Proof. The definition of a reduction order implies that, given a rewriting step $\lambda \bullet_1 (l \bullet_0 A \bullet_0 r) \bullet_1 \rho$ with $l, r \in P_1^*$, $\lambda, \rho \in P_2^*$ and $A: \phi \Rightarrow \phi' \in P_3$ suitably composable, we have

$$\lambda \bullet_1 (l \bullet_0 \phi \bullet_0 r) \bullet_1 \rho > \lambda \bullet_1 (l \bullet_0 \phi' \bullet_0 r) \bullet_1 \rho.$$

So, given a sequence of 2-composable rewriting steps $(F_i)_{i \in \mathbb{N}_k}$, where $k \in \mathbb{N} \cup \{\omega\}$ and

$$F_i: \phi_i \Rightarrow \phi_{i+1} \in P_3^*$$

for some $\phi_i \in P_2^*$ for $i \in \mathbb{N}_{k+1}$, we have $\phi_j > \phi_{j+1}$ for $j \in \mathbb{N}_k$. Since $>$ is well-founded, it implies that $k \in \mathbb{N}$. Hence, P is terminating. \square

4.3.3.3 – The case of Gray presentations. In order to build a reduction order for a Gray presentation P , we have to build in particular a reduction order for the subset of P_3 made of interchange generators. We introduce below a sufficient criterion for the existence of such a reduction order. The idea is to consider the lengths of the 1-cells of the whiskers in the decompositions of 2-cells and show that they are decreasing in some way when an interchange generator is applied.

Let $\mathbb{N}^{<\omega}$ be the set of finite sequences of elements of \mathbb{N} . We order $\mathbb{N}^{<\omega}$ by $<_\omega$ where

$$(a_1, \dots, a_k) <_\omega (b_1, \dots, b_l)$$

when $k = l$ and there exists $i \in \mathbb{N}_k^*$ such that $a_j = b_j$ for $j \in \mathbb{N}_{i-1}^*$ and $a_i < b_i$. Note that $<_\omega$ is well-founded. Given a 2-prepolygraph P , there is a function $\text{Int}: P_2^* \rightarrow \mathbb{N}^{<\omega}$ such that, given $\phi \in P_2^*$, decomposed uniquely (using Corollary 4.1.2.5) as

$$\phi = (l_1 \bullet_0 \alpha_1 \bullet_0 r_1) \bullet_1 \cdots \bullet_1 (l_k \bullet_0 \alpha_k \bullet_0 r_k)$$

for some $k \in \mathbb{N}$, $l_i, r_i \in P_1^*$ and $\alpha_i \in P_2$ for $i \in \mathbb{N}_k^*$, $\text{Int}(\phi)$ is defined by

$$\text{Int}(\phi) = (|l_k|, |l_{k-1}|, \dots, |l_1|).$$

Then, Int induces a partial order $<_{\text{int}}$ on P_2^* by putting $\phi <_{\text{int}} \psi$ when $\partial_1^\epsilon(\phi) = \partial_1^\epsilon(\psi)$ for $\epsilon \in \{-, +\}$ and $\text{Int}(\phi) <_\omega \text{Int}(\psi)$ for $\phi, \psi \in P_2^*$.

Given a Gray presentation P , we say that P is *positive* when $|\partial_1^+(\alpha)| > 0$ for all $\alpha \in P_2$. Under positiveness, the order $<_{\text{int}}$ can be considered as a reduction order for the subset of 3-generators of a Gray presentation made of interchangers:

Proposition 4.3.3.4. *Let P be a positive Gray presentation. The partial order $<_{\text{int}}$ has the following properties:*

(i) for every $\alpha, \beta \in P_2$ and $f \in P_1^*$ such that α, f, β are 0-composable,

$$\partial_2^-(X_{\alpha,f,\beta}) >_{\text{int}} \partial_2^+(X_{\alpha,f,\beta}),$$

(ii) for $\phi, \phi' \in P_2^*$ and $l, r \in P_1^*$ such that l, ϕ, r are 0-composable, if $\phi >_{\text{int}} \phi'$, then

$$l \bullet_0 \phi \bullet_0 r >_{\text{int}} l \bullet_0 \phi' \bullet_0 r,$$

(iii) for $\phi, \phi', \lambda, \rho \in P_2^*$ such that λ, ϕ, ρ are 1-composable, if $\phi >_{\text{int}} \phi'$, then

$$\lambda \bullet_1 \phi \bullet_1 \rho >_{\text{int}} \lambda \bullet_1 \phi' \bullet_1 \rho.$$

Proof. Given $\alpha, \beta \in P_2$ and $f \in P_1^*$ with α, f, β are 0-composable, recall that $X_{\alpha,f,\beta}$ is such that

$$X_{\alpha,f,\beta}: (\alpha \bullet_0 f \bullet_0 \partial_1^-(\beta)) \bullet_1 (\partial_1^+(\alpha) \bullet_0 f \bullet_0 \beta) \Rightarrow (\partial_1^-(\alpha) \bullet_0 f \bullet_0 \beta) \bullet_1 (\alpha \bullet_0 f \bullet_0 \partial_1^+(\beta)).$$

Thus, we have

$$\text{Int}(\partial_2^-(X)) = (|\partial_1^+(\alpha)| + |f|, 0) \quad \text{and} \quad \text{Int}(\partial_2^+(X)) = (0, |\partial_1^-(\alpha)| + |f|).$$

Since P is positive, we have $|\partial_1^+(\alpha)| > 0$ so that $\text{Int}(\partial_2^-(X)) >_{\text{int}} \text{Int}(\partial_2^+(X))$. Now, (ii) and (iii) can readily be obtained by considering the whisker representations of ϕ and ϕ' and observing the action of $l \bullet_0 - \bullet_0 r$ and $\lambda \bullet_1 - \bullet_1 \rho$ on these representations and the definition of Int . \square

The positiveness condition is required to prevent 2-cells with “floating components”, since Gray presentations with such 2-cells might not terminate. For example, given a Gray presentation P where P_0 and P_1 have one element and P_2 has two 2-generators \cup and \cap , there are 2-cells of P^* with “floating bubbles” which induce infinite reduction sequence with interchange generators as the following one:

$$\begin{array}{c} \bigcirc \\ \bigcirc \end{array} \Rightarrow \begin{array}{c} \bigcirc \\ \bigcirc \end{array} \bigcirc \Rightarrow \begin{array}{c} \bigcirc \\ \bigcirc \end{array} \bigcirc \Rightarrow \begin{array}{c} \bigcirc \\ \bigcirc \end{array} \bigcirc \Rightarrow \begin{array}{c} \bigcirc \\ \bigcirc \end{array} \Rightarrow \dots$$

4.3.4 Critical branchings

In term rewriting systems, a classical result called the “critical pair lemma” states that local confluence is a consequence of the confluence of a subset of local branchings, called *critical branchings*. The latter can be described as pairs of rewrite rules that are minimally overlapping (see [BN99, Section 6.2] for details). Here, we show a similar result for rewriting on Gray presentations. For this purpose, we first give a definition of critical branchings similar to the one of term rewriting systems, *i.e.*, as minimally overlapping local branchings, where we moreover filter out some branchings that involve interchange generators and that are readily confluent by our definition of Gray presentation. We then use this adapted critical pair lemma to prove coherence results for Gray presentations.

4.3.4.1 – Classification of branchings. Let P be a 3-prepolygraph. Given a local branching

$$(S_1: \phi \Rightarrow \phi_1, S_2: \phi \Rightarrow \phi_2)$$

of P , we say that the branching (S_1, S_2) is

- *trivial* when $S_1 = S_2$,

- *minimal* when for all other local branching (S'_1, S'_2) such that

$$S_i = \lambda \bullet_1 (l \bullet_0 S'_i \bullet_0 r) \bullet_1 \rho$$

for $i \in \{1, 2\}$ for some 1-cells l, r and 2-cells λ, ρ , we have that l, r, λ, ρ are all identities,

- *independent* when

$$S_1 = ((l_1 \bullet_0 A_1 \bullet_0 r_1) \bullet_1 \chi \bullet_1 (l_2 \bullet_0 \phi_2 \bullet_0 r_2)) \quad S_2 = ((l_1 \bullet_0 \phi_1 \bullet_0 r_1) \bullet_1 \chi \bullet_1 (l_2 \bullet_0 A_2 \bullet_0 r_2))$$

for some $l_i, r_i \in P_1^*$ and $A_i: \phi_i \Rightarrow \phi'_i \in P_3$ for $i \in \{1, 2\}$ and $\chi \in P_2^*$.

If moreover $P = Q_{\leq 3}$ where Q is a Gray presentation, we say that the branching (S_1, S_2) is

- *natural* when either

$$S_1 = (A \bullet_0 g \bullet_0 h) \bullet_1 (f' \bullet_0 g \bullet_0 \beta)$$

for some $A: \phi \Rightarrow \phi': f \Rightarrow f' \in P_3, g \in P_1^*$ and $\beta: h \Rightarrow h' \in P_2$, and

$$S_2 = [X_{u,\epsilon}]_{\phi, g \bullet_0 \beta} \quad \text{with} \quad u = l_1 \dots l_{|\phi|-1}$$

or

$$S_1 = (\alpha \bullet_0 g' \bullet_0 h) \bullet_1 (f' \bullet_0 g' \bullet_0 B)$$

for some $\alpha: f \Rightarrow f' \in P_2, g' \in P_1^*$ and $B: \psi \Rightarrow \psi': h \Rightarrow h' \in P_3$, and

$$S_2 = [X_{\epsilon, v}]_{\alpha, g' \bullet_0 \psi} \quad \text{with} \quad v = r_2 \dots r_{|\psi|},$$

- *critical* when it is minimal, and both its symmetrical branching and it are neither trivial nor independent nor natural.

4.3.4.2 – Critical pair lemma. Let Q be a Gray presentation and write (P, Ξ) for the rewriting system $(Q_{\leq 3}, \sim^Q)$. Our next goal is to show an adapted version of the classical critical pair lemma to our context. We start by two technical lemmas:

Lemma 4.3.4.3. *For all local branching (S_1, S_2) of P , there is a minimal branching (S'_1, S'_2) and 1-cells $l, r \in P_1^*$ and 2-cells $\lambda, \rho \in P_2^*$ such that $S_i = \lambda \bullet_1 (l \bullet_0 S'_i \bullet_0 r) \bullet_1 \rho$ for $i \in \{1, 2\}$.*

Proof. We show this by induction on $N(S_1)$ where $N(S_1) = |\partial_2^-(S_1)| + |\partial_1^-(S_1)|$. Suppose that the property is true for all local branchings (S'_1, S'_2) with $N(S'_1) < N(S_1)$. If (S_1, S_2) is not minimal, then there are rewriting steps $S'_1, S'_2 \in P_3, l, r \in P_1^*$ and $\lambda, \rho \in P_2^*$ such that $S_i = \lambda \bullet_1 (l \bullet_0 S'_i \bullet_0 r) \bullet_1 \rho$ for $i \in \{1, 2\}$, such that l, r, λ, ρ are not all identities. Since

$$|\partial_1^-(S_1)| = |l| + |\partial_1^-(S'_1)| + |r| \quad \text{and} \quad |\partial_2^-(S_1)| = |\lambda| + |\partial_2^-(S'_1)| + |\rho|,$$

we have $N(S'_1) < N(S_1)$ so there is a minimal branching (S''_1, S''_2) and $l', r' \in P_1^*, \lambda', \rho' \in P_2^*$ such that $S'_i = \lambda' \bullet_1 (l' \bullet_0 S''_i \bullet_0 r') \bullet_1 \rho'$ for $i \in \{1, 2\}$. By composing with λ, ρ, l, r , we obtain the conclusion of the lemma. \square

Lemma 4.3.4.4. *A local branching of P which is either trivial or independent or natural is confluent.*

Proof. A trivial branching is, of course, confluent. Independent and natural branching are confluent thanks respectively to the independence generators and interchange naturality generators of a Gray presentation. \square

The critical pair lemma adapted to our context is then:

Theorem 4.3.4.5 (Adapted critical pair lemma). *The rewriting system (P, Ξ) is locally confluent if and only if every critical branching is confluent.*

Proof. The first implication is trivial. For the converse, note that, by Lemma 4.3.4.3, in order to check that all local branchings are confluent, it is enough to check that all minimal local branchings are confluent. Among them, by Lemma 4.3.4.4, it is enough to check the confluence of the critical branchings. \square

4.3.4.6 – Coherence results. We now state the main result of this section, namely a coherence theorem for Gray presentations based on the analysis of the critical branchings:

Theorem 4.3.4.7 (Coherence). *Let Q be a Gray presentation and $(P, \Xi) = (Q_{\leq 3}, \sim^Q)$ be the associated rewriting system. If P is terminating and all the critical branchings of (P, Ξ) are confluent, then Q is a coherent Gray presentation.*

Proof. By Theorem 4.3.4.5, the rewriting system (P, Ξ) is locally confluent, and by Theorem 4.3.2.5 it is confluent. Since $\overline{Q} = P^*/\Xi$, it implies that \overline{Q} is a confluent 3-precATEGORY. To conclude, it is sufficient to show that the criterion in the last part of Proposition 4.3.1.4 is satisfied. But the latter is a consequence of Lemma 4.3.2.6. \square

Note that Theorem 4.3.4.7 requires the rewriting system (P, Ξ) to be confluent. If it is not the case, one can still try to apply an analogue of the Knuth-Bendix completion algorithm ([BN99, Section 7], for example) and add 3-generators together with 4-generators to obtain a confluent Gray presentation, and then apply Theorem 4.3.4.7.

Our coherence theorem implies a coherence criterion similar to the ones shown by Squier et al. [SOK94, Theorem 5.2] and Guiraud et al. [GM09, Proposition 4.3.4], which states that adding a tile for each critical branching is enough to ensure coherence:

Theorem 4.3.4.8. *Let Q be a Gray presentation and $(P, \Xi) = (Q_{\leq 3}, \sim^Q)$ be the associated rewriting system. Suppose that, for every critical branching $(S_1: \phi \Rightarrow \phi_1, S_2: \phi \Rightarrow \phi_2)$ of (P, Ξ) , there exist cells $\psi \in P_2^*$ and $F_i: \phi_i \Rightarrow \psi \in P_3^*$ for $i \in \{1, 2\}$, and a 4-generator $G: S_1 \bullet_2 F_1 \Rightarrow S_2 \bullet_2 F_2 \in Q_4$. Then, Q is a coherent Gray presentation.*

Proof. The definition of Q_4 ensures that all the critical branchings are confluent, so that Theorem 4.3.4.7 applies. \square

Remark 4.3.4.9. In fact, for the conclusion of Theorem 4.3.4.8 to hold, for every critical branching (S_1, S_2) of (P, Ξ) , it is enough to have a 4-generator G as in the statement for either (S_1, S_2) or the symmetrical critical branching (S_2, S_1) , so that a stronger statement holds.

4.3.5 Finiteness of critical branchings

In this section, we prove that Gray presentations, under some reasonable conditions, have a finite number of critical branchings (Theorem 4.3.5.8). This property contrasts with the case of strict categories, where finite presentations can have an infinite number of critical branchings [Laf03; GM09]. Our proof is moreover constructive, so that one can derive an algorithm to compute the critical branchings of such Gray presentations.

4.3.5.1 – Interchange-interchange branchings. First, we aim at showing that there is no critical branching (S_1, S_2) of a Gray presentation P where both inner 3-generators of S_1 and S_2 are interchange generators. We begin with a technical lemma for minimal and independent branchings:

Lemma 4.3.5.2. *Given a minimal local branching (S_1, S_2) of a Gray presentation P , with*

$$S_i = \lambda_i \bullet_1 (l_i \bullet_0 A_i \bullet_0 r_i) \bullet_1 \rho_i$$

and $l_i, r_i \in P_1^*$, $\lambda_i, \rho_i \in P_2^*$, $A_i \in P_3$ for $i \in \{1, 2\}$, the following hold:

- (i) either λ_1 or λ_2 is an identity,
- (ii) either ρ_1 or ρ_2 is an identity,
- (iii) (S_1, S_2) is independent if and only if

$$|\partial_2^-(A_1)| + |\partial_2^-(A_2)| \leq |\partial_2^-(S_1)| \quad \text{and} \quad |\lambda_1||\rho_1| = |\lambda_2||\rho_2| = 0.$$

If (S_1, S_2) is moreover not independent:

- (iv) either l_1 or l_2 is an identity,
- (v) either r_1 or r_2 is an identity.

Proof. Suppose that neither λ_1 nor λ_2 are identities. Then, since

$$\lambda_1 \bullet_1 (l_1 \bullet_0 \partial_2^-(A_1) \bullet_0 r_1) \bullet_1 \rho_1 = \lambda_2 \bullet_1 (l_2 \bullet_0 \partial_2^-(A_2) \bullet_0 r_2) \bullet_1 \rho_2,$$

we have $\lambda_i = w \bullet_1 \lambda'_i$ for some $w \in P_2^*$ and $\lambda'_i \in P_2^*$ for $i \in \{1, 2\}$, such that $|w| \geq 1$, contradicting the minimality of (S_1, S_2) . So either λ_1 or λ_2 is an identity and similarly for ρ_1 and ρ_2 , which concludes (i) and (ii).

By the definition of independent branching, the first implication of (iii) is trivial. For the converse, suppose that (S_1, S_2) is such that

$$|\partial_2^-(A_1)| + |\partial_2^-(A_2)| \leq |\partial_2^-(S_1)| \quad \text{and} \quad |\lambda_1||\rho_1| = |\lambda_2||\rho_2| = 0.$$

We can suppose by symmetry that λ_1 is a unit. Since $|\partial_2^-(S_1)| = |\lambda_1| + |\partial_2^-(A_1)| + |\rho_1|$, we have that $|\partial_2^-(A_2)| \leq |\rho_1|$. If $|\rho_1| = 0$, then

$$S_1 = l_1 \bullet_0 A_1 \bullet_0 r_1 \quad \text{and} \quad |\partial_2^-(A_2)| = 0,$$

thus, since $|\lambda_2||\rho_2| = 0$, we have

$$\text{either } S_2 = \partial_2^-(S_1) \bullet_1 (l_2 \bullet_2 A_2 \bullet_2 r_2) \quad \text{or} \quad S_2 = (l_2 \bullet_2 A_2 \bullet_2 r_2) \bullet_1 \partial_2^-(S_1).$$

In both cases, (S_1, S_2) is independent. Otherwise, $|\rho_1| > 0$ and, by (ii), we have $|\rho_2| = 0$ so that

$$S_1 = (l_1 \bullet_0 A_1 \bullet_0 r_1) \bullet_1 \rho_1 \quad \text{and} \quad S_2 = \lambda_2 \bullet_1 (l_2 \bullet_0 A_2 \bullet_0 r_2).$$

Since $|\partial_2^-(A_2)| \leq |\rho_1|$, we have

$$\rho_1 = \chi \bullet_1 (l_2 \bullet_0 \partial_2^-(A_2) \bullet_0 r_2)$$

for some $\chi \in P_2^*$ and, since $\partial_2^-(S_1) = \partial_2^-(S_2)$, we get

$$(l_1 \bullet_0 \partial_2^-(A_1) \bullet_0 r_1) \bullet_1 \chi \bullet_1 (l_2 \bullet_0 \partial_2^-(A_2) \bullet_0 r_2) = \lambda_2 \bullet_1 (l_2 \bullet_0 \partial_2^-(A_2) \bullet_0 r_2).$$

So $\lambda_2 = (l_1 \bullet_0 \partial_2^-(A_1) \bullet_0 r_1) \bullet_1 \chi$ and hence (S_1, S_2) is an independent branching, which concludes the proof of (iii).

Finally, suppose that (S_1, S_2) is not independent. By (iii), it implies that

$$\text{either } |\partial_2^-(A_1)| + |\partial_2^-(A_2)| > |\partial_2^-(S_1)| \quad \text{or} \quad |\lambda_1||\rho_1| > 0 \quad \text{or} \quad |\lambda_2||\rho_2| > 0.$$

If $|\lambda_1||\rho_1| > 0$, then $|\lambda_2| = |\rho_2| = 0$ by (i) and (ii), so that

$$\lambda_1 \bullet_1 (l_1 \bullet_0 A_1 \bullet_0 r_1) \bullet_1 \rho_1 = l_2 \bullet_0 A_2 \bullet_0 r_2$$

thus there exists $\lambda'_1, \rho'_1 \in P_2^*$ such that

$$\lambda_1 = l_2 \bullet_0 \lambda'_1 \bullet_0 r_2 \quad \text{and} \quad \rho_1 = l_2 \bullet_0 \rho'_1 \bullet_0 r_2,$$

and we have

$$l_2 \bullet_0 \partial_1^+(\lambda'_1) \bullet_0 r_2 = \partial_1^+(\lambda_1) = l_1 \bullet_0 \partial_1^-(A_1) \bullet_0 r_1.$$

Thus, l_1 and l_2 have the same prefix l of size $k = \min(|l_1|, |l_2|)$ and we can write

$$S_1 = l \bullet_0 S'_1 \qquad S_2 = l \bullet_0 S'_2$$

for some rewriting steps $S_1, S_2 \in P_3^*$. Since (S_1, S_2) is minimal, we have $k = 0$, so $|l_1||l_2| = 0$. We show similarly that $|r_1||r_2| = 0$. The case where $|\lambda_2||\rho_2| > 0$ is handled similarly. So suppose that

$$|\lambda_1||\rho_1| = 0 \quad \text{and} \quad |\lambda_2||\rho_2| = 0 \quad \text{and} \quad |\partial_1^-(A_1)| + |\partial_1^-(A_2)| > |\partial_2^-(S_1)|. \quad (4.13)$$

In particular, we get that $|\partial_2^-(A_i)| > 0$ for $i \in \{1, 2\}$. Let $u_i, v_i \in P_1^*$ and $\alpha_i \in P_2$ for $i \in \mathbb{N}_r^*$ with $r = |\partial_2^-(S_1)|$ such that

$$\partial_2^-(S_1) = (u_1 \bullet_0 \alpha_1 \bullet_0 v_1) \bullet_1 \cdots \bullet_1 (u_r \bullet_0 \alpha_r \bullet_0 v_r).$$

The condition last part of (4.13) implies that there is $i_0 \in \{1, 2\}$ such that l_1 and l_2 are both prefix of u_{i_0} . So, l_1 and l_2 have the same prefix l of length $k = \min(|l_1|, |l_2|)$.

We now prove that $\lambda_1 = l \bullet_0 \lambda'_1$ for some $\lambda'_1 \in P_2^*$. If $|\lambda_1| = 0$, then

$$\lambda_1 = l_1 \bullet_0 \partial_1^-(S_1) \bullet_0 r_1,$$

so $\lambda = l \bullet_0 \lambda'_1$ for some $\lambda'_1 \in P_2^*$. Otherwise, if $|\lambda_1| > 0$, since $|\lambda_1||\rho_1| = 0$, we have $|\rho_1| = 0$ and, by (i), $|\lambda_2| = 0$. Also, by the last part of (4.13), we have $|\lambda_1| < |\partial_2^-(A_2)|$. Thus,

$$\lambda_1 \text{ is a prefix of } l_2 \bullet_0 \partial_2^-(A_2) \bullet_0 r_2,$$

so $\lambda_1 = l \bullet_0 \lambda'_1$ for some $\lambda_1 \in P_2^*$. Similarly, there are $\rho'_1, \lambda'_2, \rho'_2 \in P_2^*$ such that

$$\rho_1 = l \bullet_0 \rho'_1 \quad \text{and} \quad \lambda_2 = l \bullet_0 \lambda'_2 \quad \text{and} \quad \rho_2 = l \bullet_0 \rho'_2.$$

Hence $S_1 = l \bullet_0 S'_1$ and $S_2 = l \bullet_0 S'_2$ for some rewriting steps $S'_1, S'_2 \in P_3^*$. Since (S_1, S_2) is minimal, we have $|l_1||l_2| = |l| = 0$, which proves (iv). The proof of (v) is similar. \square

We now have enough material to show that:

Proposition 4.3.5.3. *Given a Gray presentation P , there are no critical branching (S_1, S_2) of P such that both the inner 3-generators of S_1 and S_2 are interchange generators.*

Proof. Let (S_1, S_2) be a local minimal branching such that, for $i \in \{1, 2\}$,

$$S_i = \lambda_i \bullet_1 (l_i \bullet_0 X_{\alpha_i, g_i, \beta_i} \bullet_0 r_i) \bullet_1 \rho_i$$

for some $l_i, r_i, g_i \in P_1^*$, $\lambda_i, \rho_i \in P_2^*$ and $\alpha_i, \beta_i \in P_2$, and let ϕ be $\partial_2^-(S_1)$. Since $|\partial_2^-(X_{\alpha_1, g_1, \beta_1})| = 2$, we have $|\phi| \geq 2$.

If $|\phi| = 2$, then $|\lambda_i| = |\rho_i| = 0$ for $i \in \{1, 2\}$. Thus, since $\partial_2^-(S_1) = \partial_2^-(S_2)$, we get

$$\begin{aligned} & (l_1 \bullet_0 \alpha_1 \bullet_0 g_1 \bullet_0 \partial_1^-(\beta_1) \bullet_0 r_1) \bullet_1 (l_1 \bullet_0 \partial_1^+(\alpha_1) \bullet_0 g_1 \bullet_0 \beta_1 \bullet_0 r_1) \\ &= (l_2 \bullet_0 \alpha_2 \bullet_0 g_2 \bullet_0 \partial_1^-(\beta_2) \bullet_0 r_2) \bullet_1 (l_2 \bullet_0 \partial_1^+(\alpha_2) \bullet_0 g_2 \bullet_0 \beta_2 \bullet_0 r_2). \end{aligned}$$

By the unique decomposition property given by Theorem 4.1.2.4 and corollary 4.1.2.5, we obtain

$$l_1 = l_2, \quad r_1 = r_2, \quad \alpha_1 = \alpha_2, \quad \beta_1 = \beta_2 \quad \text{and} \quad g_1 \bullet_0 \partial_1^-(\beta_1) \bullet_0 r_1 = g_2 \bullet_0 \partial_1^-(\beta_2) \bullet_0 r_2.$$

So $g_1 \bullet_0 \partial_1^-(\beta_1) \bullet_0 r_1 = g_2 \bullet_0 \partial_1^-(\beta_1) \bullet_0 r_1$, which implies that $g_1 = g_2$. Hence, (S_1, S_2) is trivial.

If $|\phi| = 3$, then $|\lambda_i| + |\rho_i| = 1$ for $i \in \{1, 2\}$, and, by Lemma 4.3.5.2,

$$\text{either } |\rho_1| = |\lambda_2| = 1 \quad \text{or} \quad |\lambda_1| = |\rho_2| = 1.$$

By symmetry, we can suppose that $|\rho_1| = |\lambda_2| = 1$, which implies that $|\lambda_1| = |\rho_2| = 0$. By unique decomposition of whiskers (Corollary 4.1.2.5), since $\partial_2^-(S_1) = \partial_2^-(S_2)$, we have

$$\begin{aligned} l_1 \bullet_0 \alpha_1 \bullet_0 g_1 \bullet_0 \partial_1^-(\beta_1) \bullet_0 r_1 &= \lambda_2 \\ l_1 \bullet_0 \partial_1^+(\alpha_1) \bullet_0 g_1 \bullet_0 \beta_1 \bullet_0 r_1 &= l_2 \bullet_0 \alpha_2 \bullet_0 g_2 \bullet_0 \partial_1^-(\beta_2) \bullet_0 r_2 \\ \rho_1 &= l_2 \bullet_0 \partial_1^+(\alpha_2) \bullet_0 g_2 \bullet_0 \beta_2 \bullet_0 r_2 \end{aligned}$$

and the second line implies that $l_1 \bullet_0 \partial_1^+(\alpha_1) \bullet_0 g_1 = l_2 \bullet_0 \beta_1 = \alpha_2$ and $r_1 = g_2 \bullet_0 \partial_1^-(\beta_2) \bullet_0 r_2$. Since (S_1, S_2) is minimal, we have $|l_1| = |r_2| = 0$. So

$$\begin{aligned} S_1 &= (X_{\alpha_1, g_1, \beta_1} \bullet_0 g_2 \bullet_0 \partial_1^-(\beta_2)) \bullet_1 (\partial_1^+(X_{\alpha_1, g_1, \beta_1}) \bullet_0 g_2 \bullet_0 \beta_2) \\ S_2 &= (\alpha_1 \bullet_0 g_1 \bullet_0 \partial_1^-(\beta_1) \bullet_0 g_2 \bullet_0 \partial_1^-(\beta_2)) \bullet_1 (\partial_1^+(\alpha_1) \bullet_0 g_1 \bullet_0 X_{\beta_1, g_2, \beta_2}) \end{aligned}$$

thus (S_1, S_2) is a natural branching, hence not a critical one.

Finally, if $|\phi| \geq 4$, then, since $|\lambda_i| + |\rho_i| = |\phi| - 2 \geq 2$ for $i \in \{1, 2\}$, by Lemma 4.3.5.2, we have that

$$\text{either } |\lambda_1| = |\rho_2| = |\phi| - 2 \quad \text{or} \quad |\rho_1| = |\lambda_2| = |\phi| - 2.$$

In either case,

$$|\lambda_1| |\rho_1| = |\lambda_2| |\rho_2| = 0 \quad \text{and} \quad |\partial_2^-(X_{\alpha_1, g_1, \beta_1})| + |\partial_2^-(X_{\alpha_2, g_2, \beta_2})| = 4 \leq |\phi|$$

so, by Lemma 4.3.5.2(iii), (S_1, S_2) is independent, hence not critical. \square

4.3.5.4 – Other branchings. We now consider the branchings where not both inner generators are interchange generators. The number of critical branchings among them will be finite given some conditions on the Gray presentation. In the following, we denote by P a Gray presentation such that P_2 and P_3 are finite sets and $|\partial_2^-(A)| > 0$ for every $A \in P_3$. The first result we prove is a characterization of independent branchings among minimal ones:

Lemma 4.3.5.5. *Given a minimal branching (S_1, S_2) of P with*

$$S_i = \lambda_i \bullet_1 (l_i \bullet_0 A_i \bullet_0 r_i) \bullet_1 \rho_i$$

for some $l_i, r_i \in P_1^*$, $\lambda_i, \rho_i \in P_2^*$ and $A_i \in P_3$ for $i \in \{1, 2\}$, we have that (S_1, S_2) is independent if and only if

$$\begin{aligned} & \text{either } |\lambda_1| \geq |\partial_2^-(A_2)| \quad \text{or} \quad |\rho_1| \geq |\partial_2^-(A_2)| \\ & (\text{resp. either } |\lambda_2| \geq |\partial_2^-(A_1)| \quad \text{or} \quad |\rho_2| \geq |\partial_2^-(A_1)|). \end{aligned}$$

Proof. If (S_1, S_2) is independent, then, by Lemma 4.3.5.2(iii),

$$|\partial_2^-(A_1)| + |\partial_2^-(A_2)| \leq |\lambda_1| + |\partial_2^-(A_1)| + |\rho_1| = |\lambda_2| + |\partial_2^-(A_2)| + |\rho_2|,$$

that is,

$$|\partial_2^-(A_1)| \leq |\lambda_2| + |\rho_2| \quad \text{and} \quad |\partial_2^-(A_2)| \leq |\lambda_1| + |\rho_1|.$$

By hypothesis, we have $|\partial_2^-(A_1)| > 0$, so that $|\lambda_2| + |\rho_2| > 0$. If $|\lambda_2| > 0$, then, by Lemma 4.3.5.2(i), we have $|\lambda_1| = 0$ so that $|\partial_2^-(A_2)| \leq |\rho_1|$. Similarly, if $|\rho_2| > 0$, then $|\partial_2^-(A_2)| \leq |\lambda_1|$, which proves the first implication.

Conversely, if $|\lambda_1| \geq |\partial_2^-(A_2)|$, then, since $|\partial_2^-(A_2)| > 0$ by our hypothesis on P , we have $|\lambda_1| > 0$. By Lemma 4.3.5.2(i), we get that $|\lambda_2| = 0$. Also,

$$|\lambda_1| + |\partial_2^-(A_1)| + |\rho_1| = |\partial_2^-(A_2)| + |\rho_2| \leq |\lambda_1| + |\rho_2|,$$

so $|\rho_2| \geq |\partial_2^-(A_1)| + |\rho_1|$, thus $|\rho_1| < |\rho_2|$. By Lemma 4.3.5.2(ii), we have $|\rho_1| = 0$. Moreover,

$$|\partial_2^-(A_1)| + |\partial_2^-(A_2)| \leq |\partial_2^-(A_1)| + |\lambda_1| = |\partial_2^-(S_1)|$$

hence, by Lemma 4.3.5.2(iii), (S_1, S_2) is independent. \square

Then, we prove that minimal non-independent branchings are uniquely characterized by a small amount of information:

Lemma 4.3.5.6. *Given a minimal non-independent branching (S_1, S_2) of P with*

$$S_i = \lambda_i \bullet_1 (l_i \bullet_0 A_i \bullet_0 r_i) \bullet_1 \rho_i$$

for some $l_i, r_i \in P_1^*$, $\lambda_i, \rho_i \in P_2^*$ and $A_i \in P_3$ for $i \in \{1, 2\}$, we have that (S_1, S_2) is uniquely determined by $A_1, A_2, |\lambda_1|$ and $|\lambda_2|$.

Proof. By Corollary 4.1.2.5, let $k_1, k_2 \in \mathbb{N}^*$, $u_i, u'_i, v_i, v'_i \in P_1^*$ and $\alpha_i, \beta_i \in P_2$ be unique such that

$$\partial_2^-(A_1) = (u_1 \bullet_0 \alpha_1 \bullet_0 u'_1) \bullet_1 \cdots \bullet_1 (u_{k_1} \bullet_0 \alpha_{k_1} \bullet_0 u'_{k_1})$$

and

$$\partial_2^-(A_2) = (v_1 \bullet_0 \beta_1 \bullet_0 v'_1) \bullet_1 \cdots \bullet_1 (v_{k_2} \bullet_0 \beta_{k_2} \bullet_0 v'_{k_2}).$$

Let $i_1 = 1 + |\lambda_1|$ and $i_2 = 1 + |\lambda_2|$. Since

$$\lambda_1 \bullet_1 (l_1 \bullet_0 \partial_2^-(A_1) \bullet_0 r_1) \bullet_1 \rho_1 = \lambda_2 \bullet_1 (l_2 \bullet_0 \partial_2^-(A_2) \bullet_0 r_2) \bullet_1 \rho_2, \quad (4.14)$$

and, by Lemma 4.3.5.5, $|\lambda_1| < |\partial_2^-(A_2)|$ and $|\lambda_2| < |\partial_2^-(A_1)|$, we get

$$l_1 \bullet_0 u_{i_2} \bullet_0 \alpha_{i_2} \bullet_0 u'_{i_2} \bullet_0 r_1 = l_2 \bullet_0 v_{i_1} \bullet_0 \beta_{i_1} \bullet_0 v'_{i_1} \bullet_0 r_2$$

so that

$$l_1 \bullet_0 u_{i_2} = l_2 \bullet_0 v_{i_1} \quad \text{and} \quad u'_{i_2} \bullet_0 r_1 = v'_{i_1} \bullet_0 r_2.$$

By Lemma 4.3.5.2(iv), either l_1 or l_2 is an identity. Thus, if $|u_{i_2}| \leq |v_{i_1}|$, then $|l_1| \geq |l_2|$ so l_2 is a unit and l_1 is the prefix of u_{i_2} of size $|u_{i_2}| - |v_{i_1}|$. Otherwise, if $|u_{i_2}| > |v_{i_1}|$, we obtain similarly that l_1 is the prefix of v_{i_1} of size $|v_{i_1}| - |u_{i_2}|$ and l_2 is a unit. In both cases, l_1 and l_2 are completely determined by $A_1, A_2, |\lambda_1|$ and $|\lambda_2|$. A similar argument holds for r_1 and r_2 .

Now, if $|\lambda_1| > 0$, by Lemma 4.3.5.2(i), $|\lambda_2| = 0$. By (4.14) and since $|\lambda_1| < |\partial_2^-(A_2)|$, λ_1 is the prefix of $l_2 \bullet_0 \partial_2^-(A_2) \bullet_0 r_2$ of length $|\lambda_1|$. Otherwise, if $|\lambda_1| = 0$, then $\lambda_1 = \text{id}_{l_1 \bullet_0 \partial_1^-(A_1) \bullet_0 r_1}$. In both cases, λ_1 is completely determined by $A_1, A_2, |\lambda_1|$. A similar argument holds for λ_2 . Note that, if we prove that $|\rho_1|$ and $|\rho_2|$ are completely determined by $A_1, A_2, |\lambda_1|$ and $|\lambda_2|$, the above argument also applies to ρ_1 and ρ_2 and the lemma is proved. But

$$|\lambda_1| + |\partial_2^-(A_1)| + |\rho_1| = |\lambda_2| + |\partial_2^-(A_2)| + |\rho_2|,$$

so that if $|\lambda_1| + |\partial_2^-(A_1)| \geq |\lambda_2| + |\partial_2^-(A_2)|$, then, by Lemma 4.3.5.2(ii), $|\rho_1| = 0$ and

$$|\rho_2| = |\lambda_1| + |\partial_2^-(A_1)| - |\lambda_2| - |\partial_2^-(A_2)|.$$

Otherwise, if $|\lambda_1| + |\partial_2^-(A_1)| \leq |\lambda_2| + |\partial_2^-(A_2)|$, we get similarly that

$$|\rho_1| = |\lambda_2| + |\partial_2^-(A_2)| - |\lambda_1| - |\partial_2^-(A_1)|$$

and $|\rho_2| = 0$. In both cases, $|\rho_1|$ and $|\rho_2|$ are completely determined by $A_1, A_2, |\lambda_1|$ and $|\lambda_2|$, which concludes the proof. \square

Given $A \in P_3$, we say that $A \in P_3$ is an *operational generator* if it is not an interchange generator. We now prove that an operational generator can form a critical branching with a finite number of interchange generators:

Lemma 4.3.5.7. *Given an operational generator $A_1 \in P_3$, there are a finite number interchange generators $A_2 \in P_3$ such that there is a critical branching (S_1, S_2) of P with*

$$S_i = \lambda_i \bullet_1 (l_i \bullet_0 A_i \bullet_0 r_i) \bullet_1 \rho_i$$

for some $l_i, r_i \in P_1^*$ and $\lambda_i, \rho_i \in P_2^*$ for $i \in \{1, 2\}$.

Proof. Let $\alpha, \beta \in P_2$, $u \in P_1^*$, $A_2 = X_{\alpha, u, \beta}$, $l_i, r_i \in P_1^*$, $\lambda_i, \rho_i \in P_2^*$ for $i \in \{1, 2\}$, so that (S_1, S_2) is a critical branching of P with

$$S_i = \lambda_i \bullet_1 (l_i \bullet_0 A_i \bullet_0 r_i) \bullet_1 \rho_i$$

for $i \in \{1, 2\}$. By Corollary 4.1.2.5, let $k \in \mathbb{N}$ with $k \geq 2$, $v_i, v'_i \in P_1^*$, $\gamma_i \in P_2$ for $i \in \mathbb{N}_k^*$ be unique such that

$$\partial_2^-(A_1) = (v_1 \bullet_0 \gamma_1 \bullet_0 v'_1) \bullet_1 \cdots \bullet_1 (v_k \bullet_0 \gamma_k \bullet_0 v'_k).$$

By Lemma 4.3.5.5, since (S_1, S_2) is non-independent,

$$2 = |\partial_2^-(X_{\alpha,u,\beta})| > \max(|\lambda_1|, |\rho_1|).$$

Note that we can not have $|\lambda_1| = |\rho_1| = 1$. Indeed, otherwise, by Lemma 4.3.5.2, we would have $|\lambda_2| = |\rho_2| = 0$, so that

$$2 = |\partial_2^-(X_{\alpha,u,\beta})| = |\lambda_1| + |\partial_2^-(A_1)| + |\rho_1|$$

and thus $|\partial_2^-(A_1)| = 0$, contradicting our hypothesis on the 3-generators of P . That leaves three cases to handle.

Suppose first that $|\lambda_1| = |\rho_1| = 0$. Then,

$$l_1 \bullet_0 \partial_2^-(A_1) \bullet_0 r_1 = \lambda_2 \bullet_0 (l_2 \bullet_0 \partial_2^-(X_{\alpha,u,\beta}) \bullet_0 r_2) \bullet_1 \rho_2.$$

Thus,

$$\begin{aligned} l_1 \bullet_0 v_{1+|\lambda_2|} \bullet_0 \gamma_{1+|\lambda_2|} \bullet_0 v'_{1+|\lambda_2|} \bullet_0 r_1 &= l_2 \bullet_0 \alpha \bullet_0 u \bullet_0 \partial_1^-(\beta) \bullet_0 r_2 \\ l_1 \bullet_0 v_{2+|\lambda_2|} \bullet_0 \gamma_{2+|\lambda_2|} \bullet_0 v'_{2+|\lambda_2|} \bullet_0 r_1 &= l_2 \bullet_0 \partial_1^+(\alpha) \bullet_0 u \bullet_0 \beta \bullet_0 r_2 \end{aligned}$$

so

$$\gamma_{1+|\lambda_2|} = \alpha, \gamma_{2+|\lambda_2|} = \beta, l_2 = l_1 \bullet_0 v_{1+|\lambda_2|}, r_2 = v'_{2+|\lambda_2|} \bullet_0 r_1$$

and u is the suffix of $l_1 \bullet_0 v_{2+|\lambda_2|}$ of length $|l_1 \bullet_0 v_{2+|\lambda_2|}| - |l_2 \bullet_0 \partial_1^+(\alpha)|$. In particular, $X_{\alpha,u,\beta}$ is completely determined by A_1 and $|\lambda_2|$. And since

$$|\lambda_2| = |\partial_2^-(A_1)| - |\partial_2^-(X_{\alpha,u,\beta})| - |\rho_2| \in \{0, \dots, |\partial_2^-(A_1)| - 2\},$$

there is a finite number of possible $X_{\alpha,u,\beta}$ which induce a critical branching (S_1, S_2) .

Suppose now that $|\lambda_1| = 1$ and $|\rho_1| = 0$. Then, by Lemma 4.3.5.2, $|\lambda_2| = 0$. So

$$\lambda_1 = l_2 \bullet_0 \alpha \bullet_0 u \bullet_0 \partial_1^-(\beta) \bullet_0 r_2$$

and

$$l_1 \bullet_0 v_1 \bullet_0 \gamma_1 \bullet_0 v'_1 \bullet_0 r_1 = l_2 \bullet_0 \partial_1^+(\alpha) \bullet_0 u \bullet_0 \beta \bullet_0 r_2.$$

In particular, we have $\beta = \gamma_1$ and $r_2 = v'_1 \bullet_0 r_1$, so $|r_1| \leq |r_2|$. By Lemma 4.3.5.2(v), we have $|r_1| = 0$ and $r_2 = v'_1$. Note that we have $|u| < |v_1|$. Indeed, otherwise $u = u' \bullet_0 v_1$ for some u' and, since

$$|l_1| + |v_1| = |l_2| + |\partial_1^+(\alpha)| + |u|,$$

we get that $|l_2| \leq |l_1|$. By Lemma 4.3.5.2(iv), it implies that $|l_2| = 0$ and $l_1 = \partial_1^+(\alpha) \bullet_0 u'$, which gives

$$S_1 = (\alpha \bullet_0 u' \bullet_0 \partial_1^-(A_1)) \bullet_1 (\partial_1^+(\alpha) \bullet_0 u' \bullet_0 A_1)$$

and

$$S_2 = (X_{\alpha,u',v_1,\gamma_1} \bullet_0 v'_1) \bullet_0 ((\partial_1^+(\alpha) \bullet_0 u') \bullet_0 ((v_2 \bullet_0 \gamma_2 \bullet_0 v'_2) \bullet_1 \cdots \bullet_1 (v_k \bullet_0 \gamma_k \bullet_0 v'_k)))$$

so that (S_1, S_2) is a natural branching, contradicting the fact that (S_1, S_2) is a critical branching. Hence, $|u| < |v_1|$ and u is a strict suffix of v_1 , thus there are $|v_1|$ such possible u . Moreover, since P_2 is finite, there are a finite number of possible $\alpha \in P_2$. Thus, there are a finite number of possible $X_{\alpha,u,\beta} \in P_2$ that induces a critical branching (S_1, S_2) such that $|\lambda_1| = 1$ and $|\rho_1| = 0$. The case where $|\lambda_1| = 0$ and $|\rho_1| = 1$ is similarly handled, which concludes the proof. \square

With the above results, we can conclude the following finiteness property for critical branchings of Gray presentations:

Theorem 4.3.5.8. *Given a Gray presentation P where P_2 and P_3 are finite and $|\partial_2^-(A)| > 0$ for every $A \in P_3$, there is a finite number of critical branchings of P .*

Proof. Let $S_i = \lambda_i \bullet_1 (l_i \bullet_0 A_i \bullet_0 r_i) \bullet_1 \rho_i$ with $l_i, r_i \in P_1^*$, $\lambda_i, \rho_i \in P_2^*$ and $A_i \in P_3$ for $i \in \{1, 2\}$ such that (S_1, S_2) is a critical branching of P . By Lemma 4.3.5.6, such a branching is uniquely determined by $A_1, A_2, |\lambda_1|$ and $|\lambda_2|$. By Lemma 4.3.5.5,

$$|\lambda_1| < |\partial_2^-(A_2)| \quad \text{and} \quad |\lambda_2| < |\partial_2^-(A_1)|.$$

Hence, for a given pair (A_1, A_2) , there are a finite number of tuples $(l_1, l_2, r_1, r_2, \lambda_1, \lambda_2, \rho_1, \rho_2)$ such that (S_1, S_2) is a critical branching. Moreover, by Proposition 4.3.5.3, either A_1 or A_2 is an operational generator. By symmetry, we can suppose that A_1 is operational. Since P_3 is finite, there is a finite number of such A_1 . Moreover, there are a finite number of pairs (A_1, A_2) where A_2 is operational too. If A_2 is an interchange generator, then, by Lemma 4.3.5.7, there are a finite number of possible A_2 for a given A_1 such that (S_1, S_2) is a critical branching, which concludes the finiteness analysis. \square

Remark 4.3.5.9. The proof of Theorem 4.3.5.8 happens to be constructive, so that we can extract an algorithm to compute the critical branchings for such Gray presentations. An implementation of this algorithm was used to compute the critical branchings of the examples of the next section.

4.4 Applications

We now illustrate the techniques of the previous section and show the coherence of Gray presentations related to several well-known algebraic structures. For each structure, we introduce a Gray presentation and study the confluence of the critical branchings of the associated rewriting system. Then, when the rewriting system is terminating, we can directly apply Theorem 4.3.4.8 to deduce the coherence of the presentation. This will be the case for pseudomonoids (Section 4.4.1), pseudoadjunctions (Section 4.4.2) and Frobenius pseudomonoids (Section 4.4.3) even though, in the latter example, the termination of the rewriting system is assumed. We moreover study the example of self-dualities, where the associated rewriting system is not terminating, for which we use specific techniques in order to prove a weak coherence result.

4.4.1 Pseudomonoids

In Example 4.2.3.3, we introduced a Gray presentation P for the theory of pseudomonoids. The set P_4 of 4-generators contains only the required ones in a Gray presentation, so that we do not expect P to be coherent. Below, we compute the critical branchings of the associated rewriting system and show that the latter is terminating. Thus, by Theorem 4.3.4.8, adding a 4-generator corresponding to each critical branching will turn the presentation into a coherent one. Our method thus allows recovering a coherent definition for pseudomonoids in Gray categories, even though in a less compact form than the existing ones [SD97; Mar97; Lac00].

4.4.1.1 – Critical branchings. The critical branching of P can be computed by following the proof of Theorem 4.3.5.8, which is constructive. We obtain, up to symmetrical branchings, five

critical branchings:

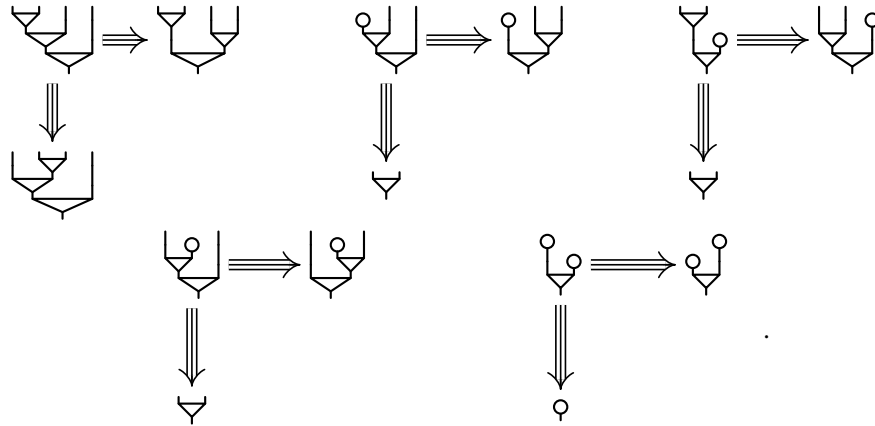

We observe that each of these branchings is joinable, and we define five formal new 4-generators that fill the holes:

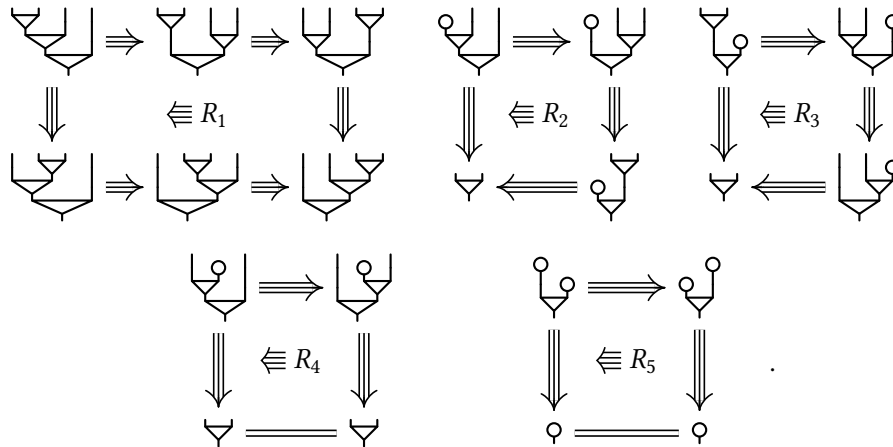

We then define $\mathbb{P}\text{Mon}$ as the Gray presentation obtained from \mathbb{P} defined in Example 4.2.3.3 by adding the 4-generators R_1, \dots, R_5 to \mathbb{P}_4 .

4.4.1.2 – Termination. In order to use our coherence criterion on $\mathbb{P}\text{Mon}$, we need to show the termination of the associated rewriting system. For this purpose, we use the tools of Section 4.3 and build a reduction order. We first define an order that handles the termination of the L, R, A generators, and then combine it with the order from Paragraph 4.3.3.3 to obtain a reduction order. For the first task, we use a similar technique than the one used in [Laf92]. Given $n \in \mathbb{N}$, we write $<_{\exists}$ for the partial order on \mathbb{N}^n such that, given $x, y \in \mathbb{N}^n$, $x <_{\exists} y$ when $x_i \leq y_i$ for all $i \in \mathbb{N}_n^*$ and there exists $j \in \mathbb{N}_n^*$ such that $x_j < y_j$. Let $\mathbb{N}\text{-Fun}$ be the 2-precateory

- which has only one 0-cell, denoted $*$,
- whose 1-cells $* \rightarrow *$ are the natural numbers $n \in \mathbb{N}$,
- whose 2-cells $m \Rightarrow n$ for $m, n \in \mathbb{N}$ are the strictly monotone functions

$$\phi: (\mathbb{N}^m, <_{\exists}) \rightarrow (\mathbb{N}^n, <_{\exists}),$$

and whose structural operations are such that

- $\text{id}_*^1 = 0$,
- composition of 1-cells is given by addition,
- given $m \in \mathbb{N}\text{-Fun}_1$, id_m^2 is the identity function on \mathbb{N}^m ,
- given $m, n, k, k' \in \mathbb{N}$ and $\chi: k \rightarrow k' \in \mathbb{N}\text{-Fun}_2$, the 2-cell

$$m \bullet_0 \chi \bullet_0 n: m + k + n \Rightarrow m + k' + n$$

is the function $\chi': \mathbb{N}^{m+k+n} \rightarrow \mathbb{N}^{m+k'+n}$ such that, for $x \in \mathbb{N}^{m+k+n}$ and $i \in \mathbb{N}_{m+k'+n}^*$,

$$\chi'(x)_i = \begin{cases} x_i & \text{if } i \leq m, \\ \chi(x_{m+1}, \dots, x_{m+k})_{i-m} & \text{if } m < i \leq m + k', \\ x_{i-k'+k} & \text{if } i > m + k', \end{cases}$$

- given $m, n, p \in \mathbb{N}$, and 2-cells $\phi: m \Rightarrow n$ and $\psi: n \Rightarrow p$ of $\mathbb{N}\text{-Fun}$, $\phi \bullet_1 \psi$ is defined as $\psi \circ \phi$.

By checking the condition (E), one easily verifies that $\mathbb{N}\text{-Fun}$ is in fact a strict 2-category. Given natural numbers $m, m', n, n' \in \mathbb{N}$, and 2-cells $\phi: m \Rightarrow n, \psi: m' \Rightarrow n'$ of $\mathbb{N}\text{-Fun}$, we write $\phi <_{\exists} \psi$ when $m = m', n = n'$ and $\phi(x) <_{\exists} \psi(x)$ for all $x \in \mathbb{N}^m$. We then have that:

Proposition 4.4.1.3. $<_{\exists}$ is well-founded on $\mathbb{N}\text{-Fun}_2$.

Proof. We define a function $N: \mathbb{N}\text{-Fun}_2 \rightarrow \mathbb{N}$ by

$$N(\phi) = \phi(z)_1 + \dots + \phi(z)_n \quad \text{for } \phi: m \Rightarrow n \in \mathbb{N}\text{-Fun}_2,$$

where z is the n -tuple $(0, \dots, 0)$. Now, given a 2-cell $\psi: m \Rightarrow n$ of $\mathbb{N}\text{-Fun}_2$ such that $\psi <_{\exists} \phi$, we have $\psi(z) <_{\exists} \phi(z)$ so that $N(\psi) < N(\phi)$. Thus, the partial order $<_{\exists}$ on $\mathbb{N}\text{-Fun}_2$ is well-founded. \square

We moreover observe that the partial order $<_{\exists}$ is compatible with the structure of $\mathbb{N}\text{-Fun}$:

Proposition 4.4.1.4. Given $m, n, m', n', k, k' \in \mathbb{N}$, and 2-cells

$$\mu: m' \Rightarrow m \quad \nu: n \Rightarrow n' \quad \phi, \phi': k \Rightarrow k'$$

of $\mathbb{N}\text{-Fun}_2$ such that $\phi >_{\exists} \phi'$, we have

$$(i) \quad m \bullet_0 \phi \bullet_0 n >_{\exists} m \bullet_0 \phi' \bullet_0 n,$$

$$(ii) \quad \mu \bullet_1 \phi \bullet_1 \nu >_{\exists} \mu \bullet_1 \phi' \bullet_1 \nu.$$

Proof. Given $x \in \mathbb{N}^{m+k+n}$, we have $\phi(x_{m+1}, \dots, x_{m+k}) >_{\exists} \phi'(x_{m+1}, \dots, x_{m+k})$ so

$$(m \bullet_0 \phi \bullet_0 n)(x) >_{\exists} (m \bullet_0 \phi' \bullet_0 n)(x).$$

Thus, (i) holds. Moreover, given $y \in \mathbb{N}^{m'}$, we have $\phi(\mu(y)) >_{\exists} \phi'(\mu(y))$. Since ν is monotone, we have $\nu(\phi(\mu(y))) >_{\exists} \nu(\phi'(\mu(y)))$. Thus, (ii) holds. \square

We define a 2-prefunctor

$$F: \text{PMon}_2^* \rightarrow \mathbb{N}\text{-Fun}$$

by the universal property of the 2-prepolygraph $\text{PMon}_{\leq 2}$: F is the unique 2-prefunctor such that $F(*) = *$, $F(\bar{1}) = 1$, $F(\eta) = f_\eta$ and $F(\mu) = f_\mu$ where

$$f_\eta: \mathbb{N}^0 \rightarrow \mathbb{N}^1 \quad f_\mu: \mathbb{N}^2 \rightarrow \mathbb{N}^1$$

are defined by $f_\eta(()) = 1$ and $f_\mu((x, y)) = 2x + y + 1$ for all $x, y \in \mathbb{N}$. The prefunctor F exhibits the 3-generators L, R and A of PMon as decreasing operations for $\mathbb{N}\text{-Fun}$:

Proposition 4.4.1.5. *The following hold:*

- (i) $F(\partial_2^-(L)) >_{\exists} F(\partial_2^+(L))$,
- (ii) $F(\partial_2^-(R)) >_{\exists} F(\partial_2^+(R))$,
- (iii) $F(\partial_2^-(A)) >_{\exists} F(\partial_2^+(A))$,
- (iv) $F(\partial_2^-(X_{\alpha,m,\beta})) = F(\partial_2^+(X_{\alpha,m,\beta}))$ for $\alpha, \beta \in \text{PMon}_2$ and $m \in \mathbb{N}$.

Proof. Let $\phi = F(\partial_2^-(L))$ and $\psi = F(\partial_2^+(L))$. We compute that

$$\phi(x) = (x + 3) \quad \text{and} \quad \psi(x) = (x)$$

for $x \in \mathbb{N}$, so $\phi >_{\exists} \psi$ and (i) holds. By a similar computation, (ii) holds. Let $\phi = F(\partial_2^-(A))$ and $\psi = F(\partial_2^+(A))$. We compute that

$$\phi(x, y, z) = (4x + 2y + z + 3) \quad \text{and} \quad \psi(x, y, z) = (2x + 2y + z + 1)$$

for $x, y, z \in \mathbb{N}$, so $\phi(x, y, z) >_{\exists} \psi(x, y, z)$ for all $x, y, z \in \mathbb{N}$, so (iii) holds. The point (iv) is a consequence of the fact that $\mathbb{N}\text{-Fun}$ is a strict 2-category. \square

Recall the definition of Int from Paragraph 4.3.3.3. We define a partial order $<$ on PMon_2^* by putting, for $\phi, \psi \in \text{PMon}_2^*$,

$$\phi < \psi \quad \text{when} \quad F(\phi) <_{\exists} F(\psi) \quad \text{or} \quad [F(\phi) = F(\psi) \quad \text{and} \quad \text{Int}(\phi) <_{\omega} \text{Int}(\psi)].$$

We then have that:

Proposition 4.4.1.6. *The partial order $<$ on PMon_2^* is a reduction order for PMon . In particular, the rewriting system induced by PMon is terminating.*

Proof. Let $G \in \text{PMon}_3$. If $G \in \{L, R, A\}$, then, by Proposition 4.4.1.5, $\partial_2^-(G) > \partial_2^+(G)$. Otherwise, if $G = X_{\alpha,u,\beta}$ for some $\alpha, \beta \in \text{PMon}_2$ and $u \in \text{PMon}_1^*$, then, by Proposition 4.4.1.5(iv),

$$F(\partial_2^-(G)) = F(\partial_2^+(G)) \quad \text{and} \quad \text{Int}(\partial_2^+(G)) <_{\omega} \text{Int}(\partial_2^-(G)).$$

So $\partial_2^-(G) > \partial_2^+(G)$. The other requirements for $<$ to be a reduction order are consequences of Proposition 4.4.1.4 and Proposition 4.3.3.4(ii)(iii). The rewriting system induced by PMon is then terminating by Proposition 4.3.3.2. \square

4.4.1.7 – Coherence. Since the rewriting system is terminating, we can conclude using our coherence criterion:

Theorem 4.4.1.8. *PMon is a coherent Gray presentation.*

Proof. By Proposition 4.4.1.6, the rewriting system induced by PMon is terminating. By Theorem 4.3.4.8, since $R_1, \dots, R_5 \in \text{PMon}_4$, PMon is a coherent Gray presentation. \square

Remark 4.4.1.9. The original definition of pseudomonoids of [SD97] uses a smaller set of 4-generators for the presentation, namely $\{R_1, R_4\}$. Thus, the coherent presentations obtained using Theorem 4.3.4.8 are not necessarily the smallest ones. The same situation happens in the setting of strict categories [GM09], where the presentation of pseudomonoids obtained through rewriting has five 4-generators, whereas the common definition of pseudomonoids in strict 3-categories only requires two 4-generators: MacLane’s pentagon, which is an analogue of R_1 in strict categories, and R_4 (c.f. the definition of monoidal categories in Paragraph 1.5.1.1). Guiraud and Malbos shows that the equalities on the 3-cells associated with R_2, R_3, R_5 can be recovered from the ones associated with R_1 and R_4 . Their proof relies on the invertibility of the 3-cells, which suggests that R_1 and R_4 might not be sufficient for a coherent presentation of *lax pseudomonoid* expressed in lax Gray categories, where the 3-cells L, R, A are not required to be invertible. In this lax context, it would be interesting to know whether the 4-generators R_1, R_2, R_3, R_4, R_5 still provides sufficient equalities for a coherent presentation of lax pseudomonoids and, more generally, whether rewriting techniques can be used to find coherent presentations in the context of lax Gray categories.

4.4.2 Pseudoadjunctions

We now show the coherence of the Gray presentation of pseudoadjunctions introduced below. The way we do this is again by using Theorem 4.3.4.8. However, we need a specific argument to show the termination of the interchange generators on the associated rewriting system. For this purpose, we introduce a notion of “connected” diagrams and use a result of [DV18] saying that interchange generators terminate on such connected diagrams.

4.4.2.1 – Gray presentation. We define the 3-prepolygraph for pseudoadjunctions as the 3-prepolygraph P such that

$$P_0 = \{x, y\} \quad P_1 = \{f: x \rightarrow y, g: y \rightarrow x\} \quad P_2 = \{\eta: \text{id}_x^1 \Rightarrow f \bullet_0 g, \epsilon: g \bullet_0 f \Rightarrow \text{id}_y^1\}$$

where η and ϵ are pictured as \cap and \cup respectively, and P_3 is defined by $P_3 = \{N, \mathcal{N}\}$, where

$$N: (\eta \bullet_0 f) \bullet_1 (f \bullet_0 \epsilon) \Rightarrow \text{id}_f^2 \quad \text{and} \quad \mathcal{N}: (g \bullet_0 \eta) \bullet_1 (\epsilon \bullet_0 b) \Rightarrow \text{id}_g^2$$

which can be represented by

$$N: \cap \cup \Rightarrow | \quad \text{and} \quad \mathcal{N}: \cup \cap \Rightarrow |.$$

We then extend P to a Gray presentation by adding 3-generators corresponding to interchange generators and 4-generators corresponding to independence generators and interchange naturality generators like we did for pseudomonoids in Example 4.2.3.3, following the definition of Gray presentation given in Paragraph 4.2.3.1. For coherence, we need to add other 4-generators to P_4 . Provided that P is terminating, by Theorem 4.3.4.8, it is enough to add 4-generators corresponding to the critical branchings.

4.4.2.2 – Critical branchings. Using the constructive proof of Theorem 4.3.5.8, we compute all the critical branchings of P . We then obtain, up to symmetrical branchings, two critical branchings

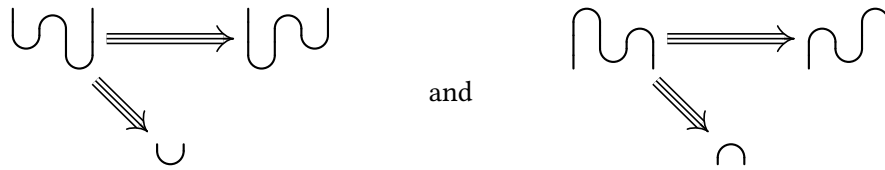

We observe that each of these branchings is joinable, and we define formal new 4-generators that fill the holes:

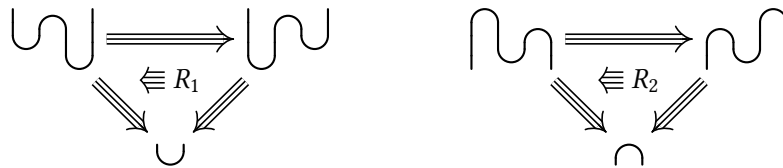

We then define $PAdj$ as the Gray presentation obtained from P by adding R_1 and R_2 to P_4 .

4.4.2.3 – Connectedness. We now aim at showing that the associated rewriting system is terminating. However, we can not build a reduction order using Proposition 4.3.3.4 to handle interchange generators, like for the case of pseudomonoids, since P is not positive. Instead, we invoke the result of [DV18] that states the termination of interchange generators on “connected diagrams”. Given a 2-prepolygraph Q , a 2-cell of Q_2^* is connected when, intuitively, each 2-generator on its graphical representation is accessible by a path starting from a top or bottom wire. For example, given the 3-prepolygraph Q such that $Q_0 = \{*\}$, $Q_1 = \{\bar{1}\}$ and $Q_2 = \{\bar{\cap}: \bar{0} \Rightarrow \bar{2}, \bar{\cup}: \bar{2} \Rightarrow \bar{0}\}$, we can build the following two 2-cells of Q_2^*

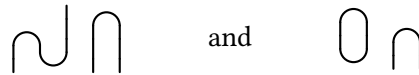

where the one on the left is connected whereas the one on the right is not, since the two 2-generators of the “bubble” can not be accessed from the top or bottom border.

A more formal definition of connectedness can be obtained by computing the “connected components” of the diagram, together with a map between the top and bottom wires of the diagram to the associated connected components. This is adequately represented by cospans of \mathbf{Set} . Based on this idea, we define a 2-precategory that allows to compute the connected components of the 2-cells of Q^* , for a 2-prepolygraph Q .

We define the 2-precategory \mathbf{CoSpan} as the 2-precategory

- which has a unique 0-cell, denoted $*$,
- whose 1-cells are the natural numbers, with 0 as identity and addition as composition,
- whose 2-cells $m \Rightarrow n$ are the classes of equivalent cospans $\mathbb{N}_m^* \xrightarrow{f} S \xleftarrow{g} \mathbb{N}_n^*$ in \mathbf{Set} ,

where two cospans $A \xrightarrow{f} S \xleftarrow{g} B$ and $A \xrightarrow{f'} S' \xleftarrow{g'} B$ are said *equivalent* when there exists an isomorphism $h: S \rightarrow S' \in \mathbf{Set}$ such that $f' = h \circ f$ and $g' = h \circ g$. Given $m \in \mathbf{CoSpan}_1$, the identity $\text{id}_m^2 \in \mathbf{CoSpan}_2$ is the cospan

$$\mathbb{N}_m^* \xrightarrow{1_{\mathbb{N}_m^*}} \mathbb{N}_m^* \xleftarrow{1_{\mathbb{N}_m^*}} \mathbb{N}_m^*$$

and, given 2-cells $\phi: m_1 \Rightarrow m_2$ and $\psi: m_2 \Rightarrow m_3$ of \mathbf{CoSpan} , represented by the cospans

$$\mathbb{N}_{m_1}^* \xrightarrow{f} S \xleftarrow{g} \mathbb{N}_{m_2}^* \quad \text{and} \quad \mathbb{N}_{m_2}^* \xrightarrow{f'} S' \xleftarrow{g'} \mathbb{N}_{m_3}^*$$

respectively, their composite is represented by the cospan

$$\begin{array}{ccccc} & & S'' & & \\ & & \swarrow \quad \searrow & & \\ & & h \quad \quad h' & & \\ & & \vdots \quad \quad \vdots & & \\ & & \swarrow \quad \searrow & & \\ & & S & & S' \\ & \swarrow \quad \searrow & & \swarrow \quad \searrow & \\ \mathbb{N}_{m_1}^* & & \mathbb{N}_{m_2}^* & & \mathbb{N}_{m_3}^* \end{array}$$

where the middle square is a pushout. Given $\phi: m \Rightarrow n \in \mathbf{CoSpan}_2$ represented by

$$\mathbb{N}_m^* \xrightarrow{f} S \xleftarrow{g} \mathbb{N}_n^*$$

and $p, q \in \mathbf{CoSpan}_1$, the 2-cell $p \bullet_0 \phi \bullet_0 q$ is represented by the cospan

$$\begin{array}{ccc} & \mathbb{N}_p^* \sqcup S \sqcup \mathbb{N}_q^* & \\ (1_{\mathbb{N}_p^*} \sqcup f \sqcup 1_{\mathbb{N}_q^*}) \circ \theta_{p,m,q} & \swarrow \quad \searrow & (1_{\mathbb{N}_p^*} \sqcup g \sqcup 1_{\mathbb{N}_q^*}) \circ \theta_{p,n,q} \\ \mathbb{N}_{p+m+q}^* & & \mathbb{N}_{p+n+q}^* \end{array}$$

where $\theta_{p,r,q}: \mathbb{N}_{p+r+q}^* \rightarrow \mathbb{N}_p^* \sqcup \mathbb{N}_r^* \sqcup \mathbb{N}_q^*$, for $r \in \mathbb{N}$, is the evident bijection. By checking the condition (E), one easily verifies that \mathbf{CoSpan} is in fact a strict 2-category.

Given a 2-prepolygraph Q , by the universal property of 2-prepolygraph, we define a 2-prefunctor

$$\text{Con}^Q: Q^* \rightarrow \mathbf{CoSpan}$$

such that

- the image of $x \in Q_0$ by Con^Q is $*$,
- the image of $a \in Q_1$ by Con^Q is 1 ,
- the image of $\alpha: f \Rightarrow g \in Q_2$ by Con^Q is represented by the unique cospan

$$\mathbb{N}_{|f|}^* \xrightarrow{*} \{*\} \xleftarrow{*} \mathbb{N}_{|g|}^*$$

We can now give a formal definition for connectedness: a cell $\phi \in Q_2^*$ is *connected* when $\text{Con}^Q(\phi)$ is represented by a cospan

$$\mathbb{N}_m^* \xrightarrow{f} S \xleftarrow{g} \mathbb{N}_n^*$$

with $m = |\partial_1^-(\phi)|$ and $n = |\partial_1^+(\phi)|$ such that f, g are jointly epimorphic. Since the latter property is invariant by equivalences of cospan, if ϕ is connected, then for all representant

$$\mathbb{N}_m^* \xrightarrow{f'} S \xleftarrow{g'} \mathbb{N}_n^*$$

of $\text{Con}^Q(\phi)$, f', g' are jointly epimorphic.

Connectedness is not changed by 3-generators that are similar to interchange generators, as a consequence of the following property:

Lemma 4.4.2.4. *Let P be a 2-prepolygraph, $\alpha, \beta \in P_2$ and $g \in P_1^*$ such that α, g, β are 0-composable. Then,*

$$\text{Con}^P((\alpha \bullet_0 g \bullet_0 \partial_1^-(\beta)) \bullet_1 (\partial_1^+(\alpha) \bullet_0 g \bullet_0 \beta)) = \text{Con}^P((\partial_1^-(\alpha) \bullet_0 g \bullet_0 \beta) \bullet_1 (\alpha \bullet_0 g \bullet_0 \partial_1^+(\beta))).$$

Proof. This is a direct consequence of the fact that \mathbf{CoSpan} is a 2-category. □

Moreover, in the case of \mathbf{PAdj} , the 3-generators \mathbb{N} and \mathbb{I} do not change connectedness:

Lemma 4.4.2.5. *We have*

$$\text{Con}^{\mathbf{PAdj}}((\eta \bullet_0 f) \bullet_1 (f \bullet_0 \epsilon)) = \text{Con}^{\mathbf{PAdj}}(\text{id}_f^2)$$

and

$$\text{Con}^{\mathbf{PAdj}}((g \bullet_0 \eta) \bullet_1 (\epsilon \bullet_0 g)) = \text{Con}^{\mathbf{PAdj}}(\text{id}_g^2).$$

Proof. By calculations, we verify that

$$\begin{array}{ccc} & \{*\} & \\ * \nearrow & & \nwarrow * \\ \mathbb{N}_1^* & & \mathbb{N}_1^* \end{array}$$

is a representant of both $\text{Con}^{\mathbf{PAdj}}((\eta \bullet_0 f) \bullet_1 (f \bullet_0 \epsilon))$ and $\text{Con}^{\mathbf{PAdj}}(\text{id}_f^2)$, so that

$$\text{Con}^{\mathbf{PAdj}}((\eta \bullet_0 f) \bullet_1 (f \bullet_0 \epsilon)) = \text{Con}^{\mathbf{PAdj}}(\text{id}_f^2)$$

and similarly,

$$\text{Con}^{\mathbf{PAdj}}((g \bullet_0 \eta) \bullet_1 (\epsilon \bullet_0 g)) = \text{Con}^{\mathbf{PAdj}}(\text{id}_g^2). \quad \square$$

We now prove a technical lemma that we will use to show the connectedness of the 2-cells in \mathbf{PAdj}_2^* :

Lemma 4.4.2.6. *Let P be a 2-prepolygraph and $\phi, \phi' \in P_2^*$ and $\mathbb{N}_{n_1}^* \xrightarrow{f} S \xleftarrow{g} \mathbb{N}_{n_2}^*$ be a representant of $\text{Con}^P(\phi)$ for some $n_1, n_2 \in \mathbb{N}$ such that ϕ, ϕ' are 1-composable and f is surjective. Then, $\phi \bullet_1 \phi'$ is connected if and only if ϕ' is connected.*

Proof. Let $\mathbb{N}_{n_2}^* \xrightarrow{f'} S' \xleftarrow{g'} \mathbb{N}_{n_3}^*$ be a representant of $\text{Con}^P(\phi')$ for some $n_2, n_3 \in \mathbb{N}$. Then, $\text{Con}^P(\phi')$ is represented by

$$\mathbb{N}_{n_1}^* \xrightarrow{f'' \circ f} S'' \xleftarrow{g'' \circ g'} \mathbb{N}_{n_3}^*$$

where S'', f'' and g'' are defined by the pushout of g and f' as in

$$\begin{array}{ccccc} & & S'' & & \\ & f'' \nearrow & \vee & \nwarrow g'' & \\ & S & & S' & \\ f \nearrow & \leftarrow g & & f' \nearrow & \leftarrow g' \\ \mathbb{N}_{n_1}^* & & \mathbb{N}_{n_2}^* & & \mathbb{N}_{n_3}^* \end{array}$$

Suppose that ϕ' is connected, i.e., f' and g' are jointly surjective. Since f is surjective by hypothesis and f'' and g'' are jointly surjective (by the universal property of pushout), we have that $f'' \circ f, g'' \circ f'$ and $g'' \circ g'$ are jointly surjective. Moreover,

$$g'' \circ f' = f'' \circ g = f'' \circ f \circ h$$

where h is a factorization of g through f (that exists, since f is supposed surjective). Thus, we conclude that $f'' \circ f$ and $g'' \circ g$ are jointly surjective.

Conversely, suppose that $\phi \bullet_1 \phi'$ is connected, i.e., $f'' \circ f$ and $g'' \circ g$ are jointly surjective and let $y \in S'$. We have to show that y is in the image of f' or g' . Recall that

$$S'' \simeq (S \coprod S') / \sim$$

where \sim is the equivalence relation induced by $g(x) \sim f'(x)$ for $x \in \mathbb{N}_{n_2}^*$ so either y is in the image of f' or [y is the only preimage of $g''(y)$ by g'' and $g''(y)$ is not in the image of f'']. In the former case, we conclude directly, and in the latter, since $f'' \circ f$ and $g'' \circ g'$ are jointly surjective, there is $x \in \mathbb{N}_{n_3}^*$ such that $g'' \circ g'(x) = g''(y)$, so that $g'(x) = y$, which is what we wanted. Thus, f' and g' are jointly surjective, i.e., ϕ' is connected. \square

We can now prove our connectedness result for pseudoadjunctions:

Proposition 4.4.2.7. *For every $\phi \in \text{PAAdj}_2^*$, ϕ is connected.*

Proof. Suppose by contradiction that it is not true and let $N \in \mathbb{N}$ be the smallest such that the set $S = \{\phi \in \text{PAAdj}_2^* \mid |\phi| = N \text{ and } \phi \text{ is not connected}\}$ is not empty. Given $\phi \in S$, let

$$(f_1 \bullet_0 \alpha_1 \bullet_0 h_1) \bullet_1 \cdots \bullet_1 (f_N \bullet_0 \alpha_N \bullet_0 h_N)$$

be a decomposition of ϕ .

Note that there is at least one $i \in \mathbb{N}_N^*$ such that $\alpha_i = \epsilon$. Indeed, given $f, h \in \text{PAAdj}_1^*$ such that f, η, h are 0-composable, a representant

$$\mathbb{N}_m^* \xrightarrow{u} T \xleftarrow{v} \mathbb{N}_n^*$$

of $\text{Con}^Q(f \bullet_0 \eta \bullet_0 h)$ has the property that v is an epimorphism. Since epimorphisms are stable by pushouts, given $\phi' \in \text{PAAdj}_2^*$ such that $\phi' = (f'_1 \bullet_0 \eta \bullet_0 h'_1) \bullet_1 \cdots \bullet_1 (f'_k \bullet_0 \eta \bullet_0 h'_k)$ with $f'_i, h'_i \in \text{PAAdj}_1^*$ for $i \in \mathbb{N}_k^*$, a representant

$$\mathbb{N}_{m'}^* \xrightarrow{u'} T' \xleftarrow{v'} \mathbb{N}_{n'}^*$$

of $\text{Con}^{\text{PAAdj}}(\phi')$ has the property that v' is an epimorphism (by induction on k), and in particular, ϕ' is connected. So let i_0 be minimal such that there is $\phi \in S$ with $\alpha_{i_0} = \epsilon$.

Suppose first that $i_0 = 1$. Then, given a representant

$$\mathbb{N}_{m_1}^* \xrightarrow{u_1} T_1 \xleftarrow{v_1} \mathbb{N}_{m_2}^*$$

of $\text{Con}^{\text{PAAdj}}(f_1 \bullet_0 \alpha_1 \bullet_0 h_1)$, we easily check that u_1 is an epimorphism. By Lemma 4.4.2.6, we deduce that

$$(f_2 \bullet_0 \alpha_2 \bullet_0 h_2) \bullet_1 \cdots \bullet_1 (f_k \bullet_0 \alpha_k \bullet_0 h_k)$$

is not connected, contradicting the minimality of N .

Thus $i_0 > 1$. By the definition of i_0 , we have $\alpha_{i_0-1} = \eta$. There are then different cases depending on $|f_{i_0-1}|$:

- if $|f_{i_0-1}| \leq |f_{i_0}| - 2$, then, since $\partial_1^+(f_{i_0-1} \bullet_0 \alpha_{i_0-1} \bullet_0 h_{i_0-1}) = \partial_1^-(f_{i_0} \bullet_0 \alpha_{i_0} \bullet_0 h_{i_0})$, we have

$$f_{i_0} = f_{i_0-1} \bullet_0 \partial_1^+(\eta) \bullet_0 g \quad \text{and} \quad h_{i_0-1} = g \bullet_0 \partial_1^-(\epsilon) \bullet_0 h_{i_0}$$

for some $g \in \text{PAAdj}_1^*$. By Lemma 4.4.2.4, we have

$$\text{Con}^{\text{PAAdj}}((\eta \bullet_0 g \bullet_0 \partial_1^-(\epsilon)) \bullet_1 (\partial_1^+(\eta) \bullet_0 g \bullet_0 \epsilon)) = \text{Con}^{\text{PAAdj}}((\partial_1^-(\eta) \bullet_0 g \bullet_0 \epsilon) \bullet_1 (\eta \bullet_0 g \bullet_0 \partial_1^+(\epsilon)))$$

thus, by functoriality of $\text{Con}^{\text{PAAdj}}$, the morphism ϕ' defined by

$$\begin{aligned} \phi' = & (f_1 \bullet_0 \alpha_1 \bullet_0 h_1) \bullet_1 \cdots \bullet_1 (f_{i_0-2} \bullet_0 \alpha_{i_0-2} \bullet_0 h_{i_0-2}) \\ & \bullet_1 (f_{i_0-1} \bullet_0 g \bullet_0 \epsilon \bullet_0 h_{i_0}) \bullet_1 (f_{i_0-1} \bullet_0 \eta \bullet_0 g \bullet_0 h_{i_0}) \\ & \bullet_1 (f_{i_0+1} \bullet_0 \alpha_{i_0+1} \bullet_0 h_{i_0+1}) \bullet_1 \cdots \bullet_1 (f_k \bullet_0 \alpha_k \bullet_0 h_k) \end{aligned}$$

satisfies that $\text{Con}^{\text{PAAdj}}(\phi) = \text{Con}^{\text{PAAdj}}(\phi')$. So ϕ' is not connected, and the (i_0-1) -th 2-generator in the decomposition of ϕ' is ϵ , contradicting the minimality of i_0 ;

- if $|f_{i_0-1}| \geq |f_{i_0}| + 2$, then the case is similar to the previous one;
- if $|f_{i_0-1}| = |f_{i_0}| - 1$, then, since $\text{Con}^{\text{PAAdj}}((\eta \bullet_0 f) \bullet_1 (f \bullet_0 \epsilon)) = \text{Con}^{\text{PAAdj}}(\text{id}_f^2)$ by Lemma 4.4.2.5, the 2-cell ϕ' defined by

$$\begin{aligned} \phi' = & (f_1 \bullet_0 \alpha_1 \bullet_0 h_1) \bullet_1 \cdots \bullet_1 (f_{i_0-2} \bullet_0 \alpha_{i_0-2} \bullet_0 h_{i_0-2}) \\ & \bullet_1 (f_{i_0+1} \bullet_0 \alpha_{i_0+1} \bullet_0 h_{i_0+1}) \bullet_1 \cdots \bullet_1 (f_k \bullet_0 \alpha_k \bullet_0 h_k) \end{aligned}$$

satisfies $\text{Con}^{\text{PAAdj}}(\phi) = \text{Con}^{\text{PAAdj}}(\phi')$ (by functoriality of $\text{Con}^{\text{PAAdj}}$), so that ϕ' is not connected, contradicting the minimality of N ;

- if $|f_{i_0-1}| = |f_{i_0}| + 1$, then the situation is similar to the previous one, since, by Lemma 4.4.2.5,

$$\text{Con}^{\text{PAAdj}}((g \bullet_0 \eta) \bullet_1 (\epsilon \bullet_0 g)) = \text{Con}^{\text{PAAdj}}(\text{id}_g^2);$$

- finally, the case $|f_{i_0-1}| = |f_{i_0}|$ is impossible since

$$f_{i_0-1} \bullet_0 \partial_1^+(\alpha_{i_0-1}) \bullet_0 h_{i_0-1} = f_{i_0} \bullet_0 \partial_1^-(\alpha_{i_0}) \bullet_0 h_{i_0}$$

and

$$\partial_1^+(\alpha_{i_0-1}) = f \bullet_0 g \neq g \bullet_0 f = \partial_1^-(\alpha_{i_0}). \quad \square$$

4.4.2.8 – Termination. We are now able to prove the termination of the rewriting system:

Proposition 4.4.2.9. *The rewriting system associated to PAAdj is terminating.*

Proof. Suppose by contradiction that there is a sequence $S_i : \phi_i \Rightarrow \phi_{i+1}$ for $i \in \mathbb{N}$ with S_i rewriting step in PAAdj_3^* . Since

$$|\partial_2^-(N)| = |\partial_2^-(\mathcal{N})| = 2 \quad \text{and} \quad |\partial_2^+(N)| = |\partial_2^+(\mathcal{N})| = 0,$$

if the inner 3-generator of S_i is N or \mathcal{N} , for some $i \in \mathbb{N}$, then $|\phi_{i+1}| = |\phi_i| - 2$. Since

$$\partial_2^-(X_{\alpha,f,\beta}) = \partial_2^+(X_{\alpha,f,\beta}) = 2$$

for 0-composable $\alpha \in \text{PAAdj}_2$, $f \in \text{PAAdj}_1^*$, $\beta \in \text{PAAdj}_2$, it means that there is $i_0 \in \mathbb{N}$ such that for $i \in \mathbb{N}$ with $i \geq i_0$, the inner generator of S_i is an interchanger. By [DV18, Theorem 16], there is no infinite sequence of rewriting steps made of interchangers. Thus, by Proposition 4.4.2.7, there is no infinite sequence of rewriting steps whose inner 3-generator is an interchanger of PAAdj , contradicting the existence of $(S_i)_{i \in \mathbb{N}}$. Thus, PAAdj is terminating. \square

4.4.2.10 – Coherence. Finally, we can apply our coherence criterion and show that:

Theorem 4.4.2.11. *PAdj is a coherent Gray presentation.*

Proof. By Proposition 4.4.2.9, the rewriting system associated to PAdj is terminating. By Theorem 4.3.4.8, since $R_1, R_2 \in \text{PAdj}_4$, the conclusion follows. \square

4.4.3 Frobenius pseudomonoid

We now consider the example of *Frobenius pseudomonoids* [Str04] that categorify the classical notion of Frobenius algebras. Sadly, our methods do not apply to show the coherence of the full structure since the units induce non-joinable critical branchings, so that we only consider non-unitary Frobenius pseudomonoids. Moreover, we were not able to show termination of the associated rewriting system, so that our coherence result is assuming termination. We still present this partial example, hoping it might motivate the developments of termination arguments as future works. We refer to [DV16] for a more complete treatment of the coherence of Frobenius pseudomonoids.

4.4.3.1 – Gray presentation. We define the 3-prepolygraph P of non-unitary Frobenius pseudomonoids as follows. We put

$$P_0 = \{*\} \quad P_1 = \{\bar{1}\} \quad P_2 = \{\mu: \bar{2} \rightarrow \bar{1}, \epsilon: \bar{1} \rightarrow \bar{2}\}$$

where we write \bar{n} for the composite $\bar{1} \bullet_0 \cdots \bullet_0 \bar{1}$ of n copies of $\bar{1}$ for $n \in \mathbb{N}$. We picture μ and ϵ by ∇ and \triangleleft respectively, and we define P_3 by $P_3 = \{N, \mathcal{I}, A, A^{\text{co}}, M, M^{\text{co}}\}$ where

$$\begin{array}{ccc} N: \begin{array}{c} \diagup \quad \diagdown \\ \nabla \end{array} \Rightarrow \begin{array}{c} \diagdown \quad \diagup \\ \nabla \end{array} & A: \begin{array}{c} \diagdown \quad \diagup \\ \nabla \end{array} \Rightarrow \begin{array}{c} \diagup \quad \diagdown \\ \nabla \end{array} & M: \begin{array}{c} \diagdown \quad \diagup \\ \nabla \end{array} \Rightarrow \begin{array}{c} \diagup \quad \diagdown \\ \nabla \end{array} \\ \mathcal{I}: \begin{array}{c} \diagdown \quad \diagup \\ \nabla \end{array} \Rightarrow \begin{array}{c} \diagup \quad \diagdown \\ \nabla \end{array} & A^{\text{co}}: \begin{array}{c} \diagup \quad \diagdown \\ \triangleleft \end{array} \Rightarrow \begin{array}{c} \diagdown \quad \diagup \\ \triangleleft \end{array} & M^{\text{co}}: \begin{array}{c} \diagup \quad \diagdown \\ \triangleleft \end{array} \Rightarrow \begin{array}{c} \diagdown \quad \diagup \\ \triangleleft \end{array} \end{array}$$

As before, we then extend P to a Gray presentation by adding 3-generators corresponding to interchange generators and 4-generators corresponding to independence generators and interchange naturality generators.

4.4.3.2 – Critical branchings and coherence. Using the constructive proof of Theorem 4.3.5.8, we find nineteen critical branchings for the above Gray presentation, which induce nineteen associated formal 4-generators R_1, \dots, R_{19} shown on Figure 4.1. We then define PFrob as the Gray presentation obtained from P by adding to P_4 the above 4-generators R_1, \dots, R_{19} . Since we were not able to show termination, we only conclude that:

Proposition 4.4.3.3. *If the rewriting system associated to PFrob is terminating, then PFrob is a coherent Gray presentation.*

Proof. This is a consequence of Theorem 4.3.4.8. \square

4.4.4 Self-dualities

We now consider the last example of *self-dualities*, which is an untyped variant of the one of Section 4.4.2. This example requires a special treatment since the underlying rewriting system is not terminating, and, more fundamentally, the induces (3, 2)-Gray category is not expected to be fully coherent. We show instead a partial coherence result by adapting the general methods of Section 4.3.

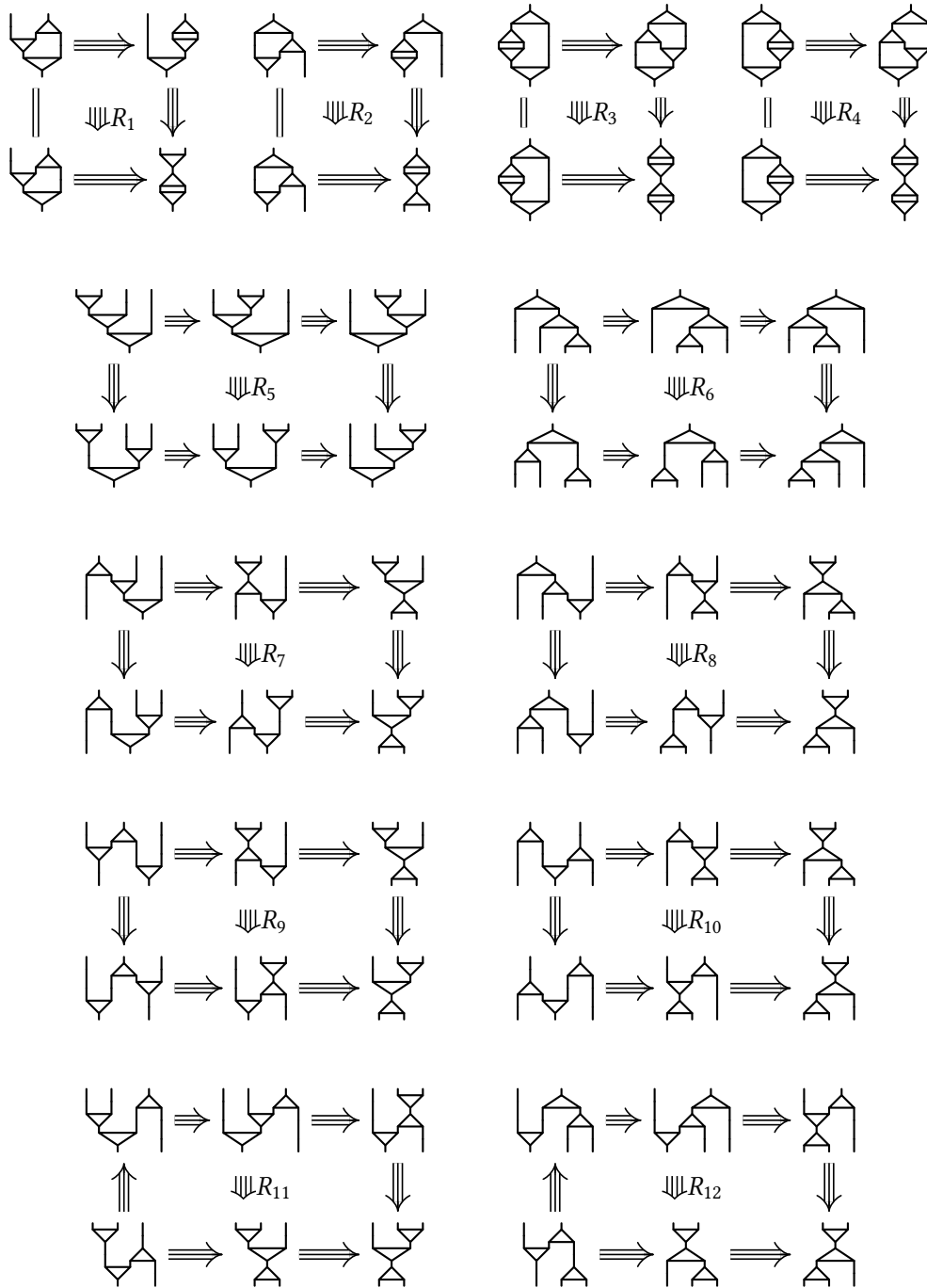

Figure 4.1a – The critical branchings for Frobenius pseudomonoids

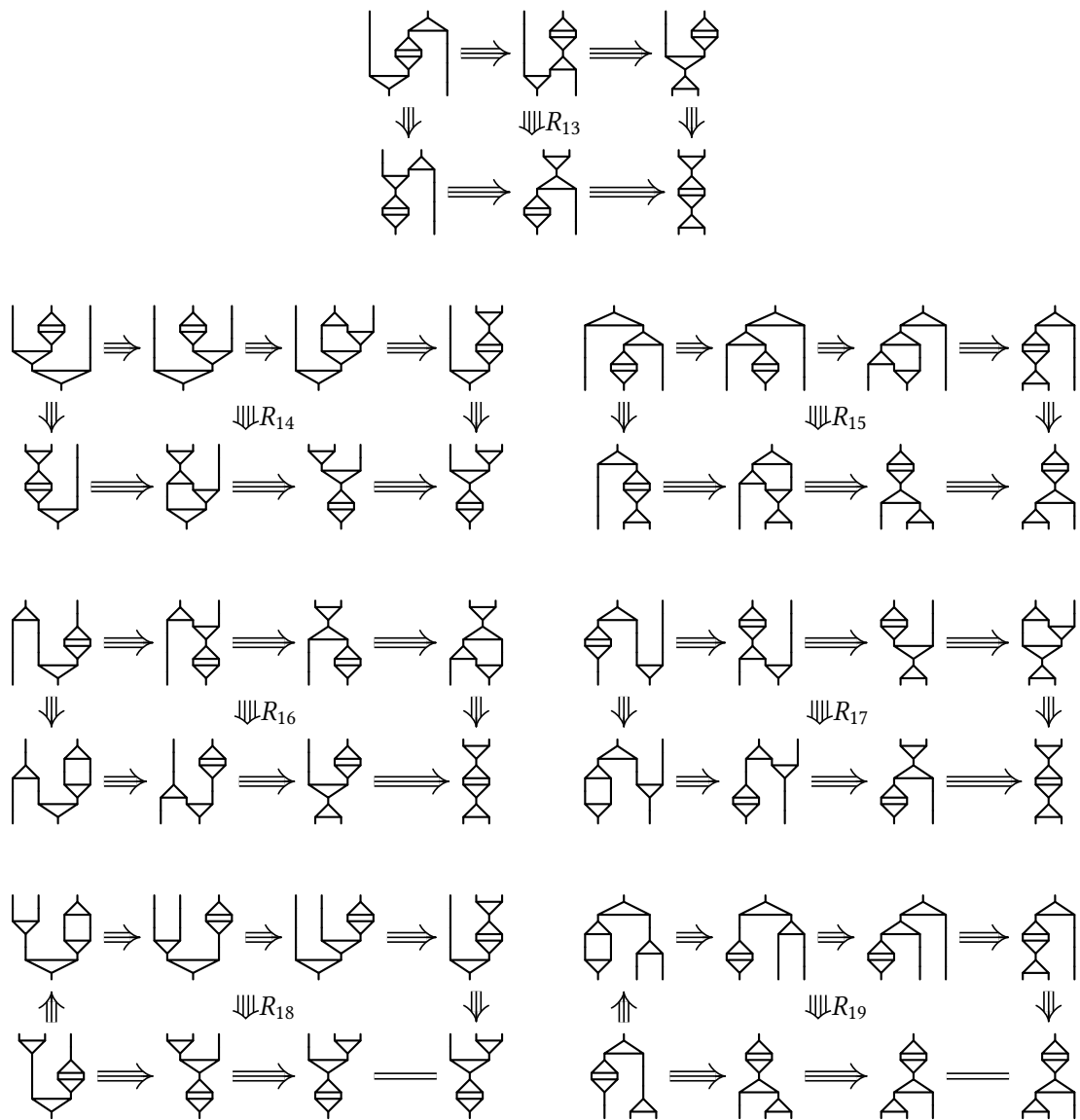

Figure 4.1b – The critical branchings for Frobenius pseudomonoids

4.4.4.1 – Gray presentation. We define the 3-prepolygraph of self-dualities as the 3-prepolygraph P such that

$$P_0 = \{*\} \quad P_1 = \{\bar{1}: * \rightarrow *\} \quad P_2 = \{\eta: \text{id}_* \Rightarrow \bar{2}, \epsilon: \bar{2} \Rightarrow \text{id}_*\}$$

where we write \bar{n} for the composite $\bar{1} \bullet_0 \cdots \bullet_0 \bar{1}$ of n copies of $\bar{1}$ for $n \in \mathbb{N}$. The 2-generators η and ϵ are pictured as \cap and \cup respectively, and P_3 is defined by $P_3 = \{N, \mathcal{I}\}$ where

$$N: (\eta \bullet_0 \bar{1}) \bullet_1 (\bar{1} \bullet_0 \epsilon) \Rightarrow \text{id}_1^2 \quad \text{and} \quad \mathcal{I}: (\bar{1} \bullet_0 \eta) \bullet_1 (\epsilon \bullet_0 \bar{1}) \Rightarrow \text{id}_1^2$$

which are pictured by

$$N: \text{ } \cap \xRightarrow{N} | \quad \text{and} \quad \mathcal{I}: | \xRightarrow{\mathcal{I}} \cup$$

As usual, we then extend P to a Gray presentation by adding 3-generators corresponding to interchange generators and 4-generators corresponding to independence generators and interchange naturality generators. We also add the same 4-generators that we added for pseudoadjunctions

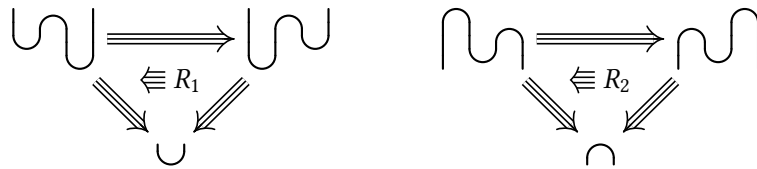

to P and we denote SD the resulting Gray presentation. We would like to apply Theorem 4.3.4.8 to obtain a coherence result, but it is not possible here. Indeed, SD is not terminating, since we have the reduction

$$\text{ } \cap \cap \Rightarrow \text{ } \cap \text{ } \cap \Rightarrow \text{ } \cap \text{ } \cap \Rightarrow \text{ } \cap \text{ } \cap \Rightarrow \text{ } \cap \cap$$

Moreover, this endomorphism 3-cell is not expected to be an identity, discarding hopes for the presentation to be coherent. Following [DV16], we can still aim at showing a partial coherence result by restricting to 2-cells which are connected (in the sense of Section 4.4.2). In this case, termination can be shown by using the same arguments as for pseudoadjunctions. However, there is still the problem that some critical branchings are not joinable since, for instance, we have

$$| \cup \Leftarrow \text{ } \cup \Rightarrow \text{ } \cup$$

for which there is little hope that a Knuth-Bendix completion will provide a reasonably small presentation. However, one can obtain a rewriting system, introduced below, which is terminating on connected 2-cells and confluent by orienting the interchangers. Using this rewriting system, we are able to show a partial coherence result.

4.4.4.2 – A better rewriting system. We define an alternate 3-prepolygraph Q such that

$$Q_i = P_i \quad \text{for } i \in \{0, 1, 2\} \quad \text{and} \quad Q_3 = \{N, \mathcal{I}\} \sqcup Q_3^{\text{int}}$$

where Q_3^{int} contains, for $n \in \mathbb{N}$, the following 3-generators, called Q -interchange generators:

$$\begin{array}{ll} X'_{\eta, \bar{n}, \eta}: \cap \text{ } \cap \Rightarrow \cap \text{ } \cap & X'_{\eta, \bar{n}, \epsilon}: \cap \text{ } \cup \Rightarrow \cap \text{ } \cup \\ X'_{\epsilon, \bar{n}, \eta}: \cup \text{ } \cap \Rightarrow \cup \text{ } \cap & X'_{\epsilon, \bar{n}, \epsilon}: \cup \text{ } \cup \Rightarrow \cup \text{ } \cup \end{array}$$

There is a 3-prefunctor $\Gamma: \mathbb{Q}^* \rightarrow \overline{\mathbb{P}}^\top$ uniquely defined by $\Gamma(u) = u$ for $i \in \{0, 1, 2\}$ and $u \in \mathbb{Q}_i^*$ and, for $n \in \mathbb{N}$, mapping the 3-generators as follows:

$$\begin{array}{ll} \mathbb{N} \mapsto \mathbb{N} & \mathbb{N} \mapsto \mathbb{N} \\ X'_{\eta, \bar{n}, \eta} \mapsto X_{\eta, \bar{n}, \eta}^{-1} & X'_{\eta, \bar{n}, \epsilon} \mapsto X_{\eta, \bar{n}, \epsilon} \\ X'_{\epsilon, \bar{n}, \eta} \mapsto X_{\epsilon, \bar{n}, \epsilon}^{-1} & X'_{\epsilon, \bar{n}, \epsilon} \mapsto X_{\epsilon, \bar{n}, \epsilon} \end{array}$$

We get a rewriting system (\mathbb{Q}, Ξ) by putting $F \Xi F'$ if and only if $\Gamma(F) = \Gamma(F')$ for parallel 3-cells $F, F' \in \mathbb{Q}_3^*$. Note that, given $F: \phi \Rightarrow \phi' \in \mathbb{Q}_3^*$, the 2-cell ϕ is connected if and only if ϕ' is connected. Indeed, one easily checks that for every $A \in \mathbb{Q}_3$, we have

$$\text{Con}^{\mathbb{Q}}(\partial_2^-(A)) = \text{Con}^{\mathbb{Q}}(\partial_2^+(A))$$

so that $\text{Con}^{\mathbb{Q}}(\phi) = \text{Con}^{\mathbb{Q}}(\phi')$.

4.4.4.3 – Termination. We first show a weak termination property for \mathbb{Q} , stating that it is terminating on connected 2-cells:

Proposition 4.4.4.4. *Given a connected 2-cell ϕ in \mathbb{Q}_2^* , there is no infinite sequence $F_i: \phi_i \Rightarrow \phi_{i+1}$ where $\phi_0 = \phi$ and F_i is a rewriting step for $i \in \mathbb{N}$.*

Proof. Since a rewriting step whose inner 3-generator is \mathbb{N} or \mathbb{N} decrease by two the number of 2-generators in a diagram, it is enough to show that there is no infinite sequence of composable rewriting steps made of elements of $\mathbb{Q}_3^{\text{int}}$. Given a 2-cell $\phi = (\bar{m}_1 \bullet_0 \alpha_1 \bullet_0 \bar{n}_1) \bullet_1 \cdots \bullet_1 (\bar{m}_k \bullet_0 \alpha_k \bullet_0 \bar{n}_k)$ of \mathbb{Q}_2^* , with $\alpha_i \in \mathbb{Q}_2$ and $m_i, n_i \in \mathbb{N}$ for $i \in \mathbb{N}_k^*$, we define $N_1(\phi) \in \mathbb{N}$ by

$$N_1(\phi) = |\{(i, j) \in (\mathbb{N}_k^*)^2 \mid i < j \text{ and } \alpha_i = \eta \text{ and } \alpha_j = \epsilon\}|.$$

Moreover, if we write $p, q \in \mathbb{N}_k$ and $i_1, \dots, i_p, j_1, \dots, j_q \in \mathbb{N}_k^*$ for the unique integers such that

$$i_1 < \cdots < i_p \quad j_1 < \cdots < j_q \quad \{i_1, \dots, i_p, j_1, \dots, j_q\} = \mathbb{N}_k^*$$

and $\alpha_{i_r} = \eta$ and $\alpha_{j_s} = \epsilon$ for $r \in \mathbb{N}_p^*$ and $s \in \mathbb{N}_q^*$, we define $N_2^\eta(\phi) \in \mathbb{N}^p$ and $N_2^\epsilon(\phi) \in \mathbb{N}^q$ by

$$N_2^\eta(\phi) = (m_{i_p}, \dots, m_{i_1}) \quad \text{and} \quad N_2^\epsilon(\phi) = (n_{j_1}, \dots, n_{j_q}).$$

Finally, we define $N(\phi) \in \mathbb{N}^{1+p+q}$ by

$$N(\phi) = (N_1(\phi), N_2^\eta(\phi), N_2^\epsilon(\phi))$$

and we equip \mathbb{N}^p , \mathbb{N}^q and \mathbb{N}^{1+p+q} with the lexicographical ordering $<_{\text{lex}}$. Now, keeping ϕ as above, let

$$\lambda \bullet_1 (l \bullet_0 A \bullet_0 r) \bullet_1 \rho: \phi \Rightarrow \phi' \in \mathbb{Q}_3^*$$

be a rewriting step for some $l, r \in \mathbb{Q}_1^*$, $\lambda, \rho, \phi' \in \mathbb{Q}_2^*$ and $A \in \mathbb{Q}_3$ with

$$\phi' = (\bar{m}'_1 \bullet_0 \alpha'_1 \bullet_0 \bar{n}'_1) \bullet_1 \cdots \bullet_1 (\bar{m}'_k \bullet_0 \alpha'_k \bullet_0 \bar{n}'_k)$$

for some $\alpha'_i \in \mathbb{Q}_2$ and $m'_i, n'_i \in \mathbb{N}$ for $i \in \mathbb{N}_k^*$. If $A = X'_{\eta, \bar{u}, \epsilon}$ or $A = X'_{\epsilon, \bar{u}, \eta}$ for some $u \in \mathbb{N}$, then $N_1(\phi') = N_1(\phi) - 1$.

Otherwise, if $A = X_{\eta, \bar{u}, \eta}$ for some $u \in \mathbb{N}$, then we have $N_1(\phi) = N_1(\phi')$ and, writing r for $|\lambda| + 1$, we have $m_s = \bar{m}'_s$ for $s \in \mathbb{N}_k^* \setminus \{r, r+1\}$. Moreover, we have $m'_{r+1} \leq m_{r+1} - 2$, so that $N_2^\eta(\phi') <_{\text{lex}} N_2^\eta(\phi)$.

Otherwise, $A = X'_{\epsilon, \bar{u}, \epsilon}$ for some $u \in \mathbb{N}$. Then $N_2^\eta(\phi) = N_2^\eta(\phi')$ and, by a similar argument as before, $N_2^\epsilon(\phi') <_{\text{lex}} N_2^\epsilon(\phi)$. In any case, we get that $N(\phi) <_{\text{lex}} N(\phi')$. Since $<_{\text{lex}}$ is well-founded, we conclude that there is no infinite sequence of rewriting steps $R_i: \phi_i \Rightarrow \phi_{i+1}$ for $i \in \mathbb{N}$ with ϕ_0 connected. \square

4.4.4.5 – Confluence. We now aim at showing the confluence of the branchings of Q . The idea is to use a critical pair lemma (Theorem 4.3.4.5) and a Newman’s lemma (Theorem 4.3.2.5) adapted to the specific setting of Q where the notion of critical branching is different and where we only consider connected 2-cells as sources.

We say that a branching (S_1, S_2) of Q is *connected* when $\partial_2^-(S_1)$ is connected. We say that it is *Q-critical* when it is local, minimal, not trivial and not independent. We first state adapted versions of the critical pair lemma and Newman’s lemma to the setting of Q :

Lemma 4.4.4.6. *If all connected Q-critical branchings (S_1, S_2) of (Q, Ξ) are confluent, then all connected local branchings of (Q, Ξ) are confluent.*

Proof. By a direct adaptation of the proof of Theorem 4.3.4.5 to connected 2-cells and rewriting steps between connected 2-cells. \square

Lemma 4.4.4.7. *If all connected local branchings of (Q, Ξ) are confluent, then all connected branchings of (Q, Ξ) are confluent.*

Proof. By a direct adaptation of Theorem 4.3.2.5 to connected 2-cells and rewriting steps between connected 2-cells, using Proposition 4.4.4.4. \square

By the above properties, in order to deduce the confluence of the branchings of Q , it is enough to check that the critical branchings of Q are confluent, fact that we verify in the following property:

Lemma 4.4.4.8. *The connected Q-critical branchings of (Q, Ξ) are confluent.*

Proof. We first consider the Q-critical branchings (S_1, S_2) that are *structural-structural*, i.e., such that the inner 3-generators of S_1 and S_2 are Q-interchange generators. We classify them as *separated*, *half-separated* and *not separated*. There are eight kinds of separated structural-structural Q-critical branchings listed below:

$$\begin{array}{l}
 (1) \quad \cup \begin{array}{|c} \dots \\ \dots \\ \dots \end{array} \cup \begin{array}{|c} \dots \\ \dots \\ \dots \end{array} \cup \begin{array}{|c} \dots \\ \dots \\ \dots \end{array} \Leftarrow \cup \begin{array}{|c} \dots \\ \dots \\ \dots \end{array} \cup \begin{array}{|c} \dots \\ \dots \\ \dots \end{array} \cup \begin{array}{|c} \dots \\ \dots \\ \dots \end{array} \Rightarrow \cup \begin{array}{|c} \dots \\ \dots \\ \dots \end{array} \cup \begin{array}{|c} \dots \\ \dots \\ \dots \end{array} \cup \begin{array}{|c} \dots \\ \dots \\ \dots \end{array} \\
 (2) \quad \cap \begin{array}{|c} \dots \\ \dots \\ \dots \end{array} \cup \begin{array}{|c} \dots \\ \dots \\ \dots \end{array} \cup \begin{array}{|c} \dots \\ \dots \\ \dots \end{array} \Leftarrow \cap \begin{array}{|c} \dots \\ \dots \\ \dots \end{array} \cup \begin{array}{|c} \dots \\ \dots \\ \dots \end{array} \cup \begin{array}{|c} \dots \\ \dots \\ \dots \end{array} \Rightarrow \cap \begin{array}{|c} \dots \\ \dots \\ \dots \end{array} \cup \begin{array}{|c} \dots \\ \dots \\ \dots \end{array} \cup \begin{array}{|c} \dots \\ \dots \\ \dots \end{array} \\
 (3) \quad \cup \begin{array}{|c} \dots \\ \dots \\ \dots \end{array} \cap \begin{array}{|c} \dots \\ \dots \\ \dots \end{array} \cup \begin{array}{|c} \dots \\ \dots \\ \dots \end{array} \Leftarrow \cup \begin{array}{|c} \dots \\ \dots \\ \dots \end{array} \cap \begin{array}{|c} \dots \\ \dots \\ \dots \end{array} \cup \begin{array}{|c} \dots \\ \dots \\ \dots \end{array} \Rightarrow \cup \begin{array}{|c} \dots \\ \dots \\ \dots \end{array} \cap \begin{array}{|c} \dots \\ \dots \\ \dots \end{array} \cup \begin{array}{|c} \dots \\ \dots \\ \dots \end{array} \\
 (4) \quad \cap \begin{array}{|c} \dots \\ \dots \\ \dots \end{array} \cap \begin{array}{|c} \dots \\ \dots \\ \dots \end{array} \cup \begin{array}{|c} \dots \\ \dots \\ \dots \end{array} \Leftarrow \cap \begin{array}{|c} \dots \\ \dots \\ \dots \end{array} \cap \begin{array}{|c} \dots \\ \dots \\ \dots \end{array} \cup \begin{array}{|c} \dots \\ \dots \\ \dots \end{array} \Rightarrow \cap \begin{array}{|c} \dots \\ \dots \\ \dots \end{array} \cap \begin{array}{|c} \dots \\ \dots \\ \dots \end{array} \cup \begin{array}{|c} \dots \\ \dots \\ \dots \end{array} \\
 (5) \quad \cup \begin{array}{|c} \dots \\ \dots \\ \dots \end{array} \cup \begin{array}{|c} \dots \\ \dots \\ \dots \end{array} \cap \begin{array}{|c} \dots \\ \dots \\ \dots \end{array} \Leftarrow \cup \begin{array}{|c} \dots \\ \dots \\ \dots \end{array} \cup \begin{array}{|c} \dots \\ \dots \\ \dots \end{array} \cap \begin{array}{|c} \dots \\ \dots \\ \dots \end{array} \Rightarrow \cup \begin{array}{|c} \dots \\ \dots \\ \dots \end{array} \cup \begin{array}{|c} \dots \\ \dots \\ \dots \end{array} \cap \begin{array}{|c} \dots \\ \dots \\ \dots \end{array} \\
 (6) \quad \cap \begin{array}{|c} \dots \\ \dots \\ \dots \end{array} \cup \begin{array}{|c} \dots \\ \dots \\ \dots \end{array} \cap \begin{array}{|c} \dots \\ \dots \\ \dots \end{array} \Leftarrow \cap \begin{array}{|c} \dots \\ \dots \\ \dots \end{array} \cup \begin{array}{|c} \dots \\ \dots \\ \dots \end{array} \cap \begin{array}{|c} \dots \\ \dots \\ \dots \end{array} \Rightarrow \cap \begin{array}{|c} \dots \\ \dots \\ \dots \end{array} \cup \begin{array}{|c} \dots \\ \dots \\ \dots \end{array} \cap \begin{array}{|c} \dots \\ \dots \\ \dots \end{array} \\
 (7) \quad \cup \begin{array}{|c} \dots \\ \dots \\ \dots \end{array} \cap \begin{array}{|c} \dots \\ \dots \\ \dots \end{array} \cap \begin{array}{|c} \dots \\ \dots \\ \dots \end{array} \Leftarrow \cup \begin{array}{|c} \dots \\ \dots \\ \dots \end{array} \cap \begin{array}{|c} \dots \\ \dots \\ \dots \end{array} \cap \begin{array}{|c} \dots \\ \dots \\ \dots \end{array} \Rightarrow \cup \begin{array}{|c} \dots \\ \dots \\ \dots \end{array} \cap \begin{array}{|c} \dots \\ \dots \\ \dots \end{array} \cap \begin{array}{|c} \dots \\ \dots \\ \dots \end{array} \\
 (8) \quad \cap \begin{array}{|c} \dots \\ \dots \\ \dots \end{array} \cap \begin{array}{|c} \dots \\ \dots \\ \dots \end{array} \cap \begin{array}{|c} \dots \\ \dots \\ \dots \end{array} \Leftarrow \cap \begin{array}{|c} \dots \\ \dots \\ \dots \end{array} \cap \begin{array}{|c} \dots \\ \dots \\ \dots \end{array} \cap \begin{array}{|c} \dots \\ \dots \\ \dots \end{array} \Rightarrow \cap \begin{array}{|c} \dots \\ \dots \\ \dots \end{array} \cap \begin{array}{|c} \dots \\ \dots \\ \dots \end{array} \cap \begin{array}{|c} \dots \\ \dots \\ \dots \end{array}.
 \end{array}$$

Each one can be shown confluent for Ξ by considering the confluence of a natural branching in the rewriting system $(SD_{\leq 3}, \sim^{SD})$. For example, (5) is joinable as follows:

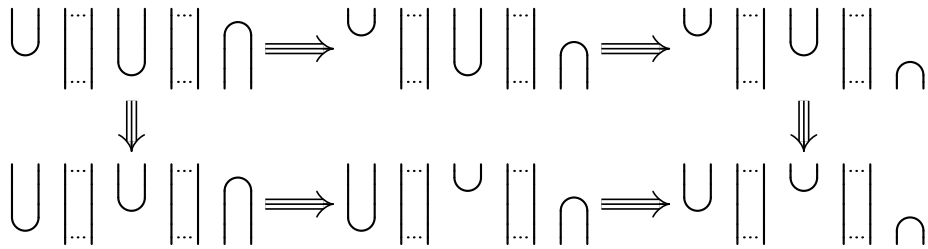

Up to inverses, it corresponds to the following confluent natural branching of (SD, \sim^{SD}) :

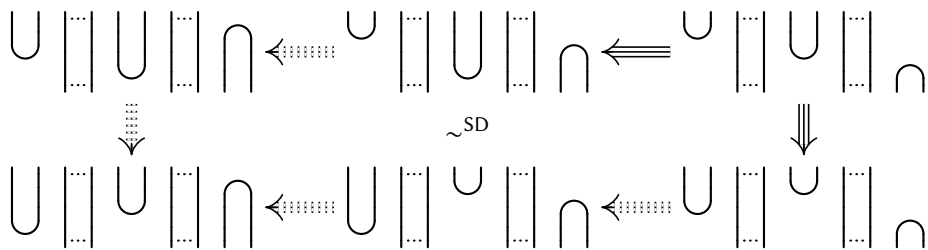

By the definition of Ξ , (5) is then confluent for Ξ . The other kinds of separated structural-structural Q-critical branchings are confluent by similar arguments.

There are four kinds of half-separated structural-structural Q-critical branchings listed here

- (1)
- (2)
- (3)
- (4)

Each one can be shown confluent for Ξ by considering the confluence of a natural branching in $(SD_{\leq 3}, \sim^{SD})$. For example, (1) is joinable as follows

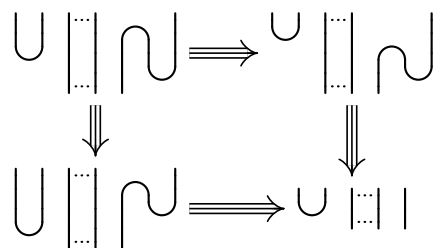

Up to inverses, it corresponds to the following confluent natural branching of $(SD_{\leq 3}, \sim^{SD})$:

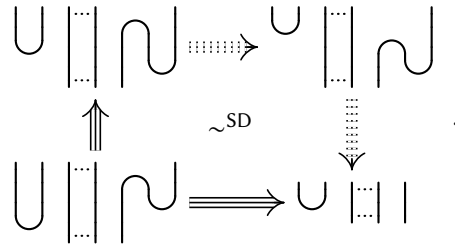

By definition of Ξ , it implies that (1) is confluent for Ξ .

There are two kinds of not separated structural-structural Q-critical branchings listed below:

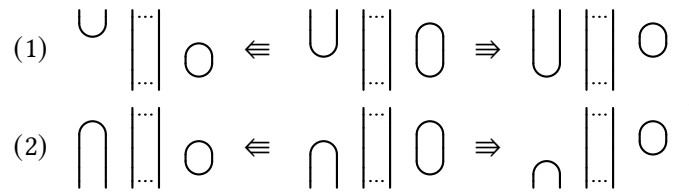

They are not confluent but they are not connected branchings.

We now consider *structural-operational* Q-critical branchings, *i.e.*, those Q-critical branchings (S_1, S_2) such that the inner 3-generator of S_1 is a Q-interchange generator and the inner 3-generator of S_2 is N or \mathcal{N} . We classify them as *separated* and *half-separated*. There are four kinds of separated structural-operational Q-critical branchings listed below:

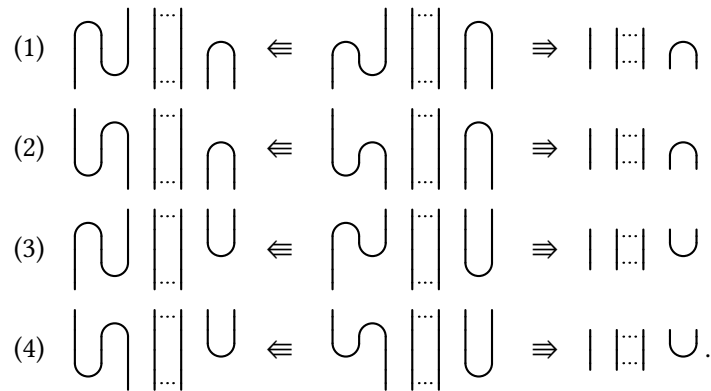

Each one can be shown confluent by considering a natural branching of $(SD_{\leq 3}, \sim^{SD})$, like was done above.

There are two kinds of half-separated structural-operational Q-critical branchings listed below:

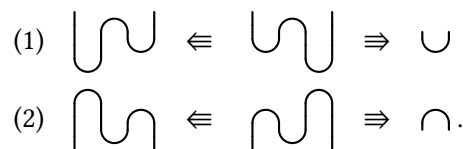

As above, each one of them can be proved confluent by considering the associated critical branching in $(SD_{\leq 3}, \sim^{SD})$.

Note that there are no *operational-operational* Q-critical branching, *i.e.*, Q-critical branchings (S_1, S_2) where the inner 3-generators of both S_1 and S_1 are in $\{N, \mathcal{N}\}$. Hence, all connected Q-critical branchings are confluent. \square

We can conclude the following weak confluence property:

Proposition 4.4.4.9. *All the connected branchings of (Q, Ξ) are confluent.*

Proof. By Lemmas 4.4.4.6 to 4.4.4.8. □

4.4.4.10 – Coherence. In order to obtain a weak coherence property for SD, we first state several adapted versions of the properties of Section 4.3.1 to the setting of connected 2-cells:

Lemma 4.4.4.11. *Given $F: \phi \Rightarrow \phi' \in \overline{Q}_3^\top$ where either ϕ or ϕ' is connected, we have $F = G \bullet_2 H^{-1}$ for some $G: \phi \Rightarrow \psi$ and $H: \phi' \Rightarrow \psi$.*

Proof. By a direct adaptation of Proposition 4.3.1.3 involving connected 2-cells only, and using Proposition 4.4.4.9. □

Lemma 4.4.4.12. *Given $F_1, F_2: \phi \Rightarrow \phi' \in \overline{Q}_3$, if ϕ is connected, then $F_1 = F_2$ in \overline{Q}_3^\top .*

Proof. Since ϕ is connected, ϕ' is connected. By Proposition 4.4.4.4, there is $G: \phi' \Rightarrow \psi \in \overline{Q}_3$ such that ψ is a normal form for Q. By Proposition 4.4.4.9, there is $H_1, H_2: \psi \Rightarrow \psi' \in \overline{Q}_3$ such that $F_1 \bullet_2 G \bullet_2 H_1 = F_1 \bullet_2 G \bullet_2 H_2$. Since ψ is a normal form, $H_1 = H_2 = \text{id}_\psi$. So $F_1 \bullet_2 G = F_2 \bullet_2 G$, thus $F_1 = F_2$ in \overline{Q}_3^\top . □

Lemma 4.4.4.13. *Given $F_1, F_2: \phi \Rightarrow \phi' \in \overline{Q}_3^\top$, if ϕ is connected, then $F_1 = F_2$ in \overline{Q}_3^\top .*

Proof. By directly adapting the proof of Proposition 4.3.1.4, using Lemmas 4.4.4.11 and 4.4.4.12. □

We can now conclude with a weak coherence property for SD:

Theorem 4.4.4.14. *Given $F_1, F_2: \phi \Rightarrow \phi' \in \overline{SD}_3^\top$ with ϕ or ϕ' connected, we have $F_1 = F_2$.*

Proof. Let $\Gamma': \overline{Q}^\top \rightarrow \overline{SD}^\top$ be the 3-prefunctor which is the factorization of Γ through the canonical 3-prefunctor $(Q_{\leq 3})^* \rightarrow \overline{Q}^\top$. By definition of \overline{SD}^\top , for $i \in \{1, 2\}$, we have

$$F_i = G_{i,1} \bullet_2 H_{i,1}^{-1} \bullet_2 \cdots \bullet_2 G_{i,k_i} \bullet_2 H_{i,k_i}^{-1}$$

for some $k_i \in \mathbb{N}$, 2-cells $\phi_{i,0}, \dots, \phi_{i,k_i}, \psi_{i,1}, \dots, \psi_{i,k_i} \in Q_2^*$ such that $\phi_{i,0} = \phi$ and $\phi_{i,k_i} = \phi'$, and, for $j \in \mathbb{N}_{k_i}^*$, 3-cells

$$G_{i,j}: \phi_{i,j-1} \Rightarrow \psi_{i,j} \quad \text{and} \quad H_{i,j}: \phi_{i,j} \Rightarrow \psi_{i,j}$$

of \overline{SD}_3 . Since either ϕ or ϕ' is connected, we have that all the $\phi_{i,j}$'s and the $\psi_{i,j}$'s are connected. Moreover, all the $G_{i,j}$'s and the $H_{i,j}$'s are in the image of Γ' . So, for $i \in \{1, 2\}$, $F_i = \Gamma'(F'_i)$ for some $F'_i: \phi \Rightarrow \phi' \in \overline{Q}^\top$. By Lemma 4.4.4.13, we have $F'_1 = F'_2$, so that $F_1 = F_2$. □

Bibliography

- [AR94] Jiří Adámek and Jiří Rosický. *Locally Presentable and Accessible Categories*. London Mathematical Society Lecture Notes Series 189. Cambridge University Press, 1994.
- [ABS00] Fahd A. Al-Agl, Ronald Brown, and Richard Steiner. *Multiple categories: the equivalence of a globular and a cubical approach*. 2000. arXiv: math/0007009.
- [AM16] Dimitri Ara and Georges Maltsiniotis. *Joint et tranches pour les ω -catégories strictes*. 2016. arXiv: 1607.00668.
- [AM18] Dimitri Ara and Georges Maltsiniotis. “Un théorème A de Quillen pour les ∞ -catégories strictes I : la preuve simpliciale”. In: *Advances in Mathematics* 328 (2018), pp. 446–500.
- [AK00] Chris J. Ash and Julia Knight. *Computable Structures and the Hyperarithmetical Hierarchy*. Studies in Logic and the Foundations of Mathematics 144. Elsevier, 2000.
- [BN99] Franz Baader and Tobias Nipkow. *Term Rewriting and All That*. Cambridge University Press, 1999.
- [BS10] John Baez and Mike Stay. “Physics, topology, logic and computation: a Rosetta Stone”. In: *New structures for physics*. 2010, pp. 95–172.
- [BKV16] Krzysztof Bar, Aleks Kissinger, and Jamie Vicary. “Globular: an online proof assistant for higher-dimensional rewriting”. In: *Leibniz International Proceedings in Informatics (LIPIcs)*. Vol. 52. 2016, 34:1–34:11. arXiv: 1612.01093.
- [BV17] Krzysztof Bar and Jamie Vicary. “Data structures for quasistrict higher categories”. In: *32nd Annual Symposium on Logic in Computer Science (LICS)*. 2017, pp. 1–12. arXiv: 1610.06908.
- [Bat98a] Michael A. Batanin. “Computads for finitary monads on globular sets”. In: *Contemporary Mathematics* 230 (1998), pp. 37–58.
- [Bat98b] Michael A. Batanin. “Monoidal globular categories as a natural environment for the theory of weak n -categories”. In: *Advances in Mathematics* 136.1 (1998), pp. 39–103.
- [Bec67] Jonathan M. Beck. “Triples, algebras and cohomology”. PhD thesis. Columbia University, United States of America, 1967.
- [Bén67] Jean Bénabou. “Introduction to bicategories”. In: *Reports of the midwest category seminar*. 1967, pp. 1–77.

- [Ber99] Clemens Berger. “Double loop spaces, braided monoidal categories and algebraic 3-type of space”. In: *Contemporary Mathematics* 227 (1999), pp. 49–66.
- [Bir84] Greg J. Bird. “Limits in 2-categories of locally-presented categories”. PhD thesis. University of Sydney, Australia, 1984.
- [Bor94a] Francis Borceux. *Handbook of Categorical Algebra*. Vol. 1: *Basic Category Theory*. Encyclopedia of Mathematics and its Applications 50. Cambridge University Press, 1994.
- [Bor94b] Francis Borceux. *Handbook of Categorical Algebra*. Vol. 2: *Categories and Structures*. Encyclopedia of Mathematics and its Applications 51. Cambridge University Press, 1994.
- [Bou07] Nicolas Bourbaki. *Algèbre. Chapitres 1 à 3*. Éléments de mathématique. Springer, 2007.
- [Buc15] Mitchell Buckley. “A formal verification of the theory of parity complexes”. In: *Journal of Formalized Reasoning* 8.1 (2015), pp. 25–48.
- [Bur93] Albert Burroni. “Higher-dimensional word problems with applications to equational logic”. In: *Theoretical Computer Science* 115.1 (1993), pp. 43–62.
- [Bur12] Albert Burroni. “Automates et grammaires polygraphiques”. In: *Diagrammes* 67 (2012), pp. 9–32.
- [Cam16] Alexander Campbell. “A higher categorical approach to Giraud’s non-abelian cohomology”. PhD thesis. Macquarie University, Australia, 2016.
- [Chu36] Alonzo Church. “An unsolvable problem of elementary number theory”. In: *American journal of mathematics* 58.2 (1936), pp. 345–363.
- [CM17] Pierre-Louis Curien and Samuel Mimram. *Coherent presentations of monoidal categories*. 2017. arXiv: 1705.03553.
- [Deh11] Max Dehn. “Über unendliche diskontinuierliche Gruppen”. In: *Mathematische Annalen* 71 (1911), pp. 116–144.
- [DV18] Antonin Delpuch and Jamie Vicary. *Normalization for planar string diagrams and a quadratic equivalence algorithm*. 2018. arXiv: 1804.07832.
- [Dos18] Matěj Dostál. “Two-dimensional universal algebra”. PhD thesis. Czech Technical University in Prague, Czech Republic, 2018.
- [DV16] Lawrence Dunn and Jamie Vicary. *Coherence for Frobenius pseudomonoids and the geometry of linear proofs*. 2016. arXiv: 1601.05372.
- [Ehr65] Charles Ehresmann. *Catégories et structures*. Dunod, 1965.
- [EM42] Samuel Eilenberg and Saunders MacLane. “Natural isomorphisms in group theory”. In: *Proceedings of the National Academy of Sciences of the United States of America* 28.12 (1942), p. 537.
- [EM45] Samuel Eilenberg and Saunders MacLane. “General theory of natural equivalences”. In: *Transactions of the American Mathematical Society* 58.2 (1945), pp. 231–294.
- [FM19] Simon Forest and Samuel Mimram. “Describing free ω -categories”. In: *34th Annual Symposium on Logic in Computer Science (LICS)*. 2019, pp. 1–13.
- [GU06] Peter Gabriel and Friedrich Ulmer. *Lokal präsentierbare Kategorien*. Lecture Notes in Mathematics 221. Springer, 2006.
- [GGM15] Stéphane Gaussent, Yves Guiraud, and Philippe Malbos. “Coherent presentations of Artin monoids”. In: *Compositio Mathematica* 151.5 (2015), pp. 957–998. arXiv: 1203.5358.

- [Göd34] Kurt Gödel. *On undecidable propositions of formal mathematical systems*. Notes by Stephen C. Kleene and Barkely Rosser of lectures given at the Institute for Advanced Study. 1934.
- [GPS95] Robert Gordon, A. John Power, and Ross Street. *Coherence for Tricategories*. Memoirs of the American Mathematical Society 558. American Mathematical Society, 1995.
- [Gra06] John W. Gray. *Formal Category Theory: Adjointness for 2-Categories*. Lecture Notes in Mathematics 391. Springer, 2006.
- [Gue20] Léonard Guetta. “Polygraphs and discrete Conduché ω -functors”. In: *Higher Structures* 4.2 (2020).
- [GM09] Yves Guiraud and Philippe Malbos. “Higher-dimensional categories with finite derivation type”. In: *Theory and Applications of Categories* 22.18 (2009), pp. 420–478.
- [GM12] Yves Guiraud and Philippe Malbos. “Coherence in monoidal track categories”. In: *Mathematical Structures in Computer Science* 22.6 (2012), pp. 931–969.
- [GM18] Yves Guiraud and Philippe Malbos. “Polygraphs of finite derivation type”. In: *Mathematical Structures in Computer Science* 28.2 (2018), pp. 155–201. arXiv: 1402.2587.
- [GMM13] Yves Guiraud, Philippe Malbos, and Samuel Mimram. “A homotopical completion procedure with applications to coherence of monoids”. In: *24th International Conference on Rewriting Techniques and Applications (RTA)*. Vol. 21. 2013, pp. 223–238.
- [Gur06] M. Nick Gurski. “An algebraic theory of tricategories”. PhD thesis. University of Chicago, United States of America, 2006.
- [Gur13] M. Nick Gurski. *Coherence in Three-Dimensional Category Theory*. Cambridge Tracts in Mathematics 201. Cambridge University Press, 2013.
- [Had18] Amar Hadzihasanovic. *A combinatorial-topological shape category for polygraphs*. 2018. arXiv: 1806.10353.
- [Har98] Valentina S. Harizanov. “Pure computable model theory”. In: *Studies in Logic and the Foundations of Mathematics* 138. Elsevier, 1998, pp. 3–114.
- [Hen17] Simon Henry. *Non-unital polygraphs form a presheaf category*. 2017. arXiv: 1711.00744.
- [Hen18] Simon Henry. *Regular polygraphs and the Simpson conjecture*. 2018. arXiv: 1807.02627.
- [Jan84] Matthias Jantzen. “Thue systems and the Church-Rosser property”. In: *International Symposium on Mathematical Foundations of Computer Science*. 1984, pp. 80–95.
- [Joh87] Michael S. J. Johnson. “Pasting diagrams in n -categories with applications to coherence theorems and categories of paths”. PhD thesis. University of Sydney, Australia, 1987.
- [Joh89] Michael S. J. Johnson. “The combinatorics of n -categorical pasting”. In: *Journal of Pure and Applied Algebra* 62.3 (1989), pp. 211–225.
- [Joy02] André Joyal. “Quasi-categories and Kan complexes”. In: *Journal of Pure and Applied Algebra* 175.1-3 (2002), pp. 207–222.
- [JK06] André Joyal and Joachim Kock. *Weak units and homotopy 3-types*. 2006. arXiv: math/0602084.
- [JS93] André Joyal and Ross Street. “Braided tensor categories”. In: *Advances in Mathematics* 102.1 (1993), pp. 20–78.

- [KV91a] Mikhail Kapranov and Vladimir Voevodsky. “ ∞ -groupoids and homotopy types”. In: *Cahiers de Topologie et Géométrie Différentielle Catégoriques* 32.1 (1991), pp. 29–46.
- [KV91b] Mikhail Kapranov and Vladimir Voevodsky. “Combinatorial-geometric aspects of polycategory theory: pasting schemes and higher Bruhat orders (list of results)”. In: *Cahiers de Topologie et Géométrie Différentielle Catégoriques* 32.1 (1991), pp. 11–27.
- [KS06] Masaki Kashiwara and Pierre Schapira. *Categories and Sheaves*. Grundlehren der mathematischen Wissenschaften 332. Springer, 2006.
- [Kel82] G. Max Kelly. *Basic Concepts of Enriched Category Theory*. London Mathematical Society Lecture Notes Series 64. Cambridge University Press, 1982.
- [Knu72] Donald E. Knuth. “Ancient babylonian algorithms”. In: *Communications of the ACM* 15.7 (1972), pp. 671–677.
- [Lac00] Stephen Lack. “A coherent approach to pseudomonads”. In: *Advances in Mathematics* 152.2 (2000), pp. 179–202.
- [Laf92] Yves Lafont. “Penrose diagrams and 2-dimensional rewriting”. In: *Applications of Categories in Computer Science* 177 (1992), pp. 191–201.
- [Laf95] Yves Lafont. “A new finiteness condition for monoids presented by complete rewriting systems”. In: *Journal of Pure and Applied Algebra* 98.3 (1995), pp. 229–244.
- [Laf03] Yves Lafont. “Towards an algebraic theory of boolean circuits”. In: *Journal of Pure and Applied Algebra* 184.2 (2003), pp. 257–310.
- [Lei98] Tom Leinster. *General operads and multicategories*. 1998. arXiv: math/9810053.
- [Lei04] Tom Leinster. *Higher Operads, Higher Categories*. London Mathematical Society Lecture Notes Series 298. Cambridge University Press, 2004.
- [Mac63] Saunders MacLane. “Natural associativity and commutativity”. In: *Rice University Studies* 49.4 (1963).
- [Mac13] Saunders MacLane. *Categories for the Working Mathematician*. Graduate Texts in Mathematics 5. Springer, 2013.
- [MP85] Saunders MacLane and Robert Paré. “Coherence for bicategories and indexed categories”. In: *Journal of Pure and Applied Algebra* 37 (1985), pp. 59–80.
- [Mak05] Michael Makkai. *The word problem for computads*. 2005.
- [MP89] Michael Makkai and Robert Paré. *Accessible Categories: The Foundations of Categorical Model Theory*. Vol. 104. American Mathematical Society, 1989.
- [Mar47] Andreï A. Markov. “Невозможность некоторых алгоритмов в теории ассоциативных систем (Impossibility of certain algorithms in the theory of associative systems)”. In: *Доклады Академии наук СССР* 55 (1947), pp. 587–590.
- [Mar97] Francisco Marmolejo. “Doctrines whose structure forms a fully faithful adjoint string”. In: *Theory and Applications of Categories* 3.2 (1997), pp. 24–44.
- [Mét08] François Métayer. “Cofibrant objects among higher-dimensional categories”. In: *Homology, Homotopy and Applications* 10.1 (2008), pp. 181–203.
- [Mim14] Samuel Mimram. “Towards 3-dimensional rewriting theory”. In: *Logical Methods in Computer Science (LMCS)* 10.1 (2014), pp. 1–47. arXiv: 1403.4094.
- [Ngu17] Christopher Nguyen. “Parity structure on associahedra and other polytopes”. PhD thesis. Macquarie University, Australia, 2017.

- [Nov55] Pyotr S. Novikov. “Об алгоритмической неразрешимости проблемы тождества слов в теории групп (On the algorithmic unsolvability of the word problem in group theory)”. In: *Труды Математического института имени В.А. Стеклова СССР* 44 (1955), pp. 3–143.
- [PV07] Erik Palmgren and Steven J. Vickers. “Partial Horn logic and cartesian categories”. In: *Annals of Pure and Applied Logic* 145.3 (2007), pp. 314–353.
- [Pen99] Jacques Penon. “Approche polygraphique des ∞ -catégories non strictes”. In: *Cahiers de Topologie et Géométrie Différentielle Catégoriques* 40.1 (1999), pp. 31–80.
- [Pos47] Emil L. Post. “Recursive unsolvability of a problem of Thue”. In: *The Journal of Symbolic Logic* 12.1 (1947), pp. 1–11.
- [Pow91] A. John Power. “An n -categorical pasting theorem”. In: *Category theory*. 1991, pp. 326–358.
- [Rog87] Hartley Rogers Jr. *Theory of Recursive Functions and Effective Computability*. MIT Press, 1987.
- [Sim98] Carlos Simpson. *Homotopy types of strict 3-groupoids*. 1998. arXiv: math/9810059.
- [Sim11] Carlos Simpson. *Homotopy Theory of Higher Categories. From Segal Categories to n -Categories and Beyond*. New Mathematical Monographs 19. Cambridge University Press, 2011.
- [Sko23] Thoralf Skolem. *Begründung der elementaren Arithmetik durch die rekurrierende Denkweise ohne Anwendung scheinbarer Veränderlichen mit unendlichem Ausdehnungsbereich*. Dybusach, 1923.
- [Squ87] Craig C. Squier. “Word problems and a homological finiteness condition for monoids”. In: *Journal of Pure and Applied Algebra* 49.1-2 (1987), pp. 201–217.
- [SOK94] Craig C. Squier, Friedrich Otto, and Yuji Kobayashi. “A finiteness condition for rewriting systems”. In: *Theoretical Computer Science* 131.2 (1994), pp. 271–294.
- [Ste04] Richard Steiner. “Omega-categories and chain complexes”. In: *Homology, Homotopy and Applications* 6.1 (2004), pp. 175–200.
- [Str72] Ross Street. “The formal theory of monads”. In: *Journal of Pure and Applied Algebra* 2.2 (1972), pp. 149–168.
- [Str76] Ross Street. “Limits indexed by category-valued 2-functors”. In: *Journal of Pure and Applied Algebra* 8.2 (1976), pp. 149–181.
- [Str87] Ross Street. “The algebra of oriented simplexes”. In: *Journal of Pure and Applied Algebra* 49.3 (1987), pp. 283–335.
- [Str91] Ross Street. “Parity complexes”. In: *Cahiers de Topologie et Géométrie Différentielle Catégoriques* 32.4 (1991), pp. 315–343.
- [Str94] Ross Street. “Parity complexes: corrigenda”. In: *Cahiers de Topologie et Géométrie Différentielle Catégoriques* 35.4 (1994), pp. 359–361.
- [Str96] Ross Street. “Categorical structures”. In: *Handbook of Algebra*. Vol. 1. 1996, pp. 529–577.
- [Str04] Ross Street. “Frobenius monads and pseudomonoids”. In: *Journal of Mathematical Physics* 45.10 (2004), pp. 3930–3948.
- [SD97] Ross Street and Brian Day. “Monoidal bicategories and Hopf algebroids”. In: *Advances in Mathematics* 129 (1997), pp. 99–157.

- [Ter03] Terese. *Term Rewriting Systems*. Cambridge Tracts in Theoretical Computer Science 55. Cambridge University Press, 2003.
- [Thu14] Axel Thue. “Probleme über Veränderungen von Zeichenreihen nach gegebenen Regeln”. In: *Christiana Videnskabs-Selskabs Skrifter: Matematisk-naturvidenskabelig klasse*. 10. 1914.
- [Tur36] Alan M. Turing. “On computable numbers, with an application to the Entscheidungsproblem”. In: *Proceedings of the London Mathematical Society (2)* 42.1 (1936), pp. 230–265.
- [Tur37] Alan M. Turing. “Computability and λ -definability”. In: *The Journal of Symbolic Logic* 2.4 (1937), pp. 153–163.
- [Web09] Mark Weber. *Free products of higher operad algebras*. 2009. arXiv: 0909.4722.

Index

- activation, 216
- acyclic, 194
- adjunction, 20
- algebra over a monad, 10
- algebraic higher category, 2
- arity of a symbol, 5
- atom
 - of a pre-*adc*, 207
 - of a pre-pasting scheme, 202
 - of an ω -hypergraph, 197
- augmentation, 205
- augmented directed complex (*adc*), 205

- basis of an *adc*, 205
- bicategory, 2
- boundary operator, 205
- branching, 301

- cartesian monoidal structure, 78
- categorical action, 104
- k*-category, 14
- category of elements, 175
- cell
 - of a *k*-category, 14
 - of a (pre-)*adc*, 206
 - of an ω -hypergraph, 196
- k*-cellular extension, 40
- closed fgs, 202
- closed-well-formed, 244
- code
 - of a categorical action, 141
 - of a cellular extension, 141
 - of a function, 132
 - of a function w.r.t. encodings, 134
 - of a globular set, 140
 - of a precategory, 141
 - of a strict category, 140
 - relatively to an encoding, 134
- cofinal functor, 17
- coherence cell, 2
- coherent
 - 3-precategory, 299
 - Gray presentation, 299
- comparison functor, 11
- composable, 13, 268
- composition operation
 - for (pre-)*adc* cells, 207
 - for ω -hypergraph cells, 197
 - for closed fgs's, 243
 - for maximal fgs's, 243
 - for pre-pasting scheme fgs's, 203
- computable
 - categorical action, 141
 - cellular extension, 141
 - globular set, 140
 - polygraph, 152
 - precategory, 140
 - strict category, 140
- computable function, 134
- concrete category, 174
- concrete presheaf category, 175
- concretely equivalent categories, 174
- concretization functor, 174
- Conduché functor, 116
- confluent

- 3-precategory, 299
- branching, 302
- rewriting system, 302
- congruence, 274
- connected
 - 2-cell, 320
 - branching, 329
 - category, 17
- context (class), 106
- context (for a theory), 5
- convergent rewriting system, 302
- critical branching, 306
- Q-critical branching, 329
- datatype, 135
- decidable
 - encoding, 134
 - relation, 138
 - subset, 133
- diagram, 3
- direct loop, 202
- directed, 3
- effectively factorizable
 - categorical action, 143
 - precategory, 142
 - strict category, 142
- effectively right-finite relation, 138
- Eilenberg-Moore category, 10
- encoded by a datatype, 135
- encoding, 134
 - of a cellular extension, 141
 - of a globular set, 140
- enriched category, 78
- equality-decidable encoding, 134
- equivalence of concrete categories, 174
- equivalent cospans, 319
- essentially algebraic
 - category, 7
 - theory, 6
- essentially unique factorization, 4
- evaluation
 - of a context (class), 106
 - of a whisker, 267
- evaluation of terms
 - of precategories, 273
 - strict categories, 155
- exchange law, 58
- finitary
 - functor, 5
 - monad, 5
 - relation, 201
- finite
 - classes, 138
 - polygraph, 51
- finite graded subset (fgs), 202
- finitely factorizable
 - categorical action, 143
 - precategory, 142
 - strict category, 142
- finitely presentable
 - monoid, 4
 - object, 4
- fork-free
 - for an ω -hypergraph, 194
 - for an adc, 256
 - for an adc cell, 256
- free category
 - on a cellular extension, 43
 - on a polygraph, 47
- free extension, 43
- Frobenius pseudomonoid, 324
- n -functor, 58
- funny tensor product, 79
- generator
 - of a cellular extension, 40
 - of a polygraph, 47
 - of an ω -hypergraph, 193
- globe, 12
- globular algebra, 14
- n -globular group, 89
- globular set, 12
- glueable, 216
- gluing, 216
- graded set, 193
- Gray category, 283
- (3, 2)-Gray category, 284
- Gray presentation, 285
- greatest lower bound, 205
- n -group, 89
- Henry's measure, 99
- ω -hypergraph, 193
- identity context (class), 110
- identity operation
 - for (pre-)adc cells, 207
 - for ω -hypergraph cells, 197

- for closed or maximal fgs's, 243
 - for pre-pasting scheme fgs's, 203
- identity whisker, 269
- inclusion
 - of a globular algebra, 16
 - of a globular set, 13
 - of a strict category, 62
 - of precategory, 68
- independence generator, 285
- independent branching, 306
- initial set, 194
- injective encoding, 134
- inner generator, 301
- instantiable type, 106
- interchange generator, 285
- Q-interchange generator, 327
- interchange naturality generator, 286
- interchanger, 283
- isofibration, 38

- joinable branching, 301

- labelling of a categorical action, 148
- lax Gray category, 283
- lax Gray tensor product, 282
- length
 - for a free precategory, 271
 - for a free strict category, 123
 - of an n -sequence, 122
- linear extension, 225
- linearization of a category, 93
- local branching, 301
- localization functor, 276
- locally finitely presentable category, 4
- loop-free basis, 208
- loop-free pasting scheme, 204

- Makkai's measure, 100
- maximal
 - fgs, 238
 - generator, 238
- maximal-well-formed, 244
- minimal branching, 306
- model of an essentially algebraic theory, 6
- monadic functor, 11
- monoidal category, 77
- morphism
 - of n -globular groups, 89
 - of n -groups, 90
 - of algebras, 10
 - of categorical actions, 105
 - of enriched categories, 78
 - of essentially algebraic theories, 8
 - of globular sets, 12
 - of lax Gray categories, 284
 - of linear extensions, 225
 - of models, 7
 - of monads, 11
 - of precategories, 67
 - of set-encoded polygraphs, 157
 - of strict categories, 58
- movement, 196

- natural branching, 306
- normal form, 301

- operational generator, 312
- orthogonal, 214

- parallel, 13
- parity complex, 198
- pasting scheme, 203
- plex, 176
- plex lifting, 181
- polygraph, 47
 - of precategories, 69
 - of strict categories, 64
- polyplex, 177
- polyplex lifting, 181
- positive
 - for a free abelian group, 99
 - Gray presentation, 304
- pre-augmented directed complex, 205
- pre-cell
 - of a (pre-)adc, 206
 - of an ω -hypergraph, 196
- pre-pasting scheme, 201
- precategory, 66
 - (3, 2)-precategory, 276
- n -prefunctor, 67
- prepolygraph, 69
- presentation (of precategories), 276
- primitive element, 175
- principal
 - element, 175
 - polygraph, 176
- pseudo Gray category, 284
- pseudo Gray tensor product, 282

- radical, 257

- recursive function, 132
- recursive model
 - of a categorical action, 141
 - of a cellular extension, 141
 - of a function, 134
 - of a globular set, 140
 - of a precategory, 141
 - of a strict category, 140
- recursive subset, 133
- relevant, 197
- rewrite, 301
- rewriting path, 301
- rewriting step, 273
- rewriting system, 302
- right-finite relation, 138

- segment, 194
- self-duality, 324
- n -sequence, 122
- n -sequence class, 123
- set-encoded polygraph, 157
- signature, 5
- sort, 6
- source
 - for an ω -hypergraph, 193
 - iterated, 13
 - of a closed fgs, 241
 - of a context (class), 109
 - of a globe, 12
 - of a maximal fgs, 241
 - of a pre-pasting scheme fgs, 202
 - of a whisker, 268
- source-finite, 148
- specialization, 175
- split coequalizer, 59
- stable subset of a polygraph, 164
- strict category, 57
- structural-operational branching, 331
- structural-structural branching, 329
- support function, 162
- support of an encoding, 134
- symbol, 5
- symmetric branching, 301

- target
 - for an ω -hypergraph, 193
 - iterated, 13
 - of a closed fgs, 241
 - of a context (class), 109
 - of a globe, 12
 - of a maximal fgs, 241
 - of a pre-pasting fgs, 202
 - of a symbol, 5
 - of a whisker, 268
- tensor product, 77
- term definition of a polygraph, 159
- term on a polygraph
 - of precategories, 273
 - of strict categories, 155
- term on a signature, 5
- terminal set, 194
- terminating, 301
- tight, 198
- torsion, 209
- torsion-free complex, 209
- total function, 131
- translation function, 239
- trivial branching, 305
- (weakly) truncable monad, 31
- truncation
 - of a globular algebra, 16
 - of a globular set, 13
 - of a strict category, 61
 - of precategory, 68
- type, 106

- unital basis, 208

- weird 2-category, 15
- well-formed fgs (wfs), 203
- well-typed term
 - of precategories, 273
 - of strict categories, 155
- whisker, 267
- word problem instance, 161
- word problem on polygraphs
 - of precategories, 273
 - of strict categories, 156

- zigzag (localization), 276
- zigzag equations (adjunctions), 20

Glossary

\mathcal{C}^T the Eilenberg-Moore category w.r.t. the monad T	10
\mathcal{C}^ϕ the functor derived from a morphism of monad ϕ	11
$X_k \times_i X_l$ the set of pairs of i -composable k - and l -globes	13
X_{-1} by convention, the singleton set of (-1) -globes of a globular set	13
$\rightarrow, \Rightarrow, \Rrightarrow, \Rrightarrow$ arrows which indicate the source and target of globes of a globular set	13
(T^k, η^k, μ^k) the k -truncation of a monad T on globular sets	14
$\sim^{\mathcal{C}}$ the equivalence relation which describes how connected a category \mathcal{C} is	17
$-[-]^k, C[X]$ the free functor which maps a k -cellular extension to a $(k+1)$ -category	43
$(-)^{*,k}, P^*$ the functor which maps a k -polygraph to the associated free k -category	47
$(-)_i^k, P_i$ the functor which maps a k -polygraph to its set of i -generators	48
$*_i$ the composition operation for strict categories	57
\bullet_i the composition operation for precategories	66
\square the funny tensor product	79
$ - , C $ the functor which maps an n -category to the disjoint union of the sets of cells ...	93
$ - , P $ the functor which maps a polygraph to the disjoint union of the sets of generators	97
\approx_m the relation which witnesses that two m -contexts are equivalent	106
$-[-]^A, C[A]^A$ the functor which maps an n -cellular extension to the associated free n -categorical action	116
A^\star the set of n -sequences over A	122
$ u $ the length of the cell u	122
\approx the relation which witnesses that two n -sequences are equivalent	123
A^\approx the set of n -sequence classes over A	123
$-[-]^\approx, C[A]^\approx$ the functor which maps an n -categorical action to the associated free strict $(n+1)$ -category	126
$\circ_{k,(l)_i}$ the composition operation on partial functions on natural numbers	131
$X^{<\omega}$ the set of finite sequences of elements of X	136
$\uparrow_A^n(X)$ the trivial n -categorical action whose set of top cells is X	148
$\hat{\approx}_m$ a relation equivalent to \approx_m but with a more efficient definition	153
$t_1 \bar{*}_{i,k} t_2$ a term representing the i -composition of t_1 and t_2	155
$\llbracket - \rrbracket^P$ the evaluation function from well-typed terms on P to cells of P^*	156
\bar{D} the polygraph induced by a term definition D	159
P^{u+} the polygraph obtained from P by adding a formal generator of source u	178

$(-)^-, (-)^+$ the source and target operations of an ω -hypergraph	193
$\triangleleft_U, \triangleleft$ a pre-order on the generators of an ω -hypergraph	194
$(-)^{\mp}, (-)^{\pm}$ the border operations for sets of generators of an ω -hypergraph	195
$\langle u \rangle$ the atom associated to the generator u	197
$(-)^{\mp}, (-)^{\pm}$ the border operations on a pre-adc	205
$u \wedge v$ the greatest lower bound of u and v	205
$[u]$ the atom associated to the basis generator u of a pre-adc	207
$<_i$ a pre-order on the basis of a pre-adc	208
\curvearrowright a pre-order on the generators of an ω -hypergraph	212
$S \perp T$ the property that S and T are orthogonal	214
$*_i^M$ the composition operation on maximal fgs's	243
$*_i^{Cl}$ the composition operation on closed fgs's	243
P^H the ω -hypergraph associated to the polygraph P	247
\sim^C the canonical congruence on $C_{\leq n}$ derived from the $(n+1)$ -precategory C	274
$(-)$ the functor which maps an $(n+1)$ -prepolygraph to the presented n -precategory	276
\sim^P the equivalence relation \sim^{P^*}	276
$(-)^T$ the localization functor of 3-precategories	276
\boxtimes^{lax} the lax Gray tensor product	278
\boxtimes the pseudo Gray tensor product	282
$\phi \sqcup \psi$ the graph of the shuffles of words on ϕ and ψ	286
$[-]_{\phi, \psi}$ the interpretation functor for shuffles of words on ϕ and ψ	287
$\text{Act}(X, G)$ the activation of G on X	216
adc "augmented directed complex"	205
\mathcal{A}_k the functor which maps a k -cellular extension to its underlying k -algebra	40
\mathbf{Alg}_k the category of k -algebras	14
$(-)^{\text{Alg}}_{\leq k, l}, A_{\leq k}$ the truncation functor for globular algebras	16
$(-)^{\text{Alg}}_{\uparrow l, k}, A_{\uparrow l}$ the inclusion functor for globular algebras	16
$(-)^{\text{Alg}}_{\uparrow n, k}, A_{\uparrow n}$ the right adjoint to the truncation functor $(-)^{\text{Alg}}_{\leq k, n}$	35
\mathbf{Alg}_k^+ the category of k -cellular extensions	40
B the source relation of a pasting scheme	201
\mathbf{Cat}_n^A the category of n -categorical actions	105
$(-)^{\text{Cat}}_{\leq k, l}, C_{\leq k}$ the truncation functor for strict categories	61
$(-)^{\text{Cat}}_{\uparrow l, k}, C_{\uparrow l}$ the inclusion functor for strict categories	62
\mathbf{Cat}_n the category of strict n -categories	58
\mathbf{Cat}_n^+ the category of n -cellular extension for strict categories	64
$\mathcal{V}\text{-Cat}$ the category of categories enriched in \mathcal{V}	79
$\text{Cell}^*(K)$ the set of cells of the pre-adc K	207
$\text{Cell}(P)$ the graded set of cells of the ω -hypergraph P	196
$\text{Cell}(P)^{n+}$ the strict $(n+1)$ -category $\text{Cell}(P)_{\leq n}[P_{n+1}]$	234
$\text{Closed}(P)$ the graded set of closed fgs's of P	238
$\text{Closed}_{\text{WF}}(P)$ the graded set of closed-well-formed fgs's of the ω -hypergraph P	244
Con^P the evaluation prefunctor from P^* to \mathbf{CoSpan}	320
\mathbf{CoSpan} the strict 2-category of cospans on sets	319
δ_C the linearization functor for a strict category C	96
δ_P Henry's measure	99

δ_p^M	Makkai's measure	100
D_n	the set of n -term definitions	159
$\partial_i^-, \partial_i^+$	the source and target operations of a globular set	12
$\bar{\partial}_i^-, \bar{\partial}_i^+$	the source and target operations on closed fgs's	241
$\tilde{\partial}_i^-, \tilde{\partial}_i^+$	the source and target operations on maximal fgs's	241
d_k^-, d_k^+	the source and target operations for generators of cellular extensions or polygraphs	46
E	the target relation of a pasting scheme	201
\mathcal{E}_{k+1}	the canonical functor which maps a $(k+1)$ -polygraph to a k -cellular extension	47
$\text{Elt}(C)$	the category of elements of the concrete category C	175
ϵ^T	the counit of the adjunction $\mathcal{F}^T \dashv \mathcal{U}^T$	10
ϵ^k	the counit of the adjunction $\mathcal{F}_k \dashv \mathcal{U}_k$	29
$\text{eval}^n, \text{eval}$	the evaluation $(n+1)$ -functor from $\text{Cell}(P)^{n+}$ to $\text{Cell}(P)_{\leq n+1}$	235
$E[w]$ ($F[w]$)	the evaluation of a context E (class F) at a cell w	106
\mathcal{E}_X	an encoding for the set X	134
fgs	"finite graded subset"	202
\mathcal{F}_k	the canonical free functor associated to the Eilenberg-Moore category \mathbf{Alg}_k	14
\mathcal{F}^T	the canonical free functor of an Eilenberg-Moore category	10
$\mathcal{F}(X, Y)$	the set of functions from X to Y	137
$\overline{\text{gen}}_k(g)$	a term representing the k -generator g	155
\mathbf{gGrp}_n	the category of n -globular groups	89
\mathcal{G}_k	the functor which maps a $(k-1)$ -cellular extension to its underlying k -globular set	40
\mathbf{Glob}_n	the category of n -globular sets	12
$(-)^{\text{Glob}}_{\leq m, n}, X_{\leq m}$	the truncation functor on globular sets	13
$(-)^{\text{Glob}}_{\uparrow n, m}, X_{\uparrow n}$	the inclusion functor on globular sets	13
$(-)^{\text{Glob}}_{\uparrow m, n}, X_{\uparrow n}$	the right adjoint to the truncation functor $(-)^{\text{Glob}}_{\leq n, m}$	14
$\text{Glue}(X, G)$	the gluing of G on X	216
\mathbf{Grp}_n	the category of n -groups	90
η^A	the unit of the adjunction $(-)^{\text{Alg}}_{\uparrow k+1} \dashv (-)^{\text{Alg}}_{\leq k}$	44
$i^{m, n}, i^m$	the counit of the adjunction $(-)^{\text{Glob}}_{\uparrow n, m} \dashv (-)^{\text{Glob}}_{\leq m, n}$	13
$I^{(u, u')} (\bar{I}^{(u, u')})$	the identity context (class) on (u, u')	110
id^k	the identity operation for strict categories	57
id^k	the identity operation for precategories	66
$\overline{\text{id}}_k^{k+1}(t)$	a term representing an identity cell on t	155
$j^{k, n}$	the unit of the adjunction $(-)^{\text{Glob}}_{\leq k, n} \dashv (-)^{\text{Glob}}_{\uparrow n, k}$	35
$\text{LinExt}(S)$	the category of linear extensions of $(S, <)$	225
$\text{Max}(P)$	the graded set of maximal fgs's of the ω -hypergraph P	238
$\text{Max}_{\text{WF}}(P)$	the graded set of maximal-well-formed fgs's of the ω -hypergraph P	245
μ_k	the minimization operation on partial functions on natural numbers	132
$\mathbb{N}^*, \mathbb{N}_n, \mathbb{N}_n^*, \mathbb{N}_\omega$	different standard subsets of $\mathbb{N} \cup \{\omega\}$	xv
PAdj	the Gray presentation of pseudoadjunctions	319

$\text{Part}(X, Y)$	the set of partial functions from X to Y	131
$(-)_{\leq k, l}^{\text{PCat}}$, $C_{\leq k}$	the truncation functor for precategories	68
$(-)_{\uparrow l, k}^{\text{PCat}}$, $C_{\uparrow l}$	the inclusion functor for precategories	68
$(-)_{//n, n+1}^{\text{PCat}}$, $C_{//n}$	the left adjoint to the inclusion functor $(-)_{\uparrow n+1, n}^{\text{PCat}}$	274
$\text{PCat}_n^{(\text{E})}$	the category of precategories which satisfy the exchange condition (E)	71
PCat_n	the category of n -precategories	67
$\text{PCell}^*(K)$	the set of pre-cells of the pre-adc K	206
$\text{PCell}(P)$	the graded set of pre-cells of P	196
PFrob	the Gray presentation of non-unitary Frobenius pseudomonoids	324
$\mathcal{P}_f(X)$	the set of finite subsets of X	136
PMon	the Gray presentation of pseudomonoids	315
Pol_k	the category of k -polygraphs	47
Pol_ω	the category of ω -polygraphs	49
Pol_ω^*	the category Pol_ω equipped with the concretization functor $ (-)^* $	175
$(-)_{\leq k}^{\text{Pol}}$, $P_{\leq k}$	the truncation functor for polygraphs	47
pre-adc	“pre-augmented directed complex”	205
R	the closure relation for a pasting scheme or, more generally, an ω -hypergraph	202
Rec_k	the set of recursive functions with k arguments	132
ρ_k	the recursion operation on partial functions on natural numbers	131
$S(X)$	the ω -hypergraph pre-cell associated to the adc pre-cell X	261
SD	the Gray presentation of self-dualities	327
sePol_n	the category of set-encoded n -polygraphs	157
$\bar{S}(X)$	the adc pre-cell associated to the ω -hypergraph pre-cell X	260
$\bar{S}_n(S)$	the adc element associated to a subset S of the basis of the adc	256
$S_n(s)$	the set associated to an element of an adc with basis	256
supp^P	the support function for the polygraph P	162
$T_M^{\text{PC}}, T_{\text{PC}}^{\text{M}}, T_{\text{Cl}}^{\text{M}}, T_M^{\text{Cl}}, T_{\text{Cl}}^{\text{PC}}, T_{\text{PC}}^{\text{Cl}}$	translation functions between $\text{PCell}(P)$, $\text{Max}(P)$ and $\text{Max}(P)$..	239
θ_n	the recursive bijection from \mathbb{N}^n to \mathbb{N}	134
t^k	the natural transformation which describes the truncability of a monad on globular sets	31
\mathcal{T}^P	the set of terms on the polygraph P	155
\mathcal{U}_k	the forgetful functor associated to the Eilenberg-Moore category Alg_k	14
v_k	the universal function for recursive functions with k arguments	132
\mathcal{U}^T	the canonical forgetful functor of an Eilenberg-Moore category	10
\mathcal{V}_k	the forgetful functor from a $(k+1)$ -algebra to a k -cellular extension	40
Weird	the category of weird 2-categories	15
$\text{WF}(P)$	the graded set of well-formed n -fgs's (or n -wfs's) on P	203
wfs	“well-formed fgs”	203
W_n	the set of n -word problem instances	161
\mathcal{W}^P	the set of well-typed terms on the polygraph P	155
\mathcal{X}	the exchange relation for the top cells of categorical actions	123
$X_{\alpha, g, \beta}$	the interchange generator associated to α, g, β	285
$X_{\phi, \psi}$	the interchanger of ϕ and ψ	283

$X_{w,w'}$ the arrow between the words w and w' in a shuffle graph	287
$\mathbb{Z}(-), \mathbb{Z}C$ the linearization functor for strict categories	93

Titre : Descriptions calculatoires de catégories supérieures

Mots clés : catégories supérieures, catégories strictes, catégories de Gray, réécriture, problème du mot, diagrammes de recollement

Résumé : Les catégories supérieures sont des structures algébriques constituées de cellules de différentes dimensions et équipées d'opérations de composition. Elles ont trouvé plusieurs applications en mathématiques (en particulier, dans le domaine de la topologie algébrique) et en informatique théorique. Ce sont des structures notoirement complexes, dont la manipulation est technique et sujette aux erreurs. Le but de cette thèse est d'introduire plusieurs outils informatiques pour les variantes strictes et semi-strictes des catégories supérieures qui facilitent l'étude de ces objets. Afin de représenter les catégories supérieures par des données finies, de sorte que ces dernières puissent être transmises comme entrée à un programme, on utilise la structure de polygraphe, initialement introduite par Street et Burroni pour les catégories strictes, et généralisée par Batanin à toute théorie algébrique de catégorie supérieure, qui permet de présenter des catégories supérieures par des systèmes de générateurs. Le premier problème abordé par cette thèse est celui du problème du mot sur les catégories strictes, qui consiste à déterminer si deux composées formelles de cellules d'une catégorie stricte représentent la même cellule. On donne une solution implémentable et relativement efficace pour ce problème en améliorant la procédure de décision initialement donnée par Makkai. Ensuite, nous traitons les formalismes pour les diagrammes de recollement. Ces derniers permettent de représenter effica-

cement les cellules de catégories strictes en utilisant des structures ensemblistes et pour lesquels une implémentation efficace est désirable. On étudie en particulier les trois principaux formalismes qui ont été introduits jusqu'ici : les complexes de parité de Street, les schémas de recollement de Johnson et les complexes dirigés augmentés de Steiner. Notre étude révèle que les axiomatiques des deux premiers est défectueuse, ce qui motive l'introduction d'une nouvelle structure, appelée complexe sans torsion, dont les axiomes ont de bonnes propriétés et généralisent ceux des autres formalismes. On montre que cette nouvelle structure est adéquate pour représenter informatiquement les catégories strictes en en donnant une implémentation. Pour finir, on considère le problème des présentations cohérentes de structures algébriques exprimées dans les catégories faibles de dimension 3, ces dernières étant connues pour être équivalentes aux catégories de Gray. En s'inspirant d'un résultat important de Squier dans le contexte des monoïdes, on adapte les résultats classiques de la théorie de la réécriture au contexte des catégories de Gray et relie la cohérence de présentations de catégories de Gray à la confluence de branchements critiques d'un système de réécriture associé. Avec ce résultat, nous déduisons une procédure semi-automatique pour produire des présentations cohérentes de catégories de Gray, et nous l'appliquons sur plusieurs exemples.

Title: Computational Descriptions of Higher Categories

Keywords: higher categories, strict categories, Gray categories, rewriting, word problem, pasting diagrams

Abstract: Higher categories are algebraic structures consisting of cells of various dimensions equipped with notions of composition, which have found many applications in mathematics (algebraic topology in particular) and theoretical computer science. They are notably complicated structures whose manipulation is technical and error-prone. The purpose of this thesis is to introduce several computational tools for strict and semi-strict variants of higher categories that ease the study of these objects. In order to represent higher categories as finite data, so that they can be given as input to a program, we use the structure of polygraph, initially introduced by Street and Burroni for strict categories and then generalized by Batanin to any algebraic theory of higher category, which allows presenting higher categories by means of systems of generators. The first problem tackled by this thesis is then the one of the word problem on strict categories, which consists in deciding whether two formal composites of cells of strict categories represent the same cell. We give an implementable and relatively efficient solution for it by improving the decidability procedure initially given by Makkai. Then, we turn to pasting diagram formalisms for strict categories, that enable to efficiently

represent cells of strict categories using set-like structures and for which a reliable implementation is desirable. We consider the three main formalisms that have been introduced until now, namely Street's parity complexes, Johnson's pasting schemes and Steiner's augmented directed complexes. Our study reveals that the axiomatics of the first two ones are defective, which motivates the introduction of a new structure, called torsion-free complexes, whose axioms have nice properties and generalize those of the three other formalisms. We also show that they are amenable to concrete computation, by providing an implementation of those. Finally, we consider the problem of coherence of presentations of algebraic structures expressed in 3-dimensional weak categories, the latter being known to be equivalent to Gray categories. Taking inspiration from a celebrated result given by Squier in the context of monoids, we adapt the classical tools from rewriting theory to the setting of Gray categories and relate the coherence of presentations of Gray categories to the confluence of the critical branchings of an associated rewriting system. From this result, we deduce a semi-automated procedure to find coherent presentations of Gray categories that we apply on several examples.