



HAL
open science

Procédé d'extraction des huiles essentielles et des hydrolats aromatisés des plantes aromatiques et médicinales (PAM) par énergie solaire

Soukaina Hilali

► To cite this version:

Soukaina Hilali. Procédé d'extraction des huiles essentielles et des hydrolats aromatisés des plantes aromatiques et médicinales (PAM) par énergie solaire. Autre. Université d'Avignon; Université Cadi Ayyad (Marrakech, Maroc), 2020. Français. NNT : 2020AVIG0281 . tel-03155410

HAL Id: tel-03155410

<https://theses.hal.science/tel-03155410>

Submitted on 1 Mar 2021

HAL is a multi-disciplinary open access archive for the deposit and dissemination of scientific research documents, whether they are published or not. The documents may come from teaching and research institutions in France or abroad, or from public or private research centers.

L'archive ouverte pluridisciplinaire **HAL**, est destinée au dépôt et à la diffusion de documents scientifiques de niveau recherche, publiés ou non, émanant des établissements d'enseignement et de recherche français ou étrangers, des laboratoires publics ou privés.

THESE

Présentée pour obtenir le grade de Docteur en Sciences d'Avignon Université

SPECIALITE: CHIMIE

Thermal solar energy applications on eco-extraction and drying of orange peels and rosemary leaves

par:

Soukaina HILALI

(Master of Science in Sustainable Energy Management)

Soutenue le 21/10/2020 devant la commission d'examen :

Président :	Naaila Ouazzani	PES	FSSM, Université Cadi Ayyad, Marrakech, Maroc
Rapporteurs :	Xavier Fernandez	PES	Université Côte d'Azur / CNRS, Nice, France
	Mohamed Asbik	PES	ENSET, Université Mohammed V, Rabat, Maroc
	Abderrahmane Romane	PES	FSSM, Université Cadi Ayyad, Marrakech, Maroc
	Ali Idlimam	PES	ENS, Université Cadi Ayyad, Marrakech, Maroc
Co-directeurs de thèse :	Anne-Sylvie Fabiano	PH	Université d'Avignon, Avignon, France
	Farid Chemat	PES	Université d'Avignon, Avignon, France
Directeurs de thèse:	Laila Mandi	PES	FSSM, Université Cadi Ayyad, Marrakech, Maroc
	Antoine Bily	Dr	NATUREX - Givaidan, Avignon, France

FICHE PRÉSENTATIVE DE LA THÈSE

- **Nom et Prénom de l'auteur** : HILALI Soukaina
- **Intitulé du travail**: Thermal solar energy applications on eco-extraction and drying of orange peels and rosemary leaves.
- **Encadrants** :
 - Nom, prénom et grade : MANDI Laila (PES)
 - Laboratoire et institution : Laboratoire Eau, Biodiversité et Changement Climatique, Faculté des Sciences Semlalia, Marrakech

 - Nom, prénom et grade : CHEMAT Farid (PES)
 - Laboratoire et institution : Laboratoire GREEN, Université d'Avignon, France
- **Co-encadrants**:
 - Nom, prénom et grade : IDLIMAM Ali (PES)
 - Laboratoire et institution : Equipe de l'Energie Solaire et Plantes Aromatiques et Médicinales, Ecole Normale Supérieure, Marrakech

 - Nom, prénom et grade : Anne-Sylvie Fabiano Texier (PH)
 - Laboratoire et institution : Laboratoire GREEN, Université d'Avignon, France
- **Lieux de réalisation des travaux (laboratoires, institution,...)** :
 - Centre National, d'Etudes et de Recherche sur l'Eau et l'Energie (CNEREE), Université Cadi Ayyad, Marrakech
 - Laboratoire Eau, Biodiversité et Changement Climatique, Faculté des Sciences Semlalia, Marrakech
 - Equipe de l'Energie Solaire et Plantes Aromatiques et Médicinales, ENS, Marrakech
 - Laboratoire GREEN, Université d'Avignon, France
 - Naturex, Avignon, France

Période de réalisation du travail de thèse : 2016-2020

- **Rapporteurs autres que l'encadrant** (nom, prénom, grade, institution) :
 - Xavier Fernandez, PES, Université Côte d'Azur / CNRS, Nice, France
 - Mohamed Asbik, PES, Equipe de Recherche en Thermique et Energie, ENSET, Université Mohammed V, Rabat
 - Romane Abderrahmane, PES, Laboratoire Chimie Appliquée, Faculté des Sciences Semlalia, Marrakech

Cadres de coopération (ou de soutien) :

Thèse en cotutelle Université Cadi Ayyad (Maroc)-Université d'Avignon (France).

Ce travail a donné lieu aux résultats suivants (communications, publications,...) :

Publications:

- Green Extraction of Essential Oils, Polyphenols, and Pectins from Orange Peel Employing Solar Energy: Toward a Zero waste Biorefinery. **S. Hilali**, A. Fabiano-Tixier, K. Ruiz, A. Hejjaj, F. Ait Nouh, A. Idlimam, A. Bily, L. Mandi, F. Chemat. *ACS Sustainable Chemistry & Engineering*. 2019, 7(13):11815-11822. doi:10.1021/acssuschemeng.9b02281.
- Deodorization by Solar Steam Distillation of Rosemary Leaves Prior to Solvent Extraction of Rosmarinic, Carnosic, and Ursolic Acids. **S. Hilali**, A. Fabiano-Tixier, M. Elmaataoui, E. Petitcolas, A. Hejjaj, F. Ait Nouh, A. Idlimam, M. Jacote-Navarro, A. Bily, L. Mandi, F. Chemat. *ACS Sustainable Chemistry & Engineering*. 2018, 6(8), 10969–10979. doi:10.1021/acssuschemeng.8b02347

Chapitre de Livre:

- Solar as sustainable energy for processing, preservation, and extraction. L.Mandi, **S. Hilali**, F. Chemat, A. Idlimam. In: F. Chemat, E. Vorobiev (Eds.). *Food Processing Techniques: Preservation, Transformation and Extraction*. United Kingdom: Academic Press, pp. 499-511.

Communication:

- Effect of Convective Solar Drying Conditions on Drying Kinetics, Total Polyphenol Content, and Antioxidant Properties of Rosemary leaves. **S. Hilali**, A. Idlimam, A. Fabiano-Tixier, F. Chemat, L. Mandi. *Maghrebian Drying Symposium 2019 (14-16 November 2019) –Marrakech (Oral presentation)*.

“Everything that is not forbidden by laws of nature is achievable given the right knowledge”

-David Deutsch

Acknowledgments

This Ph.D. was completed as a co-shared thesis (Cotutelle) between the Faculty of Sciences Semlalia, Cadi Ayyad University, Marrakech, Morocco and Avignon University (UMR 408, INRA - AU, GREEN), Avignon, France. For that reason, I would like to express my gratitude towards the CED Cadi Ayyad and the ED Avignon for facilitating the paperwork and giving me the opportunity to join this program thus allowing me to benefit from this amazing collaboration.

This brief section is not enough to thank all the people whose help, support and patience had great importance all through my research. In fact, it's hard to know how to start... given that there have been many people around me who have supported me with their smile, their presence, their guidance, and their love.

I want to sincerely thank my thesis directors. It has been my good fortune to do my thesis under the supervision of Pr. Laila Mandi (Cadi Ayyad University, Morocco) and Pr Farid Chemat (Avignon University, France) who are both great professors and supervisors. I thank them for their thoughtful guidance, constant concern in my improvement, and helpful support through critical comments and useful suggestions during my thesis. I have learned several notions from them that I was successfully able to use and apply in my thesis. I truthfully thank them for all the guidance and sustainably assisting.

I would like to thank especially my co-supervisor Dr. Anne-Sylvie Fabiano-Tixier. I want thank her for the enthusiasm with which she supervised my work, and for her brilliant comments and suggestions. Her constant help, keen interest and sympathetic attitude during the experiments and the preparation of this thesis are gratefully acknowledged. I would also like to thank my Moroccan co-supervisor Pr. Ali Idlimam for believing in me, providing me with the right advice and giving me the necessary pep-talks whenever I started doubting myself.

I was lucky to conduct many experiences in Naturex under the supervision of Antoine Billy and Magali Jacotet-Navarro that allowed me to improve my work quality. I am deeply thankful to both for all their support, guidance and time.

It is important for me to also mention all the National Center for Studies and Research on Water and Energy (CNEREE) staff that helped me gets costumed with the thesis world by showing me the ropes, mainly Dr. Fatima Aitnouh, Dr. Hejjaj Abdessamad and Pr. Faissal Azziz. Deepest appreciations are also due to all the Water, Biodiversity and Climate change

Laboratory (FSSM) team and Solar Energy & Medicinal plants Laboratory (ENS) team in Cadi Ayyad University mainly Leila Midhat, Tawfik Elmoussaoui, and Haytem Moussaoui as well as GREEN team of Avignon University; Vincent, Njara, Maryline and Sandrine. I cannot forget Karine and Emmanuel who helped me on many occasions.

I would like to show my appreciation to all the members of my thesis committee starting with Pr. Asbik, Pr. Romane, and Pr. Fernandez for their thorough revision and wise comments. I would like to address a special thanks to the committee president Pr. Ouazzani and thank them all for taking their valuable time to come and carefully revise my manuscript.

I am heartily thankful to my parents and my two wonderful siblings; Ihssane and Fathallah and my aunt Bahija and my cousin Chayma for their encouragement and unconditional support. Especially my dad to whom I would like to express my sincere gratitude, he has always been there for me encouraging me and supporting me through thick and thin both economically and morally. To you who left us too soon, my mom Fouzia BOUSSANE to whom I dedicate all my efforts; I hope this work will make you proud (you will never be forgotten). The distance due to my research abroad was not always easy to handle but their love, memories, and constant help provided my inspiration and gave me my driving force. Without their encouragement and understanding it would have been impossible for me to finish this work.

Finally, I would like to address massive thanks to my dearest friends Meriam Hamdi my birthday twin; Amini Youssef for always being true to himself, Boutheina Khedraoui, for her beautiful heart and thoughtful advices; Malak Tabib for always being there as a wonderful friend; Sara Madji for her brave heart and strong will. They all have been there for me and supported me in their own way. I would also like to address a special thanks to Harish Karthikeyan Ravi for his great help and support through it all.

Scientific Publications

Publications

Green Extraction of Essential Oils, Polyphenols, and Pectins from Orange Peel Employing Solar Energy: Toward a Zero waste Biorefinery. S. Hilali, A. Fabiano-Tixier, K. Ruiz, A. Hejjaj, F. Ait Nouh, A. Idlimam A. Bily, L. Mandi, F. Chemat. *ACS Sustainable Chemistry & Engineering*. 2019, 7(13):11815-11822. doi:10.1021/acssuschemeng.9b02281.

Deodorization by Solar Steam Distillation of Rosemary Leaves Prior to Solvent Extraction Of Rosmarinic, Carnosic, and Ursolic Acids. S Hilali, A. Fabiano-Tixier, M. Elmaataoui, E. Petitcolas, A. Hejjaj, F. Aitnouh, A. Idlimam, M. Jacote-Navarro, A. Bily, L. Mandi, F. Chemat. *ACS Sustainable Chemistry & Engineering* 2018, 6(8), 10969–10979. doi:10.1021/acssuschemeng.8b02347

Book chapter

Solar as sustainable energy for processing, preservation, and extraction. L. Mandi, S. Hilali, F. Chemat, A. Idlimam. In: F. Chemat, E. Vorobiev (Eds.). *Food Processing Techniques: Preservation, Transformation and Extraction*. United Kingdom: Academic Press, pp. 499-511.

Communications

Effect of Convective Solar Drying Conditions on Drying Kinetics, Total Polyphenol Content, and Antioxidant Properties of Rosemary leaves. S. Hilali, A. Idlimam, A. Fabiano-Trixie, F. Chemat, L. MANDI, *Maghrebian Drying Symposium 2019 (14-16 novembre 2019) –Marrakech (Oral presentation)*.

Résumé de la thèse

Le monde a connu une augmentation exponentielle de l'énergie; ces demandes sont principalement couvertes par les combustibles fossiles. Cependant, compte tenu des conditions non durables d'une telle source telles que la rareté et les effets environnementaux nocifs, les chercheurs ont dirigé leurs attention vers la recherche de nouvelles sources d'énergie alternatives. L'énergie solaire est une énergie renouvelable propre, abondante et facilement disponible. L'utilisation de l'énergie solaire pour des applications thermiques offre la possibilité de plusieurs études sur l'énergie, les avantages et l'analyse des bio-composés. Dans le présent travail, le séchage solaire et l'extraction solaire ont été envisagés pour une application expérimentale utilisant deux matrices; feuilles de romarin comme plantes aromatiques et médicinales et écorces d'orange comme sous-produit. Pour l'extraction solaire, une unité de distillation couplée à un réflecteur solaire a été utilisée afin de désodoriser les feuilles de romarin par distillation par entraînement à la vapeur et de valoriser les écorces d'orange ciblant une bio-raffinerie zéro déchet par hydro-distillation. Les avantages de l'extraction d'énergie solaire thermique sont remarquables, permettant une diminution d'environ 37% du temps d'extraction pour les deux matrices étudiées par rapport aux procédés conventionnels. En termes de qualité, plusieurs analyses ont été réalisées afin de comparer les systèmes solaires thermiques et conventionnels. Le rendement et la qualité de l'huile essentielle de romarin et d'écorce d'orange obtenus par GC/MS étaient relativement similaires pour les deux processus. Cependant, les antioxydants dosés par HPLC-DAD présents dans les feuilles de romarin étaient mieux conservés après extraction solaire. Dans l'ensemble, les résultats indiquent que la distillation solaire-vapeur (SSD) est une alternative écologique, efficace et économique pour l'extraction des huiles essentielles et la désodorisation des feuilles. La pectine et les flavonoïdes des pelures d'orange (principalement la narirutine et l'héspéridine) ont également été mieux conservés après le processus d'hydro-distillation solaire. Pour le séchage, un processus conventionnel en couche mince a été envisagé, l'étude expérimentale de cette section s'est concentrée sur l'influence des températures de séchage sur la perte en eau des matrices fraîches séchées à différentes températures, 40 °C, 50 °C, 60 °C, 70 °C pour les feuilles du romarin et 60 °C, 65 °C, 70 °C, 75 °C, 80°C pour les écorces d'orange. Ce travail présente les résultats de l'étude expérimentale de la cinétique de séchage. Les résultats sont utilisés pour déterminer la courbe caractéristique de séchage et simuler par des modèles mathématiques le comportement de séchage des feuilles de romarin ou des écorces d'orange afin de trouver le modèle le mieux adapté. Dans l'ensemble, l'extraction solaire et le séchage par convection se sont révélés être des procédures fiables qui préservent la qualité du produit et peuvent être utilisées efficacement comme alternative aux procédés conventionnels.

Mots clés: distillation par entraînement à la vapeur solaire; hydro-distillation solaire; séchage solaire par convection, bioraffinerie; feuilles de romarin, écorces d'orange.

Abstract

The world has witnessed an exponential increase of energy; those demands are mainly covered by fossil fuels. However, giving the unsustainable conditions of such source such as scarcity and harmful environmental effects, researchers were required to investigate newer alternative power sources. Solar energy is a clean, abundant and easily available renewable energy. It is also one of the most economical alternatives with outstanding processes and applications diversity machineries. Usage of solar energy for thermal applications provides a scope for several studies on energy, benefits, and bio-compounds analysis. The main objectives of this thesis are to promote the use of solar energy for extraction and drying applications, to confront them with the conventional technique usually used, and to better understand the process, outcomes and benefits of such green and sustainable source. Two matrices were considered: rosemary leaves as aromatic and medicinal plants and, orange peels as by-product. For solar extraction a distillation unit coupled with a solar reflector was used to deodorize rosemary leaves via steam distillation and to valorise orange peels targeting a zero-waste bio-refinery via hydro-distillation. The advantages of thermal solar energy extraction are noteworthy, allowing approximately 37 % decrease of extraction time for both the studied matrices in comparison to conventional processes. Quality wise, several analyses were carried in order to compare thermal solar and conventional systems. The rosemary and orange peels essential oil yield and quality obtained by GC/MS was relatively similar for both processes. However, antioxidants assayed by HPLC-DAD present in rosemary leaves were better preserved after solar extraction. Overall, the results indicate that Solar-Steam-Distillation (SSD) is a green alternative, efficient and economical process for essential oil extraction and leaves deodorization. Orange peels pectin and flavonoids (mainly narirutin and hesperidin) were also better preserved after solar hydro-distillation process. For drying, the study was performed on rosemary leaves and orange peels by thin convective solar drying to valorize these matrices, to increase their shelf-life, and to investigate the impact of solar drying on their antioxidant properties. The experimental study focused on the influence of drying temperatures on water loss and quality of fresh matrices dried at different temperatures: rosemary leaves (40°C, 50°C, 60°C, 70°C) and orange peels (60°C, 65°C, 70°C, 75°C, 80°C). Obtained results showed that Midilli– Kucuk and two terms were the most fitted and appropriate models to describe the convective solar drying kinetics of rosemary leaves and orange peels respectively. For rosemary leaves, it was found that with solar drying (40, 50, 60°C, and sun-dried) an increase of carnosol was observed, coupled with a decrease of carnosic acid values; while at high temperature (70°C) both carnosic acid and carnosol contents decrease. This could imply that high temperature may lead to quality deterioration of rosemary leaves. Moreover, at 70°C Total polyphenols (TPC) values decrease and the IC₅₀ value increased illustrating the negative effect of high drying temperatures on rosemary leaves. Contrary to rosemary leaves, the results showed that TPC and DPPH degradation was elevated in both 60°C, 65°C and the natural shade dried orange peels in comparison to high temperatures 75°C, and 80°C. This may state that the product gives better TPC and DPPH concentration if being dried at high temperature. As for the DPPH analysis, it was found that starting from 75°C, the antioxidant activity improves. This may be due to the new substances formation or precursor that occurs between several molecules via non-enzymatic inter-conversion at 70 °C for citrus fruits. Thus, stating that drying at high temperature may be a way to improve the phenolic extraction of orange peels.

Overall, solar extraction and convection drying were proven to be reliable procedures that preserve product quality and can be efficiently used as an alternative to conventional processes.

Key words: solar-steam distillation; solar hydro-distillation; convective solar drying, biorefinery; rosemary leaves, orange peels.

Table of contents:

Introduction	1
1. Context.....	2
2. Research axes	4
3. Thesis outline	7
Part I: Thermal Solar Energy as Sustainable Energy for Processing, Preservation, and Extraction	11
Abstract.....	12
1. Introduction.....	12
1.1 Why thermal solar energy?	12
1.2 Collectors: History and classification.....	15
2. Solar energy in Food process Engineering	17
2.1 Extraction.....	19
2.2 Solar Cooking.....	26
2.3 Solar drying systems.....	33
2.4 Solar pasteurization	36
3. Environmental impacts using solar energy	37
4 HACCP and HAZOP considerations using solar energy	38
Conclusion	39
References.....	40
Part II: Material and Methods.....	47
1. Plant materials	48
2. Chemical and reagents.....	48
3. Extraction processes	49
3.1 Conventional extraction.....	52
3.2 Solar extraction	53
3.3 Essential oil yield	54
3.4 Solvent extraction.....	54
3.5 Pectin Extraction	55
4. Drying processes	56
4.1 Drying apparatus	57
4.2 Drying conditions.....	58
4.3 Theory/calculation.....	60
5. Chemical analyses	63
5.1 Antioxidants Analysis.....	63

5.2	Gas Chromatography-Mass Spectrometry (GC-MS/GC-FID analyses of essential oil).....	64
5.3	HPLC for naruritin and hesperidin.....	65
5.4	Free radical scavenging activity (DPPH)	65
5.5	Total polyphenols analysis.....	66
5.6	Total flavonoid content (TFC)	66
6.	Microscopy analysis	67
6.1	Scanning electron microscopy (SEM).....	67
6.2	Fluorescence microscopy.....	67
	References.....	69
Part III: Results and Discussions		72
Chapter I: Thermal solar energy applications on Eco-extraction of rosemary leaves and orange peels		73
I-I. Rosemary leaves		74
1.	Rosemary leaves as aromatic and medicinal plant.....	74
2.	Context.....	77
3.	Deodorization by solar steam-distillation of rosemary leaves prior to solvent extraction of rosmarinic, carnosic, and ursolic acids.....	78
	Abstract	78
3.1	Introduction.....	78
3.2	Results and discussion	81
	Conclusion.....	93
	References.....	94
I-II. Orange peels.....		97
1.	Orange peels, as by-products	97
2.	Context.....	99
3.	Green extraction of essential oils, polyphenols and pectin from orange peel employing solar energy; Towards a Zero-Waste Bio-refinery.....	102
	Abstract	102
3.1	Introduction.....	102
3.2	Results and discussion	104
3.3	Industrial prospects.....	109
	Conclusion.....	111
	References.....	112
Chapter II: Thermal solar energy applications on Drying of rosemary leaves and orange peels		

II-I. Rosemary Leaves	117
1. Context	117
2. An economical and experimental study of convective drying effect on the environment and antioxidants properties of rosemary leaves	118
Abstract	118
2.1 Introduction	118
2.2 Experimental section	120
2.3 Results and discussion	120
Conclusion	136
References	137
II-II. Orange Peels	142
1. Context	142
2. Bio-refinery and valorization of orange peels via convective thin layer solar drying	143
Abstract	143
2.1 Introduction	143
2.2 Material preparation and treatment	145
2.3 Results and discussion	146
Conclusion	158
References	159
General Conclusion and Perspectives	162

Abbreviations and Nomenclature

- A_t : Solar reflector surface
- a, k, k_0, k_1, n, b : Model equation coefficients
- CSD: Conventional steam distillation
- CHD: Conventional Hydro-distillation
- c_a : Remaining compound cost (fraction of the collector cost)
- D_0 : Pre-exponential factor of the Arrhenius equation (m^2 /s)
- D_{eff} : Effective diffusion coefficient
- d : Discount rate
- DPPH: organic chemical compound (2,2-diphenyl-1-picrylhydrazyl)
- E_a : Useful energy
- E_{PR} : Energy provided to the reflector
- F_f : Rays deviation
- f : Dimensionless drying rate

- IC_{50} : Half concentration of inhibition (of antioxidant that inhibits free radical).
- I_d : Daily solar radiation
- MR_{Ei} : Experimental moisture ration
- M_i : Initial moisture content
- M_f : Final moisture content
- MR_{Pi} : Predicted moisture ration
- $M(t)$: Moisture content at time (t)
- M_i : Initial moisture content at time
- M_e : Equilibrium moisture content
- M_r : Reference mass
- p_r : Reflector price
- r : Correlation coefficient
- r_c : Annual repair cost (as fraction of the capital)
- RMSE: Standard error
- RSS: Residual sum of squares
- SSD: Solar steam distillation
- SHD: Solar hydro-distillation

- T : Temperature ($^{\circ}\text{C}$)
- t_l : Life time
- t_d : Drying time
- TPC: Total polyphenol content
- ε : Sensible heating ratio
- h_e : Latent heat of vaporization of water
- η_d : Drying efficiency
- θ : Temperature (K)
- ρ_{PR} : Reflection factor of mirrors
- ρ_{SR} : Reflection factor of the aluminum sheet
- : Energy provided to the reflectory χ^2 : Chi-square

List of Figures

Figure 1. Thesis structure.....	3
Figure 2. Six principles of eco-extraction.....	5
Figure 3. Treatment protocol for the deodorisation of rosemary leaves.	8
Figure 4. Treatment protocol	9
Figure 5. Classification of solar reflectors	16
Figure 6. Diagram of distillation processes by steam distillation: 1 - direct steam distillation 2 - water / steam distillation.	20
Figure 7. A-scheme of microwave apparatus, B-Scheme of ultrasound apparatus.....	23
Figure 8. Solar distillation and extraction of aromatic and medicinal plants (French, 1651)	26
Figure 9. Classification based on the storage system	32
Figure 10. Solar drying techniques.....	36
Figure 11. Extraction process schemes. 1-conventional steam distillation process, 2-solar steam distillation process, 3-conventional hydro-distillation process, 4 solar hydro-distillation process.	51
Figure 12. Solar distillation apparatus. (A and C) solar reflector; (B) solar apparatus; (D)	54
Figure 13. Solvent extraction.....	55
Figure 14. Convection solar dryer.....	58
Figure 15. Scanning electron microscopy operation principle.....	68
Figure 16. Botanical taxonomy and chemical structure of some major components of rosemary essential oil.	76
Figure 17. Deodorization by solar steam distillation context.....	77
Figure 18. Floral water and beam radiation variation.....	82
Figure 19. Essential oil yield profiles as a function of time for Conventional Steam Distillation	83
Figure 20. Scanning electron micrograph of raw rosemary leaves.	85
Figure 21. Fluorescence microscopic investigation of rosemary leaf	86
Figure 22. Material balance of essential oils and antioxidants extracted from rosemary leaves.....	90
Figure 23. Process assessment of SSD and CSD according to Green Extraction	92
Figure 24. Cross section of orange fruit showing the inner composition and description of major sections.	97
Figure 25. Summary of Citrus fruits utilisations.....	98
Figure 26. Solar valorisation of orange peels (context).....	101
Figure 27. Essential oil yield as a function of time for conventional hydro-distillation.....	105
Figure 28. Material balance	107
Figure 29. Solar drying techniques.....	117
Figure 30. Moisture content variation as a function of the drying time.....	121
Figure 31. Drying rate variation as a function of moisture content.....	122
Figure 32. Characteristic drying curve of rosemary leaves.....	123
Figure 33. A-Moisture ratio Experimental data versus drying time fitted values.	125
Figure 34. Predicted moisture ratio (predicted by two term's model) as a function of the experimental moisture ratio	126
Figure 33. Effects of temperature on rosemary leaves effective diffusion coefficient.	127
Figure 34. $\ln(De_{eff})$ as a function of $1/T$ at different temperatures.	128
Figure 35. Comparison between drying methods.....	134
Figure 36. Scheme of the drying apparatus (convection solar dryer).	146
Figure 37. Moisture content variation in time.....	147
Figure 38. Drying rate variation as a function of moisture content.....	148

Figure 39. Characteristic drying curve of orange peels	149
Figure 40. Moisture ratio Experimental data versus drying time fitted values.	152
Figure 41. Predicted moisture ratio (predicted by two term's model) as a function of the experimental moisture ratio	153
Figure 42. Effects of temperature on orange peels effective diffusion coefficient	154
Figure 43. <i>Ln(Deff) as a function of 1/T at different temperatures</i>	155
Figure 44. Effect of drying temperatures on the TPC and antioxidant activity	157

List of Tables

Table 1. Examples of solar energy applications in food processing	18
Table 2. Solar extraction of aromatic and medicinal plants	25
Table 3. Comparison between modern and traditional cooking techniques	28
Table 4. Classification based on solar collectors	29
Table 5. Classification of solar cookers based on the cooking methods	30
Table 6. Applications of solar pasteurization	37
Table 7. Solvents, reagents, and standards used for analysis and extraction	49
Table 8. Experimental drying conditions of rosemary leaves	59
Table 9. Experimental drying conditions	59
Table 10. Mathematical models for the drying curves	61
Table 11. Chemical composition of rosemary essential oils extracted by SSD and CSD	88
Table 12. Orange peels essential oils composition	106
Table 13. Moisture ratio fitting for the 4 temperatures	124
Table 14. Values of effective diffusivity of rosemary leaves	127
Table 15. TPC and DPPH free radical scavenging activity values	129
Table 16. Carnosic acid and carnosol quantification	130
Table 17. Parameters used in the economical calculations	131
Table 18. Financial saving per year and CO ₂ Mitigation values for drying 100kg of rosemary leaves	133
Table 19. Moisture ratio fitting for the 5 temperatures	151
Table 20. Values of effective diffusivity of Orange peels	154

Introduction

1. Context

The word energy has and still relies heavily on fossil fuels; according to researchers each year the energy consumption increases by 1% in the developed countries and 5% in developing countries¹. With those expectations, fossil fuel resources won't be able to meet the incrementing energy demand; the cost will subsequently increase sharply. Fossil fuel price fluctuation, in addition to unsustainable and non-renewable nature as well as environmental issues related to those sources' issues such as pollution, greenhouse effect, and global warming led to shift the focus toward alternative source investigation. Nowadays, renewable energies have gained remarkable interest world widely. Renewable sources of energy are environmentally friendly and they are currently supplying about 14% of the world energy demand; this value is expected to increase in the future². Solar energy is one of the most promising sources in this category; in fact, it is considered to occupy the throne of renewable energies. The solar that falls on the earth in one day is equivalent to energy demand required in 20 years. The greatest advantage of solar energy in comparison to other forms of energy is that it is freely usable, clean and can be supplied without environmental pollution. The international Energy Agency expects solar energy to cover by 2050 approximately 45% of the world energy demand³. Solar energy is used in numerous applications some of them relies on the conversion of energy into thermal energy such as solar drying and extraction that will be the subject of this study. The thesis tackles, two systems, solar extraction while referring to the six principles of green extraction and thermal drying.

The main objectives of this work are to promote the use of solar energy for extraction and drying applications, to confront them with the conventional technique usually used, and to better understand the process, outcomes and benefits of such green and sustainable source. To tackle and shed light on the aforementioned challenges this manuscript is structured into two parts in addressing concerning issues: solar valorisation of rosemary leaves as medicinal and aromatic plants followed by the solar valorisation of orange peels as by-product; each part is sub-devised into two chapters (for each product) as shown in figure 1.

¹Herez, A.; Ramadan, M.; Khaled, M. Review on solar cooker systems. Economic and environmental study for different Lebanese scenarios. *Renewable and Sustainable Energy Reviews*. 2018, 81, 421–432. doi.10.1016/j.rser.2017.08.021

² Panwar N.L.; Kaushik, S.C.; Kothari, S. Role of renewable energy sources in environmental protection. a review. *Renew Sustain Energy Rev.* 2011, 15 (3), 1513-1524.

³Mekhilef, S.; Saidur, R.; Safari A. A review on solar energy use in industries. *Renew Sustain Energy Rev.* 2011; 15(4), 1777–1790.

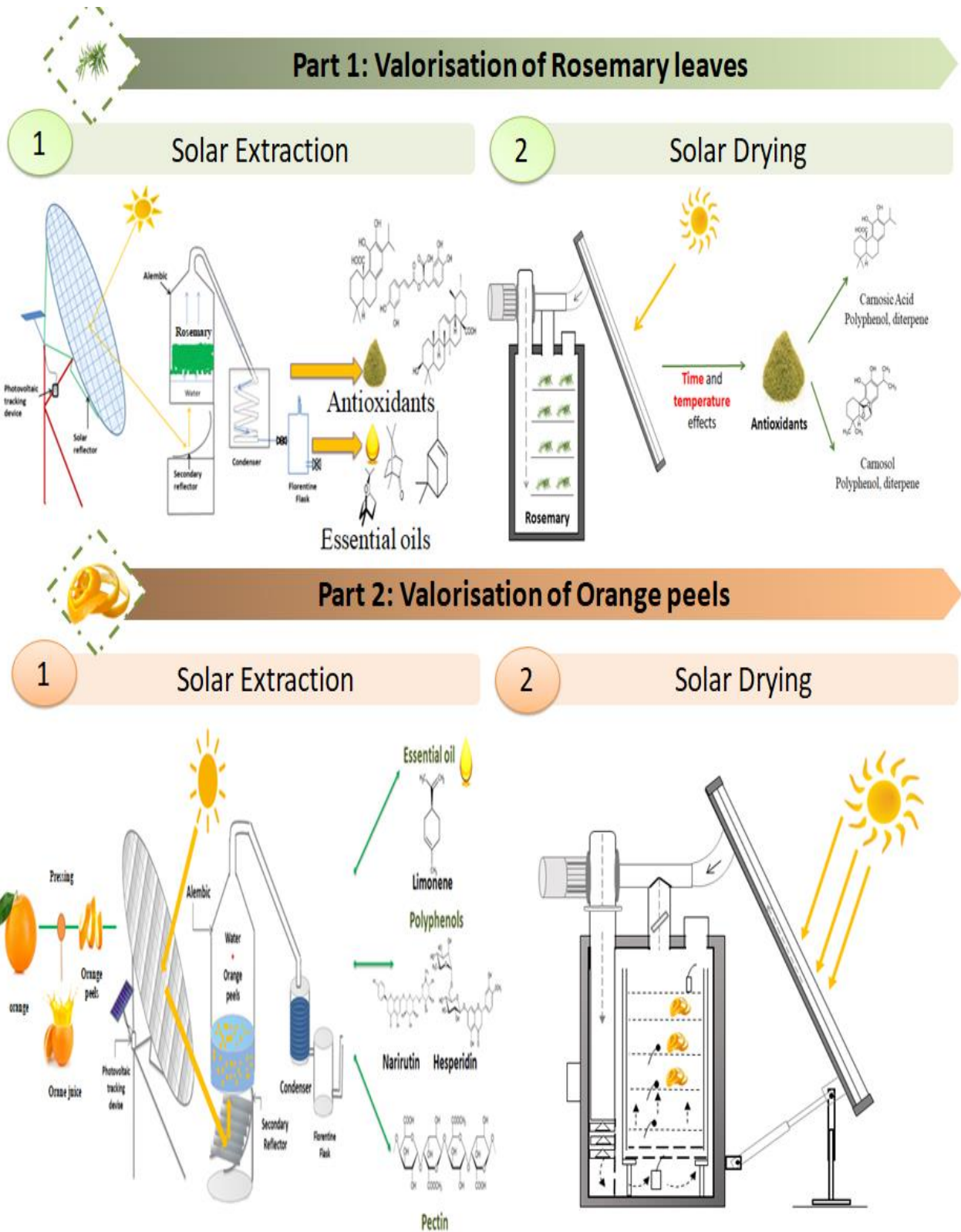

Figure 1. Thesis structure

2. Research axes

In this work, the research focused on the feasibility and investigation of solar drying extraction performance using two different matrices. The goal is to adequately exploit the sustainable systems toward a zero waste and green valorisation of vegetal matrices:

➤ Solar Extraction

Extraction of natural products may be as ancient as the fire discovery. Greeks and Romans, Egyptians and Phoenicians, Jews and Arabs, Indians and Chinese, and even Mayas and Aztecs, all possessed ground-breaking extraction processes knowledge and processes such as maceration, alembic distillation, *etc*⁴. used for multiple applications such as perfume, medicine and/or food. In the present days, most production processes in the perfume, cosmetic, pharmaceutical, food, biofuel, or fine chemical industries use extraction processes, with multiple application such as maceration, steam or hydro-distillation, pressing, decoction, infusion, percolation and Soxhlet extraction. In the food industry, besides the well-established huge extraction processes of sugar beet and sugar cane, and the preparation of decaffeinated tea and coffee, many formulations have been developed by adding plant extracts and nutraceutical concentrates.

With the “green” revolution resulting from multiple established benefits of bio-compounds such as antioxidants that have shown their efficiency in the prevention of cancer, cardiovascular diseases, osteoporosis, obesity, diabetes and against skin aging as well as the consumer concern toward alarming synthesized product effects, many industrial manufacturers of bio-based products use plant extraction. Bioactive compounds or their precursors (antibiotics, chemo-preventive agents, alkaloids, etc.) are extracted by the pharmaceutical industry, either by conventional methods or modern technologies. The term “clean” is usually used to describe natural product extraction, especially when it is compared to heavy chemical industries. However, researchers have pointed out the environmental impact of the industrial extraction cycle that is not easily estimated and is far greater than it appears. This is due to the required energy been at least 50% of the entire industrial process. And in some cases, even with the high energy consumption and important solvent amount, the yield is indicated in decimals.

⁴ Chemat, F.; Rombaut, N. ; Sicaire, A.-G. ; Meullemiestre, A.; Fabiano-Tixier, A-S. ; Abert-Vian, M. Ultrasound assisted extraction of food and natural products. Mechanisms, techniques, combinations, protocols and applications. A review. *Ultrasonics Sonochemistry*. 2017, 34, 540–560.

This was coupled with a shift towards “Eco-extraction”, to develop and offer industrialists more “sustainable” chemistry using fewer solvents, less energy, and minimizing waste, while at the same time ensuring the final product quality. It is in this context that eco-extraction and its 6 principles were defined in 2011 (Figure 2). According to the definition adopted by the academic and industrial players in the field of natural product extraction, eco-extraction is based on the discovery and design of extraction processes that reduce energy consumption, use alternative solvents and renewable plant resources, while ensuring a safe and high-quality product /extract.

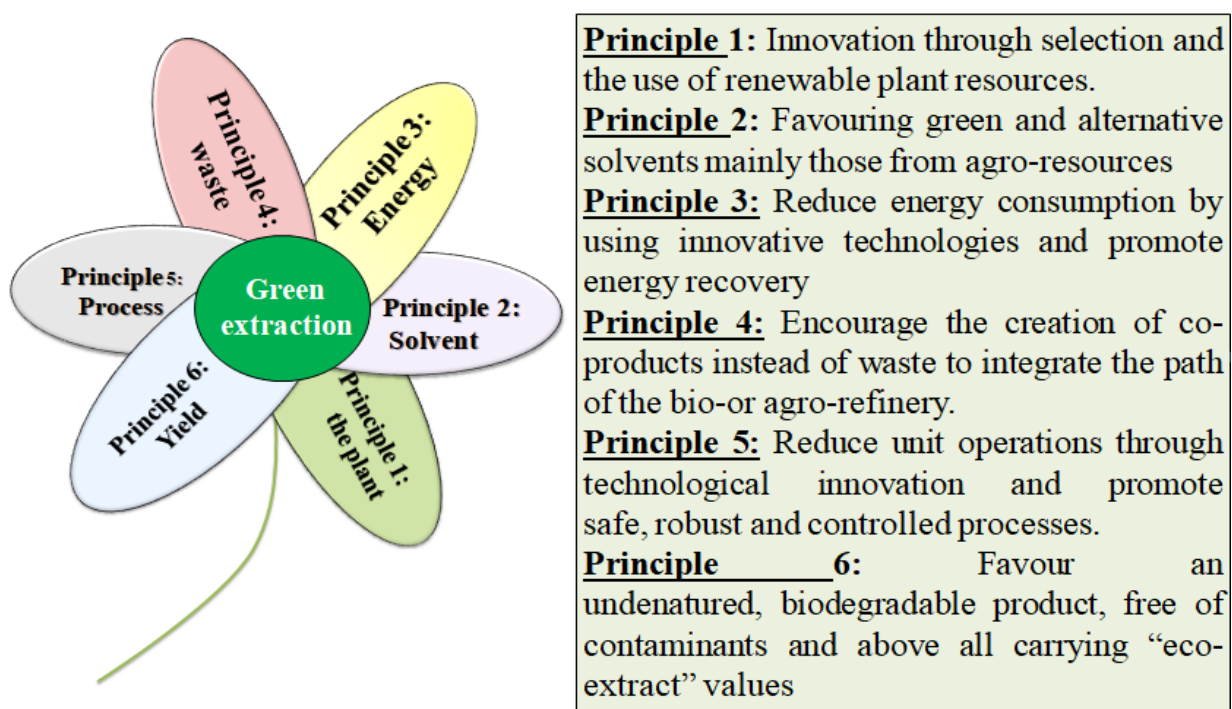

Figure 2. Six principles of eco-extraction

The challenges launched by the competitiveness of the globalized market and environment protection strongly require technological innovations that break away from the past rather than simple continuing into the same pace and path. The solar process may present a green innovative technique with the potential to replace conventional processes while being fully in line with the six principles of eco-extraction.

➤ Convective Solar Drying

Drying of fruits, vegetables, and plants are without a doubt one of the oldest processes for food preservation known to man. The process involves the removal of biologically active water to a safe level to reduce deteriorative chemical reactions, provides microbiological stability thus increasing the product shelf life. This will consequently and significantly reduce weight and volume thus minimizes packaging, storage and transportation costs.

Among all the drying methods, sun drying is a well-known method for drying agricultural products directly after harvest, mainly in developing countries and abundant solar energy. Although, sun drying is the more established technique; it is plagued with problems, since the product during drying is unprotected from rain, storm, windburn dirt, dust and infestation by insects, rodents, and other animals. As a result, the quality of dried products may be negatively affected, and won't be able to meet the required local and international standards which may impact adversely the economic value of the product.

Processes such as conventional drying (using conventional fuels) or freeze, drum and cyclone drying can be used to solve such problems; however, these techniques are costly and hazardous to the environment. Therefore, nowadays, the focus was directed towards the use of convective solar energy as an alternative for agricultural produces drying. Solar drying technology has the potential to be one of the most promising alternatives to reduce the post-harvest losses. The attractiveness of convective solar dryers lies in its ability to rapidly dry the product, uniformly and hygienically to meet national and international standards with zero energy costs. However, it has been noted that, drying at higher temperatures may cause damage to the quality of the dehydrated products.

This study, therefore, assessed the convective thin solar dryer's performance for two matrices (orange peels and rosemary leaves) while taking the dried product quality into consideration in order to establish the potential and feasibility of solar in drying application.

3. Thesis outline

Since solar energy is one of the cleanest energy resources that does not compromise or add to the global warming, it is often considered as an alternative to fossil fuel energy sources such as oil and coal. The sun radiates more energy in one second than people have used since the beginning of time. Availability of cheap and abundant energy with minimum environmental and ecological hazards associated with its production and use is one of the important factors for desiring to harvest this energy and use it for diverse applications. Taking that into account two solar processes were considered in this thesis (solar extraction and solar drying) and the work was developed according to the outline described in below:

Part 1:

This part, titled thermal solar energy as a sustainable energy for processing, extraction and preservation, encapsulates a literature review of thermal solar definition, processes and applications in order to better explain the importance of solar energy.

Part 2:

It describes the different extraction and drying protocols, the experimental methodologies, and the microscopy techniques used in this thesis. Qualitative, quantitative and modelling analysis methods will also be illustrated in this part.

Part 3:

This part is titled results and discussion; it encapsulates two chapters (Solar drying and extraction) each divided into subchapter (rosemary leaves and orange peels).

➤ Chapter I:

- Subchapter I- I: the extraction of essential oil by solar steam distillation (SSD) for rosemary leaves as a deodorization process to reduce and remove aroma from the leaves while conserving the antioxidant compounds the results were compared with the one obtained by conventional steam distillation. Scanning electron and fluorescence microscopy was performed to understand and demonstrate the effect of both extraction processes on the leaf glandular trichomes. The protocol followed in this study is described in figure 3. After each steam-distillation, the oil was collected and analyzed by GC-MS while the remaining rosemary leaves were submitted to solvent extraction. Resulting extract was analyzed afterward by HPLC to quantify the compounds of interest.



Figure 3. Treatment protocol for the deodorisation of rosemary leaves.

- Subchapter I- II: For orange peels valorisation via extraction, the extraction method was hydro-distillation; the aim was to consider a bio-refinery concept for essential oils, polyphenols (hesperidin, naruritin), and pectin extraction from grinded orange peels before and after the distillation process by integrating a green and zero-energy consuming process based on solar energy. Like rosemary leaves, the results from this study on orange peels were compared to a conventional process (hydro-distillation).

This study followed the protocol described in figure 4. Oranges were manually pressed to extract orange juice. Five hundred grams of the recovered orange peels considered as by-product in the study were coarsely grinded (particle size between 4 to 5 mm, density about 0.45 g/cm³) before they were submitted to both a conventional and solar hydro-distillation extraction. Composition of essential oils has been analysed qualitatively by GC-MS and quantitatively by GC-FID.

To compare the impact of solar extraction on different bioactive compounds, orange peels before and after extraction were frozen, lyophilized, and extracted with methanol: water (80:20), and then used for quantification using HPLC-DAD for naruritin and hesperidin, glass reactor extraction for pectin, and Folin Ciocalteu method for total polyphenol contents.

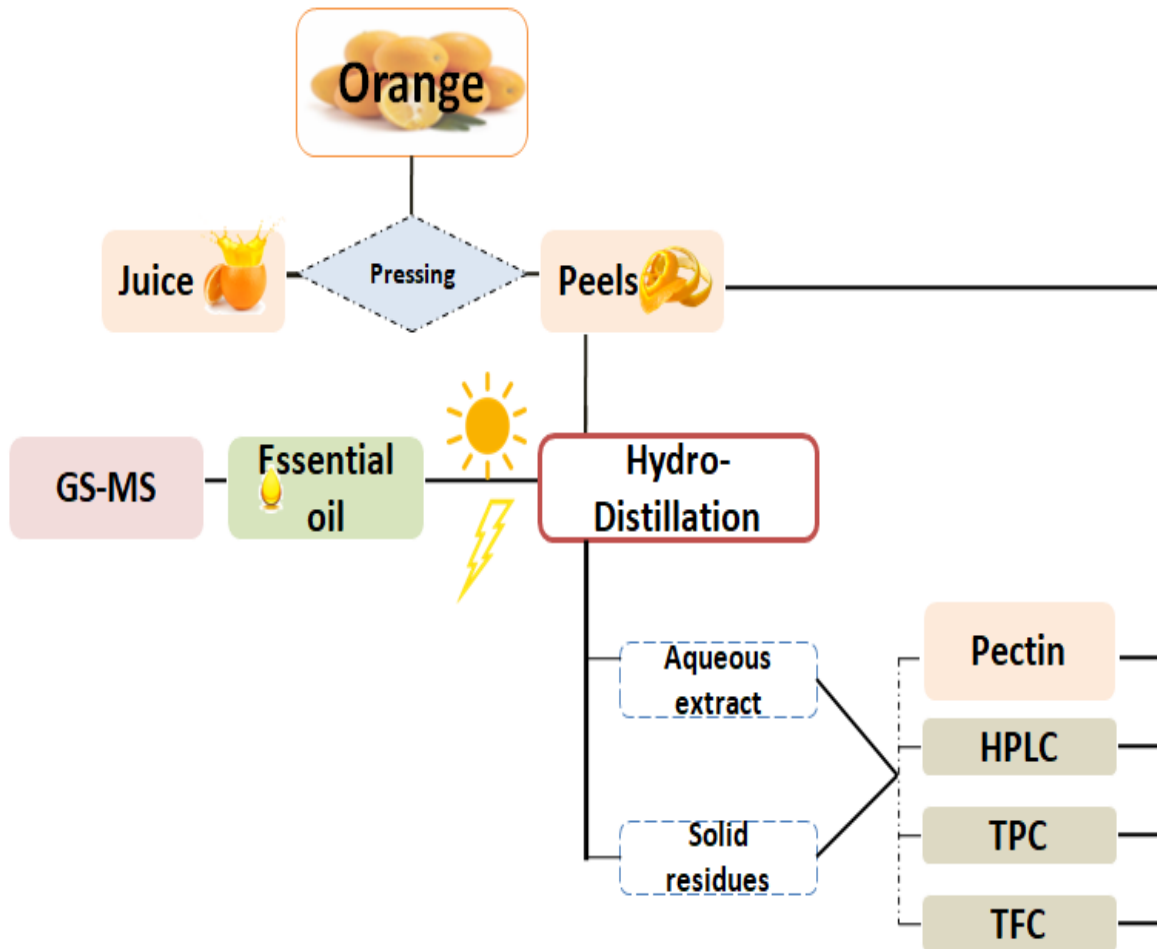

Figure 4. Treatment protocol

➤ **Chapter II:**

The chapter tackles solar drying as energy and time saving technique used primarily to preserve and enhance the shelf life of post-harvest products.

- Subchapter II-I: In the first case, rosemary leaves. The objectives of this work were to develop a mathematical model for predicting solar convection drying of rosemary leaves at different air-drying temperature to better understand the drying process and the behaviour of rosemary leaves as well as the impact of such process on the plant quality. For that purpose, total polyphenol content and antioxidant properties were quantified, while also investigating the degradation of carnosol into carnosic acid.

An economic and environmental analysis was also considered in order to study the financial feasibility and CO₂ mitigation related to this innovative green process.

- Subchapter II-II: Orange peels are often considered as waste; however, if treated as such, they could generate numerous environmental problems, mainly water pollution resulting from biomaterial's present in the peels especially essential oil, sugar, and pectin. But if valorized as by-product, this same composition has the potential to increase the economic value while preserving at the same time the environment. In order to further valorise a highly hydrated product (orange peels) a drying is elementary, for that reason solar drying was considered. To better understand this process, the characteristic drying curve and modelling analysis were required as well as quality analysis to illustrate the effect of drying on orange peels.

**Part I: Thermal Solar
Energy as Sustainable
Energy for Processing,
Preservation, and
Extraction**

Abstract

Driven by the rising energy demand, the need to preserve the environment, and the scarcity of fossil fuels, researchers were required to investigate newer alternative power sources. Solar technologies, as one of the most economical alternatives, have reached in the recent years an outstanding edge duly noted by the diversity of applications and machineries. In just an hour, the earth receives more solar energy than its inhabitants could consume in 1 year and in one day more than the population could consume in 27 years. The use of this green sustainable energy presents a promising alternative and an important source compared to all know conventional ones with a huge exploitation potential in many fields and sectors. One of those sectors is the food industry with several fields of applications. Indeed, solar energy could be used for food processing in several daily practices such as cooking, milk pasteurization as well as food drying and even solar extraction. Several studies have focused on developing efficient systems that relay on solar power either thermal or photovoltaic energy. This chapter provides a wide view on those systems by applications; it is a culmination of all existing literature data on the utilization of solar in a plethora of day-to-day application of solar thermal energy in the agro-alimentary industry. It explains the processes related to each field and the environmental impact and benefits related to it. A HACCP and HAZOP analysis was also provided to identify and prevent the hazards or process–operating problems that are likely to occur during those processes.

1. Introduction

1.1 Why thermal solar energy?

Located in approximately 150 million km from the sun, the earth receives $1.8 \cdot 10^{14}$ kW. An amount of 60% within those emissions reaches the earth surface while the rest is absorbed by the atmosphere and reflected toward the space (Hosseini and Hosseini, 2012). It was assessed that only 30 min of radiation that falls on earth can generate the world energy demand for a year. About 3,400,000 EJ present the annual solar radiation that reaches the surface of the earth, this magnitude order is estimated to be way greater than all the identified non-renewable energies sources. Only 0.1% of this energy (with 10% efficiency) has the possibility to generate till four times the total earth capacity (Kalogirou, 2010).

Solar energy radiation is the main causes of all-natural activities and cycles including photosynthesis, wind, rain, and numerous life crucial phenomena. In fact, even fossil fuels notably coal, gas, and oil are considered as a converted form of solar energy (Tiwari, 2016; Fudholi et al., 2008; Bahloul et al, 2009; Ekechukwu, 1999).

Nevertheless, at the present time, fossil fuels still encapsulate 80% of worldwide generated energy since there are way cheaper and mostly more convenient compared to other alternative energy sources, and up to recent times environmental and ecological pollution were not considered yet alarming.

It should be known that pollution is deeply related to energy consumption. Despite the documented environmental effect of combustibles, the world daily consumption records are up to 76 million barrels daily this value is expected to reach 123 million barrels a day by 2025 (Dincer, 1998). While the population is expected to double by the middle of the century, the energy demand and economic growth will certainly follow in the same incrementing track. The outcome with sureness given the concrete evidence both for the future generation and the planet, if kept in those same conditions, is going to be negatively impacted. Three main environmental problems are gaining a global attention lately;

- Acid rain. A pollution form caused by SO_2 and NO_x that results from the fossil fuels combustion; these substances react and mixed with other chemicals such as oxygen and water after being transported higher into the atmosphere. The ending product deposit on the earth via precipitation (acid rain) causing damages and negative ecological effects on numerous aquatic environments and ecosystems that is vulnerable to acid rain. There is a big correlation between acid rain and energy consumption, in fact the more energy is consumed, the more human contribute to acid rain; meaning that the only possible way the latter can be controlled is by decreasing the energy consumption (Dincer and Rosen, 1998).
- Climate change. Greenhouse in natural levels is crucial for the proper functioning and sustaining of the atmosphere and life in the planet; they keep the earth warm thus saving all form of life from freezing in a dry and waterless environment. However, this term was largely related in recent years to CO_2 contribution estimated to 50% to what is commonly called man-made or anthropogenic greenhouse effects and disrupt the natural balance of GHGs. Other gases produced in either industrial or domestics activities such as ozone, CH_4 , N_2O , and halons contribute also to this dangerous effect. Increasing GHGs concentration in the atmosphere will ultimately raise the earth temperature.

As a matter of fact, over the last century a temperature increase of 0.6 °C was recorded for the earth surface (Colonbo, 1992). The sea level was thus estimated to be succumbed to a 20 cm increase. Those man-made emissions that essentially result through fossil fuel combusting maintain the same incremental rate; the temperature of the earth can increase in the following century by 2 till 4 °C (Kalogirou, 2004). If this condition is met, a rising sea level of 30 till 60 cm is expected before the end of the century. This will have enormous harmful effect that could threaten human survival such as flooding, water and fertile agricultures zone scarcity, and air quality degradation.

- Ozone depletion. Ozone is a layer that protects the earth natural equilibrium and living organisms by absorption of UV and infrared radiation. The latter is present in the lower part of a stratosphere. Ozone depletion essentially caused by Chlorofluorocarbons (CFCs), NO_x, and halons can cause s many harms to a range of living been as well as an increase of skin cancer, immune system damage and eye cataracts for human. The full recovery of such a layer that is predicted to happen in 2050 is deeply affected by climate change (Dincer, 1999).

Naturally, to outcome such harmful and dangerous effects an ongoing research for alternative sources precisely renewable sources is taking place world widely. Efficient utilisation of such energy resources, mainly solar energy has witnessed an increasing endorsement as a promising sustainable key to environmental concerns and alarming global warming effects. The utmost solar advantage over other energy is meanly the fact that solar is the cleanest source with the ability to supply demands without any impact or environmental pollution. There several applications in which the solar energy can be exploited such as food growing, drying, water desalination, building cooling and heating in both active and passive ways, electricity generation, and engine and pump operating. Many alternatives to polluting fossil fuel sources exist such as wind, tidal, hydraulic, and biomass; the decision for which energy shall be used in every case depend on environmental, economic, and safety basis (Kalogirou, 2004). However, even when the cost is slightly higher, it is widely common to be more bias toward solar energy as an alternative due to both environmental, economic and safety aspect of this source.

Solar thermal energy is the conversion of radiation into heat. It is associated to the most cost-effective alternative source among renewable technologies with a potentially huge global market. This energy covers a range of application that includes water heating, building heating

and cooling, and industrial process heating, representing up to 90% of the solar installed world capacity.

1.2 Collectors: History and classification

At 212 BC, Archimedes the Greek scientist discovered a method to set the Roman fleets on fire, the attack was carried by the help of a concave metallic mirror composed of a hundred of polished shields that concentrate and reflect solar radiation towards the same ship. This attack made the Roman believe that they were fighting against the gods according to Plutarch (AD 46-120). The question is whether Archimedes possess enough optic science and physique knowledge to harvest and use solar radiation to the point of setting fire from a far point since no copy of Archimedes book "On burning ships" survived. Yet what is intriguing is that the very first application of solar energy consisted of concentrating collectors which are by their nature (accurate shape and requirement to follow the sun) somewhat harder to apply (Anderson, 1977). In the 18th century, solar furnaces were used all over Europe and the Middle East. They were composed of polished iron, mirrors and glass lenses were able to melt different metals such as iron and copper. It was reported that the furnace developed by French scientist Antoine Lavoisier was composed of 1.32 m and a secondary 0.2 lens could reach up to 1750°C. The developments of solar reflectors technologies have led to the continually increasing ability of these technologies to concentrate and harness solar energy for multiple applications that includes electricity production (Kalogirou, 2004).

The development of concentrating solar power field that relies on solar reflectors gained special attention after the oil crisis between 1973 and 1979 where CSP (concentrated solar power) was viewed as possible solution to face energy dependency. Early research focused on developing parabolic trough and dishes for solar energy generation, mainly electricity. Solar collectors and storage components are the mandatory component of solar thermal application. For highly efficient functioning, solar reflectors are required to have an excellent optical performance with the ability to absorb an important amount of radiation while storage systems are required to have a high thermal storage density and an outstanding heat transfer rate (Meinel and Meinel 1976).

Solar collectors are classified under two categories (Fig.5); collectors with no sun tracking systems where the interception area correspond to the absorbing area and the reflectors with sun tracking system that are usually concave to better intercept and fully focus the

radiation towards a receiving end thus increasing heat flux allowing the thermodynamic cycle to achieve better Carnot efficiency while working with high temperatures.

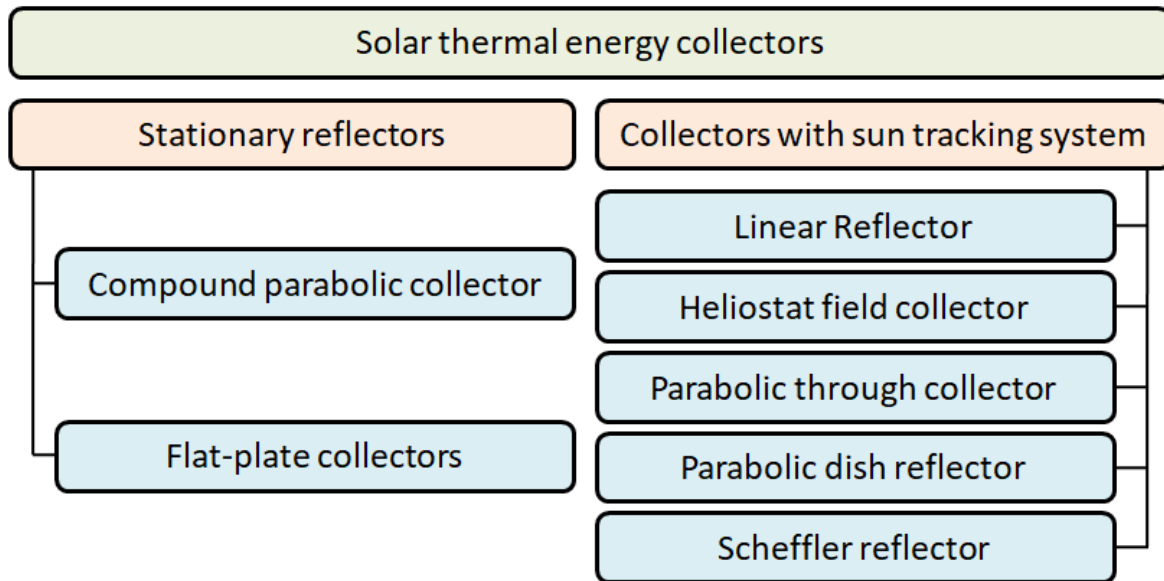

Figure 5. Classification of solar reflectors

However, it should be noted that most of those systems are used mainly to heat the water or other substance considered as the medium of heat transfer. Solar collectors are not only used for electricity generation but also to generate thermal energy for industrial processes. This application aim to both reduces dependency on fossil fuel resources and minimizes greenhouse emissions such as CO₂, SO₂, NO_x (Kalogirou, 2004). Some solar thermal applications in the industrial sectors are listed below.

- Water heating/ steam generation
- Dehydration and drying processes
- Cooking/Preheating
- Pasteurization/ sterilization
- Washing/ cleaning
- Chemical reactions
- Extraction

This review is mainly focused on thermal solar energy reflectors and their application in the agro-alimentary industry which include cooking, drying and extraction.

2. Solar energy in Food process Engineering

In pre-historic ages, the competition of food urged the processing of food to preserve it for longer times. Nowadays, the processed foods that are flourishing in supermarkets are modern processed foods and traditional foods, but their manufacturing, processing and packaging technologies have been advanced and rationalized to an incomparable extent. The principle aims of these technologies are to reduce the processing time, save energy and improve the shelf life and quality of food products. Thermal technologies (radio frequency and microwave heating), vacuum cooling technology, high pressure processing, pulsed electric field, and solar energy are those novel technologies who have potential for producing high-quality and safe food products but current limitations related with high investment costs, full control of variables associated with the process operation, lack of regulatory approval and importantly consumer acceptance have been delaying a wider implementation of these technologies at the industrial scale. In recent years, solar food processing represents an environmentally developed technique that provides a high food quality at an almost negligible or minimum cost; it has a very wide scope in food disinfection, shelf life allowance, drying, cooking, and substance quality improvement (Aravindh and Sreekumar, 2015). Solar food processing is not a new technique; in fact, this practice goes back to early ages with known process such as solar cooking and solar drying, in times where preservation was by adding salt (Claflin and Schollers, 2012). There are many potential applications of solar energy in food processing of which a number are discussed in table 1.

Table 1. Examples of solar energy applications in food processing

Application	Solar principle	Advantages	Disadvantages	Products	References
Cooking	Uniform heat transfer	Less time	Needs direct sunlight to operate	Meat and legumes	Sharaf(2002)
		Efficient	Can't function during cloudy days Suitable for cooking for only a fraction of each day. Needs adjustment to keep it aligned with the sun	Rice, vegetables, meat, bake cakes	Buddhi (1997)
	Scheffler dish direct	Short time convenience of cooking in kitchen	Needs direct sunlight to operate	Meals	Indora&Kandpal, 2018)
	Scheffler dish indirect direct (via solar steam generation)	under shade, automatic sun tracking fast rate	Can't function during cloudy days Suitable for cooking for only a fraction of each day.		
Husking	Photovoltaic electricity	Decrease energy consumption attenuate health hazards and environmental impact	Only functional for 6 hours daily The husked rice quantity per month is less than the grid powered rice husking system	Rice	Uddin et al. (2017)
Drying	Uniform heat transfer	Less time	Waste heat	Dehydrated products (fruits, vegetables, etc.)	Yaldýz and Ertekýn (2001)
		Improving quality Improving heat transfer Characteristic drying curve	Not a suitable option for large scale drying Usually requires an additional energy source	Medicinal plants	Bicer (2008) Idlimam et al. (2016)
	Open sun	Cheapest method	Long drying time Possible infection of the end product	Turmeric	Lakshmi et al. (2018)
Pasteurization	Thermal energy	Efficient	Needs direct sunlight to operate	Milk, water and juices.	Atia <i>et al.</i> (2011) and Caso <i>et al.</i> (2008)

2.1 Extraction

Extraction has been used probably since the discovery of fire. Egyptians and Phoenicians, Jews and Arabs, Indians and Chinese, Greeks and Romans, and even Mayas and Aztecs, all possessed innovative extraction and distillation processes used even for perfumes or food.

The development of extraction technologies is an essential element to improve the overall performance and quality of the essential oil. Traditional technologies for treating essential oils are of great importance and are still used in many parts of the world. Hydro-distillation, steam-distillation, maceration are the most used traditional methods. Maceration is adapted when the yield of distillation oil is low. Distillation methods are suitable for powdered almonds, rose petals and rose flowers, while solvent extraction is suitable for expensive, delicate and thermally unstable materials such as jasmine, tuberose and hyacinth. Hydro-distillation is the most preferred method of producing lemongrass oil from plant material.

Several studies have found that the effect of distillation time modifies both the essential oil content and the composition for several aromatic plants (Kumar et al., 2016; Bousbia et al., 2009). Researchers have also shown that the extraction method influences the composition and yields of essential oils as well as the antioxidant and antimicrobial properties.

2.1.1 Conventional extraction techniques

Essential oils are defined as products extracted from natural plants by physical means such as distillation, cold pressing and dry distillation. However, the loss and degradation of some unsaturated components by thermal effects or by hydrolysis can be generated by these conventional extraction techniques.

➤ Hydro-distillation

The material is completely immersed in water, which is boiled by applying direct fire heat (or other energy source). The main feature of this process is that there is direct contact between boiling water and plant material. The distillation stills (alembic) are the simplest type and are widely used by small producers for essential oils extraction. The disadvantages of this technique are related to uncontrolled heat meaning that distillation rate is variable. Also, there is a possibility of local overheating and "burning" of the raw material which can lead to low quality oil. Another disadvantage of this system is that it requires the heating of a large amount of water in addition to the cost and time required for each distillation (Sovová and Aleksovski 2006).

➤ Steam-distillation

There are two types of steam-distillation. water/steam distillation and direct steam distillation (figure 6). Water/steam distillation is an improved method of distillation; the still contains a grid that keeps the plant material above the water level. The water is boiled under the plant material, the steam passes through it. During distillation, only very small molecules can evaporate, so they are the only ones to leave the plant. These extremely small molecules constitute the essential oil. This process involves the use of steam to filter and evaporate the essential oils of the plant material, resulting in the condensation of steam and essential oil before separation. The most advanced type of distillation is direct steam supplied by a separate boiler. The alembic contains an open steam pipe from which the steam is supplied. The advantage of this type of “dry” steam distillation is that the process is relatively fast; therefore, the loading and emptying of the still is much faster and the energy consumption is lower (Khan and Dwivedi, 2018; Yadav et al 2017).

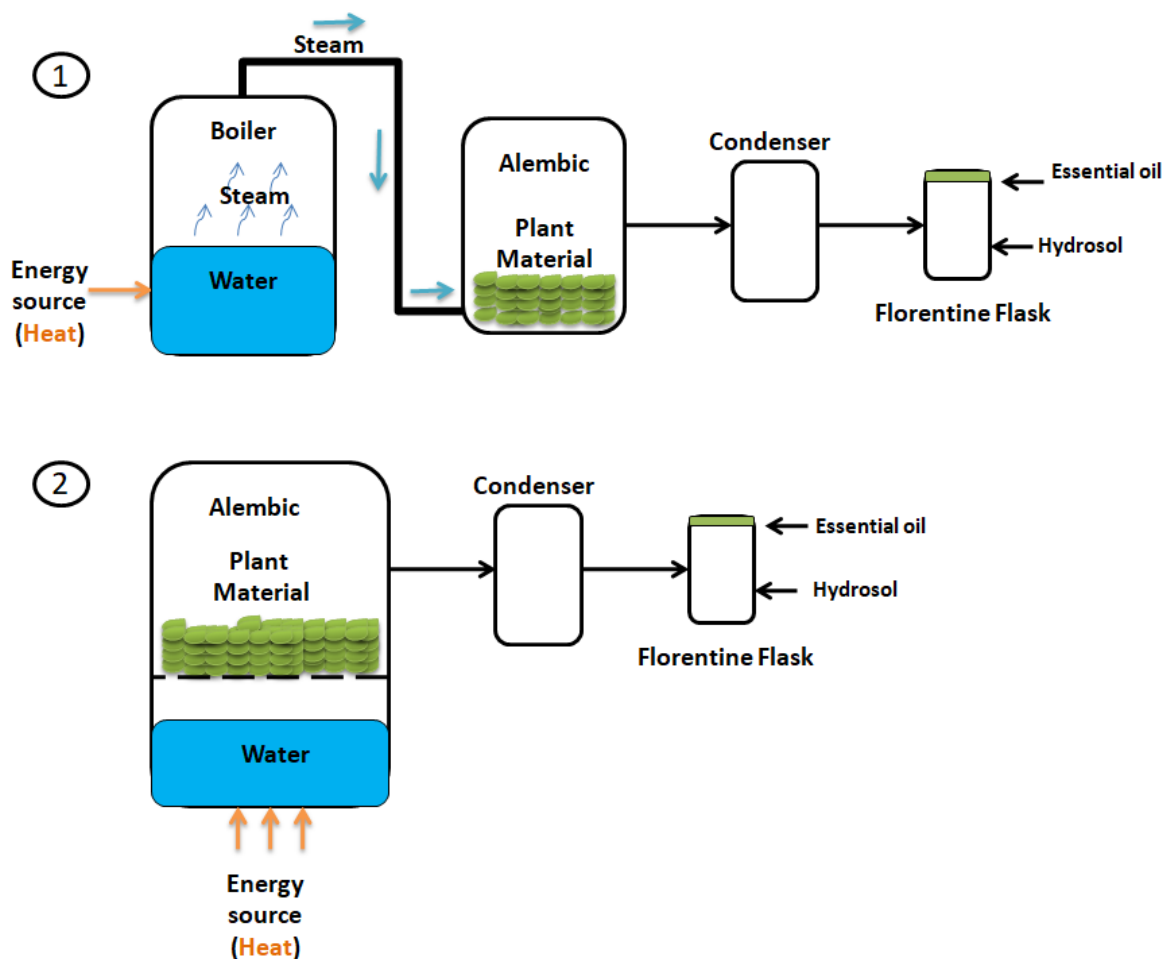

Figure 6. Diagram of distillation processes by steam distillation: 1 - direct steam distillation 2 - water / steam distillation.

➤ The hydro-diffusion

Unlike steam distillation, the injected steam travels from the top to bottom of the alembic. The steam and essential oil are directly condensed under the plant support through a perforated tray. The way of separating HE is the same as that of other distillation methods. This method makes it possible to reduce the steam consumption and the distillation time with a better yield compared with the steam distillation.

➤ Cold-pressed

The term cold pressed is used to obtain citrus essential oils, such as bergamot, grapefruit, lemon, lime, orange and mandarin oils. In this process, the outer layer of the skin of the fruit containing the oil is removed by washing. Then the whole fruit is squeezed to extract the juice from the pulp and release the essential oil. The essential oil rises to the juice surface and is separated from the juice by centrifugation (Khan and Dwivedi 2018).

➤ Solvent extraction

Solvent extraction, also known as liquid-liquid extraction, is a separating method of a compound based on the solubility of its parts. This is done using two liquids that do not mix, for example, water and an organic solvent. This method is used in the treatment of perfumes, vegetable oil or biodiesel. It is used on delicate plants to produce larger quantities of essential oil at a lower price (Khan and Dwivedi 2018).

2.1.2 Innovative extraction techniques

Traditional essential oils and bio-compound extraction methods are relatively simple but have several drawbacks: long operating time, high energy consumption, and the risk of thermal degradation and hydrolysis of aromatic molecules that can give the essential oil a different smell from that of the raw material. Conventional solvent extraction processes require a very long treatment time and can result in the loss of volatile compounds upon removal of the solvent coupled with the presence of the residual solvent in the extracts. Because of the disadvantages of these conventional techniques, food manufacturers have nowadays directed their focus towards researching new treatment technologies (Sahraoui et al., 2016). Among those extraction techniques developed in recent years, there are:

➤ Extraction by supercritical fluid

Supercritical fluid extraction by carbon dioxide is a new extraction method using carbon dioxide gas, which is kept under high pressure and at a constant temperature.

The plants are placed in a stainless-steel tank. The carbon dioxide is injected into the tank, thus increasing the pressure inside the tank. Under this high pressure, carbon dioxide turns into a liquid and acts as a solvent to extract essential oils from plants. When the pressure decreases, the carbon dioxide returns to the gaseous state, leaving no residue. The equipment used for this process is very expensive, as are the resulting oils. Carbon dioxide extractions have aromas that are cooler, cleaner and crisper than steam-distilled essential oils and smell more like raw plants because no intense heat is used. This extraction method produces a higher yield. Many essential oils that cannot be extracted by steam distillation can be obtained with the extraction of carbon dioxide. Nevertheless, this technique is very expensive and difficult to manage (Khan and Dwivedi 2018).

➤ Microwave assisted extraction

Microwaves are electromagnetic radiation with a frequency between 0.3 to 300 GHz. In order to avoid interference with radio communications, household and industrial microwaves that typically operate at 2.45 GHz (Kaufmann and Cristen, 2002). They are a non-contact heat source that allows more efficient and selective heating. With the help of microwaves, the distillation can now be completed in minutes instead of hours, with various benefits that are consistent with the principles of green extraction chemistry. This technique provides a greener implementation strategy through minimizing of solvent usage, energy, waste, CO₂ emission and toxicity. In this method, the plant materials are extracted in a microwave reactor either with or without organic solvents or in water under different conditions depending on the experimental protocol. According to the literature, the technique has been applied for the extraction of different organic compounds such as flavonoids, polyphenols and caffeine (Azmir et al, 2013). For the extracted essential oils, it was found that it has organoleptic properties very close to the original natural materials. In addition, the occurrence of thermal degradation decreases due to the low extraction temperature. Moreover, there are several modern microwave-assisted techniques, such as hydro-distillation, hydro-diffusion, and microwave turbo-distillation, as well as simultaneous microwave distillation with a micro-wave that shorten treatment time and lower the solvent consumption (Li et al 2013).

➤ Ultrasonic extraction

Ultrasound have a significant potential process in the chemical and food industry. Using ultrasound, for extractions purposes can nowadays be completed in minutes with high reproducibility and purity of the final product, less solvent, simple manipulation and work-up,

and no post-treatment of waste water. Compared to conventional extraction method such as Soxhlet extraction, maceration or Clevenger distillation, ultrasound consume less energy. Several classes of food components such as aromas, pigments, antioxidants, and other organic and mineral compounds have been extracted, analyzed and formulated efficiently from numerous matrices mainly animal tissues, microalgae, yeasts, food and plant materials (Chemat et al. 2017). In general, ultrasonic assisted extraction has been developed to increase extraction yields and reduce energy consumption, while simultaneously improving efficiency and reducing the extraction time.

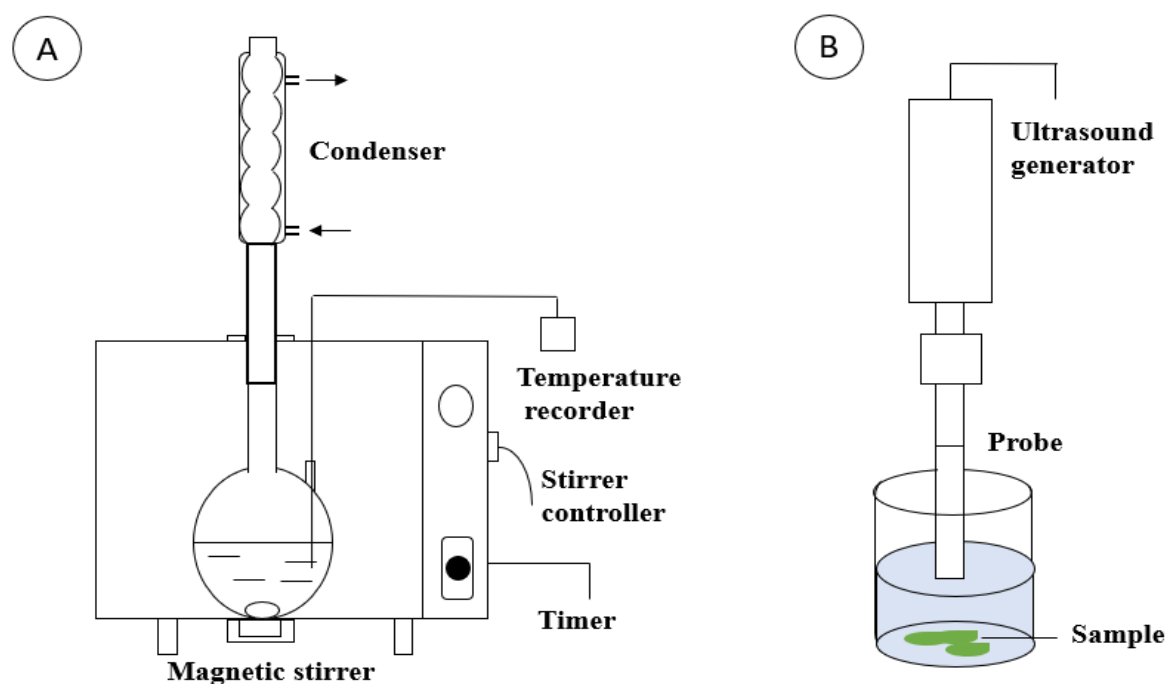

Figure 7. A-scheme of microwave apparatus, B-Scheme of ultrasound apparatus

The cavitation bubbles generated during ultrasonication creates micro-jets intended to destroy the glands that contain the essential oils in order to facilitate mass transfer and the release of essential oils from plants. This cavitation effect dependent strongly on the operating parameters (ultrasound frequency and intensity, temperature, treatment time, etc.) those parameters are essential for effective design and operation of sono-reactors. According to literature, the essential oils obtained by ultrasound-assisted extraction showed less thermal degradation, high quality and good flavour with high yield (Shirsath et al., 2012).

➤ Solar extraction

Solar energy is a clean source, and since the sun provides more energy than necessary, it is therefore constructive to develop adaptable systems for various uses that consume this abundant energy such as extraction (fig. 8).

Many solar systems have been developed to ensure an efficient solar extraction process. Yen and Lin (2017) propose a solar extraction system composed of a solar energy tube, solar cell as well as a sunlight shade coupled with a temperature controller to regulate the intensity of solar rays for an approximate extraction temperature of 100 °C, and an essential oil collection unit with the following component, a collecting bottle and a cooling tank with a thermo-electrical cooler. The energy for both regulating the temperature via the shading and cooling is delivered by a battery.

Munir et al. (2014) proposed a different solar system using Scheffler reflector, this fixed focus concentrators are successfully used for medium temperature applications in different parts of the world. They are taken as lateral sections of paraboloids and provide fixed focus away from the path of incident beam radiations throughout the year. Their automatic tracking system with a stationary focus point has made it even more attractive for decentralized industrial applications in underdeveloped areas, where there is no electricity or fossil fuels availability. One of those applications is the processing of aromatic and medicinal plants composed of a parabolic reflector (Scheffler reflector) with an area of 8 m² composed of mirrors with an electronic and mechanical system for the daily and seasonal monitoring of the sun which reflect the sun's rays towards an aluminium secondary reflector, This frame is curved in such a way that it reflects the total radiation from the main reflector on the bottom of the distillation still; therefore, the secondary reflector is used as a conventional oven under the still.

Kulturel and Tarhan (2016) proposed a similar solar apparatus also used for the essential oil distillation; which was composed of multiple compound parabolic solar collectors as well as a distillation unit. The solar collectors were used to transfer the heat from the heat transfer oil that was circulated by a pump from the solar collectors to the distillation water (Table 2).

Table 2. Solar extraction of aromatic and medicinal plants

Application	Matrix	Treatment conditions	Benefits (B) and Disadvantages (D)	References
Essential oil extraction	<i>Cymbopogon citrus</i>	Hydro-distillation T.100 ± 5 °C Cooling T. 4 ± 0.5°C	B. Similar extraction yields with hydro-distillation. Citral extracted by solar energy is higher D. Needs additional energy	Yen and Lin (2017)
Essential oil extraction	Melissa Peppermint Rosemary leaves Cumin (Seed) Cloves (buds)	Steam distillation Temperature range (300 to 450°C) S=8m ²	B. The payback period is 2336 sunny hours. Reducing fossil fuel consumption D. needs solar tracking Direct solar radiation	Munir et al. (2014)
Deodorization prior to solvent extraction and essential oil extraction	Rosemary leaves	Steam-distillation S=10 m ²	A. Deodorization of rosemary leaves D. needs solar tracking Direct solar radiation Essential oil yield of solar and conventional process is relatively similar	Hilali et al. (2018)
Bio-refinery and essential oil and pectin extraction	Orange peels	Hydro distillation S=10 m ²	A. Valorization of orange peels D. needs solar tracking Direct solar radiation. Essential oil yield of solar and conventional process is relatively similar	Hilali et al. (2019)
Essential oil extraction	Eucalyptus Peppermint leaves or Pinus	Steam distillation S=10m ²	B. Reducing fossil fuel consumption D. needs solar tracking and additional source of energy	Afzal et al. (2017)
Essential oil extraction	<i>Mentha piperita</i> <i>Mentha spicata</i>	Steam distillation	B. No solar tracking D. electricity is needed to operate the heat transfer oil pump. Essential oil yield is lower than the one extracted by Neo Clevenger device.	Kulurel and Tarhan (2016)

Existing extraction technologies have considerable technological and scientific bottlenecks to overcome often requiring petroleum solvents and more than 70% of total process energy.

These shortcomings have led to the consideration of the use of enhanced extraction techniques, which typically require less solvent and energy, such as solar extraction and/or distillation (Chemat and Strube, 2015).

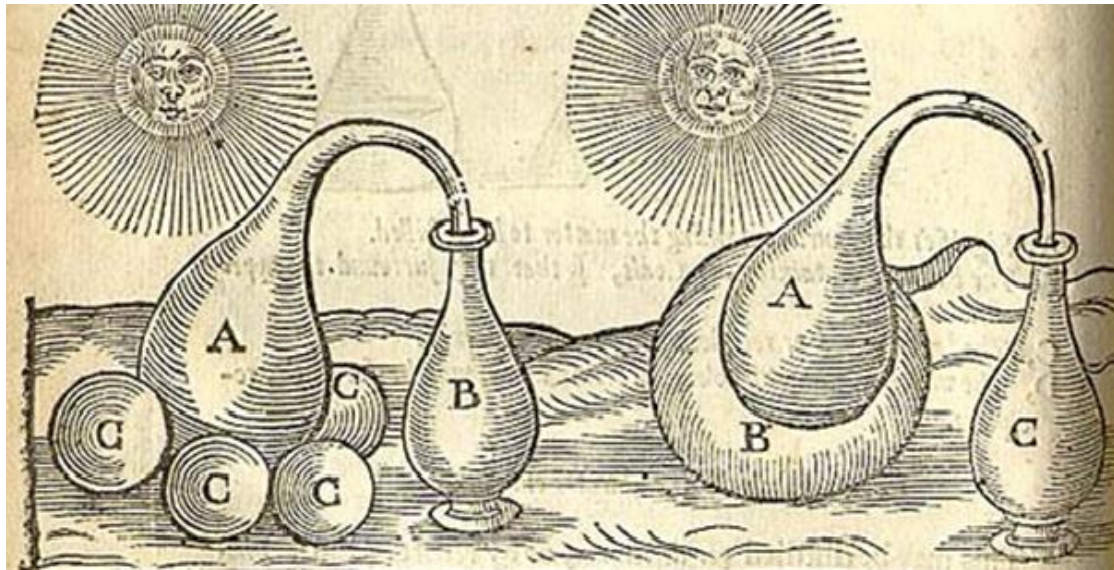

Figure 8. Solar distillation and extraction of aromatic and medicinal plants (French, 1651)

2.2 Solar Cooking

Cooking is a necessity for human all over the world; this imperative practice presents an important energy consumption share, thus the critical need to find affordable and appropriate alternatives to use especially in developing countries. Considering the current global discussion on environment and energy, renewable alternatives have gained much attention as a solution for both issues. Solar energy has proven it worth as it was able to meet a large share of population energy demands such as cooking. Most countries, particularly developing countries are usually blessed with an abundant amount of solar energy, having more than 275 sunny days a year (Wentzel and Pouris, 2007). Consequently, solar cookers offer an adequate alternative in the domestic sector mainly in such environment.

In fact, solar cookers are among the most promising application of solar energy especially in the domestic sector giving that the cooking demand represents 36% of the total primary energy consumption (Herez and al., 2018). They represent smoke-free solutions for cooking used in order to reduce the consumption of firewood or conventional fuel and are well recognized by various national and international organizations (Table 3).

The technology has multiple advantages such as labour reducing, no frequent cost and high food durability and quality. However, Despite of numerous efforts, the widespread use of solar cookers has yet to become possible due to diverse reasons that including the impossibility of using the system during period that lacks sufficient radiation for cooking, high prices, the necessity of specific cooking tools (Nkhonjera et al. 2017), as well as the high initial cost compared with traditional cooking devices.

Taking all those concerns into consideration, researchers have developed multiple types of commercial cookers designs that can attract economically and, in a way, help the uneasiness towards this technology. Promoting such technology will not only lessen the dependency on conventional fuels but will also reduce CO₂ emission. Even though solar cooking goes back to 1650, it was only given attention after World War 2, where the disastrous outcome included fuel shortages took place (Laird, 2005). In fact, the first known person that created a solar cooking box was a Swiss naturalist called Horace de Saussure also known as the grandfather of solar cooking and he published his work in 1767 (Wentzel and Pouris, 2007). Researchers have concluded through the years that well-built and designed solar cookers do not only provide nutritiously cooked food but are also user friendly. Solar cookers offer undoubtedly an efficient cooking technique, however, there is still an uneasiness to accept such technology especially since the market provide low-cost alternative.

Table 3.Comparison between modern and traditional cooking techniques

	Traditional		Modern				
	Three-stones	Mud	Firedclay	Electric	Gas fuel	Liquid fuel	Solar cooker
Source of energy	Wood	Wood	Wood and/or charcoal	Electricity	Liquefied petroleum gas	Kerosene/ethanol...	Solar rays
Efficiency	Very low	Low	Low	Very High	Very High	Very High	time-variations of the efficiency
Environmental impact	Very High	Very High	Very High	Low	High	high	Very low
References	Mac Carty <i>et al.</i> (2010)	Anozie <i>et al.</i> (2007)	Manibog (1984)	Anozie <i>et al.</i> (2007)	Mac Carty <i>et al.</i> (2010)	Mac Carty <i>et al.</i> (2010)	Öztürk (2004)

The characterization of solar cooker as well as their performance is a complex and difficult tasking due to the variety range of available cookers and their operation. They can be classified based on the used solar collector (Farjana *et al.*, 2018) as shown in table 4.

Table 4. Classification based on solar collectors

Solar collector	Description	Indicative Temperature	References
Non convecting Solar Pond	Stationary	$300 < T < 360$	Farjana et al. (2018)
Cylindrical Reflector	Motion-Single Axis/Solar tracking	$340 < T < 540$	Farjana et al. (2018)
Compound Parabolic Collector	Stationary/Motion-Single Axis/Solar tracking	$340 < T < 510$, $340 < T < 560$	Oommen and Jayaraman (2002)
Fresnel Reflector	Motion-Single Axis/Solar tracking	$340 < T < 540$	Sonune and Philip (2003)
Parabolic Reflector	Motion-Single Axis/Solar tracking	$340 < T < 560$	Farjana et al. (2018)
Flat-plate Absorber	Stationary	$300 < T < 350$	Farjana et al. (2018)
Spherical Bowl Reflector	Motion-Single Axis/Solar tracking	$340 < T < 1000$	Farjana et al. (2018)
Parabolic Dish Reflector	Motion-Single Axis/Solar tracking	$340 < T < 1000$	Farjana et al. (2018)

They could be also classified based on the type of cooking methodologies (Klemens and Da Silva, 2008) as presented in table 5.

Table 5. Classification of solar cookers based on the cooking methods

Solar cookers	Collector type	Methods
Concentrating (Disk type)	Transmitting concentrator Reflecting concentrator. <ul style="list-style-type: none"> • Parabolic • Cylindric • Spherical • Frensel 	The concentrated solar rays are reflected to the pot
Non-concentrating (Box type)	Withreflector Without reflector. <ul style="list-style-type: none"> • Single • Double • Multiple 	The pot is placed in the collector.
Indirect use	Steam based Chemical based CPC Organic fluid	the energy is transferred by a heat transfer medium

They can also be classified based on whether they possess a storage unit. In this case they are divided into two groups Figure 8.

- Solar cooker without storage system.
 - Solar cooker-Direct type.
 - Box type solar cooker (either with or without reflector). Composed of both an insulated box and a single or double transparent glass or plastic window made up of glass or plastic. Solar rays cross the window and get absorbed by the cooking kit (cookers walls and the bottom). For the heating effect to take place effectively the interior part of the box as well as the pots designed for cooking shall be painted in. The window offers greenhouse effect thus trapping the solar radiation inside the cooking apparatus and with that heating the air (Mahavar et al., 2013; Harmin et al 2013; Kumaresan et al., 2015). A reflector can be placed additionally as to reflect solar rays. (Arabacigil et al., 2015).

- Concentrating type (either from above or below). Composed of parabolic reflector and a cooking pot placed on the cooker focus point, this type cooks food by directly by absorbing the solar radiation heat from without any relying on any objects between the sun rays and the cooking pot (Panwara et al., 2012). It is based on solar optics principals that allow the concentrating of direct solar radiation onto the bottom or the top of the cooking pot to attain exceedingly high temperatures (Kumaresan et al., 2015).
- Solar cooker-Indirect type. It is composed of a collector that collects the heat from the solar radiation and a cooking unit that uses this heat. The cooking parts is protected and separated from radiation; the heat in this system is transferred from the collector via a heat transfer fluid (a small pump may be utilized for the circulation of the fluid) they are categorized based on the type of collector either flat plate, evacuated tube or compound parabolic (Kassem and Youssef, 2011).
- Thermal storage system for solar cookers.

In order to cook food in periods that lacks sunlight, solar thermal energy storages systems were designed for solar cookers to enhance their efficiency and usefulness. It is feasible to cook in a separate place or to store energy during sunshine as are they are two options to store thermal energy aimed for solar cooking purposes as either sensible or latent energy. The thermal storage can increase solar cookers performance by optimizing the irregularity of solar radiation and thus improve the process competitiveness.

- Solar cookers with latent heat storage. The system makes use of the energy stored when a substance changes from one phase to another. Phase Change Material (PCM) which allows a significant amount of energy storing over narrow temperature range. They are now for their high thermal energy storage capacity, they could absorb energy during heating process and release it to the environment during cooling process (Muthusivagami et al., 2010)
- Solar cookers with sensible heat storage. is considered as the simplest storage methods for thermal energy that occurs by raising solid or liquid temperature. The heat transfer fluid heated by solar radiation in the collector crosses towards to the cooking unit. Part of its sensible energy transfers towards to the double-walled cooking pot. The key sensible heat compounds that increase the heat capacity with temperature for energy storage are water, oil, iron and rocks that have increasing heat capacity with temperature.

Storing thermal energy may allow cooking at night maintaining food warm and decreasing the time needed to reach high temperature in short time. However, there are limitations related to this system mainly the fact that most materials have small capability to store sensible heat (Mawire et al., 2014).

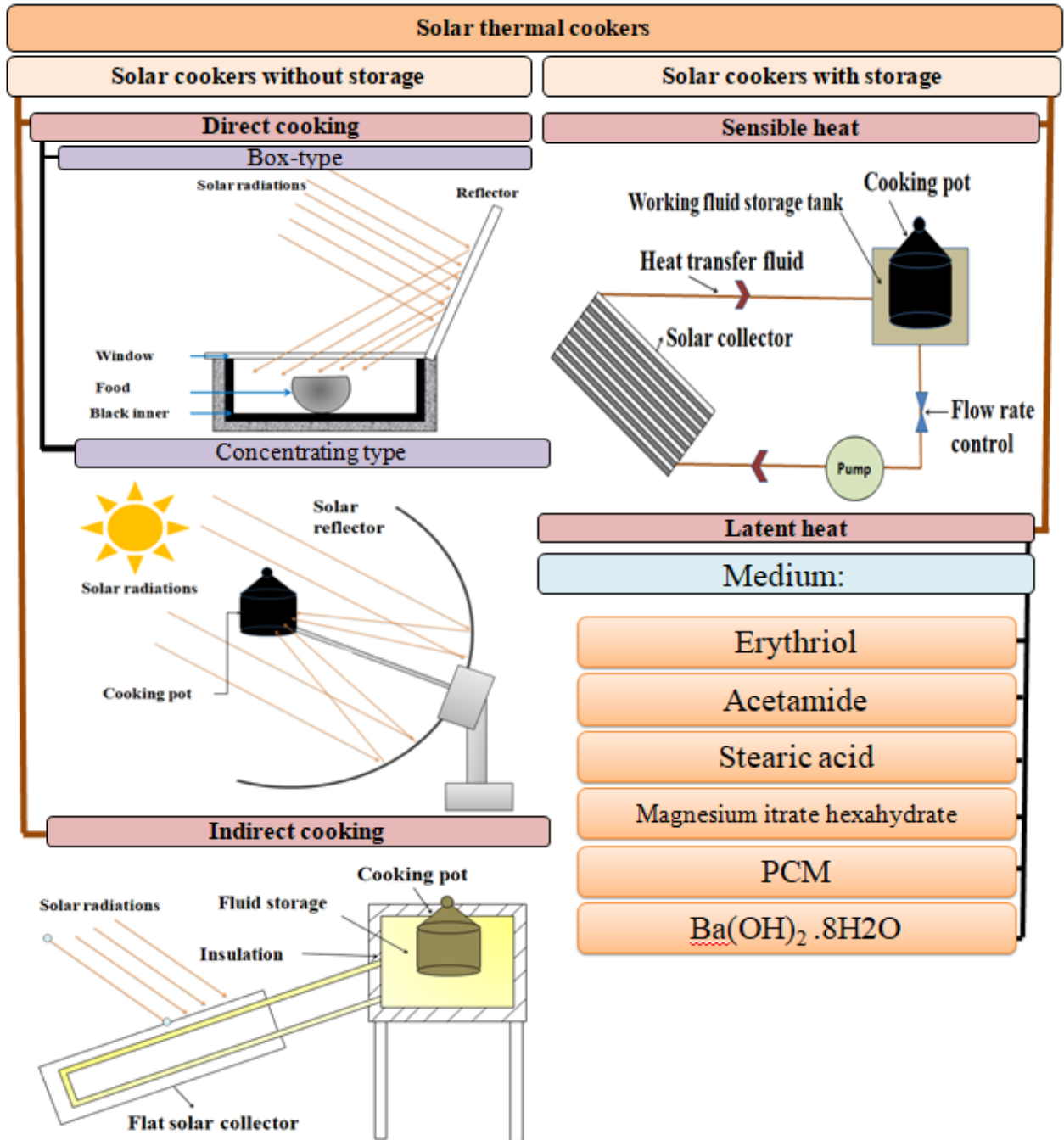

Figure 9.Classification based on the storage system

2.3 Solar drying systems

- Drying definition.

Drying is one of the oldest methods of preserving food and can be specified as a simultaneous heat and mass transfer operation in which water activity of a foodstuff is lowered by the removal of water by evaporation into an unsaturated gas stream. The conventional method of air drying is represented by a typical drying curve of a food product. This drying phenomenon is subdivided into three stages. During the first stage, the drying rate is constant because the surface of the product contains free moisture. In the second stage, moisture is transported from the inner of the product to the surface, and the critical moisture content is reached, this is called the *first falling rate period*. In the *second falling rate period*, there is a slow diffusion of water to the inner surface leading to desorption and diffusion through pores to the surface.

Drying is used for the preservation of food; it involves heating a product to evaporate the water it contains (or another solvent). There is a distinction between boiling and entrainment drying. Boiling is when the product reaches the boiling point of water. During the drying by entrainment the product to be dried is brought into contact with a current of hot air. The warm air transmits some of its heat to the product that develops a partial water pressure at its surface greater than the partial pressure of the water in the air used for drying. This pressure difference causes a transfer of material from the surface of the solid to the "drying agent". In order to dry a product, liquid or solid, it is necessary to provide heat, energy. Overall, it is considered that drying operations consume about 12% of the industrial energy used in the manufacturing process (Brunetti et al. 2015). This part is important and it is vital to find ways to optimize those processes, in both economic and ecological approach.

The open solar drying is a traditional solar drying method established for food preservation techniques was defined by Brenndorfer et al. (1987) as the direct spreading to the sun of a product on a flat surface since the later is heated by direct sun radiation and the moisture is reduced by natural circulation not requiring any additional source of energy making it the cheapest method.

This method is however time, space and labour demanding and has many limitations. The product only absorbs a portion of the radiation and reflects the rest additionally the technique does not preserve the quality of the food since it is an unprotected environment and can be infected by insect, dust, dirt, and animals which may lead to negative effect on the economic value of the product. Therefore, it is best to use solar-energy systems. (Lahsasni et al. 2004;Visavale 2014)

- Solar-energy drying systems: History and classification

Human have discerned since prehistoric ages the sun as the engine responsible for all-natural phenomenon; thus, explaining why certain tribes viewed the sun as a god. It was even emphasized in some ancient scripts that the great pyramid in Egypt was rather build as a stairway to reach the sun. This is mainly due to the variety of useful utilization of this renewable source. Drying under open sky is one of the oldest solar utilization methods used for food and crops preserving practiced since ancient times. It is process based on product heating till water contained evaporation not to confuse with boiling that refers water reaching it boiling point. Solar drying is described as a synchronized operation of heat and mass transfer marked by a lowering of the water activity of a foodstuff due to water removal by evaporation into an unsaturated gas stream. The air-drying process is represented by a food product typical drying curve divided into three stages (Purohit et al, 2006; Tiwari, 2016). Within the first stage, since the product surface contains free moisture the drying rate is constant. During the second stage, also called the first falling rate periods, is marked by moisture transportation from the inner to the surface of the product thus reaching the critical moisture content. The third and final stage named also the second falling rate period where a slow diffusion of water took place to the inner surface that leads to both desorption and diffusion through pores to the surface.

Nevertheless, the process presents many disadvantages mainly deterioration of the product due to several effects such as rain, moisture, dust, insect, animals, fungi, etc. This means that the final product quality will not be protected thus leading to even economical negative effects. Not to forget that the drying process call for an intensive labour, is time consuming, and require an immense spreading area. Even if artificial mechanical drying is used, it is still expensive and energy consuming.

Considering the previously discussed issues it is better to use solar-drying systems. While the system may have many advantages it also has numerous limitations since it can be only be used during day time when enough solar energy is present meaning that it is less efficient compared to modern type dryers and need a backup heating system.

Thus, even where there is a demand for technical changes toward green alternatives, consumers, industrials and farmers may find it difficult to adopt the solar recommended technologies, because of economic problems, labour constraints, or lack of materials. To promote solar drying, due to its known potential, some governments are providing financial and technical assistance to the emerging entrepreneurs in this field (Tiwari, 2016).

The process of drying involves using heat to extract product moisture and air to carry the resulting vapour. For ambient conditions, the procedure carries on till the product held moisture vapour pressure equals the atmosphere pressure.

Solar-energy drying systems are normally classified by both the heating and heat utilization modes. In general, there are two major groups as shown in figure 10 (Ekechukwu and Norton 1999) :

- Active solar-energy dryer (hybrid);
- Passive-energy Dryer (natural-circulation).

Each of them is sub-categorized in three classes.

- Integral-type solar dryers;
- Distributed-type solar dryers;
- Mixed-mode solar dryers.

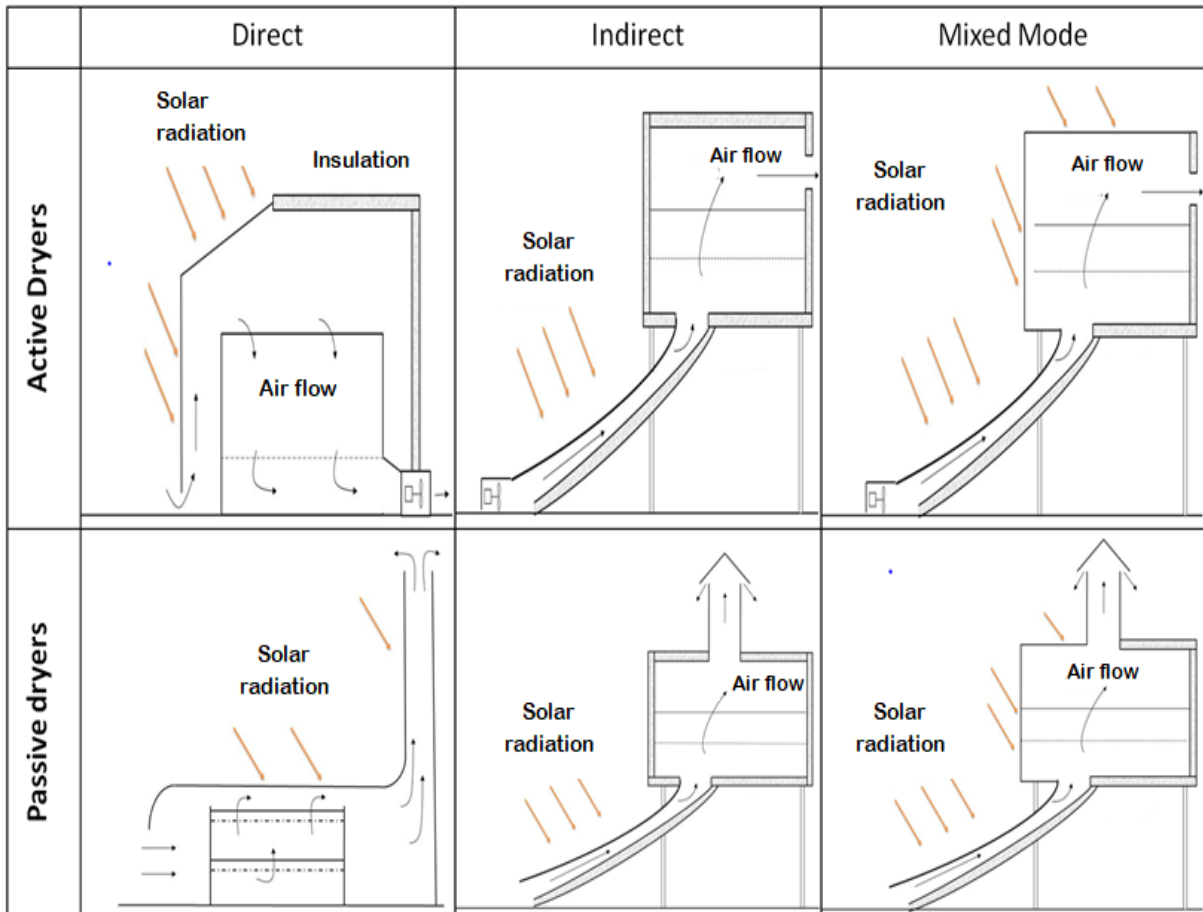

Figure 10. Solar drying techniques

2.4 Solar pasteurization

Pasteurization is defined as heating food process with as purpose to kill and eliminate harmful organisms while reducing the banal flora (Caso et al., 2008). Researchers were interested in developing and designing pasteurization systems that obtain their thermal energy from a green source that is why they turned to solar. First studies focused on water pasteurization knowing that diseases caused by water are the reason behind five million deaths per year (Burch and Thomas, 1998). Solar pasteurisation has been established as a very low-cost disinfection method to produce drinking water out of non-turbid fresh water. Nonetheless, solar pasteurisation is not that easy to implement and monitor, thus explaining why the method is not yet a wide spread method for point-of-use water treatment.

Further studies also focused on milk pasteurization as an energy consuming process. Milk is obtained from Cows, buffalos and goat and is a fundamental product for human nutrition and growth.

However, raw milk should not be consumed directly by a person since it can carry harmful bacteria notably *Salmonella*, *E. coli*, *Listeria*, *Campylobacter* and can causes foodborne illness, frequently referred to as food poisoning. Hence, milk heating is required at precise temperature to kill bacteria and harmful microorganisms (Panchal et al. 2018).

Harvesting the sun's energy for such application may represent a rational solution to resolve the energy problems caused by fuels scarcity and unsustainable nature. Table 6 depicts certain applications of solar pasteurization.

Table 6. Applications of solar pasteurization

Used system	Aims and finding	Reference
Pasteurizer unit (Solar Milk Minder) used for heat treatment of waste milk.	<ul style="list-style-type: none"> • Experiments on solar pasteurisation system by supplying hot water • Evaluating the effectiveness of a batch pasteurizer unit housed on a local dairy farm to kill <i>M. paratuberculosis</i> in waste milk fed to calves. • generating a clean product to feed to young calves 	Stabile (2001)
Low-cost Fresnel lens concentrator	<ul style="list-style-type: none"> • Pasteurising goat milk. • 1 h is required for pasteurising of 101 l of milk. 	Franco et al. (2008)
Flat plate collector	<ul style="list-style-type: none"> • Pasteurization of animal milk. • 65–70° is the best temperature for pasteurization 	Zahira et al. (2009)
Flat plate collector	<ul style="list-style-type: none"> • low-cost solar milk pasteurizer could be efficiently used for arid and remote areas where electricity or gas is not available 	Obuoro et al. (2011)

3. Environmental impacts using solar energy

Two main environmental impacts can be easily identified, the first one is the mitigation of deforestation giving; indeed the annual consumption of forests is at a rate of 1.3% of the total forest area which stand for (10-15 million hectares per year) and fuel wood gathering represents a major compounds in this equation (Manibog, 1984). Another example is the Sub-Saharan countries with 70% of their energy derived from wood fuel and it is mostly used for cooking purposes (Mwampamba, 2007). The second one is reducing global pollution as well as its effects on human health. In fact, the exposure to cooking fuels was found to be a major cause of respiratory symptoms which includes also chronic bronchitis (Behera et al., 2001)

Solar technologies are known as green, clean, and renewable energy source that provide significant environmental benefits compared to the conventional energy sources; however, these systems are not perfect and they often exhibit some negative yet minor environment impacts during their operational process.

- *Land Use and Thermal Pollution.* The large covered land ecosystem and productivity as well as the thermal balance can be affected (Tsoutsos et al., 2005). There is also the possibility of accidentally burning or polluting the surrounding area.
- *Visual Impacts.* Visual impacts are related to the reflectivity of the used solar system coupled with visual pollution.
- *Impacts on Natural Resources.* Solar energy systems have negative environment impacts during their production since they still use conventional energies for manufacturing.
- *Air Pollution.* Emissions are produced during both manufacturing and transportation.

4 HACCP and HAZOP considerations using solar energy

HACCP (Hazard Analysis and Critical Control Points) concept is a systematic approach to food safety management based on 7 recognized principles designed to identify and prevent the hazards likely to occur at any stage in the food supply chain (Sicaire et al. 2017). A critical control point (CCP) is a step in the flow diagram of the food process at which control measures can be applied. These CCPs are essential to prevent or eliminate a food safety hazard or reduce it to an acceptable level. Solar energy is nowadays used in many unit operations during food processing considering their physical effects for extraction and drying, but also considering their biological effects for pasteurization for example. However, the use of solar energy in food engineering requires the setting-up of an HACCP program in which the CCPs are identified, so that potential hazards in producing a safe quality product can be controlled. In the solar energy treatment, the critical processing factors are assumed to be the time of exposure/contact, the volume of food to be processed, the composition of the food, and the temperature of the treatment.

Hazard and operability (HAZOP) study is a formal, systematic, logical, structured investigative study for examining potential deviations of operations from design conditions that could create process–operating problems and hazards (Sicaire et al. 2017).

The main hazard the users may face is from accidental contact exposure to the solar irradiation and high temperature. Direct contact exposure can cause tissue injury for the operator. High temperature induced by solar energy can cause burns, and be a potential fire hazard. Irradiation with UV could imply damages to the eyes.

Conclusion

Due to the global warming, energy scarcity, and environmental impact of fossil fuels; solar energy become very a very attractive alternative. Solar energy is a renewable source of energy available freely. It can be harnessed either by solar thermal and solar photovoltaic technologies.

This part presented a simple comprehensive review of various applications of solar thermal technologies. Starting from the most established technologies such as cooking and drying to new applications mainly solar pasteurization and extraction. From what we could find in the literature, solar extraction had a significant potential, however it was only used for essential oil extraction. Starting from this point the aim of our study was to develop a process in which essential oil and bio-active compound extraction could be feasible for a set of matrices.

References

- Afzal, A.; Munir, A.; Ghafoor, A.; Alvarado, J.L. Development of Hybrid Solar Distillation System for Essential Oil Extraction. *Renewable Energy*. 2017.113, 22–29. <https://doi.org/10.1016/j.renene.2017.05.027>.
- Akpinar, E. K.; Bicer. Y. Mathematical Modelling of Thin Layer Drying Process of Long Green Pepper in Solar Dryer and under Open Sun. *Energy Conversion and Management*. 2008, 49 (6). 1367–75. <https://doi.org/10.1016/j.enconman.2008.01.004>.
- Anderson, B. Solar energy. fundamentals in building design. New York. McGraw-Hill; 1977.
- Anozie, A. N., Bakare, A. R.; Sonibare, J. A. Oyebisi, T. O. Evaluation of Cooking Energy Cost, Efficiency, Impact on Air Pollution and Policy in Nigeria. *Energy*. 2007, 32 (7). 1283–90. <https://doi.org/10.1016/j.energy.2006.07.004>.
- Arabacigil, B.; Yuksel, N.; Avci, A. The use of paraffin wax in a new solar cooker with inner and outer reflectors. *Therm Sci*. 2015,19.
- Aravindh, M.A.; Sreekumar, A. Energy Sustainability through Green Energy. 2015.<https://doi.org/10.1007/978-81-322-2337-5>.
- Atia, M. F., M. M. Mostafa, M. F. Abdel-Salam, and M. A. El-Nono. 2011. Solar Energy Utilization for Milk Pasteurization, no. October 2011. 0–15.
- Bahloul, N.; Boudhrioua, N.; Kouhila, M.;Kechaou, B.; Effect of convective solar drying on colour, total phenols and radical scavenging activity of olive leaves (*Olea europaea* L). *Int J Food Sci Technol*. 2009, 44. 2561-2567.
- Azmir, J.; Zaidul, I.S.M.; Rahman, M.M.; Sharif, K.M.; Mohamed, A.; Sahena, F.; Jahurul, M.H.A; Ghafoor, K.; Norulaini, N.A.N.; Omar, A.K.M. Techniques for extraction of bioactive compounds from plant materials: A review. *Journal of Food Engineering*. 2013, 117(4), 426–436. doi:10.1016/j.jfoodeng.2013.01.014
- Behera, D.; Chakrabarti, T.;Khanduja, K.L. Effect of Exposure to Domestic Cooking Fuels on Bronchial Asthma. *The Indian Journal of Chest Diseases & Allied Sciences*. 2001., 43 (1). 27–31. <http://www.ncbi.nlm.nih.gov/pubmed/11370503>.
- Bousbia, N.; Abert Vian, M.; Ferhat, M. A.; Petitcolas, E.; Meklati, B. Y.; Chemat, F. Comparison of two isolation methods for essential oil from rosemary leaves. Hydrodistillation and microwave hydrodiffusion and gravity. *Food Chemistry*. 2009, 114(1), 355–362. doi.10.1016/j.foodchem.2008.09.106

- Brunetti, L.; Giametta, F.; Catalano, P.; Villani, F.; Fioralba, J J.; Fucci, F. ; La Fianza, G. Energy consumption and analysis of industrial drying plants for fresh pasta process, *Journal of Agricultural Engineering*. 2015. <https://doi.org/10.4081/jae.2015.478>.
- Buddhi, D., Sahoo, L.K. Solar Cooker with Latent Heat Storage. Design and Experimental Testing. *Energy Conversion and Management*. 1997, 38 (5). 493–98.
- Burch, J.D.; Thomas E.K. water disinfection for developing countries and potential for solar thermal pasteurization. *Solar energy*. 1998, 64 (98). 87–97.
- Chemat, F., Strube, J. Green Extraction of Natural Products, Wiley, Weinheim, 2015.
- Claflin K., Schollers P. Writing food history - a global perspective. Berg Publications, 2012.
- Colonbo, U. Development and the global environment. In: Hollander JM, editor. The energy environment connection. Washington. Island Press; 1992. p. 3 – 14.
- Dincer I. Energy and environmental impacts. present and future perspectives. *Energy Sources*. 1998, 20(4–5), 427–453
- Dincer, I.; Rosen, M.A. A worldwide perspective on energy, environment and sustainable development. *International Journal of Energy Research*. 1998, 22(15).
- Dincer, I. Environmental impacts of energy. *Energy Policy*. 1999, 27(14), 845– 54.
- Ekechukwu, O.V.; Norton, B. Review of Solar - Energy Drying Systems II . An Overview of Solar Drying Technology. *Energy Conversion & Management*. 1999, 40. 615–55. [https://doi.org/10.1016/S0196-8904\(98\)00092-2](https://doi.org/10.1016/S0196-8904(98)00092-2).
- Ekechukwu, O.V. Review of solar-energy drying systems I. an overview of drying principles and theory. *Energy Convers Manag*. 1999, 40. 593-613.
- Farjana, S.H., Huda, N.; Parvez Mahmud, M.; Saidur A.R. Solar Process Heat in Industrial Systems – A Global Review. *Renewable and Sustainable Energy Reviews*. 2018, 82 (January). Elsevier Ltd. 2270–86. <https://doi.org/10.1016/j.rser.2017.08.065>.
- Franco, J.; Saravia, L.; Javi, V.; Caso, R.; Fernandez, C. Pasteurization of Goat Milk Using a Low Cost Solar Concentrator. *Solarenergy*. 2008. 82. 1088–94. <https://doi.org/10.1016/j.solener.2007.10.011>.
- Fudholi, A.; Sopian, K.; Othman, M.Y.; Ruslan MH, AlGhoul, M.A.; Zaharim, A.; Zulkifly, R. Heat transfer correlation for the V-Groove Solar Collector. Santander, Cantabria, Spain. 2008. 8th WSEAS International Conference on simulation, modelling and optimization. Santander, Cantabria, Spain, September 23-25, 2008.
- Harmim A, Merzouk M, Boukar M, Amar M. Design and experimental testing of an innovative building-integrated box type solar cooker. *Sol Energy*. 2013, 98.

- Herez, A.; Ramadan, M.; Khaled, M. Review on solar cooker systems. Economic and environmental study for different Lebanese scenarios. *Renewable and Sustainable Energy Reviews*. 2018, 81, 421–432. doi.10.1016/j.rser.2017.08.021
- Hosseini, A.A.; Hosseini, S.H. Utilizing Solar Energy Instead of Fossil Fuels as Domestic Energy (Case Study. Dehloran City, Ilam Province, Iran). *Energy Exploration & Exploitation*. 2012, 30(3), 389–401. doi.10.1260/0144-5987.30.3.389
- Idlimam, A.; Kouhila, M.; Lamharrar, A.; Kechaou, N. Isothermes de sorption et séchage solaire convectif des plantes aromatiques et médicinales. Théorie et applications. 2016. 1ère Edition, ISBN. 978-9954-37-715-4, dépôt légal. 2016 MO 1913.
- John French. The art of distillation, Cotes Editions, London, 1651.
- Kabir, E.; Kumar, P.; Kumar, S.; Adelodun, A. A.; Kim, K-H. Solar Energy. Potential and Future Prospects. *Renewable and Sustainable Energy Reviews*. 2018, 82 (September 2016), 894–900. <https://doi.org/10.1016/j.rser.2017.09.094>.
- Kalogirou, S.A. Solar thermal collectors and applications. *Progress in Energy and Combustion Scienc*. 2004,30(3), 231–295. doi.10.1016/j.pecs.2004.02.001
- Kassem, T.K.; Youssef, M.S. Solar cookers and its application for food cooking in remote areas. Review. *J Eng Sci*. 2011, 39.
- Kaufmann, B.; Christen, P. Recent Extraction Techniques for Natural Products . Microwave-Assisted Extraction and Pressurised Solvent Extraction. *Phytochemical Analysis*. 2002, 113. 105–13.
- Khan, M.F; Dwivedi, A.K.. A Review on Techniques Available for the Extraction of Essential Oils from Various Plants. *International Research Journal of Engineering and Technology*, 2018, 5 (5).
- Kulurel, Y.; Tarhan, S. Performance of a Solar Distillery of Essential Oils with Compound Parabolic Solar Collectors. *Journal of Scientific & Industrial Research*. 2016, 75 (November). 691–96.
- Kumar, R.; Sharma, S.; Sharma, S.; Kumar, N. Drying methods and distillation time affects essential oil content and chemical compositions of *Acorus calamus* L. in the western Himalayas. *Journal of Applied Research on Medicinal and Aromatic Plants*. 2016,3(3), 136–141. doi.10.1016/j.jarmap.2016.06.001
- Kumaresan, G.; Raju, G.; Iniyani, S.; Velraj, R. CFD analysis of flow and geometric parameter for a double walled solar cooking unit. *Appl Math Model*. 2015, 39.

- Lahsasni, S.; Kouhila, M.; Mahrouz, M.; Idlimam, A. Thin Layer Convective Solar Drying and Mathematical Modelling of Prickly Pear Peel (*Opuntia Ficus Indica*). 2004, 29, 211–24. <https://doi.org/10.1016/j.energy.2003.08.009>.
- Laird, F. The society whose time had come. *Solar Today* July/ August, 36–39, 2005.
- Lakshmi D.V.N., Muthukumar P., Layek A., Nayak P.K. 2018. Drying kinetics and quality analysis of black turmeric (*Curcuma caesia*) drying in a mixed mode forced convection solar dryer integrated with thermal energy storage. *Renewable Energy* 120 (2018) 23-34.
- MacCarty, N.; Still, D.; Ogle, D. Fuel Use and Emissions Performance of Fifty Cooking Stoves in the Laboratory and Related Benchmarks of Performance. *Energy for Sustainable Development*. 2010, 14 (3). Elsevier Inc. 161–71. <https://doi.org/10.1016/j.esd.2010.06.002>.
- Mahavar, S.; Rajawat, P.; Marwal, V.K.; Punia, R.C.; Dashora, P. Modelling and on-field testing of a solar rice cooker. *Energy*. 2013;49.404–9.
- Manibog, F.R. Improved Cooking Stoves in Developing Countries. Problems and Opportunities. *Annual Review of Energy*. 1984, 9 (1). 199–227. <https://doi.org/10.1146/annurev.eg.09.110184.001215>.
- Mawire, A.; Phori, A.; Taole, S. Performance comparison of thermal energy storage oils for solar cookers during charging. *Appl Therm Eng*, 2014, 73, 1323–1333.
- Meinel, A.B.; Meinel, M.P. Applied solar energy. an introduction. Reading, MA. Addison-Wesley; 1976.
- Munir, A.; Hensel, O.; Scheffler, W.; Hoedt, H.; Amjad, W.; Ghafoor, A. Design, Development and Experimental Results of a Solar Distillery for the Essential Oils Extraction from Medicinal and Aromatic Plants. *Solar Energy*. 2014, 108. Elsevier Ltd. 548–59. <https://doi.org/10.1016/j.solener.2014.07.028>.
- Muthusivagami, R. M.; Velraj, R.; Sethumadhavan, R. Solar cookers with and without thermal storage—A review. *Renewable and Sustainable Energy Reviews*. 2010,14(2), 691–701. doi.10.1016/j.rser.2008.08.018
- Mwampamba, T.H. Has the Woodfuel Crisis Returned? Urban Charcoal Consumption in Tanzania and Its Implications to Present and Future Forest Availability. *Energy Policy*. 2007, 35 (8),4221–34. <https://doi.org/10.1016/j.enpol.2007.02.010>.
- Nahar, N.M. Performance and Testing of an Improved Hot Box Solar Cooker. *Energy Conversion and Management*. 1990, 30 (1). 9–16. [https://doi.org/10.1016/0196-8904\(90\)90051-Y](https://doi.org/10.1016/0196-8904(90)90051-Y).

- Nkhonjera, L.; Bello-Ochende, T.; Geoffrey, J.; King'onde, C. A Review of Thermal Energy Storage Designs, Heat Storage Materials and Cooking Performance of Solar Cookers with Heat Storage. *Renewable and Sustainable Energy Reviews*. 2017, 75 (October 2016). 157–67. <https://doi.org/10.1016/j.rser.2016.10.059>.
- Obuoro, F.W.; Okot, W. M.; W. John. Design and performance assessment of a flat plate solar milk pasteurizer for arid pastoral areas. *J Food Process Preserv*. 2013, 37, 120–5. <https://doi.org/10.1111/j.1745-4549.2011.00628.x>
- Oommen, R.; Jayaraman, S. Development and Performance Analysis of Compound Parabolic Solar Concentrators with Reduced Gap Losses - 'V' Groove Reflector. *Renewable Energy*. 2002, 27 (2). 259–75. [https://doi.org/10.1016/S0960-1481\(01\)00185-9](https://doi.org/10.1016/S0960-1481(01)00185-9).
- Öztürk, H. H. Experimental Determination of Energy and Exergy Efficiency of the Solar Parabolic-Cooker. *Solar Energy*. 2004, 77 (1). 67–71. <https://doi.org/10.1016/j.solener.2004.03.006>.
- Panchal, H.; Patel, R.; Chaudhary, S.; Patel, D.; Sathyamurthy, R.; Arunkumar, T. Solar energy utilisation for milk pasteurisation: A comprehensive review. *Renewable and Sustainable Energy Reviews*. 2018, 92, 1-8. doi: 10.1016/j.rser.2018.04.068.
- Panwara, N.L.; Kaushik.; S.C, Kothari, S. State of the art of solar cooking. an overview. *Int J Sustain Energy*. 2012,16.
- Parida, B.; Iniyar, S.; G, R. A Review of Solar Photovoltaic Technologies. *Renewable and Sustainable Energy Reviews*. 2011, 15 (3). Elsevier Ltd. 1625–36. <https://doi.org/10.1016/j.rser.2010.11.032>.
- Purohit, P.; Kumar, A.; Kandpal, T.C. Solar drying vs. open sun drying. A framework for financial evaluation. *Solar Energy*. 2006 80(12), 1568–1579. doi.10.1016/j.solener.2005.12.009
- Saxena, A.; Goel, V., Karakilcik., M. Solar Food Processing and Cooking Methodologies 2018.
- Sahraoui, N.; Boutekdjiret, C. Innovative Process of Essential Oil Extraction . Steam Distillation Assisted by Assisted by Microwave. *Progress in Clean Energy*. 2015, 1.<https://doi.org/10.1007/978-3-319-16709-1>.
- Schwarzer, K.; da-Silva, M.E.V. Characterisation and Design Methods of Solar Cookers. *Solar Energy*. 2008, 82 (2), 157–63. <https://doi.org/10.1016/j.solener.2006.06.021>.

- Sharaf, E. A New Design for an Economical, Highly Efficient, Conical Solar Cooker. *Renewable Energy*, 2002, 27 (4). 599–619. [https://doi.org/10.1016/S0960-1481\(01\)00136-7](https://doi.org/10.1016/S0960-1481(01)00136-7).
- Shirsath, S.R.; Sonawane, S.H.; Gogate, P.R. Chemical Engineering and Processing . Process Intensification Intensification of Extraction of Natural Products Using Ultrasonic Irradiations — A Review of Current Status. *Chemical Engineering & Processing. Process Intensification*. 2012, 53. Elsevier B.V.. 10–23. <https://doi.org/10.1016/j.cep.2012.01.003>.
- Sicaire, A.G.; Vian, M.; Chemat, F. Handbook of Ultrasonics and Sonochemistry. 2017. <https://doi.org/10.1007/978-981-287-470-2>
- Sonune, A V, and S K Philip. 2003. Development of a Domestic Concentrating Cooker. 28. 1225–34. [https://doi.org/10.1016/S0960-1481\(02\)00187-8](https://doi.org/10.1016/S0960-1481(02)00187-8).
- Sovová, H.; Aleksovski, S. A.. Mathematical model for hydrodistillation of essential oils. *Flavour and Fragrance Journal*. 2006, 21(6), 881–889. doi.10.1002/ffj.1729
- Sunil, I.; Kandpal, T.C. Institutional cooking with solar energy. A review. *Renewable and Sustainable Energy Reviews*. 2018, 84 (2018) 131–154.
- Stabel J.R. *On-Farm Batch Pasteurization Destroys Mycobacterium paratuberculosis in Waste Milk J. Dairy Sci.* 2001, 84:524–527
- Tiwari, A. A review on solar drying of agricultural produce. *J. Food Process Technol.* 2016, 7.9 DOI. 10.4172/2157-7110.1000623
- Tsoutsos, T.; Frantzeskaki, N.; Gekas, V. Environmental Impacts from the Solar Energy Technologies. *Energy Policy*. 2005, 33 (3). 289–96. [https://doi.org/10.1016/S0301-4215\(03\)00241-6](https://doi.org/10.1016/S0301-4215(03)00241-6).
- Uddin, M.R.; Tasneem, Z.; Annie, S.I.; Salim, K.M. Performance Assessment of a Solar Powered Rice Husking System with a VFD Controlled High Capacity 3-Phase Inverter. *IEEE International Conference on Power and Renewable Energy*, ICPRE 2016, 630–34. <https://doi.org/10.1109/ICPRE.2016.7871154>.
- Visavale, G. Principles, Classification and Selection of Solar Dryers, no. January 2012.
- Wentzel, M.; Pouris, A. The development impact of solar cookers. A review of solar cooking impact research in South Africa. *Energy Policy*. 2007, 35(3), 1909–1919. doi.10.1016/j.enpol.2006.06.002
- Yaldýz, O.; Ertekýn, C. Thin Layer Solar Drying of Some Vegetables. *Drying Technology*. 2001, 19, (3–4). 583–97. <https://doi.org/10.1081/DRT-100103936>.

- Yen, H.Y.; Lin, Y.C. Industrial Crops & Products Green Extraction of Cymbopogon Citrus Essential Oil by Solar Energy. *Industrial Crops & Products*. 2017, 108 (April). Elsevier. 716–21. <https://doi.org/10.1016/j.indcrop.2017.07.039>.
- Zahira, R.; Akif, H.; Amin, N.; Azam M.; Zia-ul-Haq. Fabrication and performance study of a solar milk pasteurizer. *Pak J Agric Sci*. 2009, 46(2), 162–70.

Part II: Material and Methods

This part describes raw materials, chemicals solvents, standards, experimental methods and protocols (used for the analysis), as well as microscopic techniques (used to understand the impact of solar extraction on rosemary leaves). The solar and conventional processes used for extraction and drying are also depicted in this part.

1. Plant materials

The studies have been performed, in this study, mainly on two matrices: Rosemary (*Rosmarinus officinalis L.*) and orange peels. These plant species were selected for two main reasons.

- They present two different categories. Rosemary is an aromatic and medicinal plant while orange peels are considered as citrus fruits processing by-product.
- Both are rich in bio-compounds and have a significant valorisation potential.

The leaves of spontaneous plants of rosemary (*Rosmarinus officinalis L.*) were collected in 2017 Taourirt city (altitude 394m) located in the northern part of Morocco (Oriental region). Leaves moisture after air drying was 4.72%.

As for oranges (*Citrus sinensisL.*), they were purchased from a local supermarket in Marrakech province (Morocco). The fruits were manually pressed to extract orange juice; the left out orange peels had 63% moisture content and were submitted to a hydro-distillation extraction by both a conventional and a solar distillation process. The experiments were carried in triplicate with a ration of 1.5 (peels. water) and an orange peels weight of 500g per experiment.

2. Chemical and reagents

Solvents and chemicals used for the experimentation and analysis are presented in this section. For extraction in both the solar and conventional processes only distilled water was used, however, for analysis, Soxhlet extraction, pectin quantification, and extraction prior to antioxidant and total polyphenol and flavonoids content estimation numerous solvents were used, such as acetone, ethanol, methanol acetone and ethanol (Table 7). It should be noted that all solvents used for analysis (HPLC, and GC) were of analytical grade.

Table 7. Solvents, reagents, and standards used for analysis and extraction

Type	Provider and N° CAS
Solvents	
Methanol (analysis)	Sigma-Aldrich 67-56-1
Methanol (Analysis)	VWR-67-56-1
Acetone (Analysis)	Sigma-Aldrich 67-64-1
Acetone (Extraction)	VWR 67-64-1
Ethyl Acetate (analysis)	Sigma-Aldrich 141-78-6
Water (Analysis)	Sigma-Aldrich 7732-18-5
Ethanol	VWR 64-17-5
Reagent	
DPPH	Sigma-Aldrich 1898-66-4
Folin-Ciocalteu's phenol	Emsure Merck Millipore
Sodium carbonate (Na ₂ CO ₂)	Sigma-Aldrich 497-19-8
quercetine	Sigma-Aldrich 854061-97-8
Aluminium chloride (AlCl ₃)	Fluka 7446-70-0
potassium acetate	Sigma-Aldrich 127-08-3
Standards	
Rosmarinic acid	Sigma-Aldrich 20283-92-5
Carnosicacid	Sigma-Aldrich 3650-09-7
Ursolicacid	Sigma-Aldrich 77-52-1
Carnosol	Sigma-Aldrich 5957-80-2
Hesperidin	Extra-Synthese 520-26-3
Naruritin	Extra-Synthese 10236-47-2

3. Extraction processes

This section aims to describe the extraction processes used for the experimental part with special focus on solar treatments (Solar steam distillation used for rosemary leaves as a deodorization process and solar hydro-distillation used for orange peels as a bio-refinery process) compared to conventional processes (Steam and hydro-distillation). Experimental conditions were selected based on the weather conditions for solar process.

For each matrix a different process was considered (fig. 11).

- Rosemary leaves recovered after steamed distillation (solar and conventional) were submitted to Soxhlet extraction to determine the content in rosmarinic acid, carnosic acid, ursolic acid, and carnosol. This process was performed also on initial rosemary (before deodorization) Acetone (100%) was used to determine the content in carnosic acid, carnosol, and ursolic acid, while 35% ethanol was used to determine rosmarinic acid content. The extraction process was carried out for 8 h, and each experiment was performed in triplicate. To investigation of process-related structural impacts on rosemary, studied leaves were submitted to fluorescent and scanning microscopic technique
- Oranges were manually pressed to extract the juice. The recovered orange peels were coarsely ground (particle size between 4 and 5 mm, density about 0.45 g/cm³) and submitted to both conventional and solar hydro-distillation extractions. To compare the impact of solar extraction on different bioactive compounds, orange peels before and after extraction were frozen, lyophilized, and extracted with methanol–water (80:20).

To assess extraction efficiency of these processes, chemical analyses (Spectrophotometric determination of antioxidants, total polyphenols and/or flavonoid content, HPLC, GC) as well as pectin extraction on orange peels were performed on solar and conventional obtained extracts.

Finally, comparison between experimental results and investigations were made to draw final conclusions on solar processes compared to the conventional extraction techniques (steam and hydro-distillation). All experimental methods are detailed in this section.

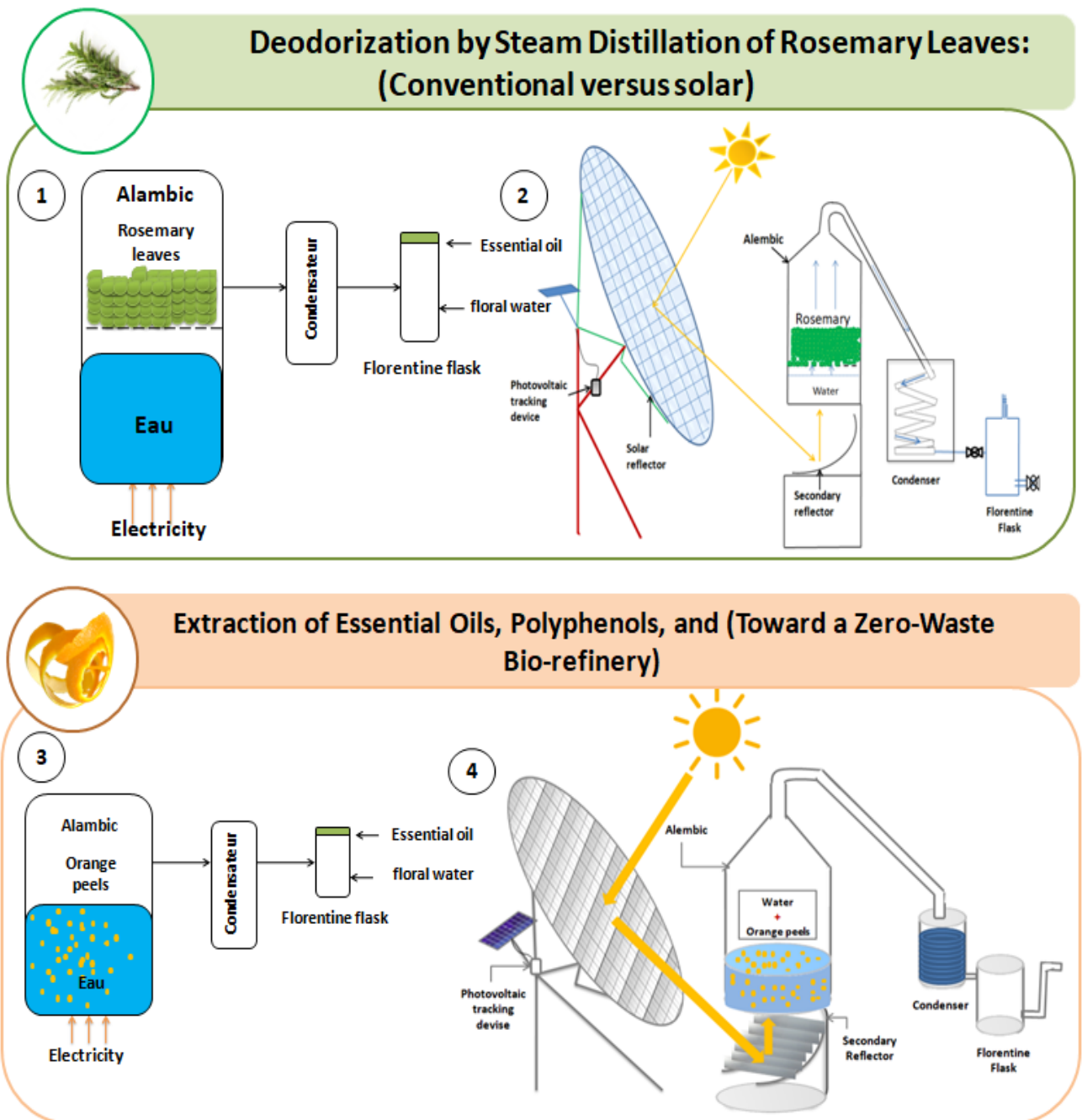

Figure 11. Extraction process schemes. 1-conventional steam distillation process, 2-solar steam distillation process, 3-conventional hydro-distillation process, 4 solar hydro-distillation process.

3.1 Conventional extraction

For an accurate comparison, conventional extractions were carried with the same operating conditions that have been used for conventional steam distillation (fig 11 scheme 1 and 3).

- Clevenger Hydro-distillation for rosemary leaves in which five hundred grams of rosemary leaves were submitted to hydro-distillation with 5L of water for 6 hours with a Clevenger-type apparatus according to the European Pharmacopoeia (Conseil de l'Europe, 1996). The collected essential oil was dried with anhydrous sulphate and stored at a temperature of 4°C.
- Conventional steam distillation used for rosemary leaves, this system consisted of water boiling under the plant material, the steam passes through it. During distillation, only very small molecules can evaporate, so they are the only ones to leave the plant. These extremely small molecules constitute the essential oil. This process was considered for deodorization since it involves the use of steam to filter and evaporate the essential oils of the plant material, resulting in the condensation of steam and essential oil before separation.
- Hydro-distillation used for orange peels, this method meant that the material is completely immersed in water, which is boiled by applying direct heat (electricity in this case using a resistance). The main feature of this process is that there is direct contact between boiling water and plant material. The distillation stills (alembic) are the simplest type and are widely used by small producers for essential oils extraction. The disadvantages of this technique are related to uncontrolled heat meaning that distillation rate is variable. Also, there is a possibility of local overheating and "burning" of the raw material which can lead to low quality oil. Another disadvantage of this system is that it requires the heating of a large amount of water in addition to the cost and time required for each distillation.

The aromatic steams resulting from both processes is condensed and recovered in a Florentine flask. The extraction continued until no more essential oil was obtained. The collected essential oil was dried with anhydrous sodium sulphate and stored at 4 °C until used.

3.2 Solar extraction

Experimental solar steam and hydro-distillation setup is depicted in figure 12. The solar energy extraction apparatus for the processing of aromatic and medicinal plants was placed at the National Center for Studies and Research on Water and Energy, University of Cadi Ayyad (Marrakech, Morocco). The solar system is mainly composed of a Scheffler fixed focus solar reflector and a distillation unit, each of which has specific characteristics. The 10 m² parabolic reflector is equipped with solar tracking system. The primary reflector rotates along an axis parallel to the earth axis of rotation and keeps the reflected beam aligned with the fixed secondary reflector as the sun moves. Its total area is covered with mirrors (reflectivity of 87%) with as its purpose the reflection of most solar rays to the secondary reflector placed below the alembic. This secondary reflector serves basically as a conventional oven. It is a steel frame covered with seven sheets of aluminium with a 700 mm length and 100 mm width; this frame is curved in such a way that it reflects the total radiation from the main reflector to the bottom of the distillation still. The solar system is composed of the following; an alembic with a 400 mm diameter, 1020 mm height, and 2 mm thickness with a capacity of 15 kg of plant and 15 L of water; a coil condenser, with a steel coil of 10 mm diameter surrounded by a stainless cylindrical steel envelope with the characteristics of 250 mm diameter, 3 mm thickness, and 350 mm height; and a Florentine flask.

- For rosemary leaves. (SSD) the steam produced by solar heating of the alembic gets charged with essential oil while crossing the plant, and then it is condensed before being received by the Florentine flask. The extraction was performed during summer days and was carried out until no more essential oil was obtained. The collected essential oil was dried with anhydrous sodium sulphate and stored at 4 °C until used.
- Orange peels. The steam generated from the boiling of orange peels by the hydro-distillation process is charged with essential oils that eventually get recovered after condensation.



Figure 12. Solar distillation apparatus. (A and C) solar reflector; (B) solar apparatus; (D) distillation unit.

3.3 Essential oil yield

The essential oil yield is estimated by the ratio of the masses of the essential oil over the dried plant material weight. It is expressed in percent (%).

$$Y_{ESS} = \frac{M_{E.O}}{M_{DM}} \times 100 \quad (1)$$

Where Y_{ESS} is the essential oil yield (%), $M_{E.O}$ Mass of the essential oil (g) and M_{DM} is the dry matter mass (g).

3.4 Solvent extraction

Soxhlet extraction or solvent extraction was performed in the case of rosemary leaves to determine the content in rosmarinic acid, carnosic acid, ursolic acid, and carnosol in raw materials via HPLC-DAD (fig.13). This process was done on initial rosemary before any deodorization and on remaining rosemary after essential oil extraction which was previously dried in the sun. Acetone (100%) was used to determine the content in carnosic acid, carnosol, and ursolic acid, while 35% ethanol was used to determine rosmarinic acid content. The extraction process was carried out for 8 h, and each experiment was performed in triplicate.

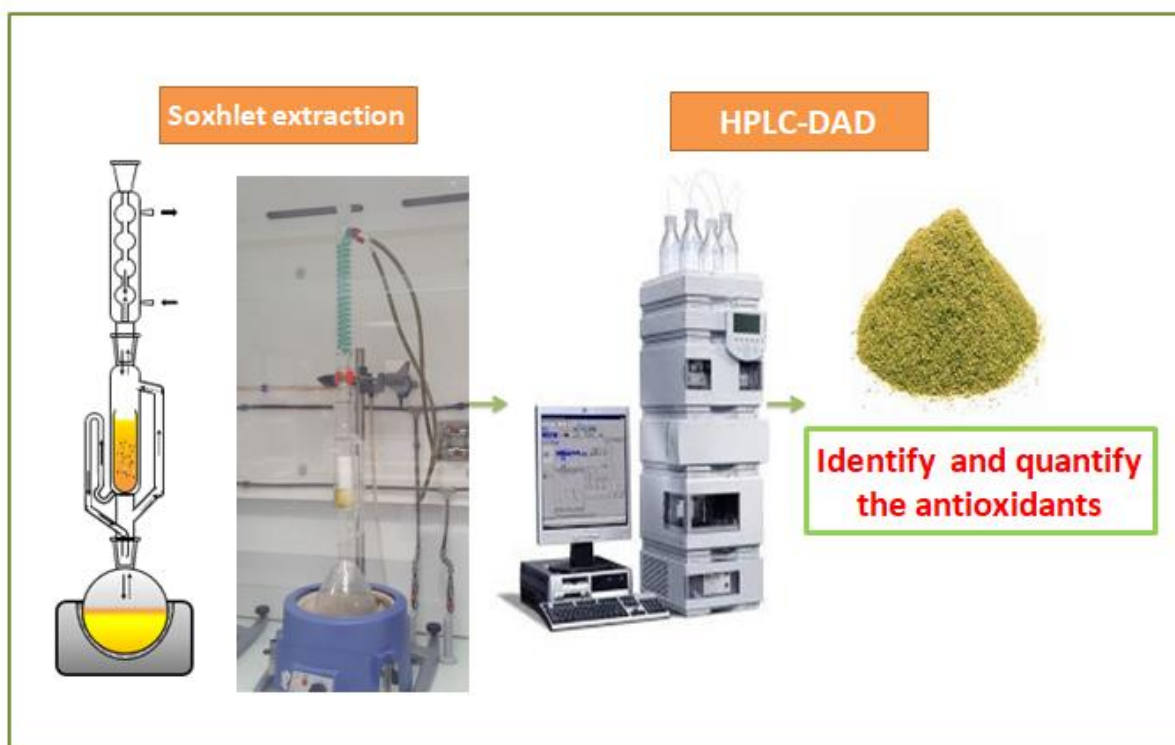

Figure 13. Solvant extraction

3.5 Pectin Extraction

The dried orange peels were crushed into powder, weighed (5g), and placed into a 100 mL glass reactor flask for a distilled water extraction; whereas, the powder obtained from the freeze drying of the water inside of the alembic was 2g into a 40 mL. The distilled water pH was adjusted with hydrochloric acid(1N) till a pH of 2.5(Maran, 2015; Boukroufa et al., 2015). The extraction was performed under a temperature of 75°C and an extraction time of 5 hours.

In general, the pectin extraction was carried according to the procedure showed in fig.13. The glass reactor flasks were covered with an aluminum wrap all through the extraction experimentation in order to minimize solvent evaporation. Following the extraction, the obtained mixtures were filtered by the help of cheese cloth and cooled to room temperature. Ethanol (95%) was then added to the filtrate extract with a 2:1 ratio and the final mixture was stored for 24 h at 4°C. The removal of the polysaccharides containing pectin was performed by 2 times centrifugation (9,000 rpm/ 10 min) and ethanol washing to remove the mono and disaccharide. The precipitate and filtrated pectin were dried in a 55°C air hot until a constant weight was attained.

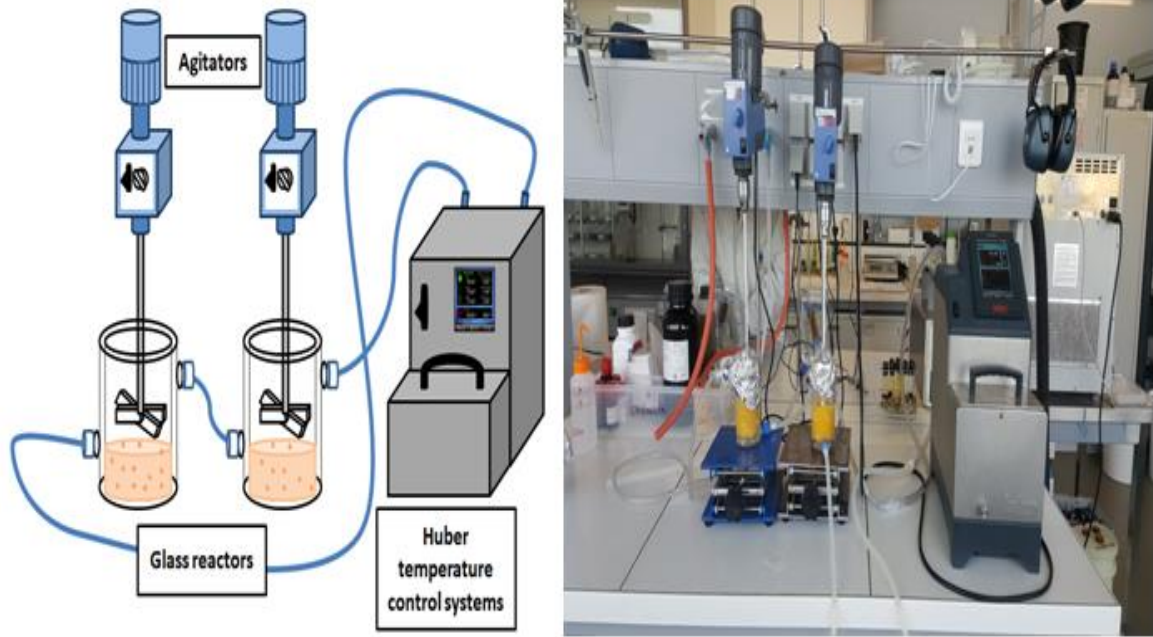

Figure II-4. Design of the pectine extraction process.

The pectin yield was expressed in percentage and calculated by following equation.

$$Y_P = \frac{M_p}{M_T} \times 100(2)$$

Where Y_p is the pectin yield, M_p is the mass of the extracted pectin, and M_T is the total powder mass.

4. Drying processes

Drying of a product is a process that consists of water extraction via vaporization. This method is used in a wide field of application. In addition to food product drying, there are studies that focus on other products, such as cotton drying (Akyol et al., 2010), roller dryers that treat paper and biomass drying (Ståhl et al., 2004). The energy source used for most of those drying application is often wood combustion, hydrocarbon or electrical energy. Taking into consideration the environmental impact of such sources as well as the monetary fluctuation often due to the unsustainable nature of fossil fuels, solar dryers were introduced to promote the use of green energy while solving conventional drying issues.

In solar drying, the energy is either the sole or the complementary source to provide the necessary drying heat. The drying air can be generated by either natural or forced-convection. The heating process involves either the passage of preheated air throughout the product or by exposing directly the product to solar rays or the combination of both applications (Hachimi et al., 1998). It should be noted that there are several techniques to dehydrate an agricultural product. However, convection drying remains the most widespread and most used technique. The drying is based on the heat transfer from the air mass and surrounding surfaces (with a temperature higher than the temperature of the product) to the product by convection, conduction and/or radiation.

4.1 Drying apparatus

The experimental apparatus proposed in this study is indirect forced convective solar dryer that allows the production of got air flow rate with aero-thermal characteristic (temperature and air flow) (Lahnine et al., 2016; Bahammou et al., 2019) It consists of (fig.14).

- Solar air collector with a dimension of 2.5 m^2 (2.5m over 1m) with a 31° inclination from the horizontal level and oriented southward. The transparent outer of the solar collector is made of ordinary glass, the opaque absorber of 0.5 thickness is composed iron galvanized sheet blackened by non-selective surface, and t back thermal isolator of thick polyurethane foam of 0.05 m sandwiched between two steel sheets. The absorber isolator distance is 0.025 m and the absorber-cover distance is 0.02 m.
- An aspirating aeraulic channel constituted of tunnel of parallelepiped section. A double T of recycling (composed of two nested T) allows complete or partial recirculation of the air leaving the drying chamber after passing through all the shelves. The double T has a valve butterfly to adjust the airflow rate;
- A drying chamber composed of ten floors in trays, dimensions 1.40 m high, 0.90 m deep and 0.50 m wide.
- A centrifugal fan ($0.083 \text{ m}^3/\text{s}$; 80 mm EC; 220 V, 0.1 kW) that allows a theoretical velocity of 1.7 m/s, with a regulator which allows air flow rate variation from 0.028 to $0.083 \text{ m}^3/\text{s}$.
- A thermo-regulator with a precision ranges from $0\text{--}100^\circ\text{C}$ and 0.1°C connected to a PT100 platinum probe acting on the electric auxiliary heater used to set the desired temperature at the inlet of the drying chamber.
- Electrical resistances with 4 kW of power acting as auxiliary source.

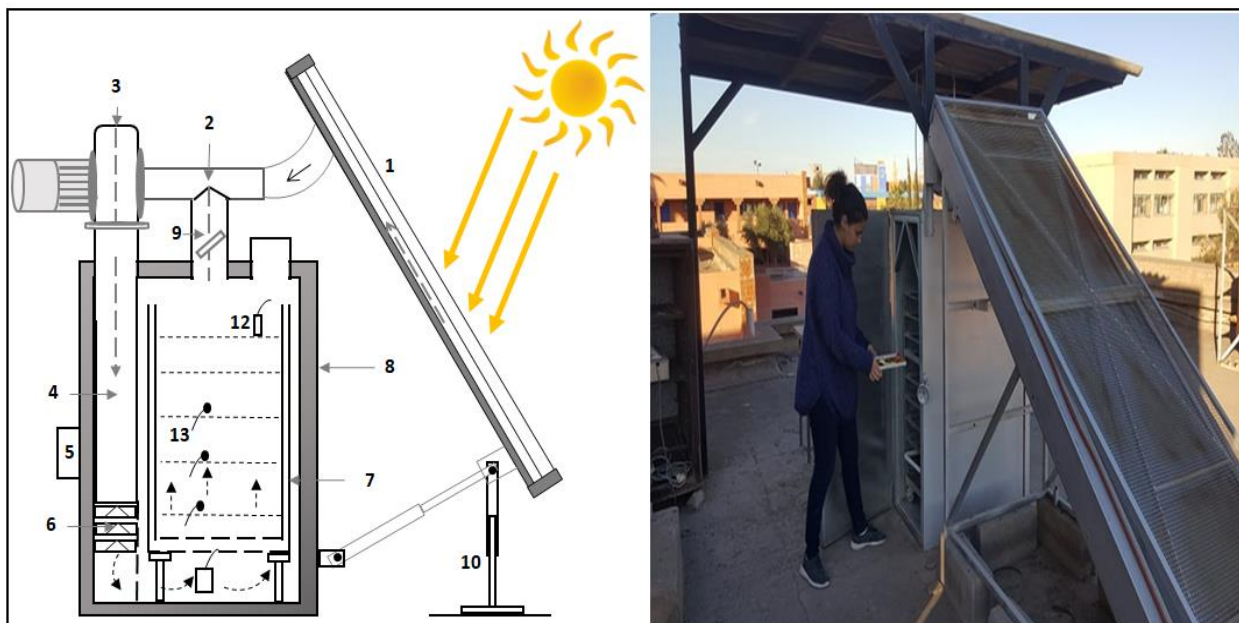

Figure 14. Convection solar dryer. (B) Scheme of the apparatus; (1) Solar collector; (2) direction of fan; (3) fan; (4) direction of aspiration; (5) control-box; (6) Auxiliary heating system; (7) shelves; (8) drying cabinet; (9) recycling air; (10) control foot; (11) exit of air; (12) humidity probes; (13) thermocouples.

The fresh air collected from the outside is preheated in the solar collector and gathered afterward at the solar collector outlet by means of a 15 cm diameter pipe. The centrifugal fan draws hot air from the insulator towards the aspirating aerodynamic channel, the air heated at this level by electrical resistors that provides if needed an auxiliary heater thus ensure a constant and adjustable temperature in the inlet of the drying chamber. At outlet of the drying chamber either the drying air is either evacuated to the outside or recycled through the aspirating aerodynamic channel totally or partially.

4.2 Drying conditions

For each experiment a set of drying conditions were taken into consideration. The mass loss during the drying process was measured using a digital weighing apparatus (± 0.001 g); each 10 min the product was removed from the trays for about 20 seconds and the mass was calculated till the weight stabilizes. The moisture is obtained by the calculation of the mass before and after 105°C oven drying for 24 hours. The measurements of the relative humidity were given by capacitance sensors. As for temperatures, the measurement was taken by a (0.2 mm diameter) thermocouple linked to a data-logger. The drying airflow was set at $300\text{m}^3/\text{h}$.

- Rosemary leaves: the experiment was carried under the condition shown in the table 8

Table 8. Experimental drying conditions of rosemary leaves

Drying temperature	Average Ambient temperature	Average Relative Humidity	Drying time
Conventional drying	27°C	51%	2 days
40 °C	27°C	57%	230 min
50°C	25°C	48%	160 min
60°C	30°C	52%	100 min
70°C	26°C	46%	70 min

The experiments were carried out to study the influence of drying temperature on both the drying process and the product quality; it also helped to establish the characteristic drying curve.

The results were modelled by nine mathematical equations to better present the drying process.

- Orange peels: The experimental conditions are as depicted in table 9.

Table 9. Experimental drying conditions

Drying temperature	Average Ambient temperature	Average Relative Humidity	Drying time
Shade-drying	23°C	59%	4 days
60 °C	27°C	51%	690 min
65°C	25°C	56%	570 min
70°C	32°C	47%	420 min
75°C	26°C	43%	330 min
80°C	30°C	54%	270 min

The set experiments were conducted in order to understand and study the influence of drying temperature on the drying process and behavior as well as the effect of different temperature on the product quality. The drying rate was thus obtained empirically via the characteristic curve, while the drying curves were fitted by nine established drying mathematical models.

4.3 Theory/calculation

4.3.1 Drying curves and moisture ration determination

Drying can be studied graphically and mathematically by moisture content or drying rate trailing in time. The mass loss was measured in a defined interval to track its variation for moisture content in time (10 min) till mass stabilization. The equation below was used to calculate MR(t) (moisture ratio) variation (Bahammou et al., 2019; Lahnine et al., 2016):

$$MR(t) = \frac{M(t) - M_X}{M_i - M_X} \quad (3)$$

The characteristic drying curve (CDC) for orange peels identification depends on the initial and equilibrium moisture content based on the theoretical approach of Van Meel. The method was used to normalize the moisture ratio as well as the dimensionless drying ($-dM/dt$) and the characteristic drying curve form it is given by $f = f(MR)$. It was used by several authors to identify the drying rates of multiples vegetable matrices (Ait Mohamed et al., 2004; Babalis and Belessiotis, 2004; Lahsasni, et al., 2004.; Idlimam et al., 2016) based on the equation below:

$$f = \frac{\left(-\frac{dM}{dt}\right)_t}{\left(-\frac{dM}{dt}\right)_0} \quad (4)$$

The characteristic drying curve of orange peels best polynomial equation was identified by non-linear regression method using a computer program.

4.3.2 Drying curve fitting

In the literature, mathematical models in shape of empirical and semi-empirical models were intensely used to describe and model the drying kinetic curves (Bahammou et al., 2019; Tagnamas et al., 2019). Those equations are well recognized as drying models that describes water loss variation in time. They contain constants that can be adjusted to establish an agreement between theoretical predictions and experimental drying curves results. Marquardt-Levenberg nonlinear optimization method was thus applied using “Curve Expert” computer software) to fit the drying curves of orange peels and rosemary leaves at different temperature with nine models in order to obtain the best fitting model for our product.

The nine different moisture ratio equation used are depicted in Table 10 and selecting criteria were correlation coefficient r , standard error (RMSE) and reduced chi-square (χ^2) square calculated as followed.

$$\chi^2 = \frac{\sum_{i=1}^N MR_{Ei} MR_{Pi}}{N-n} \quad (5)$$

Were MR_{Ei} is the experimental moisture and MR_{Pi} is the model predicted moisture while N is the number of observation and n is the number of constant.

Table 10. Mathematical models for the drying curves (Mghazli et al., 2017; Lahnine et al., 2016; Idlimam et al., 2007; Togrul and Pehlivan 2002)

Names	Model Equations	
MidiliKucuk	$MR = a. \exp(-k. t^n) + b. t$	(6)
Logarithmic	$MR = a. \exp(-kt) + c$	(7)
Verma and al.	$MR = a. \exp(-k. t) + (1 - a)\exp(-k_0. t)$	(8)
Henderson and Pabis	$MR = a. \exp(-kt)$	(9)
Diffusion Approximation	$MR = a. \exp(-kt) + (1 - a). \exp(-k. b. t)$	(10)
Newton	$MR = \exp(-k. t)$	(11)
Page	$MR = \exp(-k. t^n)$	(12)
Two-term exponential	$MR = a. \exp(-k. t) + (1 - a)\exp(-k. a. t)$	(13)
Two-term	$MR = a. \exp(-k_0. t) + b. \exp(-k_1. t)$	(14)

4.3.3 Effective diffusivity and activation energy calculation

The drying process of food stuff consist a process of water emigration from interior to surface of a giving product. In this case, the water liquid diffusion is a factor of the water pressure gradient between the inside and the surface. According to the experimental drying curves of orange peels, only a falling drying rate period and liquid diffusion controls process were observed. To describe the drying behaviour, Fick's second law is used according to the following equation. (Mghazli et al., 2017; Lahnine et al., 2016; Lahsasni et al., 2004)

$$X^* = \frac{8}{\pi^2} \sum_{n=0}^{\infty} \frac{1}{(2n+1)^2} \exp\left(-\frac{(2n+1)^2 \pi^2 D_{eff} t}{4L^2}\right) \quad (15)$$

The Eq. 15 can be expressed for a long drying period in a logarithmic form as shown below.

$$\ln(X^*) = \ln\left(\frac{8}{\pi^2}\right) - \left(\frac{\pi^2 D_{eff} t}{4N^2}\right) \quad (16)$$

Where x^* is the moisture ratio, while N is defined as the half thickness of either rosemary leaves or orange peels and D_{eff} is the effective diffusion coefficient of each of those 2 matrices.

A plot of $\ln(X^*)$ as a function of time for each drying air temperature allows the identification of the effective diffusivity from slope defined as fallow.

$$Slope = \frac{\pi^2 D_{eff}}{4L^2} \quad (17)$$

The activation energy E_{act} is equivalent to the potential value that opposes the drying reaction progress that shall be overcome in order for the drying process to occur (Mghazli et al., 2017; Lahnine et al., 2016). There is a correlation between the determined values of the effective diffusivity and the drying conditions expressed by an Arrhenius equation used in order to calculate the value of activation energy.

$$D_{eff} = D_0 \exp\left(-\frac{E_{act}}{RT}\right) \quad (18)$$

Where E_{act} is the activation energy, D_0 is the Arrhenius equation defined as the pre-exponential factor (m^2 / s), R is the universal gas constant ($J / mol.k$), and T is the absolute air temperature.

5. Chemical analyses

5.1 Antioxidants Analysis

High-Performance Liquid Chromatography equipped with a diode array detector (HPLC-DAD from Agilent 1100, France) was used in this study to analyze rosmarinic, ursolic, and carnosic acids. The analytic protocol for each analysis is described below; the antioxidants analyses were performed in triplicate and validated in our internal laboratory.

For rosmarinic acid analysis, the used column was a C18 (5 μ m, 4.6 mm x 250 mm, Zorbax SB, Agilent Technologies, France). The mobile phase in this analysis was composed of 32% acetonitrile and 68% water with 0.1% TFA (v/v); while the flow rate was set at 1 mL/min. The column oven temperature was set to 20°C, while the run time was 10 min. 5 μ L of the extract were injected. The wavelength value of the Rosmarinic Acid was of 328 nm.

For carnosic acid and carnosol analysis, the column used here was also a C18 (1.8 μ m, 4.6 mm x 50 mm, Zorbax Eclipse XBD-C18, Agilent Technologies, France). The mobile phase in this analysis was isocratic and composed of 0.5% H₃PO₄ (in water)/acetonitrile (35/65, v/v); while the flow rate was set at 1.5 mL/min. The column oven temperature was set to 25°C; 5 μ L of the extract were injected, the wavelength of the carnosic acid and carnosol was of 230 nm.

For ursolic acid analysis, the used column was a C18 column (3 μ m, 4 mm x 150 mm, All C18, Agilent Technologies, France). The mobile phase in this analysis was isocratic and composed of acetonitrile. 0.1% H₃PO₄ in water (90/10, v/v); while the flow rate was set at 0.6 mL/min.

The column oven temperature was set to 30°C while the run time was 15 min. 5 μ L of the extract were injected. The detectable wavelength value of ursolic acid was of 210 nm (Jacotet-navarro et al., 2015).

- Quantitative analysis

The identification and quantification of active compounds by HPLC-DAD method were provided by the help of a calibration curves. The values were given by percentages taking into consideration the dilution of rosemary in the solvent. The final results are expressed by g/kg. The carbon emission estimation from the electrical consumption is determined by considering that 1 kWh = 800 g CO₂ (Li et al., 2013).

5.2 Gas Chromatography-Mass Spectrometry (GC-MS/GC-FID analyses of essential oil)

- Rosemary essential oil analysis

Rosemary essential oils analysis was carried out using a GC Hewlett–Packard 6890N gas chromatograph equipped with a flame ionisation detector (FID), under the following operation conditions. vector gas, helium; injector and detector temperatures, 250°C; injected volume, 0.2 µl; split 1.100; VF-WAX (30 m × 0.25 mm, film thickness 0.25 µm; constant flow 1.1 mL/min); the oven temperature program was 60°C for 1 min increased at 3°C/min to 240°C and held at 250°C for 5 min. Retention indices were determined with C5-C28 alkane standards as reference. Essential oils were analyzed and qualified by gas chromatography coupled to mass spectrometry (GC–MS) (Hewlett-Packard computerized system, comprising a 6890 gas chromatograph coupled to a 5973A mass spectrometer). Analyses were carried out using two fused-silica-capillary columns with different stationary phases. non-polar column (HP5MS) polar column (Stabilwax). The following conditions have been applied. gas vector, helium; injection and detecting temperature at 250°C; flow rate of 1 ml/min; the injection volume was 1 µl with split mode 1/20; oven temperature program was 60°C for 8 min, increased with 2°C/min till 250°C and held at 250°C for 15 min; the ionization mode used was electronic impact at 70 eV.

Components identification of the components was based on computer matching to commercial libraries (McLafferty and Stauffe,1989), laboratory mass spectra libraries, and MS literature data (Adams, 1995; Joulain et al., 2001; .B.A.C.I.S, 2001) this was combined with comparison of GC retention indices (RI) on both apolar and polar column. The RIs were then calculated with the help of a series of linear alkanes C6-C26 on apolar and polar columns (HP5MSTM and CarbowaxTM).

- Orange essential oil analysis

The identification of orange peels essential oils volatile components was determined by gas chromatography equipped with mass spectrometry (GC–MS) analysis on an Agilent 7890A gas chromatograph coupled to a 5975C mass spectrometer, using wisely 6, Nist 02, and ADAMS databases. The used column in this analysis was a HP5 non-polar column (30m x 0.25mm x 0.25 µm). The MS spectra were obtained by the use of the following conditions. helium carried gas with a flow rate of 1.25 mL/min; a temperature programmed at 50°C for 3 min then 4°C/min till 100°C held for 2 minutes, then 6 ° C / min till 265 ° C, then 15 ° C / min

up to 300 ° C, maintained 5 minutes; a split of 1.100; an injection volume of 0.1 µl and an injection temperature of 256°C. The used rinsing solvent was Ethyl acetate / acetone.

The obtained chromatographic peaks were characterized by both their retention times (RTs) and retention indices for the 5HP5M5 column (RIs). The retention time is calculated basing on ones of C₇ to C₃₀ n-alkanes. The volatile compositions of orange peels essential oil were cautiously identified by comparing their mass spectra with those reported in Wiley 6, Nist 02, ERINI database using AMDIS (automatical mass spectral deconvolution and identification system) software.

5.3 HPLC for narirutin and hesperidin

High pressure liquid chromatography (Waters e2695, Milford-USA) apparatus equipped with a photodiode detector (2998PDA) was used to assay the narirutin and hesperidin in present in orange peels and extract. HPLC pump, column temperature, autosampler, as well as the diode array system were both controlled and monitored by Waters Empowered 2 chromatography Data software. The LiChroCart 205-4 purospher RP-18 (5 µm) (Merck, Darmstadt, Germany) column inside the oven was set at 25°C for chromatographic separation. The mobile phase was initially composed of 90% eluent A (water with 0.5% acetic acid) and 10% B (acetonitrile), followed by a gradient from 10 to 30% of eluent B in 20 min, and later on, to 35% eluent B until 30 min. The mobile was set at initial conditions to until the end of run (45 min). Each new run column was equilibrated for 2 min. The injection volume was 20µL. Hesperidin and narirutin standards were injected for identification. The wavelength used for the determination was 280 nm. Analyses were performed in triplicate and the final concentrations were calculated in mg/g dm.

5.4 Free radical scavenging activity (DPPH)

Free radical scavenging activity was determined by DPPH free radical. The method is based on the reduction of DPPH free radicals by the extract antioxidants. In general, 25 mg of DPPH were solubilised into 100 mL of methanol and diluted 1.10 with methanol. This was based on Brand-Williams et al. Procedure (Jacotet-Navarro et al., 2018). One hundred µL of the extract were mixed with 3.9 mL DPPH solution, and incubated at a temperature of 22 °C for 30 minutes while been sheltered from light.

The absorbances were measured at 517 nm by using an UV-vis spectrophotometer (UV-1800, Shimadzu, Japan). The absorbances were then converted to percentage that stands for the antioxidant activity (% AA) by using the following equation.

$$\%AA = 100 - \left(\frac{\text{Sample absorbance} - \text{blank absorbance}}{\text{Reference absorbance}} \times 100 \right) \quad (19)$$

The determined of the IC₅₀ that corresponded to the 50% was based on the curve's linear equation of the extract concentrations.

5.5 Total polyphenols analysis

The Total Phenolic Content (TPC) was determined by the Folin-Ciocalteu method (Singleton et al., 1998) with some minor modifications. Briefly, 50 µL of extract filtered on 0.45 µm were mixed with 1250 µL of a 5-fold diluted Folin-Ciocalteu's reagent into water. The solutions were mixed thoroughly and incubated at room temperature (22 °C) for 1 min. 1 mL of 10 % sodium carbonate (Na₂CO₃) was then added to the solution and mixed thoroughly. Solutions were incubated at room temperature (22°C) for 30 min sheltered from light. Absorbances were measured at 760 nm by using an UV-vis spectrophotometer (UV-1800, Shimadzu, Japan). Standardization curves were carried out with solutions at different concentrations. The TPC was expressed as mg of gallic acid equivalent/ gram. The data were presented in triplicate analysis.

5.6 Total flavonoid content (TFC)

The estimation of total flavonoid content was carried by the chloride colorimetric method reported by Chang and al, 2002. The calibration curve was established by the use of quercetin with solutions at different concentrations (Ravi et al., 2018). The 500 µL extract was thoroughly mixed with a 1.5 mL of 95% ethanol, 100 µL of 10% AlCl₃, 100 µL of 1 M potassium acetate, and finally 2.8 mL of distilled water. Solutions were incubated at room temperature (22 °C) for 45 min sheltered from light. Absorbances were measured at 415 nm by using a UV-vis spectrophotometer (UV-1800, Shimadzu, Japan). Results were expressed in milligrams of quercetin equivalents (QE) per gram of dry matter.

6. Microscopy analysis

6.1 *Scanning electron microscopy (SEM)*

All the specimens (rosemary leaves) were sliced in a cross section, fixed with an aluminum tape on the specimen holder, and then finally sputtered with gold. All the specimens were examined at INRA Avignon, Plant Pathology Unit (France) under vacuum condition by a Philips XL30 with an accelerating voltage of 10kV, a spot size 5, and a working distance of 15 mm.

6.2 *Fluorescence microscopy*

The scanning electron microscope (SEM) uses a focused beam of high-energy electrons to generate a variety of signals at the surface of targeted specimen. The signals that derive from electron-sample interactions reveal information about the sample including external morphology (texture), chemical composition, and crystalline structure and orientation of materials making up the sample

For a better understanding of the physical impacts of the steam-distillation processes, leaves before and after distillation were analyzed using a fluorescence microscope (Leica DM 2000, 196 Leica Microsystems, Germany) (fig. 15).

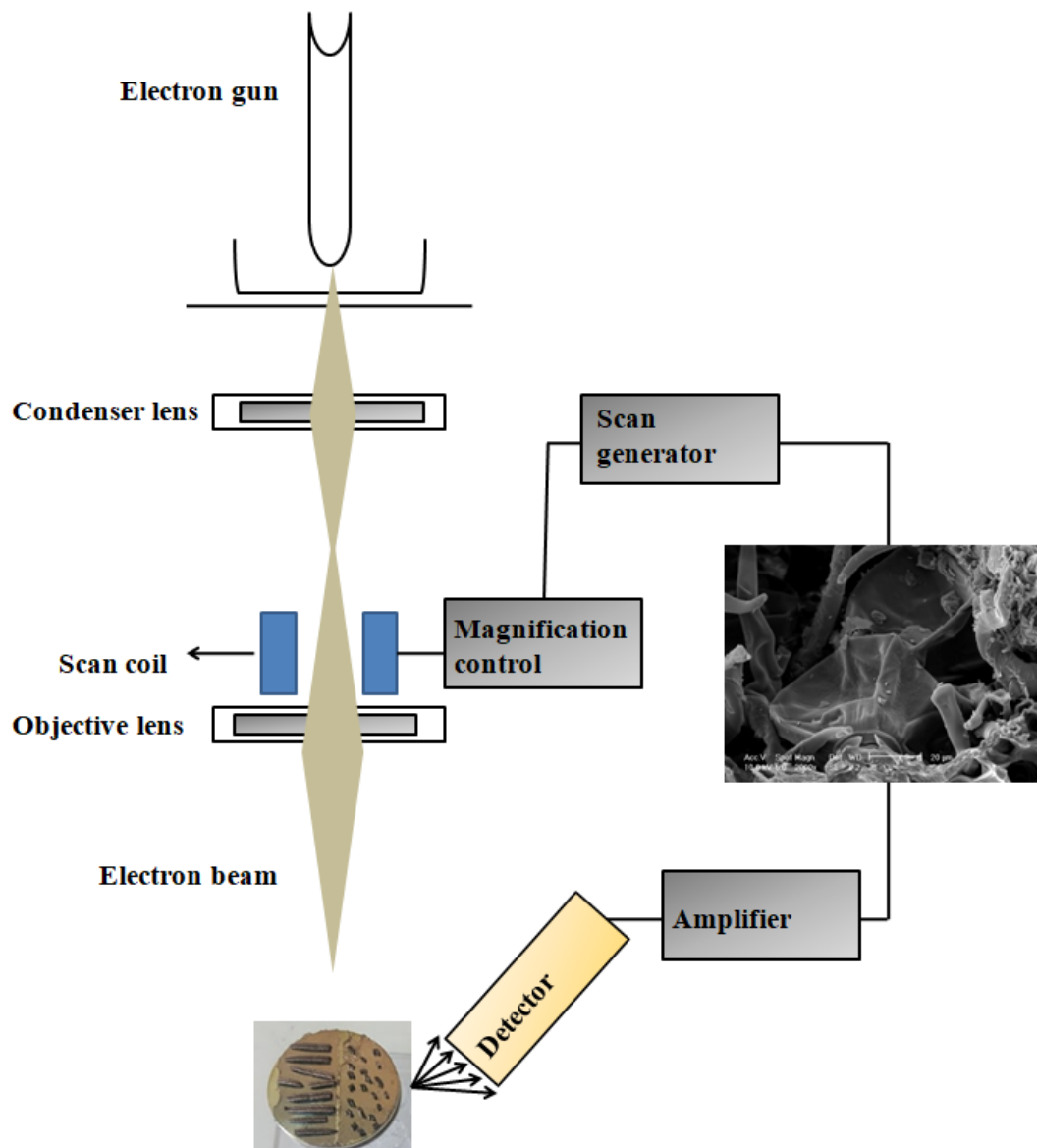

Figure 15. Scanning electron microscopy operation principle

The Leaves were cut out in small fragments (width of 5-7 mm) and immersed directly in a fixative mixture of. 4 % paraformaldehyde, 4% glutaraldehyde and 1 % caffeic acid in a phosphate buffer (0.2M, pH=7) for exactly 48 hours. For a better fixation, the fragments were then subjected to moderate vacuum for 20 min. Samples were rinsed, after the fixation, with distilled water (3 x 1 h) and dehydrated in a graded alcohol series starting from 70 to 100 %. Afterward, the samples were infiltrated and embedded in histoiresine (Technovit 7100, Kultzer). After histoiresinepolymerization, leaves fragments were cut using a rotating microtome (Supercut 2065, 204 Reichert-Jung, Leica Microsystems, Germany) and mounted on glass slide for fluorescence microscopy analysis (Khadhraoui et al., 2018).

References

- Adams, R. P. Identification of Essential Oil Components by Gas Chromatography/Mass Spectroscopy; Allured Publishing. Carol Stream, IL, 1995.
- Ait Mohamed, L.; Kouhila, M.; Jamali, A.; Lahsasni, S.; Kechaou, N.; Mahrouz, M. Single layer solar drying behaviour of Citrus aurantium leaves under forced convection. *Energy Conversion and Management*. 46 (2005) 1473–1483. <https://doi.org/10.1016/j.enconman.2004.08.001>
- Babalis, S.J.; Belessiotis, V.G. Influence of the drying conditions on the drying contents and moisture diffusivity during the thin layer drying of figs. *Journal of Food Engineering*. 2004, 65, 449–458. <https://doi.org/10.1016/j.jfoodeng.2004.02.005>.
- B. A. C. I. S. the Complete Database of Essential Oils. Boelens Aroma Chemical Information Service, The Netherlands.(1999) Eso **2000**.
- Bahammou, Y.; Tagnamas, Z.; Kouhila, M.; Lamharrar, A.; Idlimam, A. Thin-layer solar drying characteristics of Moroccan horehound leaves (*Marrubium vulgare* L.) under natural and forced convection solar drying. *Solar Energy*. 2019, 188, 958–969.
- Boukroufa, M.; Boutekedjiret, C.; Petigny, L.; Rakotomanomana, N.; Chemat, F. Ultrasonics Sonochemistry Bio-refinery of orange peels waste. A new concept based on integrated green and solvent free extraction processes using ultrasound and microwave techniques to obtain essential oil, polyphenols and pectin. *Ultrason. Sonochem.* 2015, 24, 72–79.
- Conseil de l'Europe. Pharmacopée Européenne; 1; Maisonneuve Editions. Sainte Ruffine, 1996.
- Hachemi, A.; Abed, B.; Asnoun, A.; Theoretical and experimental study of solar dryer. *Renewable Energy*. 1998, 13(4), 439–451. doi.10.1016/s0960-1481(98)00022-6
- Idlimam, A.; Lamharrar, A.; Bougayr, E.H.; Kouhila, M.; Lakhel, I.; El Khadir, A. Solar convective drying in thin layers and modeling of municipal waste at three temperatures. *Applied Thermal Engineering*. 108, 2016, 41–47. doi.10.1016/j.applthermaleng.2016.07.098
- Idlimam, A.; Kane, C.S.E.; Kouhila, M. Single layer drying behaviour of grenade peel in a forced convective solar dryer, *Rev. des Energies Renouvelables*, 2007, 10, 191-203.

- Joulain, D.; König, W. A.; Hochmuth, D. H. Terpenoids and related constituents of essential oils. Library of Mass Finder 2.1; University of Hamburg, 2001.
- . Jacotet-navarro, M.; Rombaut, N.; Fabiano-tixier, A. ;Danguien, M. ; Bily, V.; Chemat, F. Ultrasonics Sonochemistry Ultrasound versus microwave as green processes for extraction of rosmarinic, carnosic and ursolic acids from rosemary. *Ultrason. Sonochem.* 2015, 27, 102–109.
- Jacotet-Navarro, M.; Laguerre, M.; Fabiano-Tixier, A.-S.; Tenon, M.; Feuillère, N.; Bily, A.; Chemat, F. What is the best ethanol-water ratio for the extraction of antioxidants from rosemary? Impact of the solvent on yield, composition and activity of the extracts. *Electrophoresis.* 2018, DOI. [10.1002/elps.201700397](https://doi.org/10.1002/elps.201700397).
- Khadhraoui, B.; Turk, M.; Fabiano-Tixier, A.-S.; Petitcolas, E.; Robinet, P.; Imbert, E.; Maâtaoui, M.; Chemat, F. Histocytochemistry and scanning electron microscopy for studying spatial and temporal extraction of metabolites induced by ultrasound. Towards chain detexturation mechanism. *Ultrason. Sonochem.* 2018, 42, 482–492.
- Lahnine, L.; Idlimam, A.; Mahrouz, M. ; Mghazli, S. ; Hidar, N.; Hanine, H.; Koutit, A. Characterization by solar convective drying of thyme conserved by an innovative thermal-biochemical process. *Renewable Energy.* 2016, 94, 72-80. <https://doi.org/10.1016/j.renene.2016.03.014>.
- Lahsasni, S.; Kouhila, M.; Mahrouz, M.; Ait Mohamed, L.; Agorram, L. Characteristic drying curve and mathematical modelling of thin layer solar drying of prickly pear cladode (*Opuntia ficus indica*). *Journal of Food Engineering.* 27(2004) 103–117. <https://doi.org/10.1111/j.1745-4530.2004.tb00625.x>
- Li, Y.; Fabiano-Tixier, A. S.; Vian, M. A.; Chemat, F. Solventfree microwave extraction of bioactive compounds provides a tool for green analytical chemistry. *TrAC, Trends Anal. Chem.* 2013, 47, 1–11.
- McLafferty, F.W.; & Stauffer, D.B. The Wiley/Nbs Registry of Mass Spectral Data, Wiley, New York. 1989.
- Maran, J. P. Optimization of aqueous extraction of pectin from waste durian rinds. *Int. J. Biol. Macromol.* 2015, 73, 92–98.
- Mghazli, S.; Ouhammou, M.; Hidar, N.; Lahnine, L.; Idlimam, A.; Mahrouz, M. Drying Characteristics and Kinetics Solar Drying of Moroccan Rosemary Leaves, *Renewable Energy*, 108 (2017) 303-310. doi. [10.1016/j.renene.2017.02.022](https://doi.org/10.1016/j.renene.2017.02.022).

- Ravi, H. K.; Breil, C.; Vian, M. A.; Chemat, F.; Venskutonis, P. R. Biorefining of Bilberry (*Vaccinium myrtillus* L.) Pomace Using Microwave Hydrodiffusion and Gravity. *ACS Sustainable Chem. Eng.* 2018, 6, 4185–4193.
- Ståhl, M.; Granström, K.; Berghel, J.; Renström, R. Industrial processes for biomass drying and their effects on the quality properties of wood pellets. *Biomass and Bioenergy*. 2004, 27(6), 621–628. doi.10.1016/j.biombioe.2003.08.019
- Tagnamas, Z.; Bahammou, Y.; Kouhila, M.; Hilali, S.; Idlimam, A.; Lamharrar, A. Conservation of Moroccan truffle (*Terfezia boudieri*) using solar drying method. *Renewable Energy*. 2020, 146.
- Togrul, I.T.; Pehlivan, D. Mathematical modelling of solar drying of apricots in thin layers. *Journal of Food Engineering*. 2002, 55;209–216. [https://doi.org/10.1016/S0260-8774\(02\)00065-1](https://doi.org/10.1016/S0260-8774(02)00065-1)

Part III: Results and Discussions

**Chapter I: Thermal solar
energy applications on Eco-
extraction of rosemary
leaves and orange peels**

I-I. Rosemary leaves

1. Rosemary leaves as aromatic and medicinal plant

Aromatic and medicinal plants (AMP) are closely related to human civilization. They have been used from ancient cultures until the Middle Palaeolithic (60,000 years ago) to the present day in the fields of medicine, cosmetics, pharmacy and food (Fabricant and Farnsworth 2001, Lubbe and Verpoorte 2011). According to the literature, many AMPs have antioxidant compounds used for preserving foods instead of synthetic antioxidants that have been the subject of numerous epidemiological studies conducted to address the health threats of such antioxidants (Lubbe and Verpoorte 2011; Barlow 1990) Natural antioxidants could provide a preservation effect, protect against the oxidation of lipids and proteins, while preserving the colour, texture and aroma (Lara et al., 2011; Gramza-Michalowska et al, 2011; Ding et al., 2015). These plants can also be used to extract essential oils; up to 3000 species were valorized.

Rosemary (*Rosmarinus officinalis* L.) is an aromatic plant with evergreen leaves. It belongs to the Lamiaceae family with green leaves and bright blue flowers; most plant extracts are derived from its leaves and are of great interest in the food industry because of their phenolic compound (Mena et al., 2016; Santos-sánchez et al., 2017). Rosemary extracts have been widely used as preservatives in the food industry because of their innate high antioxidant activity. In this sense, many major biological properties have been attributed to this plant. mainly hepatoprotective, antimicrobial, antithrombotic, diuretic, antidiabetic, anti-inflammatory, antioxidant and anticancer. In addition, it has been previously reported that rosemary extracts and their isolated components exhibit inhibitory effects on the growth of breast, liver, prostate, lung and leukemia cancer cells (Tai et al., 2012). The main families present in rosemary are the phenolic diterpenes, notably carnosic acid, carnosol or rosmanol; flavonoids such as genkwanin, cirsimaritin or homoplantagin; and triterpenes such as ursolic acid. Phenolic diterpenes possess various health-promoting properties, such as antimicrobial, anti-inflammatory, neuroprotective, anti-oxidant and anti-cancer properties. In particular, carnosic acid and carnosol are two of the main antioxidant compounds present in this plant. Its anticancer properties have been reported to be extensive in several cell line models, including prostate, breast, leukemia, and others (Jacotet-Navarro et al., 2018, Borrá 2014; Ltinier et al., 2007).

The name rosemary comes from the Latin *rosmarinus* or sea dew to make an allusion to its particular scent and its habitat on the sea slopes. Its botanical taxonomy is depicted in fig.15 (Bousbia, 2013).

Rosemary (*Rosmarinus officinalis*, L.) is also known by its volatile composition which represents between 0.7 and 3% of the fresh weight mainly containing monoterpenes and derivatives of monoterpenes with as main compounds the α -pinene, the camphor, the verbenone and eucalyptol (Serban et al 2011; Szumny et al., 2010). The rich source of phenolic compounds and its properties are derived from the plant's extracts and essential oils (Mastro and Ruta, 2004). Both products are used for disease treatment and in food preservation.

The chemical composition of rosemary oil has been the subject of several in-depth studies. There are two main types of rosemary oil with regard to their main constituent. oils containing more than 40% of 1,8-cineole (Morocco, Tunisia, Turkey, Greece, Yugoslavia, Italy and France) and oils having approximately equal ratios (20-30%) of 1,8-cineole, α -pinene and camphor (France, Spain, Italy, Greece and Bulgaria) (Mastro and Ruta, 2004). The literature has also revealed unusual chemical compositions for rosemary oils. The more recent interest for this species concerns the biological action (antioxidant, antimicrobial and insecticide) of specific components of the rosemary essential oil. Fig. 16 below represents some major components of essential oils (Khadhraoui et al., 2018, Bousbia, 2013).

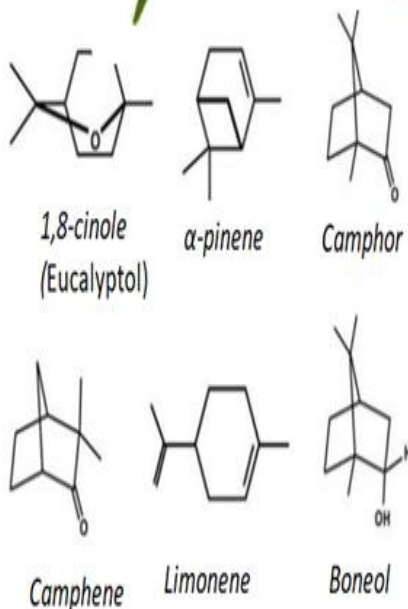

Kingdom	Plantae
Division	Magnoliophyta
Class	Magnoliopsida
Order	Lamiales
Family	Lamiaceae
Genre	Rosmarinus
Species	Rosmarinus officinalis L. 1753
Common Names	Rosemary, Incense, Crown Grass, Sea Rose, Rose from the sea, Rose-marine.
Flowering period	February to April
Flower colour	Blue / purple
Exhibition	Sun
Height	150 cm
Habitat and origin	Perennial, shrubby plant, native to scrubland, scrubland and rock Mediterranean Basin, now it is widespread everywhere in temperate climates with mild winters.

Figure 16. Botanical taxonomy and chemical structure of some major components of rosemary essential oil.

It should be noted that additionally to the antioxidant and antimicrobial action, rosemary essential oil also has pediculicidal, aromatherapeutic and anticarcinogenic activities (Husnu and Gerhard, 2016).

2. Context

The oxidation is one of the most relevant processes in food degradation. Antioxidants are compounds capable of scavenging free radicals delaying, retarding or even preventing auto-oxidation. Human have shifted their interest towards more natural foods due to the concern related to some human health ramification about potential toxicological long-term effects of the synthetic antioxidants, such as butylated hydroxyanisole (BHA) and butylated hydroxytoluene (BHT), thus paving the way for more efficient and cleaner extraction processes development to isolate natural antioxidants. Natural antioxidants are mainly polyphenolic compounds, aromatic secondary plant metabolites. In rosemary, the most important ones are rosmarinic acid, carnosic, and ursolic acid. They are found mainly in rosemary leaves. The study aims to develop an original concept of a bio-refinery using Solar Steam-Distillation (SSD) as a deodorization process to extract essential oil as prior step before solvent extraction of antioxidants (Fig17).

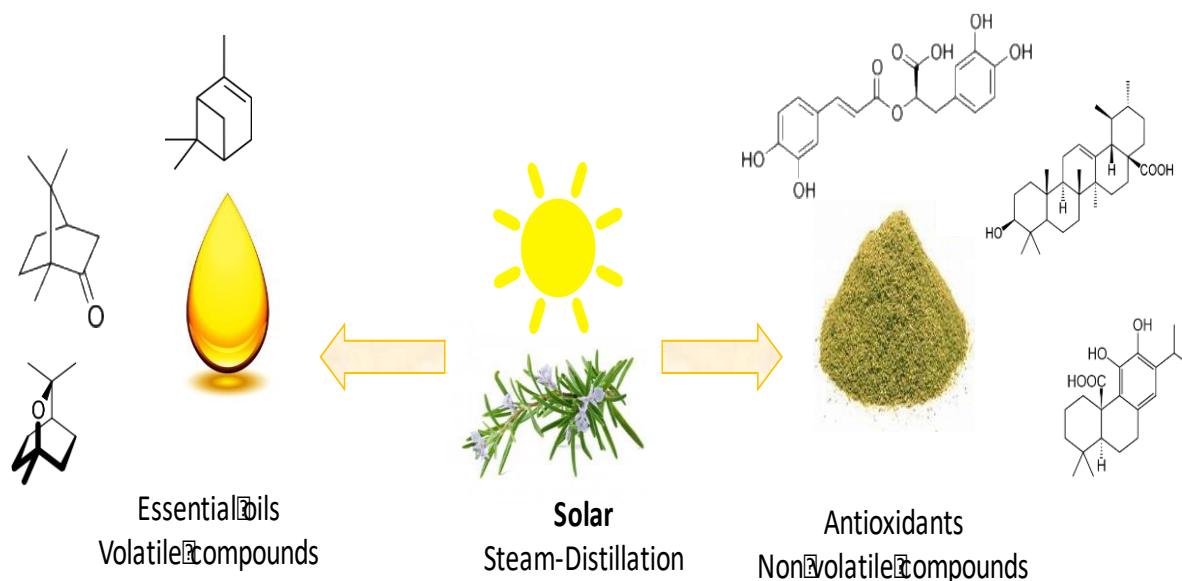

Figure 17. Deodorization by solar steam distillation context

3. Deodorization by solar steam-distillation of rosemary leaves prior to solvent extraction of rosmarinic, carnosic, and ursolic acids

Abstract

This study aims total valorization of rosemary for food applications, moving towards developing an original bio-refinery concept using Solar Steam-Distillation (SSD) to both extract essential oil and while preserving active compounds in the raw material, mainly antioxidants for a further extraction. The deodorization process is important to avoid the extraction of antioxidants with strong aromas which limit their utilization for food preservation. SSD process was compared with the Conventional Steam-Distillation (CSD) for essential oil extraction as well as deodorization of dried rosemary leaves. The treated leaves were recovered afterward for the extraction of antioxidants by solvent extraction to recover rosmarinic, carnosic, and ursolic acids. With standard protocol extraction and analysis, antioxidants seem to be mostly preserved by SSD than by CSD. Folin-Ciocalteu was used to determinate the polyphenol content; whereas, the DPPH was used to analyse the antiradical properties. It was found the both polyphenol content and antioxidants activity was preserved after SSD. Scanning electron microscopy (SEM) and fluorescence microscopy showed completely destructuration of glandular trichomes for both processes which indicate that the extraction of essential oil was complete. Overall, the results specify clearly that Solar Steam-Distillation (SSD) is a green alternative, efficient and economic process for essential oil extraction and leaves deodorization.

3.1 Introduction

Herbs especially Aromatic and Medicinal Plants (AMP) are strongly related to the human civilization. They were used since ancient cultures as far as the Middle Palaeolithic (60 000 years ago) until modern days in cosmetic, pharmaceuticals, food sectors, and medicinal purposes such as anti-allergic, anti-inflammatory, antioxidant, or even anti-bacterial; those attributes are due to their Biological Active Compounds (BACs) such as polyphenols, alkaloids, and terpenoids. Many studies were carried to find an adequate approach for a high-value BACs recovery starting by defining the right solvent for each particular plant and extraction process (Fabricant and Farnsworth, 2001; Barata et al., 2016; Lubbe and Verpoorte, 2011; Barlow, 1990; Lorenzo et al., 2018).

Antioxidants are also considered as high-value BACs and according to literature, many AMP possess antioxidant compounds used for food preservation instead of synthetic antioxidants which were subject to many epidemiological studies carried to point their health threats (Barlow, 1990; Lubbe and Verpoorte, 2011). Natural antioxidants were able to provide a preservation effect, a protection against lipid and protein oxidation while also preserving the colour, texture, and aroma of the food products. (Lara et al., 2011; Ding et al., 2015; Gramza-michalowska et al., 2011) AMPs are also used to extract essential oils, with approximately 3000 valorised species. Essential oils are extremely concentrated, volatile, and hydrophobic combination of chemicals with fragrance properties. They are valorised in many sectors essentially in flavour and fragrance industry (Ramya et al., 2013; Lubbe and Verpoorte, 2011). Many of the procedures used to extract essential oil are both time and energy consuming such as steam-distillation using conventional energy.(Bousbia et al.,2009) Therefore, many green extractions methods were developed such us ultrasonic extraction(Khadhraoui et al., 2009) microwave (Bousbia et al.,2009) as well as solar extraction that will be the subject of our study. In fact, the earth receives each day an enormous solar energy supply; it is more than its inhabitants could consume in a twenty-seven years. Using this sustainable energy emitted from the sun could be a promising and important source compared to any known present conventional ones (Zhanga et al., 2013; Afzal et al., 2017; Gunerhan et al., 2009).

It should be known that there is large number of potential applications of solar energy in food sector such as processing with mainly drying and cooking processes (Sharaf, 2002; Akpınar and Bicer, 2008 as well as extraction. Numerous systems were developed principally for essential oil extraction; one of those solar processes is the one described in (Yen and Lin, 2017) where the solar energy tubes were used as a renewable energy to extract Cymbopogon citrus essential oil and compared it to hydro-distillation; in this case relatively similar essential oils yield value were found. Therefore, the noteworthy difference is the fact that the solar energy is free of any electricity utility charge, results also emphasized on the weather effect on the extraction yield; indeed, the system yield varied in function of the solar radiation. Similar results were also found in other studies. (Kulurel and Tarhan, 2016; Munir et al; 2014)

Rosemary (*Rosmarinus officinalis L.*) is an AMP and an evergreen aromatic plant that belongs to the Lamiaceae family with green leaves and purplish blue flowers; most of the plant extract is derived from rosemary leaves and are engendering interest in the food industry due to their phenolic compound (Mena et al., 2016; Santos-sánchez et al., 2017) and great antioxidant activity with as main extract rosmarinic, carnosic, and ursolic acids. (Jacotet-navarro et al., 2015) Essential oil represents between 0.7 to 3% of the fresh weight material; it contains monoterpenes and its derivatives with as main compounds α -pinene, camphor, verbenone and eucalyptol (Szumny et al., 2010 ; Serban et al., 2011 ; Flamini et al., 2002).

Green extraction of rosemary leaves was carried in previous studies with ultrasonic and microwave where it was proven that those processes present an innovative and excellent alternative to conventional one for the extraction of antioxidants (Khadhraoui et al., 2018; Jacotet-navarro et al., 2015). As for solar extraction it was the first time that this process was used prior to solvent extraction of antioxidants.

The aim of this study is the extraction of essential oil by solar steam-distillation (SSD) as deodorization process to reduce and remove aroma from the leaves while conserving the antioxidant compounds. Steam-distillation was used in a previous study by (Miraballes et al, 2012) for Uruguayan native plants where it was found that this procedure allowed the decrease of both odours and flavours while not affecting in a large extent neither the phenolic content nor the antioxidant activity. The SSD process was compared with the Conventional Steam-Distillation (CSD). Scanning electron microscopy was performed to understand and demonstrate the effect of both extraction processes on the leaf's glandular trichomes.

3.2 Results and discussion

3.2.1 Thermal balance of the solar system

The system requires direct radiant energy emitted from the sun. The amount of the radiation varies due to many factors; mainly the season and the specific day since those two are linked to the angle in which the sun strikes the surface. There are other factors such as local weather or location as well as clouds which make it impossible to replicate the same solar energy conditions. Thus, dealing with solar energy is not an easy task since although it affords a green solution to many issues it still not a stable or a controlled energy. With that in mind, the experiences were carried during different weathers conditions as well as season to optimize the extraction period. It was found that the system gives better results during summer period which is characterized by high solar radiations in the middle atlas region in where the system is located.

The validation of the proposed method has been performed for multiple plants such as melissa, cloves, and rosemary in different dates during summer season (Munir et al., 2014) as well as in our internal laboratory for plants such as lavender, thyme, and rosemary. It was found that the main parameter that affects extraction efficiency is the daily solar radiation. Solar powers as well as cloud cover density have an impact on the efficiency of the system since the reflector only uses direct radiation, thus making the performance higher in bright and clear day, while it could be reduced to zero in the gray and drab days.

As it was explained, solar energy received varies each day since the solar rays hit the primary reflector surface at an angle of $43.23 + \delta/2$; then the energy provided to the reflector can be written as followed in equation (2) with A_t corresponding to the reflector surface (10 m^2), δ representing the solar declination (equation (3)), and representing the annual calendar.

$$E_{PR} = E_G \times A_t \times \cos(43.23 \pm \delta/2) \quad (2)$$

$$\delta = 23.45 \sin\left(\frac{360}{365} \times (n + 248)\right) \quad (3)$$

The pyrano-meter attached to the reflector allows the measurement of the global illumination for each day. This energy is then reflected by the primary reflector to the secondary reflector following equation (4) with ρ_{PR} representing the reflection factor of mirrors ($\rho_{PR} = 0.87$) and F_f the deviation of rays due to dust or wrong orientation. ($F_f = 0.85$).

$$E_{SR} = E_{PR} \cdot \rho_{PR} \cdot F_f \quad (4)$$

This energy reaches its final destination by being reflected to the bottom of the alembic. Thus, the useful energy will be expressed in equation (5) as followed with ρ_{SR} representing the reflection factor of the aluminum sheet ($\rho_{RP} = 0.80$).

$$E_A = E_{SR} \times \rho_{SR} \tag{5}$$

Additional losses related to convection, conduction, and radiation should also be taking into consideration in a more precise understanding of the system. The energy was calculated in the summer time in different days and months from June till august to identify the approximate value of the useful energy (E_a); it was found that the useful energy in bright and clear days is about 4429.9 ± 40 W. This means that the energy varies around 4.4 kW thus we can say that the system delivers energy close to 4kW in good weather condition days if we take the other losses in consideration. The figure below represents the variation of beam radiation in relation to the floral water in a specific day.

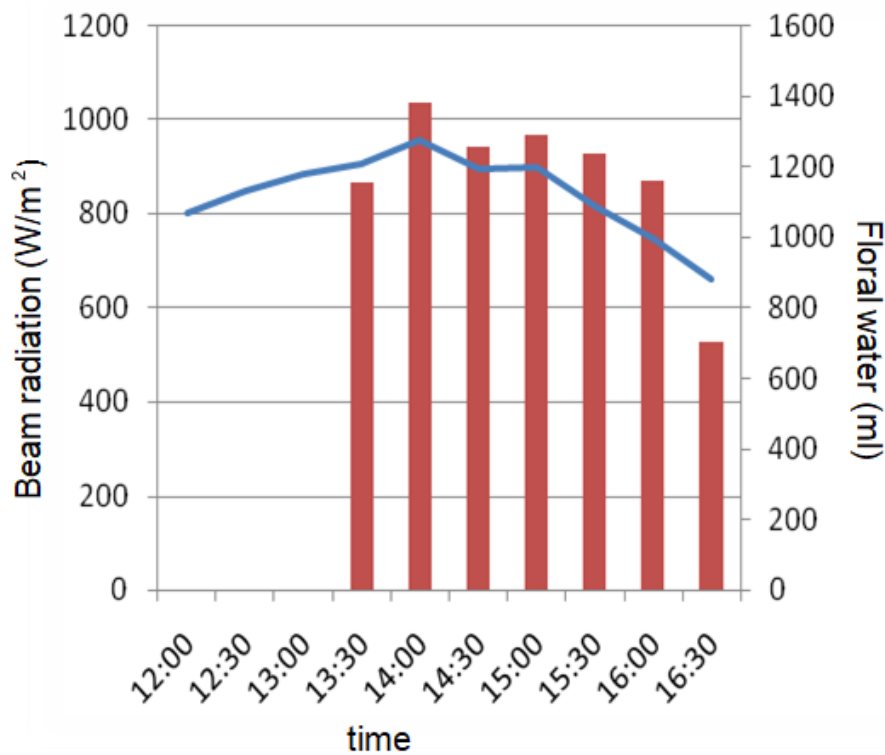

Figure 18. Floral water (■) and beam radiation (—) variation.

Figure 18 represents how the beam radiation impacted the volume of floral water recovered in each 30 minutes in a specific day (09/08/2017) as it could be seen after each high

beam value a high floral volume is retrieved; this impact directly the extraction process, as it was observed during multiple trails, since with high beam radiation extraction time decreases.

3.2.2 Kinetics of solar and conventional steam-distillation

As shown in figure 19, essential oil extraction yields are respectively $0.82\pm 0.06\%$ and $0.85\pm 0.03\%$ for Solar Steam-Distillation (SSD) % and Conventional Steam-Distillation (CSD). Figure 18 shows the variation of extraction yields according to the extraction time. Four phases were observed in this process starting with “Step 0” that represents the heating process from ambient temperature to 100°C . The following phase is “Step 1” which basically characterizes the first quantity of EO’s extracted which is located at the surface of the leaves. it represents in this case 79% of total yield obtained in 130 min by CSD and 87% of total yield obtained in 80 min by SSD respectively. The following phase is “Step 2” which states the intern diffusion of essential oil that occurs from the internal part of the particles to external medium due to the intern warming of the plant’s cells. the oil extracted represent 21% released into 190 min for CSD and 13% released into 120 min for SSD respectively. The last phase is “Step 3” corresponds to a horizontal line which marks the end of the extraction process (fig. 19)

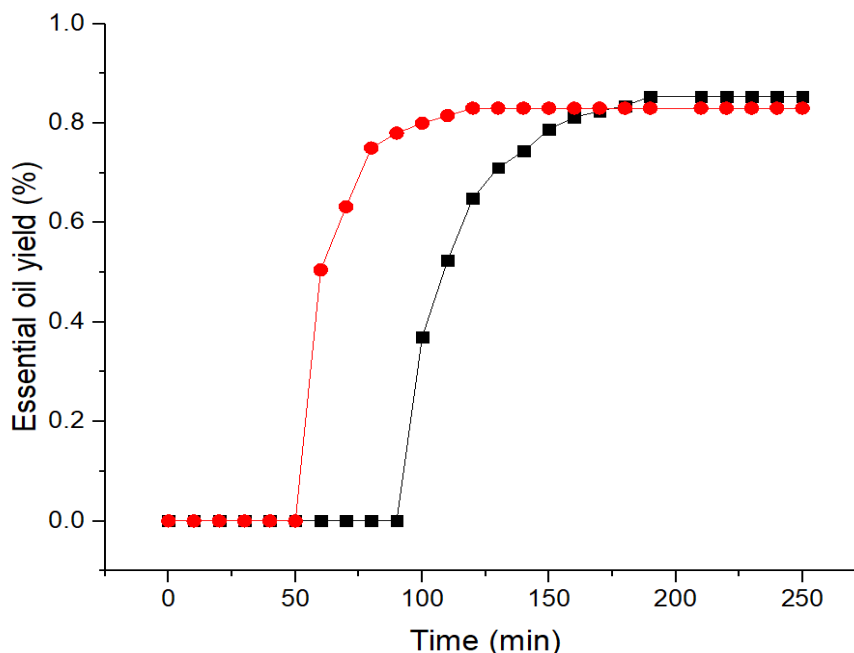

Figure 19. Essential oil yield profiles as a function of time for Conventional Steam Distillation-CSD (■) and Solar Steam Distillation-SSD (●)

3.2.3 *Microscopy analysis*

The analysis was carried with both Scanning Electron Microscopy (SEM) and fluorescence microscopy. SEM analysis of rosemary leaves before and after each extraction is displayed in the figure III-5. Morphology difference can be largely seen between the before and after the extractions. Cross-sections were carried out to identify the inner structures of each rosemary leaf in order to assess the effect of each distillation procedure.

The observed initial leaf exhibits a well-organized cell structure with an adaxialcuticular layer (CU) that covered a thin layer of adaxial epidermal cells (E). Collenchyma cells (CL) were located right below the epidermal layer. In this case, the structures can be described as intact with ramified non-glandular trichomes (NGT) and continuous glandular trichomes (GT) (structures that contain volatile essential oils) with intact envelopes. However, in the case of recovered CSD leaf, a total erosion of branches was observed; they seemed to be emptied of their content. This was coupled with a total explosion of GT. Their structures seemed to be completely deformed especially the thick cuticular layer which preserves the GT and their content. Indeed, after the CSD process, the GT cuticular layer was exploded allowing the access to GT volatile compounds. In addition to the structures mentioned above, this process impacted the entire leaf. As it is shown in the figures 20.C and 20.D, total detexturation and dehydration were noticed in all the internal tissues of the collenchyma's. As for the recovered SSD leaf, the induced erosion was less phenomenal; some branches remain intact while GT were completely exploded and emptied of their content. As for the internal tissues, they were significantly damaged as shown in figures 20.E and 20.F. Those different observations proved that both processes impacted significantly rosemary leaves especially GT, thus ensuring an efficient extraction of essential oils.

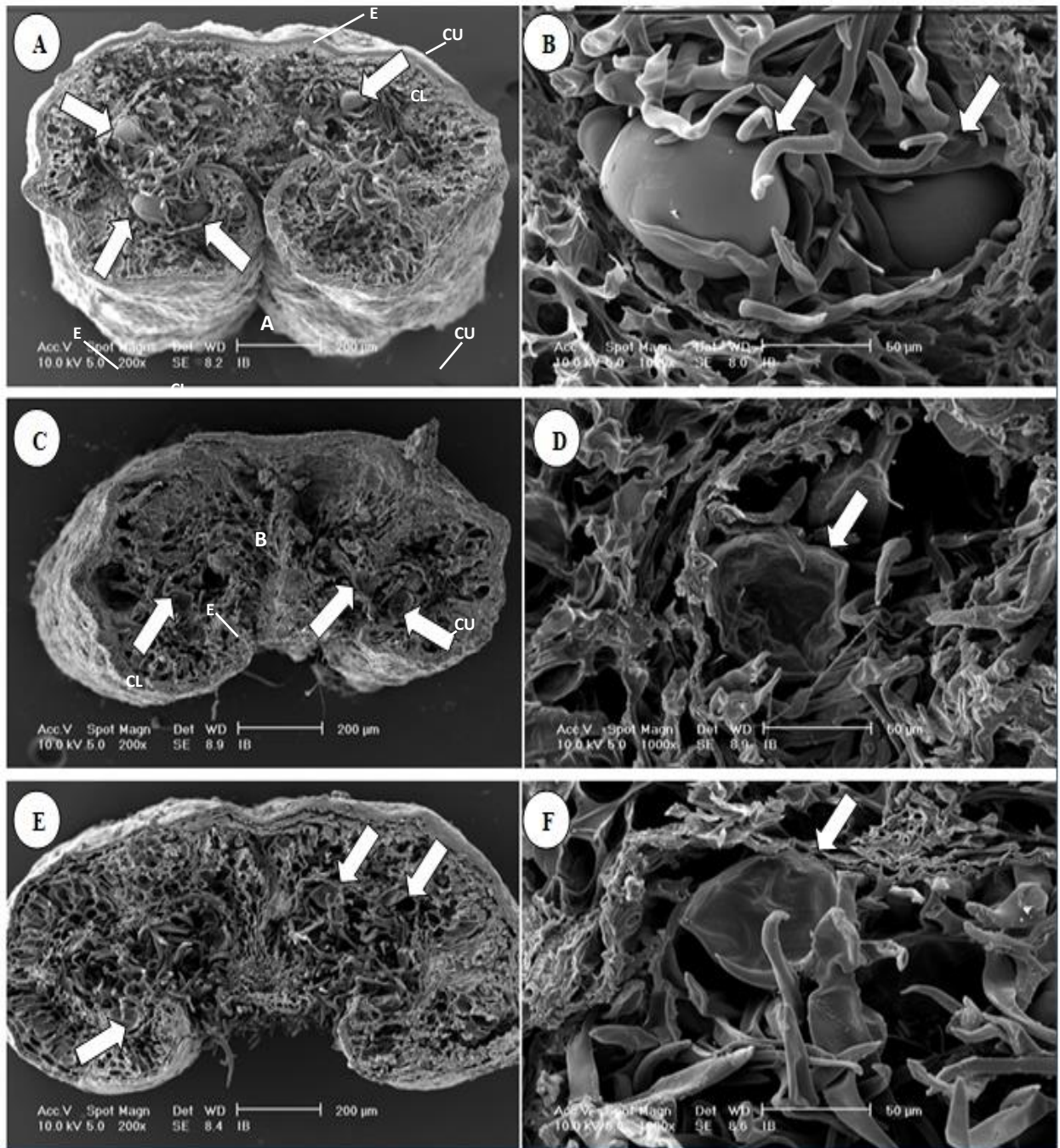

Figure 20. Scanning electron micrograph of raw rosemary leaves (A-B); rosemary leaves after CSD (C-D); rosemary leaves after SSD (E-F); (glandular trichomes (\Rightarrow); CU. Cuticle, E. Epidermal cells; A. Adaxial surface; B. Abaxial surface).

Figure 21 presents the fluorescence microscopic investigation of untreated and treated leaves. Natural fluorescence level illustrates the presence of natural active compounds. As shown in figure 21.A, fluorescent active compounds are highly present at different levels of untreated Rosemary leaves. It is worth mentioning that green fluorescence is related to polyphenol content while the yellow own reveals the chlorophyll.

As for the process impact, it could be seen that treated leaves either by SSD or CSD present a relatively similar fluorescence level (figure 21.D. 21.G). For both process a detexturation of the internal tissues was observed. As for the glandular trichomes (figure 21.F. 21.I), they shrank and seemed emptied of their content. In conclusion CSD and SSD process physically impact plant structures resulting in a modification of fluorescence level compared to that of the initial leaf.

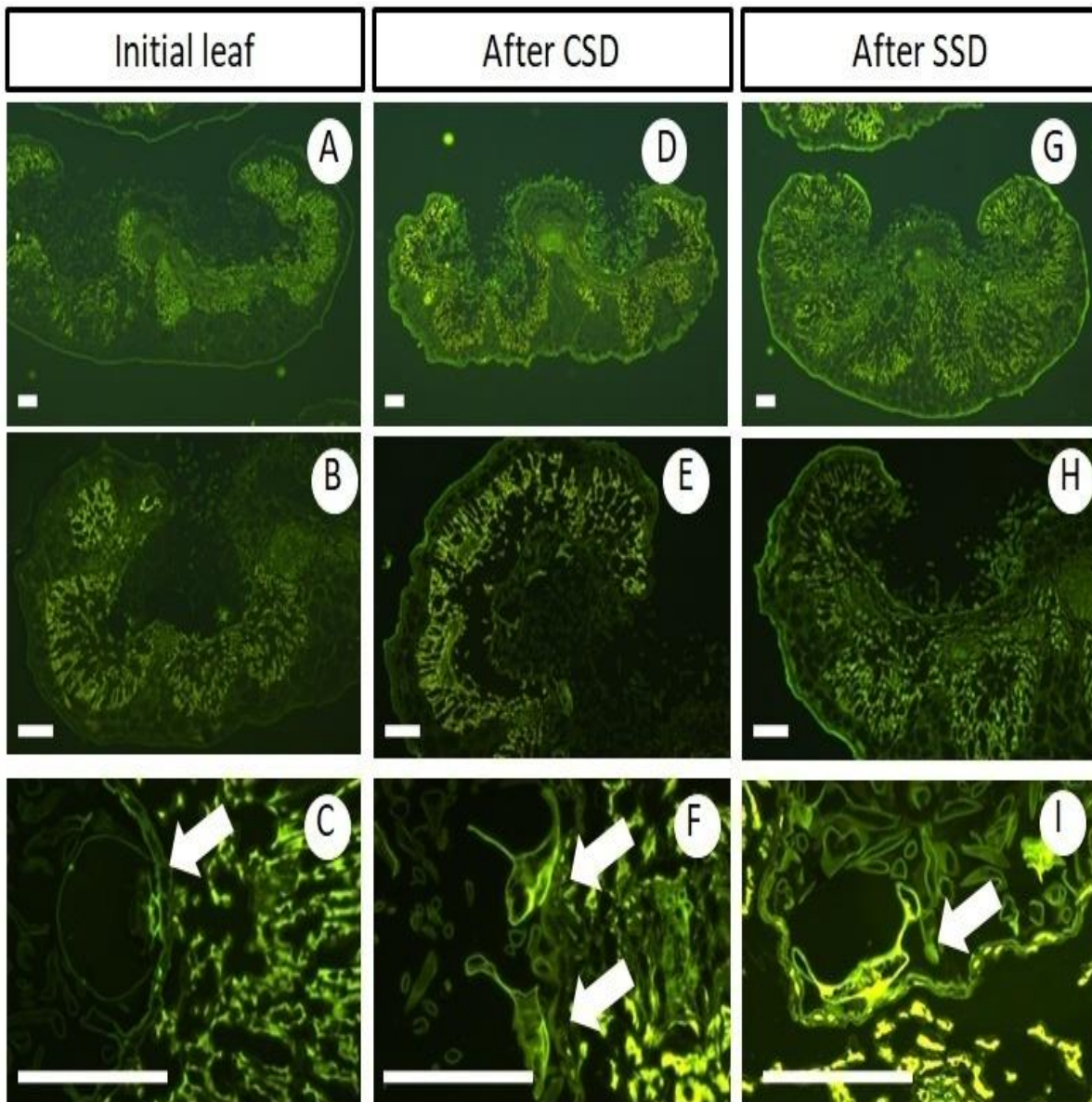

Figure 21.Fluorescence microscopic investigation of rosemary leaf: raw rosemary leaves (A-B-C); rosemary leaves after CSD (D-E-F); rosemary leaves after SSD (G-H-I) (glandular trichomes (\Rightarrow); scale bar 100 μ m (\square))

As for the polyphenols preservation, leaves before and after SSD or CSD process present a relatively similar fluorescence level (figure 21A. 21D. 21.G) this could mean that the polyphenols were preserved after the process. To verify this observation the total polyphenol content of before and after each steam-distillation was quantified by Folin–Ciocalteu reagent. The TPC obtained from the leaves has a value of 5.89 ± 4.56 mg EQ gallic acid/ g dry matter; 53.07 ± 4.19 mg EQ gallic acid/ g dry matter, 57.73 ± 2.15 mg EQ gallic acid/ g dry matter for initial, CSD, SSD, respectively. The value expressed in this analysis shows that the polyphenols were highly preserved after SSD process. Those results were complementary to what was observed by fluorescence microscopy and confirms that the polyphenols were highly preserved after the extraction of essential oils after SSD process in comparison to both initial content and CSD process.

3.2.4 Essential oil Composition

A total of 18 compounds were identified in rosemary essential oils using the two techniques SSD and CSD. As shown in table 11, components of essential oil such as monoterpenes and sesquiterpenes were classified according to their chemical category, particularly between oxygenated and non-oxygenated compounds. Generally, oxygenated compounds are more valuable due to their high odoriferous characteristic, thus contributing to essential oil fragrance.

Table 11. Chemical composition of rosemary essential oils extracted by SSD and CSD

n°	Compounds ^a	HD (%)	CSD (%)	SSD (%)	R.I ^b	R.I ^c
Monoterpenes						
1	α -Pinene	9.33±0.067	15.91±0.21	15.9±0.09	926	1023
2	Camphene	2.93±0.041	4.13±0.049	4.13±0.037	942	1103
3	β -Pinene	2.44±0.014	1.05±0.062	1.05±0.052	974	1109
4	β -Myrcene	1.05±0.032	1.18±0.012	1.18±0.014	988	1165
5	α -Terpinene	0.03±0.001	0.3±0.002	0.3±0.001	1020	1083
6	Limonene	2.21±0.026	2.83±0.032	2.83±0.012	1030	1206
7	γ -Terpinene	0.40±0.002	0.1±0.001	0.1±0.001	1103	1285
8	Para-Cymene	1.83±0.069	2.34±0.033	2.34±0.014	1025	1250
9	Terpinolene	0.17±0.012	0.08±0.007	0.08±0.003	1120	1304
Oxygenated Monoterpenes						
10	Linalool	1.17±0.085	0.93±0.043	0.93 ±0.057	1125	1538
11	Camphor	15.49±0.76	15.01±0.321	15.03±0.473	1158	1514
12	Borneol	5.06±0.421	2.38±0.532	2.39±0.329	1176	1679
13	Eucalyptol	33.06±0.072	44.46±0.054	44.45±0.127	1029	1210
14	α -Terpineol	5.0±0.023	3.09±0.064	3.1±0.383	1203	1677
Other oxygenated compounds						
15	Bornyl acetate	1.74±0.092	0.38±0.042	0.38±0.063	1263	1579
16	Methyl eugenol	0.02±0.001	0.01±0.004	0.02±0.001	1397	2020
Sesquiterpenes						
17	Caryophyllene+terpinen	5.74±0.639	2.76±0.482	2.76±0.648		
	Extraction time (min)	300	120	190		
	Yield (%)	0.84±0.02	0.85±0.06	0.83±0.03		
	total Oxygenated compounds	61.54±0.9	66.27±615	66.29±0.312		
	Total non-oxygenated compound	26.12±1.45	28.43±1.06	30.66±1.43		
	Total	87.66±2.357	94.7±1.278	96.95±1.74		

^aEssential oil compounds categorized by both chemical families and percentages via GC-FD on VF-WAX capillary column. ^b Retention Indices (RI) related to the calculated C₅- C₂₈ n-alkenes on a non-polar HP5MS capillary column. ^cRI related to the calculated C₅- C₂₈ n-alkenes on a polar Stabilwax capillary column.

Essential oils obtained with both processes are very similar qualitatively. Indeed, the oxygenated compound content is 66.29 % for SSD and 66.27 % for CSD. Beyond oxygenated compounds, eucalyptol (1,8-cineol) was mainly predominantly detected in both essential oils 44.46% for CSD and 44.45% for the SSD, this content varies from 1 to 45 % (Bousbia, 2013). For monoterpene hydrocarbons category, the main component in both essential oil was α -pinene also in similar amounts 15.91% for CSD and 15.90% for SSD.

3.2.5 *Material Balance*

Material balance was established to assess the amounts of volatiles and non-volatile active compounds before and after deodorization in rosemary leaves. The rosemary leaves before and after steam-distillations were submitted to a Soxhlet extraction as described in material and methods. The extract was then analysed by GC-MS to quantify antioxidants. The results are presented in figure 22. Calculations were done for 1 kg of initial raw material for an easier understanding.

Characterization of rosemary leaves in active compounds was performed before and after deodorization. More particularly, content in rosmarinic, carnosic, ursolic acids, and carnosol was assessed in rosemary leaves before and after essential oil extraction by steam distillation to underline a potential loss in these compounds. Results showed that compounds were generally more preserved after SSD. Indeed, loss of carnosic acid was higher in the case of CSD with a loss value of 50.8% while the value was 20.89% for SSD, as for the rosmarinic acid there was no noticeable degradation after SSD while the degradation was about 16.25% after CSD. However, for ursolic acid the degradation was higher after SSD (26.6 after SSD against 21.01% after CSD). Figure 22 showed a decrease in carnosic acid value after both steam-distillation CSD and SSD processes coupled with an increase in the value of the carnosol. This is generally indicating degradation of carnosic acid into carnosol. To assess the possible degradation of carnosic acid into carnosol a ratio between those two was calculated. It was found that for the initial leaves the ratio value was 10.29 ± 0.87 while it was found to be 4.80 ± 0.33 and 3.37 ± 0.35 for SSD and CSD, respectively. As it is shown the ratio is higher for SSD than CSD which means that the preservation of carnosic acid was higher for SSD.

Essential oil extraction was used to deodorize the extract. The compounds of interests obtained afterward were mostly preserved after SSD. Thus, this process has a potential to be integrate in the conventional process for obtaining antioxidant by solvent extraction.

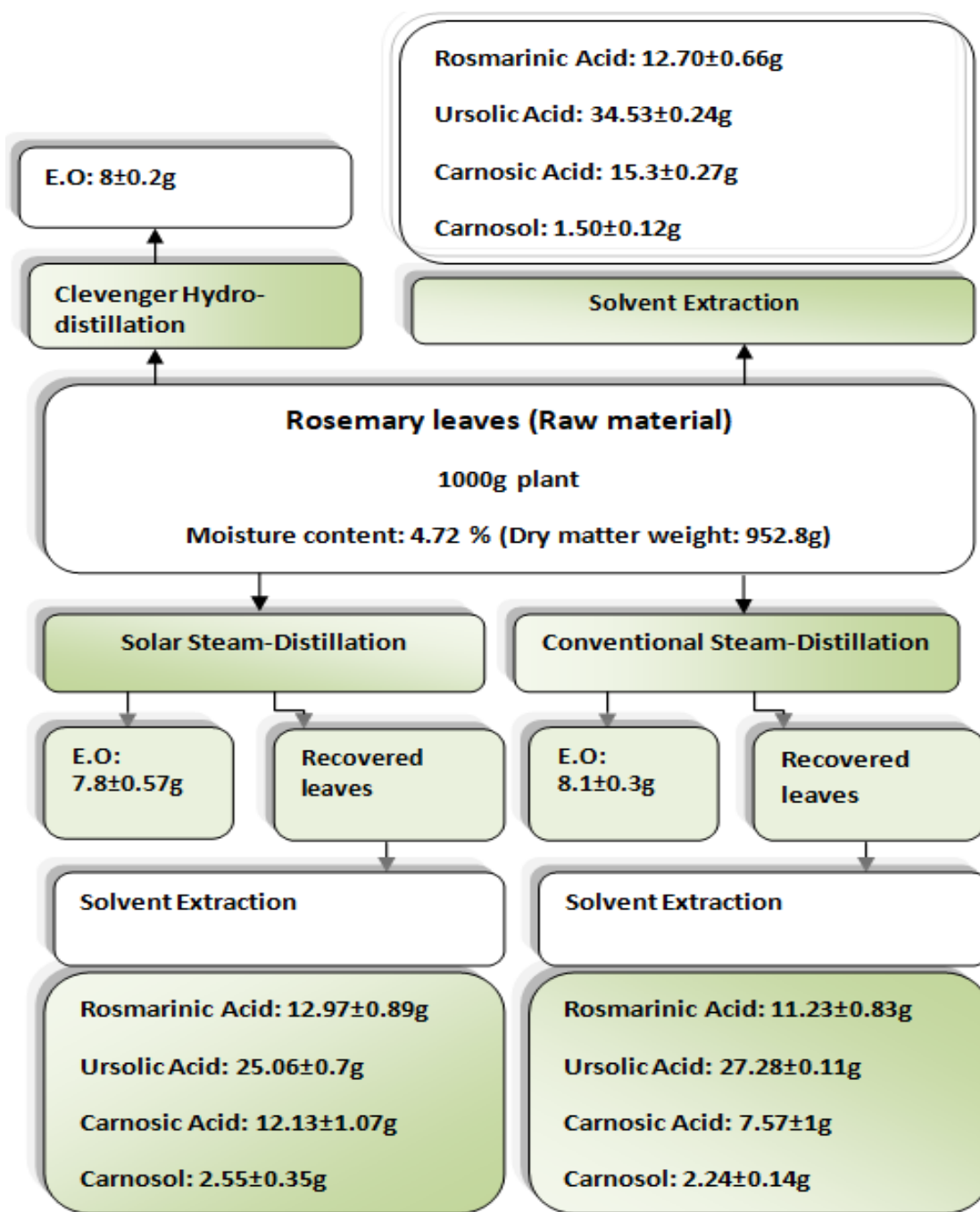

Figure 22. Material balance of essential oils and antioxidants extracted from rosemary leaves

DPPH scavenging activity was carried to verify either the antioxidant activity was preserved after each steam-distillation. The extracts were prepared at several concentrations with methanol: 2.5, 2, 1.5, 1, 0.5 mg/mL. It should be noted that the higher the antioxidant activity, the lower IC_{50} . The results presented the following IC_{50} value; 1.31, 1.52, 1.37 mg/mL for the initial, CSD, and SSD, respectively. Therefore, according to the results, the antioxidant activity difference between the initial and SSD is not very significant which can be explained by the fact that the antioxidant activity was preserved after the treatment.

As for the comparison between the SSD and CSD, it was observed that the antioxidant activity is higher for the CSD leaves than SSD. This was also observed in material balance and total polyphenol compound analysis; in those both part we found that polyphenol content as well as the preservation of antioxidants was higher after SSD process.

3.2.5 *Degradation Investigation of Carnosic acid to Carnosol*

Both figure 22 and table 11 summarize the phenolic compounds found and extracted from the rosemary leaves. As shown apart from the compounds found in the essential oil there are numerous antioxidants that can be extracted from the rosemary leaves; however, there are many factors like temperature or light that can engender degradation of these active compounds. In this case degradation of CA into carnosolis already known, but it should be noted that carnosol also possess antioxidant properties. It should be noted that there are other minor degradation derivatives of carnosic acid such as epirosmanol, 7-methyl-epirosmanol, as well as rosmanol 9-ethyl ether but in rosemary leaves carnosol naturally occurs (Jacotet-navarro et al., 2015).

3.2.6 *Process Assessment*

Both SSD and CSD processes were evaluated according to the six principles of green extraction that were developed by Chemat et al. (2012) and Jacotet-navarro et al. (2013). Those principles allow the design of extraction methods that aims to grant a natural and safe extract from well-reasoned sourcing with instead of waste a high add value while reducing the organic solvents, the energy consumption, as well as the process time. This approach was followed to assess the sustainability of the processes (Figure 23).

- Raw material (Principle 1). The valorized raw material of rosemary leaves (in %)
- Solvent (Principle 2). The total solvent mass used in the process in (%)
- Energy (Principle 3). energy consumption for the distillation of 1 kg of raw material (kWh)
- Waste (Principle 4). $(\text{mass of waste})/(\text{total mass of solvent} + \text{mass raw material})$ (in %)
- Process (Principle 5). extraction duration (in minutes)
- Product recovery (Principle 6). $(\text{mass of final product recovered})/(\text{mass of available product in the plant material})$.

It should be noted that in figure 21 a value close to the center is considered as a positive result which means that a value far from the center is a negative result. Thus, for “yield”, the center corresponds to a 100% extraction.

For both “Energy” and “Process”, the maximal reported values on the axis are the one obtained by CSD. Compared to conventional one SSD enabled us to reduce the extraction time from 190 minutes to 120 minutes. Furthermore, with SSD, energy consumption was reduced to zero since it is a sustainable and charge free source. Solvent value was considered as zero since both processes do not use any organic solvents. The waste was higher in the case of CSD, it could be considered as a fixed loss related to the process and more important in the case of the conventional process. However, SSD was not as sufficient as CSD in terms of extraction yields, but the difference can be ignored since it was not significant. The surface calculation for both CSD and SSD process from the radar in figure 23 showed that CSD covered double than SSD surface, which basically means that SSD present more positive features and since the solar is a free source while the conventional consume approximately 3.2 kWh which stands for 2560 g CO₂ during the extraction period, it is possible to say that the SSD is an efficient, sustainable, and economical process for essential oil extraction.

7

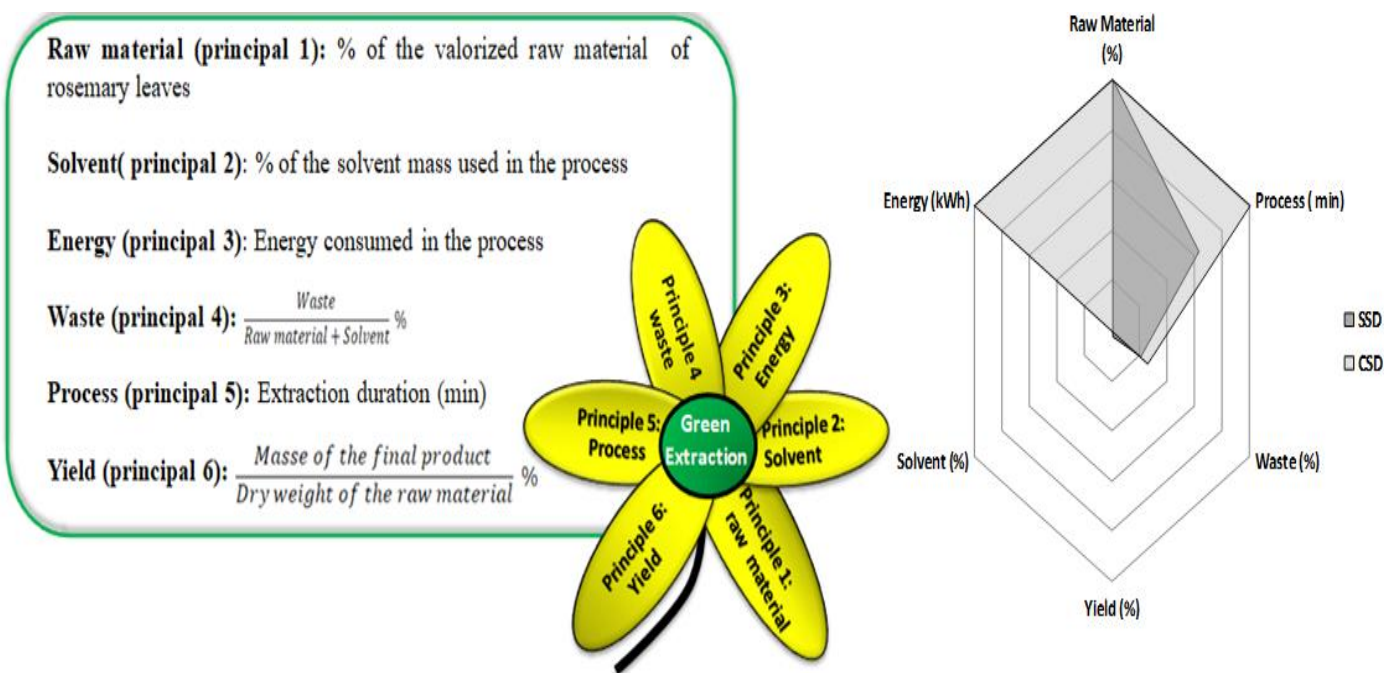

Figure 23. Process assessment of SSD and CSD according to Green Extraction

Conclusion

This study describes solar steam-distillation as deodorisation process of dry rosemary leaves to extract essential oil in order to remove the aroma prior to solvent extraction of non-volatile compounds mainly antioxidants. This environmentally friendly process was used for the first time as a deodorization process prior to solvent extraction. It offers important advantages over the conventional alternatives. Namely; a decrease in the extraction time given that the SSD can reach approximately the same yield in 2 hours instead of 3h (37% decrease in extraction time), a decrease in energy consumption since this energy is a sustainable charge free source, and a better antioxidant preservation giving that both carnosic and rosmarinic acid had higher value after SSD compared to CSD. The Total polyphenols analysis and DPPH free radical scavenging activity showed that polyphenols and antioxidants activity were highly preserved after SSD process. Overall, the results indicated that SSD is an innovative, sustainable, and charge free deodorizing process allowing an efficient extraction of both volatiles and non-volatiles from rosemary. Further improvements are required to optimize the yield and recovery of actives.

References

- Afzal, A.; Munir, A.; Ghafoor, A.; Alvarado, J.L. Development of hybrid solar distillation system for essential oil extraction. *Renew Energy*. 2017, 113, 22-29. doi.10.1016/j.renene.2017.05.027.
- Barata, M.A.; Rocha, F.; Lopes, V.; Carvalho, M.A. Conservation and sustainable uses of medicinal and aromatic plants genetic resources on the worldwide for human welfare. *Ind Crop Prod*. 2016, 88, 8-11. doi.10.1016/j.indcrop.2016.02.035.
- Barlow, S.M. Toxicological Aspects of Antioxidants Used as Food Additives. In Food Antioxidant. Hudson, B.JF.,Eds.; Elsevier Applied Food Science Serie.1990, 253-307
- Borrás-Linares, I.; Stojanović, Z.; Quirantes-Piné, R.; Arráez-Román, D.; Švarc-Gajić, J.; Fernández-Gutiérrez, A. ; Segura-Carretero, A. Rosmarinus officinalis Leaves as a Natural Source of Bioactive Compounds. *International Journal of Molecular Sciences*. 2014, 15(11), 20585–20606. doi.10.3390/ijms151120585
- Bousbia, N. Extraction des huiles essentielles riches en anti-oxydants à partir de produits naturels et de co-produits agroalimentaires.Ph.D. Dissertation, Avignon University,2013.
- Bousbia, N.; Vian, M.; Ferhat, M.A.; Petitcolas. E.; Meklati, B.Y.; Chemat, F. Comparison of two isolation methods for essential oil from rosemary leaves . Hydrodistillation and microwave hydrodiffusion and gravity. *Food Chem*. 2009, 114(1), 355-362. doi.10.1016/j.foodchem.2008.09.106
- Chemat, F; Vian, M.A; Cravotto G. green extraction of natural products . concept and principles.2012, 8615-8627. doi.10.3390/ijms13078615
- Ding, Y.; Wang, S.; Yang, D.; Chang, M-H.; Chen, Y-C. Alleviative effects of litchi (Litchi chinensis Sonn .) flower on lipid peroxidation and protein degradation in emulsified pork meatballs. *J Food Drug Anal*. 2015, 23(3), 501-508. doi.10.1016/j.jfda.2015.02.004.
- Fabricant, D.S.; Farnsworth, N.R.; The value of plants used in traditional medicine for drug discovery. *Environmental Health Perspectives*. 2001,109, 69-75.
- Flamini, G.; Cioni, P.L.; Morelli, I.; Macchia, M.; Ceccarini, L. Main agronomic – productive characteristics of two ecotypes of rosmarinus officinalis l . and chemical composition of their essential oils. *J. Agric. Food Chem*. 2002, 50, 3512-3517. doi.10.1021/jf011138j.
- Gramza-michalowska, A.; Sidor, A.; Hes, M. Herb extract influence on the oxidative stability of selected lipid. *J. food. Biochem*. 2011; 35(6), 1723-1736.
- Gunerhan, H.; Hepbasli, A.;Giresunlu, U. Environmental impacts from the solar energy

- systems. *Energy Sources, Part A Recover Util Environ Eff.* 2009, 31(2), 131-138. doi.10.1080/15567030701512733
- Husnu Can Baser, K.; Buchbaver. G. 2016. *Handbook of Essential Oils. Science, Technology, and Applications, Second Edition.*
 - Jacotet-Navarro, M.; Laguerre, M.; Fabiano-Tixier, A-S. ; Tenon, M.; Feuillère, N.; Antoine, B.; Chemat, F. What is the best ethanol-water ratio for the extraction of antioxidants from rosemary? Impact of the solvent on yield, composition and activity of the extracts. *Electrophoresis.* 2018.1-19. doi.10.1002/elps.201700397.
 - Jacotet-Navarro, M.; Rombaut, N.; Fabiano-tixier, A.; Danguien, M.; Bily, A.; Chemat, F. Ultrasonics Sonochemistry Ultrasound versus microwave as green processes for extraction of rosmarinic , carnosic and ursolic acids from rosemary. *Ultrason Sonochem.* 2015, 27, 102-109. doi.10.1016/j.ultsonch.2015.05.006.
 - Jacotet-Navarro, M.; Rombaut, N.; Deslis, S.; Pierre, F.; Bily, A.; Chemat, F. Towards a“dry” bio-refinery without solvents or added water using microwaves and ultrasound for total valorization of fruit and vegetable by-products. *Green Chem.* 2016, 18,3106-3115. doi.10.1039/c5gc02542g.
 - Khadhraoui, B. ; Turk. M. ; Fabiano-Tixier, A-S. ; Petitcolasb, E.; Robineta, P.; Imberta, E.; Maâtaouic, M.; Chemat, F. Histo-cytochemistry and scanning electron microscopy for studying spatial and temporal extraction of metabolites induced by ultrasound. Towards chain detexturation mechanism. *Ultrason Sonochem.* 2018; 42.482-492. doi.10.1016/j.ultsonch.2017.11.029
 - Kulurel ,Y.; Tarhan, S. Performance of a Solar Distillery of Essential Oils with Compound Parabolic Solar Collectors. *J Sci Ind Res.* 2016, 75, 691-696
 - Lara, M.S, Gutierrez, J.I.; Timón, M.; Andrés, A.I. Evaluation of two natural extracts (Rosmarinus of fi cinalis L . and Melissa of fi cinalis L .) as antioxidants in cooked pork patties packed in MAP. *MESC.* 2011, 88(3), 481-488. doi.10.1016/j.meatsci.2011.01.030.
 - Lorenzo, J.M.; Khaneghah, A.M.; Gavahian, M.; Marszałek,k.; Eş, I.; Munekata P.; Ferreira & Francisco, I.; Barba, F.J.To Understanding the potential benefits of thyme and their derived products on food industry and health . From extraction of high- added value compounds to the evaluation of and antimicrobial activities. *Critical Reviews in Food Science and Nutrition,* 8398, 1-17. doi.10.1080/10408398.2018.1477730
 - Ltinier, G.; Silvio, S.; Aquino, R.T.; Mencherini, T.; Della Logie, R.; Tubaro, A. Characterization of Topical Antiinflammatory Compounds in Rosmarinus Officinalis L . *J. Agric. Food Chem.* 2007, 55, 5, 1718-1723.

- Lubbe, A.; Verpoorte, R. Cultivation of medicinal and aromatic plants for specialty industrial materials. *Ind Crop Prod.* 2011, 34(1), 785-801.
- Mastro, G.; Rota, C.; Mincione, A.; Poiana, M. Bio-Morphological and Chemical Characterization of Rosemary (*Rosmarinus Officinalis* L.) Biotypes. *Acta Horticulturae.* 2004 (629), 471–482. doi.10.17660/actahortic.2004.629.61
- Mena, P.; Cirlini, M.; Tassotti, M.; Herrlinger, K.A.; Dall'Asta, C.; Del Rio, D. Phytochemical Profiling of Flavonoids, Phenolic Acids, Terpenoids, and Volatile Fraction of a Rosemary (*Rosmarinus officinalis* L .) Extract. *Molecules.* 2016,1-15. doi.10.3390/molecules21111576.
- Munir, A.; Hensel, O.; Scheffler, W.; Hoedt, H.; Amjad, W.; Ghafoor, A. Design , development and experimental results of a solar distillery for the essential oils extraction from medicinal and aromatic plants. *Sol Energy.* 2014, 108, 548-559. doi.10.1016/j.solener.2014.07.028.
- Ramya, H.G.; Palanimuthu, V.; Rachna, S. Singla, R. An introduction to patchouli (*Pogostemon cablin* Benth .) – A medicinal and aromatic plant . It’s importance to mankind. *J. CIGR.* 2013, 15(2), 243-250.
- Santos-sánchez, N.; Salas-coronado, R.; Valadez-blanco, R.; Hernández-carlos, B.; Guadarrama-mendoza, P.C. Natural antioxidant extracts as food preservatives .*Acta Sci. Pol. Technol. Aliment.* 2017.
- Serban, E.; Ionescu ,M.; Matinca, D. Screening of the antibacterial and antifungal activity of eight volatile essential oils. *Farmacia.* 2011, 59, 440-446.
- Sharaf, E. A new design for an economical, highly efficient, conical solar cooker. *Renew Energy.* 2002, 27(4), 599-619. doi.10.1016/S0960-1481(01)00136-7.
- Szumny, A.; Figiel, A.; Gutiérrez-ortíz, A.; Carbonell-barrachina, A.A. composition of rosemary essential oil (*rosmarinus officinalis*) as affected by drying method. *J Food Eng.* 2010, 97(2), 253-260. doi.10.1016/j.jfoodeng.2009.10.019
- Yen, H.Y, Lin, Y.C. Green extraction of *Cymbopogon* citrus essential oil by solar energy. *Ind Crop Prod.* 2017, 108, 716-721. doi.10.1016/j.indcrop.2017.07.039.
- Zhanga, H.L.; Baeyens, J.; Degréve, J.; Cacéres, G. Concentrated solar power plants . Review and design methodology. *Renew Sustain Energy Rev.* 2013, 22, 466-481. doi.10.1016/j.rser.2013.01.032

I-II. Orange peels

1. Orange peels, as by-products

Citrus fruits have been cultivated for over 4000 years and are the most produced fruit crops in the world. They belong to the family Rutaceae, in which the leaves normally contain transparent oil glands while the flowers possess an annular disk. The fruits belonging to this family are produced widely in large amounts for their juices and essential oils as by-products. Citrus oils are obtained primarily from the peel and cuticles of the fruits by cold-pressing method. The oils are mainly used for food flavouring industries, perfumery and aromatherapy (Dharmawan, 2008).

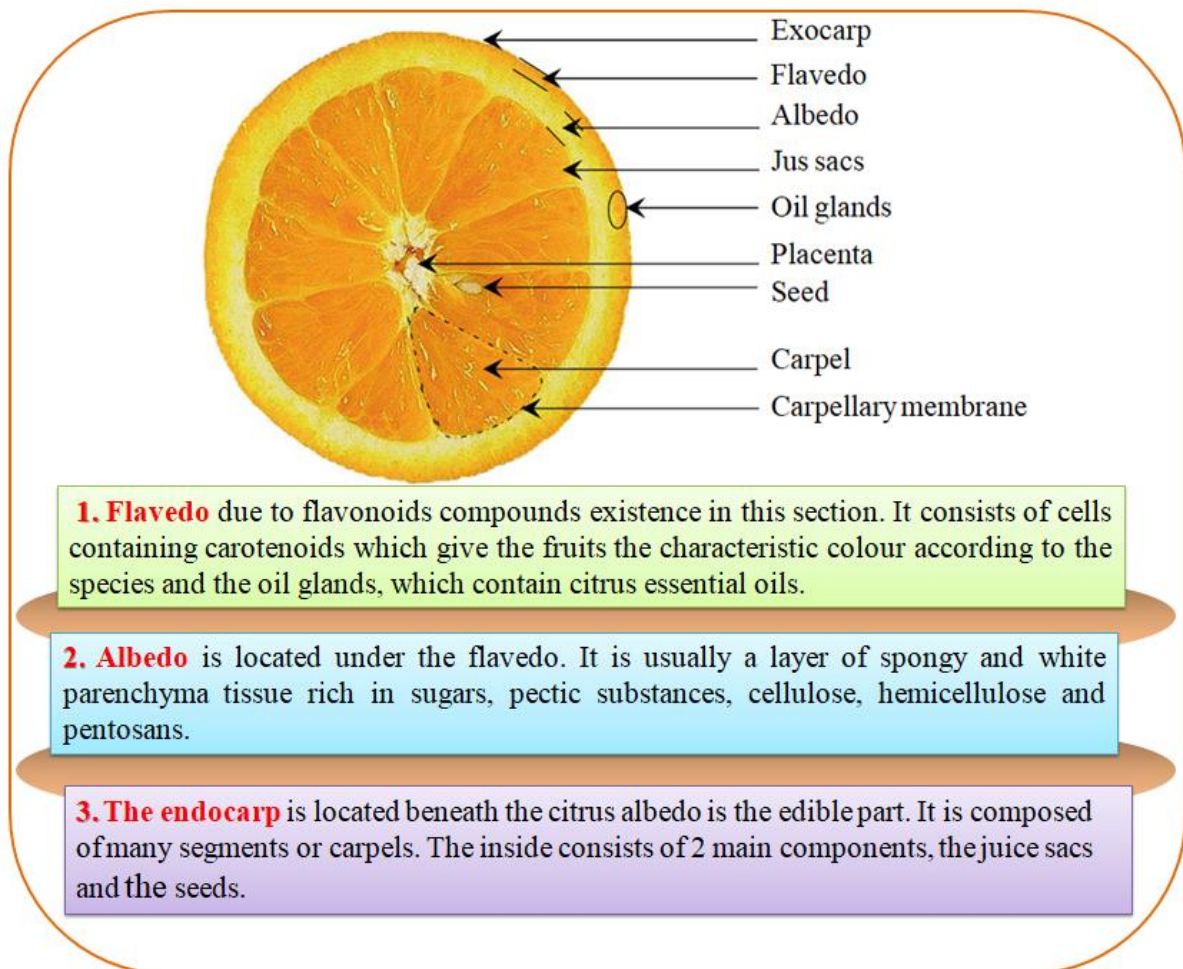

Figure 24. Cross section of orange fruit showing the inner composition and description of major sections.

Ample studies have been carried out to investigate the volatile compounds in the various citrus oils. The production of citrus fruits world widely knows an incrementing growth. Its total global production reached 110 million metric tonnes in 2004 and has increased about 26% over the past 10 years. Citrus peels are generally composed of 3 major sections (Simmons, 2016 ;Dharmawan, 2008) : Flavedo, Albedo and Endocarp (fig.24).

There are different varieties of Citrus fruits consumed and used industrially all over the world such as. Oranges, Bigarades, Mandarins, Lemons, Limes, Pomelo, grapefruits, Bergamot, and Kumquats. They are used for juice and essential oil as shown in figure 25 (Husnu and Gerhard, 2016 ; Fidalgo et al., 2016 ; Boukroufa et al., 2015, Dharmawan, 2008).

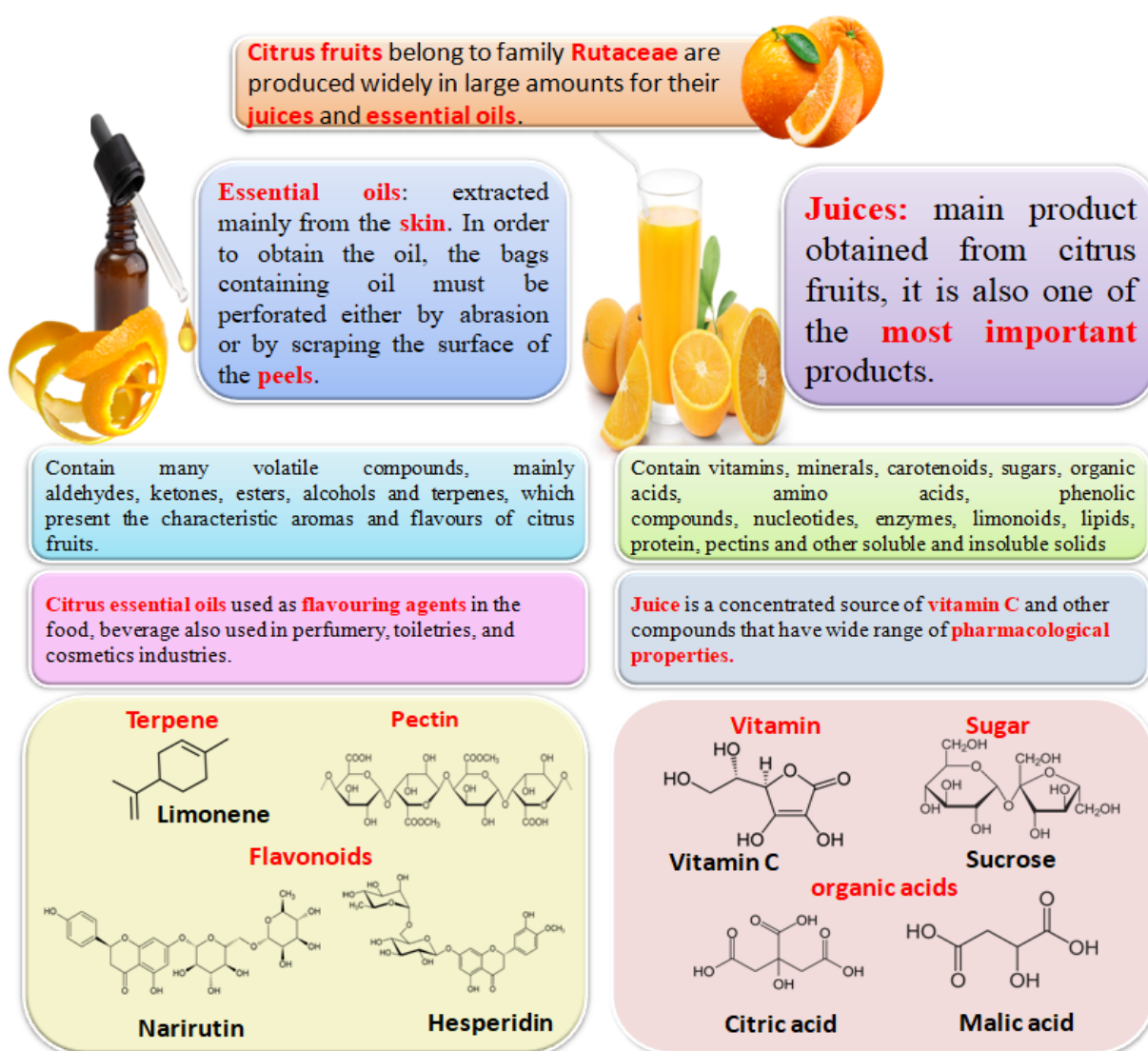

Figure 25. Summary of Citrus fruits utilisations

The main by-products of citrus processing are the peel, pulp and seeds, which present between 40-60% of raw material weight (Licandro and Odio, 2002). These by-products can be further processed in 3 main categories: animal feed, food product, and raw material utilized for further extraction. This thesis focuses on the valorisation of orange peels as by-product via solar extraction as an original concept employing Solar Hydro-Distillation as a zero-waste bio-refinery process to extract essential oil and pectin.

2. Context

The main by-products of citrus processing are the peel, pulp and seeds, which present between 40-60% of raw material weight (Licandro and Odio, 2002). These by-products can be further processed in 3 main categories: animal feed, raw material utilized for further extraction of marketable products and food products. Even though citrus by-products are mainly for animal feed, there are various useful applications for by-products made from different parts of the citrus fruits, such as pectin, dried pulp, molasses, citric acid, bland syrup, marmalades, candied peel, seed oil, peel seasoning, purees, beverage bases, citrus alcohol, flavonoids and other products. While for numerous citrus industries by-products became an important source of additional revenue for many citrus with low juice values, using citrus by-products to produce more valuable products are getting increasingly important as future world citrus production increases and then surpasses the demand for citrus juices and beverage products. Furthermore, the fact that the consumers are nowadays more nutrition-conscious and citrus fruits are a rich source of essential minerals, vitamins and dietary fibers with its distinctive natural flavour have also contributed to the increased demand for citrus fruits and their by-products.

Orange is the most important commercial species of Citrus in the world. It contains on average 12% of carbohydrates (40% of sucrose), vitamin C (80mg / 100g), vitamins P, B1, B9, E, provitamin A. Rich in calcium (40 mg / 100 g), rich in pectin, it acts as a regulator of intestinal transit. It contains a mesophilic flora (yeasts and lactobacilli) essential for good digestion. It contains up to 16.9% soluble sugar, 9.21% cellulose, 10.5% hemicelluloses and 42.5% pectin (Rivas et al., 2008).

Orange peel can be used for multiple application mainly essential oil extraction; in fact, orange essential oil is used to add orange aroma from the orange to products such as carbonated drinks, ice creams, cakes, air-fresheners, and perfumes. It is also used for its germicidal, antioxidant, and anti-carcinogenic properties (Guenther et al, 1974). Several epidemiological studies have suggested the beneficial effects of citrus fruits (rich in flavanones) against many degenerative diseases like cardiovascular diseases and some type of cancers (Mabberley, 2004; Benavente-Garcia et al., 1997; Tripoli, Guardia et al., 2007). Due to the confirmed positive influences of citrus fruits on human health, citrus consumption has recently witnessed an incremental increase with an annual estimated world production of over 120 million tons, of which oranges constitute about 60% of the total production (Scordino and Sabatino, 2014). With a high utilization for juice extraction for both domestic and industrial usage, a high amount of by-product mainly peels is accumulated. This by-product can be used for multiple applications such as for pectin, essential oils, and limonene extraction. In fact, orange peel is a raw material which can be direct utilized in daily life such as animal feed and organic fertilizer. The use of orange peel waste as an organic fertilizer seems to be low cost if compared with chemical fertilizer which can pollute the soil. According to Zhou et al., 2007 orange peel also can be used to produce fuel ethanol. Bioethanol is an alternative fuel derived from biologically renewable resources. It is a good substitute for gasoline in spark-ignition engines.

Additionally, citrus by-products represent a good source of phenolic compounds, principally the characteristic flavanone glycosides which mainly include naringin, hesperidin, narirutin, and neohesperidin. Nowadays, due to the harmful effect on human health of synthetic additive such as butylated hydroxyanisole (BHA) and butylated hydroxytoluene (BHT), which are toxic could be carcinogenic and might damage the liver (Shahidi et al., 2019; Rafiq et al, 2018), several researches have shifted their focus toward plants and their by-products to extract both natural and low-cost antioxidants that can replace synthetic additives. According to the literature, several conventional extraction techniques have been reported for the extraction of essential oil, pectin, and phenols from citrus peels like solvent extraction (Aboudaou et al., 2018), hot water extraction (Gedikoğlu et al., 2018), alkaline extraction, resin-based extraction, and supercritical fluid extraction.

The aim of this study is to develop an original concept employing Solar Hydro-Distillation (SSD) as a zero-waste bio-refinery process to extract essential oil, polyphenols and pectin (fig. 26).

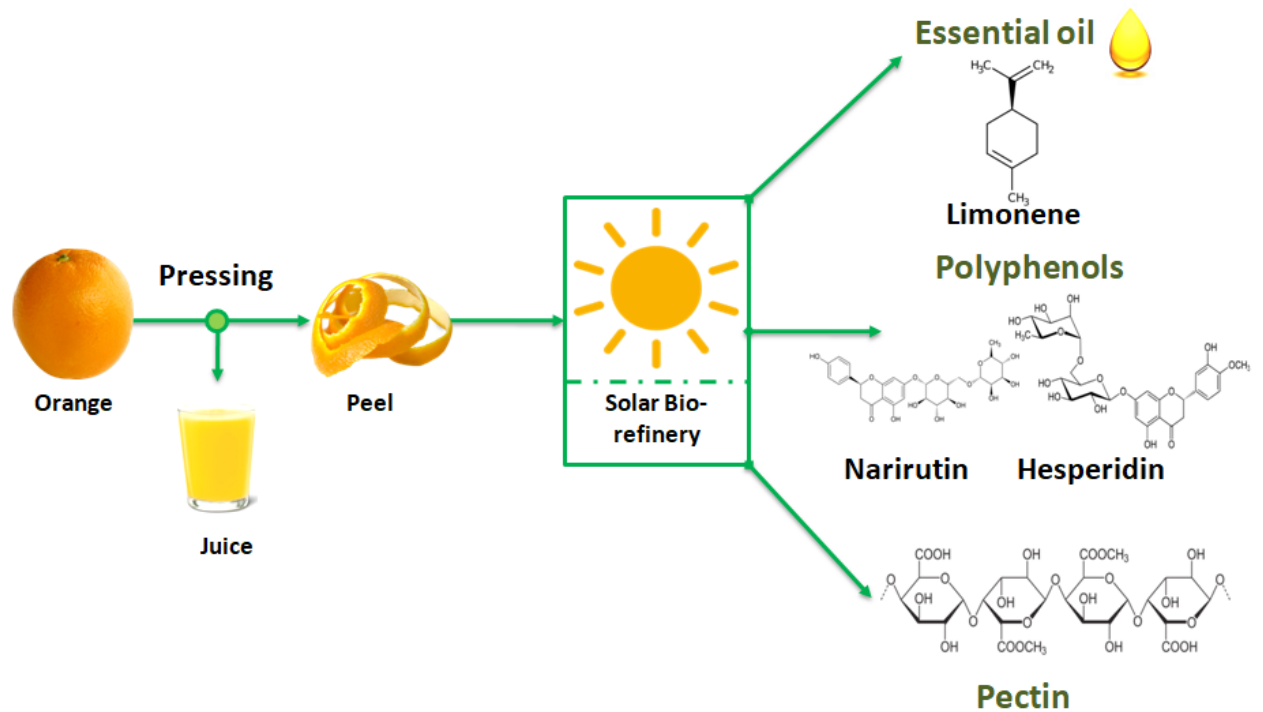

Figure 26. Solar valorisation of orange peels (context)

3. Green extraction of essential oils, polyphenols and pectin from orange peel employing solar energy; Towards a Zero-Waste Bio-refinery

Abstract

Following a rising demand for both environment friendly technologies and bio-active compounds, this study aims to develop a bio-refinery concept that uses solar radiation instead of fossil source derived energies to essential oils, pectin, and polyphenols extracts from orange peels. Hydro-distillation system has been used for extraction of volatiles (essential oils) and non-volatiles (polyphenols and pectin) compounds using solar or conventional fossil energy. It was found that the essential oil quality and yield were similar; however, the extraction time was 36.8% higher for the conventional procedure. Total polyphenol content (TPC) and total flavonoid content (TFC) analysis of orange peels, extracted by solar or conventional fossil energy, showed that a higher amount of polyphenol and flavonoid compounds were preserved when solar energy was applied. Indeed, 75% of the TPC and 70% of the TFC after conventional and 77% of the TPC and 77.8% of the TFC respectively after solar extraction were still found in the orange peels. Analysis of narirutin and hesperidin, main flavonoids present in Citrus species, showed that both flavanones were not entirely solubilised in the distillation water. Similar results were observed after pectin extraction since most of it was preserved in the peels after essential oil extraction.

3.1 Introduction

Each year, more than 100 million tons of diverse types of Citrus fruits are used in juice production; 40-50 % of this mass is considered as Citrus peel waste (Rizza, 2015; Anwar et al., 2008). Those by-products present a valuable source of numerous functional benefits and bioactive compounds that are of use to human health such as phenolic compounds, antioxidants and pectin (Wang et al., 2008; Ghasemi et al., 2009). They also contain flavonoids that have a wide range of biological effects including anti-tumour, anti-inflammatory, and antimicrobial activities with a protection against certain diseases; protection against coronary heart disease is one such example (Ghasemi et al., 2009).

The major flavonoids present in Citrus species are narirutin, hesperidin, naringin and eriocitrin (Boukroufa et al., 2015; Boukroufa et al., 2017; Ghasemi et al., 2009). Those bioactive compounds may play a vital role in human health due to their high antioxidant activities (Lara et al., 2011). Citrus by-product wastes have been valorised for fuel production, animal feed molasses, and pectin production (Li et al., 2006). In fact, the commercial pectin is usually derived from a range of Citrus fruits such as lime, grapefruit, and orange (Wang et al., 2008). The world market demand for Citrus fruits is up to 30,000 tons annually and still growing by 4 to 5% per year (Yeoh et al., 2008).

Orange is the most and widely consumed Citrus fruit (Sayinci et al.; 2010; Boukroufa et al., 2015) and contributes to 60% of the world Citrus fruit production. During juice processing a huge amount of by-products are generated mainly peels representing approximately 45% of the total mass (Yeoh et al., 2008; Farhat et al., 2011). Several studies had pointed that treating orange peel as waste could create numerous environmental problems such as water pollution resulting from biomaterials present in the peels especially essential oil, sugar, and pectin (Yeoh et al., 2008; Farhat et al., 2011; Bousbia et al., 2009). Whereas, valorising those by-product increases the potential return while at the same time preserves the environment. The orange peels when subjected to water and steam distillation release essential oils (Ferhat et al., 2007). Till now, several extraction techniques have been reported for the extraction of essential oil and phenols compounds from orange peels such as solvent extraction (Li et al., 2006), enzyme-assisted (Li, Smith, and Hossain, 2006), supercritical fluid (Mira et al., 1999), cold pressing (Ferhat et al., 2007), hydrodistillation (Ferhat et al., 2007), ultrasonic (Boukroufa et al., 2015), and microwave (Farhat et al., 2011, Ferhat et al., 2006) extraction.

Sun is a major source of immense inexhaustible free energy. New technologies are being developed worldwide to harvest solar energy in different fields. Most of those approaches have well tested and are used for different practices such as food processing industry; yet the solar energy contribution to the global energy supply is till now at negligible values (Kabir et al., 2018). Scheffler reflector presents an improved design that provides temperature in the medium ranges. Multiple processing can be carried out effectively with this technology and the return on investment was calculated to be around two years if used daily (Munir et al., 2014).

A bio-refinery concept is considered in this work for essential oils, polyphenols (hesperidin, naruritin), and pectin extraction from grinded orange peels before and after hydro-distillation process by integrating a green and zero-energy consuming procedure based on solar energy. This system is composed of a Scheffler solar reflector coupled with a hydro-distillation unit. The solar system was compared to a conventional hydro-distillation process.

3.2 Results and discussion

3.2.1 Hydro-distillation kinetics of Solar and Conventional Systems

Essential oil extraction yield was calculated each 10 minutes to establish the extraction kinetics; total yield was calculated and expressed in percentage for each process. The hydro-distillation yield was $1.03 \pm 0.015\%$ for the solar and $1.05 \pm 0.011\%$ for the conventional process. The extraction was practically completed at 120 min for solar process and at 190 for conventional one. Figure 27 shows the extraction yield variation in time. The essential oil extraction kinetics of both processes has the same extraction profile which is characterized by four distinctive phases. The starting phase (step 0) that expresses the heating progression from the ambient temperature till 100 °C, followed by phase 1 also known as “step 1” that displays the extracted initial essential oil located at the surface of the peels, then phase 2 that expresses the internal diffusion, and finally phase 3 in the form of a linear line that states the end of the experimental extraction. The yield difference between both systems does not count as significant knowing that the solar procedure is a green and energy free system.

Similar results were reported in numerous studies (Munir et al., 2014; Hilali et al., 2018; Afzal et al., 2017) for melissa, peppermint, rosemary, cumin and cloves where it was found that solar and conventional extraction provide similar essential oil yield with a negligible deviation.

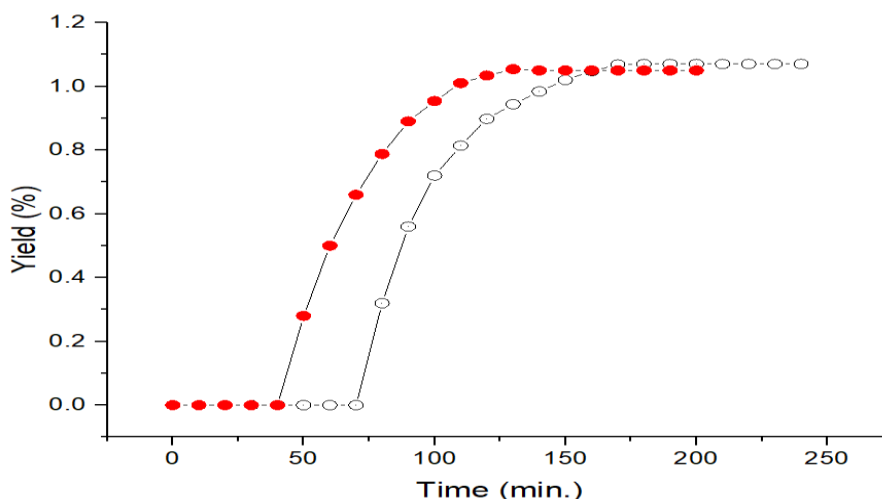

Figure 27. Essential oil yield as a function of time for conventional hydro-distillation

(○) and solar hydro-distillation (●)

It was established in previous work (Hilali et al., 2018) that the solar extraction efficiency is affected by both the daily solar radiation and the cloud cover density since the solar reflector only uses direct radiation. More importantly, it was proven that the temperature at the fixed focus can reach 500°C thus exceeding the required constant temperature needed for water boiling and eventually reducing the processing time of orange peels. This shows the advantages over conventional methods since the energy can exceed 4 kWh. The solar extraction system can be effectively utilized for duration of 10 to 12 hours continuously on bright and clear sunny days.

3.2.2 Essential peel oil composition

The compounds identified by GC-MS of the orange peel essential oil are shown in table.12. Overall, both oils have equivalent relative amounts of essential oil compounds. The main abundant components were limonene that represented 95.24% for conventional and 95.96% for solar procedure followed by Myrcene with value of 1.73% and 1.7% for the conventional and solar hydro-distillation, respectively. Therefore, for the solar procedure, solar radiation accelerated by 36.8% the extraction time, without any significant modifications in the volatile oil composition. Previous research (Farhat et al., 2011; Ferhat et al., 2006) have reported that Citrus peels essential oils present a mixture of volatile with monoterpene hydrocarbons as the abundant compounds in which the limonene represent more than 70% followed by myrcene. In general, the essential oil results found in this research agree with previously reported results. (Farhat et al., 2011; Ferhat et al., 2006; Hosni et al., 2010).

Table 12. Orange peels essential oils composition

N ^o	Compound ^a	R.I calc. ^b HP5MS	R.I lit. Adams ^c DB5	Conv (%)	Solar (%)	Method of identification
Monoterpenes						
1	α -Pinene	930	932	0.39	0.37	GC-FID; GC-MS
2	Camphene	947	946	0.01	0.01	GC-FID; GC-MS
3	Sabinene	970	969	0.19	0.16	GC-FID; GC-MS
4	β -Pinene	975	974	0.02	0.02	GC-FID; GC-MS
5	Myrcene	988	988	1.73	1.7	GC-FID; GC-MS
6	α -Phellandrene	1004	1002	0.08	0.05	GC-FID; GC-MS
7	δ -3-Carene	1007	1008	0.14	0.08	GC-FID; GC-MS
8	α -Terpinene	1015	1018	0.02	0.01	GC-FID; GC-MS
9	Limonene	1031	1024	95.24	95.96	GC-FID; GC-MS
10	γ -Terpinene	1057	1054	0.03	0.02	GC-FID; GC-MS
Oxygenated Monoterpenes						
11	Linalool	1099	1095	0.3	0.23	GC-FID; GC-MS
12	Citronellal	1148	1148	0.01	0.01	GC-FID; GC-MS
13	Nerol	1225	1227	0.01	0.01	GC-FID; GC-MS
14	Neral	1240	1235	0.01	0.01	GC-FID; GC-MS
15	Geraniol	1253	1249	0.01	0.02	GC-FID; GC-MS
16	Geranial	1269	1264	0.01	0.01	GC-FID; GC-MS
Sesquiterpenes						
17	α -Copaene	1374	1374	0.02	0.02	GC-FID; GC-MS
18	β -Cubebene	1386	1387	0.01	0.01	GC-FID; GC-MS
19	β -Elemene	1388	1389	0.02	0.02	GC-FID; GC-MS
20	β -Caryophyllene	1417	1417	0.02	0.02	GC-FID; GC-MS
21	Valencene	1491	1496	0.11	0.13	GC-FID; GC-MS
Oxygenated Sesquiterpenes						
22	Caryophellene oxide	1582	1582	0.02	0.01	GC-FID; GC-MS
23	β -Sinensal	1693	1699	0.01	0.02	GC-FID; GC-MS
24	α -Sinensal	1748	1755	0.01	0.01	GC-FID; GC-MS
25	Nootkatone	1803	1806	0.01	0.02	GC-FID; GC-MS
Other oxygenated compounds						
26	Decanal	1206	1201	0.16	0.17	GC-FID; GC-MS
27	α -Terpenyl Acetate	1346	1346	0.02	0.02	GC-FID; GC-MS
28	Citronellyl Acetate	1350	1350	0.01	0.01	GC-FID; GC-MS
Total oxygenated compounds (%)				98.03	98.58	
Total non-oxygenated compounds (%)				0.59	0.55	
Extraction time (min)				190	120	
Yield (%)				1.05±0.011	1.03±0.015	

^aEssential oil compounds sorted by chemical families and percentages calculated by GC-FID on non-polar HP5MSTM capillary column.

^bRetention indices relative to C7-C28 n-alkanes calculated on non-polar HP5MSTM capillary column. ^cReference retention indices on polar DBS capillary column.

3.2.3 Material Balance

The material balance was set in order to express the procedures outcomes (fig. 28). TPC, TFC, narirutin, hesperidin, and pectin assessment before and after hydro-distillation along with the E.O yield were expressed. 500g of fresh peels and 632±4.2g of orange juice were obtained after the pressing of 1.2±0.2 kg of fresh oranges as well as an approximately amount of 60g of fibers and seeds.

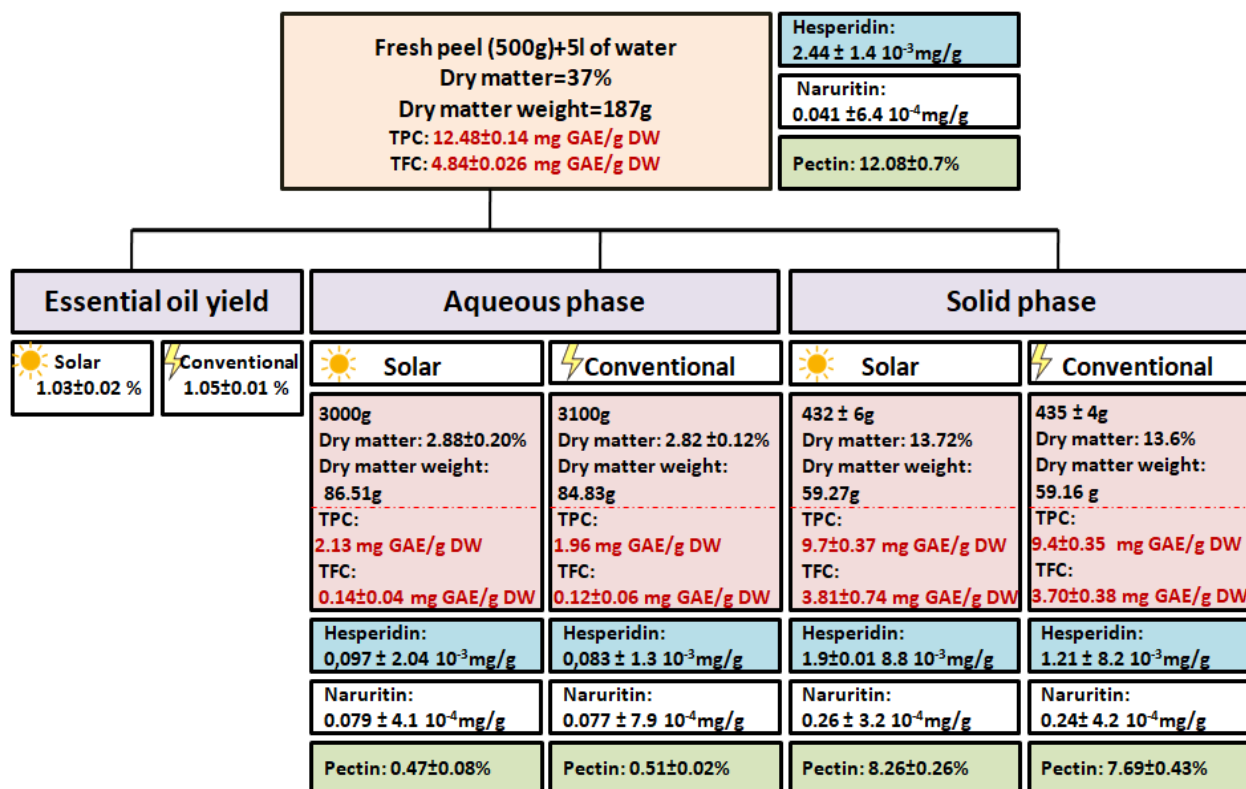

Figure 28.Material balance

- Total polyphenol content analysis

To evaluate the hydro-distillation impact on the TPC extraction, a comparison between the TPC values before and after each hydro-distillation was carried. The TPC of the grinded orange peel ranged between 12.48±0.14 to 9.4±0.35 for the conventional and 9.7±0.37 mg EGA/g dry matter for the solar. The phenolic content of the freeze-dried extract was also assayed after hydro-distillation; it had values of 2.13±0.03 and 1.97±0.072 mg EGA/g for solar and conventional procedures, respectively. It was observed that peels submitted to solar treatment had a slightly higher value compared to the conventional process.

It could be noted from those results that only an amount of approximately 15.7% for conventional and 17.06% for solar of TPC were found in the aqueous phase. While more than 75% after conventional and 77% of TPC is still present in the orange peels. Thus, meaning that the vegetable matrix components were not exhausted but rather preserved especially after solar hydro-distillation. Comparing those results to previous reported data is a difficult and complex task. In fact, the phenolic content varies due to the diversity of orange varieties, genetic factors, environmental conditions, extraction methods and of course their susceptibility to both oxidation and hydrolysis (Lagha-benamrouche and Madani, 2013).

- Total flavonoid, narirutin, and hesperidin content

The amounts of total flavonoid content of the peels before and after hydro-distillation extraction is shown in fig 28. Total flavonoid content ranged from 3.70 ± 0.38 to 4.84 ± 0.026 mgEQ / g. The highest levels have been reported for the initial peels and the lowest for orange peels after conventional extraction while peels after solar extraction had a value of 3.81 ± 0.74 mgEQ/g. The TFC of the extract inside of the alembic had a value of 0.14 ± 0.039 and 0.12 ± 0.06 mg EQ/g for conventional and solar, respectively. The amount of flavonoids in the extracted peels counting on the initial content was 76% for the conventional and 78% for the solar hydro-distillation. Hesperidin and narirutin known as flavanone glycosides (Khan et al., 2010) were also assayed in this study. The hesperidin, one of the main Citrus flavonoids in oranges with physiological properties associated with disease prevention potential benefits (Al-ashaal and El-sheltawy, 2011) was preserved in the peels by almost 70% and 77.8% for both conventional and solar hydro-distillation, respectively, while the water used for hydro-distillation only had 3.4% for conventional and 3.97% for solar.

Similar results were reported for narirutin with a preservation of 58.5% for conventional and 63.4% for solar in the orange peels; whereas, the water had values of 18.78% and 19.26% for conventional and solar, respectively. Hesperidin and narirutin can be considered as the most important phenolic compounds present in the soluble fraction (Gil-Izquierdo et al., 2003), yet it is proven from those results that it is hard to solubilise them completely with water meaning that the extracted peels still need to be valorized after essential oil extraction.

- Pectin yield

The pectin yield of the peels before and after conventional and solar hydro-distillation is $12.08 \pm 0.7\%$, $7.69 \pm 0.43\%$, and $8.26 \pm 0.26\%$, respectively. For the freeze-dried water, the values were $0.51 \pm 0.02\%$ for the conventional and $0.47 \pm 0.08\%$ for the solar procedure. Value of pectin in the aqueous phase is somewhat higher after conventional hydro-distillation this could be the results of the extraction time since pectin needs more time to solubilise in water. Even after solubilisation pectin is still present with high values in the solid phase; thus, the valorisation of the peels after extraction is a necessary part in a bio-refinery concept for orange peels. A solvent free microwave pectin extraction could be suggested in this case for a green zero-waste bio-refinery extraction process (Fidalgo et al., 2016).

3.3 Industrial prospects

3.3.1 Feasibility study and cost estimate

Nowadays there is a rising drive toward reducing the universal, environmental, and economic recurrent and alarming issue that is global carbon emissions. Thus, the need for green alternatives to mitigate energy security and climate change concerns; in fact, the sun is a major source of inexhaustibly green and free energy and present an adequate solution for those issues. Presently, new technologies are being employed worldwide to harvest and directly use solar energy (Kabir et al., 2018). Those approaches have already been widely practiced as renewable alternatives to conventional technologies in multiple fields such as food industry. The solar cooking is among the numerous technologies that have been developed along with solar dryers; they both offer ecological and environmental benefits through the savings on conventional sources (mainly fossil fuels and firewood), social-economic benefits created via employment for the production and functioning of solar cookers and dryers, and monetary saving by reducing energy employment created through the production of the cookers and dryers as well monetary savings on cooking and drying energy expenses (Nkhonjera et al.; 2017). A Green processes were also developed for essential oil extraction, one of the major systems is the one described in this study. The Scheffler concentrator coupled with a distillation unit was studied for different vegetal matrixes and different reflector areas (Munir et al., 2014; Hilali et al.; 2018). Yields of essential oils between conventional and solar system are quantitatively similar; whereas, distillation time and energy consumption are lower when solar energy is applied.

In fact, the distillation time is usually reduced by more than 30% as for the energy consumption, solar system uses direct radiation, and thus there is no need for additional source of energy (Munir et al., 2014). The investment cost for developing a complete Scheffler reflector (USD 2000) based distillation system (USD 1500) is USD 3500, whereas a conventional distillation system (USD 1500) equipped with a steam generator (USD 1000) costs USD 2500, therefore the price difference between both the systems is 28.5% (Hilali et al., 2018). However, the solar system has an almost two-year payback period (Hilali et al., 2018), doesn't need additional expenses, and represent a green solution; whereas, the conventional system needs an important amount of energy delivered by fossil sources for each individual application.

3.3.2 HACCP and HAZOP study toward solar process industrialization

HACCP (Hazard Analysis and Critical Control Points) concept is a food engineering requirement defined as a systematic approach established for a better food safety management. It based on seven acknowledged principles set in order to pinpoint and avoid the hazards that can likely occur during various food supply stages (Sicaire et al., 2016). HACCP is the most cost-effective and secure method set to control potential product contamination resulting from numerous hazards by defining the critical control point (CCP) in the flow diagram of the food process. These CCPs are necessary to prevent or eliminate food safety hazard or at least decrease those late to tolerable level all through the production process. Solar energy supplied machineries are recently used in many operating units during food processing and of course extraction. Nevertheless, exploiting solar energy for extraction requires the establishment of an HACCP process with CCPs in order to guaranty a safe quality product. In the case of solar energy, the process must ensure extraction that follows safety and quality requirements, without contamination of the final product. Critical processing parameters such as temperature, extraction time, physical properties of the product, solar radiation and power, are points which need to be monitored as part of HACCP measures.

Hazard and operability (HAZOP) study is investigation study to identify possible deviation that potentially leads to process operating problems and hazards (Sicaire et al., 2016). For solar extraction, the operators may be exposed to numerous hazards; the most important one is the accidental direct exposure to the concentrated solar irradiation and high temperature. Human body is vulnerable to such exposure thus causing tissue injury and damage for the operator. High temperature generated by thermal solar energy can cause body burns and even

be a potential fire source hazard. As for the UV irradiation usually caused by the high reflectivity of the reflector mirrors could potentially causes damages to the eyes.

All these operating measures were established to allow the production of a qualitative product in a safe environment with various risks managing approach in order to avoid any hazard on both the system user and the product consumer.

3.3.3 Eco-footprint of solar extraction process

The “green extraction” is based on six principles that allow the design of methods that aims to reduce energy consumption and guaranty a natural, safe, environment-friendly, and economic extract from well-reasoned sources. It grants at the same time a cutback on the energy and organic or hazardous solvent consumption with instead of waste a significantly high added value. The six-governing principal (Chemat et al., 2012) that ensure the sustainability of the processes are the following: P-1(raw material), P-2 (Solvent), P-3 (Energy), P-4 (Waste), P-5 (Process), and P-6 (Product recovery).

Solar extraction was assessed in this part while considering the six eco-extraction principles and the environmental impact of this later, for that purpose solar extraction was compared to conventional extraction with similar conditions. According to the results, there is no significant difference between the final essentials oils quality; whereas, the TPC and TFC value were higher after solar extraction. Compared to conventional process, solar extraction allows the obtaining of higher narirutin, hesperidin, TFC, and TPC contents as well as a somewhat similar in quality and yield essential oil in only 120 minutes instead of 190 minutes. These results agree with those established in our previous work (Hilali et al., 2018). The assessed amount of CO₂ emitted for the conventional process was around 2560 g of CO₂ (Hilali et al., 2018); whereas, solar doesn't need any additional source of energy, making its CO₂footprint a nil value. After taking all these aspects in consideration, this study seeks the use of solar as a way to reduce or even nullify the eco-footprint of extraction.

Conclusion

This study proposes an original concept using Solar Hydro-Distillation (SSD) as a zero-waste bio-refinery process to extract essential oil, polyphenols and pectin. It was noted from this study that TPC, TFC, hesperidin, narirutin, and pectin are still present in the peels after extraction with a high preservation amounts particularly after solar hydro-distillation. This may be due to the distillation time needed for essential oil extraction being less for solar hydro-distillation making the peel after extraction still needs to be valorised.

References

- Aboudaou, M.; Ferhat, M.A., Hazzit, M., Ariño, A., Djenane, D. Solvent Free-microwave Green Extraction of Essential Oil from Orange Peel (*Citrus sinensis* L.). Effects on Shelf Life of Flavored Liquid Whole Eggs during Storage under Commercial Retail Conditions. *Preprints* 2018, 2018010055 (doi. 10.20944/preprints201801.0055.v1).
- Al-ashaal, H.A.; El-sheltawy, S.T. Antioxidant capacity of hesperidin from Citrus peel using electron spin resonance and cytotoxic activity against human carcinoma cell lines. *Pharmaceutical Biology*. 2011, 49,276-282.
- Anwar, A.; Naseer, R.; Bhangar, M.I.; Ashraf, S.; Talpur, F.N.; Aladedunye, F.A. Physico-Chemical Characteristics of Citrus Seeds and Seed Oils from Pakistan. *J Am Oil Chem Soc*. 2008, 85,321–330.
- Afzal, A.; Munir, A.; Ghafoor, A.; Alvarado, J.L. Development of hybrid solar distillation system for essential oil extraction. *Renew Energy*. 2017, 113,22-29.
- Benavente-García, O., Castillo, J., Marin, F. R., Ortuño, A., & Del Río, J. A. (1997). Uses and Properties of Citrus Flavonoids. *Journal of Agricultural and Food Chemistry*, 45(12), 4505–4515. doi.10.1021/jf970373s
- Boukroufa, M.; Boutekedjiret, C.; Petigny, L.; Rakotomanomana, N. Chemat, F. Ultrasonics Sonochemistry Bio-refinery of orange peels waste. A new concept based on integrated green and solvent free extraction processes using ultrasound and microwave techniques to obtain essential oil, polyphenols and pectin. *Ultrason - Sonochemistry*. 2015, 24,72-79.
- Bousbia, N.; Abert, M.; Ferhat, M.A.; Petitcolas, E.; Meklati, B.Y.; Chemat, F. Comparison of two isolation methods for essential oil from rosemary leaves. Hydrodistillation and microwave hydrodiffusion and gravity. *Food Chem*. 2009, 114(1),355-362.
- Farhat, A.; Fabiano-tixier, A.; El Maataoui, M.; Maingonnat, J.; Romdhane, M.; Chemat, F. Microwave steam diffusion for extraction of essential oil from orange peel . Kinetic data, extract' s global yield and mechanism. *Food Chem*. 2011, 125(1), 255-261

- Ferhat, M.A.; Meklati, B.Y.; Chemat, F. Comparison of different isolation methods of essential oil from Citrus fruits. cold pressing, hydrodistillation and microwave ‘dry’ distillation. *Flavour Fragr. J.* 2007, 22, 494–504.
- Ferhat, M.A.; Meklati, B.Y.; Smadja, J.; Chemat.F. An improved microwave Clevenger apparatus for distillation of essential oils from orange peel. *J. of Supercritical Fluids.* 2006, 1112, 121-126.
- Fidalgo, A.; Ciriminna, R.; Carnaroglio, D.; Cravotto, G.; Grillo, G.; Ilharco, L.M.; Pagliaro, M. Eco-Friendly Extraction of Pectin and Essential Oils from Orange and Lemon Peels. *ACS Sustain Chem Eng.* 2016, 4, 2243–2251.
- Gedikoğlu, A.; Clarke, A.; Gruen, I. Determination of flavonoids in citrus fiber and the impact of processing method on total phenolic content, total flavonoid content, total carotenoid content and oxygen radical absorbance capacity. *Gıda* ,2018, 43(6), 917-924 . DOI. 10.15237/gida.GD18072
- Ghasemi, K.; Ghasemi, Y.; Ebrahimzadeh, M.A. Antioxidant activity, phenol and flavonoid contents of 13 Citrus species peels and tissues. *Pak. J. Pharm. Sci.* 2009, 22(3),277-281.
- Gil-Izquierdo, A.; Gil, M.I.; Tomaäs-Barberaä F.A.; Ferreres, F. Influence of Industrial Processing on Orange Juice Flavanone Solubility and Transformation to Chalcones under Gastrointestinal Conditions. *J. Agric. Food Chem.* 2003, 51,3024-3028.
- Hilali, S.; Fabiano-Tixier, A.; Elmaataoui, M.; Petitcolas, E.; Hejjaj, A.; Aitnouh, F.; Idlimam, A.; Jacotet-Navarro, M.; Bily, A.; Idlimam, A.; Mandi, L.; chemat, F. Deodorization by Solar Steam Distillation of Rosemary Leaves Prior to Solvent Extraction of Rosmarinic, Carnosic, and Ursolic Acids. *ACS Sustainable Chem. Eng.* 2018 6, 10969–10979. <https://doi.org/10.1021/acssuschemeng.8b02347>
- Hosni, K.; Zahed, N.; Chrif, R.; Abid, I.; Medfei, W.; Kallel, M, Ben Brahim, N.; Sebei. H. Composition of peel essential oils from four selected Tunisian Citrus species. Evidence for the genotypic influence. *Food Chem.* 2010, 123(4), 1098-1104.
- Husnu Can Baser, K.; Buchbaver. G. 2016. Handbook of Essential Oils. Science, Technology, and Applications, Second Edition

- Kabir, E.; Kumar, P.; Kumar, S.; Adelodun, A.A.; Kim, K-H. Solar energy. Solar energy: Potential and future prospects. *Renewable and Sustainable Energy Reviews*. 2017, 82, 894–900.
- Lagha-benamrouche, S.; Madani K. Phenolic contents and antioxidant activity of orange varieties (*Citrus sinensis* L. and *Citrus aurantium* L.) cultivated in Algeria. Peels and leaves. *Ind Crop Prod*. 2013, 50,723-730.
- Lara, M.S, Gutierrez, J.I.; Timón, M.; Andrés, A.I. Evaluation of two natural extracts (*Rosmarinus of fi cinalis* L . and *Melissa of fi cinalis* L .) as antioxidants in cooked pork patties packed in MAP. *MESC*. **2011**, 88(3), 481-488. doi.10.1016/j.meatsci.2011.01.030.
- Li B.B.; Smith, B.; Hossain, M. Extraction of phenolics from citrus peels I. Solvent extraction method. *Separation and Purification Technology*. 2006, 48,182-188.
- Li, S.; Lambros, T.; Wang, Z.; Goodnowa, R.; Chi-Tang, H. Efficient and scalable method in isolation of polymethoxyflavones from orange peel extract by supercritical fluid chromatography. *Journal of Chromatography*. 2007, B (846), 291–297. <https://doi.org/10.1016/j.jchromb.2006.09.010>.
- Licandro, G. Olio, C.E..2002. Citrus by-products. In. G. Dugo& A. Di Giacomo (eds.), *Citrus. The genus Citrus*. 159–178. Taylor & Francis, London & New York.
- Mabberley, D. J. Citrus (Rutaceae). A Review of Recent Advances in Etymology, Systematics and Medical Applications. *Blumea - Biodiversity, Evolution and Biogeography of Plants*. 2004, 49(2), 481–498. doi.10.3767/000651904x484432.
- Munir, A.; Hensel, O.; Scheffler, W.; Hoedt, H.; Amjad, W.; Ghafoor, A. Design, development and experimental results of a solar distillery for the essential oils extraction from medicinal and aromatic plants. *Sol Energy*. 2014, 108,548-559.
- Nkhonjera, L.; Bello-Ochende, T.; John, G.; King’onde, C.K. A review of thermal energy storage designs, heat storage materials and cooking performance of solar cookers with heat storage. *Renew Sustain Energy Rev*. 2017, 75,157-167.
- Rafiq, S., Kaul, R., Sofi, S. A., Bashir, N., Nazir, F., & Ahmad Nayik, G. (2016). Citrus peel as a source of functional ingredient. A review. *Journal of the Saudi Society of Agricultural Sciences*. doi.10.1016/j.jssas.2016.07.006
- Rizza, G. Citrus limonoids. Functional chemicals in agriculture and foods, Ph.D. Thesis, University of Catania, 2015.

- Scordino, M., Sabatino, L. Characterization of Polyphenolic Profile of Citrus Fruit by HPLC/PDA/ESI/MS-MS. *Polyphenols in Plants*. 2014, 187–199. doi.10.1016/b978-0-12-397934-6.00009-7
- Shahidi, F., Vamadevan, V., Oh, W.Y., and Peng, H. Phenolic compounds in agri-food by-products, their bioavailability and health effects. *J. Food Bioact.* 2019, 5, 57–119.
- Sicaire, A.; Fine, F.; Vian, M.; Chemat, F. Handbook of Ultrasonics and Sonochemistry. 2017.
- Simmons, D. 2016. Citrus Fruits. Production, Consumption and Health Benefits (Food and Beverage Consumption and Health) UK ed. Edition.
- Tripoli, E., Guardia, M. L., Giammanco, S., Majo, D. D., & Giammanco, M. (2007). Citrus flavonoids. Molecular structure, biological activity and nutritional properties. A review. *Food Chemistry*, 104(2), 466-479. doi.10.1016/j.foodchem.2006.11.054
- Wang, Y-C.; Chuang, Y-C.; Hsu, H-W. The flavonoid, carotenoid and pectin content in peels of citrus cultivated in Taiwan. *Food chem.* 2008, 106, 277-284. doi.10.1016/j.foodchem.2007.05.086
- Yeoh, S.; Shi, J.; Langrish, T.A.G. Comparisons between different techniques for water-based extraction of pectin from orange peels. *Desalination*. 2008, 218,229-237

**Chapter II: Thermal solar
energy applications on
Drying of rosemary leaves
and orange peels**

II-I. Rosemary Leaves

1. Context

Many agricultural products, consumed in large quantities are not always available during the seasons. Several solutions are proposed to overcome this handicap; greenhouse cultivation, freezing, as well as preservation by drying. The later has a simple, safe and adequate solution for many products. The drying of rosemary leaves is a necessary unit operation that requires high energy and is also a time-consuming operation. Drying plays a vital role in increasing shelf-life and reducing the bulk weight of the product. The high moisture content in this product facilitates several chemical reactions and promotes the growth of microorganisms capable of deteriorating product final quality.

This work aims to develop a solar drying concept used to identify the characteristic curve, model the drying behaviour and assess the effect of time and temperature on the antioxidants properties of rosemary while at the same time study the economic and environmental feasibility of the solar drying of rosemary leaves (fig.29).

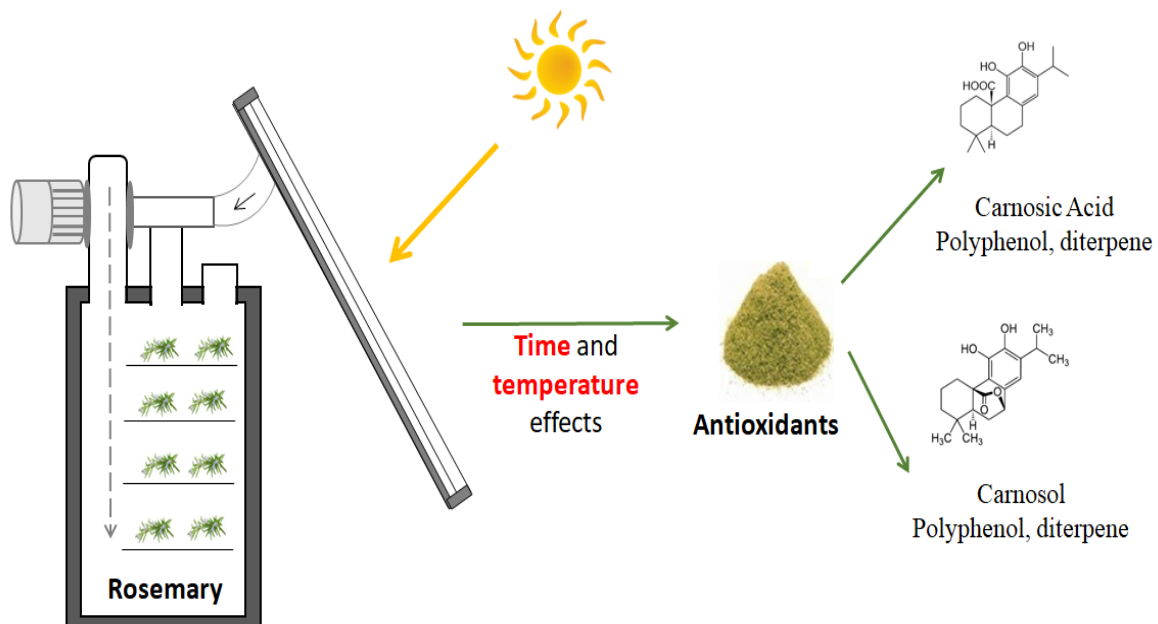

Figure 29. Solar drying techniques

2. An economical and experimental study of convective drying effect on the environment and antioxidants properties of rosemary leaves

Abstract

This research aimed to investigate natural solar drying and solar convection drying effect at different temperatures (40°C, 50°C, 60°C, 70°C) on the total phenolic compounds (TPC), antioxidant properties, as well as the degradation of carnosic acid to carnosol in rosemary leaves. The drying kinetic was studied for five air temperatures to determine the characteristic drying curve. The obtained results showed that an increase in temperature reduced drying duration. To simulate the drying behaviour, out of nine models, Midilli Kucuk model was the best fit to adequately describe the convective solar drying of rosemary leaves. Both TPC and antioxidant activities (AA) results showed relatively similar results for naturally dried rosemary at temperatures lower and equal to 60°C. However, at 70°C, TPC and AA values decrease. Carnosic acid value decreased with an increase of carnosol compared to the initial, whereas at 70°C both degradation of carnosic acid and carnosol were witnessed. The economic feasibility and the annual CO₂ emissions mitigation analysis showed solar energy potential for both fossil monetary saving and CO₂ emissions mitigation. Overall, this study suggested that solar convection drying at low temperatures (40-60°C) can reduce drying time while offering a high-quality dried product.

2.1 Introduction

Aromatic and medicinal plants are a major source of compounds with bioactive properties, highly valorized in the extraction field. They are used for day-to-day application due to the diversity of usages and benefits. Rosemary (*Rosmarinus officinalis* L.) is an aromatic and medicinal plant (AMP) used widely all around the world for different purposes and cultivated along the Mediterranean Sea. Rosemary has been commonly acknowledged as one of the herbs with high antioxidant properties due to the phenolic compounds it contains, such as carnosol, carnosic, and rosmarinic acids that are of great interest (wang et al., 2008; Erkan et al., 2008; zhang et al., 2010). The essential oil extracted from this plant is also used as an antifungal, antibacterial, and anticancer agent.

AMPs are not available throughout the year hence the collected biomass is generally submitted to drying process before extraction as an attempt to reduce the moisture content. The aim of drying is to prevent product deterioration by reducing the moisture content, thus allowing a longer and better storage condition (Blanco-Cano et al., 2016). In fact, drying is one of the most important processes when it comes to agricultural products pre-processing. A proper AMPs drying is essential if one aspires to achieve a high product quality (Okoh et al., 2008). In fact, drying is considered as one of the oldest and important food dehydration, conservation, and preservation process. It is used to reduce the water content responsible for food deterioration. There are very close and established relation between both the shelf-life of food products and their hydration degrees. Knowing that the water is involved in a plethora of phenomena such as biochemical, biophysical, microbiological and enzymatic reactions and modification, it is possible to significantly increase shelf-life of a food product by lowering its water activity (Lahnine et al., 2016; Bahammou et al., 2019; Koukouch et al., 2015; Mghazli et al., 2017). Vegetable, plants, and fruits solar drying is one of the oldest application of renewable energies; even though numerous energy sources can be used for drying, solar energy embodies an inexhaustible, abundant, non-polluting, and viable alternative to conventional systems with no related environmental hazards (Mghazli et al., 2017; Akpinar and Bicer, 2008; Ullah and Kang, 2017). Given that open-air drying depends on the weather variation, the dried product quality is usually affected and damaged by air pollution, microbes, birds, rodents, and insects, thus the use of sophisticated industrial solar dryers represents a more effective solution. Solar drying has shown according to multiple researchers and investigators an efficient, consistent, and technical potential in the preservation and the drying sector. And compared to open-solar drying the drying time is reduced by 65%, the dried product is protected from multiple infections, and the quality is improved. This can also be translated into an economic gain by reducing energy cost. Usually, solar dryers have a payback period that ranges from 2 to 4 years according to their rate of utilization (Rabha et al., 2017; Ait Mohamed et al., 2004).

Convection drying is a process characterized by a simultaneous heat and mass transfer; the water in the product in this process is transferred by diffusion to the air-product interface and to the air-steam afterwards by convection. Mathematical models have been proven as effective designs to analyse those transfer processes during the drying process (Babalís et al., 2004). They are generally used in order to understand the drying process, establish drying curves and estimate drying times of the desired product.

Many mathematical models for different products were established by numerous researchers for convection solar drying; for instance, Ghost Chill Pepper (Rabha et al., 2016), prickly pear cladode (Lahsasni et al., 2004), thyme (Lahnine et al., 2016), and olive pomace waste (Bahammou et al, 2019).

The aims of this study were to develop a mathematical model for predicting solar convection drying of rosemary leaves at different air-drying temperature as well as understanding the drying process and impact of such process in the polyphenol and antioxidant properties by quantifying total polyphenol content and antioxidant activity, while also investigating the degradation of carnosol into carnosic acid.

2.2 Experimental section

The material used in this section is rosemary leaves. This aromatic and medicinal plant was collected from High School of Trainee Teachers, Cadi Ayyad University (Marrakech, Morocco) and were subjected to 4 drying temperatures (40°C, 50°C, 60°C and 70°C) and a conventional air-dried for 2 days (drying temperature was around 27°C); the product mass used for each experiments was 100 ± 3.4 g of fresh matter and was evenly distributed on the trays of the drying cabinet (the process is developed in the material and methods chapter).

2.3 Results and discussion

2.3.1 Drying kinetic

To better present and analyse the drying kinetic of a giving product a variation of the moisture content in time is usually used. In this study four experimental drying tests with four temperatures (40 °C, 50°C, 60 °C, 70°C) were carried out in order to study rosemary solar drying temperature effect on the herb antioxidant properties. Figure 30 corresponds to the moisture content variation as a function of moisture content. The drying curves obtained from these experiments display a moisture content decrease resulting from an increase of the drying time.

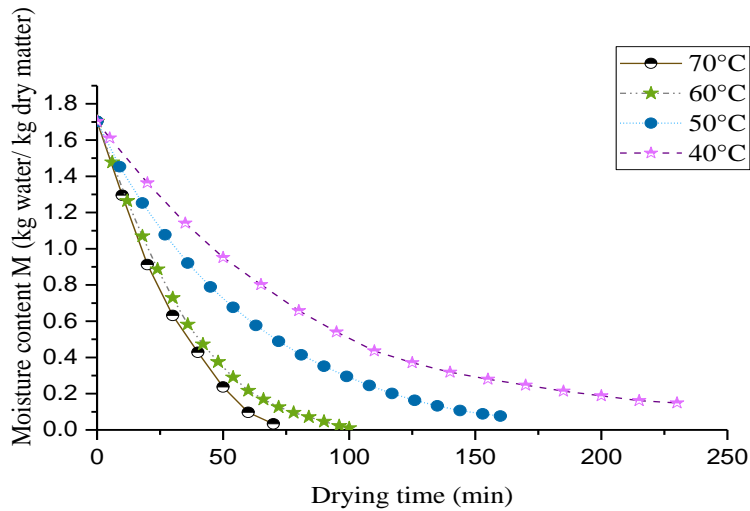

Figure 30. Moisture content variation as a function of the drying time

The figure 30 demonstrates the notable impact of the temperature on the drying time. In fact, according to the results it was proven that drying rate is reduced by 69.5% between 40°C and 70 °C. The drying time needed for rosemary leaves was 70min, 100min, 160min, and 230 min, respectively for air drying temperatures of 70°C, 60°C, 50°C, and 40 °C at an air flow rate of 300 m³/h. The only existent phase represented in this figure is phase 2 also called the falling rate period. Generally, moisture content as a function of the drying time representation lacks both phase 0 (initial period) and phase 1 (constant rate). The drying rate was initially higher due to the high amount of free water available in the product. The moisture is normally removed easily during the first drying periods this is observed due to initial high drying rate. Those results were reported in similar drying studies for Moroccan horehound leaves (Bahammou et al. 2019), Moroccan truffle (Tagnamas et al. 2020), and grenade peel (Idlimam et al. 2007). The drying during the second falling rate period is typically illustrated by the water diffusion in the material; this phenomenon is defined as a complex mechanism that involves water in both vapour and liquid states. It influenced and primarily depends on drying pressure and temperature and of course the water content of the product.

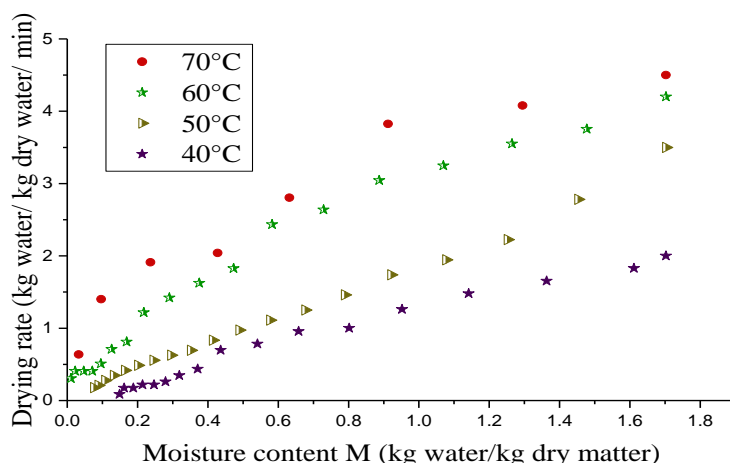

Figure 31. Drying rate variation as a function of moisture content

Figure 31 corresponds to the drying rate variation as a function of moisture content. It shows an increase of the drying rate of rosemary leaves that corresponds to an increase of the drying temperature. From these results, it was drawn as a conclusion that the drying kinetics of rosemary leaves is significantly impacted by the drying air temperature. In the work conducted by Mghazli et al. (2017), in which rosemary was dried in four different air temperatures (50, 60, 70 and 80 °C) and two air flows drying (300 m³/h and 150 m³/h), it was observed that the drying rate of rosemary leaves increases with high drying temperature whereas high air flow rate does not significantly impact the drying rate of rosemary leaves.

2.3.2 Characteristic drying curve

The characteristic drying curve is established in order to present a theoretical normalization to better express the drying law of a certain matrix while taking the experimental data and as reference (fig. 32). In this experiment, based on the four drying tests and a non-linear optimization method of Levenberg-Marquard used using Origin 6.1 software; the characteristic drying curve was identified. It took the form of a polynomial of order 3.

$$f = 2.0681 MR - 2.2658 MR^2 + 1.1986 MR^3$$

The goodness of fit is evaluated by. The residual sum of square (RSS = 0.445) and correlation coefficient (r = 0.986).

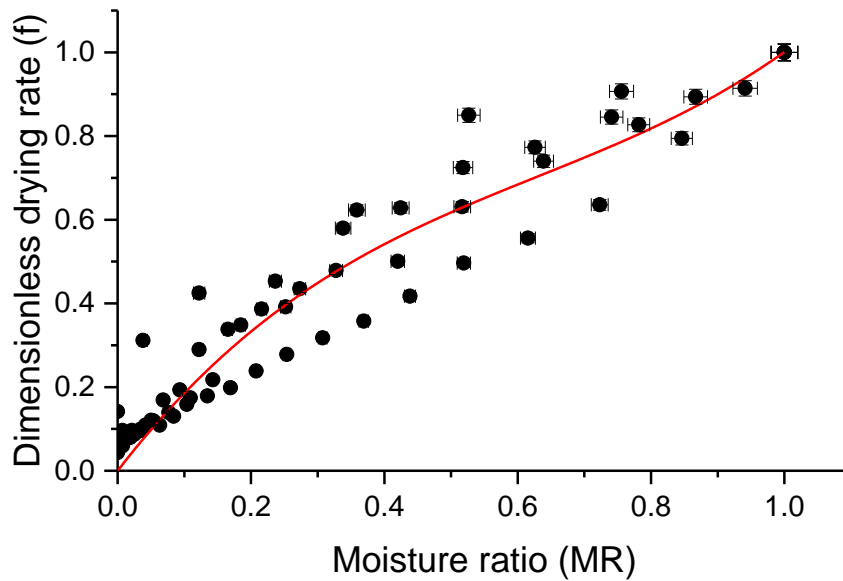

Figure 32. Characteristic drying curve of rosemary leaves.

2.3.3 *The drying curves modelling and fitting*

Modelling the drying behaviour of rosemary leaves requires essentially statistical regression and correlation analysis methods. The mathematical models are well documented in the literature and presents mandatory tools to establish the relation between a set of variables that do not possess an empirical relationship. Nine of those models, usually used for drying fitting, were applied to rosemary leaves drying experimental data as an approach to adequately predict the water content in the product. The drying constants as well as the values of r and Standard Error (RMSE) of the nine models for all the experimental points were obtained by the non-linear optimization method of Marquerd-Levenberg with the help of curve expert software. The results of statistic and non-linear regression analyses applied to the nine models are presented in table 13.

Table 13. Moisture ratio fitting for the 4 temperatures

Models	T°C	Parameters	R	Standard Error
Midilli-kucuk	40	a= 0.9460, k= 8.1843.10 ⁻³ , n= 1.1170, b= -1.2081.10 ⁻⁴	0.9998	0.0056
	50	a= 0.9970, k= 1.6710.10 ⁻² , n= 1.0109, b= -4.0407.10 ⁻⁴	0.9999	0.0028
	60	a= 0.9942, k= 1.5050.10 ⁻² , n= 1.1830, b= -3.0132.10 ⁻⁴	0.9999	0.0044
	70	a= 1.0001, k=1.9730.10 ⁻² , n= 1.1271, b= -1.4399.10 ⁻³	0.9997	0.0095
Logarithmic	40	a= 1.0789, k= 1.2560.10 ⁻² , c= -6.7784.10 ⁻²	0.9992	0.0098
	50	a= 1.0822, k= 1.6128.10 ⁻² , c= -8.5414.10 ⁻²	0.9999	0.0021
	60	a= 1.1203, k= 1.2738.10 ⁻² , c= -9.6404.10 ⁻²	0.9991	0.0136
	70	a= 1.2548, k= 2.4068.10 ⁻² , c= -2.4656	0.9995	0.0122
Verma et al.	40	a= 1.4391.10 ⁺¹⁰ , k= 1.6006.10 ⁻² , b= 1	0.9971	0.0271
	50	a= 8.1238.10 ⁺⁵ , k= 1.1029.10 ⁻² , b= 1	0.9999	0.0039
	60	a= 1.9654.10 ⁺⁶ , k= 5.3483.10 ⁻² , b=1	0.9994	0.0109
	70	a= 4.1071.10 ⁺⁶ , k= 1.4192.10 ⁻² , b=1	0.9996	0.0256
Henderson	40	a= 1.0294, k= 1.4904.10 ⁻²	0.9974	0.0245
	50	a= 1.0257, k= 2.0007.10 ⁻²	0.9968	0.0247
	60	a= 1.0549, k= 3.2773	0.995	0.0324
	70	a= 1.0423, k= 3.810.10 ⁻²	0.9904	0.0530
Diffusion approximation	40	a= 7.2449 k= 8.6977.10 ⁻³ , b= 9.2355.10 ⁻¹	0.9997	0.0084
	50	a= 1.0530.10 ⁺³ , k= 2.9492.10 ⁻² , b=1	0.9987	0.0159
	60	a=1.1071, k=1.6652.10 ⁻² , b=0.9399	0.9992	0.0131
	70	a=1.5145, k=1.4755.10 ⁻² , b=0.9316	0.9996	0.0112
Newton	40	k= 1.4492.10 ⁻²	0.9969	0.0263
	50	k= 1.9522.10 ⁻²	0.9964	0.0255
	60	k= 3.1170.10 ⁻²	0.9933	0.0364
	70	k= 3.6673.10 ⁻²	0.989	0.0526
Page	40	k= 6.9620.10 ⁻³ , n= 1.1652	0.9995	0.0105
	50	k= 1.1616.10 ⁻² , n= 1.12534	0.9985	0.0170
	60	k= 1.3013.10 ⁻² , n= 1.2386	0.9994	0.0100
	70	k= 1.2276.10 ⁻² , n= 1.3141	0.9978	0.0256
Two term exponential	40	a= 7.9124.10 ⁻⁴ , k= 1.8280.10 ⁻¹	0.9968	0.0273
	50	a= 1.6148, k= 2.4456.10 ⁻²	0.9986	0.0164
	60	a= 5.9609.10 ⁻⁴ , k= 1.8459	0.9933	0.0377
	70	a= 5.2433, k= 5.2437.10 ⁻²	0.9971	0.0293
Two term	40	a= 9.1900.10 ⁻¹ , k1= 1.49.10 ⁻² , b= 1.09.10 ⁻¹ , k0= 1.4904.10 ⁻²	0.9968	0.0273
	50	a= 7.443.10 ⁻¹ , k0= 2.10 ⁻² , b= 2.81.10 ⁻¹ , k1= 2.10 ⁻²	0.9968	0.0264
	60	a= -1.1960.10 ⁻¹ , k0= 6, b= 1.1196, k1= 3.4686.10 ⁻²	0.9969	0.0271
	70	a= 7.94.10 ⁻¹ , k0=3.8102.10 ⁻² , b= 2.48.10 ⁻¹ , k1=3.81.10 ⁻²	0.9904	0.0652

Based on the table 13 results, it is appropriate to state Midili-kucuk as the best fitting model to effectively describe the convective solar drying of rosemary leaves since it has both the highest r and the lowest standard values compared to the other models. Midilli Kucuk, in multiple studies, was found as the best fitting model that better describes the drying of multiple matrices such a Moroccan truffle (Tagnamas et al. 2020), Thymus (Lahnine et al. 2016), Moroccan horehound (Bahammou, et al., 2020), and rosemary leaves (Mghazeli et al., 2017). Both Fig. 33 and 34 show the perfect agreement between the experimental moisture ratio and the one predicted by Midilli-Kucuk fitting model for all four drying temperatures.

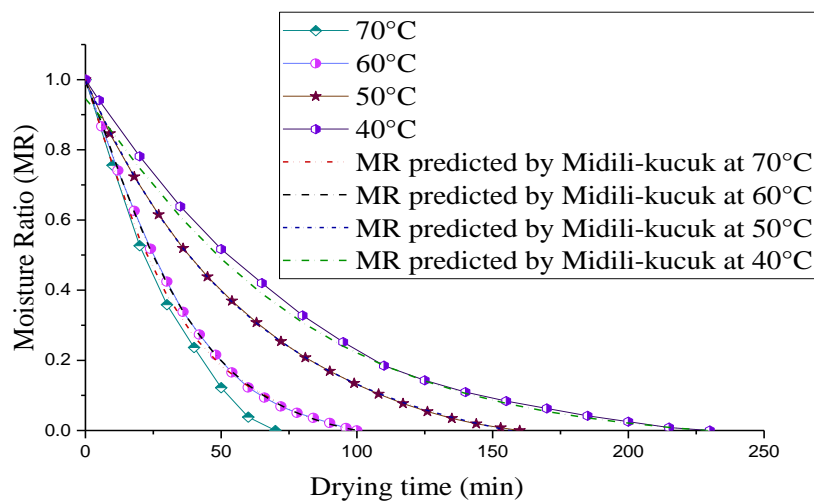

Figure 33. Moisture ratio Experimental data versus drying time fitted values.

Taking the drying temperature effect into consideration, the coefficients of the Midilli-Kucuk equation (a , k , n and b) are expressed in terms of the temperature as shown below:

$$a = -1.1275^{-4}\theta^2 + 0.014\theta + 0.5896$$

$$k = -9.614^{-6}\theta^2 + 0.0013\theta - 0.031$$

$$n = -1.4^{-4}\theta^2 + 0.0206\theta + 0.39$$

$$b = -2.13 \cdot 10^{-6}\theta^2 + 1.966 \cdot 10^{-4} \theta - 0.0046$$

Those four expressions of the Midilli-Kucuk model predicted adequately the moisture ratio (MR) at five drying temperatures 40, 50, 60, and 70°C for the rosemary leaves.

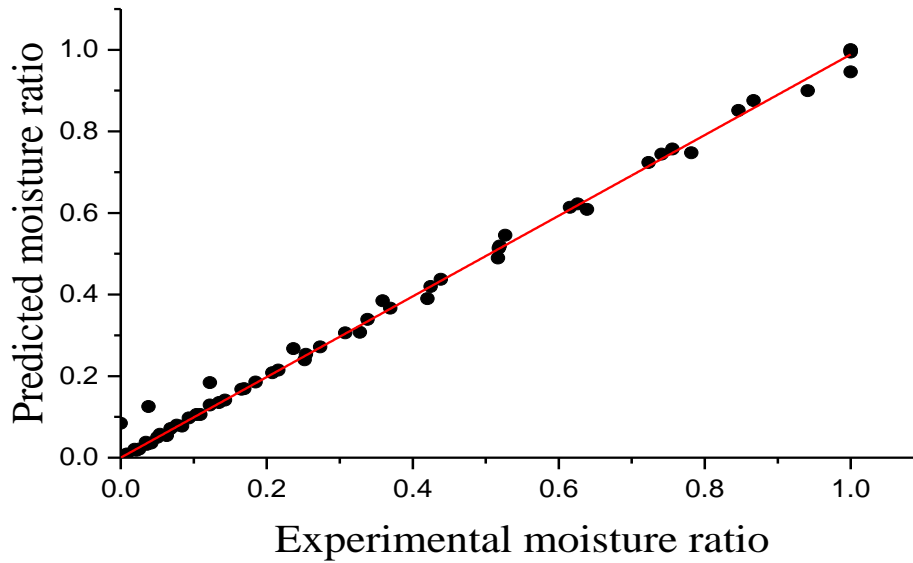

Figure 34. Predicted moisture ratio (predicted by two term's model) as a function of the experimental moisture ratio

2.3.4 *Effective diffusivities and activation energy*

According to the experimental drying curves of rosemary leaves, a falling drying rate period as well as a liquid diffusion control process was observed. To explain and describe the drying behaviour, Fick's second law can be used. The measure of the diffusivity is presented in figure 33 that shows the plot of experimental results of $\ln(Y^*)$ versus drying time for the four different studied temperatures.

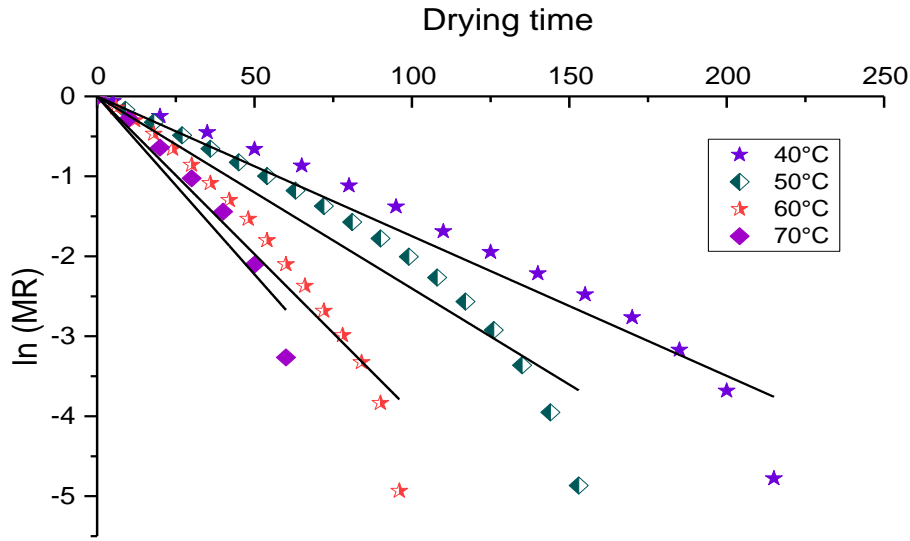

Figure 35. Effects of temperature on rosemary leaves effective diffusion coefficient.

The higher temperatures of drying will eventually increase the energy, thus leading to an increase the activity of water molecules which mean high moisture diffusivity as shown in figure 33 (Idlimam et al., 2007). This values usually lies within in a range of 10^{-8} to 10^{-12} . The results found in this experience are depicted in table 14 and lay within the appropriate range.

Table 14. Values of effective diffusivity of rosemary leaves.

Temperature (°C)	D_{eff} (m^2/s)	(r)
40	$2.7046 \cdot 10^{-11}$	0.989
50	$3.5498 \cdot 10^{-11}$	0.984
60	$6.5925 \cdot 10^{-11}$	0.962
70	$7.4377 \cdot 10^{-11}$	0.955

The activation energy is basically a drying process E_{act} equivalent to the potential value that go up against the drying reaction progress to be overcome in order for the drying process to happen (Lahnine et al., 2016; Mghazli et al., 2017).

To calculate the value of activation energy the Arrhenius equation is used.

$$D_{eff} = D_0 \exp\left(-\frac{E_{act}}{RT}\right) \quad (1)$$

Where E_{act} is the activation energy, D_0 is the Arrhenius equation defined as the pre-exponential factor (m^2 / s), R is known as the universal gas constant ($J / mol.k$), and T is the absolute air temperature.

The activation energy can be calculated via a presentation of the effective diffusivity natural logarithm verse the temperature inverse as shown in figure 34. This helps represent the drying temperature influence on the effective diffusivity.

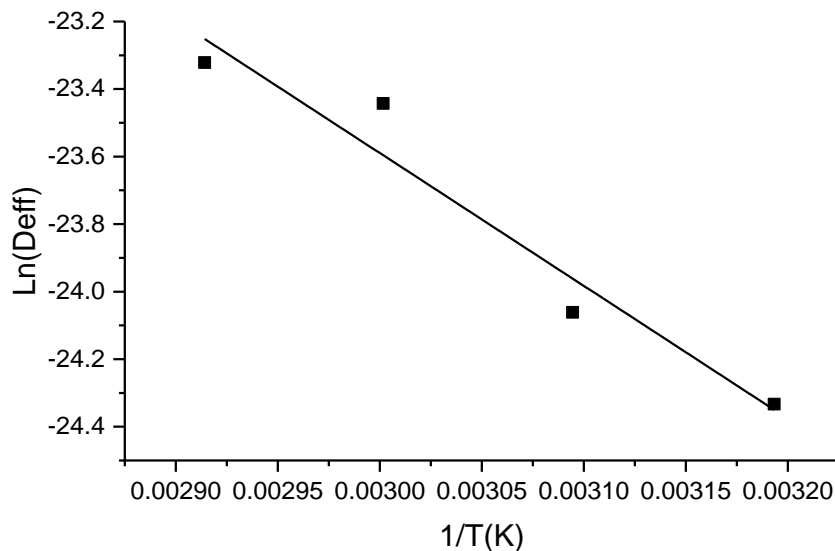

Figure 36. $\ln(D_{eff})$ as a function of $1/T$ at different temperatures.

$$\ln(D_{eff}) = -3933 - 11.78(1/T)$$

$$r = 0.945$$

The average activation energy of rosemary leaves is found to be 39.33kJ/mol or 2185kJ/kg.

2.3.5 Quality Analysis

i. Determination of Total Phenolic Content (TPC)

Table 15 showed the different changes in TPC values after the thin layer convective solar drying at different temperatures in comparison to natural thin layer solar drying (rosemary leaves) were dried for two days under normal circumstances, the ambient temperature of drying was around 30°C). The quantity of total phenols in the methanol extract of the fresh rosemary leaves was found to be 78.15 ±1.36 mg equiv of Gallic Acid/g of dry matter, whereas the second highest value was found in the conventional solar dried rosemary leaves (74.14 ±1.83) this may be due to the fact that those leaves were not submitted to a high drying temperature. After convective solar drying at (40, 50, and 60°C) it was noted that TPC values were somewhat similar to a relative increase with a decrease of drying time (a value of 72.34±2.08 at 60°C) this was noted for other matrices such as sage (Bahammou et al. 2019) and olive leaves (Bahloul et al. 2009).

Table 15. TPC and DPPH free radical scavenging activity values

Analysis	Fresh	Sun dried	Convection Solar Drying			
			40°C	50°C	60°C	70°C
TPC*	78.15 ±1.36	74.14 ±1.83	72.19±2.681	70.96±3.67	72.34±2.08	69.73±3.23
DPPH [†]	2.63±0.18	2.91±0.04	2.83±0.053	2.86±0.20	2.82±0.16	3.03±0.078

*GAE mg /g of dry matter

[†]IC₅₀- mg of dry matter/ mL of solvent

However, According to Table 15, the TPC decreases at 70°C. It could be stated from this result that the phenolic content decreases significantly with high drying temperatures. Similar results were reported by Doymaz and Karasu (2018) for another aromatic and medicinal plant's sage leaf, where the degradation rate increased significantly with the drying temperature higher than 50 °C. Sour cherries were also investigated and the study showed that 68.7–81.7% of TPC was lost during the drying process (Horouz et al. 2017). Consequently, high drying temperatures result in a decrease of the polyphenol content. This could be explained by the heat-sensitive properties of some phenolic compounds (Doymaz and Karasu2018; Zielinska and Michalska 2016). Wojdyło et al. (2013) suggested that temperatures and long treatment time could cause degradation of phenolic components, thus resulting in a decrease of antioxidant activity; this indicates that phenolic compounds may be degraded for rosemary leaves by heat treatment at temperatures higher or less than 60 °C, since, according to the results, both extensive drying time and temperature may result in polyphenols degradation.

ii. Radical-scavenging activity (DPPH)

The DPPH scavenging potential of rosemary leaves different conditions was also measured and the results are depicted in table 15. It was found that the DPPH radical scavenging activity of dried rosemary leaves was significantly influenced by drying air temperatures ($P < 0.05$). IC_{50} values were the fairly similar from the natural air dried till the 60°C solar convective dried rosemary leaves. In fact, however, starting 70°C, the IC_{50} values were above the initial value of fresh rosemary leaves, thus indicating that with higher drying temperatures (in this case 70°C) the antioxidant activity decreases. Doymaz et al. (2018) reported that the degradation rate significantly increased with temperature drying higher than 50 °C for sage. Similar results were found in other studies (Horouz et al. 2017, Wojdylo et al. 2013) where it was demonstrated that higher temperatures decrease the antioxidant activity of vegetable matrices. The higher degradation rate that occurs at high temperatures and/or long drying time is due to heat-sensitive properties of certain phenolic compounds, such as a carnosic acid (Horouz et al. 2017), the later is unstable and can easily be submitted to degradation during drying or extraction (Milevskaya et al. 2017).

iii. Carnosic acid degradation investigation

Antioxidants are of great interest in the food industry due to their food rancidity prevention capability. Many spices including thyme, cloves, black pepper, cinnamon, and rosemary display antioxidative activities in a numerous biological system (Lacroix et al., 1997). Several successful antioxidant applications of rosemary were reported in literature including turkey sausages (Barbut and Josephson, 1985) safflower oil (Lee et al., 2004), palm oil (Jaswir et al., 2000) and others.

Table 16. Carnosic acid and carnosol quantification

	Fresh leaves	air-dried	40°C	50°C	60°C	70°C
Carnosol (%)	0.154714	0.216894	0.210603	0.205	0.20951	0.131751
Carnosic acid (%)	2.55582	1.760997	1.728538	1.64368	1.76826	1.561392

There are numerous antioxidants compounds that could be extracted from the rosemary leaves; nevertheless, factors such as temperature or light could engender active compounds degradation; the degradation of carnosic acid into carnosol is well established (Hilali et al., 2018; Jacot-Navaro et al., 2015).

To better understand the effect of rosemary drying on rosemary, fresh leaves and solar dried leaves at different conditions were submitted to a Soxhlet extraction. The extract was analyzed to quantify both carnosic acid and carnosol (table 16). It was found that after solar drying (40, 50, 60°C, and air dried) values of carnosol were higher coupled with a decrease of carnosic acid values thus indicating a degradation of carnosic acid into carnosol. However, with high temperature (70°C) both carnosic acid and carnosol value decreases. This may indicate that high temperature values impact the antioxidant properties of rosemary leaves. It should be noted carnosol also possesses as well antioxidant properties.

2.3.6 Economic and environmental feasibility of convective solar dryer

i. Economical study and estimation

By introducing solar dryers, a chance to produce a high marketable quality product with minimal cost will be presented to the farmer thus improving the economic situation while promoting a green alternative. The solar dryer can meet the energy required for food product drying while significantly contributing to CO₂ emissions reduction resulting from fuel switching. This part evaluates the financial feasibility of solar drying of rosemary leaves at a drying temperature of 60°C, the temperature was chosen according to the quality analysis results (Tiwari, 2016).

Table 17. Parameters used in the economical calculations

Parameters	value
Reference mass (M_r)	100g
Latent heat of vaporization of water (h_e)	2.26 MJ/kg
Drying efficiency (Π_d)	0.25
Daily solar radiation (I_d)	5.053 kWh/m ² /day
Reflector price (p_r)	45.63USD/m ²
Annual repair cost (as fraction of the capital) (r_c)	0.05
Discount rate (d)	0.1
Life time (t_l)	10
Remaining compound cost (fraction of the collector cost) (c_a)	0.1
Initial moisture content (M_i)	0.8
Final moisture content (M_f)	0.3
drying time (t_d)	4 days
Sensible heat fraction required to raise the temperature (ϵ)	0.5

The parameters used for the economical evaluation for 100 g (mass used in this experiment) are depicted in table 17 (Purohit and Kandpal 2005; Purohit, Kumar and Kandpal 2006). Solar radiation was previously reported in the Marrakech region to have a value of 5.053 KWh/m²/day (Aarich et al. 2018). The initial and final moisture of rosemary leaves values were taken according to the experimental results found in this study. As for the efficiency, it was stated that for convection dryers the efficiency varies between 20–30%, thus in this part a 25% efficiency was considered. The fraction of the sensible heat needed to raise the temperature to the targeted drying temperature value was considered as 0.5 in this study (Purohit, Kumar and Kandpal 2006).

The specific heat of the product also defined as the amount of heat per unit mass necessitated to raise the temperature by one degree Celsius, the value could be approximately calculated for rosemary leaves (in MJ/kg/C°) using the Siebel's formula (ASHRAE,1974).

$$Q_r = (0.80 M_i + 0.20)4.1868 \times 10^{-3} \quad (2)$$

The obtained value from the calculation is $Q_r = 3.5169.10^{-3}$

The collector area A_T needed for drying 100g of rosemary leaves can be calculated using the following equation (Purohit and Kandpal, 2005; Purohit et al., 2006).

$$A_T = \left(\frac{M_R}{I_d \cdot \eta_d \cdot t_d} \right) \left[\left\{ \left(\frac{1 - M_f}{1 - M_i} \right) \cdot Q_r (T_d - T_{amb}) \right\} + \left\{ \left(\frac{M_i - M_f}{1 - M_i} \right) h_e \right\} \right] \quad (3)$$

The T_{amb} is the average ambient temperature (32°C) and T_d is the drying temperature (60°C). A_r was found to be: 14.74 m².

The capital (C_i) for 100g of the solar drying was calculated according the following equation.

$$C_i = \left(\frac{M_R \times p_r \times (1 + c_a)}{I_d \cdot \eta_d \cdot t_d} \right) \left[\left\{ \left(\frac{1 - M_f}{1 - M_i} \right) \cdot Q_r (T_d - T_{amb}) \right\} + \left\{ \left(\frac{M_i - M_f}{1 - M_i} \right) h_e \right\} \right] \quad (4)$$

Where p_r is the price of solar collectors (the estimation was 45.63USD/m²); c_a represent the remaining compounds cost as a fraction of p_r (the price of the solar collector). The estimates obtained for the equation above for 100 kg of rosemary leaves, is 462.4 USD 672.28 USD for the capital and solar collector price, respectively.

The annually monetary worth of saved fuel can be measured according to the equation below.

$$S = \left(\frac{365 \times CUF \times M_R}{C_f \cdot \eta_f \cdot t_d} \right) \left[\left\{ \left(\frac{1 - M_f}{1 - M_i} \right) \cdot Q_r (T_d - T_{amb}) \right\} + \left\{ \left(\frac{M_i - M_f}{1 - M_i} \right) h_e \right\} \right] \times p_f \quad (8)$$

CUF stands for the capacity utilization factor of solar dryer it varies according to depends on the number of days in which the dryer could be used in a year as well as the amount of dried rosemary leaves per batch (the estimated value for this parameter in this part was set to 0.7). η_f is the utilization efficiency (0.6, 0.7, and 0.8 for coal, diesel oil, and natural gas, respectively) C_f the calorific value (20 MJ/kg, 35.6 MJ/l, 39 MJ/kg for coal, and natural gas, respectively) and p_f the estimated fuel market price (0.0780 USD/kg, 0.34USD/kg and 0.17USD/kg for coal, and natural gas, respectively) (Purohit and Kandpal, 2005).

Table 18. Financial saving per year and CO₂ Mitigation values for drying 100kg of rosemary leaves

	Coal	Diesel oil	Natural gas
Annual monetary saving	14.75USD	31.97 USD	12.96 USD
Annual saved fuel	189.20 kg	94.04 l	76.25 kg
CO ₂ Mitigation	16108.48kg	6895.57 kg	4760.74kg

The values depicted in table 18 present the estimated annual saving according to the fuel the estimated fuel price in the market. It could be deduced the financial benefits is higher with the substitution of diesel oil with a value of 31.75 USD saving per year.

ii. Eco-footprint of solar drying process and CO₂ mitigation estimation

Drying is a process deemed essential for food and agricultural goods preservation. Drying under controlled conditions (temperature and humidity) allows foodstuff to dry rapidly to a safe moisture content thus ensuring a high product quality. For example, fruit and vegetables requires for “safe drying” a drying temperature that ranges from 45–60 °C (Bal, Satya and Naik 2010). For controlled drying, the hot air for industrial drying is provided by fossil fuels burning, meaning that an important quantity of fuels is world widely to serve drying applications. Fossil fuel price fluctuation and scarcity coupled with environmental impact related to this later put restraining constraints on such source consumption (Rabha, et al 2016; Thirugnanasambandam, et al 2010; Jäger-Waldau 2007; Kousksou 2015).

In fact, drying in developing countries is a major compound of the energy consumption; however, for farmers in many of those countries’ access to the electricity grid and non-renewable sources is expensive or considered off limit for that reason drying with fan systems and heaters that use non-renewable sources are unsuitable. Thus, solar open drying is commonly used in such regions (Bal, Satya and Naik 2010).

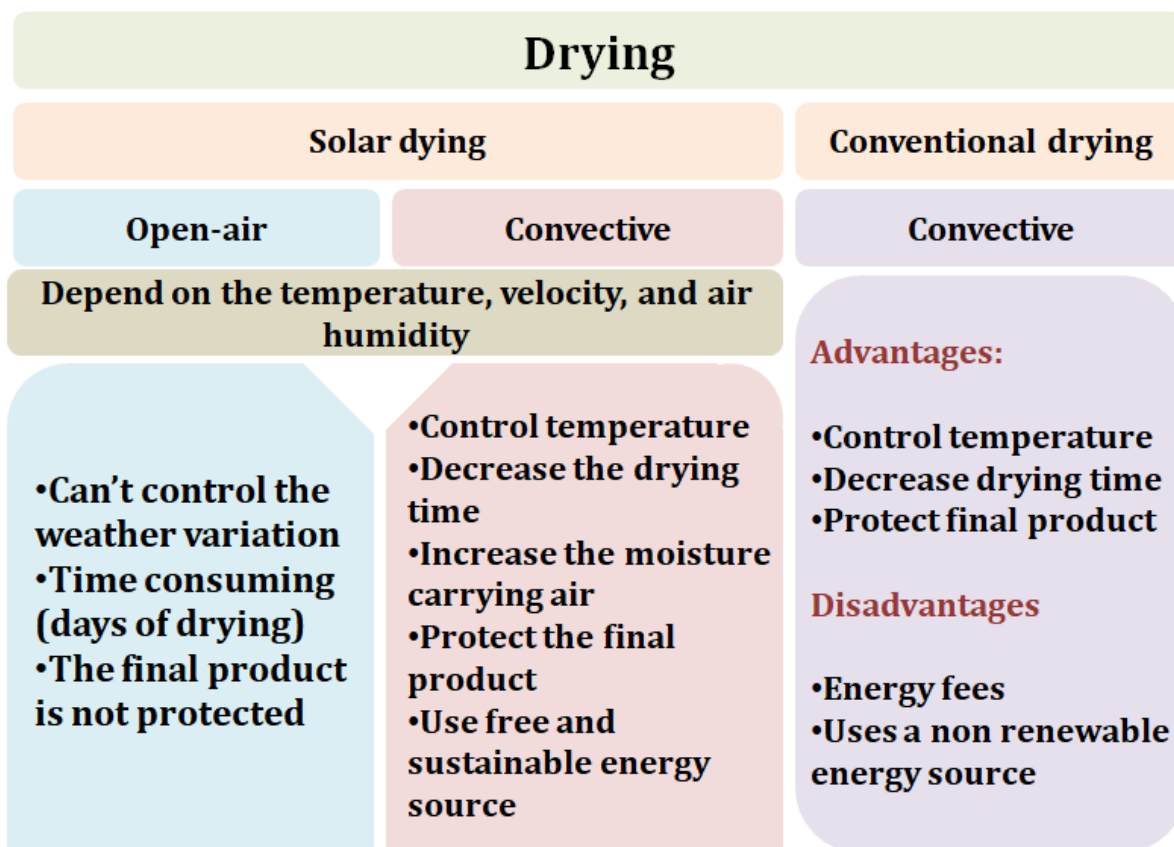

Figure 37. Comparison between drying methods

While, open solar drying presents a solution to the problem in hand (fig. 35), it is still an unperfected process since the drying conditions cannot be controlled and the dried product quality is left unprotected and is usually affected by dirt, air pollution, birds, rodents, insects and microbes. This will decrease both the quality and the economic value of the product (Mghazli et al., 2017). Therefore, to mitigate energy security and climate change alarming concerns while at the same time preserving the foodstuff quality, a shift toward renewable energy is heavily considered mainly solar energy. Given that the sun is a free source of an inexhaustible green energy, different technologies have being developed and universally used in to adequately harvest and exploit solar energy. Solar controlled drying offers a green preservation process for multiples vegetables matrices, such as, fruits, grains, vegetables, and herbs while at the same time preserving quality of the product and the environment by decreasing the amount consumed fossil fuel. In fact, economically speaking, many studies affirmed that solar dryer is more financially attractive as an alternative to commercial fuels for the end user (Purohit and Kandpal, 2005; Purohit et al., 2006).

It should be noted that most of the promoted solar dryers are developed for a targeted class of product or a specific agricultural matrix. For that purpose, the dryer is developed considering the product drying characteristics, quality conditions and economical concerns. As shown in fig. II-I-7 the dryer performance depends on drying air characteristics (drying air temperature, humidity, and air velocity), product characteristics variables (such as moisture content, size and distribution of the product), and finally dryer configuration and dimensional variables (length, width, and diameter) (Purohit et al., 2006).

Nowadays it is important to promote green energies such solar energy to lessen climate change concerns. Thermal solar energy was assessed in several studies as main to reduce CO₂ emissions. In fact, several methods were developed as to study and analyze the potential of CO₂ mitigation (Purohit et al., 2005; Tripathy, 2013; Kandpal et al., 2003). It is possible to estimate via those calculations the gross annual CO₂ mitigation emission that results from using thermal solar drying as an alternative to different fuels. In this part, CO₂ estimated mitigation potential was calculated for fossil fuels (coal, diesel oil, fuelwood, and natural gas) via the following equation.

$$E_{est} = (C_{emis} \times f_{co} \times AS_f) \times (44/12) \quad (9)$$

Where C_{emis} is the carbons emission factor considered as 25.8, 20.2, 17.2 tC/ TJ for coal, diesel oil, and natural gas, respectively; f_{co} is the carbon oxidized fraction during combustion with a value of 0.9 for coal, 0.99 for diesel oil and 0.99 (tripathy,2013). AS_f is the annual saved fuel calculated as followed.

$$AS_f = \left(\frac{365 \times CUF \times M_R}{C_f \cdot \eta_f \cdot t_d} \right) \left[\left\{ \left(\frac{1 - M_f}{1 - M_i} \right) \cdot Q_r (T_d - T_{amb}) \right\} + \left\{ \left(\frac{M_i - M_f}{1 - M_i} \right) h_e \right\} \right] \quad (10)$$

Results summarized in Table 18 represent the annual CO₂ emissions. The values vary from 16108.48kg for coal 6895.57 kg for diesel oil and 4760.74kg for natural gas. Similar results were found by Tripaty, 2003 where it was found that for potato cylinders the potential CO₂ emission mitigation value is highest for coal followed by diesel oil and natural gas.

Conclusion

This study was performed on rosemary by thin convective solar drying as a way to valorize rosemary leaves, to increase its shelf-life, and investigate the impact of solar drying on rosemary antioxidant properties. From the drying kinetics for the multiple drying temperatures and the obtained experimental drying curves of rosemary leaves in a forced convection solar dryer under controlled air conditions, several results were noted. Out of the nine models considered, the most fitting model to better explain the drying behaviour of rosemary leaves for thin layer forced solar drying, according to statistical analysis results, was Midilli-Kucuk. Effective diffusivity values (D_{eff}) were obtained by Fick's diffusion model ranged from $2.7046 \cdot 10^{-11}$ to $7.4377 \cdot 10^{-11}$; those results indicate that with high temperatures the value of D_{eff} increases. Activation energy value was calculated as follows, for rosemary leaves, 39.33kJ/mol. The DPPH and TPC analysis were carried to investigate the effect of drying temperatures on the polyphenol content and antioxidant activity of rosemary leaves. TPC and IC_{50} values were relatively similar to the fresh values, while with a high value (70°C) TPC values decrease and the IC_{50} value increased, thus indicating a negative effect of high drying temperatures on rosemary leaves. The degradation of carnosic acid into carnosol resulting from exposure to high temperatures was also investigated. Results showed that with solar drying (40, 50, 60°C, and sun-dried) showed an increase of carnosol coupled with a decrease of carnosic acid while at high temperature (70°C) both carnosic acid and carnosol value decreases. Those results possibly signify that high temperature drying values (superior to 60°C) impact negatively the antioxidant properties of rosemary leaves. A mathematical analysis was also conducted in this work to study both the economic feasibility and the annual CO₂ emissions mitigation for different fossil fuels while drying rosemary; results showed that the application of solar energy for rosemary drying, in this case, has great potential for both fossil monetary saving and CO₂ emissions mitigation.

References

- Aarich, N.; Raoufi, M.; Bennouna, A.; Erraissi, N. Outdoor comparison of rooftop grid-connected photovoltaic technologies in Marrakech (Morocco). *Energy and Buildings*. 2018, 173, 138–149. doi.10.1016/j.enbuild.2018.05.030
- Akpınar, E.K.; Bicer, Y. Mathematical modelling of thin layer drying process of long green pepper in solar dryer and under open sun. *Energy Convers Manag*. 2008, 49(6),1367-1375. doi.10.1016/j.enconman.2008.01.004
- Ait Mohamed, L.; Kouhila, M.; Jamali, A.; Lahsasni, S.; Kechaou, N.; Mahrouz, M. Single layer solar drying behaviour of Citrus aurantium leaves under forced convection. *Energy Conversion and Management*. 2005, 46, 1473–1483. <https://doi.org/10.1016/j.enconman.2004.08.001>
- ASHRAE (1974). ASHRAE Handbook and Product Dictionary. 1974 Application. American Society of Heating, Refrigerating and Air-Conditioning Engineers (ASHRAE), New York, p. 42.1.
- Babalis, S.J.; Belessiotis, V.G. Influence of the drying conditions on the drying contents and moisture diffusivity during the thin layer drying of figs. *Journal of Food Engineering*. 2004,65, 449–458. <https://doi.org/10.1016/j.jfoodeng.2004.02.005>.
- Bahloul, N.; Boudhrioua, N.; Kouhila, M.; Kechaou, N. Effect of convective solar drying on colour, total phenols and radical scavenging activity of olive leaves (*Olea europaea*L.). *International Journal of Food Science & Technology*. 2009, 44, 2561–2567. doi.10.1111/j.1365-2621.2009.02084.x
- Bahammou, Y.; Tagnamas, Z.; Kouhila, M.; Lamharrar, A.; Idlimam, A. Thin-layer solar drying characteristics of Moroccan horehound leaves (*Marrubium vulgare* L.) under natural and forced convection solar drying. *Solar Energy*. 2019, 188, 958–969.
- Bal, L. M.; Satya, S.; Naik, S. N. Solar dryer with thermal energy storage systems for drying agricultural food products. A review. *Renewable and Sustainable Energy Reviews*. 2010, 14, 2298–2314. doi.10.1016/j.rser.2010.04.014
- Barbut, S.; Josephson, D. B.; Maurer, J. Antioxidant properties of rosemary oleoresin in turkey sausage. *J. Food. Sci.* 1985, 50, 1356-1363.
- Blanco-Cano, L.; Soria-Verdugo, A.; Garcia-Gutierrez, L. M.; Ruiz-Rivas, U. Modelling the thin-layer drying process of Granny Smith apples. Application in an indirect solar dryer. *Applied Thermal Engineering*. 108 (2016) 1086–1094. doi.10.1016/j.applthermaleng.2016.08.001
- Bousbia, N. Extraction des huiles essentielles riches en anti-oxydants à partir de

produits naturels et de co-produits agroalimentaires. Ph.D. Dissertation, Avignon University, 2013.

- Doymaz, I.; Karasu, S. Effect of air temperature on drying kinetics, colour changes and total phenolic content of sage leaves (*Salvia officinalis*). *Quality Assurance and Safety of Crops & Foods*. 2018, 10, 269-276
- Erkan, N.; Ayranci, G.; Ayranci, E. Antioxidant activities of rosemary (*Rosmarinus O_cinalis* L. extract), blackseed (*Nigella sativa* L.) essential oil, carnosic acid, rosmarinic acid and sesamol. *Food Chem*. 2008, 110, 76–82.
- Hilali, S.; Fabiano-Tixier, A.; Elmaataoui, M.; Petitcolas, E.; Hejjaj, A.; Aitnouh, F.; Jacotet-Navarro, M.; Bily, A.; Idlimam, A.; Mandi, L.; Chemat, F. Deodorization by Solar Steam Distillation of Rosemary Leaves Prior to Solvent Extraction of Rosmarinic, Carnosic, and Ursolic Acids. *ACS Sustainable Chem. Eng.*, 2018, 6, 10969–10979. <https://doi.org/10.1021/acssuschemeng.8b02347>
- Horouz, E.; Bozkurt, H.; Karataş, H.; Maskan, M. Effects of hybrid (microwave-convective) and convective drying on drying kinetics, total phenolics, antioxidant capacity, vitamin C, color and rehydration capacity of sour cherries. *Food chemistry*. 2017. <http://dx.doi.org/10.1016/j.foodchem.2017.03.046>.
- Idlimam, A.; Kane, C.S.E.; Kouhila, M. Single layer drying behaviour of grenade peel in a forced convective solar dryer, *Rev. des Energies Renouvelables*. 2007, 10, 191-203.
- Idlimam, A.; Lamharrar, A.; Bougayr, E.H.; Kouhila, M.; Lakhali, I.; El Khadir, A. Solar convective drying in thin layers and modelling of municipal waste at three temperatures. *Applied Thermal Engineering*. 2016, 108, 41–47. doi.10.1016/j.applthermaleng.2016.07.098
- Jäger-Waldau, A. Photovoltaics and renewable energies in Europe. *Renew Sustain Energy*. 2007, 11, 1414–37.
- Jaswir, I.; Che Man, Y. B.; Kitts, D. D. Use of natural antioxidants in refined palm olein during repeated deep-fat frying. *Food Research International*. 2000, 33, 501–508. doi.10.1016/s0963-9969(00)00075-2 .
- Joulain, D.; König, W.A.; & Hochmuth, D. H. Terpenoids and related constituents of essential oils. library of mass finder 2.1. Hamburg. 2001.
- Kandpal, T.C.; Purohit, P.; Kumar, A.; Techno-economic evaluation of solar crop dryer. In. *Proceedings of the Second International Conference on Renewable Energy Technology for Rural Development (RETRUD-03)*, Katmandu, Nepal, 12–14 October

2003, pp. 197–201.

- Khadhraoui, B. ; Turk. M. ; Fabiano-Tixier, A-S. ; Petitcolasb, E.; Robineta, P.; Imberta, E.; Maâtaouic, M.; Chemat, F. Histo-cytochemistry and scanning electron microscopy for studying spatial and temporal extraction of metabolites induced by ultrasound. Towards chain detexturation mechanism. *Ultrason Sonochem.* 2018;42:482-492. doi.10.1016/j.ultsonch.2017.11.029
- Kouhila, M.; Kechaou, N.; Otmani, M.; Fliyou, M.; Lahsasni, S. Experimental study of sorption isotherms and drying kinetics of Moroccan Eucalyptus globulus. *Drying Technol.* 2002, 20, 027–39. <https://doi.org/10.1081/DRT-120015582>.
- Koukouch, A.; Idlimam, A.; Asbik, M.; Sarah, B.; Izrar, B.; Bah, A.; Ansari, O. Thermophysical characterization and mathematical modelling of convective solar drying of raw olive pomace. *Energy Conversion and Management.* 2015, 99, 221–230. <https://doi.org/10.1016/j.enconman.2015.04.044>
- Kousksou, T.; Allouhi, A.; Belattar, M.; Jamil, A.; El Rhafiki, T.; Arid, A. Renewable energy potential and national policy directions for sustainable development in Morocco. *Renew Sustain Energy Rev.* 2015, 47, 46–57.
- Lacroix, M.; Smoragiewicz, W.; Pazdernik, L.; Koné, M. I.; Krzystyniak, K. Prevention of lipid radiolysis by natural antioxidants from rosemary (*Rosmarinus officinalis* L.) and thyme (*Thymus vulgaris* L.). *Food Research International.* 1997, 30, 457–462. doi.10.1016/s0963-9969(98)00002-7
- Lahnine, L.; Idlimam, A.; Mahrouz, M.; Mghazli, S.; Hidar, N.; Hanine, H.; Koutit, A. Characterization by solar convective drying of thyme conserved by an innovative thermal-biochemical process. *Renewable Energy.* 94 (2016)72-80. <https://doi.org/10.1016/j.renene.2016.03.014>.
- Lahsasni, S.; Kouhila, M.; Mahrouz, M.; Ait Mohamed, L.; Agorram, L. Characteristic drying curve and mathematical modelling of thin layer solar drying of prickly pear cladode (*Opuntia ficus indica*). *Journal of Food Engineering.* 2004, 27, 103–117. <https://doi.org/10.1111/j.1745-4530.2004.tb00625.x>
- Lee, J-H.; Shin, J-A.; Lee, J-H, Lee, K-T. Production of lipase-catalyzed structured lipids from safflower oil with conjugated linoleic acid and oxidation studies with rosemary extracts. *Food Research International.* 2004,37, 967–974
- Li, Y.; Fabiano-tixier, A.S.; Vian, M.A.; Chemat, F. Solvent-free microwave extraction of bioactive compounds provides a tool for green analytical chemistry. *Trends Anal Chem.* 2013, 47, 1-11. doi.10.1016/j.trac.2013.02.007.

- Mghazli, S.; Ouhammou, M.; Hidar, N.; Lahnine, L.; Idlimam, A.; Mahrouz, M. Drying Characteristics and Kinetics Solar Drying of Moroccan Rosemary Leaves, *Renewable Energy*. 2017, 108, 303-310. doi. 10.1016/j.renene.2017.02.022.
- Milevskaya, V.V.; Temerdashev, Z.A.; Butyl'skaya, T.S.; Kiseleva, N.V. Determination of phenolic compounds in medicinal plants from the Lamiaceae family. *Journal of Analytical Chemistry*, 72017, 2, 342-348.
- Montoya, F.G.; Aguilera, M.J.; Manzano-Agugliaro, F. Renewable energy production in Spain. a review. *Renew Sustain Energy Rev*. 2014, 33, 509–31.
- Okoh, O.O.; Sadimenko, A.P.; Asekun, O.T.; Afolayan, A.J. The effects of drying on the chemical components of essential oils of *Calendula officinalis* L. *African Journal of Biotechnology*. 2008, 7, 1500-1502.
- Purohit, P.; Kandpal, T.C. Solar crop dryer for saving commercial fuels. a techno-economic evaluation. *International Journal of Ambient Energy*. 2005, 26, 3–12.
- Purohit, P.; Kumar, A.; Kandpal, T. C. Solar drying vs. open sun drying. A framework for financial evaluation. *Solar Energy*. 2006, 80(12), 1568–1579.
- Rabha, D.K.; Muthukumar, P.; Somayaji, C. Experimental Investigation of Thin Layer Drying Kinetics of Ghost Chill Pepper (*Capsicum Chinense* Jacq.) Dried in a Forced Convection Solar Tunnel Dryer, *Renewable Energy*. 2016, 105, 583-589. doi. 10.1016/j.renene.2016.12.091.
- Singleton V.L., Orthofer R., Lamuela-Raventós R.M. Analysis of total phenols and other oxidation substrates and antioxidants by means of folin-ciocalteu reagent. *Methods Enzymol*. 1998;299(1974).152-178. doi.10.1016/S0076-6879(99)99017-1
- Tagnamas, Z.; Bahammou, Y.; Kouhila, M.; Hilali, S.; Idlimam, A.; Lamharrar, A. Conservation of Moroccan truffle (*Terfeziaboudieri*) using solar drying method. *Renewable Energy*. 2020, 146.
- Thirugnanasambandam, M.; Iniyar, S.; Goic, R. A review of solar thermal technologies. *Renewable and Sustainable Energy Reviews*. 2010, 14, 312–322. doi.10.1016/j.rser.2009.07.014
- Tiwari, A. A Review on Solar Drying of Agricultural Produce. *Journal of Food Processing & Technology*, 7(2016).
- Togrul, I.T.; Pehlivan, D. Mathematical modelling of solar drying of apricots in thin layers. *Journal of Food Engineering*. 2002, 55, 209–216. [https://doi.org/10.1016/S0260-8774\(02\)00065-1](https://doi.org/10.1016/S0260-8774(02)00065-1)
- Tripathy, P. P. Investigation into solar drying of potato. effect of sample geometry on

- drying kinetics and CO₂ emissions mitigation. *Journal of Food Science and Technology*. 2013, 52, 1383–1393.
- Ullah, F.; Kang, M. Impact of air flow rate on drying of apples and performance assessment of parabolic trough solar collector. *Applied Thermal Engineering*. 2017, 127, 275–280. doi.10.1016/j.applthermaleng.2017.07.101
 - Wang, W.; Wu, N.; Zu, Y.;Y. Fu, Antioxidative activity of *Rosmarinus officinalis* L. essential oil compared to its main components. *Food Chem*. 2008, 108, 1019-1022.
 - Wojdyło, A.; Figiel, A.; Lech, K.; Nowicka, P.; Oszmiański. J. Effect of convective and vacuum–microwave drying on the bioactive compounds, color, and antioxidant capacity of sour cherries. *Food Bioprocess Technology*. 2013 7, 829-841.
 - Zhang, Y.; Smuts, J. P.; Dodbiba, E.; Rangarajan, R.; Lang, J. C. ; Armstrong, D. W. Degradation Study of Carnosic Acid, Carnosol, Rosmarinic Acid, and Rosemary Extract (*Rosmarinus officinalis* L.) Assessed Using HPLC. *Journal of Agricultural and Food Chemistry*. 2010, 60, 9305–9314. doi.10.1021/jf302179c.
 - Zielinska, M.; Michalska, A. Microwave-assisted drying of blueberry (*Vaccinium corymbosum* L.) fruits. Drying kinetics, polyphenols, anthocyanins, antioxidant capacity, colour and texture. *Food Chem*. 2016, 212, 671–680. doi.10.1016/j.foodchem.2016.06.003

II-II. Orange Peels

1. Context

Citrus peels contains insoluble carbohydrates (cellulose, pectin), other sugars (glucose, fructose, sucrose, galactose), acids (mostly citric, malic acids and benzoic acid...), lipids (oleic, linoleic, linolenic, palmitic, stearic acids...), mineral elements (nitrogen, calcium and potassium), volatile compounds (alcohols, aldehydes, ketones, ester, hydrocarbons), flavonoids (flavanones, flavones, anthocyanins), limonoids (limonin, isolimonin), EO (mainly D-limonene, up to 95% in oranges), enzymes (pectinesterase, phosphatase, peroxidase), pigments and carotenoids (carotene, xanthophylls, lutein), polyphenolics (phenolic acid), nitrogen constituents (ammonia, nitrogen, and nitrates) and vitamins (ascorbic acid, complex B vitamins). Thus, the peels are a rich provider of bio-compounds. This by-product can be used wet or after pressing and usually drying processes, in order to increase the shelf-life reduce weight and consequently storage and transport costs. If peels are exposed to the sun, water content will be reduced from about 80% to 10% (Zema et al., 2018).

Drying is a process used to reduce moisture levels of a giving product to minimize ongoing reactions and prevent microbial deterioration. Sun-drying is the most used method; however, this process is very tricky process since it takes longer than conventional drying and involves the product being exposed to a range of contaminants such as pests, and disease agents that includes dust, birds, rodents, and microorganisms. That type of contamination could result in significant decrease in the quality of the final product. Consequently, innovative solar drying, especially convective drying, is used in this study to overcome the apparent problems of sun-drying. Convective can be used reliably for orange peels drying in large quantities and shorter periods without any negative impacts on the final product quality.

2. Bio-refinery and valorization of orange peels via convective thin layer solar drying

Abstract

The orange peels are residue of juices production rich in terpenes and flavonoids with a wide range of biological effects. Considering the use of those bio-compounds in multiple fields orange by-products processing appears as a suitable source for high sub-product. The work was carried in a convective solar dryer in order to study and understand the drying kinetic and obtain the characteristic drying curves of orange peels at different temperatures (60°C, 65°C, 70°C, 75°C, 80°C). Two-term model was better fitted to the drying behaviour out of nine models. The diffusivity coefficient increases with drying and the activation energy was 2161.67KJ/Kg. The Total Polyphenol Content (TPC) and antioxidant activity showed better results for high drying temperature compared to 60°C, 65°C and shade-dried meaning that TPC and antioxidant activity were significantly affected by the drying temperature. Such drying treatment could be used to increment TPC and antioxidant activity in orange peels.

2.1 Introduction

Citrus fruits are a worldwide consumed fruit with an estimated production of 89 million tons in the year of 2014 (USDA, 2014). They are crucial for a healthy human diet since they contain bioactive compounds and present a very rich source of some unique to citrus phenolic compounds essentially, flavanone glycosides, carotenoid, phenolic acid, and limonoid; the latter is known for its biological properties and is frequently used in perfumes and cosmetics production (Mata-Bilbao et al., 2007; Park, Lee and Park, 2014; Kodal, Aksu, 2014; Chen, Yang, Liu, 2011). Those compounds can be found in both the fruit juice and the peels that are usually considered as juice processing by-products (Chen, Yang, Liu, 2011; Marin et al.; 2005) In the recent years an increased interest in the citrus peels valorisation have been emphasized in multiple studies (Jeong et al., 2004), those by-products were generally used to obtain bioactive compounds, pectin, molasses, and essential oil (Kahrilas et al., 2014). Citrus peels were also used for volatile flavouring compounds, biogas and ethanol production.

Orange is a citrus fruit known as an important source of vitamin C. Multiple studies have reported that orange peels contain Polymethoxy flavones (PMFs) that is known for its health benefits. This is due to numerous properties that it has, such as anti-inflammatory, anti-viral, anti-carcinogenic, atherogenic, anti-thrombogenic and antioxidant activities (Huanga et al., 2009; Li et al., 2007). However, orange peels have high moisture content making them extremely sensitive to both biochemical and microbial degradations; therefore, the stabilization of the orange peels through dehydration is an indispensable process in order to decrease the water activity of the product and thus allowing a long shelf-life for a better valorise and further use the product to extract numerous bioactive compounds (Bahammou et al., 2019).

This study falls within the framework of by-products bio-refineries which aims to valorise by a series of experimental testing, orange peels as an abundant source of bio-compounds by using thermal energy for drying purposes. In fact, through history, solar drying was established as a food preservation technique for agricultural product to reduce moisture content and therefore prevent product deterioration and increases the shelf-life (Koukouch et al., 2015; Mghazli et al., 2017; Lahnine et al., 2016). Nevertheless, with such practice, the product is left unprotected from rain, dust, insect infection, rodents, air-pollution and microbes thus degrading its final economical and nutritive value. To overcome this obstacle, a more suitable alternative in the form of a convective solar dryer that assure a better quality and a low sustainable green energy demand was developed. Thin layer modeling is typically carried out to understand the drying behaviour and characteristic of a giving product (Rabha et al., 2016; Ait Mohamed et al., 2004). Recent studies highlight mathematical modeling as the primary research focus to study the convection drying process characterized by an instantaneous heat and mass transfer (the water in the product is transferred to the interface by diffusion and to the air-steam by convection) of numerous vegetables, fruits, and plants (Babalís and Belessiotis, 2004). Numerous mathematical models were established in the literature for convection solar drying of different products such as rosemary leaves (Mghazli et al., 2017), thyme (Lahnine et al., 2016), prickly pear cladode (Lahsasni, et al., 2004), olive pomace waste (Koukouch et al., 2015).

The aim of this study was to develop a mathematical model for predicting solar convection drying of orange peels at different air-drying temperature as well as to understand the drying behaviour of this by-product. Different suitable models were thus analysed in order to describe the solar drying curves of orange peels. A quality analysis was also developed by analyzing the Total Phenolic Contents (TPC) for fresh, shade dried and solar dried orange peels in order to develop a bio-refinery based on thermal energy to valorize orange peels for economical and nutritive purposes.

2.2 Material preparation and treatment

- **Plant Materials**

The material used in this study is orange peels. This by-product was bought from a supermarket in Marrakech (Morocco) and used after orange juices processing. Orange peels were subjected to 5 temperatures heat solar drying treatment (60°C, 65°C, 70°C, 75°C and 80°C) as well as a four days natural air-shade drying (drying temperature that correspond also to the ambient temperature was around 23°C); the product mass used for each experiment was 100 ± 3.4 g of fresh matter and was thinly and uniformly distributed on the trays of the drying cabinet Mghazli et al., 2017; Lahnine et al., 2016).

- **Experimental solar dryer setup**

The experimental apparatus consists of an indirect forced convection solar dryer. The system is composed of a solar air collector oriented south with an angle of 31° with a dimension of 1 by 2.5 m coupled with an auxiliary heater, a drying cabinet and a circulation fan (all parts are shown in fig. 36 and detailed in material and methods chapter).

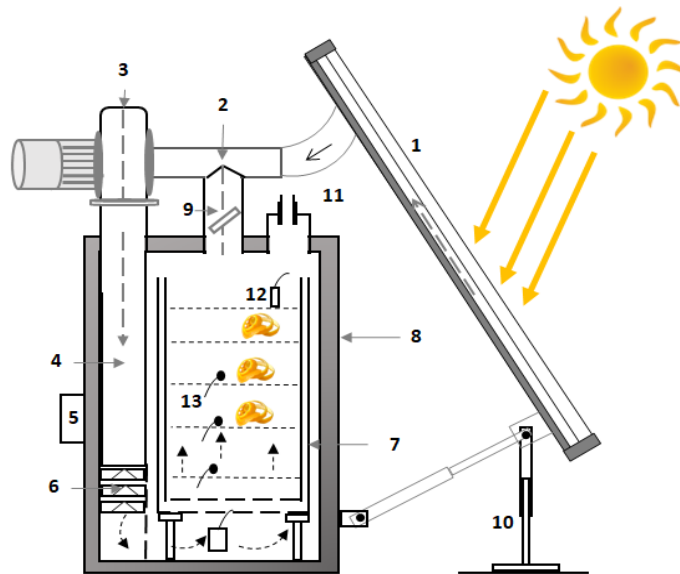

Figure 38. Scheme of the drying apparatus (convection solar dryer) (1)Solar collector; (2) direction of fan; (3) fan; (4) direction of aspiration; (5) control-box; (6) Auxiliary heating system; (7) shelves; (8) drying cabinet; (9) recycling air; (10) control foot; (11) exit of air;(12) humidity probes; (13) thermocouples.

2.3 Results and discussion

2.3.1 Drying kinetic

The variation of the moisture content in the sample in relation to the drying time can represent the drying kinetic of the desired product; the drying kinetics shows the mass loss and can be illustrated by drying rate. Five experimental drying tests were carried on to study orange peels solar drying. Fig. 37 represents the moisture content versus the drying time. The obtained drying curves show a considerable decrease of moisture in time as well as a decrease when temperature values increase for the five tests.

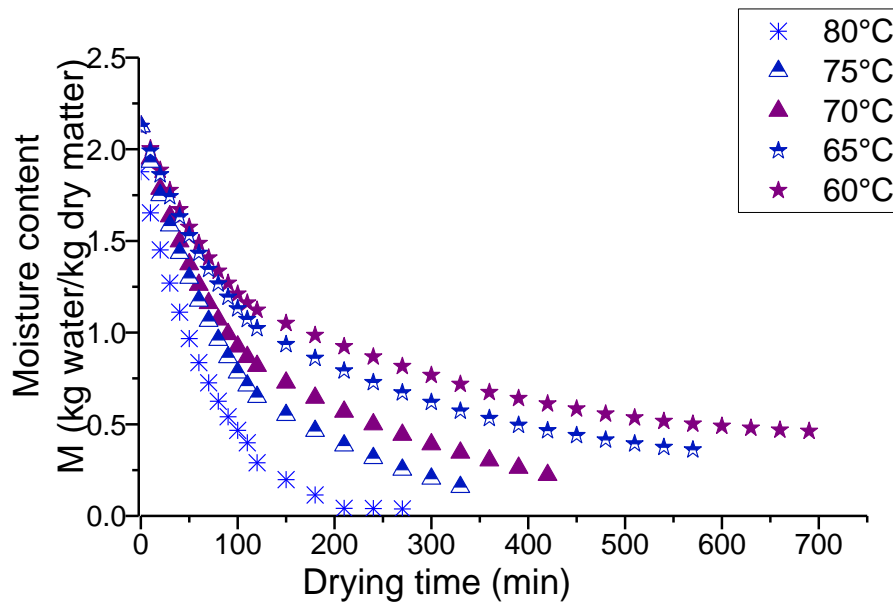

Figure 39. Moisture content variation in time

It could be deduced from the graph that the drying temperatures significantly affect the total drying time. The experimental data showed that the drying time decreased with a rate of 39.1% when the drying temperature increases from 60 till 80°C. The drying time of orange peels that were dried under solar convective dryer were respectively 690, 570, 420, 330, and 270 minutes for air drying temperatures of 60, 65, 70, 75 and 80 °C at a 300 m²/h flow air rate, respectively.

It should also be noted that the graph lacks phase 0 (initial period) and phase 1 (constant rate period), and the only existing phase is phase 2 (the falling rate period). The drying rate was initially higher due to the high amount of free water available in the product. Thus, the vapour pressure at the surface equals the saturation value. The phase is defined by water diffusion in the product; the mechanism is complex and is characterised by the effective diffusion that involves water in vapour and liquid states oversees by the water diffusion in the product, thus depending primarily on drying temperature, pressure, water content of the matrixes. This moisture is hence easily removed during the first stages of drying. Those results were also found in different other drying studies (Ait Mohamed et al., 2004; Babalis and Belessiotis; 2004; Lahsasni et al., 2004)

In Fig. 38, it could be seen that drying rate of orange peels increases with relation the drying temperature. Thus, it is concluded that the drying kinetics of orange peels is influenced by the drying air temperature. Similar results were also noted in other convection solar drying studies (Doymaz and Pala, 2002; Sarsavadia et al., 1999; Ozdemir and Devres, 1999; Ertekin and Yaldiz, 2004). Grenade peels drying showed also similar behaviour (Idlimam, Ethmane Kane and Kouhila, 2007).

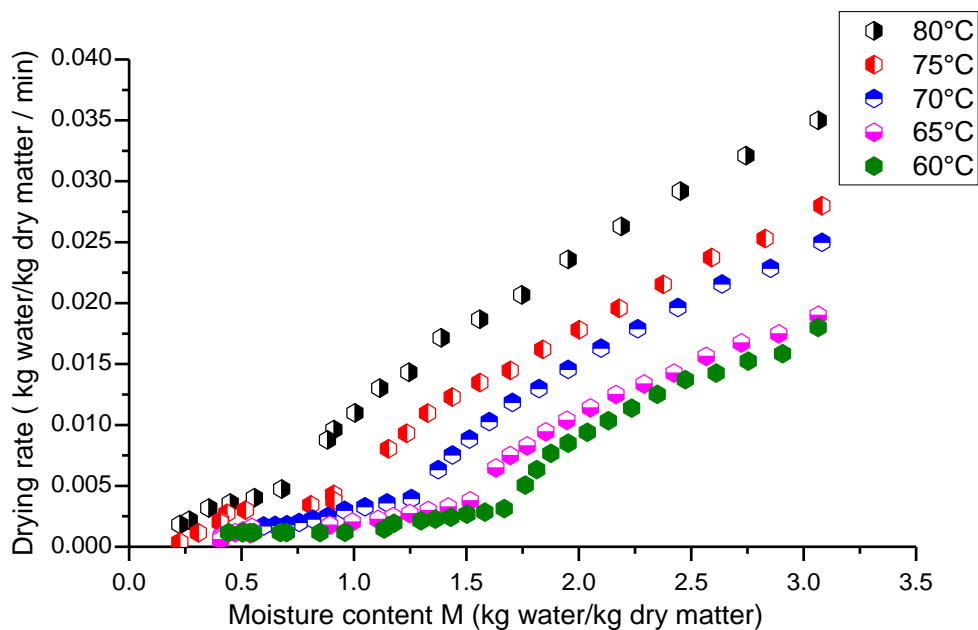

Figure 40. Drying rate variation as a function of moisture content

2.3.2 Characteristic drying curve

The characteristic drying curve is a theoretical normalization that makes it possible to establish a law of drying taking the experiments results and data into consideration. This method allows a correlation establishment based on the non-linear optimization method of Levenberg-Marquard in the form of a third-degree polynomial equation. Origin 6.1 software was used for this purpose. The dimensionless drying rate value f depicts the behaviour at any air-drying condition. The main reason for a characteristic drying curve is to reduce all experimental data and present them in an exploitable form for the scientific community.

The characteristic drying curve that took a polynomial of order 3 forms is plotted in figure 39.

$$f = 0.690 MR + 1.040 MR^2 - 1.214 MR^3$$

The criteria needed to evaluate the goodness of fit are the standard error (RSS = 0.04577) as well as the correlation coefficient (r = 0.9874).

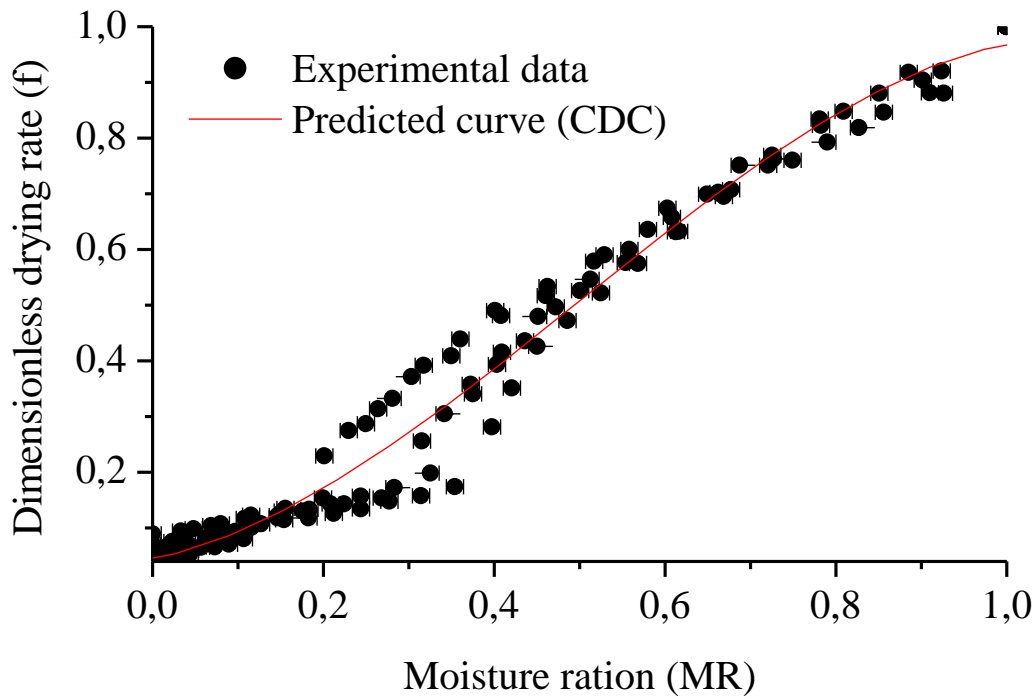

Figure 41. Characteristic drying curve of orange peels

The graph shows a higher concentration of the point in the interval between 0 and 30% this indicate that the product can be stored for a higher period. The characteristic drying curve of orange peels allows the prediction of the drying rate for different experimental conditions.

2.3.3 *The drying curves modelling and fitting*

The modeling of drying curve is required for moisture content prediction in a targeted product. The moisture content measured at the set drying air temperatures were converted to moisture ratio. The drying curves were then plotted as a function of time. Modelling the drying behaviour of orange peels requires statistical regression and correlation analysis methods. Mathematical models are considered as important tools to find the correlation between variables with no empirical established relationship. Nine of those models were considered and applied to the experimental data in order to adequately predict the water content and describe the shape of the drying curve of orange peels. The determination of drying constants, the values of r , chi-square and Standard Error (RMSE) of the nine models is obtained by the non-linear optimization method of Marquerd-Levenberg using curve expert software for all the experimental points. The results of statistic and non-linear regression analyses applied to the nine models are shown in table 19. The appropriate model for describing the drying kinetics of orange peels is picked based on certain criteria; high correlation coefficient (r), minimal Standard error, and minimal chi-square.

From Table 19, the two-term model has the highest r coupled with the lowest standard error and reduced chi-square (χ^2) value; therefore, it could be concluded that the two-term model is the best fit model for obtained experimental data from the drying experiments and adequately describes the convective solar drying of orange peels. Both Figure 40 and 41 show the perfect agreement between the experimental moisture ratio and the one predicted using two-term fitting model for all five drying temperatures.

Table 19. Moisture ratio fitting for the 5 temperatures

Models	T°C	Parameters	R	RMSE	χ^2
Midili-kucuk	60	a= 1.0311, k= 2.18236.10 ⁻² , n= 7.693577.10 ⁻¹ , b= -4.95937.10 ⁻⁵	0.9983	0.0182	3.315.10 ⁻³
	65	a= 1.02543, k= 1.7801.10 ⁻² , n= 8.2474.10 ⁻¹ , b= -4.4998.10 ⁻⁵	0.998	0.0164	3.291.10 ⁻³
	70	a= 1.01976, k= 1.68283.10 ⁻² , n= 8.743625.10 ⁻¹ , b= -3.489171.10 ⁻⁵	0.9985	0.0173	3.041.10 ⁻³
	75	a= 1.00766, k= 1.1668.10 ⁻² , n= 9.8865.10 ⁻¹ , b= -2.48457.10 ⁻⁵	0.9992	0.0123	8.364.10 ⁻⁴
	80	a= 1.0038, k= 1.2331.10 ⁻² , n= 1.010367, b= -3.983585.10 ⁻⁵	0.9991	0.0099	9.651.10 ⁻⁴
logarithmic	60	a= 9.3475.10 ⁻¹ , k= 7.0615.10 ⁻³ , c= 2.6529.10 ⁻²	0.9954	0.0296	5.243.10 ⁻³
	65	a= 9.54579.10 ⁻¹ , k= 7.82851.10 ⁻³ , c= 2.4154.10 ⁻²	0.9972	0.0234	4.293.10 ⁻³
	70	a= 9.67042.10 ⁻¹ , k= 9.75455.10 ⁻³ , c= 2.42126.10 ⁻²	0.9979	0.2028	4.030.10 ⁻³
	75	a= 1.009, k= 1.10813.10 ⁻² , c= -3.6126.10 ⁻³	0.9985	0.0121	2.579.10 ⁻³
	80	a= 1.01906, k= 1.273873.10 ⁻² , c= -1.325924.10 ⁻²	0.9995	0.0078	5.641.10 ⁻⁴
Verma et al.	60	a= 1.445.10 ⁺⁵ , k= 6.9804.10 ⁻³ , b= 9.999.10 ⁻¹	0.9929	0.037	6.607.10 ⁻³
	65	a= 3.76649.10 ⁺⁴ , k= 7.63221.10 ⁻³ , b= 1	0.992	0.0282	6.752.10 ⁻³
	70	a= 3.92249.10 ⁺⁵ , k= 9.36279.10 ⁻³ , b= 1	0.9972	0.0234	4.175.10 ⁻³
	75	a= 4.3899.10 ⁺⁴ , k= 1.1044.10 ⁻² , b= 0.999	0.9992	0.0124	8.484.10 ⁻⁴
	80	a= 2.46402.10 ⁺⁶ , k= 1.5696.10 ⁻² , b=1	0.9994	0.0104	7.937.10 ⁻⁴
Henderson	60	a= 9.4528.10 ⁻¹ , k= 6.42214.10 ⁻³	0.9947	0.0313	5.903.10 ⁻³
	65	a= 9.66018.10 ⁻¹ , k= 7.24175.10 ⁻³	0.9967	0.025	4.786.10 ⁻³
	70	a= 9.805656.10 ⁻¹ , k= 9.0972.10 ⁻³	0.9974	0.0218	4.226.10 ⁻⁴
	75	a= 1.0099, k= 1.31572.10 ⁻²	0.9992	0.0118	8.218.10 ⁻⁴
	80	a= 1.0067, k= 1.1183.10 ⁻²	0.9994	0.1038	7.603.10 ⁻⁴
Diffusion approximation	60	a= 1.0819, k= 6,9826.10 ⁻³ , b= 9.999.10 ⁻¹	0.9929	0.037	6.610.10 ⁻³
	65	a= 3.19367, k= 7.6101.10 ⁻³ , b= 1	0.996	0.0282	4.813.10 ⁻³
	70	a= 1.3335, k= 9.34335.10 ⁻³ , b= 1	0.9972	0.0234	4.173.10 ⁻³
	75	a= 1.0129, k= 1.12669.10 ⁻² , b= 1.432	0.9992	0.012	8.425.10 ⁻⁴
	80	a=1.0332, k=1.3462.10 ⁻² , b=5.3715	0.9995	0.0099	5.757.10 ⁻⁴
Newton	60	k= 6.9826.10 ⁻³	0.9929	0.0358	6.427.10 ⁻³
	65	k= 7.6101.10 ⁻³	0.996	0.0272	4.834.10 ⁻³
	70	k= 9.34334.10 ⁻³	0.9972	0.0223	4.371.10 ⁻⁴
	75	k= 1.10899.10 ⁻²	0.9992	0.0118	8.223.10 ⁻⁴
	80	k= 1.30035	0.9993	0.0107	8.006.10 ⁻⁴
Page	60	k= 6.9397.10 ⁻³ , n= 8.4457.10 ⁻¹	0.9977	0.0205	4.241.10 ⁻³
	65	k= 1.30922.10 ⁻² , n= 8.87560.10 ⁻¹	0.9983	0.0176	3.301.10 ⁻³
	70	k= 1.36131.10 ⁻² , n= 9.1843.10 ⁻¹	0.9984	0.0173	3.315.10 ⁻³
	75	k= 1.05035.10 ⁻² , n= 1.0121	0.9992	0.0119	8.146.10 ⁻⁴
	80	k= 1.300.10 ⁻² , n= 1.031968	0.9995	0.0097	5.937.10 ⁻⁴
Two term exponential	60	a= 2.42213.10 ⁻¹ , k= 2.1640.10 ⁻²	0.9973	0.0184	4.471.10 ⁻⁴
	65	a= 3.23048.10 ⁻¹ , k= 1.69498.10 ⁻²	0.9987	0.0157	1.846.10 ⁻³
	70	a= 4.1563.10 ⁻¹ , k= 1.58818.10 ⁻²	0.9986	0.0158	1.437.10 ⁻⁴
	75	a= 1.2157, k= 1.1555.10 ⁻²	0.9992	0.0121	8.205.10 ⁻⁴
	80	a= 1.386937, k= 1.4633.10 ⁻²	0.9994	0.0099	7.908.10 ⁻⁴
Two term	60	a= 7.263566.10 ⁻¹ , k ₁ = 4.99688.10 ⁻³ , b= 2.9205.10 ⁻¹ , k ₀ = 2.25809.10 ⁻²	0.9981	0.017	3.512.10⁻³
	65	a= 7.49552.10 ⁻¹ , k ₁ = 5.811.10 ⁻³ , b= 2.649.10 ⁻¹ , k ₀ = 2.094. 10 ⁻²	0.9989	0.0154	1.967.10⁻³
	70	a= 2.82628.10 ⁻¹ , k ₀ = 2.082807.10 ⁻² , b= 7,299.10 ⁻¹ , k ₁ = 7.281632.10 ⁻³	0.9988	0.0159	2.127.10⁻³
	75	a= 7.60214.10 ⁻² , k ₀ = 1.48426.10 ⁻² , b= 9.315.10 ⁻¹ , k ₁ = 1.094.10 ⁻²	0.9992	0.0125	8.345.10⁻⁴
	80	a= 8.201.10 ⁻¹ , k ₀ = 2.325.10 ⁻¹ , b= 1.898.10 ⁻¹ , k ₁ = 1.315.10 ⁻²	0.9994	0.0111	7.908.10⁻⁴

Taking the drying temperature effect into consideration, the coefficients of the two-term equation (a , k_0 , b and k_1) are expressed in terms of the temperature as shown below.

$$a = 0.004 \theta^2 - 0.690 \theta + 24.79$$

$$k_0 = -7.10 - 5 \theta^2 + 0.010 \theta - 0.383$$

$$b = -0.006 \theta^2 + 0.929 \theta - 32.49$$

$$k_1 = -5 \theta^2 - 0.001 \theta + 0.402$$

Those four expressions of the two-term model predicted well the moisture ratio (MR) at five drying temperatures 60, 65, 70, 75 and 80°C for the orange peels.

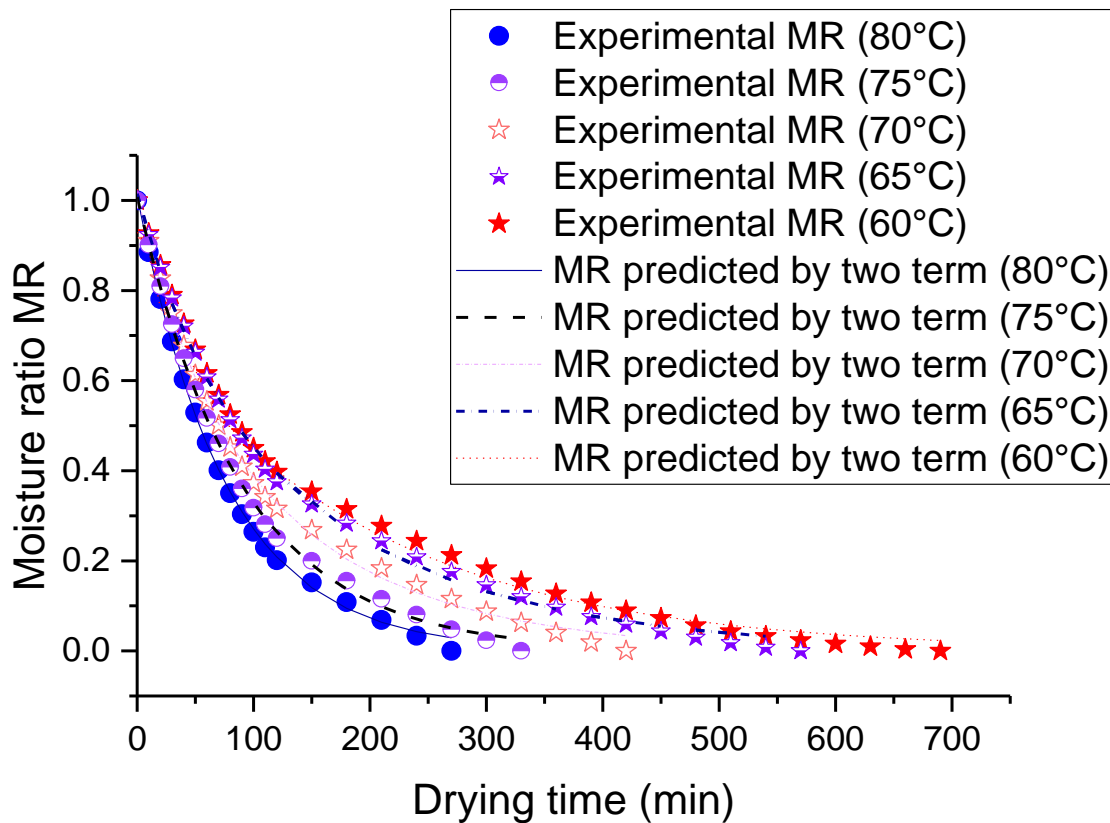

Figure 42. Moisture ratio Experimental data versus drying time fitted values.

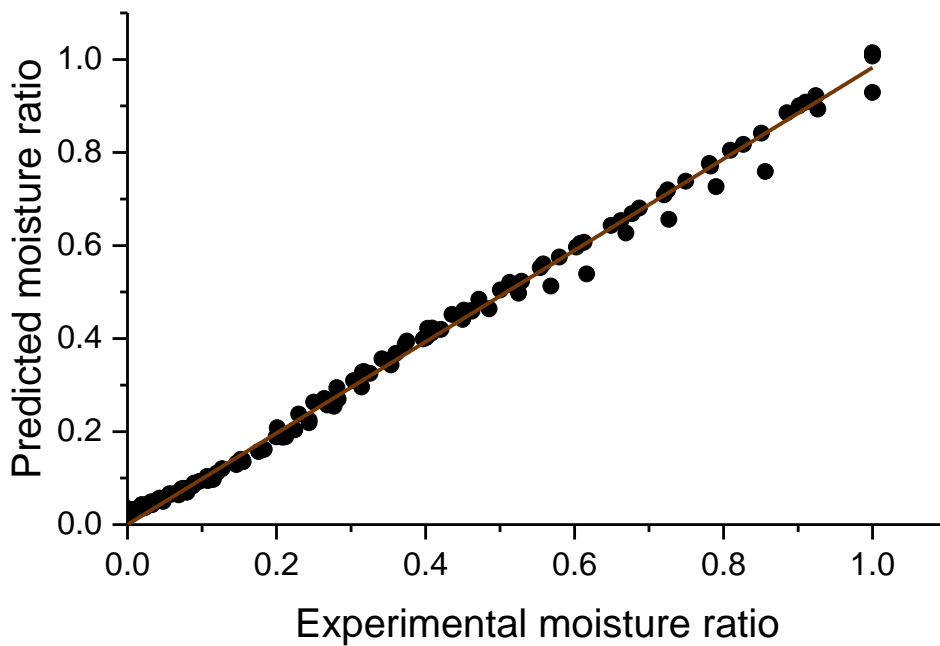

Figure 43. Predicted moisture ratio (predicted by two term's model) as a function of the experimental moisture ratio

2.3.4 *Effective diffusivity and activation energy*

The Experimental drying curves of orange peels confirm that the drying rate happens solely in the falling drying rate period as results of liquid diffusion controlling the moisture transportation process. For this case, the second law by Fick's equation using drying analysis data could be used to calculate the effective moisture diffusivity of orange peels, thus to describe the drying behaviour. Effective diffusivity values are defined from the plot (fig.42) of experimental results of $\ln(Y^*)$ versus drying time for different temperatures. D_{eff} values are illustrated in table 20.

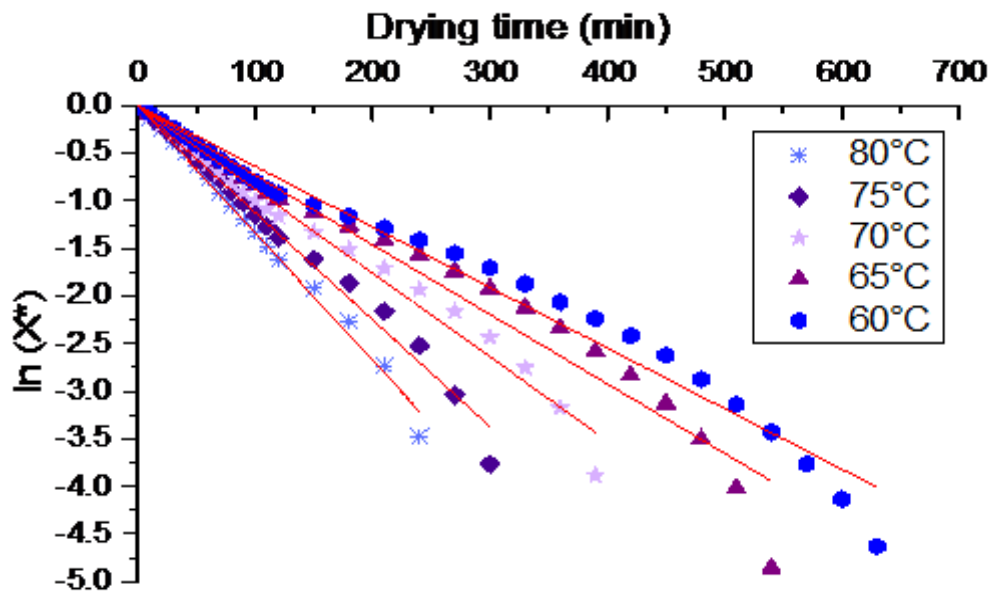

Figure 44. Effects of temperature on orange peels effective diffusion coefficient

The higher temperatures of drying will eventually increase the energy, thus leading to an increase the activity of water molecules which mean high moisture diffusivity (Idlimam et al., 2007). This values usually lies within in a range of 10^{-8} to 10^{-12} (Table 20).

Table 20. Values of effective diffusivity of Orange peels

Temperature (°C)	D_{eff} (m^2/s)	(r)
60	$1.6211 \cdot 10^{-10}$	0.992
65	$1.8913 \cdot 10^{-10}$	0.982
70	$2.161 \cdot 10^{-10}$	0.989
75	$2.972 \cdot 10^{-10}$	0.992
80	$3.5124 \cdot 10^{-10}$	0.996

To dry a targeted product the required energy must surmount the activation energy value for the process to happen. Arrhenius law can describe the equation since the diffusion phenomenon is activated via the thermal agitation. The activation energy can be calculated via a presentation of the effective diffusivity natural logarithm verse the temperature inverse as shown in figure 42. This helps represent the drying temperature influence on the effective diffusivity.

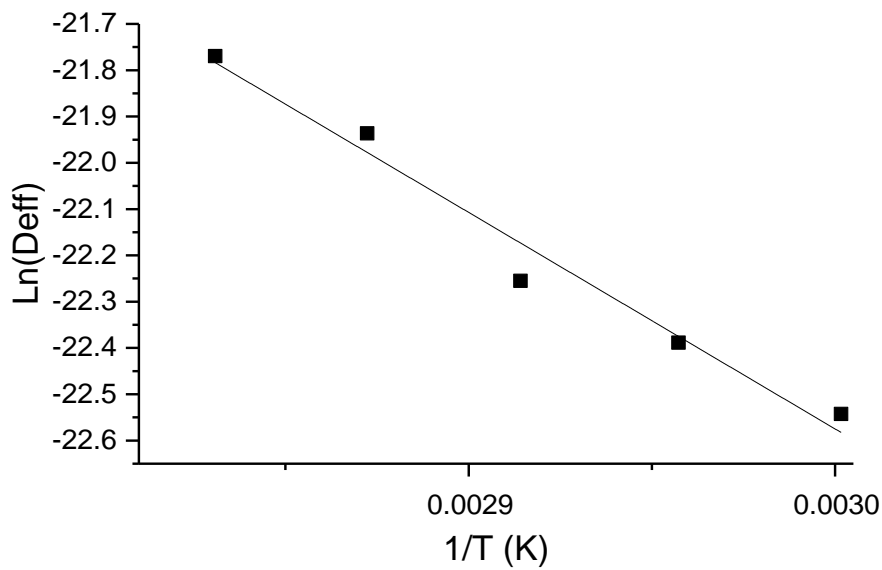

Figure 45. $\ln(D_{eff})$ as a function of $1/T$ at different temperatures

$$\ln(D_{eff}) = -8.542 - 4677(1/T)$$

$$r = 0.98$$

The average activation energy of orange peels is found to be 39.33kJ/mol.

2.3.5 *Temperatures effect on the Total Phenolic Content (TPC) and radical-scavenging activity (DPPH)*

Figure 43 showed the effect solar drying at different temperatures on the TPC in comparison to natural thin layer shade drying (orange peels were dried for four days under normal conditions). The amount of total phenols in the methanol extract of the fresh rosemary leaves was found to be 78.15 ± 1.36 mg equiv of Gallic Acid/g of dry matter. After both conventional shade drying and convective solar drying at (40, 50, and 60°C) that implies longer drying time, it was noted that TPC were considerably lower than the values found in the fresh peels. This TPC decrease could be the result of a drying process that wasn't able to inactivate the oxidative enzymes, which would result in a degradation of certain polyphenols (Garauet al., 2007).

However, as shown in figure 44, the TPC increases with higher temperature since the peak value was found in the orange peel dried at 80 °C. It could be stated from this result that the phenolic content improves gradually with high drying temperatures. It could be drawn from those results that temperature is a determining factor, since with an increase of temperature the drying time decreases; in fact, drying duration decrease by approximately 60% between 60°C and 80°C. Other studies have reported similar results and affirmed that for citrus species, the phenolic content increases with high heating temperature; thus, indicate that phenolic compounds can be liberated by heat treatment at temperatures higher than 70 °C (Jeong et al., 2004; Chen, Yang, Liu, 2011) In a study conducted for Marrubian vulgar plants drying it was found that the temperature influence the polyphenol content and the highest value was found at 80°C, since the drying at this temperature decreases time by a factor of 4 in comparison to 50°C (Bahammou et al., 2019). This may be due to new substances formation or precursor that occurs between several molecules via non-enzymatic inter-conversion at 70 °C drying temperature (Jeong et al., 2004).

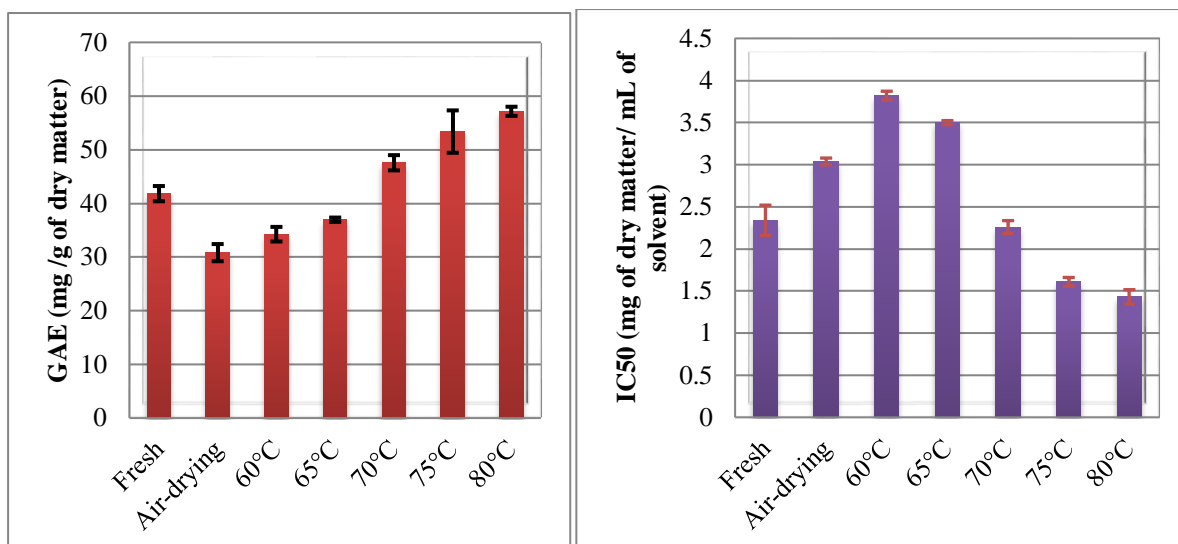

Figure 46. Effect of drying temperatures on the TPC and antioxidant activity

Those results were also found for other product such apricots. It was found that the apricot dried at 75°C had better features when it comes to antioxidant and polyphenol contents thus making it a better product quality wise (Madrau et al., 2009) The DPPH scavenging potential of orange peels at different conditions was also measured and the results are depicted in figure 44, IC₅₀ values were higher for the lowest drying value starting from the natural shade dried till the 70°C solar convective dried orange peels. However, starting 75°C, the IC₅₀ values were below the initial value of fresh orange peels thus indicating that with higher drying temperatures (in this case 75°C and 80°C) the antioxidant activity increases. Similar results were found by (Madrau et al., 2009; Azeez et al., 2017), where it was demonstrated that higher temperatures improve the antioxidant activity of orange peels and tomato slices.

Conclusion

This study was carried for the first time on the orange peels by thin convective solar drying to valorise this by-product and to increase its shelf-life. From the drying kinetics of the multiple drying temperatures and the obtained experimental drying curves of orange peels in a forced convection solar dryer under controlled air conditions, several results were noted. First, only the falling drying rate period exists; it started from the initial moisture content in the orange peel till the final moisture content. Second, the drying kinetics is influenced by the drying temperatures. Finally, the characteristic drying curve was obtained as well as the drying rate equation.

The drying behaviour of orange peels was described by mathematical modelling after fitting nine models for the forced solar drying processes. It was found after considering the statistical values of each model that two term was the most fitted and appropriate model to describe the drying kinetics of orange peels. As for the diffusivity coefficient, it has been found that the diffusivity coefficient increases with drying and it varies from $1.6211 \cdot 10^{-10}$ for 60°C till $3.5124 \cdot 10^{-10}$ for 80°C. The Arrhenius relation, allowed the calculation of the activation energy that was found to be 2161.67kJ/kg.

A change of total phenolic contents and antioxidants activity in orange peels was seen in the obtained results this was influenced by hot air drying at different temperatures. The results showed TPC degradation in both 60°C and 65°C and the natural shade dried orange peels yet with higher temperatures (70°C, 75°C, and 80°C) the products give a better TPC concentration. As for the DPPH analysis, it was found that starting from 75°C, the antioxidant activity improves. Convective solar drying at temperatures above 65°C could be considered to increment TPC and antioxidant activity in orange peels.

References

- Ait Mohamed, L.; Kouhila, M.; Jamalia, A.; Lahsasni, S.; Kechaouch, N.; Mahrouz, M. Layer solar drying behaviour of *Citrus aurantium* leaves under forced convection. *Energy Conversion and Management*. 2004, 46, 1473–1483. <https://doi.org/10.1016/j.enconman.2004.08.001>
- Azeez, L.; Abebisi, S.A.; Yedeji, A.O.; Adetoro, R.O.; Tijani, K.O. Bioactive compounds' contents, drying kinetics and mathematical modelling of tomato slices influenced by drying temperatures and time. *Journal of the Saudi Society of Agricultural Sciences*. 2017. <http://dx.doi.org/10.1016/j.jssas.2017.03.002>
- Babalis, S.J.; Belessiotis, V.G. Influence of the drying conditions on the drying contents and moisture diffusivity during the thin layer drying of figs. *Journal of Food Engineering*. 2004, 65(3), 449–458. <https://doi.org/10.1016/j.jfoodeng.2004.02.005>.
- Bahammou, Y.; Tagnamas, Z.; Kouhila, M.; Lamharrar, A.; Idlimam, A. Thin-layer solar drying characteristics of Moroccan horehound leaves (*Marrubium vulgare* L.) under natural and forced convection solar drying. *Solar Energy*, 2019, 188, 958–969.
- Bousbia, N.; Abert, M.; Ferhat, M.A.; Petitcolas, E.; Meklati, B.Y.; Chemat, F. Comparison of two isolation methods for essential oil from rosemary leaves. Hydrodistillation and microwave hydrodiffusion and gravity. *Food Chem.* 2009, 114(1), 355–362.
- Capannesi, C.; Palchetti, I.; Mascini, M.; Parenti, A. Electrochemical sensor and biosensor for polyphenols detection in olive oils. *Food chem.* 2000; 71:553–562.
- Chen, M.L.; Yang, D.J.; Liu, S.C. Effects of drying temperature on the flavonoid, phenolic acid and antioxidative capacities of the methanol extract of citrus fruit (*Citrus sinensis* (L.) Osbeck) peels. *International Journal of Food Science and Technol.* 2011, 46, 1179–1185. <https://doi.org/10.1111/j.1365-2621.2011.02605.x>.
- Chemat, F.; Vian, M.A.; Cravotto, G. Green Extraction of Natural Products. Concept and Principles. *International J. of Molecular Sciences*. 2012, 8:615–8627.
- Djilas, S.; Canadanovic-Brunet, J.; Cetkovic, G. By-products of fruits processing as a source of phytochemicals. *Chem Ind Chem Eng.* 2009, 15(4), 191–202. [doi.10.2298/CICEQ0904191D](https://doi.org/10.2298/CICEQ0904191D).
- Doymaz, I.; Pala, M. Hot air drying characteristics of red pepper. *J. Food Eng.* 2002, 55:331–335.
- Ertekin, C.; Yaldiz, O. Drying of eggplant and selection of a suitable thin layer drying model. *J. of Food Eng.* 2004, 63 (4), 349–359. <https://doi.org/10.1016/j.jfoodeng.2003.08.007>
- Garau, M.C.; Simal, S.; Rossello, C.; Femenia, A. Effect of air-drying temperature on physico-chemical properties of dietary fibre and antioxidant capacity of orange (*Citrus aurantium* v. *Canoneta*) by-products. *Food Chem.* 2007, 104, 1014–1024. <https://doi.org/10.1016/j.foodchem.2007.01.009>
- Guenther, E. 1974. *The Essential Oils*, 3, R.E. Kreiger Publishing, New York.
- Huang, Y.W.; Liua, Y.; Dushenkova, S.; Hoc, C.T.; Huang, M.T. Anti-obesity effects of epigallocatechin-3-gallate, orange peel extract, black tea extract, caffeine and their combinations in a mouse model. *Journal of functional foods*. 2009, (1), 304–310. <https://doi.org/10.1016/j.jff.2009.06.002>
- Idlimam, A.; Kane, C.S.E.; Kouhila, M. Single layer drying behaviour of grenade peel in a forced convective solar dryer. *Revue des Energies Renouvelables*. 200, 10 (2), 191 – 203.

- Jeong, S.M.; Kim, S.Y.; Kim, D.R.; Jo, S.C.; Nam, K.C.; Ahn, D.U.; Lee, S.C. Effect of Heat Treatment on the Antioxidant Activity of Extracts from Citrus Peels. *Agric. Food Chem.* 2004, 52, 3389–3393. DOI. 10.1021/jf049899k
- Kahrilas, G.A.; Wally, L.M.; Fredrick, S.J.; Hiskey, M.; Prieto, A.L.; Owens, J.E. Microwave-Assisted Green Synthesis of Silver Nanoparticles Using Orange Peel Extract. *ACS Sustainable Chem. Eng.*, 2014, 2 (3), 367–376. DOI. 10.1021/sc4003664.
- Khan, M.K.; Abert-vian, M.; Fabiano-Tixier, A.; Dangles, O.; Chemat F. Ultrasound-assisted extraction of polyphenols (flavanone glycosides) from orange (*Citrus sinensis* L.) peel. *Food Chem.* 2010, 119(2),851-858.
- Kouhila, M.; Kechaou, N.; Otmani, M.; Fliyou, M.; Lahsasni, S. Experimental study of sorption isotherms and drying kinetics of Moroccan Eucalyptus globulus. *Drying Technol.* 2002, 20(10), 027–39. <https://doi.org/10.1081/DRT-120015582>.
- Kouhila, M.; Kechaou, N.; Otmani, M.; Fliyou, M.; Lahsasni, S. Experimental study of sorption isotherms and drying kinetics of Moroccan Eucalyptus globulus. *Drying Technol.* 2002, 20(10), 027–39. <https://doi.org/10.1081/DRT-120015582>.
- Kouhila, M. Experimental and theoretical study of convective solar drying kinetics of medicinal and aromatic plants (mint, verbena, sage and eucalyptus) of the Marrakech region, Doctorat. Cadi Ayyad University, Marrakech, Morocco. 2001.
- Koukouch, A.; Idlimam, A.; Asbik, M.; Sarh, B.; Izrar, B.; Bah, A.; Ansari, O. Thermophysical characterization and mathematical modelling of convective solar drying of raw olive pomace. *Energy Conversion and Management.* 2015, 99, 221–230. <https://doi.org/10.1016/j.enconman.2015.04.044>
- Kodal, S.P.; Aksu, Z.J. Phenolic Pigment Extraction from Orange Peels. Kinetic Modeling. *15th International Conference on Environmental Science and Technology Rhodes*, Greece, 31 August to 2 September 2017.
- Lahnine, L.; Idlimam, A.; Mahrouz, M.; Mghazli, S.; Hidar, N.; Hanine, H.; Koutit, A. Characterization by solar convective drying of thyme conserved by an innovative thermal-biochemical process. *Renewable Energ.* 2016, 94, 72-80, <https://doi.org/10.1016/j.renene.2016.03.014>
- Lahsasni, S.; Kouhila, M.; Mahrouz, M.; Ait Mohamed, L.; Agorram, L. Characteristic drying curve and mathematical modelling of thin layer solar drying of prickly pear cladode (*Opuntia ficusindica*). *Journal of Food Engineering.* 2004, 27(2),103–117.<https://doi.org/10.1111/j.1745-4530.2004.tb00625.x>.
- Li B.B.; Smith, B.; Hossain, M. Extraction of phenolics from citrus peels I. Solvent extraction method. *Separation and Purification Technology.* 2006, 48,182-188.
- Madrau, M.A.; Piscopo, A.; Sanguinetti, A.M.; Del-Caro, A.; Poiana, M.; Romeo, F.V.; Piga, A. Effect of drying temperature on polyphenolic content and antioxidant activity of apricots. *Eur. Food Res. Technol.* 2009, 228, 441–448. <https://doi.org/10.1007/s00217-008-0951-6>
- Maran, J.P. Optimization of aqueous extraction of pectin from waste durian rinds. *Int J BiolMacromol.* 2015, 73, 92-98.
- Marin, F.A.; Soler-Rivas, C.; Benavente-Garcio, O.; Castillo, J.; Perez-Alvarez, J.E. By-products from different citrus processes as a source of customized functional fibres. *Food Chem.* 2007,100, 736-741. <https://doi.org/10.1016/j.foodchem.2005.04.040>.
- Mata-Bilbao, M.D.L.; Lacueva, C.A.; Jauregui, O.; Lamuela–Raventos, RM. Determination of flavonoids in a Citrus fruit extract by LC-DAD and LC-MS. *Food chemistry.* 2007, 101(4), 1742- 1747. <https://doi.org/10.1016/j.foodchem.2006.01.032>
- Mghazli, S.; Ouhammou, M.; Hidar, N.; Lahnine, L.; Idlimam, A.; Mahrouz, M. Drying Characteristics and Kinetics Solar Drying of Moroccan Rosemary Leaves. *Renewable Energy.* 2017,108, 303-310. doi. 10.1016/j.renene.2017.02.022.

- Mira, B.; Blasco, M.; Berna, A.; Subirats, S. Supercritical CO extraction of essential oil from orange peels. Effect of operation conditions on the extract composition. *Journal of Supercritical Fluids*. 1999, 14,95-104.
- Ozdemir, M.; Devres, Y.O. The thin layer drying characteristics of hazelnuts during roasting. *J. of Food Eng.* 1999, 42, 225-233. [https://doi.org/10.1016/S0260-8774\(99\)00126-0](https://doi.org/10.1016/S0260-8774(99)00126-0)
- Park, J.; Lee, M.; Park, E. Antioxidant Activity of Orange Flesh and Peel Extracted with Various Solvents. *Prev. Nutr. Food Sci.* 2014, 19(4), 291-298. doi. 10.3746/pnf.2014.19.4.291
- Rabha, D.K.; Muthukumar, P.; Somayaji, C. Experimental Investigation of Thin Layer Drying Kinetics of Ghost Chill Pepper (*Capsicum Chinense* Jacq.) Dried in a Forced Convection Solar Tunnel Dryer, *Renewable Energy*. 2016, 105. 583-589. doi. 10.1016/j.renene.2016.12.091.
- Sarsavadia, P.N.; Sawhney, R.L.; Pangavhane, D.R.; Singh, S.P. Drying behavior of brined onion slices. *J. of Food Eng.*1999, 40,219–226.[https://doi.org/10.1016/S0260-8774\(99\)00058-8](https://doi.org/10.1016/S0260-8774(99)00058-8).
- Sayinci, B.; Ercisli, S.; Ozturk, I.; Eryilmaz, Z, Demir, B. Determination of Size and Shape in the ‘Moro’ Blood Orange and ‘Valencia’ Sweet Orange Cultivar and its Mutants Using Image Processing. *Not Bot HortiAgrobo*.2012, 40(1),234-242.
- Tagnamas, Z.; Bahammou, Y.; Kouhila, M.; Hilali, S.; Ildimam, A.; Lamharrar, A. Conservation of Moroccan truffle (*Terfeziaboudieri*) using solar drying method. *Renewable Energy*. 2020, 146.
- Togrul, I.T.; Pehlivan D. Mathematical modelling of solar drying of apricots in thin layers. *Journal of Food Engineering*. 2002,55, 209–216. [https://doi.org/10.1016/S0260-8774\(02\)00065-1](https://doi.org/10.1016/S0260-8774(02)00065-1)
- Tripoli, E., Guardia, M. L., Giammanco, S., Majo, D. D., & Giammanco, M. (2007). Citrus flavonoids. Molecular structure, biological activity and nutritional properties. A review. *Food Chemistry*, 104(2), 466-479. doi.10.1016/j.foodchem.2006.11.054
- USDA, United States Department of Agriculture Citrus. World Markets and Trade 2014. (<http://www.fas.usda.gov/data/citrus-world-markets-and-trade>).
- Zema, D. A., Calabrò, P. S., Folino, A., Tamburino, V., Zappia, G., &Zimbone, S. M. Valorisation of citrus processing waste. A review. *Waste Management*. 2018, 80, 252–273. doi.10.1016/j.wasman.2018.09.024
- Zhang, H.; Xi, W.; Yang, Y.; Zhou, X.; Liu, X.; Yin, S.; Zhang, J.; Zhou, Z. An on-line HPLC-FRSD system for rapid evaluation of the total antioxidant capacity of Citrus fruits. *Food Chem*. 2015. 172,622-629.
- Zhou, W.; Widmer, W.; Grohmann, K. An Economic Analysis of Ethanol Production from Citrus Peel Waste. *Proc. Fla. State Hort. Soc.* 120.310–315. 2007

General Conclusion and Perspectives

General conclusion

The thesis was divided into two parts each of them focuses on the utilisation of a solar thermal system.

➤ Solar extraction.

Rosemary leaves were studied as an aromatic and medicinal plant. The value of essential oils in rosemary leaves is known. Their extraction is often considered a specific objective, due to their high economic value. However, new researchers and industrials are placing the interest of rosemary to its non-volatile bioactive compounds, specifically natural antioxidants. To valorise those compounds, “deodorization” to reduce and remove aroma from the leaves is a primarily concern since it is time and energy consuming. While considering this issue, solar steam distillation (SSD) was considered as green and charge free solution for rosemary leaves deodorization the system was compared with a conventional steam distillation process (CSD). In a view of the findings, it can be concluded that the process allowed the deodorization of rosemary leaves; this was observed thanks to the scanning electron microscopy that showed the explosion of trichomes glands and branch erosion and illustrated by HPLC results that proves the preservation after SSD of the targeted antioxidant (ursolic acid, rosmarinic acid and carnosic acid). The process has also multiple advantages over the conventional technique. Overall, antioxidant studied in this work were better preserved after SSD, the essential oil yield was somewhat similar however the extraction time needed for SSD was 37% less than CCS. DPPH free radical scavenging activity and fluorescence microscopy and polyphenol analysis showed also that polyphenol and antioxidant activities were highly preserved after the SSD process. It can further be concluded that the innovative SSD technique used for deodorisation, decreases the energy consumption since solar energy is a sustainable charge-free while allowing an efficient extraction of both volatiles and non-volatiles compounds from rosemary leaves.

In the other hand, Industries are now more than ever ready to recycle "waste", rather called recently "by-products", into commercial products with high added value. Annual citrus production worldwide has doubled in the past 5 years and is now estimated at over 100 million tonnes. Almost 50% of citrus fruits are used to produce juice.

The massive amount of waste leads to a disturbing situation in respect to the environment. Orange peel contains essential oil, which is found in small glands in the part called "flavedo", and flavonoid (mainly naruritin and hesperidin) found in "albedo". In that respect solar hydro-distillation was considered as an original concept toward a zero-waste bio-refinery that aims to extract essential oils, flavonoid, and pectin from orange peels after pressing (used to obtain orange juice). The system was compared to a conventional hydro-distillation. It was possible to demonstrate via results that TPC, TFC, hesperidin, narirutin, and pectin are still present in the peels after extraction with high preservation amounts, particularly after solar hydro-distillation. This may be due to the distillation time needed for essential oil extraction being less for solar hydro-distillation, and the peel after extraction still needed to be valorized. With reference to those results a valorisation system after essential extraction could be suggested to better valorise orange peels.

➤ Solar drying

Solar drying has potential to extend shelf life of dried leaves and peels. Same matrices of solar extraction were considered for this application as well. In order to increase the shelf life of rosemary leaves several convective solar dryer temperatures were taken into consideration (40°C, 50°C, 60°C and 70 °C) and obtained results were compared with open solar drying. Kinetic analysis helped obtain, under controlled air conditions, the characteristic drying curve of rosemary leaves. In order to explain the drying behavior and to develop the mathematical modeling of rosemary leaves, nine models were studied for thin layer forced solar drying processes. According to statistical analysis of the experimental results, it could be concluded that Midilli– Kucukmodel is the most appropriate for describing the convective solar drying kinetics of rosemary leaves. Effective diffusivity values (D_{eff}) obtained by Fick's diffusion model were in the cover ranged and varied from $2.7046 \cdot 10^{-11}$ to $7.4377 \cdot 10^{-11}$ indicating that with high temperatures D_{eff} values increase. The Arrhenius relation was used to calculate the activation energy found to be 39.33kJ/mol. The results express the effect of temperature on the diffusion coefficient and this range corresponds with the energy of activation of other food products. Activation energy value was calculated as follows, for rosemary leaves. The degradation of carnosic acid into carnosol resulting from the exposure to a range of temperatures was also investigated.

It was found that with solar drying (40, 50, 60°C, and sun-dried) an increase of carnosol was observed coupled with a decrease of carnosic acid values, while at high temperature in this case 70°C both carnosic acid and carnosol value decreases. This could imply that high temperature may lead to quality deterioration. To better explain this process and understand the effect of high temperature on the quality of rosemary leaves and further choose the adequate temperature drying range, an additional DPPH and TPC analysis were carried to exemplify the effect on the polyphenol content and antioxidant activity of rosemary leaves. The results values were relatively similar between open solar dried, fresh values, and drying temperature inferior or equal to 60°C; however, at 70°C TPC values decrease and IC₅₀ value increased illustrating the negative effect of high drying temperatures on rosemary leaves. A mathematical analysis was additionally conducted in this work. The main purpose of this study was to point out the economic feasibility and the annual CO₂ emissions mitigation in contrast to certain fossil fuels (coal, natural gas and diesel oil) while drying rosemary at 60°C. Solar energy for rosemary drying, according to the simulation results, exhibits a colossal potential for both fossil monetary saving and CO₂ emissions mitigation. This could help promoting solar drying for the energy free, environmentally friendly, and the exceptionally attractive financial gains thus enhance their acceptance among the potential users.

Like the study above, drying kinetics of the multiple drying temperatures used in this study (60, 65, 70, 75 and 80°C) helped to established the experimental drying curves of orange peels under controlled air conditions. It was observed from the results that only the falling drying rate period exist (it started from the initial moisture content in the orange peel till the final moisture content), the drying kinetics is influenced by the drying temperatures, and finally the best fitting model to describe the drying behaviour of orange peels out of nine models is two terms. The diffusivity varies from $1.6211 \cdot 10^{-10}$ for 60°C till $3.5124 \cdot 10^{-10}$ for 80°C (under the covered range) and the activation energy was found to be 2161.67kJ/kg.

Contrary to rosemary leaves, the results showed that TPC and DPPH degradation was elevated in both 60°C, 65°C and the natural shade dried orange peels in comparison to high temperatures 75°C, and 80°C. This may state that the product gives better TPC and DPPH concentration if being dried at high temperature. As for the DPPH analysis, it was found that starting from 75°C, the antioxidant activity improves. This may be due to new substances formation or precursor that occurs between several molecules via non-enzymatic inter-conversion at 70 °C for citrus fruits. Thus, stating that drying at high temperature may be a way to improve the phenolic extraction of orange peels.

Overall, the concept that consumers share responsibility for pollution and its cost has been increasingly accepted leading to a universal shift toward sustainable solution. The use of solar thermal energy was proven, through this study, to be a green feasible and sustainable application that can be used as an alternative to the conventional system while providing better outcome.

Perspectives

It is obvious that thermal solar applications and processes have a great beneficial impact on both the environment and economic. That is why it is expected that their will spread all over the world especially in countries with abundant solar energy.

- Solar extraction:

The distillation method has been used throughout the world for numerous applications. With the introduction of innovative solar collectors, a new possible avenue for utilization of solar energy in the medium temperature ranges boosts its suitability for adaptation in growing economies. The study considers the potential of solar distillation system for the processing of medicinal and aromatic plants and by-products. The end results convey the numerous possibilities for the incorporation of solar for the valorization of such matrices. Multiple issues occur in relation to whether it is better to move towards up-scaling or numbering of the installation. The used system had a 10m² surface collector, with the availability of 20m² and 30 m² surface systems it is possible to compare the yield, extraction time, bio-compound extraction or preservation; thus, resolving this concern.

- Solar drying:

Drying is a post-harvest technique used to preserve the quality of a targeted product. The study of the drying behaviour of different products has been a subject of interest of many studies on both theoretical and experimentally grounds. Based on results of this study and literatures, it is particularly essential to develop low-cost solar dryer preferably using local materials and skills as part of continuous post-harvest treatment to elongate the shelf of the fresh produce.