



**HAL**  
open science

# An approach to preparing hand gesture maintenance training based on Virtual Reality

Manoch Numfu

► **To cite this version:**

Manoch Numfu. An approach to preparing hand gesture maintenance training based on Virtual Reality. Human-Computer Interaction [cs.HC]. Université Grenoble Alpes [2020-..], 2020. English. NNT : 2020GRALI071 . tel-03158358

**HAL Id: tel-03158358**

**<https://theses.hal.science/tel-03158358>**

Submitted on 3 Mar 2021

**HAL** is a multi-disciplinary open access archive for the deposit and dissemination of scientific research documents, whether they are published or not. The documents may come from teaching and research institutions in France or abroad, or from public or private research centers.

L'archive ouverte pluridisciplinaire **HAL**, est destinée au dépôt et à la diffusion de documents scientifiques de niveau recherche, publiés ou non, émanant des établissements d'enseignement et de recherche français ou étrangers, des laboratoires publics ou privés.

## THÈSE

Pour obtenir le grade de

### DOCTEUR DE L'UNIVERSITE GRENOBLE ALPES

Spécialité : **Génie industriel**

Arrêté ministériel : 25 mai 2016

Présentée par

**Manoch NUMFU**

Thèse dirigée par **Andreas RIEL**, Professeur associé HDR,  
Grenoble INP

et codirigée par **Frédéric NOËL**, Professeur, Grenoble INP

préparée au sein du **Laboratoire G-SCOP**  
dans l'**École Doctorale I-MEP2**

**Une approche pour la préparation de  
formations aux gestes de la main en  
maintenance basées sur la réalité virtuelle**

**An approach to preparing hand gesture  
maintenance training based on Virtual  
Reality**

Thèse soutenue publiquement le **18 décembre 2020**,  
devant le jury composé de :

**Pr. Lionel ROUCOULES**

Professeur à LISPEN, ENSAM Aix-en-Provence, France, President

**Pr. Vincent CHEUTET**

Professeur à DISP, INSA Lyon, France, Rapporteur

**Dr. Florent LAROCHE**

Maitre de Conférences HDR à LS2N, ECN, France, Rapporteur

**Dr. Siranee NUCHITPRASITCHAI**

Professeure assistante à Faculty of IT, KMUTNB, Thaïlande, Membre

**Pr. Frédéric NOËL**

Professeur à G-SCOP, Grenoble INP, Co-Directeur de thèse

**Pr. Andreas RIEL**

Professeur associé HDR à G-SCOP, Grenoble INP, Directeur de thèse





## Acknowledgements

I would like to express my deepest gratitude and sincere thanks to my supervisors Prof. Andreas Riel and Prof. Frédéric Noël for the trust in my abilities. They encouraged me from the beginning until the end in a very respectful, sensitive and professional way.

I also wish to thank all my defense committee members for the attention they have kindly given to this work: Dr. Florent Laroche, Prof. Vincent Cheutet, Prof. Lionel Roucoules, Dr. Frédéric Vignat and Dr. Siranee Nuchitprasitchai. Particular thanks goes to Dr. Laroche and Prof. Cheutet for having accepted to be reviewers and therefore studying my thesis in very much detail and giving highly appreciated constructive criticism.

I also thank the G-SCOP laboratory at Université Grenoble Alpes for supporting my research. In addition, I would like to express my sincere gratitude to many friends, colleagues and experts at G-SCOP laboratory who took part in this research.

Additionally, I would like to thank the Thai government who supported the scholarship throughout the course. Furthermore, I would like to thank the Rajamangala University of Technology Lanna where was my agency for giving me a great opportunity to study in France.

Finally, I deeply thank my family. Without their patience and support, this research would not have been possible.



## Résumé

Au cours de la dernière décennie, la technologie de la réalité virtuelle (RV) a évolué rapidement. Les environnements et appareils de la RV sont de plus en plus puissants et permettent des expériences utilisateur exceptionnelles. De tels environnements et dispositifs ont un potentiel énorme dans une grande variété d'applications industrielles, en particulier dans la formation à la maintenance. L'industrie, cependant, a encore des difficultés à obtenir des résultats de formation satisfaisants, principalement en raison de choix et de configurations inappropriés d'infrastructures de formation basées sur la RV. Afin de soutenir systématiquement le processus de préparation des formations de maintenance basées sur la réalité virtuelle, cette thèse propose un concept holistique pour la préparation de séquences de formation sur la maintenance basée sur la réalité virtuelle en mettant l'accent sur l'expérimentation, l'évaluation et la comparaison de différentes configurations de réalité virtuelle. Ce concept est appelé « Processus de préparation des formations basées sur la technologie de réalité virtuelle » (VR-TPP), et il a été mis en œuvre pour la validation dans des configurations non immersives et entièrement immersives. Parmi celles-ci, trois études de cas différentes montrent comment cette approche systématique aide les apprenants à trouver le processus de travail et les gestes de la main appropriés, ainsi que les formateurs à déterminer l'environnement de formation, la séquence et les instructions de travail les plus appropriés. Afin de tenir compte des spécificités des opérations de formation à la maintenance, un accent particulier a été mis sur la bonne saisie des gestes de la main et leur association avec différents types d'articulations mécaniques et le démontage des pièces mécaniques en fonction de leur adéquation. Ceci est considéré comme une contribution importante à la mise à niveau, au complément ou même au remplacement des instructions de travail traditionnelles sans participation active de l'utilisateur à des instructions de travail virtuelles offrant une expérience utilisateur. De plus, l'utilisation du concept VR-TPP permet également de révéler la cause des erreurs commises par les utilisateurs lorsqu'ils travaillent dans un environnement virtuel. Ces connaissances peuvent être réinjectées dans la conception du processus de formation ainsi que dans l'infrastructure. Outre les formations à la maintenance industrielle (donc au montage et au démontage), le concept peut être facilitateur pour de nombreuses autres applications.

**Mots-clés :** Réalité virtuelle, formation basée sur la réalité virtuelle, formation à la maintenance, formation au montage et démontage, processus de préparation de la formation basée sur la réalité virtuelle



## Abstract

Over the last decade, Virtual Reality (VR) technology has been evolving rapidly. VR environments and devices are more and more powerful and enable exceptional user experiences. Such environments and devices have a huge potential in a wide variety of industrial applications, in particular in maintenance training. Industry, however, still has difficulties achieving satisfactory training results, mainly due to inappropriate choices and setups of VR-based training infrastructures. In order to systematically support the preparation process of VR-based maintenance trainings, this thesis proposes a holistic concept for preparing VR-based maintenance training sequences with a focus on experimenting with, and evaluating and comparing different VR setups and configurations. This concept is called “Virtual Reality technology for Training Preparation Process” (VR-TPP), and it has been implemented for validation in both non-immersive and fully-immersive setups. Within those, three different case studies demonstrate how this systematic approach supports trainees in finding out the appropriate working process and hand gestures, as well as trainers in determining the most appropriate training environment, sequence and work instructions. In order to account for specificities in maintenance training operations, a particular focus has been directed on properly capturing hand gestures and associating them with different types of mechanical joints and the disassembly of mechanical parts according to their appropriateness. This is considered an important contribution to upgrading, complementing or even replacing traditional work instructions without active user involvement to virtual work instructions providing user experience. Furthermore, the use of the VR-TPP concept also helps revealing the cause of mistakes that users make when working in a virtual environment. From these insights, the learnings can be fed back into the design of the training process as well as the infrastructure. Apart from industrial maintenance (therefore assembly- and disassembly-) trainings, the concept enables and supports numerous other applications.

**Keywords:** Virtual Reality, VR-based training, maintenance training, assembly/disassembly training, VR-training preparation process





# Table of Contents

<b>Acknowledgements .....</b>	<b>3</b>
<b>Résumé.....</b>	<b>5</b>
<b>Abstract .....</b>	<b>7</b>
<b>Table of Contents.....</b>	<b>9</b>
<b>List of Acronyms.....</b>	<b>15</b>
<b>List of Figures .....</b>	<b>17</b>
<b>List of Tables .....</b>	<b>21</b>
<b>List of Published Articles .....</b>	<b>23</b>
<b>1 Introduction.....</b>	<b>25</b>
1.1 General Introduction.....	25
1.2 Thesis background.....	26
1.3 Research motivation .....	27
1.4 Research question .....	29
1.5 Methodology.....	29
1.6 Thesis structure.....	30
<b>2 State of The Art.....</b>	<b>33</b>
2.1 Introduction .....	33
2.2 Conventional maintenance training .....	33
2.2.1 Off-site training.....	34
2.2.1.1 Classroom lectures.....	34
2.2.1.2 Offsite lab-work.....	35
2.2.2 On-site training .....	35

2.2.3	Summary of conventional maintenance training .....	36
2.2.4	Limitations of conventional maintenance training.....	36
2.3	Virtual Reality technology.....	38
2.3.1	Virtual Reality systems .....	39
2.3.1.1	Non-immersive system .....	39
2.3.1.2	Semi-immersive system.....	39
2.3.1.3	Fully-immersive system.....	39
2.3.2	VR devices and interaction techniques .....	40
2.3.2.1	Input devices .....	40
2.3.2.2	Output devices .....	42
2.3.2.3	Interaction techniques .....	46
2.4	VR technology for maintenance training.....	49
2.5	Virtual reality for Dis/Assembly task .....	49
2.6	VR training effectivity evaluation studies .....	52
2.7	Hand gesture simulation for training in VR environments.....	53
2.8	Summary.....	56
<b>3</b>	<b>A Systematic Approach to Preparing VR Maintenance Training... 59</b>	
3.1	Introduction .....	59
3.2	The concept of VR-TPP.....	59
3.3	Systematic approach of VR-TPP concept.....	61
3.3.1	Preparation Task .....	62
3.3.1.1	Model preparation module.....	62
3.3.1.2	Work instruction (WI) making module .....	70
3.3.2	Execution .....	72
3.3.2.1	Recording module.....	72
3.3.2.2	VR using module .....	73
3.3.2.3	Translation module .....	79
3.3.3	Implementation task.....	82

3.3.3.1	Assessment .....	82
3.3.3.2	Classification of hands gestures.....	82
3.4	Summary of systematic approach of VR-TPP concept .....	85
<b>4</b>	<b>A VR-TPP Maintenance Training Preparation Environment.....</b>	<b>87</b>
4.1	Introduction .....	87
4.2	Derivation from the VR-TPP concept .....	87
4.3	The VR-TPP platform implementation.....	88
4.3.1	The system preparation .....	89
4.3.1.1	3D Parts .....	90
4.3.1.2	Assembly parts.....	91
4.3.1.3	Scene components .....	93
4.3.2	The design of devices and interaction techniques.....	94
4.3.2.1	Input devices .....	94
4.3.2.2	Output device.....	95
4.3.2.3	Interaction technique .....	96
4.3.3	Recording method.....	98
4.3.3.1	Image sequence.....	98
4.3.3.2	Animation clip .....	99
4.4	Summary of implementation on the VR-TPP platform .....	100
<b>5</b>	<b>Case Studies.....</b>	<b>101</b>
5.1	Introduction .....	101
5.2	Validation of VR-TPP concept by disassembling process .....	101
5.2.1	Recording the disassembling process of the Jigsaw .....	102
5.2.2	Discussion of the sequence of pictures .....	103
5.3	VR-TPP for creating a knowledge base of hand gestures.....	105
5.3.1	Building a library of hand gestures .....	105
5.3.1.1	Selecting the section of maintenance task .....	106
5.3.1.2	Creating virtual environment .....	107

5.3.1.3	Classifying hand gestures .....	107
5.3.1.4	Executing and recording hand gestures .....	108
5.3.1.5	Specifying hand gestures as patterns .....	108
5.3.1.6	Building a library of hand gestures.....	109
5.3.2	Discussion of building a library of hand gestures.....	110
5.4	Virtual Reality for Training in Maintenance Task.....	114
5.4.1	Maintenance content definition.....	114
5.4.2	System configuration .....	115
5.4.3	Virtual environment.....	116
5.4.4	Discussion of the VR for training in maintenance task .....	118
5.5	Summary.....	120
<b>6</b>	<b>User Experience Evaluation.....</b>	<b>121</b>
6.1	User Experience Study .....	121
6.2	Experiment setup .....	121
6.3	Evaluation and explanation.....	122
6.4	User experience evaluation.....	124
6.4.1	User experience testing in NI-VR.....	124
6.4.1.1	Perception of ease of use of VR device .....	124
6.4.1.2	Perception of realism .....	125
6.4.2	User experience testing in FI-VR .....	127
6.4.2.1	Perception of virtual reality experience .....	128
6.4.2.2	Perception about HMD usage .....	132
6.4.2.3	Side effects from using VR device. ....	133
6.5	Summary.....	136
<b>7</b>	<b>Discussion, Conclusions and Perspectives.....</b>	<b>137</b>
7.1	Discussion of the results against the research questions.....	137
7.2	VR-TPP concept and platform and implementation.....	139
7.3	Key contributions to research and practice.....	140

7.3.1	A generic VR-training preparation concept .....	140
7.3.2	Working instruction preparation .....	141
7.3.3	Hands gesture library for mechanical joints .....	141
7.3.4	VR device performance, realism and side effects .....	141
7.4	Limitations .....	142
7.5	Perspectives .....	143
7.5.1	Full body capture .....	143
7.5.2	Physical perception .....	143
7.5.3	Machine Learning .....	144
7.5.4	Taxonomy of hand gestures and mechanical joints .....	144
7.5.5	Taxonomy of VR-devices and setups .....	144
7.5.6	Future research in VR-based training in Thailand .....	145
7.5.6.1	VR technology for knowledge transfer .....	145
7.5.6.2	Maintenance training for high-speed trains .....	145
	<b>References.....</b>	<b>147</b>



## List of Acronyms

<b>VR</b>	Virtual reality
<b>VE</b>	Virtual environment
<b>LMC</b>	Leap Motion Controller
<b>HMD</b>	Head Mounted Display
<b>PC</b>	Personal Computer
<b>AR</b>	Augmented Reality
<b>IR</b>	Infrared Radiation
<b>VR-TPP</b>	Virtual Reality technology for Training Preparation Process
<b>VR-TMT</b>	Virtual Reality technology for Training in Maintenance Task
<b>AIO</b>	Anchor In Object
<b>AP</b>	Anchor Position
<b>WMR</b>	Windows Mixed Reality
<b>IM</b>	Interaction Manager
<b>IB</b>	Interaction Behavior
<b>RB</b>	Rigid Body
<b>MC</b>	Mesh Collider
<b>MR</b>	Mesh Render
<b>NI-VR</b>	Non-immersive VR level
<b>FI-VR</b>	Fully-immersive VR level





## List of Figures

Figure 1: The Learning Pyramid.....	28
Figure 2: Research methodology .....	30
Figure 3: Thesis structure .....	30
Figure 4: Training with classroom lecture method .....	34
Figure 5: Workshop training method .....	35
Figure 6: Conventional Training Methods.....	37
Figure 7: The head mounted display (HMD) .....	42
Figure 8: The stereoscopic display .....	43
Figure 9: The Cave Automatic Virtual Environment (CAVE).....	43
Figure 10: Assembly simulation using haptic device .....	45
Figure 11: Data glove in a six-sided CAVE .....	45
Figure 12: Go-Go interaction technique: egocentric coordinate system.....	47
Figure 13: Rigid-body fingers.....	48
Figure 14: The “sticky finger” image-plane pointing technique.....	48
Figure 15: Key features of some virtual assembly platforms. ....	51
Figure 16: Grasping patterns.....	54
Figure 17: Gesture with virtual hand related to a basic shape .....	55
Figure 18: GRASP taxonomy .....	55
Figure 19: The process of traditional training and VR training method.....	60
Figure 20: The position of the systematic approach of VR-TPP concept.....	60
Figure 21: The systematic approach of VR-TPP .....	61
Figure 22: The characteristics of 3D object on STL file format .....	63

Figure 23: OBJ file representing a cube .....	63
Figure 24: The characteristics of 3D object on STEP file format .....	64
Figure 25: Non-permanent joints and permanent joints .....	65
Figure 26: Different type of bolts and screws .....	66
Figure 27: Different type of nuts .....	67
Figure 28: Studs .....	67
Figure 29: Typical Press-Fit Male/Female Interconnect .....	68
Figure 30: Cotter joint parts .....	69
Figure 31: Knuckle joint parts .....	69
Figure 32: Type of kinematic joints .....	70
Figure 33: UML class diagram for interactions between WI and BOM.....	71
Figure 34: Recording module .....	72
Figure 35: Workflow diagram of grasping record method .....	73
Figure 36: The Unreal Engine .....	75
Figure 37: The Scene view in Unity Engine .....	76
Figure 38: Amazon Lumberyard Game Engine .....	77
Figure 39: CryEngine Game Engine .....	77
Figure 40: Interaction activity diagram of VR-TPP system. ....	78
Figure 41: Leap Motion Controller.....	79
Figure 42: Oculus HMD device .....	80
Figure 43: Vive HMD device .....	80
Figure 44: Acer Windows Mixed Reality HMD device .....	81
Figure 45: The components of the VR-TPP system in implementation task.....	81
Figure 46: The process of classification and recording the hands gestures .....	83
Figure 47: The main working gestures .....	84
Figure 48: The position of fingers .....	84
Figure 49: Abstract WI sequence model.....	85
Figure 50: The technical framework of VR-TPP concept .....	88
Figure 51: The components of 3D object .....	89

Figure 52: The creation of the virtual environment by Unity 3D .....	90
Figure 53: The physics of 3D part .....	90
Figure 54: A basic XR rig with the Interaction behaviour.....	92
Figure 55: Assembly parts with behaviour setting .....	92
Figure 56: Structure of anchor behaviour .....	93
Figure 57: Scene components in the virtual environment.....	94
Figure 58: Virtual hands by Leap Motion module.....	95
Figure 59: 2D system with desktop screen .....	96
Figure 60: 3D system with WMR device .....	96
Figure 61: Virtual camera at a first person perspective .....	98
Figure 62: Unity Recorder package is used to be recording method .....	99
Figure 63: Recording method by image sequence function.....	100
Figure 64: Repairing a saw blade by virtual hands .....	102
Figure 65: The platform and devices for disassembling process of Jigsaw .....	102
Figure 66: The trainees practice in virtual environment .....	103
Figure 67: The picture sequence recorded in the system .....	103
Figure 68: The hands moving method .....	104
Figure 69: Summary of the hand gestures for the jigsaw .....	105
Figure 70: A building process of virtual work instruction.....	106
Figure 71: The process of building a hand gesture library .....	106
Figure 72: The virtual workshop model.....	107
Figure 73: Type abstraction of mechanical joints .....	108
Figure 74: Recording an image sequence of hands gestures .....	109
Figure 75: Building a library of hand gestures in VR-TPP.....	110
Figure 76: Pattern of hand gestures for screws .....	110
Figure 77: Pattern of hand gesture using with bolts and nuts .....	111
Figure 78: Pattern of hand gestures for the snap fit technique.....	111
Figure 79: Foldable STRIDA bicycle folded (left), and unfolded (right).....	112
Figure 80: Work instruction specification for folding the STRIDA bicycle ...	113

Figure 81: STRIDA folding gesture sequence recorded in VR-TMT .....	114
Figure 82: The small virtual factory simulation .....	115
Figure 83: A storyboard displaying the different tasks of working process ....	117
Figure 84: Working environment in VE .....	117
Figure 85: Recording of image sequences by VR-TMT platform .....	118
Figure 86: An inappropriateness of participants' hand motion.....	119
Figure 87: An inappropriateness of participants' working position .....	119
Figure 88: An inappropriateness of participants' working step .....	119
Figure 89: Perception level for using a keyboard .....	125
Figure 90: Perception level for using a mouse.....	126
Figure 91: Perception level for using a leap motion .....	126
Figure 92: Perception level for using all of those tools .....	126
Figure 93: Testing result of the perception level in realism .....	127
Figure 94: The user preference in VR experience .....	128
Figure 95: The user's attention level from VR experience.....	129
Figure 96: The immersive level from experiencing the virtual environment ..	129
Figure 97: The user's attention level in the virtual reality .....	130
Figure 98: The level of user's curiosity .....	130
Figure 99: User's feedback on the possibility on VR technology .....	131
Figure 100: Users' beliefs in VR technology for training .....	131
Figure 101: The ease of use of VR technology for training.....	132
Figure 102: The interaction flexibility of HMD device .....	133
Figure 103: The user's feedback on the ease of use of the HMD device .....	133
Figure 104: Users' headache caused by using VR devices.....	134
Figure 105: Users' physical tiredness in the virtual environment .....	135
Figure 106: Users' visual tiredness in the virtual environment .....	135

## List of Tables

Table 1: The quality of image from Unity recorder.....	73
Table 2: The quality of animation from Unity recorder.....	73
Table 3: Selection and manipulation technique for 2D and 3D system.....	97
Table 4: Navigation technique for 2D and 3D system.....	98
Table 5: The format used for storing the hand gesture .....	109
Table 6: Questionnaire on the ease of use of VR tools.....	122
Table 7: Questionnaire on the perceptions level in realism .....	123
Table 8: Questionnaire on the virtual reality experiencing.....	123
Table 9: Questionnaire on the perception level from using VR devices .....	123
Table 10: Questionnaire on the side effects from using VR devices .....	124
Table 11: The rating of the ease of use perception .....	124
Table 12: Rated using the scale for perception level in realism .....	127
Table 13: The user ratings in VR experience.....	128
Table 14: The user ratings in perception level from using VR device .....	132
Table 15: The user ratings concerning side effects from using VR devices....	134



## List of Published Articles

### International Journals:

1. Numfu M., Riel A., Noël F. (2020) Virtual Reality Technology for Maintenance Training. International journal of Applied Science and Engineering Progress, Vol. 13, No. 3, pp. 274-282.

### International Conferences:

1. Numfu M., Riel A., Noël F. (2020) A Concept for Virtual Reality Based Industrial Maintenance Training Preparation. In: Yilmaz M., Niemann J., Clarke P., Messnarz R. (eds) Systems, Software and Services Process Improvement. EuroSPI 2020. Communications in Computer and Information Science, Vol. 1251, Springer, Cham, pp. 820-829.
2. Numfu M., Riel A., & Noël F. (2020). Virtual reality based digital chain for creating a knowledge base of hand gestures in maintenance tasks. Procedia CIRP, Vol. 90, pp. 648-653.
3. Numfu M., Riel A., Noël F. (2019). Virtual Reality Based Digital Chain for Maintenance Training. Procedia CIRP, Vol. 84, pp. 1069-1074.





# 1 Introduction

## 1.1 General Introduction

Virtual Reality (VR) technology has been rapidly evolving over the last decade. Nowadays there are many VR devices and platforms which are applied for training. As an example, maintenance research in nuclear power plants uses virtual technology and demonstrates the advantages of using virtual technology to design and monitor maintenance processes in nuclear power plants compared to conventional methods (Weijun, Xiao, & Lin, 2016). There are many companies which apply VR technology in place of traditional training. Their employees can learn more quickly, remember the learnings longer and make better decisions<sup>1</sup>. Also, trainings can be localized, eliminating the need for trainers and/or trainees to travel, and transport bulky training equipment (if at all possible).

Almost all research studies suggest that VR technology could be applied to the training process and thereby improve learning efficiency and experience. However, studies do not mention the expected effort and difficulties encountered when creating the training session sequence and content. One key point for a good deployment of VR in maintenance is to facilitate the creation of the VR content and behavior with the appropriate tools and systems. Therefore, the following issues shall be addressed in this work:

- There are many different immersion levels of VR tools that have effects on user awareness level. How can we determine and select those levels and related tools that are most suitable for a particular training task sequence, taking into account different levels of training task complexity?
- How can we render the creation of training content on any VR platform uncomplicated by facilitating the experimentation of the training process using different devices in the same environment?

---

<sup>1</sup> <https://eonreality.com/platform/>

The key contribution of this thesis is a systematic approach to creating a VR training preparation platform addressing exactly the issues listed before. The added value of this work is its focus on the training preparation process, which facilitates huge savings of time and cost required for selecting the appropriate VR devices and training sequence. This is expected to help accelerate the successful adoption of VR for industrial training purposes.

## 1.2 Thesis background

I am a lecturer at industrial engineering department of Rajamangala University of Technology Lanna Tak, Thailand<sup>2</sup>. My expertise is in CAD, CAM and CAE technology, including industrial process design. I used to work and research about designing and simulation process in vehicle industry in Thailand. During the past 4-5 years, Thai economy has grown rapidly. The Thai government has planned to develop and expand the transportation system by a high-speed train and rail transportation system. At present, Thailand does not have sufficient technology and know-how for the maintenance of high-speed trains and light-rail transport, so there are plans to train manpower in maintenance technology for rail transportation. In order to train staff to be able to work on maintenance tasks or working on the high-speed rail transport system, the government must invest in machinery and equipment, as well as in installation of these tools and equipment. It is a very high investment budget prospective. In addition, the parts and tools used in rail transportation systems are large and heavy, so if there is no suitable working method and appropriateness of working posture is likely to endanger the operator and trainee. Furthermore, Rajamangala University of Technology Lanna Tak also has a policy to establish a department of a rail transport system to support future development plans of the government. Therefore, they provided the scholarship to lecturers who worked in university in Thailand. I was very interested in this scholarship because I previously worked with Dr. Suthep Butdee who is a professor and researcher in the field of simulation of railway systems at King Mongkut's University of Technology North Bangkok (KMUTNB). KMUTNB has a long-standing scientific collaboration with the G-SCOP laboratory of Université Grenoble Alpes, which is an internationally renowned center of design and manufacturing sciences. Their cutting-edge VR-lab represented the ideal working environment for me. Against this background, I took the challenge to move to France in order to research into the topic of this thesis.

---

<sup>2</sup> <https://tak.rmutl.ac.th/>

### 1.3 Research motivation

VR technology is increasingly used for training purposes in industry, as VR has shown tremendous potential to revolutionize the way companies leverage knowledge and skill acquisition of their employees<sup>3</sup>. Virtual reality training systems are already used in a variety of domains (Ragan., et al., 2015), especially in maintenance tasks. Maintenance is a process that maintains the working condition of devices and machine to work under good conditions and safety. The heart of good maintenance is the knowledge and experience of workers. The knowledge and experience of the workers is achieved from the experiential learning session or from doing by themselves. The more workers can spend time on practically learning how to do their work, the more they will acquire the required practical skills and experience. Traditional methods often neglect this aspect, leading to low training effectiveness and efficiency. These methods also do not address the need to cater to different learning styles: visual, aural, verbal, etc.<sup>4</sup>. According to the National Training Laboratories, people gain only 10% knowledge from reading and 20% from audio and visual devices, as shown in Figure 1. Hence, workers have to invest huge amounts of time in getting trained, giving a lot of opportunities for improvement. Training can be more effective by learning practice, leading to an improved efficiency by 75%-90%. However, workers do not have a lot of time to train in practice because the situation and environment in the real work does not support them in learning session. The company has to pay and invest all of tools and devices in the training processes. In addition, the increasing density and complexity of mechanical parts and assemblies makes maintenance tasks increasingly difficult and hazardous (Liu X., Cui, Song, & Xu, 2014).

In order to fix these problems, there is a lot of research applying VR technology to increase efficiency, to reduce costs as well as the risk in the training process maintenance tasks. In fact, there are many research studies about the use of virtual reality technology to improve learning and training processes. The virtual environment is by itself a system that must be designed and developed. Most of them focus on the overall picture of the training process, rather than digging into the previous steps before training. The previous steps are the preparation phase that we have to design and consider before we deploy training. Because we have to consider these steps before using it in training process, if we set something wrong or unsafe, the bad situation will occur with users who operate with such training process.

Currently the training content is defined by experts and its translation into VR environment is a long process made by hand. On the other hand, if we do not have a manual and appropriate content for creating such training process, we cannot

---

<sup>3</sup> <https://learningsolutionsmag.com/articles/vr-training-development-in-four-steps>

<sup>4</sup> <https://www.controleng.com/articles/how-ar-and-vr-are-transforming-training-in-manufacturing/>

train with VR. Moreover, we have no guarantee that a usual physical training session provides what experts require for an appropriate and safe training process.

Normally in the traditional training process, many companies prefer using the real product over a physical mock-up training because this method is easy to set up and clearly close to real practice. However, both the availability and accessibility of the real product and equipment is typically a usual problem. Furthermore, training on real system should be avoided when we face high safety risks.

Despite the availability of increasingly mature VR devices, it is still difficult to achieve the level of realism needed for the effective training of particular manipulation gestures that are vital for specific assembly and disassembly procedures. Therefore, there is a need for a concept and an environment allowing to experiment with different devices and setups, and to compare their performance against each other. This thesis seeks to address exactly these shortcomings by focusing on the preparation phase of VR-driven maintenance trainings.

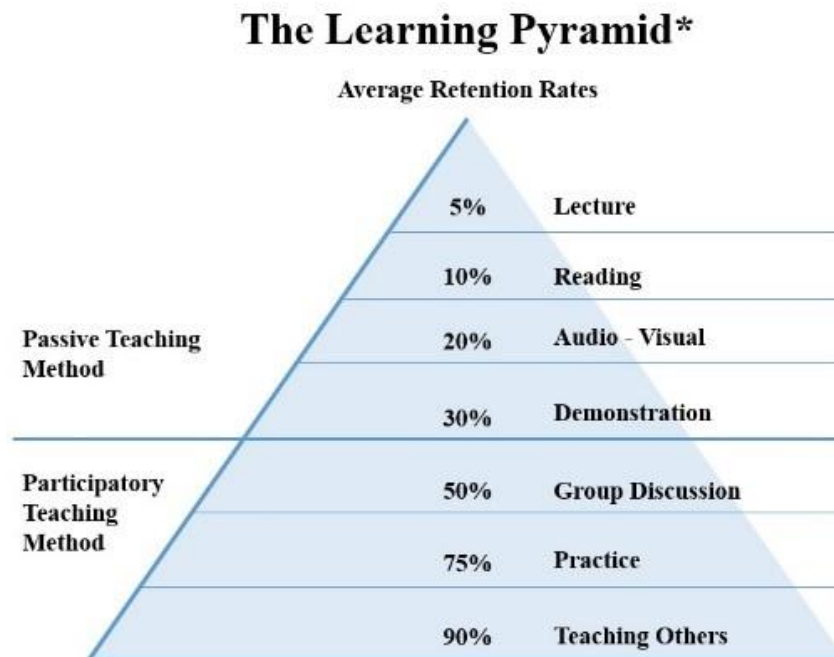

\*Adapted from the research of National Training Laboratories. Bethel, Maine.

Figure 1: The Learning Pyramid  
(Er. & Dag., 2009)

## 1.4 Research question

Based on the research motivation outlined above, the initial research questions for this thesis work are:

**Research question 1:** Can a structured VR-based training preparation process support the determination of appropriate VR-training environments, devices, and approaches?

The key hypothesis contained in this research question is that by taking a particular focus on the preparation phase of VR-based training environments and scenarios, there is the opportunity for increasing the effectivity of VR-based training. My intention is to propose a systematic and structured concept that supports exactly this crucial training preparation phase, both with respect to the VR environment and devices used, as well as the most appropriate training sequence. This concept shall also include a systematic way of evaluating user experience, perception of realism, as well as side effects coming from the use of different VR devices.

**Research question 2:** How to integrate hand gestures as digital models such that these can leverage the creation of training procedures, work instructions, and training evaluations?

Since maintenance training typically involves manipulating several kinds of mechanical joints with very specific hand gestures, and these are particularly challenging to represent in VR environments, I want to focus my methodical investigations on digitally modelling hand gestures. In order to define the appropriate gestures related to mechanical joint, I want to study and explore how to capture and select such hand gestures through virtual reality technology. Then, I intend to link these gestures and operating processes to mechanical joints to create a standard work instruction that can be used in the training process.

## 1.5 Methodology

The overall process of this research begins with a literature survey and an analysis of virtual reality technology for maintenance. Then, the key contribution of this thesis, the virtual reality for training preparation process (VR-TPP) concept, will be presented. Subsequently the thesis elaborates on the experimental implementation of this concept with selected VR devices. The validation of the concept using this implementation is the subject of the second part of this thesis.

Figure 2 shows the chosen methodology, which consist of three levels: (i) design and creation, (ii) validation and implementation, (iii) evaluation and conclusion. At the beginning, the VR-TPP conceptual design will be used to build

the VR-TPP platform in two steps (designing and execution of the VR-TPP platform). Furthermore, both steps have been permanently improved based on the insights gained from experiments in the selected case studies in the implemented environment. The second level is the experimentation and examination of the VR-TPP concept and VR-TPP platform. Case studies evaluated with trainer and trainees provide the basis for validating the concept and the platform. The third level is the evaluation and conclusion of the use of concept and the platform.

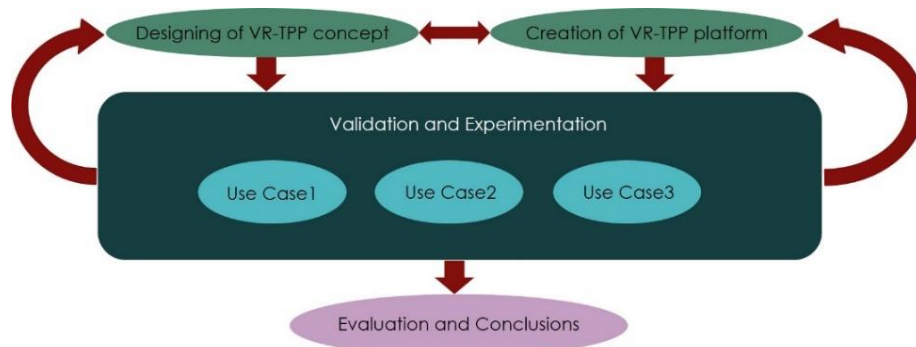

Figure 2: Research methodology

## 1.6 Thesis structure

The overall structure of this thesis is depicted in Figure 3 below.

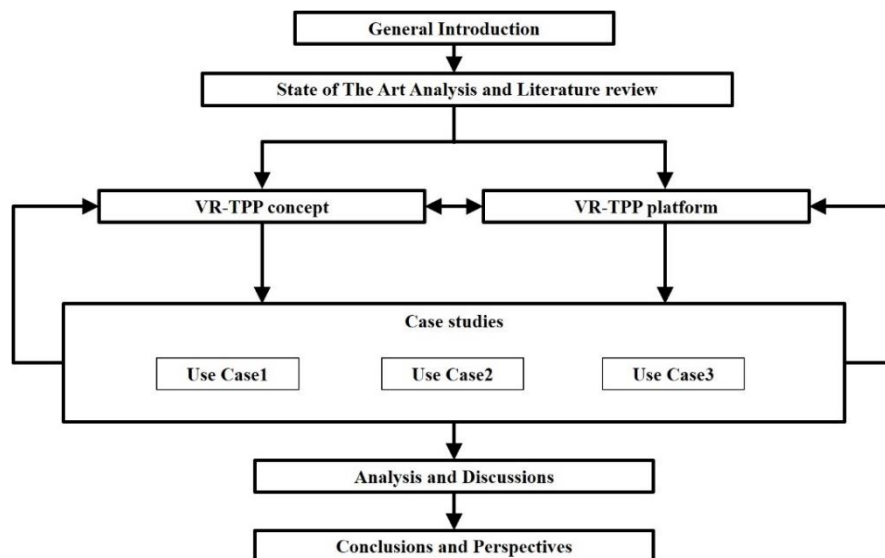

Figure 3: Thesis structure

Chapter 1 describes the research motivations, research context, research question, methodologies and the organization of the thesis in this chapter.

Chapter 2 contains a literature survey and an analysis of virtual reality technology for maintenance looking for maintenance techniques as well as devices and interactions techniques. The research begins with the domain of application of virtual technology in maintenance work. In addition, equipment, tools and interaction techniques will be presented in this chapter.

Chapter 3 presents the VR-TPP concept and approach which has been designed to support the training preparation process for maintenance work. The VR-TPP concept is composed of several tasks, namely the preparation task, the execution task, and the implementation task. Such tasks are defined in the preparation training phase which will also be explained in this chapter.

Chapter 4 demonstrates how the VR-TPP concept as a systematic approach can be implemented in the maintenance session and preparation process. This chapter explains creation process of a VR-TPP platform that derives from VR-TPP concept.

Chapter 5 demonstrates case studies to validate our concept and platform. Three different use cases will be implemented in case studies as follows:

- Validation of VR-TPP concept by disassembling process
- VR-TPP for creating a knowledge base of hand gestures
- Virtual Reality for Training in Maintenance Task

These case studies involve the use of both non-immersive and fully-immersive VR levels.

In chapter 6, user experience assessment will be analyzed through the case study 1 and 3. We evaluate and explain about the ease of use of VR devices, the realism perception and the side effects from participant's experience. Several potential directions for future research will also be proposed based on the insights of the case study analysis.

Chapter 7 concludes and gives perspectives based on the limitations of this research.





## **2 State of The Art**

### **2.1 Introduction**

This chapter presents the context of the virtual reality technology for training in maintenance task. The aim is to explain the evolution of training from the conventional training method to virtual reality technology for training. The traditional methods such as training manuals, job shadowing, and evaluations and certification processes often lack both efficiency and effectiveness. These methods also do not address the need to cater to different learning styles. However, workers do not have a lot of time to train in practice because the situation and environment in the real work does not support them in learning session.

In order to understand VR technology for trainings, some currently available environments and devices will be presented. Then, the VR technology for maintenance training, the VR for dis/assembling tasks, the VR training effectivity evaluation studies, and the hand gesture simulation for training in VR environments will be discussed and analyzed in terms of the stat of the art.

The final section discusses the results of review issues mentioned to study the problems and gaps for VR technology for maintenance training. It provides keys to assess to create and develop the concepts of integration of virtual reality technology in to the maintenance and operation of public transport systems.

### **2.2 Conventional maintenance training**

Whenever a company recruits new workers, they must train them before letting them work in the real working place. They must acquire expert knowledge and understand the process correctly, otherwise accidents and damage may occur to them. The training process is therefore necessarily the first step also in maintenance operations that shall be taken over by unskilled personnel. The training methods for such maintenance tasks depend in many ways on where the training is performed and the available training infrastructure.

This section presents training methods for off-site training and on-site training. Both training method are not only use for maintenance work, they also apply to other jobs as well.

### 2.2.1 Off-site training

Off-the-job training is conducted in a location specifically designated for training. It may be near the workplace or away from work<sup>5</sup>. Off-the-job training is conducted in a location specifically designated for training. It may be near the workplace or away from work. Training away from the workplace can reduce distractions and allow the trainees to fully concentrate on the training process. Offsite training has a variety of methods, these are often talk about lecturing, reading, watching visual and audio, etc.

#### 2.2.1.1 Classroom lectures

In this training method, the trainees learn the operations of machines and equipment, as well as all of the working process in a classroom where a trainer instructs them. In the classroom, there are many tools and methods used by trainees. They depend on the techniques of the trainer. For example, learning with diagrams, PowerPoint slides and videos.



Figure 4: Training with classroom lecture method<sup>6</sup>

An advantage of classroom lectures is the capacity to train large groups. However, the active participation of learners is important for learning and knowledge development, which may be limited if there is too much information.

<sup>5</sup> <https://www.ag5.com/training-on-the-job/>

<sup>6</sup> <https://www.victronenergy.com/blog/2020/01/21/victron-energy-training-in-the-americas/>

While interacting with an environment that has a lot of information, people can feel confused and irritated (De Koning, Tabbers, Rikers, & Paas, 2007). Another disadvantage is that it remains “theatrical”. We can show and present with video but we cannot let the trainees go to execution for “learning by doing”.

#### 2.2.1.2 Offsite lab-work

This training method is widely used to train the technicians and employees who deal with tools and machines. Employees learn their work with the equipment and machine they will be using on maintenance task, but the training will be conducted away from the actual work area. Tools and equipment are transported to the place where the training takes place, typically a workshop. It can be seen that both methods, classroom lectures and workshop training, are conducted distant from the actual work area relating to safety reasons of the workers. Sometimes the trainers or trainees need to travel to attend the training in the location for training.

Although the tools and equipment are used during the training, there are still limitations with tools and equipment that are large and expensive. Therefore, this off-site training is suitable for tasks that are not too complicated and it could be efficient for training many people per training session.



Figure 5: Workshop training method<sup>7</sup>

#### 2.2.2 On-site training

On-site training is a technique where the trainees can practice directly on the actual working area. Trainees can learn the skills needed in real working

<sup>7</sup> <http://www.poma.net/en/solutions-2/customer-service-performance-and-durable-evolutions-2/customer-service-performance-and-durable-evolutions/>

conditions and become familiar with the work environment. In addition, the companies do not need to invest any additional costs in setting up classrooms or installing models for training but they use the standard production line which can be shown down. With this method, a person will be teaching the skills needed to work on their job. Trainees learn under the supervision and guidance of workers. On-site training is a technique that based on the principle of “learning by doing” as well.

According to the TJinsite survey<sup>8</sup>, the on-site training method is voted the most preferred training method for employees by 71%. While the advantage of this training method is that it is directly on the job context. It is the most effective compared with other conventional training method because it is learned from experience and the trainees are highly motivated. Although this training method has many advantage, it is obviously less safe. Insufficient planning and control may be the cause of accidents and damage. Furthermore, some working areas cannot be productive during the training session.

### **2.2.3 Summary of conventional maintenance training**

Conventional maintenance training can be used for both training methods off-site and on-site. The use of both of them depends on many factors such as budget, training objective, number of participants, suitability of training institutions, etc. The off-site training is far from the actual workplace. This training method is most likely to be a part of lecture with PowerPoint slide and presentation with visual. Sometimes this method also simulates work situations that are close to the actual work by bringing actual equipment and tools to demonstrate practice to trainees. However, this method still has limitations about moving tools and equipment that are large and expensive. With on-site training, trainees can practice at the actual workplace and real working condition, with actual tools and equipment. The trainees are more familiar with the work than the off-site training. There is also a risk of improper planning. Furthermore, the machine and workplace have to be paused in order for setting up and conducting the training sessions. During this time, the equipment cannot be used for productive purposes.

### **2.2.4 Limitations of conventional maintenance training**

Currently, the conventional training method are not effective to meet the demands of modern factories considering the complexity of mechanical part and operation process<sup>9</sup>. Moreover, training with traditional method on the complex and dangerous industrial are high risk for worker life. In addition, the continuously rising density and complexity of mechanical parts and assemblies

---

<sup>8</sup> <https://tomfisherassociates.com/on-the-job-training-boosts-employee-morale/>

makes maintenance tasks increasingly difficult and hazardous (Liu X. , Cui, Song, & Xu, 2014). The traditional training method such as training manuals, job shadowing, classroom and workshop training appear therefore more and more often not efficient enough anymore.



Figure 6: Conventional Training Methods

The conventional training methods (off-site and on-site training) have been implemented in many industries:

- Most industrial processes include dangerous tasks which entrain risk for workers' lives and health, therefore it is difficult to train the people with the conventional on-site training method by facing without accident and damage.
- Off-site training makes a feeling of trainees different from real work, they cannot imagine the real workplaces and the tools they need to use including the lack of understanding of the real work process. They cannot deeply perceive appropriate gesture.
- Conventional on-site training may require a long training period, which leads to the absence of workers. In addition, some machinery and department need to be paused for training sessions. In addition, if the equipment is damaged during training sessions, the additional repair costs will increase. Furthermore, if a worker is injured during training, the increased expenses lead to legal problems, a negative company image, plus an unacceptable individual issue.

In addition, maintenance tasks are increasingly complex due to the increasing variety and complexity of the mechanical component design. The procedure and repairing process must be taken care of properly. Most maintenance processes involve disassembly and assembly in order to perform maintenance, repairing, remanufacturing, recycling and disposal. In this research, we focus on the disassembly and assembly processes.

As for the disassembly process, there are two main types of disassembly methods: destructive disassembly and non-destructive disassembly (Wang C. , 2014). The destructive disassembly, the components is removed from the product

---

<sup>9</sup> <https://www.simulanis.com/impact-story.php>

previously disassembled, by destroying or damaging some other components of the product. By contrast, the non-destructive disassembly, each one of the components can be removed without destroying. The non-destructive disassembly will be our target to apply with training preparation process because it is more common in maintenance, repairing, remanufacturing, recycling and disposal (Wang C. , 2014).

As for the maintenance process, workers have to learn how to disassemble and assemble parts in the correct position. Most of these methods are identified by paper manuals. There are no details about appropriate gestures or methods. In addition, work conditions that may be necessary about safety are not specified including the conditions about damage to mechanical parts such as force using, chemical and electrical factor, and other. The details of these factors cannot be demonstrated to the operator through the traditional training methods. Therefore, the training preparation process is an importance to design and show the detail of the appropriate working process as well as the correct conditions for working. The operators must learn from those steps first before going to work in the real work.

In recent years, many research papers applied AR/VR technology to improve the training of maintenance processes. (Vélaz, Rodríguez Arce, Gutiérrez, Lozano-Rodero, & Suescun, 2014) used virtual reality (VR) systems for teaching industrial assembly tasks and studied the influence of the interaction technology on the learning process. They used four devices for training with the VR system on the assembly task (mouse-based, Phantom OmniVR haptic, MMocap3D and MMocap2D). (Weijun., Xiao., & Lin., 2016) presented a method for constructing a nuclear power plant in service maintenance virtual simulation scene and virtual maintenance process. They demonstrate the advantage of using virtual reality technology to design and verify an in-service maintenance process of nuclear power plants compared to the conventional way. As the result of using VR system training, it could be applied to the training preparation process in order to address and build the right work instruction.

### **2.3 Virtual Reality technology**

Virtual reality is a product of the evolution of the computer from an instrument that merely received input from a user to a machine that can adapt to the user's cues to create an almost lifelike experience. Virtual reality is a term coined in 1989 by Jaron Lanier (Conn., Lanier., Minsky., Fisher., & Druin., 1989). Others describe this idea as "Virtual World". Virtual reality combines state-of-the-art imaging with computer technology to allow users experience a virtual environment. Virtual reality is a digital experience that can be representative or completely different from the real world. Virtual reality technology is used to create immersive experiences that can help educate and entertain people as well

as training. Virtual reality technology is used in a variety of industries such as medicine, architecture, military, advertisement, etc.

### **2.3.1 Virtual Reality systems**

It is difficult to categorize all VR systems, most configurations fall into three main categories and each category can be ranked by the sense of immersion (T.S.Mujber., T.Szecs., & M.S.J.Hashmi., 2004). There are three main types of virtual reality system used today, composing non-immersive (Desktop) system, semi-immersive system, and fully-immersive system.

#### **2.3.1.1 Non-immersive system**

Non-Immersive system also called Desktop VR system or Windows on World system (Bamodu., Oluleke., & Ye., 2013). It is the least immersive and it is also very cheap compared to other system, because it requires widdy speed components. Non-immersive system provides users with a computer-generated environment without feeling immersed in the virtual world. The feature of this immersive system allows users perceive virtual world around them with sound, image, and textile integration.

#### **2.3.1.2 Semi-immersive system**

The semi-immersive system is developed from the non-immersive system. It also keeps the simplicity of the semi-immersive system, but with a high level of immersion and using physical models (Bamodu., Oluleke., & Ye., 2013). Semi-immersive experiences provide users with a partially virtual environment to interact with. This type of VR is mainly used for educational and training purposes and the experience is made possible with graphical computing and large projector systems. With semi-immersive system, the people can see what is going on around them and interact with the objects they need. Semi-immersive system simulates on high-resolution displays and powerful computers or computer desktop.

#### **2.3.1.3 Fully-immersive system**

The fully-immersive system is a technology that allows users to experience virtual environment as the real world. This system allows users to perceive the experience in virtual world as the real world. The purpose of this system is to make users feel that they are in the real world while they are actually in the virtual world. Users can interact with virtual objects with VR tools such as Data glove (Karam., 2006). Fully-immersive systems are not limited to the use of head-mounted displays and controllers. With this hardware, the technology becomes more available for ordinary users. However, there are advanced solutions that offer a more realistic VR experience. One of them is CAVE, a term that stands for CAVE automatic virtual environment. The CAVE fully-immersive virtual



reality is a cubic room equipped with a set of stereoscopic display, built-in speakers, and motion capture system.

### **2.3.2 VR devices and interaction techniques**

Virtual reality equipment is constantly evolving and improving as well as software known as the reality engine. This section shows an overview of VR devices and interaction techniques to human perception to understand the working of VR systems. The VR devices are divided into major type: input and output devices. In addition, this section is presenting the interaction techniques in order to interface VR input and output devices.

#### **2.3.2.1 Input devices**

An input device is used to capture and interpret user actions in order to interface with the virtual environment. In this section, we focus on a simple connection device called Desktop input devices and the other connection device called tracking devices.

##### **1. Desktop input devices**

This input device is essentially a piece of hardware that sends data to a computer. The most common input devices are mouse and keyboard, as well as touchpad and touch screen, for recent technology.

- The keyboard is one of the primary input devices used to input data and commands. It has function keys, control keys, arrow keys, keypad and the key button with the letters, numbers and commands.
- The mouse interacts with a computer through a process known as “point and click”. The mouse is used to control the cursor and coordinates. It also includes buttons and possibly a scroll wheel to allow users to interact with the graphic user interface (GUI).
- The touchpad is a common substitute for a computer mouse. It is essentially a specialized surface that can detect the movement of a user's finger and use that information to direct a pointer and control a computer.
- The touch screen is a touch-sensitive monitor screen that reacts to fingers moving across it (Walker, 2012). Touch screens are particularly common in portable devices, such as tablets, palmtops, laptops, and smartphones. It has

the same initial function as touchpad, but 2D rendering is synchronized with finger activity.

## 2. Tracking devices

A tracking device is used to observe body movement or some part of body of user. Tracking devices are components in the VR system. Corresponding devices communicate with the VR platform in order to tell the orientation of a user's gaze. In systems that allow users to move around within a physical space, trackers detect where the users are, the direction users are moving and users speed. They can capture the full skeleton geometry at a very high frame rate. There are several different kinds of tracking systems used in VR systems. This section focuses on tracking methods including markers tracking and camera tracking.

- Marker tracking method uses infrared light to identify markers with optical tracking devices such as infrared camera (IR). In this method, a target is fitted with markers which form a pattern constellation. The visible markers serve as markers for optical tracking. A camera or multiple cameras constantly seek the markers and then use various algorithms to extract the position and orientation of the object from the markers. By synchronizing the camera, it is easier to block out other IR lights in the tracking area and reflect the IR light back towards the source almost without scattering. Then 3D movement of markers are captured. The implementation of this technology was applied by OptiTrack, MotionAnalysis, and etc.
- Camera tracking method uses a set of computer vision algorithms and tracking devices such as a camera of visible, a stereo camera and a depth camera. Cameras have to determine the distance to the object and its position in space, so it's necessary to calibrate. Camera tracking are reliable and relatively non-expensive.
- Video tracking method uses a set of computer vision algorithms and tracking devices such as a stereo camera and a depth camera. The capture data recovers the pose of an articulate body, which consists of joint and rigid parts using image-based observations. These system track the user to render their position. In addition, the system perform task like gesture recognition to enable the user to interact with the application. These technology is implemented by Leap Motion, Microsoft Kinect, etc.
- Magnetic tracking method is based on measuring the intensity of inhomogeneous magnetic fields with electromagnetic sensors. A base station is associated to the system transmitter or a field generator generate an alternating or a static electromagnetic field. The magnetic fields are generated by three coiled wires arranged in a perpendicular orientation to one another.

Each small coil becomes an electromagnet, and the system's sensors measure how its magnetic field affects the other coils. This measurement tells the system the direction and orientation of the emitter. A good electromagnetic tracking system is very responsive, with low levels of latency. One disadvantage of this system is that anything that can generate a magnetic field can interfere in the signals sent to the sensors. The magnetic tracking is implemented by Polhemus and in Razor Hydra by Sixense.

### 2.3.2.2 Output devices

An output device is used to send data from a computer to simulate information to users through the human perception system. In this topic, we focus on a sensorial channel fed back by interfaced devices including displays devices, sound devices and haptic devices.

#### 1. Display devices

Display devices are electromechanical systems capable of full motion graphic displays in order to display the information from the computer system to the human visual system. The performance of these devices depends on the following parameters: field of view, spatial resolution, screen geometry, light transfer mechanism, refresh rate and comfort of use. Display devices have various system, typical examples include a cathode ray tube (CRT), a liquid crystal display (LCD), a head mounted display (HMD), a projection screen, a stereoscopic display and CAVEs. These display devices are characteristics different perception also.



Figure 7: The head mounted display (HMD)<sup>10</sup>

---

<sup>10</sup> <https://www.anandtech.com/show/11778/dell-enters-vr-arena-with-visor-hmd>



Figure 8: The stereoscopic display<sup>11</sup>



Figure 9: The Cave Automatic Virtual Environment (CAVE)  
(P. Marayong, et al., 2020)

---

<sup>11</sup> <https://www.pressebox.com/pressrelease/schneider-digital-josef-j-schneider-ek/Beam-splitter-technology-New-passive-3D-PluraView-monitor/boxid/871431>

## 2. Sound devices

Sound devices present audio information through the human auditory system in order to generate and display a 3D spatialized sound allowing user to determine the location and direction of the sound. Sound devices also include any device that attaches to a computer for the purpose of playing sound, such as music or speech. There are many formats of audio, among them mono, stereo, surround, and 3D sound.

- Mono (meaning one) audio<sup>12</sup> is single channel audio. With mono, all audio is sent through one channel for playback. For example, if we are listening to mono audio, we will notice that whatever we hear in the right earbud, we will hear in the left earbud. That is because the speakers are playing back the same single channel audio file into both earbuds. We will not hear the drums in the left ear, or the guitar in the right. Everything will just sound like its right in front of us, evenly dispersed through both earbuds.
- Stereo is an upgrade format from mono<sup>12</sup>, the stereo audio is two channel audio. With stereo audio user can localize audio sources to the left and right when listening, but not above, behind or below.
- Surround sound<sup>3</sup> is a mixing process and playback experience. The surround sound is mixed from several mono and stereo audio files by computer program. Once this surround sound mix is created, it can be played back through a surround sound speaker system. Surround systems can be 5.1 (5 speakers, one subwoofer) to 7.1 to 21.1, all depends on the number of speakers to mix for during the mixing process.
- 3D audio is the newest in the world of audio<sup>12</sup>. Virtual Reality has brought about this format as most audiences in VR experiences want the sound to move around them as they explore virtual environments just like the visuals do.

## 3. Haptic devices

The haptic devices simulate physical interaction between user and virtual objects within virtual world. Users are able to perceive the physical interaction to 3D objects by tactile and force feedback. Tactile is a perception by the skin. Tactile feedback allows users to feel things such as the texture of surfaces, temperature and vibration. While, force feedback reproduces directional forces that can result from solid boundaries, the weight of grasped virtual objects, mechanical compliance of an object and inertia (Berkley, 2003). Haptic devices

---

<sup>12</sup> <https://hookeaudio.com/blog/binaural-3d-audio/difference-mono-stereo-surround-binaural-3d-sound/>

are input and output devices, that mean they track a physical manipulation from users (input) and provide the sensations of tactile or force feedback back (output) to the users. Examples of haptic devices for perception of force feedback and tactile feedback such as PHANTOM™ device and Data Gloves device.

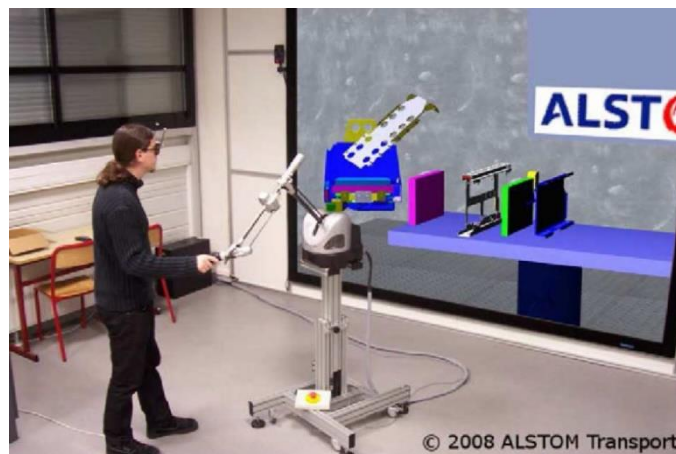

Figure 10: Assembly simulation using haptic device  
(Ladeveze, Fourquet, & Puel, 2010)



Figure 11: Data glove in a six-sided CAVE  
(S. & Zaldivar-Colado, 2007)

### 2.3.2.3 Interaction techniques

Interacting the input device to the virtual environment system requires interaction technique. There are many differences interaction techniques used in virtual reality technology. Interaction techniques allow people to interact with the technology without the need of intermediate devices for the user interaction; these interactions rather take place directly using hand gestures or body movements (Kharoub, Lataifeh, & Ahmed, 2019). Thus, it is very important to understand how the interaction techniques can be used in virtual reality technology. These interaction techniques should consider the necessary compenence for an effective learning which includes input devices and interaction techniques for the purpose of navigation, selection and manipulation in the virtual environment. These three key interaction modes were identified by Bowman (Bowman, Kruijff, LaViola, & Poupyrev, 2001).

#### 1. Navigation

The computer needs to provide the user with information regarding location and movement. Navigation tasks have two main modalities: travel and wayfinding. The travel is a movement from the current location to target point. The wayfinding is the finding and setting the way to get to a travel goal within the virtual environment.

- Travel perception is mainly defined by the control of the user's viewpoint motion from one location to another in the 3D environment. Furthermore, a good travel techniques allow the user to easily move through the environment. There are several travel techniques: physical movement, manual viewpoint manipulation, steering, target-based travel and route planning.
- Wayfinding in virtual space is different and more difficult to do than in the real world because synthetic environments are often missing perceptual cues and movement constraints. It can be defined by cognitive navigation action in a physical space using the users' space knowledge in relation to objects, landmark, road sign, etc. (Khundam C. , 2019).

#### 2. Selection and manipulation

In the virtual environment, users can interact with a virtual object through selection task and manipulation task (Bowman. D. A., 1998). The selection task refers to the act of specifying or choosing an object for some purpose. Sometime it is called a target acquisition task (Zhai & Milgram, 1994). Manipulation is the task of setting the position, rotation and scaling of a selected object. The positioning is used to change the 3D position of the objects. The positioning in virtual environment is a movement of the objects from a starting location to target location. Then, the rotation is used to change the orientation of the objects.

Furthermore, the scaling is used to change the size of the objects. Other techniques include the Go-Go technique, Finger-Based Grasping techniques, Ray-Casting techniques and Image-Plane Pointing techniques.

- Go-Go techniques (Poupyrev, Billinghurst, Weghorst, & Ichikawa, 1996) attempt to improve on the simple virtual hand by providing an unobtrusive technique that allows the user to interactively change the length of the virtual arm. Go-Go techniques therefore provide a simple way to interactively change the length of the virtual arm—simply by stretching the real hand out or bringing it closer.
- Finger-Based Grasping techniques lets the user interact with and manipulate the objects with more precision. It enables new interactions, such as holding a virtual object between one's virtual fingers. However, this technique is still without haptic feedback, it may be difficult to determine to move the finger to interact with virtual objects in the virtual environment.
- Ray-Casting techniques (Jr., Kruijff, McMahan, Bowman, & Poupyrev, 2017) is used to point at objects with a virtual ray that defines the direction of pointing, and a virtual line segment attached to the hand visualizes the pointing direction. The pointing vector in the case of the simple ray-casting technique is estimated from the direction of the virtual ray that is attached to the user's virtual hand.

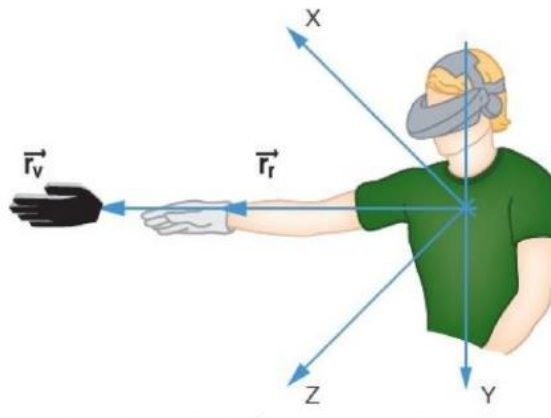

Figure 12: Go-Go interaction technique: egocentric coordinate system  
(Poupyrev, Billinghurst, Weghorst, & Ichikawa, 1996)



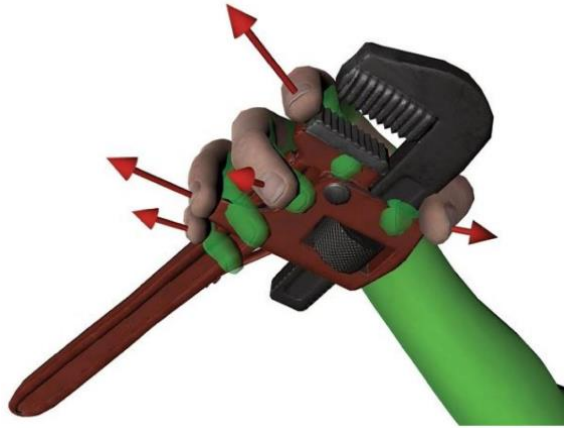

Figure 13: Rigid-body fingers  
(Jr., Kruijff, McMahan, Bowman, & Poupyrev, 2017)

- Image-Plane Pointing techniques is used to select and manipulate 3D objects by touching and manipulating their 2D projections on a virtual image located in front of the user.

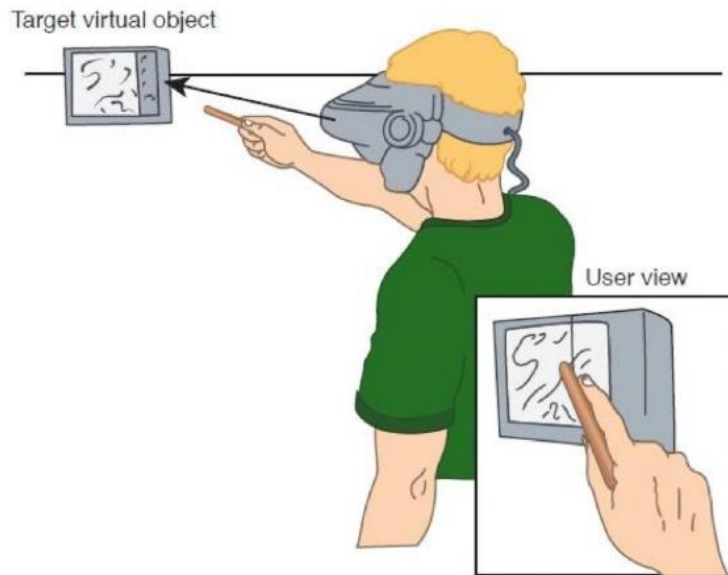

Figure 14: The “sticky finger” image-plane pointing technique  
(Jr., Kruijff, McMahan, Bowman, & Poupyrev, 2017)

## **2.4 VR technology for maintenance training**

At the present, the industrial competition and the products complexity push the industrial companies to develop and to adopt new design methods (Ayadi, et al., 2013). Especially, in maintenance section. Maintenance work has a complex operation that requires a specific knowledge and techniques for each machinery and equipment. Due to the variety of machineries and equipment are continues to increase, industrial companies find themselves required to provide regular training for technicians. The result is a time consuming and expensive training process. Therefore, finding a way to train technicians to work more efficiently will benefit the industry. In a virtual environment, a VR technology promise to make a maintenance training better and more efficient. The VR systems use a computer-generated environment to simulate interactions with a real system or machine. The system has the potential to be cost effective and saving both time and money, while receiving a high level of training (Gavish., et al., 2015).

The application of VR technologies for training has been found to provide a range of benefits compared to traditional training systems. It allows training under the learning-by-doing approach when constraints prevent training in the real environment (e.g. safety, time, or cost constraints) (Derossis, M., J., & Fried, 1998) (Gosselin, Ferlay, Bouchigny, Mégard, & Taha, 2010) (Nishino, Murayama, Kagawa, & Utsumiya, 2010). The VR technology is used also to practice training in human activities such as aviation (Blake, 1996), medical training (Albani & Lee, 2007), paintings (Baxter, Scheib, Lin, & Manocha, 2001) and industrial design (Portillo-Rodriguez, et al., 2006).

The concept of virtual maintenance has been proposed so far, and the study of virtual maintenance has developed to various industries. However, the definition of virtual maintenance is not clear, and there are no uniform international standards (Rao, Xu, Jing, Zhang, & Zhao, 2017). Many examples of VR systems for maintenance training have been presented in the literature, the main content of maintenance training is dis/assembling task. In addition, VR systems can provide extra instruction that can facilitate the learning of the task and they allow simulating the task in a flexible method to adapt it to users' needs and training goals (Derossis, Bothwell, Sigman, & Fried, 1998).

## **2.5 Virtual reality for Dis/Assembly task**

Virtual reality for dis/assembly can be roughly divided into two categories (Wang C. , 2014). The first category's purpose is to check the general assemblability of the design: part accessibility, tool usage, generation of sequences and trajectories of assembly operations, etc. The second category focuses on some sort of snapping mechanism which automatically completes an assembly operation when two parts close enough are moved in a virtual environment. Today, VR environments have significantly developed towards

dis/assembling simulation. For instance, Gavisha et al. (Gavisha., et al., 2015) compared the VR and AR training platforms with the traditional assembly process of an electronic actuator. Gutierrez et al. (Gutierrez, et al., 2010) described a multimodal virtual training system for the cognitive and motor skills transfer involved in industrial maintenance and assembly tasks. Al-Ahmari et al. (Al-Ahmari A. M., Abidi, Ahmad, & Darmoul, 2016) detailed the design of a virtual manufacturing assembly simulation system (VMASS) which they used for manual manufacturing assembly training. Murray and Fernando (Murray & Fernando, 2004) presented procedures and environments for realistic component assembly, constraint recognition, automatic disassembly sequence generation, and maintenance review and training. Imbert et al. (Imbert, Vignat, Kaewrat, & Boonbrahm, 2013) demonstrated the realistic feeling on assembling the virtual model by Augmented Reality (AR) technology. The main objective was to reduce unforeseen problems in designing of maintenance process. All these simulations address different tasks such as: dis/assembling sequencing, working time evaluation, transferring knowledge, etc.

Surprisingly, only few works have empirically studied how to apply virtual dis/assembling simulation to investigate appropriate hand gesture in order to create work instructions. Gue et al. (Guo, et al., 2018) proposed an immersive maintainability verification and evaluation system (IMVES) based on virtual reality. In order to develop a cost-effective, rapid and precise method to improve the maintainability design in the early design stages, they presented a case study applying IMVES to an aero-engine project to demonstrate the effectiveness and feasibility of the system. In order to reduce the lifetime operating costs of large scale mechanical products during a products design phase, Murray and Fernando (Murray & T., 2004) have investigated the design and implementation of a virtual prototyping environment, which can support the assessment of assemblability and maintainability of mechanical products in the early design stages. They have also shown how this environment can be used to support maintenance training for engineers by case studies. These works, however, also do not focus on the particular challenges associated with hand gesture simulation.

There have been proposed different virtual assembly platforms that used to simulate the manufacturing process and dis/assembly operations. Germanico et al. have been presented a literature review of different VR platforms as shown in Figure 15. All this platforms are physics-based, constraints-based or a combination of both of them.

System	Year	Assembly method	Key Features	Haptic Device
HIDRA[16]	2001	Collision detection	Integrates a haptic feedback into a (dis) assembly simulation environment Manipulate parts using two fingers	Phantom desktop
MIVAS [10]	2004	Physics based	Optimization techniques for complex models and assembly operations Tracking of user movements and voice commands Realistic virtual hand interaction for grasping of virtual parts Documentation of assembly planning results	CyberGrasp one hand
VADE [12]	2004	Physics and constraints	Users can perform the assembly using hands and tools such as screw drivers During the assembly process VADE maintains a link with the CAD system Let the user to make decision and design changes Swept volume generation and trajectory editing	CyberGlove two handed
SHARP [11]	2006	Physics based	Capability of create subassemblies Swept volumes for maintainability Network module for communication with different VR systems Portable, runs on different VR systems such as HMD, CAVE, projection walls and monitors	Phantom omnidual handed
VEDAP-II [7]	2009	Physics based	Oriented to assembly planning and evaluation Focuses on modeling the dynamic behavior of parts during virtual assembly operation	CyberGrasp one hand
MRA [21]	2009	Physics based	Use of low cost technologies for two hands assembly Real scale projection and tracking system to change point of view The system demonstrates the assembly procedures and the user must repeat it	6D35-45 / Wii-mote
VCG [3]	2010	Constraint based	Oriented to assembly planning and training Method of constraint guidance to perform the assembly Use of virtual fixtures, use of mechanical constraints, intuitive assembly, on-line activation of kinematic constraints	Virtuose 6D35-45 one hand
IMA-VR [5]	2010	Constraint based	Virtual training system for the cognitive and motor skills transfer combining haptic, gestures and visual feedback Uses the concept of spring-damper model to avoid parts interpenetration Visual dynamic behavior of parts to represent manipulation of real parts	Phantom/LHifAM/ GRAB two hands
HITsphere system [6]	2011	Physics and constraints	Immersive virtual environment with walking capability to simulate ground walking Free manipulation of virtual objects Automatic data integration interface Constraint-based data model is rebuilt to construct the virtual assembly environment	Phantom Premium one hand

Figure 15: Key features of some virtual assembly platforms.

Constraint-based modeling methods use inter-part geometric constraints to determine the relationships among components in the assembly. They are based on formalizing each contact as a one-sided constraint and solving the resulting system of equations for the object positions. Constraint-based modeling has two advantages: first, it does not require intensive computing power, and it uses information that is available in the CAD models (Marcelino, Murray, & Fernando, 2003). Constraint-based application can produce realistic results, without unwanted artifacts and with the possibility to computer contact friction correctly (Perret, Kneschke, Vance, & Dumont, 2013) (Tching, Dumont, & Perret, 2010). There are two types of constraints modeling, which are positional constraints and geometric constraints (Seth, Vance, & Oliver, 2011). Position constraints can be represented by a set of equations, which can be solved based on numeric, symbolic or graph-based methods (Gao & Chou, 1998). By contrast, The geometric constraints focus on the rigid body transformations which satisfy a set of constraints presenting the relationships among all components (Leu, et al., 2013).

Physics-based system modeling is based on the simulation of physical interaction in time (Wang., 2014). It is applied primarily in the interactive dynamic simulations with human operators involved. Physics-based modeling simulates realistic behavior of parts in virtual environment, where parts are assembled with each other. The method is always accurate and enables fast collision detection related to the calculated velocities and forces at the contact points. The forces can be returned to the operator through force feedback devices. There are two types of physics-based modeling algorithms, depending on the used method: the penalty force and the impulse algorithm (Leu, et al., 2013).

## **2.6 VR training effectivity evaluation studies**

There are numerous methods for evaluating the usability of interactive computer applications. These methods have well-known limitations, especially for evaluating virtual environments (Bowman., A., L., & Hix, 2002). The roles involved in usability evaluation typically include a developer (who implements the application and/or user interface software), an evaluator (who plans and conducts evaluation sessions), and a user or subject (who participates in evaluation sessions). Bowman et al. (Bowman., A., L., & Hix, 2002) have compiled a list of usability evaluation methods that have been applied to virtual environment. These methods include: Cognitive Walkthrough, Formative Evaluation, Heuristic or Guidelines-Based Expert Evaluation, Post-hoc Questionnaire, Interview/Demo, and Summative or Comparative Evaluation.

- **Cognitive Walkthrough**

This evaluation approach is used to evaluate a user interface based on learning through common tasks that a user would perform and evaluating the user interface's ability. This approach shall help understand the usability of a system, e.g. (Abate., Guida., Leoncini., Nappi., & Ricciardi., 2009).

- **Formative Evaluation**

This evaluation method is used to observe and evaluate the user interaction. Users are requested to practice in a virtual environment to identify usability problems from the system. This method is also used to assess the design's ability to support user exploration, learning, and task performance. Formative evaluations can range from being rather informal, providing mostly qualitative results such as critical incidents, user comments, and general reactions, e.g. (Ragan E. D., et al., 2015), (K., Y., & Z., 2016), (Bailey, Johnson, Schroeder, & Marraffino, 2017), (Ma, Laroche, Hervy, & Kerouanton, 2013).

- **Heuristic or Guidelines-Based Expert Evaluation**

This method is used to evaluate a user interface design by applying relevant design guidelines. The results from several experts are then combined and ranked to prioritize design of each usability problem discovered. The experts will also be asked to observe and evaluate the working process during user operated, e.g. (Nielsen & Mack, 1994), (Gleeson, MacLean, Haddadi, Croft, & Alcazar, 2013).

- **Post-hoc Questionnaire**

This evaluation method uses a question set to get the information and views and interests of users after they participated in experiments in a virtual environment. The questionnaire is good method to collect the subjective information, and is often more convenient than a personal interview, e.g. (Gavish, et al., 2015), (Borsci., Lawson., Jha., Burges., & Salanitri., 2016), (Vora, et al., 2002), (Qiu, Fan, Wu, He, & Zhou, 2013), (Segonds, Iraqi-Houssaini, Roucoules, Veron, & Aoussat, 2010).

- **Interview/Demo**

This evaluation technique is used to collect information from users by talking to them directly. Such interviews can gather more information than a questionnaire and go into more details. Interviews are great to give responses and opinions related to problematic issues. In order to obtain unbiased information that is not pre-formatted, the interviewer should to ask broad questions without a fixed set of answers, and also follow the path of questions that may spontaneously arise during the interview, e.g. (Hix & Hartson, 1993).

- **Summative or Comparative Evaluation**

This method is used to compare a statistical information of two or more configurations of user interface designs. For example, Vora et al. (Vora, et al., 2002) have compared the VR simulator and ASSIST using subjective evaluation to see user's preference from such training program.

## **2.7 Hand gesture simulation for training in VR environments**

Virtual hands are one of the most challenging applications of virtual reality. In order to perform maintenance tasks in virtual environments, virtual hand interaction have a key role (Huagen, Shuming,, & Qunsheng, 2004). Virtual hand applications have been introduced in the late 1980s (Shu & Niandong, 2010). Many researchers have worked on the problem and proposed different solutions. Sun and Hujun (Sun & Hujun, 2002) have proposed a framework of a two-handed virtual assembly planner for assembly applications which coordinated two hands jointly for feature-based manipulation, assembly analysis and constraint-based task planning. Lu et al (Lu, Shark, Hall, & Zeshan, 2012) have developed and

evaluated an immersive human–computer interaction system based on stereoscopic viewing and natural hand gestures. The user can use a number of simple hand gestures to perform basic object manipulation tasks involving selection, release, translation, rotation and scaling. Ullmann and Sauer (Ullmann & Sauer, 2000) studied a basic algorithm for grasping with one or two hands through a data glove. They have described a method to precisely manipulate the grasped objects between the virtual fingers. Morst and Borst (Mores & Borst, 2012) studied a virtual grasp release method. They used heuristic analysis of finger motion and a transient incremental motion metaphor to manage a virtual hand during grasp release. A virtual hand is often used as the avatar of the user’s hand to interact with mechanical components within virtual environment (Morst & Borst, 2015). As for the user’s hand interaction, almost all of these works focused on grasping the objects in a virtual environment. By contrast, the specification of appropriate grasps and hand gestures have received much less attention. The definition of a grasp comprises every static hand posture with which an object can be held securely with one hand, irrespective of the hand orientation (Feix, Romero, Schmiedmayer, Dollar, & Kragic, 2015). Huagen et al. (Huagen, Shuming, & Qunsheng., 2004) described the grasping related to size and shape of the objects as shown in Figure 16. In the same way, Liu et al. (Liu X. , Cui, Song, & Xu, 2014) also classified a grasp gestures related to a basic shape such as cuboid, cylinder, and sphere etc. as shown in Figure 17. Feix et al. (Feix, Romero, Schmiedmayer, Dollar, & Kragic, 2015) have analyzed and compared existing human grasp and synthesize them into a single new taxonomy. The grasps are arranged classified in four types as shown in Figure 18.

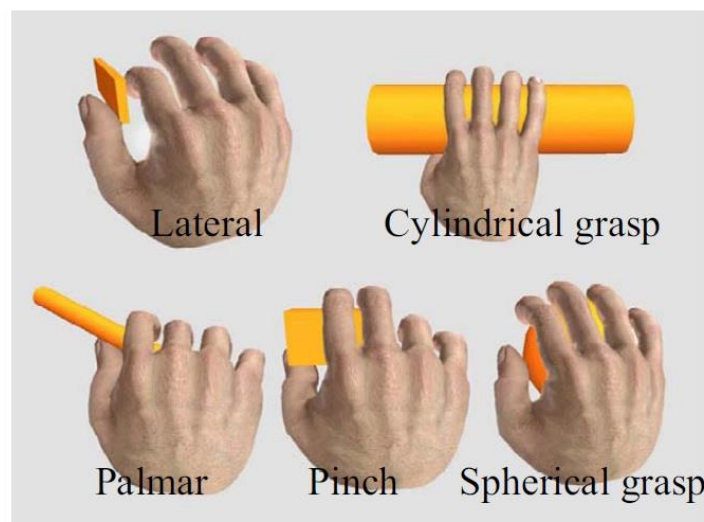

Figure 16: Grasping patterns  
(Huagen, Shuming, & Qunsheng., 2004)

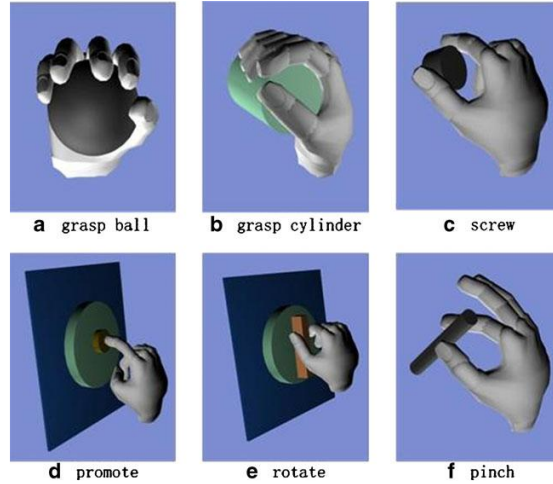

Figure 17: Gesture with virtual hand related to a basic shape  
(Liu X. , Cui, Song, & Xu, 2014)

Opp: VF:	Power					Intermediate		Precision					
	Palm		Pad			Side		Pad		Side			
Thumb Abducted	3-5	2-5 1: Large Diameter 2: Small Diameter 3: Medium Wrap 10: Power Disk 11: Power Sphere	2 31: Ring	2-3 28: Sphere Finger	2-4 18: Extension Type 26: Sphere 4-Finger	2-5 19: Distal Type 23: Adduction Grip	3	3-4 21: Tripod Variation	2 9: Palmar Pinch 24: Tip Pinch 33: Inferior Pincer	2-3 8: Prismatic 2-Finger 14: Tripod	2-4 7: Prismatic 3-Finger 27: Quadpod	2-5 6: Prismatic 4-Finger 12: Precision Disk 13: Precision Sphere	3 20: Writing Tripod
Thumb Adducted		17: Index Finger Extension 4: Adducted Thumb 5: Light Tool 15: Fixed Hook 30: Palmar				16: Lateral 29: Stick 32: Ventral	25: Lateral Tripod					22: Parallel Extension	

Figure 18: GRASP taxonomy  
(Feix, Romero, Schmedmayer, Dollar, & Kragic, 2015)



In research literature, the virtual hands are used to execute tasks in virtual environments. In order to classify and create a gesture taxonomy, the shape and size of the object to be grasped are considered. So far, however, it seems that such a gesture taxonomy has not yet been used for a specific purpose linked with VR-based dis/assembly training. Furthermore, while some basic geometric objects have been used in order to classify and characterize hand gestures, mechanic joints that play a decisive role in mechanical dis/assembly have not been investigated in relationship with appropriate hand gestures.

## **2.8 Summary**

This chapter has investigated the evolution of VR-based maintenance training in research literature. It begins with the evolution of training from conventional training methods to the virtual reality technology for training. The beginning section explains conventional training methods: the off-site training and on-site training. In the past, these conventional training methods are widely used form of training. Nowadays, the mechanical parts and related assembly processes are increasingly complex and dangerous. Training with conventional training methods are therefore hazardous and safety-critical. Consequently, for many modern industrial applications, conventional training is often inappropriate.

A particular focus was directed on the use of VR technology for dis/assembly. It was confirmed that VR technology provided a range of benefits compared to traditional training systems and allows training in a learning-by-doing approach. Furthermore, the VR environments have significantly developed towards dis/assembling simulation. All these simulations address different challenges, most notably dis/assembling sequencing, working time evaluation, as well as transferring knowledge.

Although VR technology is widely used in maintenance work, the definition of virtual maintenance is not yet clear and there are no similar international standards (including platforms and devices used), as well as the VR training assessment. For evaluating VR training effectivity, different methods have been published, each with their particular strengths and weaknesses.

The chapter studied in depth how to use virtual hands for training. It was found that the virtual hand was widely applied in creating training courses. In particular, the study of the classification of hand gestures used to grasp the objects. Those gestures are distinguished by the way of grasping objects that have basic geometric shapes. The object's size is also a factor in the classification.

From the research literature, it was found that the virtual hands are widely used to create and operate in a virtual environment. Those hand gestures simulations are mostly used in the training process. Surprisingly, however, only few works have empirically studied on how to use virtual hands to characterize gestures and link them with work instructions for VR-based dis/assembly trainings. In addition, the platforms and devices that are most appropriate for

particular virtual dis/assembly trainings have not yet been characterized. Consequently, it is difficult to determine and compose the VR environment that is the most appropriate for a particular training task and scenario to be taken to virtual space. Furthermore, there is only few experiences about creating specific training sequences, and compile them in the form of a work instruction. This gap leads to industrials being reluctant to adopt VR-based dis/assembly trainings at a large scale. In the following, this thesis will try to at least partly fill this gap through the contribution of a holistic concept that aims at supporting in particular the preparation phase of VR-based trainings and related work instructions.



## **3 A Systematic Approach to Preparing VR Maintenance Training**

### **3.1 Introduction**

The state the art analysis in the previous chapter resulted in the identification of a research gap characterized by the lack of frameworks formalizing the preparation phase of VR-based trainings, which is however crucial for the determination of the appropriate VR devices, their setup, as well as the training sequence and related work instruction. Furthermore, the focus on dis/assembly operations in mechanical maintenance requires particular attention to be given to the appropriate integration of virtual hands, as well as their interactions with mechanical joints.

This chapter presents a key contribution of this thesis to address these shortcomings, the “Virtual Reality technology for Training Preparation Process” (VR-TPP) concept for structuring the training preparation phase, as well as creating working instructions with appropriate gesture simulation and specification.

### **3.2 The concept of VR-TPP**

The concept of Virtual Reality technology for Training Preparation Process (VR-TPP) is designed to support the training preparation process of maintenance work. Normally, in the traditional training process, many companies prefer using the real product over a physical mock-up training because this method is easy to set up and clearly close to real practice. However, both the availability and accessibility of the real product and equipment is typically a usual problem. Furthermore, training on real system should be avoided when we face high safety risks.

Many companies have developed training methods based on virtual reality technology as shown in Figure 19. They can create the training process and use it to train the new worker without trainers having to go anywhere. However, the trainees must still learn the correct working posture from an expert first.

### Traditional training method



### VR training method



Figure 19: The process of traditional training and VR training method

The appropriate hand gestures and operating process should be clarified before using in the training process in order to reduce operation time as well as the risk of accidents. The VR-TPP concept is used for capturing the expert hand gestures and operation process in the training preparation process as shown in Figure 20.

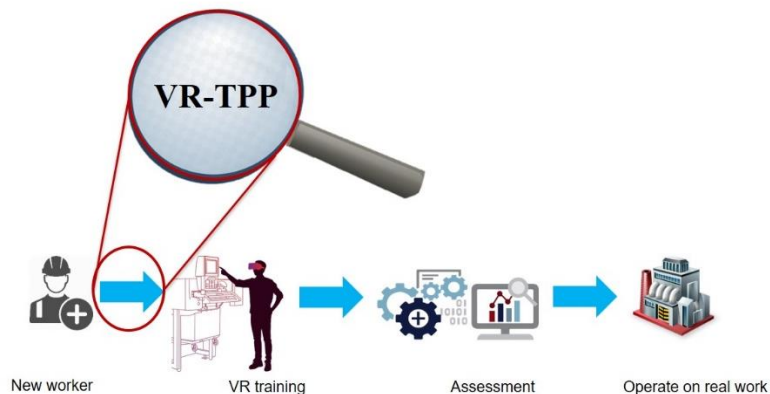

Figure 20: The position of the systematic approach of VR-TPP concept

### 3.3 Systematic approach of VR-TPP concept

The systematic approach of VR-TPP concept consists of the following four tasks: preparation, execution, implementation and training, clustered in two phases, the preparation phase and the training phase as shown in Figure 21. The preparation phase consists of 3 tasks: preparation, execution and implementation. The preparation task consists of 2 modules: model preparation and work instruction (WI) making. Then, the execution task consists of 3 modules: recording, translation and VR using. While the implementation task has an assessment module.

The VR-TPP environment consists of several modules. We need a data model which manages the information shared for all the other modules. While VR is used for the training session, the originality is to use VR also to track real hand gestures and to prepare the training content. Depending on the nature and difficulty of the gesture necessary for maintenance, the concept allows for different devices to be evaluated. Various tracking systems for fine gestures exist (e.g. mouse manipulation, Leap Motion, data glove, IR tracking system as well as real sense accelerometer). Almost all these systems require global positioning which is invasive in industrial context and not efficient because of potential occlusion. It is therefore hard to record the expert gesture in a real workshop. Consequently, this systematic approach of VR-TPP is to invite the maintenance expert to reproduce gesture within a VR environment. The main benefit of this systematic approach is to prepare appropriateness of postures and hands gestures in training preparation phase.

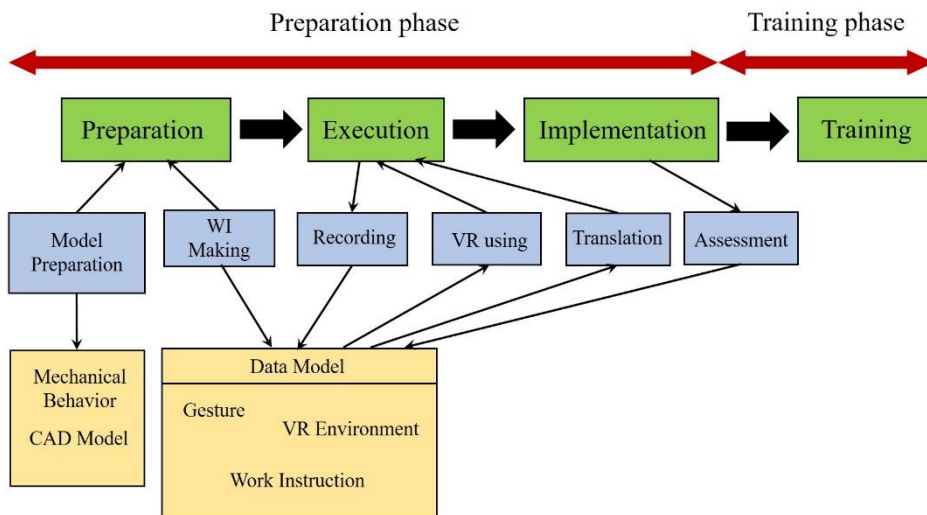

Figure 21: The systematic approach of VR-TPP

### 3.3.1 Preparation Task

The preparation task prepares information about the import of the necessary 3D objects that are used to create a virtual environment, including the determination of various conditions to the input such objects. The preparation task consists of two modules: model preparation and WI making.

#### 3.3.1.1 Model preparation module

The model preparation module is used to import the 3D model (3D CAD) to the virtual environment. This module also describes the relation between parts in the virtual environment. In addition, the mechanical behavior of 3D models in the virtual environment have to be configured for the types of mechanical and kinematic joints.

##### 1. CAD model

This is obtained by importing 3D CAD data to the virtual environment. Usually, the 3D models are created with a commercial software and exported from there to the virtual environment. A 3D file format is used to store the information about 3D models. There are many 3D file formats in use. The most common 3D file formats today: STL, OBJ, FBX, COLLADA, 3DS, IGES; STEP, and VRML/X3D. In the following, some of these will be discussed: STL, OBJ and STEP. These files format are widely used for virtual reality technology.

*The STL file format* is one of the most important neutral 3D file formats in the domain of 3D printing, rapid prototyping, and computer aided manufacturing. It is native to the stereolithography CAD software made by 3D Systems. The corresponding file extension is STL format (.stl). The STL file stores information about 3D model but it ignores appearance, scene, and animations. It is one of the simplest and leanest 3D file formats available today. The format represents the raw surface of a model with small triangles and encodes the surface geometry of a 3D model approximately using a triangular mesh as shown in Figure 22.

*The OBJ file format* is a standard 3D image format that can be exported and opened by various 3D image editing programs. This file format contains a three-dimensional object, which includes 3D coordinates, texture maps, polygonal faces, and other object information. The OBJ file may be accompanied by a MTL (Material Library) file, which references the materials and colors used as shown in Figure 23.

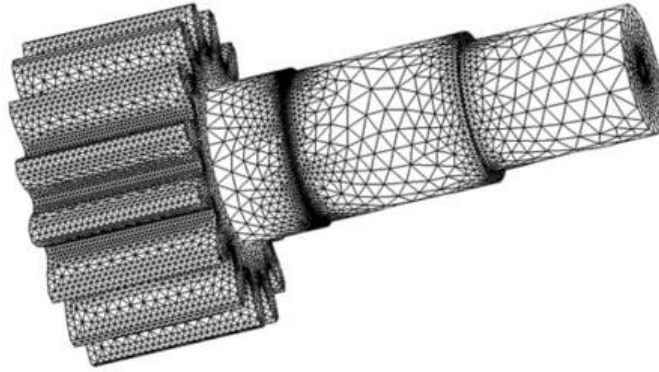

Figure 22: The characteristics of 3D object on STL file format<sup>13</sup>

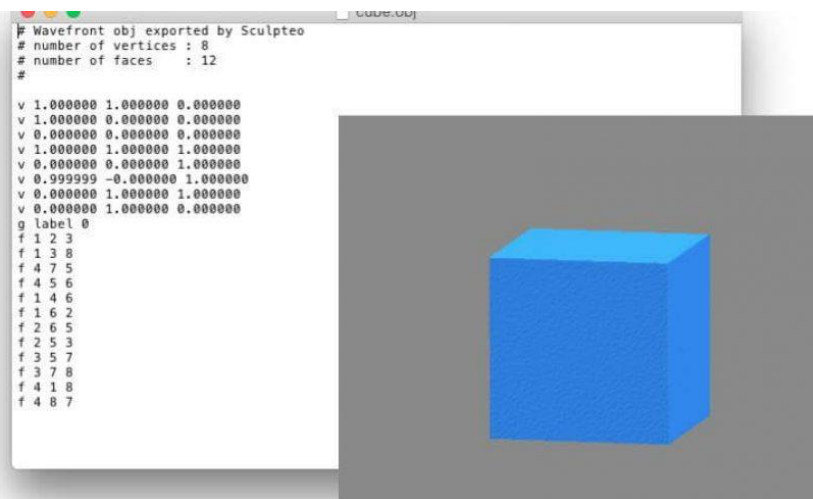

Figure 23: OBJ file representing a cube<sup>13</sup>

*The STEP file format* (The Standard for the Exchange for Product Data) or ISO 10303 is developed as a successor of the IGES file format. The objective of developing STEP is to create a mechanism that is capable of describing product data throughout the life cycle of a product, independent from any particular system. The STEP format encode topology, geometrical tolerances, material properties like textures, material types, and other complex product data as shown in Figure 24.

<sup>13</sup> <https://www.sculpteo.com/en/glossary/obj-file-3d-printing-file-format/>



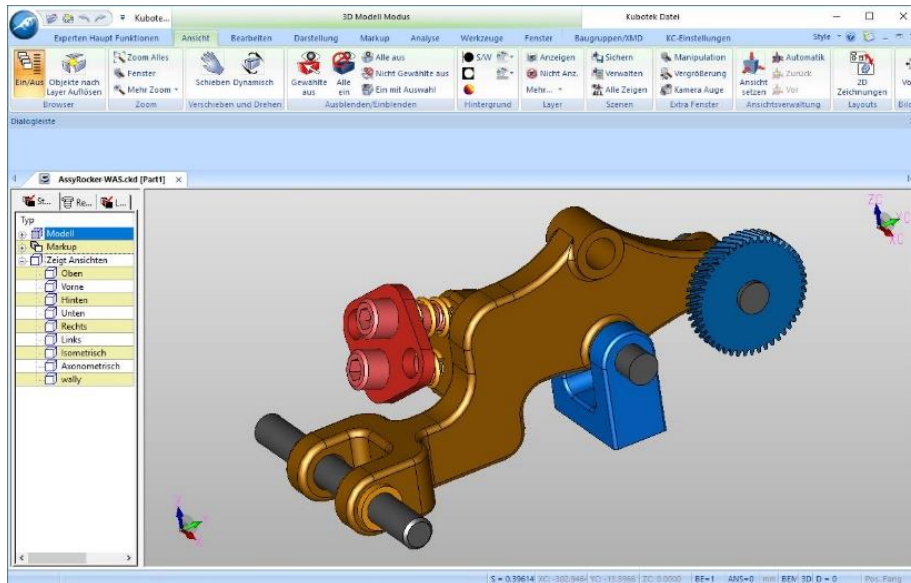

Figure 24: The characteristics of 3D object on STEP file format<sup>14</sup>

## 2. Mechanical behavior

The mechanical behavior means the determination of the interaction behavior between 3D virtual objects in the virtual environment that refer to types of mechanical joints. Understanding their specific behaviors and properties is vital for achieving realism in the virtual environment. In addition, the weight and factors that relate to gravity and impact force have to be defined.

*Types of mechanical joints* are broadly classified into two classes: non-permanent joints and permanent joints. Non-permanent joints can be assembled and disassembled without damaging the components. For examples of non-permanent joints are threaded fasteners, keys and couplings etc. For the permanent joints, this joints cannot be disassembled without damaging the components. For example, riveted joints, welded joints, brazed joints and etc.

<sup>14</sup> <https://3d-printing-expert.com/step-design-files-is-a-3d-cad-design-file-format-for-manufacturing-production/>



Figure 25: Non-permanent joints and permanent joints<sup>15</sup>

The non-permanent joints are widely used in assembly and disassembly process in maintenance work that involves fasteners, press fit (snap fit), cotter joint, and knuckle joint technique.

- Fasteners technique

The fasteners technique is used to mechanically join two or more objects together. Mechanical fasteners are usually made of stainless steel, carbon steel, or alloy steel. There are many different types of mechanical fasteners used in many different industry sectors. For example, bolts, screws, nuts, studs, and etc. as shown in Figure 26, Figure 27 and Figure 28.

---

<sup>15</sup> <http://www.differencebox.com/engineering/difference-between-temporary-joining-and-permanent-joining/>

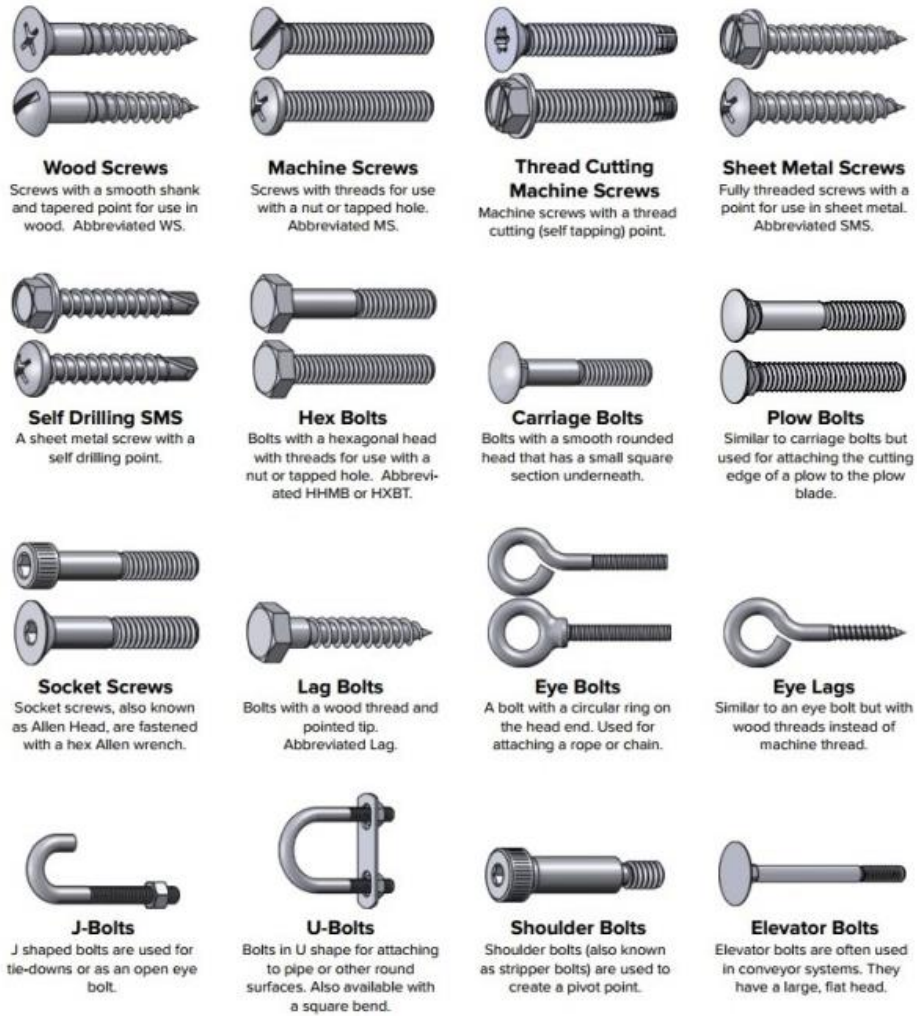

Figure 26: Different type of bolts and screws<sup>16</sup>

<sup>16</sup> <https://www.theprocesspiping.com/a-short-article-on-mechanical-fasteners/>

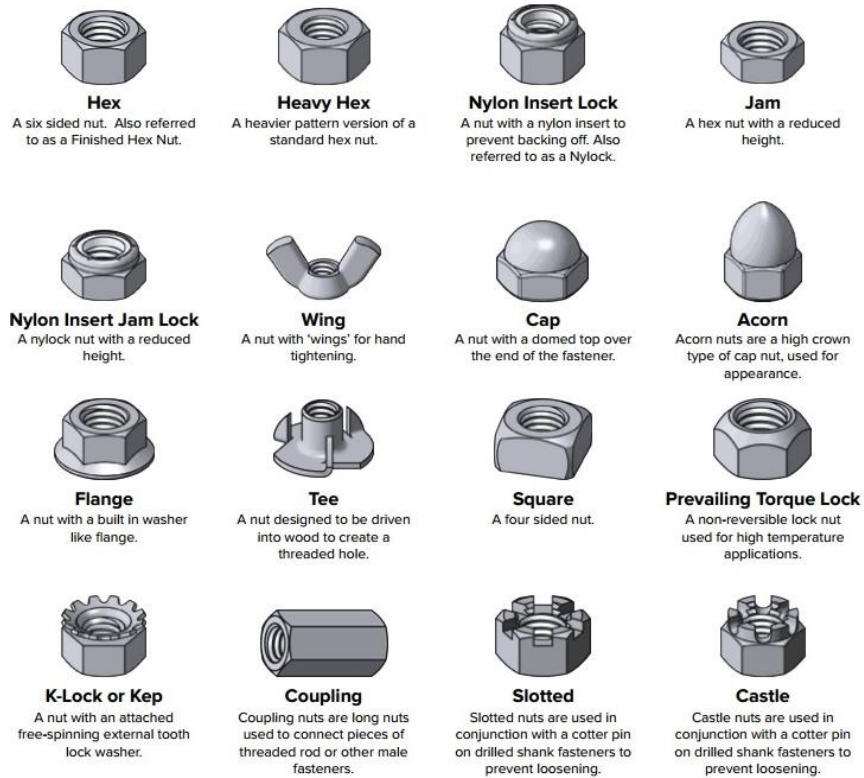

Figure 27: Different type of nuts<sup>17</sup>



Figure 28: Studs<sup>17</sup>

<sup>17</sup> <https://www.theprocesspiping.com/a-short-article-on-mechanical-fasteners/>

- Press fit (snap fit) technique

The press fit technique or an interference fit is the fastening of two parts that is achieved by normal force and friction. This technique happens when a shaft is inserted tightly into a slightly smaller hole in another part, with the interference holding both parts in place. The press fit technique is widely used in the manufacturing of electronic components<sup>18</sup>.

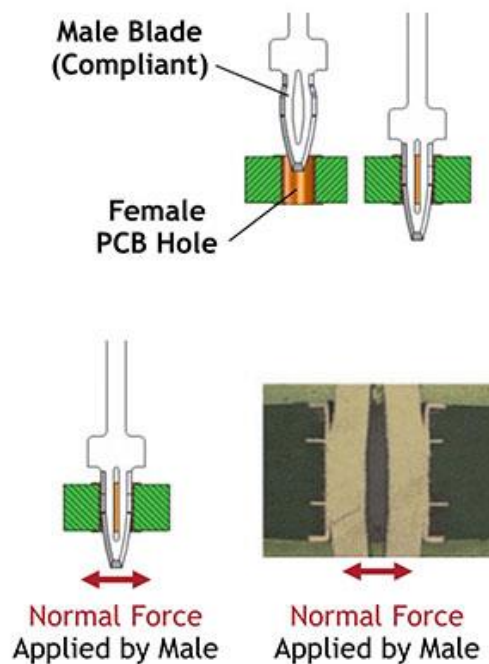

Figure 29: Typical Press-Fit Male/Female Interconnect<sup>18</sup>

- Cotter joint technique

Cotter joint is used to join two axial rods or bars<sup>19</sup>. It also known as a socket and spigot joint. This joint is used to support axial loads between the two rods, tensile or compressive. Cotter joint is mainly made of three parts: spigot, socket, and cotter as shown in Figure 30.

<sup>18</sup> <https://interplex.com/press-fit-guide/>

<sup>19</sup> <http://www.mechanicalwalkins.com/cotter-joint-parts-and-applications/>

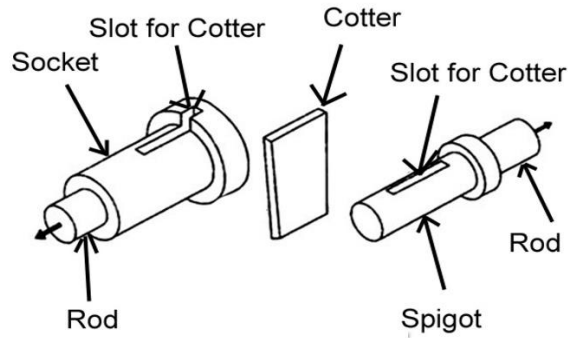

Figure 30: Cotter joint parts<sup>19</sup>

- Knuckle joint technique

The knuckle joint<sup>20</sup> is used to connect two cylindrical rods whose axes lie on the same plane and are under a tensile load. It is used to transmit axial tensile force. The knuckle joint is made of many parts which are two rods which are to be connected, eye end, double eye end or fork end, knuckle pin, collar, and taper pin as shown in Figure 31.

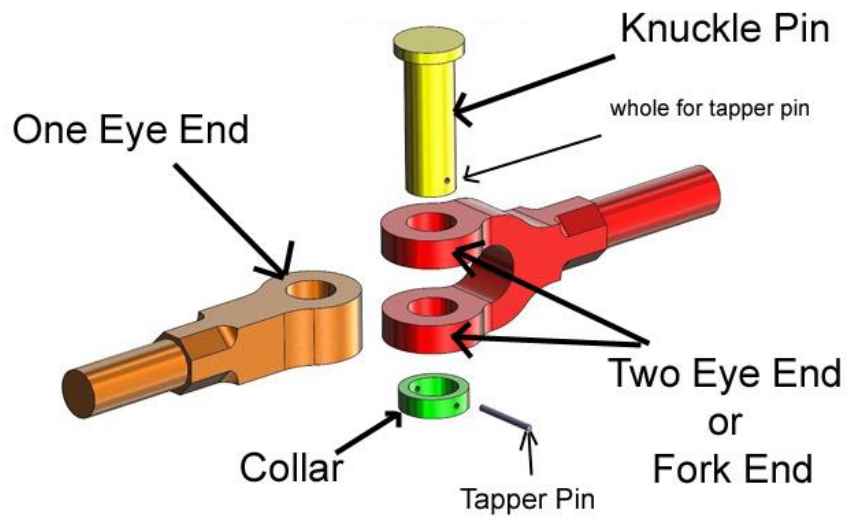

Figure 31: Knuckle joint parts<sup>20</sup>

<sup>20</sup> <http://www.mechanicalwalkins.com/knuckle-joints-parts-and-functions/>

*Types of kinematic joints* are classified based on the type of contact between the two members making a joint, determining the nature of relative motion between the elements in contact. There are six types of kinematic joints in common (Xiong, Chen, Ding, Wu, & Hou, 2019): prismatic joint, revolute joint, helical joint, cylindrical joint, spherical joint, and planar joint as shown in Figure 32.

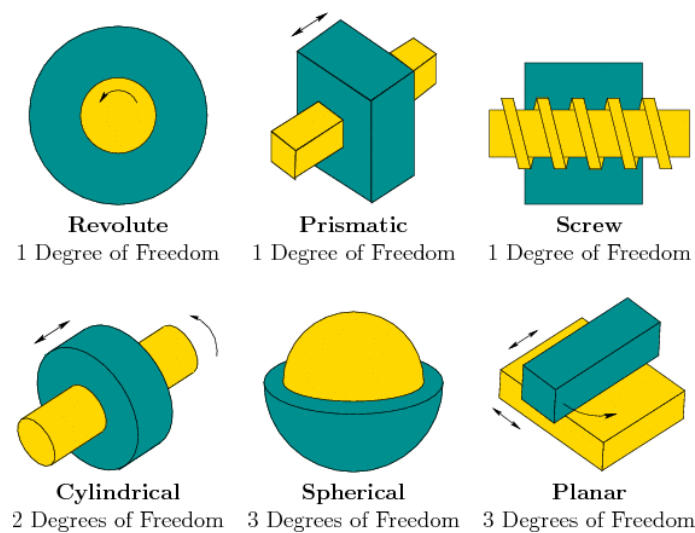

Figure 32: Type of kinematic joints<sup>21</sup>

In the real world, the hand gestures that we use for (dis)assembly and maintenance tasks are various. The use of hand gestures can be classified and summarized depending on different situations. In this case, we focus on the appropriate hand gestures to use in maintenance tasks. Any maintenance work of mechanical products involves disassembling and assembling mechanical parts as well as mechanical joints.

### 3.3.1.2 Work instruction (WI) making module

The work instruction (WI) making module is used to describes the process and sequence of working. Usually, the process and sequence of working is the manual or the already exist process, it come with the machine or working process at the first step of factory setting. The designing of work instruction is important in today's maintenance because if this aspect is not considered, it could lead to inefficient operations and excessive material usage including risk in working

<sup>21</sup> <https://mechtics.com/machine/mechanics-of-machines/classification-of-kinematic-pairs/>

(Battaia, Dolgui, Heragu, Meerkov, & Tiwari, 2019). Although the work instructions are specified with the installation of machinery and equipment, but that is not used for all situation. In addition, workers have different skills and methods for working such as some people who are right-handed and others are good at using the left hand. The work instruction is just a basic introduction and it can not determine whether the such instruction is suitable for everyone or every situation. The VR-TPP model could be adapted to operator to find out which gestures or operation method are appropriate for their work. In the module of work instruction making is determined by UML class diagram as shown in Figure 33.

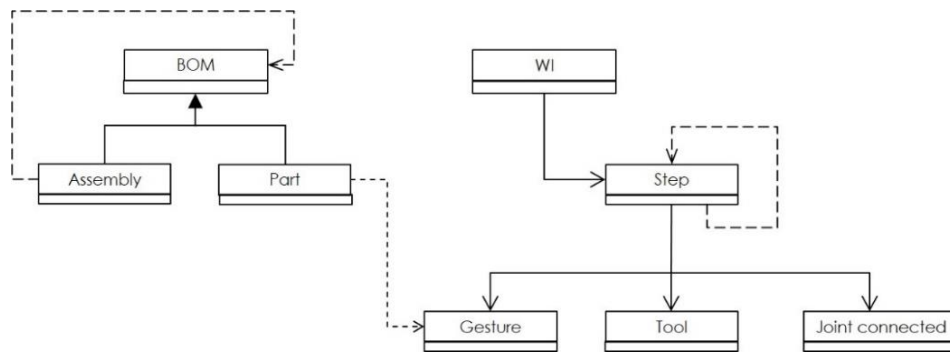

Figure 33: UML class diagram for interactions between WI and BOM

The UML model class diagram consists of two main models: BOM (Bill of Materials) and WI (Work Instruction). Both models have a relationship through the classes representing a mechanical part and a gesture. The BOM consists of assemblies and parts. On this level, the assembly is a group of components or parts. Each assembly can be linked to other assemblies. The class of part represents a mechanical part that constitutes a product component or any subset of parts of a product. The BOM contains several parts that can be manipulated using different gestures. While, the parts are composed of one or several 3D objects. The WI is composed of a sequence of working steps by the specific gestures required to perform the maintenance task correctly. Instantiations of this generic, WI model will be used to specify training sequences which can subsequently be replayed and provided that the corresponding image sequences have been recorded before (e.g. by filming an expert performing the sequence), and the logical model entities assigned. Under the sequence of each working step, it is necessary to specify the gesture and suitable tools to work in accordance with the characteristics of the type of joint connected including suitability to work part. Gestures will be interacted with the part in order to constitute the WI model that describes the hands gestures used for each step.



### 3.3.2 Execution

The execution task is used to operate and interface the VR devices within the virtual environment. In addition, this task also used to build the library of hands gestures as well as used to navigate and manipulate the objects in virtual environment. The execution task consists of three modules: recording, VR using, and translation.

#### 3.3.2.1 Recording module

The recording module is used to record the data from virtual environment. The hands gestures and position are recorded in type of images and 3D animations in order to classify and store it in the library. This module is the fundamental step towards being able to systematically associate mechanical joint types, required expert gestures and appropriate VR device configurations. Data recording can be configured in two methods: fully record and grasping record as shown in Figure 34. The fully record method is used to record the hands gestures in virtual environment since the beginning of the process. In this method, it can be saved the hands gesture in term of pictures or animation. This method is suitable for recording the whole operation process including hand gestures. While the grasping record method is used to record the hand gestures at grasping position. This method starts recording when the virtual hands contact the 3D objects and stops recording when the virtual hands move away from the 3D objects.

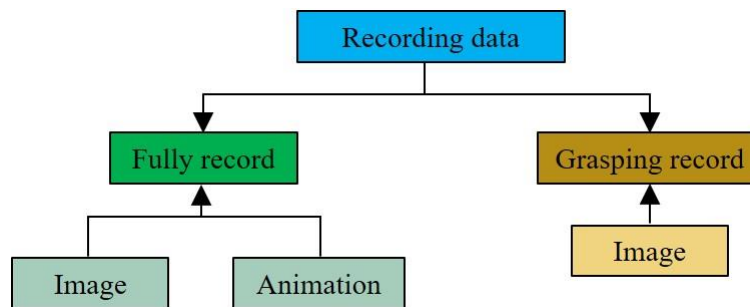

Figure 34: Recording module

At the full recording method, the system will be imported the basic Unity package in order to record hands movement in the virtual environment. The resolution of image from this package is shown in Table 1 and the quality of animation is shown in Table 2.

Table 1: The quality of image from Unity recorder

List	Value
Resolution	HD - 720 p
Frame rate	30
Type of image	JPEG

Table 2: The quality of animation from Unity recorder

List	Value
Frame rate	30
Type of animation	.anim for Unity

In addition, recording with the grasping method is also a special recording. In order to obtain only the hands gestures while holding or working with 3D objects, this method is designed to use the boundary of virtual hand to control the operation of the camera. In principle, when the virtual hands grab the 3D objects in the virtual environment, the camera is started to record and stopped when the virtual hands release the 3D object as shown in workflow in Figure 35.

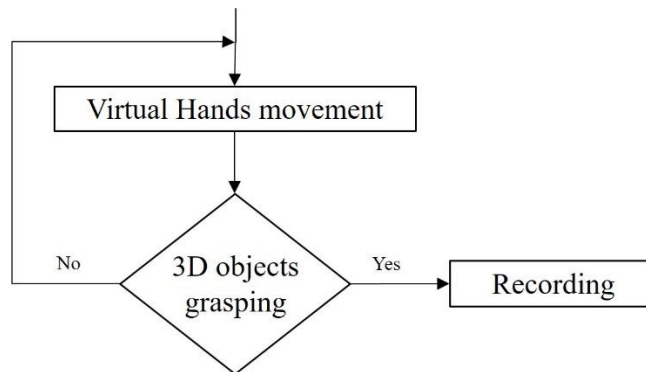

Figure 35: Workflow diagram of grasping record method

### 3.3.2.2 VR using module

The VR Using module is used to interface the VR devices with VR-TPP platform including prepare the virtual scene in virtual environment. VR devices are the tool that could be input and output devices. While software is used to build

the virtual working place. In addition, navigation and manipulation technique are the technique that used to interact the devices with virtual environment.

## 1. VR software

A VR software is a specialized software application that assists to make a video game, it is also known as a game engine. It provides set of features and several core areas to build a game such as graphic, audio, GUI, scripting, and etc. (Khundam C. , 2019). The main objective of game engine is to create a game and it provides many components that support physical simulation in the scene of game element. In addition, the game engine provides facilities that support to cinematics. With these capacities of game engine tool, it can apply to create the platform of virtual reality training. There are many game engines that could be used to build game and virtual reality platform. Nowadays, there are five top game engines that use in the developer group<sup>22</sup>. There are Unreal Engine, Unity, Amazon Lumberyard, CryEngine, and Their own game engine. While their own game engine is a game engine that is built by private game development studios. This game engine will not be explained in this section.

- Unreal engine

Unreal engine is a top game engine developed by Epic Games since 1998. The Unreal engine is a complete suite of development tools for any working with real-time technology. From design visualizations and cinematic experiences to high-quality games across PC, console, mobile, VR, and AR<sup>23</sup>. Unreal engine could be run on Windows, OS X, and Linux. Developers have a toolset and accessible workflows to quickly iterate on ideas and see real-time results without coding as shown in Figure 36.

- Unity engine

Unity engine is a top game engine developed by Unity technologies since 2005<sup>24</sup>. Unity makes game development more accessible, with notable screen reader support. Unity engine can use to develop games across platforms. Unity engine is now used in industries beyond game development, including architecture as shown in Figure 37. It also has a reputation for mobile game development on Android. The Unity engine supports game creation by providing objects-oriented scripting framework available in three languages: Boo, JavaScript, and C#. These languages can be used to create custom code components that come from a generic class called MonoBehaviour. It gives an access to override method in various stages of game execution. Scripts with

---

<sup>22</sup> <https://www.perforce.com/blog/vcs/most-popular-game-engines>

<sup>23</sup> <https://www.unrealengine.com/en-US/features>

<sup>24</sup> <https://www.perforce.com/blog/vcs/most-popular-game-engines>

classes derived from MonoBehaviour can be attached to game objects to control their behavior at runtime. It can be used to respond to user input, implement custom user interface, store and load data, and are general mechanic. The script components inherited from MonoBehaviour can be associated with various game objects for use of interoperability, and that multiple scripts can be use with the same object to create interoperability (Khundam C. , 2019).

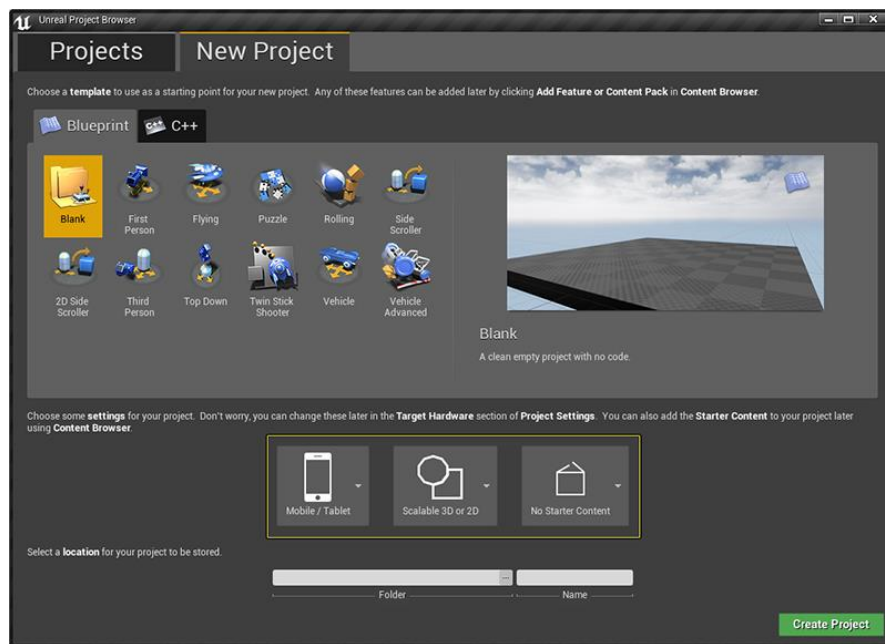

Figure 36: The Unreal Engine<sup>25</sup>

- Amazon Lumberyard

Amazon Lumberyard is a top game engine developed by Amazon since 2016. It was licensed and reworked from CryEngine<sup>26</sup>. Amazon Lumberyard is a free high-performance 3D engine with a professional suite of tools, editors, and libraries that can create captivating real-time graphics, immersive experiences, awe-inspiring virtual worlds, and dynamic visualizations. Lumberyard brings the capabilities of Amazon Web Services and the community of Twitch to connect the ideas to players as shown in Figure 38.

<sup>25</sup> <https://docs.unrealengine.com/en-US/Platforms/VR/DevelopVR/ContentSetup/index.html>

<sup>26</sup> <https://www.perforce.com/blog/vcs/most-popular-game-engines>

- CryEngine

CryENGINE is a top game engine developed by CryTek since 2002. The latest engine is CryEngine V. CryEngine is a cross-platform engine. It can be used to create photorealistic first-person games, especially shooters. CryEngine is used in all games from CryTek, as well as other studios. As mentioned above, CryEngine was licensed and reworked to create Amazon Lumberyard as shown in Figure 39.

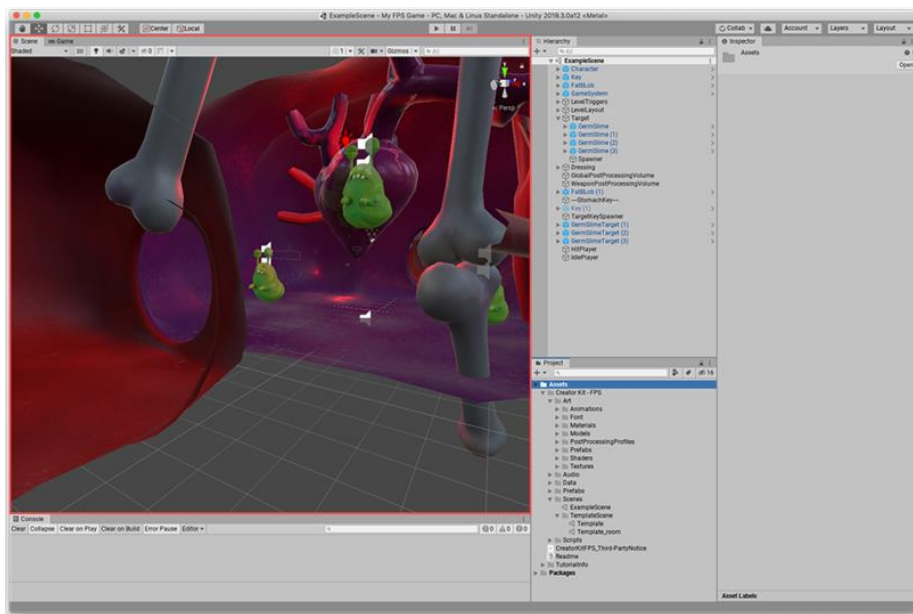

Figure 37: The Scene view in Unity Engine<sup>27</sup>

<sup>27</sup>[https://docs.unity3d.com/Manual/UsingTheSceneView.html?\\_ga=2.214798032.618277146.1594289230-1401108530.1594289230](https://docs.unity3d.com/Manual/UsingTheSceneView.html?_ga=2.214798032.618277146.1594289230-1401108530.1594289230)



Figure 38: Amazon Lumberyard Game Engine<sup>28</sup>

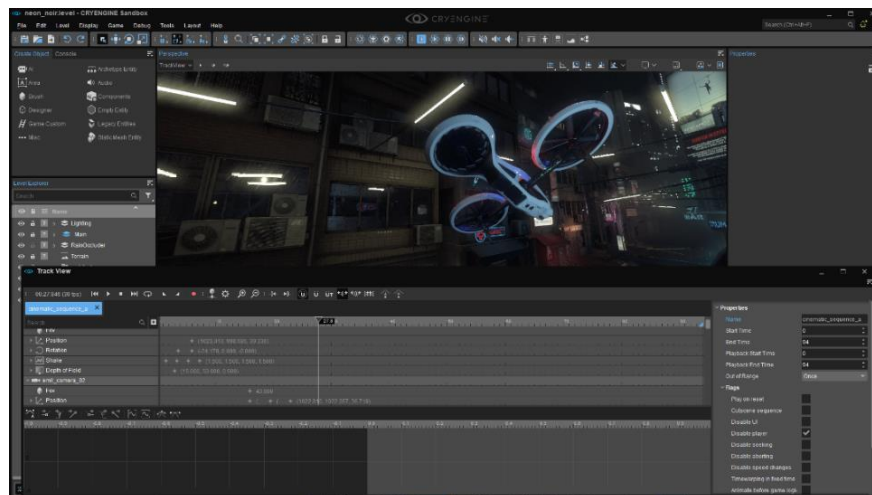

Figure 39: CryEngine Game Engine<sup>29</sup>

## 2. VR tools

User can interact to the virtual environment by input and output VR devices. The input VR devices are used to select and manipulate the objects within virtual scene via Leap Motion Controller (LMC). While the output VR devices are used to display the result. There are two types of output VR devices related immersive level which are 2D desktop and 3D with Head-Mounted Display (HMD) Figure

<sup>28</sup> <https://aws.amazon.com/th/lumberyard/downloads/>

<sup>29</sup> <https://www.cryengine.com/features/view/sandbox>

40. Through the LMC, user can interact with virtual objects by bare hands, while the HMD is used to display the virtual working place and user can point and move working position by turning and pointing the HMD. The input and output VR devices can interact with the system through the interaction technique which are navigation and manipulation. Navigation is a traveling or moving of working position of user in the virtual environment. The traveling is used physical movement technique through sensor tracked on display device. The working position and viewpoint are moved following to direction and position of display device. While manipulation is the interaction technique that use to interact a virtual hands and a virtual object in virtual environment. Finger-based grasping techniques are used to select and manipulate the virtual object in virtual environment.

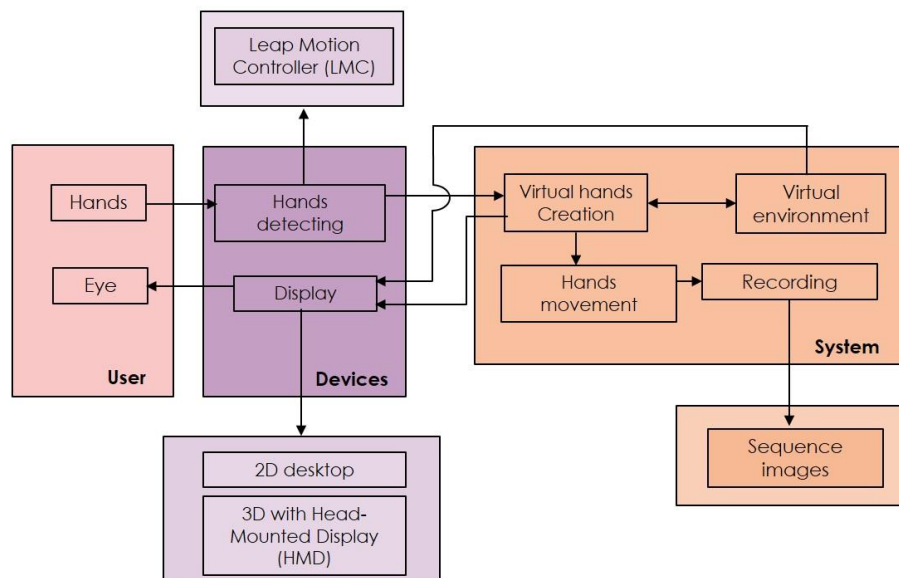

Figure 40: Interaction activity diagram of VR-TPP system.

- Leap Motion Controller (LMC)

The Leap Motion controller is a small USB peripheral device which is designed to be placed on a physical desktop, facing upward. It can also be mounted onto a virtual reality headset. The Leap Motion Controller is an optical hand tracking module that captures the movements of user hands with accuracy. A monochromatic IR cameras and three infrared LEDs is used to capture hands movement. The LEDs generate pattern-less IR light (Weichert, Bachmann, Rudak, & Fisseler, 2013) and the cameras generate almost 200 frames per second of reflected data. This is then sent through a USB cable to the host computer. The

smaller area and higher resolution of the device differentiates the product from the Kinect, which is more suitable for whole-body<sup>30</sup>.



Figure 41: Leap Motion Controller

- Head-Mounted Display (HMD)

The Head-Mounted Display (HMD) is a display device that is used to wear on the head. A typical HMD has one or two small displays, with lenses and semi-transparent mirrors embedded in eyeglasses, a visor, or a helmet. The display units are miniaturized and may include cathode ray tubes (CRT), liquid-crystal displays (LCDs), liquid crystal on silicon (LCos), or organic light-emitting diodes (OLED). The monitors in an HMD are most often Liquid Crystal Displays (LCD). Nowadays, there are many kinds of HMD devices in the market, such as the Oculus Rift, and HTC Vive (Hui, 2017). The HMD are not only used in virtual reality gaming, it has also been utilized in military, medical and engineering contexts (Louison, Ferlay, Mestre, & R., 2017) (Abate, Guida, Leoncini, Nappi, & Ricciardi, 2009) (Dyer, Swartzlander, & Gugliucci, 2018) (Liu, Zhang, Hou, & Wang, 2018).

### 3.3.2.3 Translation module

The translation module is used to change the technical data to program data and translate that data to simulation media. This module is also used to translate numerical results to graphical displays through a component of VR-TPP system. The component of VR-TPP system consists of three main parts: operation system, VR input device (Leap Motion Controller: LMC), and VR output (Head Mounted Display: HMD) as shown in Figure 45.

---

<sup>30</sup> <https://www.cnet.com/news/leap-motion-3d-hands-free-motion-control-unbound/>





Figure 42: Oculus HMD device<sup>31</sup>



Figure 43: Vive HMD device<sup>32</sup>

---

<sup>31</sup> <https://www.oculus.com/>

<sup>32</sup> <https://www.vive.com/sea/product/vive-cosmos-elite/overview/>



Figure 44: Acer Windows Mixed Reality HMD device<sup>33</sup>

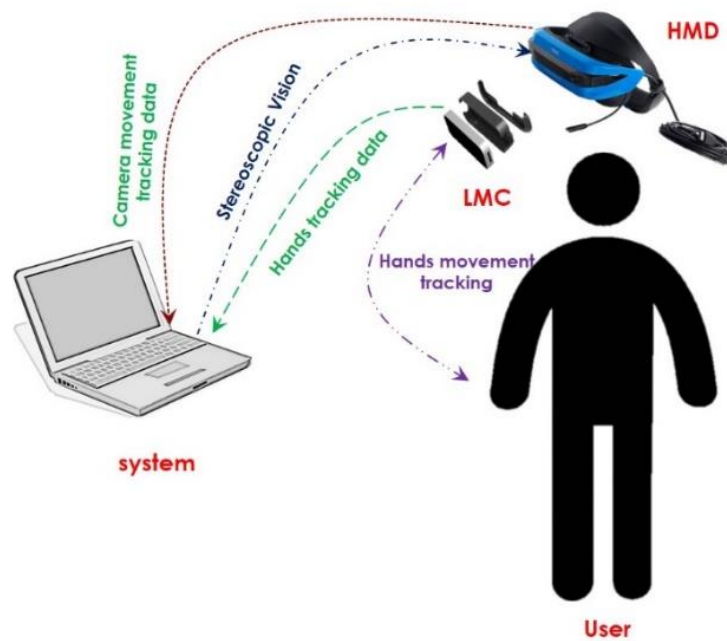

Figure 45: The components of the VR-TPP system in implementation task

During training on the VR-TPP platform, users must wear the Head Mounted Display (HMD) and stand in front of the laptop at a distance of 0.3 to 0.5 meters. The virtual environment is displayed in real time on the HMD screen. The HMD screen integrates the Laser Distance Measuring device (LMC), allowing the

<sup>33</sup> <https://www.acer.com/ac/th/TH/content/series/acerojo500>

system to detect and display the virtual hands in the virtual environment. While the user rotates and moves the head, the camera will display the image on the HMD screen in the first person view, which is like the own human eyes' view.

### **3.3.3 Implementation task**

The implementation task is used to learn the hands gesture and operation process in virtual environment. In addition, the implementation task is an implementation of systematic approach of VR-TPP into an executable virtual reality environment. This task allows users to execute, practice and assess the maintenance task within virtual environment. During practicing in the virtual environment, the hands gestures will be recorded. After that, those hands gestures will be evaluated by human experts.

#### **3.3.3.1 Assessment**

The assessment module enables assessing the ease of using of VR devices and the realism of VR training. While users operate on the VR-TPP, they can receive both of active and passive information. The active information is physical interaction by using devices. Users can recognize the physical reaction while they work on the VR training. Every device might not fit to all people. However, we are looking for the devices that are most appropriate for a specific maintenance work. The passive information is visual interaction by watching the media. User can recognize the realism level with the VR display. The realism is depended on the level of technology.

The assessment can be performed at two levels: non-immersive VR level and fully-immersive VR level. The non-immersive VR level is displayed on 2D screen and controlled with a basic controller such as keyboard and mouse. While the fully-immersive VR level will be enhanced by displaying on 3D display of HMD screen. Both non-immersive and fully-immersive VR level will be used the leap motion controller in order to create the virtual hands for using in the virtual environment. The assessment is assessed by the participants after testing the usability of both level the non-immersive VR level and fully-immersive VR level with questionnaires. The ease of use of VR tools and perception level in realism will be assessed on the non-immersive VR level. On the fully-immersive VR level, the perception level in virtual reality experiencing, as well as the side effects from using the VR devices will be assessed.

#### **3.3.3.2 Classification of hands gestures**

The classification of hand gestures is a step after the recording process of the execution task. The pictures of hands gesture will be considered from group of experts by arguing whether those gestures are appropriate for working. Then the gestures selected are defined and recorded in the library of the hands gestures in order to use in the virtual working instruction in the training process.

The hand gestures using for maintenance tasks are various. The use of hand gestures can be classified and summarized depending on different situations (Li, Huang, Tian, Wang, & Dai, 2019). Nowadays, one of main problem about classification of gestures is that there are not having any commonly used terms for describing the type of gesture. Therefore, the meaning of type of gesture have many definitions. For example, the natural gestures often refer to bare handed gestures (Hardenberg & Bérard, 2001), while symbolic gestures are described as stroke gestures (Kopp, Tepper, & Cassell, 2004). In addition, humans grasp the objects with either one hand or two hands, depending on its shape, size and weight. While the real objects have a variety of shapes as well as complex. Therefore, some group of researcher (Huagen., Shuming., & Qunsheng, 2004) have classified hand gestures by grasping of different shape of the objects. They concentrated on thumb-finger combinations and limited to mechanical components that can be grasped with one hand. While, (Gleeson., MacLean., Haddadi., Croft., & Alcazar, 2013) has identified the gestures from the use. There are other interesting studies. They have described a classification in the taxonomy not only based on hand gesture but the taxonomy can be classified by the type of touch between the hand and the object (Thomas Feix, Javier Romero, Heinz-Bodo Schmiedmayer, Aaron M. Dollar, & Kragic, 2016).

For our method to classify the hands gesture, we have designed a method for classifying the hands gestures that correspond to the mechanical parts and hands gestures by working gestures and position of fingers in order to define the type of hands gestures. Then record those gestures type in the gesture library as shown in Figure 46.

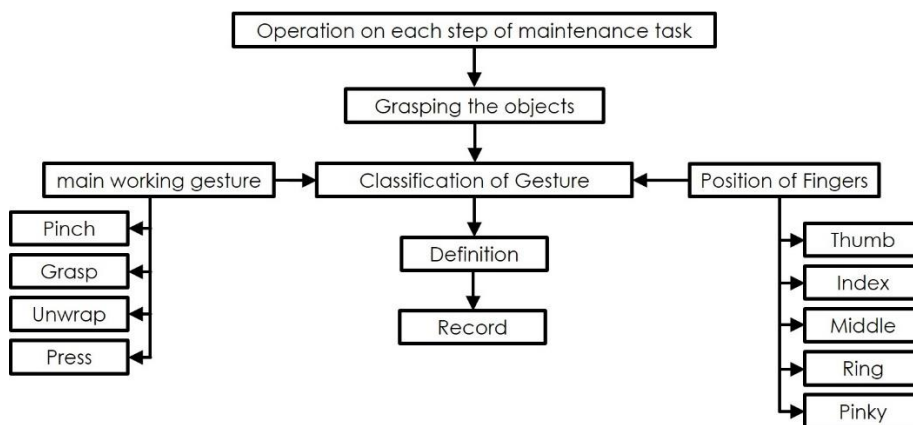

Figure 46: The process of classification and recording the hands gestures

Classification of gesture can be defined initial in four main working gestures: Pinch, Grasp, Unwrap, and Press as shown in Figure 47. In each main working

gestures can be further broken down depending on finger position. The position of fingers consists of five fingers which are Thumb, Index, Middle, Ring, and Pinky as shown in Figure 48.

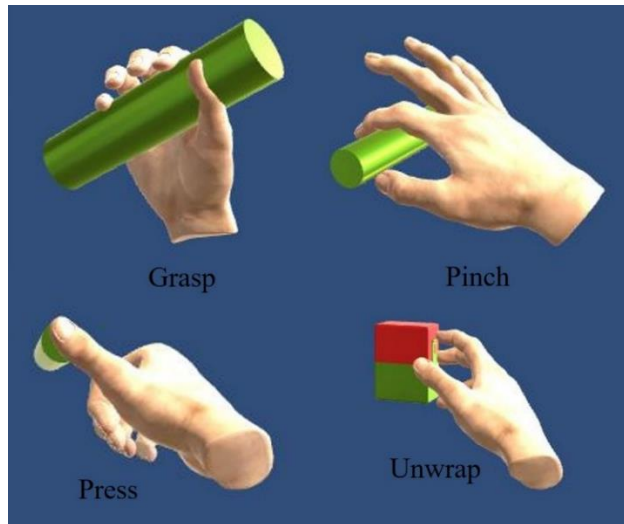

Figure 47: The main working gestures

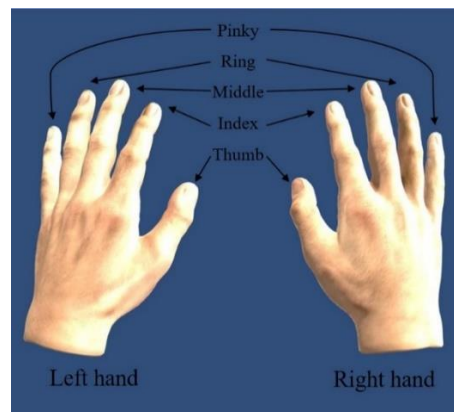

Figure 48: The position of fingers

Based on the UML model class diagram in Figure 33, we created a generic interaction model for the specification of BOM and WI, as shown in Figure 49. This generic interaction model is used to classify and define the hand gesture that will be used to operate the dis/assembling of mechanical part. The appropriate hand gesture and working process will be defined in a working instruction.

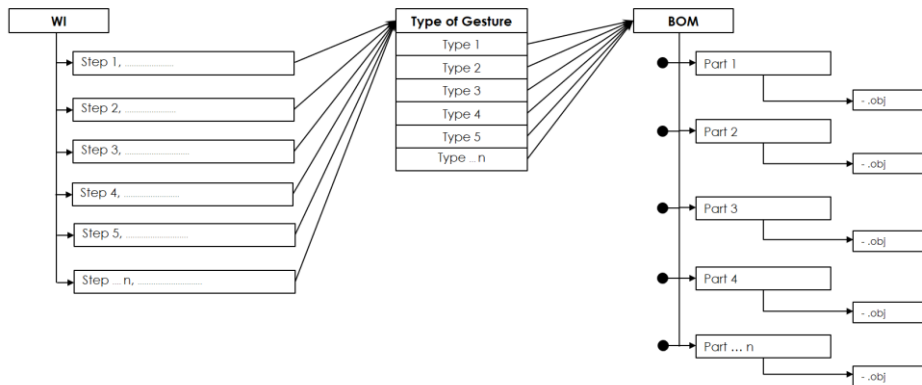

Figure 49: Abstract WI sequence model

Within the model, the BOM contains several parts that can be manipulated using different gestures. Parts are composed of one or several 3D objects. A WI is composed of a sequence of steps each characterized by the specific gestures required to perform the maintenance task correctly. Instantiations of this generic WI model will be used to specify training sequences, which can subsequently be replayed, provided that the corresponding image sequences have been recorded before (e.g. by filming an expert performing the sequence), and the logical model entities assigned.

### 3.4 Summary of systematic approach of VR-TPP concept

This chapter presents the concepts and systematic approach of the Virtual Reality for Training Preparation Process (VR-TPP), which has been designed to support the training preparation process for maintenance tasks. In this concept, the training preparation phase which consists of three main task: the preparation task, the execution task, and the implementation task. The preparation task is used to provide the information needed that used to create and define maintenance conditions for working in a virtual environment. Within the preparation task, there are two modules, which are the model preparation and WI making. The model preparation comprises importing 3D files model into the virtual environment and setting the mechanical behaviour for those 3D files. The WI making includes the process and sequence of working for building the work instruction. The execution task is about the operation and interfacing the VR devices within the virtual environment. It includes the recording process and method of hand gestures capturing, as well as the VR using module. The chapter also elaborated on the VR software and VR tools used to implement an experimental VR-TPP platform. Finally, the implementation task includes the assessment of VR-TPP platform in terms of the ease of using of VR devices and

the realism of VR training as well as the side effect from using VR device. In addition, the method of classification of hand gestures has also been introduced in this section.

## **4 A VR-TPP Maintenance Training Preparation Environment**

### **4.1 Introduction**

This chapter explains the creation process of the virtual platform that was used to execute and investigate the case studies in this thesis. The platform is aligned with a technical framework which is derived from the VR-TPP concept introduced in the previous chapter. The case studies will be build and operated on the VR-TPP platform. The three case studies show the potential of the VR-TPP concept and platform and how to apply this platform to maintenance work. The VR-TPP platform is used to verify the dis/assembly process and used to create a knowledge base of hands gestures as well as used to demonstrate the appropriate gesture and working process from dis/assembly process.

### **4.2 Derivation from the VR-TPP concept**

The technical framework will be a guide to operate the VR-TPP platform to consider a gesture and VR devices that appropriate to use in maintenance training preparation process. Within the technical framework, each step is aligned with the modules of the VR-TPP concept, as shown in Figure 50. Based on this technical framework, we focus on evaluating two key aspects: gestures and devices. The gesture consideration is the process to select a gesture recorded in the data recording step. The gestures will be considered by experts, the right gestures will be recorded in a gesture library. The training process will be repeated at the pick and move component step when the experts consider that the gestures are wrong. In the consideration of devices, it is the process of selecting devices used to control and manipulate the job in a virtual environment. In order to obtain the completed information of gestures and operation process, the devices will be evaluated at this stage. The appropriate devices will be chosen to connect with the platform. The selection of a new device will be re-considered at the step of define devices if the devices are inappropriate to obtain the information.



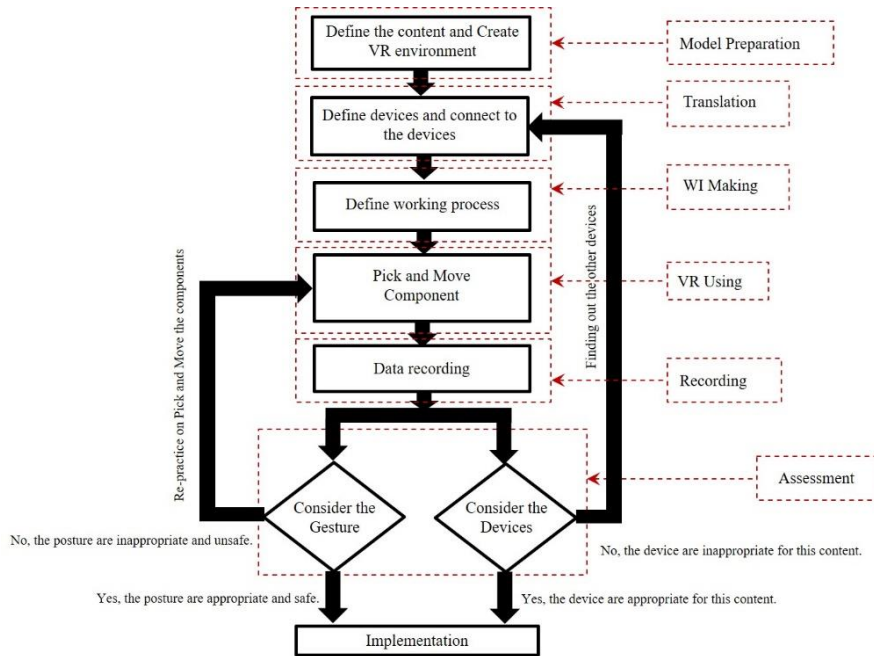

Figure 50: The technical framework of VR-TPP concept

### 4.3 The VR-TPP platform implementation

VR-TPP is implemented on top of the unity 3D software taking benefit of various standard packages and functions. In this first implementation, we focus on the deployment of VR-TPP platform on cheap and portable VR devices (indeed HMDs) to demonstrate its deployment capacity. So that it can be used everywhere and any time according to the needs of the trainee. The basic idea of creating this platform is to support the training preparation process in order to find the appropriate gestures and working process before entering into the training process. In addition, the VR-TPP platform is also used to create a library of hands gestures for processing virtual working instructions (VWI). The VR-TPP platform requires three main parts: the system preparation, the interaction definition, and a recording method. The system preparation is the process of creating a virtual 3D model of the system with the complete behaviour (kinematic information) to simulate the maintenance process. The interaction definition is used to interface between device and user through interaction techniques. The recording method is a part of storing a specific hand gesture. The classification of hand gestures is performed by the expert. This process allows the expert to identify the appropriate hands gestures and store them in the database in order to re-use them for creating work instructions.

### 4.3.1 The system preparation

The system preparation is the process that creates the virtual environment by referring to the real situation and conditions of the maintenance work. The scene is created on a commercial software utility called “Unity 3D”. The Unity 3D is a cross-platform game engine for the development of 2D and 3D video games, including the creation of simulations on computers (both desktop and laptop), consoles, smart TVs, websites and various portable devices. Unity uses C# as the primary language for developing games on the engine. Components and scripts are installed in the GameObject to define and control the behaviour of the GameObject and all the objects within the virtual environment. Scripts are important parts for treating the input values. The unity scene is controlled by our VR-TPP scene model which describe the system and its environment as shown in Figure 51. Within the scene, there are three types of objects: the 3D part, the assembly part, and the scene components. These objects have to define a physics and behaviour. The physics of object is used to simulate physics in the scene to ensure that the objects correctly accelerate and respond to collisions, gravity, and various other forces. The behaviour is used to simulate interaction result when the object interacts with the other objects in the scene.

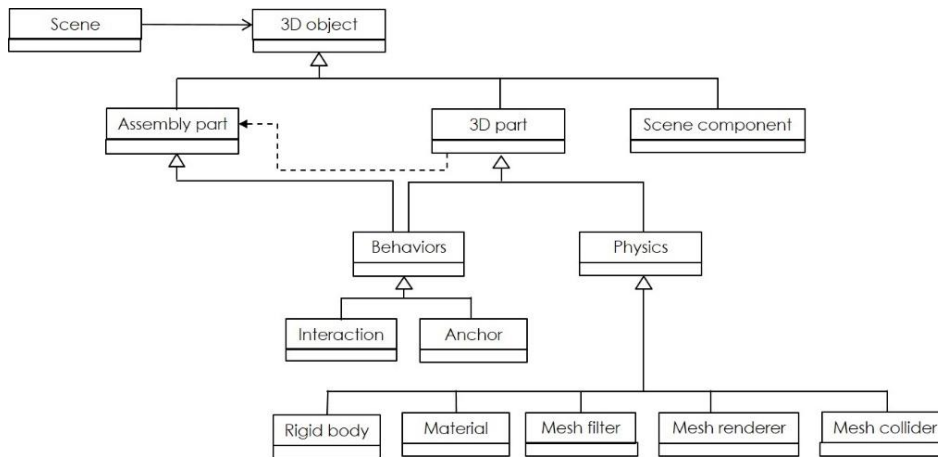

Figure 51: The components of 3D object

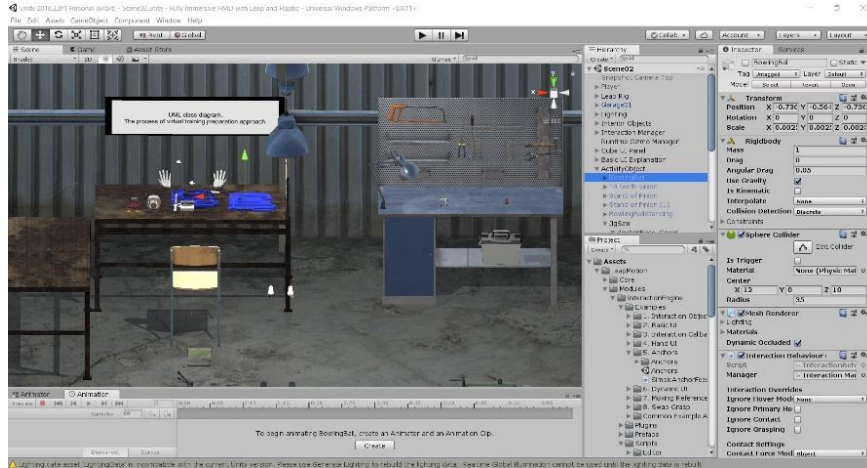

Figure 52: The creation of the virtual environment by Unity 3D

#### 4.3.1.1 3D Parts

3D part is an independent part that can interact with other parts through behavioural function such as collisions and impact. The 3D parts are generally designed in 3D software such as Autodesk, Solid Work or the other 3D software. There are many types of 3D file created from 3D software. For importing the 3D file into the scene, the 3D file is converted to OBJ file format (wavefront format) in order to import this 3D file to Unity 3D software. Within the scene, the 3D file will be a 3D object and it must be associated to physical properties to enable this 3D object to work under the conditions of the physical rules. The physics that will be determined in the 3D object are the Rigid body, Material, Mesh filter, Mesh renderer, and Mesh collider. While the behaviour will be determined in the 3D object when they are interacted with other object. There are two behaviours: interaction behaviour and anchor behaviour.

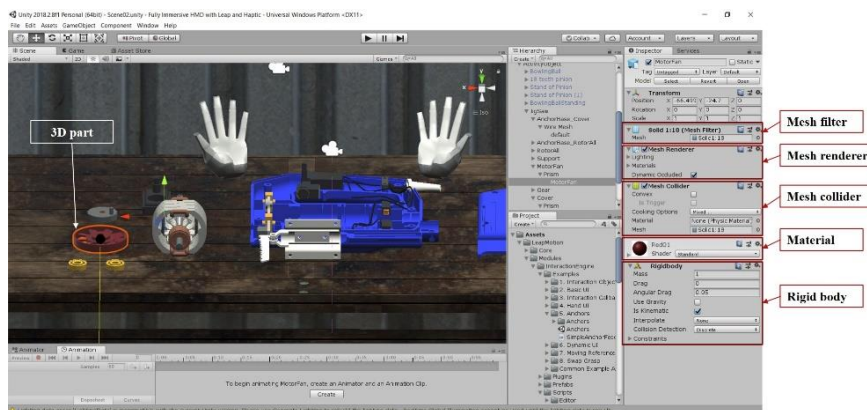

Figure 53: The physics of 3D part

#### 1. Rigid body

The rigid body enables the 3D object to act under the control of physics. The rigid body can receive forces and torque to make 3D objects move in a realistic way. Any 3D object must contain a rigid body to be influenced by gravity, act under added forces via scripting, or interact with other objects through the physics engine.

#### 2. Material

The physic material is used to adjust friction and bouncing effects of colliding objects. This physics is also used to define the colour and texture of 3D object.

#### 3. Mesh filter

The mesh filter takes a mesh from standard assets and passes it to the mesh renderer for rendering the object on the screen.

#### 4. Mesh renderer

The mesh renderer takes the geometry from the mesh filter and renders it at the position defined by the object's transform component.

#### 5. Mesh collider

The mesh collider is used to build the collision detection. The mesh collider is a representation of the mesh attached to the 3D object, and it is a properties of the attached transform to set the 3D object position and scale correctly. The benefit of this is that we can make the shape of the collider exactly the same as the shape of the visible mesh for the 3D object, which creates more precise and authentic collisions. In addition, Unity software can automatically create a collider shape based on the shape of the 3D object.

#### 4.3.1.2 Assembly parts

The assembly part is a group of 3D parts. This assembly part interacts with 3D parts and can also interact with other a group of assembly part. In order to obtain the assembly part, the behaviours will be set on the assembly part, which are interaction behaviour and anchor behaviour.

#### 1. Interaction behaviour

The interaction behaviour allows users to interact with virtual objects in virtual environment. The interaction behaviour allows users to grasp the objects within virtual environment with the real hands. To keep costs low, we selected a standard package created by Ultraleap.

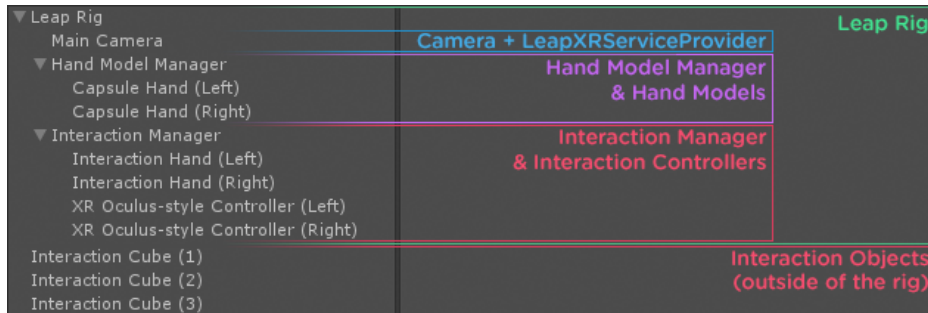

Figure 54: A basic XR rig with the Interaction behaviour

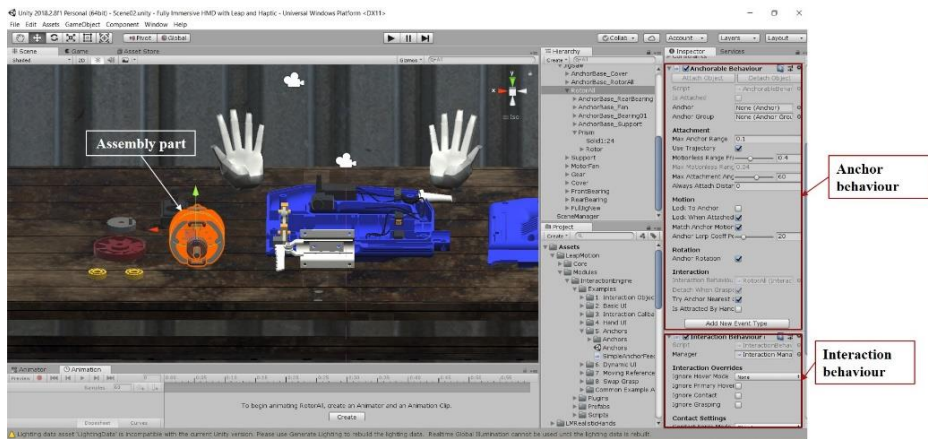

Figure 55: Assembly parts with behaviour setting

## 2. Anchor behaviour

The anchor behaviour is a sub-function of interaction behaviour. The anchor behaviour is used to set the position of the 3D object and control the object automatically moves when the object is moved close to the position. The anchor behaviour is also used to determine the position in the process of assembling. The anchor behaviour will be created in pairs of Anchor In Object (AIO) and Anchor Position (AP). The AP is used as the base embedded with fixed position or stationary object. For the AIO, it is used to be moving the object move to the fixed position (AP) when the object is moved close to the fixed position (AP).

Figure 56 presents an instance of the interaction model. Objects are defined based on three types of physics: Rigid body, Mesh renderer, and Mesh collider. All of these physics are used to make those 3D objects work under the control of physics laws. Under the physics function, there are AP (Anchor Position) type of anchor behaviour which is the object or fixed position. There is the base

embedded and it wait for the movable object come to contact. While AIO (Anchor In Object) type of anchor behaviour is used to indicate moving type. The object remembers the motion position when it is moved close to fixed position.

The anchor behaviour is therefore important for positioning objects during assembling and disassembling processes.

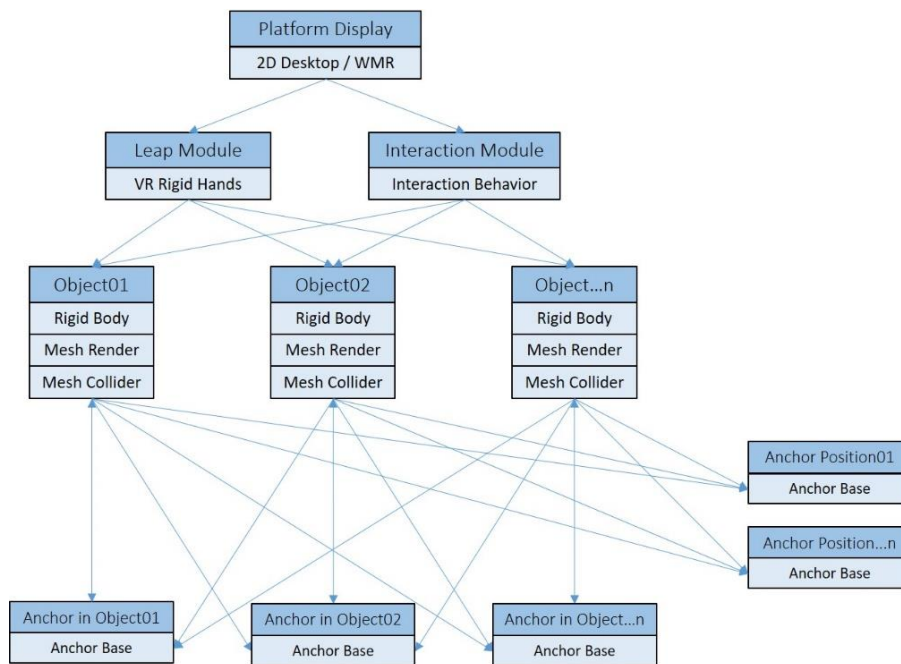

Figure 56: Structure of anchor behaviour

#### 4.3.1.3 Scene components

The scene components are extra 3D objects that are not used to interact with others. These 3D objects are used to build scene environment to be close as the actual working place such as pallet, machinery, table, and etc. as shown in Figure 57. They add more immersion perception, and make the environment more realistic, but do not need to be defined with complex physics.



Figure 57: Scene components in the virtual environment

### 4.3.2 The design of devices and interaction techniques

This step describes the interaction preparation, which is split into three parts: input device, output device, and interaction technique. The input device is used to select and control the objects within the virtual environment by the user. The output device is used to display the operation through the display screen which may be 2D or 3D. While the interaction techniques are used to link the input and output devices with the system in order to allow user navigation, selection and manipulation of objects in the virtual environment.

#### 4.3.2.1 Input devices

The input devices are used to receive action from human users. They must be processed and converted to interact with the system in order to control, select and manipulate the virtual environment. There are basic input devices such as keyboards and mouse, while specialized input devices are based on the principles of sensors such as Leap Motion Controller or HMD controller.

##### 1. Mouse and keyboard

The mouse is used to move the camera in order to look at the working area and around it in the virtual environment. While keyboard is used to move the direction of camera to left-right and front-rear.

##### 2. Leap Motion Controller

The Leap Motion Controller (LMC) is an optical hand tracking module that captures the hands movement of user. The LMC is used to receive the movement

of user hands and to convert it to positions sent to the system. The LMC is also used to create virtual hands in the virtual environment. A predefined module connects it with Unity software through Leap Motion SDK package.

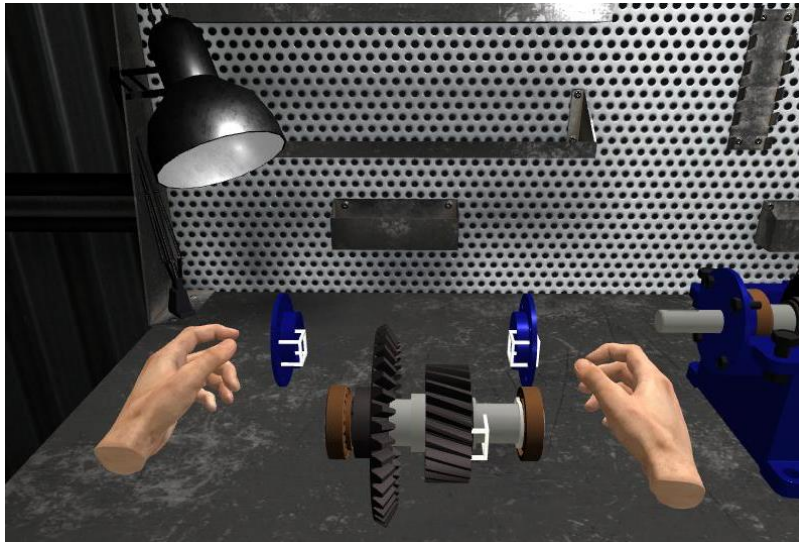

Figure 58: Virtual hands by Leap Motion module

### 3. HMD controller

The main function of the head-mounted display (HMD) is used to display the virtual scene while the other function of the HMD can be used to control the direction and movement of virtual camera within virtual environment. For the input function, HMD controller is used to control camera in the virtual environment. The user can control the position of virtual camera by moving from a position to another position in the real world. In addition, user looks around in the virtual environment by turning his head while he wears the HMD. The HMD position and simulation are tracked and used by the environment.

#### 4.3.2.2 Output device

The output devices are display device, it can be divided into two systems: 2D system and 3D system. The 2D system is a non-immersive VR level is since it displays the virtual environment on 2D screen such as desktop screen and tablet screen as shown in Figure 59. While the 3D system is fully-immersive VR level since it provides stereoscopy perception through head-mounted display (HMD) or windows mixed reality (WMR) device to simulate the virtual environment as shown in Figure 60.





Figure 59: 2D system with desktop screen



Figure 60: 3D system with WMR device

#### 4.3.2.3 Interaction technique

The interaction technique links software and hardware. It is used to interact between the platform and the user. The typical generic interaction tasks of VR-TPP platform are the navigation, selection and manipulation (Bowman D. A., 1998).

##### 1. Selection and manipulation

The selection and manipulation technique is installed within the leap motion package (called interaction engine). The interaction engine is composed of an interaction manager and an interaction behavior script. Each script is used to control the objects in virtual environment. The interaction manager script is used to link the device and system, while the interaction behavior script is used to define behavior of the objects in virtual environment. Furthermore, the interaction

behavior script must work with the Rigid Body, Mesh Collider and Mesh Renderer in order to interact between virtual objects and virtual hands. The selection and manipulation technique are used to interact on the objects in virtual environment through selection function, position function, and rotation function.

- The selection function is a selection of the virtual object by virtual hands or finger from the virtual environment. The selection function can be used through virtual hands by “pressing” the virtual objects.
- The position function is the method to change the position of the virtual object by grasping and placing.
- The rotation function is used to change the orientation angle of the virtual object. The rotation function rotates the object from its initial orientation to the target orientation by virtual hand.

Table 3: Selection and manipulation technique for 2D and 3D system

<b>Interaction</b>	<b>2D system</b>	<b>3D system</b>
Selection function	Click by Mouse	Press or Push by Virtual hands
Position function	Grasp and Place by Virtual hands	Grasp and Place by Virtual hands
Rotation function	Grasp and Turn by Virtual hands	Grasp and Turn by Virtual hands

## 2. Navigation

Navigation is a fundamental function for camera movement in virtual environment. In the virtual environment, the navigation allows the user to move and rotate the camera viewpoint depending on system selected. In the VR-TPP platform, the navigation is defined within two systems which are 2D and 3D system. The navigation in 2D system allows user to move and rotate the camera viewpoint through mouse and keyboard. Users can rotate the camera viewpoint by clicking and dragging mouse to look around the virtual environment. While the keyboard is used to move the direction of camera to left-right and front-rear. For the navigation in 3D system, HMD controller is used to control the camera in the virtual environment.

Table 4: Navigation technique for 2D and 3D system

Navigation	2D system	3D system
Movement	Press the direction key on keyboard	Wear the HMD device and move head
Rotation	Click and drag mouse	Wear the HMD device and turn the head around

### 4.3.3 Recording method

In the recording process, various experts are asked to practice the task in the platform. During practice, their hand gestures are recorded with the image recording and animation function at a first person perspective corresponding to the real human eyes' position.

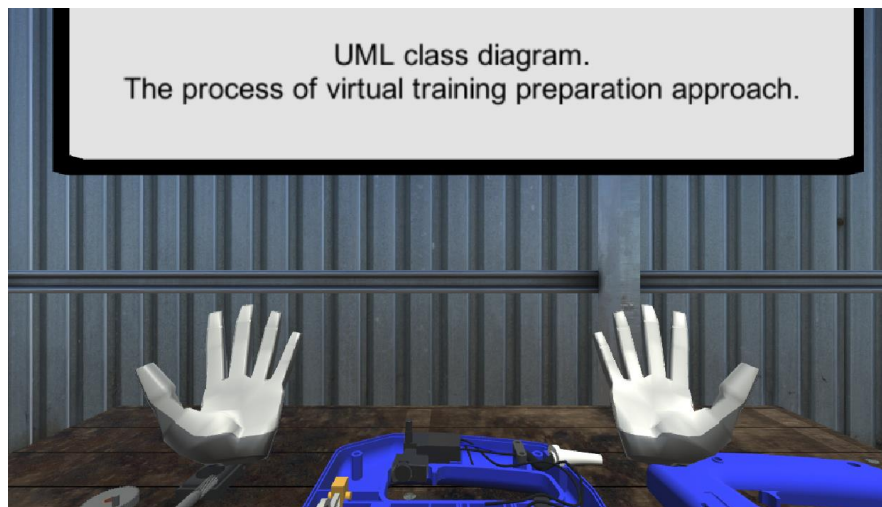

Figure 61: Virtual camera at a first person perspective

The Unity Recorder package is used with the platform in order to record the operation process and hands gestures as shown in Figure 62. It is used to capture and save gesture data during practice.

#### 4.3.3.1 Image sequence

The image recording function is used to capture the process and hands gestures of experts or users in term of image sequence as shown in Figure 71. The image recording function is set to capture as 30 frames per second and an image

resolution of 720 pixels. The sequence of image is set automatic by numeric at initial setting.

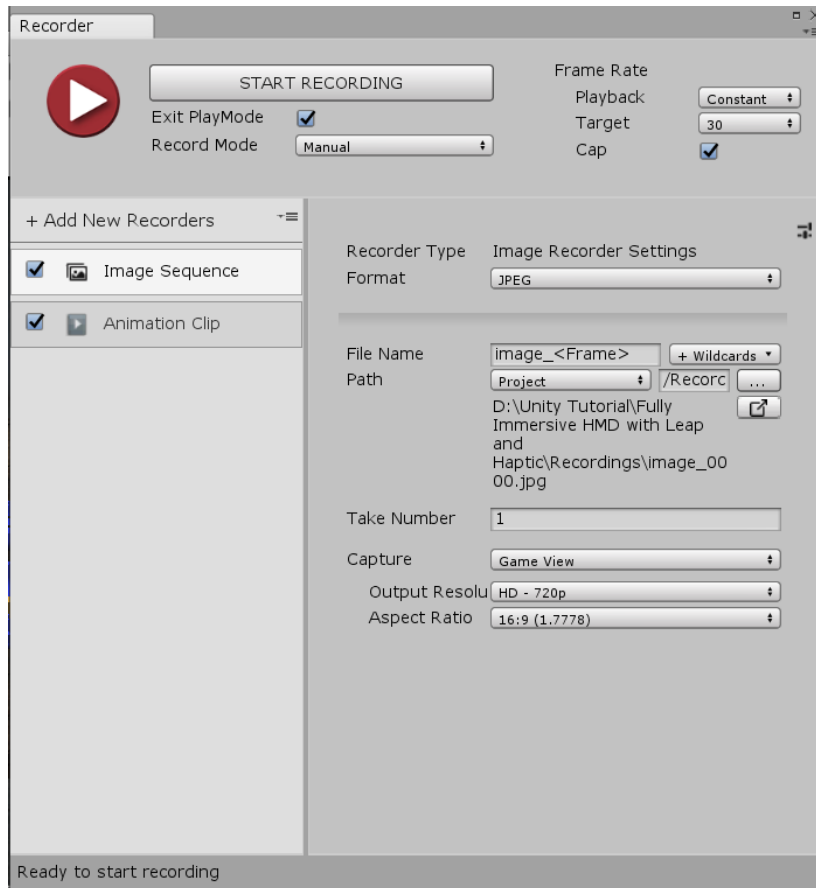

Figure 62: Unity Recorder package is used to be recording method

#### 4.3.3.2 Animation clip

The animation recording function is used to record the operation process of experts or users in term of video media format. The animation recording function is set to record as 30 frames per second in mp4 file format.



Figure 63: Recording method by image sequence function

#### 4.4 Summary of implementation on the VR-TPP platform

In this chapter, we described the process of building a general platform based on the concept of VR-TPP. The VR-TPP platform is a generic platform that is built to support the training preparation process of maintenance task. The VR-TPP platform begin with the process of creating of the virtual environment by importing 3D objects into the virtual scene. In the virtual scene, the 3D objects have to define a physical properties and mechanical properties which have to be a factors as close to the objects in the real world. In addition, the interaction method between the device and the system is defined. This method consists of 2 VR level which are a non-immersive VR level and fully-immersive VR level. Non-immersive VR level, the virtual environment is displayed via a 2D screen and used a basic device such as a mouse, a keyboard to control the view in the virtual environment. While the fully-immersive VR level will be displayed the virtual environment through the HMD display and used the sensor on HMD display to control the view in the virtual environment. Then, we described the interaction techniques that is used to interact between user and system. During the trainees or expert work in that virtual environment, the hand gestures of the them will be recorded as a picture or animation in order to classify and record them in a library of hand gestures.

The overall process has been converted in an operational proof of concept. We then used this platform to create and operate the case studies. In next chapter demonstrate such case studies.

## **5 Case Studies**

### **5.1 Introduction**

In order to implement and validate the concept and the platform, three case studies were used to demonstrate the contribution of our concept and approach in this chapter. The first case study demonstrates the appropriate method for removing the saw blade from jigsaw machine. In addition, this case study is also used to study the perception level and ease of use of VR devices with non-immersive VR level. The second case study shows how to build a gesture library related to mechanical joint by VR technology. Furthermore, this case study also shows how to specify a work instruction for the most important gestures required to fold a foldable STRIDA bicycle which related to a gesture library. The third case study shows the benefits of a VR platform in designing process of disassembly process of a gearbox. This case study is also used to study the perception level and ease of use of VR devices as well as side effects from using VR devices with fully-immersive VR levels.

### **5.2 Validation of VR-TPP concept by disassembling process**

The case study aims at validating VR-TPP concept by demonstration of designing and assessing of the repairing process of a jigsaw blade (Figure 64). The demonstration is created on PC computer. While the virtual environment is created by Unity 3D software and simulated on a 2D Desktop PC as shown in Figure 65.

There are two kinds of controllers for controlling the movement of the view point: the mouse and the keyboard. The mouse is use to move the camera in order to look at the working area and around it in the virtual environment. The keyboard is used to move the direction of camera to left-right and front-rear.



Figure 64: Repairing a saw blade by virtual hands



Figure 65: The platform and devices for disassembling process of Jigsaw

### 5.2.1 Recording the disassembling process of the Jigsaw

In the disassembling process of the Jigsaw, the trainees were asked to practice in the virtual environment with non-immersive VR level in order to move a saw blade out from a Jigsaw machine without prior knowledge of how to capture and remove the saw blade as shown in Figure 66.



Figure 66: The trainees practice in virtual environment

During the users practice on the platform, the hand gesture and operation process are recorded as shown in Figure 67. The recording process is automatically activated at the beginning process by recording function of Unity 3D. The sequence of pictures of each trainee will be analysed by experts to decide if they are appropriate and which gesture must be selected. In addition, the trainees were asked to answer the questionnaire about the ease of use of VR devices and the perception level from using this system (non-immersive VR level).



Figure 67: The picture sequence recorded in the system

### 5.2.2 Discussion of the sequence of pictures

This case study is a beginning process which is used to create a design process and work instruction by virtual reality technology. The VR-TPP concept and environment shall leverage the identification of the appropriate VR tools and



approach providing the ability to train maintenance operators in the training preparation process. In order to identify the appropriate process and hands gesture, to move the saw blade out from Jigsaw machine, 10 participants were invited to test on the case study.

According to sequence of pictures recorded in the system, we considered each participant's gestures during their practice in the virtual environment. We can summarize how to remove saw blade from jigsaw in three methods from the participants. First method, the trainees moved their hands to hold the saw blade directly from the front of cutting edge side. Second method, the trainees moved their hands to hold the saw blade directly from the bottom of sharp side and third method, trainees moved their hands to hold the saw blade directly from the back side of saw blade as shown in Figure 68.







Hands moving step Type of moving method	Step1	Step2	Step3
Type 1			
Type 2			
Type 3			

Figure 68: The hands moving method

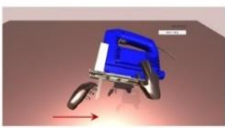
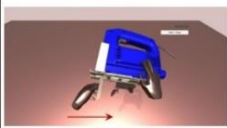
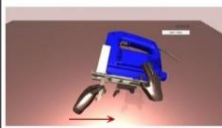
From those methods, we can realize that the appropriate method was the third method because we can see that the first and second method will cause injury with trainees when they use those methods to practice in real situation as shown in Figure 69.

In order to improve the working instruction, the experts will be invited to test and reproduce the work instruction in the VR environment. The work instruction is re-used for maintenance training in various formats, from classical paper instruction, to complex VR training modules, passing through simple video preparation. The main benefit comes with the fine gesture capacity which make sense because we avoid occlusion issue.

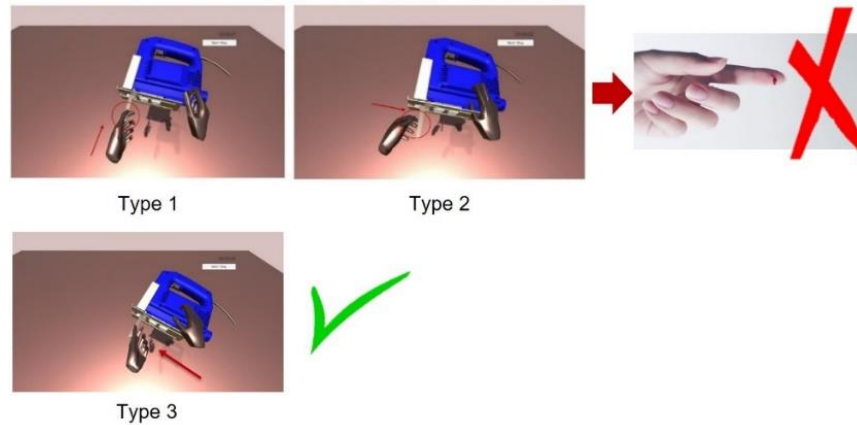

Figure 69: Summary of the hand gestures for the jigsaw

### 5.3 VR-TPP for creating a knowledge base of hand gestures

This case study presents a methodology to classify and record the hand gestures. This is also used to organize and store the gestures in a library for using in particular in the training preparation process. Within this library, we can characterize each gesture and relate them to mechanical assembly and disassembly operations with respect to their appropriateness. Through this relationship, we can create a knowledge base that can be used for suggesting hand gestures. Furthermore, key elements of work instructions for operators can be derived from this library.

#### 5.3.1 Building a library of hand gestures

At the traditional training method, when we have a new worker they have to learn how to work with the traditional training method such as training in a classroom, training in a workshop. Then, they are allowed to work on the real situation. Now, we were developed the training method with VR technology. We were created the training process and use it to train the new worker. However, the trainees must still learn the correct working posture from an expert first. From this point, we can create and record the gestures from experts. This process is a building process of hand gestures library in order to create a virtual work instruction as shown in Figure 70.



Figure 70: A building process of virtual work instruction

The building process of the hand gestures library comprises six steps as shown in Figure 71.

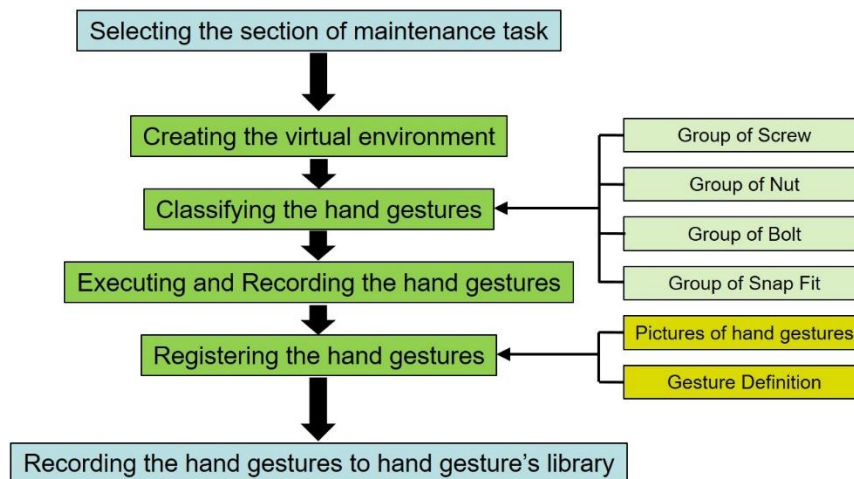

Figure 71: The process of building a hand gesture library

### 5.3.1.1 Selecting the section of maintenance task

The process of classification and registration of hand gestures starts with identifying and selecting the maintenance task the user need to design and to create the knowledge base of maintenance hand gestures. In this case, we opt for understanding and documenting the most appropriate hand gestures required for assembling and disassembling mechanical joints. We decided for this case because it is universal, however it is just representative for any other usual or special types of mechanical parts that need special manipulation during the

assembly and disassembly process. We built up a joint/gesture library on this basis.

#### 5.3.1.2 Creating virtual environment

The reality level achieved by the virtual environment plays a crucial role in the training preparation process. It is important to make users recognize and accept the fully immersive level of virtual reality. Once we identified the maintenance task, we created a virtual environment (VE) that is close to the real work environment and therefore providing working conditions like in real situations. Figure 72 shows the entire workplace model we used.



Figure 72: The virtual workshop model.

#### 5.3.1.3 Classifying hand gestures

In the real world, the hand gestures that we use for (dis)assembly and maintenance tasks are various. The use of hand gestures can be classified and summarized depending on different situations. In this case, we focus on the appropriate hand gestures to use in maintenance tasks. Any maintenance work of mechanical products involves disassembling and assembling mechanical parts as well as mechanical joints. To simplify the classification, we grouped the various existing mechanical joints into four types of temporary joints; screw, nut, bolt, as well as snap fit and tabs. In order to understand the even greater variety of hand gestures, we defined three types of screws; Hex Lag Screws, Sheet Metal Screws and Wood Screws. As for the nut, we defined two types; Hex Head Bolts and Socket Cap Screws. For the bolt we defined two types; Hex Finish Nuts and Wing Nuts. Snap fit and tabs is a rather complex task in a virtual environment.

Therefore, we defined only one example from disassembling plastic box as shown in Figure 73.

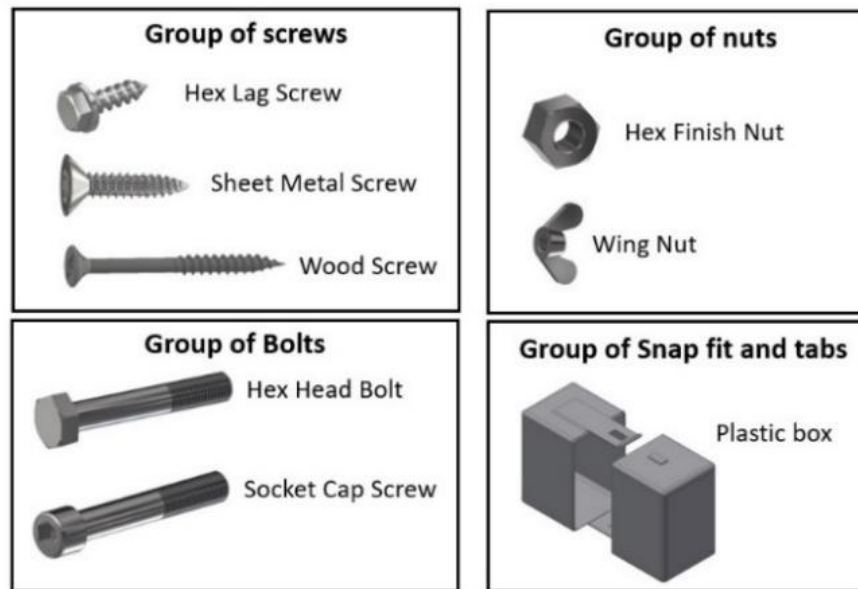

Figure 73: Type abstraction of mechanical joints

#### 5.3.1.4 Executing and recording hand gestures

In this step, various experts were asked to practice in VR platform. While they were doing so, we observed and recorded their hand gestures with the picture recording function as 30 frames per second and an image resolution of 720 pixels as shown in Figure 74. The virtual camera is set in the first person perspective corresponding to the real human eyes' position. The experiment started with the process of disassembling Hex Head Bolts, Hex Finish Nuts, and Socket Cap Screws with Wing Nuts. The removing process of Hex Lag Screws, Sheet Metal Screws and Wood Screws out from the wooden pedestal will be next step. As the final step, a plastic box will be manipulated by the snap fit technique.

#### 5.3.1.5 Specifying hand gestures as patterns

In this step, we analyzed the experts' recorded hand gestures focusing on the appropriate ones for being able to add them to work instructions later. We defined patterns of hand gesture based on postures of the hand and the fingers used, then we explained the definition for those gestures referring to Finger-Based Grasping techniques.



Figure 74: Recording an image sequence of hands gestures

### 5.3.1.6 Building a library of hand gestures

Building a library of classified hand gestures is the fundamental step towards being able to systematically associate mechanical joint types, required expert gestures and appropriate VR device configurations. In this case, we stored those gestures in the format of doc and pdf as shown in Table 5, since the gestures that we registered for demonstration are not numerous. In order to build the library of hand gestures, we implemented this process in a virtual reality environment using a laptop computer running the Unity 3D. The 3D objects have been imported to virtual environment in OBJ format and other formats depending on the imported object's characteristics. To enable the user to realize the realism at the fully immersive level, an Acer Mixed Reality head mounted display (HMD) has been chosen and a Leap Motion device is used to track hand movements as shown in Figure 75.

Table 5: The format used for storing the hand gesture

Type of maintenance task	Pattern of hand gesture	Definition	Virtual hand gesture
This table is used to specify the type of maintenance task.	This table is used to define the pattern of hand gesture by a keyword or an abbreviations.	This table is used to define the definition of hand gesture and to explain how to use the hand gesture.	This table is used to demonstrate the picture of virtual hand gesture.



Figure 75: Building a library of hand gestures in VR-TPP

### 5.3.2 Discussion of building a library of hand gestures

In this case, an approach to recording, classifying and clustering such hand gestures of maintenance tasks are proposed. In the library, we can characterize each gesture and relate them to mechanical assembly and disassembly operations with respect to their appropriateness as shown in Figure 76, Figure 77 and Figure 78.

According to Finger-Based Grasping techniques, we can define the type of maintenance task, pattern of hand gesture and definition to the virtual hand gesture.

Type of maintenance task	Pattern of hand gesture	Definition	Hand gesture
Removing Sheet Metal Screws	Pinch with T11 T = Thumb I1 = Side of Index	This hand gesture use Thumb and side of Index to pinch the screw and rotate the screw to left or right. This hand gesture will use with the small head of screw and round head screw.	
Removing Hex Lag Screws	Pinch with T12 T = Thumb I2 = End of Index	This hand gesture use Thumb and End of Index to pinch the screw and rotate the screw to left or right. This hand gesture will use with the hexagonal screws and square screws.	
Removing Wood Screws	Pinch with T11 T = Thumb I1 = Side of Index	This hand gesture use Thumb and side of Index to pinch the screw and rotate the screw to left or right. This hand gesture will use with the small head of screw and round head screw.	

Figure 76: Pattern of hand gestures for screws



Type of maintenance task	Pattern of hand gesture	Definition	Hand gesture
Removing Hex Finish Nuts out from Hex Head Bolts	Pinch with TIM T = Thumb I = Index M = Middle	This hand gesture use three fingers to catch the bolt and nut. Thumb, index and Middle will be used to catch the head of bolt and nut. Using three fingers is easy used to catch and rotate.	
Removing Wing Nuts out from Socket Cap Screws	Pinch with TIMP T = Thumb I = Index M = Middle P = Ring	This hand gesture is a special type, it use four fingers to catch the wing nut (Thumb, Index, middle and Ring). Thumb and Middle use to pinch the middle of head of wing nut. Index and Ring use to control upper wing and lower wing because it will use to rotate clockwise or counterclockwise.	

Figure 77: Pattern of hand gesture using with bolts and nuts

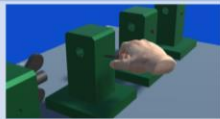
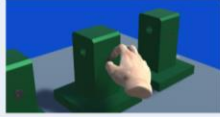
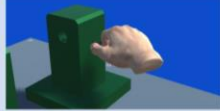
Type of maintenance task	Pattern of hand gesture	Definition	Hand gesture
Removing plastic part by snap fit technique	Unwrap and pull with Thumb	Using thumb to unwrap and pull the plastic slightly out from locking. Then, take off one of them out together.	
	Unwrap and pull with Index	Using index to unwrap and pull the plastic slightly out from locking. Then, take off one of them out together.	

Figure 78: Pattern of hand gestures for the snap fit technique

Figure 76 shows a pattern of hand gesture used with screws. For removing sheet metal screws, the user can remove the metal screw out by pattern of pinch with TI1 which is used thumb and side of index to pinch the screw and rotate the screw to left or right. This type TI1 is used with the small head of screw and round head screw and it is also used for removing wood screws. For removing hex lag screws, user can remove the hex lag screws out by using pattern of pinch with TI2 which is used thumb and end of index to pinch the screw and rotate the screw to left or right. This type TI2 is used with the hexagonal screw and square screw.

Figure 77 shows a hand gesture pattern used with bolts and nuts. For removing hex finish nuts out from hex head bolts, user can use the pattern of Pinch with TIM in order to remove hex finish nut out from hex head bolt. The pattern TIM use three fingers to catch the bolt and nut which consist of thumb, index and middle. While the pattern TIMP is used to remove nuts out from socket cap screw. The pattern TIMP is a special type, it uses four fingers to catch the wing nut which

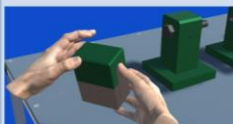
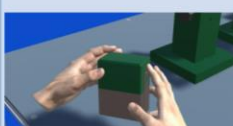

consist of thumb, index, middle and ring. Thumb and middle are used to pinch the middle of head of wing nut, while index and ring are used to control upper and lower wing.

Figure 78 depicts a pattern of hand gesture to snap fit technique. In this type, the user can remove a plastic part out by two patterns: unwrap and pull with thumb, unwrap and pull with index. The first pattern uses thumb to unwrap and pull the plastic slightly out from locking and take off one of them out together. The second pattern uses index to unwrap and pull the plastic slightly out from locking and take off one of them out together.

The hand gestures are key aspects in maintenance work. Within this library, we characterize each gesture and relate them to mechanical assembly and disassembly operations with respect to their appropriateness. Through this relationship, we create a knowledge base that can be used for suggesting hand gestures, as well as for rating them in e.g. training tasks. In addition, key elements of work instructions for operators can be derived from it. It is complementary to the previous used case approach.

Base on the building a library of hand gestures, we also demonstrate a brief insight into the creation of a work instructions for the gestures required to fold a foldable STRIDA bicycle correctly. The particular bicycle we had for this study is depicted in Figure 79, both in folded (left) and unfolded form (right). In fact, this bicycle can be folded conveniently only by applying the right gestures of holding the bicycle and manipulating the right joints in the correct sequence. This requires studying the work instruction and practice on the real object. Although the printed, “static” work instruction delivered with this bicycle is helpful, there is clearly a gap to overcome between the theory shown there, and its practical application to the real object. This is mainly due to the fact that the manipulation of the individual joints is not evident and requires investigation and practice.



Figure 79: Foldable STRIDA bicycle folded (left), and unfolded (right)

Figure 80 shows the instantiation of the generic WI/BOM model that was generated from the abstract WI sequence model (Figure 49). This model is used to specify the individual steps required for folding the bicycle. Each step is associated with the gestures that are appropriate for manipulating the concerned parts of the BOM.

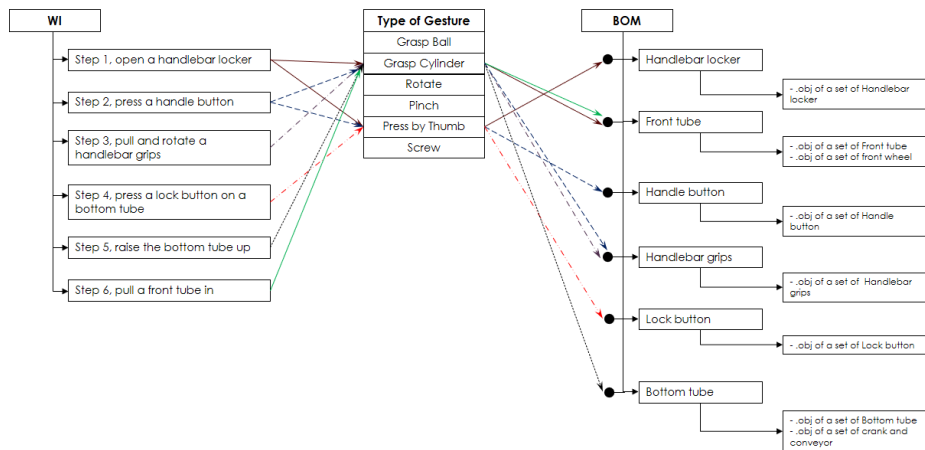

Figure 80: Work instruction specification for folding the STRIDA bicycle

In this environment, the parts of the virtual bicycle are identified by the system as the user touches them with his virtual hands (using his real hands). The particular characteristics of the gestures are added from the library of gestures by relating the manipulated joints with the appropriate gestures. In this way, we avoid the need for a highly realistic simulation of gestures in the VR environment. The bicycle folding process sequence consists of the following six steps: i) open the handlebar locker, ii) press the handle button, iii) pull and rotate the handlebar grips, iv) press a lock the button on the bottom tube, v) raise the bottom tube up, and vi) pull the front tube in.

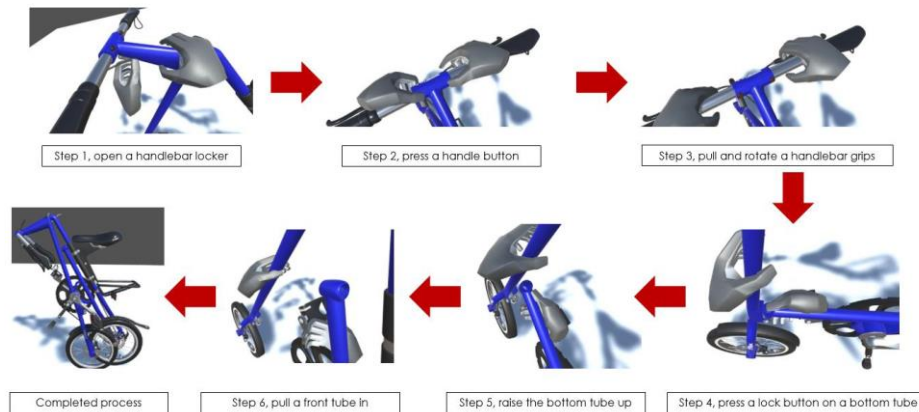

Figure 81: STRIDA folding gesture sequence recorded in VR-TMT

The recorded sequence of these steps executed in the VR-TPP platform are shown in Figure 81. This recorded sequence can be used for multiple purposes, in particular for creating a visual work instruction, for instructing trainees both in real and virtual environments, as well as for studying typical mistakes trainees make during their manipulations. We can also think about analysing the recorded sequences of different experts' or trainees' approaches to performing the tasks, and extract from them alternative ways of achieving the same result.

## 5.4 Virtual Reality for Training in Maintenance Task

In order to apply the virtual reality technology to maintenance task training, this case study is applied the VR-TPP concept to a Virtual Reality for Training in Maintenance Task (VR-TMT) platform. The VR-TMT is a platform that use to simulate the disassembly process of a gearbox. The VR-TMT platform is used to evaluate the correctness of the trainees' performances, as well as to understand the reasons for any mistakes or alternative ways of performing the tasks. In this case study, a fully immersive VR level will be chosen based on an easily accessible low-cost VR equipment. The devices, models and techniques exploited in building the VR-TMT application will be described as well as the system configuration and user interaction.

### 5.4.1 Maintenance content definition

Content creation will be determined based on the needs of the customer or user who wants to create training courses with virtual technology. The virtual environment shall resemble the actual environment appropriately, including working conditions and procedures. This particular demonstration is the

simulation of disassembling and assembling a gearbox to demonstrate the ability of virtual technology in the maintenance task. For this, a virtual factory environment has been built on a fully-immersive VR level, so that users can perceive the highest level of immersion. In order to dis/assemble the gearbox, the working area is positioned at the front end of the table. It is necessary to place those parts at the position of a white cube. User can choose to place according to the position of the white cube as shown in Figure 82.

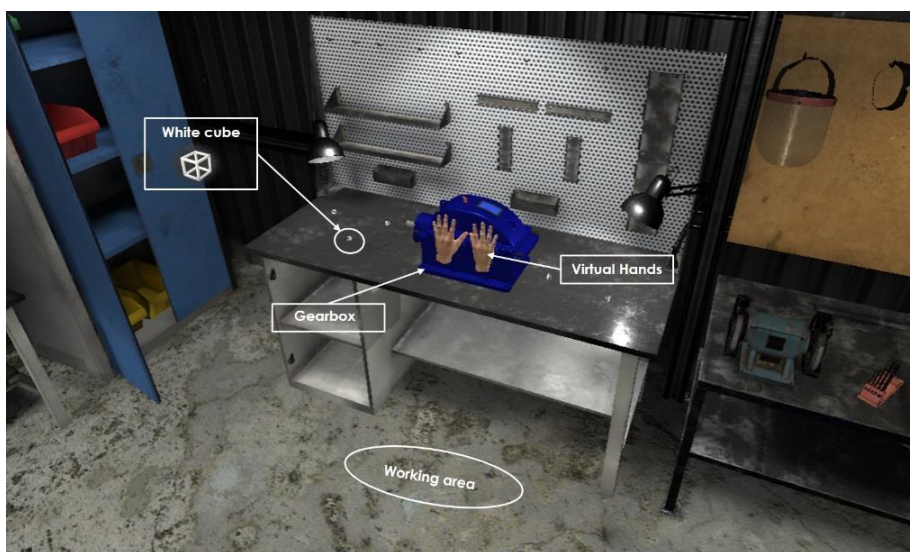

Figure 82: The small virtual factory simulation

In the process of disassembly, if user removes the parts and move it closer to its docking position (white cube), the parts will be placed and positioned automatically. In the process of assembling, if users move the parts closer to the right assembly position, the parts will be positioned at the same position automatically as well. With this content, users can practice anytime according to their needs for increasing their skills and experience

#### 5.4.2 System configuration

The VR-TMT system has been developed on the Unity 3D game engine that can be executed on a typical PC running the Windows operating system. The system platform for this experiment consisted of a laptop running Windows equipped with NVIDIA GeForce GTX 950M graphics card, ACER Windows Mixed Reality HMD, Leap Motion Controller (LMC), keyboard and mouse. The LMC was installed in front of the Head Mounted Display (HMD), and the devices

were connected to the PC over USB cables and HDMI. The communication between the Unity platform and the LMC was implemented using a C# program language script.

Scripts are important parts for treating the input values. A useful Unity asset type is the Prefab. Prefabs are instances of a GameObject, cloning the complete original one with its components and its properties. Any changes made to a prefab are immediately applied to all its instances. The advantage of Prefabs is that they are re-usable and they can be easily instantiated or destroyed throughout the runtime. The virtual hands were created by “Core” of leap motion with a few lines of code. In the scenario implemented composite patches creation, selection and placement were implemented with prefabs (Matsas. & Vosniakos, 2015).

### **5.4.3 Virtual environment**

The virtual environment is displayed in real time with the HMD screen. The calibration of the virtual hands is done by the user raising both hands in front of the HMD screen which has the LMC installed, so that the system will detect and display the virtual hand in a VE. After calibrating, user can walk around in the real space to discover the virtual environment in an area of approximately 1.5 square meters, due to the limitation of cable lengths of HMD and LMC. While the user rotates and moves the head, the camera will display the image on the HMD screen in the first person view, which is like the own human eyes' view.

In this particular case, a group of 27 participants were asked to disassemble a gearbox by separating five pieces from each other. The disassembly process starts with (a) removing the cover and placing it on the table; (b) removing the gear set and placing it on the table; (c) moving the gear set to the maintenance area; (d) removing the front bearing support cover and placing it on the maintenance position; (e) removing the rear bearing support cover and placing it on the maintenance position as shown in Figure 83. The whole process was recorded as image sequences. Then the users were asked to reassemble those parts to a gearbox. The users were asked to operate on the process A and B at the X position and operate on the process C, D and E at Y position as show in Figure 84.

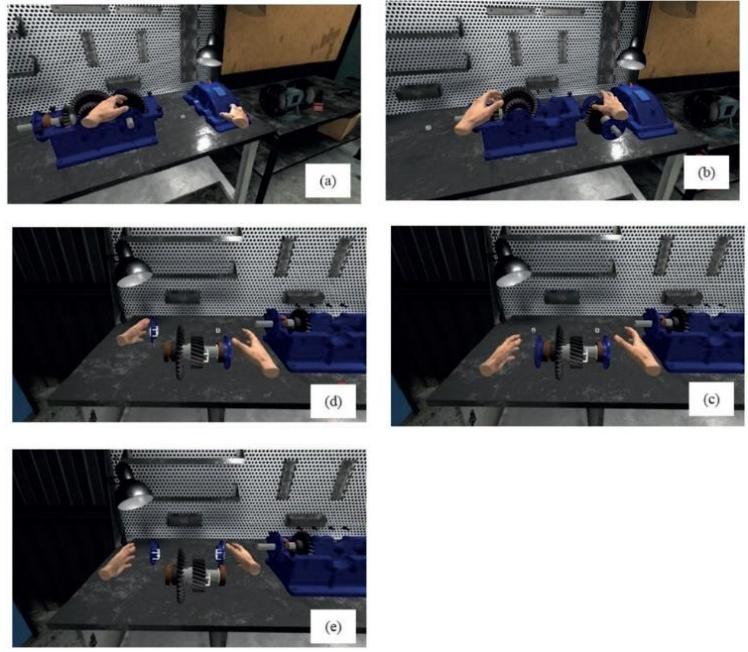

Figure 83: A storyboard displaying the different tasks of working process

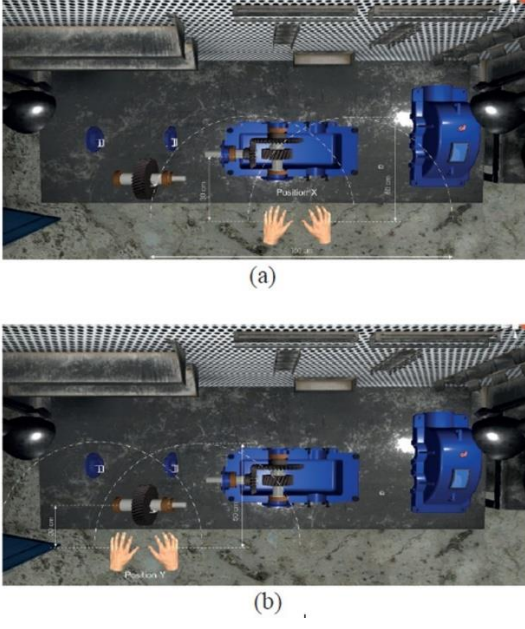

Figure 84: Working environment in VE  
 (a) Working on position X, (b) Working on position Y

#### 5.4.4 Discussion of the VR for training in maintenance task

The VR-TMT platform is used to simulate the disassembly and assembly process related to maintenance task in order to evaluate the correctness of the trainees' performances. The VR-TMT platform is also used to understand the reasons for any mistakes or alternative ways of performing the tasks from trainees. In this case, only the participants' hand motion characteristics were recorded in the virtual environment and resulted in image sequences like the one shown in Figure 85.

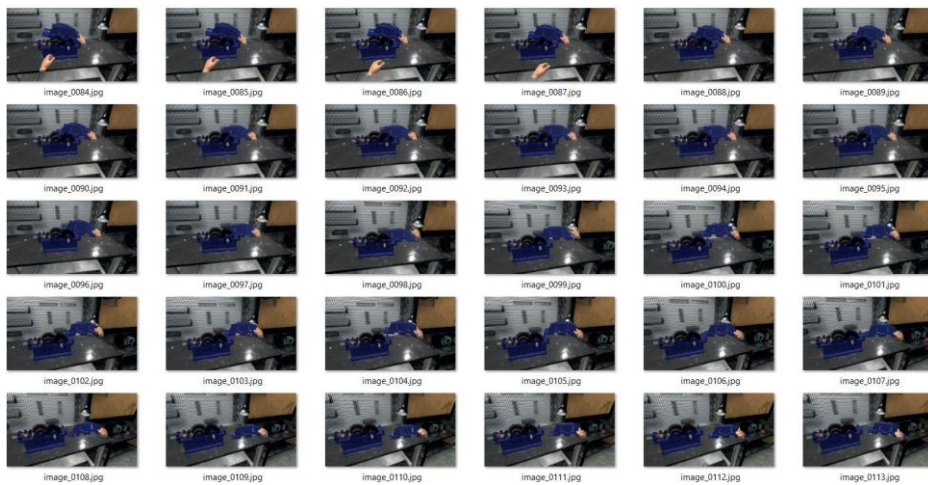

Figure 85: Recording of image sequences by VR-TMT platform

The observation from the image sequences revealed that there were five participants using their left hands to separate the cover part in step A, instead of their right hands which is an inappropriateness of motion as shown in Figure 86. Due to this process is designed for a person who is good at using the right hand. From the result, we should consider the process and placing area of the cover part for left-handed and ambidextrous people. Then, there were two participants trying to work in steps C, D and E at the X position, which is an inappropriate working position as shown in Figure 87. Due to the fact that the working areas at the position X and Y are closely together, some participants felt that it was convenient when they performed their tasks at the same position. In addition, there were three participants trying to work in step D and E at the same time, instead of having to separate piece by piece as shown in Figure 88. They would like to challenge the work on process D and E at the same time in order to reduce working time. According to an inappropriateness of participants' working step, the participants felt like safe and were therefore inclined to make mistakes. We should to add some warnings to virtual environment to indicate to them that they are about to perform tasks in a manner that is unsafe or simply not correct.

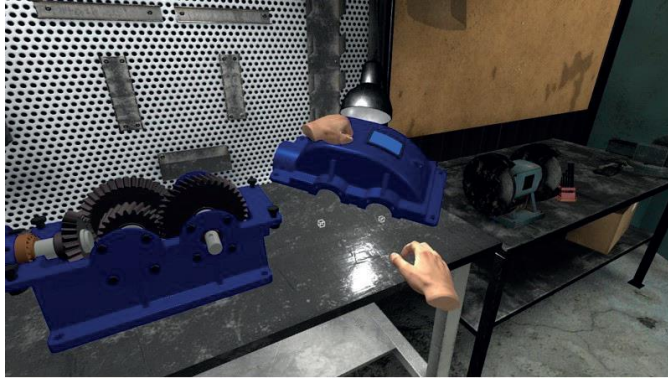

Figure 86: An inappropriateness of participants' hand motion

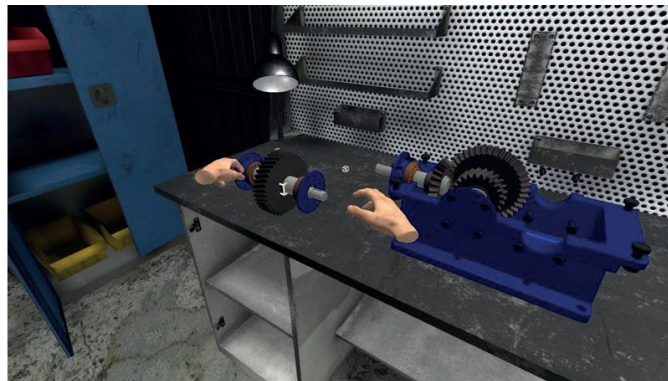

Figure 87: An inappropriateness of participants' working position

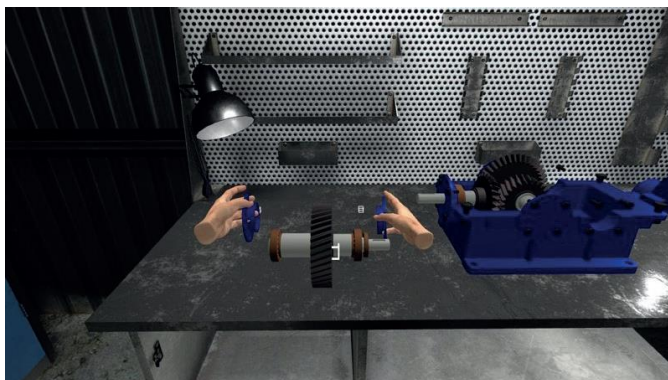

Figure 88: An inappropriateness of participants' working step



## 5.5 Summary

This chapter presented the three case studies used to implement and validate the VR-TPP concept. The first case study confirmed that the VR-TPP concept can be implemented, and that the adoption of VR technology in the training preparation process shows the appropriate gestures and sequences for removing the saw blade. It can also explain why other working processes are inappropriate and even dangerous. In the second case study, we applied the VR-TPP concept to creating a library of hands gestures. These hand gestures can be used during the training process for defining virtual work instructions (VWI). Within this case study, we also demonstrated how to link the generic WI/BOM model to the UML gesture model by folding and unfolding the STRIDA bicycle in virtual environment. The third case study is the study of the basic working method in the training preparation process in order to find out how to design the workflow and working conditions before the training process. User experiments confirmed that the selection of the appropriate work instruction and virtual object representation are crucial for a successful training process.

From these case studies, it is possible to see that systematically applying virtual reality technology in the process of training preparation for maintenance task is possible and can provide added value. In addition, it can also assist in the identification and modelling of appropriate hand gestures and workflow in the training process. In these case studies, we have also evaluated the results of the usability and ease of use of the VR-TPP platform as well as the side effects coming from using the platform devices. The results will be summarized in chapter 6.

## 6 User Experience Evaluation

### 6.1 User Experience Study

Chapter 5 demonstrated three case studies of VR-TPP implementation and application, each with a different focus. In the case study 1 (Validation of VR-TPP concept by disassembling process) and case study 3 (Virtual Reality for Training in Maintenance Task), user experience has also been evaluated using questionnaires. While in case study 1, the evaluation focus was on the ease of use of the VR devices and the realism of the platform, the perception level and side effects from using VR devices and the virtual reality experience were evaluated for case study 3. This chapter elaborates on the evaluation procedures, artefacts, and results.

### 6.2 Experiment setup

In order to demonstrate the necessity of VR-TPP, as well as to evaluate the latter's capability of supporting different VR environments, the experimental concept implementation included non-immersive and fully-immersive VR levels. Both systems are connected to the VR-TPP platform, however the VR devices used to control and manage the scene in the virtual environment are different per immersion level.

The non-immersive VR level has been implemented in the VR-TPP platform using basic VR devices (mouse, keyboard, and leap motion controller) to control and manage the maintenance task in the virtual environment. This was applied in case study 1 (Validation of VR-TPP concept by disassembling process). The participants were asked to operate in a virtual environment by controlling and managing the task through the basic VR devices while perceiving the virtual environment through a 2D screen.

The fully-immersive VR level has been implemented in the VR-TPP platform using a HMD controller and leap motion device. This was applied in case study 3 (Virtual Reality for Training in Maintenance Task). The participants were asked to wear the HMD glasses during operating the task in a virtual environment. In addition, the participants were asked to operate the task by bare hands, while the participants accessed to the virtual environment through the HMD's 3D monitor.

### 6.3 Evaluation and explanation

The ease of use of VR tools and the perception using VR device define the ability of users to accomplish the specific task with efficiency, effectiveness, and satisfaction in a context of use (Dix., E., Finlay., Abowd., & Beale, 1993). Usability testing is concerned with measuring the user’s performance on the task (Daniel & Jared, 2003). The performance is measured directly by observing users when while they are operating.

- The ease of use of VR devices is defined by the performance and appropriateness of the device used to interact with the virtual reality technology for maintenance and operation process. The degree of ease of use of each device determines how appropriate the device is for transferring a given training task into the virtual environment.
- The level of realism as well as the virtual reality experience is defined by the appropriateness of the device used to access a virtual environment for interacting with virtual reality technology.
- The side effects from using VR have also been investigated, in order to get an idea about their influences on training performance, as well as on well-being.

The measurement on non-immersive VR level will be assessed in both the ease of use of VR tools and perception level in realism. The ease of use of VR tools is evaluated by qualitative measurement through four questions as shown in Table 6. The perception level in realism is used to explain the user preference in visual perception as shown in Table 7.

Table 6: Questionnaire on the ease of use of VR tools

No.	Questions	Level of using tools				
		1	2	3	4	5
1	I can use <i>keyboard</i> to manipulate the scene.					
2	I can use <i>mouse</i> to manipulate the scene.					
3	I can use <i>leap motion</i> to manipulate the scene.					
4	I can use <i>all of those tools</i> to manipulate the scene in the same time.					

Table 7: Questionnaire on the perceptions level in realism

No.	Questions	Level of perceptions			
		1	2	3	4
1	I perceived the realism level of <i>visual</i> from using VR environment.				

The fully-immersive VR level will be assessed in three types of questions: perception level in virtual reality experiencing (Table 8), perception about using the VR devices (Table 9), as well as the side effects from using VR devices (Table 10).

Table 8: Questionnaire on the virtual reality experiencing

No.	List	Level of perceptions				
		1	2	3	4	5
<b>Perceptions level in virtual reality experiencing</b>						
1	I enjoyed experiencing the maintenance training through virtual reality technology.					
2	I would say that the virtual reality experience for maintenance training is very interesting.					
3	I felt fully immersive about the virtual reality environment.					
4	When experiencing the virtual reality, my attention was totally focused on it.					
5	Experiencing the virtual reality is made my curiosity and want to learn more.					
6	I believe that using virtual reality technology has possibilities of enhancing the effectiveness of training.					
7	I believe that virtual reality technology could be useful for training.					
8	Learning by using the virtual reality technology for maintenance training was easy for me.					

Table 9: Questionnaire on the perception level from using VR devices

No.	List	Level of perceptions				
		1	2	3	4	5
<b>Perceptions level form using VR device</b>						
9	I found that the HMD device flexible to interact with.					
10	It was easy for me to use the HMD device and the content of this platform.					

Table 10: Questionnaire on the side effects from using VR devices

No.	List	Level of perceptions				
		1	2	3	4	5
	<b>Side Effect from using VR device</b>					
11	I felt headache during using VR device.					
12	I suffered physical tiredness when I interacted with VR device and virtual environment.					
13	I suffered visual tiredness when I interacted with VR device and virtual environment.					

## 6.4 User experience evaluation

In the following, we will use NI-VR to signify the non-immersive VR experiment setup, while FI-VR stand for the fully-immersive variant.

### 6.4.1 User experience testing in NI-VR

In this experiment, the participants had to practice and find an appropriate way of removing the saw blade from the jigsaw without any prior work instruction. The expectation was to identify which different methods and behaviors the participants would show to accomplish this task. At the same time, the participants' feelings about the devices used and the level of visual perception should be determined based on the questionnaire elaborated earlier.

We tested this experience with 10 participants (8 males and 2 females), with an average age of 29 years (SD=3.94 years). The youngest was 25 and the oldest 37 years old. None of these participants had made any experience with virtual reality technology before.

#### 6.4.1.1 Perception of ease of use of VR device

To assess device appropriateness, we observe and request information from participants about their perception. It explains how much the chosen VR environment is suitable for maintenance training. Participants describe also the difficulties they faced during a particular operation in the VR training environment. We separated the level of perception of every device (keyboard, mouse and Leap Motion). Each device is rated using the same 5-levels scale.

Table 11: The rating of the ease of use perception

No.	Questions	Level of using tools				
		1	2	3	4	5
1	I can use keyboard to manipulate the scene.	20%	40%	40%	0%	0%
2	I can use mouse to manipulate the scene.	30%	30%	30%	10%	0%
3	I can use leap motion to manipulate the scene.	20%	20%	40%	20%	0%
4	I can use all of those tools to manipulate the scene in the same time.	0%	20%	30%	50%	0%

As shown in Table 11, we found that 40% of participants felt a medium level of ease for using a keyboard to control the direction and position of the camera in the scene. 40% of participants felt that it was easy, and 20% of participants felt it was very easy using a keyboard (Figure 89). 10% of participants found it difficult to control the view in the scene by using a mouse, 30% of participants found it medium, 30% of participants found it easy, and 30% of participants found it very easy (Figure 90). 20% of participants found it difficult to use the leap motion device, 40% medium, 20% easy, and 20% very easy (Figure 91).

50% of participants found it difficult to use the keyboard, the mouse, and the leap motion to manipulate and control the scene in the same time. 30% of participants found it medium, and 20% of participants found it easy (Figure 92).

This result clearly shows that the provided VR configuration is far from optimal for the given training task to be performed in the virtual environment.

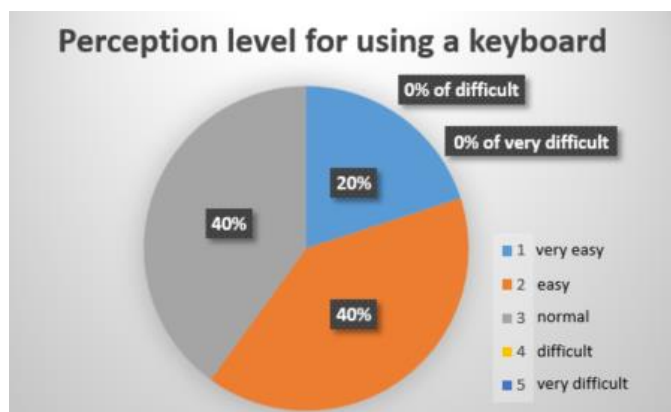

Figure 89: Perception level for using a keyboard

#### 6.4.1.2 Perception of realism

The realism perception level was rated in four levels as shown in Table 12, i) user cannot perceive the realism, ii) user can perceive a bit of the realism, iii) user can perceive the realism close to the realty, iv) user can perceive the realism as the same level of realty. The results are summarized as shown in Figure 93. 30% of participants perceived realism close to the realty. 60% of participants perceive a bit of the realism, and 10% of participants could not perceive any realism. This results leads to a conclusion about the suitability of the chosen experimental setup that complies with the one obtained from the ease of use evaluation.

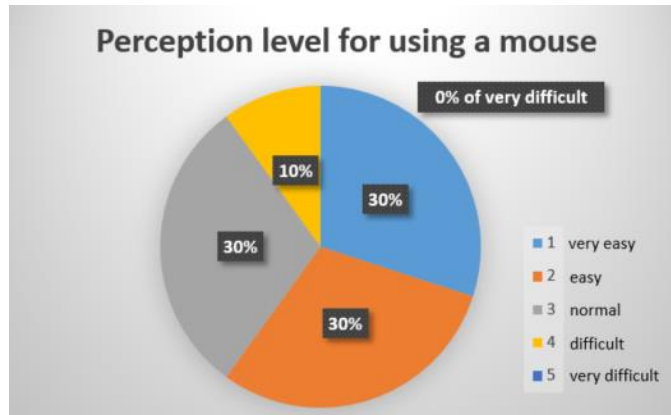

Figure 90: Perception level for using a mouse

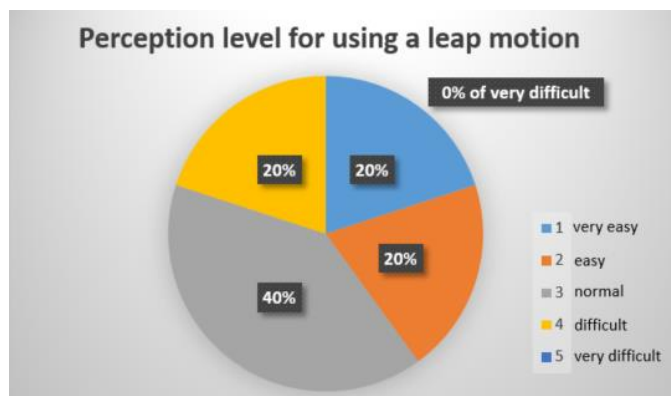

Figure 91: Perception level for using a leap motion

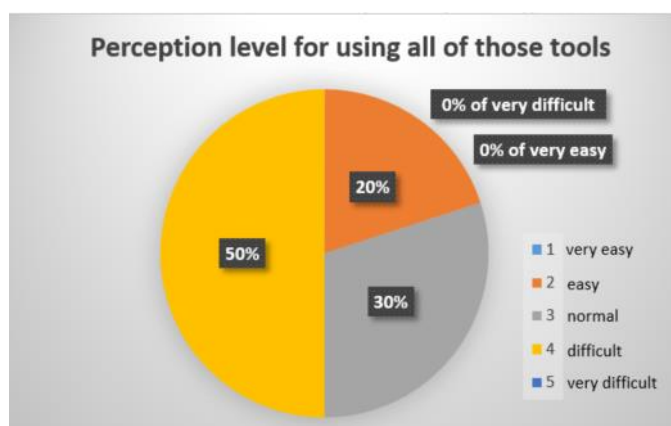

Figure 92: Perception level for using all of those tools

Table 12: Rated using the scale for perception level in realism

Level of perceptions	Description
1	I have not perceived the level of realism.
2	I have perceived a bit of realism level.
3	I have perceived the level of realism close to reality.
4	I have perceived the level of realism as the same level of reality. (Perception is at the same level as working in a real location.)



Figure 93: Testing result of the perception level in realism

#### 6.4.2 User experience testing in FI-VR

The user experience testing for fully-immersive VR level is used to investigate the perception level in virtual reality experiencing, the perception level from using the VR devices, as well as the side effects from using VR devices. In this particular experiment, trainees were asked to disassemble a gearbox by separating five pieces from each other. From the primary result, we described the posture and working process from image sequences of participants' working sequence as shown and described in chapter 5. In this session, three factors were investigated which are the perception level in virtual reality experiencing, the perception level from using VR device, and the side effect from using VR device. Five judgment levels were provided per question (1: strongly disagree, 2: disagree, 3: neutral, 4: agree, 5: strongly agree).

A group of 27 industrial engineering students (11 males and 16 females) were asked to perform the described task in the virtual environment. An average age of participants were 21 years (SD = 1.76 years). The youngest was 18 and the oldest 25 years old. From these 27 students, 7 were left handed, 19 participants right handed, and 1 of the latter was ambidextrous (i.e., both right- and left-handed).



#### 6.4.2.1 Perception of virtual reality experience

The user experience testing in this session is to assess the virtual reality experience from operating in virtual environment with fully-immersive VR technology. We request information from participants with eight questions that concern the perception level in virtual reality experiencing.

Table 13: The user ratings in VR experience

		Level of perceptions (%)				
		Low  High				
No.	List	1	2	3	4	5
<b>Perceptions level in virtual reality experiencing</b>						
1	I enjoyed experiencing the maintenance training through virtual reality technology.	0.00	0.00	14.81	29.63	55.56
2	I would say that the virtual reality experience for maintenance training is very interesting.	0.00	0.00	18.52	33.33	48.15
3	I felt fully immersive about the virtual reality environment.	0.00	0.00	18.52	51.85	29.63
4	When experiencing the virtual reality, my attention was totally focused on it.	0.00	0.00	11.11	29.63	59.26
5	Experiencing the virtual reality is made my curiosity and want to learn more.	3.70	0.00	7.41	51.85	37.04
6	I believe that using virtual reality technology has possibilities of enhancing the effectiveness of training.	0.00	0.00	7.41	44.44	48.15
7	I believe that virtual reality technology could be useful for training.	0.00	0.00	3.70	33.33	62.96
8	Learning by using the virtual reality technology for maintenance training was easy for me.	0.00	3.70	25.93	44.44	25.93

From the results shown in Table 13, we found that 55.56% of participants strongly enjoyed in experiencing the maintenance training through virtual reality technology. While 29.63% of participants enjoyed and 14.81% of participants were neutral as shown in Figure 104.

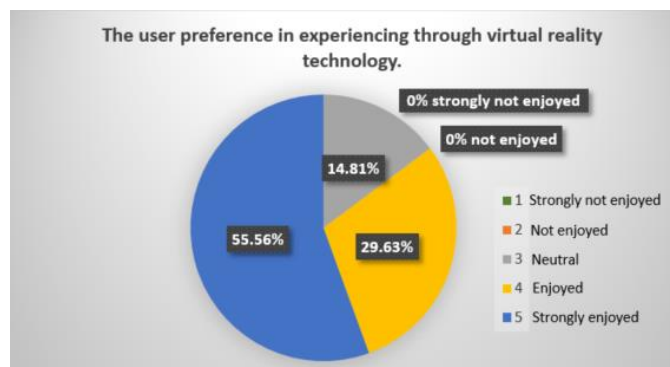

Figure 94: The user preference in VR experience

The result of user's attention level from experiencing the virtual reality technology for maintenance training shows that 48.15% of participants are very

interested in virtual reality technology for maintenance training. In addition, 33.33% of participants are interested and 18.52% of participants are neutral as shown in 101.

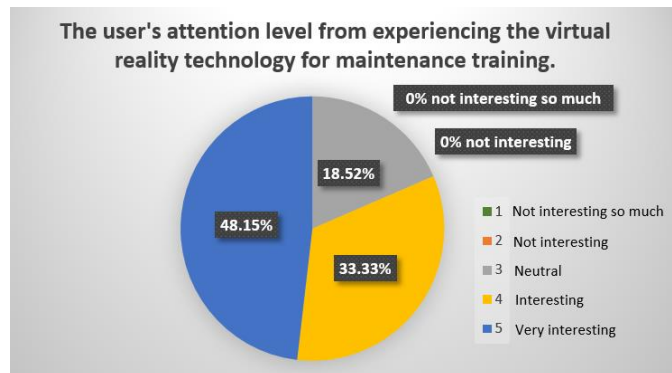

Figure 95: The user's attention level from VR experience

29.63% of participants felt very high immersion in the virtual reality environment. Then, 51.85% of participants felt high immersive and 18.52% of participants felt neutral in the virtual reality environment as shown in Figure 96.

As for user's attention levels: 59.26% of participants were very highly focused on the virtual environment when they experienced it. 29.63% of participants were highly focused and 11.11% of participants were neutral on the virtual environment when they experienced it (Figure 97).

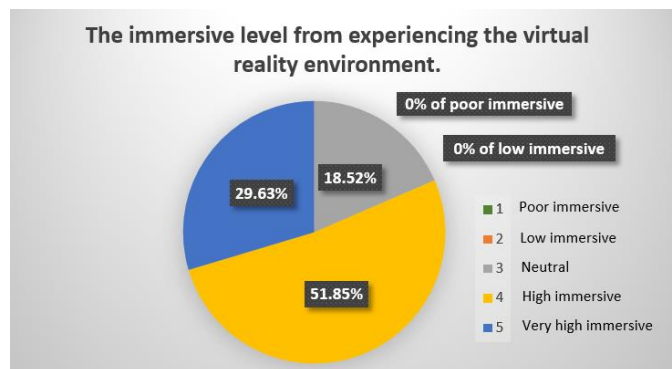

Figure 96: The immersive level from experiencing the virtual environment

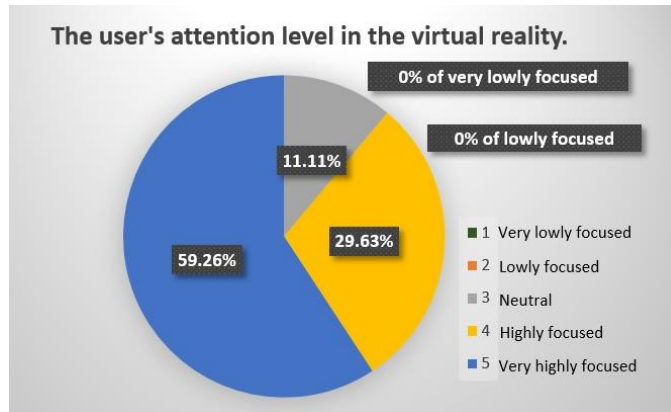

Figure 97: The user's attention level in the virtual reality

As for user's curiosity levels, 37.04% of participants were highly curious when they experienced the virtual reality technology. 51.85% of participants were curious and 7.41% of participants were neutral. 3.70% of participants had very low curiosity when experiencing the virtual reality technology (Figure 98).

As for enhancing the training effectiveness, 48.15% of participants strongly believed that using virtual reality technology has possibilities to enhance the training effectiveness. 44.44% of participants believed and 7.41% of participant were neutral (Figure 99).

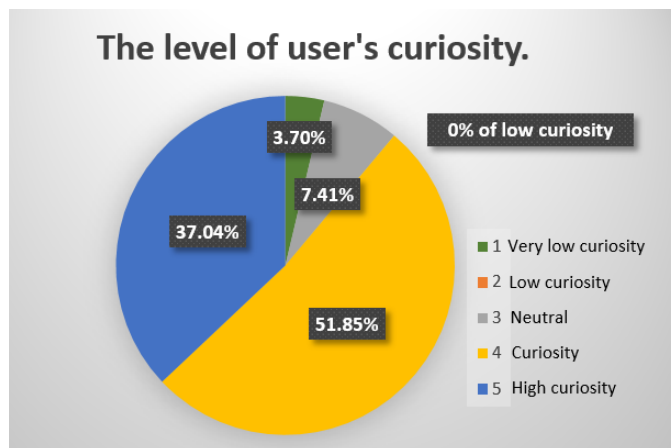

Figure 98: The level of user's curiosity

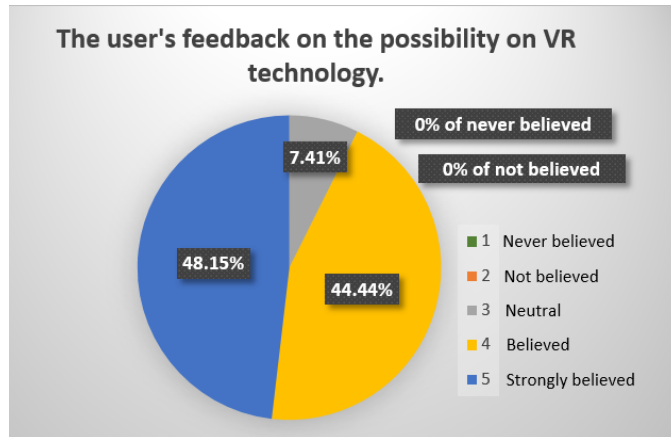

Figure 99: User's feedback on the possibility on VR technology

As for the usefulness perception, 62.96% of participants strongly believed and 33.33% of participant believed that virtual reality technology could be useful for training. The remaining 3.70% of participants had a neutral attitude (Figure 100).

As for the capacity to learn with VR technology, 25.93% of participants believed that learning by using the virtual reality technology was very easy. 44.44% believed that it was easy and 25.93% were neutral. 3.70% of the participants found it hard (Figure 101).

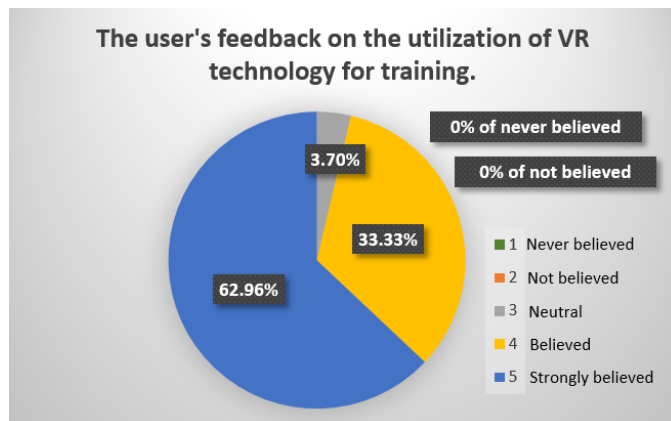

Figure 100: Users' beliefs in VR technology for training

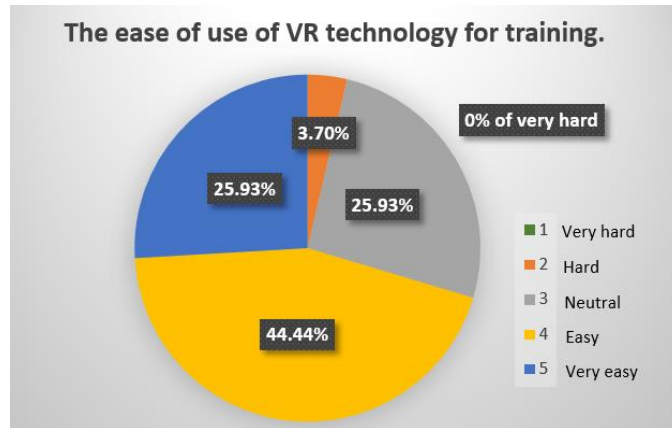

Figure 101: The ease of use of VR technology for training

#### 6.4.2.2 Perception about HMD usage

The user experience testing in this session assesses the virtual reality experience from using VR devices. We request information from participants with two questions that concerned the perceptions level from using VR device as shown in Table 14.

40.74% of participants said that the HMD device has high interaction flexibility; 55.56% of participants declare interaction flexibility. 40.74% of participants judged interaction flexibility neutral (Figure 102).

Table 14: The user ratings in perception level from using VR device

No.	List	Level of perceptions (%)				
		1	2	3	4	5
<b>Perceptions level from using VR device</b>						
9	I found that the HMD device flexible to interact with.	0.00	0.00	3.70	55.56	40.74
10	It was easy for me to use the HMD device and the content of this platform.	0.00	0.00	25.93	48.15	25.93

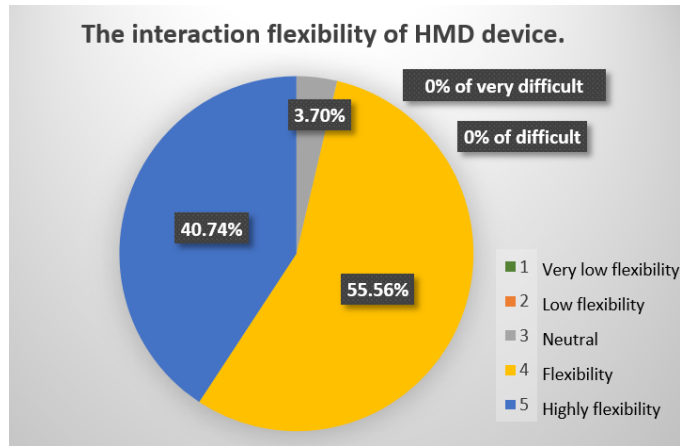

Figure 102: The interaction flexibility of HMD device

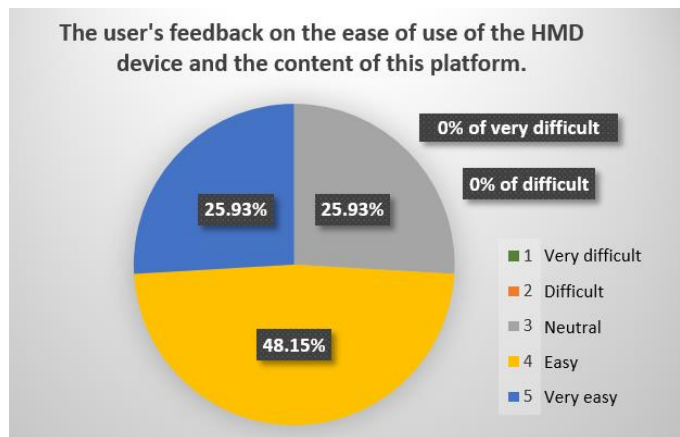

Figure 103: The user's feedback on the ease of use of the HMD device

25.93% of participants felt HMD device and the content in this platform is very easy to use and 48.15% of participants felt that it is easy to use. 25.93% of participants felt that HMD device is normal (Figure 103).

#### 6.4.2.3 Side effects from using VR device.

The user experience testing in this session is to assess the side effect from using VR device. We inquired information from participants with three questions that concern about the side effects from using VR devices as shown in Table 15.

Table 15: The user ratings concerning side effects from using VR devices

No.	List	Level of perceptions (%)				
		1	2	3	4	5
<b>Side Effect from using VR device</b>						
11	I felt headache during using VR device.	29.63	33.33	18.52	11.11	7.41
12	I suffered physical tiredness when I interacted with VR device and virtual environment.	37.04	33.33	14.81	7.41	7.41
13	I suffered visual tiredness when I interacted with VR device and virtual environment.	29.63	22.22	33.33	3.70	11.11

29.63% of participants felt very low headache, 33.33% of participants felt low headache. 18.52% of participants felt normal. However, there were 11.11% of participants who felt high and 7.41% of participants felt very high headache with VR devices (Figure 104).

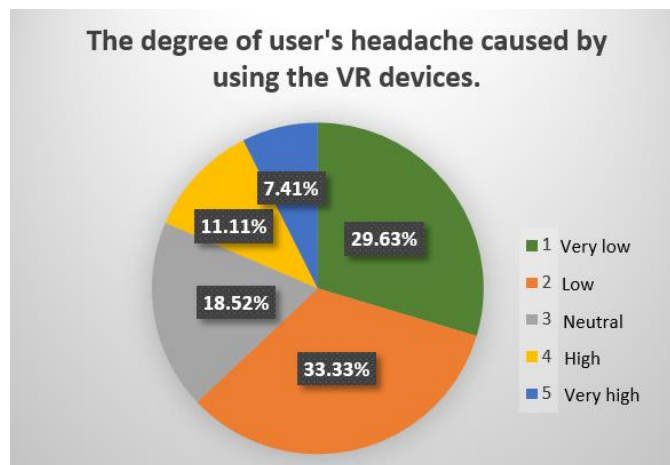

Figure 104: Users' headache caused by using VR devices

37.04% of participants did not suffer from physical tiredness, 33.33% of participants suffered from low physical tiredness. 14.81% declared neutral tiredness. However, 7.41% of participants suffered physical tiredness as high and very high (Figure 105).

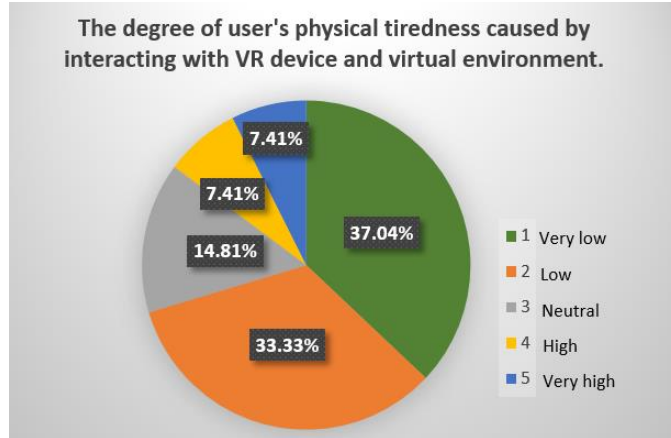

Figure 105: Users' physical tiredness in the virtual environment

From the feedback on the degree of users' visual tiredness caused by interacting with VR device and virtual environment, we found that 29.63% of participants suffered visual tiredness very low when they interacted with VR devices and the virtual environment. Furthermore, 22.22% of participants suffered from low visual tiredness. 33.33% of participants suffered from medium visual tiredness. However, 3.70% of participants suffered from high visual tiredness and 11.11% of participants suffered from very high visual tiredness (Figure 106).

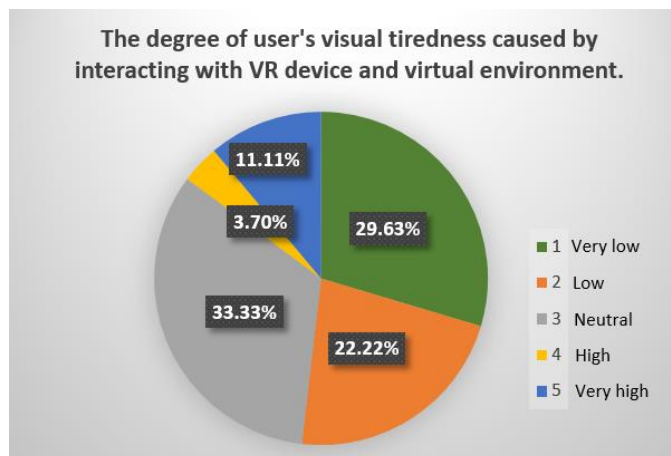

Figure 106: Users' visual tiredness in the virtual environment



## 6.5 Summary

From both levels of user experience testing, non-immersive VR level and fully-immersive VR level, we can summarize the following insights:

For the non-immersive VR level, participants felt that the distance between the part and the hands does not correlate sufficiently well with reality. Especially, they felt losing the perception of touching. With the VR hands it is also difficult to catch and work with the small parts in the relatively narrow space of the leap motion device. To use all the tools at the same time is difficult (from Figure 92). Participants were confused about how to practice and control each of them (keyboard, mouse and Leap Motion) in the scene as the same time. On the other hand, they understood well how to use those tools alone (from Figure 89, Figure 90, Figure 91). As for realism perception, most participants have perceived only a bit of realism (from Figure 93). The non-immersive VR level is sufficient for demonstrating the working process for removing the saw blade from the jigsaw machine, as well as the appropriate hand gesture to grasp the saw blade. It is, however, insufficient in terms of ease of control and manipulation, most notably because users need to control the viewpoint and movement concurrently with grasping and working with the virtual objects.

For the fully-immersive VR level, participants felt interested and curious to learn more when learning with virtual reality technology (from Figure 96, Figure 98). They also believed that virtual reality technology can enhance training efficiency (from Figure 99, Figure 100). In addition, virtual reality technology with HMD tool is easy and flexible to use (from Figure 102, Figure 103). Even though the HMD tool has a high level of realism (from Figure 96) but it also has a few side effects, both physical tiredness and visual tiredness (from Figure 105, Figure 106). Although the fully-immersive VR system has only minor side effects, both physical tiredness and visual tiredness appeared in even less than 20 minutes of training time.

Although both systems can be applied to study and find the suitable working process as well as the appropriate hand gestures in the virtual environment, there are still some difficulties and inconveniences in both systems. In the process of capturing and recording hand gestures, many images of the working process and hand gestures were captured, so this may cause the system to slow down and delay due to the process of sending those images into the database. In addition, the identification and classification process of appropriate hand gesture still requires an analyzation from experts.

## 7 Discussion, Conclusions and Perspectives

This chapter summarizes the results of my research starting with a discussion of the results against the research questions in section 7.1. Section 7.2 discusses insights gained from the VR-TPP concept generation and platform implementation. Section 7.3 analyses the key contributions to research and practice. Section 7.4 elaborates on limitations of my research, which then lead to the proposal of future research topics in section 7.5.

### 7.1 Discussion of the results against the research questions

VR technology is now widely applied in training processes, in particular for dis/assembly training operations. In such operations, the level of realism of particular gestures in relationship with the manipulated object models, as well as user experience and skill play a key role. Many researches have been done on training methodology to enhance the user experience and skill from traditional training to VR technology training method. However, the achieved training results almost never go beyond some rough user experience, far from the level required for being suitable for sending trainees to the real workplace right after. Therefore, this thesis aims at giving a contribution to rendering the experimentation with different VR environments, devices and setups systematic in a way that results can be used in order to optimize the training infrastructure, content and approach before investing in expensive VR equipment. The related research question formulated in Chapter 1 is therefore “*Can a structured VR-based training preparation process support the determination of appropriate VR-training environments, devices, and approaches?*”

In order to answer this research question, we need a concept and a systematic approach that allows us to flexibly create VR environments and use them to experiment with the training creation and execution, as well as evaluating the obtained results. This led to the proposal of the VR-TPP concept (Chapter 3) that was implemented in the form of the VR-TPP platform (Chapter 4). This platform provided the environment for three cases studies each centered around mechanical dis/assembly operations that are characteristic for maintenance operations carried out for mechanical systems (Chapter 5). A questionnaire-based

evaluation helped formalizing our impressions from observing trainers and trainees acting in this platform (Chapter 6).

The cases studies clearly showed the necessity of experimenting with different environments and setups. Although the used setups were sufficient for capturing expert gestures for creating work instructions for trainees, they were only partially appropriate for providing a training experience that would give confidence about the trainees achieving the targeted skill and performance levels. However, thanks to the systematic data capturing during the critical training steps and phases, VR-TPP enables the detailed analysis of the strengths and weaknesses of each setup, even without a large number of experiments. The proposed underlying data model is generic enough for allowing a practically unlimited amount of installations and experiments.

The second research question focusses on the particular role of hand gestures in mechanical dis/assembly tasks that are an essential part of maintenance operations: *“How to integrate hand gestures as digital models such that these can leverage the creation of training procedures, work instructions, and training evaluations?”*

Here, this thesis contributes the following elements:

- 1) A hand gesture model linking training objects with training steps for supporting the creation of work instructions.
- 2) A hand gesture library containing hand gesture definitions and relationships with different types of mechanical joints.

The creation of this library was done within the VR-TPP itself, by letting experts manipulate different mechanical joints using the virtual representation of these experts' hands. It was also demonstrated, how a work instruction for the training procedure can be created based on the recorded gestures that can be related with dedicated training sequence steps.

As for the three case studies, which were used in order to elaborate these key contributions, as well as to validate them, their main focus points are as follows:

- Case study 1: Validation of VR-TPP concept by a disassembling process. In order to validate the VR-TPP concept, we created the VR-TPP platform derived from the systematic approach of VR-TPP and demonstrated the creation process of VR training content through this platform. In addition, this case study also showed how VR-TPP can be used to capture and select the appropriate operation process for removing a saw blade from a jigsaw device.
- Case study 2: VR-TPP for creating a knowledge base of hand gestures. In this case study, we presented the approach of recording, classifying and clustering the hand gesture to build a library of virtual hand gestures. Those virtual hand gestures were classified according to the mechanical assembly and

disassembly tasks that can be achieved with them. These tasks were all related to different types of mechanical joints, which are considered key elements to manipulate during mechanical maintenance operations. Based on the library of hand gestures, we also demonstrated the creation of a work instructions for the gestures required to fold a foldable STRIDA bicycle correctly. Within this demonstration, individual steps were associated with the appropriate gestures used for manipulating the concerned parts of the bike's BOM.

- Case study 3: Virtual Reality for Training in Maintenance Task. This case study, we applied VR-TPP concept to a Virtual Reality for Training in Maintenance Task (VR-TMT). The VR-TMT is used to evaluate the correctness of the trainees' performances, as well as to understand the reasons for any mistakes or alternative ways of performing the tasks through virtual dis/assembling process of a gearbox.

These three case studies together highlight the role of hand gestures in maintenance training. In this context, they also show the necessity and efficiency of VR-TPP to support the difficult choice of appropriate devices and setups.

## **7.2 VR-TPP concept and platform and implementation**

A VR-TPP platform was created based on the concept of VR-TPP for validating the concept with the following objectives:

- To build a creation process for VR training content.
- To focus on hand gestures in the maintenance training preparation process.
- To support the creation of work instructions for virtual environments.

In chapter 4, we described the creation of VR-TPP platform. Then we implemented the VR-TPP platform with three case studies as described in chapter 5. The case studies demonstrated the building process of VR training content. Especially, the case study 2, it showed the role of hand gesture in maintenance training, as well as this study also showed the creation process of work instruction through virtual folding process the STRIDA bicycle. These case studies also demonstrated the performance and realism perception of VR-TPP platform through two VR systems: Non-immersive VR level and fully-immersive VR level. Each VR system has different interaction devices as well as immersion levels. Mouse, keyboard and leap motion controller was used as the control device of non-immersive VR level. This VR level enables user access to the virtual environment through a 2D desktop. By contrast, to implement the fully-immersive VR level, we used a leap motion controller and HMD controller to

enable control and manipulation of the scene in virtual environment. The fully-immersive VR level therefore enables user access to virtual environment through a HMD display

### **7.3 Key contributions to research and practice**

The research questions have been investigated by the demonstration of the process to build VR training content and to define the role of hand gestures in maintenance training through case studies, as well as assessment the device performance, realism perception and side effect from using VR device. The result of this study will help us design and create VR training content with appropriate devices and work instructions. As for the impact beyond this thesis' scope, we summarize our key contributions in the following subsections.

#### **7.3.1 A generic VR-training preparation concept**

The systematic VR-TPP concept and related approach contributes a systematic yet generic way of studying the creation of VR training content in different VR environments and setups. VR-TTP concept implementations in form of flexible experimentation platforms allow researchers to study the creation process of VR training content, devices performance and realism perception through user experience testing. It also allows them to direct their focus on the vital role of hand gestures in particular maintenance operations. training preparation process. This is very useful for researches about the creation process of VR training content and work instructions for the training preparation phase.

In our research, we have set up a platform for our experience testing with two immersion levels: non-immersive VR level and fully-immersive VR level. Through both immersion levels, we have set up basic and cheap VR devices. New devices will be integrated in this platform in the future to enlarge the investigation of appropriateness and therefore improve the level of realism perception and therefore training effectivity. Any configuration in between non-immersive and fully-immersive setups can be implemented and evaluated, the concept we proposed is open to this.

In terms of practical value, we believe that VR-TPP concept implementations can provide a significant help to industry in the process of evaluating different VR setups and approaches to adopting VR-based trainings. Instead of investing huge amounts of money in VR equipment before having the chance to evaluate their effectiveness for particular hand-gesture focused trainings, VR-TPP implementations can support them in experimenting and evaluating upfront. Furthermore, thanks to the built-in recording facility, they can also capture expert gestures, and thereby build up a knowledge library for expert tasks.

### **7.3.2 Working instruction preparation**

Work instructions constitute an important element of trainings as well as of knowledge management in industrial organizations. While written, textual work instructions, some of them illustrated with static photos and images, are commonly used, “living” and “livable” work instructions are still rare. Based on its capability of capturing hand gestures and associating them with training sequence steps, VR-TPP can support the creation of work instructions of any format. In addition, due to the fact that hand gestures can be stored as digital models with semantic information, work instructions can be integrated in VR trainings in the form of guidance and automated evaluation of performed gestures. Based on the generic UML model describing work instructions as sequences of particular gestures, as well as recorded expert gestures, work instruction editors could also be implemented. They could allow the visual composition of work instruction from image data stored in the VR-TPP platform.

### **7.3.3 Hands gesture library for mechanical joints**

We believe that our idea of associating hand gestures with mechanical joints, and storing the characterization of those in a library is an original contribution providing the basis for the digital use of the gesture-joint relationship for different purposes related to VR-based training. Work instruction generation, the evaluation of the correctness of training tasks, as well as the guidance of trainees in the VR environment during the training process, are only a few examples.

A hand gesture library based on a taxonomy tailored to mechanical joints could become an important element of knowledge management in the domain of mechanical maintenance operations. Using an integrated VR-TPP environment for recording hand gestures that are the most appropriate to manipulate a particular type of joint, will facilitate the stepwise filling of a gesture library from trainer sessions used to record work instructions.

### **7.3.4 VR device performance, realism and side effects**

As for VR device performance, we found that basic VR tools interacting with non-immersive VR system are difficult to use when all devices are used simultaneously. By contrast, the HMD controller that we used to interact with fully-immersive VR system is flexible and easy to use. In addition, the realism perception level of fully-immersive VR system allows user access to high immersion in VR experience. It can also attract users to learn more about the training content by VR technology.

As for the side effects, most of the participants experienced only few side effects, particularly physical and visual tiredness. While investigating these uncomfortable side effects more closely was out of this thesis’ scope, we must not neglect, in particular in prolonged VR training sessions. Also here, VR-TPP

can provide a useful support in comparing systematically different immersion levels and setups.

#### **7.4 Limitations**

Given the particular context and the wide subject area of this work, this research suffers from numerous limitations. In the following, we will elaborate on a few of them:

- Due to numerous technical challenges that had to be overcome in order to link different VR devices to constitute two different experimental VR-TPP platform configurations, we could not test more and more diverse VR-TPP setups. It would have been interesting to study the effect of different non-immersive and fully-immersive VR configurations on the training results, and derive detailed recommendations for the design of training setups and sequences for all the three case studies.
- The integration of haptic feedback devices in the experimental VR-TPP platform would have rendered the training experience more realistic, and evaluation results would have been much more focused on the gesture execution and perception level. This integration, however, was out of scope because of the technical barriers to overcome in the VR laboratory that was used for this research.
- There is also some limitation in the structured investigation of mechanical joints and appropriate hand gestures. In this work so far, we picked joint samples in order to validate the feasibility of associating hand gesture models with joints, and integrating the digital model in training preparation. While most of the digital hand model information has been captured as descriptive text, an object-oriented specification approach should be followed in future implementations, providing important hand gesture characteristics as object attributes and methods that can be used in various applications.
- The creation of work instructions from training sequences, as well as elements from the gesture library has not been formalized completely in this research. We did not show and prove the full potential of work instruction creation and generation based on captured hand gestures and training step specifications. This is also linked to technical implementation work that could not be achieved as planned.
- The evaluation of the three case studies was limited to questionnaires, and could have been complemented by systematic observations and comparisons. Furthermore, experiment participants have been limited to student

communities. They should be extended to industrialists with specific expertise and skills.

- The VR-TPP platform used a leap motion controller attached in front of HMD glasses to detect the real hands. According to the limitation of the leap motion controller, it can detect the user's hands only within a small area of a distance of 0.3 to 0.5 meters. It also does not detect the user's hands accurately when they move very fast. These limitations contributed to some extent to low experience ratings.

Many of these limitations have their origin in technology issues and difficulties which took a lot of time and effort to be overcome. However, we believe that the achieved results provide a proof of concept that demonstrates the potential of the proposed approach.

## **7.5 Perspectives**

Based on the results achieved in this thesis, as well as their limitations elaborated before, the following perspectives for further research are proposed:

### **7.5.1 Full body capture**

In this research, we designed the VR-TPP platform that connects with VR devices to capture appropriate hand gestures. We focus only on the hands gesture. It will be interesting to also integrate the capturing of the experts' body movements while practicing their jobs. Integrating body movements would open our concept to a wider field of VR training application, providing entire body movement information for building work instructions. The interfacing with appropriate devices such as full-body sensor costumes would have to be accomplished in order to investigate the opportunities and limits of this approach.

### **7.5.2 Physical perception**

Training in a virtual environment should integrate both visual and physical perception. Our implementation of the fully-immersive VR level presents a high level of visual perception through the HMD display, however it lacks physical perception. It will be interesting to study the effectiveness of learning and the level of user experience once physical perception through e.g. haptic feedback devices are integrated in the VR-TPP platform.



### **7.5.3 Machine Learning**

Based on the capturing, recording and work instruction making capabilities of VR-TPP, many data can be collected from training sessions. Machine learning algorithms could be applied to these data in a way to find out similar approaches of achieving a particular training task, and to compile image-sequence based work instructions in a semi-automated way. Furthermore, the obtained information can be used to introduce machine-guidance during the training process, as well as to semi-automatically assess the performance of trainees in accomplishing the training tasks.

This approach could even be extended to a suggestion system, where the platform could recognize mechanical joints by itself, and suggest appropriate gestures based on the stored information obtained from similar or equal cases (much like a Case Based Reasoning approach).

### **7.5.4 Taxonomy of hand gestures and mechanical joints**

The proposed digital modelling of hand gestures could be extended to an entire taxonomy relating hand gestures, mechanical joints, and information about suitable VR-devices and setups with each other. Such a taxonomy would provide the basis for implementing digital expertise about hand gestures that are suitable for given dis/assembly tasks and scenarios, as well as devices and their configurations that are suitable for implementing realistic and effective VR-based training sequences. Beyond VR-based training, such kind of formalized empirical data can be used for a variety of other knowledge-based applications, such as the compilation of work instructions, the design and optimization of tools, safety investigations of workplace equipment, etc.

### **7.5.5 Taxonomy of VR-devices and setups**

The generic VR-TPP concept could be taken further as to formalize the used VR setups down to the level of detail of individual devices, and how they have been configured for specific training scenarios. Each of the individual VR-TPP steps could have its characteristic taxonomy, and implemented setups could be expressed as instantiations of underlying generic classes and relationships. In this way, VR-device and setup information could also be exchanged between different parties and sites, fostering experiences sharing, as well as the duplication of setups in different places. Furthermore, such kind of facility supports traceability of configurations, which is often an important criterion in trainings and certifications performed in industrial contexts.

### **7.5.6 Future research in VR-based training in Thailand**

As a lecturer and researcher at Rajamangala University of Technology in Thailand, I have some plans to apply and further develop my research as follows:

#### **7.5.6.1 VR technology for knowledge transfer**

Based on the results of the user experience testing from the VR-TPP platform, users show increasing curiosity for learning when training and working in a virtual environment. Therefore, I would like to apply the VR technology to education system. This concept may help to increase learning efficiency. As mentioned in chapter 1, as a lecturer at Rajamangala University of Technology Lanna in Thailand I teach engineering students, who have to practice and work with large machines. Accidents occur due to lack of good training before working on those machines. I plan applying the VR-TPP concept to this challenge and create a virtual environment for students to get familiar with those machines without danger, before they I actually train them on the real machines.

#### **7.5.6.2 Maintenance training for high-speed trains**

The faculty of Engineering of Rajamangala University of Technology Lanna has a plan to establish an operation and maintenance centre for the railway transportation system in north of Thailand. This is a large project with a long-term plan. I am the one who will work on this project thanks to the scholarship I received. I would like to take advantage of our research with this project. To start with, I will apply my research results to creating training courses in the area of maintenance of braking systems of high-speed trains. Since the high-speed train's braking system are complex and large, entering to work without good training may cause serious accidents to the trainees. In addition, training in the real environment requires the installation of both equipment and tools that are very expensive and difficult to transport. Therefore, incorporating the VR technology into the training preparation process will help in both increasing training safety and reducing the cost of installing the training tools and equipment.



## References

- Abate, A. F., Guida, M., Leoncini, P., Nappi, M., & Ricciardi, S. (2009). A haptic-based approach to virtual training for aerospace industry. *Journal of Visual Languages and Computing*, 318-325.
- Al-Ahmari, A. M., Abidi, M. H., Ahmad, A., & Darmoul, S. (2016). Development of a virtual manufacturing assembly simulation system. *Advances in Mechanical Engineering*, Vol. 8, 1-13.
- Albani, J., & Lee, D. (2007). Virtual reality-assisted robotic surgery simulation. *Journal of Endourology*, 21, 285-287.
- Ayadi, M., Affonso, R. C., Cheutet, V., Masmoudi, F., Riviere, A., & Haddar, M. (2013). Conceptual model for management of digital factory simulation information. *International Journal of Simulation Modelling, Daaam International*, 12 (2), 107-119.
- Bailey, S. K., Johnson, C. I., Schroeder, B. L., & Marraffino, M. D. (2017). Using virtual reality for training maintenance procedures. *Interservice/Industry Training, Simulation, and Education Conference (IITSEC)*, (pp. 1-11).
- Bamodu, O., & Ye, X. (2013). Virtual Reality and Virtual Reality System Components. *International Conference On Systems Engineering and Modeling (ICSEM-13)*, (pp. 921-924). Paris.
- Battaïa, O., Dolgui, A., Heragu, S. S., Meerkov, S. M., & Tiwari, M. K. (2019). Design for manufacturing and assembly/disassembly: joint design of products and production systems. *International Journal of Production Research*, 7181-7189.
- Baxter, B., Scheib, V., Lin, M. C., & Manocha, D. (2001). Dab: Interactive haptic painting with 3d virtual brushes. *SIGGRAPH 2001* (pp. 461-468). Los Angeles, CA. New York, NY: ACM Press.
- Berkley, J. J. (2003, May 5). Haptic Devices. *Mimic Technologies Inc*, pp. 1-4.
- Blake, M. (1996). The NASA advanced concepts flight simulator – a unique transport aircraft research environment. *AIAA Flight Simulation Technologies Conference*. San Diego, CA.
- Borsci., S., Lawson., G., Jha., B., Burges., M., & Salanitri., D. (2016). Effectiveness of a multidevice 3D virtual environment application to train car service maintenance procedures. *Virtual Reality*, 41-55.

- Bowman, D. A. (1998). Interaction techniques for immersive virtual environments: Design, evaluation, and application. *Journal of Visual Languages and Computing*, 1-8.
- Bowman, D. A., Kruijff, E., LaViola, J. J., & Poupyrev, I. (2001). An Introduction to 3-D User Interface Design. *The MIT Press Journals*, 96-108.
- Bowman, A., D., L., G. J., & Hix, D. (2002). A survey of usability evaluation in virtual environments: classification and comparison of methods. *Teleoperators & Virtual Environments*, 11(4), 404-424.
- Conn, C., Lanier, J., Minsky, M., Fisher, S., & Druin, A. (1989). Virtual environments and interactivity: windows to the future. In *ACM SIGGRAPH 89 Panel Proceedings (SIGGRAPH '89)* (pp. 7-18). New York, USA: DOI:<https://doi.org/10.1145/77276.77278>.
- Daniel, D. M., & Jared, M. S. (2003). *User-Centered Web Site Development: A Human-Computer Interaction Approach*. .
- De Koning, B. B., Tabbers, H. K., Rikers, R. M., & Paas, F. (2007). Attention cueing as a means to enhance learning from an animation. *Applied Cognitive Psychology*, Vol.21, 731-746.
- Derossis, A. M., Bothwell, J., Sigman, H. H., & Fried, G. M. (1998). The effect of practice on performance in a laparoscopic simulator. *Surgical endoscopy*, 12(9), 1117-1120.
- Dix, A., E., J., Finlay, J., Abowd, G. D., & Beale, R. (1993). *Human-Computer Interaction*. Madrid: Mateu Cromo Artes Graficas.
- Dyer, E., Swartzlander, B. J., & Gugliucci, M. R. (2018). Using virtual reality in medical education to teach empathy. *Journal of the Medical Library Associatio*, 498-500.
- Er., N. F., & Dag., H. (2009). Comparison of Cost-Free Computational Tools for Teaching Physics. *2009 Fifth International Conference on Soft Computing, Computing with Words and Perceptions in System Analysis, Decision and Control* (pp. 1-4). Famagusta: doi: 10.1109/ICSCCW.2009.5379414.
- Feix, T., Romero, J., Schmiedmayer, H. B., Dollar, A. M., & Kragic, D. (2015). The grasp taxonomy of human grasp types. *IEEE Transactions on human-machine systems*, 66-77.
- Gao, X. S., & Chou, S. C. (1998). Solving geometric constraint systems. II. A symbolic approach and decision of Rc-constructibility. *Computer-Aided Design*, 30(2), 115-122.
- Garbaya, S., & Zaldivar-Colado, U. (2007). The affect of contact force sensations on user performance in virtual assembly tasks. *Virtual Reality*, 11(4), 287-299.
- Gavish, N., Gutierrez, T., Webel, S., Rodriguez, J., & Tecchia, F. (2011). Design guidelines for the development of virtual reality and augmented reality training systems for maintenance and assembly tasks. *BIO web of conferences*, 1-4.

- Gavish., N., Gutiérrez., T., Webel., S., Rodríguez., J., Peveri., M., Bockholt., U., & Tecchia., F. (2015). Evaluating virtual reality and augmented reality training for industrial maintenance and assembly tasks. *Interactive Learning Environments*, 23:6, 778-798.
- Gleeson, B., MacLean, K., Haddadi, A., Croft, E., & Alcazar, J. (2013). Gestures for industry intuitive human-robot communication from human observation. *ACM/IEEE International Conference on Human-Robot Interaction (HRI)* (pp. 349-356). IEEE.
- Gosselin, F., Ferlay, F., Bouchigny, S., Mégard, C., & Taha, F. (2010). Design of a multimodal VR platform for the training of surgery skills. *International Conference EuroHaptics 2010* (pp. 109–116). Amsterdam, The Netherlands: Berlin: Springer Berlin Heidelberg.
- Guo, Z., Zhou, D., Chen, J., Geng, J., Lv, C., & Zeng, S. (2018). Using virtual reality to support the product's maintainability design: Immersive maintainability verification and evaluation system. *Computers in Industry*, 101, 41-50.
- Gutierrez, T., Rodriguez, J., Velaz, Y., Casado, S., Suescun, A., & Sanchez, E. J. (2010). IMA-VR: a multimodal virtual training system for skills transfer in industrial maintenance and assembly tasks. *19th International Symposium in Robot and Human Interactive Communication*, 428-433.
- Hardenberg, C. v., & Bérard, F. (2001). Bare-Hand Human-Computer Interaction. *Proceedings of the 2001 workshop on Perceptive user interfaces*, 1-8.
- Hart, S. G., & Staveland., L. E. (1988). Development of nasa-tlx (Task Load Index): results of empirical and theoretical research. *In advances in psychology*, Vol.52, 139-183.
- Hix, D., & Hartson, H. R. (1993). *Developing user interfaces : ensuring usability through product and process*. New York, NY: Wiley.
- Huagen., W., Shuming., G., & Qunsheng, P. (2004). Virtual Grasping for Virtual Assembly Tasks. *Third International Conference on Image and Graphics (ICIG'04)*, 448-451.
- Hui, Z. (2017). Head-mounted display-based intuitive virtual reality training system for the mining industry. *International Journal of Mining Science and Technology*, 717-722.
- Imbert, N., Vignat, F., Kaewrat, C., & Boonbrahm, P. (2013). Adding Physical Properties to 3D Models in Augmented Reality for Realistic Interactions Experiments. *2013 International Conference on Virtual and Augmented Reality in Education* (pp. 364-369). Procedia Computer Science.
- Jr., J. J., Kruijff, E., McMahan, R. P., Bowman, D., & Poupyrev, I. P. (2017). *3D User Interfaces: Theory and Practice (2nd Edition)*. Addison-Wesley Professional.
- K., W., Y., X., & Z., L. (2016). Research of Nuclear Power Plant In-Service Maintenance Based on Virtual Reality. *Journal of Nuclear Engineering and Radiation Science, Volume 2*, 1-6.

- Kao, Y.-C., Lee, C.-S., Liu, Z.-R., & Lin, Y.-F. (2017). Case study of virtual reality in CNC machine tool exhibition. *MATEC Web of Conferences*, (pp. 1-6).
- Karam, M. (2006). *A framework for research and design of*. Southampton, England: University of Southampton.
- Kharoub, H., Lataifeh, M., & Ahmed, N. (2019). 3D User Interface Design and Usability for Immersive VR. *Applied Sciences*, 1-29.
- Khundam, C. (2019). *Evaluation of the virtual reality usage for the promotion of historical heritage*. Grenoble: University Grenoble Alpes.
- Kopp, S., Tepper, P., & Cassell, J. (2004). Towards Integrated Microplanning of Language and Iconic Gesture for Multimodal Output. *Proceedings of the 6th international conference on Multimodal interfaces*, (pp. 97-104). Pennsylvania.
- Leu, M. C., ElMaraghy, H. A., Nee, A. Y., Ong, S. K., Lanzetta, M., Putz, M., & Bernard, A. (2013). CAD model based virtual assembly simulation, planning and training. *CIRP Annals*, 62(2), 799-822.
- Li, J.-R., Khoo, L. P., & Tor, S. B. (2003). Desktop virtual reality for maintenance training: an object oriented prototype system (V-REALISM). *Computers in Industry*, 109-125.
- Li, Y., Huang, J., Tian, F., Wang, H.-A., & Dai, G.-Z. (2019). Gesture interaction in virtual reality. *Virtual Reality & Intelligent Hardware*, 84-112.
- Likert, R. (1932). *A technique for the measurement of attitudes*. New York: The Science Press.
- Liu, X., Cui, X., Song, G., & Xu, B. (2014). Development of a virtual maintenance system with virtual hand. *The International Journal of Advanced Manufacturing Technology*, 2241-2247.
- Liu, X., Zhang, J., Hou, G., & Wang, Z. (2018). Virtual Reality and Its Application in Military. *2nd International Symposium on Resource Exploration and Environmental Science*, 1-7.
- Louison, C., Ferlay, F., Mestre, D. K., & R., D. (2017). Operators' accessibility studies for assembly and maintenancescenarios using virtual reality. *Fusion Engineering and Design*, 1-5.
- Lu, G., Shark, L. K., Hall, G., & Zeshan, U. (2012). Immersive manipulation of virtual objects through glove-based hand gesture interaction. *Virtual Reality*, 16(3), 243-252.
- Ma, N., Laroche, F., Hervy, B., & Kerouanton, J. L. (2013). Virtual conservation and interaction with our cultural heritage: Framework for multi-dimension model based interface. *In 2013 Digital Heritage International Congress (DigitalHeritage)*, Vol. 1, 323-330.
- Marcelino, L., Murray, N., & Fernando, T. (2003). A constraint manager to support virtual maintainability. *Computers & Graphics*, 27(1), 19-26.
- Matsas, E., & Vosniakos, G.-C. (2015). Design of a virtual reality training system for human-robot collaboration in manufacturing tasks.

- International Journal on Interactive Design and Manufacturing (IJIDeM)*, 139-13.
- Mores, P., & Borst, C. W. (2012). Virtual grasp release method and evaluation. *International Journal of Human-Computer Studies*, 828-848.
- Morst, P., & Borst, C. W. (2015). Design and evaluation of visual interpenetration cues in virtual grasping. *IEEE Transactions on Visualization and Computer Graphics*, 22(6), 1718-1731.
- Mujber, T., Szecsi, T., & Hashmi, M. (2004). Virtual reality applications in manufacturing process simulation. *Journal of Materials Processing Technology*, 1834-1838.
- Nasr, E. S., El-Tamimi, A. M., Abidi, M. H., & Al-Ahmari, A. M. (2013). Virtual assembly in a semi-immersive environment. *International Journal of Mechanical, Aerospace, Industrial, Mechatronic and Manufacturing Engineering*, 223-232.
- Nielsen, J., & Mack, R. L. (1994). Usability Inspection Methods. *Executive summary. In J. Nielsen & R. L. Mack (Eds.)*, 1-23.
- Nishino, H., Murayama, K., Kagawa, T., & Utsumiya, K. (2010). A Japanese calligraphy trainer based on skill acquisition through haptization. *24th IEEE International Conference on Advanced Information Networking and Applications (AINA)* (pp. 1225-1232). Perth, Australia: IEEE.
- P. Marayong, P. Shankar, J. Wei, H. Nguyen, T. Z. Strybel, & Battiste, V. (2020). Urban Air Mobility System Testbed using CAVE Virtual Reality Environment. *2020 IEEE Aerospace Conference* (pp. 1-7). Big Sky, MT, USA: doi: 10.1109/AERO47225.2020.9172534.
- Perminova, O., Gustafsson, M., & Wikström, K. (2008). Defining uncertainty in projects—a new perspective. *International journal of project management*, 26(1), pp. 73-79.
- Perret, J., Kneschke, C., Vance, J., & Dumont, G. (2013). Interactive assembly simulation with haptic feedback. *Assembly Automation*, 214-220.
- Pontonnier, C., Samani, A., Badawi, M., Madeleine, P., & Dumont, G. (2013). Assessing the ability of a vr-based assembly task simulation to evaluate physical risk factors. *IEEE transactions on visualization and computer graphics*, 20(5), 664-674.
- Portillo-Rodriguez, O., Avizzano, C. A., Chavez-Aguilar, M., Raspolti, M., Marcheschi, S., & Bergamasco, M. (2006). Haptic desktop: The virtual assistance designer. *The 2nd IEEE/ASME International Conference on Mechatronic and Embedded Systems and Applications* (pp. 1-6). Beijing, China: IEEE.
- Poupyrev, I., Billinghamurst, M., Weghorst, S., & Ichikawa, T. (1996). The go-go interaction technique: non-linear mapping for direct manipulation in VR. *Proceedings of the 9th annual ACM symposium on User interface software and technology*, (pp. 79-80). Seattle Washington.
- Prachyabrued, M., & Borst, C. W. (2012). Virtual grasp release method and evaluation. *International Journal of Human-Computer Studies*, 828-848.



- Qiu, S., Fan, X., Wu, D., He, Q., & Zhou, D. (2013). Virtual human modeling for interactive assembly and disassembly operation in virtual reality environment. *The International Journal of Advanced Manufacturing Technology*, 69(9-12), 2355-2372.
- Ragan, E. D., Bowman, D. A., Kopper, R., Stinson, C., Scerbo, S., & McMahan, R. P. (2015). Effects of field of view and visual complexity on virtual reality training effectiveness for a visual scanning task. *IEEE transactions on visualization and computer graphics*, 21(7), 794-807.
- Rao, Y., Xu, B. L., Jing, T., Zhang, F., & Zhao, X. Y. (2017). The current status and future perspectives of virtual maintenance. *Procedia Computer Science* 107.C, 58-63.
- Segonds, F., Iraqi-Houssaini, M., Roucoules, L., Veron, P., & Aoussat, A. (2010). The use of early design tools in engineering processes: a comparative case study. *International Journal of Innovation and Design Research*, 1-16.
- Seth, A., Vance, J. M., & Oliver, J. H. (2011). Virtual reality for assembly methods prototyping: a review. *Virtual reality*, 15(1), 5-20.
- Shamsuzzoha, A., Helo, P., Kankaanpää, T., Toshev, R., & Tuan, V. V. (2018). Applications of Virtual Reality in Industrial Repair and Maintenance. *Proceedings of the International Conference on Industrial Engineering and Operations Management*, (pp. 1-9). Washington DC.
- Shu, L. Y., & Niandong, W. (2010). Research on multi-finger grasping in virtual environment. *Journal of Computer-Aided Design & Computer Graphics*, 22(10), 1728-1733.
- Sun, H., & Hujun, B. (2002). Two-handed assembly with immersive task planning in virtual reality. *Virtual reality*, 6(1), 11-20.
- T.S.Mujber., T.Szecszi., & M.S.J.Hashmi. (2004). Virtual reality applications in manufacturing process simulation. *Journal of Materials Processing Technology, Volumes 155–156*, 1834-1838.
- Tching, L., Dumont, G., & Perret, J. (2010). Interactive simulation of CAD models assemblies using virtual constraint guidance. *International Journal on Interactive Design and Manufacturing (IJIDeM)*, 4(2), 95-102.
- Thomas Feix, Javier Romero, Heinz-Bodo Schmiedmayer, Aaron M. Dollar, & Kragic, D. (2016). The GRASP Taxonomy of Human Grasp Types. *IEEE Transactions on Human-Machine Systems*, 66-77.
- Ullmann, T., & Sauer, J. (2000). Intuitive virtual grasping for non haptic environments. *In Proceedings the Eighth Pacific Conference on Computer Graphics and Applications* (pp. 373-457). Hong Kong, China: doi: 10.1109/PCCGA.2000.883961.
- Vélaz, Y., Rodríguez Arce, J., Gutiérrez, T., Lozano-Rodero, A., & Suescun, A. (2014). The Influence of Interaction Technology on the Learning of Assembly Tasks Using Virtual Reality. *Computing and Information Science in Engineering*, 1-9.

- Vora, J., Nair, S., Gramopadhye, A. K., Duchowski, A. T., Melloy, B. J., & Kanki, B. (2002). Using virtual reality technology for aircraft visual inspection training: presence and comparison studies. *Applied ergonomics*, 33(6), 559-570.
- Walker, G. (2012). A review of technologies for sensing contact location on the surface of display. *Journal of the society for Information Display*, 20(8), 413-440.
- Wang, C. (2014). *Disassembly sequences generation and evaluation : Intregation in virtual reality environment*. Grenoble: Université de Grenoble.
- Weichert, F., Bachmann, D., Rudak, B., & Fisseler, D. (2013). Analysis of the Accuracy and Robustness of the Leap Motion Controller. *Sensors (Basel)*, 6380-6393.
- Weijun, K., Xiao, Y., & and Lin, Z. (2016). Research of Nuclear Power Plant In-Service Maintenance Based on Virtual Reality. *Journal of Nuclear Engineering and Radiation Science*, Vol. 2, 1-6.
- Xia, P., Lopes, A. M., Restivo, M. T., & Yao, Y. (2012). A new type haptics-based virtual environment system for assembly training of complex products. *The International Journal of Advanced Manufacturing Technology*, 379-398.
- Xiong, T., Chen, L., Ding, J., Wu, Y., & Hou, W. (2019). Recognition of Kinematic Joints of 3D Assembly Models Based on Reciprocal Screw Theory. *Mathematical Problems in Engineering*, 1-13.
- Zhai, S., & Milgram, P. (1994). Asymmetrical Spatial Accuracy in 3D Tracking. *Human Factors and Ergonomics Society*, Vol. 38, 245-249.